

Wireless Weekly

Vol. 7. No. 15.

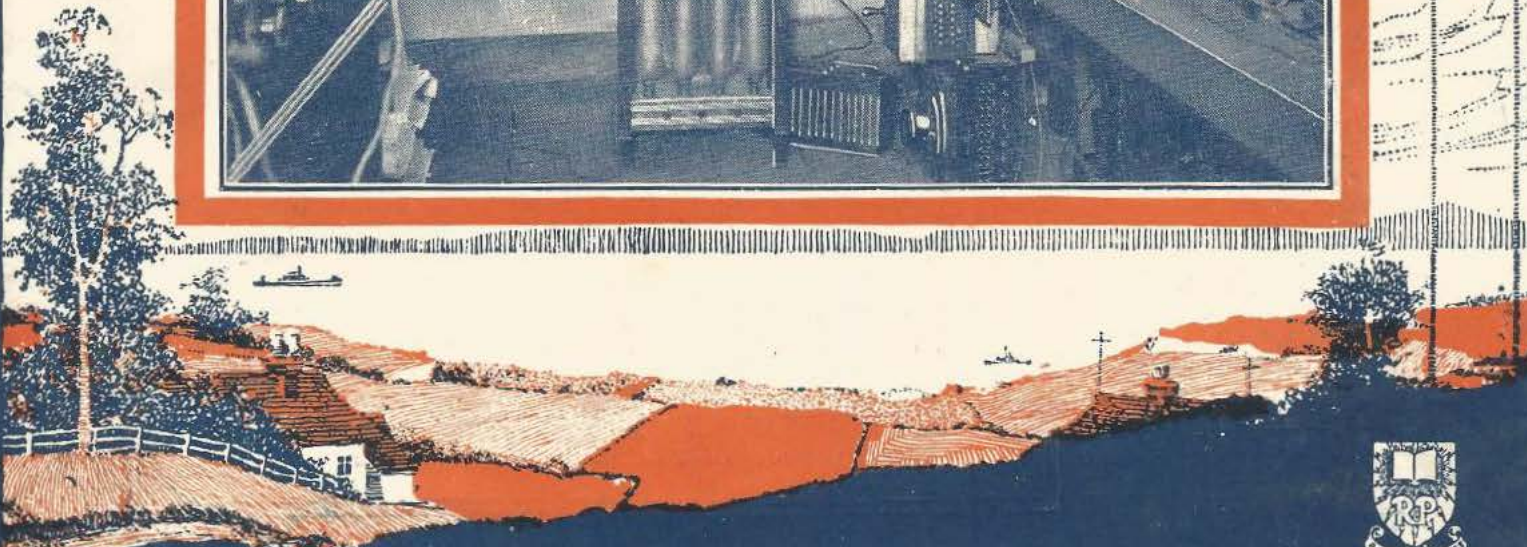

Start the New Year well with Burndept Components

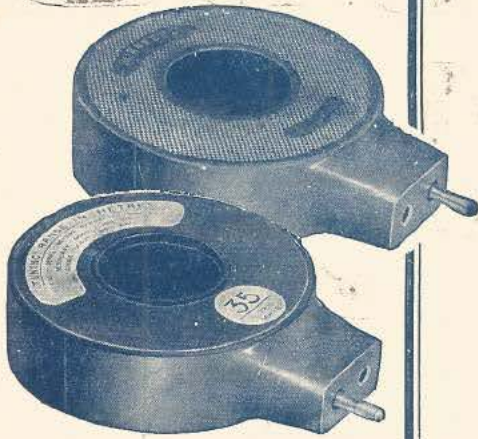

Burndept new-pattern Coils can be purchased separately or in sets, as follows:

Set of four Concert Coils (200-800 metres), 16s.
Set of eight Long-Wave Coils (700-22,000 metres), £3 17s. 6d. Complete set of nineteen Coils (20-22,000 metres), £6.

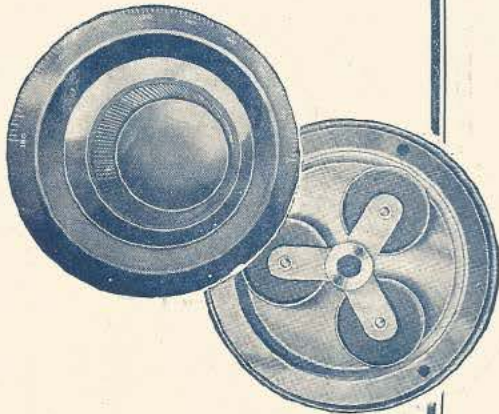

Illustrations show the neat appearance of the **Burndept Super-Vernier Dial** and its novel, concealed mechanism. Model A for $\frac{1}{4}$ " spindles, with knob and full instructions, 7s. 6d. Model B for $\frac{3}{16}$ " and $\frac{1}{4}$ " spindles (one-hole fixing condensers, etc.), with knob, distance ring, etc., 8s. 6d.

OF the New Year resolutions you make, there is one that should be carried through if you want to get the best from wireless. This resolution is that you insist on buying nothing else but British wireless apparatus—made by Burndept. By trying one Burndept Component when building a wireless receiver, you will learn to rely on Burndept for all future purchases. You will have formed a new habit—and a good one.

The efficiency of Burndept new-pattern Coils is unsurpassed. Immediately they are tried the difference will be noticed—clearer tone and greater volume result. Each Coil is completely enclosed in an hermetically-sealed container, on the face of which the number and wave-length range are clearly indicated. The Coil is perfectly protected against damp and dust and will maintain its high efficiency indefinitely. Externally, all the Coils are the same size.

To take full advantage of the selectivity of your set, fit Burndept Super-Vernier Dials. They enable the finest adjustments to be made with ease by means of a novel friction-driven epicyclic gear which gives a reduction movement of about 7 to 1. Unlike most vernier devices, the Super-Vernier Dial is unobtrusive in appearance and resembles an ordinary dial. The concealed mechanism is quite silent in operation and is completely free from "back-lash." When fitted to condensers, vario-couplers, etc., Burndept Super-Vernier Dials render the manipulation of a receiver remarkably simple.

The Burndept range includes everything for radio reception, from components to complete installations.

BURNDEPT

WIRELESS LIMITED

Head Office: Aldine House, Bedford St., Strand, London, W.C.2

Telephone: Gerrard 9072. Telegrams: Burndept, Westrand, London.

Branches and Agents Everywhere.

NEW SUBSIDIARY COMPANY: Burndept Wireless (Dublin) Ltd., 17, Dawson Street, Dublin.

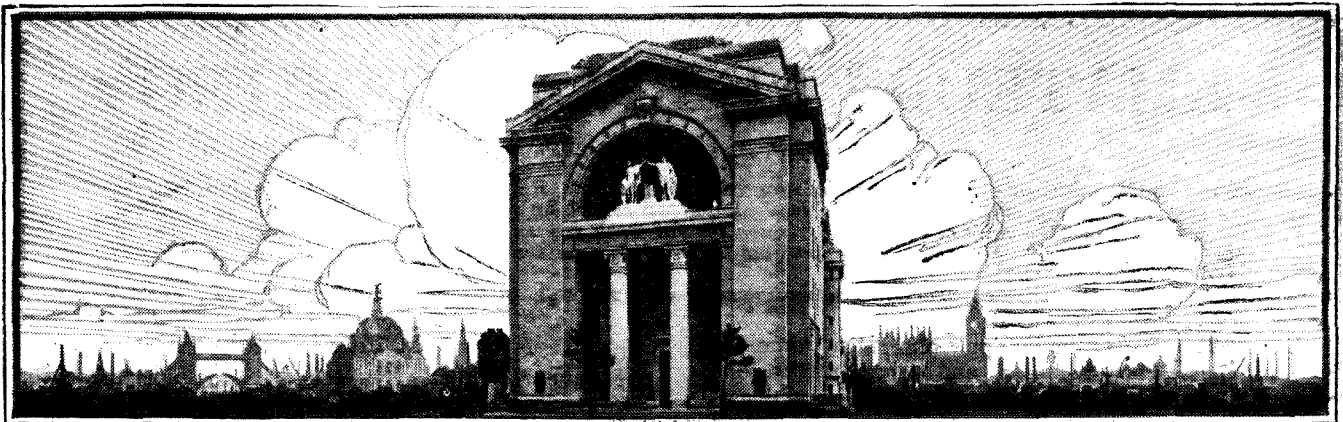

Radio Press LTD

Wireless Weekly
Phone City, 9911.

Bush House STRAND-WC2

Captain Eckersley's Amazing Statement

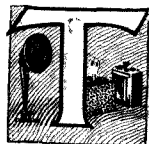

THE wireless public and trade alike have read with considerable surprise the extraordinary statements made by Captain Eckersley in the Christmas number of "The Radio Times." In an article, entitled "A Talk to Home Makers," he writes as follows:—

"Surely it is only fair to the trade to point out that the justification for home making only arises when a home maker is really legitimately an experimenter and knows what he is doing. If home making simply means copying what someone else has taken pains to design, might I suggest that mental indigestion may result and more, might I point out that a new and great industry is being hampered? I feel that even if we could do it the issuing of cut and dried instructions on how to make a particular set would be unfair to those whose livelihood is to sell sets at a legitimate profit to the public." He then goes on to argue that it costs thousands and thousands of pounds to find out a new thing, and that there is no inducement to spend such money if the manufacturer receives no return for it.

Captain Eckersley is Assistant Controller and Chief Engineer of the B.B.C., and any statements of his are looked upon as official. Speaking bluntly, Captain Eckersley's policy is purely concerned with the broadcasting service, and not with emitting propaganda on matters which are entirely outside his province.

On the merits of his remarks, the manufacturers of sets are almost a clique in the trade, the great bulk of which is done in component parts. Indeed, the proportion of set to component advertisements in, for example,

are thousands, if not millions, of people to whom the advantages of home construction make a strong appeal, and who, without the facility to build their own sets, would undoubtedly forego the pleasure that broadcasting brings. It is thus perfectly clear that a very great proportion of the revenue of the B.B.C. comes from the home constructor.

The reference to the "experimenter" is almost ingenuous. We all know that the title, "genuine experimenter," is an old gag which was used by the Post Office to cover up its antagonism to the home constructor. According to the Post Office, the number of "genuine experimenters" in this country reckoned by their own standard is but a few thousands.

Previous indiscretions by the Chief Engineer of the B.B.C. have related to the radio situation in America. After having all facilities afforded him in U.S.A., his descriptions of the state of affairs, subsequently expressed in articles and broadcast through the microphone, were deeply resented on the other side of the Atlantic, as being distorted. This resentment was expressed on numerous occasions to Mr. Harris during his recent trip to the United States.

We regard Captain Eckersley as a very likeable and popular personality—perhaps because he does tend to be irresponsible—but his incursions into journalism seem to lead him into officious indiscretions.

CONTENTS

	Page
Amateur Re-broadcasting	490
The Future of Broadcasting	492
Short-wave Notes and News	494
Further Experiments on the Tight-Coupled Aerial Circuit	495
Radio Press Calibration Scheme	499
Jottings by the Way	500
The Transatlantic Broadcasting Tests	502
Methods of Modulation in Transmission	503
Wireless News in Brief	507
The Practical Design and Use of Frame Aerials	508
Broadcasting in Norway	511
Inventions and Developments	513
Apparatus We have Tested	517
Correspondence	519
Information Department	523

a leading trade journal, is but one to ten—so small as to remove any possible doubt. The Albert Hall Exhibition, in September last, showed quite clearly that the trade was preponderantly inclined to components.

In the early days of broadcasting the "set" clique very actively combated the tendency for the listener to build his own apparatus, but common-sense removed the irksome and unfair restrictions which had been placed upon home building, and the trade, as a whole, immensely benefited. There

Director of Research :
Major JAMES ROBINSON, D.Sc., Ph.D., F.Inst.P.

Deputy Director of Research :
Capt. H. L. CROWTHER, M.Sc.

Assistant Editor :
PERCY W. HARRIS, M.I.R.E.

Edited by
JOHN SCOTT-TAGGART,
F. Inst. P., A.M.I.E.E.
December 30, Vol. 7, No. 15.

Nothing contained herein is to be regarded as permission or encouragement to infringe any patent rights.

Scientific Adviser :
Prof. G. W. O. HOWE, D.Sc., M.I.E.E.

Advisory Editors :
Prof. R. WHIDDINGTON, M.A., D.Sc., F.R.S.
Prof. C. L. FORTESCUE, M.A., M.I.E.E.

AMATEUR RE-BROADCASTING

By F. A. MAYER (G-2LZ).

Mr. Mayer's achievement in re-broadcasting the programme from Daventry and successfully transmitting it to Tasmania is well known. In the following article he discusses the possibilities of Imperial Broadcasting and the value of the higher frequencies for such transmissions, giving also some account of the apparatus used at his own station.

SEVERAL articles have appeared from time to time in various technical and other publications on the possibilities of inter-Empire re-broadcasting, but there are many divergent views on how such a scheme is to be carried out, and no one appears to know much about it from the practical point of view.

Imperial Wireless

The B.B.C. have a vision of such a scheme, and there is no doubt that sooner or later programmes will be exchanged with all parts of the Empire. The question of the moment is how to link up, and a great deal of experimental work will have to be done before the most practical way of accomplishing the link is found out. If it is to be by wireless all the way, will it be at low frequencies with high power, or at ultra-high frequencies with low power? The only remaining way is partly by wireless and partly by land-line, and I believe such a scheme has already been put forward as a possibility, but I doubt if it would be as practicable as the wireless all-the-way link.

Distortion

Take, for instance, linking up with Australia. It has been suggested that wireless be used from England to Canada, then across Canada by land-line, with another wireless link from Western Canada to

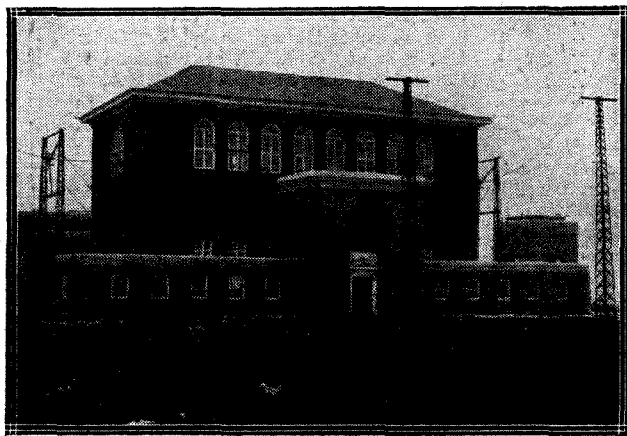

The main station building at the Rugby wireless station, which has been carrying out its first test transmissions, and has been heard in New Zealand.

Australia. One of the greatest difficulties to be overcome is the elimination of distortion, and this difficulty is usually greater with land-line work than with wireless. Also the greater the number of times the transmission is relayed, the more possibility would there be of distortion occurring, owing to the amount of apparatus employed.

Relaying Daventry

I have recently carried out several experiments on relaying one of the B.B.C. stations, mostly Daventry, at a frequency of 6,667 kilocycles (45 metres). Several reports have appeared in the Press lately of the Daventry programme being received at a frequency of 6,667 kilocycles (45 metres), and it has been suggested that Daventry has been experimenting at this frequency, but I do not think this is correct, and it is probable that the transmission which has been reported on has emanated from my station.

Broadcasting at High Frequencies

Considering the possibilities of a frequency of 6,667 kilocycles (45 metres) to begin with, this frequency is quite unsuitable for local broadcasting. Local conditions change very rapidly at various times of the day. After dark it is almost impossible to use this frequency for local communication under 150 to 200 miles. During daylight local signals are very strong, but a very rapid fading effect takes place, which results in bad distortion of speech every few seconds at these fading periods. At the same time perfect speech may be received at the Antipodes, when the distortion observed locally is non-existent at such a great distance.

Distant and Local Distortion

The question is—how far away does this distortion trouble end? This varies at different times of the day and at different periods of the year. Even at 3,000 miles this trouble is often apparent, as has often been noticed with the transmissions of KDKA on 4,839 kilocycles (62 metres). I have carried out several tests with Mosul, Iraq, about 2,500 miles away, and on one occasion, when bad distortion was reported by this station on a Daventry re-broadcast, the transmission was received quite well at Hobart, Tasmania. I have found that it is far easier to work Australia on telephony than other countries comparatively near.

Modulation

The degree of modulation which can be used on these short waves is another question to be determined. I do not think that more than 25 per cent. to 30 per cent. modulation of the carrier wave dare be attempted, owing to the possibility of a slight frequency change which again will produce bad distortion. Even with a master-oscillator transmitter this frequency change tends to take place.

High or Low Frequency?

Another point in favour of the higher frequencies is the elimination of interference from other stations and the comparative absence of static as compared with the lower frequencies. Also quite low power can be used, so that the upkeep cost of such a station would be very low.

As regards the utilisation of a low frequency, this would probably be the most practicable, but enormous power would have to be used, and it would only be possible to establish such a link with a super station of the Rugby type. For broadcast relaying a station of this type would be almost out of the question, owing to the high initial cost and the great expense of upkeep.

Land-Lines

To relay to Australia partly by wireless and partly by land-line would also be almost out of the question when utilising the present band of broadcast frequencies. There would be great possibility of interference in both the wireless links between this country and Eastern Canada, and between Western Canada and Australia. Then there is the upkeep cost of the two wireless stations required, and the cost of the use of the land-line across Canada, and the possibility of breakdowns. With luck an intelligible transmission might be got through, but it could not be depended upon at any time.

High Frequencies the Best Solution

My experiments have been confined to 6,667 kilocycles (45 metres), but there are, of course, innumerable other ultra-high frequencies which could be experimented with and which would probably produce the desired result. It might be necessary to use different frequencies on different occasions, according to atmospheric conditions. I certainly think that these high frequencies should be thoroughly explored, to find out the practicability of using them for inter-Empire re-broadcasting, as this could be done with comparatively little expense, and there is little doubt that herein lies the solution of the problem.

The Time Problem

The principal disadvantage in exchanging programmes with other countries at great distances is the time difference. When our transmissions are taking place in the evening it is early morning at the Antipodes, and if we wanted to hear Canada or the U.S.A. we should have to get up in the middle of the night. This would appeal to very few broadcast listeners after the novelty had worn off. The only country favourably placed as regards time is South Africa, which is about 1½ hours ahead of us, but from my experiences this is the most difficult country to communicate with. South Africa seems to be suffering from perpetual static interference, even on the ultra-high frequencies, so that it must be very bad on the lower ones. Also conditions vary enormously from day to day and hour to hour, whereas this trouble is not experienced so much at the Antipodes, as communication at the higher frequencies can be effected practically daily and at almost any time.

Difficulties Experienced

My experiments have been carried out under certain difficulties which would not be experienced by the B.B.C. I have to receive by wireless in the first instance, whereas it would be much better and more successful to have the transmission in the first place by land-line. The arrangement I have is as follows: An ordinary loose-coupled receiver operating on an aerial parallel to and within 20 ft. of the transmitting

aerial is used. No interference whatever is experienced from the transmitter operating at 6,667 kilocycles (45 metres), although the two aerials are so close together.

The Apparatus Used

The set consists of one H.F., detector and one L.F. transformer coupled. The output of this set is passed by land-line over to my transmitting room, and is plugged direct into the modulator panel. A change-over switch is fitted to this panel, and when relaying this switch substitutes a one-to-one open-core transformer for the microphone transformer which is used for speech. This transformer is coupled to a resistance-coupled amplifier using 1,000 volts H.T., suitably biased. The valve is a low-power, dull-emitter transmitting valve, type D.E.T.1. This circuit is coupled to the grids of the main control valves.

Choke control is used, with two type T250 transmitting valves in parallel. Two more T250 valves are used as oscillator valves. The power input to the oscillator valves is 500 watts, and to the modulators about 180 watts; filament consumption, 21 amps. total. Osram valves are used throughout.

Experimental Stations Needed

As a final remark, I have no doubt that some of the critics will disagree with my suggestion as to the utilisation of the higher frequencies for re-broadcasting, but my remarks are based on actual results and experiments with low power, and I should like to see the results achieved by the B.B.C. or other parties, with the cash available to equip and maintain a high frequency station for this purpose. So long as they keep off the present band of frequencies allotted to the amateur experimenters, I am sure there will be no opposition from this direction.



The low-tension switchboard in the valve room at the Rugby wireless station.

A NEW METHOD OF MEASURING COIL RESISTANCES.

Mr. J. H. Reyner's second article on the above subject is unavoidably held over until next week's issue of *Wireless Weekly*.

THE FUTURE OF BROADCASTING

FURTHER EVIDENCE BEFORE THE COMMITTEE OF ENQUIRY

We give below a summary of the evidence submitted to the Broadcasting Committee on behalf of the Press, the Theatres, the Music Publishers' Associations and Messrs. Chappell. An account of the evidence given previously, by the B.B.C. and the Wireless League, will be found in the issue of "Wireless Weekly" for December 16.



Lord Riddell, who submitted evidence to the Committee on behalf of the Press.

ON December 17 Lord Riddell and Sir James Owen appeared on behalf of the Press interests to give evidence before the Committee on Broadcasting. They were supported by Mr. H. D. Robertson, of the Scottish Daily Newspaper Society.

The "7 p.m. Rule"

The Press representatives were emphatically opposed to any extension of the existing facilities for the broadcasting of news. Especially was exception taken to a modification of what one might term the "7 p.m. rule," i.e., the existing agreement which provides



Mr. Walter Payne, O.B.E., who represented the interests of the theatres.

that no item of news shall be transmitted before 7 p.m.

Reasons for Opposition

The three main conclusions on which the Press based their opposition were:—

That the reasonable requirements of the public do not necessitate any change in existing arrangements for the supply of broadcast news; and that, by placing their news ser-

vices at the disposal of the B.B.C., subject to certain limitations as to hours, the newspapers have shown sympathy with broadcasting, and have given an adequate *quid pro quo* for any concession involved in existing arrangements.

Advertising and Propaganda

That from all points of view it is unnecessary and undesirable to utilise the broadcasting organisation for advertising purposes.

That adequate safeguards must be imposed to prevent broadcasting from being used for propaganda or party purposes; and that the final decision in such matters should not be vested in a Government department or a Minister of the Crown.

Possible Effects of Broadcasting More News

Lord Riddell constantly reiterated the importance of the Press as a national industry, both from the point of view of financial expenditure and the number of persons to whom this industry gives employment both directly and indirectly. It was submitted that if, as a result of the broadcasting of news, newspaper circulations were seriously curtailed, large numbers of people would be deprived of a livelihood, without any corresponding gain by the public, "as there was no reason for contending that the oral communication of news was superior to its visual communication, or that the newspapers had failed to meet public requirements."

Comparative Outlay on News

Some interesting financial details of the expenditure of the papers were disclosed. About £62,000,000 per annum were spent in newspaper production, and some 700,000 tons of paper, mostly manufactured in this country, to the value of £12,500,000, were absorbed.

The cost of the collection of news accounted for £5,000,000.

The B.B.C. paid only £8,000 a year for their news service, little

more than the sum paid by any one newspaper.

Lord Riddell was questioned by Sir Thomas Royden as to whether the Press would withdraw any opposition if a greater sum were paid. Lord Riddell said that the question of payment did not enter into the case.

Further Points

They were opposed to the broadcasting of news at all hours.

Sir Thomas Royden then dealt with the question of people who did not buy newspapers—people in inaccessible districts.

Lord Riddell thought the number was so small as to be negligible.

Questioned further as to whether the present restrictions should be retained in their entirety, Lord Riddell thought they should, not only because of the points quoted about the Press, but also in the public interest.

In his opinion various subjects which could be dealt with in the news sheet were not suitable for general dissemination into the family circle. He instanced certain classics, topics such as birth control, racing and betting, and the Law Courts reports.

Lord Rayleigh desired to be informed to what extent the Press had been prejudiced by the existing news service.

Provincial Papers

Lord Riddell said there had been no competition up to the present. Sir James Owen here stated that a questionnaire, addressed to provincial papers which could not be in the hands of readers until after 7 p.m., had disclosed a noticeably prejudicial effect.

Sir James Owen was most insistent that the 7 p.m. rule should not be removed. He felt sure that the provincial papers would be so seriously affected that many of them would be withdrawn. In this case the public would sustain a very definite loss, since many of these papers were devoted to diverse local interests, social, administrative, and general. Much good was done in aiding the administration of justice, and so on.

Broadcasting of Parliament

Captain Frazer, who has asked various witnesses regarding their attitude towards the broadcasting of the proceedings of Parliament, again put the same query. Lord Riddell suggested that many of the proceedings would not be of general interest, but stated that the Press had no objection, and that the present agreement with the B.B.C. allowed them to accomplish this, so long as they confined themselves to speeches which could be picked up directly by the microphone.

Vitalising the News

In reply to further questions by Captain Frazer with regard to narrators or observers, as, for instance, at the signing of the Locarno treaty, Lord Riddell made the interesting disclosure that a committee had been set up to which the B.B.C. would apply for special permission for this type of broadcast. In the case of the Locarno Treaty, they had not made any such application.

Public Demand

Lord Blanesburgh desired to be informed on what authority or on what grounds the Press were entitled to prevent a legitimate demand (if such demand existed) from the public for more news.

Lord Riddell did not see that the public should be indulged in all their demands. Perhaps Lord Blanesburgh thought they should have free beer if they demanded it. Lord Blanesburgh did not concur

in the view that this was an analogy. He quite realised that the Press had something to sell, and that they were entitled to inflict conditions as some return for their services. Should the

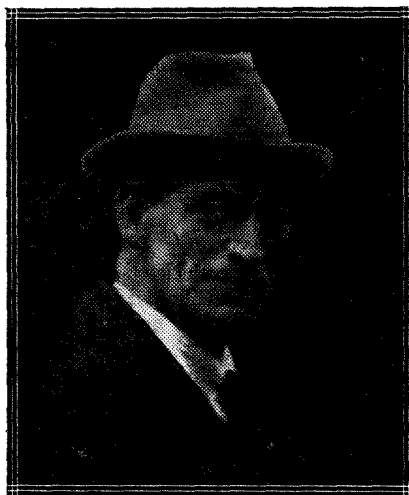

Sir James Owen supported Lord Riddell in giving evidence for the Press.

public, however, desire more news, there was no reason in law to prevent the B.B.C. from supplying it. In fact, should a certain agreement entered into between the B.B.C. and the Press appear to restrict the public demand unreasonably, then the B.B.C. would be entitled to repudiate such agreement. The public, he had no doubt, would desire to be informed as to why they were so deprived.

Supply of News to the B.B.C.

Lord Riddell said the restrictions were agreed to by the P.M.G., who had many interests to reconcile before granting the B.B.C. their licence. If the news service were to be extended they would have to reconsider their position. He felt sure that the four Press agencies, of which number the Press owned two, would consider their best customers first. If the Press, who maintained (excepting for the "mere bagatelle" of £8,000 per annum) the Press agencies, did not desire them to supply news to the B.B.C., he felt sure they would not. If the Press agencies did not supply news, the B.B.C. would have to set up and maintain a world organisation for news alone.

The Thin End of the Wedge

Lord Blanesburgh suggested that the Press might meet the B.B.C. and allow them to broadcast events of national importance, such as the

Derby and the Boat Race, immediately after the result was known.

Sir James Owen opposed even this slight extension on the grounds that it was "a slippery slope," or what one might term the thin edge of the wedge.

Religion

Dealing with religion and some other controversial matters, Lord Riddell said that, no doubt, we should have Freethinkers demanding a service. Many opponents of certain controversial matter broadcast were just realising the enormous power wielded by this new social force.

This closed the case for the Press.

The Theatres

On December 18 Mr. Walter Payne, O.B.E., gave evidence on behalf of the Society of West End Theatre Managers, Entertainments' Protection Association, and the Entertainments' and Organisations' Joint Broadcasting Committee.

The memorandum dealt with the history of the relations between the entertainment industry and the B.B.C. briefly as follows:

Unlimited Powers of the B.B.C.

Shortly after the B.B.C. received the Wireless Licence, dated January 18, 1923, those interested in the provision of public entertainment became accidentally aware of the powers which had been given to the B.B.C. to broadcast, to an unlimited extent, concerts and theatrical entertainments. Realising the very serious injury which might be done to the Entertainment Industry, a Committee was formed, representing every section of this industry, and delegates representing employers and employees were nominated.

Restriction Desired

Attention was drawn to the significant fact that negotiations had taken place with the Press which had resulted in certain restrictions. They contended, and still do contend, that such restriction was right and proper, and that it should have been extended to cover entertainments.

The B.B.C. apparently attached great importance to the value of broadcast entertainments, and endeavoured to persuade the Committee that broadcasting was an admirable advertisement. Results had not confirmed this contention. With a view to the prevention of friction, the B.B.C. had voluntarily agreed to certain restrictions. In the opinion of the Society of Theatre Managers not more than 10 per

(Continued on page 516.)

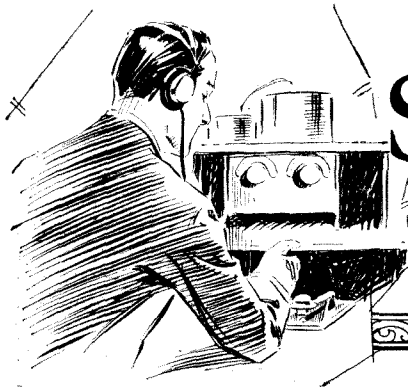

SHORT-WAVE

Notes & News



WITH the advent of the mild weather, reception conditions seem to have suffered a general decline, so far as the higher frequencies are concerned. Most of the American and Antipodes stations have only been of very moderate strength, and during the last week-end even the European stations have found some difficulty in communicating with one another.

Jamming

The problem of local interference is becoming extremely serious again, the "local" stations now being French transmitters employing their favourite high-powered "raw" A.C. Half-a-dozen of these stations can make enough noise to occupy the whole band of frequencies between 6,670 and 7,500 kc. (40 and 45 metres), so broad is their tuning and so troublesome their numerous "side-bands." One is now sometimes prevented from working with a station ten miles away on account of the interference from another transmitter two or three hundred miles distant.

News from Ireland

We hear from GI-6MU, of Belfast, that he has established two-way communication with P-3FZ, thus being the first Irish station to work Portugal. His input was then 5 watts, but he has worked several British stations on telephony with an input of 2 watts to a Cossor P2 valve. He is shortly fitting up an 80-watt generator, and hopes to make a larger "splash" in the ether.

Other Irish stations now working include 5NJ, 6TB and 6QD (all of Belfast), 2WK of Portadown, Ulster, and 2IT of Armagh. A few more hope to be working after Christmas.

The North of England

There are now more Lancashire stations active on the 6,670 kc.

band than have ever been heard before. 2QV (Ormskirk) and 2QB (Widnes) are both heard at great distances, though they are unable to work each other. The former wants to erect a small aerial for short-wave work, but the powers that be do not consider that enough



The earth connections at the Rugby station are no less carefully insulated than the aerial lead-in.

sky is visible from the garden as it is! He employs an L.S.5 valve with an input of six watts. 6RW, of Rock Ferry, Cheshire, is another "big noise" from the North; in addition, 2KW, of transatlantic fame, is making a real "transatlantic noise."

Poor Conditions

2KF reports that the conditions were so bad during the week-end that he only succeeded in working one New Zealand station and one American. He heard PI-1HR on Sunday afternoon; the latter station was handling traffic with American sixth district stations for the entire afternoon. Some South Africans were also heard during the evening, but we have little doubt that conditions will improve enormously if the weather becomes colder again.

It is sad to think of the fate of those who wish to do "DX" work in the early mornings if the best conditions only accompany bitterly cold weather. This appears, however, to have been the case ever since amateurs commenced to work on the 6,670 kc. band.

3,333 kc.

We have been listening on 3,333 kc. (90 m.), and it is hard to believe that the frequency band which saw the accomplishment of so much good work last season is so absolutely deserted now. Is it possible that by next year the now overcrowded 6,670-kc. band will be in the same state? Though it does not seem likely, we must remember that, at this time last year, we little dreamt that the 3,333-kc. band would ever lose its popularity. It would certainly be a good thing if one-third of the stations now using the higher frequency would go back again to 3,333 kc., and so relieve some of the present congestion around 6,670 kc.

American Telephony

We hear from a correspondent that a station, apparently of American origin, with the call-sign 2XG, and using telephony, has been heard on 6,977 kc. (43 metres). We have no information as to the nature of the tests or the power used, but believe this to be an experimental station working in conjunction with one of the broadcasting stations.

Further Experiments with the Tight-Coupled Aerial Circuit

By G. P. KENDALL, B.Sc.

In previous issues of "Wireless Weekly" Mr. Kendall has discussed certain problems connected with the use of a tight-coupled aerial circuit. He now sums up the results of his investigations, and demonstrates clearly what degree of "aperiodicity" one may expect to obtain with this form of circuit.

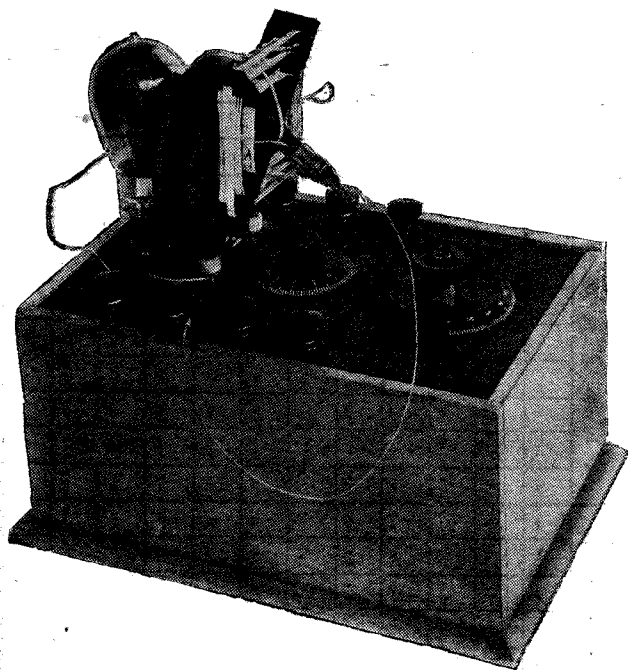

The oscillator used by Mr. Kendall for these experiments was made up in the form shown here. The 2-turn coil (L2 in Fig. 1), to be seen in the photograph on the next page, was fixed on the side of the valve remote from the other two coils.

relying upon its width and relative flatness to cover the band of frequencies which it is desired to receive.

Previous Investigations

A number of experiments have been described recently in *Wireless Weekly* and elsewhere in which the method of test was to measure the signal strength obtained from the carrier wave of the local station, in my own case 2LO, with various arrangements of this type, and a certain amount of information has been obtained; but it has been evident that with only this method at command it was not possible to obtain a true idea of the actual width of the frequency band which could be covered with a practical degree of uniformity by one of these tight-coupled circuits.

A Later Method

It has been evident that some method was required in which some sort of signal was employed whose frequency could be varied at will, in order that the point might be investigated, and a good deal of work has been carried out by the writer to arrive at a suitable experimental method.

A method was finally arrived at which has given some decidedly interesting results, which I believe to be capable of yielding general deductions of practical value, and it is proposed in this article to describe the method and results in question.

Measuring Circuit

The measuring circuit consisted of the usual aerial and earth system containing a tapped primary coil,

CONSIDERABLE practical interest attaches to the question of the degree of uniformity which can be obtained in the response over a band of frequencies of a circuit of the conventional type employing a coil of fixed turns number in the aerial circuit, fairly tightly coupled to a secondary coil which alone is tuned by means of a condenser. It has been shown that this circuit is probably simply a tuned primary and secondary scheme, in which the degree of

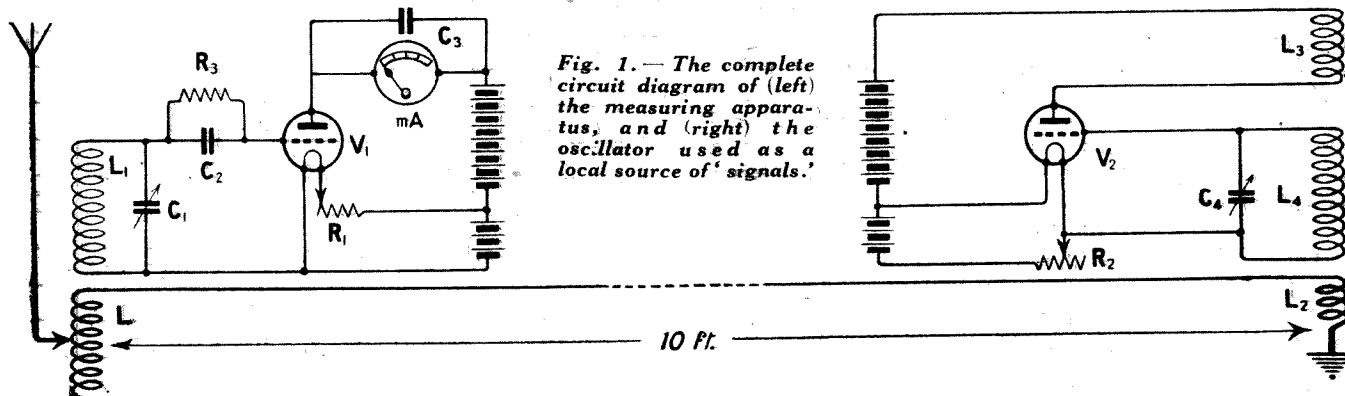

Fig. 1.— The complete circuit diagram of (left) the measuring apparatus, and (right) the oscillator used as a local source of signals.

coupling is so great that the resonance curve of the primary circuit becomes one of the familiar double-humped variety, the two humps being very considerably flattened by the tightness of coupling, and the usual practice being to work upon one of these humps,

tightly coupled to the usual secondary winding tuned by a variable condenser, the signal voltage across this latter circuit being determined by the usual Moullin voltmeter arrangement. The primary and secondary coils were the same as those recently described in

connection with a somewhat similar investigation, the primary being of the same diameter as the secondary viz., about $3\frac{1}{4}$ in., the winding being composed of No. 26 d.c.c. wire. Tappings were taken from this coil at the 6th, 9th, 12th, 15th, etc. turns, up to a total of 60. The source of signal energy was an oscillating valve circuit of conventional type, shown upon the right in Fig. 1, the method of feeding the energy into the circuit under investigation being by the use of a small coupling coil very loosely coupled to the oscillating circuit. This coupling coil was inserted in the earth lead, the oscillator being arranged at a distance of 10 ft. from the main portion of the measuring circuit.

A Convenient Source of Signals

We have here a means of introducing into the aerial circuit small high-frequency currents which may be taken as being equivalent to those induced by the signals of a distant station, but certain precautions must obviously be observed in its use if results of any



Illustrating the relative positions of the oscillator and pick-up coils to secure a suitable coupling between them. Referring to Fig. 1, L2 is the 2-turn coil, L3 the coil on the X former, and L4 the plug-in coil.

significance are to be obtained. In the first place, it will be observed in using any valve oscillator that as the tuning condenser of the oscillating circuit is varied so will the strength of the oscillations also vary.

Difficulties

In the oscillator employed in these experiments, for example, as the reading of the condenser governing the frequency of the oscillation was increased, i.e., as more capacity was added to the circuit, so the oscillations became weaker and weaker. This in itself is a considerable difficulty, but it can be overcome in a manner which will be described at a later point. Further, the coupling between the oscillator coil and the coil in the earth lead must be decidedly weak, and in these circumstances it is necessary to employ a really strong oscillator to introduce a sufficient amount of energy into the aerial circuit.

The Oscillator

In practice, the oscillator consists of an ordinary bright emitter general-purpose valve run at rather a high filament temperature, and with fairly high anode voltages, up to 168 volts. The grid coil of the oscillating system was either a Lissen No. 60 or a Gambrell B, to this being coupled a coil consisting of two turns of Glazite wire, as a pick-up winding. This latter coil was placed at a distance of about 3 in. from the oscillator coil, and it was found under these conditions that a sufficient amount of signal energy was introduced into the receiving circuit for the purpose of

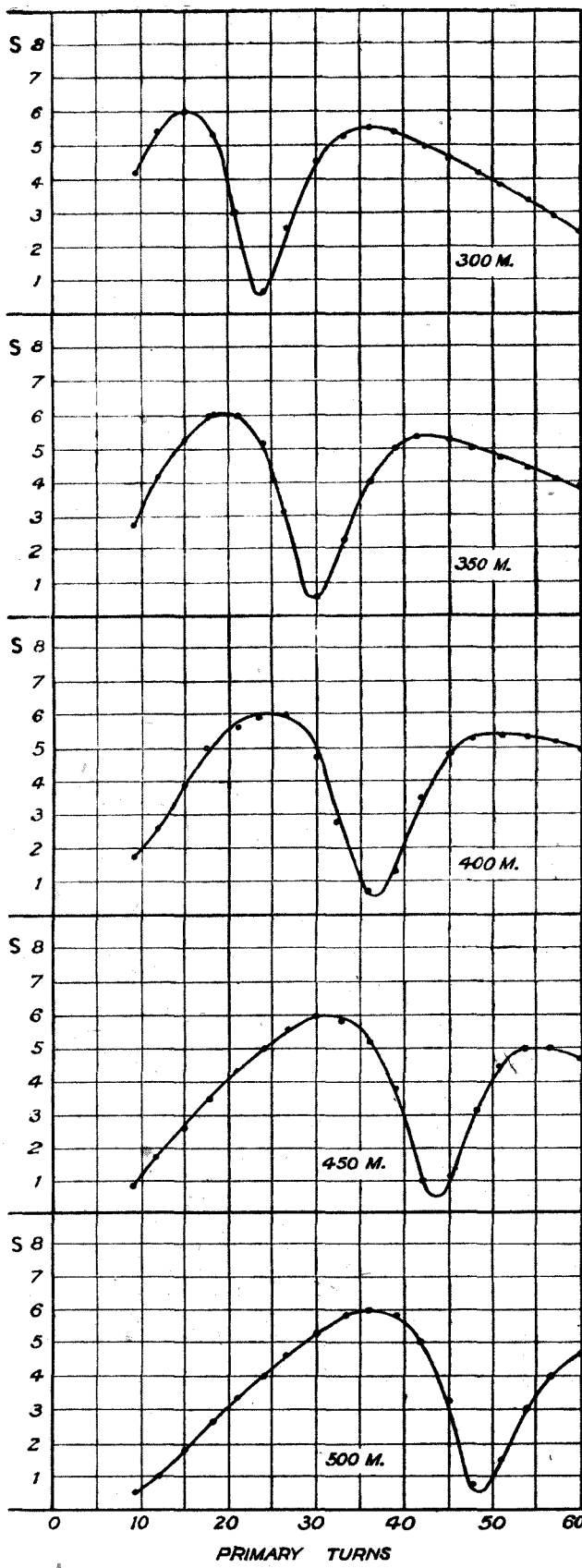

Fig. 2.—The above curves were obtained by varying the number of turns in the primary winding, and plotting turn numbers against measured signal strength at various frequencies.

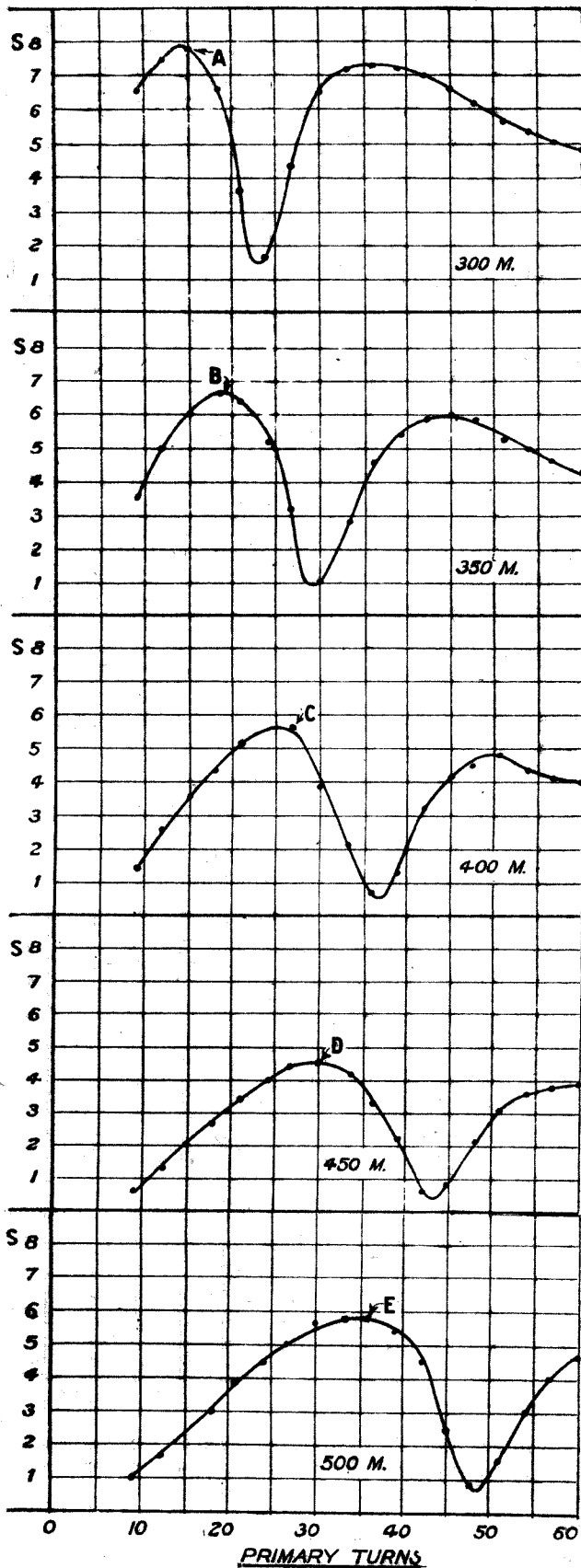

Fig. 3.—These curves were plotted in the same manner as those of Fig. 2, but in this case precautions were taken to secure a constant reading of signal strength from the oscillator at the different frequencies.

the experiment, the actual signal strength figures being roughly equivalent to those observed from the local broadcasting station, at a distance of 8 miles.

The First Experiment

The procedure in the first experiment was to set the local oscillator to give a frequency of 1,000 kilocycles (300 metres), and then to vary the number of turns upon the primary winding of the circuit under investigation, measuring the signal strength across the secondary with each tapping point. The result is shown in the top diagram of Fig. 2, and of course the familiar double humped curve is produced.

It is to be noted in passing that the two humps of this curve appear to be widely different in width, but this is largely a matter of the horizontal scale upon which the diagram is drawn.

Primary Turns and Signal Strength

It will be noted that horizontally I have marked off the turns upon the primary, while vertically is the signal strength scale, and it is to be remembered that a variation of, say, three turns in the neighbourhood of the peak of the first hump represents a very much greater percentage change of total inductance than a similar variation of three turns upon the peak of the second hump, where there are already as many as 33 turns in circuit. In the first case, of course, there would be only about 12 or 15 turns in circuit. This point should be borne in mind in all cases in interpreting diagrams of this type.

Lower Frequency Readings

The next step was to increase the reading of the condenser in the oscillating circuit to give a frequency of 857 kilocycles (350 metres) and to repeat the procedure. The curve thereby derived is shown in the second diagram from the top in Fig. 2, and once more we see a curve of the same general type, with two humps and a sharp dip between them, where the primary circuit has come into tune with the input frequency, with correspondingly poor results on account of the very tight coupling. The oscillator was next adjusted to give a frequency of 750 kilocycles (400 metres) and the procedure repeated, curve three reading from the top of Fig. 2 being plotted as a result of this series of measurements. For frequencies of 667 kilocycles (450 metres) and 600 kilocycles (500 metres) respectively, the procedure was also carried out, the curves being also seen in Fig. 2.

Comparison of Curves

Several interesting things come to light upon an examination and comparison of these curves, one being that for a given number of turns in the aerial circuit we shall find that we are working upon points of widely different character at the various different frequencies under consideration. For example, if we take 15 turns, we shall find that with a frequency of 1,000 kilocycles (300 metres) we are just nicely on the peak of the first hump; with a frequency of 857 kilocycles (350 metres) we are still in a good position upon the peak of the first hump; with a frequency of 750 kilocycles (400 metres) we are no longer in a very favourable position, being half-way down the outer slope of the first hump, where the signal strength is only half the maximum possible, but where selectivity is fairly high.

Signal strength is poorer still in the case of the frequencies of 667 kilocycles (450 metres) and 600 kilocycles (500 metres). Further, it will be observed that what one may describe as danger points, namely,

the dips between the two humps (where it will be remembered that selectivity is exceedingly poor and signal strength also deficient), fall at numbers of turns ranging from 24 in the case of the 1,000 kilocycle frequency to about 48 in the case of the 600 kilocycle signal.

Varying Oscillator Output

It will be observed that these different curves rise to different maxima, resulting from the fact that the

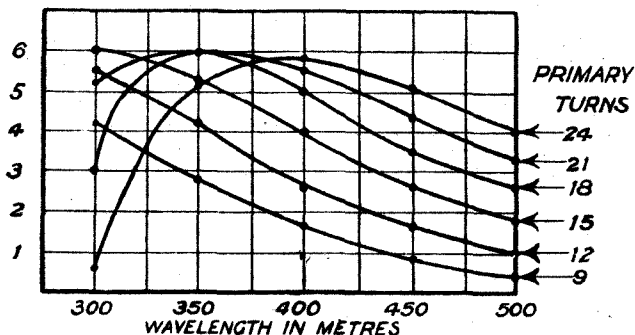

Fig. 4.—From these curves, which are plotted from the data provided in Fig. 3, and on a scale of wavelength against signal strength, may be deduced the degree of "aperiodicity" of the primary circuit over a particular band of wavelengths.

output from the oscillator was not constant in strength at the different frequencies under investigation, but altered progressively as the frequency was lowered, i.e., as the wavelength was increased. This became so acute that in the case of the curve for the 600 kilocycle frequency (500 metre wavelength), it was necessary to increase the strength of the oscillator somewhat by applying a greater H.T. voltage in order to obtain a signal strength that could conveniently be measured, and it will be observed that this curve rises to a greater height than the preceding one for the 667 kilocycles (450 metres) signal.

Equalising Signal Strength

In order to carry out a proper comparison to determine the actual degree of relative efficiency obtained at different frequencies with a primary of fixed size, it was decided to determine corresponding points from the five curves of Fig. 2, and then to adjust the oscillator at the various frequencies under consideration so that an equal signal strength was obtained at each of the points chosen. It will be observed upon inspection of Fig. 2 that points A, B, C, D and E have been marked, which are all roughly equivalent to each other in relative position upon the curve appropriate to the frequency chosen.

Oscillator High-Tension Voltage

The next step was to determine by experiment what value of high-tension voltage upon the oscillator valve would give the same signal strength, a value of 6 being chosen, when turn numbers appropriate to each of the points mentioned were included in the aerial circuit. These were found to be as follows:—

Test Frequency.	Aerial Turns.	Oscillator Voltage.
1,000 kilocycles	15	84
857 "	18	102
750 "	27	120
667 "	30	138
600 "	36	168

Second Series of Curves

The operation of taking the series of readings upon the five different frequencies chosen was then repeated, using the voltages upon the oscillator which had been determined, and the five curves were then plotted again, the result being seen in Fig. 3, in which it will be observed that the heights of the peaks are identical in each case. From this second set of curves it is possible to read off in a vertical direction figures which can be taken as a measure of the efficiency of a given number of turns in the aerial circuit upon the five different frequencies in question. For example, with 9 turns in the aerial circuit, a signal strength of 4.2 is obtained from a signal of 300-metres wavelength, of 2.8 from one of 350-metres wavelength, 1.7 with a wavelength of 400 metres, .9 from a signal of 450-metres wavelength, and .5 from one of 500-metres wavelength.

Wavelengths and Frequencies

If we now take the figures just quoted and plot them upon a horizontal scale of wavelength and a vertical scale of signal strength, we shall obtain a graph which will show the signal strength given by that primary upon any desired wavelength between 300 and 500 metres. (It should be noted that I am now quoting wavelengths only, because it seems most convenient to do so in the case in question, wherein we are dealing with the efficiency of a primary upon a band of frequencies on which are distributed a number of wavelengths of broadcasting stations which most of us have memorised.)

Other Turn Numbers

In Fig. 4 will be seen the result of plotting this curve and a number of others, the latter being appro-

A transformer installed at the Rugby station, the dimensions of which may be gathered from the photograph.

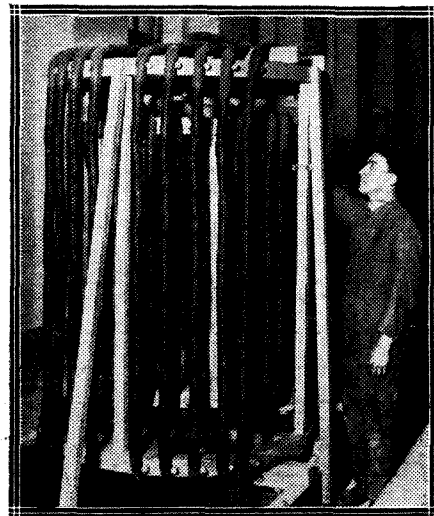

appropriate to 12, 15, 18, 21 and 24 turns in the aerial circuit. The figures for the plotting of these curves were all read, of course, from those given in Fig. 3, by simply drawing an imaginary line in a vertical direction appropriate to the number of turns in question, and noting the points at which it cuts the curves. It will be observed that up to 15 turns we have a simple falling characteristic, which starts at a fairly high value for 300 metres and falls off steadily to a low one

at 500 metres, these being the conditions under which we normally work with one of these tight-coupled aerial circuit arrangements, the reduction of signal strength upon the higher wavelengths having been noticed in actual practice by many experimenters.

Effect of Wavelength Changes

As a matter of fact, slight reductions in efficiency with change of frequency are not in fact so noticeable as one would expect; it must be remembered that when one passes from a station on 400 metres to another on 500 metres, it is most difficult to make an actual comparison, since one has changed from one station to another, from one programme to another, from one set of conditions as regards interference to another set, and furthermore, the two stations which are being compared are no doubt at quite different distances from the receiving point, so that some change in signal strength is naturally to be expected, regardless of the relative efficiency of the receiving circuit upon the two frequencies.

Turn Numbers for Particular Wavelengths

When larger numbers of turns than 15 are included in the aerial circuit, it will be observed that we start with a low value of signal strength for a 300-metre signal, arriving at the maximum possible figure of 6 at some point further along the wavelength scale, and then fall off again towards the upper wavelengths. This, of course, is because when the larger numbers of turns are used, we may be starting somewhere near the dead region between the humps for the short-wave signal, passing away from it as the wavelength is increased. This, as will be seen, becomes quite an acute difficulty in the case of the 24-turn primary, which would be practically useless for a 300-metre signal, although good for anything between 350 and 500 metres.

Conclusions Reached

From this latter point a useful deduction can be drawn, viz., that it is very much wiser to choose a really small number of turns in the aerial circuit and endure the falling-off of signal strength upon the lower frequencies, rather than to risk the possibility of striking a dead region for the higher frequencies.

Tappings on Primary Winding

It would further be justifiable to draw the inference that a primary of fixed turn numbers cannot be taken as covering so wide a band of frequencies as that embraced between the wavelengths of 300 and 500 metres with any reasonable degree of uniformity, and that it would seem justifiable to provide tappings, one or two in number, upon such primary windings, or alternatively, to use plug-in or other interchangeable coil units for the purpose. It must be borne in mind, however, that such changes in efficiency as are apparent in Fig. 4 are not by any means so noticeable in actual reception as one would at first sight assume.

Effects of Aerial and Earth Systems

A word of warning must be given at this point to the effect that all the measurements shown were carried out upon one particular aerial and earth, and it will be remembered that it has been shown in the past that different aerials behave somewhat differently in their response to experiments of this nature. In general, the position of the peaks and dips of the characteristic

curve will fall at different numbers of turns, and the degree of sharpness or otherwise of the peaks will vary. The general inferences, however, would seem to hold good, and they are commended to the attention of those experimenters who make use of tight-coupled primary windings in their receivers.

**RADIO PRESS CALIBRATION SCHEME:
FREQUENCY TESTS THIS EVENING**

As announced in the last issue of *Wireless Weekly*, the frequencies of all the B.B.C. main stations, and also of certain Continental stations, will be measured this evening (December 30), commencing at 7.45 p.m. The exact times of measurement for each station are given below, together with their approximate frequencies:—

Time.	Station.	Frequency. Kilocycles	Wave-length metres.
7.45 p.m.	Cardiff	850	353
7.50 p.m.	Seville	840	357
7.55 p.m.	London	822	365
8. 0 p.m.	Madrid (Union Radio) ..	804	373
8. 5 p.m.	Manchester	794	378
8.10 p.m.	Oslo	785	382
8.15 p.m.	Bournemouth	777	386
8.20 p.m.	Madrid (Radio Iberica) ..	765	392
8.25 p.m.	Dublin	752	399
8.30 p.m.	Newcastle	743	404
8.35 p.m.	Munster	732	410
8.40 p.m.	Glasgow	711	422
8.50 p.m.	Rome	706	425
8.55 p.m.	Toulouse	696	431
9. 0 p.m.	Belfast	682	440
9. 5 p.m.	Ecole Superieure	655	458
9.10 p.m.	Frankfurt	638	470
9.15 p.m.	Birmingham	626	479
9.20 p.m.	Aberdeen	606	495
9.25 p.m.	Zurich	583	515

It is, of course, possible that some of the above stations may be badly jammed, or not working, at the above times; this, however, will be stated in the report of the results.

Other Calibrations

Calibrations of other stations may be taken at the same time, so that it will be well worth while to listen to, and take the readings of, any other stations that may be heard on that evening.

Transatlantic Tests

In view of the Transatlantic Broadcasting Tests, arranged to take place at the end of January, 1926, as announced elsewhere in this issue, listeners should find it particularly useful to calibrate their wavemeters and receivers now. The assistance rendered by accurate calibration of a receiver in picking up distant stations is too obvious to need further comment.

“MODERN WIRELESS”
NEW YEAR ISSUE.
OUT JANUARY 1st
MAKE SURE OF YOUR COPY.

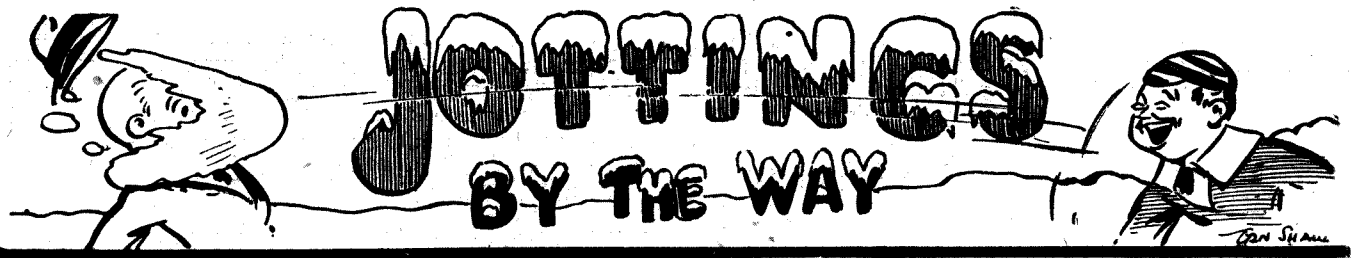

The Merry Season

I AM writing this on the eve of what they call the merry season. By the time that it appears in print both you and I will be experiencing that "morning after" feeling which is produced by our coming up with a jerk against rent, rates and income tax, and a lot of other little troubles of the same sort. Personally, I am

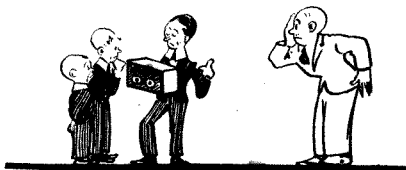

... They criticise my own set ...

having just now a thoroughly bad time, and I feel sure that I shall have the sympathy of any fathers of families who read these pathetic lines.

Briefly, what has happened to me is that each and every one of my young hopefuls, who are now home for the holidays, has taken up wireless with an enthusiasm that only the very youthful know. Matters were not so bad this time last year, when only the eldest had leanings that way. I used to miss a variable condenser now and then (or rather somebody else did, since mine are invariably borrowed), and transformers would disappear, whilst occasionally one of my (that is, Snaggsby's) valves would be found to have burnt out mysteriously. I did not mind all this; I encouraged the lad, helping him with his wiring, and then leaving him to straighten things out after I had attempted to make up one of Professor Goop's super-circuits for him. But now that the other two have followed in his footsteps, I am beginning to wonder whether there should not be an age limit for wireless, and also whether a law should not be passed limiting the number of devotees in any family to

one or possibly two. Four is really too much of a good thing.

The Devastated Area

Intending to undertake a small constructional job the other day, I strolled out to my workshop. Words fail me to describe the sight that met my eyes. The place was positively strewn with broken drills, taps, and hacksaw blades; my best chisels had obviously been used for trimming the edges of ebonite panels, and my most treasured files for cutting lead or solder or something equally devastating to their keenness.

The absolute limit was reached when after a frenzied search for my 4B.A. die I ran it literally to earth upon a crystal set, where it was doing duty as the top of the E. terminal. The culprit stated that he could not find a single milled nut—the same thing has been occurring to me since the holidays began—and that the die did jolly well as a substitute. I have put my foot down on valve sets for the younger ones; but does that ensure me peace? Certainly not. They have each rigged up indoor aerials and spend their time fiddling with cats-whiskers, whilst my loud-speaker clicks and scrapes unceasingly, and sometimes brings in snatches of youthful conversation, some of which is by no means complimentary to me.

Poddleby, Too

Striding in my despair from my wrecked workshop, I went round to Poddleby's house to seek consolation. I was sure that things would be all right there, for Poddleby has no boys. When I entered his den I found him looking a little worried, I thought, and he was much more silent than usual, to begin with.

When I told him I had come for sympathy and consolation, he told me that his own need was greater than mine, adding that in such cases it was infinitely more blessed to receive than to give.

As we were talking, there was a little tap at the door, and

Poddleby's four small daughters, ranging from fourteen down to eight, came shyly in. When they had shaken hands very prettily with me, Poddleby suggested that they should run away and play. However, they lingered by the door, standing first on one foot and then on the other. Then suddenly they found their voices and all began to talk at once. The burden of the chorus was, "We have used all those 4B.A. nuts. Could we please have another dozen?" "Nuts!" screamed Poddleby, "Nuts! This place is becoming an infernal monkey house."

A Fellow Feeling

When we were alone once more I seized Poddleby by the hand. "My friend," I said, "I had no idea that you also were for it. It appears that the modern woman has taken to wireless, even as a duck takes to water. Still, you ought to be thankful that they are girls. You should just see my house, my workshop, my gadget cupboard." There is nothing so comforting as another's adversity. On hearing my tale, Poddleby at once began to brighten up. "You are not half so badly off as I am," he said warmly. "I have been

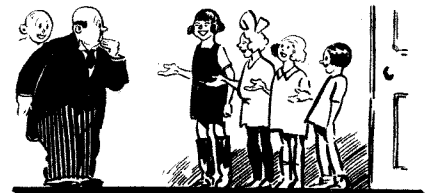

... We have used all those 4B.A. nuts ...

turned right out of my workshop. Those kids have put up their wireless set there and are using it as their receiving cabin." I saw a chance of scoring a point. "Then they have only one set?" I asked. "Yes," cried Poddleby. "Why, my dear fellow," I said, "you are not suffering at all. I have three boys and they each have a set. They have all rigged up aerials in their bedrooms." "My good fellow,"

cried Poddleby, "you are in clover. My girls may only have one set, but they have pinched my aerial!"

In Search of Sympathy

Eventually we agreed that we were each suffering equally badly, and, feeling brothers in adversity, we resolved to go and call upon the General. As he has no family, we felt sure that our sad tales would move him to pity. "At any rate," remarked Poddleby, "we shall be able to listen to some wireless in comfort, and that will be something. We were so cheered by this idea that we strode forward with elastic steps. As we were walking along the hedge in front of Simla Villa towards the gate, a large and very squashy snowball sailed over googly-wise, catching Poddleby, who was, luckily, on the inside, fairly and squarely upon the ear.

I hastened to render first aid by scooping the snow out of his ear with a B.A. spanner which I happened to have in my pocket. I was still engaged, despite Poddleby's protests, in my noble work of mercy when a second snowball, larger and squasher than the first, descended upon the back of my neck, and as I was leaning forward at the time, several pounds went inside my collar and slithered like an avalanche down my back. "Just you wait a moment, General!" I yelled. "Come on, Poddleby. We are two to one, and I am never afraid of such fearful odds."

The General

Poddleby and I set off at a smart double for the gate, other snowballs removing our hats before we got there. Taking cover behind the

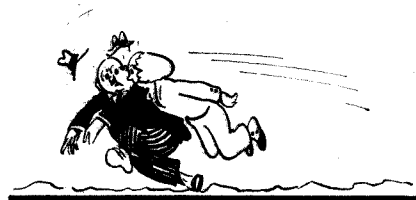

Larger and squasher than the first . . .

gate posts, we collected a supply of ammunition and sailed in. There was not a soul in sight. We searched the garden thoroughly and found no trace of the enemy. Suddenly the front door opened and the General, purple in the face and roaring like an infuriated bull, came bounding down the steps. "What the blue blazes are you two doing

walking all over my . . . ?" he bellowed. He would have said a good deal more, I believe, had not my own well-directed missile at that moment found its billet in his widely-opened mouth. Poddleby's first shot caught him on the fourth waistcoat button. The General leapt, but whilst he was still in the air two more clinking good shots got him. They apparently upset his balance, for he reached the ground in a sitting posture, and having him thus at our mercy, Poddleby and I took full advantage of the situation.

At Simla Villa, Too

At length, when our ammunition was exhausted, we helped him to his feet. By this time he had recovered his powers of speech, but was no longer roaring; instead, he was calm and exceedingly acid. "And what," he inquired, "is the meaning of this disgraceful assault?" "Ha, ha!" I shouted, slapping my thigh. "He, he!" chuckled Poddleby, bending double in his glee. "Jolly good I call that. Dashed well acted, General." "Acted?" inquired our victim in scathing tones. "Will you have the goodness to tell me what you mean?" "Oh, splendid," we roared in concert. "Come, now," said Poddleby, "you can't say that you didn't ask for it." "You go slinging your beastly snowballs about over the hedge," I cried, "and then wonder why we retaliate." "Snowballs?" shouted the General, his calm deserting him. "You accuse me of going and chucking snowballs about. What on earth do you mean? I have never done such a thing for thirty years." And then, quite suddenly, his growing rage was replaced by a wave of sadness. "Well, well," he moaned, "I think I understand how it happened. Come inside, won't you?" We went in, Poddleby going first.

More Violence

As he passed the door of the dining room, a small arm holding a bladder tied to a stick was visible for a second, and Poddleby was shrewdly smitten where the thatch is thin. He was still recovering from his surprise when something whizzed down the stairs and crashed violently into our legs, sending the three of us down in a struggling heap. Picking ourselves up, we observed a small boy bearing a teatray and retreating as rapidly as

possible up the stairs again. The General hastily pushed us into his study, banged the door, and locked it. "Good heavens!" I exclaimed, "What on earth is all this? Poddleby and I came round to see you because we were suffering at the hands of our own young, and we felt that we should be safe with you, since you have no family."

A Fellow Sufferer

"No," replied the General gloomily, "I have no family, but my sister has. She is just back from



Something whizzed down the stairs . . .

India, and I invited her down for Christmas, forgetting all about her brats. She has collected three boys and two girls from their various schools and brought them on down here, without a word of warning." Poddleby smiled. "Are they gone on wireless?" I asked. "Do they use 4B.A. nuts by the gross?" inquired Poddleby. "How on earth did you guess?" cried the General. We told him something of our own sufferings. These, he assured us, were nothing compared with the things that had happened to him. They had pulled his five-valve set to pieces and made it into five separate single-valvers. They had rigged up aerials all over the garden—he pointed them out from the window. P.C. Bottlesworth had already called upon him to insist upon his taking out five additional licences, and an official from the Post Office had threatened him with the withdrawal of the original one if he did not stop oscillating.

Never Again

We have decided that before the next holidays come round a series of large cupboards shall be erected for wireless gear. One of these will be allotted to each family man, and space will be also reserved for those who have families of others thrust upon them. When the arrival of the youngsters is imminent, the *Gazette's* Ford van will collect each threatened member's wireless apparatus and his tools, which he will be able to store in his cupboard until peace returns once more.

WIRELESS WAYFARER.

The Transatlantic Broadcasting Tests

We give below some further details of the Broadcasting Tests, which have been arranged to take place early next year between Europe and America.

IN a previous issue of *Wireless Weekly* (Vol. 7, No. 11), we published some preliminary information regarding the third annual Transatlantic Broadcasting Tests, which are to take place next month. We are now able to supply further details of the arrangements made, the organisation of the tests being well advanced.

In America the necessary arrangements are being made by our contemporary, *Radio Broadcast*, in conjunction with a representative committee, while Radio Press, Ltd., are the organisers for this side of the Atlantic.

Period Chosen for Tests

The actual period decided upon for the tests is the last week of

tests will begin on Sunday, January 24, and will last for a week.

Nightly Periods

The American, Canadian, Mexican and Cuban broadcasting stations will transmit from 10 to 11 p.m., Eastern Standard Time, on every night throughout the week. These times correspond to 3 a.m. to 4 a.m., G.M.T. Following after the above transmissions, the British and Continental stations will transmit from 4 a.m. to 5 a.m., G.M.T. (11 p.m. to 12 midnight, Eastern Standard Time).

Grouping of Stations

Some interesting special tests may also be carried out in America. For instance, it is proposed to group the stations in America on

group in turn transmitting for 15 minutes in the hour allotted, the remaining three groups meanwhile being silent. This arrangement might be expected to provide to the more distant stations a better chance of being well received and identified in Europe.

Effects of Latitude

Another special form of test, for which arrangements are in hand in America, is being planned to enable observations to be taken of the effect of latitude on reception. The stations would be grouped in a northerly and southerly direction, Canada, the Northern States, the Southern States, and Mexico and Cuba each being allotted a 15-minute period in the hour's transmission period.

Good Conditions for Reception

It is hoped that as many listeners as possible will participate in the tests, owing to the value of a number of independent observations in various parts of the country. Since the broadcasting stations in this country will not be working during the period allotted for reception of American stations, the consequent freedom from local interference should provide listeners with a good opportunity for good long-distance reception.

Calibrate Your Receiver

In picking-up and identifying the various stations, the assistance rendered by an accurately calibrated receiver hardly requires emphasising. Elsewhere in this issue will be found details of the Radio Press Calibration Tests to be carried out on December 30.

Another series of tests will also be carried out during January, the date and times for which will be announced later.

If listeners can adjust their receivers accurately to the required frequency, without resorting to the assistance of oscillation to find stations, a great deal of interference will be eliminated.

Further information on the subject of the tests will be published in subsequent issues of *Wireless Weekly*.

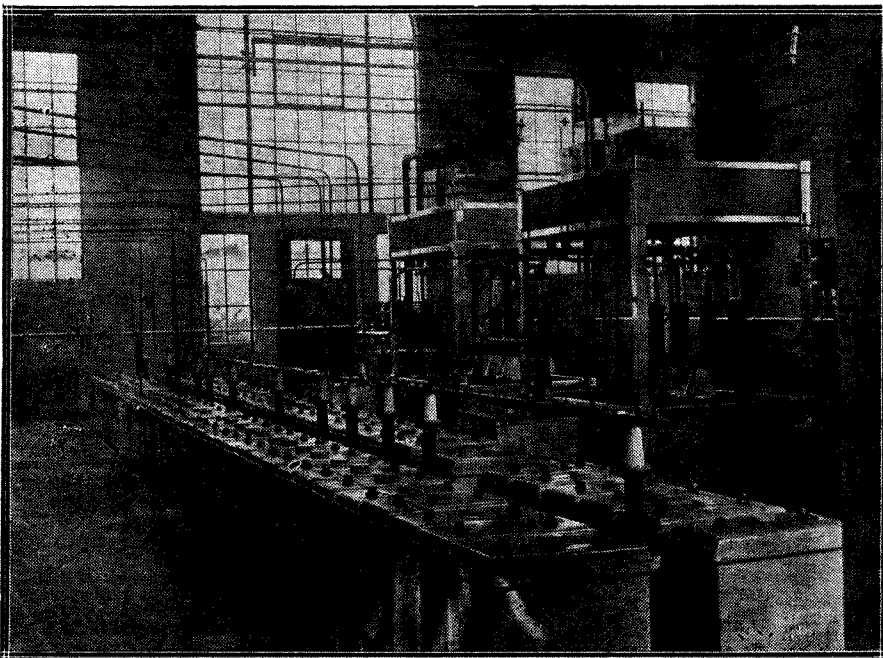

Two alternative programmes are to be broadcast from the Daventry station every week, beginning on January 11. A large bank of condensors at Daventry is shown here, and the water circulation system for cooling the transmitting valves may be seen on the right.

January, 1926. This time of the year has been decided upon as a result of previous experience, and it is likely to be the most satisfactory period for the purpose. The

one or more nights. Under this scheme the American stations might be split up into the Eastern, Central, Western Mountain, and Pacific groups, the stations in each

Methods of Modulation in Transmission

(Continued)

By the Staff of the Radio Press Laboratories.

Following on a discussion in last week's article in this series of methods of keying transmitters, modulation at definite musical frequencies is dealt with here, including the use of interrupters and the employment of A.C. for high-tension supply.



IN last week's issue of *Wireless Weekly* we showed how the modulation of an oscillating valve circuit could be divided under three headings, namely:—

- (a) Modulation by keying.
- (b) Modulation at some definite musical frequency.

(c) Modulation of the radio oscillation by impressed sound vibration of varying frequency and amplitude.

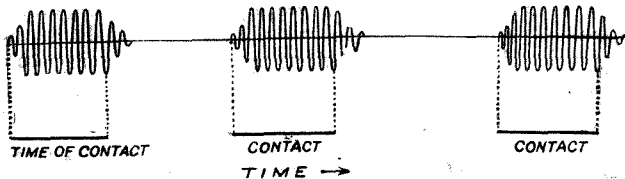

Fig. 1.—Showing the wave-form of the oscillations when the circuit is interrupted at a definite musical frequency.

We have already dealt generally with the question of keying, so we will now consider the problem of modulation under headings (b) and (c).

Modulation at a Musical Frequency

A valve oscillation can be modulated in several different ways, so as to give a so-called musical note. Although the resultant effect on an ordinary receiver is approximately the same whichever method is used, the actual wave-forms of the radio oscillations are distinctly different.

Interrupted Continuous Waves

If in series with the key shown in the circuits given in last week's *Wireless Weekly* we connect some type

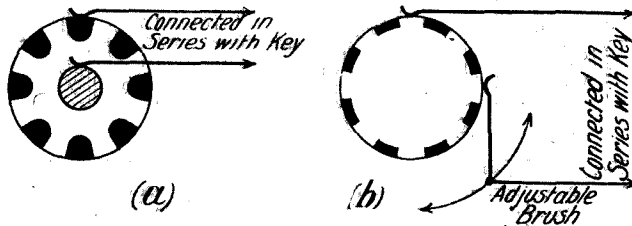
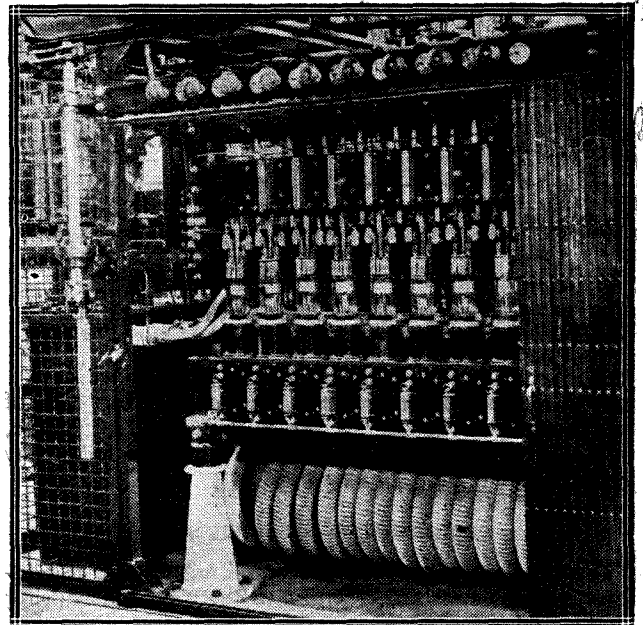

Fig. 2.—Two types of interrupter discs used for producing interrupted continuous waves. In the (b) type the adjustable brush can be moved, so as to vary the relative times of "make" and "break."

of interrupter, which opens and closes the circuit at some definite musical frequency when the key is depressed, we obtain trains of continuous wave oscillations as shown in Fig. 1. In this case the durations



One of the banks of nine transmitting valves at the Rugby station. The panels and controls are shown in the photograph on the next page.

of make and break are approximately equal. Although these relative times can be varied, it will be found that an equal ratio is the best in practice.

An Interrupter

A suitable interrupter for this purpose consists of a commutator as shown in Fig. 2, which is fixed to a small electric motor. Such an interrupter can easily be made from a solid disc of copper or brass about 2½ in. diameter by ¼ in. to ½ in. thick, by drilling

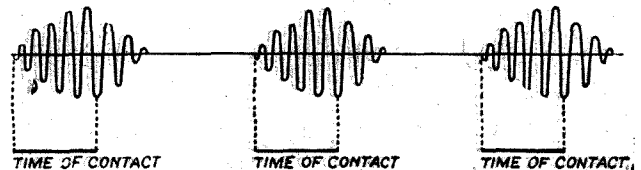

Fig. 3.—The wave-form of the oscillations when the circuit is broken at a high musical frequency. With a high musical frequency and low transmitting frequency (long wavelength) the amplitude of the radio-frequency oscillations may never remain constant.

equally-spaced holes as near the circumference as possible, and fitting these with cylindrical pieces of ebonite or other good insulating material. The disc, together with the insulator fittings, is then turned down in a lathe, so that rather less than half the diameter of the insulator rods is cut away. This will give an interrupter disc as shown in Fig. 2a.

Wave Form of I.C.W.

Referring to Fig. 1, it will be seen that when the interrupter makes contact, the amplitude of the oscillations

lations increases to a maximum value, at which they remain steady for a number of complete oscillations. On breaking the contact the oscillations do not fall to zero immediately, but only do so after a number of oscillations of decreasing amplitude. The rate of

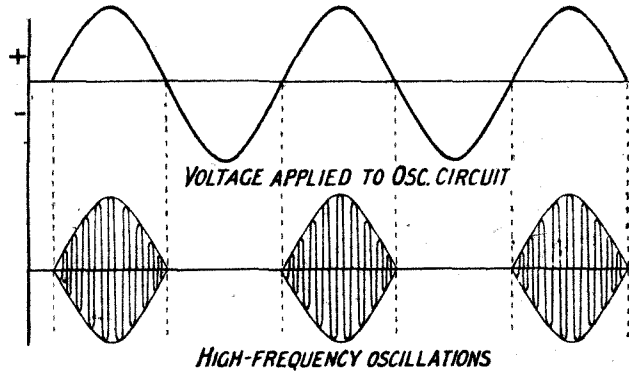
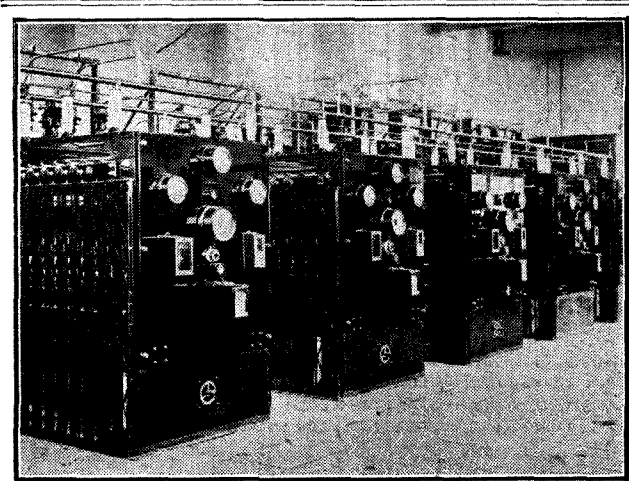

Fig. 4.—Showing the wave-form of the high-frequency oscillations when the oscillating valve is supplied with alternating current.

growth at the making of the contact and the rate of decay when the contact is broken depends, of course, upon the resistance in the circuit and the frequency of the oscillations.

Frequency of Interruption

The time during which the amplitude of the oscillations remains constant, relative to the total time during which the circuit is oscillating, depends on the frequency of interruption. Thus with a high frequency of interruption and a long wavelength it is possible to get a condition under which the amplitude of the oscillations does not remain constant at all, but is either increasing or decreasing. Fig. 3 shows the wave-form under these conditions. In some cases the amplitude may not even reach its maximum value



A general view of the five banks of valve panels at the Rugby station, one of which is illustrated in greater detail on the preceding page.

same order of that caused by a spark station, the damping of which is relatively low. The interference caused by an oscillator whose wave-form is shown in Fig. 1 is, on the other hand, comparatively small.

Modulation with A.C. Supply

Another form of modulation can be obtained by applying an alternating potential to the valve circuit

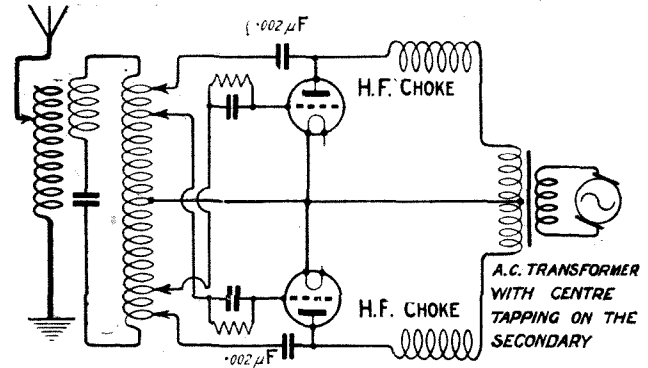

Fig. 5.—Illustrating the general principles of a circuit designed to make use of both halves of the A.C. cycle when an alternating current supply is employed for high-tension.

instead of the usual D.C. voltage. If the ordinary single-valve circuit is used we obtain a wave-form as shown in Fig. 4. Oscillations only occur during the positive half of the alternating current cycle.

Using Both Halves of Cycle

By arranging two valves as shown in Fig. 5 it is possible to make use of both halves of the alternating potential. One valve operates during one half of the cycle, and the second valve operates during the other half of the cycle. Energy is therefore put into the aerial during both halves of the cycle, and we obtain a wave-form for the radio oscillations as shown in Fig. 6.

In this type of modulation the groups of oscillations are not discontinuous, as in the case in Figs. 1 and 3,

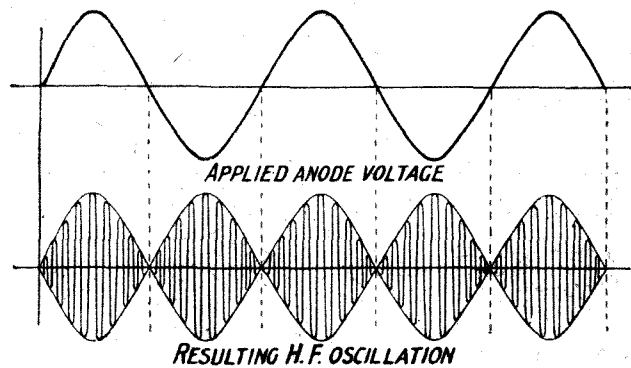

Fig. 6.—When an alternating voltage is applied to the type of circuit illustrated in Fig. 5 the wave-form of the radio-frequency oscillations is as shown here.

but the whole series of groups forms one continuous function. This type of wave-form is practically equivalent to two continuous waves of equal amplitude, but differing in frequency to the extent of twice the frequency of the alternating current. This type of modulation would cause no more interference than two equal power continuous wave stations differing by, say, 500 cycles. Therefore, from an interference

before the circuit is broken. In these cases when the amplitude never remains constant the wave-form of the oscillation is practically equivalent to that of a good spark transmitter. The interference caused by such transmission may be considerable—in fact, of the

point of view, it is preferable to use this type of modulation rather than those shown in Fig. 1 or 2.

Superimposing A.C. on D.C. Supply

A still further method of modulating in order to give a musical note is to superimpose an alternating current potential on the direct current high-tension supply. This can easily be done by connecting the secondary of an A.C. transformer direct in one of the high-

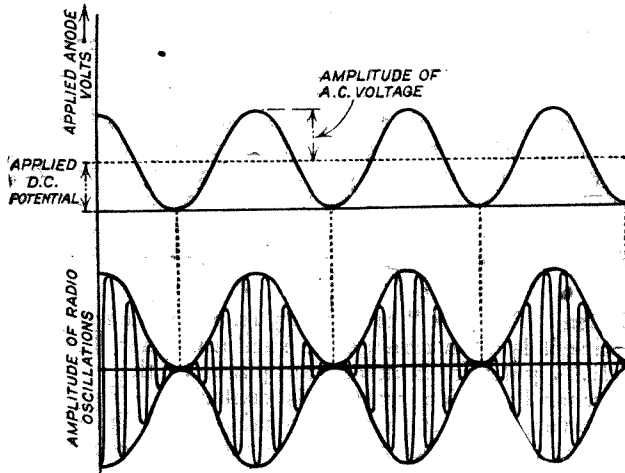

Fig. 7.—The wave-form of the modulation obtained by superimposing an alternating voltage on the direct current high-tension supply.

tension leads to the oscillator, and connecting the primary to a source of A.C. supply. The peak value of the voltage across the secondary should not exceed that of the D.C. supply. If the two are equal we get a wave-form as shown in Fig. 7. Although the amplitude of the oscillations falls to zero, and the curve looks very similar to that of Fig. 6, there is a distinct difference in that the "envelope" or trace in the case of Fig. 6 consists of two approximate sine waves

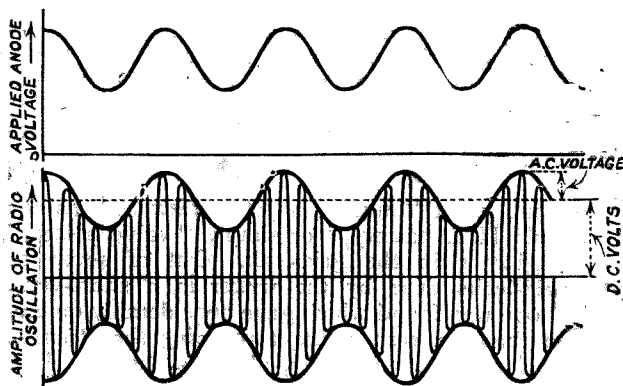

Fig. 8.—A form of modulation similar to that shown in Fig. 7. Here, however, the D.C. voltage is greater than the superimposed alternating potential.

which cross over the zero line, whereas the "envelope" in the case of Fig. 7 consists of two sine waves, one above the zero line and one below it. If the amplitude of the superimposed A.C. voltage is less than that of the D.C. supply, we get a similar wave-form to that of Fig. 7, but in this case the amplitude of the oscillations does not decrease to zero. This is shown in Fig. 8.

Wave-Forms

On analysing the wave-form of the oscillations produced by this method of modulation, it will be found that it is equivalent to three continuous wave oscilla-

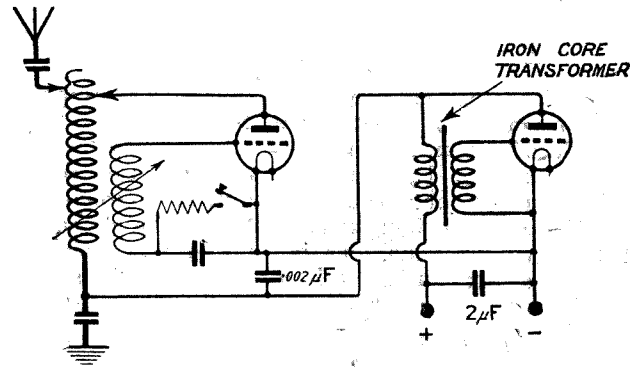
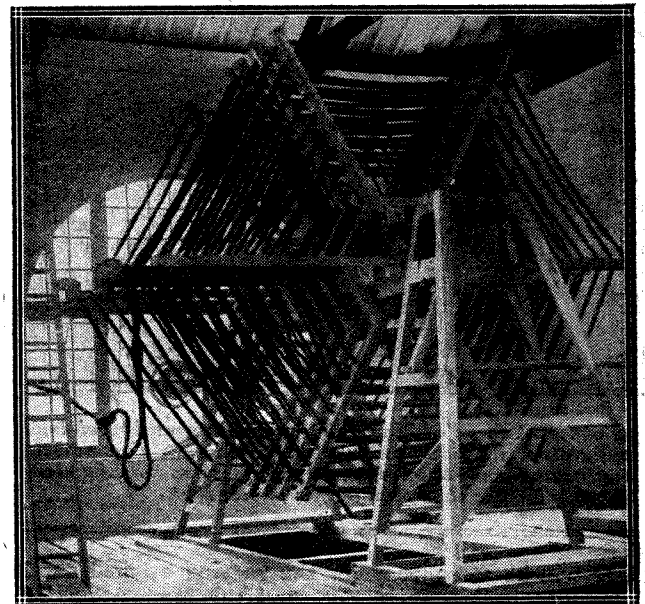

Fig. 9.—A form of circuit used for effecting modulation by means of a low-frequency oscillating valve.

tions which differ in frequency to the extent of the frequency of the alternating current; that is, the difference in frequency between the two extremes is twice that of the alternating current.

Carrier Wave and Side Bands

For example, if the frequency of the alternating current is 1,000 cycles, and the frequency of the oscil-



Behind these large "spider-web" form inductances at the Rugby station can be seen the lead-in insulator. An exterior view of this part of the building will be found on page 510.

lations before any A.C. is applied is 500 kilocycles, then the wave-form of the modulated oscillation is equivalent to three continuous waves, whose frequencies are 499 kilocycles, 500 kilocycles, and 501 kilocycles. The mean frequency, namely, 500 kilo-

cycles, is called the carrier wave, and the two frequencies on either side are what are known as the "side band" frequencies. These two side band frequencies beat with the carrier wave frequency to produce a received note equal in frequency to that of the applied alternating potential.

Another Method of Modulation

Instead of modulating the high-tension supply voltage by means of an alternator, the same effects can be produced by means of a valve oscillating at an audio frequency. By such means any desired pitch of note can be obtained. A convenient circuit is shown in Fig. 9. One valve can be made to carry out the two functions, but in this case the circuit adjustments are rather critical for good results, particularly if a varying range of radio frequency is required.

An Important Point

One important point to be remembered in all these modulated C.W. circuits in which the main source of power is a D.C. generator, is that it is essential to connect a large condenser of the order of 2 μ F across the D.C. supply. If this is not done only very feeble modulation will be obtained, owing to the choking effect of the inductance in the armature of the generator. The high-frequency by-pass condenser should, on the other hand, be kept small, otherwise

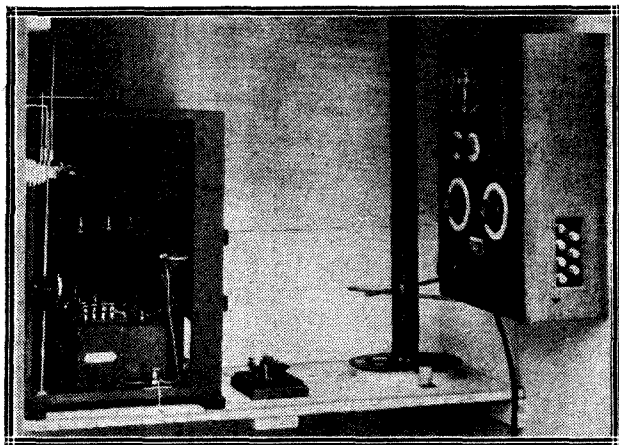

A compact form of Marconi transmitting and receiving apparatus, intended for use on lifeboats. The petrol engine and generator for power supply are mounted under the shelf seen in this photograph.

there will be a tendency for the varying applied anode voltage to be smoothed out, and the modulation will be poor.

Speech Modulation

If, instead of modulating the high-tension voltage at a constant frequency and amplitude, we vary it in accordance with the variations in current obtained from a microphone, we can obtain a radio-frequency oscillation which will give a reproduction of speech in the receiver.

Some of the problems in connection with radio telephony will be considered in the next article.

RECEIVER HINTS FOR THE EXPERIMENTER

We give below a number of useful hints, which should make a special appeal to short-wave experimenters, though applicable also, in some measure, to broadcasting and other receivers.

IT is common knowledge that the presence of dielectric material in the electrostatic field of a condenser usually has a detrimental effect on its operation. As most variable condensers are placed fairly near the baseboard of a receiver, as also are the inductances, an improvement generally results when the receiver is raised off the table by means of four "stand-off" insulators or small wooden blocks. This is only materially the case with short-wave receivers.

* * *

When "Reinartz" or capacity reaction is employed, the circuit is often arranged in such a manner that the full H.T. potential is across the plates of the variable condenser by which reaction is controlled. This fact causes very worrying noises to arise when the plates of the condenser become at all dusty, on account of minute leaks between the fixed and moving plates. This may be cured very simply by connecting a fixed condenser *in series with* the variable. If the capacity of the variable condenser is larger than is necessary for the purpose (and this often is the case), it will be advantageous to use a fixed condenser of about the same capacity in series with it, thus reducing both the maximum and minimum capacity. If the variable is of the correct size, a larger fixed condenser should be used.

* * *

It is also advisable, when using capacity reaction, to take care, when designing the set, that the reaction condenser is at the end of the coil nearest earth potential; thus, instead of placing it between the anode and the end of the anode inductance, as is done in many circuits, it is sometimes preferable to break the coil in the middle, and place it between the bottom of the anode coil and the connection to the low-tension and earth. This helps to reduce hand-capacity effects to a minimum.

* * *

The troublesome "mush" so often dismissed as due to "an old H.T. battery," or simply "valve noises," often originates in the grid-leak. Out of seven or eight grid-leaks tried by the writer in a short-wave receiver, one was found which gave considerably quieter reception than the rest, *without reducing the strength of weak signals*. Incidentally, all tests such as these should be carried out on *weak* signals, as any difference in efficiency is much more noticeable than when one is listening to a signal of even moderate strength.

* * *

When "mush" is being received from external sources, such as an arc station working on the lower frequencies, it may often be reduced in volume, where L.F. amplification is employed, by using a resistance across the secondary of the L.F. transformer. This, of course, also reduces the strength of signals to some extent, but the "signal-mush" ratio almost always seems to be improved.

L. H. T.



Wireless News in Brief.

Forthcoming B.B.C. Items. The following are some selections from the B.B.C. programmes for the week commencing Sunday, January 3:—

January 3.—London: Christmas Oratorio (Bach), Elsie Suddaby, Mary Foster; Leonard Gowings, Roy Henderson. Service from Glasgow: St. Enoch's U.F. Church, Prof. C. Milligan; Irene Sharrer, Chopin Recital; J. H. Squire, Celeste Octet, Helen Henschel; John Goss.

January 4.—Daventry: Broadcast to Europe. London programme.

January 5.—Glasgow: London Repertory Players in "Loyalty."

January 6.—Bournemouth: Winter Gardens Night; Ivy Fenell Williams, vocalist.

January 7.—London and Manchester: Hallé Orchestra relayed from Free Trade Hall, Manchester.

January 8.—Cardiff: "Carmen."

January 9.—Cardiff: England v. Wales—Rugger prospects.

Manchester: "Romeo and Juliet." Descriptive notes by John F. Russell.

Belfast: Band of 1st Seaforth Highlanders. Belfast Radio Players.

Daventry: London and Manchester programmes.

Broadcast Jamming. A spark station which has made itself notorious as a jammer of several of the B.B.C. stations is that situated at Boulogne, call sign FFB. Complaints have been received as far inland as Maidstone and Ashford, that FFB blots out a considerable portion of the broadcast frequency band during its transmissions.

Alternative from Daventry. We understand that from January 11 Daventry will transmit two alternative programmes every week, instead of one, as at

present. In last week's issue of *Wireless Weekly* attention was drawn to the decision of the B.B.C. to reconsider the question of alternative programmes. Many listeners have expressed the opinion that Daventry should always transmit programmes of its own.

Another "Pirate" Fined. Another wireless listener, residing at Kentish Town, London, N.W., has been fined for installing apparatus for wireless telegraphy without a licence. Mr. A. G. Galagher, who prosecuted for the Postmaster-General, said that in the interests of the people who paid for their licences, the Postmaster-General felt that it was necessary to prosecute all those who failed to take out a licence.

Television Claim. M. Edouard Belin has announced at a lecture in Paris that he has solved the problem of television. The principal piece of apparatus, we understand, is a multi-faced mirror mounted on a vertical steel disc, the image to be transmitted being placed between a powerful arc lamp and the mirror, the latter being made to revolve at high speed.

Geneva Meeting. It is reported that a recent meeting of the Council of the International Radiophone Union at Geneva approved of the new plan for the redistribution of frequencies between European wireless stations. The scheme arranges for the European stations to work on frequencies between 500 and 1,500 kc. (200 and 600 metres).

A Disastrous Fire. A large amount of transmitting and receiving apparatus belonging to Captain P. P. Eckersley, the chief engineer of the British Broadcast-

ing Company, was destroyed by fire a few days before Christmas, at his experimental station at Hendon. No clue regarding the origin of the fire could be found. Photographs of the damaged hut will be found elsewhere in this issue.

Wireless on Trains. Recent experiments in Germany in communication with railway trains having proved definitely successful, we understand that travellers between Berlin and Hamburg will be provided with means of communicating with their families and friends, etc., as conveniently as though they were at home.

We learn that Mr. R. M. Ford, who was recently prosecuted by the Postmaster-General for failing to take out a licence for a wireless installation at his house, intends to test before a civil court the application of the 1925 Act to broadcasting.

Eskimo Listeners. We hear that a four-valve receiver has been taken out to Labrador and installed at the Makkrovik boarding school by Captain J. C. Jackson on the occasion of his twenty-fifth annual visit to the mission stations of the country. Daventry is regularly picked up, and its transmissions afford the Eskimos huge glee and cause for wonder. Captain Jackson states that it is hoped to equip other mission stations with similar sets.

Wireless for Bart's. St. Bartholomew's Hospital, the largest in London, has been provided with wireless apparatus for the benefit of the patients, under the *Daily News* scheme for hospital wireless equipment. The equipment includes headphones for 688 beds.

The Practical Design and

By Major JAMES ROBINS
Director of Research

A substantial reduction in transmitting stations may be effected by the use of a frame aerial in conjunction with a receiver. This article is the work of Major James Robinson, who is recognized as an expert on the subject of frame aerials and their design.

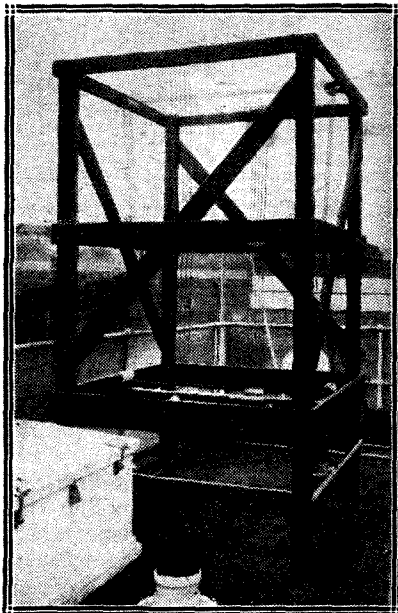

A Marconi fixed frame aerial, intended for direction finding on board ship.

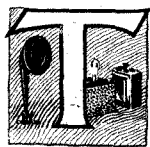

THE first practical use of frame aerials was for direction-finding purposes. In the very early days there was hesitancy to use

loops of such small dimensions that they could be classified as frames, but very large loops were made use of. One of the reasons for this was that amplifiers had not then reached a stage of certainty, and it was considered essential to have large loops so as to absorb as much energy from the electro-magnetic waves as possible. The system of direction-finding known as the Bellini Tosi system was the first practical

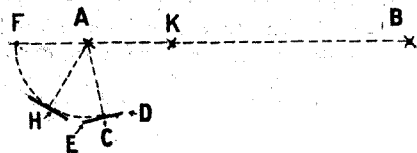

Fig. 1.—If the frame aerial ED is set at C as shown, it will be favourably placed for reception from B, while not responding strongly to A, the local station.

system, which gave good results, and the loops employed were so large that fairly high masts were necessary. A common arrange-

ment was to have four masts, each 80 ft. in height, with the distance apart of the diagonals 60 to 80 ft. Two loops were employed at right angles, each being supported on the masts at opposite corners of the square of masts.

Development

As amplifiers came into more general use, it was found that signals could be obtained on loops of a much more convenient size, and a variety of forms of such loops made their appearance towards the end of the Great War. Amongst these types the frame aerial ap-

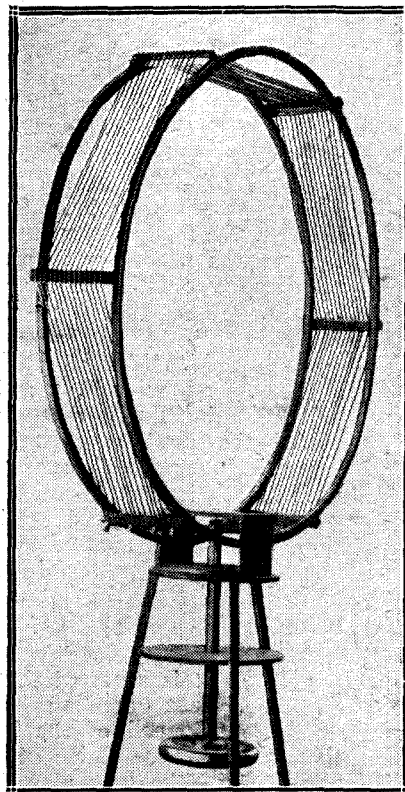

This home-made frame aerial is built up on two wooden hoops, and may be rotated by the wheel at the bottom.

peared, this consisting of a framework of various shapes, square, hexagonal, etc., on which a number of turns of wire were wound, the turns all being parallel to each other.

Special Types

Loops were made of various sizes according to the purpose for which each was required. Thus on aeroplanes loops were wound with the wings and struts of the aeroplane as the framework, and such loops were made as large as possible. In the case of a Handley-Page aeroplane, a loop of side 10 ft. by 60 ft. was usual, four turns being employed. Cases when such large loops can be employed are rare, however, and the most usual situation where loops are used is on the ground. In this case the most convenient size for the framework is about 3 ft. square.

Directional Properties

Although the initial use of frame aerials was in direction finding, it was not long before they began to have application in other directions. The remarkable property of loops of receiving no energy when the direction of propagation is perpendicular to the plane of the loop began to be employed to eliminate interference.

Selective Transmission

One application of this principle was in the case of a transmitting and receiving station working with a distant station. In this case, where it was possible to separate the receiving station some little distance from the transmitter, say, by a mile, a frame aerial could be erected in such a manner as to receive no energy from the local transmitter. It could also be arranged to set the frame in its best direction for reception from a distant station.

Use of Frame Aerials

ON, D.Sc., Ph.D., F.Inst.P.,
to Radio Press, Ltd.

Interference from unwanted
often be effected by the use
action with a sensitive re-
first of a series by Dr.
ed as an authority on the
their practical applications.

An Example

Reference to Fig. 1 shows how this is possible. A suitable position for the frame aerial with regard to its local transmitting station A is at C. The loop is arranged with its plane ED perpendicular to the line AC in order to eliminate the effect of the local signals. The position C is best for a distant transmitting station B; the position F would be bad, and H only fairly good. In the case of position H, when the frame is in the best direction for eliminating local signals from A, it is not by any means well placed for receiving maximum signals from the distant station B. In such an application it is obviously essential to prevent the direct effect of the local signals on the amplifier.

Reducing Interference

Another application of loops was in the case where two signals were arriving from two distant stations, with approximately the same signal strength and at a somewhat similar frequency. Here it is often possible to use a frame aerial and rotate it to such an orientation as to give the zero effect on one of the signals. This usually results in cutting down the signals from the other station, but the final result of a comparatively weak signal free from interference is better than a stronger signal with interference. Fig. 2 shows this case, where the receiving station is at C, and there are two transmitting stations A and B. In order to receive the strongest signals from the transmitter A, the loop should be along the line KL. In this position, however, signals would also

be heard from the second transmitter B. By rotating the loop to the position DE the signals from the station A are diminished in strength, but those from the station B disappear altogether.

Application to Broadcasting

These cases are of interest in the more general application of wireless for broadcasting purposes, to enable listeners to avoid interference from a local broadcasting station or from other local transmitters such as in the case of coast towns. Again there are cases where an interfering signal may arrive from a distance, and, provided this is not in the same direction as the desired signal, it is possible with frame aerials to eliminate the interference. Atmospherics can sometimes be cut down in effect by such means, as on occasion they arrive from a definite

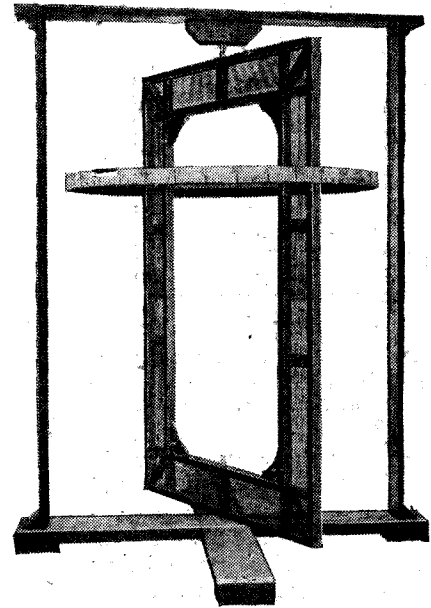

A large rotatable frame aerial, of a type frequently used in laboratory work.

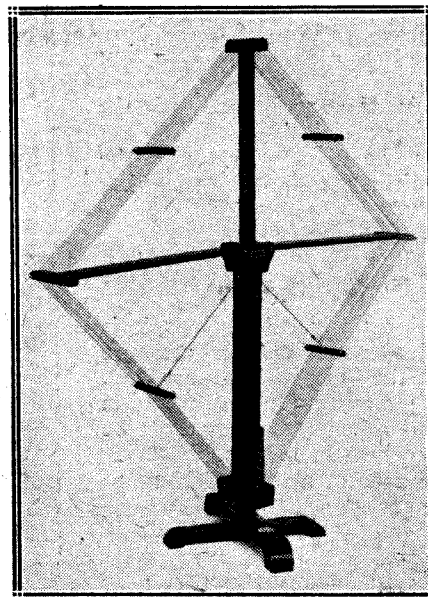

This type of frame aerial may be folded up into a compact form when not in use.

direction over a considerable period of time.

An Extreme Case

It is even possible nowadays to eliminate interference which comes along the line along which the desired waves arrive. This may

occur when the receiving station is on the line of and between the interfering station and the station from which signals are desired. In Fig. 1 the receiving station should be at K between the interfering station A and the distant station B. This is made possible by using loops which give only one zero effect for one complete rotation of 360 degrees.

Analysis of Frame

Frame aerials are in fairly

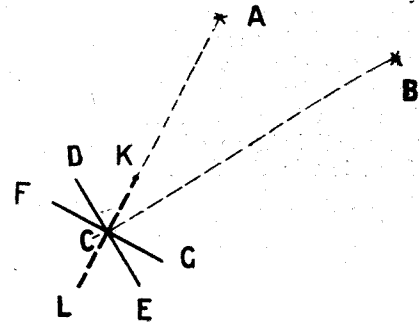

Fig. 2.—The best position for the loop to eliminate signals from B and receive them from A is shown as DE.

common use for broadcast reception, but in nearly every case they are used with good amplifiers. This is necessary because these loops do

not pick up as much energy from electro-magnetic waves as do open aerials. In Fig. 3 a loop of a single turn is shown. This is arranged to be capable of rotation about a vertical axis, so that the loop is always vertical, no matter how it is rotated. We shall con-

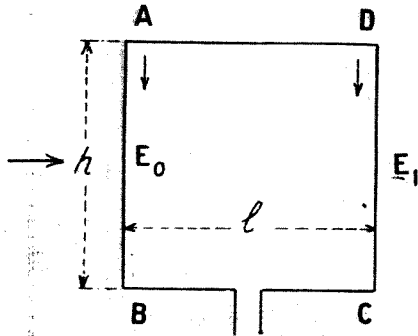

Fig. 3.—The arrow on the left of this diagram represents the wave arriving at the loop.

sider at present that waves arrive in the plane of the loop, as indicated by the arrow. The loop is equivalent to two vertical aerials AB and DC of the same size, these being joined by horizontal wires AD and BC, in the latter case through the receiver.

Time Lag

These two vertical aerials, being identical, receive the same amount of electromotive force from the waves, and, as they are joined really in opposition, it would be expected that the effects would balance out. They do not, in effect, balance out, because the electromotive force in each aerial varies with time, both being oscillatory. The waves arrive at the aerial AB some little time before they arrive at DC, so that the varying currents produced in DC lag behind those in AB. Thus when the electromotive force in AB is a maximum, that in DC is just less than its maximum, and there is a small balance of electromotive force left in the loop.

Effect of Width

The magnitude of this resultant depends on the distance apart of the two aerials. Thus, suppose that the distance l is equal to half a wavelength, the electromotive forces will be a maximum in both aerials at the same time, but in opposite directions. In this case the effects in the two aerials will assist each other. In the case where the distance l is equal to a quarter of a wavelength, the electromotive force in one aerial will be

zero when it is a maximum in the other one. When the distance l is a small fraction of a wavelength there is a small lag between the effects, and we find that this lag increases as we increase l .

Actual Relationship

If at any particular instant the varying electromotive force is E_0 in AB, it will be E_1 in DC where $E_1 = E_0 \cos \theta$, where θ is the lag between the two effects, or the phase difference. θ can be represented in terms of l and the wavelength λ , and then

$$\theta = \frac{2\pi l}{\lambda}$$

Current Obtained in Loop

Without going deeply into the mathematics of the problem, it will be of interest to give the result in the form of the current obtained in the case of an open aerial, and of a loop with N turns.

In the case of an open aerial we have

$$I_r = \frac{188Ah_r}{dR\lambda}$$

Where I_r is the received current, A is a property of the transmitting aerial called the metre ampere, being the product of the effective height and the transmitting aerial current.

h_r is the height of the receiving aerial.

R is the resistance of the receiving aerial.

d is the distance between the transmitting and the receiving aerials.

λ is the wavelength.

Number of Turns

In making any calculations it is essential to use the same measure for all the quantities involved. Thus if wavelength is used in metres all other quantities must be similarly given in metres.

In the case of a loop of N turns we have

$$I_r = \frac{1184 ANh_r l}{dR\lambda^2}$$

where l is the horizontal length of the loop and all the other quantities are as in the former case.

Width and Wavelength

These formulæ apply only to cases when the width of the loop is small compared with the wavelength, and thus frame aerials of the ordinary size, whose widths are seldom more than 4 ft., are included in these cases, as the wavelengths in use for broadcasting are about 300 times as great.

Received E. M. F.

Some idea of the magnitudes of the currents which can be obtained in loops and in open aerials will be given by an example. We shall, first of all, ignore any difference in the resistances of the receiving systems, and thus the relations we shall give will relate to the electromotive forces rather than to the currents.

The example that we shall consider is that of a plane vertical aerial of height 10 metres (33 ft.), compared with a frame aerial of 10 turns on a square frame of 1-metre side, the wavelength being 300 metres (frequency 1,000 kc.). In this case calculation by the above formulæ shows that the open aerial receives 48 times as much electromotive force as does the frame aerial.

Resistance of Open Aerial

When we consider the currents it is necessary to take into account the resistance of the two aerial systems. It is a much easier matter

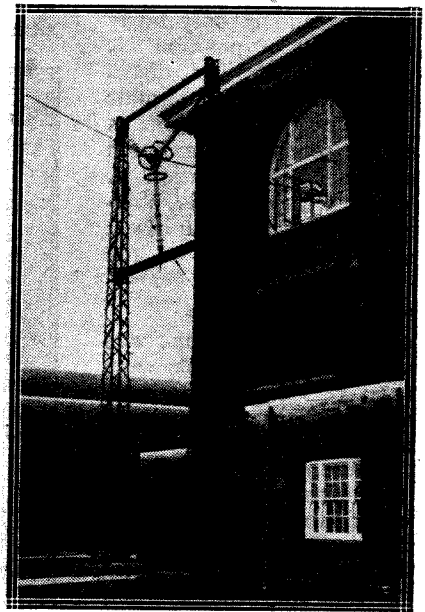

The leads-in from the aerial at the Rugby Station are taken through the end windows of the main building. An interior view of this point will be found on page 505.

to diminish the ohmic resistance of a loop than of an open aerial. In the latter case the resistance is a complex affair, being made up of ohmic losses in the aerial and leads, losses in the earth due to various causes, such as bad contacts with earth

(Continued on page 516.)

BROADCASTING IN NORWAY

From the account of Norwegian broadcasting conditions given in this article interesting comparisons may be made with the conditions prevailing in this country, especially at the present time, when the future organization of the broadcasting service is under discussion.

EVEN the least susceptible cannot fail to lose his heart to Norway, that cold virgin of the North, land of the midnight sun, split in twain by the Arctic Circle; land of rugged snow-clad mountains, of deep valleys bottomed by gleaming streams and shining lakes, of still, fathomless fjords hemmed in by precipitous heights, of roaring waterfalls and cool green forests.

Norway

A land of beauty, but beauty cruel as the jagged rocks beneath the gentle snow, a beauty treasured deep down in the hearts of the Norwegian people, but "the very attributes of which form their deadliest adversary. For the loveliness that draws travellers from all the ends of the earth will not support life, and the land, greater by far than the United Kingdom, contains a population of only two-and-a-half millions.

The smallness of the population of Norway and the configuration of the country have proved a great handicap to nearly all Norwegian enterprise, and to the *Kringskasting Selskap* or "Broadcasting Company" it has been particularly severe.

Financial Difficulties

The "*Kringskasting Selskap*" is a public company with a capital of Kr. 350,000 (about £14,000), holding a concession for five years, and, as in the case of the B.B.C., the State, through the medium of the Telegraph Service Department, has a good deal to say in the matter of control and management. The official area allotted to the company extends over a radius of 150 kilometres round Oslo, the capital of the country.

It naturally follows from the size of the population that the initial

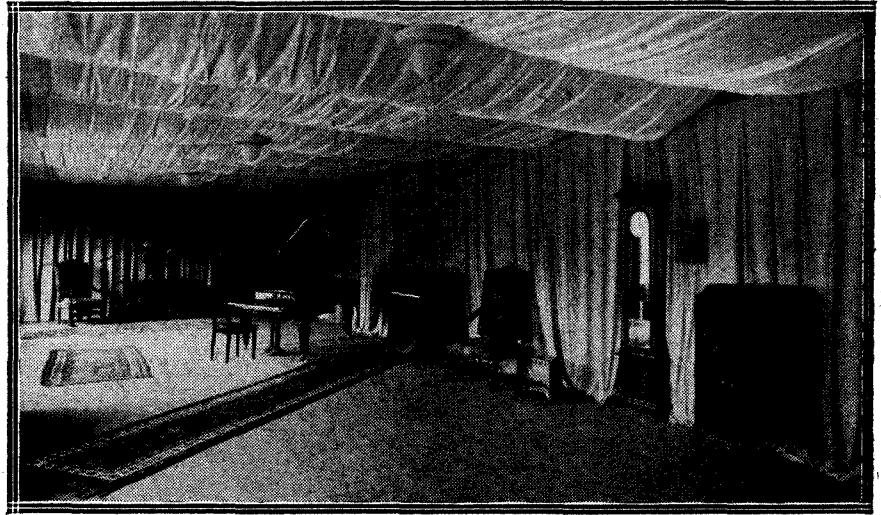

A general view in the studio of the Oslo broadcasting station.

difficulty faced by the company in promoting so costly an undertaking is financial, and in consequence the Norwegian, as compared to the Englishman, must pay dearly for his luxury.

Licences

Within the company's area listeners are required to pay the sum of Kr.20 (about 16s.) per annum for a licence to use a receiving set, and of this sum 80 per cent. is taken by the company and 20 per cent. is retained by the State to meet the expense of issuing and collection. Outside the area the licence costs Kr.5 (about 4s.) per annum, and the whole of this sum is kept by the State.

Duty on Apparatus

There is a further tax borne by purchasers of wireless instruments by way of a duty of 10 per cent. on all receiving sets and parts, such as head-phones, valves, condensers, loud-speakers, etc., and the company benefits by the whole of this. To facilitate the collection of this duty all dealers in wireless instruments must obtain a licence for the sale of them, and the tax is collected by the State. Yet another tax is imposed upon those using loud-speakers in public places, as in cinemas or concert halls.

A Further Difficulty

It may seem surprising that in this large country, in which most of the towns and villages and many of the homesteads are completely

isolated, no less than 80 per cent. of those licensed to receive are domiciled within the comparatively small area allotted to the company. But there is a very good reason for this, and here we arrive at the second difficulty to be faced by the Company.

Fading

Norway is one of those countries described in the Guide Book as "Mtnous," and, may we say, it is very "Mtnous" indeed. The mountains have a very deleterious effect upon reception, causing a constant fading and swelling of the sound, and so serious is this trouble in Norway that over the major portion of the country reception of Oslo is almost impossible. In some of the valleys, only 90 kilometres from the broadcasting station, this defect is so great that one cannot receive with any pleasure. The company are doing their utmost to overcome this trouble, and as soon as finances permit they hope to alleviate it by setting up broadcasting stations in other parts of the country.

Crystal Users

It is peculiar that, although conditions are such as to make powerful reception desirable, the majority of listeners own crystal sets.

In ordinary circumstances it would not be a matter for comment that Norway, out of its population of two-and-a-half millions, has 30,000 licensed listeners, but the circumstances being such as they are

it speaks volumes for the enthusiasm of the people.

The Programmes

The entertainment provided by the company does not differ in kind from that offered by the B.B.C., although the financial situation does not permit of entertainment on so grand a scale. The finest native

are not entirely expended on the provision of entertainment. By special arrangement with the State, there has been instituted a service which not only benefits the company by greatly adding to the number of subscribers, but which is also of very considerable use to the business men of the country. Twice, during the course of every

that this practice will be discontinued, it is, at present, in the nature of an experiment—for the State. The Telegraph and Telephone services in Norway are administered by the State, and it may prove that the revenue from these services will be materially diminished. Should this be the case there is no doubt that the difficulty will be solved by a monetary arrangement between the State and the company.

Advertising

Another departure, which is as yet untried in England, is the use of the broadcasting station for advertising. The Kringkasting Selskap is permitted to do this on the condition that not more than 15 per cent. of the time allotted to broadcasting is used for the purpose. The fee for advertising amounts to Kr.2 (about 1s. 8d.) a word, and it has proved to be a paying proposition both to the company and the advertiser. A considerably less time, however, than the proportion allotted is actually used for advertising, as the present financial situation of the company is such that it is under no necessity to exploit this form of revenue.

Future Prospects

It appears that, in spite of difficulties, the Kringkasting Selskap has every reason to be optimistic. Mr. Gythfeldt, the technical adviser to the company, informs us that the number of those applying for licences for reception is steadily increasing, and that it is hoped that before long it will have attained 50,000. Beyond that they dare not look at present.

Taking into consideration the enormous difficulties with which the Kringkasting Selskap has been faced, and which it has for the most part overcome, broadcasting in Norway has so far been more than a success.

QRA'S WANTED

As we are at present revising our list of British amateur call signs, all amateurs who are licensed for transmission are invited to send the following particulars:—Call sign, name, and full address.

Please address communications to Book Editorial Dept., Radio Press, Ltd., Bush House, Strand, London, W.C.2.

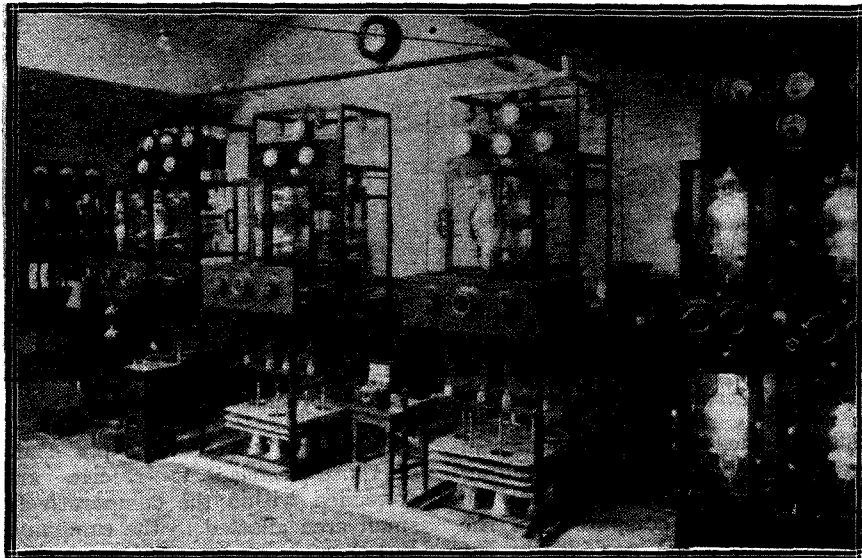

In the transmitting room at the Oslo broadcasting station.

soloists, actors and singers are engaged and provide a programme of excellence. Concerted music is provided by the Radio Orchestra, which, though small in numbers, is disposed in such a manner as to obtain the best quality of tone and effect.

Good Music

On each Friday evening the "Oslo Philharmonic Orchestra," under the direction of Kapelmester Jose Eibenschutz, leave their concert hall and move to the new and roomy studio which has just been completed especially to receive them, and broadcast a carefully chosen programme of classical and good popular music. It is the aim of Mr. Berg Jaeger, who is in charge of the studios and responsible for the programmes, gradually to cultivate popular musical taste and to give modern native composers opportunities to obtain a hearing. Dancing enthusiasts have not been overlooked, and for them the Grand Hotel Dance Orchestra is broadcast from the hotel every Friday, Saturday and Sunday evening after 11 p.m.

Market Reports

But the energies of the company

morning, are broadcast the International Money Exchange, the Stock Exchange prices, and the market prices of agricultural produce, and on each Friday morning are broadcast the market prices of the principal articles of import and export.

Assistance for Business

Every business man will at once appreciate the importance of this departure, and business men in Norway are appreciating it to some effect, for a great number of them have equipped their offices with wireless receiving sets, and the number of them who are so doing is increasing every day. In the old pre-wireless days the country banks kept "au courant" with the foreign exchange by means of the trunk-call telephone service, but now many of them have entirely dispensed with this method and rely upon radio, thereby greatly adding to the saving of time and expense.

State Control

We have observed that this commercial activity is being carried on by the company by a special arrangement with the State. Although it is extremely unlikely

Inventions and Developments

UNDER THIS HEADING
MR. J. H. REYNER, B.Sc. (Hons.), A.C.G.I., D.I.C., AM.I.E.E., OF
THE RADIO PRESS LABORATORIES, WILL REVIEW
FROM TIME TO TIME THE LATEST
DEVELOPMENTS IN THE RADIO WORLD.



SOME time ago reference was made to the results published by E. V. Appleton and M. A. F. Barnett in a paper read before the British Association, in which direct experimental proof of the existence of a reflecting layer of atmosphere (Heaviside Layer) was produced. Many readers must have wondered exactly what the experimental evidence was that could be taken as definitely establishing the existence of reflection in the upper atmosphere, a problem which has been disputed by the most



Fig. 1.—Fading may be explained as due to interference between a direct ray and a secondary ray reflected from the upper atmosphere.

eminent scientists of the time for some years.

Publication of Evidence

The complete paper has recently been published in the proceedings of the Royal Society (No. A752, page 621) and the results are of such importance that a brief résumé will not be out of place.

The evidence which is put forward is twofold in character. The fading which is observed on medium range transmission has been explained in terms of interference between two waves arriving at the receiving point by different routes. One of these waves is the direct ray travelling along the surface of the earth, the other being a ray which has travelled to the receiving point by another route.

If we can find any cause which will produce variations in the second ray, then we can assume that the

direct ray and the indirect ray interfere with each other to a variable extent. Thus when the two waves are assisting each other, maximum signals will be produced, and when they are opposing each other, the signals will be reduced and may be completely wiped out.

Route of Indirect Ray

The only difficulty arises in deciding first by which route the second ray, the indirect ray, travels. Fading could be produced on this theory if the indirect ray merely travels in a circuitous manner along the surface of the earth; so that on the basis of the simple theory just quoted it is not necessary for any reflection from the upper atmosphere to be called into play.

Preliminary Experiments

The results of Appleton and Barnett first of all demonstrate the fact that the phenomena of fading obey all the laws which would be expected from the theory just outlined. From preliminary investigations it appeared that the maximum fading would be obtained at distances of about 100 miles from the transmitter, at which point the direct and the reflected ray would be of the same order of magnitude.

Preliminary experiments were carried out at Cambridge on the transmissions from 2LO, and suitable apparatus was devised for recording the fluctuations in signal strength.

Method of Investigation

Now assuming the fading to be due to interference between two sets of waves, one taking the shortest route and the other a roundabout route, the interaction of the two waves at the receiving point

will depend upon the difference in length between the two routes and also upon the wavelength of the waves. It can easily be shown that other things being equal, a continuance of small change in wavelength will produce successive maxima and minima at the receiving point.

This point was therefore tested on the transmission from the Bournemouth Station, arrangements being made by the B.B.C. to produce periodical variations of wavelength in a special test after the normal programme was completed.

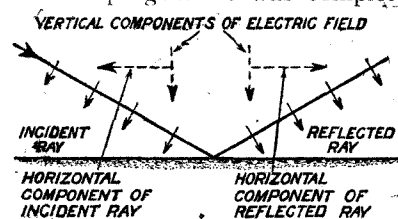

Fig. 2.—The horizontal components of the incident and reflected rays cancel out, leaving only a vertical component, as shown.

As was expected, maxima and minima were produced alternately at the receiving point, and the number of these for a given change in wavelength was exactly what would be expected if the simple theory of interference is correct.

Reflection

The next and more important question to be determined is whether the indirect wave travels by a circuitous route on the surface of the earth or whether it is reflected from an ionised layer of upper atmosphere. It should be borne in mind that in order to produce fading phenomena at such comparatively short ranges, it is necessary for reflection to take place at a fairly

acute angle of the order of 60 degrees. There is considerable evidence of the existence of reflection at much longer ranges, the recent report of the Marconi Expedition to the Antipodes ("Journal I.E.E.," Vol. 63, page 933) being particularly interesting in this respect. It was found here that of all the theoretical formulæ which have been devised from time to time, that of Watson, based on the assumption of reflection at an ionised layer was in very close agreement with the actual observed values. Moreover, the values of field strength which were obtained were considerably larger than could possibly have been obtained by any purely refracting mechanism, having the constants which our atmosphere is known to have.

No Satisfactory Evidence

At short ranges, however, the existence of this comparatively acute

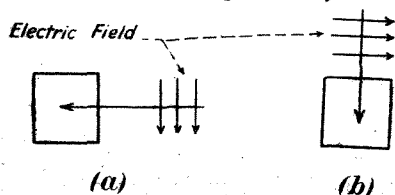

Fig. 3.—The angle at which the reflected ray is arriving has no effect on the EMF induced in a frame, so long as the reflected ray and the frame are in the same plane.

reflection had not been thoroughly demonstrated previously, and attention was turned, therefore, to the production of some definite evidence on this particular aspect of the question. At first sight it would appear a comparatively simple matter. If there is any wave coming down to the earth at an angle from the upper atmosphere, it should be comparatively easy to detect such a wave by means of a suitably arranged frame aerial.

All attempts to detect such a wave, however, have been found fruitless by previous investigators, and it was finally shown as a result of some measurements by Smith-Rose and Barfield (*Experimental Wireless*, September, 1925) that the earth was a sufficiently good conductor to provide almost total reflection at the normal frequencies employed for broadcast purposes, so that the wave coming down at an angle was immediately reflected again at an equal angle, somewhat in the manner indicated in Fig. 2. It will be seen that the horizontal components of the inci-

dent and reflected waves cancel out, leaving only a vertical component, so that there is no evidence whatever of the existence of such an oblique wave.

Vertical and Frame Aerials

It was obviously necessary, therefore, to tackle the problem from a different aspect. Fortunately, a method is available, if it is possible to compare the signals received upon a frame aerial and a vertical aerial both receiving at the same time.

Consider the case of a simple vertical aerial. Here we have two waves arriving at the receiving point. The field strength of the direct ray is E and the field strength of the reflected ray is E_1 . If the reflected ray is arriving at an angle ϕ with the ground then the EMF induced in the vertical aerial is proportional to $E + 2E_1 \cos \phi$. The 2 is due to the presence of a ray reflected from the ground.

Loop Aerials

In the case of a loop aerial, however, it will be clear that the angle at which the reflected ray arrives has no effect upon the EMF induced in the loop. The EMF induced is proportional to the field strength and the dimensions of the loop only,

the total EMF in the loop is given by $E + 2E_1$.

Fading

The fading produced is dependent upon the ratio of the current produced by the reflected ray to that produced by the direct ray, and inspection of the two formulæ just given will show at once that the fading is more pronounced in the case of the loop aerial. Furthermore, if the subject is investigated, it will be seen that the reverse would be the case if the reflected ray were not arriving from the upper atmosphere.

Path of Indirect Ray

If the indirect ray travelled by a different route on the surface of the earth and so arrived at the receiving point from a different direction to the direct ray, then the EMF produced in the frame aerial would be proportional to the direction of the incoming wave, whereas in this case the EMF induced in the vertical aerial would be independent of the direction. This therefore establishes at once the validity or otherwise of the reflecting layer. If it is found that the fading obtained on a loop aerial is greater than that on a vertical aerial, then the indirect ray may fairly be assumed to arrive by reflection from the upper atmo-

The private experimental station belonging to Capt. P. P. Eckersley, Chief Engineer of the B.B.C., was destroyed by fire on Dec. 17.



irrespective of the angle at which the wave arrives.

Fig. 3b shows an extreme case of a wave coming down at an angle of 90 degrees. This arrangement is quite obviously exactly the same as that in Fig. 3a, except that it has been turned on its side. Thus the angle at which the reflected ray is arriving has no effect whatever upon the EMF induced in the frame, provided the reflected ray and the frame are in the same plane. Thus

sphere. If the reverse is found to be the case, then the indirect ray cannot arrive from the upper atmosphere, but must travel over the surface of the earth by a circuitous route.

Proof by Experiment

Actual experiments demonstrated perfectly conclusively that the loop aerial fading was always greater than that obtained with a vertical aerial, so that the results may be taken as conclusive proof of the

existence of a reflecting medium at some height above the earth's surface.

Horizontal Polarisation

It has previously been shown by P. Eckersley and others that reflection from an ionised layer at a fairly acute angle would give rise to horizontally polarised waves; that is to say, in addition to the ordinary reflected wave, there would be another wave produced, having its electric and magnetic fields at right angles to those of the normally polarised wave.

Errors in Direction Finding

Experiments were made by Appleton and Barnett which indicated that this wave was present, and, moreover, from the values they found, they were able to verify that this horizontally polarised wave was responsible for errors in direction finding, even over quite short ranges of 30 miles only. It should be noted, however, that the presence of this wave does not affect the theory which has been outlined so far, because in all the experiments the loop aerial employed was pointing in the direction of maximum reception. It was therefore at right angles to the electric field of horizontally polarised rays.

Height of Ionised Layer

In the original paper several secondary results are deduced from the results obtained, but the one of principal interest to radio engineers is that the existence of a reflecting layer is definitely established, the height of this layer at night time being of the order of 80 to 90 kilometres.

ERRATUM

It is regretted that in last week's issue of *Wireless Weekly* Fig. 3 on page 467 was incorrectly drawn.

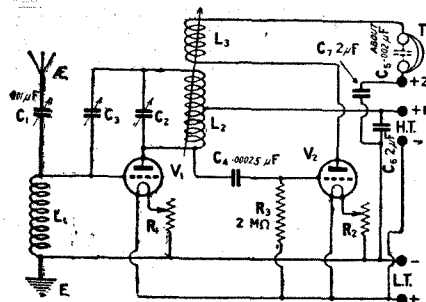

This should have been as shown here.

THE RADIO SOCIETY OF GREAT BRITAIN.

Report of the 12th Annual General Meeting.

At the 12th annual general meeting of the Radio Society of Great Britain, which was held at the Institution of Electrical Engineers on Wednesday, December 16, the members had a somewhat lengthy agenda with which to deal.

Annual Report

The first item was the presentation of the annual report for the year ended September 30, 1925. A perusal of this shows that the Society has indeed had a busy year.

Standardisation of Ebonite

One point of outstanding interest to amateur constructors is worthy of particular reference in these

Officers and Council

The next item to receive attention was the election of officers and Council for 1926. The Chairman (Brigadier-General Sir H. C. L. Holden, K.C.B., F.R.S.) announced that the following were the nominations:—

President.—Sir Oliver Lodge, D.Sc., LL.D., F.R.S. *Acting Vice-President.*—Brigadier-General Sir H. C. L. Holden, K.C.B., F.R.S. *Hon. Treasurer.*—Professor Ernest Wilson, M.Inst.C.E. *Hon. Secretary.*—Maurice Child. *Members of Council.*—O. F. Brown, Captain Ian Fraser, C.B.E., M.P., O. W. Nicholson, M.P., J. H. Reeves, M.A., M.B.E., Earl Russell, Major T. Vincent-



The extent of the damage caused by the fire in Captain Eckersley's wireless station may be clearly seen here. The transmitting valve on the table on the left was the only one of twenty valves to survive.

columns. Early in the year the Society was responsible for commencing negotiations with the British Engineering Standards Association for the standardisation of ebonite for radio purposes. The negotiations were successful, and a standard specification for ebonite panels for radio purposes is now available. The result of this effort is obvious; it will be possible for every amateur constructor to purchase a reliable and guaranteed component.

Smith, M.I.E.E., Dr. R. L. Smith Rose, Ph.D., H. Bevan Swift, A.M.I.E.E.

These gentlemen were duly elected as officers and Council for 1926.

Paper Read

The Chairman next called upon Mr. Duncan Sinclair for his paper entitled, "Some Facts and Notions about Short Waves." The author put forward some interesting theories and suggestion, and a discussion of the paper followed.

THE FUTURE OF BROADCASTING

(Continued from page 493)

cent. of an entertainment usually given in theatres or music halls should be transmitted.

Payment for Broadcast Entertainments

If the Committee of Inquiry were of the opinion that 10 per cent. was too small a figure, then the Industry requested permission to provide an agreed proportion of such matter in the future and to receive an agreed percentage of the revenue derived from licences.

Mr. Payne considered that the broadcast version of an entertainment was very inferior to the combined visual and vocal presentation, but, owing to a natural inclination on the part of the public to obtain "something for nothing," they were kept at home, apparently satisfied with this cheap and inferior presentation. He did not think that the desire to see an entertainment was stimulated by such excerpts.

The Listeners' Point of View

Lord Blanesburgh desired to know if the Entertainment Industry

had any real case for objecting to the P.M.G.'s embodying in the functions of broadcasting that which the main body of listeners desire, and which the B.B.C. can provide. Mr. Payne thought that this savoured of an entertainment dole. Lord Blanesburgh was of the opinion that it was merely the jealousy of vested and conservative interests against a new means of dissemination of entertainment.

Competition

Lord Crawford, referring to Mr. Payne's use of the word "dole," said that broadcasting was undoubtedly a cheap form of amusement. The B.B.C. and the Entertainment Industry both desired to provide entertainment. He understood that the competition of the B.B.C. was overwhelming the theatres. Mr. Payne agreed. Lord Crawford said that in that case the theatres must suffer. Mr. Payne said that if the competition became more intensive the theatres would have to close.

The Music Publishers' Association

Mr. A. V. Broadhurst then submitted evidence on behalf of the Music Publishers' Association.

He submitted that broadcasting had an adverse effect upon the sale

of music. The inferior presentation on the wireless receiver deterred from buying music people who would otherwise have done so after a concert.

Licence Fees

He thought 10s. per annum far too small a licence fee, and suggested 10s. as the minimum, with a graded scale of fees dependent upon the rateable value of the residence in which the receiver was used.

Restaurants and hotels which provided music for large numbers of people by means of wireless reception should pay £10 per annum, as in Australia. Many orchestras would have to be disbanded in consequence of existing conditions.

Musical Copyright

Other evidence was given regarding the copyright situation.

Mr. Wm. Boosey submitted evidence for Messrs. Chappell and the Queen's Hall. He dealt with the effect upon the sale of instruments and gramophone records, and the learning of music.

This completed the two days' hearing, and the Committee was adjourned until a date in January, which had not been announced at the time of going to press.

THE PRACTICAL DESIGN AND USE OF FRAME AERIALS

(Continued from page 510)

plates, eddy current losses, and capacity losses. With great care it is possible to have an aerial whose resistance is less than one ohm, and this is the case with some of the large transmitting stations. The average aerial for broadcasting reception has a resistance much greater than this, being more of the order of 10 or 20 ohms.

Resistance of Loops

In the case of loops, however, losses can be kept down very much more easily, and with careful design there is no reason why the high-frequency resistance should be so great as this. To achieve the best results it will be necessary to give careful attention to the type of wire used. This point is of great importance when considering the use of loops for transmitting purposes, and will be referred to later.

The fact that the resistance of loops is usually smaller than that of

open aerials tends to make the comparison between them not quite so bad for loops. The relation still exists, however, that loops do not absorb as much energy from electromagnetic waves as do open aerials.

Loops for High Frequencies

Referring to the formulæ for the received currents in the two cases, we see that the frequency (or wavelength) affects reception in different ways. In both cases the amount of electromotive force increases as the wavelength diminishes, but in the case of the loop the electromotive force is inversely proportional to the square of the wavelength, whereas in the case of the open aerial the increase is inversely proportional to the wavelength. Thus the shorter the wavelength or the greater the frequency the better are loops in relation to open aerials for reception and also for transmission.

Frequency and Size of Loop

We cannot obtain a direct comparison immediately, because as the frequency changes the actual linear dimensions of the aerial must also change. Thus in the above example we assumed a loop of 10 turns.

We could not apply this to another frequency, say 6,000 kc. (50 metres), because in this case there would be too many turns in the loop to allow of correct tuning. This raises a point of importance in the design of loops which will be discussed later.

"Area Turns" of Loop

Another point which arises from the formula for loops is that the electromotive force is proportional to the number of turns and to the area of each, that is, it is proportional to the total area of winding of the loop. A convenient method for describing this is to call this total area the "area turns." Thus it is advisable to have the area turns of a loop as large as possible. This means that we should either increase the size of the loop, that is, the area of each turn, or the number of turns, or both. Again, however, there is a limit to this, in so far as by increasing both of these quantities we increase the inductance of the loop, and thus affect the frequency that can be employed.

We shall consider some of these points of design in a future issue.

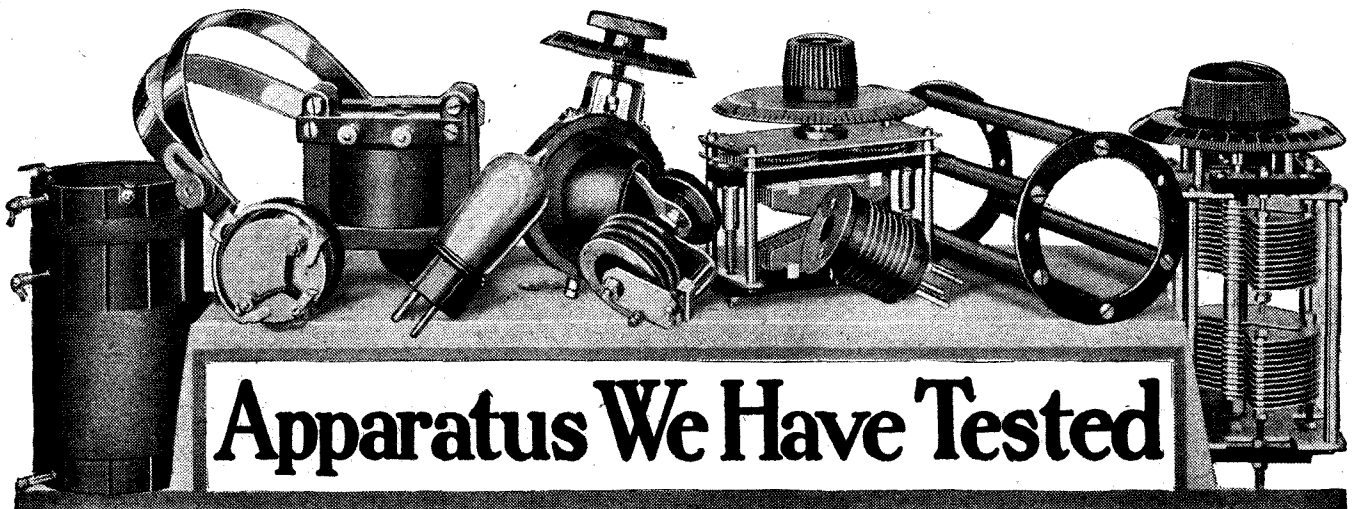

Conducted by Radio Press Laboratories, Elstree.

Vee Cee H.T. Battery

A sample of their standard 60-volt high-tension battery has been submitted for a thorough practical test by Messrs. Vee Cee Dry Cell Co., Ltd.

Description of Component.

It was contained in a cardboard case measuring 9 in. by 3 in., and was tapped at 18 points, which were unmarked save for the terminal ones.

Laboratory Tests.

It was given an extensive practical trial of several hours a day on most days in the week, supplying current to a small broadcast receiver taking about one to two milliamperes, and also for occasional use in experimental work with multi-valve receivers. After just over three months' use the voltage on open circuit still showed over 60 volts, and the battery was quite fit to use with a small receiver, provided that the customary 2 μ F blocking condenser was placed across it. In view of the usual brief life of block H.T. batteries when submitted to the searching test of daily broadcast reception, often for

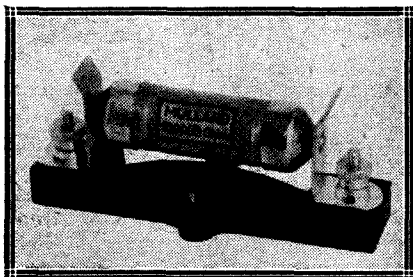

The wire-wound Anode Resistance made by the Mullard Wireless Service Co., Ltd.

seven hours a day, this must be considered a commendable performance for a battery of but moderate size.

Anode Resistance

Three sample anode resistances, each of 100,000 ohms resistance, and complete with holders, were submitted by

the Mullard Wireless Service Co., Ltd., and tested at our Elstree Laboratories.

Description of Component.

The resistance is contained in a fibrous insulating tube with conical metallic ends. This tube is mounted on a moulded insulating base complete with brass clips and terminals. Two screw holes provide for baseboard mounting. The resistance element itself consists of very fine wire wound on a length of string, more string being overwound in a solenoidal fashion completely to insulate the wire. The string is wax impregnated. The whole is now wound in a double layer on a $\frac{1}{2}$ -in. rod, the inductance effect being thus reduced, and the ends of the wire brought to the apex of the conical ends and soldered.

Laboratory Tests.

On test the resistances were found to be within 5 per cent. of their rated values. To see if they were impervious to water one sample was left in a vessel of water all night, and on retest the following morning it was found to be unaffected. When tested in Radio Press receiving sets no sign of "scratching noises" was present. The complete unit has a particularly good finish, and is robust, the insulation resistance also being exceptionally good.

Crystal Detector

Messrs. McLeod & McLeod have submitted an M. & M. Crystal Detector for our examination and report.

Makers' Claims.

It is a precision instrument in every sense of the word, is absolutely dust-proof, and the face of the crystal can be wholly explored. A micrometer adjustment for the catwhisker gives a sensitive control.

Description of Component.

The crystal and catwhisker are housed in a glass tube $1\frac{1}{2}$ in. long and nearly 1 in. in diameter, which is held in two metal collars. These collars

are mounted on an insulating base, the screw threads and nuts brought out below the base being for the purpose of panel mounting and making connection to the detector. The crystal cup has a friction-tight fit over a hollow cylinder, good contact with the crystal being secured through the agency of a spring. This cup is incorporated in a metal end plate, which fits friction-tight into the metal collar and can be rotated by means of a milled insulating knob. The catwhisker is held in a jaw attached to a small "crank arm." This can be rotated bodily by means of a metal end plate similar to that for the crystal cup. Lateral movement is given to the catwhisker through the aid of a small milled knob and screw.

The face of the crystal can be wholly explored and the micrometer adjustment for the catwhisker gives a very sensitive control. The crystal and catwhisker sections are interchangeable, giving the advantage of right or left-handed control.

General Remarks.

The workmanship of this component is particularly noteworthy, the

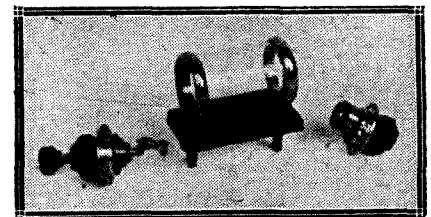

The catwhisker and crystal-holder of the M. & M. Crystal Detector are readily detachable from the glass cylinder, and are interchangeable.

ease of operation and fineness of control being good features.

Mansbridge Condensers

We have received from Messrs. Dubilier Condenser Co., Ltd., two of their Mansbridge Dubilier Condensers. These are of 1 μ F and 2 μ F capacity

respectively, and are claimed to be suitable for use with voltages up to 300.

Description of Component.

The condensers are contained in metal cases, with small drilled sheet metal lugs at the base for fixing to a baseboard. Two terminals on the top, insulated by means of ebonite bushes, enable connections to be made to the condensers. The size of the 1 μ F condenser is 2 1/4 in. by 2 in. by 3/4 in., while the 2 μ F condenser is 2 1/4 in. by 2 in. by 1 in.

Laboratory Tests.

When placed on test, the capacities of the two condensers were found to be as follow:—No. 1, 1 μ F; No. 2, 2 μ F. Insulation tests were then carried out, and the insulation of No. 1 was over 100 megohms, while that for No. 2 was 60 megohms. Both condensers were next tested at 300 volts with satisfactory results, close on double this voltage being necessary to break down the insulation.

General Remarks.

These condensers would appear to be suitable for radio work where large capacities are required, and are particularly suited to the average constructor, as they are fitted with terminals instead of soldering lugs.

Baseboard Single Coil Holder and Reversible Valve Holder

The above components have been supplied by the Athol Engineering Co. for test.

Maker's Claim.

The coil holder is made from porcelain, being rectangular in shape, and the makers claim that this component is designed for use in American type sets. It is provided with fixing holes for baseboard mounting, but in addition there is a second pair of fixing holes at right angles to the first for side mounting. This will enable it to be employed for high and low tension leads in conjunction with a coil mount or receptacle used as a plug.

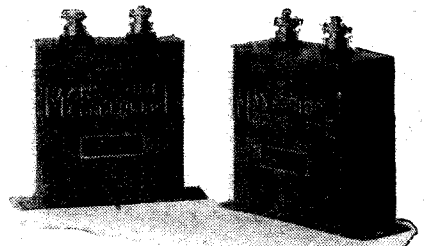

The Mansbridge Dubilier Condensers have their capacities clearly marked on the cases, and terminals are provided for making connections.

Description of Component.

An easy fit for all makes of coils was found, this fact being ensured, since the pin and socket fittings are loose in the porcelain holder. Final fixing of the brass pin and socket in the porcelain is secured by means of brass screws. These screws are also employed for the purpose of fastening the

leads from the set to the coil. The insulation resistance was found to be infinity on test.

The Valve Holder

The insulating material of the valve holder was porcelain, being free from

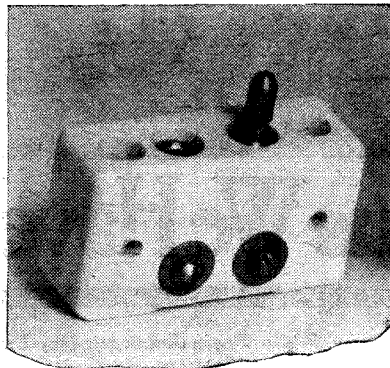

Holes are provided in the Athol Engineering Co.'s Coil Holder to enable it to be mounted in an upright or horizontal position.

flaws, and having a cylindrical shape. The four brass sockets were held in position by four screws. The sockets can be placed at either end of the holder, "through" holes in the porcelain providing for this contingency.

It is thus possible for the sockets to be fixed flush with the top of the

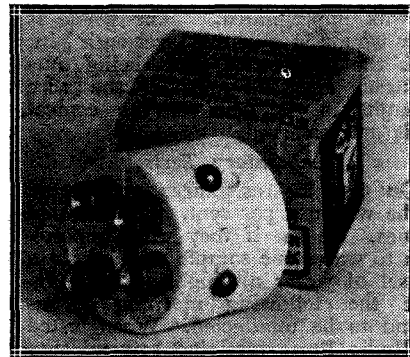

In the Valve Holder made by the Athol Engineering Co., the valve sockets may be inserted in either end of the porcelain holder.

holder at one end or be reversed and project 1/4 in. above the surface at the other end. This operation of reversing may be conveniently carried out by placing a valve in the sockets and removing the screws. Then pull the valve and sockets out of the holder together, reverse the porcelain and reinsert the valve and sockets again. The screw holes will now be in line with the holes in the porcelain. The grid and plate sockets are marked in the porcelain by the letters G and P respectively. Soldering tags are supplied for inserting under the screws holding the sockets.

General Remarks.

An easy fit of the sockets in the porcelain provides air spacing round

the metallic fittings, with the result that long leakage paths are ensured. As can be gathered from the above description, the holder is not intended to be non-microphonic, but all makes of valves fit tight into the sockets. The insulation resistance is also particularly good. Single-hole fixing for mounting on the front or back of the panel and on baseboards is secured through the medium of a central hole in the holder.

Can'tcross Connector

Messrs. J. & W. Barton have sent us a Can'tcross Connector for report and review at our Elstree Laboratories.

Makers' Claim.

Once fitted it always prevents wrong connections being made, thus assuring full life to valve filaments. It acts as a triple switch, as by the withdrawal of the socket element, the H.T., L.T. and grid bias supplies are simultaneously cut off from the set. The live member is fully insulated, and thus prevents damage to batteries by shorting.

Description of Component.

The connector consists of a moulded base 2 1/4 in. by 1 1/2 in. by 1/2 in. This base is hollowed out to a depth of 1/4 in. and three split pins project from the base being stamped (H.T.+), (H.T.— and L.T.), and (L.T.). On the underside of the base, screw ends, 7/8 in. in length, are provided for making connections to the pins and also for panel mounting. A moulded block fits into the hollowed base, and has three sunk sockets which fit on the pins. Connections to these three sockets are made along channels cut in the material, and a moulded lid is screwed over these terminals so that they are completely insulated.

General Remarks.

This connector is adaptable to any circuit where one H.T. terminal is

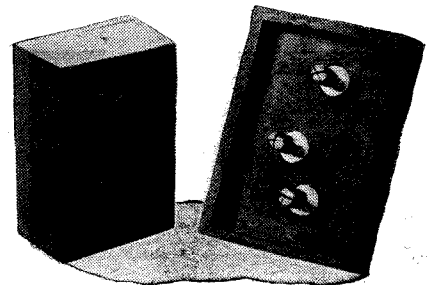

Messrs. J. & W. Barton's Can'tcross Connector is intended to be used for connecting the high-tension and low-tension batteries to a receiver, without any risk of making wrong connections or short circuits.

required, but additional terminals would be needed for further H.T. tapings. When in position the battery terminals on the set are well insulated, and short circuits cannot occur. An insulation test produced good results, and the component should prove very useful.

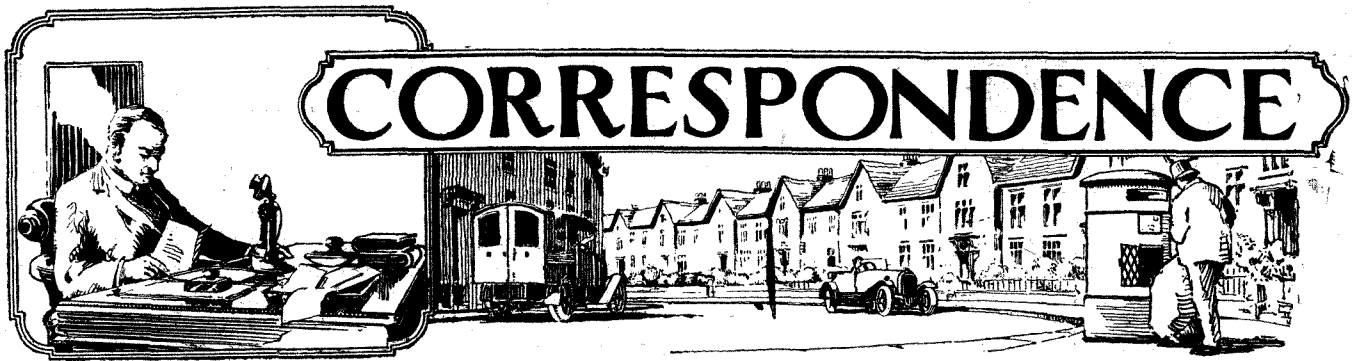

SHORT-WAVE TRANSMISSION

SIR,—5LS, situated at 56, Humber Road, Blackheath, London, one of the experimental stations of Messrs. A. J. Stevens, of Wolverhampton and London, is now operating on 45 metres with power inputs of 25 and 50 watts. A.C. plate supply is used rectified by four "S" tubes. The present circuit is a series feed loose-coupled Hartley, employing a Mullard 0/250 watt tube. A.C. also on filament.

Transmissions usually take place on Sunday afternoons and evenings, and on other evenings occasionally.

Reports will be welcomed, and 5LS will be pleased to arrange schedules with any station interested in 'phone or C.W. tests at the frequency mentioned.—Yours faithfully,

R. BLOXAM (G5LS).

Blackheath.

OXFORD UNIVERSITY RADIO SOCIETY

SIR,—Radio has at last obtained recognition in this University, and the Vice-Chancellor has given his permission for a University Society, which was formed on December 1 and already has a membership of over forty.

An attractive programme is being arranged for next term, and the Society will seek affiliation with the Radio Society of Great Britain. At the meeting on December 1 the following were elected officers of the Society for next term:—Henry Field, New College, president; Eric Cuddon, Merton, hon. secretary; C. E. G. Bailey, Balliol, hon. treasurer. Committee:—H. Richards, Merton; and E. G. Spenser, Exeter.

Of these both the president and secretary are members of the Radio Society of Great Britain and the T. & R. section.

The terminal subscription has been fixed at 7s., with an entrance fee of 10s. 6d. Will all members of the University who wish for further particulars please communicate with the Secretary.—Yours faithfully,

ERIC CUDDON.

(Founder and hon. secretary,
Oxford University Radio Society.)

CONCERNING "GROUSERS"

SIR,—Why is it that people will persist in grumbling about wireless?

First we have the people who can only get the "Local Station" and "Daventry" on the loud-speaker, and can only get one or two others on the 'phones. They say that the B.B.C. ought to use more power and also close down the "Local Station" for about one hour a day, and some go so far as to suggest that it should be closed down for one whole day.

Now if the B.B.C. were to do as these "grousers" wanted, it would mean that the people who can only afford a crystal set and one or two pairs of headphones would have to amuse themselves as best they could during the time that their station was closed, and that, I think, would not be fair, as both the man who owns a crystal set and the man who can afford valves pay the same licence fee, and to

Press weeklies, either *Wireless* or else *Wireless Weekly*, an article written by a resident of this town (Brighton) in which he states that since 5XX has moved, Brighton crystal users are out of range.

Knowing a gentleman at Hove, I tried a crystal set on his aerial (which, I may state, is shielded by trees at the back and by his house at the lead-in end, and the earth connection is a clip on the water tap), and I tuned in Daventry at good crystal strength, every word the announcer spoke being very clear, and music and singing were excellent.

On my own aerial and earth I received Daventry at loud crystal strength on the same set, and in addition I also had reception (weak) from London, so I do not think that

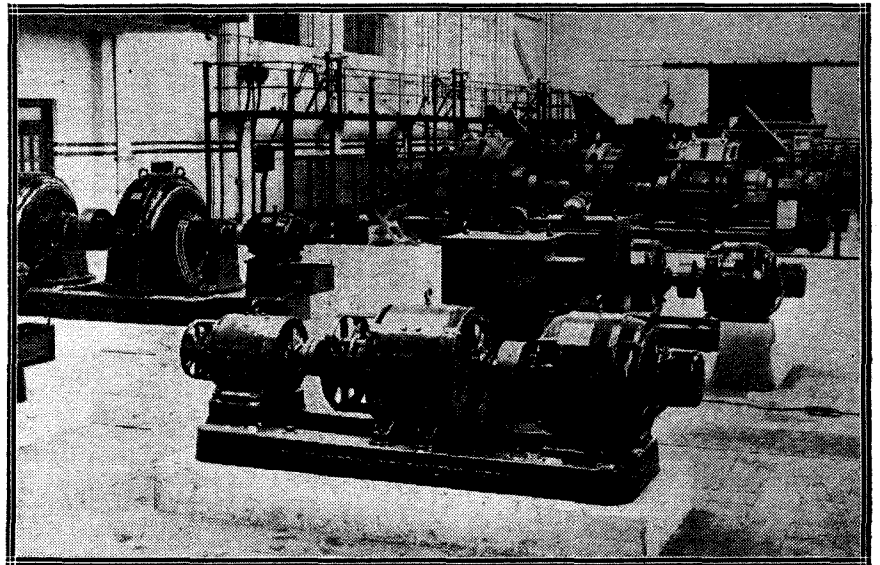

In the generator room at the Rugby wireless station at Hillmorton.

my idea both should get full value for their money.

Now we come to another "grumble," namely, the moving of 5XX from Chelmsford to Daventry. I have no doubt whatever that the shifting of this station has thrown a good many crystal sets out of use, as the owners are now out of range of Daventry; but I noticed in one of the Radio

Brighton is out of crystal range with Daventry from these results.

Now I come to the third "grumble," the "licence." In the daily and weekly papers and also in the wireless papers, both weekly and monthly, we see from time to time that people want to know why it is that the licence only lasts eleven months. Why the grumble in this case? I will own that

THE HAPPY FAMILY

"Ancestors"

Here you see the Ediswan family of to-day paying homage to the forefather of all radio valves. They think the old chap "too quaint for words," but are very proud of him and of their direct descent—because Dr. Fleming's original experimental valve was born in the Ediswan laboratories where all Ediswan valves are born.

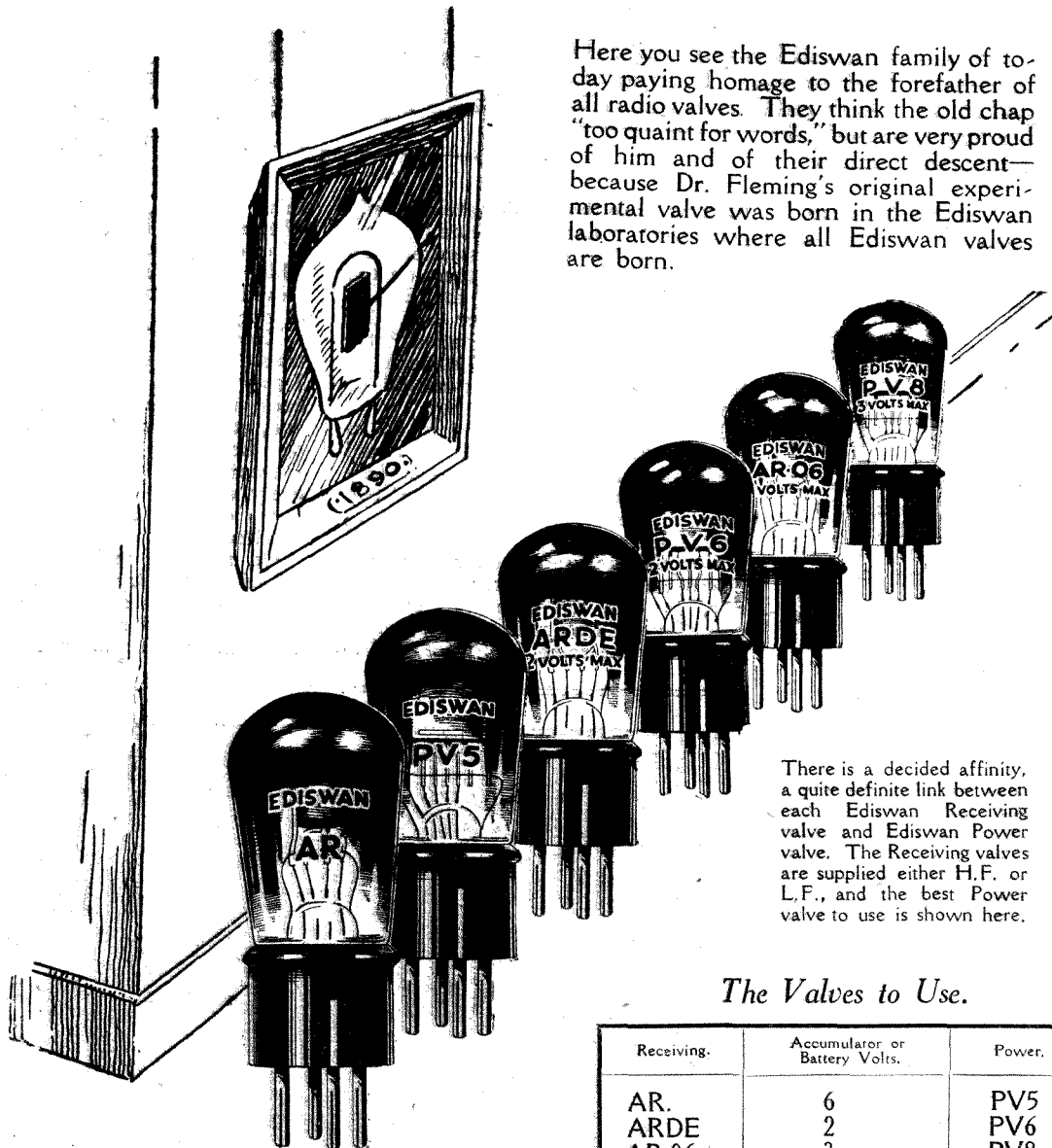

There is a decided affinity, a quite definite link between each Ediswan Receiving valve and Ediswan Power valve. The Receiving valves are supplied either H.F. or L.F., and the best Power valve to use is shown here.

The Valves to Use.

Receiving.	Accumulator or Battery Volts.	Power.
AR.	6	PV5
ARDE	2	PV6
AR 06	3	PV8

Ediswan Valves are Entirely British Made.

With these groups and Ediswan H.T. and L.T. Accumulators the ideal is attained.

EDISWAN VALVES

Will Improve ANY Set

THE EDISON SWAN ELECTRIC CO., LTD, 123-5, QUEEN VICTORIA ST., LONDON, E.C.4.

my first licence only covered eleven months, and also those of my friends, but our renewal licences are for twelve months, so I think the majority of listeners must jump at their first licence as a means of something to grumble about.

Hoping this letter has not bored you, and wishing the Radio Press, Ltd., the best of success with their excellent publications.—Yours faithfully,

H. R. EVANS.

Brighton.

SHIELDING OF HIGH-FREQUENCY TRANSFORMERS

SIR,—In perusing the December 16 issue of *Wireless Weekly* I notice in the article on the "Isosfarad" receiver reference to the shielding of H.F. transformers.

It is quite possible, in a receiver employing perhaps three stages of radio-frequency amplification, for the local station to be received on, say, the amplifier coils of the third H.F. valve.

Properly designed shields will eliminate this trouble if it is present, but at the same time it is questionable what form the shielding should take from the point of view of efficiency.

If the coils only are shielded, then they must be more or less isolated from the rest of the apparatus, particularly from the variable condensers.

If the condensers themselves are shielded either separately or in with the rest of the H.F. side of the receiver, there is the disadvantage that the minimum capacities thereof are increased, although hand-capacity effects are eliminated.

As you point out, it is again questionable whether the effective resistance and the distributed capacity are reduced to the same extent as the inductance.

The experience of some of your readers in this direction would be interesting.—Yours faithfully,

J. H. FINGLASS.

Wallasey.

CHEMICAL RECTIFIER DIFFICULTIES

SIR,—I am interested in wireless reception, and having much difficulty in getting my accumulators charged efficiently, am doing my own charging. I am up against several difficulties, and shall be glad if any of your readers can give me help to overcome them.

I have read some books on the subject and articles relating to it, but these are so at variance with one another and with my experience that it really seems they are not very reliable.

My house is wired for alternating current 240 volts. I purchased a chemical rectifier stated as suitable for charging a 6-volt accumulator at 3 to 4 amps. The cell is a stoneware jar to contain electrolyte with aluminium and steel electrodes. An auto-transformer reduces the voltage before rectification, and it is fitted with an ammeter.

The elements were stated as having a life of about a thousand hours.

The machine was put into action in accordance with instructions, distilled water from a reliable chemist being used. After a few hours' working the amperage fell off down to about one amp. The ammeter indicated continuous current showing little or no trembling of the needle.

The accumulators were efficiently charged, but very slowly.

After about 150 hours' running the aluminium element was completely eaten away and a thick, translucent sludge half-filled the jar. This seemed to indicate impure chemicals, but thinking it might be accidental, I obtained a second set of elements and salts from the makers. This acted in an exactly similar manner. The amperage fell off until less than half an amp. was indicated.

I then obtained pure ammonium phosphate from a chemist and used instead of the packet of salts supplied. This gives much better results, but

but can only get about half an amp. on the 6-volt accumulator.

Another trouble is the creeping of the salts. I have used a good $\frac{1}{2}$ in. of paraffin on the solution, and well coated the top of jar and metal parts with vaseline. Still the salts creep up and cover the metal with a thick crust.

All the books state that the cells should be kept cold and that the rectification falls off as temperature increases. I have found that the ammeter registers more rectified current passing as the temperature increases up to about 70 deg. It rises and falls consistently with the temperature of the cell contents.

Can any of your correspondents who have also experimented with Nodon valves give me information as to the correct proportions of the electrodes and electrolyte and how the salts can be prevented from reaching the vital parts of the machine?—Yours faithfully,

J. J. BOORMAN.

London, S.E.25.



At the Brussels broadcasting station a Marconi 6kw. transmitter is used. The rectifier panel may be seen on the left, while on the right are the independent drive, main oscillator and modulator panels.

only gives about $\frac{3}{4}$ amp. when charging a 6-volt accumulator.

The aluminium element is not corroded to anything like the same extent, but a hard substance forms on the iron, and the sludge is much reduced in quantity.

I wrote the makers, stating all the circumstances, but have had no reply.

I have since tried a four-cell Nodon valve, using $\frac{3}{8}$ -in. aluminium rods and 6-in. by 8-in. lead circular plates in glass jars 9 in. deep with ammonium phosphate, with the auto-transformer,

ST.100 ON BOARD SHIP

SIR,—Having had an interesting experience with dull emitter (.06 amp.) valves, I thought it might interest you.

I have used your ST.100 circuit (Radio Press Envelope No. 1, by John Scott-Faggart, F.Inst.P., A.M.I.E.E.) ever since it was published, with very good results, the valves used being U.V.199 (American), .06 ampere ones. As is usual with these valves, after various periods, the dull emitter properties vanished, so I put them with

the usual accumulation of "cast offs." About three weeks ago I decided to convert the ST.100 to a three-valve set (Det. 2LF), which gave very good results; in fact, the results were so good that I thought that I would try and get a last "kick" out of the old discarded valves (I had accumulated about five at this time). What was my surprise, on trying these valves, to find that they were nearly as good as new, say 85 per cent. The rheostats and accumulator were the same for both sets, the circuit being the only thing altered. These valves are now working with the rheostat (30 ohms) about one-quarter on, and in every respect seem, as already stated, about 85 per cent. new.

I am now trying Capt. Round's method of working the set from the ship's mains (*Modern Wireless*, October, 1925), but have not been very successful up to date. The positive side is earthed on board here, which may have some effect. As the voltage here is only 100, I have not put in R₁, R₂, R₃, and I am taking, of course, the positive mains straight through the choke to the transformers. Yours faithfully,

M. BOSTON.
(Third Officer).

R.M.S. Samaria.

THE "TWIN-VALVE" RECEIVER

SIR,—I hope I shall not be boring you if I give you the results of my "Twin-Valve" Receiver (Radio Press Envelope No. 10, by John Scott-Taggart, F.Inst.P., A.M.I.E.E.), which I have constructed as instructions given. I am more than satisfied with it—the results are wonderful. I am receiving Daventry on a medium-sized loud-speaker at good volume (distance about 120 miles), and 2LO, 6BM, Radio-Paris and many other stations at excellent phone strength. London also is fairly good on the loud-speaker (50 miles).

Wishing your excellent journals every success.—Yours faithfully,
F. W. HUGGETT.

Lewes.

A READER'S RESULTS

SIR,—I have tried many of your excellent designs, of which I will give my experiences in this letter.

I made up the "New ST100," by John Scott-Taggart, F.Inst.P., A.M.I.E.E., which appeared in the first two numbers of that splendid little publication, *Wireless*. The results obtained were London, Bournemouth, Daventry, Radio-Paris, Toulouse, Rome and one other foreign station unidentified, all on the loud-speaker, and I received on the 'phones Birmingham, Newcastle, Glasgow, Cardiff, Aberdeen, Manchester, Plymouth (once only), Hull, Sheffield, Liverpool (exceptionally strong), Brussels, Hamburg, Hilversum, Madrid, Oslo and San Sebastian. The "New ST100" is sure the goods.

The "Anglo-American Six," des-

cribed by Mr. Percy Harris, M.I.R.E., in the January, 1925, issue of *The Wireless Constructor*, was the next set I made, and after a little trouble in stabilising it, all the above stations, and many more, were easily obtained, and London, Bournemouth, Daventry, Radio-Paris, Rome, Toulouse, Newcastle and Manchester and three stations (one English and two foreign) were received on the loud-speaker.

Now, I am one of the "wireless fans" who is never satisfied with one set for more than a week or two, and so I made up the "Harmony Four," described by Mr. Harris in *Modern Wireless* for September, 1925, but I added one low-frequency stage, which is switched on and off by a D.P.D.T. switch.

Now this is really a splendid set; in fact, for purity and tone I cannot say enough to praise it, and the range, ease of control and volume, well—it is just like turning an indicator to the station you want, and you have it, and by judicious twiddling of the neutrodyne condenser you can bring it up to splendid volume, quite enough for anyone who likes to sit and listen to a nice concert, and unless the station is very distant and I require more volume, I only switch on the four valves, five being too loud and the loud-speaker cannot handle the volume. Up to the present I have received thirty-three stations on this set, and twelve of them were audible on the loud-speaker. Not a bad haul, is it?

Wishing you the best with all your publications.—Yours faithfully,

REGULAR READER.

Brighton.

ENVELOPE No. 2

SIR,—I should like to inform you that I have just constructed the "Family" Four-Valve set (Radio Press Envelope, No. 2, by Percy W. Harris, M.I.R.E.), and at present am very pleased with the result. I can tune in Daventry strong enough to be clearly audible on my loud-speaker on the detector valve alone, which for Devonshire must be fairly good.—Yours faithfully,

A. B. FORD.

Exmouth.

THE "A B C" WAVETRAP

SIR,—The following report on the "A B C" wave-trap (Radio Press Envelope No. 6, by G. P. Kendall, B.Sc.) may be of interest to some of your readers troubled by interference.

The trap was built some four months ago and has been in constant use about 2½ miles from 2LO on the "Family" Four-Valve set and a Five-Valve T.A.T. using geared condensers. The type of trap used was type "A" on a 7/22 bare copper wire aerial (twin) about 40 ft. long; it is badly screened, as it is erected outside the windows of a top floor flat. The earth is a water pipe in a different room to the set. A .001 μ F variable condenser is used

instead of a .0005 μ F as the writer had a spare one.

No trace of 2LO can be found when receiving 6BM or any station from about 10 metres on either side of 2LO, nor can any loss in signal strength be noticed.

By connecting a coil plug in series with the large coil in the wave-trap and plugging in a home-made duolateral coil of 153 turns, Radio-Paris can be received without any trace of 5XX or loss of signal strength. This coil plug is shorted when the trap is used on B.B.C. wavelengths; it does not affect the efficiency of the trap in any way.

Wishing all your publications, of which I am an old and constant reader, the best of success.—Yours faithfully,

London, S.W. C. P. YAPP.

AN EFFICIENT SINGLE-VALVE RECEIVER

SIR,—I noticed "An Efficient Single-Valve Receiver" described by Herbert K. Simpson in *Modern Wireless* for June, 1924, and made this set up. I have a single-wire aerial of Electron wire 50 ft. and 40 ft. lead-in, 40 ft. high, badly shielded by flats in Palace Gate which are 40 ft. higher than my aerial. I get London on a loud-speaker, 5XX fairly loud on the 'phones. I also get a German station at crystal set strength which is fairly loud, and I also get Edinburgh, Glasgow, Cardiff, Birmingham, Bournemouth, Newcastle, Nottingham, Brussels, and lots of amateurs, one, 2KG, on a loud-speaker. This is the finest single-valve set I have heard. I can get London louder without an aerial by simply putting the earth wire on the aerial terminal; in fact, I can get London without aerial or earth by using 75 plug-in coil in A and 50 in reaction. I am using a Dutch 4/9 valve and 40 volts H.T. and 4-volt accumulator.—Yours faithfully,

E. J. BARROW.

Kensington, W.8.

THE "NEUTRODYNE JUNIOR,"

SIR,—I am writing this in thanks for the design of the "Neutrodyne Junior" (described in the March number of *Modern Wireless*, by Percy W. Harris, M.I.R.E.). I made this set a short time ago. Since then I have received: London, Newcastle, Cardiff, Birmingham, Glasgow, Belfast, and Nottingham at various strengths. I have not tried Daventry or Radiola because I have no neutrodyne unit for this wavelength. I have heard many loud-speaker sets, and I have made several sets myself, but I have heard nothing anywhere near this set for clearness and purity of both music and speech; and the other very important item, I cannot interfere with my neighbour when I have adjusted the neutrodyne condenser.—Yours faithfully,

J. PATON.

London, E.8.

P. S.—I must add that the set is more selective than any I have handled.



P. A. U. (THURSO) is experiencing difficulty with his high-tension supply, which is required for a large set. He would like to use high-tension accumulators, but lack of facilities for charging prevents him taking this course. He asks whether there is any way out of the difficulty.

If a slight amount of trouble is not objected to in the first place, we would suggest that our correspondent employ a Leclanché wet type H.T. battery, which in practice should be found to give good service over an extended period without requiring much attention. Wet batteries of Leclanché type are now obtainable for high-tension

purposes from a number of firms, or alternatively the smaller sizes of the standard batteries normally employed for ringing bells may be used, if expense has not to be considered. A difficulty sometimes met with in Leclanché batteries is that of "creeping" of the electrolyte, which may be overcome by covering the liquid in the cells with a thin film of medicinal paraffin.

R. P. L. (BARMING) wishes to construct a frame aerial for his Supersonic heterodyne receiver, to cover a wavelength band of 200 to 600 metres with a .0005 μ F variable condenser in parallel.

If a simple "diamond" type frame is constructed with diagonals 3 ft. 6 in. long and wound with 12 or 13 turns separated by $\frac{1}{2}$ in. spacing, the desired range should be obtained with a condenser of the capacity specified. No. 18 gauge copper wire will be suitable.

R.S.P. (TUNBRIDGE WELLS) states that he cannot obtain a good earth connection for his "All Concert de Luxe" receiver, since a waterpipe is not available sufficiently near to the room in which the set is to be used. The area at the back of the house is concreted and this would have to be



RECO

The Rechargeable
H.T. BATTERY



60 VOLT BATTERY, 40/-

For particulars write to:

Radio Equipment Co., Ltd.

5, Dyer's Buildings

HOLBORN, LONDON, E.C.1



Barclays Aa.

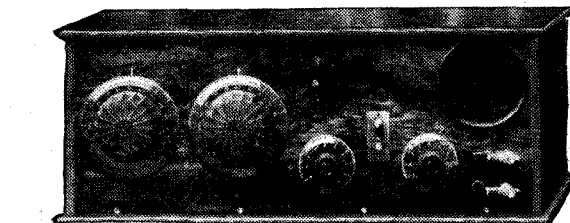

Are you building
the new Radion
Loud Speaker Set?

IN the new Radion Book full particulars for constructing this original Loud Speaker Set are given. A splendid portable Set with self-contained Loud Speaker. Just the Set for the drawing-room. Costs little to build, yet it works exceptionally well. With the details given in the Radion Book you could not possibly go wrong.

The Radion Book consists of 24 pages fully illustrated showing how to build four different high-grade Sets of which the above is one. From all Wireless Shops or direct from us

6d.

Panels **RADION** Dials

American Hard Rubber Company (Britain) Ltd.

Head Office: 13a Fore Street,
London, E.C.2
Depots: 120 Wellington Street, Glasgow,
116 Snow Hill, Birmingham.

Irish Agents: 8 Corporation Street, Belfast.

Gilbert Ad. 4277.

The rejuvenation of wireless!

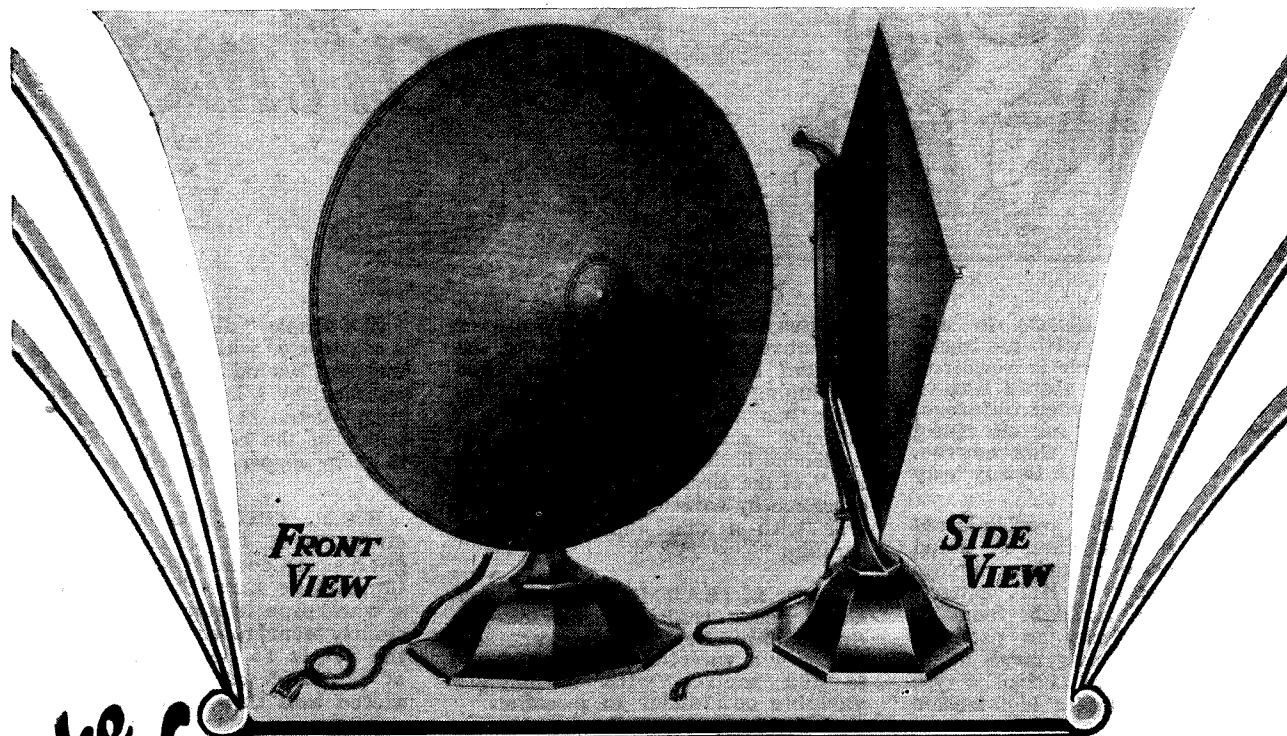

*The
New*

Kone Loud Speaker & Amplifier

HERE is the latest Loud Speaker that scientific research and experiment can offer, and which will prove a milestone on the road of advancement in the wireless art. Special characteristics of the "Kone" Loud Speaker are as follows:

Freedom from distortion. Greater purity of tone than any other Loud Speaker at present on the market. Even distribution of sound over wide area. Distinctive appearance.

It will operate successfully on any amplifier having an output impedance of 2000 to 5000 ohms. The ideal output impedance is 2000 ohms as in the "Kone" amplifier.

Do not order your new Loud Speaker until you have heard a "Kone." You will save yourself disappointment. The "Kone" Amplifier gives really wonderful results used in combination with the "Kone" Speaker, or any other standard Loud Speaker of good design. Supplied as illustrated for inclusion in any existing furniture, or encased in a handsome mahogany cabinet as a separate unit.

Standard Telephones and Cables Limited

CONNAUGHT HOUSE, ALDWYCH, LONDON, W.C.2.

WORKS:

NORTH WOOLWICH,
NEW SOUTHGATE
and
HENDON

Phones: Central 7345 (10 lines).

BRANCHES:

Birmingham, Leeds,
Manchester, Newcastle,
Glasgow, Cardiff,
Southampton, Liverpool
and Dublin

Patent No.
209345

Standard
FORMERLY
Western Electric

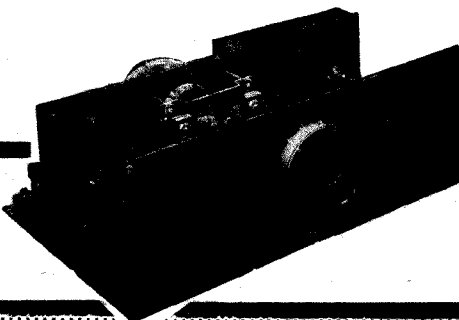

QUALITY
PRODUCTS

broken, a somewhat difficult job, to allow an earth plate to be buried. He has room, however, for a counterpoise, and asks our advice as to how to erect this latter.

A counterpoise, to all intents and purposes, is a replica of the aerial itself erected directly underneath the latter, preferably six or eight feet above the ground. Equal attention should be paid to its insulation as to that of the aerial, and a double wire or a multiple wire type may be employed.

D. O. (FOLKESTONE) wishes to add a wavetrapp to his "Family" Four-Valve receiver, in order to eliminate the transmission from 5XX when listening to Radio-Paris. He does not wish to wind his own coil for the wavetrapp.

A type "D" trap on the lines of that described by Mr. G. P. Kendall, B.Sc., in *Wireless Weekly*, Vol. 4, No. 15, should prove helpful, and a theoretical diagram of this arrangement is given in Fig. 1, in which the connections to the first valve only of the set are given for simplicity.

It will be observed that the receiver is connected up in the normal manner for plain parallel tuning, and that a part of the trap coil L1 is included in the aerial circuit. In practice this coil may conveniently be one of tapped type, such as the Lissen X type, and in this case should be a No. 250 coil. If this type of coil is employed, the turns actually in the aerial circuit

should be those between an aerial tapping and what is normally the earthed end of the coil. The method of operating the trap in practice is first to tune in Radio-Paris with the aerial connected to the normal aerial ter-

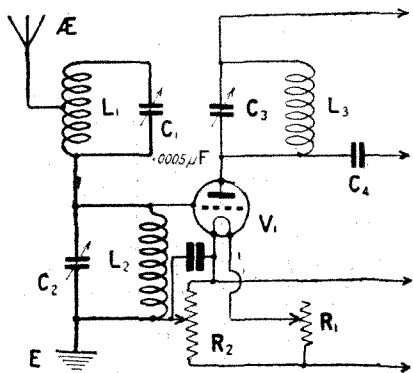

Fig. 1.—The coil L1 in this trap circuit may be a tapped plug-in coil (D.O. Folkestone).

minal, and then to bring the trap into circuit, tuning on the trap condenser C1 until a point is found where the 5XX transmission is cut out. The set condenser C2 should now be readjusted to bring in Radio-Paris at full strength, which will probably necessitate slight retuning on C1 also. With this arrangement it should be found possible with most aerial and earth systems to eliminate 5XX almost completely without reducing volume from Radio-Paris to any marked extent.

S. F. (BIRMINGHAM) is constructing the S.T. 100 receiver, described in Radio Press Envelope No. 1, by John Scott-Taggart, F.Inst.P., A.M.I.E.E., and asks whether any changes are necessitated in the wiring by employing 1.8-volt type dull emitter valves.

No alterations in the wiring whatever are necessary, since bright-emitter type filament rheostats are suitable for 1.8 volt type dull-emitter valves, a 2-volt accumulator being used. With these latter, however, care should be taken to employ heavy flex leads for the low-tension connections from the accumulator to the low-tension terminals of the set, as if these are long and of appreciable resistance a considerable voltage drop may take place in them, so that the valves do not receive sufficient voltage to function correctly.

"MODERN WIRELESS"

JANUARY ISSUE.

On Sale — January 1st.
ORDER YOUR COPY EARLY.

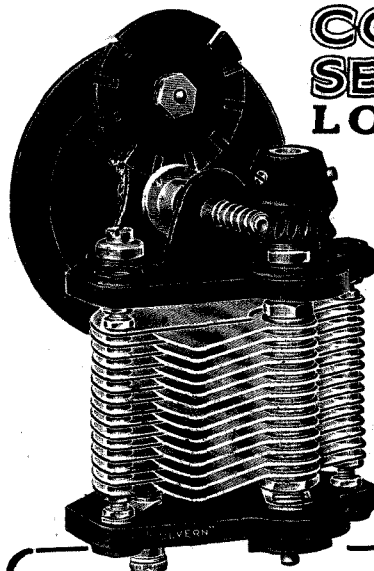

COLVERN SELECTOR LOW LOSS

The Colvern Selector Low Loss. Reading to 1/3,600th capacity.

Capacity .0005 mfd. £1 1 0

" .0003 mfd. £1 0 0

Type F, without gear attachment.

Capacity .0005 mfd. 15s. 0d.

" .0003 mfd. 14s. 0d.

One hole fixing. Other capacities if required. Descriptive folder upon request.

Colvern Independent Vernier. Price 2s. 6d.

Ask your dealer also for the Colvern Low Loss Coil Former. Price 6s. 0d.

COLVERN ESSENTIALS to long distance work

Every reader of this journal may, upon application, receive illustrated literature of Colvern essentials to a very efficient long distance receiver.

The Colvern Selector Low Loss Condenser (true geared 20 to 1) and capable of relocation to 1/3,600th part of the variable capacity.

The Colvern Low Loss Coil Former provides a very efficient inductance of low self capacity and low H.F. Resistance. Write to us to-day and your long distance experiments will be successful.

COLLISON PRECISION SCREW CO., LTD., Provost Works, Macdonald Rd., Walthamstow, London, E.17. Telephone: Walthamstow 532.



REGISTERED TRADE MARK

takes first place—why?

BECAUSE IT HAS PROVED ITSELF AND IT IS GUARANTEED FREE FROM SURFACE LEAKAGE.

Matt or Polished. Panels cut accurately to size.
RODS. TUBES. SHEET.

Ask your dealer for ebonite branded "Becol."

THE BRITISH EBONITE CO., LTD.
HANWELL — LONDON, W.7.

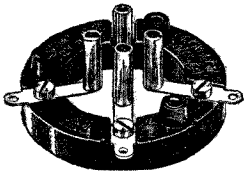

VALVE POWER

Low loss, shock absorbing, non-microphonic and universal fitting, the Antipong Valve Holder gives your sets more valve-power and saves your valves from shocks and jars. Costing so little it adds much to the strength and purity of your signals. Fit Antipong in all your sets.

BOWYER-LOWE ANTIPONG VALVE HOLDERS

3/-

Buy from your dealer or direct from Bowyer-Lowe Co., Ltd., Letchworth.

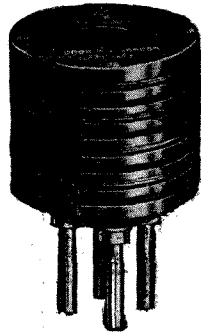

FOR EVERY H.F. STAGE

Successful amplification of more than one H.F. stage is impossible unless your Transformers match. Buy Bowyer-Lowe Transformers because every one is guaranteed to match every other in its range. 12 Months' Guarantee with every instrument. All ranges, 550 to 2000 metres, and Special Neutrodyne Unit at uniform price.

BOWYER-LOWE MATCHED H.F. TRANSFORMERS

IN ALL **7/-** RANGES

Order direct from Bowyer-Lowe Co., Ltd., Letchworth, if your dealer cannot supply.

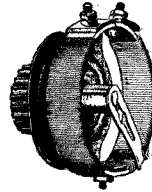

Two in One!

The new Dual Rheostat—a "Peerless" product in every way. Specially designed to meet the demand for a resistance equally applicable to bright or dull emitters. It has two windings—one offering a

resistance of 6 ohms, whilst a continuation of this is of 30 ohms resistance. The resistance element is wound on a hard fibre strip under great tension. One hole fixing is provided and the terminals are placed in convenient positions. The contact arm has a smooth, silky action, and all metal parts are nickel-plated.

Ask your Dealer to send direct

3/9 PEERLESS 3/9 DUAL RHEOSTAT

THE BEDFORD ELECTRICAL & RADIO CO., LTD., 22, Campbell Road, Bedford.

"Money saved is Money earned—
So when your 'VALVES' get old or burned
Send them to us—and we, to you,
Will send them back 'MADE GOOD AS NEW.'"

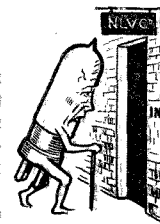

Restored to function with original characteristics.

EFFICIENCY MAINTAINED, RESULTS GUARANTEED!
B.E. 4/6, D.E. 2V. '3 7/6, D.E. '06 9/6.

Price List for Power Valves on application.

We return the actual Valve you send us, post free, within 7 days.

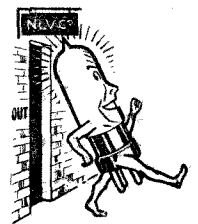

THE NORTH LONDON VALVE CO., LTD., 22, CAZENOVE ROAD - - STOKE NEWINGTON, N.16.
Liberal Discount to Wireless Agents.

ORMOND SQUARE LAW LOW LOSS CONDENSERS

YOU can increase the capabilities of any circuit by incorporating Ormond Condensers.

Distant stations that remain elusive consequent on the characteristics of other condensers can be tuned in sharp and clear with the Ormond because of its wider range of minute capacity variations.

Your Dealer Stocks them.

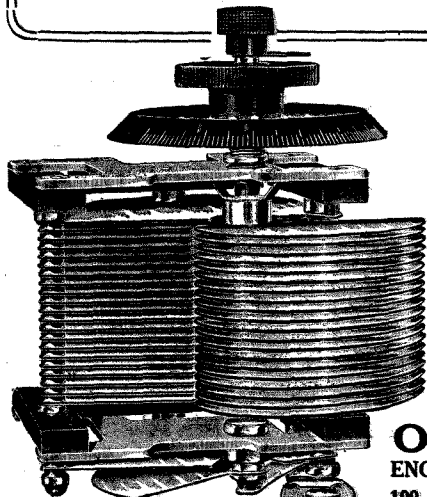

Supplied in the following sizes.

Size.	Price with Vernier.	Price without Vernier.
.00025	8/-	6/6
.0003	9/-	7/6
.0005	9/6	8/-
.001	10/6	9/-

Complete with Knob and Dial.

As used in Circuits published in Radio Press Publications.

ORMOND ENGINEERING CO., LTD.

199-205, Pentonville Road, King's Cross, London, N.1.
Factory: Whiskin St., Clerkenwell, E.C.1
Telephone:—Clerkenwell 9344, 5 and 6.
Telegrams:—"Ormondengt, Kinross."

See the inspection label on every condenser.

Barclays Ad.

AN ADVERTISEMENT IN "WIRELESS WEEKLY" IS A GUARANTEE OF SATISFACTION TO BUYERS.

FOR THE EXPERIMENTER AND WIRELESS ENTHUSIAST

RUSSELL'S

OSCILLATING ZINCITE

SPECIALLY PREPARED FOR IMMEDIATE USE ON ANY OSCILLATING CIRCUIT.

Sold only in sealed boxes bearing our name and signature. **PRICE 2/6** Obtainable from all first-class Radio dealers.

The Russell Laboratories, 1/6 Hill Street, BIRMINGHAM.

F.W. JENSEN & SONS
TRELLEBORG

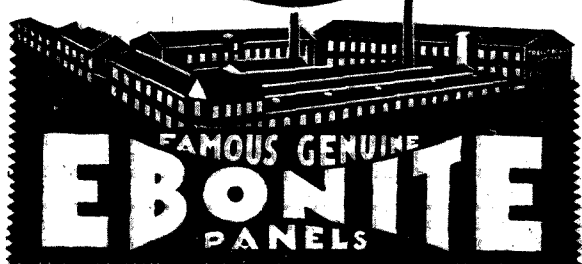

FAMOUS GENUINE **EBONITE** PANELS

"Radio Engineering"

By J. H. REYNER, B.Sc. (Hons.), A.C.G.I., D.I.C.

Every Experimenter, Engineer and Research worker in radio should own this valuable Handbook. It contains information and data of paramount importance to all who are interested in the technical aspect of the science. The whole book, comprising 484 pages, 314 illustrations, 196 pages of general mathematics, electrical and physical tables, and 111 tables, will prove invaluable to the serious experimenter.

The Book is in nine sections under the following headings:—
Radio Calculations and Measurements, Tuning and Radiation, Thermionic Valves, Radio Transmitters, Radio Receiving Apparatus, Designs of Masts and Aerials, Telegraphy and Telephony, Miscellaneous.

A COMPLETE
REFERENCE
LIBRARY FOR
15/-

or Post Free 15/9
from Dept. S,
Radio Press, Ltd.

**TWO
NOTABLE
ADDITIONS
TO THE LIST OF
RADIO PRESS
PUBLICATIONS**



"Modern RADIO COMMUNICATION"

By J. H. REYNER, B.Sc. (Hons.), A.C.G.I., D.I.C.

Here is a book that fills a decided need of those experimenters in wireless who are desirous of securing more information. The enthusiast who already possesses an elementary knowledge of electricity will find this Handbook of great assistance. The theory of radio communication is explained in considerable detail, and a large portion of the book is devoted to spark, arc and valve transmitters. Fundamental principles are dealt with in a clear and concise manner.

PRICE
5/-
or Post Free
5/6

from Dept. S,
Radio Press,
Ltd.

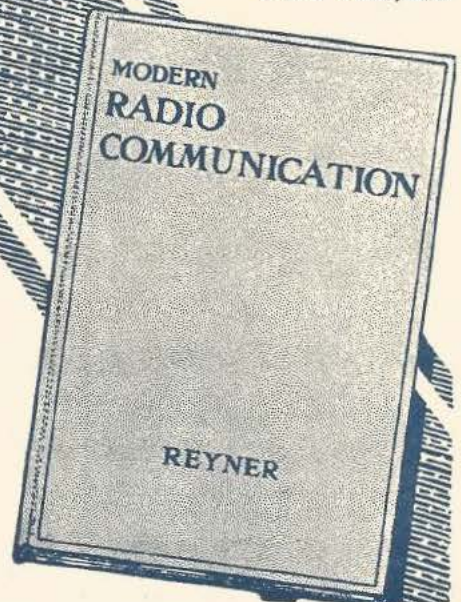

RADIO PRESS, LTD.,

Bush House, Strand, London, W.C.2



Self Capacity ONLY

18

Micro-Microfarads

THE

RESULT OF SUPREME TECHNICAL DESIGN.

The R.I. famous intervalve transformer is the only one on the market to-day with the remarkably low self-capacity of 18 micro-microfarads. After extensive research in our laboratories, and by making use of the results obtained by eminent investigators in the same field, we found that the only possible way in which the transformer could be improved was in the sub-division of the windings, thereby reducing the self-capacity. This innovation was hailed as a great advance in the design of the intervalve transformer, and since then nothing has been done to improve it.

Now the result of the remarkably low self capacity of the R.I. Transformer is the perfect and natural reproduction of speech and music. The personality of the artist lives in radio reproduction if an R.I. Transformer is used.

Unsurpassed tonal beauty is the result of the faithful reproduction of every fundamental note together with its attendant delicate overtones.

Test it for yourself—the only real test.—Take any simple receiving circuit and couple it to an amplifier built with an R.I. Transformer, with any ordinary valve, and you get perfect music or speech. In order to get equally good results with any other transformer you will have to use special valves, and in most cases you will get inferior results.

Over half-a-million R.I. users will confirm this. You cannot have better proof of the efficiency and value of a component that has obtained a classic name in the Radio Industry.

Write for the R.I. Blue and Gold Catalogue, free on application.

❖ THE MARK OF BETTER RADIO ❖

Adv. R.I. Ltd., 12, Hyde Street, New Oxford Street, London, W.C.1.

P.C.14.

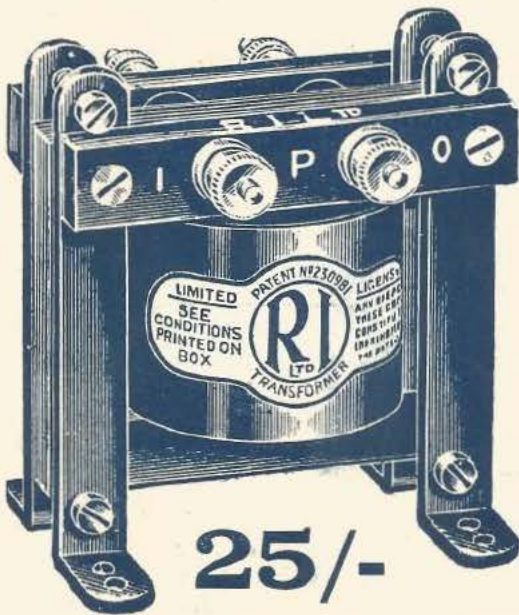

When buying R.I. Transformers see that they are contained in the R.I. Standard Sealed boxes.

