

# Wireless Weekly

Vol. 7. No. 13.



*The*  
**FUTURE of  
BROADCASTING**

**EVIDENCE BEFORE THE  
COMMITTEE of ENQUIRY**

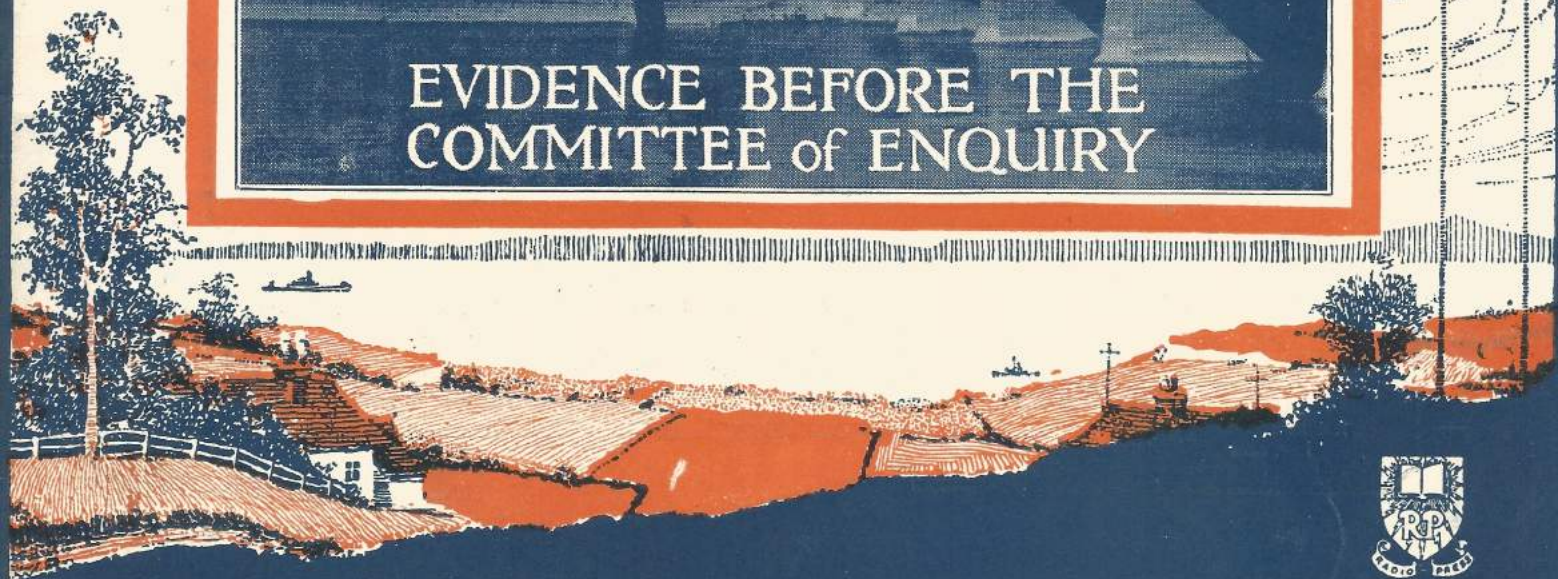

# The "Peter Pan"

— a *Burndept* loud speaker for one guinea

A new and inexpensive Burndept loud speaker has appeared at a most opportune moment — when everyone is concerned with the Christmas Present problem. This addition to the extensive Burndept Range is the "Peter Pan" Loud Speaker, obtainable at the moderate price of one guinea. It can be operated from a two-valve receiver, and gives quite sufficient volume to fill a small room while its pure tone and rendering of broadcast music and speech is all that could be desired. Like the Ethovox Models, the Peter Pan is gracefully shaped, and coloured a rich mahogany shade. The diaphragm is adjusted by means of a knurled knob.

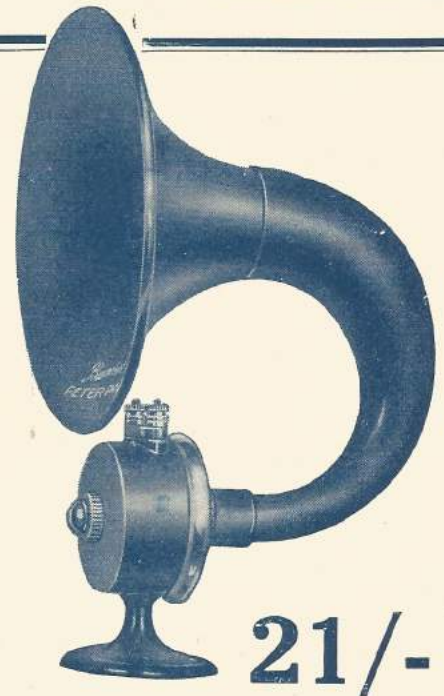

**21/-**

**2,000 OHMS RESISTANCE**

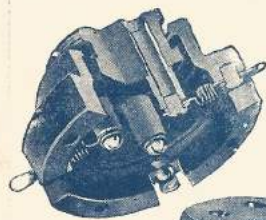

The section on left clearly shows the novel construction of the Anti-Phonic Valve Holder.

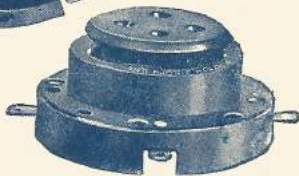

Anti-Phonic Valve Holder, for panel or base mounting, with screws, 5/-.

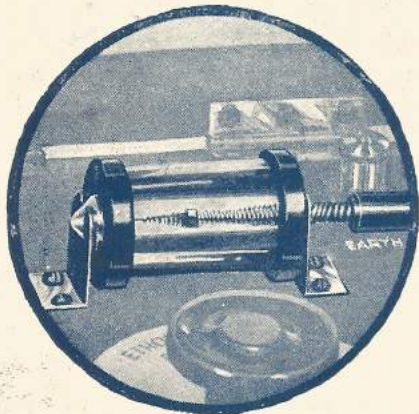

The Burndept Crystal Detector, complete with metal end plates for panel mounting, and drilling template, 4/-.

## Valve and Crystal users

who desire maximum results from their Wireless Receivers will be wise to consult the Burndept Components Catalogue. Two most interesting components described therein are the Anti-Phonic Valve Holder, and the Burndept Micrometer Crystal Detector. The Anti-Phonic Valve Holder affords complete protection for the filament of any valve, and eliminates the microphonic noises usually associated with dull-emitter valves.

Climatic conditions do not affect the Anti-Phonic Valve Holder, as there is no rubber to perish. This holder consists of an inner and an outer portion joined together by four spiral springs which make the electrical connections and also support the valve holder which is made of highly-polished bakelite. The valve sockets are countersunk to obviate the risk of short circuits. Don't leave your valves unprotected—fit Burndept Anti-Phonic Valve Holders.

The most important feature of the Burndept Crystal Detector is the micrometer screw which permits very fine adjustment of the gold catwhisker to be made with ease. The Burndept Synthetic Crystal, which is enclosed with all working parts in a glass tube, gives excellent signal strength. *Fit a Burndept Crystal Detector and obtain clear reception with easy manipulation.*

The Burndept Range includes everything for radio reception from components to complete installations.

# BURNDDEPT

WIRELESS LIMITED

HEAD OFFICE : Aldine House, Bedford Street, Strand,  
London, W.C.

Telephone : Gerrard 9072.

Telegrams : Burndept, Westrand, London.

BRANCHES AT :

Belfast, Birmingham, Brighton, Bristol, Cardiff, Exeter, Glasgow,  
Leeds, Liverpool, Manchester, Newcastle, Northampton, Nottingham.

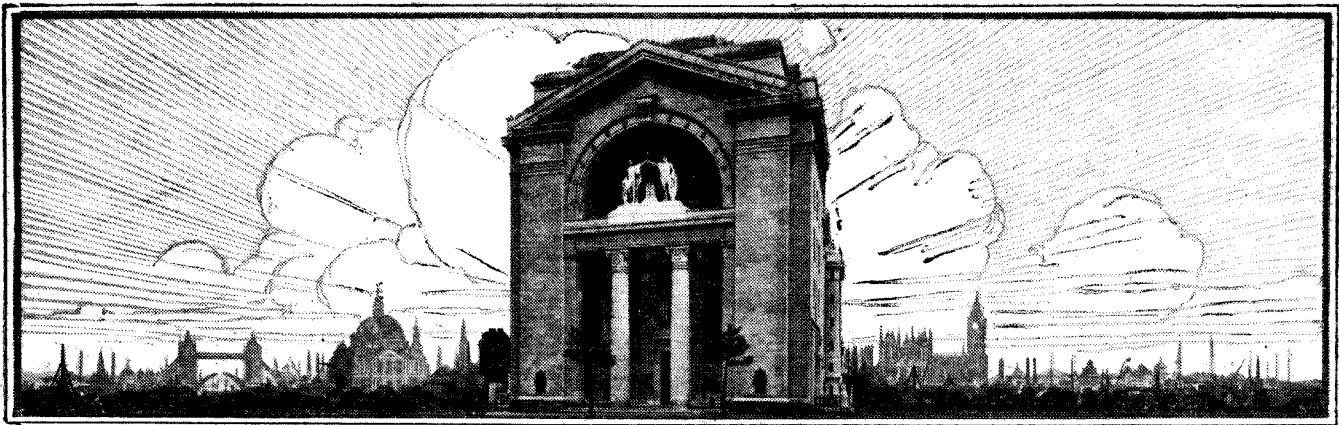

**Radio Press** LTD

**Wireless Weekly**  
Phone City, 9911

**Bush House** STRAND-WG2

## The N.A.R.M.A.T. Sees Reason

**W**E are pleased to be able to announce that in 1926 there will be one large combined wireless exhibition, organised by the National Association of Radio Manufacturers and Traders, at which both members and non-members will exhibit their goods side by side. The exhibition will be held at Olympia, and will unquestionably have an immense influence on the trade.

Both last year and this the N.A.R.M.A.T. held an exhibition at which many well-known firms of high standing were unable to show, not being members of the association in question. The public looked in vain for these firms, and immediately saw that the exhibition was not representative. When we consider that a very appreciable proportion of the visitors, both trade and private, to such an exhibition come for the purpose of making their choice among the latest apparatus, it does not take much further thought to understand how in such circumstances trade suffered. In the past the N.A.R.M.A.T. figuratively has shrugged its shoulders, and airily indicated that the cure is, of course, to join the N.A.R.M.A.T.! Although in the inner circle of the Association there have been many who felt that a single exhibition had its advantages, in the past the more violent elements have had their way. Now, fortunately, wiser council has prevailed, and the new attitude will

result in a single really representative exhibition at Olympia next year, which will form a landmark in the history of the industry.

The conversion of the N.A.R.-M.A.T. to the idea of the unified exhibition is a change of policy

proportion and forgets that first and foremost the policy must be for the benefit of its members, and not for a favoured few, it becomes, not a beneficial but a pernicious organisation.

In October, in a now well-known letter to the wireless trade, we made it perfectly clear that if N.A.R.-M.A.T. and non-N.A.R.M.A.T. members did not come together under a single roof of their own accord, Radio Press, Ltd., would itself conduct a single exhibition, as being an impartial organisation with the necessary national influence. The immediate result of the letter was that we received dozens of letters from manufacturers of high standing, promising support for such an exhibition, should it be necessary for us to conduct it, and a special company was duly formed to provide for the emergency.

Now that the N.A.R.M.A.T. has come to a wise decision, the necessity for our own exhibition will not arise. The incident, if it can be so called, is now closed, and it remains for the whole industry to appreciate the broad-minded decision of the Association in the matter. Within the next few months the National Association of Radio Manufacturers and Traders will pass through a very difficult period, but its wisdom in making the latest decision will do more to consolidate it, and gain support for it, than anything else that could have happened.

### CONTENTS.

	Page
Some Heterodyne and Rectification Effects	420
Results of Radio Press Calibration Tests	422
Short-Wave Notes and News	423
Finding the Nodal Point	424
Distortion in L.F. Amplifiers	426
Jottings by the Way	429
Some Practical Transmitting Circuits	431
Short Waves for Long Ranges—A Review	434
Inventions and Developments	436
The Future of Broadcasting	438
Wireless News in Brief	442
The Isofarad Receiver	443
Apparatus We have Tested	446
Correspondence	447
Information Department	449

which indicates a more tolerant and sympathetic attitude to the trade than they have taken in the past. We have no sympathy with those who object to the N.A.R.-M.A.T., and all its works on principle. Such an Association properly conducted can be of immense benefit to the whole industry, but its conduct requires the most careful watching, and immediately it loses a sense of

Director of Research :  
Major JAMES ROBINSON, D.Sc., Ph.D., F.Inst.P.

Deputy Director of Research :  
Capt. H. L. CROWTHER, M.Sc.

Assistant Editor :  
PERCY W. HARRIS, M.I.R.E.

*Edited by*  
**JOHN SCOTT-TAGGART,**  
F. Inst. P., A.M.I.E.E.

December 16, Vol. 7, No. 13.

Nothing contained herein is to be regarded as permission or encouragement to infringe any patent rights.

Scientific Adviser :  
Prof. G. W. O. HOWE, D.Sc., M.I.E.E.

Advisory Editors :  
Prof. R. W. HIDDINGTON, M.A., D.Sc., F.R.S.  
Prof. C. L. FORTESCUE, M.A., M.I.E.E.

# Some Heterodyne and Rectification Effects

By Captain H. J. ROUND, M.I.E.E.

In the following article Captain Round discusses in detail the effects of heterodyne rectification on selectivity, together with some notes on the supersonic heterodyne.

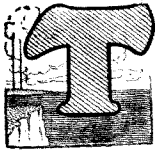

HERE are some phenomena connected with rectification which affect the question of selectivity in a way which I propose to show. Careful consideration of these points led Armstrong to evolve the super-heterodyne in Paris in

1917-1918.

The various questions involved are very difficult to keep in one's mind, and I find it wise to put the arguments down in sketch or writing form step by step.

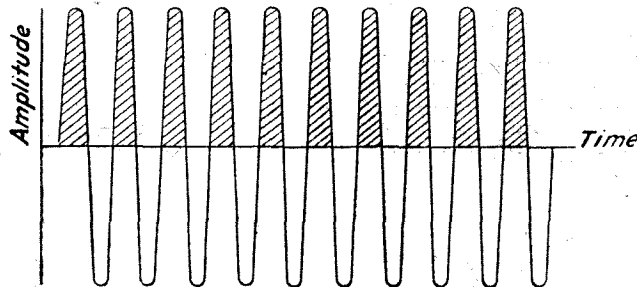

Fig. 1.—In this diagram the shaded portions of the curves represent the current which would flow if a perfect rectifier were applied to the oscillation.

## Perfect Rectification

Fig. 1 represents an oscillation frequency  $n$ , and the shaded portions represent the current which flows if we apply a perfect rectifier to it and plot the resulting current. A little later I will discuss what happens in certain local cases if the rectifier has the usual bend.

The result through the rectifier will obviously be a current that will move a galvanometer, plus a complex alternating current with a basic frequency the same as  $n$ .

## Audible Detection

Now if we added a weak oscillation from another source to the first one (Fig. 2), first at the same frequency and phase, and then of opposite phase, we should get the galvanometer increasing its reading and then decreasing its reading (the galvanometer will not respond to the H.F. component); if the change from the same to opposite phase takes place at an audible frequency, we can use a telephone instead of the galvanometer and get an audible note.

## Beat Notes

Obviously, we can get just the same note by some method of changing the strength of our original oscillation (this would be called modulation), or we can get it by adding a weak oscillation to the first one, with a frequency such that it first adds and then subtracts from the first oscillation at the same rate as the reversals. This is called producing a beat note. There is a little difference between these methods which it is not necessary to go into at present.

It is very important to note and definitely grasp the reasons why a rectifier is necessary in all these cases to produce an audible note in the telephones or a movement in the galvanometer.

## Modulation Frequency

Now even if our modulation is made of too high a frequency to hear, the rectifier is still producing a new alternating current of the modulation frequency; and, likewise, if the beat frequency is raised to this inaudible note, the new alternating current is still being produced. In all considerations here I am taking the case when the modulation produced in any way is weak; matters get very complicated otherwise, and in the beat method of simulating modulation we can assume always that one of the frequencies is much weaker than the other. Suppose that our weaker wave is now modulated by speech, and that we add it to the stronger wave, then it is quite easy to see that if the two waves are of the same frequency and phase the result is just the same as if we modulated the stronger wave, except that the amount will vary depending upon the phases of the two waves.

## Inaudible Modulation

But suppose that we alter the weaker modulated wave to such a frequency that the resulting beat note, due to beating and rectifying, becomes inaudible; is the speech modulation of the weaker wave then audible in our telephones? First the weak wave adds and then it subtracts from the strong wave amplitude; the average rectified change over one supersonic beat is obviously nil on a galvanometer or telephone, so that

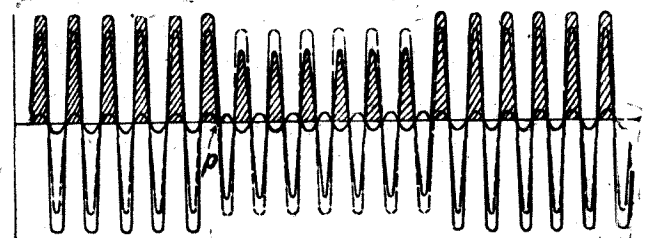

p. Position of Phase Change of Weak Oscillations.

Fig. 2.—Illustrating the effect of adding a weak oscillation to another one of the same frequency and altering the phase.

whether the speech modulation of the weaker wave is weak or strong makes no difference. Therefore the modulation will be inaudible.

## Conclusions

Summing up this point, which is of great importance, if we are receiving a weak signal on a rectifier and telephones, and if we heterodyne the rectifier with a stronger wave such that the resulting beat note is inaudible, then the modulation of the weak signal will also be inaudible. Unfortunately, owing to the fact

that rectifiers do not have quite straight line characteristics the theoretical result is not quite true, but it is very nearly true.

### Homodyning

One important point follows from this. We saw that if we modulate our weaker wave and add it to the stronger wave, and if they are the same frequency and phase, the result is the same as the modulation of the stronger wave; in fact, we shall get our speech if the modulation is a speech modulation. This operation is called "homodyning," but it is not easily realisable in practice. However, it serves to illustrate a point. Suppose, simultaneously, we applied to the rectifier a second weak oscillation, the frequency of which was sufficiently different to give an inaudible beat note with the strong oscillation, and suppose this weak oscillation was also modulated by music, the first speech would be audible, but the music would not be audible, and, in fact, no modulated wave outside the audible beat tone range would be received (except harmonics). Homodyning thus gives a selectivity which is of just exactly the correct width to take in all the frequencies we want to hear, but it cuts out everything else that gives beat tones outside the audible range.

### A Practical Test

Now, again, suppose that you are close to  $2LO$ , and that you want to get Birmingham, and that the selectivity of your receiver is only such that there is always a background of London. Tune up to Birmingham and start applying reaction. If the carrier of Birmingham

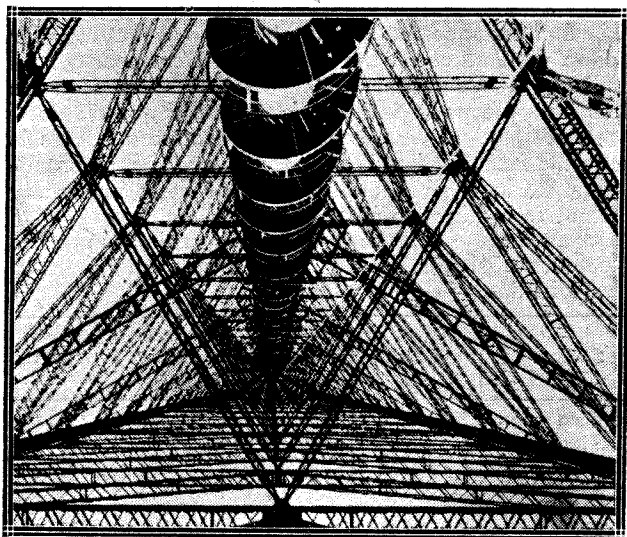

A view upwards inside the lattice structure of the mast of the recently opened wireless station at Königswusterhausen. The height of the mast is about 900 feet.

can be brought up to a strength of several times the forced wave from  $2LO$ , then as this carrier produces an inaudible beat with  $2LO$ 's wave, it tends to remove the signals from  $2LO$  altogether.

Perhaps on your receiver London is too strong; then you must weaken your coupling or decrease the size of your aerial, and use reaction more to bring up Birmingham's carrier, which will wipe out the last trace of London.

### The Reverse Effect

When one is using a selective receiver of great sensitiveness this effect is very noticeable, and it is sometimes a nuisance, as in certain cases it can work the opposite way; for as long as you keep the carrier of the wanted signal stronger than the jammer it is all right, but if the jammer takes charge then he wipes out your modulation.

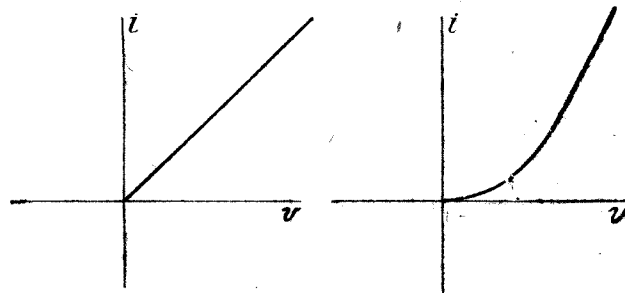

Fig. 3.—Showing (left) the characteristic of a perfect rectifier, and (right) the form of rectifier characteristic obtained in practice.

This point consequently makes it very difficult to estimate the degree of selectivity in tuning, which must be aimed at in the design of receivers, to give certain separations.

### Reducing Interference

In general, if the jammer can be reduced by tuning methods to equality with the decided signal, and you then have available reaction to bring up the signal you want, the jammer can be reduced to inaudibility. Obviously, however, the best thing to do is to have a selectivity curve on your tuning circuits, which reduces any possible jammer by pure tuning to very weak signals; the only objection is that this is so difficult to carry to the limit sometimes required that to a great extent the heterodyning effect has to be relied upon.

### A Second Rectifier

So far everything has been comparatively simple, so let us introduce a second rectifier and study the effect of it.

We have a strong oscillation and a weak one; they are combined and rectified, and the resulting alternating current is applied in some way by means of a transformer or other coupling circuit to a second rectifier. Let our weaker oscillation be of sufficient difference of frequency to produce an inaudible beat tone.

### Strength of Beat Note

Note first that through very wide limits the strength of the beat note is proportional to the strength of the weaker wave, and that alteration of the strength of the stronger wave will make only secondary differences to the strength of the beat tone.

Now if our weak oscillation is constant, and we re-rectify the beat tone, the combination will send a direct current through our telephones, and even if we modulate with speech the strong oscillation we shall hear nothing of the speech through our second rectifier. But if our weak oscillation is modulated with speech the rectification by the second detector will produce speech.

### Application to Duplex Telephony

This peculiar phenomenon is used by Franklin in his duplex telephony, in which he uses his transmitter to heterodyne to an inaudible frequency the received wave. He then re-rectifies and gets any modulation of the

received wave, but no modulation of the transmitter emission (within limits, of course), so that the receiver need never be disconnected when transmitting. Again, of course, if the receiver signals get stronger than the amount of the transmitted wave allowed to get into the receiver, the transmitter modulation will be the only one heard. The signal has taken charge, an unlikely thing to happen in this case.

**Utilising Beat Tones**

The beat tones are curious pictures at another frequency of the original weak oscillations, as, not only is the original amplitude imitated, but the phase also is imitated.

For instance, it is quite easy to make out that, if the weaker oscillation is altered in phase by 180 deg., the beat tone also shifts through 180 deg. So that if two weak signals are coming in together, and if we beat with a strong oscillation with both at once, the two oscillations will be represented as beat tones in amplitude and phase, and we can treat them as signals to be tuned, rectified and received in the ordinary way; they only suffer from distortion due to rectification once, not twice. There is, however, one very important difference between treating these beat tones as your signals to be received and using the original signals.

When dealing with the original signals, supposing that you are building a selective circuit, if it is tuned to a certain wave it will only get that wave and traces of others of nearly the same frequency. If, however, you beat first and then use the resulting beat frequencies, you are dealing with two possible groups of waves; for it is obvious that if  $n$  is the heterodyne frequency, then  $n+d$  and  $n-d$  will produce exactly the same beat tone. This effect has to be guarded against in the superheterodyne.

**Perfect Rectification**

If our rectifier is very perfect, and has a curve like that in Fig. 3 (left), it will not be necessary to have a heterodyne very much stronger than the signal, the only condition being that the signal can never reduce the total oscillation to zero. Certainly a little distortion enters, in that the resulting rectifier beat becomes a more and more pure sine wave as the heterodyne wave is strengthened, but this would not matter much in superheterodyne work. The term "optimum heterodyne" has no meaning with a perfect rectifier.

**Heterodyne Too Strong**

But suppose our rectifier curve is like Fig 3 (right). Then the result will be that for a weak oscillating voltage applied, a certain amplitude of current is produced, but for a stronger oscillation a larger proportional current is produced. Too large a heterodyne may run us into saturation.

**The Optimum Heterodyne**

In this case, however, the results are nearly the same as the hypothetical results on a perfect rectifier, if the heterodyne carries us well up to the straighter part of the curve, and if the weak signal applied does not shift us up and down from this point very much. The position is called the optimum heterodyne.

In fact, even with the practical imperfect rectifier the resulting beat tones are nearly proportional in strength to the applied signal, so that the only place in which distortion can occur in a superheterodyne is in the second rectifier, where the "square" law still applies.

**Results of the Radio Press Calibration Tests**

THE first series of measurements in connection with the Radio Press Laboratories' Calibration scheme were taken during the evening of December 10. The list of stations checked, together with the time of measurement and the frequencies, is as follows:—

Station.	Time p.m.	Frequency (kc.)	Wave-length (metres).
Aberdeen .. .. .	7.45	603.9	496.8
Birmingham .. ..	7.55	629.2	476.8
Belfast .. .. .	8.5	684.1	438.5
Glasgow .. .. .	8.15	711.9	421.4
Newcastle .. .. .	8.25	742.7	403.9
Bournemouth .. ..	8.35	779.8	384.7
Manchester .. .. .	8.45	795.8	377.0
London .. .. .	8.55	823.3	364.3
Cardiff .. .. .	9.5	854.3	351.2

Further measurements of the frequencies of the above stations were also taken at other times. In this connection readers should take special note of the fact that, in order to ensure accuracy in the calibration of their wavemeters or receivers, the time of taking their own notes of settings on their instruments should coincide with the times given for the Radio Press measurements.

**Variations of Frequency**

If, for instance, notes of the correct setting for London were taken on the evening of December 9, and the Radio Press measurements of December 10 were taken as a means of indicating the frequency obtained at this setting, an error would be introduced. This is due to the fact that the frequencies of most of the broadcasting stations given above do not remain absolutely constant from night to night.

As examples of the variations which may be expected, we give below a table of measurements taken on various dates:—

Station.	Date.	Time.	Frequency (k.c.)	Wave-length (metres).
Aberdeen ..	Dec. 9	6.30 p.m.	603.4	497.1
Birmingham ..	" 8	4.0 p.m.	630.8	475.7
		5.30 p.m.	630.0	476.2
Belfast ..	" 8	4.30 p.m.	685.2	437.8
		4.15 p.m.	684.5	438.2
Glasgow ..	Various readings		711.9	421.4
Newcastle ..	Dec. 8	p.m.	741.8	404.4
Bournemouth ..	" 9	6.15 p.m.	742.5	404.0
Manchester ..	Various readings		779.9	384.7
	Dec. 8	p.m.	794.7	377.5
	" 10	p.m.	796.2	376.8
London ..	" 9	p.m.	824.3	363.9
		" 10	p.m.	823.7
Cardiff ..	" 9	p.m.	857.9	349.7
		" 10	p.m.	854.7
Daventry ..	" 9	a.m.	187.4	1,600.9
		" 10	9.30 p.m.	187.3

**Continental Broadcasting Stations**

In next week's issue of *Wireless Weekly* we shall have an important announcement to make with regard to Continental broadcasting stations.



**T**HE past week has afforded examples of several astonishing "freaks" on the part of the somewhat mysterious conditions that govern long-distance reception. These may be best illustrated by a short account of the stations heard by the writer and the owner of another receiver, both in South London, all reception taking place on Sunday, December 6, starting at 06.00 G.M.T. Cuban 2BY and a Brazilian station were heard, but no East Coast Americans; they were heard, however, at 09.30. Between the latter time and 13.00 strong signals were received from practically every active European country, the northern British stations being, on the whole, the most powerful.

#### Further Afield

At 2.30 p.m. A-6AG was heard, the signal-strength being about R6, and half an hour later G-2KF heard PI-1HR, PI-NAJD, and U-6CTO, of California. Between 17.00 and 19.30 the following were heard:—A-3BQ, A-3EF, O-A4Z, CRP (Delhi), and HBK (Northern India). By 20.00 not one of these was audible, but several East Coast American stations suddenly appeared. By 22.00 the ether seemed quite dead, but at 23.00 several Brazilians were heard, including 1AC, 1BC, 1BD, 1IA, 1IN, 5AB, and 7AA. Chilian 2LD and 3IJ were also received at good strength.

#### A Good Effort

G-2KF had another "International field day" on the same date. Starting at 00.00 G.M.T. on Sunday he worked 6ZK, of Palestine. At 03.40 he worked O-A4Z, and U-3AHA, following this up by communicating with Z-4AS. During the day he was in communication with S-2NM, D-7EC, A-6AG, CRP (India), and A-3YX. The average report of his signal strength was R6.

#### Ireland

We hear that the Irish Free State

has been officially allotted the intermediate "GW." There are, however, very few licensed stations in operation. The amateurs in Northern Ireland use "GI" for their prefix. Up to date the only active stations that we have heard are 5NJ, 6MU, and 6TB.

Several readers probably heard a station a few months ago with the amazing call-sign of NW-4XYZ. They will doubtless be relieved to hear that he degenerated into NW-4X, and finally LA-4X. He is situated at Stavanger, Norway.

#### Special Ship Transmissions

Another Swedish boat is now active on short waves, using the call-sign SDK. As he seems to be audible only at the same times as when the Brazilian stations are coming in, he is probably somewhere

stations "on the air" than there have been for some time. 2NM is working C.W. and telephony on 9,677 kc. (31 metres), and 2KF, 5LF, 2YQ, and 2WJ are all "big noises" on about 6,670 kc. (45 metres). 6QB has at last forsaken his aged and polarising dry cells, and uses a small motor-generator. 2ZB has built a receiver *instead of a transmitter!* He is conducting "world-wide reception programmes," and has already heard five new countries on it.

#### The Eastern Counties

2XV, of Cambridge, may be heard on telephony at very good strength on 6,670 kc. 2LZ is also very strong, but, unfortunately, these seem to be the only stations working telephony consistently at the higher frequencies.

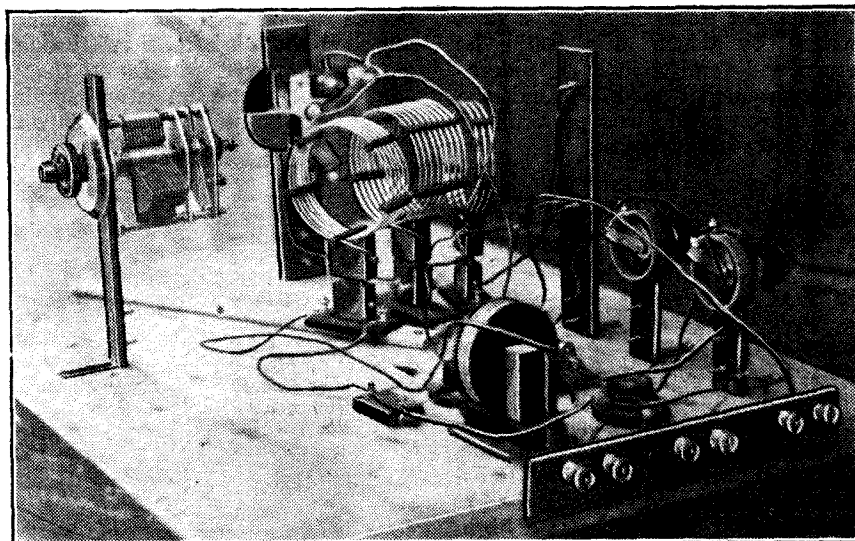

*The low-loss short-wave two-valve receiver constructed by Mr. J. J. McConochie. A letter from Mr. McConochie, describing this receiver, will be found on page 447.*

in that direction. The San Francisco (SGC) was, it will be remembered, in action between Rio de Janeiro and Stockholm.

#### London

There are now more London

The East of England seems more active than usual, being represented by 2LZ, 5QV (Clacton), 2TO (Ipswich), and 5GS (Grimsby). We have not heard a Welsh or West of England station for some weeks.

# FINDING THE NODAL POINT

By C. P. ALLINSON (6YF).

*Describing how a Moullin voltmeter may be used to determine the voltage distribution in transmitting inductances or aerial circuits.*

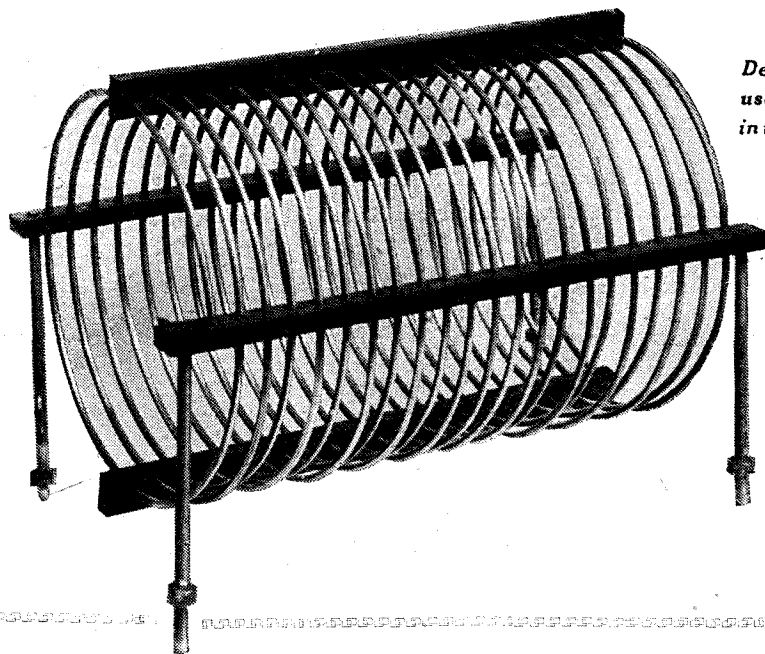

IN the course of some transmitting experiments it occurred to the writer that it would be very useful indeed if he could know definitely just where the high voltage and nodal points on his transmitting inductance were situated. It therefore became necessary to evolve a method by which this could be determined, and a little consideration showed that our old friend, the Moullin voltmeter, was particularly suitable for the purpose.

### Voltage Distribution

A case in which a knowledge of the voltage distribution would be of particular value is in the circuit shown in Fig. 1. In this case the oscillator circuit  $L_2 C_2$  is coupled to the aerial circuit  $\text{AEL}_1\text{CP}$  by means of a small coupling condenser, shown at  $C_1$ , and an R.F. feeder. The point on the transmitting inductance A, at which the condenser in series with the R.F. feeder is connected, should be a high potential point (that is a high frequency potential point), while B, the point on the aerial tuning inductance to which the R.F. feeder is connected, should be the nodal point of the aerial earth system.

### First Readings

It was therefore decided to take a number of readings on a transmitting circuit (dissociated from the

aerial-earth circuit) similar to that shown in Fig. 1. The first readings taken were with the circuit shown in Fig. 2b, in which the oscillatory circuit was connected across the grid and plate of the transmitting valve. Curve No. 1 in Fig. 2a was taken with the low-tension filament supply not connected to earth. As the A.C. mains supplied the high tension (through a transformer) it was found that a small A.C. potential was applied thereby to the inductance, even with

*Fig. 1.—A transmitting circuit used by the writer, in which  $C_1$  is a small coupling condenser. The correct point for connecting this to the inductance  $L_2$  was determined by the method described.*

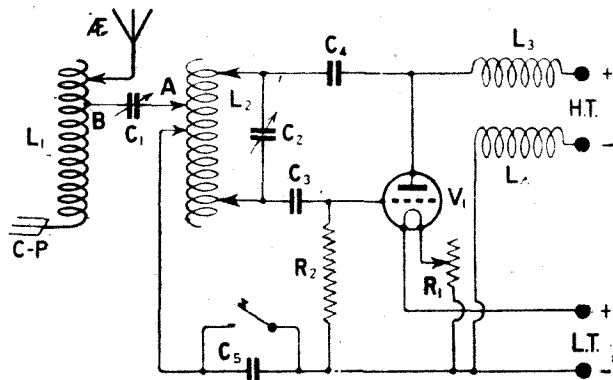

the valve switched out. This mean potential gave a reading on the Moullin voltmeter of 9 units, and this point was taken as the zero point from which to take the H.F. readings. This, therefore, resulted in the zero point with relation to the curve being shifted, the No. 1 curve being thereby obtained.

### Effect of Earth Connection

The readings were taken by connecting a flexible lead from a Moullin voltmeter, the other side of which was connected to earth, to each turn of the inductance in turn, starting from the plate end. The curve No. 1 shows the voltage distribution using a 21-turn coil. The total voltage swing will be seen to be approximately 13 units. Curve No. 2 was taken at the same frequency, but with the L.T. supply connected to earth. The total voltage swing in the No. 2 curve is 10 units, so that the actual difference between the two curves is not so great as it appears to be, and is due to the fact that they are drawn to different scales. Further, with the No. 3 curve, the L.T. supply being connected to earth resulted in the A.C. component, which previously had affected the Moullin voltmeter, not being impressed on the oscillatory circuit. The curves, therefore, show the comparative values of H.F. potential distributed along the tuning coil from turn to turn. These curves further show what would be expected, namely,

that the whole of this circuit is at H.F. potential to earth.

It will be noted that all three curves peak at approximately the same places, namely, at six and fifteen turns.

### Addition of Aerial

The next point was to try the effect of connecting aerial and



counterpoise to the oscillatory circuit, making the necessary adjustment to obtain the maximum aerial current, and then take a number of readings with the Moullin voltmeter.

The curves obtained are shown in Fig. 3a, Fig. 3b showing the circuit employed. With regard to this latter, it is interesting to note that the best position for the L.T. tap on the transmitting inductance was found to be at the fourteenth turn, but the counterpoise lead had to go to the eleventh turn, which is approximately the nodal point on the coil (which consists of twenty-one turns). The aerial tap went to the fifteenth turn, and it was found that if tighter coupling was used by including a larger number of turns in the aerial circuit, the set went out of oscillation. Actually a loading coil was used in the aerial lead, but this is not included in the circuit diagram, for clearness sake. The No. 1 curve was taken with L.T. negative connected to earth, and it will be seen that it is quite regular in shape. This would seem to indicate that the aerial and counterpoise connections had been correctly made.

**Lower Potentials**

As it was noticed in the course of experiments that the largest aerial current was registered when the low-tension side of the filament supply was not connected to earth, a further set of readings was taken under these circumstances. The curve obtained is that shown in Fig. 3, No. 2. Here we find that,

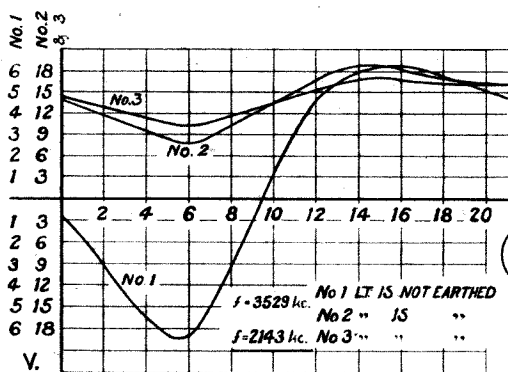

Figs. 2a and 2b.—Curve No. 1 in this diagram is drawn to a different scale from that of Nos. 2 and 3.

as the anode is the point of the transmitter which is nearest to earth potential, owing to the fact that the H.T. supply is obtained from A.C. mains, a very low reading is obtained at this end of the coil, although this point is not actually at zero potential, as is

shown in the curve. The curious step formation obtained with this curve will be noticed, but after the fourth turn from the plate end of the coil the curve becomes perfectly regular. It may be noted that, although the maximum potentials obtained with this curve are not so

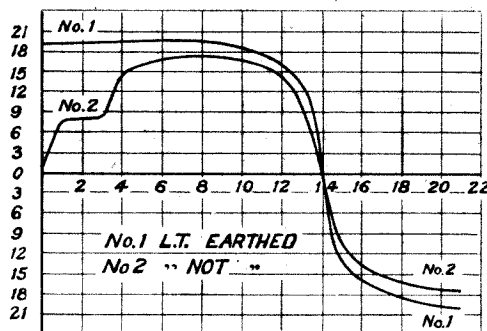

Figs. 3a and 3b.—Further readings were taken on the circuit of Fig. 2b, with the addition of the aerial system.

great as those shown in the No. 1 curve, a larger reading was obtained on the hot-wire aerial meter.

**Moullin Voltmeter**

For the guidance of those who may wish to take similar measurements on their own transmitters, it should be noted that the Moullin voltmeter employed used the leaky grid-condenser rectification method, the grid-leak being connected between the grid and low-tension. It will be realised, of course, that the readings obtained are not actually positive and negative as shown in the curves, but started at a certain positive value, declined to zero, and

The curves have therefore been drawn as reproduced herewith, since thus a better idea is obtained of the shape of the curves and what is going on in the circuit.

**Voltage Distribution in Aerial System**

The method described may fur-

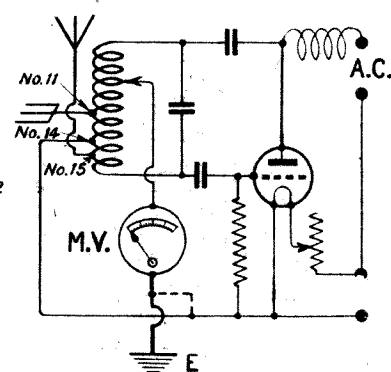

ther be used to plot the voltage distribution in the aerial-counterpoise circuit. In this case, of course, we shall not get any point which is actually at zero potential, but we shall be able to determine, from the curve obtained, which is the nodal point.

It should be noted that the nodal point is not that point at which the lowest reading is obtained. To determine which is the nodal point in the case of a curve such as that shown at No. 2 or No. 3 in Fig. 2, a horizontal straight line should be drawn, so as to divide the curve into two equal portions above and below the line. The point at which this horizontal line crosses the curve is the nodal point.

**Application of Readings**

In cases where it is desired to employ the coupling method shown in Fig. 1 it would be advisable in the first place to couple L2 to L1, plot the curve for the aerial circuit, and determine the nodal point. The transmitter can now be placed where suitable, the aerial inductance L1 being connected to the aerial and counterpoise leads wherever convenient, irrespective of the position of the transmitter. The R.F. feeder is then connected to point B on the coil, which has been found to be the nodal point, whilst the other end A may be connected to what has been found to be a high-voltage point of the transmitting inductance L2. It should, of course, be remembered that the nodal point will shift if any alteration in frequency is made.

then rose again. As, however, we are dealing with oscillatory circuits, it follows that if one end is at a certain potential and we then pass to another turn of the inductance beyond the nodal point, at any given instant this part of the coil will be of opposite potential to the other.

# DISTORTION IN L.F. AMPLIFIERS

By J. H. REYNER, B.Sc. (Hons.), A.C.G.I., D.I.C., A.M.I.E.E.

In this article Mr. Reyner discusses valve characteristics and shows how the usual representation of static characteristics may be misleading in practice. He further demonstrates how dynamic characteristics may be utilised to determine the correct value of grid bias to apply in L.F. amplifiers for the prevention of distortion.



HERE are many ideas which are held on the subject of the operation of low-frequency amplifiers in order to avoid distortion. It is now an almost universal practice to equip low-frequency amplifiers with suitable grid bias arrangements, but there seems to be little definite information as to the correct value of grid bias to employ.

## Necessity for Grid Bias

Now the use of grid bias is necessary for two reasons. The first of these is that the steady voltage applied to the grid controls the working position on the characteristic of the valve, and the second is that if the reproduction is to be reasonably faithful, then the grid current must be reduced to a small value.

## Avoiding Distortion

If, however, one refers to the characteristics of some types of power valves, it will be observed that the value of grid bias recommended by the makers usually occurs at a point such as A in Fig. 1. According to the theory of proportionate amplification, it is necessary to arrange the working point of the valve characteristic such that over the variation of voltage on the grid the anode current characteristic is approximately a straight line. This is by no means the state of affairs, as shown in Fig. 1, and at first sight it would appear that this would give considerable distortion.

## Questionable Utility of Valve Characteristics

The fact of the matter is that our present method of giving valve characteristics is unsound, and indeed the

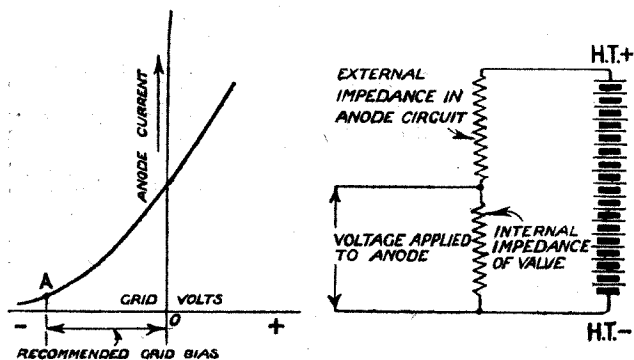

Fig. 1.—The grid bias recommended is often such as to bring the working point well down on the curved portion of the static characteristic.

Fig. 2.—The actual voltage applied to the anode of the valve is less than the H.T. voltage due to the voltage drop on the external impedance in the anode circuit.

information which can be extracted direct from the characteristics is very small. The ordinary type of characteristic is obtained under steady conditions, i.e., with no impedance in the anode circuit of the valve.

In practice, of course, there is always an impedance of some sort in the anode circuit, to enable the energy developed by the valve to be suitably extracted. The presence of this external impedance, however, modifies

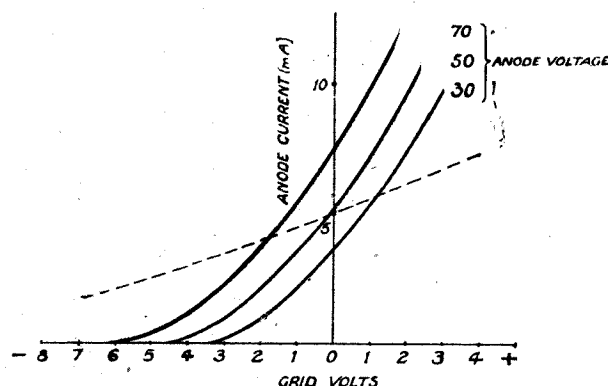

Fig. 3.—Due to the presence of the external circuit the actual working characteristic is as shown by the dotted line.

the characteristics so completely that totally misleading results can be obtained if this principle is not borne in mind.

## Effect of Impedance in Anode Circuit

The current supplied by the high-tension battery flows first of all through the external impedance in the anode circuit and then through the impedance of anode to filament path of the valve, i.e., the internal impedance of the valve. Consequently the actual voltage applied to the anode will be that of the high-tension battery minus the voltage drop of the external impedance. This point will be made clear from Fig. 2. Obviously the value of the voltage drop in the external circuit depends upon the current flowing in the circuit, so that the actual voltage applied to the anode of the valve is continually varying, if the anode current varies, as is always the case in practical reception.

## A Practical Instance

Let us consider a practical case. We will assume that the valve employed has an impedance of 10,000 ohms at zero grid volts, and we will assume that the resistance of the output circuit of the valve, whatever it may be, is 20,000 ohms. The current supplied by a high-tension battery of 150 volts will then be 5 milliamps. The actual voltage on the anode of the valve will be 50 volts, and it will be seen from the characteristics shown in Fig. 3 that at zero grid volts and 50 volts on the anode the current obtained is 5 milliamps.

## Application of Grid Voltage

Consider now what happens if a voltage is applied to the grid which causes the anode current to vary. If

the anode current is increased by 1 milliamp., so that the total anode current becomes 6 milliamps., the voltage drop on the external circuit then becomes  $.006 \times 20,000 = 120$  volts, so that the voltage actually applied to the anode becomes  $150 - 120 = 30$  volts.

### Comparison with Curve

Referring again to the curves in Fig. 3, it will be seen that to obtain 6 milliamps. at 30 volts on the anode requires about 1.2 volts positive on the grid, whereas if the anode voltage had remained at 50, we should have required only about 0.5 volts positive.

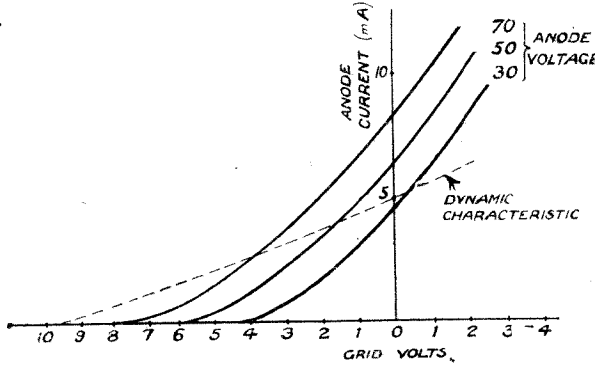

Fig. 4.—In a practical case the dynamic characteristic would be somewhat as shown in this figure.

Similarly, if the anode current decreases to 4 milliamps., the external voltage drop is only 80 volts, giving an actual anode voltage of 70. Here again we can produce the current with about  $-2$  grid volts, whereas with 50 volts on the anode we should only have required about  $-0.8$ .

### The Actual Working Curve

It will be obvious from these considerations that the characteristic over which we are working is not any of the usual curves drawn for a constant anode voltage, but one such as is shown by the dotted line in Fig. 3.

It is this working or dynamic characteristic which we require in estimating the performance of the valve under practical conditions.

It may be observed in passing that the change of  $\pm 1$  milliamp requires a grid voltage variation of 3.2 volts, whereas from the static characteristic the grid swing would be only 1.3 volts. Thus the effective amplification of the valve has been reduced.

This difference between the actual and the theoretical amplification factor has been dealt with before in these columns by Mr. A. Johnson Randall (*Wireless Weekly*, Vol. 6, No. 1).

### A Slight Modification

It will be noted that in Fig. 3 the current with 50 volts on the anode is given as 5 milliamps., a figure which is obtained by dividing the anode voltage by the internal resistance of the valve. In practice the actual anode current is somewhat greater than this, by a certain small constant amount.

A practical case, therefore, would be somewhat as shown in Fig. 4. The only difference is that the static characteristics are all raised slightly relative to the dynamic characteristic. This modification does not affect the fundamental principle as developed in the original simplified case.

### Flattening of Curve

It will thus be seen that the effect of the load in the anode circuit has been to flatten out the characteristic

very considerably. Not only this, but the dynamic characteristic actually crosses the static characteristic at a small negative grid voltage, and also it remains appreciably a straight line over a large range of negative grid voltage.

### Grid Current

Now the grid current commences to flow at or around zero grid volts. Although a small amount of grid current is permissible, any considerable grid current immediately produces distortion, and therefore we endeavour to arrange that the maximum voltage variation of the grid is never sufficient to make the grid positive in respect to the filament.

### Working Point on Characteristic

Equally obviously, if we are to avoid distortion, it is essential that the grid voltage swings shall not reduce the anode current quite to zero, because this would produce rectification and would again introduce distortion. Thus the best working point on the characteristic would be midway between these two extremes, and in the case shown would require about  $-4\frac{1}{2}$  grid volts. This point, however, on the static characteristics is well down the curved portion thereof. It will thus be seen how very misleading the static characteristics may be and also why the recommended value of this voltage often does occur at a point such as A in Fig. 1.

### Plotting Dynamic Characteristic

The plotting of the dynamic characteristic of a particular valve is a fairly easy matter, but involves a certain amount of calculation, and it is possible to

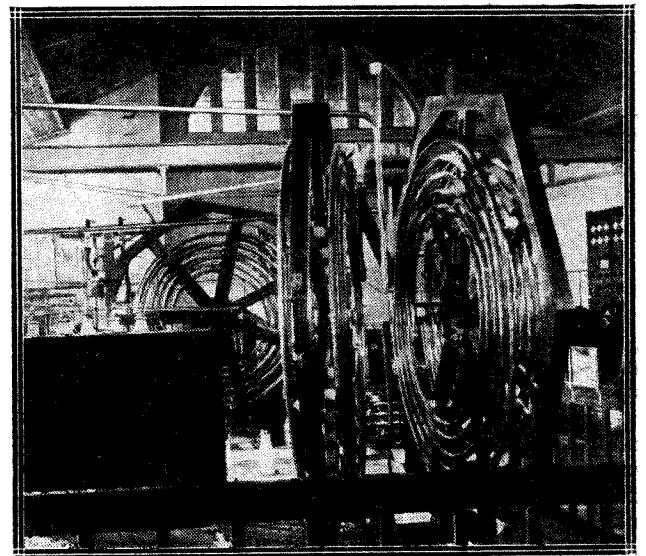

A view in the transmitter building of the new wireless station at Königswusterhausen, showing the type of inductance used. These may be compared with those designed for Rugby, illustrated on page 399 of our last issue.

obtain a rough estimate of the performance of any particular valve by working out the curve in the manner just described.

### Data Required

The value of the external impedance in the anode circuit is the only factor which is likely to be at all difficult to determine, the valve constants being

usually supplied by the makers. It may be remembered, however, that in the case of a good choke or transformer the impedance is of the order of 50,000 ohms at the mean speech frequency, *i.e.*, 800 cycles per second.

**Approximate Calculation**

Actually, of course, the value of the impedance is varying from time to time, because the frequency of the current is continually varying in accordance with the speech or music, so that an accurate calculation cannot be made in a simple manner. The approximate figure quoted, however, will give an indication of the type of dynamic characteristic one may expect, and will prove of assistance in determining what value of grid bias should be employed.

**A Useful Rule**

Captain Round has given a very useful rule of thumb, which certainly gives satisfactory results in the majority of cases. This rule is that the necessary grid bias required in volts is equal to the value of the H.T. voltage divided by twice the amplification factor of the valve. Thus a general purpose valve having an amplification factor of 10 used with 60-volt H.T. battery would require 3 volts negative grid bias.

**Check with Milliammeter**

The possession of a milliammeter enables one to make a very good practical test as to whether the correct value of grid bias is being employed. If any distortion is present, then this current which is produced by the valve will not be proportional to the voltage, but will be proportional to some power thereof. For the sake of argument let us assume that the current is proportional to the square of the voltage. Then let  $V_a + V_g \sin \omega t$  be the steady values of anode and grid voltage. Then the anode current

$$I_a = A \left[ V_a + \mu(V_g + V \sin \omega t) \right]^2$$

$$= A(V_a + \mu V_g)^2 + 2A\mu(V_a + \mu V_g) V \sin \omega t$$

$$+ \mu^2 \frac{AV^2}{2} \cos (2\omega t + \pi) + \mu^2 \frac{AV^2}{2}$$

The first term is a constant. The second term varies as the input voltage. The third term varies as the square of the input voltage, and so introduces distortion, and the fourth term is dependent on the actual amplitude of the applied E.M.F., but does not normally vary. With a varying input, however, such as telephony, this last term continuously varies, so that a milliammeter in the anode circuit will fluctuate. If there were no distortion, this variation of the mean anode current would not take place.

**Slight Distortion Only**

In a similar manner it can be shown that whatever the relation between the current and voltage, there will always be a change in the mean anode current, unless the current and voltage are directly proportional, which, of course, is the condition required for distortionless amplification. If this method is employed it will usually be found that even with a satisfactory value of grid bias, there will be very slight quiver of the needle. This will usually be found to be quite satisfactory. Such quivering may be produced by a variety of causes, some of which are referred to in the Inventions and

Developments column; but such distortion as is present is usually not evident in the quality of the loud-speaker output.

**Slight Swing Permissible**

In practice, as this grid bias voltage is increased it is found that the needle, which perhaps was first of all fluctuating violently, gradually settles down to a more or less steady state, after which the fluctuation begins to reappear. This latter condition, of course, is obtained when grid bias is so heavy that we are actually working on the bottom bend of the dynamic characteristic. This would correspond to about -10 volts in Fig. 4, where rectification would obviously take place, so that the output current would not be a faithful replica of the input current and distortion would result. In between these two extremes, the one without sufficient grid bias and the other with too much, it will be found that there is a region over which the variation of one or two grid volts does not make very much difference, and this is the satisfactory region for the operation of the amplifier.

**Correct Value of Grid Bias**

As has been stated, those who do not possess a milliammeter may ascertain the correct value of grid bias either by obtaining the dynamic characteristic and then choosing the mid-point of the portion which lies between zero grid volts and zero anode current. Alternatively a rough and ready check may be obtained by utilising the formula of Captain Round which was given, or by inspection of the static characteristic, choosing a point such as A in Fig. 1.

**AMATEUR TRANSMITTERS IN GERMANY.**

We hear that the German station KXH, who was frequently heard in this country a few weeks ago, is now officially authorised to transmit on 8,571 and 3,333 kc. (35 metres and 90 metres), using the call-sign K-K7. He has already worked a number of British amateurs on both these frequencies.

The German transmitters have organised a scheme whereby all correspondence intended for them may be sent to Mr. Rolf Formis (K-Y4), of Stuttgart, who forwards it each week to the stations for whom it is intended. They have also succeeded in obtaining certain concessions from the Government in respect of postage rates.

**CALL SIGN "INTERMEDIATES"**

Several American ships, in addition to the licensed amateurs in Hawaii, are now using the intermediate "HU." In connection with ship stations, the American Radio Relay League has standardised the practice of using the official intermediate of the country nearest which they are passing at the time. This will help to avoid confusion.

\* \* \* \*

Various stations with similar call-signs to X3F, Y2A, L6C, etc., using the intermediate "V," are United States Army stations. Some are portable and others use higher power at their various headquarters.

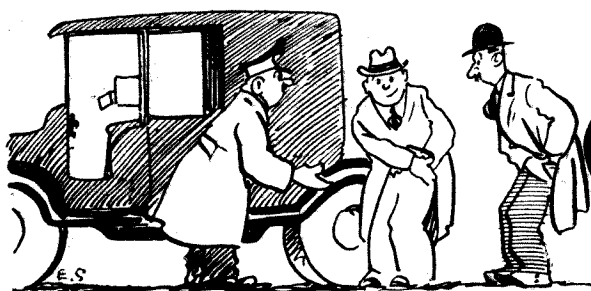

# JOTTINGS

## BY THE WAY

By Wireless Wayfarer.

**I** WAS sitting comfortably before the fire the other evening, and thanking heaven that I was not a fog signalman, when my hand-  
 maiden announced Professor Goop. Leaping up to receive him, I was horrified to see that he was, if I may so express it, in a somewhat part-worn condition. His right ear had lost its usual shell-like form, and had taken on in its stead something of the cauliflower or National Sporting Club shape. His left eye was completely closed and not a little swollen, whilst as he advanced towards me I noticed that he walked with a pronounced limp. "Good heavens, Professor!" I cried. "What have you been doing? Surely you have not crashed once more from your aerial mast!" "No," said the Professor, with a little sad smile. "No. I obtained these wounds, not whilst endeavouring to tighten

myself to listen to the words of wisdom that I was sure would pour from his lips. "I am not at all sorry," he said at length, "that I had that little spill on the slide." "I am sorry," I murmured, with the old-world politeness that never deserts me, "sorry that you took a toss, but glad that you are not sorry." "No one," growled the Professor, "can be both glad and sorry at the same time." "Nevertheless that is my condition," I returned, "and in any case there is no need for you to wink at me, as I have observed you doing several times during the last few minutes." The Professor assured me that he was not winking; the damaged eye would not work properly—that was all. I was thinking of offering once more to even matters up when he burst into speech anew. "I am not sorry," he proceeded, "that this little misadventure happened to me, for it has given me an idea. We have spoken on several occasions of the groove or rut into which our most noted designers of wireless sets have fallen at the present time. Take portable sets, for example. . . ." "I never take portable sets," I said, quickly. "Mrs. Poddleby nearly let me in for one once at a picnic, but I hastily hid behind Gubbworthy, who got the job of carrying the one that she had brought. Gubbworthy has never been quite the same man since he lugged it the necessary hundred yards or so. In fact, he was quite rude to Poddleby about what he called the Insup set." "In—what?" exclaimed the Professor. "Insup," I repeated. "Insup portable, insupportable. See? Ha, ha." The Professor did not see, and it took me quite a long time to explain the thing to him. Professor Goop has been known to boast of an old Scottish strain in his blood.

coaxed a sickly grin from the Professor, I allowed him to continue to develop his account of inspiration. "Who are portable sets designed for?" he asked. "Professional strong men," I replied, without hesitation. "Nō," said the Professor. "Henpecked husbands," I hazarded. "No," said the Professor. "Navvies," I tried. "No," said the Professor. I gave it up in order to save time. "If," said the Professor, "you will examine the designs of the portable sets that have appeared during the last twelve months, you will observe that all are designed for motorists. Now not everyone is a motorist. Take yourself, for example." "I don't know about that," said I. "Why, I often go to Bilgewater Magna by the 'bus, and if I am in Town I always take taxis, if there is anybody else with me. I am such a practised fumbler that it comes far cheaper than 'buses or tubes. You know what I mean. You get out first and say 'This is mine.' The other fellow.



. . . the lads had made a slide . . .



. . . the damaged eye wouldn't work properly . . .

my aerial balliards, but in the course of descending the hill from the Microfarads towards your comfortable home. The dear little lads of the town had made a slide upon the pavement, and I had forgotten all about it, until I suddenly slid. Still, these trifling scars are nothing at all. Nature will repair the damage in the course of a day or two."

### Inspiration

Having ministered to the eye and the ear—Professor Goop was quite nasty about my suggestion that I should make him less lopsided by giving the other ear a biff with the fire shovel—I placed a comfortable chair before the fire and sat down

### Motorists Only

When I had done quite a lot of laughing myself, and had at length

who probably knows something about fumbling, crawls out after you and says, 'No, no, I'll do this.' You then have extraordinary difficulty in getting off your glove and in unbuttoning your overcoat. If the other chap is a pretty practised hand you can always refer, as Wallows does, to the arm that you broke out hunting a year or two ago, and cuss the thing for being so clumsy. If he has a shred of manhood in him, he will at once produce the necessary shekels, but if not it is simply a question of keeping on until he does." "I am not referring," the Professor went on icily, "to casual motorists. I maintain that every portable set so

far designed has been made up with a view to its use purely and simply by the real, genuine motorist, the fellow who owns a car." "I know," I cried, "chaps like Dippleswade who pay 4s. 9d. down and the balance by monthly instalments of 7s. 11d."

**Professor Goop Explains**

"The whole basis of journalism," Professor Goop continued, "is that one should be topical. Portable sets should always meet the need of the moment." "A splendid idea," I cried. "The time draws nigh for the season of Quarter-Day. Let us design a portable set for moonlighters. That would be just a beginning. For the issue of *Wireless Weekly* which appears just before Derby Day we will have one for jockeys, and in case the favourite should win we will have in the same number one for bookmakers who practise in the half-crown enclosure."

**The Great Idea**

"All of these," said the Professor, "are quite good suggestions. We will deal with them in due course. Meanwhile what is happening at the present time of the year? For whom shall we design portable sets that are topical?" "For snow-shovellers," I cried; "for unemployed hop-pickers, for fellows who charge you tuppence for sitting on a chair in the park (theirs must be a dull existence during the winter months)..." The Professor held up his hand. "I think," he said, "what is really required is a portable set for skaters. Has it never occurred

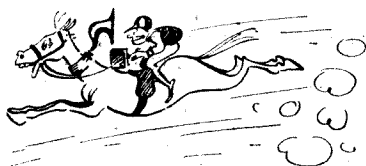

... wireless for jockeys ...

to you that when the country is in the grip, as it now is, of an iron frost, wireless enthusiasts such as Bumbleby Brown or General Blood Thunderby must be torn by conflicting desires?" "Why, yes," I exclaimed, "only yesterday I saw two of them being so rent—no, I will not use the word rent; it is too topical to be pleasant. Two of them were being fairly pulled to pieces. I was lunching at the Giddy Goat, and I found myself at

the same table as the General and Bumbleby Brown. Each of them ardently desired to have Yorkshire pudding with his roast beef, though neither really dared, because they had both found that they were putting on weight of late."

**Topical Sets.**

"No, no," gurgled the Professor. "What I mean is this. Winklesworth, say, comes back from a long day in the City and feels a two-fold urge. He desires (a) to listen to wireless, and (b) to go skating upon the flooded meadows by the side of the Pud. As things are, he cannot do both. He must choose one or the other. How about yourself? What would you do in such circumstances?" "I should go to the movies," I said. "I always believe in splitting the difference." "That," said the Professor, "is just because there exists at the present moment no really suitable portable set for the skater. This is a defect that I propose to remedy without delay. Now what in your opinion should be the outstanding feature of such a set?" I rubbed myself thoroughly at various points which had come into violent contact on recent days with the ice that covers a large area around the Pud. "Air cushions," I suggested; "several air cushions."

**A Noble Scheme**

The Professor was very much taken with my last idea. It occurred to him at once that there was not the slightest reason why the "low-loss" and "safety first" slogans should not be combined by winding coils round air-cushions, thus obtaining both air-spacing and protection. "If," he said, "you will give me a sheet of paper, I will show you the circuit that I have in mind." I dashed to my writing table. Usually it is covered with pieces of paper. At the moment there was not one. It was borne in upon me that it was the day upon which my den suffers its weekly tidying-up by the domestic staff. The Professor was therefore forced to describe in words the circuit that he would otherwise have recorded in black and white. Though you have missed a great deal on this account, the special draughtsman retained by the Radio Press for the purpose of drawing the Goop circuits was so overjoyed on hearing the news that he dashed from the office, when after seventeen different efforts at boarding

motor buses whose standing room capacity was already filled, he eventually picked up a Black Maria, and has not been heard of since.

**The Circuit**

Let me briefly outline in these poor halting words of mine the circuit which the Professor's pencil was unable to set down on paper for you. The receiving set itself consists of an eleven-valve super-heterodyne, made up in a cabinet

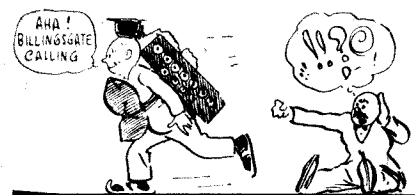

... a simple little arrangement ...

measuring 36 in. x 10 in. x 10 in. This is strapped to the skater's back by a simple little arrangement of girths and things. The loud-speaker is made by fixing a single telephone receiver to the crown of a bowler hat, which the skater must wear upside down when he wishes to tell the world what 2LO or any of the other stations is doing. The high-tension battery is carried in the right-hand pocket of the coat, and the grid battery in the left. The coat itself should be provided with poacher's pockets, and can be obtained from Messrs. Grabbit & Tabbs, my own tailors, a royalty of ten per cent. being payable to me. If only readers of *Wireless Weekly* do the right thing, my own tailor's bill will be paid off in simply no time at all, and I shall be able to think about my spring suiting. The accumulator presented a certain amount of difficulty at first, until we got into touch with the Ososophto Rubber Company, who have designed a special air cushion and accumulator combined, which the enthusiast can wear either upon his back or over his knees, according to the direction in which he is most accustomed to falling when indulging in skating. We are, however, in correspondence with the Selfwatt Company, who are designing a neat little rubber-cushioned dynamo, to be worked by the skater himself as he moves forward with alternate thrusts of the right and left foot over the ice.

**WIRELESS WAYFARER.**

(Next week the "Jorrocks" set for fox-hunters.)

# Some Practical Transmitting Circuits

By the Staff of the Radio Press Laboratories.

Continuing the "Radio Transmission" series of articles, a number of practical transmitting circuits are discussed, including both simple arrangements and more complicated apparatus, special attention being paid to methods of maintaining constant frequency in transmission.

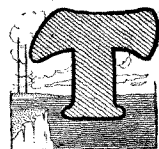

**T**HIS week it is proposed to discuss some of the more general circuits that are used in valve transmission. The question is often asked as to what is the best circuit for transmission work. The perfect transmitting circuit does not exist, just as there is no ideal receiving circuit. Each circuit has its own special features to suit certain conditions, and it is generally found that if an advantage is gained in one direction it is usually at the sacrifice of some other feature.

## The Single-Circuit Oscillator

This circuit consists of the well-known "Hartley" circuit, and is shown in Fig. 1. The tuning condenser C, which controls the frequency, is connected across

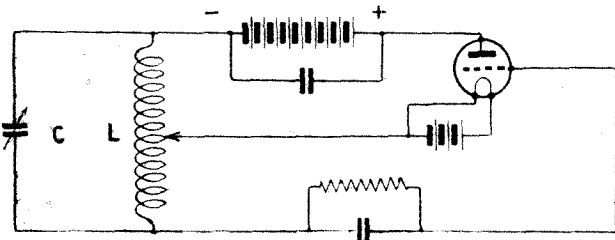

Fig. 1.—The "Hartley" circuit in its simplest form.

the whole of the inductance L, included in both the grid and anode circuits. The filament is taken to a tapping point somewhere about the centre of the coil. The high-tension supply is connected between the anode and one end of the tuning coil. In this type of circuit it is very easy to realise the phase relation existing between the grid and anode voltages. When the grid end of the coil is maximum positive with respect to the filament the anode end of the coil must be maximum negative with respect to filament, and the voltage across the anode-filament of the valve under these conditions is equal to the difference between the high-tension supply voltage and the voltage across the part of the inductance in the anode circuit.

## Similar Circuits

Fig. 2 shows the same circuit as above, but with entirely separate inductances  $L_1$  and  $L_2$  connected in the anode and grid circuits. There need be no coupling between  $L_1$  and  $L_2$ , as the reaction is obtained electrostatically by means of the main condenser C.

The Hartley circuit is very convenient for many purposes. It is simple, and will cover efficiently a wide band of frequencies with a single condenser adjustment. It is particularly suitable for directional transmission work from a frame aerial, the latter being

connected in place of the inductance L of Fig. 1, as shown in Fig. 3.

## Effect of Capacities to Earth of Anode and Filament Batteries

It will be seen from Fig. 1 that if the anode and filament batteries have a large capacity to earth, these will be the equivalent of a condenser across the anode part of the inductance L. This makes the circuit asymmetrical, and is liable to cause inefficiency and possibly failure to oscillate. It is therefore important if the circuit shown in Fig. 1 is used that both the high-tension battery or generator and the filament battery are not only well insulated from earth, but also have a low capacity to earth and, of course, to each other.

## A Remedy

To overcome the difficulty, particularly if the high-tension supply is from a generator, it is preferable to use the circuit shown in Fig. 4, in which the positive high-tension supply is fed to the anode through an efficient high-frequency inductance  $L_1$ , the negative end of the supply being connected direct to the fila-

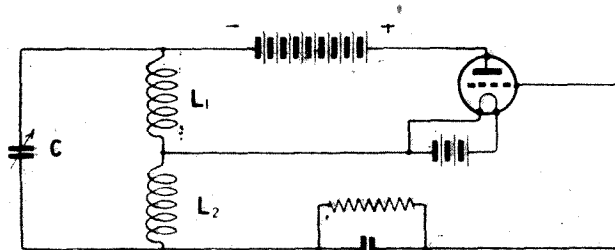

Fig. 2.—Another version of the "Hartley" circuit, no coupling being provided between the grid and anode inductances.

ment. The anode must be connected to the coil through a condenser  $C_1$  in order to prevent the H.T. supply being shorted.

This method of "top feed" to the anode has the disadvantage that it is difficult to obtain a high-frequency choke which is suitable for more than a limited band of frequencies.

**Another Method**

Another circuit which overcomes the trouble of stray capacities to earth is shown in Fig. 5. In this circuit the inductance  $L$  is broken at about its middle point, and a large condenser is inserted. The high-tension supply is connected across this condenser, the

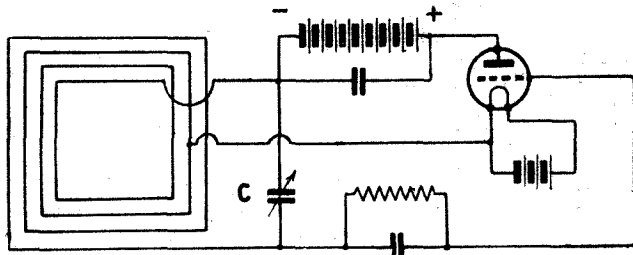

Fig. 3.—The "Hartley" circuit is particularly suitable for directional transmission with a frame aerial.

positive being fed through a high-frequency choke to the anode side of the condenser. The choke in this case is not so vitally important, and is used more as a protection against the high frequency getting back through the generator.

**Aerial and Earth System**

The Hartley circuit is not very convenient for connecting directly to an aerial and earth system, because, unless the filament is fed through efficient high-frequency chokes, the filament will necessarily be at a high-frequency potential above earth, and this will cause trouble through the circuit becoming asymmetrical. It is generally preferable to use a loosely-coupled aerial circuit to overcome these difficulties when using the Hartley circuit, although chokes in the

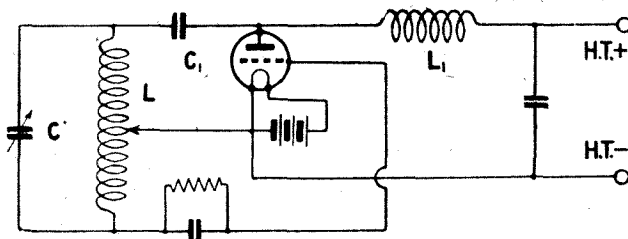

Fig. 4.—A method of "top feed" to the anode of the valve, which has the advantage of separating the high-tension supply from the oscillatory circuits.

filament leads may be found satisfactory under certain conditions.

**Another Reaction Method**

Another circuit which may be considered to operate by means of electrostatic reaction is shown in Fig. 6. By making  $C_1$  small, the voltage in  $L_1$  is 180 degrees out of phase with the voltage across  $L_2$ , which is the condition for oscillation. An aerial and earth system can be connected to the circuit in place of the condenser  $C$ , as shown by the dotted lines.

**Reaction by Inductive Coupling**

The ordinary inductive reaction circuit, suitable for low or medium power work, is shown in Fig. 7. It is simple, and with a reaction coil  $L_1$ , designed to suit the particular bands of frequencies required, it can be made very efficient. The condenser  $C$  can be replaced by an aerial and earth system. As the posi-

tive H.T. supply is connected to the aerial coil, it is important that the blocking condensers  $C_1$  and  $C_2$  be placed in the aerial and earth leads, so as to protect the generator, and prevent the aerial being at a high D.C. potential above earth.

**High-Power Transmission**

A circuit which is used for high-power transmission is shown in Fig. 8. One or two turns of the aerial circuit are coupled to the grid coil  $L_2$ , across which there is a variable condenser  $C_1$ , not for the purpose of tuning, but as a phase compensator to ensure that the grid voltage is exactly opposite in phase with the voltage across the anode inductance. The positive H.T. supply is fed direct to the anode through an efficient high-frequency choke  $L_3$ , the negative supply being connected to the filament through the H.F. choke  $L_4$ .

**Constant Frequency**

A very important requirement in continuous wave transmission, both for telegraphy and telephony, is

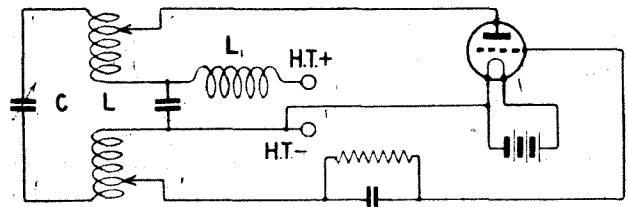

Fig. 5.—An alternative circuit to that of Fig. 4, which also overcomes the trouble of stray capacities to earth through the H.T. generator or battery.

that the frequency of the oscillation be maintained steady to within a few cycles. This is not an easy problem, particularly with regard to the higher frequencies. Any variation in high-tension voltage, filament current, or stray capacity effects will cause wide fluctuations in frequency when frequencies greater than 3,000 kilocycles (100 metres) are considered. Even at frequencies of the order of 300 kilocycles (1,000 metres), swaying of the aerial in the wind will cause variations of the frequency unless special precautions are taken. By loosely coupling the aerial to the valve circuit these variations due to aerial swing can be considerably reduced, but this precaution alone is not sufficient, particularly at very high frequencies.

**Independent Drive Oscillator**

The usual method now employed for maintaining

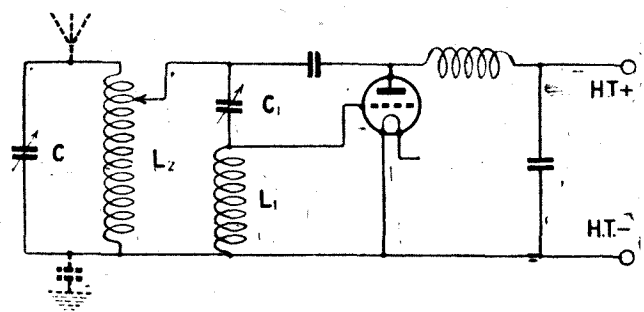

Fig. 6.—In this circuit, in which electrostatic reaction is operative, the condenser  $C_1$  should have a small value.

constancy of frequency is the independent drive, or separately excited grid circuit.



This circuit consists essentially of a high-frequency amplifying circuit, by which the oscillations from a constant frequency valve oscillator are amplified before transference to the aerial. Normally there is only one high-frequency amplifying or power valve, but two or more may be used if found necessary, and this may be the case if the initial oscillation is comparatively weak. With this type of transmitter it is possible to obtain oscillations in the aerial which are practically

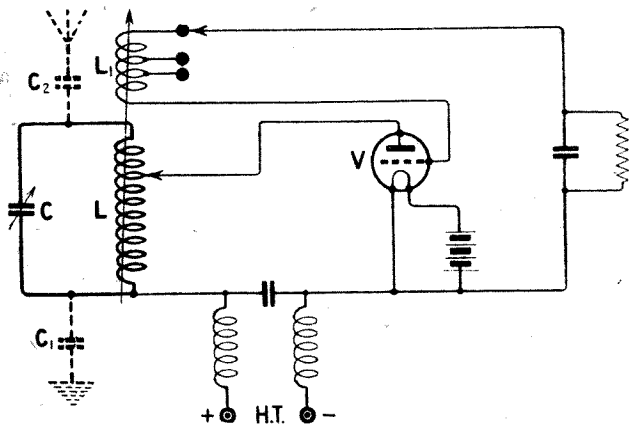

Fig. 7.—A circuit suitable for medium or low-power transmission, in which ordinary inductive reaction is employed.

independent, as far as frequency is concerned, of any small variations in aerial capacity.

**Undesirable Oscillation**

There are several important points to bear in mind when such a circuit is used, as otherwise the frequency of the independent oscillation will be affected by outside variations in aerial capacity and load on the power valve. In other words, the amplifying or power valve is very liable to take control of the oscillations. It is often found with such a circuit that on switching off the independent oscillator practically no effect is produced on the current in the aerial. This means that the amplifying or power valve is

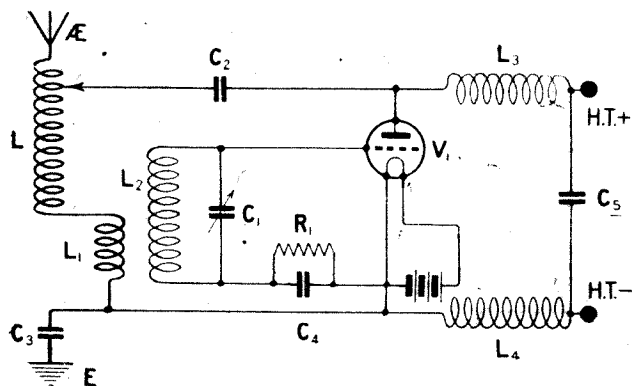

Fig. 8.—A circuit used for high-power transmission with a direct coupled aerial. The condenser C<sub>1</sub> is adjusted so that the correct phase relationship is obtained between the grid voltage and the anode inductance voltage.

oscillating on its own, due to stray reaction coupling through the capacity of the valve, or through capacity or inductive coupling between the various leads in the circuit. This trouble is particularly liable to occur when working at the higher frequencies.

**Neurodyning**

One comes up against exactly the same trouble in receiving circuits, when the grid and anode circuits of a high-frequency amplifier are tuned to the same frequency. This tendency for oscillations to occur under such conditions is well known to everyone who has used such circuits.

The most obvious solution of the difficulty would appear to be the incorporation of some form of neurodyne circuit, in which the effect of the valve capacity is balanced out by means of an external condenser.

Fig. 9 shows the general principles of an independent drive oscillator with a neurodyne adjustment to balance out the effect of the anode grid capacity of the power valve. When the neurodyne condenser is properly adjusted, slight variations in the aerial capacity should not affect the frequency of the radiated wave.

**Grid Bias**

Another important precaution is the incorporation of a grid bias battery or generator instead of the usual grid-leak and condenser. This is done with a view

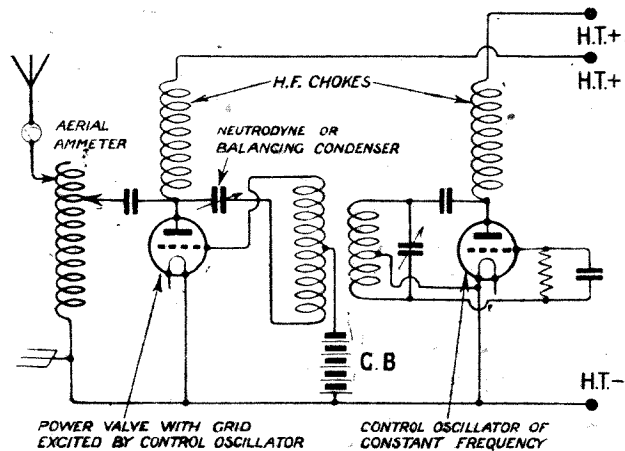

Fig. 9.—Illustrating the principle of the independent drive oscillator.

to keeping the load on the control oscillator as small as possible. A grid condenser and leak necessarily requires a certain amount of power to maintain a negative bias, and as this is liable to vary under working conditions when the load on the power valve is altered there is a tendency for the frequency of the control oscillator to vary. It is important to arrange for a sufficient negative grid bias to prevent the grid of the power valve from becoming positive, in order that no load may be taken from the control oscillator due to grid current.

In the next article in this series it is proposed to deal with the various methods by which a continuous wave can be modulated.

**“The Wireless Constructor”**

CHRISTMAS ISSUE NOW ON SALE,  
124 PAGES. PRICE 6d. AS USUAL.

**DO NOT FAIL TO SECURE YOUR COPY**

# Short Waves for Long Ranges—a Review

An abstract of a Paper read by Captain W. G. H. MILES, R.M., before the Radio Society of Great Britain.

We give here a general summary of Capt. Miles' Paper, which deals with the increasing use of short waves for long range wireless communication since 1922, compares the main features of long and short-wave working, and discusses some of the problems incident on the employment of the beam system of short-wave propagation.

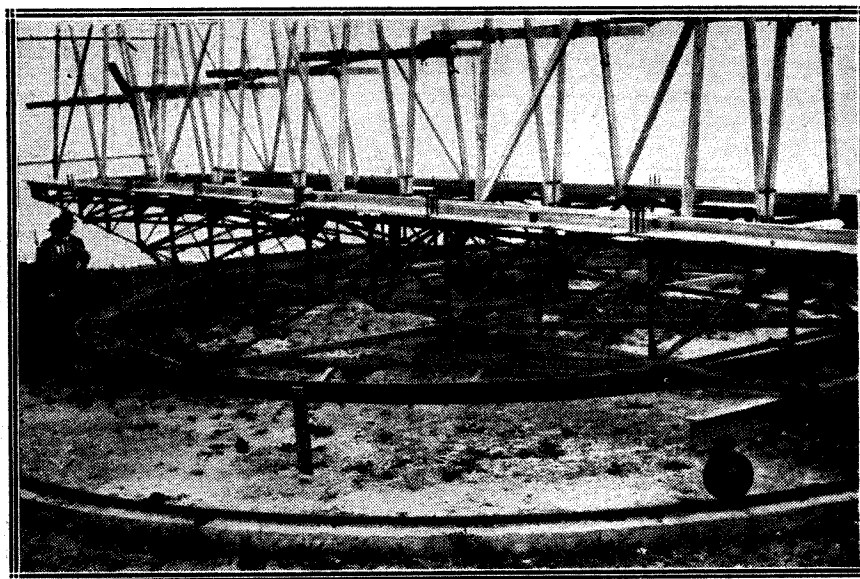

The wireless lighthouse which was demonstrated recently by Senatore Marconi, uses a very high frequency for transmission.

CAPT. W. G. H. MILES, R.M., lecturing on "Short Waves for Long Ranges—a Review," gave some interesting facts in relation to modern short-wave practice. Dividing wireless progress into three eras—spark, long-wave, and, lastly, short-wave—he dealt briefly with wireless history before dealing more fully with short waves.

### Advantages of Short Waves

There are four main advantages in the use of short waves for long range telegraphy:—

(a) Economy in power. This is well illustrated in the comparison between the power which will be utilised by two G.P.O. stations.

Rugby, which is a long-wave station designed to work Australia, requires 1,000 kw., whereas the short-wave beam station now in course of construction, designed for

allotted to the 300-30,000 metre (10 to 1,000 kc.) band were practically all employed.

Below 100 metres (3,000 kc.) the field for new services is not so restricted as might appear at first sight. An example will make this clear. Between 9 and 10 metres (30,000 and 33,333 kc.) there is as large a frequency difference as

(d) Freedom from atmospheric interference, as compared with that experienced on long waves.

### The Work of Amateurs

With these many advantages it became obvious that short waves had come to stay. Developed, as they were, from the services of amateurs, to whom a great debt was due by the professional wireless engineer, they yet became of great commercial and professional importance.

How greatly the amateurs assisted this development will be realised from the fact that when wavelengths were being allocated for the various services, those then thought to be of value were allotted to the professional users. The range 220 metres (136 kc.) and below, which was thought to be of no commercial or service use was given to the amateurs, and as a great concession 1,000 metres (300 kc.), which was thought to be the only wave with which they could possibly obtain any range.

The importance of the progress achieved between December, 1921, and May, 1925, which has resulted in practically every part of the world being bridged in daylight with a power of less than 1 kw., is too obvious to need comment.

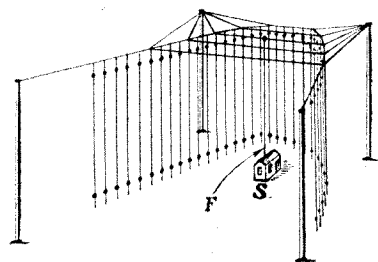

Fig. 1.—A sketch and plan diagram of one system adopted for beam transmission, vertical wires of equal length being hung round a parabolic support, with the transmitting apparatus at the focal point.

the same purpose, will require only about 40 kw.

### Solution for Overcrowding

(b) The possibility of utilising a hitherto unused wave, or frequency, band.

On the longer wavelengths the number of stations which could be

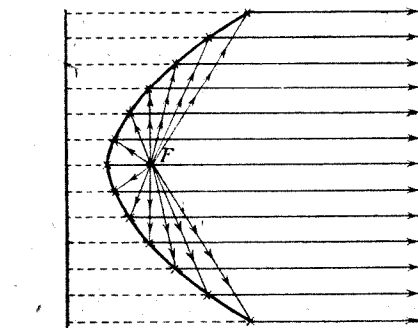

between 100 and 30,000 metres (10 and 3,000 kc.).

(c) The concentration of the propagation of short waves by means of a reflector.

Long waves may, of course, be reflected, but the size of the reflector required in such a case is quite impracticable.

**Empire Wireless Chain**

In 1920 a Government Committee proposed an Empire chain of stations every 2,000 miles, so that a message intended for Australia could be relayed by the various links. The

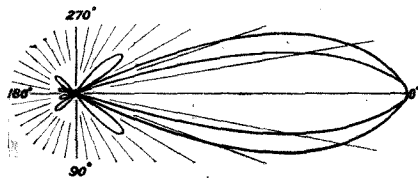

**Fig. 2.**—Illustrating the concentrated radiation mainly in one direction from a transmitting station using a reflector.

Dominions replied that they would prefer higher power to work direct.

Another committee in 1924 agreed to this, and the G.P.O. commenced the construction of Rugby, which cost about £350,000. The Dominions followed suit, and also entered into contracts.

**Senatore Marconi's Beam Experiments**

In July, 1924, Senatore Marconi announced the results of his 92 metre (3,261 kc.) experiments. These results were the satisfactory communication with Australia so long as darkness extended over the whole route.

December, 1924, produced the information that using a 30-metre (10,000 kc.) wave he had communicated with Montreal, Rio de Janeiro, and Sydney during daylight, without a reflector. September, 1925, during which his most recent experiments were conducted, gave daylight results only, on 15 metres (20,000 kc.).

As the result of these announcements, all the high-power station contracts entered into by the Dominions were cancelled, and contracts for short-wave beam stations were substituted for them.

**Short-wave Technique**

There are certain differences in technique between long- and short-wave working. In transmission on short waves every precaution must be taken to keep a constant wavelength and to avoid undesired capacity effects. An independent drive or master oscillator must be employed, as a valve cannot be allowed to oscillate the aerial direct.

**Wavelength and Aerial Length**

Account must be taken of the length of the aerial in proportion to the wavelength on which it is desired to transmit.

It is possible, and is in fact standard practice, to make the wavelength on short waves bear a definite relation to the length of the

aerial. When this is done, it is found that the radiation is directed upwards at an angle instead of horizontally.

The theory that energy is propagated in an upward direction is borne out by the fact that there is (except in the case where the wavelength is one-quarter of the aerial length) a zone near the transmitter where signals are not heard.

**Optimum Radiation Angle**

This conception suggests that there is a best angle for this energy radiation, according to the time of day and the range required, and that the wavelength and the aerial length ratio should be arranged so as to give this angle.

The energy radiated at this optimum angle can reach a higher value than when the vertical aerial is energised at its fundamental wavelength, that is to say that the third harmonic radiated at an angle of 47 degrees is  $1\frac{1}{2}$  times that radiated by a vertical aerial oscillating at a  $\frac{1}{3}$  of its wavelength. On the fifteenth harmonic, radiated at 72 degrees, the energy is  $4\frac{1}{2}$  times that on the fundamental.

**Daylight Losses**

It would have been thought that,

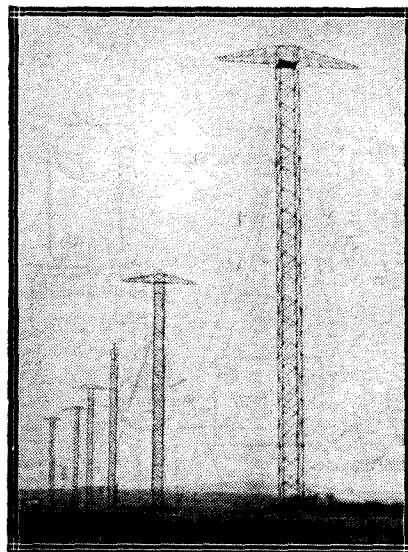

**The masts of the Marconi beam station at Bodmin, Cornwall, are arranged in the system shown diagrammatically in Fig. 3.**

as shorter waves are more efficient, there would have been something of a scramble for them. One factor militating against the use of the short waves was the greater daylight losses.

Also, before the merits of short waves were realised, it was thought

that the greater the range the greater must be the power put into the aerial. It would appear, however, that it seems to be more important to choose one's wavelength correctly.

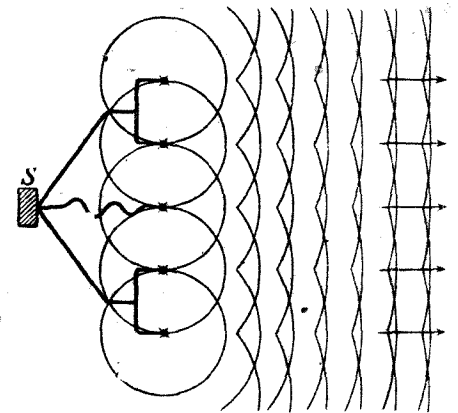

**Fig. 3.**—The modern beam system utilises a number of aerials in a row, fed in parallel from the transmitter.

**Beam Station Reflectors**

Turning to the question of beam transmission, it is well known that any ether wave may be focussed into a beam if the correct sort of reflector is used.

In the case of the wireless beam, the reflector takes the form of a number of wires hung up behind the transmitting aerial (see Fig. 1). The shape of the reflector in plan may be either parabolic or flat. The wires constituting the reflector are each separately tuned to the transmitting wave.

**Energising the Reflector**

When the transmitting aerial is energised it sets all the wires of the reflector in oscillation, and the resultant radiation from them reinforces that of the transmitting aerial in the required direction, while behind the reflector and to the sides there is little radiation (Fig. 2).

A parabolic reflector is not very convenient for long ranges, owing to the difficulty of sufficiently energising such a short aerial.

**The Modern Reflector**

It is more convenient to have a number of aerials in a row and feed them in parallel (Fig. 3).

These reflectors concentrate energy in one direction—at right angles to the plane of the aerial.

The aerial wires have no tendency to radiate in a direction in line with themselves by reason of the manner in which they are spaced. This form of aerial is being adopted by the Marconi Company both for transmission and reception.

# Inventions and Developments



UNDER THIS HEADING  
 MR. J. H. REYNER, B.Sc. (Hons.), A.C.G.I., D.I.C., AM.I.E.E., OF  
 THE RADIO PRESS LABORATORIES, WILL REVIEW  
 FROM TIME TO TIME THE LATEST  
 DEVELOPMENTS IN THE RADIO WORLD.



VERY interesting paper\* has recently been read before the Institute of Electrical Engineers on the performance of amplifiers, in which the result of a large series of measurements made at the National Physical Laboratory on the amplification of amplifiers is discussed. Hitherto the method of measuring the amplification has been subject to somewhat serious error. The telephone method, in which the actual measurement consists of comparing two sounds, is

the author is shown in Fig. 1. It consists essentially of a radio-frequency oscillator, which is made to supply current to the amplifier under test. The current input to the amplifier is required to be very small indeed, and in order to obtain this, the current in the oscillating circuit is first of all cut down by a suitable current transformer, across the secondary of which is an accurately calibrated high-frequency potentiometer. Thus it is possible, by measuring the current in the primary of the transformer with a thermo-galvanometer, to obtain a

is the best method of measuring the amplification of an amplifier. It is suggested in this paper that it is better to measure the actual amplification of the fundamental frequency only, treating any harmonics which may be introduced as detrimental to the main amplification and therefore not to be included. It is found that the difference between the two possible amplifications, one measured in terms of the R.M.S. value of output current and the other the value of the fundamental component only, may be as much as 20 per cent.

Arrangements are made, therefore, to modulate the high frequency with a suitable low frequency at about 1,000 cycles.

### Vibration Galvanometer

The current in the amplifier is subsequently rectified either in the amplifier itself or externally, and the low-frequency current produced is applied to a vibration galvanometer. This is an instrument having a small mechanical oscillating system, which is tuned to the frequency of the applied current. The actual extent of the mechanical vibration is measured by means of a spot of light thrown on to a suitable scale.

Being tuned, it will not respond appreciably to currents of a frequency other than the resonant frequency of the vibrating system. By this means, therefore, the only output measured is that at the fundamental frequency, and the harmonics do not produce any appreciable effect.

### Modulation

The modulation of the radio-frequency current is produced by means of a low-frequency oscillator, which is coupled to the radio-frequency oscillator through the

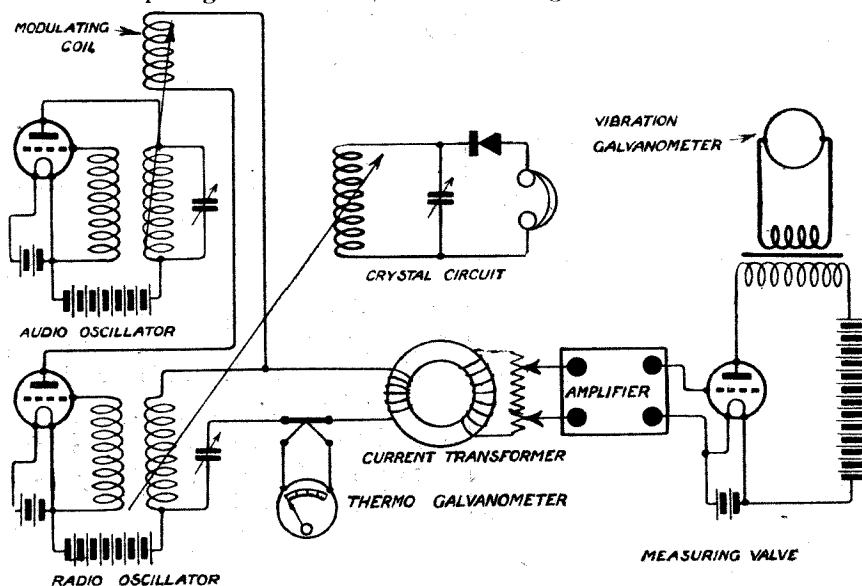

Fig. 1.—Showing the general scheme of the apparatus employed by the author.

not at all satisfactory, and indirect methods of measuring signal strength, such as "slide back" methods, are of somewhat doubtful accuracy.

### Method Employed

The actual circuit employed by

\*"The Performance of Amplifiers," By H. A. Thomas, M.Sc.

definite and accurate knowledge of the voltage supplied to the terminals of the amplifier.

### Sound Output Misleading

Although sound output is of importance, in that our interest is ultimately concerned with the sound obtained, it does not follow that this

medium of the modulating coil shown in Fig. 1. The low-frequency pulsations then actually vary the voltage applied to the anode of the radio frequency oscillator and the circuit is so arranged that complete modulation may be obtained.

If it is desired to obtain the rectifier characteristic of the amplifier as well, it is essential that the actual percentage modulation shall be known. In the measurements described the modulation was therefore adjusted to be 100 per cent. in

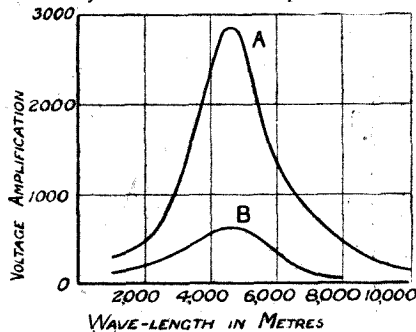

Fig. 2.—A marked difference was observed between two apparently identical 3-stage H.F. amplifiers. In curve A reaction effects increase the overall amplification.

each case, this being tested by listening in on a suitable crystal circuit loosely coupled to the radio frequency oscillator. If the radio frequency is over modulated then harmonics, i.e., octaves of the fundamental 1,000 cycle note, can easily be detected on the telephones, and the modulation is reduced until the harmonics just cease. Tests with an electrostatic voltmeter demonstrate that this method of ascertaining complete modulation is quite adequate.

**Some Conclusions**

The results obtained show that

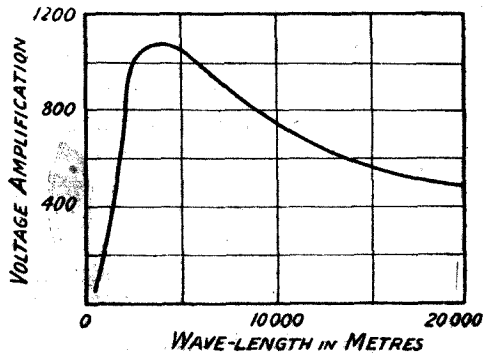

Fig. 3.—In this curve of a 6-stage resistance-coupled amplifier, it will be seen that the overall amplification falls off sharply below 4,000 metres (75 kc.).

there are considerable differences between amplifiers even of the same type, due to varying reaction effects between the various valves. An

interesting point, however, is that the amplification of a high-frequency amplifier increases considerably as the input is decreased. Certain authorities claim that for very weak input the amplification falls once more, but no tests are described in the present paper with sufficiently small input voltages to obtain any confirmation of this point.

**Low-Frequency Amplifiers**

With low-frequency amplifiers the matter of measurement presents less difficulty. In this case the audio-frequency oscillator in Fig. 1 is coupled direct to the amplifier through an ordinary low-frequency potentiometer, and the output is measured in the same way as before. It is found that in the majority of cases the amplification on a two-stage amplifier is not equal to the product of the amplifications of each individual stage. By taking suitable precautions, however, the difference can be made about 1 per cent. only.

**Effect of Amplifier on Tuned Circuit**

In the middle section of the paper the effect of the amplifier on the tuned circuit connected across the input terminals is investigated both theoretically and experimentally. Theoretically it is shown that the effect of the amplifier is to add a shunt resistance and capacity in series across the tuning circuit, as shown in Fig. 5. The results which are obtained on this assumption are found to agree very well with practical conditions.

**Measurement of this Effect**

The method of measuring the effects on the tuning circuit consisted in obtaining the resonance curves and plotting the decrement of the circuit under the varying conditions. It is interesting to note that the method adopted for these measurements was the reactance variation method employed in the measurements of coil resistance which have recently been published in *Wireless Weekly*, the only difference being that in this case the frequency was varied and not the tuning capacity.

**Values Obtained**

It appears that the value of the capacity  $C_1$  is approximately constant irrespective of the conditions, and the value given in the paper is of the order of  $9 \mu\mu\text{F}$ .

The resistance depends upon the inductance in the tuning circuit, and increases as the inductance increases. When  $L$  was  $156 \mu\text{H}$ , the

resistance  $R_1$  was approximately 20,000 ohms, while if the inductance was increased to  $654 \mu\text{H}$ ,  $R_1$  increased to about 87,000 ohms. The effects due to reaction are discussed theoretically and practical

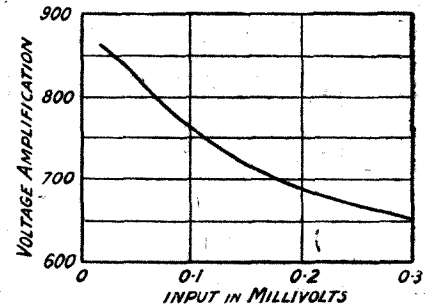

Fig. 4.—From the curve of a 6-valve untuned transformer-coupled amplifier it appears that the amplification falls with increasing input.

results indicate that the theory is correct.

**Distortion**

The third section of the paper deals with the question of distortion in low-frequency amplifiers. It would appear from the results obtained that as long as the output is small the distortion is not serious, but the effect of increasing output produces harmonics which increase much more rapidly than the fundamental. Secondly, as the frequency is lowered the distortion becomes more serious. It is pointed out that at a frequency as low as 150 cycles, with an output of about 1 milli-ampere only, the fundamental may be almost completely eclipsed by harmonics.

**Negative Grid Bias**

The effect of negative grid bias is to reduce the magnitude of the second and third harmonic, but to introduce, on the other hand, smaller harmonics of a higher order such as the 4th, 5th, 6th, etc. It will thus be seen that the introduc-

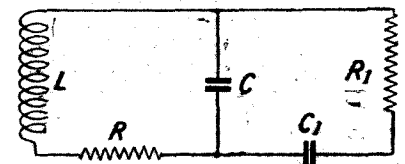
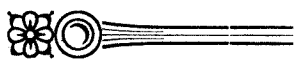

Fig. 5.—Showing how an amplifier has the effect of adding a shunt resistance and capacity across a tuned circuit.

tion of grid bias does not necessarily prove an infallible cure for distortion. The results given in this section of the paper, however, are only preliminary, and work is actually being carried on at the National Physical Laboratory on this subject, so that further developments will probably be forthcoming.



# THE FUTURE OF

## EVIDENCE BEFORE THE

*The Committee of Inquiry appointed to investigate the B.B.C. recommendations with regard to the future organisation of the subject of Broadcasting. We give below a summary of the*



*The Earl of Crawford, chairman of the Committee of Inquiry.*

**W**HAT is to be the future organisation controlling the broadcasting in this country? This subject is at present under consideration of the Committee of Inquiry appointed by the Government.

### Evidence Heard

Already evidence has been taken by the representatives of three interested parties. The first, the Post Office witness, was heard "in camera." On December 3 Mr. J. C. W. Reith, the managing director of the B.B.C., appeared on behalf of the existing organisation. The Wireless League, represented by Sir A. Stanley, Chairman, Prof. A. M. Low, Secretary, and Mr. D. S. Richards, Chairman of the Ilford and Home Counties Area Committee, gave evidence on December 4, claiming to submit the listener's point of view.

### The Committee of Inquiry

The members of the Committee present on each day were the Earl of Crawford, Chairman, Lord Blanesburgh, Sir P. Royden, Sir

H. Hadow, Mr. Wm. Graham, M.P., Mr. Ian McPherson, M.P., Dame M. Talbot, and Capt. Ian Frazer.

Further interested parties have applied to be heard, and on December 17 Lord Riddell will appear for the Press, and on December 18 various artistes' organisations, music publishers, and Messrs. Chappells will submit memoranda.

### B.B.C. Evidence

Mr. J. C. W. Reith, in his memorandum, submitted evidence on the scope and conduct of the broadcasting service, and emphasised particularly that he made no recommendation as to any future constitution.

The main object of his memorandum was to show the desirability for the service of broadcasting to be conducted as a public service, with the adoption and maintenance of definite policies and standards in all its activities and for unity of control.

### An Impartial Statement

It was submitted as an impartial statement on the administration of a public service, and must not be regarded as a submission of evidence by specific interests.

The service should not be used for entertainment alone, for, if rightly developed and controlled, its future as an influence—a world influence—for good could hardly be conceived. It was equally capable, if abused, of being a harmful influence of equal potentialities.

Mr. Reith said that the B.B.C. received an average of 8,810 letters per week, of which total 4,700 came from the London area. On analysis these showed that 95 per cent. were expressive of appreciation, 3.5 per cent. were critical, and 1 per cent. were suggestions or

constructive criticism. He thought their Sunday programmes were universally appreciated and approved. He did not concur with the view that the Sunday programmes should be secularised. At the same time, they did not wish to encroach upon the work done by the various churches, unless a complete service were broadcast. They might consider the question of a secular and a religious programme transmitted on different wavelengths, so that listeners could choose for themselves.

### A National Influence

The B.B.C. already have some 10,000,000 listeners, and the broadcasting service is available to 85 per cent. of the population, using the very simplest of apparatus.

The influence of the service was such as to "make the nation as one man." This could clearly be realised on such occasions as the opening of the British Empire Exhibition.

At present the broadcasting of such ceremonies as the Armistice Day Service at the Cenotaph, or the speeches on the signing of the Locarno Pact, depended entirely upon the individual views of the Minister or Government Departments concerned. It was to be expected and hoped that the broadcasting of such ceremonies would become automatic.

### Relations with other Interests

Their relations with other interests had progressed greatly. The advent of broadcasting had been viewed with uneasiness and hostility in certain quarters. They had adopted a conciliatory attitude, and this had resulted in co-operation in practically every case.

The Press had been of great assistance in the development and progress which they had achieved,

# BROADCASTING



## COMMITTEE OF INQUIRY.

*roadcasting service existing in this country, and to make of this service, are engaged in hearing evidence on the evidence submitted by the B.B.C. and the Wireless League.*

and they were now regarded more as an ally than a rival.

### Broadcast News

In reply to a member of the Committee, Mr. Reith said that he did not think there was a general call for news to be broadcast before 7 p.m., although it would be beneficial to have this restriction removed. They felt that an extension of their powers for news transmission was very necessary.

At present the B.B.C. were limited to what the microphones could pick up direct. Mr. Reith did feel that the presence of a narrator, as at the signing of the Locarno Pact, or the races at Brooklands, giving a "word picture" of events, would greatly increase the value and interest of such items.

### Present Restrictions

Another development would be the presence of an eye-witness at the studio to describe daily events.

The present news arrangement is that news may only be taken from four agencies, only bulletins of a certain length may be broadcast, and these not before 7 p.m.

### Broadcasting of Parliament

Replying to Mr. W. Graham as to what amount was paid for news, Mr. Reith said he had an idea it was in the nature of £6,000 per annum. Queried again as to whether he thought they got "value for money," he said they did. Questioned by Capt. Ian Frazer as to the broadcasting of debates in the Houses of Parliament, he said that they had evidence that there was a definite demand for this. Asked: "Was this practicable?" Mr. Reith said that the B.B.C. engineers were quite capable of undertaking the necessary installation. When Capt.

Frazer said that the Committee might make a recommendation to this effect, Mr. Reith said he hoped they would.

### International Aspects

The B.B.C. realised the importance of the international aspect, and they are the moving spirit in the founding of the International Bureau at Geneva. They had made routine arrangements for regular relaying of foreign programmes and a special weekly broadcast by them from their high-power station for European listeners.

### B.B.C. Announcers

The service was available for all non-party Government propaganda, and various Ministries gave a regular series of talks. Efforts were made to secure as regular announcers and speakers only those who employed the right pronunciation. The daily introduction of cultured speech into most family circles would have a considerable effect in the course of a few years.

### Education

This important aspect of their activities received great consideration. Any broadcasting service must be in touch with university, education and school authorities. The present organisation included the Education Advisory Committee, wherever there existed a broadcasting station. The educational side may be sub-divided into general informative talks, talks on specialised interests, and school talks supplementary to the existing curricula. The present development is towards a rate of some 10,000 talks a year, of an average length of 15 minutes. Some talks formed a series for the study of a particular branch.

### Transmissions for Schools

The progress with the school

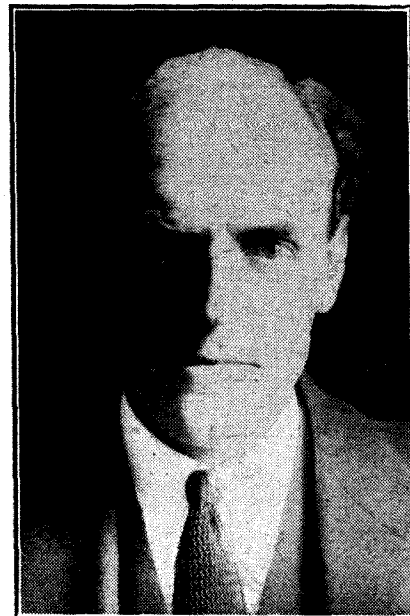

*Mr. J. C. W. Reith, managing director of the British Broadcasting Company.*

transmissions had been rapid, and an estimate gave the result that over 1,000 primary and secondary schools utilise these talks, and many of the broadcasts had received unqualified praise from teachers.

Sir Henry Hadow rather doubted whether any definite gain could be obtained from a 15-minute lecture. Mr. Reith said that psychologically it was difficult, with this medium, to hold listeners' attention for longer than that time.

### Music

The subject of the type of music to be broadcast was a vexed problem. A great number of people wrongly endeavoured to classify music arbitrarily, with resulting acrimonious disputes between so-called "high-brows" and "low-brows." All varieties of taste had to be catered for to the best of their ability. The B.B.C. considered they had a mission in educating the public musical taste. The average man had so few opportunities of hearing good music that he could not easily discriminate. They had evidence that the musical

taste of the nation was now higher than ever before.

**Choice of Programmes**

In reply to various questions, Mr. Reith again advanced the idea of two wavelengths from one or two stations, one sending a "Jazz" type of programme, and the other a programme of classical music. Listeners could then choose.

Their aim was to satisfy everybody by some method. Alternative programmes, two or more for the humblest crystal-set user and many for the cheap one-valve set, would appear to be a partial solution of the problem.

**Religion**

It was submitted that there should be a definite association with religion in general and the Christian religion in particular. Christianity is the official religion of this country, and this fact can be given as a justification, if required.

Various questions were addressed to Mr. Reith on this subject by Dame Meriel Talbot, who was anxious about the responsibility for the religious side of broadcasting. Mr. Reith said that there existed a religious advisory body for each station, including a prominent local minister or ministers, who held their position with the approval of the Bishop.

Many eminent preachers had been enabled to reach a larger audience than they could otherwise in a lifetime's work. This was instanced when the Archbishop of Canterbury, on Armistice Day, delivered an address to possibly the largest audience that has ever heard a sermon simultaneously.

**Unity of Control**

Dealing with the existing virtual monopoly, there was little doubt that the many objections in ordinary cases to a monopoly were well founded. Without such a monopoly, however, it was quite rational to doubt whether broadcasting could have expanded with sufficient rapidity and facility and at the same time have dealt with such diverse problems.

The opinion would appear to be generally held now that unity of control, in whatever hands it might be placed, was the only possible system for the beneficial development of this infant service.

**Constitution of B.B.C.**

Mr. Wm. Graham wished to know about the existing constitution. Mr. Reith explained that a number

of manufacturers were member shareholders. It was originally intended that shareholders should benefit. All ideas of benefits for shareholders had now disappeared.



*Sir Arthur Stanley, Chairman of the Wireless League.*

The B.B.C. paid a fixed rate of 7½ per cent., and were not allowed to make any profits.

**Future Policy**

The B.B.C. proposed to develop fewer stations, say 15, instead of the present 22, and to increase power. Certain stations, say Manchester, might transmit alternative programmes on two wavelengths. The state of the ether in Europe had suggested the desirability of reducing the number of stations, and perhaps even abandoning part of the wavelength range allowed. This was conditional upon higher power being sanctioned for the remaining stations. They would then have what might be termed "regional centres" for the transmission and collection of local interest items. The new Oxford studio was the first example of this. Another station similar to Daventry might be needed.

**Finance**

The early days were very unsatisfactory from this point of view. In October, 1923, the licence regulations evolved in consultation with the G.P.O. were put into force. In that month 334,000 licences were taken out, representing an income of almost £200,000. When compared with the total received prior

to that date of £46,500, it will be realised that the financial outlook suddenly improved. From that date there has been a steady increase in licensees of 40,000 per month.

**Restricted Revenue**

Mr. Reith spoke bitterly of the recent restriction of the B.B.C.'s income to £500,000 per annum. They would require at least £750,000 for next year's demands. The raising of a Treasury loan on the assets of the company might be a solution.

Should the constitution be changed as a result of the recommendations of the Committee, he thought their members should be paid at par.

He foresaw difficulties in liquidation and change over, and thought legislation might be necessary in connection with finances.

**Increasing Expenditure**

The estimated figure in 1922 of £148,000 per annum being required for operation expenses did not and could not take cognisance of the future developments. In fact, the extent of the actual development which has since taken place was not appreciated.

With the increase in the number of hours of transmission, the advent of relay stations and continual improvement in programmes, the increased revenue from the new licensing position was quickly absorbed.

During the year 1924-25 over 50 per cent. of the total expenditure was devoted to direct programme expenditure.

**Copyright**

Mr. Reith said with regard to copyright that the B.B.C. had never admitted any legal obligation. They do not admit that broadcasting is a public performance, and therefore the question of infringement does not arise.

Realising, to some extent, a moral obligation, they have met copyright charges, so long as the demand was reasonable.

The B.B.C. feel that they should secure some measure of protection against exorbitant demands.

The foregoing main features of the B.B.C. memorandum closed the submission of evidence by the B.B.C.

**The Wireless League**

On December 4 evidence was tendered to the Committee by the Wireless League.

The League claimed to represent the "listeners" of this country. In answer to the Chairman, Sir



Arthur Stanley stated that their membership was, roughly, 86,000.

On taking over the organisation in July from the *Daily Express*, who founded the League, the membership was about 80,000. Not all the members had paid their 2s. subscription.

The Committee appeared a little surprised that the membership had increased so slightly, in view of the fact that they were to tender evidence on behalf of listeners.

#### Suggested Constitution

Sir A. Stanley then presented the memorandum of the Wireless League.

A sound constitution, in their opinion, would be a British Broadcasting Commission, *i.e.*, Government control through a central authority. The P.M.G. would be represented, but not in a position of control as at present.

The suggested constitution would be as follows:—

- (a) A Chairman (unpaid).
- (b) A Vice-Chairman (an M.P., to be Parliamentary Commissioner).
- (c) A Chief Commissioner (Head Executive Officer, whole time, paid).
- (d) Seven Commissioners (appointed after consultation with the various interests concerned) and representing—
  1. The Post Office.
  2. The Listener (two Commissioners).
  3. The Radio Manufacturers.
  4. Science.
  5. Education.
  6. The Arts.

The Government would, of course, consult the responsible organisation. For Education, the President of the Board of Education; for Manufacturers, the N.A.R.M.A.T.; for the listener, the Wireless League.

The Commission would combine the Post Office licence work with the provision of a broadcasting service. Licences to be issued as at present. Revenues, less cost of collection of licences, to be wholly devoted to the improvement of the service.

The assets and staff of the B.B.C. to be transferred to the Commission, the shareholders being paid out on a basis not exceeding par.

They made no reflection on the B.B.C.; in fact, they had nothing but praise for the pioneer work, and the standard of service hitherto maintained. In reply to a question, Sir A. Stanley said that had no

change been suggested their members would have been quite satisfied with the present *régime*. He was opposed to a monopoly by a quasi-commercial concern, and thought that originally it was not realised what a vast monopoly the original concession was.

In reply to Mr. Ian McPherson, he agreed that the service should be a monopoly.

#### One Central Authority

The members agree that this is essential, and one strong body with sufficient funds to provide a good service was preferable to many with insufficient funds.

Many members wished for programmes of local interest from a local station. Educational subjects should be transmitted on a special

*Right Hon. Lord Balfour of Burleigh recently broadcast from the London Station an appeal for the Princess Louise Kensington Hospital for children.*

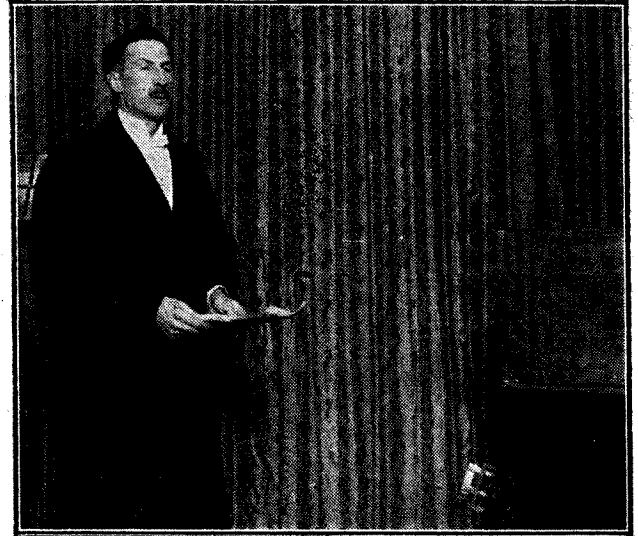

#### The Programmes

Programmes should be determined by a programme advisory committee representing the following:—

Education, the Press, Music, the Stage, Music Halls, Sport, Commerce and Industry, the Wireless League (for the listener).

This concluded Sir Arthur Stanley's memorandum.

#### Supplementary Evidence

Professor A. M. Low was then called. He stated that he was General Secretary and Technical Adviser of the Wireless League.

In his view the principal demands of the listener were for:—

- (a) The best possible programmes.
- (b) The widest choice of programme.
- (c) A voice in association with fellow-listeners in deciding the type of programme.
- (d) The licence revenue to be wholly devoted to the service.
- (e) Punishment of persons who interfere with reception, either carelessly or wilfully, by means of oscillating receiving sets or other electrical disturbances.

wavelength. More news was required.

#### Oscillation

Many members are of the opinion that powers should be obtained to punish offenders for oscillating and causing interference.

Other electrical disturbances had been mentioned, trams, etc., and the Post Office stations. These should also be dealt with, since any trouble was invariably caused by apparatus badly designed or improperly used. This concluded Professor Low's evidence.

Professor Low was followed by Mr. D. S. Richards, Chairman of the Ilford branch of the Wireless League and of the Home Counties Area Committee.

Mr. Richards principally concurred with Professor A. M. Low's statements.

He thought that the Ministry of Agriculture encroached upon the programme's time with too much uninteresting matter. This might lead to similar action by other Departments.

After some further questions by members of the Committee, the meeting was adjourned till December 17.

# Wireless News in Brief.



**B.B.C. Forthcoming Items.** The following are some selections from the forthcoming B.B.C. programmes:—

December 20.—Cardiff: Symphony Concert—solo pianoforte, Leff Pouishnoff.

December 21.—London: London Chamber Orchestra, conducted by Anthony Bernard.

Glasgow: The Pianoforte Sonatas of Beethoven.

December 23. — Newcastle: 5NO's Birthday. London: Sir Harry Lauder.

December 24.—Manchester: A Christmas Pantomime.

December 25.—London: Bow Bells.

December 26. Christmas Gather-round with John Henry.

\* \* \*

**Daventry's Aerial.** The recent collapse of the 600-ft. T-type cage aerial of the Daventry station caused much concern. After considerable trouble a temporary aerial was erected from the top of one of the 500-ft. masts to the roof of the transmitting building. Later, this arrangement was improved upon by slinging a wire between the top of one mast and a point half-way up the other. Shortly afterwards the wire was raised to the top of the second mast.

\* \* \*

**Geneva Conference.** We understand that, in addition to the two conferences which have already been held at Geneva to decide the allocation of frequencies for the European broadcasting stations, another meeting is to take place shortly. It will be remembered that at the second conference it was decided that since it had been found undesirable to allot the same frequency to two stations, the best plan would be to reduce the number of stations and provide

those remaining with more power, as a solution to the mutual interference problem. It is now understood, however, that no alterations will be made before the coming meeting takes place.

Entirely new plans will be discussed, which it is understood will involve up to a point the retention of the old grouping, reliance being placed upon the distance separating stations of closely related frequencies to prevent mutual jamming.

\* \* \*

**Wireless Operators on Strike.** The recent strike of marine wireless operators, which involved several hundred men, and which had not been settled at the time of going to press, was brought about by a proposal to reduce their wages by 22s. 6d. a month. The operators who refused to sign on at the new rates are members of the Association of Wireless Cable Telegraphists, and they regarded the movement to reduce their pay as a sequel to the surrender of the National Sailors' and Firemen's Union this year to a proposal to cancel the £1 advance conceded by shipowners in 1924.

\* \* \*

**Morse Interference.** There appears to have been a recrudescence of jamming by Morse on the broadcast frequencies within the last few weeks. We are informed that among recent offenders are Newhaven, Dieppe, Madrid (EGC) (jamming Daventry), Ushant, Boulogne, and a French steamer working on three different frequencies in the Channel.

\* \* \*

**Broadcasting in Germany.** A new high-power broadcasting station is being erected at Frankfurt, and will probably commence operations in February of next

year. This station will employ the same power as Königswusterhausen and Munich, viz., 10 kilowatts, and will represent a considerable improvement on the present station, which is situated in the Post Office buildings.

\* \* \*

The removal of restrictions on wireless receivers in occupied territory will give a new impulse to the wireless industry in that district. An official statement in regard to the release has not yet been issued by the Post Office, and it appears that there is some doubt as to the interpretation of the exemption. It is certain, however, that listeners will have to notify the police, who will in turn supply a list of names of the listeners to the military authorities. Broadcasting stations within the occupied zones will continue to be prohibited.

\* \* \*

**Wireless Control of Aeroplanes.** We hear that official trials in this country of aeroplanes controlled from a distance by wireless have been successfully carried out. So far the tests have been confined to small areas, the aeroplane never travelling far enough to be outside the ground operator's range of vision.

A further development of this method of control will be to devise some method of keeping an aeroplane to the correct course over long-distance flights.

\* \* \*

**International Radio Conference.** Representatives of no fewer than sixty countries have accepted the invitation of the State Department at Washington to take part in the great International Radio Conference which is to be held in Washington next spring.



adjustment of filament temperature on the L.F. valves is not at all critical, and for this purpose fixed resistances are admirably suited. It will be found, however, that the adjustment of detector filament

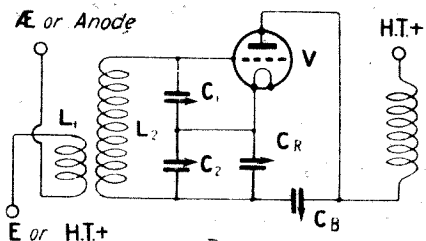

Fig. 2.—The circuit of one of the H.F. stages, CR and CB being the stabilising condensers.

temperature is rather critical. In addition to giving better reception, this scheme reduces the H.T. battery drain. H.T. batteries will be found to last about twice as long as when all filaments have fixed resistances. The total H.T. battery load of this set is from 7 to 10 milliamperes, depending upon the setting of the valve rheostats.

Special Features

The detector valve is held in an anti-vibrating socket, in order to prevent low-frequency feed-back to it from the loud-speaker through the medium of sound impulses.

The complete wiring diagram is shown in Fig. 1. Note that each of the H.F. stages has its plate supply by-passed to its filament through a 0.5 μF condenser.

Adjusting the Set

The initial adjustment of the set is as follows: Set condensers CR1 and CR2 approximately together at any arbitrary point. Tune in the highest frequency (lowest wavelength) station of moderate volume that can be found. Remove the first H.F. valve and cover one of its filament prongs with a piece of paper. Insert the valve in its socket, and, with this valve in place but its filament cold, adjust the first balancing condenser CB1 until the signal disappears. Remove the paper from the prong of valve V1, put it back in its socket, and repeat this procedure with the second valve.

Final Balancing

When both stages are balanced, tune the set to the lowest frequency (highest wavelength) to which it will tune, and if it does not oscillate the adjustment may be considered satisfactory. If, however,

oscillations occur, as indicated by squealing or steady ticking in the loud-speaker, the capacity of condensers CR1 and CR2 should be increased slightly and the balancing process repeated on a high-frequency (low-wave) station. In general, the lower the value of CR1 and CR2 the greater will be the tendency to oscillation at low frequencies (high wavelengths) after the set has been balanced at a high-frequency (low wavelength) adjustment.

Aerial Recommended

The complete set will be found to have remarkably fine tone quality with exceptional range and selectivity. It should be operated on an aerial from 50 to 100 feet long, including lead-in, depending upon

circuits and representing it in the form of a "bridge" as shown in Fig. 5. The bridge is balanced by adjusting the condenser CB, so that the ratio of the anode-grid capacity CV to CB is equal to the ratio of C1 to (C2+CR). Under these conditions there will be no transfer of oscillations from the tuned grid circuit to the anode coil and vice versa due to the self-capacity of the valve.

Effect of Frequency Changes

If the circuit is balanced for the minimum values of C1 and C2 it is clear that, with any additional fixed capacity CR across C2, the bridge becomes unbalanced as soon as the frequency of the circuit is decreased by increasing C1 and C2 to the same relative extent. It is assumed

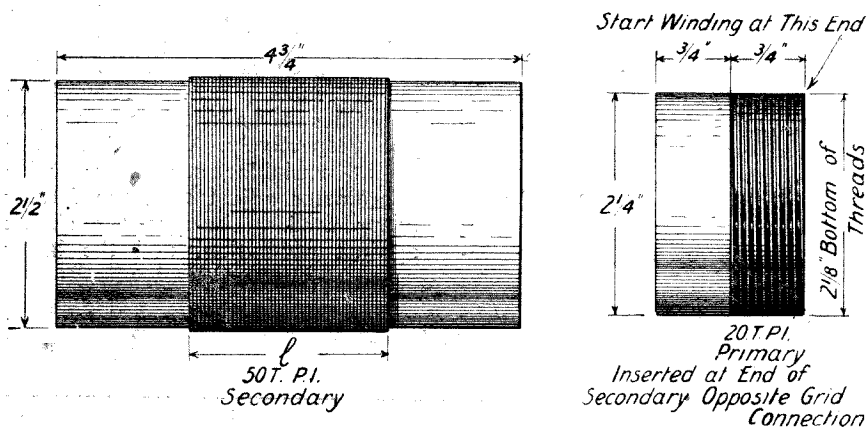

Fig. 3.—Dimensions and details of the H.F. transformer windings may be gathered from this sketch.

the amount of interference from nearby stations.

Criticism of the Isofarad Receiver

By the Staff of the Radio Press Laboratories

The Isofarad receiver described in the above article has several interesting features which are different from those found in a British designed instrument of a similar type. It is essentially a neutrodyne circuit consisting of two balanced or neutrodyned high-frequency valves, a detector, and two note amplifiers. The advantages of a neutrodyne circuit for balancing out the effect of the self-capacity between the grid and plate of a valve are so well known that they need not be discussed here.

Principle of Neutralising Method

The principle of the method for neutralising the effect of the valve capacity in the Isofarad receiver is perhaps best explained by redrawing one of the high-frequency valve

that the condensers C1 and C2 are mounted on the same shaft with a view to obtaining a constant ratio of capacity between them. It is stated in the article that "in general, the lower the value of CR1 and CR2, the greater will be the tendency to oscillation at low frequencies (high wavelengths) after the set has been balanced at a high-frequency (low wavelength) adjustment."

A Suggested Explanation

This point is not easily explained, as it would appear from the "bridge" circuit of Fig. 5 that the greater the value of CR the more unbalanced would the bridge become on tuning in to the low frequency (long wavelength), and consequently there would be a greater tendency to oscillate. If, however, the grid filament capacity is considered, and is represented by a fixed condenser Cf across C1, then if CR is about twice the value of Cf, the bridge can be balanced for

both the high and the low frequencies. For lower values of CR the bridge will tend to become unbalanced as the frequency is decreased. Therefore up to a point an increase in the value of CR will tend to make the set more stable over the whole range of frequencies.

**The High-Frequency Transformers**

The screening of the high-frequency transformers is probably quite a feature of the receiver, as it prevents stray magnetic coupling between the valve circuits, assuming, of course, that the self-capacity between the actual wires of the circuit has been reduced to a minimum. Stray magnetic coupling between the valve circuits is

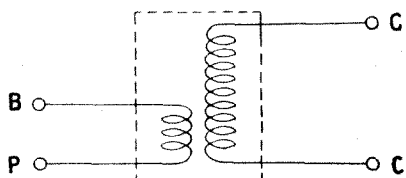

Fig. 4.—Showing the correct method of connection for the ends of the H.F. transformer windings.

particularly objectionable, as it is a variable quantity depending on the frequency, and any method of overcoming this leads to considerable improvement.

**Screens**

The screens for the high-frequency transformers must, of course, be made of copper so as to avoid any serious loss, and they should be carefully earthed. It should be noted that the screens are made considerably larger than the transformers themselves. The outside dimensions of the screening cases are given as 5 in. in diameter by 6 in. long, whereas the windings of the transformers are 2½ in. diameter by about 2 in. in length. It is important that the windings do not come too near the metal shields, as otherwise there may be serious losses.

**Doubtful Claims**

In the description of the set there is a statement that the use of shields in no way impairs the efficiency of the coils, since the unit has been so designed that the shielding reduces the effective inductance, resistance, and distributed capacity of the coil in about the same ratio. The inductance of a coil is certainly reduced by enclosing it in a copper shield, but a

reduced high-frequency resistance and self-capacity would seem a little doubtful. Some definite figures on this question would be interesting.

**By-pass Condensers**

The provision of high-frequency by-pass condensers, between the anode ends of the anode coil and the filament of the associated valve, is a good feature, as it eliminates the possibility of stray coupling between the circuits due to a common H.T. battery condenser, and possibly to long leads which are common to the high-frequency circuits.

**Construction of Receiver**

In constructing a receiver of this type from British-made components there would be several points that would require consideration. With regard to the condensers C1 and C2, which are mounted on the same shaft, it is doubtful whether there is a suitable unit made in this country. Such twin condensers are usually made of equal capacity. This, however, should not present a serious difficulty.

**Isolated Grids**

It will be noticed from the diagram of connections that the grids of the two high-frequency valves are completely isolated from the filament. This would probably give trouble with the British-made high vacuum type of valve, owing to the grids becoming charged to an excessive negative value. It would be necessary to connect a high-

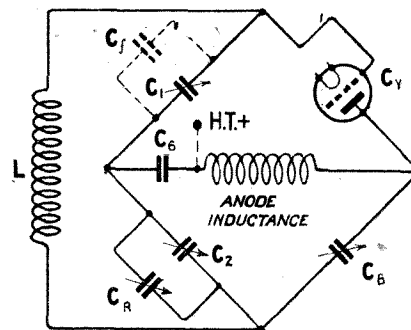
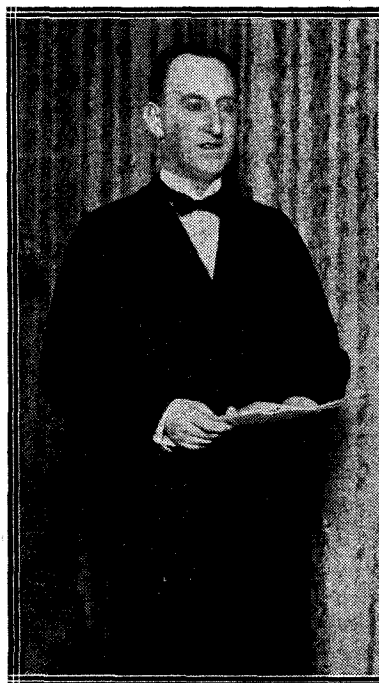

Fig. 5.—The circuit of Fig. 2 re-drawn in "bridge" form, to indicate the action of the method adopted for stabilisation.

resistance leak of about 5 megohms between the grids and the filaments of these two valves.



The Earl of Plymouth recently broadcast an appeal from the London Station on behalf of the Belgrave Hospital for Children.



Another point worthy of note is that the method of adjustment as described is hardly applicable to the 4-pin type of valves, as it would be difficult to isolate one of the filament pins by a piece of paper. Another method of disconnecting the filament would have to be devised.

**"THE WIRELESS CONSTRUCTOR."**  
**CHRISTMAS NUMBER**  
**124 PAGES.**  
**ON SALE EVERYWHERE.**  
**PRICE 6d. AS USUAL.**

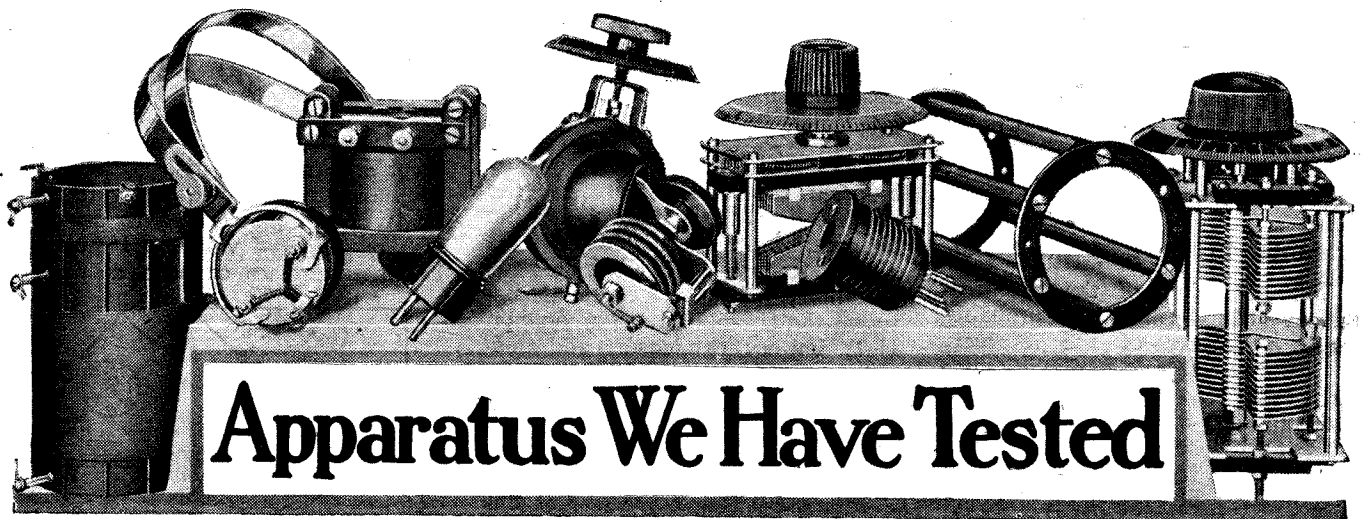

## Apparatus We Have Tested

Conducted by Radio Press Laboratories, Elstree.

### Fixed Condenser

Messrs. The British Sangamo Co., Ltd., have submitted to us for test a sample of their Sangamo mica condenser. It is claimed that this condenser is moulded throughout in bakelite, and its capacity is guaranteed under varying conditions of temperature, moisture, and pressure.

#### Description of Component.

This condenser is made of brown insulating material, and is rectangular in shape, except for its ends, which are rounded off. Its over-all length is  $1\frac{1}{2}$  in., and its width  $1\frac{3}{8}$  in. At each end of the condenser a screwed metal bush passes right through it, and evidently makes contact with the appropriate set of plates inside. A round-headed screw is used at each end of the bushes, making four screws in all. These serve as terminals, the wires being secured between the protruding ends of the bushes and the screw heads. No soldering tags are provided, but both the maker's name and the rated capacity are marked on the case. The condenser is hermetically sealed.

#### Laboratory Tests.

The condenser was found to be of the rated capacity within a sufficient degree of accuracy, and its insulation resistance was infinite. Both these qualities were found to be unaffected by exposure, the condenser having been left for a night in the open under particularly adverse atmospheric conditions. This condenser has a particularly pleasing appearance, and from the purely electrical standpoint can be recommended. It is unfortunate, however, that no adequate provision is made for soldering, and panel or baseboard mounting. Two of the terminals could, however, be utilised for fixing to a thin bracket or even to a panel 3-16 in. thick or less.

### Jack

Messrs. Harmo Products have submitted a "Crawford" Jack for test in our Elstree Laboratories.

### Construction of Component.

The plug is made from an ebonite cylinder nearly  $\frac{3}{4}$  in. in diameter and  $\frac{1}{2}$  in. high. Two pins are fixed in this plug to register with the holes in the socket. Small terminal heads screw on to the tops of these brass pins, and slots are cut in the ebonite for the insertion of telephone tags, while spade terminals are readily fixed under the terminals.

The jack consists of an ebonite cylinder  $1\frac{1}{2}$  in. diameter and  $\frac{3}{8}$  in. long. Two holes are provided for the purpose of securing the jack to a baseboard by means of countersunk screws, while in the centre of the jack is a hole for observing the contacts. Two terminals fix into the sides of the jack so that normally they are short-circuited, the ends of the terminals making good electrical contact with each other. They are provided with  $\frac{1}{8}$ -in. holes to accommodate the jack pins. One of these terminals has an axial movement of about  $\frac{1}{8}$  in., being held tight against the other terminal through the agency of a strong spring. This movable terminal, which is lengthened about  $\frac{1}{8}$  in. to allow for wear, can also rotate, so that it is necessary to see that the hole in the ebonite registers with the hole in the terminal before inserting the plug.

#### General Remarks.

This component is very useful where telephones or loud-speakers are wired in series, the withdrawal of the plug merely shorting that portion of the circuit. In the sample submitted the terminal heads were very eccentric, but the component has a reasonable insulation resistance and the finish is of fairly satisfactory order. It would be advantageous if the movable terminal was modified to prevent the rotary movement previously mentioned.

### Crystal Set

Messrs. Ward & Goldstone have submitted a new model Goltone super-crystal set for test.

### Description of Set.

It consists of a single layer solenoid inductance wound with enamelled wire and mounted between a circular moulded base and a circular moulded disc. The crystal has the usual cat-whisker with universal bearing and friction tight adjustment, and is enclosed in a glass tube which is held in position on the top of the disc by two upright pillars and nuts. Four terminals are fixed to the base for connection to aerial, earth and telephones. Tuning is effected by turning a milled knob which rotates a quick thread spiral screwed pillar carrying the movable contact bearing on the outside of the solenoidal inductance. Thus on five-and-a-half turns of the milled knob the movable contact travels the length of the tuning inductance—about  $3\frac{1}{2}$  in. A certain amount of end-play is present between contact and pillar, and this should be remedied. In order to tune in Daventry a plug is provided for insertion into a socket common with the earth terminal, and this inserts a loading coil accommodated inside the solenoid inductance.

#### Laboratory Tests.

On test it was found that the crystal had a large percentage of sensitive spots, and London was received quite clearly at the Elstree Laboratories. A deflection of 40 micro-amperes was measured on receiving London.

On inserting the plug and testing for Daventry signals were very faint, and difficulty was experienced in tuning this station.

### Fixed Condenser and Seven-way Leads

As a result of the alterations recommended by Radio Press Laboratories in the report on Messrs. Ward & Goldstone's FIXED CONDENSER and SEVEN-WAY LEADS (*Wireless Weekly*, Vol. 7, No. 10), we are informed by this firm that they are providing soldering tags for their fixed condensers and heavier spade terminals for the accumulator leads.



# CORRESPONDENCE

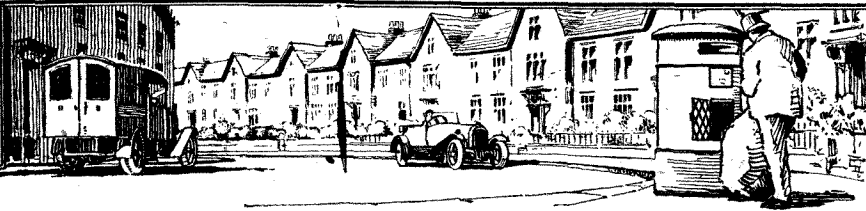

## IRISH AMATEUR TRANSMISSION

SIR,—Referring to the paragraph headed "Ireland" in "Short-Wave Notes and News" in the December 2 issue of *Wireless Weekly*, my station has now received a permit for the use of the following wavelengths and bands: 23, 45 and 90 metres (13,044, 6,667 and 3,333 kc.) and 115-130 metres (2,609-2,308 kc.) and 150-200 metres (2,000-1,500 kc.). The index letters GW have been allotted, and I understand that these are in future to be the official ones for the Irish Free State, instead of IR, which have been used. This may be of interest. This station will work mainly on 45 metres (6,667 kc.) by day and on 90 or 115 metres (3,333 or 2,609 kc.) after dark, the latter wavelength being more free from jamming than the 90-metre wavelength.

I only commenced on 45 metres within the last few days, and using only 4 watts input, signals are reported by daylight R 6-7 in various parts of England. After dark, however, they seem to "skip" England altogether, but are reported in France R 6-8 after dark with the same input (4 watts). This "skipping" effect is being investigated.—Yours faithfully,

MEADE J. DENNIS (Col.)  
(Radio GW-11B.)

Baltinglass, Co. Wicklow.

## THE "LOW-LOSS TUNER FOR SHORT WAVES"

SIR,—In these days of ultra-efficiency in short-wave apparatus it may be of interest to mention that Mr. Percy W. Harris' "Low-Loss Tuner for Short Waves" (*Wireless Weekly*, November 19, 1924) is still capable of good work. For example, on Saturday, November 28, for two hours commencing at 11.30 p.m., I listened to KDKA on the first valve alone. Reception throughout was comparable both in clarity and in volume with that of the best Spanish stations. Strangely enough, the night was cold and clear, with bright moonlight.

With regard to CW, using detector only, I have received British, French, Belgian, German, Dutch, Danish, Norwegian, Italian and Spanish amateurs. Not the least numerous of these are the Frenchmen and Belgians of the "Journal des 8" and "Réseau Belge" varieties.

Also, of course, WIR, WQO and

other U.S.A. Government stations come in powerfully on one valve, whilst both valves have brought in American amateurs strongly enough to be read with the 'phones on the lap.

Your correspondent, Mr. J. M. Drudge, inquires about the QRA of PCLL. This is the station of the Dutch State Telegraph Laboratory, Kazernestrasse 33, The Hague, Holland. I heard their CQ call last week, in which they asked for QSL's. They would probably appreciate one from Mr. Drudge.

With best wishes for the continued success of Radio Press publications.—

Yours faithfully,

Swansea, C. M. DEVONALD.

SIR,—I have had such excellent results with the low-loss short-wave two-valve circuit fully described in *Wireless Weekly* for November 19, 1924, by Percy W. Harris, M.I.R.E., that I feel I must write and tell how pleased I am with it.

On the evening of November 28, at 11.20 p.m., I received KDKA on 63

was now 12.28 a.m. The next item was the children's corner, and I switched off after a most interesting hour with KDKA.

I should like to say I have departed a little from your details regarding the coils, as you will observe from the photograph which I enclose.

By removing these and inserting Nos. 35, 50 and 75 I can get most of the B.B.C. stations and many Continental stations with the aid of a "B" wave-trap, as described in your Radio Press book, "Twelve Tested Wireless Sets" (by Percy W. Harris, M.I.R.E.). This helps to eliminate London to a great extent, especially when receiving the nearer stations. London comes in at loud-speaker strength.

By inserting Nos. 150, 200 and 250 coils I receive Daventry and Radio-Paris. You will therefore see that I can work on wavelengths from 40 up to 1,700 metres.

The valves I use are Cosmor W.1 for the first valve and a Cosmos S.P. "red-spot" for the second. I should

*During the first simultaneous broadcast programme in Australia, Mr. J. R. Collins (centre), Secretary to the Treasury, broadcast an appeal from the special studio in Melbourne. With Mr. Collins are seen Mr. S. H. Witt (left), Research Engineer, and Mr. L. Fanning (right), Superintendent of Telephones.*



metres (4,762 kc.) without the slightest trouble, loud and clear as crystal, and not a trace of atmospheric or morse. This, by the way, was on a beautiful moonlight night.

The programme which they gave came through splendidly and without distortion.

Mr. David Rennie, one of the Westinghouse officials, gave a talk on learning a trade, and following this was a talk by an Indian orator. It

just like to add in closing that if any of your readers are interested in short-wave transmission, especially KDKA, I can thoroughly recommend this most efficient little wonder, which to me is a priceless set. Congratulations and good wishes.—Yours faithfully,



J. J. McCONOCHIE.

London, N.S.

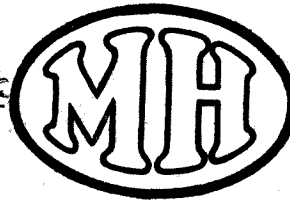
[A photograph of Mr. McConochie's receiver will be found on page 423 in this issue.—Ed.]





## Announcing Two New Products

WE describe below the latest additions to the famous range of  Wireless Components. Consistent with the  reputation for quality and efficiency, these new products represent a high standard of development and are worthy of the attention of every keen enthusiast intent upon progressive results from his radio.



### The Supersonic Outfit BRITISH AND BEST.

Supersonic reception, with its range and selectivity, is fully established in public favour.

 Supersonic Components have shown marked superiority in these two qualities and have gained universal praise for their wonderful reproduction of music and speech when used in conjunction with other  Components.

The  Supersonic Outfit contains:

- 3 M.H. Tuned Transformers .. each 21/-
- 1 M.H. Tuned Filter .. .. ., 21/-
- 1 M.H. Autodyne and Oscillator Unit., 21/-
- Full Size Blue Print—Layout Diagram and Booklet of Instructions.

GUARANTEED FOR 12 MONTHS **£5 5s. Od.**

Head Office & Works:

WEXHAM ROAD,  
SLOUGH, BUCKS.

Telephone: Slough 441 & 442

Télegraphic Address: "RADIETHER, SLOUGH."

**L.M<sup>c</sup>MICHAEL<sup>LD</sup>**

Manufacturers of Wireless and Scientific Apparatus

WEXHAM ROAD, SLOUGH, BUCKS.

London Office & Wholesale Showrooms:

HASTINGS HOUSE,  
Norfolk St. STRAND, W.C.2

Telephone: Central 8272

Cable Address: "RADIETHER, SLOUGH."

### The Resistance Capacity Coupling

The  Resistance Capacity Unit is the result of extensive research work, resulting in a component which we can, with every confidence, recommend for application to the last stage or stages of L.F. amplification in any set.

The component consists of our well-known clip-in type mica Condenser, and our Grid Leak, which is constructed in the same sturdy and permanent manner as the anode resistance. The standard unit is fitted with a leak of 0.5 Ω, a transfer Condenser of .005 μF, and an anode Resistance of 80,000 Ω, these values in practice having been found to give the best result with the average valve designed for resistance capacity coupling.

#### PRICES:

Complete with base (as illustrated) ..	12/6
Anode Resistance only .. with clips	4/6
Leak only .. . . . . .	2/6
Condenser only .. . . . . .	3/-
Base only, with fittings .. . . . .	3/6

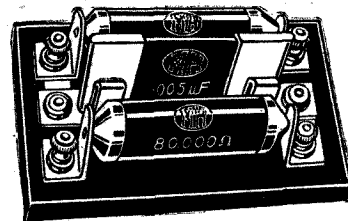

THE RESISTANCE CAPACITY UNIT.





# Information Department.

F. W. P. (E.C.2.) has constructed the receiver described by Mr. A. Johnson-Randall in the July, 1925, issue of "MODERN WIRELESS," under the title of "Full Volume with Three Valves," and constantly suffers from a howl or wail (like the tuning note, only mellower), which comes on faintly at first but gets louder and louder until it is unbearable.

Our correspondent states that he is using two .06 ampere and one .12 ampere type dull emitter valves and has the loud-speaker and the set placed on a table close to the lead-in wire.

From these particulars it would seem likely that the trouble is due to microphonic effects, the electrodes of the

valves being set into vibration at audible frequency by sound waves emitted from the loud-speaker, which would result in the set emitting a roar or howl. Our correspondent should try, therefore, the effect of removing the loud-speaker to some remote part of the room, when we think it is quite likely that the difficulty will be overcome.

S. G. (SOUTHPORT) asks us to give him a theoretical circuit and rough layout plans for a 2 valve high-frequency amplifier to add to his "Family 4-valve" receiver.

Although we can give a theoretical circuit of the type requested by our

correspondent, it is outside the scope of this department to give special layout plans, since before we could confidently do this it would be necessary for us to build and test the amplifier. It will be readily understood that this cannot be done in the case of an individual reader.

Further, we would strongly advise our correspondent to drop the project, since to build any two-valve high-frequency amplifier considerable experience in design is necessary before the instrument can be made to work successfully, and we feel certain that in practice the addition of two further high-frequency stages to the "Family Four-valve" receiver, which has one

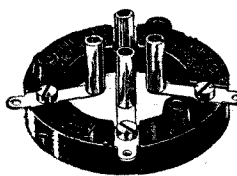

**ANTIPONG VALVE HOLDERS.**  
Low Loss, Shock Absorbing, non-microphonic, universal fitting. They protect your valves and improve the quality of reception. Use them for Dull and Bright Emitters. Price each 3/-

**LOW LOSS COIL FORMERS.**  
Skeleton Formers should always be used to ensure efficiency, especially on short wavelengths. The Bowyer-Lowe series covers most amateur needs. Prices from 5/-

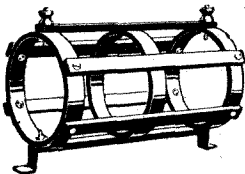

**STUD AND SERIES PARALLEL SWITCH PARTS.**

Complete sets of parts to construct Stud Switches with 2 in. radius arms. Boxes containing complete Switch Arm with real Ebonite Knob, Bush, Contact Plate, 10 Studs with 2 Nuts to each and 2 Stops, lacquered finish; Drilling Template, enabling purchaser to construct any size switch from 2 to 10 way .. 2/3

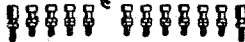
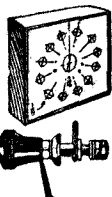

Series Parallel Switch Parts Complete .. 4/-

**EVERY ONE GUARANTEED FOR A YEAR**

Buy Bowyer-Lowe Components because they never let you down. Every one is guaranteed for a year. If within that time it shows any defect in construction or performance it will be exchanged free. Bowyer-Lowe Low Loss Parts are built by expert radio engineers to give results of the highest efficiency. Use them in all your sets.

**COMPLETE CATALOGUE FREE ON APPLICATION TO**  
**The Bowyer-Lowe Co. Ltd., LETCHWORTH.**

**MATCHED H.F. TRANSFORMERS.**  
The very fact that every Bowyer-Lowe Transformer can be guaranteed to match every other in its range without special selection is itself good evidence of the great skill and care with which these Transformers are made. Every Transformer is individually tested against standards. All ranges from 550 to 2,000 metres and up are supplied; also a special Neutrodyne Unit covering 300 to 600 metres. All ranges. Each 7/-

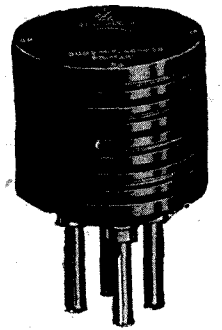

**BOWYER-LOWE PANEL SERVICE.**  
Beautifully polished, drilled and engraved Panels of Tested Grade A Ebonite are supplied by the Bowyer-Lowe Company for any set of which full-size drawings or blueprints are available. Perfectly accurate workmanship and quality of finish are features of this service. The uniform price for panels of any size is 1 1/4d. per square inch. Ask us to make your next panel.

## Bowyer-Lowe Tested Components

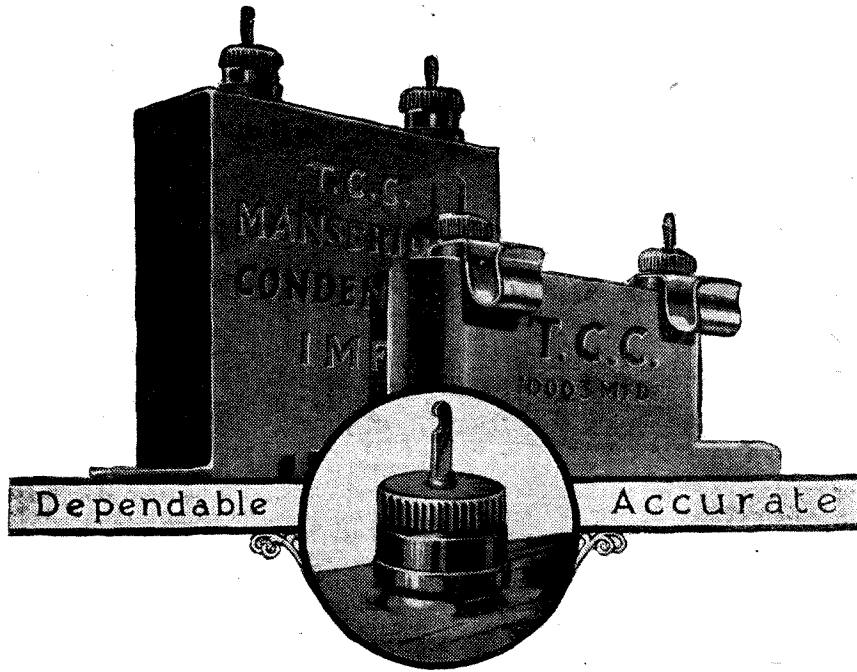

## The significance of the name T.C.C.

FOR twenty years the Telegraph Condenser Co. Ltd., have been making fixed Condensers.

During that time they have made many millions—in fact there is hardly a country where the familiar little green T.C.C. Condenser has not become well-known for its accuracy and steadfast dependability. But besides the little Condensers used so much in wireless, the T.C.C. make huge Condensers which stand more than six feet high and which weigh nearly 4 tons.

Obviously the T.C.C. would not get orders from all parts of the world for these large and expensive Con-

densers if they did not possess an exceptionally good reputation in the electrical industry. Such prestige has been gained by specialising in Condensers alone, for the T.C.C. make no other product.

And they are proud of the fact that they are the oldest exclusive Condenser manufacturers in this country.

You buy your Condenser on faith—your faith in the firm that makes it. Without an elaborate test you cannot tell whether your Condenser is functioning properly. It may look all right and yet its insulation may be imperfect.

If you choose a T.C.C. you can be absolutely certain that it is perfect, otherwise one of the many critical tests employed would have discovered the fault.

### Prices and Capacities :

Mansbridge, 2 mfd. . . . .	4/8
Mansbridge, 1 mfd. . . . .	3/10
Mansbridge, .5 mfd. . . . .	3/4
Mansbridge, .25 mfd. . . . .	3/-
Mansbridge, .1 mfd. . . . .	2/6
Mansbridge, .09 to .07 . . . . .	2/4
Mansbridge, .009 to .005 . . . . .	2/-
Mica, .004 to .001 . . . . .	2/4
Mica, .009 to .0001 . . . . .	2/4

# T.C.C. Condensers Mansbridge and Mica

The Telegraph Condenser Co. Ltd. West Park Works, Mortlake Road, Kew

Gilbert Ad. 4172.

AN ADVERTISEMENT IN "WIRELESS WEEKLY" IS A GUARANTEE OF SATISFACTION TO BUYERS.

## L & P Valve Unit

(As flatteringly commented on in the Radio Press publications).

Provides the constructor with a simple NUCLEUS around which to build an American Type valve set. Valve holder, rheostat, panel and window all in a handy unit. Only hole for window and hole for Rheostat to be drilled. The demand to-day is for easy-to-fix units.

The Valve Holder is of low capacity. Each leg separately insulated, Anode leg coloured red. Soldering tags provided. The Rheostat is smooth and velvety in action, and gives vernier control. Guaranteed not to rust, get brittle or perish with heat. Unalterable in resistance.

From Good Dealers or write at once for list. Free on request.

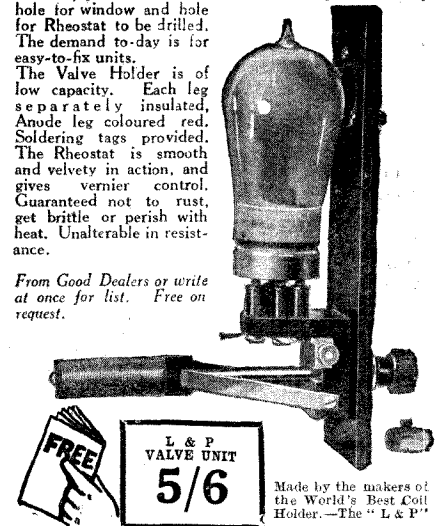

Made by the makers of the World's Best Coil Holder.—The "L & P"

Other leading "Ellanpee" Lines:—L & P Valve Windows enhance the appearance of any set. Small size 2/4d. each. Large size 3/4d. each. L & P Miniature Switches, D.P.D.T., 1/6 each. L & P Pull and Push Switch—positive action, positive satisfaction—only 2/- each. LONDON & PROVINCIAL RADIO CO., LTD., 30, Colne Lane, Colne, Lancs.



## LIBERTY PERMANENT DETECTOR

### The Original One-Hole Fixing Detector.

Stop Fiddling with Cats' Whiskers.

Refuse inferior imitations. Insist on seeing the name "Liberty" Technical Reports. Amateur Wireless: Popular Wireless: Wireless Weekly: Every "Liberty" tested on actual broadcast-casting and fully guaranteed.

50% more efficiency  
50% lower price  
"THE" 100% DETECTOR

The "Liberty" Detector gives more sensitive reception Permanently than a cat's whisker gives Temporarily. No hunting for that "special spot" lost by the slightest vibration. The "Liberty" is entirely unaffected by vibration, sensitive all over, and that loud spot cannot be lost.

FIXING.—One-hole clips or by two pieces copper wire to existing detector terminals.

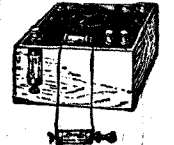

Radiarc Electrical Co., Ltd., Bennett Street, London, W.1.

From all dealers or direct. PRICE 3/6 COMPLETE.

## VALVES Repaired Quick

Let our valve making plant repair your broken or burnt-out valves efficiently and promptly (most makes). Amplification, radiation, and current consumption guaranteed same as new. Bright emitters 5/- "D.E.'s" (2 and 3 v. types) 7/6. Radions Ltd., Bolton, nr. Macclesfield, Ches. Largest Valve Repairing Firm in the world. List Free.



stage incorporated in it already, would not be successful.

C. O. (HULL) has been using a crystal set with satisfactory results and has recently connected up a long length of twin flex in order to use high resistance telephones several rooms away from that in which the set is situated. Upon slightly retuning, he now finds that signal strength is considerably improved and asks us for an explanation.

The effect of increased signal strength noted by our correspondent is by no means unusual, and is due to the fact that the long telephone extension leads are acting as a counterpoise, which would appear to be considerably more efficient than the normal earth connection used alone. It is quite probable that by dispensing with the ordinary earth connection altogether results will be still further improved.

W. F. (CARDIFF) employs a single-valve detector type of receiver on board ship, but experiences considerable difficulty in getting high-tension batteries when abroad, and if these are obtainable they are usually old and costly. He asks us whether he can employ the ship's direct current supply of 100 volts for high-tension.

Little difficulty should be experienced in obtaining an excellent high-tension

supply from the ship's direct current mains, and we give below in Fig. 1 the type of circuit which should be used. Two lamps of equal wattage and of the voltage employed on the ship's lighting system should be connected in series across the mains as shown. The negative terminal of the mains should be joined directly to the H.T. negative

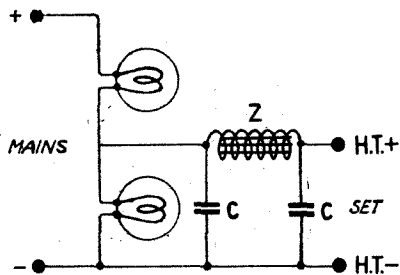

Fig. 1.—Showing the method recommended for obtaining high-tension supply from the D.C. mains on board ship. (W. F.—Cardiff.)

terminal of the receiver, and the H.T. positive terminal of the latter should be connected through a choke coil to the mid-point between the two lamps, two large condensers, shown as C, being connected across either side of the choke and H.T. negative. The choke should be of fairly high inductance, values of 60 to 100 henries being suitable, whilst the condensers C should be of 2  $\mu$ F each, or greater capacity.

For safety a large condenser should be placed between the earth terminal of the receiver and the actual earth connection, which in this case is to the hull of the ship. A suitable value for this condenser would be of .01  $\mu$ F. With the arrangement outlined, approximately 50 volts is obtained for the H.T. supply to the set.

S. D. (BASINGSTOKE) has constructed the "Special Five" receiver described by Mr. Percy W. Harris, M.I.R.E., in the November, 1925, issue of "MODERN WIRELESS," but cannot successfully neutrodyne the set. One setting of the neutrodyne condenser will not hold for the whole of the frequency range covered by the two low-loss H.F. transformers, and adjustment of the first neutrodyne condenser seems to make scarcely any difference.

It would appear likely from the particulars given by our correspondent that something is radically wrong with the wiring in the first neutralising circuit. Trouble of this kind is often traced to a broken joint, or to the two leads to the neutrodyne condenser not making actual contact with the plates. Test, therefore, for continuity, with telephones and a dry cell, between the actual plates of the neutrodyne condensers and the leads which should be connected to them.

## LOOK WHO'S HERE!

BRIGHTSON'S  
 "TRUE BLUE  
 RADIO VALVE"  
 (N.Y., U.S.A.)

True Blues consume one-half the amount of H.T. battery current required by Valves of other makes. This can readily be shown by placing a milliammeter in positive lead of H.T. battery and taking the comparative readings of True Blues as against other Valves. H.T. battery will last twice as long with True Blue Valves in the receiving set.

PRICE. Amp. 0.25. PRICE  
**£1 - 1 - 6** **£1 - 1 - 6**

**J. Y. SELLAR**

Distributor for the British Isles.

Room 43, POLAND HOUSE, 167, OXFORD ST., W.1.

'Phone: Regent 5606.

## ORMOND SQUARE LOW LOSS CONDENSERS

from all  
dealers

See our full page advertisement in "MODERN WIRELESS" and "THE WIRELESS CONSTRUCTOR" Christmas Double Numbers

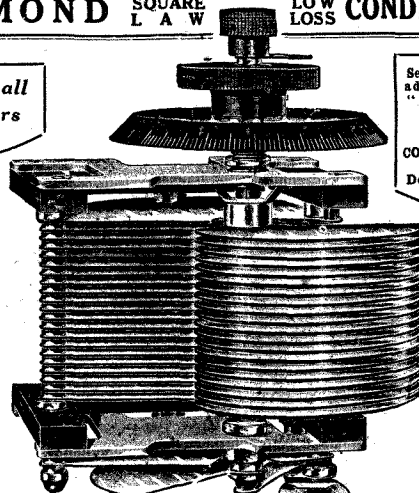

### A Triumph of Efficiency

See the inspection label on every condenser

WHENEVER perfection is approached in any radio product, the quality of that product soon becomes known to the radio public. Thus it has been with the Ormond Condenser. To the experienced experimenter and to the new constructor, the Ormond has made itself known as an instrument of high-grade quality, associated with all that is best in condenser efficiency. The Ormond Condenser can give you in practical performance, a greater and more lasting satisfaction than any other condenser of equal price.

Supplied in the following sizes.

Size.	Price with Vernier.	Price without Vernier.
.0025	8/-	6/6
.0003	9/-	7/6
.0005	9/6	8/-
.001	10/6	9/-

Complete with Knob and Dial.

ORMOND ENGINEERING Co., Ltd. 199-205, Pentonville Road, King's Cross, London, N.1.  
 Factory - Whiskin Street, Clerkenwell, E.C.1.  
 Telephone:—Clerkenwell 9344, 5 and 6. Telegrams:—"Ormondengi, Kinross."

**B L O C K**
**B L O C K**



# A Wonderful Battery

**T**HE Fuller "BLOCK" Batteries are unique. They retain their charge for extraordinarily long periods of intermittent service, and are practically proof against mechanical injury. Block Accumulators are ideal for Car Lighting, &c., while in Radio Work the High Tension Block Battery has decided advantages over Dry Cell Batteries.

*Note these remarkable points:*

1. Sulphating to any serious extent cannot occur through standing in a discharged state or accidental discharge by short circuits.
2. Internal short-circuiting is impossible.
3. Actually you can short-circuit externally without damaging the blocks. (Can you name any other accumulator that will stand so severe a test?)

**FULLER'S UNITED ELECTRIC WORKS LTD.**  
Chadwell Heath - Essex.

Telephone - Ilford 1200.  
Telegrams - "Fuller, Chadwell Heath."  
London Depot: 176 Tottenham Ct. Rd., W.1  
Telephone - Museum 9008.

Write for List No. 250 D.





**USE FULLER Ebonite**



Made and Stocked in a wide range of types and sizes.

174-42

THE PANEL
DE LUXE



**I**F after you have built up your Set you find that a component is unsatisfactory it can usually be replaced without much difficulty. On the other hand a leaky panel will render useless the work of many hours and necessitate the complete rebuilding of the Set. Be wise, therefore, and refuse to take risks. Don't ask merely for an ebonite Panel—ask for a Radion Panel and see that it bears the trade mark Radion.

**R**adion is available in 21 different sizes in black and mahogany. Radion can also be supplied in any special size. Black 1d. per square inch, mahogany 1½d. per square inch.

# RADION

**American Hard Rubber Company (Britain) Ltd.**

Head Office: 15a Fore Street, London, E.C.2    Depots: 120 Wellington Street, Glasgow; 116 Snow Hill, Birmingham.  
Irish Agents: 8 Corporation Street, Belfast.

Gilbert Ad. 4161.

## COLVERN SELECTOR LOW LOSS



The Colvern Selector Low Loss. Reading to 1/3,600th capacity.

Capacity .0005 mfd. £1 1 0  
" .0003 mfd. £1 0 0

Type F, without gear attachment.

Capacity .0005 mfd. 15s. 0d.  
" .0003 mfd. 14s. 0d.

One hole fixing. Other capacities if required. Descriptive folder upon request.

Colvern Independent Vernier. Price 2s. 6d.

Ask your dealer also for the Colvern Low Loss Coil Former. Price 6s. 0d.

## COLVERN ESSENTIALS to long distance work

Every reader of this journal may, upon application, receive illustrated literature of Colvern essentials to a very efficient long distance receiver.

The Colvern Selector Low Loss Condenser (true geared 20 to 1) and capable of relocation to 1/3,600th part of the variable capacity.

The Colvern Low Loss Coil Former provides a very efficient inductance of low self capacity and low H.F. Resistance.

Write to us to-day and your long distance experiments will be successful.

**COLLISON PRECISION SCREW CO., LTD.,** Provost Works, Macdonald Rd., Walthamstow, London, E.17. Telephone: Walthamstow 532.

AN ADVERTISEMENT IN " WIRELESS WEEKLY " IS A GUARANTEE OF SATISFACTION TO BUYERS.

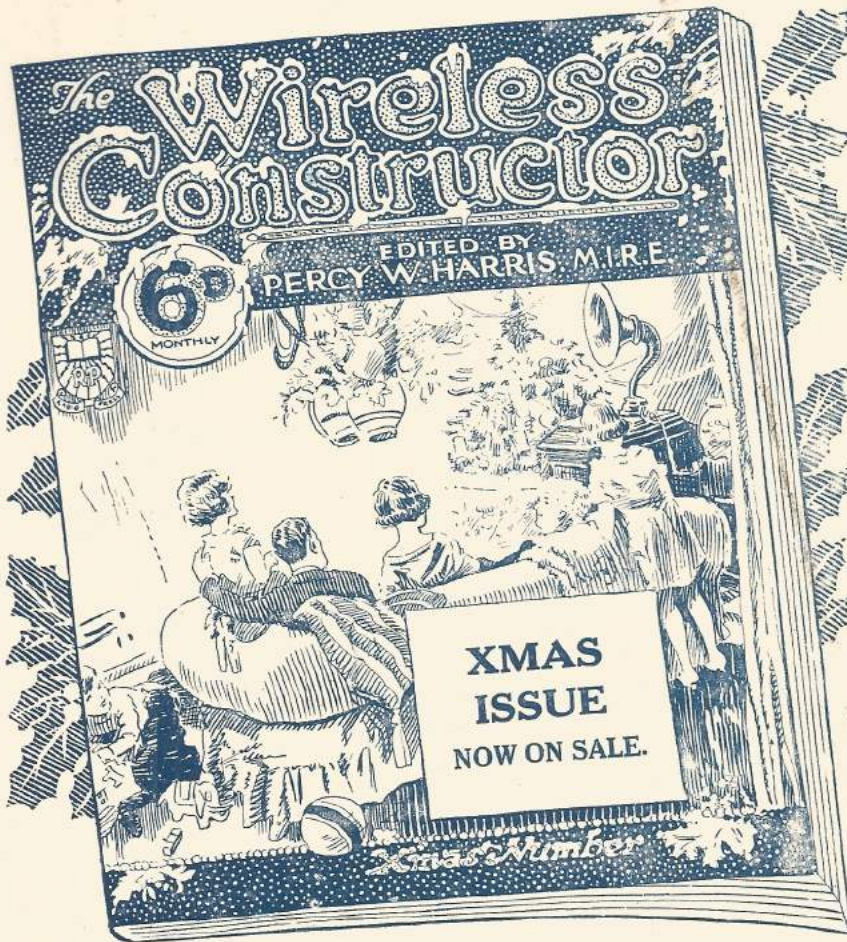

Add to your  
pleasure during  
the Festive Season

by securing a copy of the  
Christmas Issue of

**“THE WIRELESS  
CONSTRUCTOR.”**

No effort has been spared to give our readers in this issue more pleasure and value in contents than ever before offered. There are no less than five “How to Make” articles, ranging from an “All-Purpose” Crystal Set to a “Three-Valve Loud-Speaker Receiver.” Another article of great interest and value is that on “How to Use a Power Valve,” while Capt. A. G. D. West, M.A., B.Sc., of the B.B.C., contributes some interesting facts on “Where the Listener Scores.” ¶ All the other regular features are included, and there is something for each and every member of the home circle. ¶ Get all the pleasure possible from radio and see that your copy of “THE WIRELESS CONSTRUCTOR” is on hand; it will please others as well as you.

**XMAS  
ISSUE**

Price  
**6<sup>d</sup>**

**AS USUAL**

*Obtainable from all News-  
agents and Booksellers. If  
any difficulty in obtaining  
locally, send P.O. 8/6  
for 12 months or 4/3 for  
6 months' subscription to  
Dept. S., Radio Press  
Ltd., Bush House, Strand,  
London, W.C.2.*

**RADIO PRESS LTD.**

BUSH HOUSE, STRAND, LONDON, W.C.2.

**CONTENTS.**

- Selectivity and “Range,” a Compact Two-Valve Receiver. By A. V. D. HORT, B.A.
- How to Make a H.T. Accumulator Unit. By H. J. BARTON-CHAPPEL, Wh.Sch., B.Sc., A.C.G.I., D.I.C., A.M.I.E.E.
- The “All-Purpose” Crystal Set. By PHILIP H. WOOD, B.Sc., F.P.S.L.
- Famous Artists of 1925. By “CARRIER WAVE.”
- Selectivity and the Crystal User. By J. H. REYNER, B.Sc., A.C.G.I., D.I.C., A.M.I.E.E.
- Making a Cabinet for Your Set. Mr. Gumpleshorpe Makes a Wavemeter. A Single-Coil Two-Valve Receiver. By E. J. MARRIOTT.
- How to Use a Power Valve. By G. P. KENDALL, B.Sc.
- Problems of Short-Wave Reception. By C. P. ALLINSON.
- A Single-Valve 3-Circuit Set. By JOHN UNDERDOWN.
- Radio Games for Xmas.
- Useful Distributing Board.
- Questions for Our Readers.
- Smooth Reaction Control—a Three-Valve Loud-Speaker Receiver. By J. H. REYNER, B.Sc., A.C.G.I., D.I.C., A.M.I.E.E.
- Where the Listener Scores. By CAPT. A. G. D. WEST, M.A., B.Sc.

**124 PAGES!!!**

**FREE BLUE PRINT**  
of a Compact Two-Valve Receiver.

Full instructions, clear and concise, for all desiring to build this or any of the five sets described.

**The Wireless  
Constructor**

Edited by Percy W. Harris, M.I.R.E.

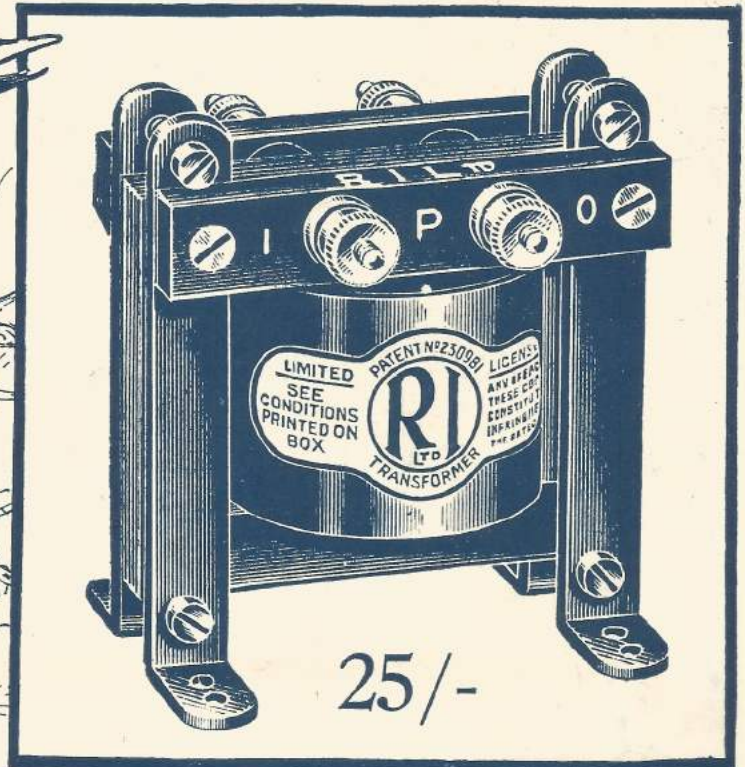

## Purity-of tone

You can't help making comparisons. The song of the nightingale—the perfect reproduction of tonal beauty by the R.I. Transformer—each in its own place is perfect loveliness.

This Transformer still maintains the position which it has held from the first—that of being the standard form of magnetic coupling which reproduces music and speech in its most natural forms.

Since this transformer first appeared, it has been followed by numbers of others, some of which, as far as external appearance goes, are obvious imitations of the R.I. Transformer, while others put forward claims of superiority and efficiency which are not borne out in practice. **The only test that really counts is that of the actual user.**

Take any simple receiving circuit and couple it to an amplifier built with an R.I. Transformer, with any ordinary valve, and you get perfect and pure music or speech. Now take any other transformer on the market and make a similar test. In some cases you will get equally good results, but it will be necessary to use special valves. In other cases, you will get inferior results, but in no

case will you get better results, because an inspection of any other transformer will prove beyond doubt that there is nothing in any of them to give purer results unless a totally different principle is employed.

We found, after extensive research, both in our own laboratories and by making use of the results obtained by eminent investigators in the same field, that the only possible way in which the transformer could be improved was in the subdivision of the windings, thereby reducing the capacity. This innovation was hailed as a great advance in the design of the intervalve transformer, and since then nothing has been done to improve it.

One of the most severe tests of an intervalve transformer is its behaviour in reflex circuits. These latter became popular by reason of the fact that they could be used in connection with low-frequency amplifiers, without distortion, if used with an R.I. Transformer. All low-frequency intervalve transformers are not suitable for reflex circuits, neither are they suitable for all types of valves. You can use an R.I. transformer with practically any valve, and any capacity.

Over half-a-million users will confirm this. This is the best proof the public can have of the efficiency and value of a component that has obtained a classic name in the Radio Industry.

Write for the R.I. blue and gold Catalogue, free on application.

### ❖ THE MARK OF BETTER RADIO ❖

Advt. R.I. Ltd., 12, Hyde Street, New Oxford Street, London, W.C.1.

P.C.12.



When buying R.I. Transformers see that they are contained in the R.I. standard sealed boxes.

