

Wireless Weekly

Vol. 7. No. 5.

LAYING OUT A SHORT-WAVE SET

By
G.P. KENDALL, B.Sc.,

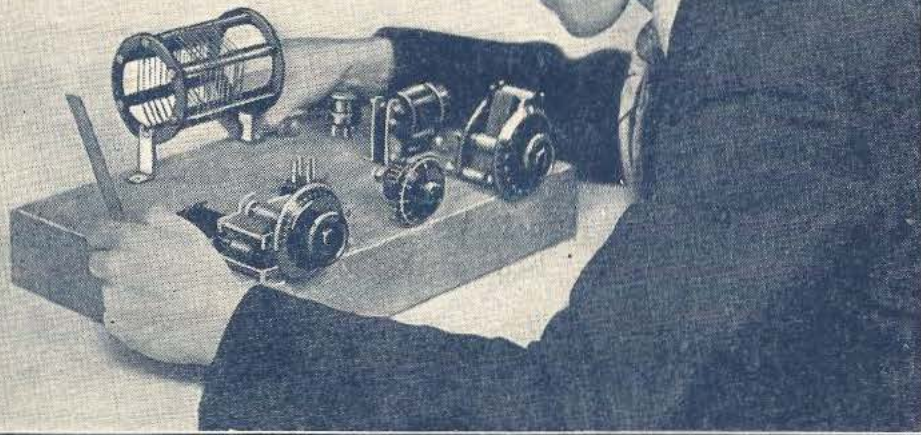

Two Burndept instruments that will make your crystal or one-valve set give loud speaker reception

If you want to listen to broadcast by means of a loud speaker and your set is giving good results on headphones, the Ethophone-Uniplex one-valve amplifier and the Ethovox Junior Loud Speaker will interest you. If cost is a consideration there will be no doubt about your choice, because these instruments are surprisingly inexpensive in spite of their efficiency!

Owing to its special construction, the Ethophone-Uniplex is a really distortionless amplifier and its reproduction of speech and music is all that could be desired. The instrument is supplied with a Burndept Super Power Valve (Type L.240).

The Ethovox Junior Loud Speaker gives splendid results with low powered sets and its rendering of broadcast is clear and very pleasing.

The instrument, which is coloured a deep shade of mahogany, is supplied with a five-foot lead.

BURNDEPT

WIRELESS LIMITED

HEAD OFFICE: Aldine House, Bedford St., Strand, London, W.C.2.

Telephone: Gerrard 9072. Telegrams: Burndept, Westrand, London.

BRANCHES at Birmingham, Brighton, Bristol, Cardiff, Exeter, Glasgow, Leeds, Liverpool, Manchester, Newcastle, Northampton, and Nottingham.



The Ethovox Junior is 16½ inches in height and the flair is no less than 11½ inches in diameter. The sensitive magnet-system is adjustable.

Price, either 120 or 2,000 ohms resistance,

£2 : 2 : 0

Price of Ethophone-Uniplex (below), complete with L.240 valve,

£4 : 4 : 0

Licence, 12/6.



Further particulars of these new Burndept products are given in the 100-page Burndept catalogue, a copy of which will be sent free on application. The Burndept Range includes everything for radio reception, from components to complete installations.

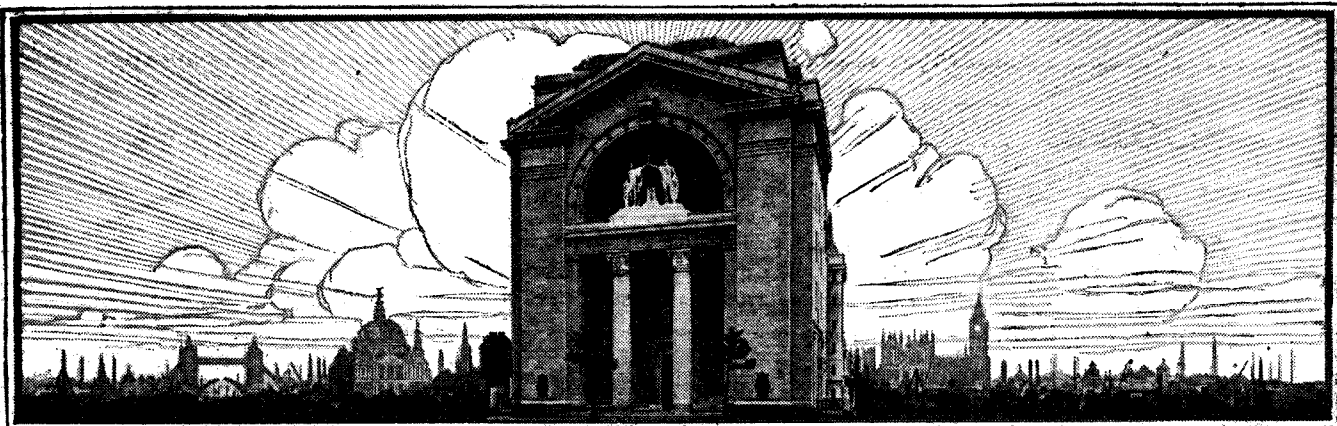

Radio Press LTD

Wireless Weekly
Phonograph City, 9911

Bush House STRAND-WG2

ANOTHER STEP FORWARD

Radio Press American House

READERS of *Wireless Weekly* will be interested to hear that following upon the visit of Mr. Percy W. Harris to the United States to investigate the radio position there, Radio Press, Limited, have now decided to open an American house, with offices in the heart of New York, thus enabling readers of our publications in this country to keep right up to date with all developments taking place in America.

The importance of this step to the British experimenter, and, indeed, to the whole art in this country, can scarcely be over-estimated. No longer will it be necessary for the British enthusiast to view new experiments in America through American eyes. New apparatus, new circuits, new valves, and, what may be still more important, new tendencies which are showing themselves in radio design and developments, will all be reported upon immediately, if necessary, by cable, by a competent radio expert, fully acquainted with radio matters on both sides of the Atlantic.

The manager of the new American house is Mr. A. H. Morse, A.M.I.E.E., M.I.R.E., who has held many important

wireless may be gauged from the fact that for some time he held the position of Managing Director of Marconi's Wireless Telegraph Co., Ltd., of Canada.

It will be seen that Mr. Morse not only has considerable experience of administrative matters, but he has also a wide technical experience of the art. This combination of administrative experience and technical knowledge is of no little importance, since the task of obtaining full information on technical matters is not easily performed. Mr. Morse's standing assures for him the entry into many places which are normally difficult of access, and his personal acquaintance and friendship with some of the greatest men in American radio will be of inestimable value to him.

The offices of Radio Press in America will be situated in the Bush Building, West 42nd Street, New York City, one of the finest office buildings in America, and we have no doubt that before long Radio Press, Bush Building, New York, will become as well known as Radio Press, Bush House, London.

CONTENTS.	
	Page
Some Methods of Connecting Valves in Circuit ..	140
Distortion in Tuning Circuits ..	142
Radio Press Ltd. and the United States ..	145
The Nature and Sources of Atmospherics ..	146
Jottings by the Way ..	150
Some Impressions of the Wireless Exhibition ..	152
Some Further Notes on Short-wave Calibration ..	153
Inventions and Developments ..	156
Wireless News in Brief ..	157
Laying out a Short-wave Set ..	158
Random Technicalities ..	161
An H.F. Selector and Radiation Preventer ..	162
Apparatus We have Tested ..	164
Correspondence ..	165
Information Department ..	169

positions in radio both in England and America, and whose practical acquaintance with the art dates back to the very earliest days. Fuller details of Mr. Morse's career are given on another page, and his standing in the world of

Director of Research :
Major JAMES ROBINSON, D.Sc., Ph.D., F.Inst.P.
Deputy Director of Research :
Capt. H. L. CROWTHER, M.Sc.
Assistant Editor :
PERCY W. HARRIS, M.I.R.E.
Scientific Adviser :
Prof. G. W. O. HOWE, D.Sc., M.I.E.E.
Advisory Editors :
Prof. R. WHIDDINGTON, M.A., D.Sc., F.R.S.
Prof. C. L. FORTESCUE, M.A., M.I.E.E.

Edited by
JOHN SCOTT-TAGGART,
F. Inst. P., A.M.I.E.E.

October 21, Vol. 7, No. 5.

Nothing contained herein is to be regarded as permission or encouragement to infringe any patent rights.

Staff Editors :
E. H. CHAPMAN, M.A., D.Sc.
A. D. COWPER, M.Sc.
R. W. HALLOWS, M.A.
G. P. KENDALL, B.Sc.
A. JOHNSON-RANDALL
STANLEY G. RATTIE, M.I.R.E.
I. H. REYNER, B.Sc. (Hons.),
A.C.G.I., D.I.C.

Some Methods of Connecting Valves in Circuit

By Captain H. J. ROUND, M.C., M.I.E.E., Chief of the Research Department of the Marconi Co., Ltd.

This article, which is the first of a series to be contributed to "Wireless Weekly" by Capt. Round, discusses the relative merits of the various methods of connecting valves in circuit for reception.



IN both transmitting and receiving circuits we use a number of alternative ways of connecting, which give equivalent results, but each of which is more convenient or more economical in a particular case. Two of the best examples of this equivalence are the so-called "top and bottom" feeds to a circuit. Both produce exactly the same result except for minor effects, but sometimes one way is more desirable than the other for purely practical reasons.

The Simplest Methods

Let us examine a very simple case where several arrangements can be used to arrive at the same result. An aerial is required to be connected to a valve, and grid bias is required on the first grid.

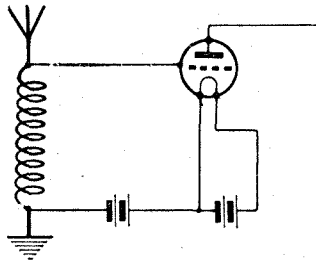

Fig. 1.—Careful insulation of the filament battery is required with this circuit.

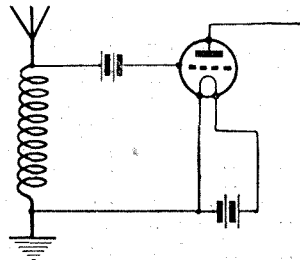

Fig. 2.—Here the grid bias battery is at H.F. potential to earth.

Fig. 1 represents a way of doing this, but we have run into an objectionable feature in that the negative terminal of our low-tension battery is no longer at earth potential; not, perhaps, a very serious error in a simple one-valve circuit if care is taken to insulate the battery, but this is not always easy to do, and a

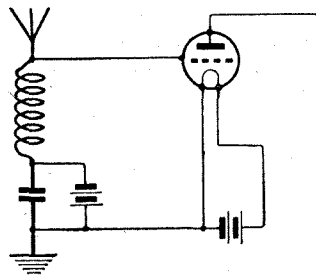

Fig. 3.—With this arrangement the grid bias cells must be shunted with a condenser.

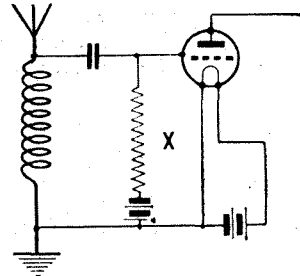

Fig. 4.—X in this circuit may be either a leak or a choke coil.

battery leaky to earth would be liable to give noises and incidentally to run down the grid bias battery. Figs. 2, 3, and 4 represent other ways of doing this. Fig. 2 is quite a possibility, but not good practice—batteries at high H.F. potential are a nuisance. Fig. 3 is also not too good, because it necessitates shunting

the battery with a low-loss condenser of large value. Fig. 4 is really the best practice. X in the figure is either a leak or a choke, and the condenser wants to be large enough not to have much potential drop across it, and, of course, if amplitudes are large, reconsideration on account of grid current is necessary.

The Use of Choke Coils

In the circuits mentioned, losses of battery energy do not enter, so that there is really nothing to choose between a choke and a leak, if the leak is of high value, but we shall meet many other cases where the use of a choke is essential, and a little careful consideration of its working will be necessary.

In Fig. 5 we have an inductance L in series with a condenser C, an ordinary resonant circuit. If we build Fig. 6, so that L₁ and L₂ in parallel have the same inductance as L, we have (neglecting resistance)

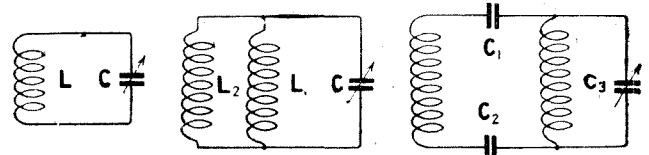

Figs. 5, 6 and 7.—These diagrams may be compared with Figs. 8 and 9 below.

an equivalent circuit. The sum of the currents through L₁ and L₂ is equal to that in L, and they are divided inversely as the inductances L₁ and L₂. If we make L₂ very large it will take negligible current compared with L₁, but it will still be part of the circuit. Incidentally trouble may occur due to capacity effects in L₂ if the inductance is made too large, but this is a practical affair.

Modifications

We may now put blocking condensers in at C₁ and C₂ (Fig. 7). If these condensers are so large that the potential across them is small compared with that

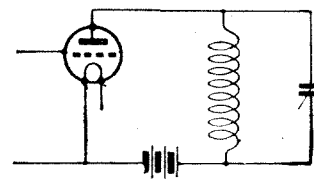

Fig. 8.—The normal "bottom feed" circuit.

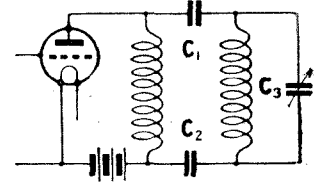

Fig. 9.—A similar method modified so that the H.T. battery is removed from the main oscillatory circuit.

across the tuning condenser (or inductance)—we have as far as the high-frequency current is concerned still not altered the circuit, and we can use this arrangement to give us apparently a quite different valve connection.

Fig. 8 is the normal bottom plate feed and Fig. 9

the modified high-frequency circuit similarly fed; the actions will be very obviously the same, but we have removed the H.T. from the main oscillating circuit. Re-draw Fig. 9 and shift the condenser C₂, and we get the very well-known choke-fed plate circuit.

Fine Wire Choke Coils

This little bit of diagram reasoning shows that the choke carries high-frequency current, and losses in it must be avoided, but as its currents are very small it can naturally be made of fine wire.

But why all this twisting and contorting of circuits?

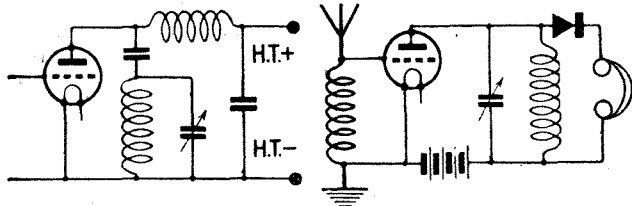

Fig. 10.—The circuit of Fig. 9 in a better known form.

Fig. 11.—This simple tuned anode circuit with crystal detector has certain disadvantages.

Because Fig. 10 is very often more convenient than Fig. 8, in that we can tap off our main inductance with the grid of another valve without having to worry about H.T. potentials getting at our grid, or in a transmitter we can remove dangerous H.T. from the oscillatory coils.

Tuned Anode Circuits

Of course, there are other methods still, such as secondary windings round our oscillating inductances, very often used, in fact, in both receiving and transmitting transformers.

We will, however, take up a case where this information regarding top and bottom-feed is useful. A single-valve tuned anode circuit without, and then with, reflex. Suppose we want to set up a simple tuned anode with crystal rectifier. The circuit of Fig. 11 is O.K. unless we want to put in a potentiometer on to the crystal, when we shall find we cannot use the valve battery for the potentiometer. Figs. 12 and

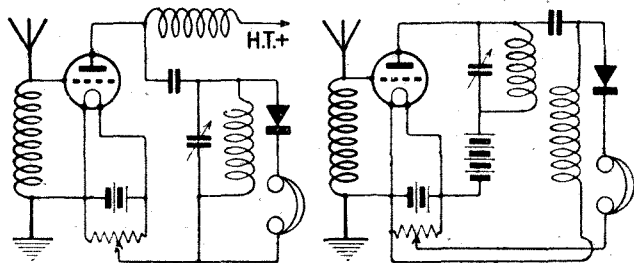

Figs. 12 and 13.—Showing two methods of using a choke coil which give more satisfactory circuits than that of Fig. 11.

13 show two ways of using the choke to get a much nicer circuit.

In both cases the H.T. gets removed from the telephones, where it is always a possible source of shock or trouble.

Reflex Circuits

Suppose we wish to reflex the circuit, Fig. 14 will be the first method we shall think of.

This will be objectionable, because any leakage of either the low-tension or the high-tension battery will tend to short the transformer secondary T₂.

Fig. 15 gets over this difficulty, and is similar to Fig. 3 in principle, but has the very obvious objection that the aerial capacity and the blocking condenser are across the transformer secondary—a place where the minimum capacity is desirable, and, secondly, the aerial system and the transformer form a resonant circuit capable of receiving (because of the aerial) low-frequency currents such as from A.C. mains. The circuit can apply these unwanted potentials to the grid, and the valve will then amplify them to the phones.

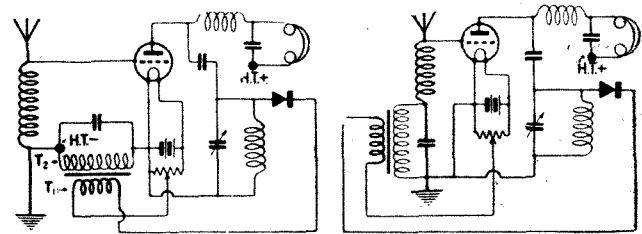

Fig. 14.—Leakage of the L.T. or H.T. battery will tend to short circuit the secondary (T₂) of the L.F. transformer.

Fig. 15.—This shows some improvement over Fig. 14, but interference from A.C. mains may be troublesome.

In some houses the trouble will not be serious, but, of course, there is no need to ask for trouble.

Low-frequency Chokes

Fig. 16 carries out the top-feed idea completely, and seems to be the best general arrangement; it has the least number of faults.

Its only serious fault is that it has left our telephones at high potential, a fault common to most receivers and not really good practice, but here again an iron core choke and a condenser will remove that trouble if necessary. The design of the high-frequency chokes has to be carefully considered, and the best form seems to be to wind them of fine wire in one layer of a value

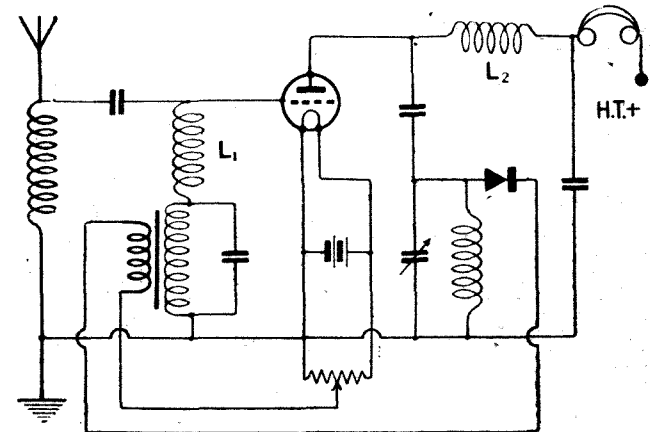

Fig. 16.—The only serious objection to this circuit is that the telephones are at H.F. potential to earth.

of inductance five or six times the main inductance. If layer-wound chokes of large value are used, there is a danger of forming wave-traps at certain frequencies.

Transformer Circuits

The greatest difficulties arise when chokes have to be made to handle a big range of wavelengths. A bold alternative to all these simple circuits is the transformer circuit, but as this introduces at once ideas of ratios of transformation, with all its complications, I will leave it till later.

DISTORTION IN TUNING CIRCUITS

By J. H. REYNER, B.Sc. (Hons.), A.C.G.I.,
D.I.C., Staff Editor.

In this article, the second of his series on the theoretical principles underlying selectivity, Mr. Reyner discusses the limitations of selectivity when telephony is the main objective of reception.

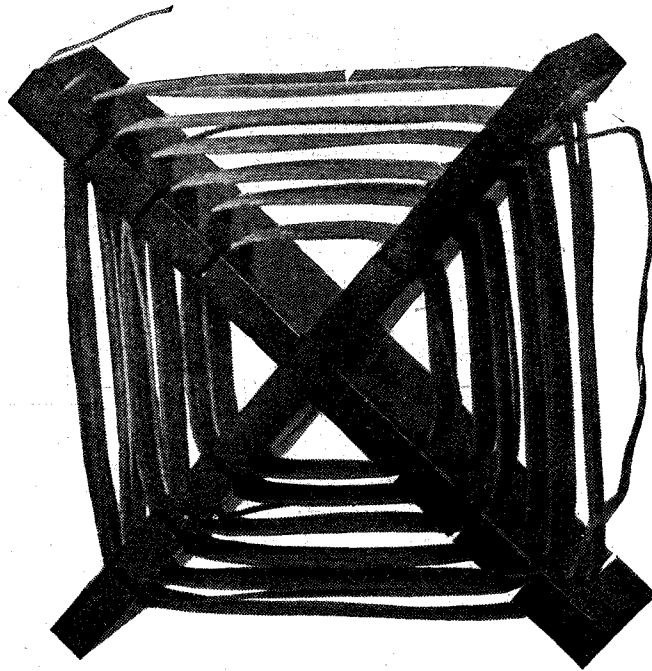

A coil of this type would have a resistance of between 5 and 10 ohms at high frequencies.

IN my article in this series last week I discussed the question of tuned circuits and the effect of resistance upon the resonance curve. At first sight it would appear that the problem of selectivity is simply that of making the resonance curve of the particular circuit chosen so sharp, that is to say having so narrow a band width, that the undesired stations may be eliminated and the wanted station brought in by a suitable adjustment of the tuning controls.

The problem, however, is not quite so simple as this, owing to the fact that telephony is not confined to an isolated frequency, but requires a considerable band of frequencies for the satisfactory transmission of speech or music.

Frequency Bands Required for Telephony

It is a little difficult at first sight to appreciate, without recourse to mathematics, why telephony should require a band of frequencies. A physical interpretation, however, may be obtained by considering the problem as the reverse of a well-known problem in receiving. If a high-frequency oscillation is modulated with a second high-frequency oscillation of a slightly different frequency, the well-known heterodyne note is obtained. This hetero-

dyne note is produced by the alternate addition and subtraction of the currents in the two oscillations. Due to the slight difference in frequency, the currents alternately come in and out of step, so producing a variation of the resultant amplitude which gives the heterodyne "beat" note.

Modulated C.W.

This principle is illustrated in Fig. 1. Now the process in a telephone transmitter is the exact reverse of this. We have here a continuous wave which is modulated at a low frequency, that is to say, if the high-frequency wave were modulated with a pure note of a definite frequency, the modulated wave would be as seen in Fig. 1. This same type of wave, however, we have just seen to be capable of being produced by two waves of different (high) frequencies. Thus it will be seen that the modulation of the original carrier wave gives rise to two additional high frequencies, which are known as side frequencies or side tones.

Side Bands

The frequencies of these side tones are constant for a given note, but in the case of speech or music where the low-frequency vibrations im-

pressed upon the microphone are of all frequencies ranging from 50 up to 5,000 or more, it is obvious that there will be two side tones for each particular frequency, so that waves radiated will consist of the carrier wave and a fairly broad band of side tones. This side band extends, as we have seen, to plus or minus 5,000 cycles on each side of the carrier wave, and if satisfactory and distortionless speech or music is to be received, then it is essential that not only the carrier wave, but the whole of this side band also, shall be satisfactorily received.

Flat-Topped Resonance Curves

Now consider the ordinary resonance curve. It will be seen that the current has a maximum at one frequency, and as the frequency varies on either side, so the current gradually falls off. The sharper the resonance curve, that is to say, the greater the selectivity of the circuit, the more rapid will be the falling away. Thus with the ordinary resonance curve the higher side band frequencies will not produce the same currents in the tuned circuit as the carrier wave will.

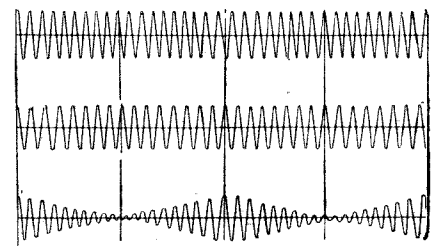

Fig. 1.—The combination of two high frequencies produces a third high frequency modulated at a lower frequency.

That is to say, if the circuit is at all selective, it will tend to cut off some of these side frequencies instead of receiving them, and the result will be distorted telephony.

The ideal resonance curve for this type of work would be one as shown in Fig. 2, having a flat top, so that it amplifies all the frequencies equally well within the band, and a sharp vertical cut-off.

An absolutely square-topped resonance curve is, of course, not a practical proposition, but fortunately we can obtain a very close approximation to this ideal condition.

Use of Band Filters

The only effect of varying the resistance in a single tuned circuit is to alter the scale of the resonance curve. This point was made clear in my last week's article, and it will shortly be seen that no matter what resistance we choose, we cannot obtain a satisfactory solution of the difficulty. It is found that if good speech is to be received, then the amplitude of the oscillation at a frequency 4,000 cycles different from resonance must not be less than one-half the resonant value. If this limit is exceeded, then the side bands will be cut off too much and distortion will result.

Selectivity Impossible with a Single Circuit

Fig. 3 shows the curve in which this condition of affairs is fulfilled, and it will be seen that at a frequency 10 kilocycles away from resonance the current is still appreciable. Now 10 kilocycles is the closest spacing which can exist between broadcasting stations without serious difficulties. The majority of broadcasting stations are spaced a little farther apart than this, but there are stations working with a frequency difference of only 12 to 14 kilocycles. Thus if a station was being received with a frequency difference of, say, 14 kilocycles from a local station which,

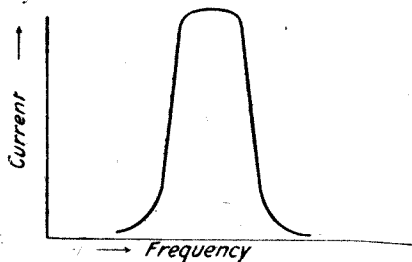

Fig. 2.—A flat-topped resonance curve is required for telephony.

by virtue of its proximity, was supplying 100 times the amount of energy or more, the selectivity of such a circuit would be totally inadequate.

Coupled Circuits

The solution of the difficulty lies in the use of a series of coupled circuits. If the first resonant circuit is coupled to a second tuned circuit, either directly with a loose coupling, or through a valve, in order to make up for any loss of

signal strength in the transfer of energy from one circuit to the other, then the resultant resonance curve is found to be somewhat more flat-topped and also steeper-sided. It can be shown that the resonance curve obtained with two similar coupled circuits is obtained by squaring the ordinates of the reson-

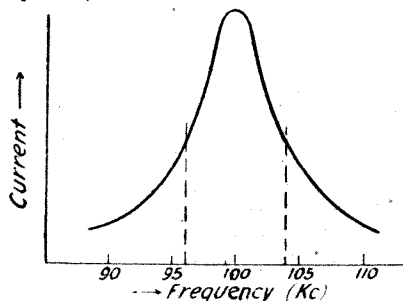

Fig. 3.—A resonance curve for a single circuit complying with the condition for good quality.

ance curve obtained for a single circuit. This has been done in Fig. 4, from which it will be seen that a considerably steeper cut-off is obtained giving a curve having a fairly uniform band width towards the peak.

Increase of Resistance Necessary

This second resonance curve, however, would produce too sharp a cut-off on the higher side bands, and it is necessary therefore to increase the band width of the resonance curve. This is done by increasing the resistance in the circuit, the effect of which is to increase the band width, and this results in a resonance curve as shown in Fig. 5. It will be seen that this curve is not only wider at the top than that of Fig. 3, but has a much sharper cut-off towards the bottom. This means to say that the various side band frequencies will all be received perfectly satisfactorily, but that interfering stations at a greater frequency difference from the resonant value than 4 kilocycles will be cut off to a greater extent than with the single circuit.

The principle can be extended to comprise a whole chain of filters, and as more and more tuned circuits are incorporated, so the curve gets more and more flat topped and steeper and steeper sided.

Band Filters

Professor G. W. O. Howe has recently worked out some actual figures for the resistances necessary in the various filters in order to comply with the conditions. He takes as his criterion of selectivity that a 10 per cent. departure from

the resonant frequency should reduce the currents to 1/10,000 of the resonance value. A 10 per cent. departure from resonance at the ordinary broadcasting frequencies employed would mean a difference of from 70 to 80 kilocycles. Such a circuit would at a frequency difference of 10 kilocycles only give a current equal to .0008 of the resonant value, which will be seen to be satisfactory for ordinary wireless reception.

Distortion Due to Reaction

Now with a single circuit having an inductance of 80 μ H and a capacity of 500 μ F, the effective resistance to obtain a resonance curve as sharp as this would have to be .008 ohms. It is possible by using suitable reaction circuits to obtain such a very low resistance, but if this were done the telephony would be horribly distorted. This would be due to the fact that the cut-off would be too sharp, and only a very small percentage of the side bands would be satisfactorily reproduced. The problem may be studied from another angle, which serves to render the importance of the side bands a little clearer.

Another Point of View

The growth or decay of current in a circuit depends on the resist-

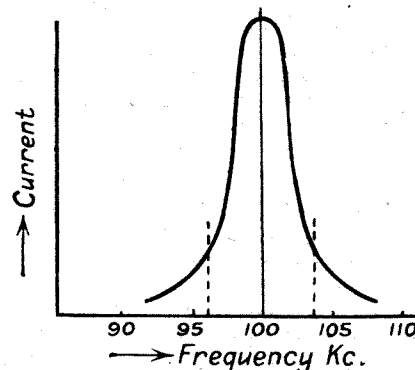

Fig. 4.—This curve has a flatter top, but the cut-off is too sharp for good quality.

ance thereof. In a circuit having extraordinarily low resistance, such as that which we have just considered, the building up and dying away of the oscillation would be so slow that it would be unable to follow the variations of current sent out by the transmitting station. Consequently, instead of the received currents varying according to the modulation impressed on the transmitter by the microphone, they would lag hopelessly and would be totally unable to follow the very rapid variations, and the result would be chaos.

Values of Resistance Required

We have just seen, however, that in the case of a chain of tuned circuits coupled to each other, the desired sharpness of cut-off may be obtained while the top of the resonance curve still remains fairly broad and flat-topped if suitable resistance

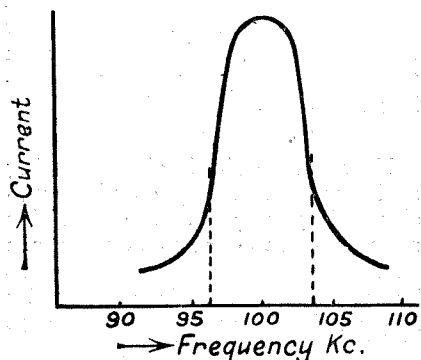

Fig. 5.—By inserting resistance the sharp cut-off is still maintained, but the band width is made larger.

is inserted. Professor Howe has worked out the resistance required in the circuit previously mentioned in order that the telephony shall be satisfactory. The criterion for this, it will be remembered, is that the current, at a frequency of 4,000 cycles removed from the resonant frequency, shall not be less than one-half. For this condition to be fulfilled, the resistance required in each circuit is

- 2.31 ohms for the single circuit,
- 3.97 ohms for two circuits,
- 5.2 ohms for three circuits,
- 6.1 ohms for four circuits.

Three Circuits Essential

If a single circuit, however, were made with such a high resistance as 2.31 ohms, then at a frequency difference of 80 kilocycles (10 per cent.) the current would only be 1/33 what it is at resonance, which, of course, is nothing like selective enough. The ratio of the currents at resonance to the currents at a frequency 10 per cent. away, is given by Professor Howe for the particular values of resistance just quoted. For a single circuit this ratio is 33.

- For two circuits 337.
- For three circuits 4,060.
- For four circuits 24,300.

It will be remembered that the criterion laid down was that the currents at 10 per cent. detuning should be 1/10,000 of the resonant value, and it will be seen that this condition is obtained somewhere in between 3 and 4 circuits. It is therefore necessary to use four tuned circuits, if adequate selec-

tivity is to be obtained with perfect reproduction; but if a certain quality can be sacrificed, then three circuits only may be employed.

Practical Application

We now come to consider what these results mean when interpreted into terms of practical conditions in a receiver. The problem really depends upon how much selectivity one is prepared to allow for. It is undesirable to multiply the number of tuning circuits more than is absolutely necessary. If we have two tuned circuits, each having a resistance at high frequency of 4 ohms, a condition which is by no means easy to comply with, then we shall get satisfactory quality, but we shall not get particularly selective results. Reaction could, of course, be introduced on to one of these tuned circuits, which would have the effect of improving the selectivity to a considerable extent. It would, however, cause a very noticeable alteration to the quality of the telephony.

Four-Circuit Tuning

The problem is a little better if three circuits are employed. Here we may arrange for the circuit to have a resistance of 5 ohms, and the speech will then be perfectly satisfactory. The selectivity will be good in the majority of cases, but in the case where the set is to be worked within one or two miles only of the local station, then a higher order of selectivity will be required for receiving those sta-

tions which are close (in frequency) to the local station.

If, as a practical compromise, one is prepared to sacrifice a certain amount of quality in receiving these stations, which after all are only a few out of the whole broadcast band, then the application of reaction upon the third circuit would result in the desired selectivity at a slight sacrifice of purity. If four circuits are used, as has been seen, both selectivity and quality are absolutely satisfactory, but the difficulty of operating such a set rules it out of court for all except the more advanced experimenters.

High-Frequency Resistances

It should be remembered that these values of resistance which are given are all high-frequency resistances. Mr. Cowper and others have shown in these columns that it requires very special construction to obtain a coil suitable for tuning at broadcast frequencies, which has a resistance as low as 5 ohms. Added to this are all the resistances due to stray capacities in the circuit, due to the damping of the valves, and here again Mr. Cowper has shown that anything from 40 to 80 ohms may be introduced by the ordinary grid condenser and leak method of rectification. It will be seen, therefore, that even if one decides to use only three circuits, very particular care must be taken, in designing those circuits, to keep the resistance down as low as 5 ohms.

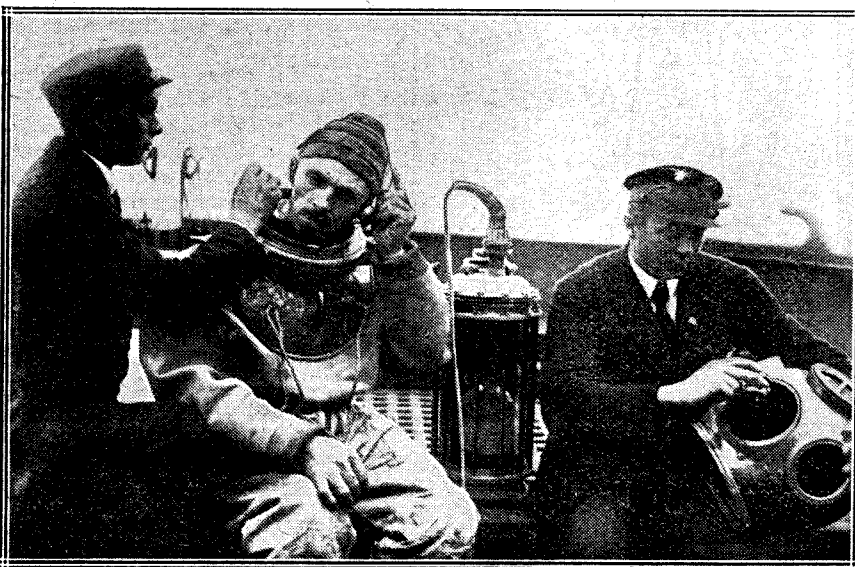

Herr Rarmstorf, who is seen testing the telephones while a microphone is attached to his helmet, recently successfully spoke by wireless from the bottom of the sea near Heligoland. His speech was relayed via land-lines from various German broadcasting stations.

RADIO PRESS LTD. AND THE UNITED STATES

APPOINTMENT OF MANAGER OF OUR AMERICAN HOUSE



Mr. A. H. Morse, A.M.I.E.E., M.I.R.E.

Information regarding the opening of our American House will be found on the Editorial page in this issue. We give below some account of the previous activities of Mr. A. H. Morse, A.M.I.E.E., M.I.R.E., who has been appointed manager.

WE have much pleasure in introducing to our readers Mr. A. H. Morse, A.M.I.E.E., M.I.R.E., on his appointment as Manager of the American House of Radio Press, Ltd. Mr. Morse has been actively concerned with the technical side of both wired and wireless telegraphy for some years.

Post Office Telegraphs

In 1897 he entered the Telegraph Service of the General Post Office in London, leaving this in April, 1900, when he left England to serve in the South African War, with the Telegraph Section of the Royal Engineers. On his return to England in 1902, for a short time Mr. Morse was engaged in journalistic work in Fleet Street. In 1904 he proceeded to West Africa, where he carried out the construction of the first telegraph line built to communicate with Sokoto.

Wireless in Canada

On completion of this contract in Africa he proceeded to Canada, where in 1906 he entered the service of the De Forest Wireless Corporation as consulting engineer. The following year he was appointed Superintendent of this Company. During his period of service with the De Forest Company, Mr. Morse was in charge of the complete system of wireless telegraph communications between

the cities of Montreal, Ottawa and Quebec.

In 1907 he proceeded to the Pacific coast to take charge of five wireless stations for the Canadian Government, and on the completion of this contract he entered the service of the United Wireless Telegraph Company in Seattle, spending the following year in Alaska. In 1909 he was appointed superintendent of construction and maintenance for the United Wireless Telegraph Company, and early in the next year he returned to London to take charge of the technical side of this Company's European business.

With the Marconi Co.

When the Marconi Company took over the business of the Northern Wireless Telegraph Company in 1912, Mr. Morse joined the former company. Three years later he was appointed adviser in wireless matters to the Indo-European Telegraph Company. Mr. Morse returned to Canada in 1919, when he accepted the position of Managing Director of Marconi's Wireless

Telegraph Co., Ltd., in Canada. This appointment he held until the beginning of 1923, when he decided to enter business on his own account, and tendered his resignation with this object in view.

Radio Press Offices

The offices of the Radio Press, Ltd., American house, will be situated in the Bush Building, 42nd Street, New York, an admirable position in one of New York's most famous thoroughfares.

R.A.F. REUNION DINNER

The annual reunion dinner for past and present officers of No. 1 (T.) Wireless School and Squadron, Royal Air Force, will be held in London on Friday, December 4, 1925.

All officers interested should communicate with the Hon. Secretary,

Mr. J. F. Herd,
Ditton Corner,
Datchet, Windsor,

who will send full particulars.

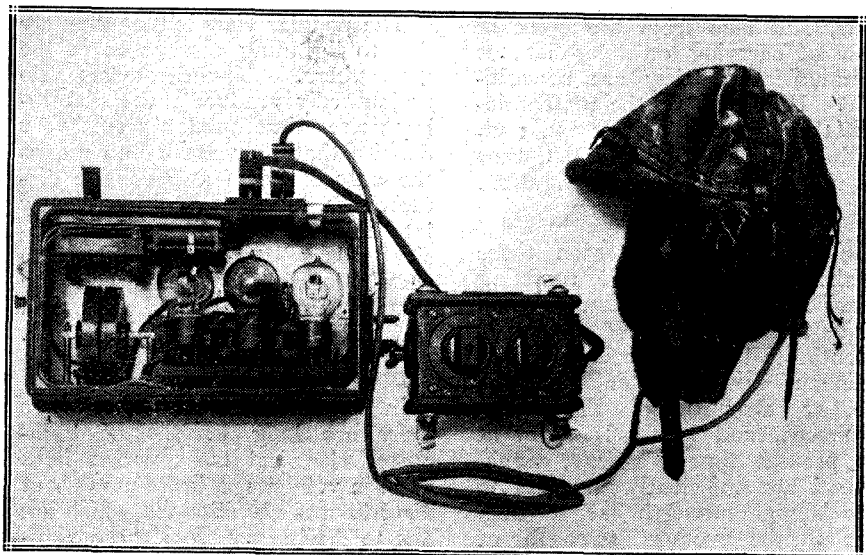

The receiving apparatus used on aircraft for the reception of telephony from ground stations. The remote control unit is seen in the centre of the photograph.

The Nature and Sources of Atmospheric

By Major JAMES ROBINSON, D.Sc.,
Ph.D., F.Inst.P., Director of Research
to Radio Press, Ltd.

Much success in the elimination of atmospheric in reception can hardly be achieved without an appreciation of the nature of these disturbances. This discussion of the extent of our present knowledge in this direction should prove of considerable interest.

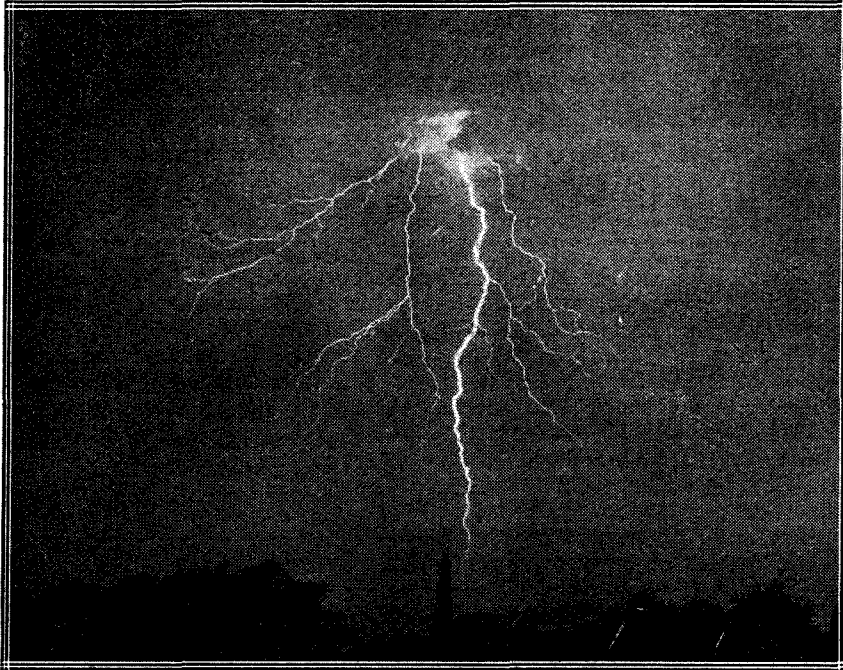

A visible lightning discharge may be regarded as one cause of atmospheric disturbances.

IN these days, with millions of people using wireless, there is no necessity to describe the crashes, clicks, and rumbling noises of atmospheric which are obtained on all wavelengths. They are a nuisance to listeners, but to some other classes of people they are extremely useful. Unfortunately from the broadcasting point of view, and also from the point of view of carrying on long-distance communication, they are unavoidable. However, to the meteorologist they are full of interest, and, further, to the pure scientist, they are a fruitful field for investigation.

Signal Strength of Disturbances

In any particular region these crashes and clicks and rumbling noises have an average strength, and for perfect broadcast reception it is essential to have the received signal strength much greater than the average strength of these disturbances, and in this country at the present time broadcast transmitters are sufficiently powerful to give signal strength larger than that of the average strength of atmospheric. This average strength of disturbance depends on geo-

graphical situation to a very large extent, some countries being very much worse than others. The crashes and clicks are usually called by the name of "Atmospherics," but they have other names, such as "Strays," "X's," "Parasitic Signals," and "Static." The most common names are Atmospheric and X's.

What Are These Disturbances?

The popular view is that they are due to lightning discharges in the atmosphere. Thunderstorms do undoubtedly produce these disturbing noises, but opinion seems very definite that they are by no means the only cause of atmospheric disturbances. Before inquiring closely into the real causes, we may consider other disturbances peculiar to certain localities, which are of the same nature as atmospheric, and which are often confused with them.

Power Lines

In Switzerland and Mexico, where there are long lengths of high-power electrical transmission lines at high voltages, a large number of disturbances are obtained which are due to discharges from these high-tension lines. Such disturbances may be easily visible or they may

be more of the nature of brush discharges. Again, in large cities where there are electric trams and electric power systems on a large scale, electric discharges of this nature also take place.

Similar Disturbances

An instance is on record where observations of atmospheric were simultaneously recorded in Berlin and other places in Germany, and it was found that there were more of these disturbances in Berlin than any other place in the country. This was undoubtedly due to the large number of electrical power lines in Berlin.

Other Causes

Also the presence of long lengths of overhead wires accentuates the disturbance due to atmospheric, as they act as collectors of the waves, re-radiating them to receiving aërials. Another source of disturbance for which atmospheric are wrongly blamed is a faulty high-tension battery in one's own receiving apparatus.

Lightning Flashes

There is not any doubt that lightning flashes do produce atmospheric disturbances. Many instances are on record where observations of lightning flashes have been recorded by eye and in telephones or loud-speakers at the same instant, and it can be considered as beyond doubt that lightning discharges are one source of atmospheric disturbances. Whether they are the only sources is a very difficult question, but opinion seems to be that lightning flashes are not by any means the only cause of atmospheric disturbances. In fact, the distance over which an atmospheric which is due to a lightning discharge can be heard is usually not greater than 150 miles.

Natural Spark Transmission

It is quite easy to understand why a lightning discharge causes a disturbance in one's receiver, because lightning is really a very long spark discharge, the spark occurring between an electrified cloud and the earth or between two electrified clouds which are charged to a high electrical potential. Such a discharge is obviously of the same type as the spark discharge of a wireless transmitter. There is no transmitting aerial other than the path which the lightning happens to follow.

Highly Damped Waves

There cannot be any definite tuning of such a system, but, on the other hand, there must be tremendous power behind a lightning flash, as much mechanical damage can be done by such a flash. In spite of the bad wireless conditions as we know them, wireless waves are produced by a lightning flash, but because of the large resistance of the natural aerial of the path of the lightning, and the low inductance, the waves will be highly damped.

Types of Disturbances

A very large number of observations has been made by very many observers on the types of noises which are characterised as atmospherics, and a large number of classifications has been made from time to time. There are very many types, but I think we can be satisfied by separating them into the four classes:—

Clicks, Crashes, Grinders, and Hisses.

The clicks are similar to the disturbances that one obtains from single lightning discharges. Crashes usually last from half a second to five seconds. They are obtained when there appears to be no thunder about, but when the weather is squally, and when there appear to be sudden violent changes of temperature. Grinders would seem to consist of a large number of clicks and crashes together, although there has been much difference of opinion as to the cause of grinders. Hisses can occur at various times. They are prevalent in local rain or hailstorms, and they may also occur in very dry weather.

Distribution of Atmospherics Over the Earth's Surface

A very large number of observations has been made regarding places where the atmospherics are of great intensity and frequency of

occurrence, and places where few atmospherics are observed. Also a great number of general conclusions has been drawn; but in running through the literature on this subject there appears to be much contradictory evidence. It is quite easy to understand why there should be such apparent contradiction, as a large number of observers have restricted their investigations to comparatively small regions of the earth's surface. Some observers give certain regions as very bad for atmospherics, and others give quite different comments. One of the reasons for this is that atmospherics vary from time to time and there are daily variations and seasonal variations, which are by no means regular.

Observations

Out of the large mass of observations of the strength of atmo-

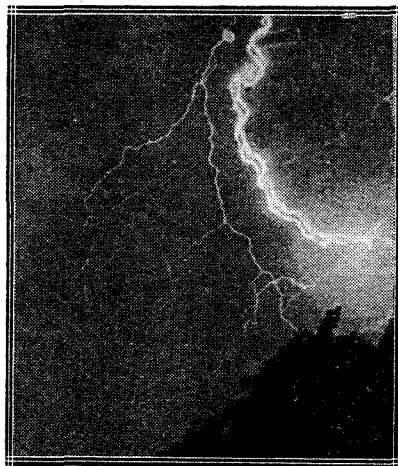

The disturbance due to a lightning flash is not usually audible at any great distance from its source.

spherics at different places in the world, and at different seasons and different times of day, one set of observations will be referred to. It would be very confusing to readers to give the results obtained by a number of different observers, and the particular set of observations chosen will serve as the most typical and probably the most reliable.

The Marconi Expedition

This record of observations was made on the Marconi Expedition round the world in 1922-1923 to study the propagation of wireless waves. A large number of observations was made, since before any general deductions could be formed, such a large mass of evidence was required. The first

observation is that the "click" type, due to thunderstorms, may occur anywhere and at any time of day or of the year.

Tropical Conditions

The "grinders," however, are worst over large areas of land in the tropics. Again, in different parts of the tropics they vary with the time of the year, being worst in the regions north of the Equator during the northern summer, and worst in the regions south of the Equator during the southern summer. The daily variation is fairly regular, the worst atmospherics occurring usually about 3 p.m. From then till midnight the intensity diminishes, a minimum being reached in the early hours of the morning, after which an increase in intensity commences and continues up to the maximum again in the afternoon.

Deductions

This complete series of observations is very instructive, and it can be used as a basis for a generalisation as regards the distribution of atmospherics. The tropics are not the only place where grinders are produced, but undoubtedly there we have the source of the most violent grinders.

Law of Distribution

With these observations of the Marconi Expedition, and with the most reliable observations of other investigators, a general law can be given, *that the most intense atmospherics of the grinder type have their origin over large areas of land in the tropics, and that the origin follows the sun with the seasons and with the time of day.*

Later in this article it will be shown that the grinder and crash types may also originate in other regions besides the tropics, and that in all cases mountainous regions have a large influence.

General Investigations

Having now some idea as to the distribution of atmospherics geographically and with the seasons and the time of day, we must consider other investigations which have been made regarding the influence on meteorology, and also how wireless reception is affected. Such problems as the frequency or the wavelength of the disturbance, the wave form, the direction from which the atmospherics come, and how to make use of the observations for enabling weather fore-

casts to be made, have all received much attention.

Forecasting of Thunderstorms

Even before the days of wireless it had been discovered that thunderstorms can be recorded by a vertical wire and a coherer. The first records were made in the year 1895 by the well-known scientist Popoff. His observations were found to be very useful from the meteorological

which was observed, and observers soon began to know when a thunderstorm was approaching. Thus it was possible to warn aircraft in advance of the approach of a thunderstorm.

Directional Observations

Later attempts were even made to give more information, and to indicate from what direction the thunderstorms were approaching.

of thunderstorms, changing his apparatus with the advance of the technique of wireless. In the early days he used the Bellini Tosi system, with an arrangement for making unidirectional observations. The moving coil of the radiogoniometer was moved to various directions, and the number of atmospherics counted for a definite time interval for each position. Later he made these observations more automatic by using a large rotating coil and recording photographically.

Sources of Atmospherics

A number of stations made simultaneous observations round the British coast, so that the origin of the atmospherics could be plotted. The general result of his observations was that the prevalent source of atmospherics was on a bearing 150 degrees from true north, actually in a south-south-east direction, thus pointing towards the Alps or to a position in Northern Africa. He further found that the maximum appeared to vary somewhat with the time of day, and also with the time of the year, practically varying over an angle of 30 degrees from the mean.

Further Investigations

In addition to determining these very general results of the most prevalent direction, he was able to forecast the approach of thunderstorms at any particular time, and also the direction of approach. His observations were of such importance that they have been repeated by various people in other countries. One typical example was in Berlin, where a slightly different direction for the prevalent atmospherics was obtained, pointing in the magnetic meridian. However, this direction again pointed towards the mountainous regions in Central Europe or to some spot in Northern Africa. As a result of these variations, the German observers are of the opinion that the source of atmospherics appears to follow the sun.

The atmospherics appear also to come from a vertical direction, and some observers consider that these are the most intense, though those from horizontal directions are most frequent.

Frequency of Oscillations

This subject has been much discussed for many years, but it can now be considered to be decided. Without definite information it was impossible to state whether an atmospheric discharge was oscillating

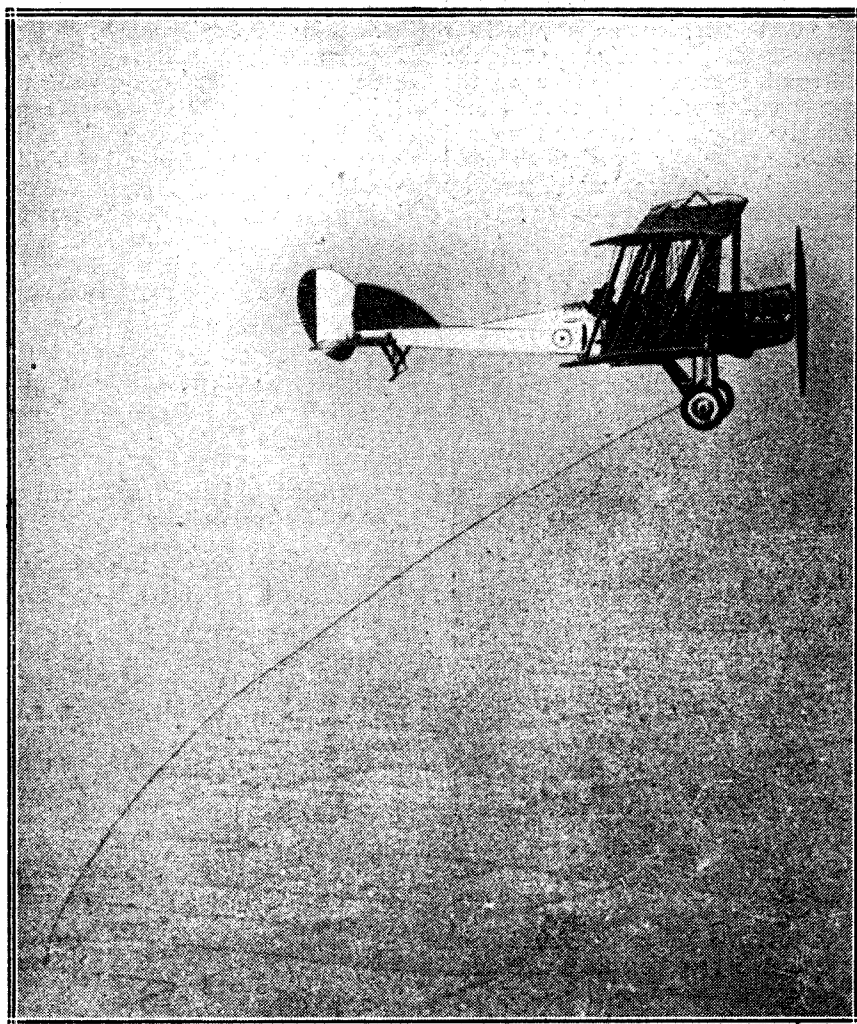

During the Great War much useful work was done with aircraft in the detecting of the approach of thunderstorms.

point of view, and were repeated and used to a considerable extent.

Observations from Aircraft

When the War started, and when aircraft began to come into their own, it was found that exceedingly useful information could be obtained by such observations of atmospherics, which by that time were made by more modern wireless apparatus. This was principally with a view to determining when thunderstorms were coming. It was the click type of atmospheric

Such information is, of course, extremely useful, as aircraft, particularly airships, with such information, could avoid the area of the thunderstorm without having to descend.

Dr. Watson Watts

This work was started about 1917 under the control of Dr. Watson Watts, who contributed very considerably to our knowledge of atmospherics as a result of this work. He has used various methods for recording the direction

tory at all, and if so what frequency it had. Observations were, of course, made on the influence of tuning wireless aerials to different wavelengths, and recording on which wavelength the atmospheric were most intense.

Long Wavelengths

The conclusion reached is that atmospheric are worst on the longest wavelengths. This result is undoubtedly correct, for on short wavelengths of the order of 100 metres, although atmospheric still appear, they are not nearly so bad as on a wavelength of 20,000 metres. In fact, a very recent observation by G. Marcuse, who has been operating on 40 metres with Australia, states that during this recent summer he was not worried by atmospheric at all. Thus the tendency was to assume that if atmospheric were oscillatory at all they would have a very low frequency, lower than 15,000 per second.

Wave Form

In the last two or three years observations have actually been made to determine what wave form an atmospheric has. This brilliant piece of work was done by Dr. Watson Watts and Professor Appleton. They used a cathode ray oscillograph to investigate the wave form of an atmospheric, and they found that, as a general rule, atmospheric are not oscillatory, although in some cases a highly-damped oscillation was recorded.

Examples

Some typical examples of the wave form are given in Fig. 1, A, B, C, D. Fig. 1A shows the most prevalent type, where it is seen that the atmospheric is merely a pulse in one direction, the voltage produced in the aerial rising very suddenly to a maximum and dying away very suddenly. Another type is shown in Fig. 1B, this again being non-oscillatory. Fig. 1C shows a form of semi-oscillatory discharge, this being very highly damped. Fig. 1D shows a form that was obtained on a number of occasions where comparatively high-frequency oscillations were superimposed on the type of pulse discharge shown in Fig. 1A.

Characteristics

The duration of these discharges was about 1/500th of a second. The electrical potential produced in the aerial corresponds to an electrostatic field of 1/10th of a volt. This corresponds to a very loud signal,

as a usual wireless signal for good communication is 1/10th of a millivolt, which is a thousand times smaller. It is thus seen that there

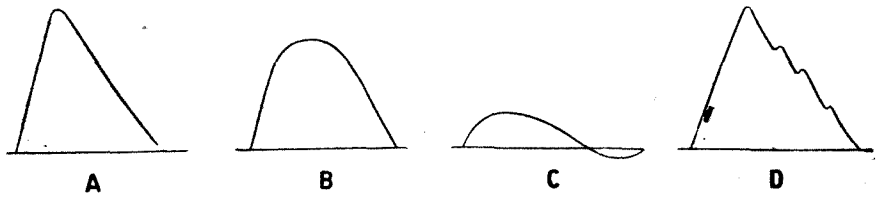

Fig. 1.—Some typical examples of the wave forms of atmospheric.

is some tremendous power behind a single atmospheric discharge, corresponding to 1,000 times that required for good communication.

Why Atmospheric Appear on all Wavelengths

It now appears fairly obvious why atmospheric appear on all wavelengths. Referring to Fig. 1A, there is a sudden rush of potential which is of very large amplitude. This will excite an aerial in such a way

the use of atmospheric received by wireless to forecast the approach of thunderstorms. Much work has been done recently with a view to extending the means of atmospheric observations towards the forecasting of weather generally, and not merely in the case of thunderstorms.

Weather Charts and Atmospheric

For this work it is necessary to study the weather charts very carefully in connection with the recorded atmospheric at certain receiving

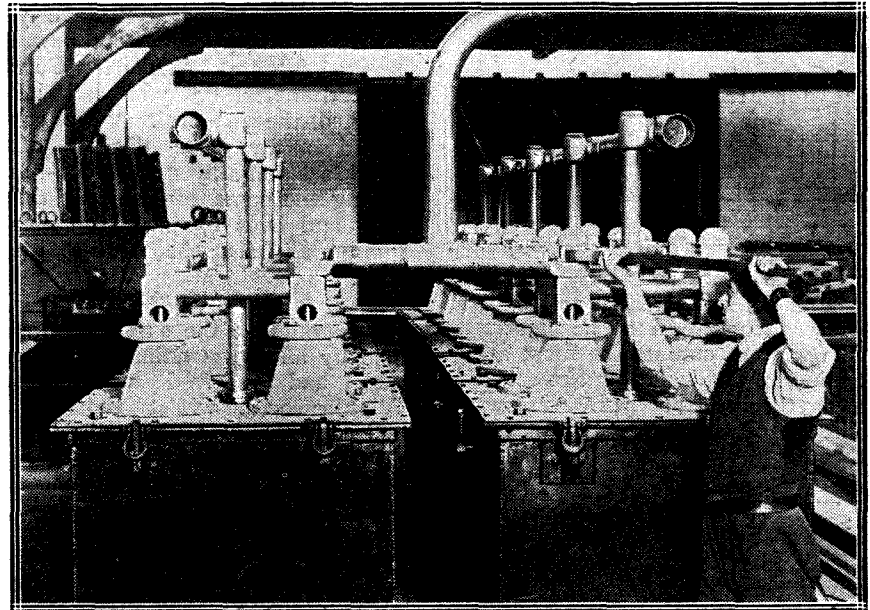

A bank of condensers at the Government Wireless Station at Hillmorton, near Rugby.

that it will make the aerial commence to oscillate at its own natural frequency, and thus we get shock excitation of aerials no matter what the tuning of the aerial may be. Obviously the shock effect will be worse the longer the wavelength, and again it appears obvious that it will be worse the greater the damping of the aerial.

stations. A considerable amount of work has been done on this subject during the last few years, and special attention has been given to it in France, particularly by Malgorn and by de Bellescize. Malgorn has come to the conclusion that the prevalent type of atmospheric as distinct from the thunderstorm type, is dependent upon temperature
(Continued on page 160)

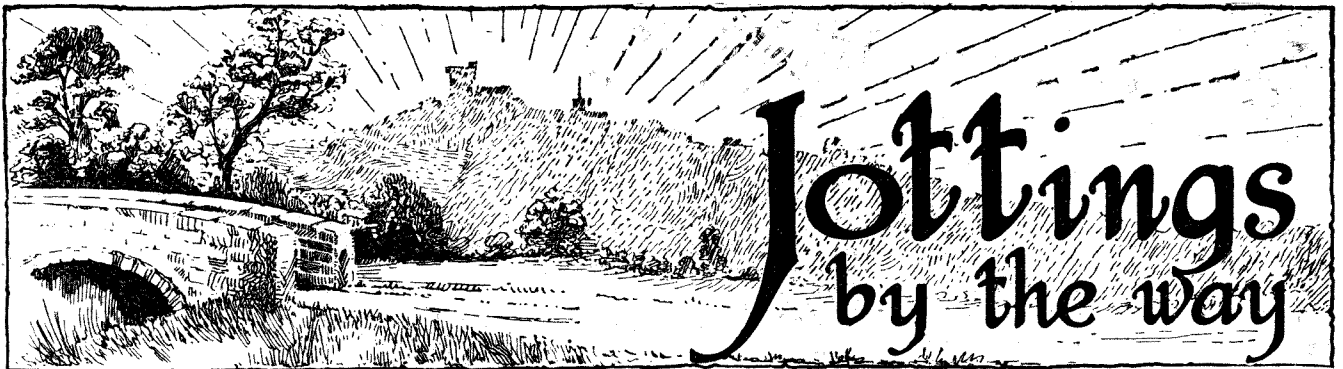

Surprising

I SHOULD never have thought it of Winklesworth, nor would you if you knew him. He is, in fact, just about the last fellow on earth from whom anyone would have expected any such thing. Never to my mind has a man been more obviously cut out for a life of bachelor freedom than Winklesworth. That is why you could have knocked me down, with a fender



... Announced he was engaged to be married ...

when he came round one day and announced with a silly simper that he was engaged to be married. She was, of course, the most beautiful, and wonderful, and sweet, and altogether perfect girl in every way. They always are until you marry them.

A Hopeless Case

The fellow simply bored me stiff. He wanted to go on telling me all this kind of thing with a far-away look in his eyes, whilst I wanted to talk about wireless. The result was that conversation became a little difficult.

The fellow would not talk sense, though I tried and tried. He just went on talking, till I began to fear that I should never get rid of him at all. I do not think that I would have, if it had not occurred to me to suggest that he should go and break the good news to Poddleby. It was then half-past eleven at night, but Winklesworth was in a state in which time seems nothing at all, and he promptly dashed off to give Poddleby all the details. Early the

next morning, when Poddleby pushed him out in the same way in the small hours, he went on to General Blood Thunderby, but the only answer that he got to his ring was a volley of boots and hair-brushes and a jug of cold water from the General's bedroom window, which happens to be just over the front door.

The Club Hears It

At the wireless club on the following evening I found that nearly everyone was there, though luckily he was not. "Have you heard Winklesworth's good news?" I asked Admiral Whiskerton Cuttle. "Good news, do you call it?" shouted the Admiral. "He came round to my place directly after breakfast and stayed till lunch-time, saying the same sort of silly thing over and over again. The man's gone mad, sir, the man's gone mad."

Indefatigable

I found that the same view was held by all the remaining members who had received visits from Winklesworth, whilst those who had not yet done so realised that they were shortly to be for it, and resolved to be "not at home"

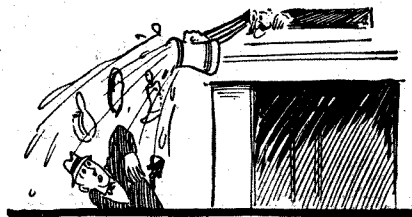

... General Blood Thunderby's answer ...

when he called. "I tried that dodge on," said Bumbleby Brown, who came in just at this moment. "The fellow called to see me after lunch to-day, and as I had got wind of the affair from Gubbsworth, I told the maid to say that I was engaged on very important business. Do you think that that choked him

off? In less than ten minutes I was rung up on the telephone by Winklesworth, who proceeded to tell me all about it.

Forewarned is . . .

The General now took the chair, and the meeting got down to business. At the end of the ordinary cut-and-dried stuff, the Chairman asked if any member had any private business to bring before the house, and, thinking that I had better say a word in season, I rose

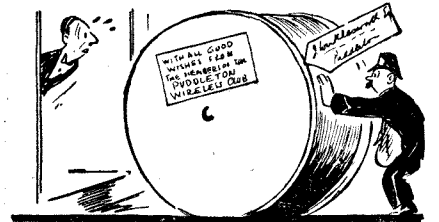

... A 10-mile drum of No. 18 cotton-covered wire ...

with my usual grace to my feet. "Many of us," I said, "have heard from Winklesworth an account of the charms of the lady who is shortly to blight her young life by marrying him. Those of us who have not so far heard will very shortly do so. Winklesworth, who should know, assures us that she is an angel and all sorts of other things. It is obviously not right that this sweet young thing should be allowed to ally herself to Winklesworth, without being properly warned beforehand. As fellow members of the wireless club, it is, I think, our duty to write her a letter telling her something about her future worse half."

None so Deaf . . .

After some discussion my proposal was carried, and the letter was drafted by Poddleby for despatch to the damsel. In it we told her that Winklesworth was a wireless fan, and we explained as carefully as we could just what that meant. Did she wish to have her

drawing-room filled with accumulators, and high-tension batteries, and condensers and wire? Did she want to have an aerial mast planted in the midst of her favourite bed of begonias? Did she desire to have a silent husband who would sit evening after evening with the 'phones upon his head, glaring at her and bidding her in terse words to make less noise if she dropped so much as a stitch? Did she wish to have the whole house flooded because her husband had been endeavouring to solder an earth lead to an ascending water main? And so on and so on. If she wished for these things, of course, she had only to marry Winklesworth. If she married Winklesworth she could not say that we had not told her what to expect. In conclusion, we bade her think matters over very carefully, and not to come to any rash decision. The letter was signed by all the members of the club and sent off. The next day the reply came. It said just this:—

"Dear Sirs,

"Thank you for your *sweet* letter, which will have the attention that it deserves. Please do not send me a wastepaper basket for a wedding present, for I already have a very nice one.

"Yours faithfully,

"ANNE NODE."

Clear Consciences

"An excellent wireless name, anyhow," I said, on reading it through, "and, when you come to think of it, they are pretty rare. You might, of course, have Constance (abbreviated to Con) Densor, and one could think of others, but at the present time, they are not very frequent. In years to come things will be better. I have a friend who has christened his twins Resistance and Capacity, and doubtless most of you know of similar cases. As regards the letter, it is obvious that the young woman is just as mad as Winklesworth, and it is not of the slightest use for us to take any further steps. We have warned her, and if she likes to pay no heed to our words there is no more to be said about it. It is sad though to think that Winklesworth, one of our most promising young experimenters, will probably find his style sadly cramped, for I deduce from her letter that she is a lady of some character, who will probably object strongly to serious wireless being carried on in her drawing-room."

The Club's Present

Everyone agreed that I was quite right, and we could only sit down, leaving Miss Anne Node to grin and bear it. It was Poddleby who suggested that the club must subscribe for a suitable wedding present, since Winklesworth is one of our original members. Naturally we all agreed to this at once, and I headed the list of subscribers, after borrowing five bob from Bumbleby Brown. Subscriptions simply rolled in, and before the list closed we found it to be quite a respectable sum. Then came the problem of deciding what to give Winklesworth. All kinds of silly suggestions were made. One fellow actually wanted to give him a complete five-valve receiving set. Just as if a fellow like Winklesworth would use for one moment a set made by anybody else! When they had all done talking I made my suggestion, which was that our present should take the form of a ten-mile drum of No. 18 cotton-covered wire. This, I explained, would probably last Winklesworth for the best part of a year, and what more appropriate present could there be for a wireless enthusiast than wire? Nobody had a word to say against my suggestion, which was carried unanimously, Poddleby being instructed to arrange for a special polished reel suitable for drawing-room purposes, with a silver plate upon it suitably engraved.

My Own Choice

"And what are you going to give him yourself?" I asked General Blood Thunderby. "I am keeping my present secret," said the General shortly. "There is no fun at all if everybody knows what everyone

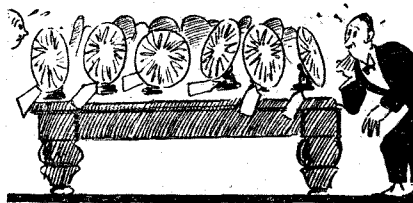

16 "Boojums" upon Winklesworth's table

else is giving." It was agreed that the nature of the private presents should be kept secret. We decided that each of us should buy his independently, and that all should be delivered on the day before the wedding. For a long time I simply could not decide what form my own should take. But two days before the wedding, whilst I was in the train going up to London, an inspi-

ration came to me. Luckily Winklesworth was travelling in the same compartment, for, on examining my note-case, I found that it was empty, and I was able to borrow a fiver from him. Arrived in London, I made my way to my favourite wireless shop, where I selected with great care a loud-speaker of the most modern type, guaranteed to be completely distortionless. Having heard a good deal of Winklesworth's loud-speaker reception, I thought that this would be the most appropriate present that could possibly be given. The loud-speaker was of the well-known Boojum make.

And the Others

On the following morning I resolved to carry my present with my own hands round to Winklesworth's abode. As I was standing on the doorstep waiting to be admitted I heard a crunch on the gravel behind me, and turning round I observed General Blood Thunderby walking up the path bearing an enormous parcel. Just then I heard the gate click, and behind the General I saw Snaggsby bearing a similar parcel. The General's I put down as a cake-stand, and Snaggsby's as a coal-scuttle. Just then the door opened, and the maid admitted us. She took us along to Winklesworth's den, where we found him profusely thanking Poddleby, Bumbleby Brown, Tippleston and Admiral Whiskerton Cuttle for their kind offerings. On the table were four large parcels. The General, Snaggsby and I placed ours beside them. We begged Winklesworth not to cut the strings, until all the members of the wireless club should have turned up. They came in one by one at intervals of a few minutes, each with his large parcel. When all were assembled, and when all the parcels had been placed upon the table, Winklesworth seized a pair of scissors and undid Poddleby's parcel. To my horror a Boojum was disclosed. Another Boojum emerged from the Admiral's, a third from Bumbleby Brown's, and, to cut short my tale of horror, when all the strings had been cut and all the paper undone, sixteen Boojums stood side by side upon Winklesworth's table. . . . "Anyhow," said the General, talking about it afterwards at the wireless club, "we said it was going to be a surprise, and I am blown if you can think of a much greater surprise than that."

WIRELESS WAYFARER.

Some Impressions of the Wireless Exhibition

In last week's issue we published details of some of the more interesting exhibits at the Wireless Exhibition, held in the Horticultural Hall from October 10 to 16. The accompanying survey is intended to provide an impression of the chief features of the Exhibition, which should prove of interest to those who were unable to be present.

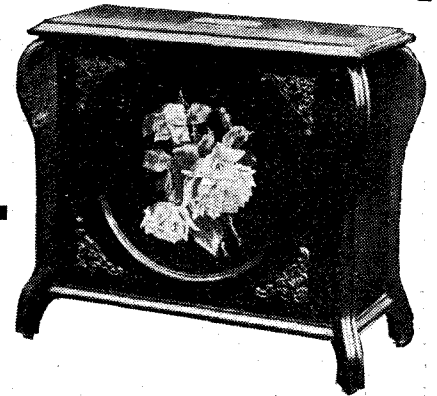

An attractive model of the "Celestion" loud-speaker, exhibited by M.P.A. (Wireless), Ltd.

THE Wireless Exhibition at the Horticultural Hall has been a most successful affair, proving a centre of attraction for large crowds, among which the home-constructor element was present in

were shown. The greater part of these were either portable sets or super-heterodynes, and several novel receivers of these types were being exhibited. One very effective display which attracted a lot of attention was in black and white, in which the black of the ebonite and white of the nickelled metal parts matched very well. Low-loss condensers were well in evidence, and many of these were provided with some form of geared control, in many cases as ingenious as they were effective, while some of the stands specialised in the production of low-loss tuners, in which inductances of special design were used.

since this time last year, not only on the technical but also on the production side. Actually there was nothing shown that was revolutionary in design, although many of the exhibits showed distinct originality in their conception.

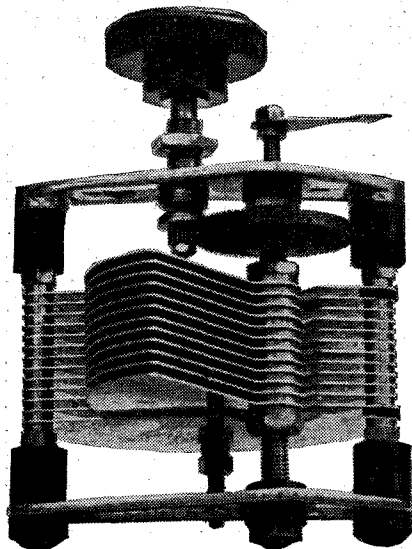

A low-loss variable condenser with reduction gearing, shown by the Penton Engineering Co.

Facilities for Customers

There were no restrictions on the sale of components at the stands, and business was quite brisk, many of the public buying freely. The whole atmosphere of the Exhibition was far more intimate than that of its predecessor at the Albert Hall, and although considerations of space forbade the provision of comfortable lounges and armchairs on the stands, this did not hamper the carrying on of business.

Special Features

A display that attracted a great deal of attention was the machine used for winding transformers demonstrated on one of the stands. This was shown in actual operation, and invariably attracted a large

large numbers. The impression one gained from mixing with the crowd was that here were no dilettanti, few of the people had come out of mere curiosity or to stroll around and look at things, but rather almost every individual was keenly interested in the subject.

Some of the questions overheard, addressed to salesmen on the stands, indicated clearly that the greater part of the enquirers had a definite knowledge of wireless, and that each knew what he wanted and was out to get that which would most nearly supply his needs.

Complete Receivers

A large proportion of the exhibits were of components and accessories such as are dear to the heart of a constructor, and a comparatively small number only of complete sets

Broadcast Music

Music was broadcast by means of one of the new Western Electric Kone loud-speakers, a special model being made for the purpose, which was close on 5 ft. in diameter. Except for slight resonance noticeable on one or two notes, the purity of reproduction was exceptionally good, while the volume was not so great as to interfere with the conversation.

Many hours could be spent at the Horticultural Hall very profitably, for there was hardly a stand which did not show many little gadgets and accessories both novel, ingenious and useful.

Design of Apparatus

The workmanship of the components and accessories shown was of a high order, and it is obvious that great progress has been made

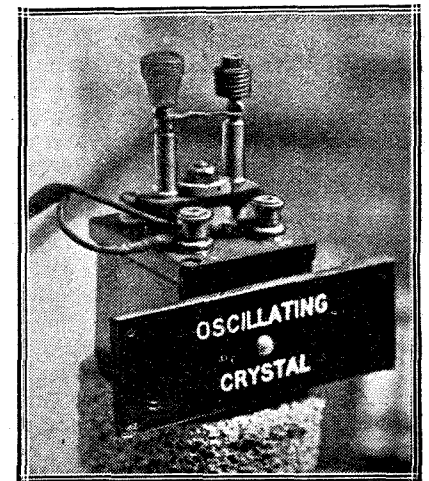

A specimen of oscillating zincite was shown by A. Hinderlich.

crowd. Another item of particular interest was one of the super-heterodyne kits being displayed on one of the stands, for which many inquiries were received. We understand that a different method from that usually employed is used for the intermediate-frequency amplifier.

SOME FURTHER NOTES ON SHORT-WAVE CALIBRATION

By D. J. S. HARTT, B.Sc.

In an article in our October 7th issue Mr. Hartt described a Lecher wire method of calibrating a short-wave absorption wavemeter. Practical details of the harmonic method of calibration are given here, this being more suitable for use at lower frequencies than those dealt with in the previous article.

IN *Wireless Weekly*, Vol. 7, No. 3, I gave some details for a simple method of calibrating a short-wave absorption wavemeter involving the Lecher wire method. This method is extremely suitable for calibrations on frequencies over 12,000 kc. (25 metres), but practical difficulties limit its usefulness for frequencies much lower than this, and we therefore have to seek other methods to enable us to calibrate a wavemeter or receiver for frequencies lower than 12,000 kc. (25 metres).

Calibration by Harmonics

One of the easiest available methods consists in detecting the harmonics of some transmitting station which is operating on a known frequency. Here, however, one has to proceed carefully, for there are several sources of error which may render such a calibration inaccurate.

First, let us examine the question of the production of harmonics. The top line in Fig. 1 shows the conventional way of illustrating a pure sine wave. In this case we have oscillations of one fundamental frequency only, and there are no harmonics, that is to say, there is nothing analogous to the overtones of a

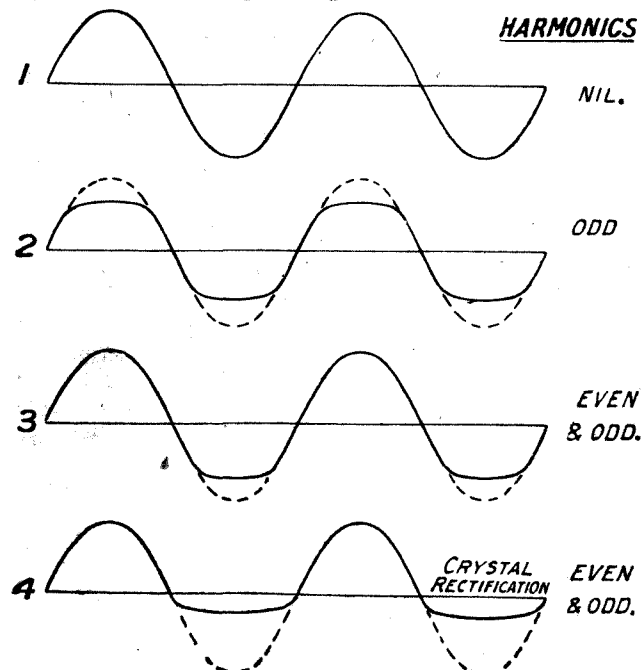
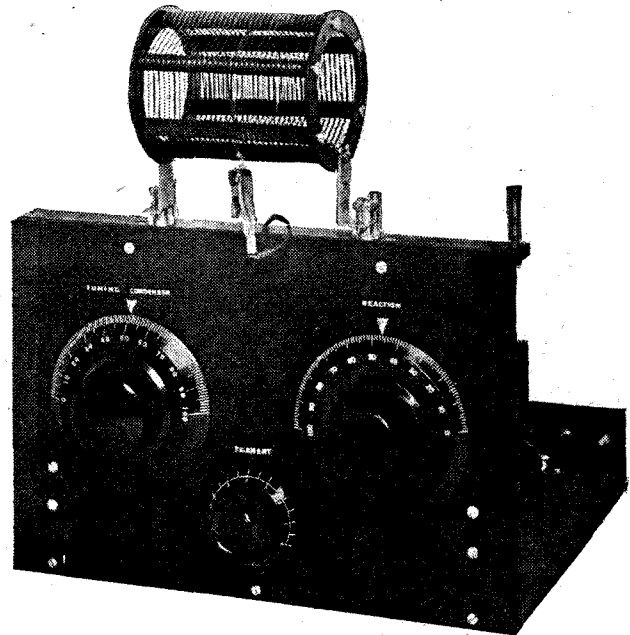

Fig. 1.—Illustrating the wave forms (2, 3 and 4) incidental to the production of harmonics, compared with a pure sine wave form (1).



The short-wave receiver used in the experiments described.

piano note or waves having frequencies which are exact multiples of the frequency of the fundamental.

Production of Harmonics

In practice it is a little difficult to obtain high-frequency oscillations which are strictly of *pure* sine wave form, so that even under the best conditions there are a few faint harmonics present. Now, when the wave is distorted, as shown in the second line, where both the positive and the negative half-cycles are flattened similarly (the pure sine wave is shown dotted), stronger harmonics are produced; under these conditions we get only the *odd* harmonics, which are those having frequencies three, five, seven, etc., times that of the fundamental.

Where, however, only the negative half-cycles are distorted, as in the third line, both the even and the odd harmonics are produced. These have frequencies two, three, four, five, etc., times that of the fundamental. Both these conditions can be produced with an oscillating valve with suitable adjustment of the filament temperature, H.T. voltage and grid bias. The condition for the production of both the even and the odd harmonics is that positive and the negative half-cycles shall be distorted to a different extent.

Reception of Harmonics

Now we can detect these harmonics from a nearby transmitting station by listening direct on a short-wave set by merely connecting the set up, setting it into a gently oscillating condition, and listening for the beat notes formed between the oscillations of the set and the harmonics of the transmitting station. This, however, does not lead us very far, for these harmonics are weak, and only the first few can be detected.

At about ten miles from a main broadcasting station only the first two or three harmonics can usually be detected.

Possible Errors

Other difficulties arise when we have an oscillating valve tuned to a known frequency, and arranged to

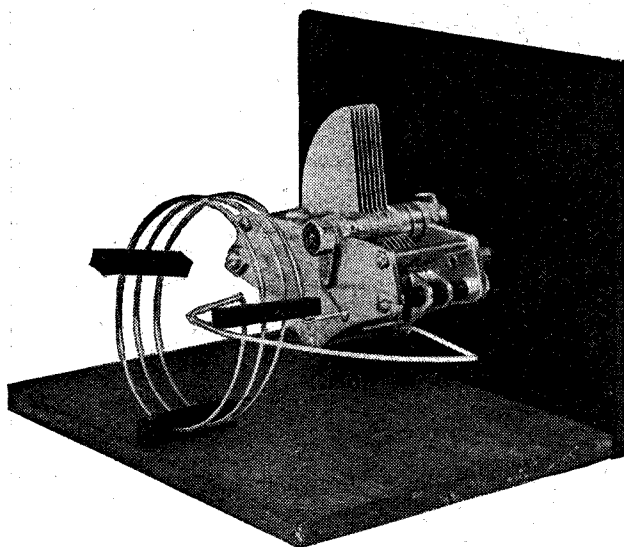

The absorption wavemeter which it is desired to calibrate.

generate strong harmonics, and in this case we must be careful to avoid confusing the harmonics with the beat notes produced by the heterodyning between them and the harmonics of the oscillations of the short-wave set. The strength of such beat notes will, it is true, be small, but where we are dealing with weak harmonics only, it is often difficult to distinguish them, particularly when we are trying to select the higher harmonics, which, of course, get nearer together in wavelength.

A Satisfactory Method

I have, however, found that the following method works well and leaves little room for any serious discrepancies to occur.

The scheme is to tune an ordinary crystal receiver to your local station and couple it to the coils of your short-wave set. Only a loose coupling is necessary, but by this means I have found it possible to detect up to the fifteenth harmonic of 2LO with comparative ease. This gives us a calibration up to about 12,500 kc. (24 metres); so that with the aid of this method and that using the Lecher wire principle we can get a complete calibration of any short-wave set or wavemeter over the whole of the useful short-wave range.

Crystal Rectifier

Reference to Fig. 1 will show that with crystal rectification we have the right condition for the production of both the even and the odd harmonics. The operation of detecting these harmonics and calibrating both a short-wave set and an absorption wavemeter, is as follows, and is illustrated diagrammatically in Figs. 2 and 3:—

Practical Calibration

The crystal set is connected to the aerial and the earth and tuned to the local station working on a known frequency. It is not essential to tune it accurately, but the higher harmonics will be stronger

if the tuning is done so that maximum signal strength is obtained. The crystal set is then brought near to the short-wave receiver, so that there is a fairly loose coupling between the coils of each set. Then, while maintaining the short-wave set in a gently oscillating condition, just past the oscillation point, rotate the tuning condenser slowly, starting from the full-in position, until the first chirp is heard. The coils in the short-wave set should, of course, be chosen so that the second harmonic comes at the upper end of the wavelength range.

The Absorption Wavemeter

Then the beat note is adjusted down to the silent point (if this is possible, otherwise get as near as you can). Finally, take the reading on the tuning dial and transfer this calibration to the absorption wavemeter. This is done by bringing the latter about a foot or nine inches from the oscillating short-wave set left adjusted in its previous condition.

Resonance Indication

When the wavemeter is tuned to the same frequency, the short-wave set will stop oscillating. When this happens a click (or pair of clicks; see *Wireless Weekly*, Vol. 7, No. 3) will be heard in the 'phones in the plate circuit of the short-wave set. If a milliammeter is available, this may be used instead of the 'phones, and a sudden change in plate current will indicate when oscillation ceases.

Precautions

Proceeding in this way we can go higher in frequency and obtain a calibration point from each harmonic. Care should be taken to rotate the tuning condenser of the short-wave set very slowly (some reduction gearing is almost essential), so as not to miss one of the harmonics. After about the tenth harmonic is passed, it will be advisable to tighten the coupling between the coils of the crystal set and the short-wave receiver, since the harmonics get very weak

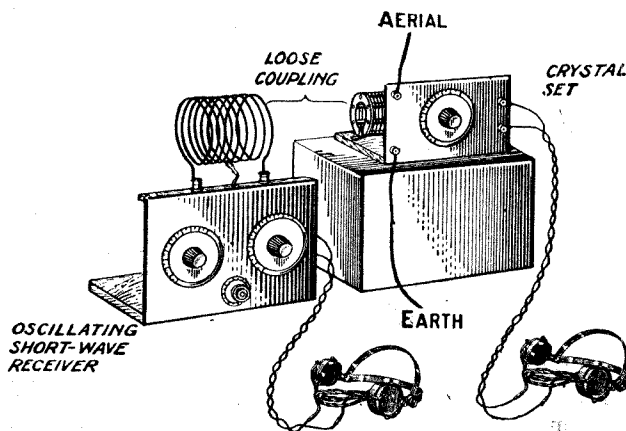

Fig. 2.—The coil of the crystal set is placed in a position of loose coupling with the valve set coil, the circuit of the former being tuned to the frequency of the local broadcasting station.

here. In my case I could only just detect the fifteenth harmonic by listening very carefully.

Different Frequency Ranges

During some part of the range it will be necessary to change coils in the short-wave set, and caution

must be exercised here. It is possible to cover the range from 15,000 kc. to 1,500 kc. (20 to 200 metres), using only two coils with a .0003 μ F tuning condenser, and for the purpose of these calibrations this is quite satisfactory if the tuning ranges of these coils overlap slightly, so that one particular harmonic occurs in both ranges.

Eliminating Overlap of Ranges

The best way, of course, is to "hold" the harmonic, which occurs just before the change-over, with the aid of a separate oscillator tuned to the same frequency, and then no confusion can occur. If this is not possible owing to lack of apparatus, you must choose your coils so that one particular harmonic

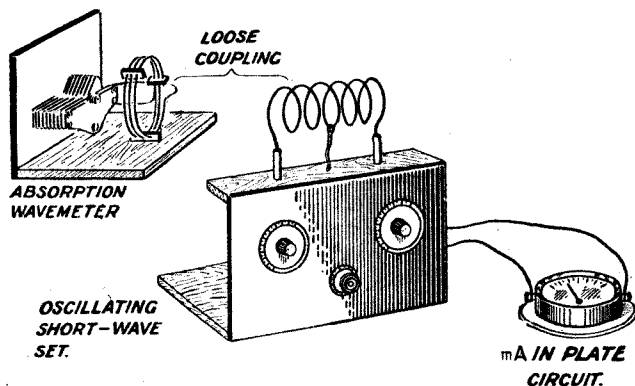

Fig. 3.—When transferring the calibration to the absorption wavemeter quite loose coupling is desirable in order to ensure accuracy.

occurs in the end of one range and the next harmonic at the beginning of the other. That is, there should be no harmonics common to both ranges.

Coils

The short-wave coils I used were as follows:—Thirty turns No. 20 enamelled wire wound double-spaced on a 3½-in. diameter Collinson low-loss former, 4 in. long, with a tap on the fifteenth turn; ten turns No. 12 bare copper wire, 4 in. diameter, and sprung out so as to be 5 in. long.

The Short-Wave Set

The usual modified Reinartz circuit was used with half of the coil for the grid turns and half for reaction, the centre tap being connected to the local earth (L.T. +). The usual leaky grid condenser rectification was used, with a V24 valve, and special attention was paid to reducing casual wiring capacities, etc. This single valve short-wave set is shown in one of the accompanying photographs.

Tuning Range

With this arrangement the tuning range, using the 30-turn coil, was from just above 5,455 kc. (55 metres) to over 1,500 kc. (200 metres), and about 5,555 kc. (54 metres) to over 15,000 kc. (20 metres) for the 10-turn coil. These coils were chosen to give a continuous range, so that they would be a guide to those who could not employ another oscillator during the change-over.

Harmonics of 2LO Station

The following is a list of the frequencies of the first sixteen harmonics of 2LO, based on a frequency of 824.6 kc. (363.8 metres), which is the latest figure supplied by our Elstree laboratories before going to press. The nomenclature adopted is that the second harmonic is double the frequency, and so on.

(Metres correct to 0.1 metre)		
1st harmonic	824.6 kc. (363.8 metres)
2nd	„	1,649.3 „ (181.9 „)
3rd	„	2,473.9 „ (121.3 „)
4th	„	3,298.5 „ (90.9 „)
5th	„	4,123.1 „ (72.8 „)
6th	„	4,947.7 „ (60.6 „)
7th	„	5,772.4 „ (52.0 „)
8th	„	6,597.0 „ (45.5 „)
9th	„	7,421.7 „ (40.4 „)
10th	„	8,246.3 „ (36.4 „)
11th	„	9,070.9 „ (33.1 „)
12th	„	9,895.6 „ (30.3 „)
13th	„	10,720.2 „ (28.0 „)
14th	„	11,544.8 „ (26.0 „)
15th	„	12,369.5 „ (24.3 „)
16th	„	13,194.1 „ (22.7 „)

Faint Harmonics

Using this method one could detect the first ten harmonics at good strength, but the higher ones were fairly faint. (I am about 10 miles from 2LO.) The addition of a note magnifier to the single-valve short-wave set will enable the higher harmonics to be found with greater ease.

Results Obtained

By means of these two methods I have calibrated the short-wave set shown in the accompanying photograph from 15,000 kc. (20 metres) to about 1,667 kc. (180 metres). It is sometimes convenient to have a short-wave set calibrated, but it is better to calibrate at the same time an absorption wavemeter such as I described in Vol. 7, No. 3. This particular instrument has been calibrated, by the methods we have discussed, from 15,000 kc. (20 metres) to below 8,570 kc. (35 metres); there was a slight discrepancy between the Lecher wire calibration and that obtained by harmonics, due probably to slight experimental errors in each, but the agreement was sufficiently good for ordinary purposes.

Wavemeter Tuning Range

By making further suitable coils for the absorption wavemeter (say, of 6 turns for the range down to 5,000 kc. (60 metres), and so on) on the same lines as those indicated for the absorption wavemeter in my previous article, it will be possible to calibrate the wavemeter for the same range as is covered by the short-wave set. If only one wavemeter is to be used for the whole range the coils will have to be made interchangeable in such a way that constancy is assured.

By this means, then, you will be able to tell where you are working on your short-wave set with a fair degree of accuracy throughout the range, simply by bringing your wavemeter near to the short-wave set which is just past the oscillation point, and then determining the point of resonance on the wavemeter. A reference to your curves will then give you the frequency.

Other Possible Methods

There are other methods available for such calibrations; but those outlined in this and in the previous article are perhaps the simplest for the amateur to carry out. Among other methods, that involving the use of the Abraham Multivibrator, may be mentioned; this is a device using valves with which it is possible to produce oscillations very rich in harmonics, so that many harmonics, even up to the 150th, can be detected.

Inventions and Developments



UNDER THIS HEADING
 MR. J.H. REYNER, B.Sc. (Hons.), A.C.G.I., D.I.C., OF THE
 RADIO PRESS LABORATORIES, WILL REVIEW
 FROM TIME TO TIME THE LATEST
 DEVELOPMENTS IN THE RADIO WORLD.

Further Developments in Gas-Filled Rectifiers

SOME time ago I described a new form of neon-filled rectifier (*Wireless Weekly*, Vol. 6, No. 21), in which the electrodes consisted of a plate and a rod enclosed in a bulb filled with neon, at a fairly low pressure.

Another form of rectifier tube has been designed recently, known as the Raytheon tube, which possesses several advantages over the neon tube.

For one thing the gas employed in this device is helium, and this enables conduction to take place at much lower potentials, of the order of 30 to 40 volts.

The rectifying properties are obtained by the usual method of making one electrode very much larger than the other, in which case the conductivity is found to be good when the large electrode is *negative*,

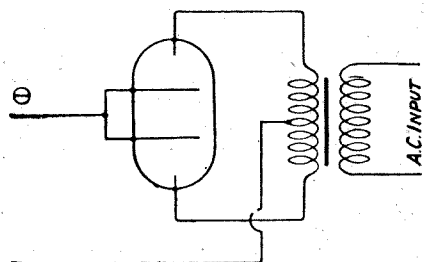

Fig. 1.—The one tube gives double-wave rectification, the circuit being as shown above.

but almost negligible when the polarity is reversed.

The tube does not commence to conduct until the voltage applied across it is of the order of 150 volts, but, as has been indicated, it will remain conducting down to comparatively low values.

Double-Wave Rectification

The device is arranged to give double-wave rectification in the one tube, the circuit being as shown in Fig. 1. The actual mechanical construction of the tube, however,

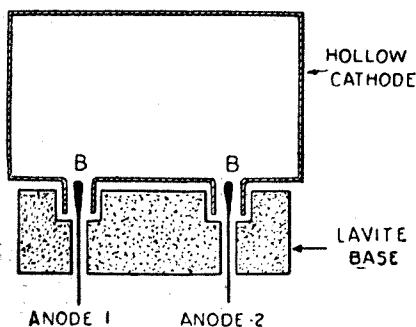

Fig. 2.—Showing the construction of the rectifier.

has a good deal to do with the results obtained.

The two small electrodes are in the form of thin rods, which are mounted in insulating material, while the two large electrodes, which are shown connected together in Fig. 1, are combined into a single casing which completely encloses the small electrodes. The construction is illustrated in Fig. 2.

Mean Free Path

The whole is mounted in a glass bulb which is filled with helium at a pressure of a few millimetres of mercury.

The thickness of the insulation round the small electrodes is so designed as to be less than the mean free path of an electron in helium at the pressure employed. Thus the discharge cannot take place across this short circuit path, which would conduct in both directions, but must spread out into the main body of the

device, so obtaining the rectifying properties.

The current carried by the particular valve described is about 300 mA, so that the application of these valves is limited at present to use with small outputs, or for employment in place of a high-tension battery, working from A.C. mains. There can be little doubt, however, that further developments will follow fairly rapidly, and that rectifiers capable of handling greater currents will soon be produced.

The chief advantage of this form of rectifier lies in the absence of

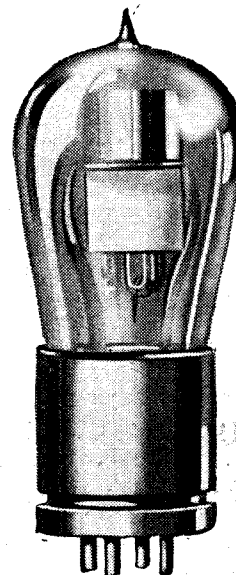

Fig. 3.—The Raytheon tube.

any hot cathode requiring a heating battery. Such a battery, of course, reduces the efficiency of thermionic rectifiers very seriously, particularly with small powers, and any satisfactory device in which the battery is eliminated will be watched with interest.

Wireless News in Brief.



Another B.B.C. High-Power Station?

Crystal users in the South-Eastern counties will no doubt be glad to learn that the B.B.C. have recently been carrying out test transmissions, with a view to the possible establishment of a second high-power station to serve this area. Many listeners will have heard transmissions from a station giving 5GB as its call-sign. This is the experimental station of the B.B.C. at Chelmsford, which uses a power of 10 kilowatts and is working at a frequency between 714 and 750 kc. (400 and 420 metres). The general purpose of these preliminary tests is to discover how much interference, if any, occurs with Government stations.

* * *

Exhibition in Manchester.

A Wireless Exhibition is being organised in Manchester by the *Manchester Evening Chronicle*, to open on October 27, the closing date being November 7.

* * *

We hear that Mr. N. G. Baguley, of Castle Gate, Newark, Nottinghamshire, has succeeded in communicating with Bermuda, which is about 670 miles distant from New York. The two stations were able to maintain communication for over two hours.

* * *

Broadcasting in the Free State.

The first two broadcasting stations to be put into operation in the Irish Free State are expected to begin transmitting before Christmas, and Irish and British listeners will therefore have two more stations within easy range.

These stations are situated at Dublin and Cork. Each will have a power of approximately 1½ kilowatts, but the wavelengths have not yet been fixed.

So far listeners in Southern Ireland, of which it is estimated that there are about 10,000, have had to be content with listening either to Belfast or to one of the other B.B.C. stations in Great Britain.

The Dublin and Cork stations will both be under the control of the Irish Post Office, and announcements will be made in English and Erse.

* * *

Wireless in the Far East.

In both China and Japan there is not only keen appreciation, but an active forward movement in wireless matters. Japan is already provided with an imposing technical literature on wireless, and it appears that young Japan is so absorbed in the new pastime that wireless is interfering with ordinary education plans.

The Shanghai station includes in its daily programme two hours of jazz music. The transmissions commence at 9.45 a.m. and conclude at 11 p.m. At Tientsin gramophone records are broadcast daily by a Japanese firm.

* * *

Owing to the fact that Yokohama has now been successful in picking up KDKA, East Pittsburgh, Pennsylvania, on its lower wavelength, the Yokohama broadcasting station will shortly attempt to re-broadcast transmissions from the American station.

* * *

Meteorological Forecasts from Daventry.

The high-power station at Daventry is being utilised in many ways other than that of broadcasting programmes. One of its most useful functions is to send out the meteorological forecasts every day at 9.30 a.m. (G.M.T.), and any vessel within the vicinity of the

British Isles may receive forecasts for the succeeding twelve hours if fitted with a suitable receiver. Local forecasts are also sent out from Newcastle, Bournemouth and Liverpool between 9.20 and 9.35 p.m.

* * *

Armistice Day Programme.

A special Armistice Day programme is in course of preparation. The arrangements will probably include the placing of a microphone in some public thoroughfare for reproducing the sounds of the throng of mourners, a performance of suitable music under the baton of a well-known conductor, and a patriotic play specially written for the occasion.

* * *

Wireless on Ships.

We now understand that the agreement recently entered into by the British, Canadian and United States Governments to prevent the use by ships of wavelengths of 300 and 450 metres when within 250 miles of the coast only applies to the coasts of Canada, Newfoundland and the United States. There is no such restriction in the case of ships within 250 miles of our own coasts.

Radio Press Measurements of Frequencies of B.B.C. Main Stations.

5.30 p.m., October 13.

	KC.	METRES.
Cardiff	852.8	351.8
London	824.6	363.8
Manchester	799.4	375.3
Bournemouth ...	780.0	384.6
Newcastle	744.2	403.1
Glasgow	711.6	421.6
Belfast	685.6	437.6
Birmingham ...	632.9	474.0
Aberdeen	601.6	498.7



LAYING OUT A

By G. P. KENDALL

Not the least important component of a short-wave receiver is the layout of its principal components. Mr. Kendall details which should prove most satisfactory to those who are confronted with the problem.

PROBABLY the wisest plan for the beginner in short-wave reception to adopt is to decide upon the two-valve circuit which we considered last week, and which is reproduced again upon these pages for reference. Such a receiver is extremely simple to build, easy to operate, and the design need present little difficulty if due attention is paid to certain well-understood points.

A Short-Wave Advantage

One of the attractions of short-wave work is to be found in the fact that the apparatus is so simple that a reader with quite moderate technical knowledge can actually design his own instrument and build it, instead of being compelled to follow some published design, with a corresponding gain in the pleasure derived from the use of the finished instrument.

I think that most readers who are making use of this series of articles will be able with the directions which I shall give, to lay out and build a successful short-wave set, using the circuit which we have been discussing, but I should like to add that any who feel doubt as to their ability to do this would be well advised to choose one of the recent designs for a short-wave receiver, such as that published recently under the name of Mr. Allinson, and to follow this carefully.

Importance of Stray Capacities

The circuit which we are to adopt is so simple and the necessary components are so few in number that there are very few pit-

falls for the unwary in laying out the receiver, provided that certain points are given due attention. First and foremost, the reader must realise that the tuning range upon the higher frequencies is very considerably affected by stray capacities, therefore very special pains must be taken to minimise all such additions to the circuit capacity. For example, a pair of wires running to a variable condenser should be given more than the usual separation, and so it should be throughout the set.

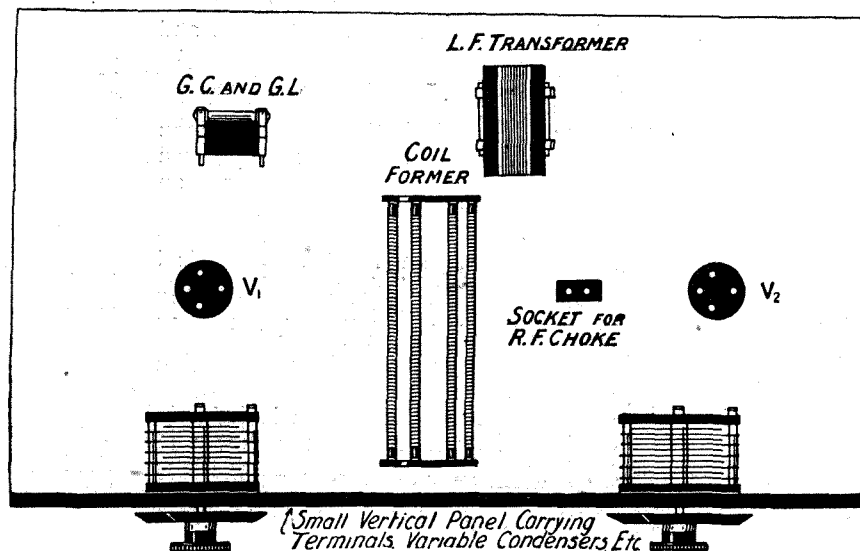

Fig. 1.—A lay-out of the principal components of a set which would prove unsatisfactory in practice. This position of the L.F. transformer relative to the coil would markedly reduce efficiency.

Spacing Essential

Long leads (within reason, of course) are not nearly so much to be feared upon moderately short wavelengths, say, below 15,000 kilocycles (20 metres), as leads which run close to others at differing potentials. It should therefore be decided that the set will cover a considerable amount of space, and that no special attempt should be made to secure compactness. The spacing-out of components is undoubtedly more important than securing short leads, unless those short leads can also be

well separated from all other leads, and unless, furthermore, the components are so far from one another that the stray capacities from one to another are not serious.

The "Bread-Board"

The general plan to adopt will naturally vary with the taste of the constructor, but since most short-wave receivers are very definitely experimental in their character, and undergo frequent alterations, I would strongly urge the use of what our American friends call a "bread-board." This simply means the use of a wooden base-board, sometimes with a narrow vertical ebonite panel attached to its front edge, to

carry the variable condensers and terminals, and possibly the filament rheostats.

Special Points

Having accepted, then, the general rule that the set shall be well spaced out, one or two of the components call for mention in regard to their placing. Let us first consider the tuning coil or coils, since their position is undoubtedly of considerable importance with regard to the working of the set. Take the greatest possible pains to ensure that the tuning coil is well away

SHORT-WAVE SET

B.Sc., Staff Editor.

Consideration in the design of a best method of arranging the wires here some interesting of assistance to those who faculties in this respect.

from all metallic objects, and on no account let any object of this nature come within the stronger part of the field of the coil.

A Common Mistake

For example, do not on any account make the common mistake of using a cylindrical coil, and pointing it at one of the variable condensers which is situated only a few inches away. To do so is simply to invite trouble in eddy current losses. On the contrary, take care the coil is well away from all the condensers and other objects, even though you may have to use leads up to 6 or 8 inches long for the connections from the coil itself.

Achieving a Compromise

A little thought devoted to the arrangement of the parts will show how the coil may be placed in such a position that it is well isolated, and the leads to it are no longer than absolutely necessary. At the same time, consideration should be given to the question of the placing of the socket for the detector valve, in such a way that the lead from its grid to the grid condenser and from the grid condenser to one end of the tuning coil, or to one of the wires which join one end of the tuning coil to the tuning condenser

may be reasonably short, and, above all, well separated from other leads.

The placing of the choke coil is a matter which calls for a little consideration, since it is most desirable that this component should be well separated from others at earth potential, and it is also desirable that the lead from the one side of the coil to the plate of the valve and also the lead from the plate of the valve to one side of the reaction condenser should be reasonably short, as well as well separated from other leads.

observed that the low-frequency transformer is placed right in the field of the coil, also that the R.F. choke is very much too close to it, and finally that the placing of the coil is such that some portion of its field cuts across both the variable condensers. These latter, however, are so far from the coil that the last point is not a very serious one.

A Better Lay-out

In the second lay-out it will be observed that the coil is well isolated, and that although the low-frequency transformer is still in such a position that some portion of the field cuts through it, yet it is so far from the coil that probably little harm would result. The second position for the coil which is illustrated also has the advantages that the wiring is straightened out and simplified, and further that one end of the coil is exposed in such a manner that it would be easy to couple to it a small coil in the aerial circuit, without the necessity for the aerial and

earth leads passing through the other wiring of the set.

Improvements

A careful examination of the left-hand lay-out will show that it violates several of the rules which have been laid down, and we will next see how these points have been improved upon in the second lay-out. The position of the coil we have already discussed, and it will next be seen that the socket for the R.F. choke is now reasonably well isolated, and this can be counted an improvement. It is

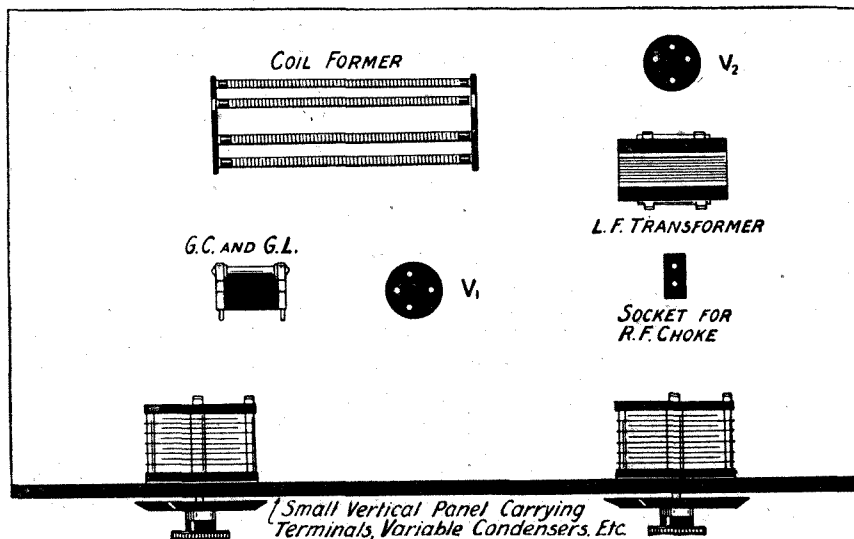

Fig. 2.—This represents an improvement on the lay-out of Fig. 1, though it would be better to place the variable condensers closer together and alter the position of the R.F. choke.

Two Examples

With these points in mind, it will probably be useful to discuss next the two alternative lay-outs for the circuit which we are considering, which are illustrated upon the first two pages of this article. On the left will be seen an example of a thoroughly bad lay-out, and we will first examine some of the reasons for describing it in this way. First observe the position of the coil former, which, for the purposes of these notes, is assumed to be a standard one of the skeleton type. As this former is placed, it will be

still, however, not in an ideal position, since it is so placed that certain of the leads connecting the choke to the anode of the valve V₁

“L.F. Transformer,” the lay-out would be further improved.

From this it follows that the position of the right-hand variable condenser, which we will assume is a reaction condenser, might also be improved upon by moving the component bodily to the left until it was separated by only about its own width from the other condenser, which performs the functions of tuning. In its first position the idea of spacing out the components had

been carried so far that much of the wiring would be unnecessarily long.

These examples should, I think, make sufficiently clear the considerations which are involved to enable the reader to carry out for himself the operations of laying out the set, since a little consideration of the two lay-outs which I have given, and the criticisms which I have made of them, should serve to make clear the factors involved.

In the actual construction of the set there still remains the question of the coils, their construction and mounting in the instrument, but this is too large a subject to be dealt with in this instalment.

tions have also been made. This seems somewhat peculiar in view of the success which has resulted from the forecasting of the approach of thunderstorms and cyclonic disturbances. The reason appears to be that cyclones and thunderstorms are associated with the advance of a Cold front which comes from the poles, whereas typhoons are pro-

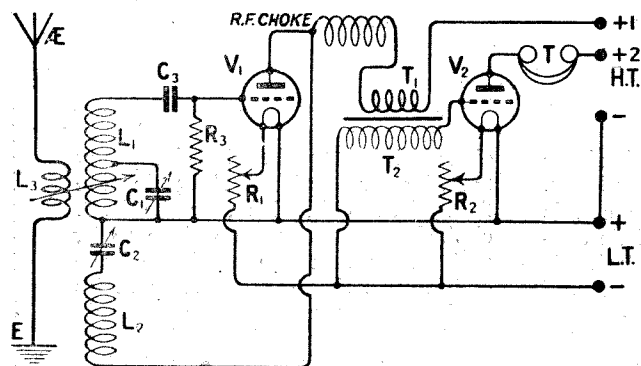

Fig. 3.—A circuit of this type employing a detector and one stage of L.F. amplification was discussed in Mr. Kendall's previous article in this series.

and to the reaction condenser will be unnecessarily long. If it were moved to the left so as to be considerably nearer to the socket of V₁, say, as far as would bring it immediately beneath the “L” in

been carried so far that much of the wiring would be unnecessarily long.

The Grid Condenser

Another point which might be improved upon in this lay-out is con-

The Nature and Sources of Atmospherics

(Continued from page 149)

changes of the atmosphere. Whenever there is an approach of a cold layer of air from the Polar regions, there is an increase in the number of the grinder type of atmospherics.

“Cold Fronts”

The march of cold air from the poles is usually referred to as a “Cold front,” and the conclusion is that, as this Cold front marches forward so the source of atmospherics marches with it. Whenever the Cold front reaches a mountainous region the atmospherics reach their maximum intensity. This again is obviously due to the fact that the temperature changes must be more violent in a mountainous region. Thus the general conclusion appears to be bearing out that of the directional observations of Watson Watt and others, including those in Germany, who have traced the most prevalent atmospherics to the mountainous regions of Europe or Northern Africa.

Malgorn's observations were also conducted over the Atlantic and Pacific Oceans, where again the observations were verified that the atmospherics follow the march of the Cold fronts. Another

general conclusion was verified by him, that the worst atmospherics are not produced over the ocean, but over large areas of land, and particularly near mountainous regions.

Regarding the Crash types of atmospherics, which sometimes last from half a second to five seconds, a view has recently been

The generator for supplying power to the wireless transmitting sets on aircraft is sometimes fixed on the lower plane, as shown. The propeller on its shaft is rotated by the blast of air from the main airscrew.

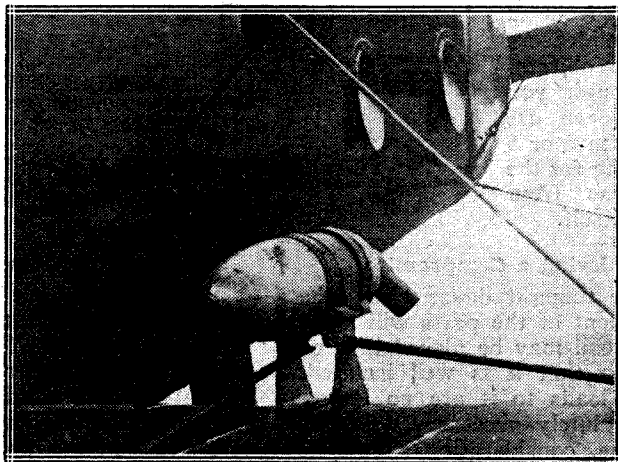

expressed in France as to their origin. The reason for this will be given in a subsequent article.

Typhoons

Attempts have been made in China to follow the approach of typhoons, but so far without success, although directional observa-

duced by the advance of hot air from the tropics. Thus the typhoon area does not appear to reach very high altitudes, nor to produce violent atmospherics.

The results of further observations will be given in a subsequent article in this series.

(To be continued)

Random Technicalities

By Percy W. Harris, M.I.R.E.,
Assistant Editor

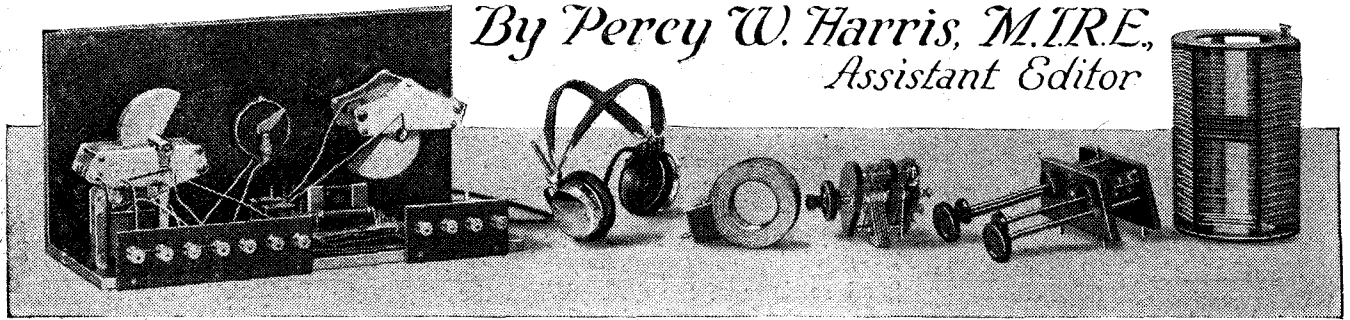

EXPERIMENTERS might quite profitably give more attention and thought than they do to the question of filament voltage, or rather filament current. Frequent warnings are given to valve users not to place the high-tension leads across the low-tension terminals, and several excellent protective devices are now on sale to prevent the early decease of precious valves from accidents of this kind. Rarely, however, do we see warnings regarding the abuse of filament resistances. I am sure that thousands of valves are consigned to the scrap-box each year for no other reason than that the user has been unable to repress his desire to fiddle with the rheostat knob. I am afraid many advertisements give the impression, when describing the virtues of the sweetly running and quiet contacts, that adjustment of the filament current is something

which goes on continuously during reception. On my own sets at home I do not touch the filament resistances from one week end to another, except when trying different valves or other special components.

A Suggestion

Personally I should like to see the valve-makers marketing valves to run with filament voltages of 6, 4 and 2 volts respectively, so that they could be run direct from accumulators without filament resistances of any kind. If a valve is designed to run at a particular filament voltage and current, this current should be maintained constant throughout the life of the valve, and not be varied in order to obtain other adjustments in the set. For this reason I am not in favour of using filament resistances for fine tuning. In the great majority of cases even with the valves such as we have at present, which are designed to operate at

voltages different from those given by an accumulator direct, I think a permanently set resistance will, in a very large number of cases, give us all we require.

Damage Done to Cells

"But," you will say, "we must have a variable filament resistance to allow for the drop in voltage of the battery." This adjustment to compensate for the drop in voltage of the accumulator has done more to ruin these excellent accessories than any other one factor. Any accumulator manufacturer will tell you with great emphasis that it is madness to attempt to get the last ampere of current out of a cell, and particularly careful instructions are always given not to let the voltage drop below 1.7 or 1.8 per cell. In spite of this, thousands of users continue to discharge their accumulator on the principle that there is "still something in it," even though the voltage has dropped far below the safe figure indicated by the makers.

Regular Charging

If you examine the discharge curve of an accumulator you will find that the voltage is maintained at 2 until practically the end of its useful discharge, when there is a fairly rapid drop. My own method is to recharge the accumulator immediately there is any sign of the voltage dropping below 2, and I never, in any circumstances, try to bring signal strength back again by readjustment of filament resistance knobs.

American Practice

In America practically all modern receivers have one filament resistance knob only for all the valves. Of course, when we use dry cells the discharge curve of which is a steady slope, filament resistances of the adjustable type are desirable.

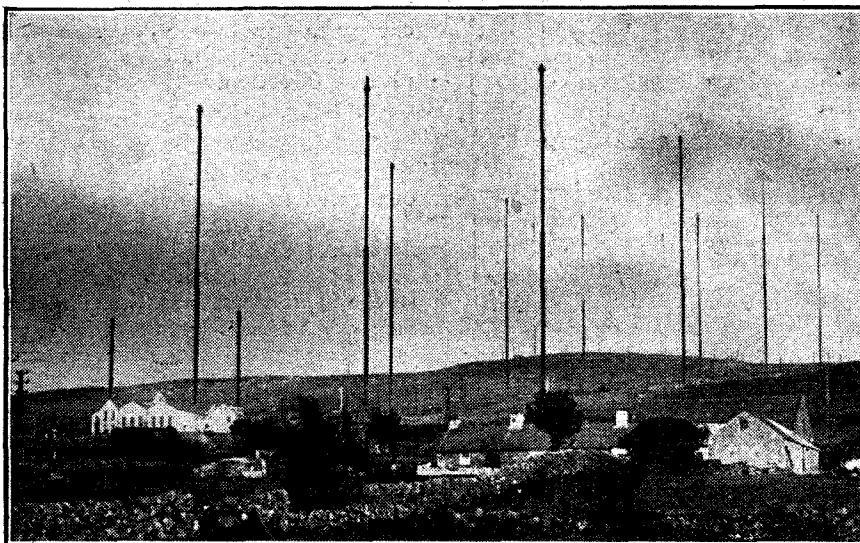

The aerial masts at the Carnarvon wireless station are situated on a hill 1,800 feet above sea level, so that some of them are almost constantly in the clouds.

An H.F. Selector and Radiation Preventer

By B. B. MINNIUM.

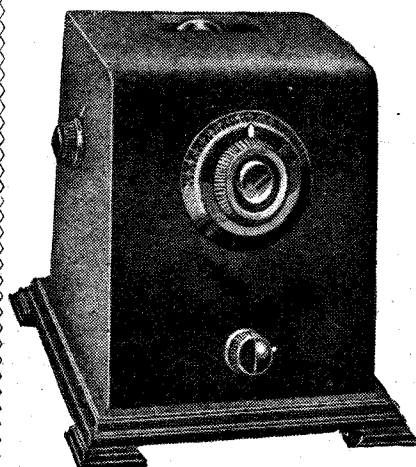

The Penetrol, a commercial form of the apparatus described in the accompanying article.

The problem of the oscillation nuisance is still sufficiently serious to arouse interest in any apparatus designed to prevent receivers from re-radiating energy. The instrument described in these pages is claimed to be satisfactory in this respect, and at the same time to provide a good measure of selectivity.

all settings of the dial. When the filament of the valve is cold, energy cannot pass in either direction through the valve; when the filament is heated and is emitting electrons, an amplified copy of the signal flows in the plate circuit through the agency of this electron stream.

No Oscillation Nuisance

Thus energy can pass from the aerial to the output of this new device, but cannot pass in the opposite direction. And also when such a stage of perfectly balanced H.F. amplification is interposed between the aerial and the receiving set any squealing originating in the receiver is isolated from the aerial and cannot interfere with the reception of other receivers in the vicinity.

Previous Fallacies

The property of radiation-prevention has wrongfully been claimed for most forms of high-frequency amplifiers connected between aerial

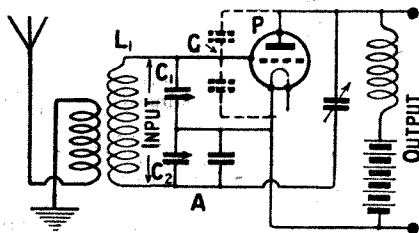

Fig. 1.—The fundamental principle of the system may be easily understood with the aid of this circuit diagram.

and receiving set, the idea being set forth that, as long as the H.F. stage itself does not oscillate, it will prevent oscillations set up in succeeding stages of the receiver (or in the detector) from reaching the aerial. Some writers have even gone so far as to state that a loosely-coupled regenerative receiver will not radiate and that the single-circuit receiver is the only transgressor in that direction.

Radiating Circuits

As a matter of fact, conclusive tests made show that all four types (oscillating H.F. amplifier, oscillating detector preceded by one or more stages of imperfectly balanced but non-oscillating H.F. amplification, single-circuit regenerative, and loosely-coupled regenerative receivers) radiate strongly and that

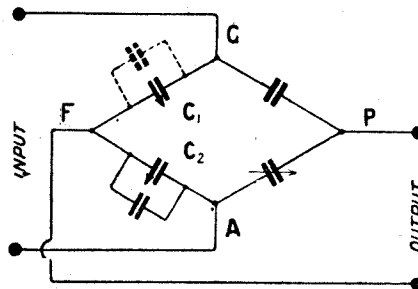

Fig. 2.—The operation of the circuit depends on the action of the bridge connection shown here, which should be compared with Fig. 1.

the so-called loosely-coupled three-circuit regenerator is capable of causing most annoying radiation. In fact, it is obvious that any method of coupling which will allow energy to flow in one direction will most certainly permit a flow in the reverse direction.

Tests with the Selector

Radiation tests were made by setting up an oscillating receiver connected to one aerial and a non-oscillating set connected to a second aerial running parallel to the first. When the two receivers were tuned to the same distant station and the first was made to oscillate, howling in the second receiver (which originated in the first) completely drowned out reception. When, however, this new device was connected between the oscillating receiver and its aerial, no interference in the second receiver resulted.

A Conclusive Test

It was found that, when the two receivers were placed side by side,

ONE of the greatest problems with which radio engineers are confronted in the design of apparatus is the prevention of radiation, or feeding oscillations back into the aerial system. Research workers have been experimenting for many months endeavouring to find a device that will prevent radiation and at the same time not interfere with the proper functioning of the receiver. There have been circuits published heretofore that will not radiate, but there are certain types of sets that will break into oscillation at the slightest excuse, and it is with the latter that engineers have concerned themselves.

"All-Capacity" Bridge

It is easily seen that a device which will stop a regenerative set from radiating annoying squeals and at the same time will not lessen the efficiency of the set is more or less a pretty stiff problem. Yet such a device has been developed in the form of a stage of high-frequency amplification, which is connected between the aerial and the input side of the receiver itself. This circuit makes the valve act as a one-way relay, so that energy can pass from the aerial, or other energy collector, such as a loop, to the succeeding valves, but cannot flow in the opposite direction. This property is due to the balance obtainable through the all-capacity bridge that is incorporated in the circuit—which balance remains constant for

enough energy was radiated from the coils and wiring of the regenerator itself to cause mild interference with the second receiver, but when they were placed about fifteen feet apart (in adjoining rooms), no interference could be heard, although the two receivers

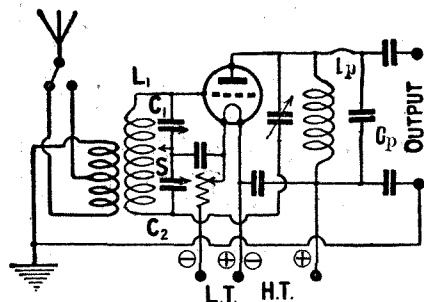

Fig. 3.—This diagram shows the arrangement of the tapped primary and the condensers.

were still connected to parallel aerials. It was also found feasible to operate two radiating-type receivers on parallel aerials without mutual interference between them, when each had been provided with the new device.

Metal Screening

In the development of this instrument, it was noticed that the output coil of the unit was capable of radiating howls originating in the oscillating receiver. For this reason the device has been completely enclosed in a sheet metal case.

Stability

Ordinarily it is impossible to add a further stage of H.F. amplification to receivers using two such stages because the addition of the third stage causes the combination to become unstable, resulting in locally-sustained oscillations and howling. This instrument is so perfectly stable that it may be added to any receiver without increasing the tendency toward oscillation.

Selectivity and Amplification

The new instrument differs from such devices as the wave-trap, in that a wave-trap admits all except a narrow band of frequencies, at the same time reducing the strength of the desired signal, while this device admits and amplifies only the desired narrow band of frequencies.

Furthermore, such a decided increase in the strength of the desired signal is obtained that, in most cases, a station which is inaudible with the receiver alone will, with the assistance of this instrument, give loud-speaker volume.

Circuit Employed

Fig. 1 shows the fundamental circuit and Fig. 2 is the all-capacity bridge involved. The same lettering is used in both figures. Thus the capacity between grid and plate is indicated by the condenser between points G and P, the grid and plate respectively, of the valve; and the balancing condenser from plate to the point A is shown connected between points P and A of the bridge. This latter condenser is adjustable, but when once set at the point at which the bridge is balanced, it does not require further adjustment at any frequency unless a valve having a different value of grid-to-plate capacity is substituted for the valve for which balance was obtained.

Constructional Details

In Fig. 3, the input inductance L_1 is more than twice the value ordinarily employed, resulting in a very high signal voltage across its terminals—and therefore increased signal strength over that ordinarily obtained. The primary inductance is tapped as shown to allow a choice in selectivity for varying conditions of operation. Fig. 3 is the actual circuit diagram for the type used with sets employing an outside aerial. It will be noticed that the shield, marked S, is not connected directly to the earth, but through a by-pass condenser. While this earths the shield and the rotor of the twin variable condensers to

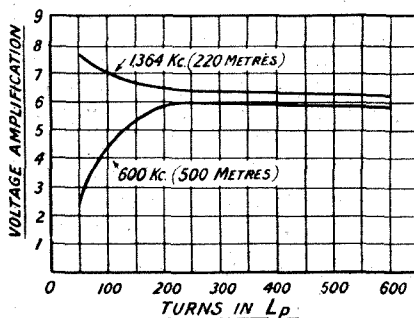

Fig. 4.—Showing how the voltage amplification varies with the number of turns on the anode inductance.

alternating currents, it removes the possibility of burning out a valve by having the positive high-tension battery lead accidentally come in contact with the shield.

The matter of which filament lead is earthed and which is connected to high-tension minus lead is determined by the wiring of the receiver itself. Thus this device will function, without change in its own wiring or that of the receiver, with

any set, no matter which battery lead is grounded or which is connected to the high-tension minus terminal.

Special Features

The special output circuit shown in Fig. 3 allows the unit to amplify

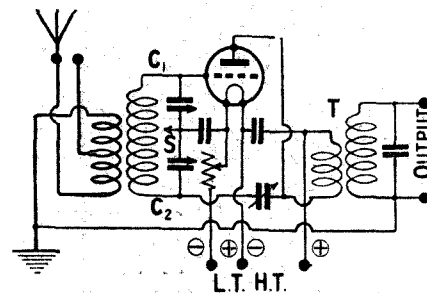

Fig. 5.—The complete wiring diagram of the instrument illustrated at the beginning of this article

the incoming signal when feeding into any type of receiver, whether it be of the fixed-tuned primary type (as in the neutrodyne) or a single circuit or loosely-coupled type, tuned either with a series or parallel condenser. C_p is so proportioned that, with the rest of the output circuit, it simulates the conditions of the average-sized aerial. This causes the tuning of the first dial of the receiver to be altered but very little—if at all.

The output inductance L_p has been chosen to give the highest possible average gain with various types of receivers. Fig. 4 shows two amplification curves run at 1,364 and 600 kc. (220 and 500 metres) and the inductance of L_p was chosen from the results of a series of such curves to give the maximum amplification possible.

For Loop Reception

For use with a set designed for loop reception, type CL has been developed. The circuit of Fig. 5 is employed. Here the loop is replaced by a very short aerial (20-50 feet long), which, it has been found by experiment, gives a better combination of selectivity and signal intensity and less static. The earth connection may be used as shown, or may be replaced by a short length of wire thrown on the floor or running under the carpet. T is a small high-frequency transformer, across the secondary of which a condenser is shunted in order to compensate for the difference between the distributed capacity of the secondary of T and that of the loop, thus preventing any marked disturbance in the reading of the first dial of the receiver.

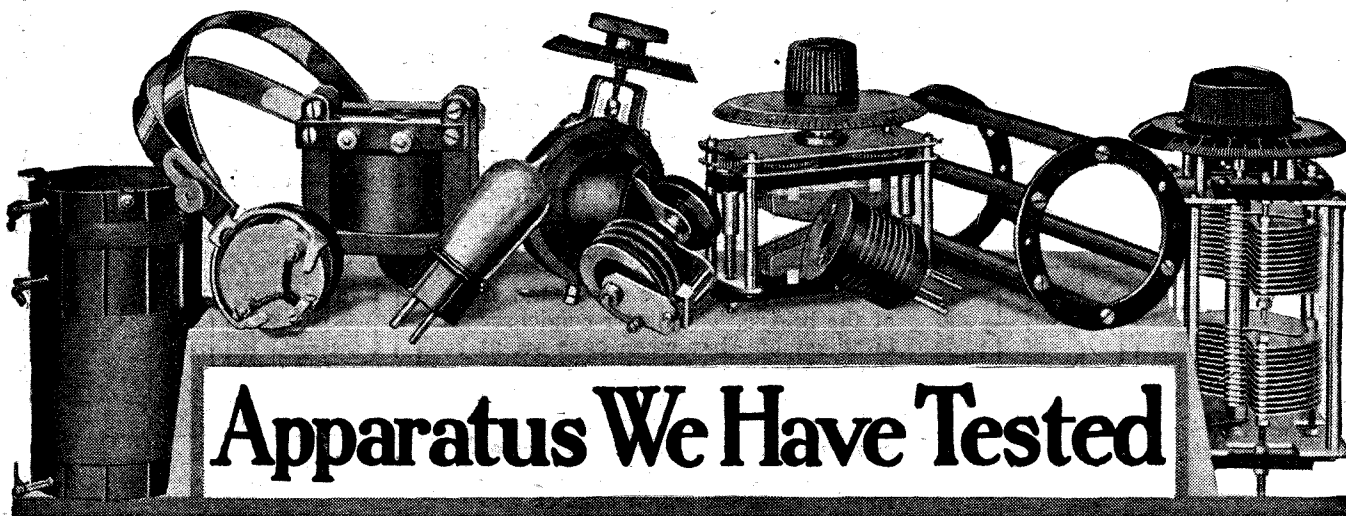

Apparatus We Have Tested

Conducted by A. D. COWPER, M.Sc., Staff Editor.

Benjamin Valve-Holders

An interesting type of anti-microphonic valve-holder, and one which lends itself particularly well to the modern base-board and vertical panel type of receiver, with valves arranged behind the panel, is the Benjamin Clearer Tone Valve-Holder, samples of which have been sent to us by Messrs. the Benjamin Electric Co., Ltd., for practical test. These have a hollow rectangular bakelite base, with drilled fixing lugs for fastening down on a base-board or panel, and with four convenient terminals at the corners as well as small soldering tags at the lower corners. An ordinary type of four-pin valve-holder is suspended within this hollow base, with the upper portion projecting through a circular aperture in the top, by four spring arms (formed into close spiral springs at the inner ends), which actually provide the valve-leg sockets at one end and the soldering tags at the other end of one continuous piece of metal. Actual trial showed that a good measure of insulation from the effects of vibration and shocks had been achieved. We are glad to note that the price asked for these well-finished and neat-looking holders is very reasonable indeed; they can certainly be recommended with every confidence. Insulation resistance, on test, proved unexceptionable.

"Soldo" Tinning Compound

A soldering compound which is rather more than a flux is "Soldo," a sample of which has recently been sent for our comment by Messrs. the Soldo Co. This material, which has been commented upon previously in these reports, consists of a greyish material, with metallic specks visible in it, packed in a small tin with a tight lid. If some of this is placed on a piece of most ordinary metals, heated to above the melting-point of solder, the metal becomes tinned at once, both the solder and the fluxing material necessary to clean the object to be tinned being present in the flux. The makers claim that an ordinary

poker can be pressed into service to act as a soldering-iron, and that there is no necessity to clean the metal in the usual manner by scraping, filing or acids. We have had this flux in almost daily use, in experimental work, for a considerable period, and can endorse the claim that the tinning of not over-clean metal is very greatly facilitated by its use. But we do not consider that it is advisable to emphasise unduly the fact that there is no need to clean metals before commencing soldering operations, particularly in radio constructional work. One application in which we have found both earlier samples and the latest product invaluable is in the repeated cleaning and retinning needed by an ordinary soldering-iron, even a gas-heated one, from day to day and during constructional work. Practical trial shows that by momentarily placing the tarnished point of the iron in this "Soldo" compound in its tin, the dirt vanishes and the iron is ready tinned for use. Similarly for tinning obstinately-resistant small brass parts and wire ends good use can be made of it, and where a large surface has to be tinned, as in sweating brass plates together, etc., the compound saves a large amount of time and wasted effort. The report from the N.P.L. quoted by the makers gives evidence of the soundness of resulting joints.

National Tapped Tuner

Messrs. National Wireless and Electric Co. have submitted for test an example of their tapped tuner, with ball reaction-rotor and with nine tapping points, which is claimed to cover from approximately 1,000 to 100 kc. (300 to 3,000 metres wavelength), with the aid of a .0005 μ F tuning-condenser in series-parallel connection. It consists of a composition tube, about 6 in. long and 3 in. in diameter, wound closely with a large number of turns of very fine silk-covered wire, except for a narrow gap just over the centre of the vario-coupler rotor. The latter has also a large number of turns of

fine wire on a moulded spherical former; it is arranged transversely in bearings towards one end of the stator tube, and is intended to be controlled by a knob (with bevel scale) projecting through the front of the panel. Two fixing screws, with suitable spacing bushes, are provided. Terminals on the tube itself, on heavy copper straps, give means of electrical connection to the rotor winding, whilst small terminal bolts and soldering tags are provided for the grid-circuit connections and for wiring up to the selector switch. The tapplings are made in a very neat manner with connections inside the stator tube. On practical trial on a small P.M.G. aerial with a .0005 μ F tuning-condenser, the requisite overlap of tuning ranges was found wanting between 630 and 612 kc. with parallel tuning-condenser; the tuner should be used with series condenser in the lower ranges. Otherwise the range from about 869 to 110 kc. was readily available, free oscillation resulting at all points. The local station, 2LO, jammed everything else up to about Belfast's wave, only Birmingham being obtained fairly clear of London (at 12 miles from the latter); on the No. 6 tapping point 5XX came in at moderate loud-speaker strength on the one valve in London, sensibly free from 2LO; on the ninth point Eiffel telephony came in weakly, and not entirely free from London, whilst Radio-Paris in the lower range was jammed by both 5XX and London. On measuring by the Moullin voltmeter method the resulting signal-voltage from the local station, without reaction, the figure recorded was lower than that for any but the least commendable of plug-in coils. The tuner can hardly be described as of a low-loss type with such high-resistance fine-wire windings and dead-end effects of a marked order. The utility of so unselective a device is somewhat hard to appreciate at a time when the problem of mutual jamming of the rapidly multiplying broadcast stations is so much to the fore.



CORRESPONDENCE

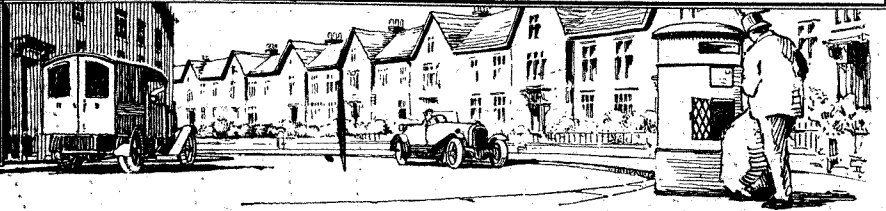

THE "NEW LOUD-SPEAKER CIRCUIT"

SIR,—I am glad to say that favourable reports on the "New Loud-speaker Circuit," as described in *Wireless Weekly* of September 2 and September 16, 1925, are coming in from all parts of the country, and hence perhaps the following remarks may be of interest.

As explained, the action of the detector valve in any form of the trigger circuit depends upon changes of voltage first and foremost, rather than changes of current. The detector is not only a rectifier, but also a voltage amplifier, rather than a power amplifier, and therefore the greater the voltage amplification factor of the detector valve, the better.

This appears to be borne out by the recently published conclusions of Messrs. Manfred von Ardenne and Heinert; they show that in connection with those stages of resistance-capacity coupled amplifiers which act as voltage amplifiers pure and simple, anode resistances of several megohms should be used with high amplification factor valves, and that used thus the filaments of ordinary valves have to be run very dim.

Von Ardenne and Heinert hope to be able to produce special-short filament valves with amplification factors as high as 70 for the benefit of their resistance amplifiers, and it is to be hoped—for the benefit of the trigger circuit—that such valves will be available also in this country.

However, one limiting factor is the natural capacity to earth of the anode circuit of the detector. In all forms of the trigger circuit used for telephony it is advisable that both the detector and the valve following it should use low-capacity sockets, and that the detector anode battery and the leads from it to the detector anode and the grid of the next valve should be kept as clear as possible from the rest of the circuit.

Finally, the merits of the trigger circuit—details of which have been divulged in *Wireless Weekly* only—are such that it is now being put on the market in the form of a cabinet receiver by Messrs. Princeps, Ltd., of 173, New Bond Street, with whom is associated Major Prince, who originated the circuit.

There is still considerable scope for experiment to find the best conditions

under which particular valves will work in the circuit.—Yours faithfully,
GUY C. BEDDINGTON.
Villa Yolanda, Ospedaletti, Italy.

ENVELOPE No. 2

SIR,—I have much pleasure in enclosing a photograph of my "Family" four-valve circuit set (Radio Press Envelope No. 2, by Percy W. Harris, M.I.R.E.), which I hope will be of interest to you. I constructed this set some months ago, and have always

to work a small loud-speaker, which can be heard all over the house. I always recommend this circuit to my friends, for in my opinion it is quite the best.—Yours faithfully,
A. HAYNES.

Peckham, S.E.

SIR,—I thought you might be interested in the following report of the "Family" four-valve set (Radio Press Envelope No. 2, by Percy W. Harris, M.I.R.E.), which I built some four or five months ago. I thought I would give it a good trial, all stations mentioned being tuned straight into the loud-speaker, not 'phones first. The following come in too loud for comfort and can be heard for hundreds of yards down avenue:—Leeds-Bradford (I am two miles from the Bradford station), Manchester, Newcastle, Aberdeen, Birmingham, Belfast, Daventry and Hamburg. In addition, the following are loud enough to be heard all over the house:—Radio-Paris, Madrid, Berlin, The Hague, Lausanne, Radio-Wien, Radiofonica and Glasgow. With a wave-trap I can get Cardiff, Bournemouth and Sheffield quite well, also Liverpool and Nottingham. All these are summer-time results, so I think the receiver good enough for anyone and a credit to Mr. Harris.—Yours faithfully,

A. TURNER.

Bradford.

A HARTLEY-REINARTZ RECEIVER

SIR,—I refer to the "Two-Valve Hartley-Reinartz Receiver," particulars of which were given by Mr. J. W. Barber in *Modern Wireless* for October, and think that you may like to know my experiences with a receiver of this kind constructed from details given by A. D. Cowper, M.Sc., in *Modern Wireless* for August ("A Selective Hartley-Reinartz Circuit for Broadcast Reception"). I followed the latter description in nearly every respect, but I utilised .0005 μ F variable condensers. In spite of this, reaction and tuning is delightfully smooth. I added one transformer coupled L.F. stage, and with this combination, and using a four-electrode valve for this stage, I have to de-tune 2LO, otherwise it is too loud on L.S. Clarity is all that can be desired. Selectivity appears

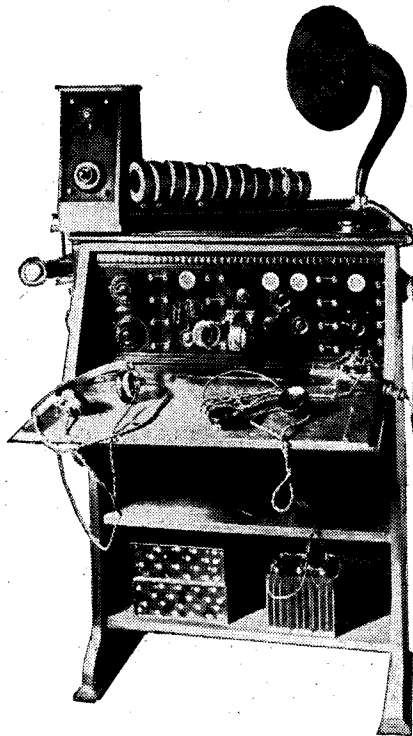

The receiver employing the "Family" 4-valve circuit, as constructed by Mr. Haynes.

derived the utmost satisfaction therefrom; in fact, I find it gives far better reception than any other of your many circuits which I have tried. You will notice that it is made out of experimental panels. I have made up your wave-trap, and with this in circuit I can cut London completely out and pick up any of the B.B.C. and many Continental transmissions without the slightest interference. For London I only use detector and one L.F. valve, and this gives sufficient power

Highest attainment in wireless production

V A L V E S

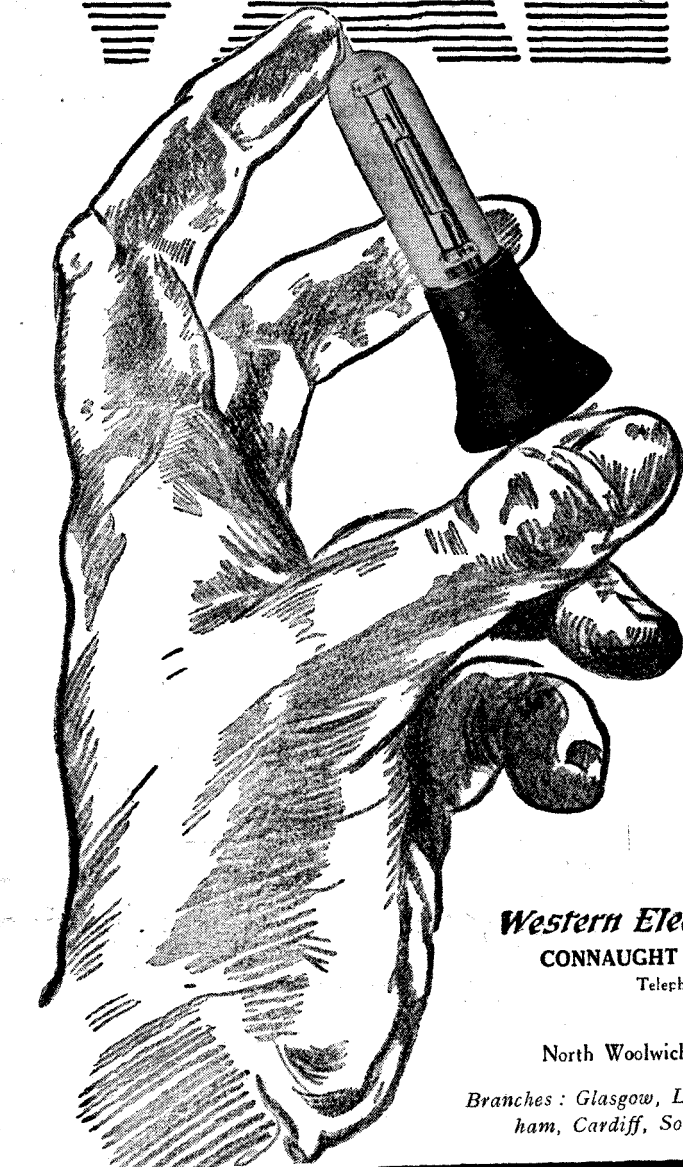

THE improved Weco valve has been fitted with a tape filament which enhances the life and performance of the valve. We can justly claim that it is the most robust dull emitter valve at present on the market.

In full operation the current used is so small that the filament glows in the dark at a dull red heat only. In daylight it would appear that the valve was not in use.

The Weco valve is especially marked for service as follows, and to obtain the best results, valves should be selected for the function they are designed to perform.

- Red Spot - - - H.F. Amplifier.
- Orange Spot - - - L.F. Amplifier.
- Green Spot - - - Detector.

OPERATING CHARACTERISTICS.

- Filament current - - - 0.25 amps.
- .. voltage - - - 0.8 to 1.1 volts.
- Detector Plate Voltage - - 15 to 22 volts.
- Amplifier .. - - - 22 to 60 volts.
- Amplification Factor - - - 5 to 6.5

Ask for our Booklet, No. W548, which gives full details of our new season's apparatus.

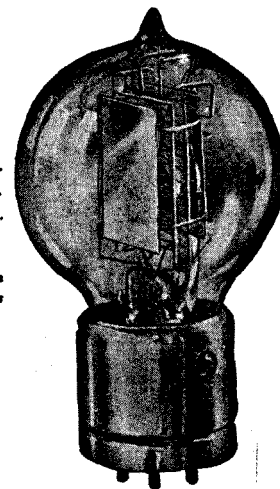

**P.A. 4 VALVE
FOR POWER
AMPLIFICATION.**

Western Electric Company Limited

CONNAUGHT HOUSE, ALDWYCH, W.C.2.

Telephone: Central 7345 (9 lines).

Works:

North Woolwich. New Southgate. Hendon.

Branches: Glasgow, Leeds, Newcastle, Manchester, Birmingham, Cardiff, Southampton, Liverpool and Dublin.

The valve with the tape filament

too high in my set to allow of any other station being tuned in, the latter process being a two-handed affair, for every setting of one condenser the other one having to be adjusted.

I find a variable grid-leak is an advantage. All the wiring is carried out in 16 gauge square wire, and all components are well spaced, and G.B. is used for last valve. As stated before, clarity is particularly good, and with a perfectly silent background. I strongly recommend this set for the local station, and it should be ideal up to 20 miles, using a power valve in the last stage for L.S.

In conclusion, I would say that my aerial is about 18 ft. high and 80 ft. long, including lead in. The set is situated on the first floor with a double flex 60-ft. lead to loud-speaker on the ground floor. The earth is a length of ribbon aerial buried about 1 ft. in the ground, running under the aerial almost to the mast. I find that this kind of earth gives me better results than any which I have tried so far, which include water-taps, a zinc pail, wire netting and pipes, the latter three being well buried in the ground. The ribbon aerial I find particularly efficient on the shorter waves, *i.e.*, from 60 down to well below 40 metres.

Trusting the above is of interest to you and congratulating you on your always most interesting and efficient circuits. I am a constant reader.—
Yours faithfully,

GEO. E. LILNS.

Harrow.

ENVELOPE No. 9

SIR,—I have constructed the "Efficient Single-Valve" set described in Envelope No. 9 (by Herbert K. Simpson), and perhaps readers would like to hear results obtained on first night.

2LO came in on loud-speaker fair, Birmingham on 'phones good strength, Newcastle on 'phones good strength; Madrid on 'phones fair, but not good volume. Several amateurs sending Morse. Glasgow fair, but 2LO difficult to cut out. Not bad for the first trial.

I have also constructed several other R.P. sets, and find them very easy to follow during construction. They get all that are claimed for them.

Wishing *Wireless Weekly* every success.—Yours faithfully,

Streatham. H. BRACEY.

SWANSEA RADIO SOCIETY

SIR,—I beg to give you a report of the Swansea Radio Society's annual general meeting. I trust that it will prove of interest to your readers.—
Yours faithfully,

E. H. WHITE (Hon. Sec.).

100, Bryn Road, Swansea.
The annual general meeting of the above Society was held on Monday, October 5, at their headquarters, Y.M.C.A. This was the Society's first meeting for the new session. A very satisfactory report was given both as to the number of members and the sound financial position of the Society. The

following officers were elected: President, Capt. Hugh Vivian; Vice-Presidents, Sir A. Whitton Brown, K.B.E., M.Inst.M.E.; Messrs. H. K. Benson, A.M.I.E.E., A.M.I.Mech.E.; R. G. Isaacs, M.Sc., A.M.I.E.E.; J. C. Kirkman, B.Sc., A.Inst.P., Fellow of Phv. Soc., London; Col. A. Sinclair, A.M.I.C.E., M.I.E.E.; W. Guy Hodge, D. W. Walters, A.M.I.E.E.; J. D. Williams, David Davies; Chairman, Mr. D. P. Williams; Vice-Chairman, Mr. T. S. Clark; Members of the Council, Messrs. A. E. Allsopp, A. Bates, H. K. Benson, C. Russell Peacock, H. B. G. Taylor and S. O. Wedlake; Hon. Auditors, Messrs. W. E. Wright and J. Turpee; Hon. Valuers, Messrs. A. E. Allsopp and A. Bates. A pleasant function was carried through at the close of the meeting, when the retired Secretary, Mr. H. T. Morgan, was presented with a clock. Mr. D. P. Williams, the Chairman, said, in making such a presentation the society were recognising the valuable services of Mr. Morgan. Mr. T. Macnamara thought the present satisfactory position of the Society was due to Mr. Morgan's efforts. Mr. T. Briggs also paid tribute, and the presentation was made by the Society's first lady member, Miss Hawken.

"WIRELESS"
Now on Sale. PRICE 2d.



"TELWAVE"

(Registered)

RADIO COMPONENTS

(MARTIN - COPELAND PRODUCTS)



"Telwave" Switch-Plug and Jack.

The "Rolls Royce" of the Radio World.

Our New Illustrated Catalogue will interest you.

TRADE ONLY SUPPLIED.

THE ELECTRICAL EQUIPMENT & CARBON CO., Ltd.,
109/111, New Oxford St., London, W.C.1



No more Accumulators to be charged

RECO

Continuous L.T. & H.T. Batteries

WRITE FOR PARTICULARS AND DEMONSTRATION TO

The Radio Equipment Co., Ltd.

5, Dyer's Bldgs., Holborn, LONDON, E.C.1

No more H. T. Batteries to be replaced



Why is



REGISTERED TRADE MARK

THE HALL MARK OF "QUALITY" EBONITE?

Because it is made from finest rubber and sulphur

IT HAS
PROVED ITSELF

ITS POLISH
SPEAKS FOR ITSELF

All branded panels guaranteed free from surface leakage.

Write for full particulars and List B.

The **BRITISH EBONITE Co., Ltd.**, HANWELL, LONDON, W.7

Rods, Tubes and Mouldings



The new improved T.C.C. Mansbridge

IN Radio—the youngest and most virile of our industries—progress is essential. While it has not been found possible to improve the accepted principles of the Mansbridge Condenser—recognised as the standard large capacity condenser throughout the world—we have found it practicable to improve the famous green T.C.C. Mansbridge in certain important constructional details.

The new Duplex terminals (patent applied for) can be used as soldering tags or to hold connections by means of their knurled heads. The top of the Condenser is now *all-metal* which is, of course, quite impervious to the heat of the soldering iron or the action of the atmosphere.

T.C.C. Mansbridge Condensers are made in the largest factory in this country solely devoted to the manufacture of condensers. They are backed by a twenty-year-old reputation for accuracy and dependability. They are fully guaranteed and British made throughout. Every Wireless Dealer stocks them in a wide range of capacities.

In labour, design and material—British throughout

Gilbert Ad. 3805

AN ADVERTISEMENT IN "WIRELESS WEEKLY" IS A GUARANTEE OF SATISFACTION TO BUYERS.

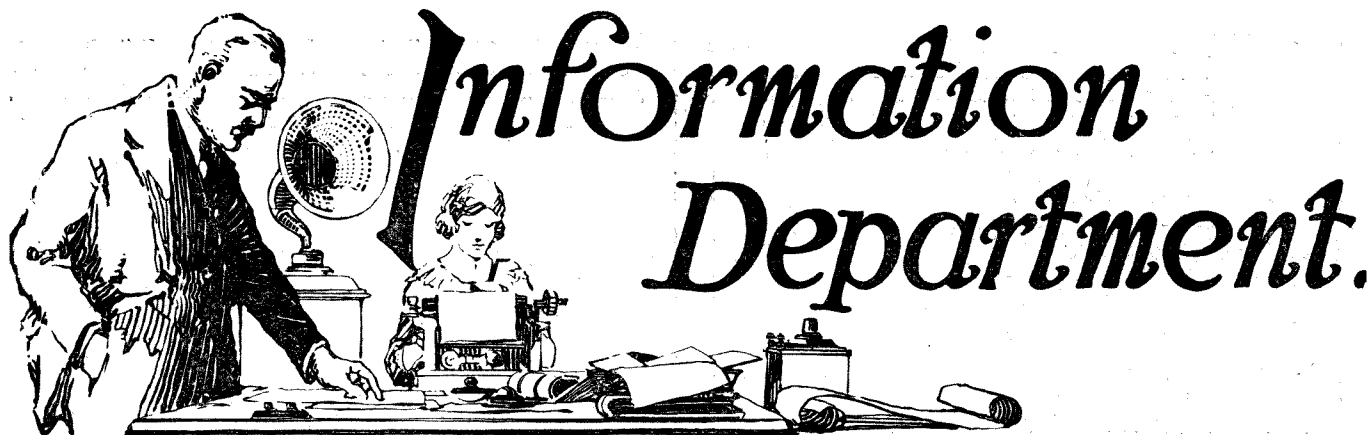

Information Department.

R. E. (HENDON) asks whether a simple scheme is possible to alter the capacity of his .0002 μ F variable condenser, incorporated in his short-wave receiver, without adding parallel fixed condensers, in order to employ this on the ordinary broadcast wavelength range of 300 to 500 metres.

Since our correspondent specifies that he does not wish to use a parallel fixed condenser to increase the capacity of the one employed in his receiver, the only solution of his difficulty is to change the dielectric in order that the capacity may be increased. It is obviously not practicable to replace the air dielectric by ebonite or mica, since this proceeding would not only take too long but would require considerable skill if intended for use when a

rapid change over was desired. It could be arranged, however, that the whole condenser be immersed in suitable oil when it was desired to employ it on the ordinary broadcast waves. Paraffin oil has a dielectric constant of 2, and hence if the condenser were immersed in this, its maximum capacity would be doubled. Incidentally, its minimum capacity would also be increased, and, frankly, we are not in favour of the method, which is very messy.

F.E.P. (TONBRIDGE) employs a straight four-valve receiver of the H.F., Detector and 2 L.F. type. He is troubled by a background of "mush." The house electric lighting supply is direct current, and when the main

switch is open he has discovered that the "mush" almost disappears. He asks our advice on how to eliminate the interference without cutting off the electric supply.

We would advise our correspondent to get an electrician to insert a 100-turn coil in series with each side of the mains near the main switch. It should be remembered that the wire employed in their construction should be of sufficiently heavy gauge to carry the total current taken by the house lights. The coils may be wound on 4-in. or larger formers, the size of the wire being decided by the consideration mentioned above.

This procedure should allow most of the interference to be cut out, although

THE PANEL DE LUXE



A RADION PANEL—with its sleek polished surface—is a joy to behold. But the wireless enthusiast knows that its advantages are more than "skin deep." Its superior insulation qualities are even more important than its handsome appearance. In every way it proves itself the "panel de luxe."

 Radion is available in 21 different sizes in black and mahogany. Radion can also be supplied in any special size. Black 1d. per square inch, mahogany 1½d. per square inch.

RADION

Trade Mark

American Hard Rubber Company (Britain) Ltd.

Head Office: 13a Fore Street, London, E.C. 2
 Depots: 120 Wellington Street, Glasgow, 116 Snow Hill, Birmingham.
 Irish Agents: 8, Corporation Street, Belfast.

Gilbert Ad. 3798

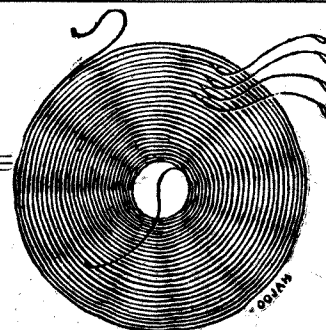

O O J A H

DAVENTRY COIL

ALL "OOJAH"

Price 1/-

Inductances are wrapped in a transparent covering and sealed with the Registered Trade Mark "OOJAH"

To meet the popular demand we have designed a tapped Basket coil which will tune to over 1,600 metres WITHOUT a parallel condenser.

GREENSLADE & BROWN

LANSDOWNE ROAD, CLAPHAM, S.W.8.

Telephone: Brixton 639

The precise device for tuning your radio set bears the trade mark



In all Igranic Coils the famous Honeycomb Duolateral (De Forest Patent No. 141344) winding is employed, and thus you are assured low self-capacity, small absorption factor, minimum H.F. resistance and high self induction—the qualities of the ideal inductance.

For all general purposes—

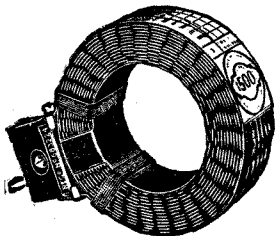

there is the plug type Igranic Honeycomb Coil — long acknowledged the standard by which all coils are judged. This type is available in nineteen sizes giving wavelength ranges of from 150 to 23,000 metres and including intermediate sizes of 30, 40 and 60 turns. Prices vary from 4/3 to 17/6 each according to wavelength range.

For the perfect reception of B.B.C. Concerts—



there is the Igranic Honeycomb Concert Coil. This coil has been specially developed in order to give listeners distortionless reproduction coupled with maximum volume when receiving B.B.C. Concerts. It is made in four sizes—C.1, 114 to 320 metres, C.2, 205 to 536 metres, C.3, 286 to 718 metres, 4/3 each; C.4, 402 to 1,114 metres, 4/5 or 17/- for the set of 4. Fits all standard plug-in coil holders.

For highly selective tuning—

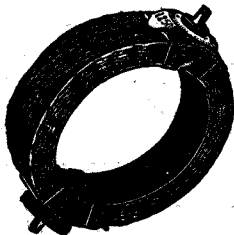

there is the Gimbal mounted Igranic Coil. The special method of mounting is the unique feature of this coil. Not only is a precise angular adjustment of the coils possible, but, in addition, by reason of the fact that each coil is rotatable about its own axis — a very fine and critical adjustment can be made. In critical, regenerative and rejector circuits this fine variation is essential. There are twenty sizes available (Nos. 15 to 1,500) covering a total wavelength range similar to plug type coils.

For short wave reception—

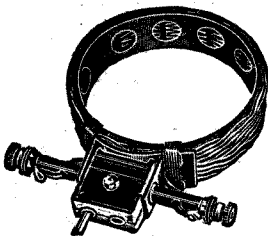

The many difficulties which arise in short wave reception owing to very high frequencies are greatly reduced by the use of the Igranic Unitone Aperiodic Fixed Coupler.

Yet there is no difficulty in fitting it to any receiver having standard coil holders. You plug the coupler into the first grid circuit, remove the aerial lead from the set and connect it to one of the terminals on the plug extension arm. The remaining terminal you connect to the "earth" terminal of the set and to earth.

Unitone Minor 75-180 metres, 7/6
 " Major 300-600 " 9/-
 All reputable dealers stock Igranic Radio Devices.

Write for List Y.71.

IGRANIC ELECTRIC CO., Ltd.,
 149, Queen Victoria St., London. Works: Bedford.

VICTORIA PRODUCTS

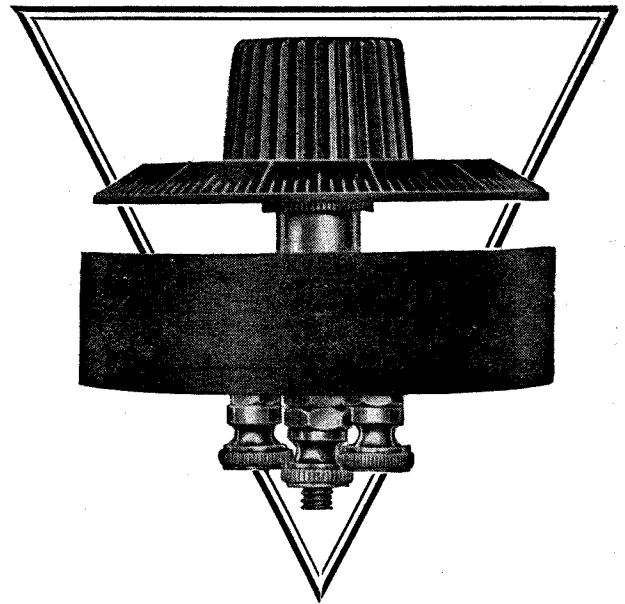

for better radio efficiency

THE VICTORIA VARIABLE GRID LEAK and VARIABLE ANODE RESISTANCE

(Illustrated above)

The exceptional features of this component make it superior to the many grid leaks now on the market.

It has a resistance variation of $\frac{1}{2}$ meg. to 5 megs. obtained by a single rotation of a Dial engraved to present readings of variation of $\frac{1}{2}$ megohms. Metal to metal contact. Wire wound. Resistance element always consistent and packing impossible. Positive contact. Self-capacity practically zero. It is one-hole fixing. Something entirely new. Price 7/6 each.

VICTORIA LOW-LOSS CONDENSER.

Observe these Points of Superiority

Lowest losses. Min. capacity: 4 micro-micro farads. Greater wavelength range obtained than in any other type. Spring contact. Ball bearings. Vanes insulated by ebonite supports outside the electrostatic field. Sturdily constructed. Highly finished aluminium end plates, nickelled supports and brass vanes. A really first-class condenser, particularly ideal for short wavelengths.

PRICES

.001, 16/- .00075, 15/6. .0005, 14/9. .0003, 14/- .0002, 13/6.
 Fitted with Vernier Dial and precision extension handle, as illustrated, 2/6 extra on prices quoted above.

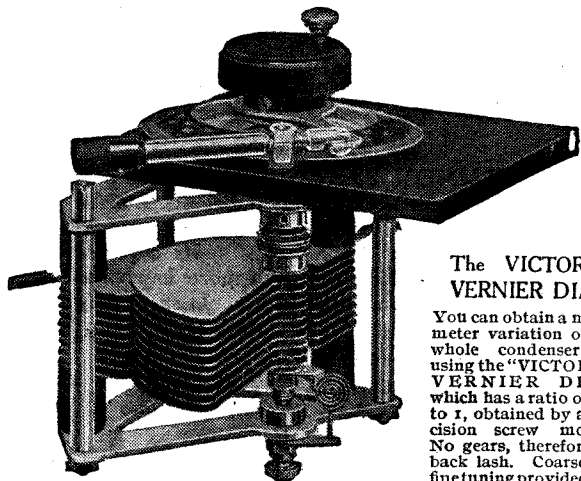

The VICTORIA VERNIER DIAL

You can obtain a micro-meter variation of the whole condenser by using the "VICTORIA" VERNIER DIAL, which has a ratio of 300 to 1, obtained by a precision screw motion. No gears, therefore no back lash. Coarse and fine tuning provided for. Suitable for use with any standard condenser or variometer. Price 4/9

For purposes of illustration section of panel is not shown in correct position.

VICTORIA ELECTRICAL (Manchester) LTD.
 Victoria Works, Oakfield Road, Altrincham, Cheshire.

Barclays Ad.

probably it will not be completely banished owing to the nature of its introduction. D.C. mains sometimes bring in "mush," and this is induced from the wiring of the house into the receiver. To effect a complete cure it would be necessary to introduce similar coils into the mains leading into neighbouring houses, since the tendency for these adjacent systems to cause the interference will still be present.

R. A. (Bexley Heath) wishes to measure the capacities of a number of small fixed condensers which he has purchased. He states that he has a buzzer wavemeter available and also one fixed condenser of .0003 μ F capacity, which value he knows to be fairly accurate.

Given an accurate buzzer wavemeter and one condenser of known capacity, it is a very simple matter to determine experimentally the capacity of other small fixed condensers. Working from the basic formula

$$\text{Wavelength} = 1,885 \sqrt{LC} \text{ (metres)}$$

where L = inductance in μ H.

C = capacity in μ F, we can apply this, in practice, as follows:—

Connect the small fixed condenser of known capacity in parallel with a coil, such, for example, as a No. 50 plug-in coil and a pair of telephones in series with a crystal detector across the oscillating circuit thus formed. Now start the wavemeter buzzing with

a suitable coil inserted in it, and measure the wavelength of the former circuit. Let X = the wavelength thus obtained, L = the inductance of the coil employed in parallel with the fixed condenser, which latter we will call C₁. We now have

$$X = 1,885 \sqrt{L C_1} \dots \dots (1)$$

Replace C₁ by the condenser, of which the capacity is required, and let this be C₂. With the wavemeter take a second reading of wavelength with the new fixed condenser. Let this reading be Y. We thus obtain

$$Y = 1,885 \sqrt{L C_2} \dots \dots (2)$$

Since L is the same for both readings, and X, Y and C₁ are known, it follows that

$$C_2 = \frac{C_1 Y^2}{X^2} \mu F \dots \dots (3)$$

From equation (3) above, the capacities of the various small fixed condensers can be readily obtained by taking two wavelength measurements as indicated. The inductance of the coil L may be taken as constant over the band of wavelengths the experimenter is likely to employ during the measurements, and fairly accurate results will thus be obtained.

W. M. (WESTERHAM) asks whether the addition of the "2-Valve Amplifier de Luxe" to his crystal set should give him good loud-speaker results from 2LO. He states that signals on his crystal set were weak, that the addition of one valve of the Amplifier

increased them to fairly comfortable telephone strength, but that the addition of both valves resulted in howling which completely drowned all signals.

In reply to our correspondent, we would state that unless good telephone strength is obtained on a crystal set alone, full loud-speaking should not be expected when a 2-valve amplifier is added. He would be well advised, therefore, to pay attention to his aerial and earth system, remembering that height and isolation from surrounding buildings of the aerial have considerable bearing on signal strength. Alternative earth connections should also be tried with a view to improving results still further. Once really good signals are obtained in the telephones it is reasonable to expect the addition of a transformer coupled 2-valve low-frequency amplifier to give fair loud-speaker results.

If on experimenting with the aerial and earth system it is found impossible to get really good signals on telephones with the unaided crystal set, we would advise that a single-valve receiver with reaction be constructed, such as that described in Radio Press Envelope No. 9.

The howling when both valves of his amplifier are in use, of which our correspondent complains, can generally be cured by the very simple expedient of connecting the negative terminal of the low-tension battery to the earth terminal of the crystal set.

Sir, you've been looking for me!

RIGHT along you've wished for a better fixed condenser, and now, at last, such an instrument is obtainable. The *Efficient Watmel* is my name—a better fixed condenser, superior in all the points that make for highest efficiency. Witness my Test Report, it speaks for itself. Next time you're at your dealers, ask to see me. Close examination will decide you that I'm the fixed condenser you've been looking for.

Watmel Test Report.	Prices.
1. Mica Insulation up to 2,000 volts	Capacities for Standard Grid Condensers.
2. Complete Condenser up to 1,000 volts.	.00005 to .0005 - 2/6 each.
3. Capacity checked.	Standard Fixed Condensers.
4. Insulation up to 500 volts after Final Assembly.	.002, .001 - 2/6 each.
5. Final Capacity Test. PASSED OUT 100% EFFICIENT.	.0025, .008 - 3/6 each.
	Combined Grid Leak and Condenser - - - 3/- each.

The Watmel Wireless Co., Ltd.
332a, GOSWELL ROAD - LONDON, E.C.1

Representative for Lancashire and Cheshire—
Mr. J. B. LEVER, 23, Hartley Street, Levenshulme, MANCHESTER.

Barclays Ad.

MAKE SURE OF PERMANENTLY GOOD RESULTS
when you build your set
by soldering all connections with the

Quality RADIO ELECTRIC SOLDERING OUTFIT.

Soldering is simplified by this new invention which works from any wireless accumulator without needing any gas, fire, or lamp. The **CARBON** soldering-bit needs no tinning or cleaning.

Always ready, everlasting, neat, and complete. Packed in wooden box with instructions.

PRICE 5/6
Postage 3d.

Or write for free descriptive leaflet No. 24.

GOSWELL ENGINEERING CO., LTD.,
95 to 98, WHITE LION ST., LONDON, N.1
LIBERAL TRADE TERMS. 'Phone: North 3051.

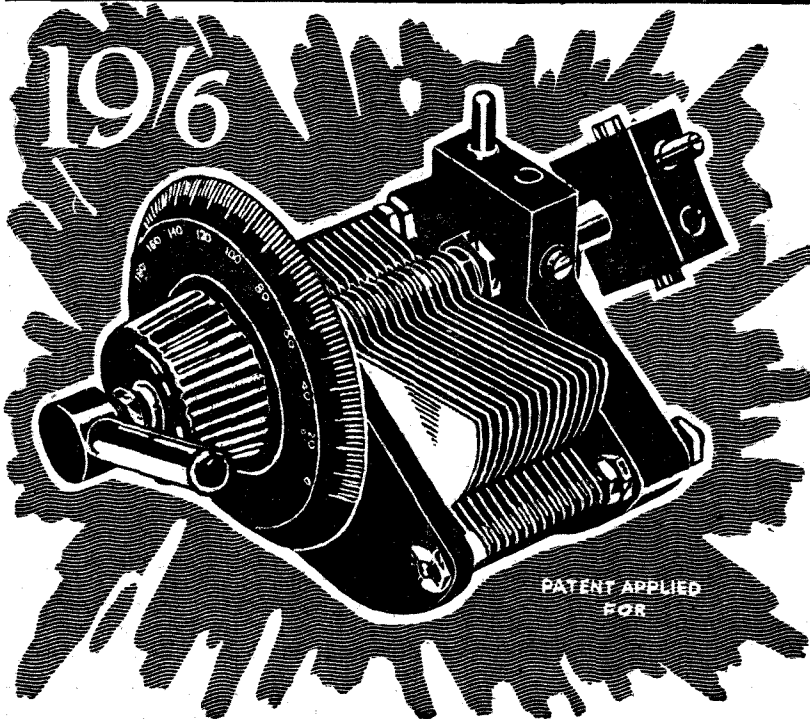

PATENT APPLIED FOR

This is the Seamark Connode

Striking a Balance

Tuning your set is very much like balancing a seesaw on a trestle. By bringing up your reaction coil, the balance is upset and the receiver "howls"; then you dash across to the condenser dial and reduce its reading, thereby stopping oscillation. In this way a balance may be struck by alternate adjustments, first on one dial and then on the other.

How much easier it would be to combine these two adjustments on one component, to introduce a balance over our trestle, as it were. The Seamark Connode is the only instrument which does this. It allows reaction or condenser to be increased and decreased until a balance is obtained, without removing the hand from one dial to another.

Moreover, increase of reaction by the coil holder can be obtained in the same direction as increase of capacity is obtained by the condenser. If one adjustment introduces instability, a compensating re-adjustment may be made on the Seamark Connode without even altering the direction in which the hand is moving.

If any difficulty is experienced in obtaining, write direct to the—

Sole Patentees & Manufacturers:
C. E. NEEDHAM & BRO., Ltd.
 6, MILK STREET - - SHEFFIELD

Direct from the factory to you

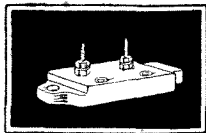

GRID CONDENSERS

In genuine ebonite moulded cases sealed against dampness, ready for fitting to panel by means of two screws. Fully tested and guaranteed accurate.

In all values from .0001 to .005 mfd. 1/3 each.
 In all values from .001 to .006 mfd. 1/6 each.

Owing to our big manufacturing facilities and our policy of dealing direct with the experimenter we can save you pounds. All components illustrated on this page can be sent per return of post. Catalogue (48 pages) post free 3d.

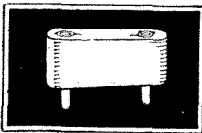

INTERCHANGEABLE CONDENSERS

An entirely new system. Each condenser plugs into the panel or into one of a different value. Takes up very little room on the panel. Each Condenser tested and calibrated. Prices: .0001 to .0009 mfd. 2/6 each. Larger values .001 to .004 mfd. 3/- each. Sockets 2d. per pair.

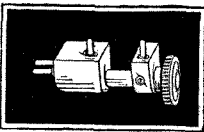

ROTARY COIL HOLDER

For panel use where space is important. To obtain variation in coupling the coil is rotated. This type of coil holder permits zero coupling being obtained. Fitted with two bolts and nuts for screwing to panel or cabinet. Cut from solid ebonite and hand polished. 6/-

Send 1d. stamp for 40 pp. Booklet on Super-Heterodynes, and how to build them.

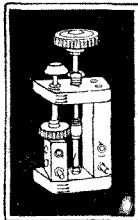

BACK-OF-PANEL COIL HOLDER

For use where coils are to be used behind the panel. Vernier movement by rotating knob. Indicator shows exact amount of coupling. One hole fixing with one additional hole for indicator spindle. Two coils 12/6. Three coils 16/6

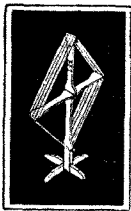

FRAME AERIAL

An exceptionally efficient folding frame aerial with centre tapping and having handsome moulded swivel base. Folds into small space when not required. 35/-

Peto-Scott Co. Ltd.
 77, City Rd., London, E.C.1.

Branches:
 62, High Holborn, London, W.C.1
 WALTHAMSTOW—320 Wood St.
 PLYMOUTH—4, Bank of England Place.
 LIVERPOOL—4, Manchester St.

P.S. 3794

AN ADVERTISEMENT IN "WIRELESS WEEKLY" IS A GUARANTEE OF SATISFACTION TO BUYERS.

HAWK COILS

MAXIMUM EFFICIENCY MINIMUM CAPACITY

— STRENGTH — DAMPING EFFECTS RESISTANCE

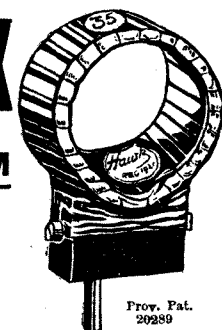

Prov. Pat. 20289

Prices below WATERPROOF Tel. 832 Kingston.

Coil	Wave Length using .001 Variable Condenser in Parallel		PRICE.
	MAXIMUM	MINIMUM	
13	—	—	2/-
25	305	190	2/4
30	435	240	2/4
35	515	360	2/6
40	630	370	2/8
50	835	485	3/-
75	1250	600	3/4
100	1820	815	3/10
150	2300	960	4/8
200	3100	1870	5/4
250	3750	2200	5/8
300	4500	2300	6/-
400	4950	2500	6/6

Sold by all Wireless Dealers

Sole Manufacturers!

The Hawk Coil Co., LTD., ST. MARY'S ROAD, SURBITON, SURREY.

"Radio Engineering"

By J. H. REYNER, B.Sc. (Hons.), A.C.G.I., D.I.C.

Every Experimenter, Engineer and Research worker in radio should own this valuable Handbook. It contains information and data of paramount importance to all who are interested in the technical aspect of the science. The whole book, comprising 484 pages, 314 illustrations, 196 pages of general mathematics, electrical and physical tables, and 111 tables, will prove invaluable to the serious experimenter.

The Book is in nine sections under the following headings:— Radio Calculations and Measurements, Tuning and Radiation, Thermionic Valves, Radio Transmitters, Radio Receiving Apparatus, Designs of Masts and Aerials, Telegraphy and Telephony, Miscellaneous.

A COMPLETE
REFERENCE
LIBRARY FOR
15/-
Post free 15/9

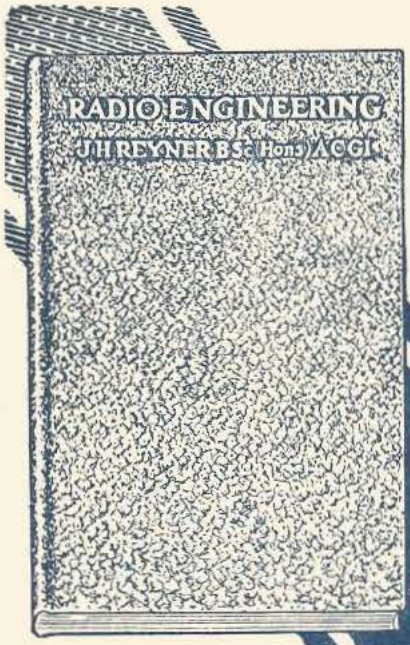

Both these Books can be obtained from Wireless Dealers, Newsagents, Bookstalls—or direct from Dept. S, Radio Press, Ltd.

For prompt and sure delivery when ordering direct, write your name in BLOCK LETTERS.

**TWO
NOTABLE
ADDITIONS
TO THE LIST OF
RADIO PRESS
PUBLICATIONS**



"Modern RADIO COMMUNICATION"

By J. H. REYNER, B.Sc. (Hons.), A.C.G.I., D.I.C.

Here is a book that fills a decided need of those experimenters in wireless who are desirous of securing more information. The enthusiast who already possesses an elementary knowledge of electricity will find this Handbook of great assistance. The theory of radio communication is explained in considerable detail, and a large portion of the book is devoted to spark, arc and valve transmitters. Fundamental principles are dealt with in a clear and concise manner.

PRICE
3/-
Post Free
5/0

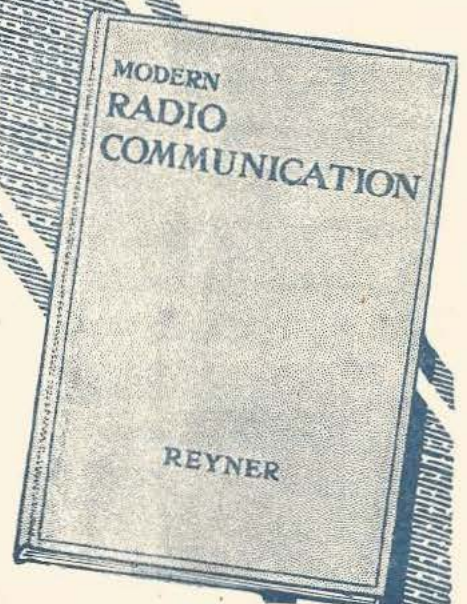

RADIO PRESS, LTD.,
Bush House, Strand, London, W.C.2

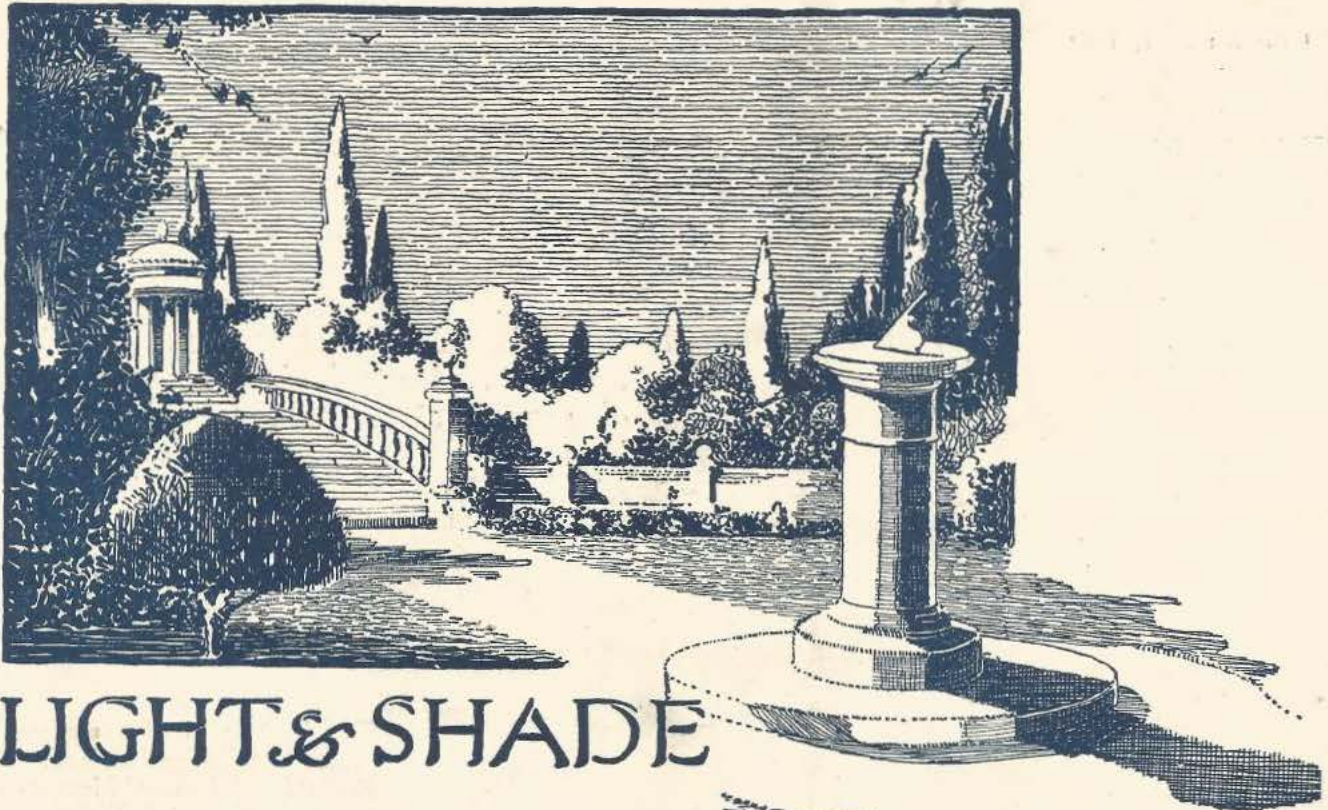

LIGHT & SHADE

A REAL PICTURE—the rays of the setting sun softened by the shadows, the wonderful colourings, and the contrasts of light and shade, all combine to give the picture a touch of real beauty.

And it is just the same with music. Although we may admire wonderful technique, we would never confuse music with the really beautiful, if it were soulless and stripped of those delicate overtones which add light and shade, and portray the real personality of the artist.

Now these overtones vary in frequency from one thousand to several thousand cycles per second, whereas the frequency of the fundamental notes generally varies between 250-1,200 cycles per second, which means that the Radio Transformer is faced with the problem of responding equally to vibrations whose frequencies differ so widely. The R.I. Transformer reproduces faithfully the fundamental notes while it loses none of those precious overtones, with the result that it gives **PERFECT MUSICAL RECEPTION**. This problem of perfect amplification calls for years of research and careful experiment. Any Transformer will give you electrical amplification. It takes the R.I. Transformer with 25 years' experience behind it to give True Musical Amplification.

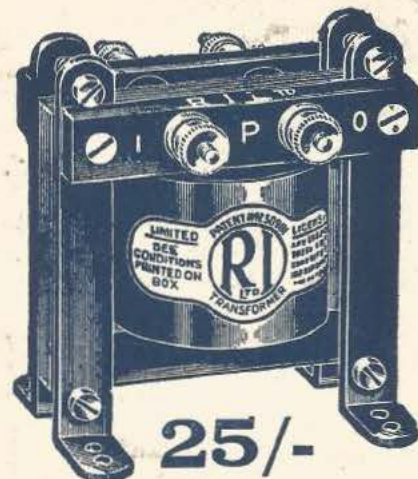

When buying R.I. Transformers see that they are contained in the R.I. Standard Sealed Boxes.

Write for New R.I. Blue and Gold Catalogue. Free on application.

◆ THE MARK OF BETTER RADIO ◆

Advt. R.I. Ltd., 12 Hyde Street, New Oxford Street, London, W.C.1.

P.C.4.