

# Wireless Weekly

Vol. 5. No. 19.

## ARE REFLEX CIRCUITS WORTH WHILE?

By JOHN SCOTT-TAGGART, F.Inst.P., A.M.I.E.E.,  
Editor.



# More about High Tension Batteries

By Frank Phillips, M.I.R.E., A.M.I.E.E., Chief Engineer of Burndept Ltd.

**I**N the early autumn of last year, I was privileged to introduce to the Public a new high tension battery which I called the Burndept Super Radio Battery. I then said that High Tension Batteries gave more trouble in our sets than any other component, the reason being that *the cells inside the average H.T. Battery were too small for present day needs*; most were designed during the war when *light weight* was more important than *long life*, and are not *suitable for modern three- or four-valve broadcast sets, which are often used regularly for four or five hours a day*. I made up my mind that my Company should sell one kind of H.T. Battery only, and that it must be so large and so well made that it would last for six months or so. Well, it seems that I was right; not only was the demand for the Burndept Super Radio Battery so unprecedented that we were unable to provide sufficient supplies, but others have done me the honour to follow my lead in providing large cell batteries! However, the Burndept Super Radio Battery was first in the field, and it will not be left behind: I will be quite frank in admitting that a small percentage of the batteries did not last as long as I had hoped, due partly to new types of valves drawing heavier currents from the battery than I had expected, and partly to the enormous demand occasioning slight defects in perhaps a single cell, thus spoiling a whole battery.

Various improvements are now being made, all of which lead to the production of a still better battery, having a still longer life. For instance, the zinc containers of each cell used to be made with a soldered seam, and a soldered bottom; solder and zinc set up local action in the cell and so all joints were covered with ozokerite; that was excellent, but it reduced the area of zinc, so we have arranged to use *seamless drawn zinc containers*, which should add another 25 per cent. or 30 per cent. to the life of the battery. Further, pin holes will be impossible, and so each cell will remain completely watertight, and thus obviate internal leakage.

The Super Radio Battery is now so well known that only a short description is necessary. The case is of very stout and strong composition covered with special polished mahogany finished coating, with a lid to match. The weight is 12½ lbs. and overall size 9¼ × 9¼ × 3½ in., and there is no external printing or marking. On removing the lid, the top of the battery is seen to be

covered with a new hard insulating compound, dull red in appearance, perfectly smooth, practically unbreakable. Rising from this surface are five very strong brass contacts, which are clearly marked — and 20, 45, 48 and 50 volts. The battery is intended to be used normally to give 45 volts, which is the proper operating voltage for all High Frequency and Detector Valves of the popular dull-emitter type; it is intended that, as the battery ages and the voltage drops, it may be kept up to the full 45 volts by moving the connection successively to the 48 and 50 volt positions; in this way the battery will retain its full rated voltage of 45 volts until the very end of its life. When higher voltages are required for Power Valves, two or more batteries should be joined in series.

On account of the improvements made and the experience we have gained, it is safe to say that the Burndept Super Radio Battery

**will operate a four-valve set four hours a day for a good six months,**

provided proper grid bias is used on the power valves; the estimate is quite conservative and should be largely exceeded, especially with smaller sets. Supplies are now ample and orders can be executed from stock.

No. 202. The Burndept Super Radio Battery, 45-50 volts, packed in sealed carton so that it may reach the customer untouched £1 4s. 3d.



**Purchase Burndept by its name—substitutes are not the same**

BRANCHES:

LEEDS: 12 Basinghall Street (near City Square).

CARDIFF: 67, Queen St.

NORTHAMPTON: 10, The Drapery.

# BURNDEPT

WIRELESS APPARATUS

**BURNDEPT LTD.,**  
Aldine House, Bedford Street, Strand, London, W.C.2.

Telephone: - Gerrard 9072.  
Telegrams: "Burndept, Westrand, London."



# Wireless Weekly

Radio Press, Ltd.  
BUSH HOUSE, STRAND, W.C.2.  
Tel.—City 9911.

Assistant Editor:  
PERCY W. HARRIS,  
M.I.R.E.

Scientific Adviser:  
Prof. G. W. O. HOWE,  
D.Sc., M.I.E.E.

Advisory Editors:  
Prof. R. WHIDDINGTON,  
M.A., D.Sc.

Prof. C. L. FORTESCUE,  
M.A., M.I.E.E.

Staff Editors:

E. H. CHAPMAN,  
M.A., D.Sc.

A. D. COWPER,  
M.Sc.

R. W. HALLOWS,  
M.A.

G. P. KENDALL,  
B.Sc.

STANLEY G. RATTEE,  
M.I.R.E.

EDITED BY JOHN SCOTT-TAGGART, F.Inst.P.,  
A.M.I.E.E.

Vol. 5, No. 19

FEBRUARY 25, 1925

Price 6d. net.

## A Sneak Bill

**T**HE new Wireless and Signalling Bill is, we must confess, one of the most brilliant examples of a Government department covering up its real intentions in an endeavour to obtain further powers which it proposes to use in a manner not disclosed in the Bill. Briefly, the word "sneak" is written over every page of this astonishing document.

Does the Post Office really imagine that the wireless public is to be gulled by legally-couched phraseology of such a disingenuous nature?

Perhaps the average member of the public, on reading the Bill, might miss some of the vital features which, if passed into law, will give the experimental movement a *coup de grâce*, and enable the permanent officials of the Post Office at any time in the future to revel in an orgy of bureaucratic interference and grandmotherly fussiness.

Let us state straight away the main objections to the Bill.

(1) The Bill relates to "any apparatus for wireless telegraphy." The Bill writhes of the Post Office might be called down upon anyone maintaining any apparatus for wireless telegraphy which would include valves, transformers, grid-leaks, and other components.

(2) Any regulations that the Postmaster may make, such as regulations regarding licences, etc., would become law almost

automatically, whereas at present they are merely departmental regulations which do not carry any legal weight, and which could be criticised by any magistrate or judge.

(3) Houses may be searched and homes invaded by interfering representatives of the Post Office.

(4) The Post Office is to control the use of etheric waves for the purpose of the sending or

the sole object of obtaining the licence is to enable him to conduct experiments in wireless telegraphy. A licence for that purpose shall be granted subject to such terms, conditions and restrictions as the Postmaster-General may think proper." The words "terms and conditions" appear superfluous. "These licences shall not be subject to any rent or royalty."

Let us consider these points in detail. It is to be noted that any apparatus for wireless telegraphy requires a licence. The Act specifically mentions a wireless telegraph station which has been established, or is being maintained, but it goes further and refers to any apparatus for wireless telegraphy which has been installed. The P.M.G. will state that in the original Bill of 1904 reference was made to "any apparatus for wireless telegraphy," but in those days this phrase had a very limited meaning, and obviously applied to a complete set in operation. The permanent officials of the Post Office since that day, however, have gradually brought the interpretation of the words "any apparatus for wireless telegraphy" beyond all recognition, and even physical experiments on oscillating valves and even simple buzzer circuits require a licence. One has only to look at all the so-called transmitting licences using dummy antennæ to see that the Post Office regard such a circuit,

### CONTENTS

	Page
Are Reflex Circuits Worth While?	694
Jottings By The Way	697
Radio Notes and News	699
Analysis of Condenser Resistance	700
Random Technicalities	704
A Simple Change-Over Switch for Transmitters	706
How to Plot Resonance Curves	707
A New Valve-Crystal Circuit on the Omni	710
A Negadyne Duplex Circuit	712
A Multi-Purpose H.F. Amplifying Unit	714
Reception Conditions Week by Week	719
Wireless Telegraphy and Signalling Bill	720
Correspondence	724
Apparatus We Have Tested	728
Information Department	731

receiving of energy without the aid of wires, as they apply to the installation and working of apparatus for wireless telegraphy.

(5) The Wireless Telegraphy Act of 1904 is stated to relate to the reception of messages, as well as their transmission.

(6) An experimental licence will be issued, provided the applicant "proves to the satisfaction of the Postmaster-General that

which is nothing more nor less than a piece of laboratory apparatus, as requiring a licence, even though any radiation does not go beyond the walls of a room. A wavemeter at one side of the room, and an oscillation circuit and detector at the other, also technically requires a licence.

It is consequently high time that some closer definition were made of "any apparatus for wireless telegraphy." The present Post Office interpretation is ridiculous in the extreme, and will be applied to component parts in the future.

#### Back-Stairs Tactics

The back-stairs element in the Bill is the clause which says that any Post Office Departmental regulations shall become law by the simple expedient of laying the regulations before both Houses of Parliament. This is an ingenious hole-and-corner method of avoiding a formal supplementary Bill giving legal effect to departmental regulations. This aspect of the Bill is a technical one which, while not readily understood by the general public, is extremely vital. In the ordinary way, if the Postmaster-General says that you shall not transmit any messages overseas without obtaining special permission from him, he is making a ridiculous regulation which no court of law in this country would uphold. If, on the other hand, the Postmaster-General, after the passing of the present Bill, made this a regulation and laid it before both Houses of Parliament (which involves no ceremony whatever, and which is a procedure which might pass unnoticed), this ridiculous regulation would have the full effect of law, and no judge or magistrate in the country, however foolish he thought the regulation, could fail to give a decision in favour of the Postmaster-General. The only possible protection is for a vigilant watch to be kept on these regulations, and then to go through the highly technical and difficult procedure of opposing them in Parliament. This process is complicated and intolerable, and the Postmaster-General is in the position of he who, having possession, also has nine points of the law. If, on the other hand, the regulations are

put into a sort of short Bill, the fullest publicity is brought to light and opposition becomes very simple.

To summarise this most important point of all, the Post Office will try to sneak through all sorts of restricted regulations entirely outside the scope of this Bill, which they think looks innocent enough, and these regulations will have the full force of law which, under the present conditions, they have not. There would be practically no safeguard of experimenters, and we would all be subject to the whims of the Post Office, which has consistently introduced regulations which are not merely repressive, but a reflection on the technical staff of this Government department, and also on the common-sense of the permanent officials in charge.

#### A Bad Record

This portion of the Bill must be opposed tooth and nail. It is no use for the Postmaster-General to say blandly that he will not introduce any oppressive regulations. In the past his permanent officials have not only introduced the harshest regulations, but have illegally refused licences to applicants with the highest qualifications and the fullest recommendations of technical bodies. What chance is there for the movement if these absurd regulations acquire the full force of law?

#### The Right of Search

Turning to another important section of the Bill, we see that the right of search is introduced into the Bill, and the Postmaster-General again blandly states that this is no new thing, because he has always had the right to do this. In considering this clause we have to regard the original Act of 1904 and the times when it was drafted. In those days wireless was regarded as a thing weird and wonderful and highly dangerous, and capable of great mischief to the country. It was regarded in those days as almost entirely a military weapon, and the same general secrecy and mystery surrounded it as in the case of some new armament. It was also realised that it would form a method of communication which would rival the Post Office telegraph monopoly, and conse-

quently it was vital, in the opinion of the Post Office, that this department should have full right of intervening where it was thought that someone was defrauding the revenue by the sending of messages by wireless telegraphy. In these circumstances it was considered desirable that the right of search should be a privilege of the Post Office, and we still think that where the Post Office has *prima facie* evidence of wireless communication being carried on in a manner calculated to defraud the telegraph system, the Post Office should have this right of entry.

#### A Ludicrous Suggestion

The idea, however, of introducing a measure at this date, giving the Post Office the right of entry of a broadcast listener's house, would be ludicrous if it were not so serious a matter. If the Bill is passed, it simply means that the Postmaster-General can send one of his officials to your district, obtain a search warrant from a magistrate by merely supplying some evidence that a wireless station or wireless apparatus is being used (e.g., an aerial would constitute such evidence, undoubtedly), enter your house and search it. Such a drastic remedy was never intended by the original Act of 1904, and at this date no such regulations should be permitted. If the Postmaster-General wishes to have certain powers where illegal transmission of messages is carried on, e.g., in the case of spies or where the inland telegraph or telephone system is being competed with, let him say so openly.

The fact of the matter is, he does not want to do these things openly; he wants to have the power of entering the private homes of broadcast listeners and to use a drastic remedy which should only be most sparingly used to provide revenue for the B.B.C. and to increase his own bureaucratic control of experimental wireless.

#### P.M.G. and the B.B.C.

We have no hesitation in saying openly and plainly that the object of this right of search is to prevent evasion of the payment of the licence fees to the British Broadcasting Company. Not a word appears in the whole

Bill regarding the collection of money by the Post Office for private enterprise. Our own views on B.B.C. royalties are well known. We think the system is a good one and that the B.B.C. is entitled to a fair and reasonable remuneration. On the other hand, wireless people and the general public will not tolerate the invasion of private houses so that the Post Office can prosecute individuals for not paying their quota to the B.B.C.—for this is what a prosecution would amount to. The right of entry of a private dwelling house is a police power which is only exercised in the case of the most serious offences, and the idea of this power being handed over to a Government department for the purpose mentioned is intolerable.

**Ridiculous Penalties**

Not having a wireless licence is little more serious than not having a dog licence, and yet we are to be subject, perhaps, to a penalty of twelve months' hard labour, or a fine of £50, penalties which might be appropriate in the case of spies or fraudulent wireless transmitters, but which are outrageous when used as a bogey towards the wireless public generally, and especially the experimenter and broadcast listener.

We are, indeed, to be classed with felons, receivers of stolen goods, manipulators of secret stills! The farce of it!

The use of this dangerous weapon for the purpose of collecting dues to a private commercial monopoly is an astonishing proposal from a Conservative government. The invasion of private houses is a measure adopted in Russia, and may have certain merits. In this country it is not only unwanted, but unjustifiable, except in the most serious cases. Again, we repeat, if the Postmaster-General desires to cover only the most serious cases, let him state so definitely in the Bill, but we know perfectly well that he will not willingly restrict himself in this way.

If the Postmaster-General complains that he cannot tell whether people are infringing the Bill or not, we can only say that he must devise new methods of finding out defaulters. After all, the Inland Revenue is not permitted to examine banking accounts and private papers of the long-suffer-

ing taxpayer. They are in a far worse position than the Post Office as regards information, but it has never been thought desirable that extraordinary powers should be given to the tax collector. For exactly the same reason such powers should not be given to the Postmaster-General.

The delightful roping in of all users of etheric waves for the purpose of the sending or receiving of energy without the aid of any wire connecting the points from and at which the energy is sent, is a fitting end to the Bill. Of course, this is limited to wireless telegraphy, but the definition of these words is sufficiently broad for Admiral Jackson to suggest that it may be necessary to have a licence to use a telescope.

Every form of publicity must be invoked to oppose the Bill on

the points mentioned. The Radio Society, with Dr. Eccles as the moving spirit on this question, is doing a great deal, but can probably do a great deal more. We ourselves have been in the closest touch with the Radio Society on the whole question. We have consistently refused to be deceived by the assumed air of friendliness of the Post Office during periods when the Radio Society alternately crawled on its hands and knees to this Government department, and smothered the officials with honours and oleaginuous praise.

Fortunately, Dr. Eccles has, in spite of a survival of some of the old gang in various capacities, instilled backbone into the Council, and if a vigorous policy is proceeded with, many of the clauses to which objection has been raised will have to be dropped.

**Useful Double Connectors**

MANY constructors have no doubt felt the need of an aerial, earth, or 'phone connector which they can in-

tates continual changing of the type of connector used on the various loose leads. A connector which may be adapted to a universal purpose may easily be made and should prove of great convenience and a good time-saver.

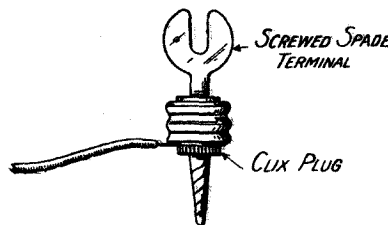

Fig. 1.—A combined Clix plug and spade connector.

stantly adapt to any form of receiver. Those who have more than one instrument may have found it advisable to mount upon the panel Clix sockets for such

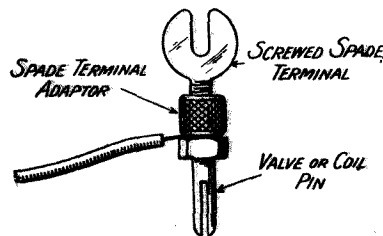
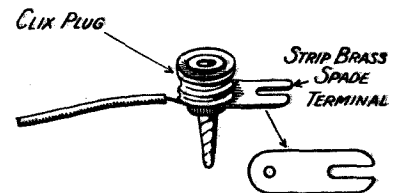
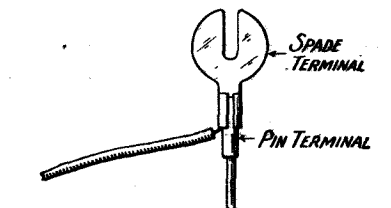

Fig. 2.—A spade terminal combined with a valve or coil pin.

connections, while on another panel they may have mounted pillar or telephone terminals. In the ordinary way this necessi-



Figs. 3 and 4 show other forms of combination connectors.

**Suggestions**

Four alternative suggestions are shown in the accompanying diagrams. Fig. 1 shows a combined Clix plug and spade terminal connector. The Clix plug may be used to plug into a Clix socket, or may be inserted into a telephone terminal. The other suggestions are obvious from the drawings.

# Are Reflex Circuits worth while?

By JOHN SCOTT-TAGGART, F.Inst.P., A.M.I.E.E., Editor.



Mr. John Scott-Taggart operating the latest form of the Three-Valve Dual Receiver.

Weekly. The question is, will this popularity continue?

### Criticism

One guide to the whole situation is the steadiness of the interest in this class of circuit. At first, much criticism was directed against the ST100, and innumerable failures were reported. Almost miraculously, however, these rapidly disappeared and gave place to a growing confidence and satisfaction. The interest has remained steady for a year and a half, which, in these progressive days, is an astonishingly long period for any particular circuit to retain its popularity. We have only to think of Flewelling circuits, and other super-regenerative receivers, to appreciate that, while they may create momentary enthusiasm, their life is an extremely short one. This applies to all sorts of unorthodox circuits, announced to the world as epoch-making or revolutionary.

**I**S the reflex circuit played out? Has this popular arrangement had its day, or will its development continue in the future?

sets have been made up from the articles which have appeared in *Modern Wireless* and *Wireless*

### Dual Circuits

These are the problems that are confronting many designers of receiving sets and also would-be constructors. The popularity of the reflex circuit dates from the summer of 1923, when certain modifications of the ten-year-old principle completely altered the ability of the general public to construct a fool-proof set which would give loud and clear signals with a minimum of valves.

### Popularity

Since that date there has been an extraordinary phase of popularity of dual circuits. Blue prints, etc., of the ST100, for example, have been sold to between 50,000 and 100,000 prospective builders of these sets. This represents the actual sales by Radio Press, Ltd., but no doubt a very large number of

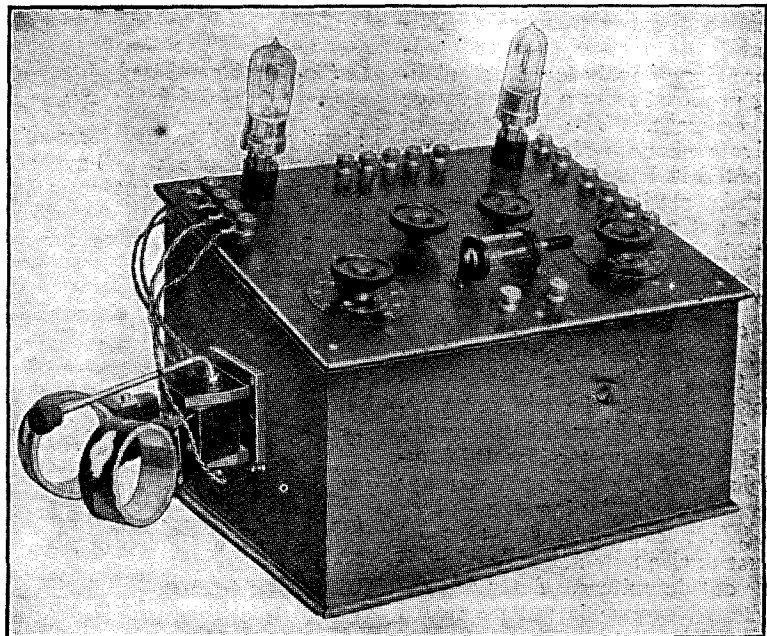

The ST100, which needs no introduction.

*A discussion by the Editor on a subject of great importance in connection with receiver design.*

#### Failure

Some circuits have died almost at birth, either because they were fundamentally weak or because they possess certain advantages which, to the broad wireless public, were not of the kind for which they looked. Selectivity at the expense of signal strength, purity at the expense of signal strength, ease of manipulation at the expense of signal strength, are qualities which are not appreciated by a public which chiefly regards results from the point of view of range and signal strength. This is a phase which may, and probably will, pass, but to achieve great popularity with an extremely wide public it is essential that the constructor should feel that he has made a bargain in making the set. He likes to feel that with his two-valve set he can get the same results as someone next door with a three- or four-valve set; hence the popularity of the reflex circuit.

#### A Prophecy

It may at first seem strange

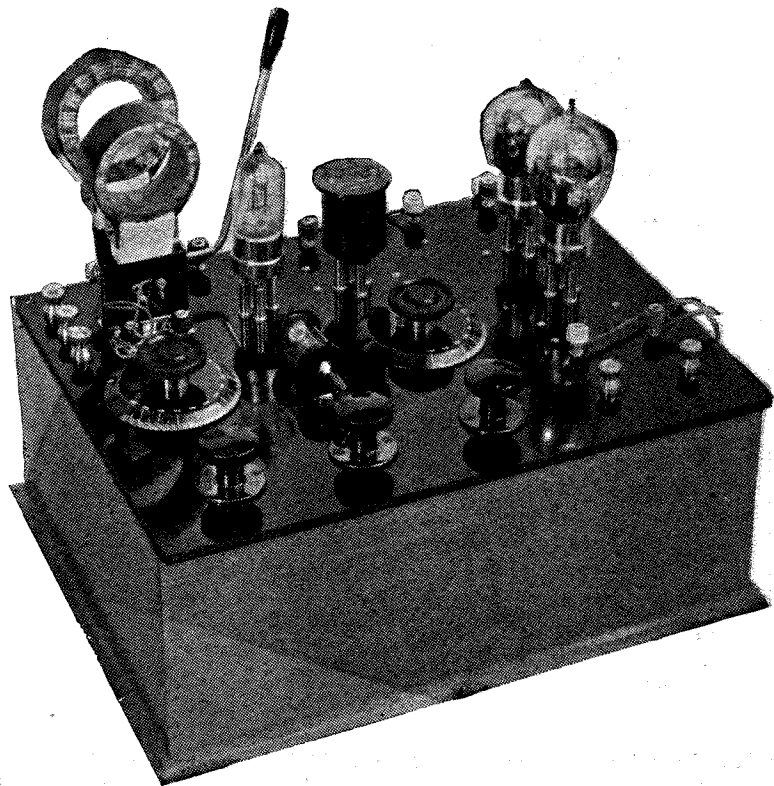

*The well-known Puriflex Receiver designed by Mr. Percy W. Harris.*

that I should raise any question as to the possibility of the fashion in reflex circuits changing. To some enthusiasts it may seem a fallacy to suggest, even, that a circuit of such wide popularity should go out of date. Nevertheless I can foresee a fairly slow, but yet a distinct,

tendency to depart from reflex circuits altogether. I think that the reduction in the price of valves and the development of the dull emitter will do more than anything else to oust the reflex circuit from popular favour. The crystal combination in a reflex circuit possesses many serious disadvantages, both from the point of view of reducing selectivity by increasing the damping of its associated oscillatory circuit and by its irregularity of action. Why, then, is the reflex circuit so popular? Simply because the great demand is for signal strength with a minimum number of valves. If, however, the cost of a valve is brought to a low value, and the running costs are also reduced by the employment of dull emitters (which, in my opinion, will be the only valves upon the market in a few years' time, provided certain technical difficulties as regards uniformity are surmounted), the general wireless public will hesitate before taking advantage of the economy of reflex circuits. Economy, in my opinion, is the one and only reason for the use of a reflex

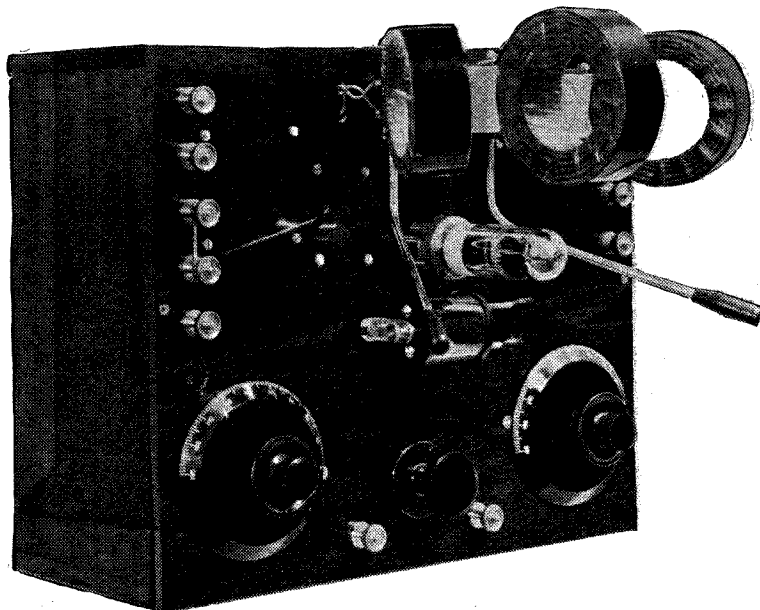

*Another of Mr. Harris' popular designs is the "Tri-cell."*

arrangement, and if, on the other side of the balance sheet, we have the advantage of cutting out the crystal, improving the selectivity and the range, and generally making the set more effective, then an extra valve will probably be cheerfully added.

on the whole, better to avoid reflex circuits altogether, if financial considerations permit. A straight circuit will give better results, in nine cases out of ten, than the same circuit condensed so as to use one less valve, the reflex principle being introduced.

I do not, of course, suggest that the reflex circuit will disappear. The man who has only one valve or two valves will find reflex circuits of great importance. Economy, in many such cases, is of primary importance, but as the time comes when the ratio of number of valves for signal strength is regarded as less important, and as valves become cheaper, I believe that the reflex type of circuit will be confined more and more to those whose facilities are limited.

**Economy in Valves**

For the vast army of those who at the present time want the maximum output with the minimum number of valves, the reflex circuit is not only not played out, but may even increase in vigour. In the case of the three-, four-, five- or six-valve enthusiasts, I give the heretical advice to leave duals alone.

**The Resistoflex Principle**

The position as regards commercial companies is rather different, and only very recently one of the largest companies in the country have produced a range of sets working on the Resistoflex principle. Even in such cases, however, when the public is properly educated and becomes experienced, the craving for economy is likely to give place to a desire for good results at a reasonably moderate price.

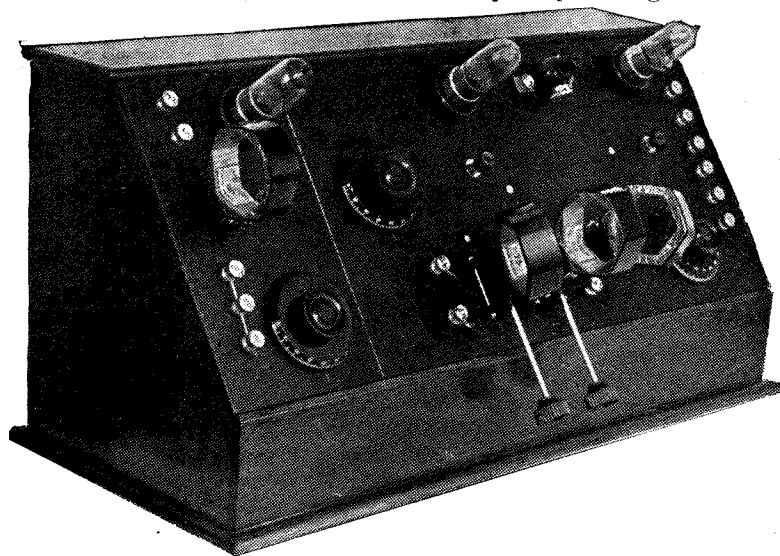

*The ST100 receiver with an extra stage of high-frequency amplification.*

**Valve Detection**

As regards those reflex circuits which do not use crystals, such as the twin-valve and three-valve dual, very careful design has been necessary before publishing details of these sets. They do not suffer from many of the advantages of the crystal receiver, but in any case these circuits only save a single valve.

Circuits have from time to time been published of multi-stage H.F. circuits with a reflex action. If there are two or more stages of high-frequency amplification, and two or more stages of low-frequency, working with the same valves, the difficulties of design are immensely increased, and distortion and buzzing is an extremely troublesome feature. I confess that my own experiments in this direction have been a failure, and although I have built a number using different kinds of circuits, the greed for economy has not been successfully assuaged. This brings us back, if my experience is shared by others, to the fact that normally only one valve will be the extent of the economy effected by the use of a reflex circuit.

**Straight Circuits**

I have come to the conclusion, I hope not prematurely, that it is,

**Reaction Control**

As regards long-range sets, the careful adjustment of reaction is often a vital factor, and this nearly always presents certain difficulties in a reflex set which, even if it embodies all the latest improvements, will tend to buzz under many conditions.

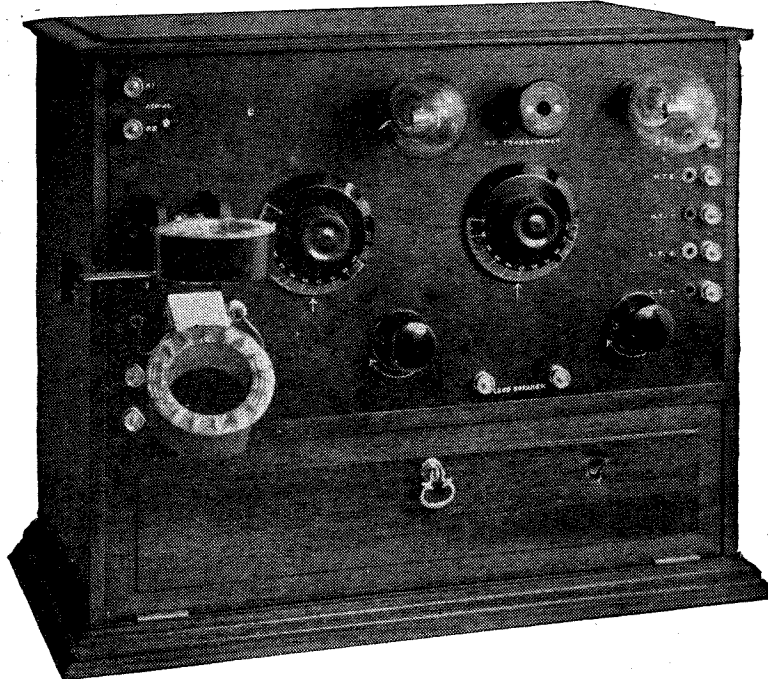

*Another popular reflex receiver is the "Twin Valve," also designed by Mr. Scott-Taggart.*





# JOTTINGS BY THE WAY By Wireless Wayfarer

## Good News

I WAS more delighted than I can tell you to see the recent reduction advertised in the prices of valves. I had been requiring a new stock for some time, but I failed signally to induce my friends to purchase freely enough to enable me to borrow as I would like. Now all is changed, and I have upon my shelves a beautiful outfit of anti-capacities, special high-frequency amplifiers, rectifiers which rectify to perfection, note "mags" which "mag" notes as they should, and power valves of the noblest kinds. Strictly speaking, none of them belongs to me. All have been sent in for me to test. Now



. . . I work 23½ hours a day . . .

testing, so far as I am concerned, is a very long business, for you cannot really see what a valve can do until you have tried it out thoroughly. If you do not know the testing tip, I will give it you free of charge. All that is necessary is for you to acquire something that looks like a milliammeter. It need not actually work so long as your friends believe that it does. Go round to the wireless club and talk a lot about valve curves. It is not usually difficult to convince your victim that unless he has proper curves for each of his valves he will never obtain the most efficient working of his set. "But how," he will ask at length, "can I obtain these curves?" You explain that you always take your own, and that, as a very

special case, you might oblige him by doing one or two on his account. The valves then come in—in fact, if you are possessed of a skilful tongue, it will positively rain valves, and you will have all you want.



. . . You will have all you want . . .

## Dealing with Impatience

You will probably find that your friends are disgustingly impatient. They will button-hole you every time they see you and ask when the curves are coming along. You explain that these things cannot be done in a moment. Of course, if they want rough-and-ready curves, well and good, they can have them in the morning. But if they want something really accurate and carefully taken they must be prepared to wait a bit. You can tell them, too, that you are so snowed under with the valves



. . . I wonder how my grandmamma would feel . . .

that have been sent to you for test, and though you are working twenty-three and a half hours a day, you simply cannot keep pace with the task. This kind of thing will usually serve to fob them off for quite a long time. If you come across a really nasty fellow—such a man I mean as Pod-

dleby, who insists upon having immediate results—then the only thing to do is to take a strong line. The best thing that I know in this case is to give him next day an emission curve for one of his valves. When the first curve has been made, graph another curve with a little more juice on the filament. The graph that you hand over should contain three satisfactory curves (you can get these by making a slightly altered copy of those supplied by the makers) at increasing filament voltages. There should also be a fourth which starts quite well but ends in an asterisk. At the bottom of the sheet you make a note: "At this point the



. . . Do not charge your accumulators from the gas bracket . . .

filament burnt out." If your tormentor demands the production of the corpse, pass him an old valve of the same kind with a filament that is no more. But beware of disgusting people of the type of Bumbleby Brown who, before handing a valve over to you, borrow a diamond ring from their better halves, and make a secret mark upon it. This scoundrel entrusted to me recently a valve which he had treated in this way. I spotted the mark at once, knowing my man, and reported to him "owing to the fact that the glass had been cut with a diamond the bulb of this valve gave out during tests." To substantiate my statement I returned to him a brass cap complete with pins.

**The Reason Why**

You may ask why I am so keen just now on accumulating a large reserve of valves. The reason, dear friends, is that I am constructing something particularly super in the way of super-heterodynes. When I say "I am constructing," I mean that I have done the drilling and the soldering and that kind of thing, but that I have not yet got the thing properly into its stride. When it supers it will not heterodyne, and when it heterodynes it declines flatly to super. I am sure that it is wonderfully sensitive, because it brings in every atmospheric within a radius of 10,000 miles; but, so far, I must confess, this is all that it has brought in. You will observe that I am quite frank with you.

**"My Super"**

As you do not live in Little Puddleton, it is unlikely that you will see or hear my super, and I could, and I would, spin you a glorious yarn about the marvellous reception that I have enjoyed of stations situated at the ends of the earth, but I much prefer to be truthful and to preserve my unblemished record as a straightforward recorder of facts that are facts. I would give you references to prove the nobility of my character if I felt that they were required, but I see from the advertisement columns of my daily papers that, owing to the splendid work of Mr. Savit Sage, references are quite out of fashion. You state your own terms, and that is that, I may mention, though, that I am not giving away free insurance policies.

**At It Again**

This brings me back somehow to the question of wireless poetry to which I referred at length last week. Untold myriads of readers have begged me by letter, postcard, wire and wireless to complete the verse beginning "Little blobs of solder." I hasten to comply. If you do not like it, all I can say is that you asked for it.

*Little blobs of solder,*

*Little dabs of flux,*

*Make for sound connections*

*That will not come unstux.*

How's that? I have received a contribution from one of the most soulful of our modern poets

—or, rather, I should say poetesses—which I feel bound to hand over to you. You will excuse the fact that it is surrounded by a border, and that the lines are not divided up. These things I am assured are essential to the beauty of the piece. Anyhow, here it is, and if you have any bricks to throw do not throw them at me.

crying "Ichabod!" and things like that, I rush round once more to the wireless shop in a vain search for something really good. What, I ask you, has happened to the high-tension battery of to-day? Why is it no longer as stout-hearted as was its fore-runner of yesteryear? Wherever I go among wireless folk I find strong men bursting into tears,

**My Wireless Set.**

I SIMPLY love my wireless set; I use it every night. I have not got a station yet, but that is quite all right. If wireless was a simple thing, as simple as could be, we'd all be bored like anything, both you and they and me. I know I ought to say "and I," but that would hardly fit. You see my prose must rhyme, that's why I twist my words a bit.

I wonder how my grandmamma would feel—there'd be deep sobs—if she could hear grand opera by simply turning knobs. Poor grannie, she is dead and gone and cannot hear my yells, when I turn all my valves full on and use all H.T. cells. I never wore a crinoline, or elastic-sided boots; but I've a Super Heterodyne that hoots and hoots and hoots.

HETERODYNE SWITCH.

**A Knotty Problem**

Speaking as we were not of aeriels brings to my mind the important question of high-tension batteries. At the present moment I am being rapidly ruined by the enormous outlay that is necessary upon these unimportant-looking parts of the wireless set. Probably you are suffering in the same way. What happens to me is roughly this: Being saluted during reception by repeated salvos of crackles, bangs, sizzles, fizzes, pops and scratchings, I apply the usual tests, and come to the conclusion that one more H.T. battery is rapidly approaching its end.

**Heavy Weapons**

Armed with good Fishers I sally forth to the wireless shop, telling them that the last battery was the most utterly disgusting that I have ever had, and demand something really good, offering to pay an enormous sum for it if necessary. They produce something. It looks all right. They guarantee it. I pay. I take it home. I wire it up. For a week, or even a month, all is well, and then the aforesaid noises break out anew. The volts are no longer there, and

and pouring into one another's ears the same tale of woe about B2. I rather suspect that if the truth were known there is a concerted movement amongst high-tension batteries to go on strike in order to mark their resentment of the affront which they received last year when, amidst a flourish of trumpets, they were abolished. Something will have to be done about it, though just what, I do not know. One solution of the difficulty is to install an accumulator outfit, and this I would do if I had electric light in the house, so that I could feed it when it became hungry. Unfortunately I have not, and I have found by experiment that it is of little use to attempt to charge accumulators by attaching them to the gas bracket. Apparently therms do not agree with them at all, which is a pity. "Surely," I hear you saying, "the combined brains of Professor Goop and Wayfarer should be able to devise some way out of the present high-tension difficulty." Thank you for those kind words. It is always a pleasure to find that one's abilities are recognised by some people, at any rate.

WIRELESS WAYFARER.

# Radio Notes and News ::

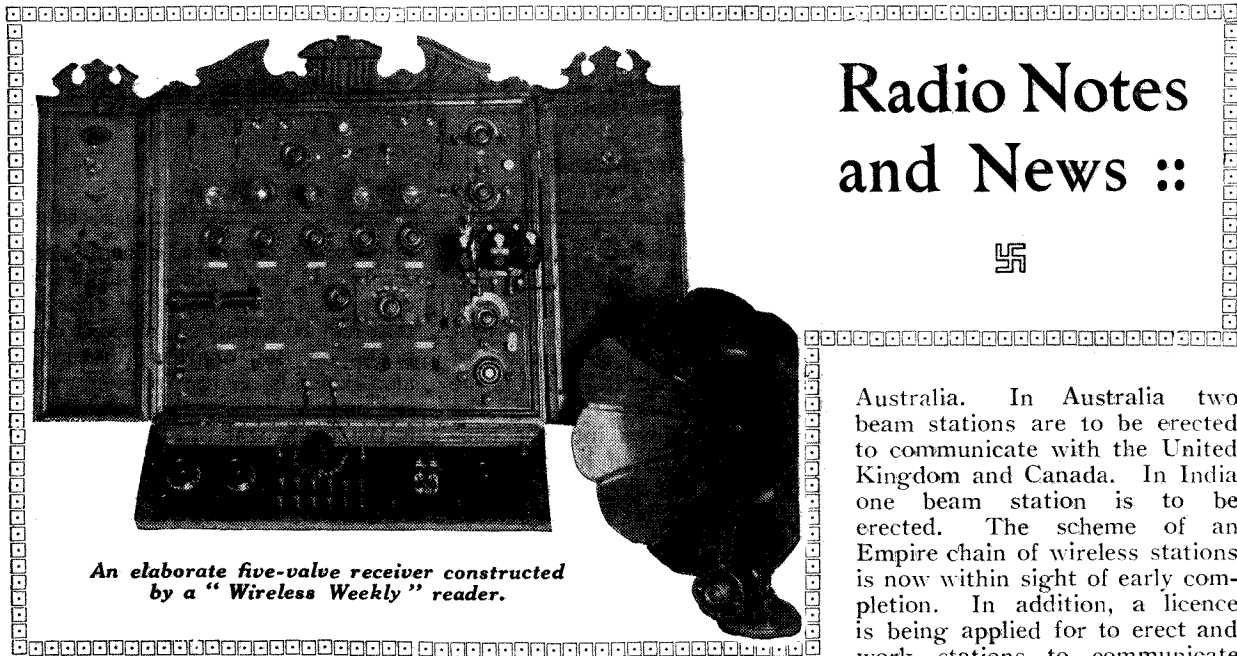

An elaborate five-valve receiver constructed by a "Wireless Weekly" reader.

Australia. In Australia two beam stations are to be erected to communicate with the United Kingdom and Canada. In India one beam station is to be erected. The scheme of an Empire chain of wireless stations is now within sight of early completion. In addition, a licence is being applied for to erect and work stations to communicate with the Continent and foreign countries outside Europe, and the main objective of the company, the establishment of a world-wide network of wireless telegraph service, is likely to be achieved.

**A NEW BOOK FOR  
THE CONSTRUCTOR**

The latest Radio Press constructional book has just been published under the title, *Six Simple Sets* (R.P. Series, No. 21), at the popular price of 1s. 6d. (post free 1s. 8d.), and is already achieving a remarkably large sale. The author is Stanley G. Rattee, M.I.R.E., Staff Editor, so many of whose popular designs have appeared in this journal and won wide approval among its readers.

The book represents a complete course in set construction, passing in its six chapters from a crystal set through one, two and three-valve receivers to a handsome four-valve instrument, and is therefore specially suited to the needs of the beginner. All the receivers bear the mark of skilful design, their simplicity to build and operate being achieved without any sacrifice of the desirable qualities of sensitivity and good appearance. Some of the designs have already appeared in *Wireless Weekly*, while others have never before been published. No one should miss this book.

**T**HE Basra port authorities have arranged for Marconi wireless telephone installations of the YB type to be fitted on their dredgers *Liger* and *Tiger*, and also for a shore station with similar equipment. A wireless bell will be included in the installation, thus obviating the necessity for maintaining a continuous watch. This equipment will enable any of the stations to call the others with the facility of an ordinary telephone. The transmitter has a power of 100 watts, and the range for telephony, depending on local conditions, varies from 35 to 80 miles. The telegraphy radius is from 100 to 200 miles.

Similar Marconi installations which have been in service for some time in various British lightships, and dock and harbour authorities' buildings, have demonstrated the economy and convenience of being able to effect instant communication with either ship or shore stations.

Another group of Trinity House light vessels and a shore station at Cromer are also to be equipped with Marconi telephone sets of the YD type, which has a power of 200 watts. This is the third group of light vessels to be equipped with wireless telephone apparatus for Trinity House by the Marconi Co. The aerial of the Cromer shore station will be supported by two towers, each 70 feet in height.

The Directors of Brown

Brothers, Limited, regret to announce that the sudden death occurred on Saturday, February 14, of their colleague, Mr. J. S. Brown, who was one of the original Managing Directors of Brown Brothers, Limited.

Mr. J. S. Brown retired from active work over five years ago, but continued to take an interest in the affairs of the Company as an ordinary Director.

\* \* \*

The annual report of Marconi's Wireless Telegraph Company, Ltd., states that the directors are confident that the future development of long-distance wireless telegraphy will be mainly along the lines of Senator Marconi's directional short-wave system. Recent tests with Sydney have shown that continuous communication throughout day and night with Australia can be secured. Agreements have been arrived at with the British Government and with the Governments of India, Australia, Canada, and South Africa for the installation and operation of the "beam" system of wireless telegraphy. Sites for the stations in this country to communicate with Canada and South Africa have been selected at Bodmin and Bridgwater. Suitable sites are being selected for communication with India and Australia. The Canadian Marconi Co. is erecting two stations to communicate with Great Britain and

# Analysis of Condenser Resistance

By SYLVAN HARRIS.

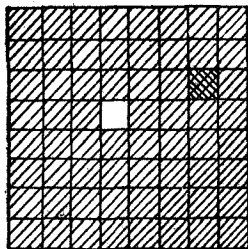

Fig. 1.—The equality of the currents in each filamentary conductor is indicated by the equal shading in the small squares.

THE different factors entering into the resistance of a condenser are as follows:—

- (1) Dielectric absorption (also known as dielectric hysteresis).
- (2) Ohmic resistance of the plates and the skin-effect in them.
- (3) Surface leakage (leakage of current across the surface of the dielectric).
- (4) Volume leakage (leakage through the body of the dielectric).
- (5) Resistance of surfaces in contact and soldered joints.
- (6) Eddy-currents in metal end-plates and metallic structure.

These points will be considered in detail one by one, explaining the nature of each, and indicating the relative magnitude of the effects as determining the value of the total resistance of the condenser.

## Dielectric Absorption

Although dielectric absorption is not very important in variable air condensers, it is of relatively more importance in condensers containing solid dielectrics of insulating material. If a condenser with solid dielectric be repeatedly charged and discharged, the dielectric will be found to become warm, indicating a transformation of some of the energy into heat. The amount of heat generated is greater than the amount that can be accounted for by ordinary resistance losses, and this excess of heat is ascribed to the dielectric absorption of the condenser.

If a series circuit containing a condenser with a solid dielectric, and a source of voltage, be closed, a sudden rush of current will take place at the instant of closing of the circuit. This is the charging current; that is, the current that flows into the condenser by virtue of its capacity, and is given by the relation:  $Q = CV$  in which  $Q$  is the quantity of electricity in coulombs (or ampere-seconds),  $C$  is the capacity of the condenser in farads, and  $V$  is the voltage in volts. The duration of this charging current is an exceedingly short period of time, perhaps a hundred-thousandth of a second.

## Absorption Current

However, in many cases it will be found that a current continues to flow for a long time after the circuit has been closed. The value of this current bears no simple relation to the capacity and voltage, and seems to depend entirely upon the nature of the dielectric used in the condenser. This is the absorption current. Attempts have been made to account for it by assuming that the substance of the dielectric is not a homogeneous mass, and that there are tiny capacity effects between various points in it which gradually charge up, thus continuing the current flow.

## Loss of Power

Obviously this represents a loss of power, since it takes energy to charge these tiny condensers, and they are not located at positions where they will do any good. In order to account for this absorption in measurements, dielectric absorption is spoken of as an *equivalent resistance* in series with the condenser, or at least its effect can be measured as if it were a series resistance.

It is evident that the quantity of electricity which flows into an absorbing condenser is greater if the charging period is greater. Some poor condensers have been known to absorb a continually decreasing charge for several days, on a direct current charge. With

alternating currents, charge and discharge take place in every cycle, and the amount of charge that can be absorbed, since it depends on the charging period, also depends on the frequency of the current, since the frequency is the reciprocal of the period. The higher the frequency the shorter the charging period, hence the smaller the absorbed charge.

## Ohmic Resistance of the Plates and Skin-effect

There is no reason for anyone to doubt that the plates of condensers have ordinary resistance the same as any other conductor of electricity. If a condenser could carry direct current, this resistance could be measured simply by Ohm's law; that is, by passing a direct current through it and measuring the current and voltage. The resistance would then be  $R = V/I$ . This cannot be measured directly, however, since condensers will not pass direct currents. That the effect is present no one will object to. Bearing this thought in mind, we will discuss the nature of skin-effect in conductors, show how this applies to condenser plates, and, later on, show how great this effect is on the resistance of the condenser.

The ordinary resistance of a conductor may be calculated by the formula:  $r = \rho \frac{l}{a}$  when the path of the current flow is known. Moreover, the distribution of current throughout the conductor must be uniform; that is, every square inch or square centimetre of the cross-section of the conductor must carry the same amount of current. In this formula ( $r$ ) is the resistance of the conductor, ( $\rho$ ) its resistivity or specific resistance, ( $l$ ) its length, and ( $a$ ) its cross-sectional area at right angles to the direction of flow of the current.

## Uneven Distribution

If, however, the distribution of current throughout the conductor is *not uniform*, these simple relations do not hold. This can

This article on the subject of losses in condensers from the pen of an American contributor makes interesting reading in view of the opinions expressed by Mr. Coursey in our last issue. The views expressed, which are not necessarily our own, should be compared with those previously given.

easily be understood from the following discussion. Imagine that a cross-section of conductor, supposed square, is divided into elements of area, and that each elementary conductor has the same resistance and carries the same fraction of the total current (Fig. 1). The equality of the currents in each elementary conductor is indicated by the equal shading in the small squares of the figure.

#### Heat Generated

Now imagine that the current in one of the filaments is removed and added to the current in another. The total current in the entire conductor is not altered, but the heat generated in the first-named filament becomes zero, for it now carries no current, and that generated in the second filament becomes four times as great. This because the heat generated is proportional to the square of the current. Accordingly the total heat generation is increased, although the total current was not altered. From this it can be seen that any distribution of current in a conductor that is not symmetrical results in a resistance higher than that for a uniformly distributed current.

#### Distribution of Current

The next thing to be considered is, what is it that causes asymmetrical current distribution in a conductor? It occurs only under the action of alternating currents, and only becomes appreciable when the frequency of the current becomes very high, more particularly in the radio frequencies. The current is forced from the centre of the conductor and is made to travel near and on the surface. In round wires of ordinary diameter at radio frequencies, the current may penetrate into the body of the conductor only as deep as, say, 0.001 mm.

#### Magnetic Field

The reason for it is found in the variations of the magnetic

field set up by the high-frequency current flowing in the conductor. The interior parts of the wire are linked by more lines of magnetic flux than are the parts nearer the surface of the wire. Hence, the self-induced voltages near the centre of the wire are greater than those near the surface, and are in a direction opposed to the direction of flow of the current. For this reason the current receives greater opposition near the centre. As a result it creeps towards the surface of the conductor.

#### Ohmic Resistance

Resistance, as defined above, for the uniformly distributed current, is known as the ohmic resistance, which depends only on the nature of the conductor and its dimensions. The effective resistance of a conductor, however, may be very different from this value, since it depends on the amount of heat generated in the conductor. It follows, then, that the effective resistance of a conductor "suffering" from skin-effect may be many times the ohmic resistance, and such is the case. The magnitude of the skin-effect is spoken of as the ratio of the effective resistance at high frequency to the ohmic resistance (at zero frequency), or in symbols,  $R/R_0$ .

#### Skin Effect

The magnitude of this effect depends mostly on the dimensions of the conductor. Small wires have less skin-effect than large ones, although in the latter the ohmic resistance is considerably less. Skin-effect also exists to a marked degree in flat conductors, such as strips or tapes. There is no doubt that it also exists in condenser plates. Moreover, the effect should be greater in condensers which use the thicker plates. The magnitude of this effect will be discussed later on in this article.

#### Surface Leakage

Any condition of the surface of

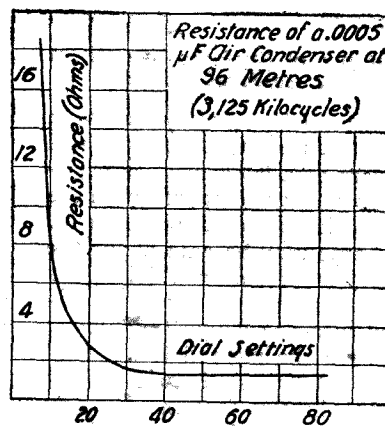

Fig. 2.—Graph showing the change in the resistance of a variable condenser with a change in dial setting.

the dielectric used in condensers which permits a leakage of current from one set of plates to the other also introduces losses which may be considered as representing an addition to the resistance of the condenser. The surface leakage in well-made condensers is not very large; in fact, it is so small that it may be neglected.

#### Insulation Resistance

The insulation resistance of a well-made condenser may be as high as several thousand megohms, and under the small voltages used in radio tuning circuits (a microvolt or two), it is obvious that no appreciable leakage will occur. The leakage, of course, depends also upon the hygroscopic nature of the material, that is, upon its ability to absorb moisture from the atmosphere or from other sources. Slight absorption of moisture will affect the surface resistivity considerably, but under ordinary conditions the effect of surface leakage on the resistance of the condenser will be negligible.

#### Volume Leakage

Volume leakage represents the leakage of current through the body of the dielectric. Little need be said concerning this, as the remarks made above in connection with surface leakage apply equally well to volume leakage. It may be added for the benefit of some experimenters that temperature also has an effect on these qualities, but it likewise has a negligible effect

on the resistance of a well-made condenser.

**Resistance of Surfaces in Contact and Soldered Joints**

The resistance of surfaces in contact, as between plates and washers of a condenser, is negligibly small, as compared with the total resistance of the condenser. The same may be said about the resistance of soldered joints, as in condensers with plates soldered into the supporting posts, or where the pig-tail is soldered to the rotating shaft. It is difficult to conceive that these resistances are even large enough to measure, so it can hardly be expected that they would contribute appreciably to the resistance of a condenser. There is one place, however, where appreciable resistance may be encountered, and that is at wiping contacts in condensers which do not have pig-tails. The resistance of this joint is extremely variable, depending upon the nature of the surfaces in contact, and the condition of these surfaces with regard to moisture, grease, etc. Under any conditions a pig-tail is a worthy addition to a condenser.

**Pig-tail Connections**

It has been thought by some that a pig-tail raises the effective resistance of a condenser because of its inductance. This is not so. A pig-tail in a condenser adds no more resistance than its own resistance, which undoubtedly is exceedingly small and in nearly all cases can be neglected.

Theoretically, the capacity of a condenser changes by reason of an inductance, such as would be furnished by a pig-tail, in series with the condenser. But how much it changes is another question. The effect can be easily calculated with the following results:—If we consider a 0.001  $\mu$ F condenser and assume the inductance of the pig-tail to be about 0.01 microhenry, which is ridiculously large, the capacity at 1,000,000 cycles will change only 0.4  $\mu\mu$ F. It is easily understood that in radio tuning circuits this is negligibly small.

**Measuring the Resistance of Condensers**

Now as to the actual resistance of condensers and a word as to methods of measuring their resistances. Numerous variations

of several methods have generally been used up to date, but investigation has disclosed the fact that few, if any, of these methods gave reliable results. It is interesting to note that many experimenters who have used these methods, and who have published results of measurements made by these methods, have never thought to check up the accuracy of their measurements by the simple process of measuring a known resistance. In other words, first measure the resistance of a condenser at the desired wavelength or frequency, and then measure the resistance of the same condenser (at the

denser to be measured or a standard condenser. The resistance of the standard condenser, specially constructed for the purpose, has often been supposed small enough to neglect; in other words, to call zero. The error encountered by this assumption is greater than is generally supposed. Common sense tells us that no piece of electrical apparatus can be constructed to have zero resistance. Furthermore, as will be shown later, there are other resistances in condensers besides dielectric absorption, which is all that the experimenters attempted to avoid in constructing these standard con-

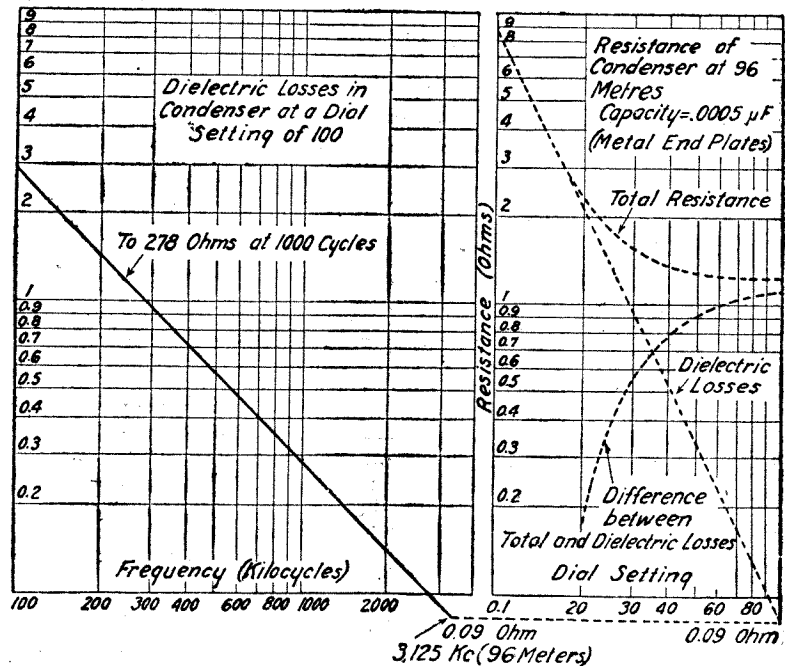

Fig. 3.—A curve plotted on logarithmic co-ordinates showing the resistance and dielectric losses in a variable condenser at different settings.

same dial setting) in series with a short piece of No. 32 (or smaller) manganin wire. The difference between these two measurements, if the method used is correct and accurate, will be the resistance of the wire, which can be checked by an ordinary D.C. measurement on a Wheatstone bridge. This check is subject to several variations, according to the whims of the experimenter.

**H.F. Methods**

Most of the methods used, at high frequencies, give the total resistance of a measuring circuit which includes a coil of relatively high resistance, and the con-

densers. The objection might be raised that the Bureau of Standards has gone to great lengths to construct special condensers with quartz or pyrex insulation. This is done because these condensers are often used in making measurements at low frequencies, under which conditions dielectric absorption is a serious matter.

**Inaccuracy**

A few methods of making the measurements directly at the high frequencies have been used by many experimenters, but even in cases where no standard condensers were used whose resistance was assumed to be zero,

great inaccuracy resulted from the fact that the total resistance of the measuring circuit was not low enough. This may be explained in simpler words as follows: In all these methods the result obtained is the total resistance of the measuring circuit, including the condenser being measured. After obtaining this, the resistance of the circuit excluding the condenser resistance, must be subtracted, leaving the condenser resistance. Thus, if the measurements show the total resistance of the measuring circuit to be, say, 1.5 ohms, and the resistance of the same circuit excluding the condenser is, say, 1 ohm, the condenser resistance will be

$$1.5 - 1.0 = 0.5 \text{ ohm.}$$

Now, if an inaccuracy of one-tenth of an ohm is made in the determination of the total resistance (1.5), this would represent a precision of

$$\frac{0.1}{1.5} \times 100 = 7 \text{ per cent. (roughly)}$$

An error in the value of the condenser resistance (0.5) of 0.1 ohm would mean a very much lower precision, viz.,

$$\frac{0.1}{0.5} \times 100 = 20 \text{ per cent.}$$

Thus, an error of 7 per cent. in making the measurements would mean an actual error in the resistance of the condenser of 20 per cent. which is rather large. It is, therefore, necessary to keep the resistance of the measuring circuit as low as the resistance to be measured (the condenser), and everyone is acquainted with the difficulty of building inductances, which must be used in the measurement, whose resistance is very low and at the same time accurately known.

#### An American Method

As a result of the objections to the prevailing methods of making measurements of condenser resistance, the writer, in conjunction with Mr. Chas. N. Weyl, of Philadelphia, devised a method\* in which the inaccuracies of the other methods are reduced to negligible quantities. The method of checking the accuracy explained above was applied, indicating that the measurements could be regarded as correct to within 0.01 ohm. The measurements were made directly at radio frequencies, without the use of any standard condenser or any

assumptions that could not be justified experimentally.

Measurements of condenser resistance at low frequencies, such as 1,000 cycles, are of little value in radio. If all the resistance of a condenser were attributed to dielectric absorption, then measurements at 1,000 cycles could be used to calculate the resistance at 1,000,000 cycles, for the resistance due to absorption decreases in the same proportion as the frequency increases. However, since the skin-effect is negligible at 1,000 cycles, and increases very rapidly as the frequency increases, it follows that the total condenser resistance would bear no such simple relation to the frequency. Resistances at radio frequencies computed by assuming an exact proportion between resistance and frequency give ridiculously low resistances for the condenser as will be seen from the following.

#### An Example

The resistance of a condenser was measured at 1,000 cycles and found to be 278 ohms. Now, assuming the direct proportion explained in the preceding paragraph, the resistance due to dielectric effects would be at 1,000,000 cycles

$$\frac{1,000}{1,000,000} \times 278 = 0.278$$

or approximately 0.3 ohm.

The resistance of this condenser, when measured at 1,000,000 cycles by the new method, was found to be 0.8 ohm. The difference between the two, or a half ohm, is due to the skin-effect in the plates. In other words, in this particular condenser, over 60 per cent. of the total resistance is due to skin-effect, while less than 40 per cent. is due to dielectric losses. We are, of course, neglecting the other small items listed above, which have been stated to be negligible. It is hardly likely that the resistances of surfaces in contact, soldered joints, surface and volume leakage can be more than about 0.01 ohm, which is the precision of the measurement.

The magnitude of the skin-effect was found to be even greater than this in some condensers. This gives rise to the following interesting thought. Since most condensers have about the same size and shape plates, and are made of materials differ-

ing very little in ohmic resistance, and the greater part of the resistance is due to skin-effect, it follows that the resistances of nearly all the condensers on the market cannot vary very much. Experiment has shown this to be so. The majority of the condensers, including both the low-loss and the old style types, had resistances slightly less than one ohm.

#### Thin Plates

Casual inspection of some of the condensers also supports this view of the subject. Some condensers of the old style type which had comparatively low resistances, were found to have thin plates. Other condensers of the low-loss type whose resistances were comparatively high, were found to have thicker plates. This point may be of interest to designers of condensers, but the writer wishes to remind them that the evidence pointing toward this is not conclusive. Further experimentation along these lines is suggested. The idea, however, is consistent with the known fact that the skin-effect in flat conductors having their large surfaces adjacent increases rapidly as the thickness of the conductors is increased.

#### Large Condensers

Larger condensers have lower resistances than smaller condensers. Moreover, the resistance of a condenser remains low and nearly constant with the dial setting, until a setting of about 25 or 20 on the dial is reached, at which point the resistance begins to increase very rapidly. At five or ten on the dial, it may be as high as 20 ohms, even in a condenser of the low-loss type (see Fig. 2). This is very serious, and it follows that condensers should not be used at low dial settings. The inductance coils in the tuning circuits should be so designed that the wavelength range can be covered without using the condenser at its bottom end. This will necessitate a slightly larger condenser, and a slightly smaller coil, but the increase in efficiency will be considerably increased, since we are not only using the condenser at positions of low resistance, but a smaller coil has likewise much lower resistance than a large one.

(To be concluded.)

\* See Proc. I.R.E., Vol. 13, No. 1, 1925.

# Random Technicalities

By *PERCY W. HARRIS, M.I.R.E.*  
Assistant Editor.

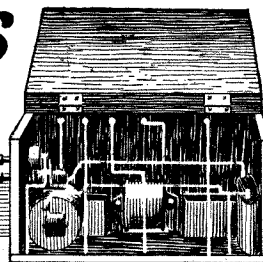
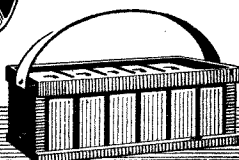

**T**HE latest reports from the United States indicate that there is a tendency towards using accumulators and home-battery chargers for the supply of low-tension current to sets in the place of dry cells which have proved such an unsatisfactory substitute. I am glad to hear of this, as I am sure that in this country it is time manufacturers ceased to talk glibly about how easily sets can be run from dry batteries only when dull-emitter valves are used. It is true that with the .06 ampere type of dull emitter the current required is extremely small, but this very fact makes it unfair to talk about dry cells replacing "large, hefty accumulators." A low-consumption valve requires only a small accumulator to run it satisfactorily, whereas the dullest of dull emitters requires quite a big dry cell to give a satisfactory discharge rate. To run a single

.06 amp. valve satisfactorily requires three dry cells, each at least as large as the round cell with which we are familiar in connection with bell ringing. Then, again, it is not made sufficiently clear to the purchaser that the cost of the dry cell is no mean item in his annual expenditure. I have just been looking over a list of dry batteries recommended by one of the leading makers for filament lighting of dull-emitter valves. The size of cells recommended for one or two .06 amp. valves costs 9s., while for two or more valves not exceeding .3 of an ampere in all the cell recommended (by cell here I really mean a combination of three cells to give the correct voltage) costs £1.

\* \* \*

Now contrast this with the small accumulator which gives adequate current in working conditions. To run this particular

type of valve you require two 2-volt units. One well-known maker sells a special dull-emitter accumulator which costs 5s. per cell; thus the cost would be 10s. for the two. It will supply three .06 amp. valves for fifty or sixty hours' continuous running without a recharge. Another maker supplies an unspillable cell no bigger than the ordinary electric bell-ringing dry battery for 12s., so that two of these cost 24s. You can easily slip them into an attaché case next time you are passing the accumulator charging station, while, if you live in a country district, you can send them by carrier to the nearest town without any fear of the acid being spilled.

Now that good small accumulators are available for dull-emitter work, it is definitely cheaper to use accumulators, for the cost of the charge is negligible compared with the cost of

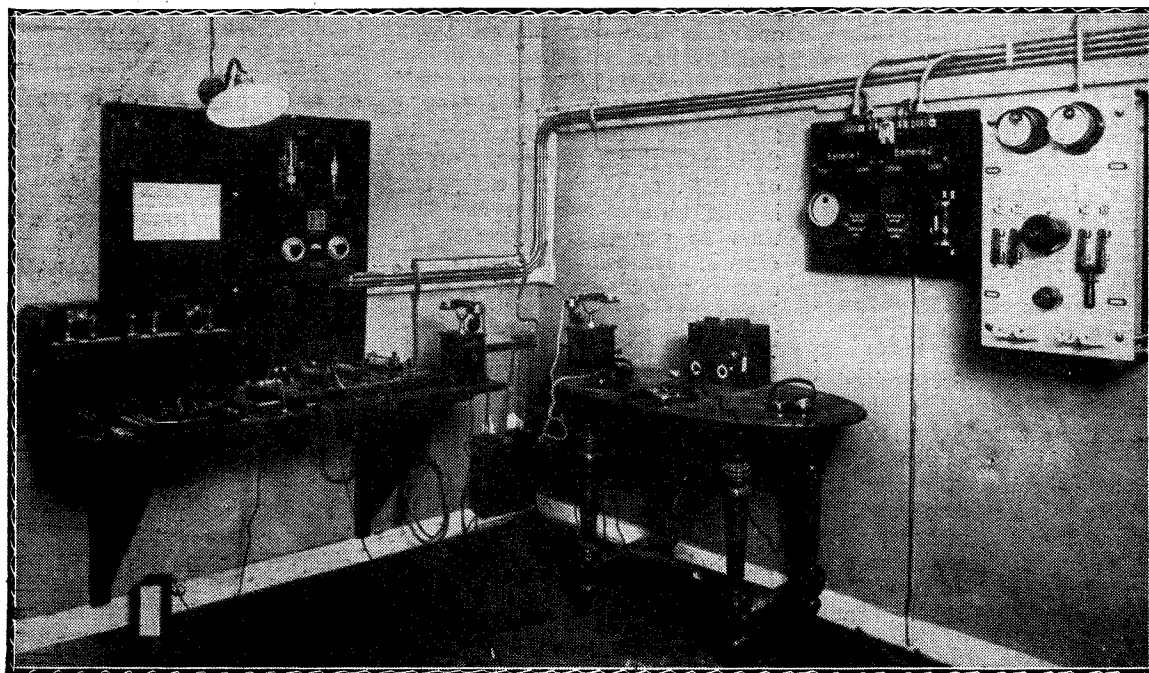

*Our photograph shows the control room at the Hamburg station.*



new dry cells, and the dry cells when discharged cannot be recovered or recharged in any fashion.

Personally I consider one of the great disadvantages in using dry cells to light the valve filaments is that the voltage steadily drops and the filament resistances have to be readjusted from time to time to make up for this drop. Unfortunately, however, an adjustment which is good last thing at night will be inaccurate for the following evening, as during the night and day time the voltage will have recovered somewhat. Accumulators, on the other hand, preserve a steady voltage until they are practically discharged, when they have a fairly rapid drop which gives the necessary warning.

\* \* \*

Speaking of accumulators reminds me that the same old way of rating wireless accumulators by the ignition rating instead of the continuous discharge rating still persists. Only the other day I passed a shop which showed in its window an accumulator plainly labelled by the makers "Radio Battery." The rating of this battery was given as 20 ampere hours (intermittent). Its proper rating for wireless purposes is, of course, 10 hours, and the makers know that as well as I do. It is therefore something in the nature of a fraud on the public to sell them specifically for wireless purposes a battery which has only half the capacity marked upon it. Where a battery is primarily designed for motor-car work, then, of course, the makers are fully justified in marking the motor-car ignition rating; but, even then, the more usual practice is to mark at the same time the actual capacity for continuous running.

\* \* \*

Lately there has been a perfect epidemic of low-frequency transformer breakdowns, and practically all of the leading makes have had more than the usual small percentage of instruments returned. The very fine wire used in intervalve transformers is derived, to the best of my knowledge, entirely from the Continent, and apparently some recent batches have been of poorer quality than usual.

The Balkite battery charger which I recently mentioned in these columns has now been running day and night for several weeks, charging my own accumulators. Any battery charger that finds its way to my house has to give up all hopes of working trade union hours. The Balkite is perfectly silent in use, and is very efficient when considered from the point of view of running costs, and is delightfully simple to handle. In fact, but for two minor criticisms, I should be inclined to call it the ideal battery charger. My first criticism is that it is a very thirsty young animal. It is sent out dry, and has to be filled with accumulator acid to within half-an-inch of the top. According to the instructions sent out by the makers, losses by evaporation should be made up by a "topping" every two or three weeks with distilled water. Actually, if it is given at all regular use (such as charging an accumulator every three or four days), the level of the electrolyte falls quite rapidly, and I think the instructions would be more useful if framed in such a way as to indi-

cate that topping up is required after, say, every other charge. Of course, this topping up is no trouble provided the user keeps by him a bottle of distilled water, which is readily obtainable from any chemist.

\* \* \*

The second criticism relates to the instructions issued with it to put two tablespoonfuls of Nujol on the top of the electrolyte when you first fill the charger. My own experience when doing this was that, after a few minutes' working, the electrolyte started to froth up and bubble, and the froth (a horrible, oily, dirty, sticky mess) exuded through the vent-plug on to the top of the container. I syphoned off this oil, and found that without it the instrument was perfectly clean and satisfactory to use. The British agents now tell me that they have decided the oil is unnecessary, and I think they are wise. In any case, the fact that there are no expensive replacements, and the perfect silence of working, more than outweigh the disadvantage of having to top up fairly frequently with distilled water.

## L.F. Transformer Housing

**G**OOD low-frequency transformers are expensive instruments, and when they are likely to be subjected to con-

ups" and board lay-outs, it is a good plan to provide safe housing for them in order to prevent mechanical damage (and, incidentally, much chagrin). Apart from this matter, good, large terminals are the exception rather than the rule on L.F. transformers, so that a containing box built on similar lines to that illustrated should appeal to many experimenters who require to effect quick changing of connections. The accompanying photograph shows a box which has now been in use for some time as the container of an early type of Igranite shrouded transformer. The connections from the transformer terminals to the terminals on the insulating top panel are made before fixing the transformer in the box, the latter being effected by wedging in a piece of wood of suitable thickness. The more elaborate method of screwing down to the base occupies more time and patience, and is *not* more effective.

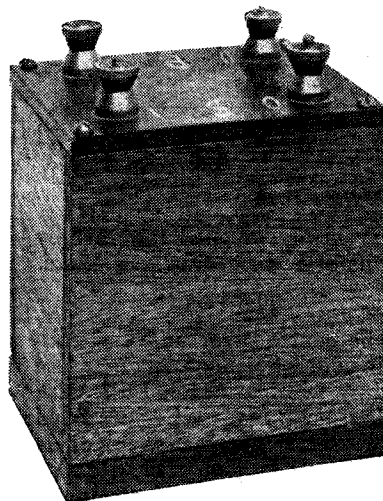

A photograph of the box referred to.

siderable handling and occasional accidental knocks, as, for instance, in experimental "hook-

C. E. L.

## A Change-over Switch for the Transmitter

By JOHN W. BARBER.



A photograph of the switch described.

HAVING spent a considerable amount of valuable time hunting among the débris of "disposals" stocks, and also in the stores and catalogues of many manufacturers and retailers, in the endeavour to obtain a change-over switch suitable for short-wave work, the present writer eventually abandoned the search as hopeless and decided to make a switch himself which would fulfil the requirements.

### Conditions

A change-over switch for use in the aerial circuit of an amateur transmitting station must fulfil certain conditions. Firstly, the switch must be of reasonable size, in order that capacity effects between the contacts may be as

In order to comply with these essentials, the switch shown in the photograph and drawing which accompany this article was made up very quickly, once the details had been decided upon, and has proved very useful in operation at my own station, 6DD.

### The Arm

The arm of the switch consists of a piece of strip copper (brass may be used if available) 6 in. long by  $\frac{3}{8}$  in. wide, and may be anything up to about  $\frac{1}{8}$  in. in thickness. In this case, the arm actually consists of two pieces of copper sweated together. This is easily accomplished by thoroughly tinning one side of each strip, and heating in a Bunsen flame, the two strips

the end of the bolt to prevent unscrewing. The ebonite base, which may be 10 in. long by 2 in. wide by  $\frac{1}{4}$  in. thick, is then drilled as shown in the drawing, the holes being countersunk on the under side, sufficiently deeply to permit the B.A. screws to lie below the surface of the ebonite. The holes for the terminals are tapped 4 B.A.

### Connections

Connection from the clips to the terminals is made by short brass strips, which may be about  $\frac{1}{4}$  in. wide, having suitable holes drilled therein for the terminal and bolt securing the clip to pass through.

In order to comply with the condition regarding accessibility of terminals, the shank of the terminal is screwed into the ebonite so as to not quite penetrate the latter, when a nut previously run on to the shank is screwed down tightly, thus giving good contact. The terminal heads are thus kept clear of the clips themselves, and while being quite easy to get at, are maintained in good contact with the arm.

The ends of the arm itself should be rounded off, and a standard ebonite knob is secured to the free end, as shown, by means of a short 2 B.A. bolt passed through a tapped hole in the arm.

### Operation

In operation, it is intended that the switch be screwed on to the top of the transmitter frame, the centre terminal being then joined to the aerial lead, while the outer clips are connected to transmitter and receiver respectively.

In a later issue I hope to describe a more elaborate switch, designed to change over the filament connections also, through "gradual" resistances.

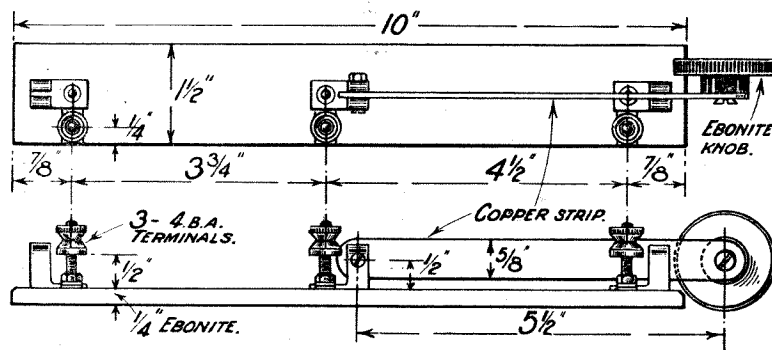

Constructional details of the switch.

far as possible minimised. The ordinary commercial form of single-pole double-throw switch is here ruled out, owing to the proximity of its contacts. Secondly, the arm of the switch must be of reasonable width, in order that there may be a good surface for contact with the end clips, and thirdly, there should be a fairly substantial knob or end-piece in order that a quick change-over may be effected, while terminals of adequate size and accessibility are a *sine qua non* of such a "gadget."

being firmly gripped together by means of two pairs of gas pliers.

### The Pivot

The centre pivot and end contacts consist of clips, such as are sold by L. McMichael, Ltd., with their "clip-in" type of fixed condenser. The centre pivot is drilled and tapped 4 or 6 B.A., as also is one end of the arm, about  $\frac{1}{4}$  in. from the edge. A suitable B.A. screw then holds the two firmly, while allowing easy swinging of the arm. A nut may, if desired, be placed on

# How to Plot Resonance Curves

By G. P. KENDALL, B.Sc.,  
Staff Editor.

A simple method of making direct comparisons between coils with the aid of the signal strength measurements recently described in these 4 pages.

IT is, as a rule, quite early in one's wireless experience that one realises that there are really considerable differences in selectivity between different makes of commercial plug-in coils. Since in these days most of us live in fairly close proximity to a broadcasting station, either main or relay, from that moment one begins to take a great interest in the performance of different coils, and also to wish that there were some easy method of deciding between different types.

### A Common Method

The method which most of us employ, of course, is the very simple one of tuning in a distant station with some coil which we may regard as a standard, after which we insert the coil regarding which we desire to form an opinion, re-tune and note the signal strength then produced, with the presence or absence of interference from our local source of trouble. Such a method, while capable of giving some sort of results, if sufficient care is taken, is, nevertheless, extremely apt to prove misleading, since every one who has tried it and observed the results really carefully will have noticed that it is most difficult to obtain anything like constant conditions in the set, and the mere change from one coil to another alters so many things, in addition to the change of tuning, that much time and patience are required to obtain a really fair idea of the relative merits of two coils.

### The Human Element

A mere change from one to the other is practically useless, if for no other reason than simply because most of us cannot retain the impression of a given audibility of signal for a sufficiently long time to enable us to compare our recollection of the previous

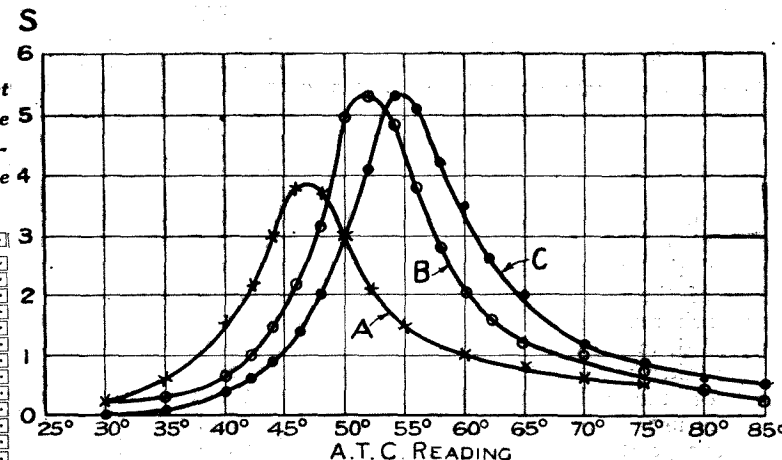

Three typical resonance curves. The discrepancies between certain of the points of the curves probably represent experimental errors.

strength with that which is being given at any particular moment.

### Reaction Difficulties

The reaction control is one of the principal difficulties, since it is quite possible that something like this may happen. Upon using a coil of poor quality, it will be found that when the set has been critically adjusted to the verge of self-oscillation, a certain signal strength is obtained, and a certain degree of selectivity. Now, upon replacing this coil with a much better one of lower high-frequency resistance, the set will at once oscillate and the reaction control will have to be re-adjusted. To do this, it will probably be necessary to make several successive adjustments of the reaction coil and the tuning, and by the time this has been done one's memory of the previous signal strength has become dulled, and, moreover, it is extremely unlikely that one will succeed in hitting exactly the same degree of reaction that existed in the former test.

### A Simple Method

A method whereby really comparative measurements can be made, eliminating as far as possible the personal element and such disturbing factors as reaction, is therefore most desirable. Such a method can be readily devised by the use of the simple signal strength measurements to which I have referred

in recent articles, and which, with due care, will enable one to obtain quite useful comparative results. One does not demand a high degree of accuracy in the method which is to be adopted for this type of measurement, since it is merely desired to compare one coil with another, and to decide which is the better from the point of view of selectivity. I have found the method in question to give extremely valuable results, provided that the necessary precautions are taken, and I think the following account of the exact method of procedure will be found useful by those who possess a suitable milliammeter for the repetition of the experiment under their own particular conditions.

### Obtaining Curves

The actual method is extremely simple, consisting in the recording of the signal strength reading of the milliammeter in the plate circuit of the Moullin circuit valve, upon condenser readings on either side of the exact reading for resonance with the local carrier wave. Upon either side of the correct tuning position signal strength will, of course, fall off, and if these readings are plotted against the dial reading expressed in degrees it will be found that a resonance curve results, from the shape of which useful information can be obtained.

### Constancy Essential

As a series of readings are required, these measurements are

somewhat more difficult to make than those involved when simply comparing the signal strength given by one coil with that of another, where only two measurements are involved, since in the case of the resonance curves a whole series of values must be read, perhaps from 12 to 16 in number, and during this time the signal strength must be maintained constant if a true result is to be obtained. Great care should, therefore, be taken in checking the "zero signals" reading of the milliammeter between each reading which is to be recorded, to see that no variation has taken place in the anode current of the valve, and, further, it is usually best with anything except the newest and largest of high-tension batteries to run this valve at its normal anode current for perhaps half an

hour before the experiment is done, in order that the battery may settle down to a steady output voltage. Of course, one is still at the mercy of actual signal strength variations from the distant station, and these are at times extremely troublesome in my own case. I believe that my troubles are mainly due to a very persistent local user of strong reaction on the London station, who renders my wireless existence a very unhappy one in a variety of ways, none more trying than this interference with my signal strength measurements. Fortunately, he appears to be a believer in "early to bed," and several times recently I have been able to find a steady period by watching the signal strength during the evening, and noting that the wild variations which he produces finally cease quite sud-

denly somewhere about 10 o'clock, leaving me a short undisturbed period in which to get some results recorded. For example, the results expressed in the three curves accompanied in this article were all obtained in great haste between my tormentor's bedtime at a quarter to ten and the closing down of the local station at 10.30.

#### Preliminaries

Since the measurements must be carried out with a constant signal strength, it follows that they must be done as rapidly as possible, and it is advisable to adopt this procedure: Insert the coil upon which measurements are to be made, note the condenser reading for resonance, and then vary the condenser above and below this value, recording the value at which the signal strength is reduced to one-half upon either side. Having done this, make a table of condenser readings, giving the reading at every two degrees between the extreme values which I have mentioned and every five degrees for a further 20 degrees upon either side of these two points. Arrange these so that you can write against each one the equivalent signal strength when the condenser is set to that particular value, so that with the table ready for use all you have to note down are the actual signal strength readings. The experiment itself may therefore be carried out with considerable rapidity, and one has a much better chance of obtaining a fairly accurate result if one takes every possible precaution to facilitate the work when once it is actually started.

#### Use of a Standard

It is a simple matter to plot the resonance curve of a single coil in this way, but what one aims at, in most cases, is a comparative result, and, therefore, it is necessary to use some sort of a standard. On many occasions, no doubt, one wishes simply to compare one coil with another, usually of the same number of turns, and, therefore, one may simply plot two resonance curves on a single piece of paper, and a valuable comparison will result. When the sets of figures have been obtained for the two coils, the appropriate curves are plotted,

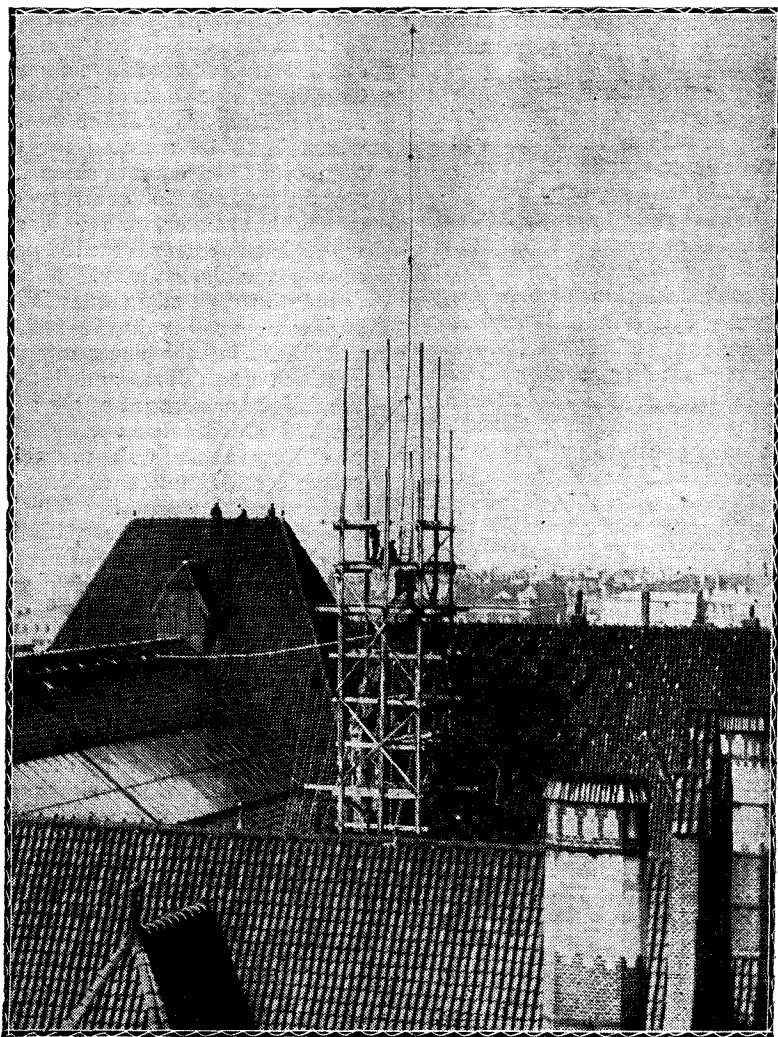

*Our photograph shows the mast at the Hamburg broadcasting station, transmissions from which are received at good strength in this country.*

recording dial readings horizontally, and signal strength vertically, and the two curves are then examined. It will perhaps be found that one is perceptibly steeper and sharper pointed than the other, and this represents the coil of greater selectivity, or, in other words, sharper tuning.

#### Testing in the Aerial Circuit

Probably the easiest method of obtaining a resonance curve for this coil is to place the inductance in the aerial circuit with the aerial tuning condenser in series, assuming that a tuning condenser of fair size is used (.0005  $\mu$ F or larger), since the shape of the curve and its steepness will depend to some extent upon the particular reading of the condenser at which resonance occurs, and, therefore, it should be made a rule only to compare coils whose dial readings for maximum signal strength are fairly closely the same, such as those illustrated in the accompanying diagram. This condition is usually quite easy to realise in practice, since one is generally comparing two coils of equivalent size of different makes.

#### Coils of Differing Size

If, under unusual conditions, it is desired to compare the sharpness of tuning of two coils of somewhat different sizes, one has the choice of two methods, the first being to strip off a few turns from the larger coil, which is not perhaps a very desirable proceeding. The second is to make a standard coil, for example, one of the cross coils which I described in a recent issue, of the same size as the larger coil, plot the resonance curve of this standard and the large coil, then strip off turns from the standard until it becomes equal in tuning value to the smaller coil which is being tested, and again plot the two resonance curves. Four curves will then be obtained, two of which are to be regarded as standards, and quite a useful comparison can be made.

#### Square-Law or Plain Condenser

Another factor which seriously influences the shape of the curve is the actual type of variable condenser employed, viz., whether it is of the square-law type or the ordinary plain type. In either case the curves will be somewhat distorted in the sense that they will be steeper upon the side to-

wards the smaller condenser readings, and flatter upon the other side, as shown in the accompanying diagrams. This is inevitable, and does not indicate any errors in measurement, while the distortion is much less in the case of a square-law condenser. A square-law condenser is therefore preferable, while if the measurements were done in a loose-coupled secondary circuit a much better degree of symmetry would be obtained, but the experimental difficulties here are much greater. I hope to deal with some points of this nature at a later date in considering various factors which affect the selectivity of a loose-coupled receiver.

#### Three Commercial Coils

The actual curves illustrated are those of three commercial coils, coil A being wound with No. 30 d.c.c. wire by a method

which produces a fairly high self-capacity, the whole winding being impregnated with insulating varnish. This coil is mounted upon one of the poor quality plugs which I referred to in my first article upon coil measurements. Coil B is the commercial standard which I have referred to upon a number of occasions, while Coil C is a pattern which I have found of quite high efficiency, giving, as it does, an equal signal strength reading when compared with the commercial standard, only falling short slightly in the matter of selectivity. It will be observed that its curve is just a trifle less steep than that of the standard. (It is interesting to note that this coil is wound with a decidedly thicker gauge of wire than the standard, yet its selectivity is not so good.)

## Securing Crystals in their Cups

**A**LTHOUGH at one time it was thought that one of the connections to the crystal of a crystal detector should be over a large area and very firm, there are now crystal detectors on the market in which both connections consist of fairly light contact by means of two whiskers. In spite of this, where the ordinary crystal detector with cat-whisker and cup is used, it is best to keep to the old method and have a good contact over a fairly large area of the crystal as the cup side connection.

#### Cups

Cups which have set screws do not provide the desired large contact surface, although they avoid the risk of spoiling the crystal by overheating it when fixing with molten metal. With this type of cup the crystal should first be packed in tightly with silver paper or tin-foil, and the set screw or screws then tightened. If the ordinary type of crystal cup is used, the crystals must on no account be fixed in with ordinary solder, as the heat will almost certainly injure the sensitiveness of the crystal. What is known as Wood's metal, which has a very low melting point, should be used, and even with this it is necessary to exercise care. The

cup should first be filled with the metal by placing a small piece in it and heating over a very small gas flame or against a soldering iron. Allow the fused metal to set, and fix the crystal by pushing it against the Wood's metal with a pair of tweezers, at the same time applying a little heat. This is in order to avoid heating the metal to a higher temperature than necessary. The source of heat is removed immediately the crystal sinks into the metal. It is best to avoid so-called plastic metals, as these, as a rule, contain a certain proportion of mercury, which is very injurious to some crystals. A. S. C.

#### Are You Oscillating?

**T**HERE is still a lot of oscillating to be heard on the ether at nights in spite of all that Captain Eckersley has had to say on this subject.

Perhaps the best method of telling whether a set is oscillating is to dab one's wetted finger on the aerial terminal, and to see if there is a loud plock as distinct from a small click in the 'phones.

Out of sympathy for one's fellow-listeners one should always try to avoid oscillation by keeping the reaction coil well away from the coil to which it is coupled.

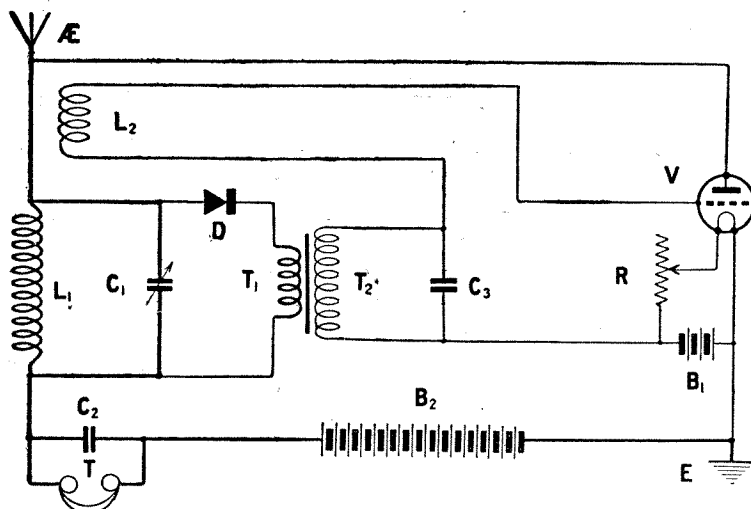

Fig. 1.—This new crystal-valve circuit may readily be connected up on the Omni receiver.

**A**N interesting valve-crystal circuit recently evolved by Mr. John Scott-Taggart is that given in Fig. 1. The circuit was first described in the March issue of the *Wireless Constructor* under the title of "A New Crystal-Valve Circuit," and although it is not claimed that the results obtainable equal those from a good single-valve reflex receiver, it is certainly an improvement on the ordinary crystal and note-magnifier circuit. It will be seen that the Fig. 1 circuit resembles quite closely the last mentioned, the chief differences being the provision of a reaction coil  $L_2$  and the inclusion of the aerial coil  $L_1$  in the anode circuit of the valve.

**The Working of the Circuit**

The high-frequency oscillations from the aerial are tuned by the aerial coil  $L_1$  and variable condenser  $C_1$  of .0005  $\mu F$  capacity. Rectification is carried out by the crystal detector  $D$ , the resultant low-frequency currents traversing the primary winding  $T_1$  of the inter-valve transformer  $T_1$   $T_2$ . The secondary winding  $T_2$  is connected between the grid and filament of the valve, the coil  $L_2$  being disregarded for the moment. Amplified low-frequency currents appear in the anode circuit of the valve, and by virtue of the fact that we have a coil  $L_1$  in the anode circuit of the valve and also one ( $L_2$ ) in the grid circuit of the valve, a reac-

tion effect will be obtained by bringing  $L_2$  up to  $L_1$  and retuning on  $C_1$ ; it must be remembered that unless  $L_2$  is connected the right way round, no increase in signal strength will be observed. The value of  $C_3$  is rather critical, and for best results should not exceed .0003  $\mu F$ ; if possible it should be eliminated altogether. It will be found, however, that the circuit oscillates less freely as the value of  $C_3$  is decreased.

**Wiring Up**

The circuit may be wired on

**A New Valve-Crystal Circuit on the Omni Receiver**

the Omni receiver in a very short space of time, the following connections being required:—

51—17	4—51
17—18	17—20
26—25	28—21
25—31	25—22
31—39	29—11
47—23	29—48
23—24	3—30
32—40	30—41
40—52	33—12

**Coil Sizes**

With the particular wiring adopted, the centre fixed socket of the three-coil holder on the side of the cabinet is that into which the aerial coil must be plugged, a suitable size being a No. 35 or a No. 50 coil on the

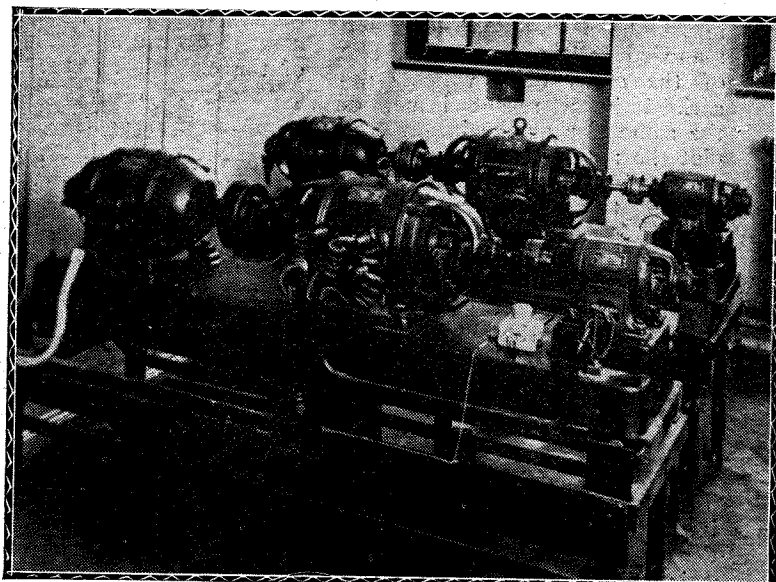

A section of the power plant used to supply power for the Hamburg broadcasting station.

An interesting experimental circuit using one valve which users of the Omni Receiver will be able to try out without difficulty.

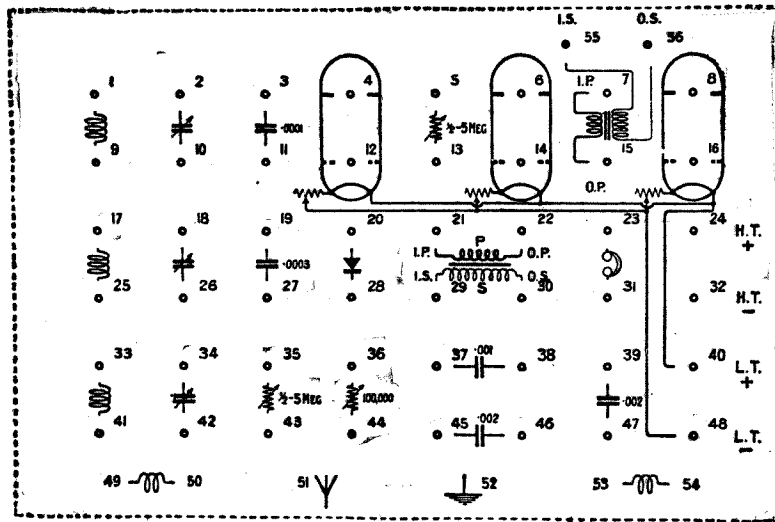

Fig. 2.—The terminal board.

usual broadcast wavelengths. The front moving socket of the same holder is wired for the reaction coil, and a No. 75 coil should be inserted for the wavelengths mentioned.

Chelmsford may be tuned in with a No. 150 coil in the aerial socket and a No. 250 for reaction.

**Operating the Circuit**

The circuit should first be treated as an ordinary crystal detector and note magnifier circuit, the two coils in the coil-holder being kept well apart. Adjust the crystal detector roughly and tune with the centre variable condenser C<sub>1</sub>. If no signals are heard, it is necessary to reset the crystal detector and tune again

until a sensitive point on the crystal has been found. Now try the effect of moving the reaction coil towards the aerial coil, with a subsequent readjustment of C<sub>1</sub>. If no increase in signal strength is noticed, the connections to the reaction coil probably require to be reversed. This is effected by disconnecting the leads 30—41 and 33—12 and joining 30—33 and 12—41.

**No Oscillation**

Should it be found that the set will not oscillate no matter which way round the reaction coil is

connected, an increase in the capacity of the condenser C<sub>3</sub> will help matters. A value of .0003 μF in place of the .0001 μF condenser at present in circuit is obtained by disconnecting 30—3 and 11—29 and joining 30—19 and 29—27. Different sizes of reaction coil should also be tried.

**An Important Experiment**

It cannot be said that the circuit has been given a fair trial until the effect of reversing the connections to both primary and secondary windings of the low-frequency transformer have been noted.

The connections to the secondary winding may be reversed in the following manner:—disconnect the leads 29—48 and 30—41, and join 29—41 and 30—48. The primary winding is reversed by disconnecting 28—21 and 22—25 and joining 22—28 and 21—25. Of course, the original connections should be reverted to if found to be superior.

**CNRA**

Readers should note that the station referred to in the first paragraph on page 670 of our last issue should read CNRA. This station is at Moncton, New Brunswick, and belongs to the Canadian National Railways.

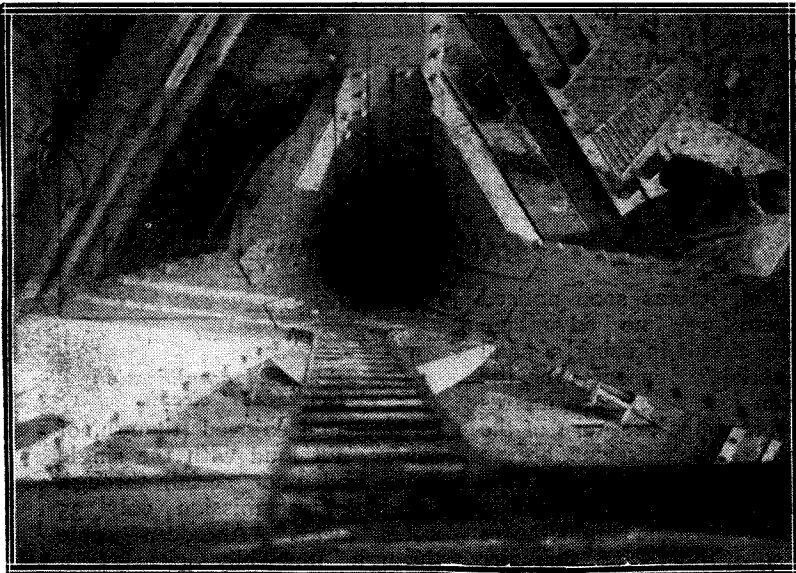

A photograph taken from the top of one of the 820 ft. masts at the Hillmorton wireless station, near Rugby, showing the interior of the mast.

# A NEGADYNE DUPLEX CIRCUIT.

By A. D. COWPER, M.Sc., Staff Editor.

A further development of the "Negadyne" which was described in "Wireless Weekly," Vol. 5, No. 12.

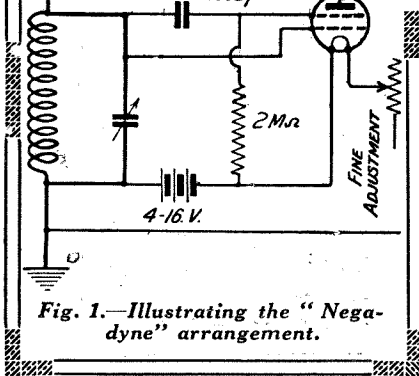

Fig. 1.—Illustrating the "Negadyne" arrangement.

THE Numans oscillator, or "negative resistance" four-electrode valve circuit, as adapted by the writer recently for use as a receiving circuit with controlled reaction, under the name of the "Negadyne," and published in *Wireless Weekly*, Vol. 5, No. 12, lends itself to an exceedingly simple and easily-controlled duplex or simultaneous amplification circuit, rather along the lines of a dual amplification circuit worked out by the writer some time ago for the De Forest Ultraudion arrangement.

### The Negadyne

In the "Negadyne" we have one tuned oscillating circuit which acts at the same time as a *grid circuit* in relation to the outer grid, and as an *anode circuit* in relation to the inner grid. The latter is really acting as an anode all the time, a very appreciable plate current flowing through the tuning inductance from the small H.T. battery and between the filament and inner grid (Fig. 1). Accordingly we can utilise this grid-tuned circuit to supply the high-frequency energy to a crystal detector circuit placed across it, as in the Ultraudion dual circuit and as in an early type of dual circuit which used a triode in a more conventional manner. The actual "plate" circuit then contains only the telephones, and no second tuned circuit is needed, which greatly simplifies the operation of the receiver.

### The Crystal

The crystal detector is placed in series with the primary of a step-up L.F. transformer, as usual; the low-frequency impulses are then applied to the outer controlling grid in a common and very convenient manner via a radio-choke and behind the usual small grid condenser, giving what is often described as the "parallel" method of dual feed (Fig. 2). A negative grid bias is given as usual by a small grid battery connected to "I.S." and to the L.T. minus. The value of this grid bias, which is more than usually critical here for the circuit to operate at all, varies from about three to five volts, negative, and must be determined by actual experiment with a tapped grid battery and with the particular four-electrode valve and H.T. value used. The Hellesens nine-volt unit, tapped every single cell, is convenient here. The radio-choke is the usual No. 250 plug-in coil, or a narrow slab-coil of 300-400 turns of fine wire, etc. The anode potential, common to the outer plate and inner grid, is conveniently from 12 to 20 volts (three to five flash-lamp batteries), depending on the valve used. With a Dutch pattern four-electrode valve, 16 volts H.T. and four volts negative grid bias operated well in conjunction with a good galena detector.

### Condenser

On trial, it was soon noticed that there was no advantage with this circuit in using a small series aerial condenser over the belt from just below 300 metres to 500 metres, where most of the interesting transmissions are to be found, but there was a very noticeable improvement when really low-resistance inductances were substituted for fine-wire ones. A low value of parallel tuning capacity also introduced difficulties in controlling oscillation: a relatively large A.T.C.,

e.g., .0005 μF maximum, seemed best in this circuit.

Actual results observed with a low-loss 28-turn basket-coil of No. 14 S.W.G. d.c.c. wire, internal diameter 2 in.—the standard primary coil recommended in connection with loose-coupled circuits, i.e.—as A.T.I. in conjunction with a .0005 μF parallel tuning condenser, or with a No. 40 Lissenagen coil for the higher range; on a low 70-ft. single-wire country test aerial on a very damp, foggy night, were distinctly encouraging. Of course, all the main B.B.C. stations (except Chelmsford) were heard, being tuned in with ease and at a strength which made it a simple task to check up the transmissions from the programme as well as by the usual wave-meter check, and Madrid, of the Continental stations, at good, steady signal strength; but, in addition, at least half-a-dozen of the relay stations were recognised, and selectivity was sufficient to allow both Cardiff and Manchester to

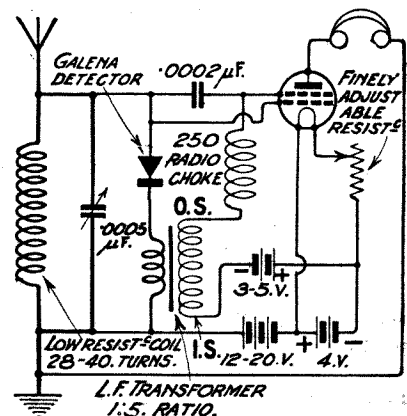

Fig. 2.—A dual amplification "Negadyne" circuit.

be read and enjoyed (though, of course, not loud with the single valve and poor aerial) through London's transmission only 35 miles away. Aberdeen came through unusually clearly; a steel-guitar performance and later on a band selection of familiar dance-tunes were enjoyable enough to cause an appreci-



able waste of the observer's time in stopping to listen to them, and there was no Morse interference here, whilst 2LO was easily readable on the L.S. at six feet. The adjustment of the filament resistance is quite critical, as in all Negadyne circuits, for this is the sole reaction control. It is, however, less critical than usual with this dual circuit, on account of the broadening effect of the heavy crystal damping. Experiment showed that serious interference could be caused with a neighbouring receiver whose aerial was adjacent to that of the Negadyne duplex if great care was not taken in tuning-in to avoid oscillation close to the wavelength of the transmission; the receiver should be worked well below self-oscillation and the point at which buzzing commences, and the crystal should

not be reset whilst tuned in to the local broadcast. This applies to almost any dual circuit using reaction. The tuning will be found to be extremely sharp.

**Experiment**

No advantage was found with this circuit, as is sometimes the case with powerful dual circuits, in the use of the more stable carborundum tinned iron combination in place of the ordinary galena cat's-whisker detector. A fine, steady setting is required. The direction of connection of the primary of the L.F. transformer is a matter for experiment to get that combination which gives the least tendency to buzz as the filament is brightened. It should be possible to search with incipient oscillation, but without a buzz or whistle, by careful adjustment of filament temperature.

**An Efficient Cat-Whisker**

A GOOD deal has been written in connection with "cat-whiskers," and still more about crystals, and, certainly, a little experimenting with these is always advisable when it is desired to obtain the utmost signal strength from any crystal receiver. There is now such a very large number of crystals on the market (chiefly of the "ite" variety) that some slight hesitation on the part of the would-be purchaser of a new crystal is not unnatural. Actually, however, there is not a great deal to choose between the numerous well-known brands, which are mostly of the synthetic galena type. Assuming, then, that a good galena crystal has been secured, a point of very great importance is the selection of a suitable cat-whisker. A cat-whisker is sometimes provided with the crystal purchased, but in some cases is too thick and stiff for satisfactory manipulation.

A whisker which the writer has found as good as any is that illustrated at B in the accompanying figure, its chief advantages being the ease with which a suitable point on the crystal is found and the subsequent stability of the adjustment. The secret lies chiefly in the gauge of the wire, a single

strand two and a half inches long being taken from a piece of rubber-covered flexible copper wire such as that used for making connections to coil-holders, etc. The shape is also important, the figure showing quite clearly how this is obtained. First clean the copper strand carefully with fine emery paper; then wind the wire in a regular manner round an evenly-sharpened pencil point as

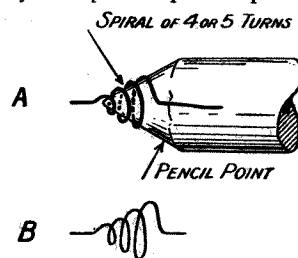

Details of the cat-whisker.

illustrated, after which the whisker may be easily removed. The ends may now be cut down to suitable lengths, the finished whisker being shown at B. The smaller end, of course, engages with the crystal.

Finally, do not forget to brush the tip of the whisker occasionally with emery paper, a clean point being essential for loudest results.

C. E. L.

**An Effective Lead-In.**

AN improvement on the usual type of home-made lead-in insulator, in which a 2 or 4 B.A. threaded rod passes through an insulating tube, a terminal being fitted to each end, is the arrangement illustrated in Fig. 1.

All that we require for this lead-in are a piece of ebonite, 1 1/2 in. by 1 1/2 in. by 1/4 in.; a 4 B.A. terminal, four wood screws,

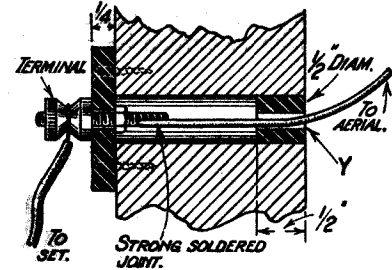

Fig. 1.—Illustrating the principle of the lead-in.

and a small piece of half-inch diameter insulating rod. Fig. 2 shows how the piece of ebonite is drilled, the terminal being fastened securely in the centre. Unless you are unable to solder, the terminal shank should be filed down, as in Fig. 1. The next step is to drill through the window frame a hole 1/2 in. in diameter in the position through which it is desired to bring the lead-in wire. Before bringing the latter through the hole, slip on the piece of insulating rod (if a hole is not already drilled through the latter, one of suit-

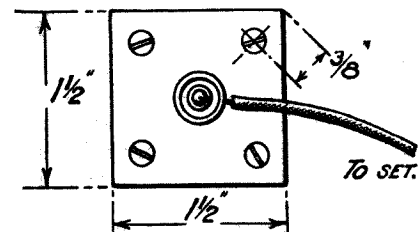

Fig. 2.—Constructional details.

able size should be made), after which the wire may be brought through the frame and soldered carefully to the terminal shank. Alternatively, the join may be made with the aid of lock-nuts.

Now screw the ebonite to the window frame, as in Fig. 1, and gently tap the piece of insulating rod into position. A little putty applied at the point Y completes the job.

## A Multi-purpose High-Frequency Amplifying Unit

By C. P. ALLINSON.

A HIGH-FREQUENCY amplifying unit is a most useful instrument to have on hand, for it can be attached to any existing detector unit in order to extend its range. Now,

giving of directions for connecting up various circuits. In order to use this amplifier with a crystal detector two terminals have been provided at T<sub>4</sub> and T<sub>5</sub> so that one may be used with tuned anode

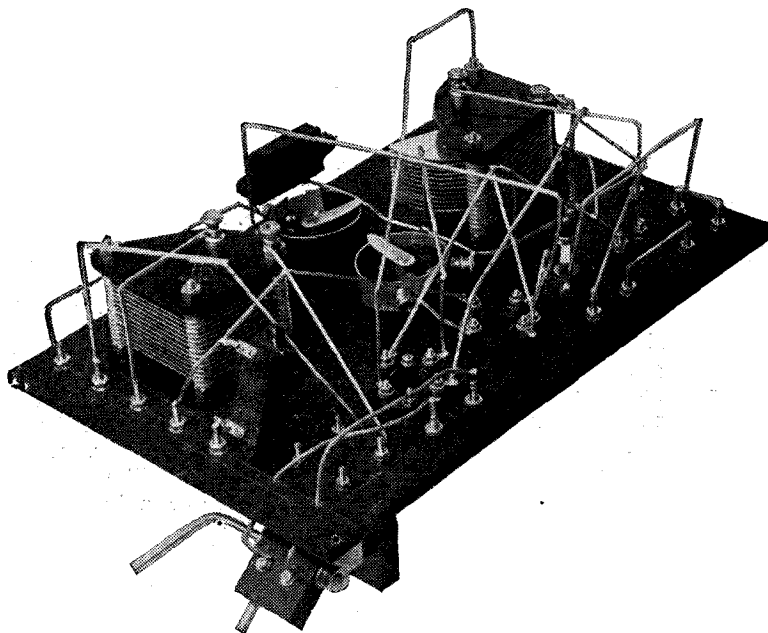

*The underside of the panel. The placing of the components is made clear by this photograph.*

most receivers already have tuning arrangements incorporated in them, and it was therefore necessary to design the following set so that a receiver using any kind of tuning arrangements may be used with it, while it may also be used by the experimenter who has a detector unit separate from his tuner.

### Necessary Conditions

First of all, it was necessary that it should be possible to use either tuned anode or tuned transformer coupling, and therefore provision was made to allow of this being done. Fig. 1 shows the circuit diagram, in which the terminals have all been given letters so as to simplify the

amplification; in certain cases explained later tuned transformer coupling may be used with a crystal receiver.

### The Design

The complete unit is shown in the photograph, and it will be seen that the lay-out is symmetrical and pleasing. In front are the two tuning condensers, between which is the potentiometer which will be found of great use for controlling oscillation. Behind this is the filament resistance, which is of 30 ohms resistance, so that a dull-emitter valve can be used if desired, while the wire is heavy enough to carry the current necessary for working with the more usual

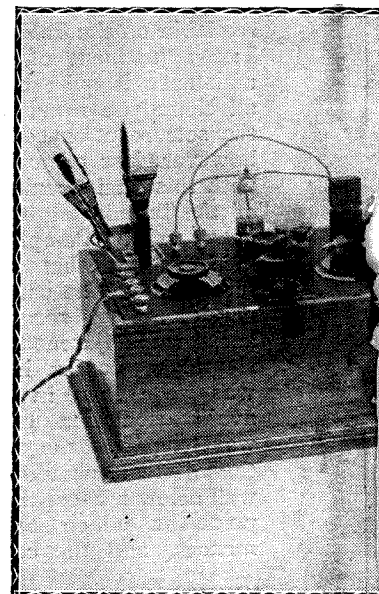

*This photograph shows the unit. The anode coil is co*

bright emitter valve. Behind this filament resistance is the valve-holder, which is of the anti-capacity type, the same type being used for the high-frequency transformer socket which is placed to the left of it, while on the right is a coil socket for use with tuned anode. An "on-off" switch is fitted so that the set can be left correctly adjusted and switched off without altering the setting of the filament resist-

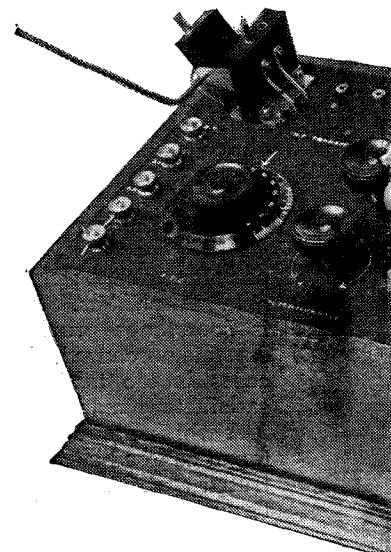

*A view of the set without coils layout wil*

*Many difficulties had to be overcome before the set described in the article below was completed as it had to be suitable for use with nearly any receiver.*

benefit of those who wish to copy the receiver exactly. Provided that good quality components are used, it is not, of course, necessary to employ the particular ones mentioned.

- 1 Ebonite panel, 12 in. x 8 in. x 1/4 in. (Paragon).
- 1 mahogany case to fit the panel, 5 in. deep (Agar).

Square tinned bus-bar and rubber-covered flex for making connections.

**Construction**

If guaranteed ebonite is used (and this can now be obtained from most dealers) the panel can be marked out and drilled without further delay; otherwise the

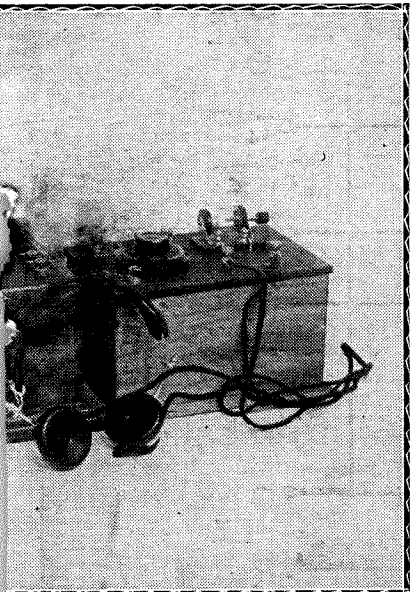

*connected to a crystal receiver. upled to the aerial coil.*

ance. The two coil-holder has the fixed socket connected to carry the tuning coil L<sub>1</sub> while the leads from the moving coil-holder are brought to two Clix sockets.

**Components**

Following our usual practice, we give a complete list of the parts needed to construct the set, and not only is the actual name of the component given, but also the manufacturer's name for the

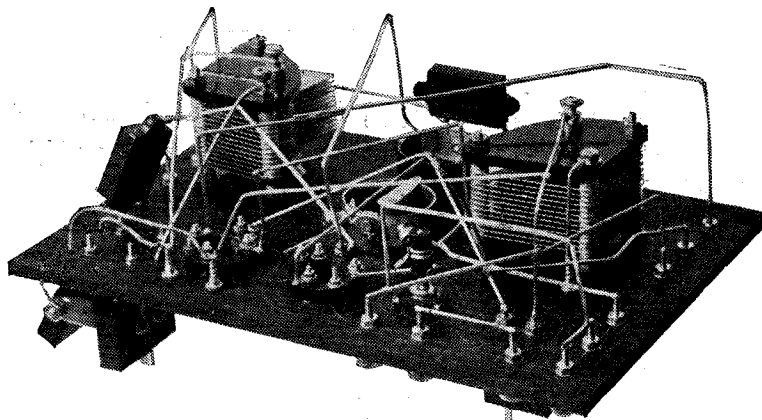

*Taken at an angle, this photograph shows the relative heights of the leads.*

- 2 variable condensers, .0005 μF square-law (Jackson Bros.).
- 1 H.F. plug in transformer for B.B.C. wavelengths (Burne Jones).
- 1 30 ohm filament resistance (Shipton).
- 1 potentiometer (Shipton).
- 2 anti-capacity valve-holders (H.T.C., type C).
- 1 on-off switch. (A two-way Lissen pull-push has been used.)
- 1 2-coil-holder (Burne Jones, type L).
- 1 single coil-holder. Panel mounting (Burne Jones).
- 14 nickel terminals (Burne Jones).
- 1 fixed condenser .0001 μF.
- 1 fixed condenser .005 μF (both Dubilier).
- 6 Clix (Autoveyors).
- 1 packet Radio Press panel transfers.

panel should first be rubbed down on both sides to remove the shiny skin with its attendant risk of leakage. No. 0 glass paper may be used, rubbing in one direction all the time. The panel having been marked out, time will be saved if all the holes of the same size are drilled at once, irrespective of their position on the panel, lastly countersinking those that require it from the front of the panel. Next apply the panel transfers where they are required, and if the panel has been sand-blasted or matted it will require rubbing over with a soft oily rag to restore its deep black lustre. The components may now be mounted on the panel and the connections made as in the wiring diagram. The back of the panel photographs show the relative heights of the various leads, and

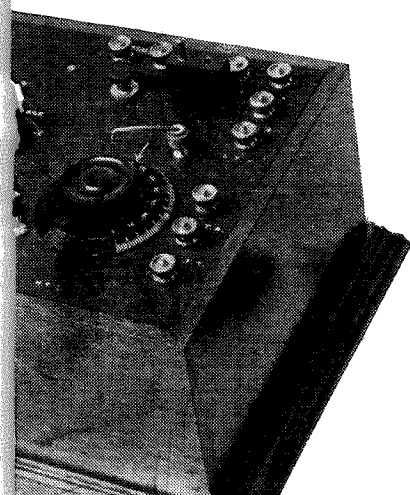

*or valve. The carefully planned connections should be observed.*

will assist in getting the correct sequence, the connections nearest to the panel being put in first, the next higher ones following, and so on. It cannot be emphasised too often that on the high-frequency side of a receiver all leads carrying H.F. currents should be well spaced, and where they cross should do so as near a right-angle as possible. The connections shown for the high-frequency transformer will be correct for using Peto Scott, McMichael, Ediswan, Burne-Jones, and one or two other makes. With certain makes it may, however, be necessary to alter the wiring so as to agree with the maker's instructions.

**Tuning**

Various forms of tuning can be employed with this unit, and are as follows:—Aerial to C.A.T.; A<sub>2</sub>, E and T<sub>1</sub> strapped together and connected to earth gives constant Aerial Tuning, Aerial to A<sub>2</sub>, with E and T<sub>1</sub> strapped together and connected to earth gives series tuning, while parallel tuning is obtained by connecting the aerial to A<sub>1</sub>; A<sub>2</sub>, E and T<sub>1</sub> being connected together and to earth. If desired, loose-coupled

tuning may also be used by plugging the aerial and earth leads into the two Clix sockets

this case oscillation can then be controlled by means of the potentiometer. If direct-coupled

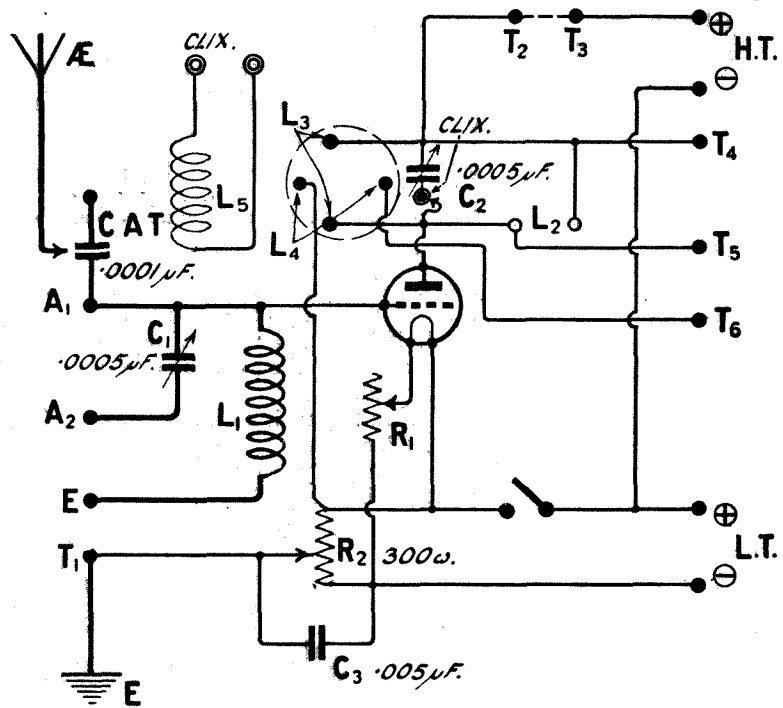

Fig. 1.—The circuit diagram of the unit shows how different schemes of connections have been allowed for.

which go to the moving coil-tuning is employed reaction effects can be obtained in two ways, either by connecting a coil

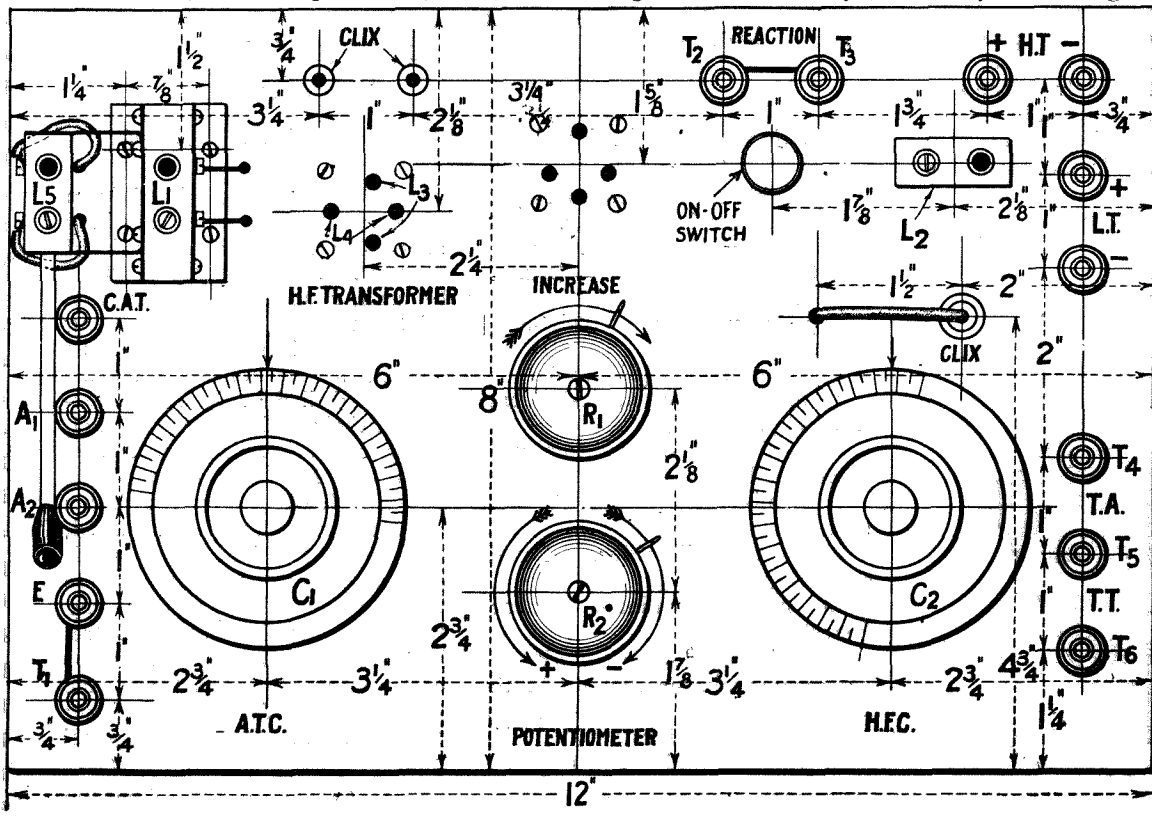

Fig. 2.—This dimensioned drawing of the panel layout is exactly to scale.

L5 plugged into the moving coil-holder, in the plate-circuit of the detector valve, if one is being used, or by using a fitting consisting of a coil plug with two leads to the ends of which Clix plugs are connected. These are plugged into the two sockets going to the moving coil-holder, the plug being placed in the tuned anode coil socket L2. By this means the tuned anode coil can be variably coupled to the aerial coil, reversing the leads being easily done in order to ensure that the correct reaction effect be obtained.

**Connecting Up**

The form of high-frequency amplification to be used will depend on what form of tuning is used in your receiver. If a variometer is employed, tuned anode must be used. It should be noted here that a *valve* receiver using variometer tuning is not suitable for use with this unit without making certain alterations to the receiver, as otherwise the high-tension battery will be short-circuited. We will assume that we wish to connect the unit to a crystal receiver employing a variometer for B.B.C. short waves. The aerial earth connections will be made according as

to what form of tuning it is desired to employ and the correct coil plugged in. The aerial and earth terminals on the crystal receiver are now connected to terminals T5 and T4 respectively. No coil or transformer will be needed, as the variometer meter will provide the necessary inductance, but as the wavelength range of a variometer as usually used for the reception of broadcasting is not big enough for use in the anode circuit, the condenser C2 will be required across it, and should be put in circuit by means of the Clix provided for that purpose. If it is wished to obtain reaction effects, a small coil L5 can be put in series in the plate circuit of the valve by means of two leads terminating in Clix connected to terminals T2 and T3 and plugging them into the Clix sockets which go to the moving coil-holder, otherwise T2 and T3 must be shorted. When using reaction it may be found desirable to use C.A.T. to allow as small a reaction coil as possible in the anode circuit. Next the L.T. battery will be connected to L.T.+ and L.T.-, and the valve switched on to the correct degree

of brightness by means of the filament resistance. If the valve lights all right, the H.T. battery may be connected next and the local station tuned in. If reaction is being used the reaction coil should at first be kept well away from the aerial coil, and then when the best setting for tuning condensers and crystal have been found, if reception is faint the reaction coil may be slowly brought up to the aerial coil retuning on the condensers. If the signals do not get louder the two Clix from terminals T2 and T3 should be reversed so as to obtain the correct reaction effects.

**Tuned Transformer**

If the crystal receiver uses a plug-in coil and variable condenser for tuning it can be used either with tuned anode or tuned transformer coupling. If the former is used, connections will be as before, and if a coil is already in position on the receiver, no coil will be required in the tuned anode socket L2. Otherwise a No. 50 or 75 coil will be plugged into this, according to what wavelength it is wished to receive. Only one tuning condenser will be required across this coil, and therefore the Clix

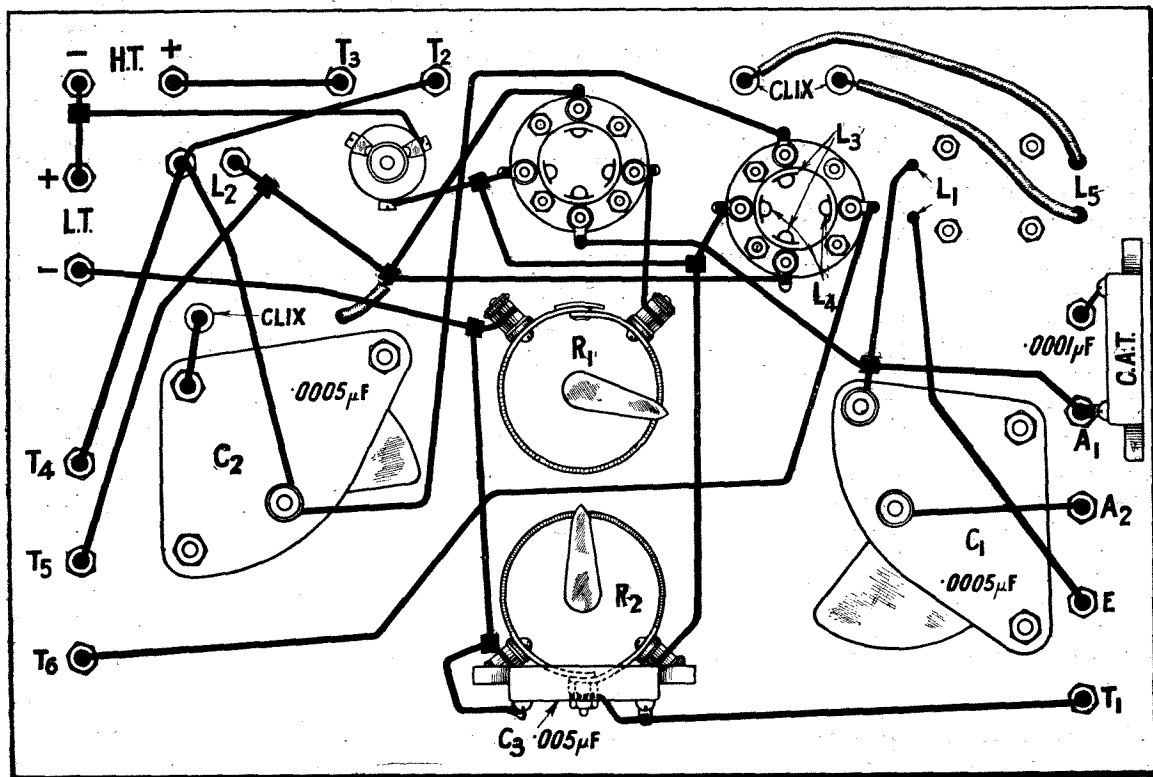

Fig. 3.—No difficulty should be experienced in wiring the unit if this diagram is carefully followed.

by means of which C2 is connected into circuit can be withdrawn from its socket and the tuning condenser on the crystal receiver employed. The tuned anode coil can be coupled to the aerial coil if it is desired by means of the fitting previously described. It will be noticed that any alteration in the coupling between the two coils will alter T3, otherwise T2 and T3 must be shorted.

To use tuned transformer coupling remove the plug-in coil from the crystal set, connecting the aerial and earth terminals of the crystal receiver to T6 and L.T. + respectively, the secondary being tuned by means of the condenser on the crystal receiver. The condenser C2 will in this case be cut out of circuit by means of the Clix, and the high-frequency transformer will be inserted into its socket, no coil, of course, being used either in the tuned anode socket or on the crystal receiver itself. Reaction effects may be obtained as before by coupling a coil to the aerial coil by means of the terminals T2 and T3, otherwise T2 and T3 must be shorted.

**H.F. and Valve-Detector**

If a receiver employing a valve detector is to be used we may employ transformer coupling, and assuming that the receiver uses single circuit tuning and we wish to use H.F. transformer coupling, the aerial terminal of the valve receiver will go to T6, the tuning coil will be taken out of its socket and the high-frequency transformer inserted into the amplifier unit. The high-frequency tuning condenser C2 will be disconnected by means of the Clix and the tuning condenser on the receiver unit used to tune the secondary of the high-frequency transformer. Reaction may be obtained from the plate circuit of the detector valve by connecting two leads with Clix on the ends in the reaction socket of the detector valve and plugging the Clix into the two sockets which go to the moving coil-holder on the unit. The L.T. and H.T. connections from the unit should be taken to the battery terminals of the valve receiver.

**A Reflex Circuit**

In this case all that is needed besides a crystal receiver is a low-frequency trans-

former and a small fixed condenser of .0005 or .001  $\mu$ F capacity. The crystal receiver will be connected to the high-frequency amplifier as previously described and the telephone terminals will be connected to the primary of the low-frequency transformer. The secondary of this will be connected to E and T1 without the link, so that OS goes to E, the fixed condenser being connected across OS and IS. (It may be found an advantage to apply a small extra negative potential to the grid of the valve,

the effect of reversing the leads to IP and OP should be tried as well as various forms of aerial connections to see which gives the best results.

**Some Remarks**

A few remarks on the operation of this receiver may not come amiss here, as a fair amount of skill is required to get the best results from a high-frequency amplifier. If it is found that the receiver goes into oscillation with a "plop," whether on moving the reaction coil or the potentiometer, adjust the H.T. and L.T. till this condition is eliminated. You cannot get the best results unless you can control reaction exactly. Greater amplification is not always obtained with the slider of the potentiometer right over on the negative end of the winding. Find out which is the best point, and always work as near to that as you can, remembering that the more negative potential you can use the better. When using tuned anode the grid-leak on the detector valve should be connected between grid and positive L.T., and this position is also desirable for transformer coupling. Tuning the anode circuit with this arrangement should be done with the condenser C2, the condenser in the valve receiver being set to zero.

(A test report upon the working of this unit will be given in our next issue.)

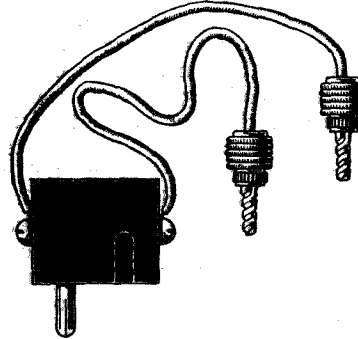

Fig. 4.—The plug fitting.

in which case a small dry cell of 1½-3 volts will be connected between IS and T1 with its negative pole to IS.) The telephones will be inserted in the plate circuit by connecting the leads to T2 and T3, the link being removed. The earth connection may be connected either to T1 or E, but on the writer's aerial earth system the best results were obtained on E. It should be noted here that

**Holding Panels**

WHEN one is drilling a panel and there is no one handy to hold it, difficulty is often experienced in keeping

method of holding a panel while drilling is very effective and simple.

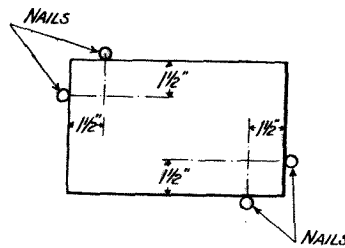

The idea illustrated.

it still. It is a distinct nuisance when coming to the end of a hole to have the panel suddenly swing round, and if there is a polished surface to it this will probably be scratched. The following

The panel is laid on a piece of wood about 1 in. thick. If it has a polished surface a piece of tissue paper is placed between it and the wood. Four 1-in. wire nails are now required. One of each of these is knocked into the wood for about ½ in. close up to each side of the panel. The nails to two adjacent sides should be placed about 1½ in. from the same corner. The diagram will make this quite clear. This method, while holding the panel quite secure, is not inclined to damage it in the way that methods requiring the clamping of the panel are.

A. S. C

## RECEPTION CONDITIONS WEEK BY WEEK

By W. K. ALFORD.

Review of reception for week  
ending February 15, 1925.

**T**HIS week has been marked by atmospheric conditions from the radio viewpoint which, in the early part of the week, approximated to mid-summer.

"X's" of tremendous intensity crashed in continuously and caused temporary paralysis of any set with more than one stage of H.F. amplification. Strange to say, during the brief quiescent periods reception was remarkably good, especially from America, whence several broadcasting stations were heard later in the evening at considerably greater than normal strength, but with considerably more discomfort!

### Conditions in America

Conditions were equally bad the other side of the Atlantic, and were bitterly commented on by two experimental stations the writer communicated with about midnight on the 10th (Tuesday). Regarding the reception of our own broadcasting stations, the following interesting point has come to light which will probably interest other people who have noticed the same thing. A very great many people are situated at respective distances from London and Chelmsford that the strength of the two are almost exactly the same. Now the power of Chelmsford is, I understand, about 17 kilowatts at the moment and roughly twelve times the power of 2LO. At an observed station, where the strengths are equal, the relative distances are 33 miles and 62 miles.

A micro-ammeter in a usual type of crystal receiver reads 8 ma. on London and 14 on Chelmsford; why, therefore, are the strengths not in the ratio of nearly 2:1.

I have been asked this question

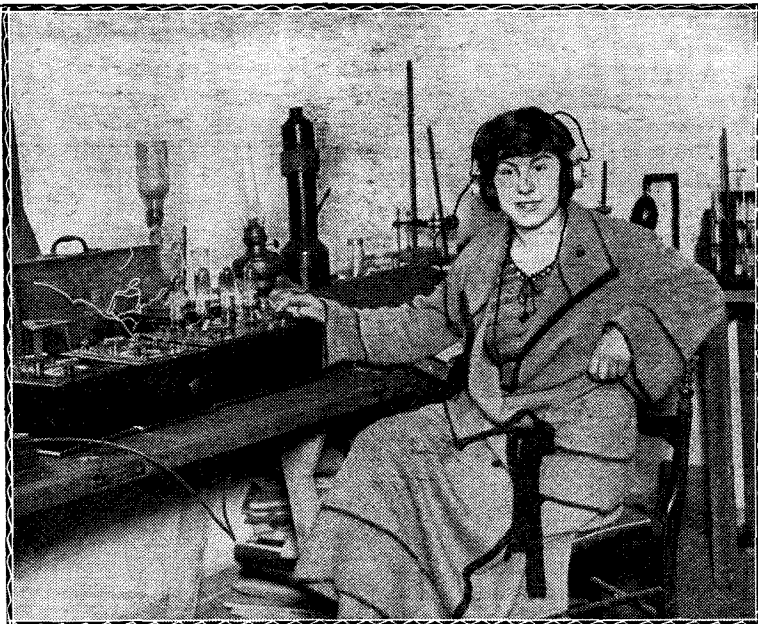

*The Rev. B. J. Corder, Rector of Radnage, Bucks, a very keen wireless experimenter, has recently invented a means of increasing the speed of cable transmission. Our photograph shows some of his wireless apparatus, and his daughter, who assists him in his experiments.*

very many times by listeners, and, of course, the answer is simple though rather obscure, and lies in the fact that it is an extremely difficult matter to modulate the full power of Chelmsford to anything like the same percentage as London on the shorter wavelength, and the net speech strength is not, of course, any function of the strength of the carrier wave, which may well represent a radiated energy of, say, 12 kilowatts, and yet speech and music impressed on this carrier may be quite weak.

### Signal Strength

The real strength of a Broadcasting station is entirely wrapped up in the efficiency of modulation (what the amateur gentlemen talk about on Sunday mornings!) and not on the stated power of the station. This point is really worth serious thought by listeners who are rather perplexed by apparent ambiguities such as that mentioned above.

### Short Waves

Rumours are abroad that a certain experimental station is about to attempt the re-broadcasting of 2LO on a wavelength of 30 metres after the manner of KDKA. May their endeavours meet with the success of that station!

There is a strong movement on foot to prolong the B.B.C. concerts by a section of the Press, and is backed largely by a community who consider radio just as they consider the domestic gramophone.

### KGO

The too "interested" listener, however, will view this idea with displeasure, as his attempts at long-distance will be removed entirely for a period of prolongation if he happens to be somewhere near the local station, or does not possess a superheterodyne. Regarding the reception of very long-distance broadcasting, there is an American station KGO which is well known to some, and whose transmissions under good conditions seem to have a tremendous range. He is situated at Los Angeles and can be heard quite well in this country on a good night over a distance which cannot be far short of 7,000 miles. His wavelength is 330 metres.

### WGY

WGY, Schnectady is supposed to be re-transmitting his ordinary broadcast on 15 metres, but nobody in this country seems to have reported having picked him up.

# Wireless Telegraphy and Signalling Bill

*Below we reproduce in full the Bill which is now before Parliament, and which has aroused so much indignation among amateurs and the general public.*



*Sir William Mitchell-Thomson, the Postmaster-General who is responsible for wireless licences.*

## A B I L L TO

Re-enact and amend the law relating to wireless telegraphy, and to make provision with respect to visual and sound signalling, and the use of etheric waves for the transmission of energy.

BE IT ENACTED by the King's most Excellent Majesty, by and with the advice and consent of the Lords Spiritual and Temporal, and Commons, in this present Parliament assembled, and by the authority of the same, as follows:—

### Licences for Wireless Telegraphy

1—(1) A person shall not establish or maintain any wireless telegraph station, or instal, work, or maintain any apparatus for wireless telegraphy, in any place or on board any ship or aircraft to which this Act applies except under and in accordance with a licence granted in that behalf by the Postmaster-General.

(2) Every such licence shall be in such form and for such period and shall be granted on and subject to such terms, conditions, and restrictions as the Postmaster-General may determine, and any such licence may include two or more stations, places, ships, or aircraft.

(3) If any person establishes or maintains a wireless telegraph station without a licence in that behalf, or instals, works, or maintains any apparatus for wireless telegraphy without a licence in that behalf, he shall be guilty of a misdemeanour, and be liable—

(a) on conviction on indictment, to imprisonment, with or without hard labour, for a term not exceeding twelve

months, or to a fine not exceeding one hundred pounds;

(b) on summary conviction, to imprisonment, with or without hard labour, for a term not exceeding three months, or to a fine not exceeding fifty pounds, and, in the case of a continuing offence, to a further fine not exceeding five pounds for each day during which the offence continues;

and in either case be liable to forfeit any apparatus for wireless telegraphy installed, worked, or maintained without a licence, but no proceedings shall be taken against any person under this Act except by order of the Postmaster-General, the Admiralty, the Army Council, the Air Council, or the Board of Trade.

(4) If a justice of the peace is satisfied by information on oath that there is reasonable ground for supposing that a wireless telegraph station has been established, or is being maintained, without a licence in that behalf, or that any apparatus for wireless telegraphy has been installed, or is being worked or maintained in any place or on board any ship or aircraft within his jurisdiction without a licence in that behalf,

he may grant a search warrant to any police officer or any officer appointed in that behalf by the Postmaster-General, the Admiralty, the Army Council, the Air Council, or the Board of Trade and named in the warrant, and a warrant so granted shall authorise the officer named therein to enter and inspect the station, place, ship or aircraft and to seize any apparatus which appears to him to be used, or intended to be used, for wireless telegraphy therein.

(5) The expression "wireless telegraphy" means any system of communication by telegraph as defined in the Wireless Telegraph Acts, 1863 to 1924, without the aid of any wire connecting the points from and at which the messages or other communications are sent and received.

### Licences for Experimental Purposes, etc.

2.—(1) Where the applicant for a licence proves to the satisfaction of the Postmaster-General that the sole object of obtaining the licence is to enable him to conduct experiments in wireless telegraphy, a licence for that purpose shall be granted, subject to such special terms, conditions and restrictions as the Postmaster-



General may think proper, but shall not be subject to any rent or royalty.

(2) Where an applicant for a licence satisfies the Postmaster-General that a wireless telegraph station is to be used solely for the sending or receiving of telegrams which are within the first or second exception from the exclusive privilege conferred upon the Postmaster-General by the Telegraph Act, 1869, a licence for that purpose, if granted, shall not be subject to any rent or royalty.

(3) The provisions of this section and of the enactment replaced thereby, providing that a licence is not to be subject to any rent or royalty, shall not prevent, and shall be deemed never to have prevented, fees (periodical or otherwise) prescribed for the purpose being charged in respect of the grant or renewal thereof.

#### Regulations

3.—(1) The Postmaster-General may make regulations—

(a) as to the terms, conditions, and restrictions on or subject to which licences or any class of licences under this Act are to be granted, renewed, suspended, or withdrawn; and

(b) requiring any operators or other persons engaged in the working of wireless telegraphy to be provided with

certificates, and making provision as to the manner and conditions of the issue and renewal of any such certificate, including the examinations and tests to be undergone, and the form, custody, production, cancellation, suspension, endorsement and surrender of any such certificate, whether issued before or after the passing of this Act; and

(c) as to the extent to which this Act is to apply to British ships and aircraft registered elsewhere than in Great Britain, Northern Ireland, the Channel Islands or the Isle of Man, and to foreign ships and aircraft, and as to the working of any apparatus for wireless telegraphy installed therein;

(d) for giving effect to, and securing compliance with, the provisions of any international convention signed on behalf of His Majesty, and any regulations made thereunder, so far as the same relate to wireless telegraphy;

(e) prescribing, subject to the consent of the Treasury, the fees to be paid periodically or otherwise in respect of the grant or renewal of any licence or certificate.

(2) Regulations under this section may provide that any person

acting in contravention of or failing to comply with the regulations or any of them, or the terms, conditions and restrictions, or any of them, on or subject to which any such licence or certificate as aforesaid has been granted, shall, on summary conviction, be liable to imprisonment for a term not exceeding three months, or to a fine not exceeding fifty pounds, and, in the case of a continuing offence, a further fine not exceeding five pounds for each day during which the offence continues, and be liable to forfeit any apparatus for wireless telegraphy in respect of which the offence is committed.

(3) Every regulation made under this section shall be laid before both Houses of Parliament as soon as may be after it is made, and, if an address is presented by either House within twenty-one days on which that House has sat next after any such regulation is laid before it, praying that the regulation may be annulled, His Majesty in Council may annul the regulation, but without prejudice to the validity of anything previously done thereunder.

#### Offences

4.—(1) A person shall not—

(a) send or attempt to send by wireless telegraphy a message or communication of an indecent, obscene, or offensive character, or a message or communication subversive of public order; or

(b) send or attempt to send by wireless telegraphy a signal of distress of a false or misleading character, or a false or misleading message as to a vessel in distress; or

(c) improperly divulge the purport of any message sent or proposed to be sent by wireless telegraphy.

(2) If any person acts in contravention of this section he shall be liable on summary conviction to a fine not exceeding ten pounds, or on conviction on indictment to imprisonment, with or without hard labour, for a term not exceeding twelve months.

#### Power to Mitigate Fines and Stay Proceedings and Application of Fines

5.—(1) The Postmaster-General may, in his discretion, mitigate any penalty incurred or alleged to be incurred under this Act, or

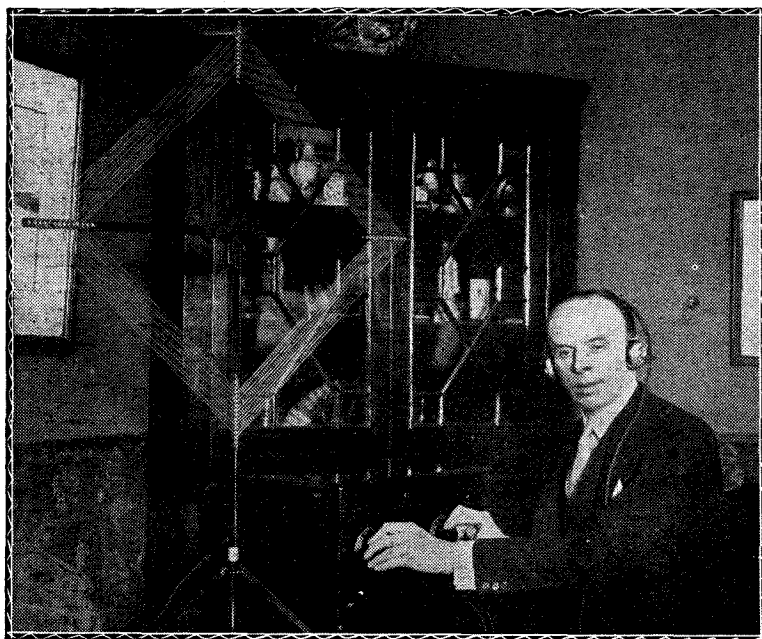

*In response to an invitation from the B.B.C., Mr. George Grossmith has accepted the appointment of Advisory Director of Programmes, and may be seen in our photograph listening-in on his own apparatus.*

rules or regulations made thereunder, without taking legal proceedings for the imposition thereof, or stay or compound any proceedings for the imposition thereof or for the seizure or forfeiture of any apparatus, and may restore anything seized or forfeited :

Provided that in the application of this subsection to Scotland, the Lord Advocate shall be substituted for the Postmaster-General so far as regards discretion conferred on the Postmaster-General to stay or compound any proceedings for the imposition of any penalty or for the seizure or forfeiture of any apparatus.

(2) All fines recovered in pursuance of this Act shall be paid into the Exchequer.

#### Application to Visual and Sound Signalling

6.—(1) The provisions of this Act shall apply to any visual or sound signalling station used or intended to be used for the purpose of communication with ships at sea as they apply to wireless telegraphy stations.

(2) For the purposes of this section "visual or sound signalling station" includes any permanent or fixed apparatus for the purpose of visual or sound signalling, and the provisions of this Act shall apply to the maintenance of any visual or sound signalling station in existence at the passing of this Act as they apply to the establishment of a visual or sound signalling station :

Provided that nothing in this Act shall apply to visual or sound signalling stations or apparatus on board ships or in aircraft, or to any signal station established by Lloyd's under the powers conferred by the Lloyd's Signalling Stations Act, 1888, or to signalling stations and lighthouses under the control of the Board of Trade or of any General or Local Lighthouse Authority.

In this section the expressions "lighthouses" and "general or local lighthouse authority" have the same meaning as in the Merchant Shipping Act, 1894.

#### Application to Use of Etheric Waves for Transmission of Energy

7. The provisions of this Act, shall apply to the installation and working of apparatus for utilising etheric waves for the purpose of the sending or receiving of energy

without the aid of any wire connecting the points from and at which the energy is sent and received as they apply to the installation and working of apparatus for wireless telegraphy.

#### Control in Emergency

8. If at any time in the opinion of a Secretary of State an emergency has arisen in which it is expedient for the public service that His Majesty's Government should have control over the sending and receiving of messages by wireless telegraphy or visual or sound signalling or the utilisation of etheric waves for the purpose of the sending and receiving of energy, and notice to that effect is published in the *Gazette*, it shall be lawful for the Postmaster-General during the continuance of the emergency to make such rules as appear necessary with respect to the possession, sale, purchase, construction, and use of apparatus for any such purpose, or component parts of such apparatus, and to impose penalties and forfeitures recoverable summarily in respect of any breach of the rules, and make such further provision as appears necessary for the enforcement of the rules :

Provided that—

(a) rules under this section shall not provide for the imposition of a term of imprisonment exceeding six months, or a fine exceeding one hundred pounds, or, in the case of a continuing offence, ten pounds for each day during which the offence continues; and

(b) any rules made under this section shall be laid as soon as may be before both Houses of Parliament.

#### Application to Ships and Aircraft

9.—(1) This Act shall apply—

(a) to British ships and aircraft registered in Great Britain, Northern Ireland, the Channel Islands or the Isle of Man, wherever such ships or aircraft may be ;

(b) to British ships and aircraft registered elsewhere than as aforesaid, and to foreign ships and aircraft, whilst in or over any part of Great Britain, Northern Ireland, the Channel Islands or the Isle of Man, or the territorial waters abutting on the coast

thereof, to such extent as may be prescribed by regulations under this Act.

(2) Sections six hundred and eighty-four, six hundred and eighty-five, and six hundred and eighty-six of the Merchant Shipping Act, 1894 (which relate to the jurisdiction of courts and justices), and section six hundred and ninety-three of the same Act (which relates to distress for sums ordered to be paid by masters and owners of ships), shall apply to the jurisdiction of courts and justices in respect of ships, and to distress under this Act.

#### Extent

10.—(1) Subject to the provisions of this Act with respect to ships and aircraft, this Act shall extend to Great Britain, Northern Ireland, the Channel Islands and the Isle of Man.

(2) In the application of this Act to Scotland the expression "misdemeanour" means crime and offence.

(3) In the application of this Act to the Channel Islands and the Isle of Man—

(a) The lieutenant governor of the Island of Jersey or the Island of Guernsey, and the governor, lieutenant governor, or deputy governor of the Isle of Man, as the case may require, shall be substituted for the Board of Trade :

(b) Offences may be prosecuted, fines recovered, proceedings taken, and search warrants issued in such courts and in such manner as may for the time being be provided in the Channel Islands and the Isle of Man by law, or, if no express provision is made, then in and before the courts and in the manner in which the like offences, fines, proceedings, and warrants may be prosecuted, recovered, taken, or issued therein, by law, or as near thereto as circumstances admit, and the bailiff or his lieutenant, or any jurat of the Royal Court in the Island of Jersey or the Island of Guernsey, and the judge or any jurat of the Court of Alderney, and the high bailiff or two justices of the peace in the Isle of Man, shall respectively be substituted for a justice of the peace.

**Repeals and Explanation of Act of 1904**

11.—(1) The Wireless Telegraphy Act, 1904, and the Wireless Telegraphy Act, 1906, are hereby repealed:

Provided that nothing in this repeal shall affect any licence granted under the enactments so repealed, but every such licence shall have effect as if granted under the Act.

(2) For removing doubts as to the construction of the Wireless Telegraphy Act, 1904, it is hereby declared that any references in that Act to transmission in relation to messages shall be deemed always to have included references to the reception of messages:

Provided that nothing in this paragraph shall render any person liable, in respect of any act or omission prior to the twelfth

day of December, nineteen hundred and twenty-four, to any penalty to which he would not but for this subsection have been liable.

**Short Title and Commencement**

12.—This Act may be cited as the Wireless Telegraphy and Signalling Act, 1925, and this Act and the Telegraph Acts, 1863 to 1924, may be cited together as the Telegraph Acts, 1863 to 1925.

**A Novel Method of Fixing an Aerial**

IT is most desirable that the aerial should be fixed as high as possible, and while this is comparatively easy at the mast end, it is often difficult to get the house end of the aerial fixed up high. The following hint will be found useful in cases where there is no convenient chimney stack or

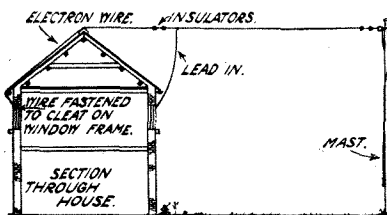

Illustrating the method of fixing the aerial.

where a fixture to the stack is not allowed.

It is assumed that the house is

**LOW TENSION CONNECTIONS**

ANYTHING that happens to most of us in one of those fits of temporary insanity to which all wireless men are prone at times is to attach the L.T.+ lead to the negative terminal of the set and L.T.— to the positive.

To make quite sure that you cannot possibly do this is a very simple matter. One way which appeals to many constructors is to use an ordinary screw-down terminal for L.T.+ and one of the telephone type for L.T.—.

**The Positive Lead**

The positive lead is fitted with a spade tag, a pin tag being soldered to the negative. A second method is to use Clix of different

of the type which has an apex to the roof which runs at right angles or nearly so to the direction of the aerial. The diagram will show clearly what is meant. The first thing to do is to call in the services of an ex-cricketer and get him to throw a large nut over the roof to which is tied a piece of twine. To the end of the twine is attached a piece of stout string, which is pulled over the roof, and then a piece of wire, such as Electron wire, is attached to the string, and in its turn pulled over the roof, after an insulator or two and the aerial wire have been fixed to it. When this is pulled up tight, the aerial will be completed. The Electron wire should be fastened to one of the front window-frames by being twisted round a cleat.

A. S. C.

colours for the panel connections of the two leads, bushes of the corresponding colours being placed on the panel. Perhaps the best of all is to mount a flush-fitting plug and socket on the panel of the set, the plug being for the positive connection and the socket for the negative. The leads from the battery are then brought to a standard plug and socket mounting, the positive being taken to the socket and the negative to the plug. If this is done it is impossible to make a wrong connection—provided that the leads are properly attached to the accumulator! To ensure that this is done a good tip is to drill small holes through two "Tiddlywinks" counters, one red and one blue, and to tie these on to the battery ends of the leads.

R. W. H.

**About Catwhiskers**

THERE are many kinds of catwhiskers, and they are made out of many different metals. Some experimenters claim that one metal gives best results, and others that other metals give the loudest signals. It is certainly the case that metals which do not corrode under the action of the atmosphere keep cleaner than those that do, and are therefore not liable to give poor signals due to bad contact; but this ceases to be an advantage if the ordinary catwhisker is kept clean by cutting a small piece off its end or rubbing its point with fine emery cloth.

**Important Points**

Although the metal out of which the catwhisker is made may not affect signals, the springiness and thickness of the catwhisker are very important points. To a certain degree the finer the wire the more sensitive does the detector become, and although the adjustment must be more delicate, and is more likely to be upset by vibration, the increase in signal strength is worth the extra trouble. A very good catwhisker may be made out of a piece of 40-gauge bare copper wire twisted into a spiral of about 3/16-in. diameter.

A. S. C.

**The Radio Society of Great Britain**

An ordinary meeting of the Society will be held at the Institution of Electrical Engineers, Savoy Place, W.C.2, at 6 p.m., on Wednesday the 25th instant, when Professor C. L. Fortescue, will deliver a lecture entitled "Resistance in Wireless Circuits."

The usual Weekly Society talk, broadcast from 2LO, will, on February 26th, be given by Capt. L. F. Plugge, continental correspondent for "Wireless Weekly."



### TRAP CIRCUITS

SIR.—We read with great interest Mr. John Scott-Taggart's article on "Trap Circuits" in the current issue of *Modern Wireless*, and think your readers may be interested to have a few details of our tests.

The Fig. 9 circuit was employed using a Gambrell "a" coil as the aerial inductance, a "C" for both anode and closed circuit, and an "A" for reaction. With this combination at a distance of five miles from 2LO, this station could be cut out entirely in 2 degrees of the closed circuit condenser (.00065  $\mu$ F), the anode circuit, of course, being adjusted at the same time. Tuning in a station, such as Cardiff, at the same time cutting out London, was a simple matter. There is no doubt that the simplicity of the tuning will make a great appeal to the amateur.

From our experiments we feel certain that a great deal of success, which can be obtained with the arrangement, depends on the use of a coil having really small losses.

Yours faithfully,  
GAMBRELL BROS., LTD.

Southfields, S.W.18.

### A CHALLENGE

SIR.—I have read with much interest the letter published in your issue of February 4, by Mr. Haddick, in which he claims he is able to get all B.B.C. stations quite easily, except Glasgow, on a straight forward direct coupled circuit, one H.F. detector and one L.F. without interference from 2BE.

I may say that I have been experimenting since the Belfast station opened with various circuits, including wave traps, but have been unable to get all stations without interference.

As one who doubts the accuracy of Mr. Haddick's claim, I am prepared to subscribe the sum of 20s. to the Sports Gala Committee in Belfast, to assist in providing wireless sets for the hospitals, etc., if he can tune in for me at comfortable phone strength the four following stations — Manchester, Bournemouth, Newcastle, and Bir-

mingham—on any evening he may choose, without interference from 2BE.

I may say, in conclusion, that I have been a constant reader of *Modern Wireless* and *Wireless Weekly* since they were first issued, and, like Mr. Haddick, have gained valuable information from these publications.

Yours faithfully,  
S. A. BOOTH.

Belfast.

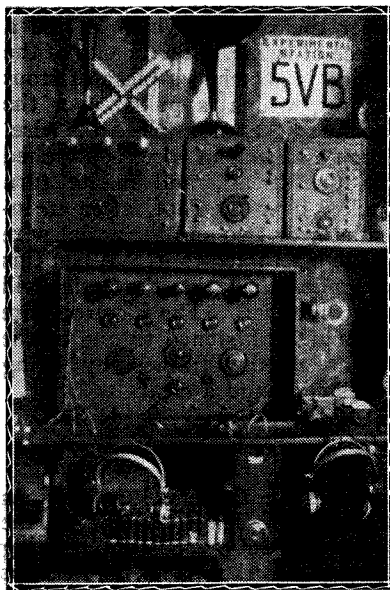

Part of the apparatus at the amateur station 5VB, operated by Mr. Curtis.

### THE "LOW-LOSS TUNER" IN S. AFRICA

SIR.—Just a short letter to advise you of the success achieved out here with the "Low-Loss Tuner" described in *Wireless Weekly* of November 29 last.

I have tried quite a large range of circuits for reception of KDKA in South Africa, but have not been rewarded with too much success.

After perusing your article, and noting particularly your objection to H.F. amplification, which, by the way, is naturally a different proposition out here, I decided to try the detector and 2L.F. The results were gratifying and remarkable. American amateurs can be

read at 'phones on table strength, and KDKA can be put on a loud-speaker. Unfortunately, the transmissions are subject to bad distortion at times, so that a good continuous reception of intelligible matter is not possible.

The distance from KDKA is approximately 7,000 miles. Local time of reception of his evening programme is as follows: Commencement, 3.45 a.m.; close down, 6.15 a.m.

At 6.15 a.m., being summer here, it is broad daylight, the sun rising at 5.30 a.m. The signal strength does not vary from start to finish, even daylight having no apparent effect.

I trust this will be of interest to you, and can assure you it has opened up very wide scope for experiment out here.

Wishing you every success for the future.—Yours faithfully,

LIONEL E. LEOUSE.

Durban.

### STATION 5VB.

SIR.—Enclosed please find a photograph of my set, which you may find of some use. The entire station is home-constructed, and consists of a five-valve receiver (comprising one tuned anode H.F., iv. det., 2 L.F. trans. coupled and one resist. coupled), and also a three-valve resistance-coupled amplifier, one valve short-wave receiver and a grid control transmitter.

Numerous American and Continental amateurs have been received.—Yours faithfully,

G. C. CURTIS, 5VB.

Edgbaston, Birmingham.

### APPRECIATION

SIR.—Just another letter of appreciation of the most excellent sets published by you in *Modern Wireless*. The first set I built was the single valve receiver described by H. K. Simpson, the one you now publish in "envelope" form (Radio Press Envelope, No. 9). The results were extremely good, as you will see from the following:—

Johannesburg, 270 miles audible 20 ft. from L.S.

Capetown, 600 miles audible 10 ft. from L.S.  
 Durban, 400 miles audible 20 ft. from L.S.  
 By adding one note-magnifier all were comfortably loud on the L.S.

The next set I tried was the "All Concert De Luxe" (R. P. Envelope, No. 4), which brought them all in at terrific strength. I adhered strictly to the original design, but have since modified it to obtain several combinations, that is, reaction on the aerial or anode, and also with the high-frequency valve neutrodyned, reaction in this case being taken on the aerial. I might add that in the first place, separate high tension terminals were provided for each valve, also grid bias on the L.F. valve.

The valves used are Myers for H.F., Ediswan for Det., and M.O. for L.F., all dull-emitters, the H.T. voltage being 60v., 45v., and 96v. respectively.

To give you some idea of the conditions for wireless prevailing in this country, it is a common occurrence to pick up stations even on a single valve at 900 miles, and there is very little difference in signal strength between summer and winter conditions, except for a slightly greater prevalence of atmospherics in the summer.

The power used by our stations is as follows:—  
 Johannesburg JB, 500 watts, wavelength 450 metres.  
 Capetown, 1 1/4 kw., wavelength 375 metres.  
 Durban, 1 1/4 kw., wavelength 300 metres.  
 Trusting I have not encroached

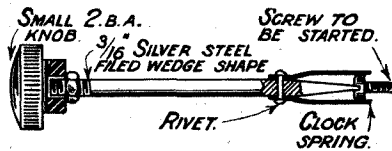

Details of the useful device suggested by Mr. Lamb.

upon your valuable space to too great an extent, and wishing the three greatest wireless magazines, *Wireless Weekly*, *Modern Wireless* and *The Wireless Constructor* all the success they deserve,  
 Yours faithfully,

"SOUTH AFRICAN EXPERIMENTER."  
 Kimberley, S. Africa.

A USEFUL TOOL

SIR,—With reference to your article on "Starting Awkward Nuts and Screws" in the February 4 issue of *Wireless Weekly*, may I be permitted to suggest the follow-

ing device? Having had some experience in instrument making and knowing the patience needed with the above job, the tool I rigged up from scrap for this work is very useful. All that is needed is a short end of 3/16 in. silver steel (this can be obtained from the local ironmonger). File it wedge shape to suit screws to be inserted. Screw the opposite end, 2 B.A., for a handle or knob. Obtain a piece of old clock spring, about 1/4 in. wide, and soften the ends slightly (do this over gas flame before cutting to required length). Drill a 1/16 in. hole in the end of each piece after bending to shape, also in the steel shank, and rivet with a piece of cycle wheel spoke.

Trusting this will be of benefit to the readers of your most valuable books, *Wireless Weekly*, *Modern Wireless* and *The Wireless Constructor*.—Yours faithfully,  
 E. LAMB.

Limehouse, E.14.

THE TYPE W4 RECEIVER

SIR,—It may be of interest to your readers to know that I was recently looking up my back numbers of *Wireless Weekly* and *Modern Wireless* to find a good three-valve straight circuit, and eventually I chose one that was

ALL POST FREE AT CALLERS' PRICES	
<b>Ebonite Panels.</b>	<b>COMPLETS</b>
9" x 8" 2/2 3/10	E
12" x 9" 4/6 3/9	I
12" x 12" 5/9 5/-	C
15" x 8" 5/6 4/8	E
15" x 12" 7/6 5/6	L
4" x 4" 5d.	I
7" x 4" 1/3 1/2	S
6" x 6" 1/3 10d.	T
Any size cut.	FREE
Sq. in. 1" id., 1 1/2" id.	
<b>Terminals.</b>	<b>Condensers</b>
Mil.-Pol. Brass 2d.	Dubilier
4 B.A. Standard 1d.	Mullard (Usual)
Lacquered 2d.	Edison-Bell (prices)
Spade type, doz. 6d.	Mansbridge 1 m.f. 1/6
Telephone type 1d.	Smf. 1/6, 1/36 mf. 9d
Multiphone 9d.	
" 6-way 1/-	
Reffy spring 3d.	
2 B.A. Small 3d.	
Contact Studs 3d.	
Spring Washers 1d.	
<b>Aerial Wire 7/22s</b>	<b>Headphones.</b>
Enamid. Bright 2/6	4,000 ohms. Brown's
" Electron 1/8	F. P. H., Siemens,
" Mars 9/6	Brands, Sterling,
Lead-in 4d. v.d.	Ericsson, all 20/-
<b>Insulators.</b>	General Radio 20/-
Shell, 2 1/2" x 2 1/2" 4d.	Fellowes 18/6
Reel 1d., Egg 1d.	Air weight 10/6
Crystal type 6d.	" Adjustable 12/6
" Lead-in 4d.	
4" & 6" do. 6d.	
9" 1/2", 12" & 15" 1/3	
<b>Valve Holders.</b>	<b>H. T. Batteries.</b>
Type A 7d., Polar 1/8	With Wander Plugs.
Screwed 8 nuts 5d.	60v. 8/- 36v. 4/10
Ebonite " 10d.	30v. 4/- 15v. 2/1
Do. Open Type 6d.	4v. F.L. Btry 5d.
	66v. Ever-Rdy 13/6
	36v. 8/- 16v. 3/6
	Siemens same price.
	<b>British Wires.</b>
	swg. doc. esc. dsc.
	18 1/11 2/11 3/5
	20 2/2 3/4 4/2
	22 2/8 3/9 4/7
	24 2/11 3/10 5/-
	26 3/4 4/2 5/9
	28 3/8 4/9 6/6
	30 4/10 5/4 7/6
	32 5/8 6/- 8/9
	36 8/- 8/8 12/-
	40 17/- 14/8 20/-
	<b>Coil Plugs.</b>
	Ebonite " 10d.
	Superior " 1/8
	Narrow " 7d.
	Basket " 1/-
	Moulded type 6d.
	Coil Formers 2d.
	Basket type 1d.
	Coil Mounts 4d.
	" Athol" Ebonite 1/8
	Do. Porcelain 1/8
	Basket Coil Sets, 1/-
	6-1/8, 4-1/1.
<b>Iron Core Chokes.</b>	
1,000 ohms " 9d.	
<b>TRADE</b>	<b>Var. Condensers.</b>
E	.001 panel type 6/6
N	.00075 " 5/9
Q	.0005 (Knob) 5/-
U	.0003 (dial in.) 4/6
I	.0002 (dial in.) 3/6
R	Stock " Square-Law "
R	" J.P. " Ormond " &
I	" Utility " usual prices
R	Vernior, no dia. 2/6
E	5 vane 3/8, 7 3/8
S	Polar types " 10/6
	<b>Variable Leaks.</b>
	Miltron 0-7 meg. 9/-
	Watmel 0-5 meg. 2/6
	Lissen type " 2/6
	Resistances 2/6
	<b>EBONITE DIALS.</b>
	Engraved 3" " 7d.
	Knobbed type 1/-
	2 1/2" Phil. Type 6d.
	<b>Transformers L.F.</b>
	Radio Inst. (new) 25/-
	Silvertown " 21/-
	Igranic 21/- & 20/-
	Burndept (new) 24/-
	Reliability 10/- & 12/6
	Ferranti " 17/6
	Xtraordinary " 8/-
	Tangent 12/6 & 14/6
	Royal " 20/-
	R.A.F. Modulation.
	Telephone & 10/1R
	" Undyne " all 8/-
	H.F. Tangent " 8/6
	Melchior's " 10/-
	Ocejan 900 " 5/6
	" 300 m. 4/8
	Formers only " 1/-
	<b>File Resistances.</b>
	Good quality 1/6
	Igranic " 4/8
	Vernior type " 7/-
	Ormond 2/- Ajax 4/-
	Burndept " 5/-
	T.C.B. 4/- & 5/-
	Microstat " 2/6
	Feeless Jr. " 2/6
	Mic-Met-Detector 3/-
	Amplion Jr. " 27/6
	<b>NEW LISTS.</b>
	Eureka Transformers
	No. 2 " 22/6
	Concert Grand 30/-
	R.I. Chokes " 10/-
	Shaw's Hertzite 1/-
	<b>Jacks 4-Contact.</b>
	Bank of 2 " 1/8
	Single Jacks " 1/-
	Standard Plugs 1/8
	Potentiometer 300
	ohms ex-Govt. 5/-
	Hydrometers " 3/6
	Microphones " 2/-
	Tapping Keys 2/-
	H'phone Cords 1/-
	Alum. H'dbnda. 2/6
	All " Igranic " Lissen,
	" Burndept," " Goods.
	<b>Coil Holders.</b>
	Ashley fixed " 2/6
	" moving " 3/6
	Igranic 3 Set " 8/6
	Ebonite 3 Coil " 8/6
	" 2 Coil " 2/6
	Single moving 1/7
	" Fixed type 5d.
	Recessed do. " 8d.
	<b>Switches.</b> Ebonite
	" Tumbler 1 1/2
	D.C.O. " 1/6
	S.C.O. " 9d.
	Devar D.C.O. 3/8
	" D.P.S.T. 2/9
	Utility 2-way " 4/-
	3w 5/- 4w 6/- 6w 8/-
	Lever Type Stooled
	Miniature Turn 6d.
	Lissen 2-way " 2/9
	" Series pad. 3/9
	Double-arm do. 2/-
	<b>M.P. Switch Sets.</b>
	D.C.O., 1/6 S.C.O., 9d

QUALITY **DUCO** SERVICE

**Crystal Detectors**

DUSTPROOF PATTERNS

Enclosed Horizontal Type. For panel mounting. Splendidly constructed of nickel-plated brass and ebonite, and rendered dustproof by means of cylindrical glass.

List No. 15419 .. each 3/9

Enclosed Vertical Type. For panel mounting. Constructed of nickel-plated brass fittings and ebonite—highly finished. Perfectly dustproof.

List No. 15418 .. each 4/6

Both types have been improved by addition of micrometer adjustment

**Brown Brothers**

— Allied Companies —

THOMSON and BROWN BROTHERS, LTD.  
 BROWN BROTHERS (Ireland), LTD.

Wholesale only. Head Offices and Warehouses:  
 GREAT EASTERN STREET, LONDON, E.C.2.  
 118, GEORGE ST., EDINBURGH. And Branches.

described by Mr. Herbert K. Simpson, namely, the Type W<sub>4</sub>, April 9, 1924 issue. I made this set up, and am getting splendid results about 1½ miles from 2LO. I can cut London right out and bring in 5XX at quite comfortable strength; all B.B.C. stations come in at full volume on a loud-speaker. My aerial is a triple indoor arrangement, consisting of No. 14 gauge D.C.C. wire. For Continental work I use a frame aerial, consisting of Litzendrahf wire. The following are some of the stations received on the frame, giving the mileage from 2LO: — SFR Radio-Paris (200 miles); PTT (200), Radio-Iberica, Spain (800); EBX Cartagena, Spain (950); SBR, Brussels (195); NSF, Hilversum, Holland (240); LP, Königswusterhausen, Germany (900). SFR, PTT, SBR, and NSF come in on speaker with fine volume.

I live in dwellings, and am at the height of 65 ft. This set is very constant, with excellent tone and volume.—Yours faithfully,

CHAS. W. NEWSON.

E.C.2.

**A THREE-VALVE NEUTRODYNE RECEIVER**

SIR,—I recently tried out a "hook-up" of the Three-valve Neuro-

dyne Receiver described by Percy W. Harris in No. 1 of *The Wireless Constructor*. I heard a voice almost at once, after 12 midnight, and after a little tuning found that it was an American station announcing the scores of some game. There was a strong whistle in the set, so I tuned out the whistle and the voice, and started again. After a little work I got the voice again without any whistle.

The voice was quite plain, announcing that the station was going to switch over for the opera, "Il Trovatore." I heard all the first part quite well, in fact, good enough to really enjoy the music. There was some fading, but not much; very few atmospheric, and very little Morse interference.

This was the first time I ever heard America, and I had no idea it ever came in so well.

Wishing *The Wireless Constructor* all the success it so well deserves.—Yours faithfully,

A. W. HAMILTON.

Belfast.

P.S.—The station broadcasting the opera was the Westinghouse Station, WBZ, Mass.

**ENVELOPE NO. 9**

SIR,—Many congratulations to Mr. Simpson on designing such a wonderful set as "The Efficient Single Valve." I made this set when it was first published in Envelope No. 9, and since then have added one stage of L.F. amplification as designed by Stanley G. Rattee in the September *Modern Wireless*. I now can receive at good 'phone strength PTT, Radiola, Petit Parisien, Eiffel Tower, Radio Belgique and Radio Iberica, and, in addition, many other Continental stations at inferior strength. Recently I tried for America; I was successful in hearing WBZ at good 'phone strength. I consider this a splendid feat for a detector and L.F. amplifier. Wishing *Wireless Weekly* and Radio Press every success,

—Yours faithfully,

R. WILLIS.

**AN IMPROVED TWO-VALVE SET**

SIR,—I am just writing a few lines to let you know I have built the "Improved Two-valve Set" described by Stanley G. Rattee, M.I.R.E., in the January *Modern Wireless*. The set is

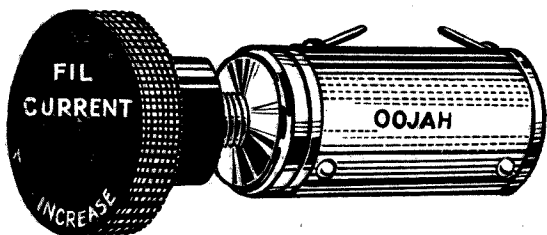

**OOJAH GRAPHITE PILE RHEOSTAT**

Price 4/- each.

The OOJAH GRAPHITE PILE RHEOSTAT is a stepless resistance variable from approximately 15 ohm (minimum) to 40 ohms (maximum).

Suitable for Dull Emitter and all other types of valves.

Regardless of what valve set you have, the OOJAH GRAPHITE PILE RHEOSTAT will improve it. Its small cost will pay you many times over in added pleasure and satisfaction.

From all Dealers or direct from the Manufacturers:

**GREENSLADE & BROWN,**  
LANSDOWNE ROAD, CLAPHAM, S.W.8.

Telephones: Brixton 639 and Brixton 325r.

**Quality RADIO DUPLEX BASKET COILS.**



The most efficient inductance coil made for short waves, mounted on standard plugs. No wax or varnish used.

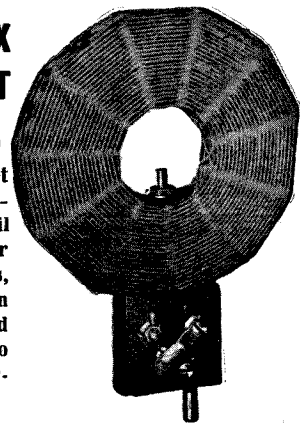

Number	Mounted	Mounted with Reaction Reverse Switch	Unmounted.	Number
25	1 6	3 0	0 9	25
35	1 9	3 3	1 0	35
50	2 0	3 6	1 3	50
75	2 3	3 9	1 9	75
100	2 9	4 3	2 3	100
150	3 0	4 6	2 6	150
175	3 6	5 0	2 9	175
200	3 9	5 3	3 0	200

Postage: 3d. each. Set of eight coils post free.

If your dealer cannot supply, we send post free if you mention his name and address.

**GOSWELL ENGINEERING CO., LTD.**

12a, PENTONVILLE ROAD, LONDON, N.1.

Liberal Trade Terms.

LIST FREE.

'Phone: North 305r.

working well and giving very good results.

I should like to give you a list of stations that I have tuned in. On test, I received all the B.B.C. stations, nine main and ten relay stations, also eight Continental stations, using No. 75 and 50 coils. I use Electron wire as aerial, and copper wire as earth. I might say I receive them all in the daytime as well as at night; also, I receive Cardiff at any time he is working. There are many here in North Wales with four-valves and three-valves who have not had this station for four months. I have also received the following:—5XX, Radio Paris, Eiffel Tower, Petit Parisien, Komarow, PCFF, Amsterdam, Lausanne, HB2, Zurich, Frankfurt, Munster, Voxhaus, Radiofonica - Italiana, K b e l (Prague), Madrid, PA5, LP (Berlin), and many other stations. All these have been received with home-made coils. I might also say that I got 2LO, 5IT, 6BM, 2ZY, 6LV, and two others, which I think were 5NO and 5SC, very clearly on a loud-speaker (Sterling).—Yours faithfully,

T. R. JONES.

Rhondda, Wrexham.

## Choke Modulation Calculations.

In Captain Round's article in our last issue Fig. 1 was incorrectly shown. The dimensions of this speech choke should be 4,000 turns

wound on a stalloy core about 16 sq. cms. cross-section and about 40 cms. length round the axial line of the core. The correct diagram is reproduced herewith.

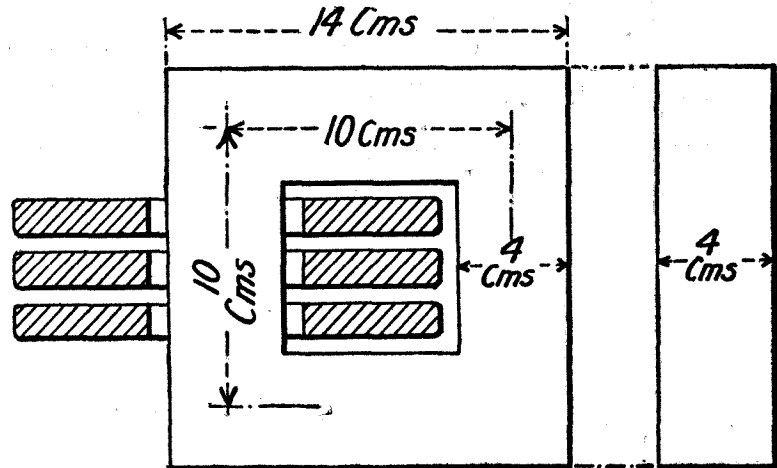

The dimensions of the core of the speech choke referred to in Captain Round's article in the Feb. 18 issue.



**The Law of Supply and Demand**

When the Demand exceeds the Supply, the price of the article tends to increase; when the Supply exceeds the Demand, the price tends to decrease. If full value is offered, the Demand will always be greater than the Supply, and there will be no need to reduce the price of the article. Moreover, the quality will remain the same. Such is the case with the

**C & S DULLEMITTER**  
2 V. 0.2 A.  
WHICH RECEIVED  
**NEW ZEALAND**

PRICE **12/-** EACH

*Show cards are now available.*  
**CRAIK AND SMITH,**  
ALLEN STREET : : LONDON, E.C.1  
*Phone: Clerkenwell 7346.*

Barclays 765.

# HAWK COILS

**MAXIMUM**

Efficiency

—

Strength

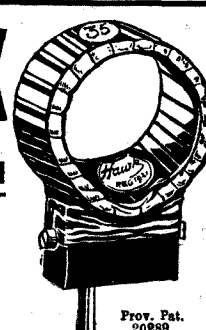

**MINIMUM**

Capacity

Damping Effects

Resistance

Prov. Pat. 20289

WATERPROOF

Prices below

Coil	Wave Length using '001 Variable Condenser in Parallel		PRICE.
	MAXIMUM	MINIMUM	
18	—	—	2/-
25	395	190	2/4
30	435	240	2/4
35	515	360	2/6
40	680	370	2/8
50	835	485	3/-
75	1250	600	3/4
100	1820	815	3/10
150	2300	960	4/8
200	3100	1870	5/4
250	3750	2200	5/8
300	4500	2300	6/-
400	4950	2500	6/6

Sold by all Wireless Dealers

Sole Manufacturers!

## The Hawk Coil Co., ST. MARY'S ROAD, SURBITON, SURREY.

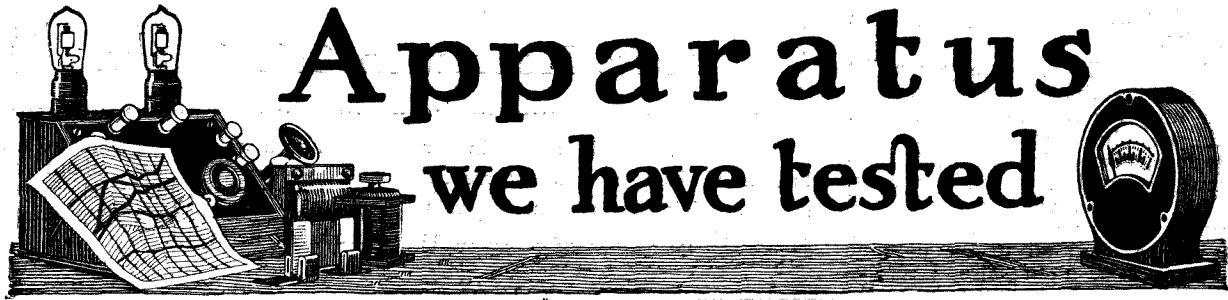

# Apparatus we have tested

Conducted by A. D. COWPER, M.Sc., Staff Editor.

## Ediswan .0003 $\mu$ F "Square-Law" Condenser

A variable condenser of .0003  $\mu$ F maximum capacity has been submitted for test by Messrs. Edison Swan Electric Co., Ltd., No. WL 259, in which the moving plates have been given the snail-cam shape which results in the capacity at any adjustment being approximately proportional to the square of the angle through which the controlling spindle has been turned.

This is a substantially built instrument, of fine finish and evidently thoughtful design, though many amateur experimenters would desire to see substantial terminals in place of the soldering-tag and extra lock-nut on one pillar which are to provide the necessary elec-

trical connections. Contact to the moving vanes and a smooth operation are ensured by a spring

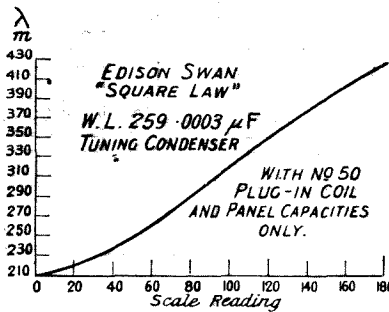

The curve referred to in the test report.

washer on the central spindle. Thick moulded composition end-

plates are fitted, and the instrument is arranged for mounting behind the panel, or horizontally on a base-board by small screws. It can be used on a temporary base-board without any fixing, if required. A good quality bevel scale and knob are provided.

On test, the insulation-resistance was excellent. The minimum capacity (on account of the use of insulating end-plates and the wide separation in the minimum position possible with the peculiar shape of the plates) was the satisfactory figure of 8.5  $\mu$ F, the maximum almost exactly .0003  $\mu$ F. The operation in actual reception was most satisfactory, and it can be described as a "low-loss" condenser. The actual wave-length scale, when plotted with an ordinary

For Selectivity,  
Sharp Tuning &  
Efficiency use

## "Tangent" Tuning Coils

The Unshrouded Coil with a guaranteed  
LOW SELF-CAPACITY.

Copy of N.P.L. signed Report on application.



Coil No.	25	35	50	75	100	150	200	250
Self-Capacity	8	9	25	31	22	16	22	22
Price	4/3	4/3	4/3	4/6	5/-	6/-	7/-	7/6

COMPLETE SETS { 4 Concert Coils (W/L 250 to 1180) - - - 16/- the set.  
11 Concert Coils (W/L 250 to 9500) - - - 67/- the set.

Obtainable from all good dealers—but in case of difficulty—write us.



Unshrouded Efficiency.

**GENT & CO. LTD.** Est. 1872.

Faraday Works

LEICESTER

LONDON: 25, Victoria Street, S.W.1.

NEWCASTLE/TYNE: Tangent House, Blackett Street.



standard type of No. 50 coil, such as might be used in a tuned-anode or secondary circuit, with only the distributed capacity of this and casual capacities in the test-panel in addition, showed a fairly flat graph, but not conspicuously approaching to the ideal straight-line law which should be given in the theoretical (but practically unattainable) case of zero minimum and casual capacities.

**"Radion" Valves**

Messrs. Radions, Ltd., have sent for test samples of the latest production of their "Radion" valves, which were reviewed in these columns on an earlier occasion. These are rated at 3.6-4 volts and .48 amperes filament current, and 30-80 volts anode potential, and are described as "general purpose" valves. The globe has a yellowish-brown discolouration, and the anode is in the form of a narrow vertical cylinder, the grid being a spiral which is neither of very fine mesh nor extremely close to the filament.

As evidently these valves are intended to be run from a 4-volt accumulator, and in most cases probably will be so operated, it was of interest to determine their performance under the conditions in, e.g., a three- or four-valve set used

with a not over-large accumulator towards the end of its charge, a state of affairs which is by no means unique.

At the lower filament rating, i.e., 3.6 volts, the filament of each of the valves tested showed very uniformly a demand of approximately .4 amperes, and a saturation plate-current (with 80 volts H.T. and heavy positive grid-bias) of the order of a milliampere, so that evidently they could be safely operated under these conditions for most purposes. The characteristic curves for 30, 50 and 80 volts plate-potential determined for one valve showed a fairly close grid control, a mean amplification factor of 7 between 50 and 80 volts H.T. (a fair average figure for a G.P. valve), and the desirable straight portion for distortionless amplification. For H.F. amplification and detection a plate voltage of between 30 and 50 volts was indicated, and for L.F. amplification an H.T. voltage up to the upper rating limit with fairly substantial negative grid bias from 3-6 volts. These figures were confirmed in actual reception tests with the valves. The latter differed appreciably amongst themselves as to filament voltage required for a given emission, but were each safely below the 4 volts limit, and the characteristics showed

similar shapes. For detection and H.F. amplification these valves compared well with the standard R, oscillating, however, with rather less ease. The mean A.C. impedance is rather high, 60,000 ohms, as compared with the more usual figure of 30,000 to 40,000 ohms for a G.P. bright emitter valve. In efficient transformer coupled L.F. amplification, excellent results were obtained, best, of course, with the filament somewhat hotter than implied by the minimum rating of 3.6 volts. With proper grid-bias, as indicated, good distortionless loud-speaking was obtained with ample H.T.; and provided the right bias was used, a considerably higher plate voltage was successfully applied for reception of loud signals which gave a large grid-voltage swing in the second stage of L.F. amplification. At the moderate price asked for these valves they can certainly be recommended for general purposes.

**Gibson Terminals**

A range of terminal fittings, equipped with a special wiring device for gripping securely a flex connecting wire, has been sent for our inspection by Messrs. The Gibson Terminal Co.

The several different types, which replace the common tag



**Another Guaranteed  
BRETWOOD Speciality  
is our improved  
ANODE RESISTANCE**

**BRETWOOD  
Patent Valve Holder**

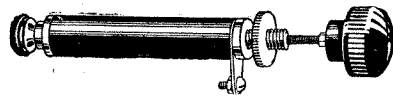

Your poor reception is probably caused by faulty valve holders Fix Bretwoods' and get the maximum results obtainable. Easy to fix. Positively no leakage or capacity effects. Perfect contact. Can be mounted on front or back of panel. Price 1/9 Postage 3d.

which gives accurate readings consistently from 10,000 ohms to over 100,000 ohms. This BRETWOOD Component is particularly suited for the ST100 circuit (Modern Wireless) the super sensitive circuit (Popular Wireless) and for resistance coupling, etc.

It is constructed on the same principles that have made BRETWOOD Components famous and, of course, it carries the BRETWOOD Guarantee. Price 3s. Postage 3d. (Patent No. 20292/23.)

**BRETWOOD ANTI-CAPACITY SWITCH**

Bretwood Specialities are known throughout the wireless world to be the last word in scientific achievement, and constructors will welcome news of a further Bretwood Product, an Anti-Capacity Switch, the principal features of which include:—

Absolute freedom from capacity effects—Perfect contact—Workmanlike finish and neatness of appearance—Simple single hole fixing and Easy to make wiring connections. Special spring loaded balls in the base, make the Bretwood Switch wonderfully smooth in action and ensure clean and perfect electrical contact at all times. It is conveniently offered to wireless constructors as the Anti-Capacity Switch *par excellence* and of course it carries the famous Bretwood Guarantee. Price 5/- Postage 3d.

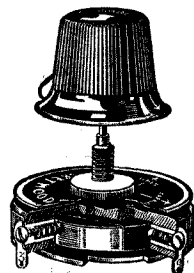

**BRETWOOD LTD.**  
12-18 London Mews, Maple St., London, W.

All Bretwood specialities are obtainable from most Wireless Dealers.

**EASY BUILDING—SURE SUCCESS**

can be obtained by all readers who write now for full details of Radiax range of sets for home construction. Also free descriptive booklet with instructions and diagrams.

**"How to Build your Radio Station."**

**RADIAX  
UNIVERSAL  
RECEIVERS**

are powerful regenerative sets which will deal efficiently with all wavelengths and embody detail refinements which few other sets, however expensive, can boast. They are wonderful for distant reception. Supplied complete with plan, diagram, fully drilled and engraved panel, and every detail required.

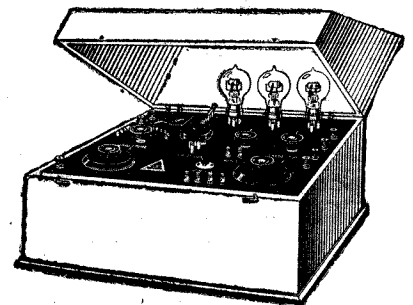

The following is a small selection:

	Constructor's Sets. Valve Units from	Completed & Tested Sets. Valve Units from 27/6
No. 31 P 1 Valve Reflex	£4 15 0	£6 12 6
No. 24 P 2 Valve Set	£4 15 0	£6 12 6
No. 26 P 3 Valve Set	£7 5 0	£10 17 6
No. 28 P 4 Valve Set	£9 15 0	£15 0 0
No. 30 P 4 Valve Set	£9 7 6	£15 0 0

(Plus Marconi Royalty, 12/6 per valve.)

In addition to the above free literature, send 3d. stamps for Complete Components Catalogue.



**RADIAX Ltd.**, 50, Radio House, Percy Street, Tottenham Court Rd., London, W.1.  
3 minutes from Tottenham Court Rd. and Goadge St. Tube Stations.  
Phone: Museum 490.

type, have insulating sleeves coloured either red or black; the end of the flex connector is held securely in these terminals by a device consisting of an arrangement of small holes and slots in the brass body of the terminal, through which the bared end of the flex is to be threaded. The sleeve then screws down over the whole, nipping the wire tightly in place and giving both excellent contact and a neat finish. The various patterns have plain, short pins, small and large diameter split ends, long taper pins, flattened hooks (for application to W.O. type terminals), and large spades respectively, whilst sockets for affixing in the panel are supplied for two sizes of split-ended terminals. For rapid attachment and quick alteration of connections this method can well be recommended, using the number 5 or 6 of the series.

Whilst they are not of the inexpensive variety, these terminal fittings are well finished, and will evidently give satisfaction and long wear in actual use. Their appearance is decidedly attractive.

**"Micro-Vernier" Two-way Coil-holder**

Messrs. London Electric Stores, Ltd., have submitted for test

samples of their "Micro-Vernier" two-way coil-holder, for panel mounting. This has a substantial ebonite and metal frame, to be affixed to the panel by four small screws (which are, however, rather short for any panel thicker than  $\frac{1}{4}$  in.). One coil-plug has a motion over about 100 degrees of arc, with the usual controlling knob and spindle projecting 3 in. from one side of the frame. The other coil-plug is also pivoted, and is moved only one way in the other direction through an angle of a few degrees against a strong spring, by a mechanism consisting of a micrometer screw-controlled metal knob riding up a ramp or cam surface formed on one side of the plug. The result is an exceedingly fine, steady adjustment of the coupling, and practically complete freedom from backlash. The micrometer screw is controlled by a similar spindle and knob, parallel and conveniently close to the coarse adjustment handle.

The device was found, on trial, to operate very well indeed, and to give the close adjustment of reaction coupling necessary for efficient reception and the avoidance of interference. The instrument appeared to be well made and neatly finished. On test, the electrical insulation proved excellent. By

proper tightening of the side bolts the holder would operate smoothly with the largest sizes of plug-in coils in ordinary use in telephony reception, even when horizontal. Connections are to be made to small terminal screws on the plugs by the ordinary flexible conductors.

We can certainly recommend this robust, and at the same time, sensitive holder.

**"Standard" Three-way Coil-holder**

A sturdy three-way coil-holder of conventional design and moderate price has been submitted by Messrs. London Electric Stores, Ltd. This has the usual central fixed plug, mounted between the side plates of a strong ebonite and metal frame, which is fixed on the panel by four small screws. The two moving coil-plugs are mounted on spindles at each end, controlled by knobs which are well away from the coils (thus avoiding hand-capacity effects), and have a movement through about a right-angle.

On test, the insulation resistance proved excellent, and the device operated smoothly. Workmanship and finish were good, and it appeared to be well worth the moderate price asked for it, for use in cases where close regulation of coupling is not required.

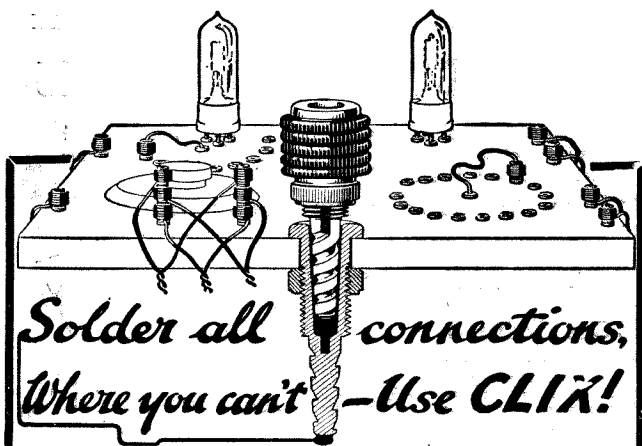

*Solder all connections, Where you can't - Use CLIX!*

**CLIX PROVIDES AN IDEAL POINT FOR SOLDERING**

- Retail Prices—  
**CLIX with Locknut 3d.**  
**CLIX Insulators (6 colours) 1d. each**  
**CLIX Bushes (6 colours) 1d. pair**

**Perfect contact**—instantaneously—everywhere.

The tapered design of CLIX plugsocket ensures full surface contact in every one of its countless applications.

That's why CLIX, the **Electro-link with 159 uses**, supersedes all forms of Plugs, Terminals and Switches, and has standardised the wiring of all radio circuits.

Obtainable from all Wireless Dealers or direct from the Patentees & Manufacturers:

**AUTOVEYORS, LTD**

Radio Engineers and Contractors

84 VICTORIA STREET, LONDON, S.W.1

**THE CENTRE OF THINGS**

More than any other single Component the variable condenser can make or mar the quality of your reception.

More than any other condenser the Bowyer-Lowe Square Law Condenser proves its superiority by the results it gives—in volume, selectivity and musical tone.

You can fit it in your present sets without making any structural alteration. Supplies can now be given, by dealers or direct, from stock.

**BOWYER-LOWE SQUARE LAW CONDENSERS**

Write for complete catalogue, containing full price lists of these tested parts. Send 1½d. stamp for postage.

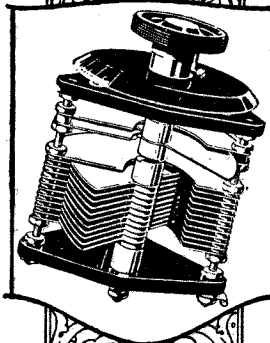

**Bowyer-Lowe Tested Radio Components**

Bowyer-Lowe Co. Ltd. Letchworth.

# Information Department

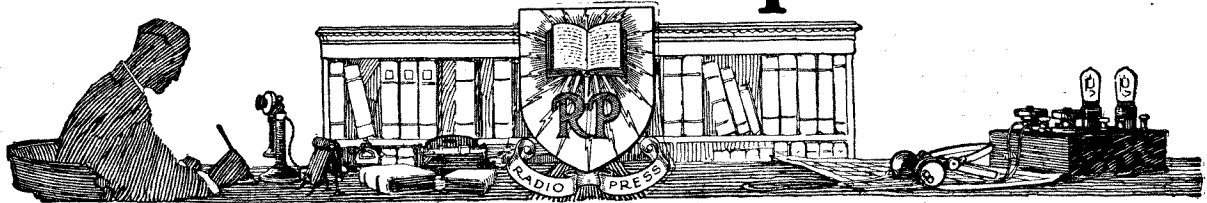

SUPPLIED BY RADIO PRESS SERVICE DEPT., LTD.

**T. R. B. (BERKHAMPSTEAD)** is building his first set, and has some little doubt as to the exact connections to his filament resistances. He states that his wiring diagram does not show whether the two wires should be connected in any particular order to the end of the resistance wire winding of the rheostat, or to the moving arm.

Quite a number of questions are received upon these general lines, and we take this opportunity of pointing out that electrically it makes no difference in any normal circuit which method of connection is adopted, that is to say, whether the moving arm of the rheostat is connected to the valve filament or to the L.T. terminal. It is purely

a matter of constructional convenience.

**A. E. L. (MANCHESTER)** states that he lives in a flat where it is impossible to obtain an outside aerial, and asks our advice regarding the use of a connection to the gaspipe for an earth. He has been told that this involves serious risks of explosion, although the gaspipe in question is no longer used, the supply having been cut off at the mains.

In general, the use of gaspipes is strongly to be deprecated, since, in the event of an aerial being struck by lightning, there is no knowing how far the discharge will run along the pipes, whether they contain gas or not, and it is quite possible that in a case like this it

might result in a serious fire by travelling so far along the pipes that a portion would be reached which is still filled with gas, a spark at a bad joint serving to burst the pipe and ignite the escaping gas. It should not be forgotten, however, that all this reasoning applies only to an outside aerial, since an inside aerial does not seem to stand much chance of picking up a lightning discharge, and it would appear that the risk is extremely remote in such a case. However, it is probably wise to be on the safe side, even here, and use some other form of earth connection, such as a crude form of counterpoise obtained by laying a number of wires under the carpet, a connection being brought up to the earth terminal of the receiving set in the ordinary manner.

## AMPLIFY WITHOUT VALVES

BY THE AID OF THE

### "DETECTAVOX"

Can be clamped direct to the earpiece of a **CRYSTAL RECEIVING SET**. A supersensitive instrument that really does what is claimed for it. **Price 17/6**. Accessories needed are Transformer, 17/6, and 3-volt Dry Battery.

Our 44-page **New Radio List** illustrates this and hundreds of other Radio Components. Send 4d. in stamps and secure a copy at once.

**ECONOMIC ELECTRIC LTD.** Head Office: 10, FITZROY SQUARE, LONDON, W.1. Showrooms: 303, EUSTON RD. N.W.1

## NEW VALVES FOR OLD!

Whenever your valves burn out or filaments are damaged in any way, send them to us and we will repair them equal to new. Perfect reception is guaranteed with our repaired valves, which are returned to you

### WITHIN SEVEN DAYS

D.E '06, 12/6. D.E 2v. '25 to '3 amp., 10/6  
Price List for Power Valves on application.

Liberal discount to Wireless Agents, Terms on application.

### The North London Valve Repairing Co.

22½, Cazenove Road, Stoke Newington, N.16.

WE ARE ALWAYS AT YOUR SERVICE.

## Scientific Research

after years of experiment has now produced this laboratory crystal which we have called

### "LANITE."

All natural product crystals now entirely superseded. Lanite is extremely sensitive all over on account of its unique crystalline structure, amazing volume and purity of tone.

If any difficulty in obtaining send 1/9 direct to the laboratories:

**Lanite Laboratories,**  
6 Booth St. East, C.-on-M.,  
Manchester.

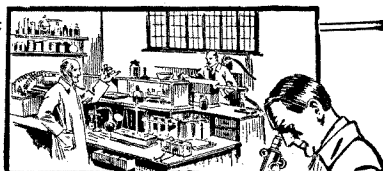

Sold in this box complete with Lanidium Catswhisker and leaflet containing circuit diagrams and other information that makes for 100% efficient reception.  
Price . . . . . 1/9

**LANITE**  
The Ultra Sensitive  
CRYSTAL



# Valves Repaired Promptly and Perfectly

Let us send you this useful Booklet. Gives curves of Radion Valves, prices for repair work, and shows what service your accumulator should give.



Bright Emitters 6/6  
Dull Emitters:  
2 volt type 9/-  
.06 type 10/6

**RADIONS LTD.,** Bollington, nr. Macclesfield

**TEST WITH THE BEST OF THE REST**  
and you'll know why

**"CLARKE'S ATLAS"**  
**LOW LOSS COILS**  
PATENT No. 215053

are the natural choice of the expert!

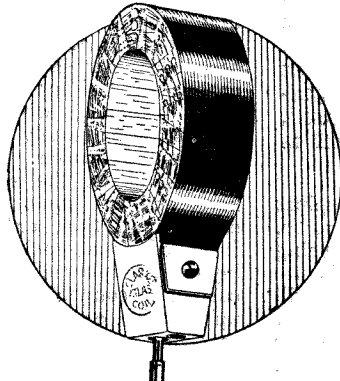

They conserve these minute particles of energy received on your Aerial. Give you **DISTANCE, SELECTIVITY,** and **VOLUME.** Are sound in design and mechanically strong.

Offer the **LEAST POSSIBLE RESISTANCE TO HIGH FREQUENCY CURRENTS,** and consequently are **THE MOST EFFICIENT COILS EXTANT.**

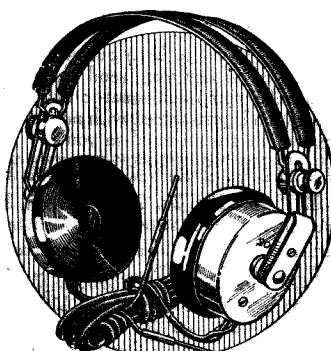

Clarke's **"ATLAS"**  
C. E. B.  
'PHONES

*The 'Phone de Luxe*

These headphones, which are designed to give you every comfort in use, are specially sensitive, and have a total resistance of 4,000 ohms. The 'Phones, which have double-leather Head Bands, are supplied with adjustable Diaphragms and long flexible cords, and the metal parts are nickel-plated. Eminently suitable for Crystal or Valve Sets.

Price **15/-** per pair

Say **"ATLAS"** and be safe.

**SOLE MANUFACTURERS:**  
**H. CLARKE & Co. (Manchester) Ltd.**  
RADIO ENGINEERS  
Atlas Works, Old Trafford, Manchester.  
Phones: 683 & 793 Trafford Park. 'Grams: "Pirtoid, Manchester."



**Contact**  
*Immediate - Perfect and Permanent*

Certain reception with as many head-phones as you wish. Experimental circuits wired-up, tried and re-wired in no time. No more need for the messy soldering-iron. These are the advantages you get with Newey Snap Terminals; although their adaptation is simplicity itself, their efficiency is proved.

FOR WIRELESS PHONE AND BATTERY CONNECTION

**NEWHEY SNAP**  
TRADE MARK

**TERMINAL**  
MADE IN - PATENT NO 14130/24 - ENGLAND

CONTENTS OF COMPLETE SET.

- 8 Terminal Studs
- 6 Multi-Connectors
- 4 Coloured Connectors
- 8 Discs (Black, Red and Blue)
- Phones + Phones -
- High Tension + High Tension -
- Low Tension + Low Tension -
- Earth Aerial

Complete with instructions.

**EL-BE UTILITIES**  
INSULATING PANEL BUSHES.  
(Insulation Test, 25,000 volts.)

2 or 4 B.A. Bushes 1/- dozen. **POST FREE**  
1/3 " "

(Will take most 1-hole fixing components.)  
**VALVE HOLDER BUSHES** 2/6 dozen.  
Make your own L.C. valve holders.

**LEIGH BROS.** 37, Sidmouth St., Gray's Inn Road, LONDON, W.C.1. 'Phone: Museum 4192

**REPAIRS TO HEADPHONES TO LOUD SPEAKERS TO COILS**

REWOUND to any RESISTANCE & MADE EQUAL to NEW.  
PRICE QUOTED ON RECEIPT OF INSTRUMENTS.  
PROMPT DELIVERY.

**The VARLEY MAGNET COMPANY**  
Established 26 Years. Phone: Woolwich 888. WOOLWICH, S.E.18.

**EBONITE**

Sheet rod and tubing in all sizes kept in stock and cut to any required size while you wait, or sent by post on receipt of cash.

**WE CAN TURN ANYTHING IN EBONITE.**  
**BURGE, WARREN & RIDGLEY, LTD.,**  
91/92, GREAT SAFFRON HILL, LONDON, E.C.1. 'Phone: Holborn 50

For Advertisement Rates for all Radio Press publications apply to—

**BARCLAYS ADVERTISING LTD.,**  
Bush House,  
'Phone: City 9911. Strand, London, W.C.2.

It will pay you always to watch WIRELESS WEEKLY Advertisements.

**ON SALE  
FEB. 28<sup>TH</sup>**

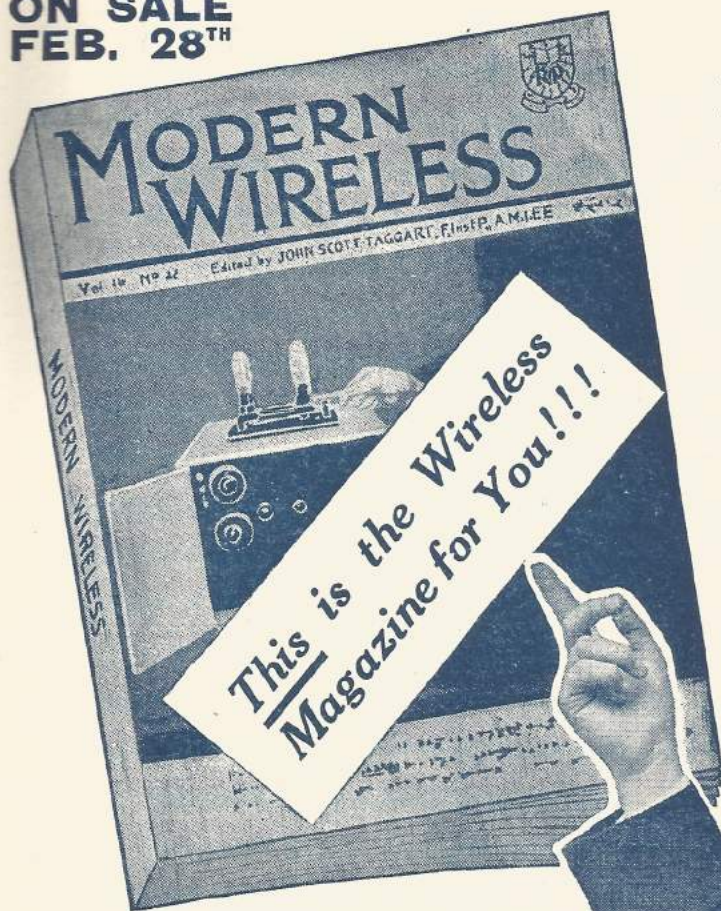

**BUY THE SPLENDID MARCH  
DOUBLE NUMBER  
156 PAGES for 1/6**



**FREE Blueprint with every copy.**

A Selection from the Contents :

**A SIMPLIFIED 3-VALVE DUAL RECEIVER.**  
Designed by John Scott-Taggart, F.Inst.P., A.M.I.E.E.

**A CABINET 3-VALVE NEUTRODYNE RECEIVER (Free Blueprint of this).**  
By Percy W. Harris, Member I.R.E.

**A VISIT TO THE EIFFEL TOWER STATION.**  
By Capt. L. F. Plugge, B.Sc.

**CHOKE AND TRANSFORMER AMPLIFIERS.**  
By Capt. H. J. Round.

**MORE TRAP CIRCUITS.**  
By John Scott-Taggart, F.Inst.P., A.M.I.E.E.

**POSTBAG PUZZLES.**  
By Arthur R. Burrows, Assistant Controller and Director of B.B.C. Programmes, FRAME AERIALS.

**HOW TO MAKE A NOVEL CRYSTAL RECEIVER.**  
By John Underdown.

**A SHORT WAVE SINGLE VALVE SET.**  
By Stanley G. Rastee, Member I.R.E.

**A TWO-VALVE TRI-COIL RECEIVER.**  
By John W. Barber.

**A NEW FOUR-VALVE SET.**  
By A. J. Randall.

And numerous other well-illustrated articles of interest

This, our first DOUBLE NUMBER for 1925, is fully in keeping with the policy of Radio Press, Ltd., which is to be well up with the times and to keep its readers abreast of the advancements which are always taking place in this interesting, instructive and fascinating science. This issue contains no less than 156 pages of authoritative and reliable articles appealing to all grades of enthusiasts.

The great popularity of these Special Double Numbers of MODERN WIRELESS is proved by the fact that they are invariably sold out immediately after publication. Some idea of the great scope of this Double Number can be gained from the partial list of contents given.

Two very fine articles on 3-Valve Receivers are contributed by the Editor, John Scott-Taggart, F.Inst.P., A.M.I.E.E., and by Percy W. Harris, Member I.R.E., while a Free Blueprint and full instructions for the building of the set described by Mr. Harris is included in every copy.

Make certain of your copy by ordering AT ONCE from your Newsagent, Wireless Dealer, or from any Bookstall. If unable to obtain locally, send 1/10 direct to Dept. S., Radio Press, Ltd., Bush House, Strand, London, W.C.2, and a copy will be sent to you by return.

MODERN WIRELESS is published by the Radio Press, Ltd., the largest wireless publishers in the world.

For the benefit of new readers, we would point out that owing to the clear and concise methods employed in describing and illustrating in detail the construction of sets (every one of which is tested and guaranteed by the Radio Press to be highly efficient), readers can be certain that provided they follow the instructions carefully, when building the set, success is assured.

There are many other articles of interest, including POST-BAG PUZZLES, which ARTHUR R. BURROWS, Director of Programmes of the British Broadcasting Company, has to solve, are dealt with in a very human and humorous article which he has written for this Special Double Number. CAPT. H. J. ROUND, the famous expert of the Marconi Company, and co-inventor of the Sykes-Round Microphone used so extensively in the studios of broadcasting stations, has written a special article on Choke and Transformer Amplifiers; this will be greatly appreciated by the more advanced section of our readers.

**ON SALE FEB. 28.**

DOUBLE NUMBER

**MODERN WIRELESS 1/6**

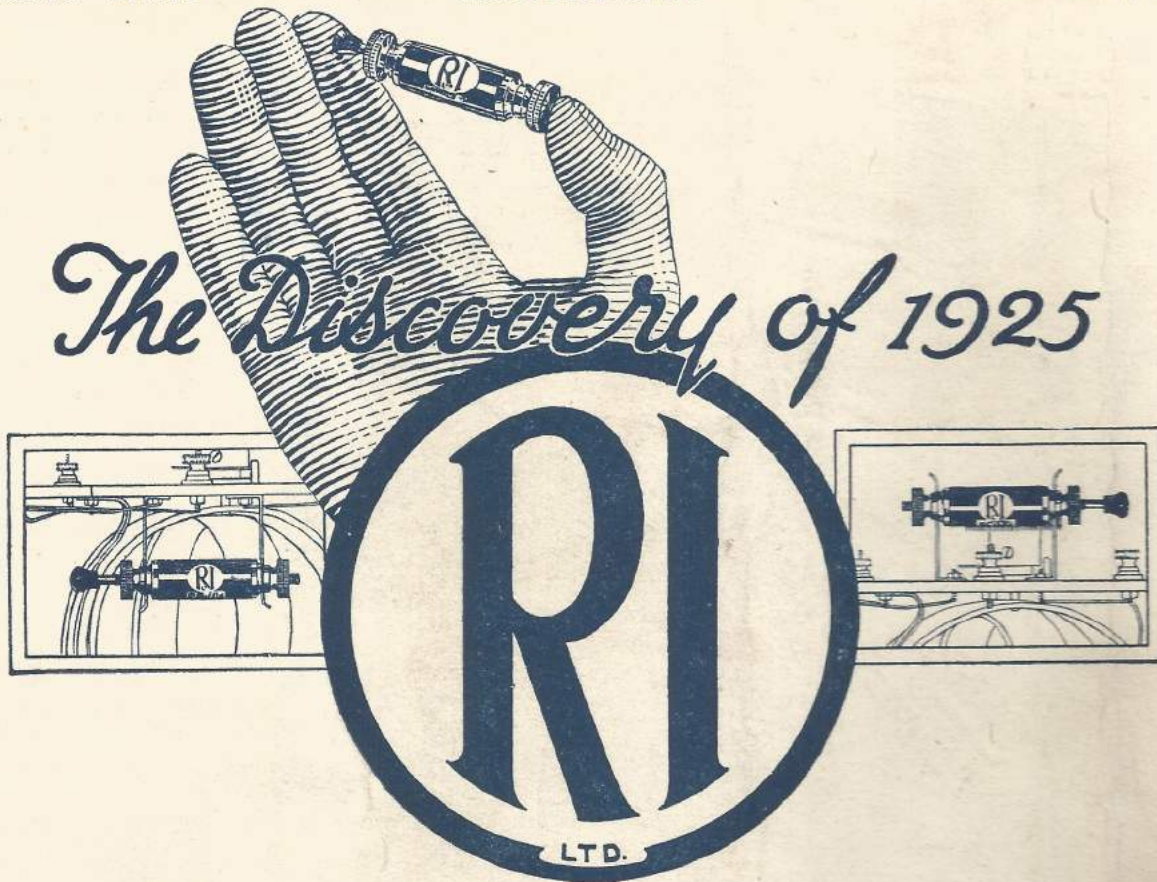

**A CRYSTAL DETECTOR THAT DOES NOT REQUIRE ADJUSTMENT.**  
 Only a wonderful scientific discovery backed by the R.I. reputation could have made this permanent mineral detector a possibility.  
 So many vain attempts have been made to attain the ideal of a detector, free from all adjustment, that the radio public have doubted that it could ever be achieved.

**HERE IS THE WAY OF IT—**

The combination of a new mineral of high refractive index, and another suitable mineral, were found to give perfect detection, irrespective of surface condition and free from the bane of catwhiskers.

There is no question of hunting for the sensitive spot. It is always everywhere on this wonderful discovery. However, the spirit of the experimenter demands satisfaction, and so one of the elements is mounted with a trigger action to change the point of contact *if desired* not *if necessary*.

As a proof of this, the manufacturers are prepared to supply the detector without the trigger adjustment. The advantages of the P.M.—

Absolute permanency under vibration.

Extreme sensitivity always everywhere.

Its inherent stability makes it particularly suitable for all valve and reflex circuit users. If you are interested, write for descriptive leaflet. If you are keen, buy one to-day.

Easy operation of any circuit in which it is employed.

Elimination of distortion if used as a rectifier.

PRICE, including metal brackets and necessary screws for mounting, 6/-

THE R.I. REPUTATION IS BEHIND IT.

Everybody is talking about this sensation of 1925. They will ask you if you have got one yet.



**Radio Instruments Ltd.**  
 12 Hyde Street, Oxford Street

Telephone: REGENT 6214 (3 lines) W.C.I. Telegrams: Instradio London.

Contractors to the Admiralty and all Government Departments.