

Wireless Weekly

and the Wireless Constructor.

Vol. 4.
No. 20

CONTENTS

A Long Range Two-Valve Receiver.

British and American Practice Compared.

A 1,600 Metre Circuit on the Omni Receiver.

Practical Wiring of the ST101 Circuit.

Experimental Station 2KW.

Jottings by the Way, Valve Notes, Box Spanners for B.A. Nuts, A Cheap Coil Stand, Correspondence, Apparatus We Have Tested, Information Department, etc., etc.

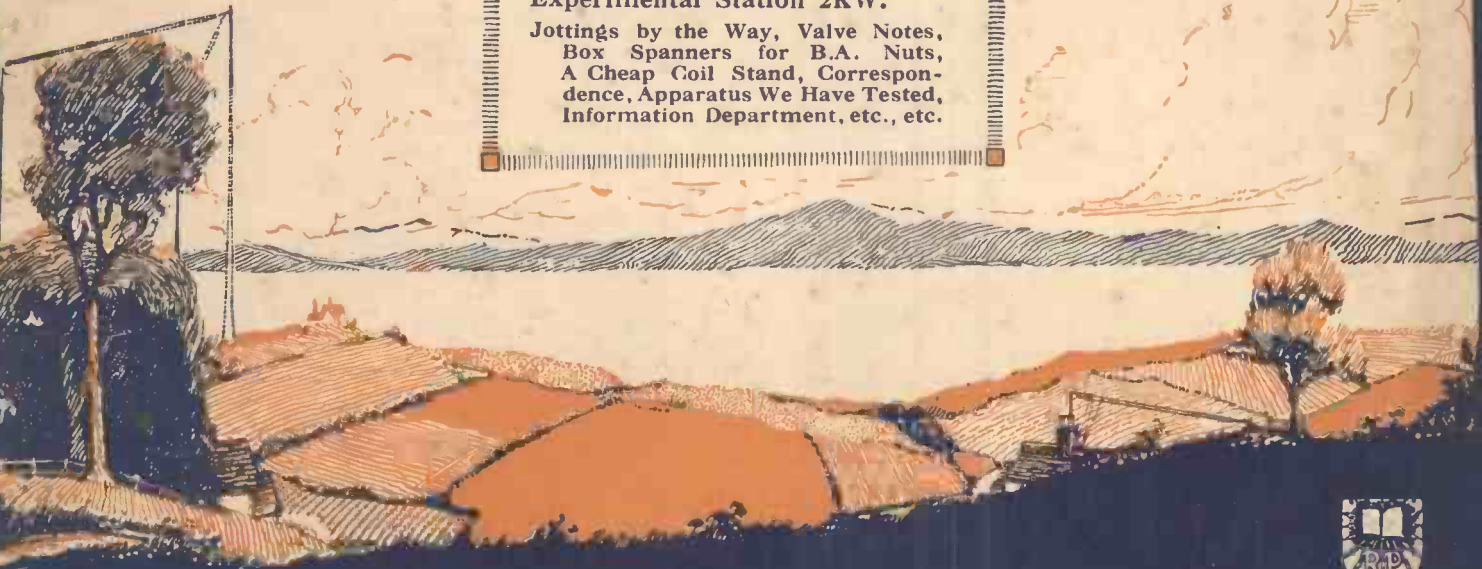

Circuits for the New Short Wavelengths

What you will see on the Burndept Stand at the All-British Wireless Exhibition

STANDS 72 and 74, BOXES 134 and 135.



Ethophone Duplex.



Ethophone Junior.



Ethophone No. 1.



*Ethophone V
(Mark IV).*



Ethophone Grand.



*Ethophone Tuner
(Mark X).*



*Ethophone H. F. 2
Receiver.*



*Ethophone Power Amplifier
(Mark IV).*



Ethophone III.

HERE are brief details of new Burndept Apparatus which you will see at the All-British Wireless Exhibition. At the same time exhibits of this apparatus will be held at our London Showrooms, Provincial Branches and Principal Agents.

RECEIVING SETS.

Ethophone Junior and Ethophone No. 1. High-grade crystal sets. Wave-length range 250-2,000 metres.

Ethophone Duplex. A five-guinea loud-speaker receiver. This entirely new two-valve set has a range of 250-5,000 metres.

Ethophone III. A powerful three-valve set for reception of home and foreign broadcast. Tunes selectively and amplifies without distortion.

Ethophone V (Mark IV). A four-valve receiver, retaining all the best characteristics of the Mark III Model, with important new features (including a self-contained selective device). Supplied to the Archbishop of Canterbury, His Holiness the Pope, Earl Haig, Signor Mussolini, the Lord Mayor of London, and the General Post Office and hundreds of satisfied users.

Ethophone Tuner, Ethophone H.F. 2 Receiver, and Ethophone Power Amplifier. A series of instruments for the more advanced worker. Wave-length range 80 to 25,000 metres.

Ethophone Grand. "Receives broadcast anywhere on any wave." The three instruments mentioned in the previous paragraph are built into a cabinet specially designed by Broadwood, and together make up what is probably the finest wireless receiver ever made. Operates on wave-lengths from 80 metres upwards, gives perfect power amplification and has absolutely selective tuning.

ACCESSORIES.

Anti-Phonic Valve Holder. A patent valve holder eliminating microphonic noises and prolonging the life of dull or bright valves.

Transformers. Steel-clad transformers, designed to give perfect results with modern valves. Three types—high ratio, low ratio, and loud-speaker output.

"Low Loss" Variable Condensers. All-metal condensers embodying entirely new features. Laboratory condensers at popular prices.

Auto-Broadcast System. A unique system by means of which broadcast music and speech can be switched on as easily as turning on the light.

Burndept Super Radio Battery. A 45-50-volt high-tension battery of very long life, completely free from noise.

We have a complete line of every possible radio accessory.

BURNDEPT

WIRELESS APPARATUS

BURNDEPT Ltd., Aldine House, Bedford St., Strand, W.C.2
LEEDS: Basinghall St. (near City Square). CARDIFF: 67, Queen St.
NORTHAMPTON: 8, The Drapery.



Wireless Weekly

Radio Press, Ltd.
DEVEREUX COURT, STRAND, W.C.2.
Tel.—Central 3763.

Assistant Editor:
PERCY W. HARRIS.
Scientific Adviser:
Prof. G. W. O. HOWE,
D.Sc., M.I.E.E.
Advisory Editors:
Prof. R. WHIDDINGTON,
M.A., D.Sc.
Prof. C. L. FORTESCUE,
M.A., M.I.E.E.

Staff Editors:
E. H. CHAPMAN,
M.A., D.Sc.
A. D. COWPER,
M.Sc.
R. W. HALLOWS,
M.A.
G. P. KENDALL,
B.Sc.
S. C. RATTEE,
Member I.R.E.

EDITED BY JOHN SCOTT-TAGGART, F.Inst.P.,
A.M.I.E.E.

Vol. 4, No. 20

SEPTEMBER 17, 1924.

Price 6d. net.

Technical Education in Wireless

One of the most surprising aspects of radio science at the present time is the almost complete lack of adequate and up-to-date technical education on the subject. During the last few weeks we have had an excellent opportunity of investigating this matter while studying applications and interviewing applicants for technical positions on the staff of Radio Press. Furthermore, we have been informed on many occasions by the larger wireless manufacturers and dealers that they, too, have great difficulty in obtaining the services of technically trained assistants. We are well aware of the existence of technical classes at various Polytechnics and Universities, but investigation goes to show that the instruction given is largely concerned with advanced theory and obsolete practice. In many cases the course wends its weary way through spark, arc, and high-frequency alternator methods, a final lecture or two being given on the valve method of transmission, to round off, so to speak, what is often called "a complete course."

We do not deny that in one or two cases very full and excellent theoretical courses are given, but these are of little practical value to the man who has to earn his living in wireless. It is too readily assumed that if a man is given a sound theoretical basis of knowledge he will be able to pick up the practical side with ease, but this is only true when the theory of the subject is developed to a far greater extent than is at present the case in radio. A theory which has been deduced from a limited number of facts may or may

not require complete revision when practical examination of the problem has led to the assembly of further facts, and we are afraid that theory is limping a long way behind practice at the present time.

Let us consider for a moment just one or two matters which the man who desires to enter the commercial side of wireless should know.

use of the wrong type of valve or transformer, unsuitable plate potentials, or other contributory causes. Without sound grounding in the principles of reflex work he will be hopelessly behind the times. It can only be the difficulty in obtaining adequately trained staff which gives rise to the pitiful displays of inefficiency so frequently found when well known commercial sets are publicly demonstrated.

There is no lack of keenness on the part of the staff concerned, and there are already enough assistants and demonstrators in the larger cities to make it worth while providing practical courses in combined theoretical and practical work for those who so badly need this type of instruction. The larger commercial firms should support such classes in every way by financial and technical assistance, and the provision of expensive apparatus, without which the work cannot be carried on.

An absolutely intimate knowledge of up-to-date circuits and practice is essential nowadays; and, generally speaking, academic institutions ignore what is going on in the outer world, with the result that many of their graduates are practically useless to commercial organisations.

In brief, there are an insufficient number of technically-trained men who are doing modern practical work.

Can nothing be done to improve this state of affairs? Have we, first of all, the necessary teachers? Wireless is a growing industry, and it should be worth while for students to regard radio as a serious and progressive profession.

CONTENTS

	Page
Some Practical Single Valve Circuits for Short Wave Reception	634
Jottings By The Way	639
Random Technicalities	641
Another Circuit on the Omni Receiver	642
American and British Radio	644
The Experimental Station 2KW	647
Valve Notes	649
Fixing Small Screws into Ebonite	651
A Long Range Two-Valve Receiver	652
Box Spanners for B.A. Nuts	656
A Cheap Coil Stand	657
Practical Back of Panel Wiring Chart	658
Correspondence	659
Apparatus We Have Tested	664
Information Department	665

First of all, he should be well acquainted with the characteristics of all the better known types of valves; he should be able to tell why distortion arises when combining a particular type of valve with a particular type of transformer. He should, for example, be able to know by a rapid examination of the set whether distortion, known to exist, is dependent upon bad lay-out, incorrect connections,

Some Practical Single-Valve Circuits for Short Wave Reception

By W. J. TARRING.

The fascination of short wave reception is too well known to comment upon, and in the following article is given many useful and interesting notes based upon practical experiment.

THE remarkable results achieved by some of our amateurs during the last few months by the use of transmissions on wavelengths in the neighbourhood of 100 metres, and the fact that the two well-known American broadcasting stations KDKA and WGY are also transmitting on these short waves, have attracted considerable attention, and it was thought that an account of some experiments in the reception of these signals with single-valve circuits might be of interest. Originality is not claimed for any of the circuits used; ideas, and in some cases the complete circuit having been culled from varying sources. The results achieved are not given as a criterion of what can be done, as the experiments were conducted during the months of April and May, by no means the best of times for DX (long dis-

signals on short wavelengths, by which is meant wavelengths of between 80 and 150 metres, certain points stand out, and, before

and where this cannot be arranged terminal nuts should be screwed down very tightly. Vibration of the set, particularly

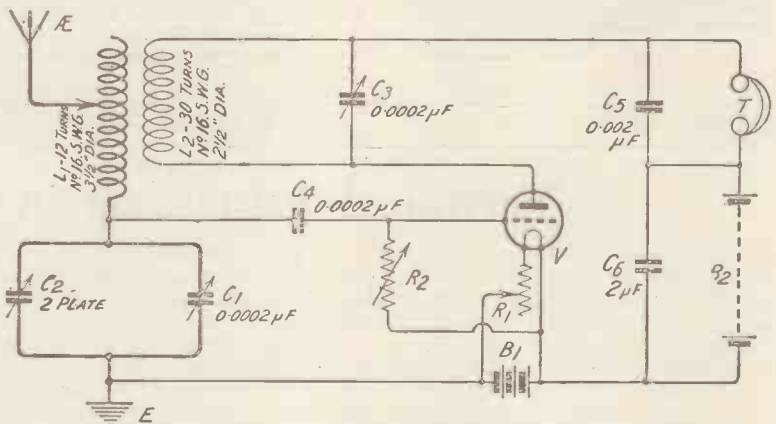

Fig. 2.—This circuit gave fair results, but would not oscillate over the full range of C3.

describing the experiments, it is proposed to touch briefly on a few of these.

of the tuning coils and valve, may give rise to crackling in the telephones, and precautions should be taken to prevent this.

It should be borne in mind that oscillatory currents flow on the surface of a wire, and that the high-frequency resistance of a conductor increases as the frequency of the oscillations flowing through it increase. In my opinion, it is therefore advisable that wire with a high conductivity and an ample surface area should be used in all circuits in which high-frequency currents are present.

Short Wiring

All wiring should be kept short and well spaced. This is much more important on these short wavelengths than on the wavelengths more commonly used for broadcasting, for two reasons—(1) since the facility with which oscillatory currents pass through a capacity varies directly as the frequency of the oscillations, the transfer of energy through stray capacities will be three or four

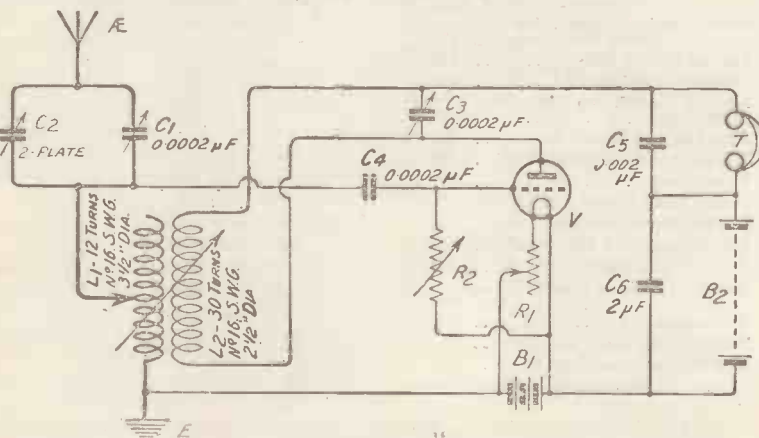

Fig. 1.—A circuit which gave difficult tuning with poor selectivity.

tance) work, and conditions at the writer's station are by no means all that could be desired.

Conditions to be Observed

From a general consideration of the conditions necessary for successful reception of radio

All component parts must be of good quality and in good order, as at the enormous frequencies with which they are called upon to deal, any slight defect becomes unpleasantly noticeable. Connections should be soldered wherever possible,

times as great as on the normal broadcast wavelengths, and (2) the higher frequency of the oscillations greatly facilitates an inductive transfer of energy.

Provision should be made for very accurate tuning owing to the extremely small waveband occupied by any transmission.

Body Capacity

Body capacity effects will be very marked unless the set is very efficiently screened or long extension handles are fitted. Removing the hand from a control knob may be sufficient to completely lose a transmission. If the aerial used is loose, or for

Aerial and Earth

The aerial used throughout these experiments was a twin wire 60 feet long, spaced 4 feet with the free ends connected. The average height of the aerial above the ground was 28 feet, but the effective height was considerably reduced by outbuildings and fairly tall bushes.

The earth connection consisted of a metal plate 5 feet by 2 feet buried in moist earth, at a depth of 2 feet 6 inches immediately under the aerial. The aerial system had a capacity of about $0.00034 \mu\text{F}$, and a natural wavelength in the neighbourhood of 120 metres.

Special Coils

For the purpose of these experiments two special coils of the single-layer solenoid type were constructed and mounted so that one could slide inside the other. The wire used was No. 16 S.W.G. bare copper. This was first wound tightly on a cardboard former, which was then removed, and strips of $3/16$ in. ebonite, with $5/64$ in. holes drilled at intervals of $5/32$ in., were threaded on. This gave coils in which the turns were well spaced and separated almost entirely by air, thereby reducing

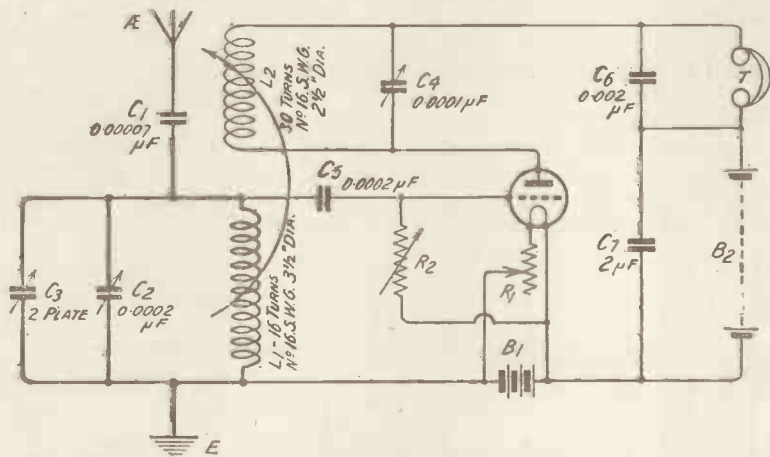

Fig. 3.—Very good results were obtained with this arrangement in the reception of European amateurs.

Perhaps the following example will emphasise the degree of accuracy necessary. The Westinghouse Company's station, KDKA, at Pittsburg works on a wavelength of 102 metres, which corresponds to a frequency of 2,941,176. Music frequencies vary this by, say, 10,000 on either side, giving resultant frequencies of 2,931,176 and 2,951,176, which represent wavelengths of 102.34 and 101.65 metres respectively, so that the transmission occupies a waveband of only .7 metres.

Fine Tuning

The variation in capacity in a tuned circuit to effect a change in wavelength of .7 metres is of the order of $0.0000015 \mu\text{F}$ (1.5 microfarads), or well under 2 deg. on a $0.0002 \mu\text{F}$ variable condenser connected in parallel with an inductance of 30 micro-henries. (On the same basis, assuming an inductance of 360 micro-henries, a transmission from 2LO would occupy a waveband of nearly 9 metres or 6 deg. on the same size of condenser.) An ordinary three-plate condenser connected in parallel with the main tuning condenser did not give sufficiently fine adjustment, so one plate was removed and the spacing between the remaining two increased.

any other reason it sways in the wind, its capacity is constantly changing, and, as a slight change in capacity has such a large effect on tuning, some means should be adopted to keep it rigid.

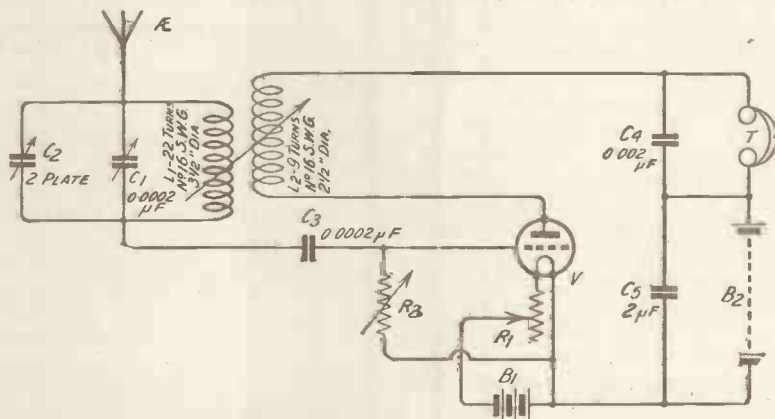

Fig. 4.—Many American and Canadian amateurs were received upon this circuit.

As no valve of the tubular type such as the V24 or Myers Universal was available, a valve of the ordinary 4-pin type, with its attendant comparatively high inter-electrode capacity, had to be used. This capacity was kept as low as possible by the use of air spacing between the pins and an anti-capacity valve-holder.

both capacity between turns and dielectric losses. For greater rigidity and freedom from vibration the wire was anchored, where it passed through the ebonite strips by means of celluloid cement. The outside coil consisted of 22 turns, and had a diameter of $3 \frac{1}{2}$ in., while the inside coil contained 30 turns of $2 \frac{1}{2}$ in. diameter.

In receiving C.W. signals without the use of a separate heterodyne oscillator, best results are obtained when the set is only just oscillating. It is therefore advisable to provide a fine control over regeneration, and a rheostat with a vernier adjustment will be found very useful for this purpose. A good variable grid leak will also be found to be a slight advantage.

Owing to the fineness of tuning and the fact that a considerable amount of reception would be of amateur stations whose transmissions are of comparatively short duration, thus giving little time for tuning, it was decided to reduce tuning controls to as few as possible, and the circuits described here were chosen with this in view.

First Tests

The first circuit tested is shown in Fig. 1, and is familiar to everyone, differing from a circuit widely used for reception of broadcasting only in the values of the components and the addition of a variable condenser across the reaction coil.

The condenser C₃ was necessary to make the circuit oscillate, and L₁ and L₂ had to be coupled quite tightly together. Owing to the tight coupling between the two coils, a variation in the tuning of the oscillatory circuit L₂ C₃ had a very considerable effect on the tuning of the aerial circuit. This made tuning of any particular transmission, especially weak C.W., difficult, as it was necessary to vary C₃ and C₁ simultaneously in opposite directions, e.g., if C₃ was decreased by 4 deg., C₁ had to be increased by about 25 deg. On strong C.W. stations it was possible to tune entirely by means of C₃. The circuit, as might be expected, was not very selective, and A.C. hum was noticeable, but not objectionably so.

Results

Very fair results were obtained with this arrangement. Towards the end of May both KDKA and WGY were received one morning between 4 and 5 o'clock, speech being practically indistinguishable, but music could be recognised by the tune. The same morning at 4.35 the Argentinian

amateur station CB8, using I.C.W., was heard very well, every letter being easily audible.

The next circuit is one recommended for short-wave reception by Mr. J. Scott-Taggart in his book, "Elementary Text Book on Wireless Vacuum Tubes," and is shown in Fig. 2.

The values of inductances and condensers were the same as for the circuit shown in Fig. 1, with which it is very similar in operation. The potentials applied to the grid of the valve are, in this case, derived from the condenser C₁ instead of from the ends of the inductance L₁, as is more usual. This arrangement was

larised in this country by publication in this journal and its companion paper, *Modern Wireless*. Owing to the ease with which radio signals on these short wavelengths pass through a capacity, the condenser C₁ in the aerial lead can be reduced below the usual value of 0.0001 μF, thereby enabling a greater number of turns to be included in L₁, and, in consequence, a greater difference of potential to be set up across the inductance. Although in the diagram C₁ is shown as a fixed condenser, in actual practice a 0.0001 μF maximum variable condenser was used.

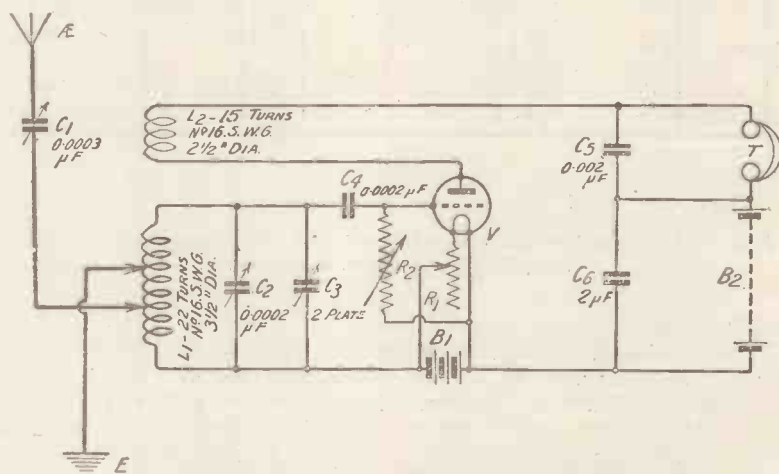

Fig. 5.—A very selective circuit upon which very good reception of KDKA and WGY was made.

difficult to push into oscillation, and with the values of L₂ and C₃ shown would not oscillate with more than about 100 deg. of C₁ included. As this setting tuned a wavelength of about 130 metres it was not considered worth experimenting to obtain oscillations over the whole range of C₁. A.C. hum was more apparent than with the Fig. 1 circuit, and parasitic noises, apparently picked up from the earth, were audible in the phones. The tight coupling of L₁ and L₂ again made tuning somewhat of a delicate operation on weak signals. The results obtained were almost identical with those given by Fig. 1, namely, weak signals from across the Atlantic, but good reception of European amateurs.

Constant Aerial Tuning

It will be seen that the circuit of Fig. 3 embodies the constant aerial tuning arrangement popu-

Another effect of the presence of the condenser C₁ is that the damping in the grid circuit is considerably reduced, with the natural result that the production of oscillations is much easier than with the two preceding circuits. This means that the coupling between L₁ and L₂ can be considerably loosened, and a lower value of C₄ used. In consequence of this weaker coupling the mutual interaction of the tuned circuits L₁ C₂ C₃ and L₂ C₄ is much less marked, with a corresponding simplification of tuning.

Further Results

This circuit gave very good results on European amateur transmissions, but on the only occasion that transatlantic reception was attempted the results were somewhat disappointing, both KDKA and WGY being conspicuously absent, and a few amateur stations being

just readable. As the circuit was not tested until the first days of June this may account for the comparatively weak signals from the United States. The selectivity exceeded that of either circuits 1 or 2.

No Earth Connection

Fig. 4 shows a somewhat unusual arrangement in which no earth connection whatever is used; a closed oscillatory circuit being included in the aerial lead. This circuit is based on one used by Captain Ainslie and referred to by him at an informal meeting of the Radio Society of Great Britain on March 12 (*Wireless Weekly*, Vol. 3, No. 15).

Reaction

The number of turns in the reaction coil L2 for satisfactory

by the first 20° of C1 and the minimum capacity of C2.

A.G. Hum

A.C. hum was noticeable at all times, but was less obtrusive when the circuit was oscillating, at no time being sufficiently bad to interfere with the reading of signals. When oscillating, the set was moderately selective, but when in a non-oscillating condition 2LO, at a distance of 7 miles, was just audible all the way round the condenser.

Like the majority of amateurs, the writer is engaged during the day on matters other than radio, and opportunities of spending the "wee sma' hours" on the set only arise occasionally. As a result this circuit was subjected to the critical test of reception of transatlantic stations for but one short hour. During this

the untuned type, the condenser C1 of which only about 25° was used, being made variable for the sake of convenience. Various experiments with coils wound over L1 between the turns of L1 and tappings taken at various points on L1 were tried, but loudest signals were obtained with the aerial and earth tappings in the position shown, i.e., the earth tapping on the grid side of the aerial tap, and with the 7 turns about the middle of the coil. The optimum value of L2 was found to be about 15 turns.

As C2 was increased from 0° to 140° the coupling between L1 and L2 had to be weakened, but beyond 140° the coupling had to be slightly tightened again. This peculiarity is apparently a variation of the effect referred to in connection with Fig. 4, the optimum ratio of inductance to capacity occurring when 140° was included. Oscillation over the whole range of C2 was easily produced.

The circuit was very selective and gave very good results, KDKA and WGY both being received well on one valve, speech from KDKA being exceptionally clear and free from distortion. Several American amateurs were easily read on one valve, and, with the addition of one L.F. valve, 31 transatlantic stations were received in the space of 2½ hours.

The Weagant Circuit

The last circuit used in these experiments is based on the American Weagant circuit. An untuned, or perhaps one should say a roughly tuned, aerial circuit was again employed, but in this case it was found preferable to wind a separate coil of 7 turns over the closed circuit, several layers of thick brown paper being between the two. From the theoretical diagram shown in Fig. 6 it will be noticed that reaction is applied on the Reinartz principle. By carefully adjusting the magnetic coupling between L1 and L2 it was possible to make the set oscillate over the whole range of C2, using a condenser with a maximum capacity of under 0.0001 μF, as the feed back condenser, C4. This gave a very delicate control over reaction, so much

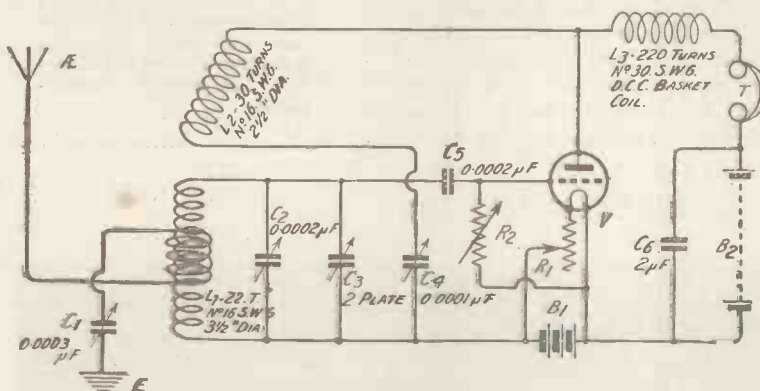

Fig. 6.—A very selective arrangement which gives that fine control of reaction usually associated with the Reinartz circuit.

operation was confined to comparatively narrow limits, either 9 or 10 turns giving the best results. Oscillation could not be produced with 7 turns, and 13 turns was rather too large. If the reaction coil was too large, it seemed to paralyse the set and prevent it from oscillating. All values of L2 were tried without avail in an attempt to make the circuit oscillate when less than 20° of C1 was included. A similar effect was noticed in the two circuits still to be described, and appears to be accounted for as follows:—Before oscillations can be produced in a circuit there must be present both inductance and capacity in some form or another. As the distributed capacity of L1 was so low, due to the wide air spacing of the turns, further capacity had to be supplied, and this was provided

time no sign of WGY nor KDKA, not even their carrier waves, was heard, but American and Canadian amateurs were received, Canadian 1AR being received particularly well.

Closed Circuits

In describing these experiments, the circuits used have been split up into two groups, the four already described deriving the potentials necessary to operate the valve directly from the aerial circuit and the remaining two working on a closed circuit. This does not represent the order in which they were tested, as the arrangement of Fig. 5 was the first one tried, it being thoroughly tested early.

Aerial Circuit

The aerial circuit included 7 turns of the coil L1 and was of

so that it was possible to adjust the circuit so close to the oscillation point that incoming signals would make the set oscillate, and with their cessation oscillation also ceased.

H.F. Choke

Various coils were tried as the high-frequency choke, L₃, from 100 turns up to 320 turns. Results gradually improved up to 220, beyond which no improvement was noticeable. Accordingly a basket coil of 220 turns of 30 S.W.G. d.c.c. on a cardboard former was used, and with this coil in circuit it was immaterial whether the 'phones were shunted or not, indicating that the high-frequency component of the plate current was being effectively choked back through L₂ C₄. (The condenser C₆ was integral with the H.T. battery, so no trouble was taken to remove it.)

The circuit was very selective, and towards the end of April good reception of American broadcasting was obtained up till

6 a.m., that is 1½ hours after dawn. Transatlantic amateurs were also received at very fair strength.

A Field for Experiment

The circuits described are only a few of the enormous number available, and were selected as each embodies some distinct feature. Under favourable conditions each one is capable of receiving America direct, and many interesting transmissions from our own and other European amateurs may be heard. Experimenters will find a most interesting field for the exercise of their ingenuity in this branch of radio, about which so little is at present known, and any time spent in this direction will be well repaid by the information gained. Close attention should be paid to reaction if it is desired to receive signals over long distances with only one valve, as that valve must be brought to its most sensitive condition by the care-

ful application of regeneration. It will probably be found that oscillation is more difficult to produce and control effectively on these short wavelengths, but once this has been done the resulting amplification appears to be greater than that obtained on higher wavelengths.

The Radio Society of Great Britain.

The Autumn Presidential Address to members of the Radio Society of Great Britain will be delivered by Professor W. H. Eccles, D.Sc., F.R.S., at the Institution of Electrical Engineers, Savoy Place, W.C.2, at 6 p.m. on Wednesday, September 24, 1924, on which occasion the President will deal with the latest developments of the position of the Scientific Amateur under the Wireless Telegraphy Regulations.

THE EDINBURGH STATION



Our photograph shows Mr. J. A. Beveridge, the engineer in charge, sitting by the transmitting apparatus.



I THINK that I have remarked before that the Little Puddleton Wireless Club is nothing if not right up to date. Ours may be a small town, in fact, I rather doubt if you can find it marked on any map, and the club may have few members; but there is no doubt about it that there are not many places in the world where you can find a finer collection of brains or a more thoroughly go-ahead spirit. Bilgewater Magna, though only a few miles away, is quite a different proposition; I am told on the best authority that there are still people there who swear by coherers and magnetic detectors. To show you how really up to date we are I may mention that our parish pump is now worked by a useful, if rather unsightly, windmill. These things being so it is not I think surprising for Gubbsworth to have mooted at a meeting of the club not long ago that it would be a good thing if we were to start an inquiry section. The idea was that members should take it in turn to go on duty for a week, during which time they should be ready to supply information on wireless subjects, not only to their fellow members but to anyone in the neighbourhood who might be in need of it. After some discussion, in the course of which General Blood Thunderby and Admiral Whiskerton Cuttle fought their customary verbal duel and almost came to their not unusual blows, a motion to the effect that the Helping Hand Department should be inaugurated was put to the meeting and carried by acclamation.

A Noble Idea

The scheme we worked out was that the member who for the week was enacting the part of the Delphic Oracle should be

at the Clubhouse from six to seven on Mondays, Wednesdays and Fridays, and that he should open sympathetic arms to all who brought their woes to him. As it was decreed that a list should be drawn up in alphabetical order, and as Wayfarer begins with a W, I felt that things would have time to settle down nicely before my turn came along. The correct thing, so far as I could see, would be to barricade oneself on the far side of a table behind a rampart of voltmeters, ammeters, milliammeters, gal-

- Breadsnapp.
- Dipplesworth.
- Professor Goop.
- Gubbsworthly.
- Poddleby.
- Snaggsby.
- Wayfarer.
- Admiral Whiskerton Cuttle.

The General Begins

I strolled round in the direction of the Clubhouse on the following Monday just to see how the General was getting on. I cannot say that I actually reached it, for the entire street in which it

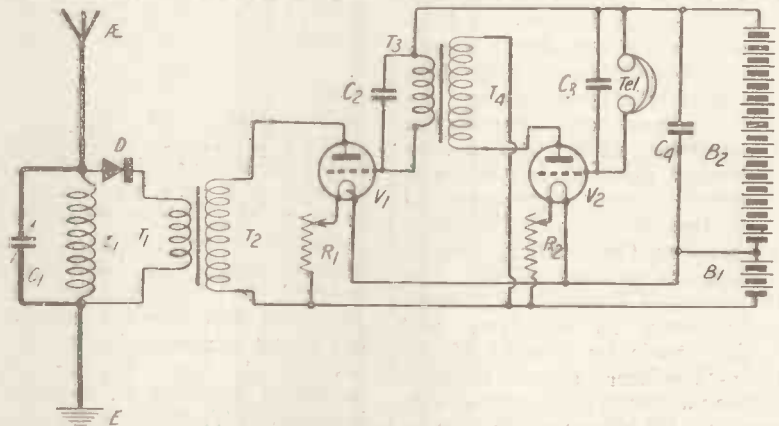

A circuit which is causing Wireless Wayfarer many sleepless nights. Why?

vanometers, meggers and things of that kind, and should an unanswerable question turn up to draw upon that supply of long words which is such a present help to wireless men when they are cornered. There was rather a hot debate as to whether General Blood Thunderby, owing to his double-barrelled name, should be classed among the B's or with the T's. Admiral Whiskerton Cuttle was very much in favour of the first half of double names counting, and the majority of the meeting was with him. The secretary therefore drew up a list consisting of General Blood Thunderby. Bumbleby Brown.

stands was blocked by a seething mass of people, whom P.C. Bottlesworth was frantically endeavouring to sort out into a queue. So far as I could make out every inhabitant of the place, old or young, male or female, married or single, had turned up with a query. It was a most engaging sight, especially as I was not on duty. I patted myself on the back on that account and registered the cheering thought that by the time that my turn came every possible querist would have offered every possible query for solution. When I met the General on the following morning and asked him brightly how things had gone,

he was, I thought, a little huffy in his response. I gathered, however, from the flow of words which proceeded from him (a) that the inhabitants of Little Puddleton were a pack of flat-footed idiots; (b) that it was beneath the dignity of the club senior member to answer such questions as: Should the cat-whisker touch the crystal? or, Why does a condenser condense? (c) that he believed that half the people asked questions just for the sake of asking them; (d) that the country was going to the dogs; and (e) that he would be jolly glad when his week was over. It struck me that if he was merely being asked only silly questions of the type mentioned the General's brain was not having sufficient exercise. I decided therefore to do what I could to provide a little real employment for him on the last day of his all-important duty. I should explain that I have a gardener. I like to say this, because it sounds important. As a matter of fact, an ancient man who rejoices in the name of Bugsnip comes in one day a month to attend to the vegetation which decorates the grounds of my desirable residence. Bugsnip has a boy who, as he told me, he christened Edward, in honour of a certain Royal Personage. I trust that his Royal Highness appreciates the honour, though he has not so far said so. The lad, Edward Bugsnip, is exceedingly keen on wireless, and having made up several of the Goop-Wayfarer super circuits, obtains at times quite remarkable results. He shows every sign of becoming a first-rate wireless man, for he has already developed a distinct handiness with the long bow.

Edward Bugsnip's Night Out

This lad, thought I to myself, is just the fellow to make the General sit up and do a bit of thinking. I will provide him with a question and he shall in due course convey himself to the wireless clubhouse and shiver the General's timbers with it. I will not tell you what the question was, because, though I do not know him, I have the greatest respect in the abstract for the chairman of your own wireless club, and I am quite sure that

if I were to give the secret away there would be horrible tales in the papers of chairmen of wireless clubs all over the country taking to drink or drugs or hurling themselves from high bridges into deep and swift rivers. This, as you will agree, would never do, and you will understand why I refrain from giving it away. It will suffice to say that when Edward Bugsnip propounded his poser the General's mulberry complexion turned first of all a rich purple and then a sickly greenish white, and his jaw wagged feebly, whilst no words issued from his throat, and with his fingers he beat the tattoo of a defeated man upon the table before him. The General had been getting a little above himself for some time; I therefore have no hesitation in working this off on him; there is, I fear, no hope of his thinking of suicide.

Unkind Fate

When your name begins with a W and the duty list goes in alphabetical order, you naturally think that you are fairly safe for some weeks to come. You will hardly believe me when I say that on the Monday of the following week we learned that Bumbleby Brown was away on holiday, that Breadsnaapp was suffering from influenza, that Dipplesworth had been called suddenly to the Continent, that Professor Goop had broken his leg whilst endeavouring to climb his aerial, that Gubbsworthy would be detained on important business in Town on every night of the week, that Poddleby was sitting at the bedside of a moribund great aunt-in-law, and Snaggsby was so bad with laryngitis that he could not use his voice at all. Now there is something very much wrong with the order of things when in alphabetical order W follows next after B. Still, so it seemed to be, and nothing that I could do would persuade the Admiral to take precedence of me by virtue of his exalted rank.

My Week

Now I was distinctly pleased with myself after the first night, for I felt that I had been a distinct success, and it added no

small measure to my already considerable reputation. On the Wednesday all was going well until on glancing up I observed about three places down in the queue no other person than Edward Bugsnip. Something told me that I was about to meet my Waterloo with this child, especially as I saw under his right arm he was carrying what appeared to be a wireless receiving set. I spent as long as I possibly could over those who came before him in the faint hope that as his bedtime was long passed the child might go home. But it was not to be. He stuck there drinking in at long range my replies to others, and obviously prepared to wait until midnight if need be for his turn. It came at last, and he placed before me his ghastly set. "Oi cawnt git nuffin wiv this 'ere, guv'nor," he said, with a smile which I suspected, and I prepared for the worst. The wiring was the worst tangle that I have ever seen in my life, leads meandering in all directions without apparent rhyme or reason. I could not answer there and then. I had to take it home with me, and the diagram published herewith shows the circuit as I eventually resolved it. Little Puddleton, I think, is not the place for Edward Bugsnip.

WIRELESS WAYFARER.

Personal.

With the large increase in the number of technical books published by this firm and in order that our readers' needs and interests be adequately catered for, the position of sales manager to the organisation has become one requiring not only business ability, but an extensive knowledge of wireless theory and practice.

Mr. E. Redpath, formerly Assistant Editor of *Wireless Weekly* and *Modern Wireless*, has now been appointed Sales Manager of Radio Press, Ltd., and our readers will therefore have the satisfaction of knowing that to whatever branch of the organisation they write, a fully competent member of the technical staff will deal with their communications.

Random Technicalities.

By PERCY W. HARRIS, Assistant Editor.

Some Notes of interest to the Experimenter and Home Constructor.

A FRIEND of mine, whose business connections bring him into contact with a large number of wireless manufacturers and dealers, tells me that recently there have been many reports of "burn-outs" in interval transformers and loud-speakers. These have not been confined to any one make, but seem to have been distributed among the well-known types fairly equally.

The wireless experimenter does not always realise the pent-up energy stored in the magnetic field of an interval transformer. When the current in the plate circuit starts to flow (by this I mean the steady anode current, not the pulsating current set up by the signals), the core becomes magnetised and a considerable magnetic field surrounds the windings. Variations of intensity in this field occur when signal currents arrive, but when there are no signals coming in we still have a steady plate current which, with low impedance valves and fairly high plate voltages, may reach a figure of 10 milliamps if no grid bias is used. Incidentally it is one of the great advantages of having suitable grid bias on note-magnifying valves that it reduces the steady plate current considerably, thus avoiding early exhaustion of the high-tension battery.

Now if for some reason or other we suddenly break the circuit, the magnetic field will collapse, the pent-up energy will be released, and will either break down the small air gap if the opening of the circuit is not wide—thus forming a spark (you can see this when you pull the plug out of a wander battery)—and will exert a tremendous strain upon all insulation, including that of the transformer. In fact, whether it sparks or not, this

strain will occur. Quite a bright little spark usually occurs when the wander plug is withdrawn, and the voltage required to produce a spark of this size is very much higher than that of the high-tension battery.

I think it will be found that in those cases where transformers and loud-speakers have been burnt out, not once, but two or three times, in the same set, that the user is too prone to play about with his high-tension voltage by pulling out the wander plugs and changing their positions at every conceivable opportunity. You will notice I have been writing about what are generally termed "burn-outs." Actually, however, a transformer rarely "burns" out in the sense of the wire fusing, as the wire used will carry considerably greater current without fusing than is ever put through it. The "burn-out" is really a break due to the stresses and strains set up in the winding.

It is very interesting these days to tune down to the very short wavelengths.

Nauen (POZ) and Paris (UFT₂) can be heard almost any evening calling the new station in South America (LPZ). Poldhu (call sign 2YM) is seldom quiet in the evening and during the night, and is generally calling ICMM. Paris usually works on about 75 metres, and Poldhu on about the same wavelength, while Nauen uses a slightly longer wavelength.

May I ask the valve manufacturers to see whether it is possible to make a good soft detector valve in this country? Such a valve is badly needed, and once it becomes generally available, those of us who write con-

structional articles will soon show the public how admirable results can be obtained with them. Every valve will rectify, of course, when used in the proper circuit, but it is only those who have actually become experienced in the handling of the soft detector valve who fully realise the great capabilities of detecting which may be obtained with these. Please give us a good soft detector valve which will at least equal any of those the Americans use.

The Latest Idea for the Constructor.

The latest Radio Press production, which has just been placed upon the market, is already meeting with a very big demand on the part of those constructors who like to give their set a good finish. The Radio Press panel transfers are unequalled, from the point of view of cheapness, high quality, and also of variety, and they have been specially designed to suit the receivers described in the various Radio Press publications.

With the aid of these transfers one can readily impart a really professional appearance to the home-built receiver with very little trouble, and at the very modest expenditure of 6d. The transfers operate on the hot pad method, and no particular experience is needed to obtain perfect results. They will be found to include every necessary letter for any type of receiving set, while a large number of special labels are included to suit the Radio Press sets.

The transfers are enclosed in a large stout envelope with a handsome design, and protected by a sheet of thick cardboard, and can be obtained through any bookseller or direct from the offices of the Radio Press, price 9d. post free.

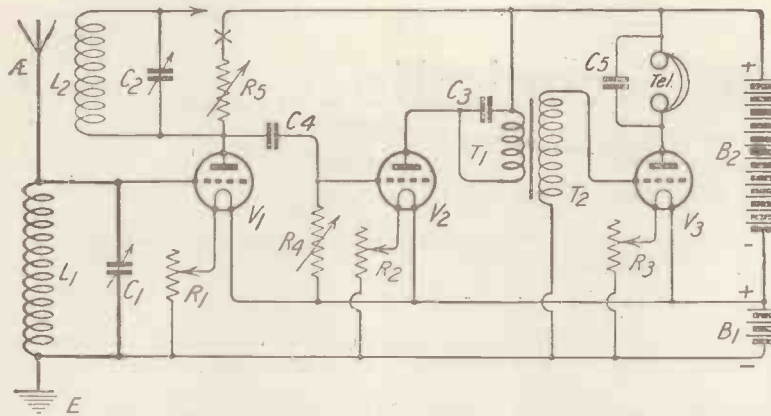

Fig. 1.—A three valve circuit which may be tried upon the Omni Receiver.

CIRCUITS with which it is possible to receive the high-power station at Chelmsford or the other British broadcasting stations at will are much in vogue just now. Such a circuit is shown in Fig. 1, from which it will be seen that either tuned anode or resistance capacity coupling between the first two valves may be employed by making only a small alteration to the circuit.

The resistance capacity method of coupling is, of course, used only when it is desired to receive Chelmsford; on the usual broadcast wavelengths this method cannot be compared with tuned-anode coupling. On the higher wavelengths, however, very good results are obtainable, whilst the tuning arrangements are very considerably simplified.

The aerial is tuned by the coil L1 and variable condenser C1, the latter having a capacity of 0.0005 μ F. In the anode circuit of V1 we have the resistance R5, for which a suitable value is 80,000 ohms. The inductance L2, tuned by C2 of 0.0005 μ F capacity, is shown connected to the plate of the valve on one side, and terminated by an arrow head on the other side. When conditions are as illustrated, resistance coupling is in use, and the anode tuning coil is substituted by breaking the lead to the high-tension battery at the point indicated by X, and joining the free end of L2 to a point above X.

C4 and R4 are the grid condenser and leak, having the usual values of 0.0003 μ F and about 2 megohms respectively. The primary winding T1 of the interval transformer T1 T2 is in-

cluded in the anode circuit of V2, and shunted by the fixed condenser C3 of 0.001 μ F. The secondary T2 is connected across the grid and negative filament lead of the low-frequency amplifying valve V3. The telephones are connected in the anode circuit of this valve and shunted by C5 of 0.002 μ F.

Connections

To wire up the Fig. 1 circuit on the Omni receiver, the following terminals should be connected together:—

- | | |
|-------|-------|
| 51—17 | 13—40 |
| 25—52 | 6—21 |
| 17—18 | 21—37 |
| 18—12 | 38—22 |
| 25—26 | 22—24 |
| 4—36 | 30—16 |
| 36—41 | 29—48 |
| 41—42 | 8—31 |
| 34—33 | 23—24 |
| 44—24 | 32—40 |
| 36—27 | 52—48 |
| 19—14 | 23—39 |
| 14—5 | 31—47 |

Another Circuit on the Omni Receiver

A further experiment for the benefit of those readers who use this popular receiver.

Operating the Set

The set is now wired, so that the resistance R5 is in circuit, its value being controlled by the centre knob of the three variable resistance knobs to the left of the panel. A No. 150 coil will be required for the reception of Chelmsford, plugged into the aerial socket in the middle of the three-coil holder. The only adjustment necessary for tuning is that of the aerial condenser in the centre of the panel. When results are obtained the values of the anode resistance R5, and the grid leak R4 to the right of it, may be varied to obtain maximum signal strength.

If it is desired to receive the usual broadcasting stations, the circuit L2 C2 may be easily substituted for R5 by disconnecting 44—24, and joining 33—24. The coil in the aerial socket should now be a No. 35 or 50 coil, with a No. 50 or 75 coil plugged into the front socket of the three-coil holder. Tuning is now car-

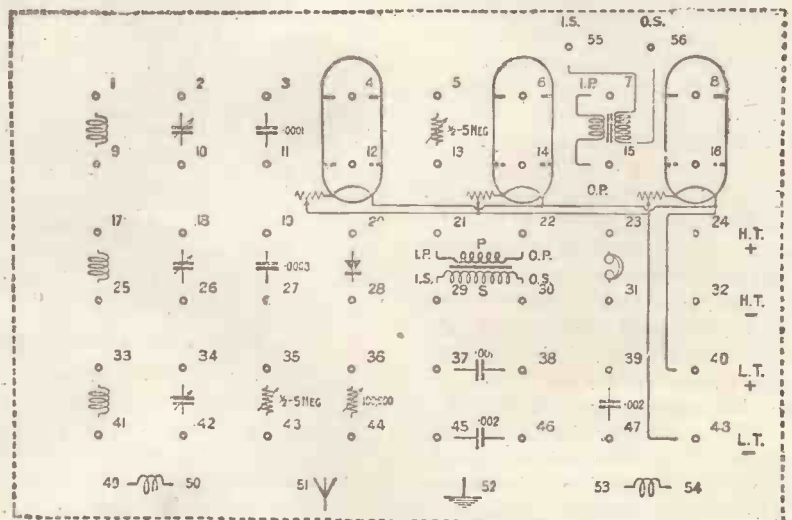

Fig. 2.—The terminal board.

ried out by variation of the centre and left-hand condensers simultaneously. A size larger coil may be tried in the aerial and anode sockets. Having tuned in a station to its maximum strength by this means, the coil in the moving socket may be brought slowly towards the fixed coil, retuning after every small movement on the two variable condensers. If the coils may be brought close together in this manner without the set oscillating, the leads to the anode coil should be reversed. This is effected by disconnecting 33—24 and 41—36, and joining 33—36 and 41—24. Best results will be obtained with the set just off oscillation point.

Experimenting with the Circuit

Assuming that we wish to listen to Chelmsford, a separate

□ □ □

I PROPOSE in this short talk to touch upon one or two of the more popular fallacies which are met with in discussion with radio enthusiasts, and the first and most common is perhaps "The Lightning Bogey."

To begin with, lightning is the result of a vast accumulation of electrical energy in the clouds. If this energy cannot leak away sufficiently fast a disruption discharge or flash takes place of somewhat terrifying aspect.

Now, any well earthed aerial of reasonable height must act as a definite leak or drain for this energy, and, in technical language, must lower the potential gradient in its immediate vicinity, thus tending to obviate the disruption discharge, which clearly makes an aerial a protection to life and property more than a danger.

On the other hand, one must look at the fatalistic side. No self-respecting lightning flash—should it occur—would condescend to travel down the usual 18 gauge earth wire without becoming disorderly, owing to the tremendous magnitude of the electrical energy. It is estimated that an amount of electricity equal to 20 coulombs will flow for 1/500th part of a second at a pressure of one million volts—or 10^{10} watts—which is four hundred thousand times the

anode voltage may be given to the detector valve with advantage. It is well known that a low-frequency amplifying valve may have a greater anode voltage than a valve working at high frequency, and in the case of the Fig. 1 circuit these conditions exist owing to the potential drop across R₅. If we give the detector valve a lower voltage without altering the voltage applied to the other valves, better results may be obtained. The only alteration necessary on the terminal board is to disconnect the lead 22—24, and join 22 by means of a piece of flexible wire to a suitable point on the high-tension battery.

This arrangement may also be used with advantage when tuned-anode coupling is employed. However, as it will often be

The Radio Society of Great Britain

A talk broadcast from 2LO on 11th September by Mr. W. Kenneth Alford, a member of the Committee of the Transmitter and Relay Section.

power of the Chelmsford Station.

To produce such a flash the average electricity company would have to charge about £20.

II.—Self Oscillating Receivers

A matter which often causes consternation is the fact that a large number of home-made or bought valve receivers have a strong propensity for self-oscillation. The question is, whether the instrument is a good one or not. The answer is that it is either very well or very badly designed; in other words, the self-oscillation may be due to careful elimination of stray capacity, in which case the set "resonates" extremely easily, or else the wiring and arrangement is so bad that the anode grid capacities are producing an uncontrollable amount of "electrostatic" reaction.

In the case of the well designed instrument the "self-oscillation" can be overcome quite easily by a small positive grid bias applied to the H.F. valves by means of a potentio-

desirable to lower the voltage applied to the high-frequency amplifying valve when this type of coupling is reverted to, the difference will not be so noticeable.

Constant aerial tuning may be used on the lower wavelengths by disconnecting 51—17 and connecting 51—3 and 11—17. For the broadcast wavelengths below 420 metres, it is now possible to state definitely that a No. 50 coil will be suitable in the aerial socket, while for wavelengths above 420 metres a No. 75 coil should be used. The value of the anode coil, of course, is not affected.

Series aerial tuning may be tried by altering the original key as follows:—Disconnect 51—17 and 26—25, and join 26—51. A size larger aerial coil may be tried with this form of tuning.

□ □ □

meter, without affecting its reception properties—whereas, in the other case, extreme positive bias is necessary, which lowers the amplification very seriously and usually introduces premature rectification, which causes distortion.

The matter of avoiding oscillation and yet maintaining a receiver in its most sensitive condition for telephony reception is exemplified in the ingenious Neutrodyne principle invented by Professor Hazeltine.

III.—The Testing of H.T. Batteries

A great fallacy occurs in people buying a cheap voltmeter for testing their H.T. batteries. You can buy such a meter for about 7s. 6d., which reads 0—6 and 0—100 volts. Now, on the second range the meters pass a current of sometimes 100 milliamperes, which is roughly 10 times the current taken from the battery by an average 3-valve set. They cannot show even an approximately true reading, and frequent use will seriously deteriorate a battery. If you can't afford a good voltmeter leave the battery alone, and don't use the popular pea-lamp, which is a worse test than ever.

If the battery gets noisy, don't throw it away until you have tried placing a 2 μ F or more condenser in parallel with it.

(Concluded on page 657)

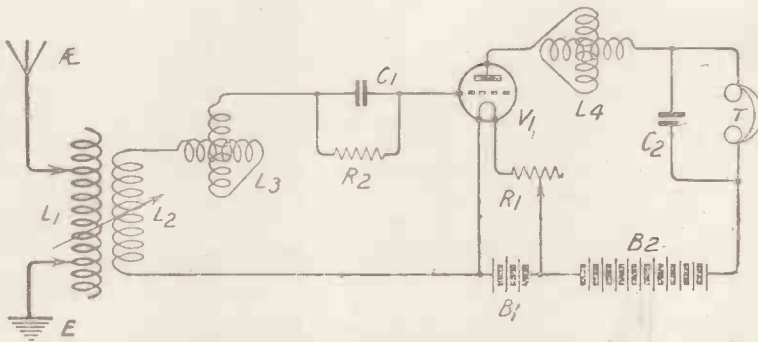

Fig. 1.—A highly popular American circuit, in which reaction is obtained by tuning the plate circuit.

American and British Radio

Interesting Points of Comparison.

By PERCY W. HARRIS, Assistant Editor.

IF, when you pick up an American radio publication, you find, as you are almost sure to do, that the claims made by constructional writers for their particular designs are far greater than you are led to expect from similar articles in this country, you are likely to jump to one of two conclusions. Firstly, you may think that American radio apparatus is greatly superior to ours, or, secondly, you may come to the conclusion that American wireless writers are—well, let us put it quite plainly—thumping liars. As a matter of fact neither conclusion would be correct.

Differences

The very considerable differences which exist between the apparatus and, what is more important, the working conditions on the two sides of the Atlantic, lead me to believe that a few notes upon the subject may be interesting to British readers. It so happens that within the last few weeks I have received two or three reports of the operation of sets made in America from designs of my own published here, thus enabling me to write with more certain knowledge than would otherwise be the case. Furthermore, I have been digging into technical literature published on the other side of the Atlantic, and have made a number of comparisons which throw a flood of light upon several points not previously made clear on this side of the Herring Pond.

Atmospheric Conditions

In the British Isles the broadcast listener is not greatly

troubled by atmospherics, save when he is using a very large aerial in some of the worst summer conditions. Please note, that by "Broadcast Listener" I mean the man who is content to receive the excellent programmes from the nearest one or two stations. I do not mean by broadcast listener the experimentalist who, with the desire to achieve the greatest possible distance, even at the sacrifice of quality and distinctness, is forcing the amplification of his



UV 201A, the American dull-emitter amplifying valve, showing base.

apparatus up to the limit, in order to cover long distances. On the other hand, the experimentalist here, who, perhaps owning a transmitting license, is anxious to receive amateur signals of low power over great distances—even from the other side of the Atlantic, may find a thoroughly bad night any time of the year. In the United States atmospheric noises or "static," to give it the American equivalent, are frequently so trouble-

some in summer months as to rule out any pleasurable participation in the radiated music, while many amateur transmitters give up work altogether in the summer months, owing to the difficulty of effecting satisfactory communication through the all-prevailing static. In winter months, on the other hand, the ether about the United States is singularly free from atmospheric troubles on short wavelengths, and almost incredible distances are covered with very low power during the hours of darkness. When the first transatlantic amateur signals were received on this side, I well remember Paul Godley, who came over from America with apparatus to receive the American amateurs here, expressing to me the greatest surprise at what he called the "impossible atmospheric conditions" over here.

Freak Ranges

When I first went to sea as a Wireless Operator some fourteen years ago, there were neither valve nor crystal receivers available, and all our receiving work was done on the very insensitive magnetic detector. Transmission, of course, took place on the spark system—not even a musical spark at that. Yet with such inefficient apparatus we were frequently able to cover enormous distances at night, and in certain parts of the globe we could generally rely upon long-distance transmission and reception after sundown. In these latitudes the difference between the day and night range was not very great, but south of the Equator the difference between

This article clears up many problems which have puzzled the British amateur when hearing of the experiments of his Transatlantic confreres:

the two ranges was considerable. In 1911, when sailing on a Union Castle liner, I was in charge of a set which had a daylight range of rarely more than a couple of hundred miles, yet almost any night after leaving the Bay of Biscay behind, I could send and receive over a thousand miles with it. In Australasian waters a similar set would frequently cover two thousand, when conditions were very favourable.

The American Ether

Now the United States seems blessed with conditions which resemble those we used to find south of the Equator in the days to which I refer. The American broadcasting stations are, on the whole, not so well equipped as ours, save in a few exceptions, such as in the case of broadcasting stations put up by one or two big corporations with the vast resources of the industry behind them. The more experienced British amateur transmitters would be ashamed to own many of the broadcasting stations listed in American publications. I have no doubt whatever, if you were to take 2LO, 5IT, or any of the other broadcasting stations known to us here, and operate it somewhere in the United States, for both quality and range covered, it would put nine-tenths of the American stations in the shade. Cynical people have said that the American broadcasting stations do not trouble greatly about their modulation, as a slight amount of distortion improves the American accent. Be that as it may, the British experimenter can take it as certain that the

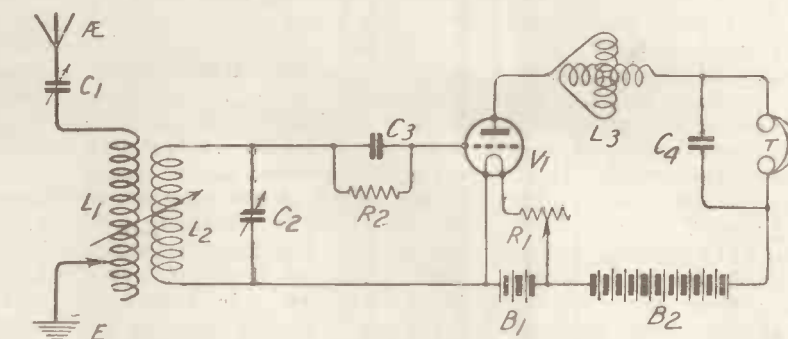

Fig. 2.—Another popular circuit on similar lines, but with aerial and secondary tuning condensers.

huge ranges common in America are due, not so much to the efficiency of the broadcasting stations as to the peculiarly favourable local conditions.

U.S. Amateur Transmitters

Speaking of power in relation to range, brings up the question of power rating common among amateur transmitters on the other side of the water. Now that amateur transatlantic communication is fairly frequent, quite a false impression of American

which the input power is 50 watts as we should calculate here. Far from it. It is probable that this power on our rating would be about 200 watts. I have just been reading about the station of 6AWT in San Francisco, and as there are some actual figures given in the description, you can judge for yourself how far my argument about under-rating is true. 6AWT employs a single 250-watt valve. He was heard quite well in Australia. His plate voltage was 6,000 and his plate current 900 milliamps—5.4 kilowatts plate input power! No doubt this was grossly overloading the tube, but I have taken the trouble to turn up the maker's catalogue of this valve, and I find that their own rating, which is obviously conservative, gives the plate voltage as 2,000 volts normal, and the plate current 250 milliamps; this, of course, gives us a normal power of half a kilowatt, although it is called a 250-watt valve. I do not wonder that the makers say "several experimenters using one of these valves have obtained 5 or 6 amperes in the aerial."



For comparison, the B4, a British valve closely resembling UV201A.

amateur efficiency has been given by the publication of reports in this country copied from American publications. We hear that, for example, Frank K. Brasspounder, of Dead Man's Gulch, Wis., has "got over" with a set having "only one 50-watt tube." Rather good you say, effecting transatlantic communication with only 50 watts! But wait a minute before you draw your conclusion. A 50-watt tube is not a valve of

Further Figures

Just to make sure I am not doing our American friends an injustice, I have turned up a tabulated report of the best American amateur transatlantic sending stations in the 1923 transatlantic tests, and I have picked out from the list the first twenty listed as using 50-watt valves. Several of these stations used two or three of these valves. I will not burden you with a lot of figures, but I think I shall be quite fair if I give you the

total number of valves used and the total plate watts. We can then see the average power used by an alleged 50-watt tube. These twenty stations used in all, forty-one 50-watt tubes. The total plate power utilised by these twenty stations was well over 7,000 watts, the average power of these 50-watt valves being about 175 watts!

It seems to be generally agreed that we are better off for receiving valves than our American cousins, at least, so far as amplifying valves are concerned, although for some reason or other which I cannot fathom, no British manufacturer has thought worth while to put on to our market a really good soft receiving valve, such as the Americans have available whenever they want. As a matter of interest, and as a guide to those who read American publications, and are somewhat mystified as to the actual valves used, here are a few particulars of the leading American receiving "tubes."

American Receiving Valves

The valves sold by The Radio Corporation of America are known as Radiotrons and have the letters UV and WD prefixing a number. The UV199 from which most of our British .06 ampere valves are copied, has a filament voltage of 3, current of .06 amperes, and a plate voltage of 20 to 40 as detector and 45 to 90 as an amplifier. In fact, these valves are almost identical with our popular .06 ampere valves. A practically identical valve sold as the C299 by T. C. Cunningham Company is made for this firm by The General Electric Company, the WD12 with a filament voltage of 1.1 and a filament current of .25 ampere with plate voltage of 20 to 40 as detector and 45 to 50 as amplifier, corresponding with our peanut valve. The UV201A, with a filament voltage of 5, filament current of .25 amp., and voltage of 45 to 90 as amplifier, is another valve copied in this country. A representative valve of this type is the B4, sold by the British Thomson-Houston Company over here; Marconi, Osram and Mullard also make a similar valve. In the United States the Cunningham equivalent is the C301A. American

valves, of course, have a slightly different mounting from ours, the four pins being much shorter. In general, too, their plate impedance is lower. I have before me as I write a specimen of the UV201A and a corresponding British valve; both are heavily silvered inside, owing to the effect of the magnesium process of finally "cleaning up" the vacuum, but there is enough clear glass to distinguish the inner structure. In each case there is a V-shaped filament, the plate being a flat open-ended box about the size of a postage stamp and about a quarter of an inch between sides. I notice the UV201A has a rib at the top and bottom of the plate, whereas the B.T.H. B4 is not so ribbed, although a close examination suggests that the general make-up of the B4 is a better mechanical job, as the plate is supported all the way up on each side, whereas the UV201A is only supported for about half of its length. The valve pins on the British tube project the ordinary distance of about three-quarters of an inch, whereas the American tube has pins which project the standard length of about 5/16ths of an inch. (See photographs.)

Where we Score

I have purposely given first of all a few examples of valves common to both sides of the Atlantic. Where the British experimenter scores heavily, however, is in our ordinary "R" type or general purpose valve, of which there seems to be no American equivalent.

American Detector Valves

The standard American detector valve is a Radiotron UV200 or a Cunningham C300. These have a filament voltage of 5 and a full ampere of filament current, while the plate voltage is 15 to 22 for detection. To get best results with this valve it is really necessary to have a vernier rheostat. Vernier rheostats are sold in this country, but I am not aware of a single valve (other than the soft Dutch tubes which are occasionally used here) in which the use of a vernier rheostat is at all helpful, save when cue is making very critical adjustments on some H.F. stages.

Receiver Design

The multiplicity of broadcasting stations has made high selectivity absolutely necessary in the American receiving set. On this side of the water we have relatively few broadcasting stations, and furthermore our broadcast listeners demand simplicity in operation. With Chelmsford on 1,600 metres, Radiola on a longer wave, Königswusterhausen and the Eiffel Tower on still longer wavelengths, aircraft telephony on 900, the Dutch concerts on 1,050, and so forth, a receiver to satisfy the British public must have a very wide wavelength range. In America a set which will tune from 300 to 600 metres covers all the broadcasting the average man wants, and, in fact, all that is available. The tuning arrangement almost universally adopted is to have what is known as a vario-coupler for coupling the aerial to a closed oscillatory circuit, reaction being obtained by tuning the plate circuit so that when it comes into resonance with the grid circuit the set will oscillate. By keeping the tuning just off the point of exact syntony it is possible to get a reaction effect without oscillation. A set of this kind (a circuit diagram is given in Fig. 1) used with a suitable soft detector valve gives exceedingly good results with very high selectivity. The aerial tuning, usually carried out by tappings and two switches, is not very critical. The secondary circuit, which can have its coupling with the aerial circuit varied by rotating the whole coil, is tuned either with a variable condenser or with a variometer in series with it, whilst plate tuning is effected almost universally with a variometer connected as shown.

Such a set, whilst being very sensitive and highly selective, needs skilled handling to get even passable results from it; further, it is not suitable for a wide range of wavelengths, and cannot be satisfactorily loaded with plug-in coils. A few British experimenters have made tuners, utilising the above circuit; but few have obtained satisfactory results from them, mainly due to the fact that suitable valves for working the circuit are not obtainable in this country. A good soft detector valve, which we unfortunately lack, is absolutely essential.

may be obtained when only half the maximum voltage is used. A chemical rectifier is used to convert the 50-cycle A.C. into D.C. current. The electrodes used are aluminium and lead, while the electrolyte is neutral ammonium phosphate solution. The method of connecting up the rectifier with a centre tap transformer will be seen from Fig. 7 and 9. Many experimenters believe that when they have effected full-wave rectification all their troubles are over and a pure C.W. note without any A.C. hum will be the result. This is by no means the case, and we must turn our attention to the very necessary problem of filtering out the A.C. hum. We generally have, if our supply is

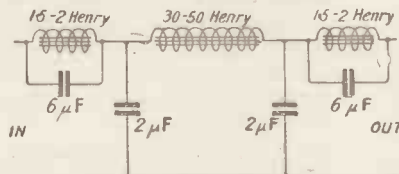

Fig. 8.—A suggested filter arrangement for a 50-cycle supply.

50 cycles, a hundred-cycle note predominating, with several harmonics of this frequency as well as a plain 50-cycle note. For telephony work it is, of course, absolutely necessary to remove this A.C. component before we can commence to speak. Happily for us, it is possible to design a filter that will remove most of the hum.

A Battery Lead Tip

WHEN double-flex leads with tagged ends are used for the connections of either high-tension battery or low-tension battery, there is always the danger of a short circuit through the two tags coming into contact when the leads are being unfastened or whilst they are lying on the table. Here is a simple little tip which removes the danger of such a short circuit occurring. Always cut one of the wires two inches shorter than the other, and bind them together quite close to the short end. When leads treated in this way swing loose there is no chance of the two tags coming together and a short circuit therefore cannot occur.

R. W. H.

Many experimenters that I have met merely kept putting condensers across the power terminals, and together with little silent prayers hoped for the best. The net result was that improvement was very slight indeed. Fig. 8 shows a suggested arrangement for a filter suitable for a 50-cycle supply. It would be as well to design the chokes so that the inductance may be varied. This may conveniently be accomplished by varying the width of the air gap in the core of the coil. If the choke control method of modulation is used, this method of filtering will be of little use, so a suggested arrangement is shown in Fig. 9. The choke is shunted by a condenser of the order of .001 μF. By altering the value of this condenser a point will be found where there is practically no A.C. hum.

The photograph given last week shows a home-made tuner and Burndept Ultra III, while a Sullivan Standard Heterodyne Wavemeter is situated behind the tuner. The next panel is a two-valve low-loss receiver; next comes the low-power transmitter. A valve full-wave rectification unit is being constructed to work with this set. The set used to transmit across the Atlantic is on the right of the photograph.

Whilst using a power of 100 watts, 2KW has been heard in the 1st, 2nd, 3rd, 4th, 5th, 8th, 9th Districts of the United States. Heard also in Canada and by the MacMillan Expedition in the Arctic Regions, WNP, 2KW has worked on several occasions with five U.S. and three Canadian stations. Two-way communication was established with CrBQ when British 2NM was there, and I was able

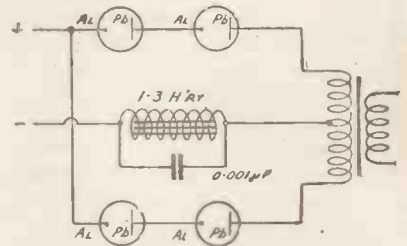
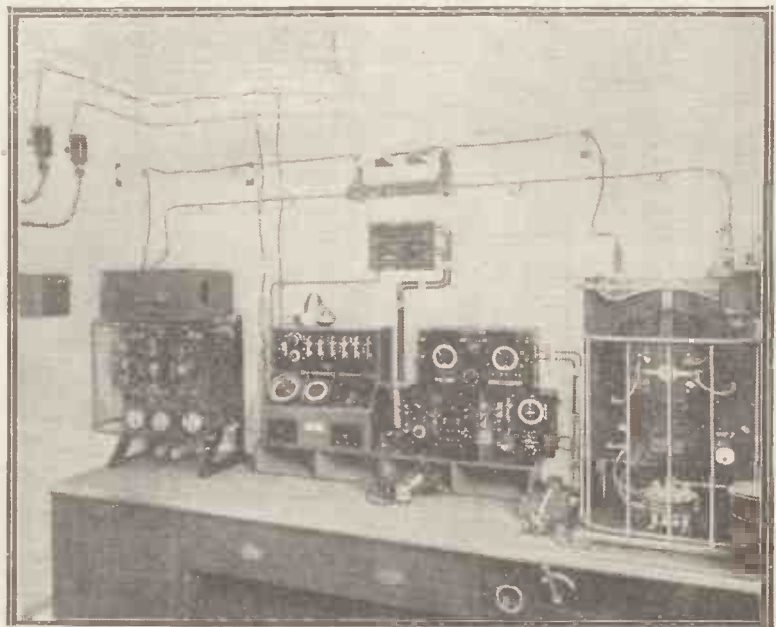

Fig. 9.—A filtering system for use with choke control.

to chat with my friend as easily as if he had been in his own station in London, instead of three thousand miles away. Over two hundred American and Canadian stations were heard last winter, using for the most part one valve and never more than two in a straight circuit! Duplex telegraphy has been effected on more than one occasion with U2XBB.



A standard 1 1/2 KW Marconi ship set with D.F. spark, C.W. and "Emergency" equipment.



Low-Frequency Resistance Coupling

Considerable interest is being taken in resistance coupling for broadcast reception, and there are naturally varying opinions regarding its use. It is important to bring out very clearly the advantages of each method and not to come to conclusions too rapidly.

iron-core transformer is a consideration which governs many experimenters, and if, at the same time, a good make of transformer is purchased, and suitable grid bias, etc., employed, better results could not be wished for, but, on the other hand, where a large amount of low-frequency amplification is desired, resistance amplification appears to be

faithful result, but it has to be remembered that the aforesaid B.B.C. thinks nothing of using five or six stages of low-frequency amplification, and that transformers for this purpose would be out of the question. Where only one or two stages of low-frequency amplification are required, then the average man will vote for transformer coupling.

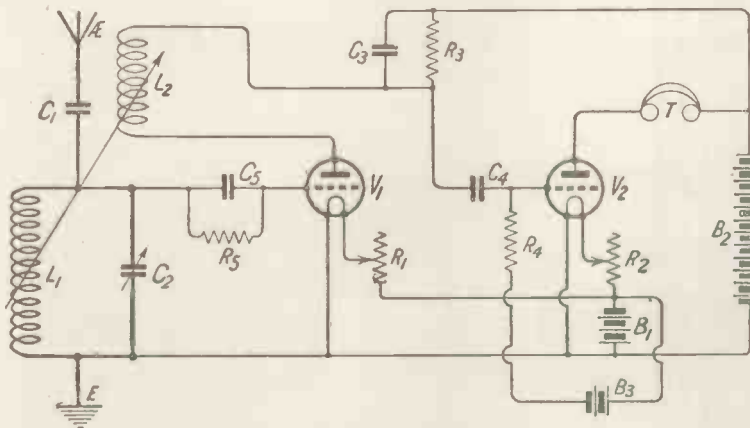

Fig. 1.—A two-valve circuit using one stage of low-frequency resistance coupling.

In the first place, resistance amplification is considerably less efficient than transformer coupling, as regards strength of signals obtained. On the other hand, it is probably correct to say that in the average hands a resistance amplifier gives purer results than a receiver using several stages of transformer coupling. To work two or more stages of low-frequency amplification without producing distortion necessitates a good make of transformer and proper operating conditions. Resistance coupling has acquired a reputation very largely because of the inferior and actually shoddy iron-core transformers on the market which, moreover, are frequently improperly used. The valve economy involved in the use of an

the only solution. Because the B.B.C. largely use resistance low-frequency amplification, it is assumed that this gives a more

Resistance Values

As regards circuits using resistance coupling, the accompanying Figures 1 and 2 will be found suitable. It will be seen in Fig. 1 that the first valve acts as a detector with reaction, and that low-frequency coupling is effected by means of the resistance R_3 , which may have a value of 50,000 or 100,000 ohms. Using an anode battery of about 70 or 80 volts it does not seem to make much difference if R_3 is 50,000 or 100,000 ohms. The condenser C_3 is merely a by-path condenser for the high-frequency anode currents of the first valve, and its capacity may be anything from .0001 μ F to .002 μ F. Larger capacities than the latter value will reduce the degree of low-

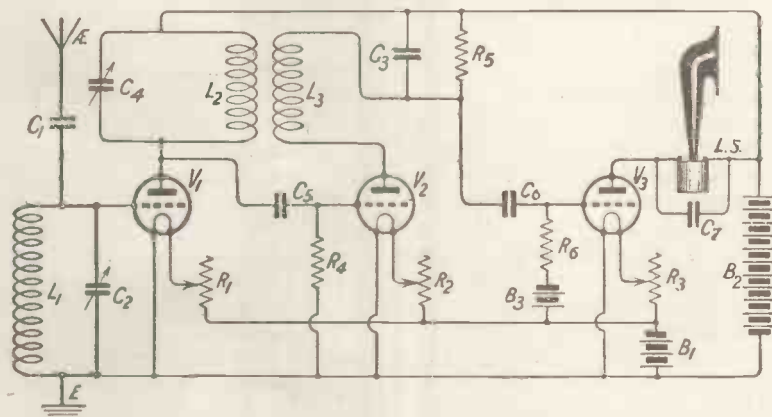

Fig. 2.—The ST34 circuit, followed by one resistance coupled low-frequency valve. Note that the L.T. positive is earthed to give stability.

frequency amplification obtained by the first valve. The condenser C_4 may have a value of from .002 μF to .25 μF ; the actual value does not seem to be at all critical. The larger sizes of grid condenser, of course, should be of the Mansbridge type, the cost working out at about 6s. each. A mica condenser would be too expensive for ordinary purposes, quite apart from the question of the size of the condenser. Grid bias may be applied to the grid of the second valve by means of a grid battery B_3 . In the case

of the Fig. 1 circuit the battery B_3 will not usually be necessary.

As regards Fig. 2, this is an ST34 circuit followed by a stage of low-frequency amplification. Here the resistance R_5 is as before—50,000 or 100,000 ohms—while the condenser C_3 across it may have any value from .0001 μF to .002 μF . A value of .0001 μF will be probably cheaper, and will work just as well as the larger capacities. The grid condenser in the grid circuit of the third valve has the same value as C_4 in Fig. 1, and ordinary

grid leaks may be used in both cases.

I would like to warn readers very solemnly about purchasing nondescript anode resistances. They may look very well outside, but the average kind sold in many shops is an extremely inferior article. Strangely enough, reputable manufacturers do not seem to have appreciated the growing demand for anode resistances. Fortunately, those who are appreciating the demand for fixed resistances are maintaining a high level of quality.

Drilling Panels Without Marking Them

IN marking out the drilling centres on ebonite panels in the ordinary way, lines are scratched on the underside of the panel. For general finish and accuracy it would often be preferable to drill from the top face of the panel, but this would necessitate laboriously removing the panel surface to eliminate the lines thus made. Another drawback in marking out centres on ebonite panels is the fact that it

folded edge rest against the corresponding edge of the panel itself. Fold the remaining piece of paper under the panel and clamp the two to the bench, as shown in the diagram. With an archimedean drill, using a fine drill, bore through the paper and lightly into the panel.

PATENTS.

This is to give notice that a considerable number of wireless patents in the name of John Scott-Taggart will be disposed of almost immediately. Any firms or persons interested should make application at once to the above-named at Devereux Court, Strand, London, W.C.2.

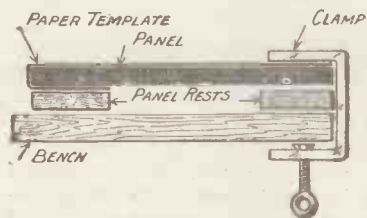

Illustrating the method of clamping the panel ready for drilling.

is very difficult to see clearly what one is doing on a jet black surface. It is as easy and as quick to accurately draft out the arrangement of the various holes on paper, as it is to do it on the panel. The writer suggests, therefore, that a drawing should first be made on paper of the drillings as they would appear from the top of the panel. If the constructor can draw his lines on ebonite, he can draw them on paper. The outside edge of the panel should also be drawn in. When this is done, cut out the paper template round three of the panel edges, leaving the fourth uncut. Fold the paper carefully along this line. Now lay the paper template, right side up, on the panel, letting the



Mr. H. M. Hill at the main oscillator at the Glasgow station.

Fixing Small Screws into Ebonite

THE tapping of ebonite to take a machine thread is very unsatisfactory, especially if a small diameter screw, such as 4, 6, or 8 B.A. be used. A good thread can be made for short distances, i.e., about a $\frac{1}{4}$ in., but very great care must be taken to use the correct size drill for the hole and very steady application of the tap to the material. The cause of taps stripping the material is due to heat generated by friction softening the ebonite. This latter then powders up, and still getting warmer expands so much that it binds the tap to the ebonite. A slight turn of the tap under these conditions will strip any thread that has been made. The tap should be totally withdrawn very frequently and cleaned with a stiff brush, and cooled by dipping into water for a second or two. A drop of water in the hole also helps matters.

In spite of very careful manipulation, the thread once formed has no great strength, and is liable to strip if too much tension is applied.

A very satisfactory method is to use wood screws, the picture showing the difference between a machine screw thread and a wood screw. It will be seen that whereas the machine screw has fairly thick, carefully designed and balanced threads, the wood screw threads are a little deeper and thinner in the walls. The top of the thread also has a fairly sharp point.

This allows the thread to easily pierce the ebonite and let itself in, instead of cutting the material away.

To use the wood screws in ebonite the following is the most satisfactory and simple method.

A hole is first drilled and cleared to allow of the first complete thread at the bottom of the screw to just enter it; the wood screws being tapered, act as a taper tap automatically.

The screw is carefully turned with a screw-driver backwards and forwards, going into the ebonite a little more each time, until the screw is in as far as required.

The best screws to use are "brassed iron" or plain "steel." The brass screws look much better, however, and their cost is a little more. Brass screws can be used, but the chance of them snapping off is very great.

The writer has found by experience that the size and length of screws usually required are as follows:— $\frac{3}{8}$ in., $\frac{1}{2}$ in. \times 4 in., $\frac{5}{8}$ in. \times 4 in., $\frac{3}{4}$ in. \times 4 in. countersunk. A $\frac{3}{32}$ in. Morse drill is the correct drill to use for these sizes. A smaller screw, $\frac{1}{4}$ in. \times 2 in., requires a $\frac{1}{16}$ in. or $\frac{5}{64}$ in. drill,

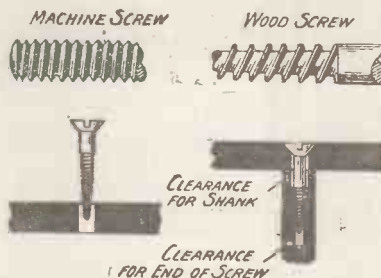

Illustrating the difference between machine and wood screws and the method of screwing the latter into ebonite.

and a few of these are very useful for fitting clips, etc. When drill-

ing into the edge of a panel, be sure to drill the hole deep enough to clear the end of the screw.

If the plain shank of the screw is liable to go into the hole, the top of the hole should be slightly enlarged, or the edge of the panel may split.

The larger hole should be drilled first and then the smaller after. An $\frac{3}{8}$ -in. drill will nicely clear the shank.

It is advisable to drill right through the panel and fill in the hole with heelball after the screw has been fixed. The reason for this is that should the screw meet the bottom of the hole in the solid, trouble may be experienced through the screw snapping close to the shank. If this should occur, the method of removing the screw is tedious, and requires a certain amount of care. A small centre punch mark is made in the top of the screw and a fine hole drilled right down the centre of the screw right through the panel. A slightly larger drill is then pushed hard into the back end of the hole sufficient to obtain a hold on the screw. Careful twisting will then bring the remnants of the metal out on top of the drill at the other side. If care is taken the original hole can still be kept at the original diameter.

W. H. F.

WIRELESS AND THE ARMY



Our photograph shows R.A.F. signallers listening to aircraft signals during the recent Army manoeuvres.



Fig. 1.—The neat layout and general appearance of the set may be seen in the photograph.

THE set to be described is particularly designed for range rather than volume on a nearby station, and although only two valves are used, on a good aerial, under favourable conditions, it should be possible to get all B.B.C. and a number of the Continental stations at good 'phone strength. With this object in view, the arrangement of one high-frequency valve, followed by a valve rectifier, has been adopted. This constitutes an ideal but quite simple arrangement for the purpose.

The Circuit

From the theoretical circuit diagram it will be seen that this is quite a simple and straightforward arrangement of a direct-coupled aerial circuit with a high-frequency valve, transformer-coupled to a detector, reaction being direct on to the aerial. This type of set is admirably adapted to adding note magnifying valves if desired for loud-speaker work.

The high-frequency side is devoid of switching, which is not to be recommended in circuits of

this type, and great care has been taken with the layout to avoid interaction. Readers are particularly advised not to modify the design in any way, as the particular layout has been found to give excellent results.

Aerial Tuning

Parallel tuning is used in the aerial circuit, and two terminals are incorporated, so that if desired a frame aerial may be tried if the particular properties of this type of aerial are required for directional work, or if space does not permit of the usual outdoor or indoor aerial being utilised. The aerial condenser in this case is across both the frame and what would, with the ordinary arrangement be the aerial coil, so that reaction may still be obtained if necessary. Of course, a much smaller coil would be necessary in this case, and possibly the reaction coil would have to be reversed for stabilising purposes.

These two terminals might also be used to insert a stabilising resistance in series with the aerial coil if necessary on a very short aerial.

A Long-Range Two-Valve Receiver

By J. UNDERDOWN.

A receiver employing plug-in coils and transformers, which may be used for all wavelengths.

Referring again to the circuit diagram, it will be seen that the secondary of the high-frequency transformer is tuned rather than the primary, as this arrangement tends to give rather greater stability. The reaction coil is connected in the plate circuit of the detector valve in the conventional manner, and is coupled to that of the aerial by a two-coil holder. Only a small coil will be found necessary to give reaction over the whole broadcast range, and care must be taken not to use this so as to cause interference to other listeners.

Rectification is obtained by the leaky grid condenser method. Separate high-tension terminals are provided so that both valves may be worked under the best conditions and suitable types used

for high-frequency amplification and detection. A suitable bypass condenser is placed across the telephones to ensure easy reaction control. The positive terminal of the low-tension battery is connected to earth, since greater stability is obtained in this way than when earthing the negative; any slight loss through this connection may be compensated for by the use of slightly tighter reaction coupling if required. On inefficient aerials with which difficulty is experienced in bringing the set into oscillation the negative may be earthed as shown dotted in the circuit diagram. In this case the lead marked \times is not required (joining the moving vanes of the .0005 μF to the positive L.T. busbar).

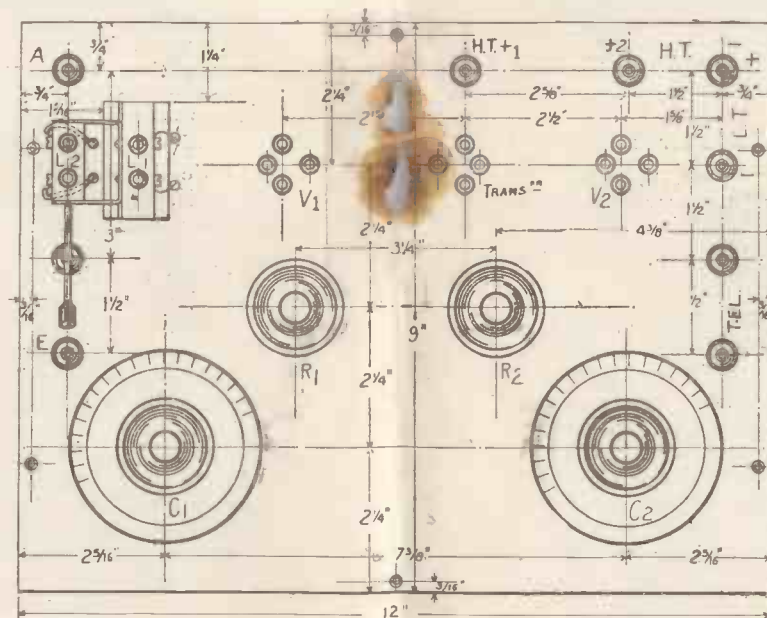

Fig. 2.—The layout of the panel. Ask for Blueprint No. 65A.

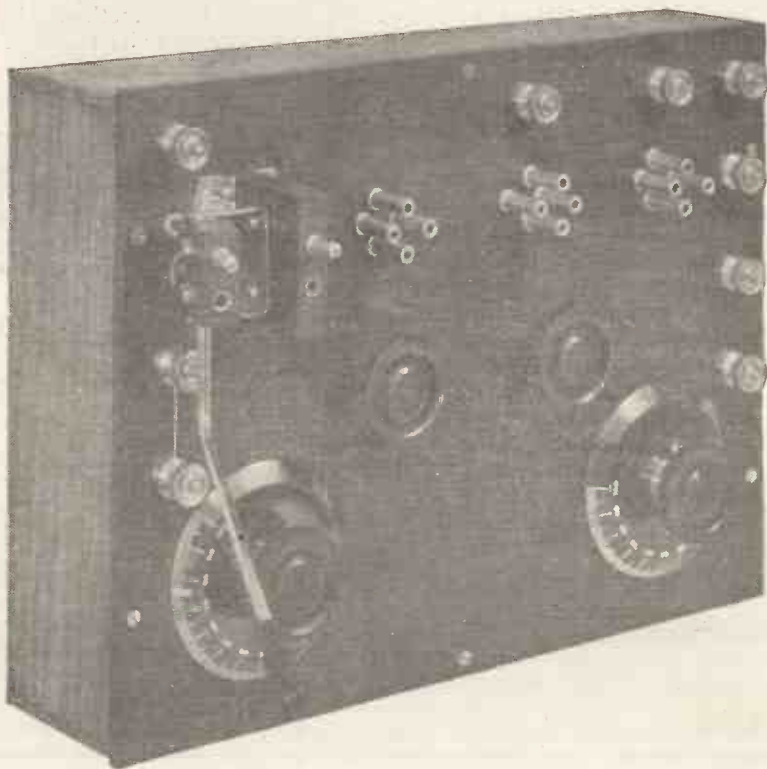

Fig. 3.—Photograph with coils and valves removed to show disposition of components on the panel.

General Layout

From the photographs the general layout may easily be seen. On the left-hand of the panel are three terminals; that at the back is for the aerial, whilst the other two are normally shorted and connected to earth. A two-coil holder is on the left-hand side of the panel, the moving holder taking the reaction coil whilst the fixed accommodates that of the aerial. Immediately in front of the coilholder is the aerial condenser of $.0005 \mu\text{F}$. At the rear of the panel the terminals for positive H.T. are placed; that on the left is for the high-frequency valve, whilst the other is for the detector. The function of the other four terminals on the right-hand side is as follows: that in the corner of the panel is a common terminal for negative H.T. and positive L.T., whilst the next is for negative L.T. The other two are for the telephones.

The two valves are at the rear of the panel, and between them is the plug-in high-frequency trans-

former. Immediately in front are the two filament resistances. The variable condenser tuning the H.F. transformer is on the right-hand side and the front of the panel. Its value is $.0002 \mu\text{F}$.

Components

The components required are as given below:—

- 1 ebonite panel 12 in. \times 9 in. \times $\frac{1}{4}$ in. thick.
- 2 square-law variable condensers of $.0005$ and $.0002 \mu\text{F}$ (Bowyer-Lowe Co., Ltd.).
- 1 2-coilholder (Burne-Jones & Co.).
- 2 filament resistance (Gambrell Bros., Ltd.).
- 2 fixed condensers of $.002$ and $.0003 \mu\text{F}$ (Dubilier Co.).
- 1 2-megohm grid leak (Dubilier Co.).
- 12 valve sockets with nuts and washers.
- 9 W.D.-type terminals 4 B.A., complete with nuts and washers.
- Quantity of 16-gauge tinned copper wire and short length of rubber-covered flex.

As is usual, names of firms from whom the components were obtained are given for the benefit of readers who wish to exactly duplicate the receiver as illustrated. Any type of cabinet may be used to take the set. That shown was made by the author, and is particularly shallow to allow of being carried in an ordinary attaché case when required. The high-frequency transformer used was that known as the Discol, and is made by Gent & Co. If any other make is used it may be necessary to try the effect of reversing the connection to the primary and secondary to get the best effect. On first test with the set hardly any signals were obtained until the correct connections were found by experiment, but when correctly connected excellent signals resulted.

Constructional Notes

If the panel is not matted or guaranteed free from surface leakage the shiny surface should be thoroughly removed by the use of emery paper; use a little lubricating oil and rub with a circular motion, when a fine-looking surface will result. Having prepared the panel, mark out the position of the various holes by means of a scribe or some sharp instrument. Next mount the various components upon the panel and clean the points which are to be soldered by means of a smooth file. All is now ready for wiring.

Connecting Up

First carefully tin all the tops of the terminals and valve sockets, taking care to use the minimum amount of flux or soldering paste possible. If the panel becomes greasy with flux, this may be removed by carefully scraping or washing off with methylated spirits.

When soldering use an adequately hot iron so that it has not to be held on the point to be tinned more than a second or so. If the terminals become heated by too lengthy application of the iron they will probably be found to have loosened, and the nuts should be given a half-turn or so with the pliers before proceeding further. The wiring in the receiver illustrated has been carried out with No. 16 gauge

tinned copper wire which was obtained on a bobbin. To straighten this the best method to adopt is to securely twist one end round some firm object, such as the knob of the oven door or a table leg if a vice is not available, and after reeling off a few feet this should be stretched until it is felt to give slightly. If cut off in short lengths this will now be found to be perfectly straight, and will look much neater and be a source of pride to the user when the instrument is completed.

Careful Wiring

Carefully carry out the wiring as shown on the wiring diagram

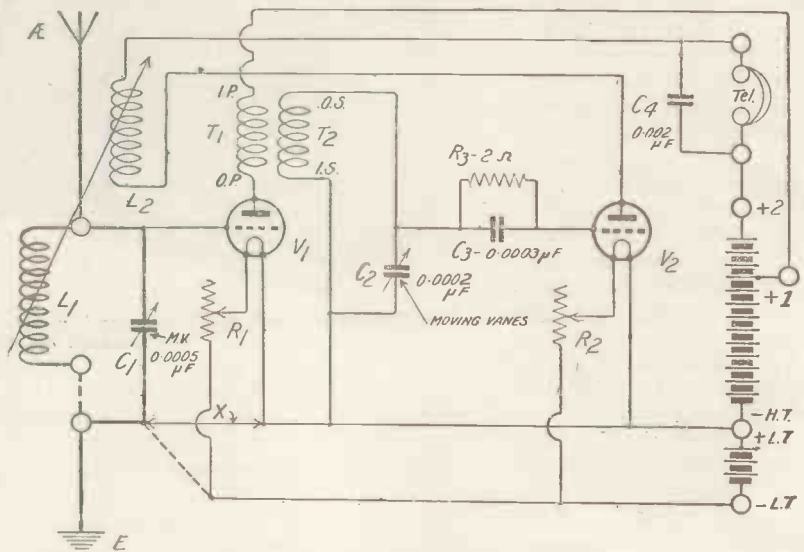

Fig. 4.—The circuit diagram showing alternative earth connection for greater freedom of oscillation.

and in the photographs, taking care to keep grid and plate leads well spaced. It will be noticed that the leads to the reaction coil are twisted together to prevent interaction. One consists of a piece of tinned copper wire almost to the holes through which the flex leads to the moving coil are taken and serves to keep the other, which consists entirely of rubber-covered flex, and is twined round it, rigid and away from the other leads. Little difficulty should be experienced with the wiring, as this is all quite straightforward and easily followed from the diagram and photograph. Readers may perhaps think too much stress has been laid on soldering hints, but our experience amply shows that it is here that great care

should be taken; as before stated, bad joints and too much flux have been found to be the cause of many failures.

Testing

The wiring being successfully completed, plug the aerial coil into the fixed block of the coil-holder and a smaller coil into the reaction or moving socket. For the broadcast band of wavelengths the writer used a Gambrell "A" coil for the aerial circuit and an "a" for reaction. For the higher wavelength stations, Aberdeen and Birmingham, a "B" coil was used in the aerial circuit. The "a"

was found suitable for reaction over the whole range and even above 600 metres. With other makes of coils a 35 or 50 will be found suitable for aerial and a 25 or 35 for reaction.

Plug in the valves and H.F. transformer and then connect the low-tension battery in circuit. Turn on the filaments and ascertain that the valves light correctly, after which the high-tension should be connected. For a start the two H.T. positives may be connected together and given about 60 volts or so with R-type bright emitter valves. Connect the aerial to the aerial terminal and join the other two left-hand terminals together and to earth.

The next step is to see that the reaction coil is connected

the right way round. To do this, first tune with the two condensers with the reaction coil as far from the fixed aerial coil as possible until a signal is heard. Then gradually bring the reaction coil towards the aerial coil, retuning at the same time on the aerial condenser. If the signal increases in strength until finally the set oscillates as evidenced by plocks in the phones on touching the aerial terminal, the coil is rightly connected. If, however, the signal gets weaker and it is impossible to make the set oscillate even by using a larger coil, the leads to it should be reversed at the moving coil block. This should be done in non-broadcasting hours to avoid interfering with other listeners.

The set being found to function correctly can now be tried on broadcast, and once the local station is obtained you have a basis on which to search for the others. Those of higher wavelength will be found to require higher condenser readings and tighter reaction coupling, and

vice versa for the lower wavelength stations. The tighter the

care should be taken to avoid oscillation.

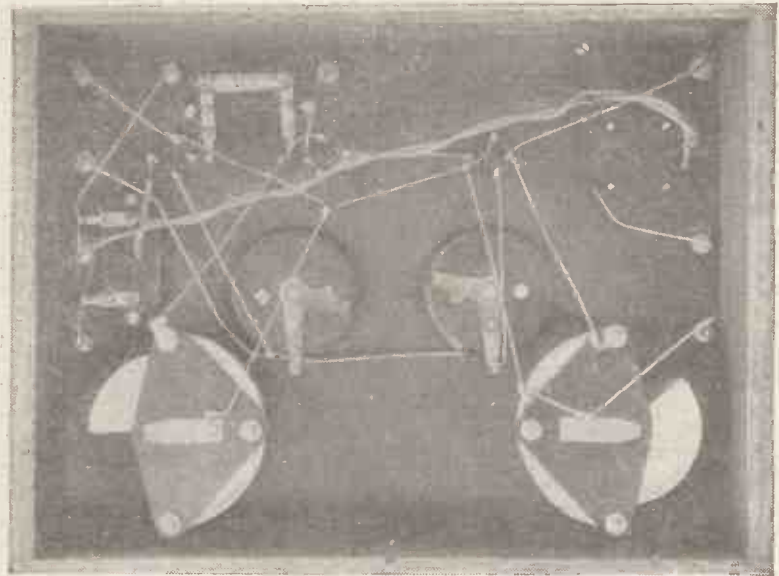

Fig. 5.—Photograph showing the wiring. Note particularly how the leads are spaced.

reaction coupling the greater will be the selectivity and the sharper the tuning, but great

A test report upon the working of this receiver will be given in our next issue.

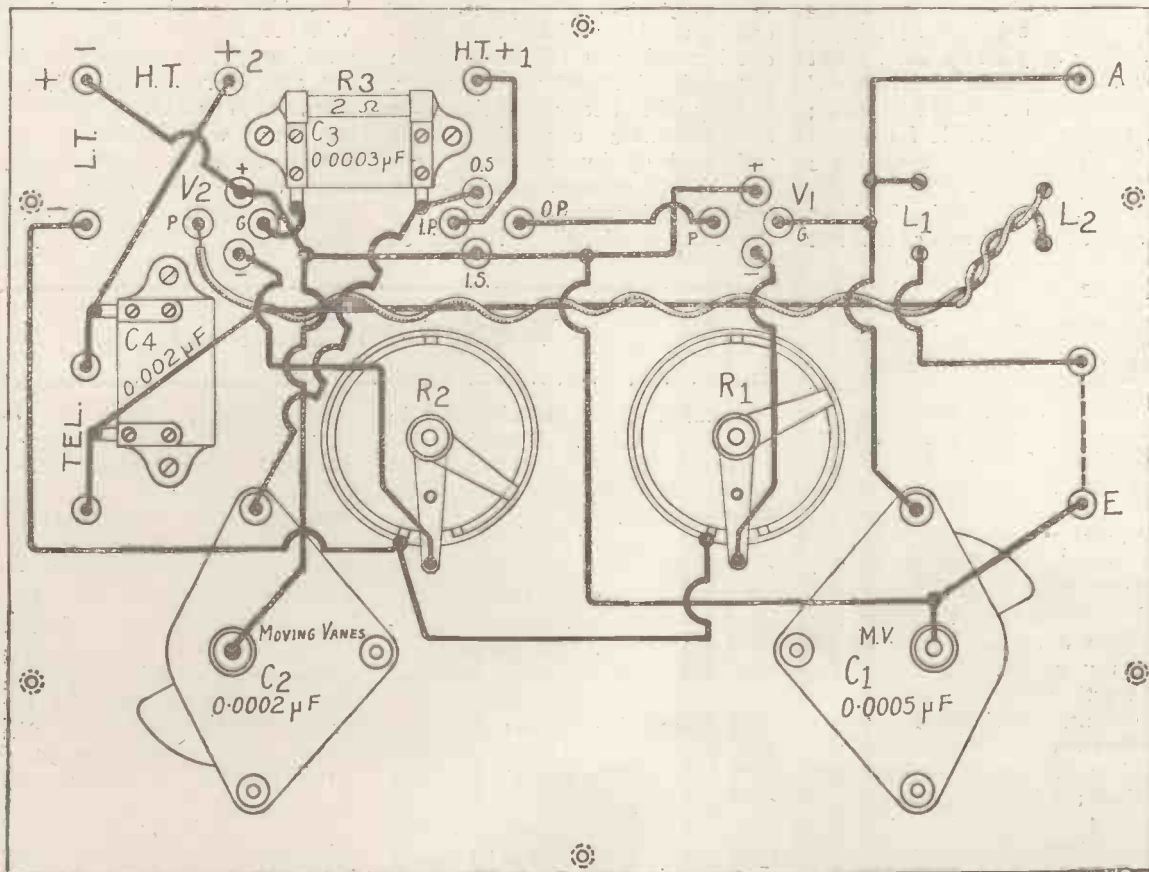
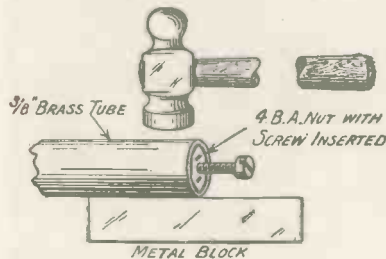

Fig. 6.—Practical back-of-panel wiring diagram. Blueprint No. 65B.

Box Spanners for B.A. Nuts

THE box spanner is one of the most useful tools, for it enables nuts to be tightened down in inaccessible corners where they could not possibly be reached by either pliers or flat spanner. It consists of a length of tubing, one end of which is made hexagonal to fit over a nut.



Method of shaping the tubing.

At the other end are drilled two holes through which a "tommy bar" can be passed so as to give one a good leverage on the spanner. A set of B.A. box spanners can be made by anyone in his own workshop at trifling cost. For 4, 5 and 6 B.A. stout brass tubing with an external diameter of $\frac{3}{8}$ in. should be used; $\frac{1}{2}$ -in. tubing is suitable for 2 and 3 B.A. To make these spanners proceed as follows.

Cut off a 6-in. length of tubing and insert into one end of it a nut

of the size which the spanner is to fit, with a screw in it. The screw is essential, for otherwise the nut itself will be flattened by the hammering which is necessary. Place the end of the tube upon a metal block and hammer all round so as to shape it to the nut. This process does not take long, but it must be done carefully in order to make the spanner a thoroughly good fit. When there is hardly any play at all between the nut and the tubing the former may be withdrawn and the end of the tubing finished up externally with a smooth file. At the other end of the tube drill a pair of $\frac{3}{16}$ -in. holes opposite to one another and cut off a 3-in. length of $\frac{3}{16}$ -in. rod to make a tommy bar. The same tommy bar will of course do for the whole set of spanners.

So long as good tubing is used the spanners will be found eminently serviceable, and they can be used for a long time without becoming at all loose upon nuts. If signs of wear appear, as they will in course of time, the box spanners can always be tightened up by repeating the hammering process with the nut and screw inserted as before into the hexagonal end. If desired

the spanners may be made double-ended. One end of the first tube, for example, might be made 6 B.A. and the other 5 B.A. Both ends of the second tube could be made 4 B.A. (since this is the most used size and this spanner will therefore get the hardest wear), and the third tube 2 B.A. at one end and 3 B.A. at the other. A set of three spanners will thus cover all the B.A. sizes that are used by the

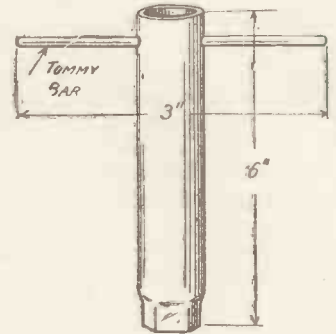

The spanner in its final form.

constructor of wireless apparatus. Rather more durable spanners can be made from medium-steel tubing by those who can undertake the process of working the metal whilst it is hot and of retempering it afterwards. The brass spanners, however, will be found good enough for all ordinary purposes, since one never exercises any great force in tightening up a B.A. nut. R. W. H.

MOST of us, I imagine, when we are engaged in some piece of constructional work, are apt to spend many valuable minutes in looking for a scribe, a centre punch, or some other small tool which has buried itself amongst a varied assortment on the workshop bench. I am not naturally a tidy person, but I have found that in the workshop a certain amount of tidiness pays so well that it is well worth while to reform to this extent. Perhaps the worst offenders are the drawers in the work bench. One is only too apt when tidying up to cast small tools and odds and ends into them indiscriminately, with the result that in time they become filled with such a medley that

one has the utmost difficulty in finding anything. Here is what I have found to be a useful and at the same time a not very irksome system.

At the back of the work bench against the wall, and quite out of the way, are twenty boxes of the kind used for containing a hundred cigarettes. Each of these has its special use. Six of them are devoted to B.A. screws and nuts from size No. 1 to size No. 6. The seventh, labelled "B.A. Miscellaneous," receives any nuts or screws that are found lying about, and these are sorted out whenever one has nothing else to do into their proper containers. Other boxes hold ter-

Workshop Tidiness

minals, tags, pieces of sheet metal, valve pins and legs, plugs and sockets, switch parts, knobs, condenser parts, bushes, and the various other small parts that one is continually using. Near these boxes are the drill stand and the taps and dies. At the back of the table there is also a larger box without a lid which holds pieces of used emery cloth. The two drawers of the bench are confined strictly to lengths of round, square and screwed rod, large pieces of sheet metal, scribes, centre punches, and unused emery cloth or glass paper.

Large tools, such as the breast drill, hammers, hacksaws, wood

saws, set squares, and the like hang on nails driven into one of the walls. For chisels and screwdrivers there is a rack in which are a couple of dozen $\frac{1}{2}$ -in. holes. Large files live in holders made by nailing strips of leather to the wall, and there are similar holders for small files. The drill plate hangs on a nail driven into the wall just above the drill stand, and from other nails close to it suspend folding footrules, dividers, compasses, calipers, and a B.A. gauge. Small measures and straight rulers have a box of their own. Pliers of various kinds repose in a rack similar to that which holds chisels and screwdrivers. Under the table are two large wooden boxes. The first contains pieces of ebonite of the size suitable for

panels, and in the second are all kinds of odd pieces of scrap ebonite. On a shelf fixed to the wall behind the bench are the oil can, the turpentine bottle, the shellac, Chatterton's compound, fluxite, and various paints and varnishes.

The golden rule in doing jobs quickly and without having to waste time in searching for tools or small parts is first of all to keep your things in an orderly way such as I have described, and secondly never to fail to put everything back into its place as soon as the job has been completed.

Two other useful accessories, which can hardly be called tools, hang from nails driven into the wall of the workshop. The first of these is a steel wire brush such

as is sold by ironmongers for cleaning stoves. Its use is to get rid of the clogging in files which have been used for trimming up ebonite. If one makes a point of using this brush on all files which have been used for working ebonite before they are put away one can always be sure that they will be keen when employed for the next job. Without some such means of getting rid of the clogging files used upon ebonite very soon become so dull that they are practically useless. The second accessory is a hearth brush, which is used for removing ebonite chips and brass filings from the table, the drilling machine, and the vice. I can strongly recommend these last two to any wireless constructor. R. W. H.

A Cheap Coil Stand

THE problem of how to keep one's spare coils is always rather a difficult one, and though one starts with the best intentions in the world, they are usually left knocking about

To make a stand for these coils cut out a piece of 1 in. or $1\frac{1}{2}$ in. oak or other hard wood $8\frac{1}{2}$ in. long by $3\frac{1}{2}$ in. wide and lay it out as shown in the drawing. Now drive in a row of screws,

three parallel rows, the distance between the screws of one row and the holes of the next being 3 in. It is thus easy to make up a compact stand for a couple of dozen coils. W. H. R.

THE R.S.G.B.

(Concluded from page 643.)

There are many little problems of all kinds which beset the experimenter, many of them due to the loose nomenclature which is so representative of the British Radio Science—for example, the unfortunate term "detector" for a "rectifying" valve is a good misnomer. All valves "detect," but only one does or should "rectify" on a receiver, although in multi-stage high-frequency amplifiers it is a matter of the greatest difficulty to obtain amplification without rectification. Rectification being, in the words of Professor L. B. Turner, "a symmetric" or lopsided amplification.

Similarly one sees low-frequency transformers which "amplify," whereas it is the valve which does the "magnifying," and the transformer is simply an "accessory after the fact." In passing, it should be noted that the accepted notation uses the term "amplifier" for H.F. valves and "magnifier" for L.F. valves, which obviated any possible ambiguity.

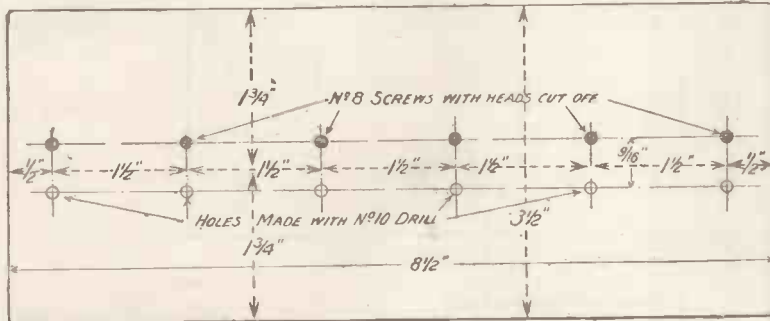

Dimensions and details of the coil stand.

either on the wireless table or loose in drawers, which is far from being good for their health. The insulation of the windings is almost bound to become injured in time at certain points, and then mysterious faults will occur in the set which may take a little tracing. The writer, who is not by any means a tidy person, has adopted a form of coil holder which is both easy to make and handy to use. The only materials required for its construction are a piece of hard wood of suitable size and some No. 8 woodscrews 1 in. in length.

cutting off their heads with a hacksaw and removing any roughness with a file. Opposite each of these drill a hole into which the coil plug is an easy fit. A No. 10 or 11 twist drill will answer for the purpose, though the exact size is not important, since there is no question of good contact. This completes the stand, though if desired certain refinements such as bevelling off the edges and glueing green baize on to the underside may be carried out. If a longer stand is required, then $1\frac{1}{2}$ in. should be added for each extra coil. Or coils can be placed in two or

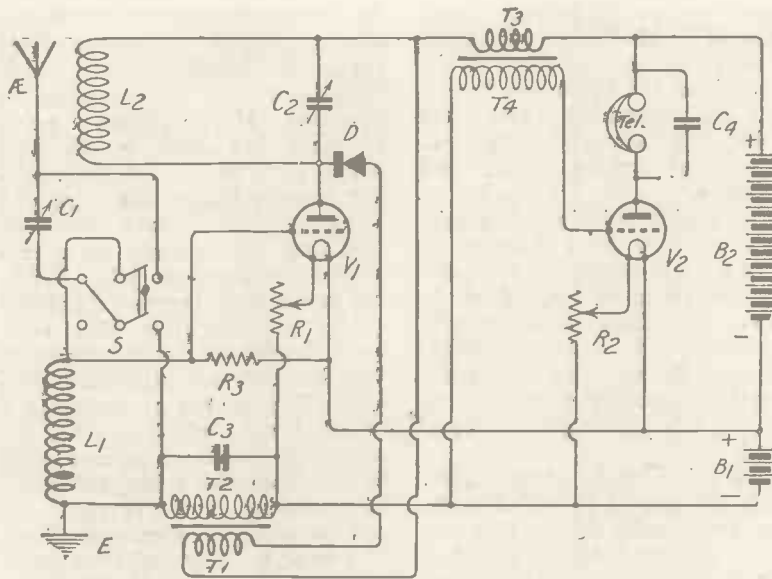

Fig. 1.—The ST101 Circuit.

THE diagram in Fig. 1 shows the ST101 circuit.

L1 is the aerial coil tuned by C1, whose capacity is 0.0005 μ F. It will be seen that this condenser may be placed either in series or parallel with L1 by means of the double-pole double-throw switch S. In the plate circuit of V1 is the tuned circuit L2 C2, the value of the condenser C2 being 0.0005 μ F. Across L2 are placed the crystal detector D and the primary T1 of the low-frequency transformer T1 T2. The secondary T2 of this transformer is placed between the negative side of the filament battery and the earth. The coupling between the two valves is effected by the trans-

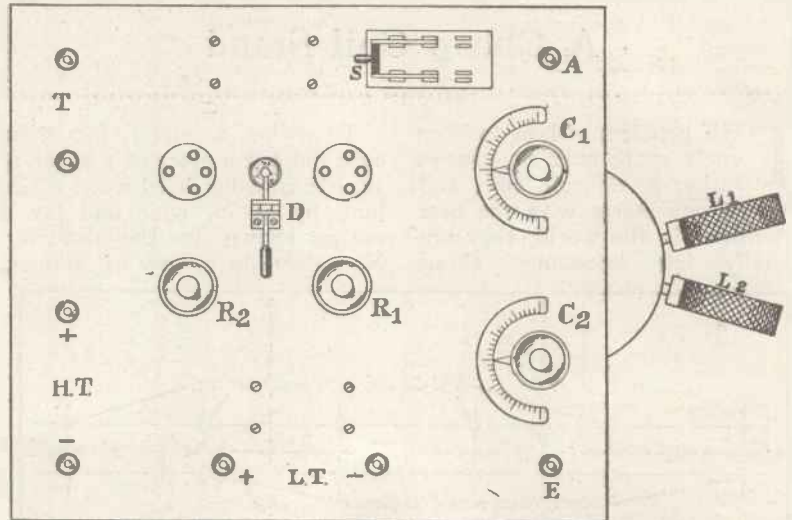

Fig. 2.—The Panel layout.

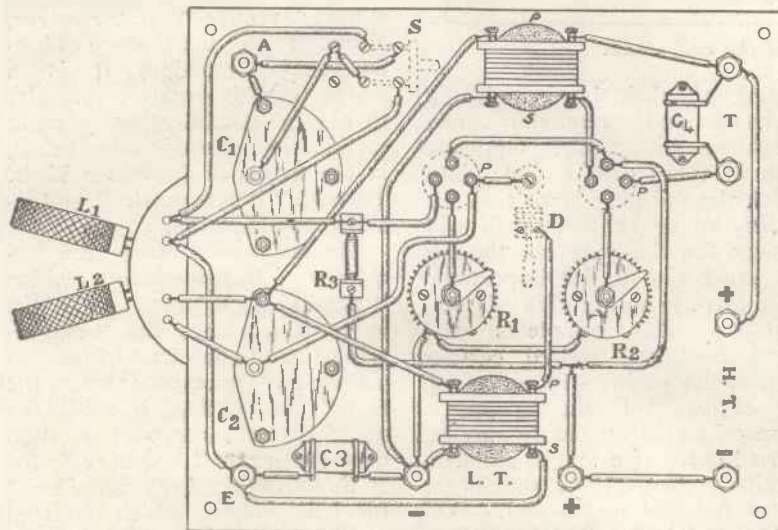

Fig. 3.—The Practical Wiring Diagram.

Practical Back-of-Panel Wiring Chart

By OSWALD J. RANKIN

The ST101 Circuit

former T3 T4, the secondary winding T4 being connected between grid and negative side of filament. The telephones, shunted by the fixed condenser C4 of 0.002 μ F, are placed in the anode circuit of V2. The correct value of the condenser C3

across the secondary of T1 T2, varies according to the make of transformer in use, 0.0003 μ F generally being quite suitable. The value of the stabilising resistance R3 is 100,000 ohms.

It is advisable before permanently wiring the set, to try changing over the connections to the primaries and secondaries of the two intervalve transformers, making permanent connections of those which give best results.

If the set will not oscillate even with the coils tightly coupled, the connections to L2 should be reversed. Ample signal strength will generally be obtained with the coils well apart.

Correspondence



THE NATIONAL ASSOCIATION OF RADIO MANUFACTURERS WIRELESS EXHIBITION, ROYAL ALBERT HALL, 1924

SIR,—I have read with some interest the leading article in the issue of the *Wireless Weekly* of the 3rd inst., wherein you deal with the above-mentioned Exhibition. To my mind, the point of view as presented by you would tend to mislead your readers, although without such intention on your part.

As a signatory to the letter sent by the editors of the wireless papers to the N.A.R.M., objecting to its policy with regard to the Exhibition, you are aware that such communication, containing as it did a veiled threat, was resented. The N.A.R.M. offered to meet the editors concerned and give them the reasons on which its policy was based. Would it not have been

fairer to the N.A.R.M. and to your circle of readers for you to have had the N.A.R.M. point of view, so as to have enabled you to put the matter fairly and squarely before your readers, instead of issuing statements which are one-sided and partially incorrect?

For the benefit of your readers, I am sure you will permit me to tell them something about the N.A.R.M. and its objects. The N.A.R.M. has at present a membership of seventy, comprising both large and small manufacturers. Its membership is open to *all* reputable manufacturers (large and small) of British-made wireless apparatus. Nobody is refused membership if he can satisfy the Committee that he makes reliable apparatus, the performance of which he is prepared to guarantee to the public. The Committee naturally require to be satisfied that

he can fulfil his guarantees. Many self-styled manufacturers apply for membership, and on investigation prove to be one-room or spare-time men who are detrimental to so many trades. They are turned down.

The great policy of the N.A.R.M. is to encourage and support the *all*-British wireless trade, and every member has to sign an undertaking that the whole of his apparatus is made in Great Britain, wholly of British material and by British labour, and if an applicant for membership will not sign this clause he is refused membership.

The N.A.R.M. also take steps to stop trade abuses, to prevent price cutting, and to protect the public against fraudulent apparatus. The Association does not control or interfere in any way with the list prices at which its members' goods

WIRELESS CABINETS

IN VARIOUS DESIGNS, and WOODS

Mahogany. Satin Walnut. White Wood polished Mahogany.

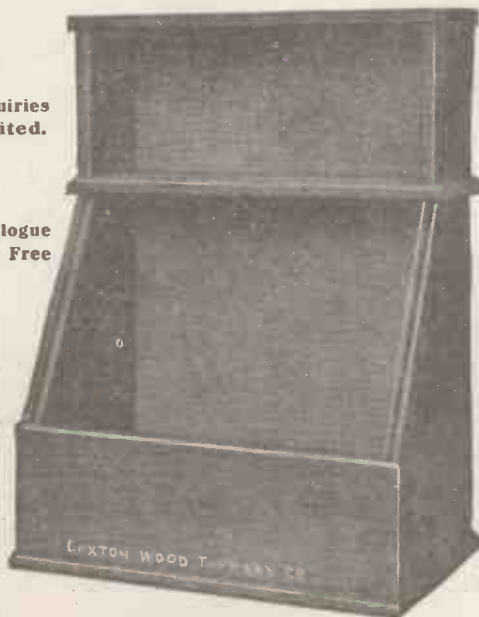

Enquiries Invited.

Catalogue Post Free

Delivery from Stock.

Specials to Order.

Makers: CAXTON CABINET & WOOD TURNERY MILLS MARKET HARBOROUGH.

Telegrams & Telephone: Haddon, 59, Market Harborough

VALVES repaired Quick!

THE advantage of sending your valve for repair to a valve manufacturer is that only a valve manufacturer can retain the valve characteristics when re-filamenting. Radions Ltd. are the pioneers of valve repairs, and still lead for good work, low price and QUICKNESS. Before sending your valve, consult this



PRICE LIST

No extra charge for New Glass or New Cap —or for both if needed.

Radion Mullard Dutch	R Type—4 volts.—.6 amps.	6/6
Marconi B.T.H. B.4.	6 volts.	17/6
Ediswan French Moorhead	Postage on these valves POST is usually about 3d. EXTRA	
Dull Emitters converted into Bright Emitters, with filaments as below:—		
B.T.H. B.5.	4/5 volts.25 amps. 15/0
B.T.H. B.4.	6 volts.6 amps. 17/6
B.T.H. B.3.	4/5 volts.6 amps. 6/8
Mar. D.E.3.	4/5 volts.25 amps. 8/8
Mullard D.F.	4/5 volts.6 amps. 6/6

Power Amplifiers.		
Mar. L.S.2.	6 volts	1.5 amps. 17/6
" L.S.3.	4/4.5 volts65 amps. 11/3
Mullard P.A.2.	5.5 volts85 amps. 13/0

Other Types—Prices and Particulars on Application.

RADIONS LTD.

Bollington, Nr. Macclesfield.



We make the new RADION Low consumption Valve. Price 10/-. Uses only a third of usual current.

are sold to the public, but it does seek to regulate the discounts allowed to the trade, making sure that the trade has a reasonable margin of profit, but not an excessive one. It must be obvious that the more discount which is allowed to the trade, the higher must be the price at which the article is sold to the public. In America, for example, a discount of 50 per cent. is allowed to the jobber and dealer, so that the American manufacturer has to increase his economic price by 100 per cent. to allow for this. The N.A.R.M. determined that the public who wish to purchase all-British apparatus made by its members should not be fleeced in this manner, hence their policy in regulating trade discounts. The knowledge that discounts are regulated in this manner encourages free competition amongst the N.A.R.M. members, and they all offer their goods to the public at the lowest possible prices, and no two firms' prices are the same.

In order to further encourage the British wireless trade, the N.A.R.M. have thrown open their doors to distributors and dealers, and these two self-governing sections, in process of formation, will be of immense assistance in furthering the cause of British industry.

I repeat, therefore, membership

of the N.A.R.M. is open to all reputable manufacturers or dealers who will whole-heartedly support British wireless trade.

I will now go on to deal with the various statements which you make in your leading article.

The Association have never claimed to be representative of the whole industry, and no firm has been refused membership without good reason. The public cannot be interested in a trade publication which they are not permitted to see, but why not tell them that the publication to which you refer carries advertisements of raw material, brass stampings and sundries, distributors' announcements, and last, but not least, advertisements of all sorts of foreign-made parts and telephones? Your own paper, I notice, carries eleven pages of N.A.R.M. advertising out of a total number of sixteen pages, not including those used for advertising your own publications.

With regard to the last two wireless Exhibitions in London, the first was very small and was held before the formation of the N.A.R.M. The N.A.R.M. were only more or less satisfied with the second Exhibition; they did not come into it early enough to have it conducted in accordance with their ideas. For this year the Association decided to

follow the lead given by other Associations (notably the Society of Motor Manufacturers and Traders), and run an Exhibition confined to its own members, and also that one or two exhibitions a year were quite enough, on account of the great expense and work involved; hence its decision not to support the numerous small exhibitions run all over the country by exhibition promoters for their own benefit.

I must absolutely deny your assertions that the Association is out to induce members of the industry to join them, either by "force or subtle pressure." I also deny your assertion that the N.A.R.M. have ever attempted to interfere "where it is both injudicious or gratuitous to interfere." I am also quite unaware that the Association has ever attempted to use their combination for purposes which no Association of its kind can successfully, or actually does, pursue.

I am glad to note that you have pointed out that the Exhibition will not be open to the whole trade. It was not our intention to suggest otherwise, and the Exhibition advertisements which we are inserting in various publications make this sufficiently clear; but the Exhibition will certainly be representative of the best class of all British wireless apparatus.

SIEMENS

DRY BATTERIES

for L.T. & H.T. Purposes.

Large Output

Long Service

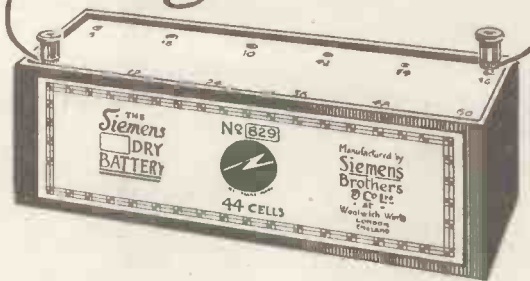

Obtainable from all Dealers.

SIEMENS BROTHERS & CO LTD WOLWICH, LONDON, S.E. 18.

You object to the term "All British," but you are probably unaware that this term is being used in conjunction with Exhibitions of Manchester, Plymouth and elsewhere, at which Exhibitions the N.A.R.M. will not be represented.

It may interest your readers to know that the more important wireless publications are supporting the Exhibition by taking space; that the Radio Society of Great Britain and the Radio Association will both have stands; that about £12,000 is being spent on the Exhibition; the lighting and decorative effects will inaugurate a new fashion in Exhibition lay-outs, and that all the latest productions of members will be shown.

In conclusion, I would like to say that the Association welcomes criticism, and wants the public to know all about it and its objects, and I hope in due course the work of the Association will merit the appreciation of the wireless community, trade, public and the Press alike.—Yours faithfully,

W. W. BURNHAM, F.I.R.E., etc.

Chairman, National Association of Radio Manufacturers.

[With reference to the above letter, our readers will appreciate that editorial opinion is invariably regarded as one-sided by those criticised. We have published, how-

ever, the above letter because we believe in being scrupulously fair in these matters.

The second paragraph of the letter deals with private correspondence between a committee of all the wireless editors and the N.A.R.M. All the wireless papers published in this country were unanimously of the opinion that an Exhibition on the lines planned was against the best interests of both the industry generally and the public. This unanimity resulted in a letter being sent to the N.A.R.M. pointing out our views. It was pointed out that if the present policy were carried out each paper would, in duty bound, have to indicate the narrow scope of the Exhibition. This presumably is the "veiled threat" mentioned in the N.A.R.M. letter given above.

The wireless papers, be it noted, are really unaffected by any other considerations than those which affect its readers. The N.A.R.M. assumed an air of outraged dignity and made the extraordinary suggestion that the considered letter of the editors should be withdrawn before the matter could be discussed. Several weeks afterwards the N.A.R.M. seemed to have arrived at the conclusion that a meeting could be arranged without the editors having to swallow their words. It

was, however, made perfectly plain by them that under no circumstances whatever could the policy be varied in any way, and that any meeting would be merely for the purpose of educating the editors. As we knew perfectly well what the N.A.R.M. policy was and their reasons for it, the editors felt that no useful purpose would be served by a belated meeting which could only involve the reiteration of facts which were perfectly well known to us when our letter was originally sent.

The letter from the N.A.R.M. published above does not contain one iota of information of which we were not aware when the original editors' letter was sent.

This matter, however, of the editors and the N.A.R.M. is purely a side issue, the only value of which, perhaps, is to show the unanimity of papers having no direct interest in the Exhibition whatever.

Our editorial meant to make it perfectly plain that the mere absence of a manufacturer from the N.A.R.M. Exhibition is in no way whatever any reflection on him; it may simply mean that the firm, in question prefers to carry on its business in its own way, rather than have its terms cut and dried by a trade organisation.

We wish to make no great point



B.T.H. Headphones

ALL BRITISH WIRELESS EXHIBITION
Albert Hall, Sept. 27 - Oct. 8
Stand No. 41

B.T.H. Headphones are supreme in all respects—in sensitiveness, tone, permanence, and comfort. Although fitting closely to the ears and thus excluding extraneous sounds, very little pressure is exerted and they can be worn for hours without discomfort.

Price per pair (4000 ohms) £1 5s. 0d.

A Proof of Superiority.
Ask your dealer to tune out his demonstration set until you can only just hear. Then substitute B.T.H. Headphones and you will be amazed at the clearness with which you can hear every word and note of music.

We also make Crystal Sets, Valve-Crystal Sets, Valve Sets, Loud Speakers, Amplifiers, Valves (including B5 type 006 amps) and Tungar Battery Chargers.

Obtainable from all Electricians and Wireless Dealers.

The British Thomson-Houston Co. Ltd.
Works: Coventry.

Offices: Crown House, Aldwych, London, W.C. 2.
Branches at: Belfast, Birmingham, Bristol, Cardiff, Dublin, Glasgow, Leeds, Liverpool, Middlesbrough, Manchester, Newcastle, Swansea, Sheffield.

out of the fact that a certain trade paper carried only 10 per cent. N.A.R.M. advertising. A careful investigation indicates that the figure should be 17 per cent., if manufacturers of raw materials and foreign manufacturers are excluded. This means that there are nearly five times as many manufacturers outside the N.A.R.M. as in it. We would not, however, regard this as a relative indication of the usefulness of N.A.R.M. and non-N.A.R.M. firms to the industry. We do not question for a moment the importance of the firms in the N.A.R.M. We simply repeat what we stated in our editorial, namely, that the Exhibition will not be representative of the industry, and that had it been free to the whole trade a very much larger and more interesting Exhibition would have been available to the wireless public.

With reference to the expression "All-British," this term, without a detailed explanation, is undoubtedly misleading, although, of course, there is no fear of our own readers being misled by it. As regards exhibitions elsewhere, there is no attempt to exclude the N.A.R.M. We simply implied that the words "All-British" should be reserved for exhibitions where all British manufacturers can, if they choose, exhibit.

The fact that wireless publications, including our own, will be represented at the Exhibition implies nothing at all, and the penultimate paragraph of the letter can only be regarded as an advertisement for it. The presence of wireless publications at an exhibition is certainly no guarantee of its representative character. We ourselves often show at small local exhibitions.

With reference to the statement of the objects and aims of the N.A.R.M., we are very happy indeed to publish the statement of its Chairman, above. We have no reason to make any comment on the statement, because, in the first place, we believe it to be a fair and accurate one, and in the second place, no criticism has been raised by us regarding the constitution and objects of this Association.

Our criticism was levelled against their Exhibition policy, and our readers will form their own judgment on this important matter.—
EDITOR.]

SPECIAL VALVES FOR RESISTANCE COUPLING

SIR,—We have read with interest the article appearing in your September 3 issue on the subject of a resistance coupled amplifier. This is a development in wireless receiver

manufacture which has for some time engaged the attention of our research laboratories and technical staff, and as a result the system has been adopted for our standard five-valve sets.

Perhaps it will be even more interesting to your readers to learn that we have now put on the market a valve designated the D.E.5B, which is specially designed for resistance-capacity work. The valve is intended to operate from a six-volt accumulator using the D.E.5 as a power amplifier in the last stage. It is a dull emitter consuming only .25 amp filament current at 5 volts. We recommend an anode resistance of about 150,000 ohms coupled with an anode voltage of about 120 in order to get the full amplification factor of 20 from the valve.

This valve should supply a long-felt need for amplifiers of this type, as, to get any volume with an ordinary general purposes valve, so many stages of amplification were required. With the D.E.5B the volume can now be obtained with a degree of clarity extremely difficult to obtain with transformer coupling.
—Yours faithfully,

For and on behalf of
THE GENERAL ELECTRIC CO., LTD.,
G. H. MARRIOTT,
Assistant Manager,
Valve Department.

THE NEW
"DEXTRAUDION"
DULL
EMITTER

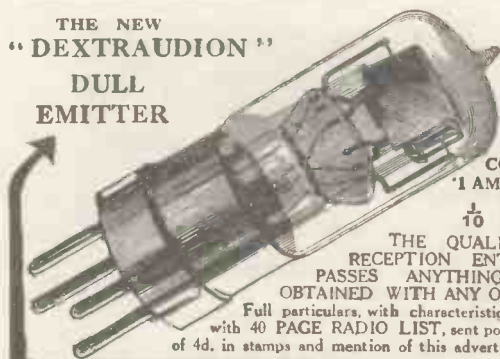

PRICE
21/-

MAXIMUM
CONSUMPTION
1 AMP. AT 1 VOLT.
1/2 WATT!

THE QUALITY OF THE RECEPTION ENTIRELY SURPASSES ANYTHING HITHERTO OBTAINED WITH ANY OTHER VALVE. Full particulars, with characteristic curves, together with 40 PAGE RADIO LIST, sent post free on receipt of 4d. in stamps and mention of this advertisement.

ECONOMIC LTD. | Head Office: 10, FITZROY SQUARE, LONDON, W.1. | Showrooms: 303, EUSTON RD. N.W.1

VALVE RENEWALS

We repair by our patent process (for which we have NATIONAL PHYSICAL LABORATORY'S Report of efficiency)

ALL STANDARD TYPES OF VALVES AT **6/6**

AND

CARRIAGE PAID

GUARANTEE { At least EQUAL EFFICIENCY to new valves.

To RETURN IN THREE DAYS

OR REFUND YOUR MONEY WITHOUT QUIBBLE.

THE ECLAT MANUFACTURING CO., LTD.

Spencer Works, Wimbledon, London, S.W.



Build a better set with



Experimental work is the life and soul of wireless advancement but—costly. In the matter of components there is no need now to experiment, for the name Igranitic on radio parts is your guarantee of first-class results from whichever circuit is used.

Igranitic Radio Devices include Honeycomb Coils, Variometers, Filament Rheostats, Inter-valve Transformers, Vario - Couplers, Battery Potentiometers, Bi-plug and Tri - plug Coilholders, Vernier Friction Pencils, Earthing Switches, etc.

The
IGRANIC
Low Frequency
TRANSFORMER

is specially designed for the distortionless reproduction of speech and music. The metal shield effectively shields from external interference. Recent improvements in design render it the finest amplifying transformer obtainable.

PRICE: Shrouded, 21/-; open, 20/-

Obtainable of all reputable dealers. Write us for List Y37.
IGRANIC ELECTRIC CO., Ltd., 149, Queen Victoria St., London
Works: BEDFORD.

Branches in Glasgow, Manchester, Birmingham, Bradford, Newcastle & Cardiff

RECEIVING 5XX

SIR,—Having read your readers' reports of reception of 5XX, I thought it might interest them to know how 5XX is received in the far North.

Using three valves, H.F.—D.—L.F., I can get 5XX just comfortably on 'phones, whereas 5NO, 6BM and 2LO on the same combination will work a loud-speaker, faintly but clearly.

These are quite normal receptions, and I have repeatedly compared them as quickly as I could change my coils. Congratulating you on your excellent papers, I am—Yours faithfully,

ERIC URQUHART.

Dingwall.

AIDS TO EASY SOLDERING

SIR,—With reference to Mr. Slater's remarks on the recent article, "Aids to Easy Soldering," where he suggests a certain method of tinning the iron which, I think, is an improvement on the method described in the article, my opinion is that the method which is most practical and more likely to appeal to the amateur is that of smearing a liberal quantity of "Fluxite" on a piece of medium glass-paper, sprinkling a few small chips of clean solder over this, and then rubbing the hot iron

briskly to and fro over the prepared glass-paper. It is most important that the abrasive action should be kept up throughout the process, and I have never yet known this method to fail, even in the hands of a raw beginner.

Regarding the shortage of tin in commercial solder, I have not yet experienced any trouble in this direction, and I think this matter can be ignored providing the best grades of solder are used.—Yours faithfully,
OSWALD J. RANKIN.

Pluckley.

TEST REPORTS

SIR,—May I respectfully draw your attention to a matter concerning the "test reports" quoted so frequently in your excellent papers, *Wireless Weekly* and *Modern Wireless*? These all appear to be carried out within approximate crystal reach of some such broadcasting station as 2LO or 5XX. If the official tester tried out a set or two on my aerial here in Cornwall his reports would be of a very different colour. Until 5XX commenced to prove such a godsend, clear reception on one or two low wavelengths was impossible, and even now with 5XX high power, Morse interference and the terrible atmospheric crashes turn what otherwise would

be a useful and delightful entertainment into a painful and sometimes earsplitting experience. Wave traps are useless on our special brand of Morse.

Can you not let us have a few test reports from this end? I can vouch for some very differently worded literature regarding new circuits and other gadgets. The reporter's difficulties experienced here might be the means of evolving something whereby we could obtain satisfaction from an article for which we pay anything from £25 upwards and a 10s. annual tax.

I have a three-valve set of well-known make working on a standard P.M.G. aerial, 75 ft. horizontal, 25 ft. at lead-in end and unshielded, earth consisting of three 1½-in. diameter iron bars driven 5 ft. into wet ground and well connected electrically.

Wishing your excellent publications continued prosperity,—Yours faithfully,

ATMOSPHERICS.

Redruth, Cornwall.

EDITOR'S NOTE.—It is of course impossible for our staff to take each receiver to half-a-dozen places in the country, but the numerous readers' letters show what can be done with these sets in various parts.



TWO, THREE & FOUR-VALVE RECEIVING SETS



Are Simply Perfect and Perfectly Simple, and are unsurpassed for Selectivity, Clearness of Reception and Power.

REVISED PRICES:

COMPLETE SETS.		PANELS ONLY.	
Two-Valve Set ..	£17 : 10 : 0	Two-Valve Panel ..	£12 : 0 : 0
Three-Valve Set ..	£22 : 5 : 0	Three-Valve Panel ..	£15 : 17 : 6
Four-Valve Set ..	£27 : 5 : 0	Four-Valve Panel ..	£20 : 5 : 0

Complete Sets consist of Panel, as illustrated, Valves, Head Phones, High and Low Tension Batteries, Aerial Wire, Insulators, Lead-in-Tube, etc.

The LIST Price of the A.J.S. Sets is the LAST Price, as with them it is not necessary to purchase numerous extras, the Specification embodying everything ready for installation, and the prices include all Royalties.

Write for Illustrated Catalogue.

A. J. STEVENS & Co. (1914) Ltd.,
WIRELESS BRANCH, WOLVERHAMPTON.

Telephone: 1550 (3 lines). Wireless Call Sign: 5 R.I. Telegrams: "Reception, Wolverhampton."



Ask to see the
TrueMusic JUNIOR
Loud Speaker.

Before you decide on the Loud-speaker for your Set, see, and listen to a TrueMusic Junior. Its clear, pure tone is a revelation.

Reproduction of Broadcasting is so faithful, because the metal in the Horn is not stretched or twisted. It is made in one piece of electrolytically deposited copper.

Drop us a Post Card for our Catalogue.

TrueMusic Junior.
£2 : 17 : 6

The Telephone Manufacturing Co., Ltd.,
Hollingsworth Works, West Dulwich, London.

British Empire Exhibition, Wembley, Palace of Engineering, B.E.A.M.A. Section, Stand O1, Avenue 11, Bays 6 and 7.



Apparatus we have tested

Conducted by A. D. COWPER, M.Sc., Staff Editor.

Coil-Former for Plug Mounting

A former for basket- or spider-coils which is adapted for subsequent mounting on the conventional plug-in fitting has been submitted by H. C. Weston. This is a disc of 4 in. diameter, with 15 wide slots each $1\frac{1}{8}$ in. deep, but with a shaped projecting tag which is of the same size approximately as the usual ebonite plug-and-socket base of plug-in coils, and will facilitate greatly the mounting of the finished coil for use in ordinary plug-in coil-holders. The slots adjacent to this tag are arranged so as to render this

practicable. We anticipate that many home-constructors who make their own coils will find this former a great convenience, as well as stronger than the usual thin cardboard.

Coil-Formers

The Highbury Engineering Works have sent for our inspection samples of their basket-coil (or "spider-coil") formers. These are slotted discs, $4\frac{1}{2}$ in. diameter, of stiff prepared insulating material, with 11 slots neatly cut in them, giving a winding depth of $1\frac{3}{8}$ in. These are evidently of a convenient size and form, and the dielectric

losses should be negligibly small with this specially-prepared material, which is stronger than ordinary thin cardboard.

SPECIAL NOTICE.

Will readers please note that Radio Press Service Department Ltd. and its Staff cannot in any circumstances advise on the choice of components advertised in "Wireless Weekly" and "Modern Wireless." This is a matter in which readers must use their own judgment, as the components advertised are uniformly of good quality. Furthermore, tests cannot be carried out for commercial firms, the department exists solely for the benefit of readers of our Journals who have themselves built sets in question from our designs. Sets built from designs other than our own cannot be tested, nor can we deal with sets made with serious departures from our instructions.

Quality RADIO PHONE & LOUD SPEAKER EXTENSION BOARD.

Fills a much needed want for conveniently using both 'phones and loud speaker at a distance from the set, either in the garden or another room.

Polished teak base with N.P. terminals and switches and a centre pillar for four pairs of 'phones.

The double switch connects either the 'phones or the loud speaker in the circuit, the single switch controls the L.T. battery circuit and does away with that annoying walk to the set to switch off and save current when an unwanted item on the programme is announced. Finished in best possible style in polished nickel plate on polished teak base, with nickel-plated terminals for flex,

25/- Postage 6d.

Special 4-strand flexible cord, with 2 thick low-resistance strands for the battery, $1\frac{1}{3}$ yard.

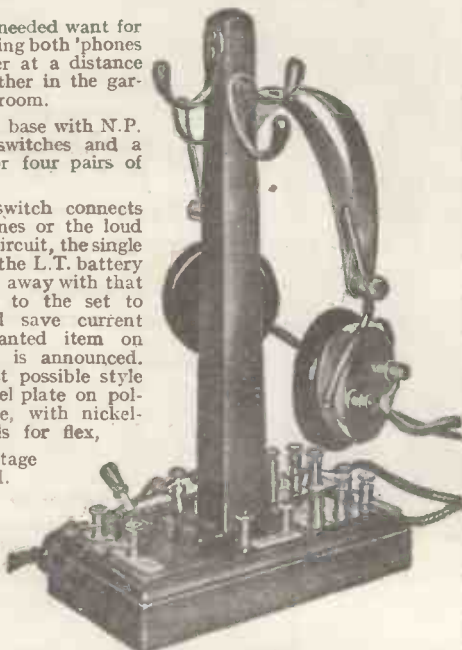

GOSWELL ENGINEERING CO., LTD.
12a, PENTONVILLE ROAD, LONDON, N.1.
Liberal Trade Terms. LIST FREE. 'Phone: North 3051.

TRADE **Grecco** MARK

"THE TONE OF THE INSTRUMENT WAS A MATTER OF FAVOURABLE COMMENT."—Vide "WIRELESS WEEKLY," September 10th, for full detailed OFFICIAL TEST.

It will give you some idea as to the **PERFECTION** to which we have brought this **LOUD-SPEAKER**.

Specification—
Laminated Poles, Adjustable Air Gap, Height 22", Flare 14" dia., Base 6".
Price, £2 10 0.
Special Packing and Post, 2/- extra. Can also be supplied with Flare hand-painted in Chinese Art Lacquer, £1 extra.

Our well-known **PANEL MOUNTING SWITCHES**. Also our own product. Supplied in Polished Brass or Nickel Plate.

SP.D.T. .. 1/-
DP.D.T. .. 1/6
Postage, 1½d.

OUR **CLIP-IN CONDENSERS** ARE OF **GUARANTEED CAPACITY** and are too well known to warrant further comment.
.001 to .001, 1/4 with clips, or 1/10 mounted.
.001 to .03, 2/- " " " 2/6 " "
Postage 2d.

PANEL MOUNTING COIL SOCKETS and PLUGS. Complete as illustrated.
Brass, 3d., N.P. 5d. pr.
Postage, 1½d.

For our complete 124 page (1500 illustrations) Catalogue full of Wireless, Electrical Goods and Tools send 3d. (Post free.)
Telephone: MUSEUM 341 Works: GLOUCESTER

ELECTRIC GRAFTON COMPANY

GRAFTON STREET, TOTTENHAM COURT ROAD,
LONDON, W.

Information Department



SUPPLIED BY RADIO PRESS SERVICE DEPT., LTD.

J. R. W. (WALTHAMSTOW) has got a receiver employing two high-frequency valves, a rectifying valve and two transformer-coupled low-frequency stages. He finds that the set is inclined to howl, and that it is difficult to distinguish between the high and low-frequency howling, and asks whether it is possible for both to be occurring at the same time.

It seems somewhat unlikely that both high- and low-frequency self oscillation should take place at one and the same time, and the usual tests should be adopted to decide upon the nature of the howling. In the first place, notice whether the pitch of the howl is appreciably altered when the tuning condensers are revolved. If a noticeable alteration takes place, the trouble is in the high-frequency circuits. The usual remedies of applying a positive bias to the grid of the valves, the connection of variable high resistances across

the tuned circuits, the removal of any reaction coils, etc., may be tried. On the other hand, the alteration of the tuning controls may make no difference to the pitch of the whistle, and one then suspects the L.F. circuits, first making sure that the trouble is not due to some form of grid-leak howl, which is often only slightly affected by revolving the tuning condenser. Make sure that the grid leak is of the correct value, and then proceed to vary the filament current on the L.F. valves. This should produce an appreciable difference in the pitch of the howl. When confirmation of this has been obtained, reverse the leads to the IS and OS of one of the transformers, make sure that the H.T. battery has not developed a high internal resistance, try the effect of shunting a condenser of at least 2 mfd. across the H.T. battery, and also, as a last resource, connect a resistance of 100,000 ohms across the secondaries of the two L.F. transformers.



It is said wireless reception is better at night than during the day.

But with a Powquip L.F. Transformer in your set you can rest assured you will receive the best results that are possible day or night.

The Powquip knows no seasons, and will give lifelong satisfaction.

Each Transformer has to pass eight exhaustive tests, which include actual performance on a standard aerial for both speech and music, before it leaves our works. Fit a Powquip to your set to-day and be ready for the long evenings. Every Powquip is guaranteed for twelve months.

Open model 14/6 Shrouded model 18/-

The **POWER EQUIPMENT COMPANY LIMITED**

KINGSBURY WORKS, THE HYDE HENDON, N.W.9.

Manufacture of Broadcasting Apparatus

USE OF PATENTS

The pioneer work of the Marconi Company in connection with wireless telegraphy and telephony is well known, and as the result of many years of research work and considerable expenditure, the Company controls numerous patents relating to the manufacture or use of wireless telegraph and telephone apparatus.

The Company is prepared to grant a licence for the use of its patents in connection with the manufacture of Broadcasting apparatus to any member of the British Broadcasting Company, Ltd

A large number of firms (including the principal manufacturers) are already so licensed and pay royalty for the use of these patents, and all apparatus manufactured under licence is so marked.

Any persons or firms manufacturing or offering for sale valve apparatus embodying patents controlled by Marconi's Wireless Telegraph Company, Ltd., without its permission render themselves liable to legal proceedings for infringement

Whilst hoping that it will not be forced to take legal proceedings the Marconi Company wishes to give notice of its intention to protect its own interests and those of its licensees, and in cases of infringement the Company will be reluctantly compelled to take such steps as may be necessary to defend its patent rights.

Marconi's Wireless Telegraph Co., Ltd.

Marconi House, Strand, LONDON, W.C.2.

Remarkable H.F. & L.F. VALVES

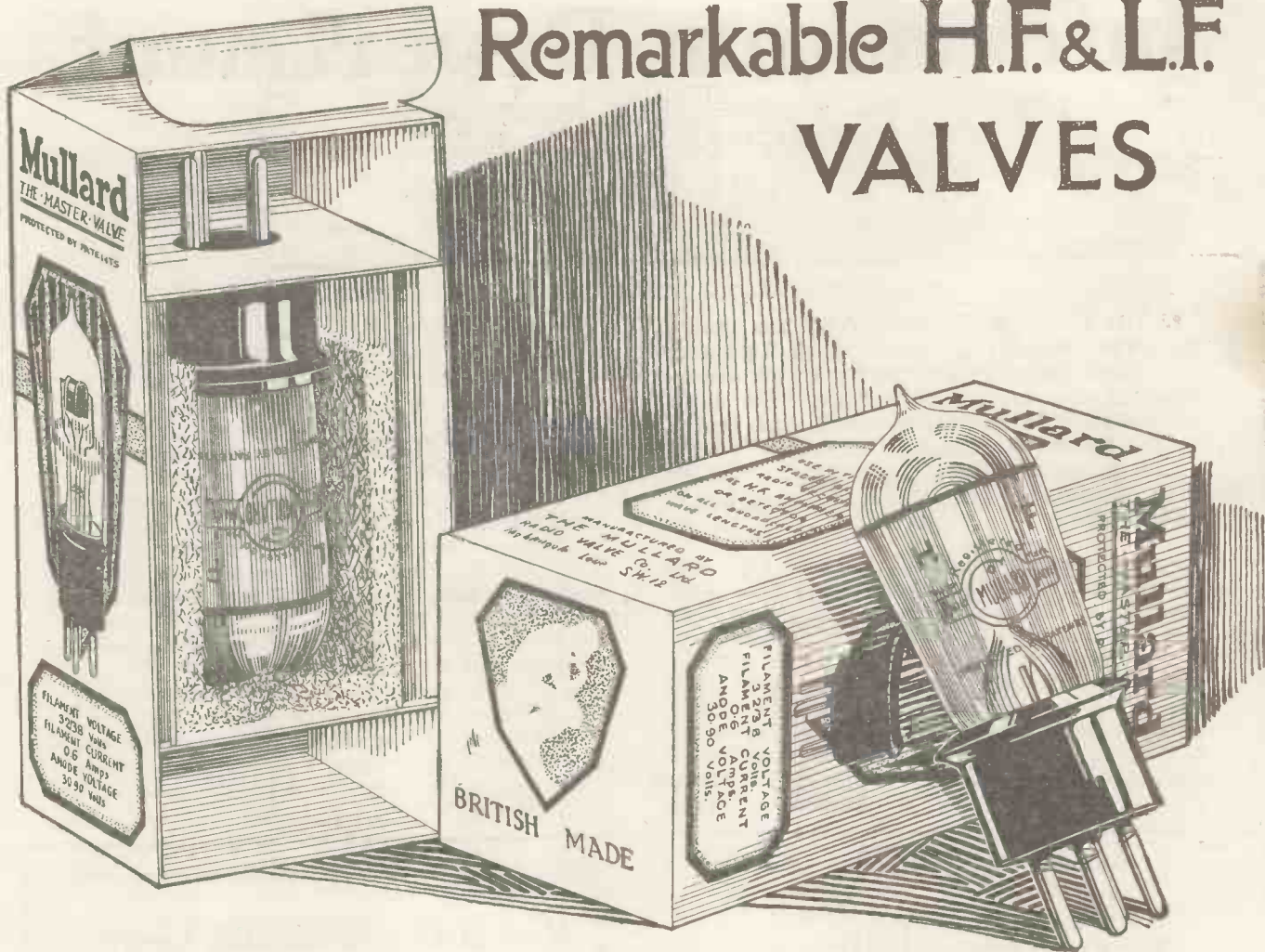

THE *very finest* reception your wireless set can give you is a pleasure you have yet to experience if you have not already purchased Mullard H.F. and L.F. valves. Every single feature in the construction of these Master Valves shows an advancement in superior design, producing, as a result, the finest bright filament valves ever offered to the radio public. Look for the unique and efficient Mullard Grid, the neat strong anti-capacity cap, and the colour distinguishing rings.

Mullard H.F. Red Ring Valves are designed for strong high frequency amplification and detection, 12/6 each.

Mullard L.F. Green Ring Valves are designed for pure low frequency amplification free from any distortion, 12/6 each.

You will be delighted with the splendid results these valves will give you.

Write for leaflet V.R. 18 for fuller information regarding these wonderful bright filament valves.

Mullard

THE MASTER VALVE

Advt.—The Mullard Radio Valves Co., Ltd. (W.W.), Nightingale Works, Nightingale Lane, Balham, S.W.12.
BRITISH EMPIRE EXHIBITION, PALACE OF ENGINEERING—Avenue 14—Bay 13.

It will pay you always to watch WIRELESS WEEKLY Advertisements.

MARCONI VALVES

MADE AT THE OSRAM LAMP WORKS

*For Resistance-Capacity
Amplification*

DE 5 B

MORE VOLUME—LESS DISTORTION

The DE 5B will give more volume in Resistance Coupled Amplifiers owing to its high Amplification factor of **20**.

Filament Volts	-	-	5-5.5
Filament Current	-	-	0.22 amps.
Impedance	-	-	30,000 ohms
Amplification Factor	-		20

Use a DE 5 Power Valve in the last stage with DE 5B Valves in the other stages and the results obtained will make the loud speaker a real pleasure to listen to.

PRICE 35/-

Obtainable from all Leading
Wireless Dealers, Electrical
Contractors, etc.

Manufacturers and Wholesale only—
The GENERAL ELECTRIC
Co., Ltd., Magnet House,
Kingsway, W.C.2.

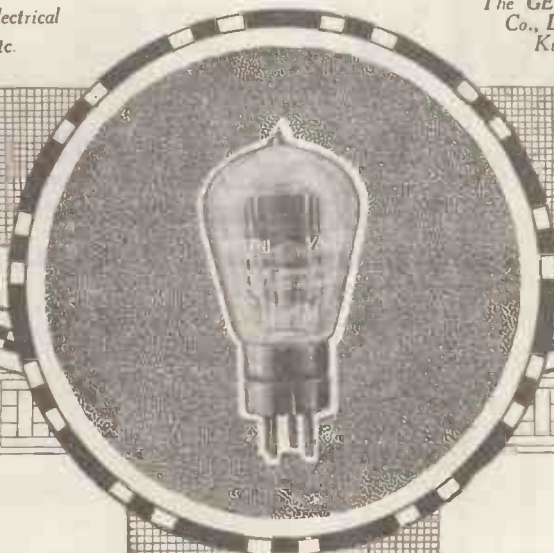

It will pay you always to watch WIRELESS WEEKLY Advertisements.



The lilt of a song or the re-introduction of an old-time melody conjures up long forgotten memories of happy moments in the fugitive past. The enjoyment of listening to the best entertainments the world produces can be yours, and your arm chair is as comfortable as a theatre stall. The Western Electric Loud Speaking Equipment, by reason of its wonderful reproduction and purity of tone, will prove a source of continual pleasure.

Loud Speaker £8
Amplifier - £24



Western Electric Company Limited,

Connaught House, Aldwych, London, W.C.2
Central 7345 (9 lines).

Branches: Birmingham, Leeds, Manchester, Newcastle, Glasgow, Cardiff, Southampton, Liverpool, Dublin.

The design of the MYERS is a proved definite advance over the construction of any ordinary valve. The bunching of electrode leads in the stem common to the four-pin method of design results in valve distortion and generally poor reception. That the MYERS brings the grid and anode leads out at opposite ends explains the striking results which users of MYERS continually experience. The high efficiency of the MYERS recommends its use for radio-frequency amplification.

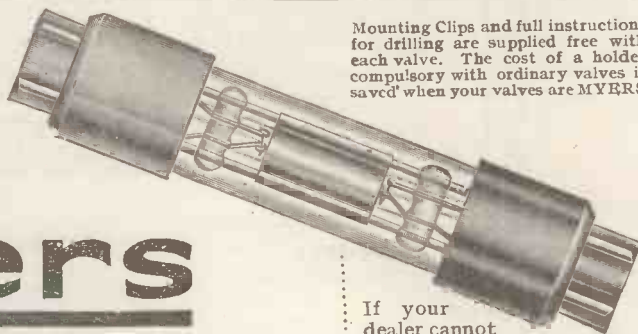

Mounting Clips and full instructions for drilling are supplied free with each valve. The cost of a holder compulsory with ordinary valves is saved when your valves are MYERS

—put the world on your dial

A New Zealand amateur picked up Alabama (10,000 miles) on one MYERS Valve. This is but one amazing performance in which MYERS are pre-eminent. Similar experience may be yours.

Myers Valves

PRACTICALLY UNBREAKABLE

Universal, 12/6 - - 4 volts - 6 amp.
Dry Battery, 21/- - - 2½ volts - 25 amp.
Plate Voltage, 2 volts - 300 volts.

Get MYERS from your dealer. If he is out of stock—be advised—send direct to nearest selling agent and be supplied—post free.

If your dealer cannot supply MYERS, you need not hesitate to have them posted to you. Their rigid construction makes accidental breaking or damage almost impossible. Such rigidity also plays an important part in reception. In fact, MYERS, for this reason, are the only really non-microphonic. Remember, while MYERS are without compeer as amplifiers, they are to an equal measure perfect detectors.

AGENTS

- LONDON—The Dull Emitter Valve Co., 83, Felham St., South Kensington, S.W.7 (Kensington 3331)
- MANCHESTER—R. Davis & Sons, Victoria Bolt and Nut Works, Bilberry St.
- LIVERPOOL—Apex Electrical Supply Co., 59, Old Hall Street, Liverpool.
- GLASGOW—Milligan's Wireless Co., 50, Sauchiehall Street, Glasgow.
- YORKSHIRE—H. Wadsworth Sellers, Standard Buildings, Leeds.
- SOUTHERN COUNTIES—D.E.D.A., 4, Tennis Road, Hove.

CUNNINGHAM & MORRISON,
Windsor House, VICTORIA ST., LONDON, S.W.1
Telephone: Victoria 827.

LISSENIUM.

Does it matter if a condenser leaks?

IT is usually asserted that condensers should be absolutely leak-proof—yet there is one position in which a fixed condenser may be used where it is immaterial whether it leaks or not. This is when the condenser is fitted in an ordinary one-valve receiver with the grid leak across the condenser. If the condenser itself were leaking when in this position, it would not make the slightest difference, BUT IF THE SAME CONDENSER WERE USED TO CONNECT THE H.F. AND DETECTOR VALVE IN A TUNED ANODE RECEIVER, THE DEFECT WOULD RESULT IN THE COMPLETE PARALYSING OF THE SECOND GRID.



CAPACITIES.

·0001 to ·0009	...	2/-
·001 to ·003	...	2/6
·004 to ·006	...	3/-

Unless, therefore, your receiver is always going to be a one-valve one, it is better to use condensers which never leak. LISSEN FIXED CONDENSERS ARE MADE WITH SCRUPULOUS CARE—THEY ARE ACCURATE TO 6%—THEY NEVER VARY—NEVER LEAK—THEY DELIVER ALL THEIR STORED UP ENERGY—ALL THE TIME.

For sharp tuning,
for strong tuning,
— use
LISSENAGON
Coils.

To equip your
receiver for the
finest detection
possible — use
LISSENSTAT
CONTROL —
(7/6, 3/6, & 10/6)

For correct grid
potential —
use the **LISSEN**
VARIABLE GRID
LEAK, 2/6.

Use a LISSEN PART
WHEREVER YOU CAN
— Don't Mix Your Parts

Should a transformer miss the low notes?

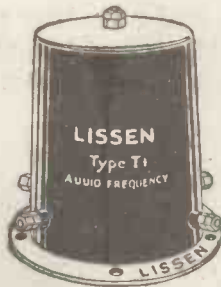

Use the LISSEN T1 for the first stage ALWAYS—for POWER WORK ALSO—and throughout when SUPERLATIVE AMPLIFICATION IS DESIRED. Price 30/-

PARTS THAT PULL TOGETHER — BUILD WITH THEM

Of musical instruments giving out notes of a complex sound construction, such as the violin or piano, the low notes are difficult to reproduce with amplification even with that of the higher notes. The higher notes are amplified much more easily than the lower ones. This accounts for the moderate reproduction which has all too generally and readily been accepted as good.

The LISSEN T1 Transformer was introduced to go immediately behind the detector valve, because at this stage the impedance of the valve before the transformer is high. And results have justified the use of this expensive transformer at this stage, FOR HERE IS LOST OR PRESERVED ALL THE BEAUTY OF PERFECT MUSIC.

If you contemplate buying an expensive transformer, you can be sure there is none to equal the LISSEN T1.

Parts with hidden power—

When you buy LISSEN Parts you have parts which you can put together knowing that even first of all your results will be better than if you had used other parts, BUT THERE IS THIS DIFFERENCE, TOO—YOUR RECEIVER WILL YIELD CONTINUALLY IMPROVING RESULTS AS YOUR OWN SKILL IMPROVES—FOR THERE IS A RESERVE IN EACH ESSENTIAL LISSEN PART WHICH OUTWARD APPEARANCE GIVES NO INDICATION OF.

LISSEN LIMITED

30-32, Woodger Road, Goldhawk Road, Shepherds Bush, London, W.12
Telephones—3380, 3381, 3382, 1072 Hammersmith. Telegrams—"Lissenium, London."

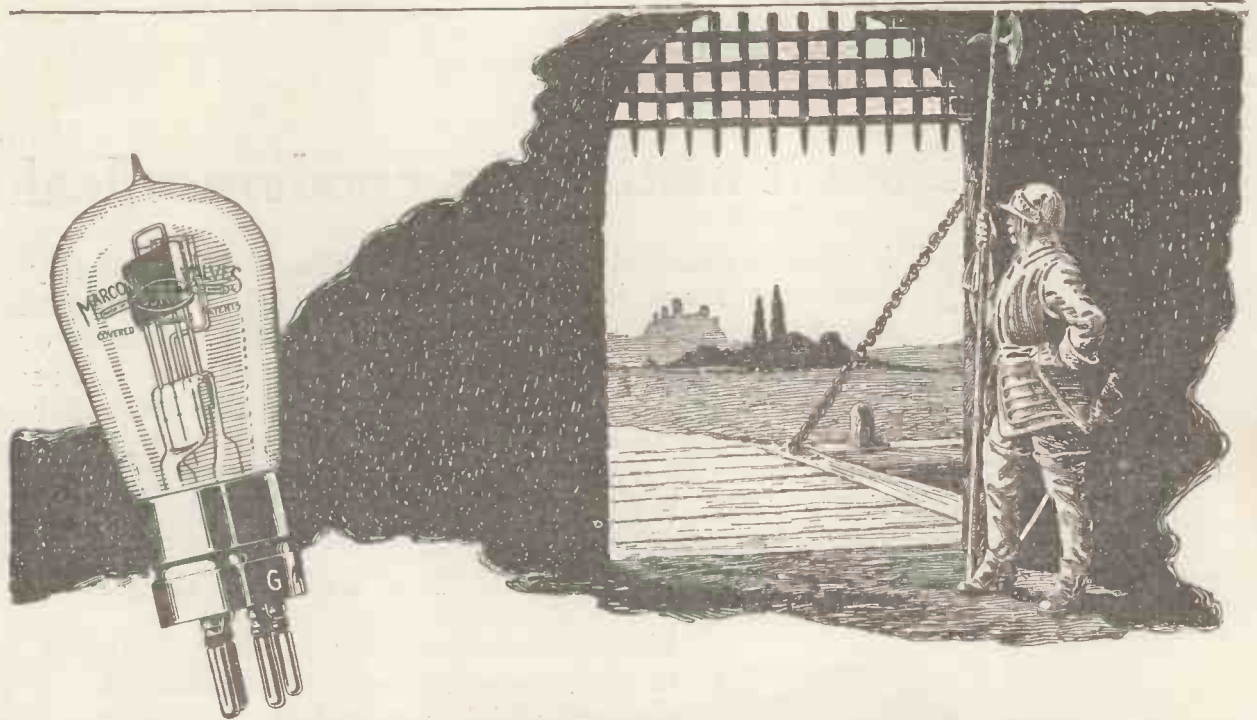

The Sentinel of Wireless

The sentinel of old stood guard at the drawbridge, with the welfare of the garrison in his keeping. Thus also to-day

MARCONI VALVES

MADE AT THE OSRAM LAMP WORKS

vigilantly safeguard the gates of wireless reception. Proudly on guard they stand, with the prestige that springs from a lifetime of unflinching devotion to the task in hand.

*Buy the Valve in the Purple Box and—
“All’s well!”*

ALL-BRITISH RADIO EXHIBITION
 (Promoted by the National Association of Radio Manufacturers)
ROYAL ALBERT HALL
 Sept. 27th to Oct. 8th.
THE M.O. VALVE Co. Ltd.
STAND No. 21.

Sold by Wireless and Electrical Dealers, Stores, etc.

Announcement of the M.O. Valve Company, Limited.



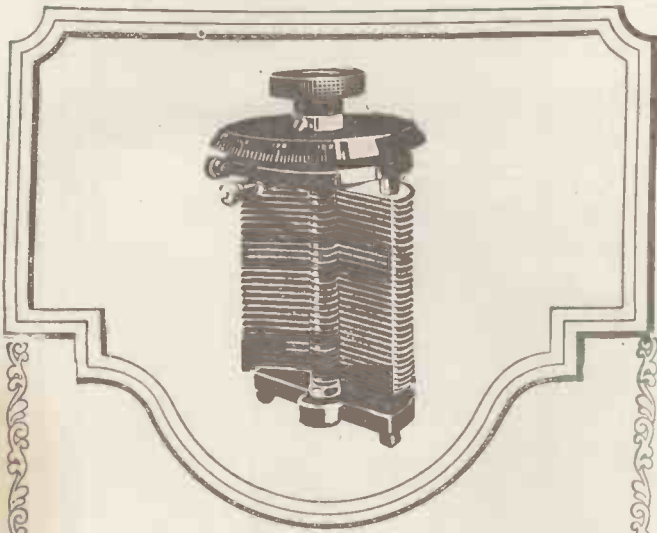

The Vanicon.

It is not until you come to examine a Vanicon closely that you appreciate the differences which can exist between condensers of similar outward appearance. But when you do, you will notice that the Vanicon is rigidly constructed, that the plates are evenly spaced; that there is no end-play in the spindle to give unexpected variations in capacity.

The moving vanes are connected to their terminal, not by means of a rubbing contact, uncertain in action, but positively by a strong phosphor-bronze strip. Sturdy safety stops are provided so that this strip cannot be damaged by overwinding, even when the dial is removed.

It is easy to be wise after the event; why not save yourself costly experience by fitting a Vanicon to your set in the first place?

Made in four standard capacities.

Capacity.	Price.	Extra for Ebonite Box.
.0003 mfd.	17 6	7 6
.0005 "	1 0 0	7 6
.0007 "	1 2 6	10 0
.001 "	1 5 0	12 6

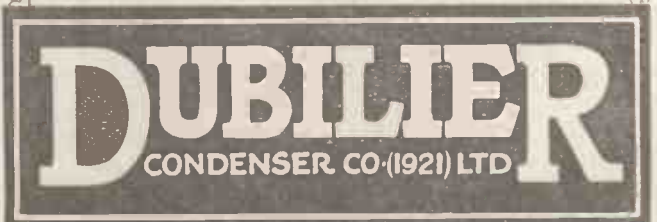

Advt. of the Dubilier Condenser Co. Ltd., Goldhawk Road, London, W.12. E.P.S. 64

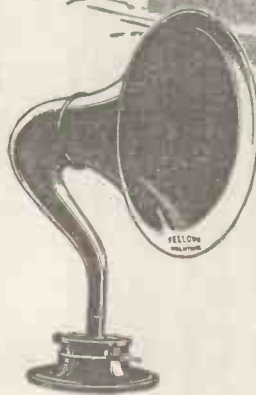

A Stolen Hour.

All the sweeter because it is stolen—and from my work, too. The so-called slack season has proved so successful that I simply don't get a minute to myself; it doesn't look as if I'll even get a holiday. I don't really mind, though; perhaps it's because of my record wireless Summer, but somehow a quiet hour or two in the garden after dinner—with my Volutone—seems to me easily enough recompense for just a holiday.

I'm really glad, however, we did produce the Volutone; the Junior is a fine little instrument, even better now we're fitting it with an adjustable diaphragm, but you do need something a little more powerful in the open air. You want to listen to a Volutone to appreciate how perfectly a modern Loud Speaker can give a large volume of sound without distortion. But more than anything I'm pleased about its price. It really is

Quality Apparatus at Low Cost.

Fellows Volutone.
£4 : 10 : 0

Fellows Junior.
£1 : 17 : 6



E.P.S.77.

Advt. of the FELLOWS MAGNETO CO., LTD., PARK ROYAL, LONDON, N.W.10.

AMPLION



The World's Standard Wireless Loud Speaker

Amplion Loud Speakers are world-famous for sensitivity, full volume, clarity and wonderfully natural tone—qualities due to the incorporation of many exclusive features including a non-resonating sound conduit with wood horn and an improved unit embodying the "floating" diaphragm.

ALL BRITISH RADIO EXHIBITION **STAND Nos. 45-46** ROYAL ALBERT HALL
Sept. 27th—Oct. 8th

ALFRED GRAHAM & COMPANY (E. A. GRAHAM)
St. Andrew Works, Crofton Park :: :: LONDON, S.E.4

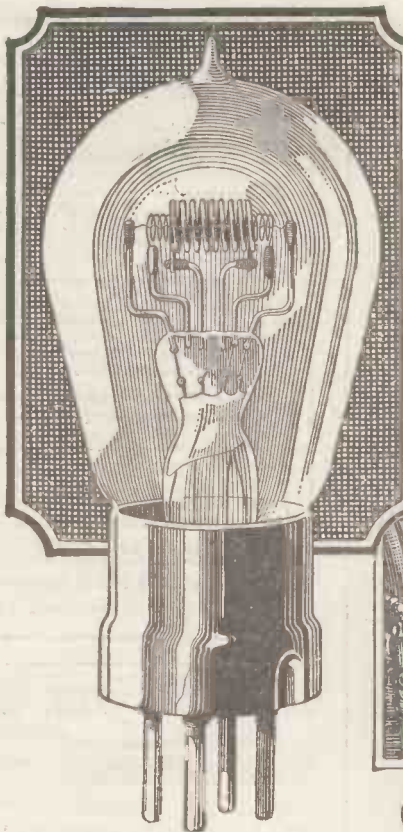

Louden



Columbus and the egg

Missing the obvious is a fault most of us are guilty of at some time or other and valve designers have proved no exception.

One of their chief aims has been to eliminate "mush"—that roaring or hissing sound which so often spoils what otherwise would be perfect reproduction.

It was found that "mush" was due to objectionable charges of electricity congregating near the anode and interfering with the electron stream.

All sorts of experiments were tried. Some increased the volume but at the expense of purity; others were free from distortion but still had "mush," and so on; and we seemed as far off as ever from our ideal valve, giving ample

volume, no distortion and no mush.

Then suddenly came the obvious solution. We simply made a way of escape for these objectionable charges—we made the anode like a spiral and immediately we got silver clear reproduction with plenty of volume.

It has been decided to put the Silver Clear Louden on the market at the extraordinarily low figure of 10/- This represents a certain faith on our part. To justify it the Louden must sell in enormous quantities.

But we cannot pretend to be taking much risk.

Once you have tried the Silver Clear Louden you will be satisfied with no other.

**Louden
VALVES**



The Plain Louden for Detecting and Low Frequency Amplifying.

Filament Volts 4.8-5.
Filament Amps. 0.4.
Anode Volts 40-80.

10/-

The Blue Louden for H.F. Amplification.

All Loudens are silver clear and free from mush. The current consumption is low and the life long.

Louden Valves - Silver Clear



No. 1 of a Series of Advertisements describing various processes in the manufacture of Brown Wireless Apparatus.



Grinding the Magnets

FROM the manufacture of the aluminium cases to the final assembly and testing, every process in BROWN Headphone and Loud Speaker manufacture is carried out under one roof and under the same supervision. Obviously during the many years S. G. Brown, Ltd., have devoted to the manufacture of Wireless Apparatus, their varied experience has enabled them to discover many improved methods of manufacture which combine to lift BROWN Headphones and Loud Speakers into a class by themselves. Even the magnets on the F. type Headphone—sold at the exceptionally low price of 25/- per pair—are ground to a limit of less than

1/1000th part of an inch. This ensures that every pair of Headphones functions at its most sensitive point, and that the distance between each pole-piece and the diaphragm is identical. Incidentally this process is a positive guarantee that every pair of F. type Headphones—no matter where or when purchased—attain the same degree of efficiency. Whichever type of BROWN Headphones or Loud Speaker you select it will have been made with the same scientific precision from material of the highest grade—there is only one standard of quality for BROWN Wireless Apparatus.

A-type.		D-type.		F-type.	
PER PAIR		PER PAIR		PER PAIR	
120 ohms	- 53/-	120 ohms	- 43/-	120 ohms	- 22/6
2000 & 4000 ohms	62/-	2000 & 4000 ohms	52/-	4000 ohms	- 25/-
8000 ohms	- 66/-				

S. G. BROWN, Ltd.
Head Office & Works :
Victoria Road, N. Acton, W.3.

From all Dealers.

Showrooms :
19, Mortimer Street, W.1.
15, Moorfields, Liverpool.



Gilbert Ad. 1404

It will pay you always to watch WIRELESS WEEKLY Advertisements.

THAT NEW SET

Before buying any components, get our quotation for parts and cabinets for any of the receivers described in "Wireless Weekly" or "Modern Wireless."

OUR SPECIAL LINES

"FYNETUNE." Admitted by all to be the best vernier adjuster, 2/6, post free.

"RADIOHM" BUS BAR with tinned, square copper wiring rod, as used on many "Wireless Weekly" sets, 2/- per dozen, 2 ft. lengths with tags, postage 3d.

"RADIOHM" COPPER STRIP makes a most efficient aerial, 3/- per 100 ft., postage 5d.

FLUSH PANEL MOUNTING COIL SOCKETS and plugs, also valve sockets 8d. per set, post free.

SPARKS RADIO SUPPLIES,
43, Gt. Portland Street, London, W.1.

Telephone: Langham 2463.

IT'S all in THE LEAK



The "BRETWOOD" GRID LEAK

is the only one used by serious experimenters, who always want the very best results possible.

PRICE

3/-

Manufactured by
RADIO IMPROVEMENTS LTD.
Trade 95, Gt. Portland St.,
Supplied. LONDON, W.1.

WIRELESS WEEKLY

SMALL ADVERTISEMENTS.

STUDENTS, successfully completing our 12 months' course on Wireless, are definitely guaranteed a position within one month of completion. Salary £150 to £500 per annum. (No Postal Tuition.) Prospectus free.—Wireless College, Bournemouth.

HEADPHONE REPAIRS.—Rewound, re-magnetised, readjusted. Lowest prices quoted on receipt of telephones. Delivery three days. Est. 26 years.—Varley Magnet Co., London, S.E.18.

TELEPHONE RECEIVERS and Loud Speakers Rewound, 2,000 ohms, 3/6.—A. Roberts & Co., 42, Bedford Hill, Balham, S.W.12.

FOR SALE, hack numbers "Modern Wireless," from first number to current issue inclusive. Apply, making offer to M. Brown, 9, Dora Road, S.W.19.

BATY Condenser, High Max., Low Min., High insulation, Min. weight, 5/3 post free. Coil to match, 230/4,000 metres, 6/9 post free. Combined space 4" x 1", weight 2 oz. Suitable for all circuits. Technical reprints giving circuits, 1/3 post free. Ernest L. Baty, Luton.

WIRELESS DEPT. (Wholesale) Assistant wanted for orders and sales. Capable and trustworthy. Apply letter only stating salary and experience. Simons, 100, Houndsditch, E.1.

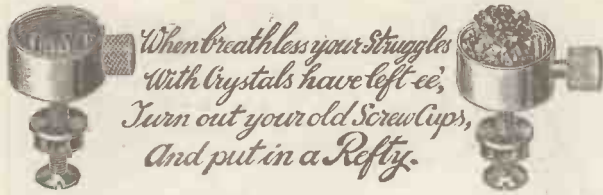

*When breathless your struggles
With crystals have left-ee,
Turn out your old Screw Cups,
And put in a Reftly.*

IMPORTANT NOTICE

re

**WATMEL
VARIABLE GRID LEAK**

(Patent No. 206098).

The Watmel Wireless Co. wish to notify the trade and public that their Variable Grid Leak Patent Application No. 206098 was contested in the Comptroller's Court, and on Appeal; in both instances the Patent Grant was upheld and costs awarded.

It is only fair to bring these facts to the notice of persons and firms purchasing or dealing in Variable Grid Leaks, otherwise the successful issue achieved might not be known, and the public and trade might be persuaded that no Patent is involved in the Watmel Variable Grid Leak.

It is the aim of this Company to protect traders', customers' and also its own interests by securing Patent protection for the novelties in its specialities, as it is these novelties, invented by experts and exhaustively tested, which are the Hall Mark of all Watmel Products.

All goods of our manufacture bear our Reg. Trade Mark 

Watmel Grid Leaks & Resistances are the best for the following reasons.

- Constantly variable.
- Silent in operation.
- Constant in any temperature.
- Dust and damp proof.
- Each tested and guaranteed.
- Neat and well made.



5 to .5 Megohms **2/6** 50,000 to 100,000 Ohms **3/6**

Other Resistances to suit any circuit.

Send P.C. for Descriptive Folder.

SEE THE TRADE MARK ON EVERY GRID LEAK.



BEWARE OF IMITATIONS.

Coil Former for Winding Inductance Coils **4/6**
For full details see "Apparatus Tested," June 1924, "Wireless Weekly."

Insist upon "WATMEL" at your Dealers.

NOTE OUR NEW ADDRESS:

WATMEL WIRELESS CO.

332a, Goswell Road, London, E.C.1.

Phone: CLERKENWELL 7990.

AT LAST

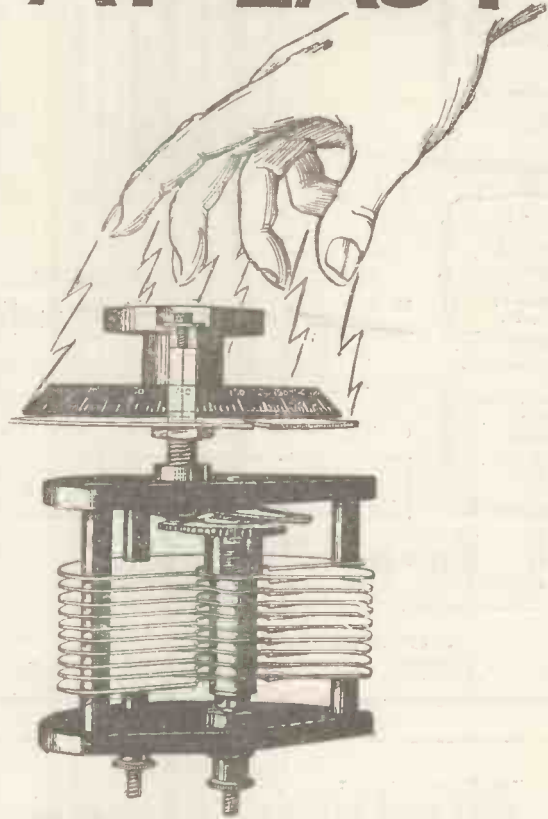

HAND CAPACITY ENTIRELY ABOLISHED.

The absolute elimination of all hand capacity effects is the outstanding feature of the Naylor Fulstop Condenser.

Beautiful clarity of tone and smoother operation is the result. Adjusted by means of a patent gear which allows for extremely fine tuning and removes all necessity for having a separate vernier condenser. An instrument possessing many refinements and conveniences which are over and above the actual requirements of the Condenser and make it absolutely complete and a luxury to use.

PRICES

.001.....	13/6	.0003.....	10/3
.0005.....	11/3	.0002.....	9/6

Stocked by most Wireless Dealers, but if you have any difficulty send direct to

J. H. NAYLOR, Ltd., Central Brass Works, WIGAN



BUY BRITISH
GOODS ONLY
AND
USE ONLY
THOSE MARKED



Visit our Stand
at
WEMBLEY,
Palace of
Engineering
Avenue 13,
Bay 13.

Complete
Catalogue,
profusely
illustrated,
Post Free 1/-



TRANSFORMERS



H.F. PLUG-IN TRANSFORMERS.

No. 00	80 to 150 Metres	8/-
0	150 to 300	7/-
1	300 to 600	7/-
2	550 to 1,200	7/-
3	1,100 to 3,000	7/-
4	2,500 to 7,000	7/-

Complete set of 6, £2.

Can be supplied in matched pairs at NO EXTRA CHARGE

VISIT STAND No. 75,
All-British Exhibition, Sept. 27th to Oct. 8th

L.M. MICHAEL LTD

IN CONJUNCTION WITH **B. HESKETH LTD**

Wireless Engineers,
RADIO CORNER, 179, Strand, London, W.C.2.



"Why didn't someone think of it before?"

How on earth did people manage without bootlaces?

No one will ever know. No hint of the small tragedies that were eternally springing from the absence of the prosaic bootlace can ever penetrate to twentieth century ears.

It's not merely a matter of doing up your boots. Every bootlace in the course of its brief and self-sacrificing existence fulfils a dozen other functions.

A world without CLIX is as unthinkable to-day as a world without bootlaces. CLIX supercedes all forms of switches, plugs and terminals, for it does all their work—and does it better.



The Electro-Link with 159 uses

Retail Prices

CLIX with Lock-nut 3d.

INSULATORS (Six colours) 1d. each

BUSHES (Six colours) 1d. pair

CLIX is patented all over the world.

The introduction of this ingenious combination plugsocket marks the advent of a standardised system of instantaneous wiring.

Obtainable from all good Wireless Dealers or direct from the Patentees and Manufacturers:

AUTOVEYORS LTD

Radio Engineers and Contractors
84 Victoria Street, London, S.W.1

**No Bigger
Much Better**

Amateurs everywhere are installing Bowyer-Lowe Square Law Condensers in sets they have made. They can do this without dismantling and re-arranging their receivers because these new condensers are no larger than the ordinary type.

But the difference they make is astonishing even to those who bought them with full expectations of obtaining improved reception.

They simplify tuning, they increase wavelength range, they yield louder and purer signals, they increase selectivity.

Insist on having them.



Prov. Pat. 7213/24



Bowyer-Lowe Tested Square Law Condensers

represent the highest standard yet attained in condenser construction. All particulars and prices free for a postcard. - - Write now.

Bowyer-Lowe Co., Ltd., Radio Works, Letchworth

**ALL BRITISH WIRELESS EXHIBITION
STAND 26 ROYAL ALBERT HALL
September 27th to October 8th**

**Rigid as a Motor Wheel.
Unshrouded—open to air.**

"Tangent" Tuning Coils

Electrically efficient.
Damping reduced to minimum.
Low distributed capacity.
Will stand unkind treatment.
Standard Plugs will fit your set.

STOCKED SIZES.				
Coll No.	Min. W/L	Max W/L	Price	
25	250	390	4/3	
35	330	520	4/3	
50	430	840	4/3	
75	660	1070	4/6	
100	840	1430	5/-	
150	1100	2030	6/-	
200	1610	2720	7/-	
250	2009	3520	7/8	
300	2400	4250	8/-	
400	3300	6450	9/-	
500	4500	8750	10/-	



Send for Leaflet—it will please you
GENT & Co., Ltd.

Est. 1872.
Manufacturing Electrical Engineers,
**FARADAY WORKS,
LEICESTER.**

We are showing at the
**N.A.R.M. Exhibition—
Albert Hall, Sept. 27th-
Oct. 8th. STAND 64.**

London: 25, Victoria St., S.W.1.
Newcastle-on-Tyne: Tangent House, Blackett St.

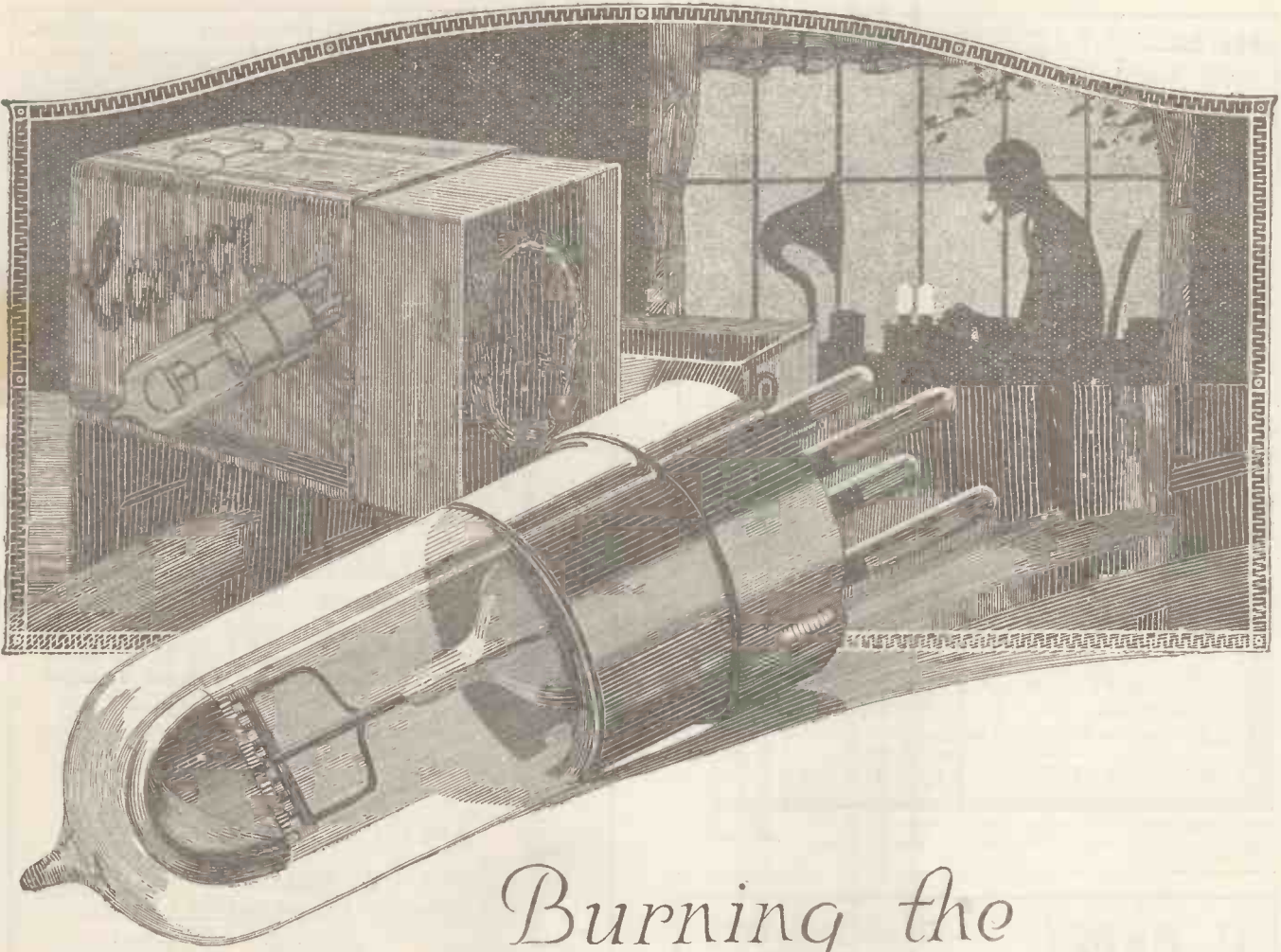

Burning the midnight oil

C Experimenters should note that due to its design and the stringent care lavished upon it during every detail of manufacture, that the Cossor Valve is particularly suitable for reflex and other circuits where a high efficiency Valve is required. Owing to the construction of the Grid—in which each wire is securely anchored in three positions—microphonic and other noises are totally eliminated, and the Cossor Valve enjoys an exceptional reputation for quiet working.

THAT'S just the trouble with Cossor Valves! It is so easy to pick up long-distance stations and the "10-Watters" who shake the ether after the B.B.C. stations have closed down, that one is sorely tempted to sit up late and see how many can be logged. And the reason for this marked superiority in long-distance reception lies in the unique construction of the Cossor Valve. Its curved filament, inside the hood-shaped Grid and Anode, gives off an immense stream of electrons, and, because it is thoroughly shielded against leakage, practically the whole of the electron stream is used.

But this special design of the Cossor is productive of other advantages. In the ordinary Valve, for

instance, the straight filament is stretched between two supporters, and because metal when heated expands, and when cool contracts, so the filament is constantly undergoing a stretching and shrinking process as current is passed through it. Obviously, this is not good for it, and sooner or later (generally sooner!) it fractures, and the Valve is rendered useless.

The curved filament of the Cossor is not kept under tension, but is held in such a position that it supports its own weight—like the arch of a bridge—and the result is exceptionally long life.

Next time you buy a Valve see that it is a Cossor—no other Valve in the world can be an effective substitute, no matter what price you are prepared to pay.

A. C. Cossor, Ltd.

P.1. For Detector and Low Frequency use

12/6

P.2. (With red top) for H.F. use only

12/6

From all Dealers.

Highbury Grove, N.5

HELLO!!!

EVERYBODY
Let me introduce
THE PERFECT COIL
HOLDER.

One hole fixing, large metal to metal bearings, swivel adjustable for wear and absolute micrometer adjustment of coils, can be set to zero instantly. Illustration shows moving holder turned to right with handle. Micrometer adjustment is obtained with knob which advances and retards moving holder in relation to stationary one.



Prov. Patent
14684.
PRICE
10/6
Postage 6d.

(Trade Inquiries Invited.)
J. TELFORD, Electrical & Radio Engineer,
26, Margery St., CARLISLE.

Radiax Universal Sets for Home Construction.

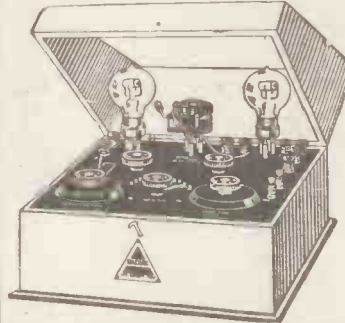

Complete with plan-diagram, instructions, all components ready assembled, panel fully drilled and engraved, and every item required to successfully build with ease. The set you want. The following prices include all Royalties:

- No. 81. 1 Valve Crystal Reflex 25 7 6
- No. P.24. 2 Valve Set .. 26 5 0
- No. P.26. 3 Valve Set .. 29 2 6
- No. P.28. 4 Valve Set .. 32 5 0

RADIAX LIMITED
10, RADIO HOUSE, PERCY STREET, TOTTENHAM COURT ROAD, LONDON, W.1.

Museum 490.



The above is only a small selection; send for Complete Free List of the full range of Radiax Crystal, Valve and Unit Receivers, or 3d. stamps to include Accessories Catalogue.

3 minutes from Tottenham Ct. Rd. or Goodge St. Tube Sta'n.

An Invitation.

You are cordially invited to attend an Exhibition of Radio equipment, including Television apparatus in its present state of advancement, to be held by the General Radio Company, Ltd. at 235, Regent Street, W.1, from Wednesday September 24th, to Wednesday, October 8th. (10 a.m. to 10 p.m. daily.)

You will be made most welcome.



GENERAL RADIO COMPANY

Radio House, 235, Regent St., London, W.1.
Telephone: *Mau*fair 7152. Telegrams: "Algenrad, London."

"Perfect Reception"

GUARANTEED

WITH OUR

REPAIRED VALVES

Whenever your valves burn out or filaments are damaged in any way

Send them to us

We repair them equal to new.

DON'T DELAY

The actual valve you send us is repaired

and returned to you within 7 days.

PRICE	POSTAGE	PRICE
6/6	3d.	6/6

(Bright Emitter Valves).

WE ARE ALWAYS AT YOUR SERVICE.

Price list for D.E. and Power Valves

on Application.

The North London Valve Repairing Co.,
22½, Cazenove Road, Stoke Newington, N.16.

P. CAPEL, 3/4, Queen St. Arcade,
CARDIFF.

All Wireless Accessories stocked. Immediate deliveries
Retail Price.

- Two-way Coil Holders 2/9, 4/6, 5/6
- 10 Tapped Coil 200/3,000 Metres 4/6
- Vernier Pencils 2/-
- "Grip" Detectors set of parts, boxed .. 1/-
- Detectors, Universal movement on base .. 2/-, 2/3
- "IDEAL" Slider Crystal Set 15/-
- Interchangeable Filament Resistance for 5 and 30 ohms. 4/6
- Miniature Switches, unmounted DPDT .. 1/6
- Do. do. do. SPDT .. 1/-

A FEW SPECIALITIES:

- Dull Emitter Valves, '06 20/-
- French R5 Valves 10/6
- Metal 8/6
- Four Electrode Valves, five pin type, nickel base 17/6
- "Monopole" Transformer, two transformers in one, latest invention unequalled for purity, volume, and no interaction effect .. 24/-

CRYSTALS:

My Crystals are noted for their marvellous sensitivity.
Write for sample "Vocalite" in glass tubes .. 1/-

Send your enquiries for anything "Wireless."
Liberal Trade Discount. Illustrated Wholesale List on receipt of Trade Card.

Telephone: 3298, Cardiff. Telegrams: "Waves," Cardiff.

YOURS FOR 20/-

Send 20/- to-day, together with your order for the "Tonyphone," and this wonderful set, which receives all B.B.C. stations, will be delivered complete, including all accessories. You pay a further £1 each month afterwards. The total cost is only £15 9s., or if you prefer, £14 5s. cash.

"Tonyphone" Super Two-Valves Complete with Accumulator, H.T. Battery, Aerial, 1 pair 4,000 ohms Headphones, and two Valves—one High Frequency and one Detector. All Royalties paid. Send to-day and enjoy broadcasting NOW.



BRITISH ENGINEERING PRODUCTS CO.,
(Wireless Dept.), WINDSOR HOUSE, VICTORIA ST., LONDON, S.W.1

B.S.A.

EL-BE UTILITIES
 The "MIKROTUNE" MAKES TUNING
 SIMPLE & CERTAIN

Reversible
 Coil-holder.



Adds 50%
 value to
 any set.

12/6

Coils under minutest control. A Perfect VARIOMETER
 Send us the name of your Dealer and
 we will arrange a demonstration for you.

LEIGH BROS., 37, Slomouth St., Gray's Inn Rd.,
 LONDON, W.G.1
 Telephone: MUSEUM 4192.

REPAIRS
 TO HEADPHONES
 TO LOUD SPEAKERS
 TO COILS

Est. 26 years
 Rewound to any Resistance and
 made equal to new. Price
 quoted on receipt of instruments.

Prompt Delivery.
The VARLEY MAGNET
 Company WOODWICH, S.E.18.
 Phone: Woolwich 888.

Cabinets for Constructors.



PICKETT'S Cabinets—they're
 good value, from 1/6 each,
 highly polished.

Cabinet Works, Albion Road,
 Bexley Heath, S.E.
 Write for Lists W.L.

SPENCER'S STORES
 4-5, Mason's Avenue,
 Basinghall Street, London, E.C.2.
 Telephone: LONDON WALL 2292.

KENITE
 Highest Dielectric Strength,
 6" x 6" 1/2, post free. Any size pro rata.

VALVES REPAIRED
 WITH NEW BULBS
 AND FILAMENT. **6/6** POST FREE.

The Master One-Valve Set
 Receives all B.B.C. and
 CONTINENTAL STATIONS
 Operates Loud Speaker under
 favourable conditions. Simple to
 operate.

37/6 plus Royalties. Marvellous
 Range and Power,
 Genuinely worth £4.

World's Wireless Stores
 WALLINGTON.

RADIO PRESS INFORMATION DEPT
2/6 QUERY
 COUPON

WIRELESS WEEKLY.
 Vol. 4, No. 20. Sept. 17, 1924.
 (This coupon must be accompanied by
 a postal order of 2/6 for each question,
 and a stamped addressed envelope.)

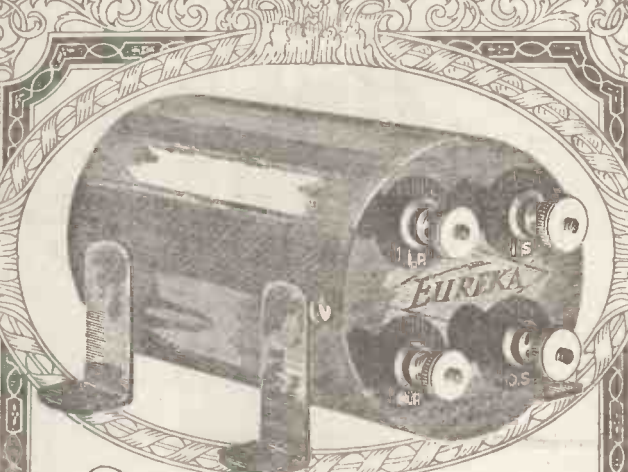

*The economy
 of good Quality*

AT last—probably as the result of
 much editorial space being devoted
 to the subject—the L.F. Transformer is
 being selected on quality and performance.
 Not as so much iron and copper wire, but as
 a definite part of a Receiving Set which
 can make or mar a reputation for clear
 and truthful reception.

The design of the Eureka is such that its
 production costs must necessarily be higher.
 For instance, its coils contain more than
 2½ miles of fine drawn copper wire of the
 highest grade. Its steel casing—the princi-
 pal factor in eliminating interaction—
 is covered with a deposit of copper. Its
 expensive core—the process of hermetically
 sealing the contents against atmospherical
 influences—the ruggedness of its construction,
 all these processes could be simplified and
 reduced in cost, but only at the cost of efficiency.
 This we cannot do. Every Eureka owner
 knows that he owns the finest possible
 L.F. Transformer money can buy and
 appreciates that the exceptional results
 he obtains have more than justified the
 extra expense.

Concert Grand, 30/- Eureka No. 2, 22/6
 (For 2nd stage.)

Sold by all Dealers and Manufactured only by—
PORTABLE UTILITIES CO., LTD.,
 7 & 8, FISHER STREET, LONDON, W.G.1
 Scottish Agents: FULLER, BLACKIE & RUSSELL, LTD.
 30, Gordon Street, Glasgow.

EUREKA
 —the Quality Transformer

Gilbert Ad. 1417.

"Pilot" Panel Service—

An entirely new development for the benefit of the Home Constructor by Peto-Scott Co., Ltd.

WHEN a man decides to build a good Receiving Set he immediately comes up against the difficulty of a suitable cabinet and the drilling and engraving of the Panel. Cabinet making is a skilled man's job and many a perfectly good piece of ebonite has been spoiled by a hole in the wrong position or because it has been incorrectly cut to size.

To eliminate most of the difficulties in Set-building we have instituted the "Pilot" Panel Service. In future all Sets described in *Modern Wireless* or *Wireless Weekly* will be available in sets of parts for the Home Constructor with panels ready drilled, tapped and engraved. Two types will be placed on the market—Type A following the author's literal specification and using his actual components and Type B, an adaptation using Peto-Scott guaranteed components. Naturally, through standardisation of components and our lower manufacturing costs due to large output, Type B will often show a large saving over Type A.

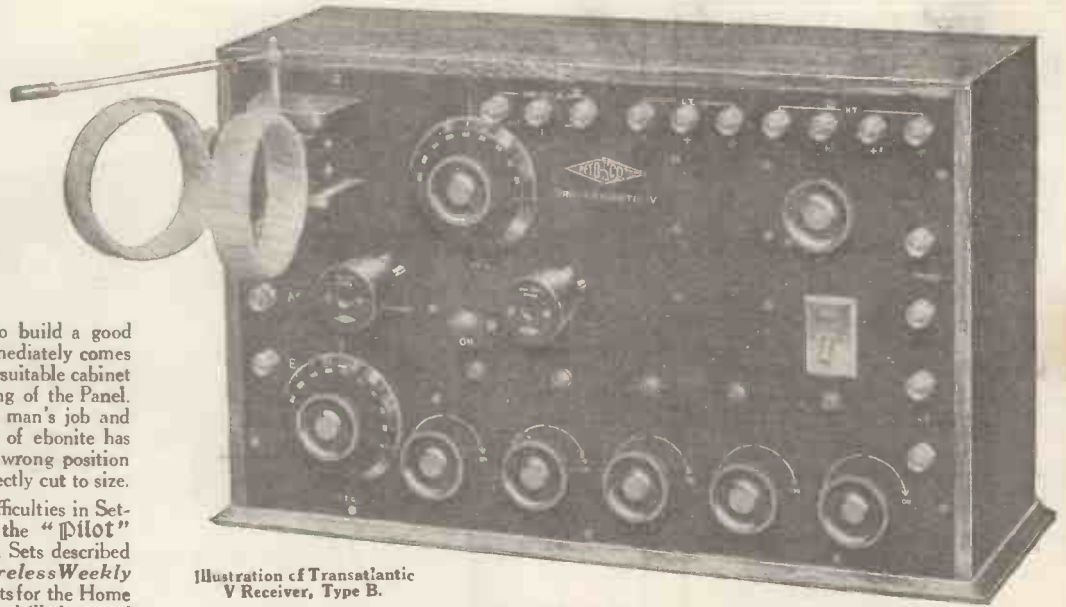

Illustration of Transatlantic V Receiver, Type B.

The All-Britain Receiver

("Modern Wireless," Sept. issue).

The new All-Britain Receiver in the September issue of "Modern Wireless" is proving one of the most popular Sets of the season. A 3-valve Set, it has much to recommend it on account of its simplicity and ease of operation. By including it in our "Pilot" Panel Service experimenters are able to build it up at a big reduction in cost. It should be noted that the author's design of the All-Britain Receiver is so similar to our own standard Type B Receivers that the Cabinets for both types are identical. The fundamental difference is that in Type A the Valves project outside the panel in a horizontal position, while in Type B they are totally enclosed at rear of panel entirely out of harm's way. Therefore, in the list of prices it will be seen that Pilot Cabinet B is fitted with an additional baseboard to screw on to the ebonite panel to carry all the components.

PRICES:

Type A.—Ebonite Panel, guaranteed Post Office quality, of highest grade, 10 in. by 16½ in., drilled, tapped and fully engraved 16/-
 Polished Oak Cabinet, with sliding back, to take above panel 15/6
 Complete kit of components, exactly as author's specification, but with Max-Amp Transformer and Peto-Scott all-ebonite improved Coil Holder £4 12 0

Type B.—Ebonite Panel, guaranteed Post Office Ebonite of highest grade, drilled and tapped to take Peto-Scott guaranteed components, size 10 in. by 16½ in., matt finished by hand 10/-
 Engraving extra 3/-
 Polished Oak Cabinet, with sliding back, but fitted in addition with panel baseboard 17/-
 Complete kit of guaranteed Peto-Scott Components. In this kit we include Polar Condensers and Lissenstats, but otherwise everything else is of our own manufacture and fully guaranteed in every respect £4 2 6

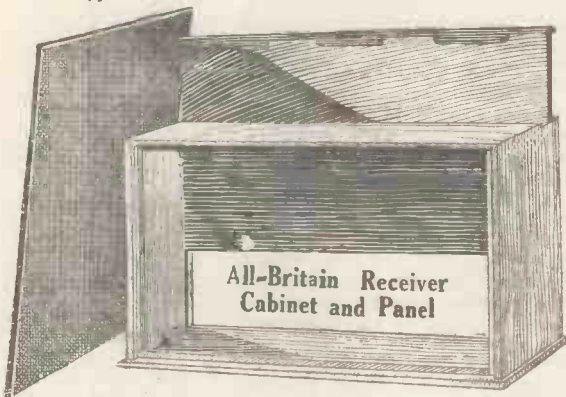

All-Britain Receiver Cabinet and Panel

Other Receivers available under the "Pilot" Panel Service

In addition to the two Sets described in this Advertisement, we also supply the following Modern Wireless Receivers in Type A and Type B for home construction. Finished instruments in either type are also available.

- The Puriflex Receiver.
- The All Concert-de-Luxe Receiver.
- The 3-Valve Dual Receiver.
- The Transatlantic V (and others).

Remember that if our instructions are followed we positively guarantee that all Type B Receivers are the equal in every respect to the more expensive Type A Sets. Our Service Dept. is available for all our customers and will test and rectify errors of construction at a nominal charge. We want all our customers to have the utmost confidence in every Set produced under the "Pilot" Panel Service.

PETO-SCOTT Co., Ltd.

Registered Office & Mail Orders: 77, CITY ROAD, E.C.
 Branches: LONDON—62, High Holborn, W.C.1. PLYMOUTH—4, Bank of England Place. LIVERPOOL—4, Manchester Street. CARDIFF—94, Queen Street
 WALTHAMSTOW—230, Wood Street.

It will pay you always to watch WIRELESS WEEKLY Advertisements.

The Family 4-Valve Set

(Radio Press Envelope No. 2).

Exactly as Author's specification, except that an ebonite panel is used instead of one made of wood. This permits components being mounted flush on the panel and greatly improves the appearance of the whole Set. Valve-Holders are of the same anti-capacity type, but of our own manufacture. Two Max-Amp Transformers are supplied instead of one Max-Amp and one Igranic, and an Igranic Potentiometer is substituted for the T.C.B.

Complete kit of Components, only as above amended specification, £6 1 0
 Ebonite Panel, 24 in. by 8 in. by ¼ in., drilled, matt finished, and fully engraved £1 2 6
 Panel only (undrilled and not engraved) 12 6
 Polished Oak Cabinet, 24 in. by 8 in. by 4 in. £1 5 0

No. 5 of a Series of
Advertisements on behalf
of Radio Press, Ltd.

C O U R A G E

GALILEO for his statements that the earth is round was cast into a dungeon until he should recant. Although offered his freedom he steadfastly stood by his beliefs and suffered intense agonies—eventually losing the sight of both eyes.

To-day we are often faced with decisions that may make or mar our reputations for straight dealings and honest convictions. We of the Radio Press often feel it necessary for the betterment of the Industry to criticise fearlessly. At one time, perhaps, a Trade organisation which may be adopting unfair tactics—at another time, a Manufacturer making extravagant claims for an inferior article. Any of these honest criticisms may be the direct loss of advertising revenue.

But readers of Modern Wireless and Wireless Weekly know that the power exercised by Radio Press, Ltd., is an important factor in maintaining a high standard of journalism and in preserving the interests of the broadcast listener and experimenter.



Gilbert Ad. 1391.

STERLING PRIMAX LOUD SPEAKER

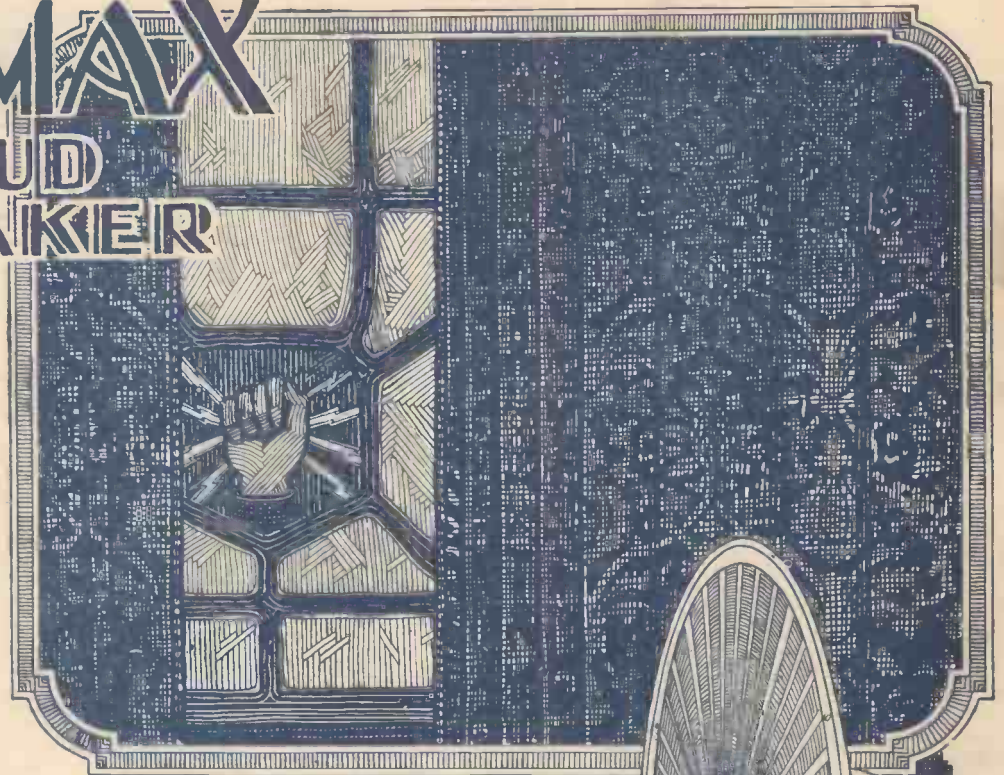

Widespread Interest in this—the greatest of Loud Speakers

The advent of the Sterling "Primax" Loud Speaker has created intense interest all over the country. Its performance, charm and novelty are everywhere commented on. New in conception, new in design, the "Primax" provides better reproductive quality and sound distribution than has ever been attained before.

The Sterling "Primax" Loud Speaker consists of a very attractively shaped aluminium standard, attached to which is a neat cylindrical case containing electro-magnetic mechanism. This in turn is connected with a white pleated circular diaphragm, specially prepared and surrounded with an aluminium rim. The "Primax" is connected in the usual way with the receiving set and a knurled knob provides absolute control of volume.

Ask your dealer for explanatory leaflet

(Lumiere's
Patent)

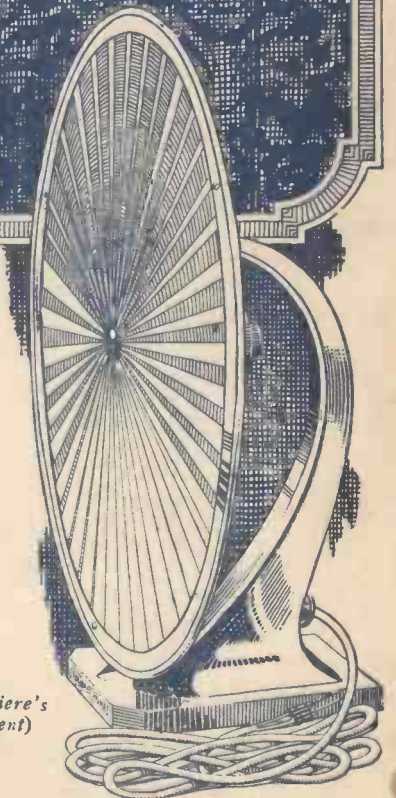

The Sterling "Primax" Loud Speaker
(Patent Nos. 11015/09, 205413, 205573, and
208665), 2,000 ohms resistance, complete with
12 feet of flexible cord. PRICE **£7:7:0**

Advt. of **STERLING TELEPHONE & ELECTRIC Co., Ltd.**, Manufacturers of Telephones and Radio Apparatus, etc.
210-212 TOTTENHAM COURT ROAD, LONDON, W.1

Works: Dagenham, Essex

Visit the Sterling Exhibit, Palace of Engineering, Avenue 15, British Empire Exhibition.