

Wireless Weekly

and the Wireless Constructor

Vol. 3.
No. 13.

CONTENTS

The B.B.C. on the 1,600-metre Station.

A Combined H.F. Crystal Unit.

A Three Valve Panel Receiver.

How to use the Omni Receiver.

Improving Cheap Transformers.

C.W. and Telephony Transmission using Valves, Broadcasting News, Jottings by the Way, An Experimenter's Unit Receiver, A Drilling and Tapping Hint, Valve Notes, Apparatus We Have Tested, Information Department

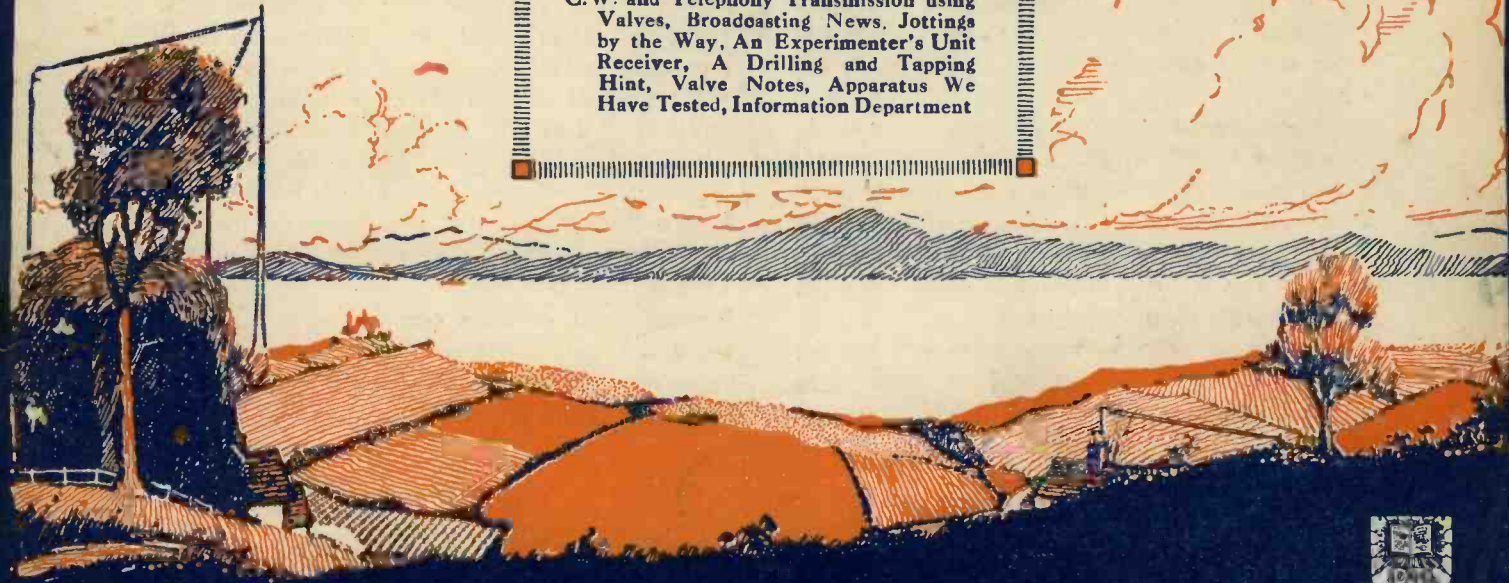

Relaying America (Special Photographs).

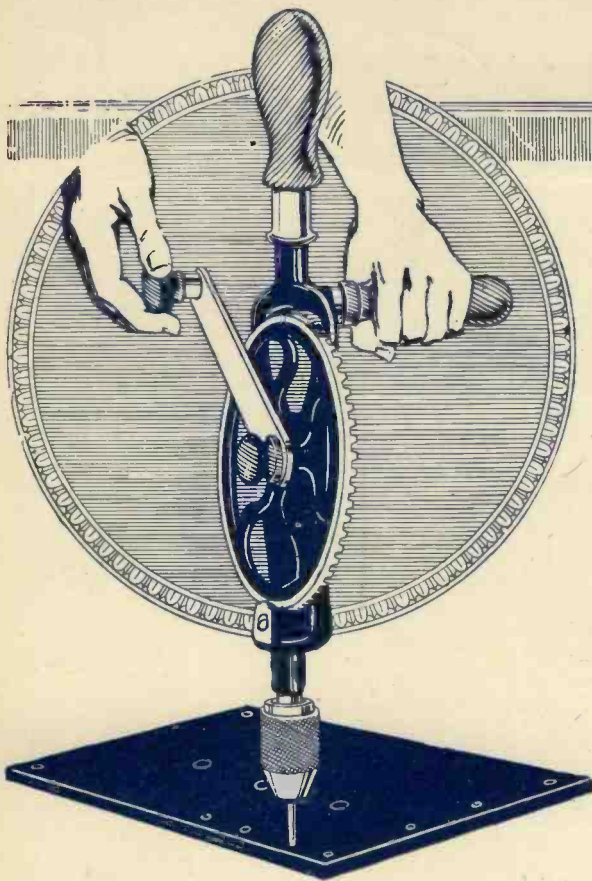
RADIO PRESS.
Series No. 8.

Stop!

Are you sure your
circuit is correct?

Eighteenpence invested
now may save you hours
of wasted labour.

IT'S easy to be wise after the event—and it is poor satisfaction for the man who has ruined a sheet of ebonite costing 5/- to find out that when the Set does not work, the fault lies in the circuit.

Many circuits are published to-day which can only give good service in the hands of the expert; therefore, the beginner often finds it difficult to make a choice.

Further, many beginners are quite unable to read a circuit diagram and are thus quite at sea when they commence building up a set.

To those—and also to many more experienced wireless enthusiasts—the new Book, "Pictorial Wireless Circuits," by Oswald J. Rankin, will

particularly appeal. Not only is each circuit shown clearly and free from unnecessary complication, and in actual picture form (with every component actually illustrated), but every one of the scores of circuits shown can honestly be recommended as the best possible arrangement. Already this Book has run through one large edition and as soon as it gets a little more widely known there will hardly be a home constructor in the country who hasn't a copy handy on his bookshelf.

Remember, it contains complete details for all types of Circuits from simple Crystal Circuits to those suitable for multi-Valve Sets; and you'll save its cost the very first time you use it.

From all Booksellers, or
18 post free direct from
Publishers:

Radio Press Ltd., Devereux Court, Strand,
W.C.2.

16

Pictorial Wireless Circuits

Wireless Weekly

Vol. 3, No. 13
Mar. 5, 1924.

CONTENTS

	Page
Editorial	406
The 1,600 Metre Station	407
Jottings By the Way	409
Some Simple Wireless Questions Answered	410
Broadcasting News	411
A Combined High-Frequency Crystal Unit	414
C.W. and Telephony Transmission Using Valves No. VIII	417
Improving Cheap Transformers	418
How to Make a 3-Valve Panel Receiver	419
Making Large Holes in Ebonite	423
Relaying KDKA	424
An Experimenter's Unit Receiver	426
How to Use the "Wireless Weekly" Omni Receiver	427
A Drilling and Tapping Hint	430
A Tubular Condenser	431
Valve Notes	432
Apparatus We Have Tested	434
Correspondence	435
Information Dept.	437

Editor: JOHN SCOTT-TAGGART, F. Inst. P., A. M. I. E. E.

Assistant Editors { E. REDPATH.
P. W. HARRIS.

Radio Press, Ltd.

Publishers of Authoritative Wireless Literature.
DEVEREUX COURT, STRAND, W.C.2

Tel.—Central 3763.

Advertisement Managers: } SCHEFF PUBLICITY ORGANIZATION,
LTD., 125, Pall Mall, London, S.W.1
Tel.—Regent 2440.

Scientific Adviser:
Prof. G. W. O. Howe,
D.Sc., M.I.E.E.
Advisory Editors:
Prof. R. WHIDDINGTON,
M.A., D.Sc.
Prof. C. L. FORTESCUE,
M.A., M.I.E.E.

Staff Editors:
E. H. CHAPMAN, M.A., D.Sc.
A. D. COWPER, M.Sc.
G. P. KENDALL, B.Sc.
R. W. HALLOWS, M.A.
S. G. RATTEE.



All correspondence relating to contributions is to be addressed to the Editor of "Wireless Weekly."

Nothing contained herein is to be regarded as permission or encouragement to infringe any patent rights.



More about the 1,600 Metre Wave.

IN our Editorial for February 27 we criticised the proposal of the B.B.C. to use a 1,600-metre wave for high-power transmission of broadcasting. In the present issue we have pleasure in publishing from the pen of Captain P. P. Eckersley, Chief Engineer of the British Broadcasting Company, an article answering certain of the criticisms raised. It will be noticed that although Captain Eckersley answers a number of questions raised in the Press by those who are not fully acquainted with the facts of broadcasting, some of the most important technical criticisms remain unanswered. Thus, whilst Captain Eckersley points out that it is a simple matter to convert crystal sets to the longer wave (we, ourselves, have never disputed this), he does not refer to our chief criticism regarding selectivity. It is this very point of selectivity which is of the greatest concern to the crystal user. The great majority of such listeners are situated within half-a-dozen miles of a broadcasting station. We claimed in our Editorial that the mere fact of loading a set sufficiently to receive the 1,600-metre wave would not make it selective so that close to a low-power broadcasting station the user would receive not only the more powerful station, if he is within range of it, but the local station as well. To make the set selective would require more than the mere addition of a loading coil.

After all, is the crystal user being considered so much as is suggested by Captain Eckersley? He himself states that if the user is more than 100 miles from the high-power station it is useless to talk of conversion because the crystal set will not receive the new station at over 100 miles. Let us assume that the new high-power station is situated at Chelmsford, where we believe the first experiments will be conducted. What follows from this choice? A circle of 100 miles radius drawn round Chelmsford cuts through the Birmingham area and obviously includes London. The Birmingham listeners will find signals quite weak, and therefore will be more

prone to be jammed by their local stations. Bournemouth, Cardiff, Manchester, Newcastle, Glasgow and Aberdeen listeners with crystal sets will be right outside the range of this high-power station, and therefore, even if the Chelmsford site is not finally selected, will be unable to give their opinion on the experiment. The same remark, of course, applies to the crystal users around every one of the relay stations.

As regards the conversion of valve sets, this presents a very real problem. It looks as though manufacturers will have to design their sets to use plug-in coils.

With regard to the criticism that people will hold off and not buy sets now but will await the high-power station, it is surely idle to suggest that people will be no better off with a new high-power station except that they will have two services to choose from. A very large number of otherwise excellent sets are incapable of easy conversion, and we have already shown that the problem is not merely one of the conversion of crystal sets for the great majority of country listeners must use sets with more than a single valve to get satisfactory results. Such people will naturally wait to make sure that their apparatus is suitable, and will not buy many of the present sets which cannot be readily converted.

Although we favour, in principle, the establishment of a new station, we think the trade have some justification for complaint on the score of the effect on the sale of existing sets. We ourselves are designing all our sets for home construction, so as to be adaptable to the wavelength.

We sympathise in large measure with the B.B.C. Progress will never be made without many being adversely affected, and the B.B.C. position is an awkward one, even when they are taking a step in a forward direction.

More relay stations are, in our opinion, the real need at present.

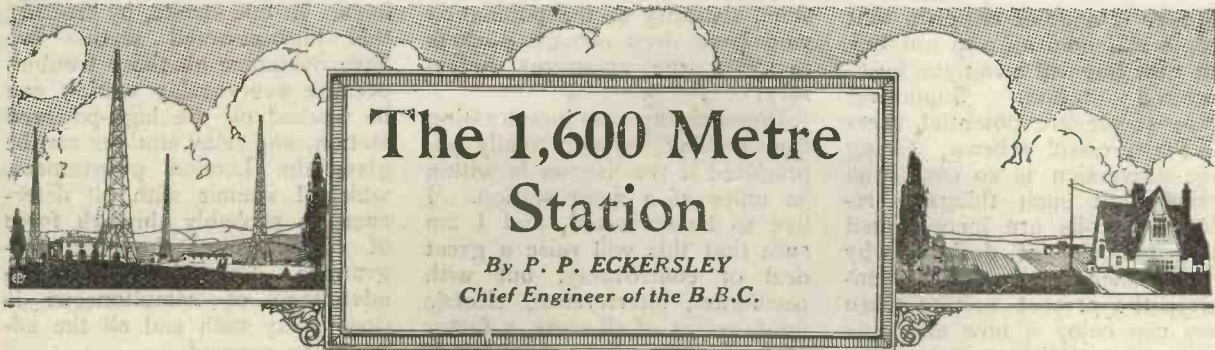

THERE is undoubtedly a good deal of misconception about the high-powered station, and whereas it was expected that this new departure on the part of the B.B.C. would be hailed with acclamation, and while this has been so in most quarters, there has been a certain amount of criticism about the station. Let us take these criticisms under their various heads, and let us examine, as far as we can, what ground there is for complaint.

Converting Crystal Sets

The first criticism and the most obvious one is that it may be difficult for users of crystal and other sets to convert such sets so that they can hear the 1,600 metre transmissions. Let us suppose for a moment that it is difficult to convert sets. It should be pointed out here and now that conversion is not absolutely necessary, because listeners will get exactly the same service from the existing stations as they had before, and

it is only a universal Oliver Twist feeling in all listeners that will cause them to worry about conversion. The new station, if it comes about, is additional to the present service. It is not replacing any existing service.

But now let us examine in more detail whether it is so amazingly difficult to convert a set to listen to the new high-powered station. We will take the ordinary crystal set that has been used with a local station. If the user is more than 100 miles from the high-powered station it is useless to talk of conversion because the crystal set will not receive the new station at over 100 miles, but those crystal users in London who may wish to receive the high-powered station can convert their sets at a cost, which I hesitate to name, but which will be very small, by simply adding a loading coil, or more simply still, a variable condenser to be connected between aerial and earth. The cost of such a variable condenser will be very

small. Once more, if the user cannot afford to buy such an attachment he will have the same service as he had formerly. The whole point is that, thanks to the enormous power of the new station, the apparatus to detect it need be of the very simplest character and need not be so sensitive as heretofore; thus the conversion is made even easier than it might appear at first sight. Surely, then, this criticism is dealt with at once.

Question of Cost

There has been some talk in the Press and elsewhere saying a conversion will be a most costly and difficult matter, but the critics have not realised the enormous power of the station, which makes all conversion so vastly simpler than they had contemplated. It is true that there may be sets which are not susceptible of conversion very easily, but I am convinced that these represent a very small proportion of the total number.

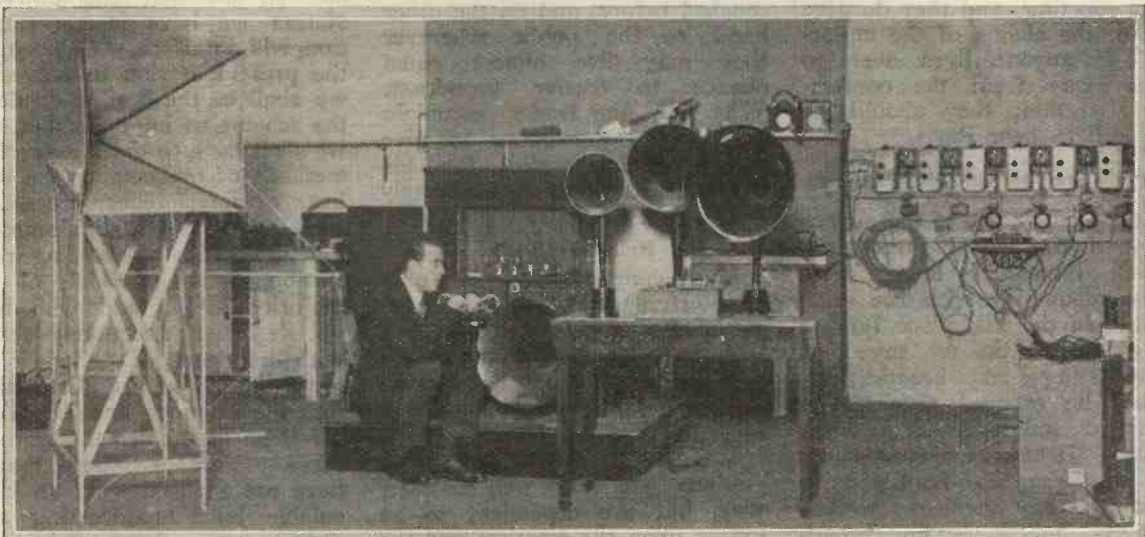

Our photograph shows Capt. P. P. Eckersley experimenting with power amplifiers and loud speakers.

There is another criticism that people will hold off and not buy sets now but will await the high-powered station. Supposing these people are potential users of the present scheme, seeing that conversion is so easy, and seeing that such things as replaceable coils are incorporated in a majority of designs, why should such people deny themselves the present service when they can enjoy it now and only await the addition of another service? They will be no better off with the new high-powered station except that they will have two services to choose from. Why should they be so timorous as to hold off until they can get two services?

Interference with Continental Stations

Another criticism has been raised which says that many people have heretofore listened to the concerts from Continental stations at 1,750 metres, and that these transmissions will be now denied them. In some places this may be true, but I think everyone will realise that we must study the majority, and because .00001 per cent. of the population may be denied certain services they have enjoyed beforehand are we to hold up the whole progress of broadcast on account of them, and are we to deny vast areas the advantages they will enjoy on account of this tiny minority? I am sure the first people to agree with these sentiments will be the minority. British people are normally fairly sporting, and they do give way to the claims of the majority. If anyone lives over 30 miles away from the contemplated station, they should be able still to hear Paris.

Advantages of the New Station

Now let us come to the advantages of the new high-powered station, having, I hope, dealt fairly adequately with the criticisms. In the first place I think it is axiomatic to say that broadcasting as broadcasting cannot be enjoyed much more than 30 miles from a main station. It may be very interesting to listen to Aberdeen in Cornwall or Sheffield in the Orkneys, but it is not broadcasting as such, and it is a very

small minority of the population who have deep enough pockets to afford the apparatus necessary.

Broadcasting as broadcasting can, I think, be only really appreciated if the listener is within 30 miles of a main station. I live to be corrected, and I am sure that this will raise a great deal of controversy, but with oscillation, interference, electric light, noises of all sorts, a factor of safety is no longer present if the signal is weak compared to these extraneous noises. It is a nice hobby, but it is not broadcasting as such. Take, then, a map of England and draw round our main stations circles of 30 miles radius. Draw round relay stations circles of five miles radius. Has the whole of England been covered with broadcast? Is it possible for the majority of people to receive broadcast on simple sets? The answer obviously is "No," and only those privileged by chance to live within a certain distance of a certain point can enjoy broadcast to the full. Why, because of trivial disadvantages, should dwellers in other areas be denied broadcasting? Why should all our programmes be jammed and interfered with, simply because there may be some difficulty, and I submit a very small difficulty, inherent to the scheme? Obviously, we must study the majority, and this high-powered station will open up, on the one hand to the manufacturers and traders a vast amount of virgin soil untouched before, and on the other hand to the public wherever they may live almost equal chance to receive broadcast. Why will the trader complain because we are going to give him a triple market for his wares? It would seem surely unreasonable.

Relay Stations

Many complain to us not only of interference, which in one fell swoop we would overcome, but they complain that simultaneous broadcast is not all that can be desired because of induction and cross-talk on the lines.

We further submit that relay stations are very well in their way, but are dependent to an extent upon the weather and the conditions obtaining on the land

lines. In one stroke, by erecting this high-powered station we have overcome all those troubles because every relay station can be worked off the high-powered station, and relay stations can be given the London programme, which I submit with all deference, is probably through force of circumstances the best programme. Thus the present disadvantage of simultaneous is done away with and all the advantages secured.

Lastly, it is a question of national pride. France will be erecting such a station; are we to be behind? If we are successful in our experiment, the British broadcasting will stand supreme and unique throughout the world, and even the most captious critic will find little to complain of. This, indeed, is looking ahead, for the high-powered station is not yet, not a single turn of inductance has been wound, not a valve has been bought, not an aerial erected; the whole scheme depends entirely upon the success or otherwise of the experiments.

Co-operation of Amateurs

We are hoping to have the co-operation of all wireless amateurs in our experiments, and we are hoping that they will give us data to enable us to determine the all-important question as to whether this contemplated addition to our service will interfere with the present service. If it can be proved and substantiated that whatever we may do to eliminate harmonics and so on that the powerful station we have in contemplation will interfere with or upset the present station in any way, we shall be the first to condemn the scheme as impracticable, and we shall have to think over other methods of overcoming the bugbear of interference, cross-talk, and induction on simultaneous; the difficulties of feeding relay stations and the claims of the majority in England who have not yet been adequately served with broadcast. Dwellers in the towns have infinite distractions for the evenings and broadcast for them is supplementary to all these. Perhaps your readers have not realised what an incalculable boon broadcasting may convey to those who are

(Concluded on page 430)



Human Receivers

WE are very much intrigued down here at Little Puddleton by the accounts we have seen in the papers of these human receivers. Certain people, it appears, have the happy (or unhappy) faculty of being able to pick up wireless without the use of any of the expensive and annoying gadgets that you and I must press into service for the purpose. These folk have no need to bother their heads over the question of aerial insulation; they have no worries with valves or crystals. They do not sit for hours, as you and I do, wangling "vernier" condensers in hopeful, but vain, efforts to bring in unintelligible voices from incredible distances. They have none of these worries. All that they have to do is to think of GNF—possibly some process is necessary to attune the aura (not to be confused with the Ora) to his wavelength—and there he is pinging away in their ears as stoutly as if he had passed through the mazes of a five-valver's 'innards! Or, again, should the human breast be savage, music can be called in at once to charm it as per the time-honoured recipe. Think of a broadcasting station, make a noise like an aerial, and there you are.

Now this seemed to me to be a splendid state of affairs, and I was thinking seriously of taking a postal course in auto-reception from the famous Hoodlum Correspondence University of Bunkville, Wis., U.S.A. But it has occurred to me that it is not all quite such plain sailing as might appear at first sight. How often the otherwise eminently desirable ointment is spoilt by the presence of the ubiquitous and unwanted fly; how often do the best-laid schemes of mice and men run off the rails; how often does the scythed chariot of fate

upset the most promising of appercarts! Yes, life is very sad. My radiant dreams were rudely shattered by a horrid realisation. The fellow who runs about the country picking up broadcast transmissions just as he wants to for nothing is a pirate of the deepest dye, liable to have his footsteps dogged by the B.B.C.'s direction-finding lorry. His, I think, would be a worse fate than that of the Wandering Jew—unless he made his peace by paying the royalty upon himself, taking out the broadcasting licence, and having the B.B.C. stamp branded upon his fair white body between the shoulder blades.

A Dreadful Fate

There are other things to consider when one goes deeply into the matter. Could one guarantee, for instance, that one's tuning would be sufficiently selective to enable one to hear, say, Birmingham by himself? I can imagine a no more terrible experience than to be compelled willy-nilly to listen to a quartet composed of, say, a violinist at 5IT, a comic man in Glasgow, a contralto in Cardiff and a bassoon at Aberdeen. So far as I can see, there is no guarantee that you can switch off or close down when you want to. That seems to be the weak point of an otherwise excellent system. You have got to have the children's hour, or possibly eight children's hours all on top of each other, even on your least childish days. Though you be the world's worst misogynist, you must endure the inanities of the women's hour. When you want to think about racing or football, your brain will be buzzing with millibars. No; the self-starter seems to be there all right, but until somebody invents a self-stopper, I have decided not to become a human receiver.

Imagine your awful feelings if something went wrong with the

works. This, of course, would be bound to happen, for no wireless receiver is worthy of the name unless it occasionally goes on strike. There would be no fun at all about a set which always worked perfectly. It would be like shooting sitting rabbits, or like being the father of a son who invariably returned from school with the good conduct prize. Uncertainty and variety are the spice of life; monotony is killing. What, then, does your human receiver do when signal strength falls off or when parasitic noises announce that something is seriously wrong somewhere? The average doctor, I imagine, would avail you nothing, and if you were wise you would certainly keep out of the hands of any skilled surgeon who was also a wireless maniac, otherwise you might find yourself as enthusiastically pulled to pieces as a recalcitrant wireless set undergoing treatment by an expert.

The Case of Chuckleby

You might have thought that such considerations as these would have been sufficient to deter anyone from taking up set-less reception as a hobby. But such, I am sorry to say, is not the case. Despite all our warnings, the fellow Chuckleby, who announced some months ago that he was hearing pings interspersed with occasional zips, zooms and zizz's, proceeded to do all in his power to develop the faculty which he believed himself to possess and of which he was inordinately proud. All was well so long as he kept the thing to himself, functioning as a mere unaided rectifier; but, as we all know, no one can possess a small set without promptly wishing to enlarge it. Chuckleby's highest ambition, therefore, became to equip himself with at least two high-frequency stages and a note magnifier in order, as he said,

that not he alone but others also might obtain the full benefit of his marvellous gift. His main difficulty was to obtain valves whose impedance would match that of his head, which has always been distinctly upon the thick side.

I think that we might have cured the poor fellow if his obsession had not suddenly taken a rather violent form. He decided that he would function more efficiently as a rectifier if he were standing in the middle of a helix through which a pretty hefty voltage was passed. I regret to say that in the course of some experiments in which he made use of an X-ray coil borrowed from a radiological friend Chuckleby made the common mistake between high- and low-tension leads and was burnt out.

A Grouse

What I really want to do is to find the fellow who designs the small parts upon which you and I spend the money which really ought to go towards purchasing our children's boots. I want to talk to him quite calmly, putting my case with the utmost politeness and in the most unimpassioned way. Still, if ever our

The Main Points to Observe when Erecting an Aerial

WHEN contemplating the erection of a receiving aerial, carefully survey the site with a view to obtaining:—

1. The greatest length and height for the aerial.
2. Reliable points of support in order to have adequate mechanical strength.
3. The greatest freedom from screening, due to adjacent buildings, etc.

When actually proceeding with the erection, the above-mentioned points should be kept in mind, also the following:—

1. Pay careful attention to the insulation of the aerial. Two or three small insulators (connected in series) at each point where the aerial is supported by attachment to a building or mast, will be found preferable to a large single insulator. In the case of an aerial consisting of two or more wires, the insulators should be between the mast (or chimney as the case may

meeting is arranged, I shall take with me my stoutest cudgel for use as a final argument if he points the finger of scorn, or shrugs the shoulders of pitying contempt, or raises the eyebrows of derision. All that I want to ask him is why he cannot stick to 4B.A. I want to tell him that 3B.A. and 5B.A. have been condemned as useless and unnecessary by an august body of engineers in council. I wish to point out that my temper has become ruffled, my hair thin, my peace of mind destroyed by his wretched habit of slinging his 5B.A. tap and his 5B.A. die about in and out of season. Doubtless you have had the same heartbreaking experience as mine. The other day I drilled and tapped a noble panel for the housing of a five-valver. Naturally I made the holes 4B.A., for any Christian man engaged in making small parts would put this thread on to his valve legs. When those that I had ordered arrived by post, were they 4B.A.? They were not. But mark this, valve pins ordered from the same criminal were.

Possibly makers are believers in the theory which I have enun-

ciated in a previous paragraph, that variety is the spice of life. Possibly they really have our welfare at heart. "If," one imagines them saying to each other, "if we standardised all our parts there would be no adventure, no romance left in the lives of constructors. Things would be too easy for them, they would know always what to expect and would become sick of their monotonous existence. Let us cunningly introduce 5B.A. threads without apparent rhyme or reason to give them the grievance without which no true Englishman is ever really happy. We will go further. Why should all 4B.A. threads be of the same size? Let us make some that will strip in their nuts and let us also manufacture screws so fat that the constructor must run the die down each before he can use it. These things will add brightness to his otherwise dull existence." I do not know whether this is how they talk amongst themselves, but I do know that my 4B.A. taps are worn to shadows by their continual passage through nuts and that my dies must have travelled several miles down so-called 4B.A. studding.

WIRELESS WAYFARER.

Some Simple Wireless Questions Answered

Is it necessary to use fairly heavy wire for the filament lighting circuits of a valve set?

In the receiving set itself, the filament lighting connection is usually fairly short, being only a few inches in length, and there is no need to use wire thicker than about No. 20 S.W.G. In the case of the external leads from the set to the accumulator, a fairly heavy conductor should be used, especially in the case of multi-valve sets; otherwise the drop in voltage produced by the resistance in these leads may be so considerable as to be possible to heat the valve filaments to the necessary temperature when a 4-volt accumulator is being used. Incidentally, it may be deduced from this answer that it is always better practice to use a 6-volt accumulator.

Do wireless waves of different wavelengths travel at the same speed?

Yes, the speed of the wave depends upon certain properties of the ether, and is 186,000 miles a second.

(Continued on page 426.)

be) and the bridle. Insulators placed on the separate wires forming the aerial are in parallel with one another and therefore not most efficiently used.

2. The down-lead to the receiving instrument should be taken from the most convenient end of the aerial, and should be kept as far as possible from the walls of the building, down-pipes, etc.

In general, a single wire aerial having a length of about 70 or 80 ft., well insulated and supported at a height of from 25 to 35 ft. above the ground, will give excellent results. If this length cannot be obtained, a two wire aerial is recommended (with spreaders at least 5 or 6 ft. long).

Broadcasting News

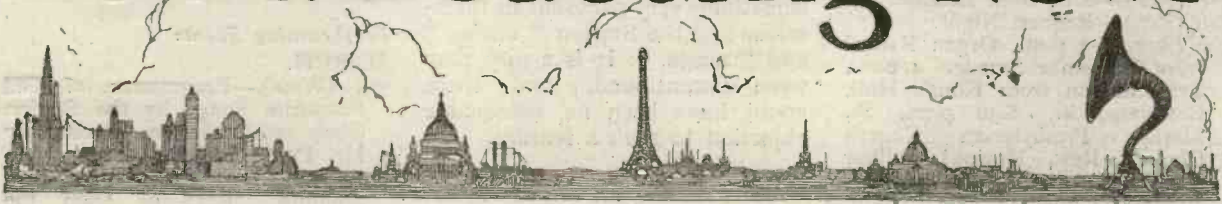

LONDON.—It is rather fascinating to note the extension of interest in the operations of the B.B.C. Every large paper in the country, and many of the smaller, are in direct touch with the B.B.C. for their information, but of late representatives from papers from the Colonies, from the American papers, and from Continental papers have been making a habit of calling at 2, Savoy Hill, one and all stating that the interest in British broadcasting is exceptionally keen.

On the occasion when the Rev. Dr. Sheppard allowed his service at St. Martin's-in-the-Fields to be broadcast he received over 1,000 letters of appreciation and only one of depreciation.

In connection with this transmission, the Rev. James Smith, of Aberdeen, has been condemning the broadcasting of sermons in that such transmissions present an easy, tempting, and selfish substitute for Church going. As a matter of fact the B.B.C. have studiously refrained at all times from broadcasting their usual service during the Church service, with two exceptions, once in Aberdeen and the other from St. Martin's-in-the-Fields. It is quite possible that the for and against the broadcasting of Church services is equal, but nothing is further from the mind of the B.B.C. than to induce people to stay away from Church.

One of the most pleasant features lately was the transmitting of the symphony concert, conducted by Mr. Percy Pitt, from the Central Hall. The audience was almost entirely composed of those people who had never attended a first-class concert; this fact was abundantly demonstrated by the number of people

who applied for tickets, stating that they had never attended a first-class concert in a London Hall in their lives, and were looking forward with great interest to the opportunity.

Forthcoming Events

MARCH.

- 5th (WED.). — B.B.C. Dramatic Critic. The Wireless Orchestra.
- 6th (THURS.). — B.B.C. Musical Critic. John Drinkwater reading from his works. Savoy Bands.
- 7th (FRI.).—B.B.C. Film Critic. Symphony Concert from the Central Hall, Westminster.

dral; this latter is one of the oldest edifices in Scotland, and one of the two granite cathedrals in Europe. For so historic a function an endeavour is to be made to obtain the services of Dr. Walford Davies as leader of the singing.

Another happy event is the securing of Mrs. Kennedy Fraser, Patuffa and Margaret, to sing their well-known Hebridean songs, this being the first occasion on which these talented collectors and composers have broadcast their works.

BROADCAST TRANSMISSIONS	
	Call-Sign Wavelength
LONDON	2LO 365 metres
ABERDEEN	2BD 495 ..
BIRMINGHAM	5IT 475 ..
BOURNEMOUTH	6BM 385 ..
CARDIFF	5WA 353 ..
GLASGOW	5SC 420 ..
MANCHESTER	2ZY 375 ..
NEWCASTLE	5NO 400 ..
TIMES OF WORKING	
Weekdays	3.30 to 4.30 p.m. and 5.0 to 10.30 p.m. G.M.T.
Sundays	3.0 p.m. to 5.0 p.m. and 8.30 to 10.30 p.m. G.M.T.

- 8th (SAT.).—Popular Music and "Carmen" from the "Old Vic."
- 9th (SUN.).—The Wireless Orchestra. The Salvation Army. The Langham Orchestra.
- 10th (MON.). — B.B.C. Literary Critic. Operatic Evening.
- 11th (TUES.). — Royal Engineers String Band.

ABERDEEN.—So successful was 2BD's venture in Church communal singing that the experiment is to be twice repeated in the near future in St. Andrew's Church and St. Machar's Cathed-

Forthcoming Events

MARCH.

- 5th (WED.).—Songs of the Hebrides. Messrs. Pitt and Marks, entertainers.
- 6th (THURS.).—Popular Programme. Miss M. Davies, singer. Mr. James Sharp, tenor. Address by Dr. John Chrystie.
- 7th (FRI.).—S.B. of Concert from Central Hall, London.
- 8th (SAT.).—Dance Night.
- 9th (SUN.).—Afternoon Programme. Boys' Brigade Band. The Rev. Frederick J. Japp, religious address.
- 10th (MON.).—Popular Night.
- 11th (TUES.).—Classical Night. The Song of Hiawatha.

BOURNEMOUTH.— Judging from the amount of enthusiasm shown, and remarks heard, the High Low Concert arranged by Mr. Percy Scholes, and transmitted from 2LO simultaneously to all stations, stands out as a landmark in the history of B.B.C. programmes. It is freely stated in this neighbourhood that no concert which has hitherto been broadcast, has given so much pleasure to so many listeners as the one in question.

Forthcoming Events

MARCH.
 5th (WED.).—Wessex Music Night.
 6th (THURS.).—Popular Night.
 7th (FRI.).—S.B. from London.
 8th (SAT.).—Request Night.
 9th (SUN.).—3 p.m., Organ Recital from Boscombe Arcade. 4 p.m., Transmission from King's Hall, Bournemouth. 8.30 p.m., St. Mark's Presbyterian Church Choir. Rev. Howard Wilbur Ennis, B.A., religious address. Reginald Movat, solo violin. Thomas Illingworth, solo 'cello.
 10th (MON.).—A Night of "String Music." The Bournemouth Wire-

less Orchestra. Reginald Movat, violin. Thomas Illingworth, 'cello. Charles Leeson, piano.
 11th (TUES.).—Musical Comedy Night. David Openshaw, baritone. Gertrude Newsom, soprano. Harold Stroud, tenor.

was certainly rather drastic, and was keenly felt, no doubt, by many thousands of kiddies who had come to regard the corner as something very personal to themselves and the Station "uncles" and "aunts." It is a pity they were discontinued, and there could have been no reasonable objection to such a feature.

Forthcoming Events

MARCH.
 5th (WED.).—Programme of Old Favourite Songs by the Station Choir and Orchestra. Recitals by Mr. Percy Edgar.
 6th (THURS.).—Old Memories' Programme. Readings from the Works of Browning.
 7th (FRI.).—Popular Classic Programme.

The interesting announcement has been made that 5IT is soon to broadcast complete Church ser-

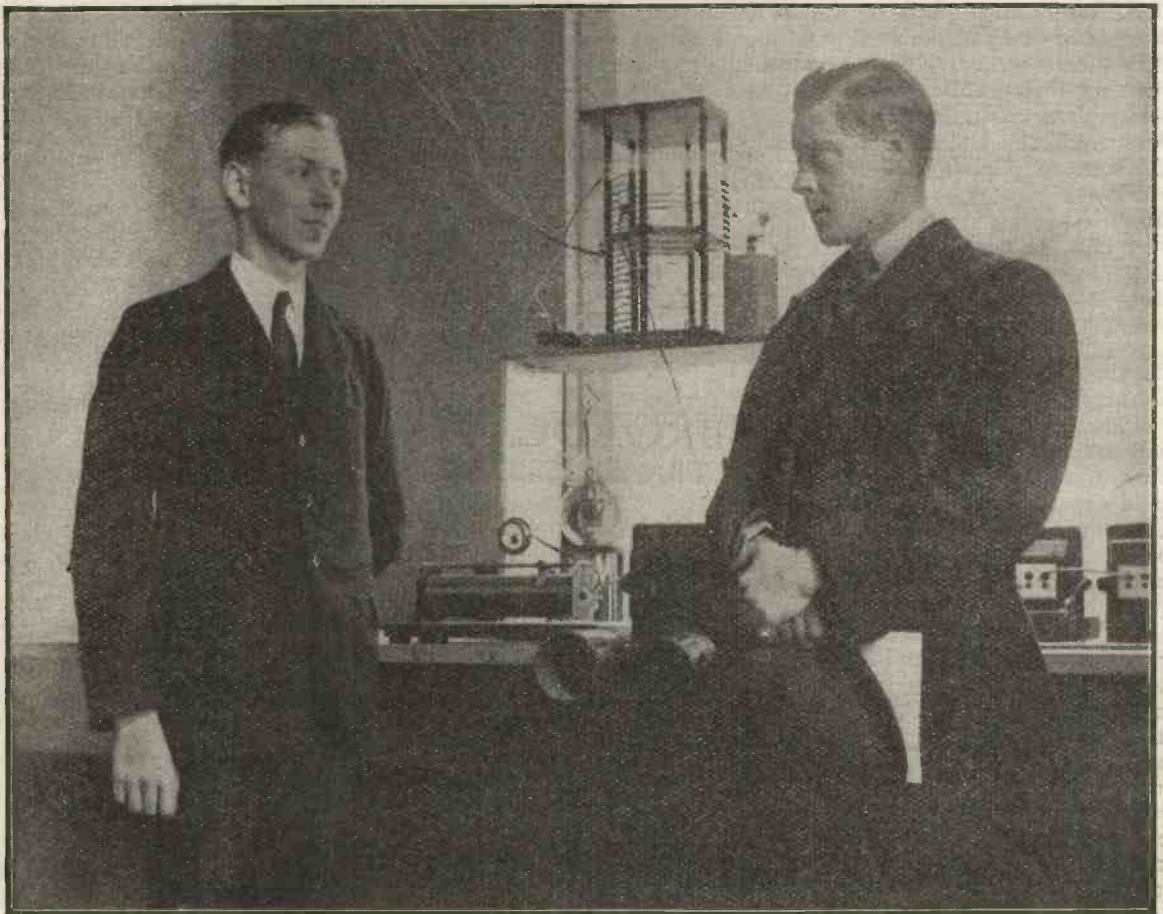

less Orchestra. Reginald Movat, violin. Thomas Illingworth, 'cello. Charles Leeson, piano.
 11th (TUES.).—Musical Comedy Night. David Openshaw, baritone. Gertrude Newsom, soprano. Harold Stroud, tenor.

Our photograph shows the Prince of Wales and Mr. Cyril Goyder, at the Mill Hill School. It will be remembered that Mr. Goyder was recently in communication by wireless with the Maine University, U.S.A.

8th (SAT.).—S.B. from London.
 9th (SUN.).—Station String Quartet. Rev. J. W. Morley, religious address.
 10th (MON.).—Orchestral Concert.
 11th (TUES.).—Miscellaneous Programme.

BIRMINGHAM.—A storm of protest filled the correspondence columns of the Birmingham Press when 5IT suddenly discontinued the bedtime kisses with which the Kiddies Corner had always been concluded. The effect

vices. The dates mentioned are March 30 and April 27, and the Churches will probably be the Cathedral and the Carrs' Lane Church, which is the leading

CARDIFF.—Shakespeare Night on Tuesday, February 19, was much enjoyed by Cardiff listeners, when "The Merry Wives of Windsor" was performed by the Cardiff Station Repertory Company, under the

direction of the Station Director. The next evening the Cross Keys Music Lovers' Male Octette Party gave several renderings, which were much appreciated, but transmissions of this character never seem to come through very well, being usually accompanied, more or less, by a certain amount of "blasting." The Symphony Concert S.B. from London is regarded locally as being of rather a "high-brow" character.

□ □ □

Forthcoming Events

- MARCH.**
 5th (WED.).—Popular Night.
 6th (THURS.).—Some Pleasant Songs and Solos.
 7th (FRI.).—S.B. from London.
 8th (SAT.).—Popular Night.
 9th (SUN.).—Rev. W. E. Roberts, religious address. Station Symphony Orchestra.
 10th (MON.).—The Kingswood Evangel Prize Silver Band.
 11th (TUES.).—Shakespeare Night.

□ □ □

GLASGOW.—There is at present a storm of controversy in the Glasgow Press in connection with the quality of the programmes sent out by 5SC, as compared with those broadcast by the London Station. This has been brought about by the proposal of the B.B.C. to curtail S.B. programmes from London in order that Glasgow might cater more exclusively for her own listeners-in. The great majority of the correspondents advocate, instead of curtailment, an increase in the number of simultaneous items broadcast from London. The Savoy Orpheans Band has made Glasgow wireless users dissatisfied with the music provided by the local wireless orchestra, and the excellent fare which has been relayed from 2LO to all stations has given the impression in this part of the country that the general level of programmes in the metropolis is infinitely superior to that supplied by 5SC. It is pointed out that the Edinburgh public have decided to have their programmes supplied through London, and Glasgow people feel that their neighbours in the Scottish capital by their decision will be more favourably circumstanced in the matter of wireless programmes than themselves. It is how-

ever, generally agreed that the S.B. programmes from London to Glasgow should not be cut out.

□ □ □

Forthcoming Events

- MARCH.**
 5th (WED.).—Professor Donald N. Covey. Musical Talk.
 6th (THURS.).—Our Birthday Celebration Evening. Address by the Lord Provost of Glasgow.
 7th (FRI.).—S.B. from London.
 8th (SAT.).—Popular Dance Night.
 9th (SUN.).—Wireless Quartet. Capella Church Music. Rev. R. G. McConochie, religious address. Examples of Russian Church Music.
 10th (MON.).—Popular Night.
 11th (TUES.).—Orchestra. Chat on Music.

□ □ □

MANCHESTER.—The first Symphony Concert broadcast from Central Hall, Westminster, was not the success we anticipated. The music itself, both orchestral and violin, was undeniably good, but the broadcast reception here was not entirely satisfactory owing to persistent echo and blasting. Each note had an echo like the tail of a comet, reverberating through the hall and continuing whilst the next note or two were being played. Had the performance been given in the studio at 2LO the reception would have been more enjoyable.

□ □ □

The All-British concert given by the 2ZY Orchestra recently was entirely successful. Mr. Dan Godfrey, Jr., can not only inspire his orchestra with true musical genius, but can also create a delightful element of humour on occasion, and his cheery voice can be heard leading many a humorous refrain. Another programme we enjoyed very much was the "Tales of Hoffman" S.B. from London; the whole performance was excellent and the transmission good.

□ □ □

Forthcoming Events

- 5th (WED.).—3.30, Miscellaneous Concert. 7.30, Orchestral and Choral Concert. 2ZY Augmented Orchestra and 2ZY Opera Company in Operatic Selections, including "Damnation of Faust." Solo violincello by Miss Beatrice Eveline. 10.15, Spanish Talk.

- 6th (THURS.).—11.30, 2ZY Trio. 6.40, French Talk. Mr. T. H. Morrison, solo violin. Miss Molly Gray, soprano. Mr. Tom Case, baritone.
 7th (FRI.).—3.30, Miscellaneous Concert. 7.30, Symphony Concert, S.B. from Central Hall, London.
 8th (SAT.).—3.30, Concert by Versatile Six Concert Party. 7.45, 2ZY Orchestra. Light British Music. Miss Glyn Williams, soprano. Mr. H. Spencer, baritone.
 9th (SUN.).—3 p.m., Symphony Concert by 2ZY Augmented Orchestra, conducted by Mr. Percy Pitt. Miss Gertrude Johnson, soprano. Mr. Walter Widdop. 8, Talk to Young People by Mr. S. G. Honey. 8.35, Talk by Rev. G. Davies, of Chorlton-cum-Hardy. 8.55, Concert, S.B. from London.
 10th (MON.).—3.30, 2ZY Trio. 6.30, Church Lads' Brigade Bulletin. 6.40, French Talk. 8, 2ZY Orchestra, Popular Programme. Talk on "English," by Miss G. D. Jackson. Mr. Victor Smythe will talk on "Unnatural History." Mr. Archie Camden, solo bassoon.
 11th (TUES.).—3.30, Miscellaneous Concert. 8, Keyboard Kitty. Miss Eleanor Lomas, contralto. Mr. Jay Kaye, entertainer. Mr. F. Taylor, tenor. Talk on "More About Trees," by Prof. F. E. Weiss, D.Sc., F.R.S.

□ □ □

NEWCASTLE.—It is the intention of Mr. Odhams that, in the future, the programmes for Sunday afternoons and for each evening in the week should bear a distinctive label. Thus, on Sunday afternoon, we shall have a "Classical Programme," and from those already arranged it is evident that some very excellent Sunday afternoon concerts are to be anticipated in the near future. Tuesday will be a "Literary and Dramatic" evening, while as a contrast Wednesday's programme will be in lighter vein. Another evening will be for suggestions which listeners are invited to send in, as to items or artistes they would like to hear.

□ □ □

Forthcoming Events

- MARCH.**
 5th (WED.).—3.45, Walker's Band relayed from Tilley's. 7.30, The Complete Opera, "Ill Trovatore." Newcastle's Late Night. (Concluded on page 429)

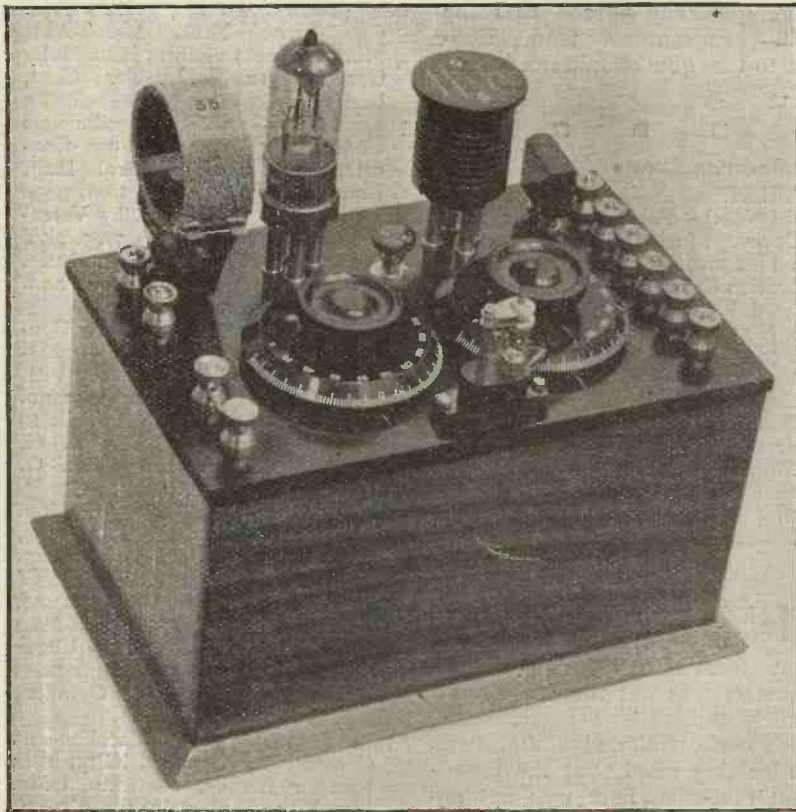

Fig. 1.—The unit is exceptionally compact and can be “reflexed” if required.

A LETTER received a few days ago interested me more than usual. “The enthusiast with an outside aerial,” wrote my correspondent, “is well catered for in your journal. Can you not give a little more attention to the flat-dweller? So many people are prevented from erecting an outdoor aerial and yet cannot afford the elaborate multi-valve sets which are sold for use with frame aerials. If at the same time you can give us something really economical in filament consumption so much the better!” The present instrument is designed to meet the needs of just such people.

To invert the usual procedure, let me tell you something of the results obtained with this little set. It has but one valve and a crystal, and does not utilise dual amplification in any way, yet I have had no difficulty in getting quite loud signals 6 miles from 2LO on a 2-ft. frame, whilst on the outdoor aerial Birmingham and Aberdeen were quite good enough for two pairs of phones. Using a length of wire round a

picture rail as an indoor aerial, the results on London were all that could be desired for telephones, whilst the manipulation is the simplest.

The Circuit

Readers will agree that these results are good, yet the circuit is a “straight” one, and an examination of the arrangement shown in Fig. 2 would not suggest that efficiency was so high. The principle of the set is to use a high-frequency valve, one of the many available plug-in transformers, and a crystal detector shunted across the secondary winding of this latter. The advantage of using a transformer here is that the crystal is removed from the circuit carrying the high-tension current, and is therefore far less likely to be injured than in those cases where it is shunted across a tuned anode coil. The make-up is exceptionally compact, which may possibly account for the unusual efficiency, the whole instrument being contained in a box measuring 9 in. by 5½ in. by 5½ in. Aerial tuning is effected by means of a variable condenser

A Combined High-Frequency and Crystal Unit

By PERCY W. HARRIS,
Assistant Editor

shunted across any of the well-known plug-in coils, whilst for frame aerial reception it is only necessary to connect the ends of the frame across the aerial and earth terminals and to withdraw the usual tuning coil. Any wavelength range may be covered, depending, of course, upon the coil plugged-in and the particular transformers used; thus the set, when built, will be quite suitable for the proposed 1,600 metre wave if this should eventually be adopted.

Novel Features

Two novelties have been introduced into this set, and will appeal to most experimenters. First of all there are two additional terminals on the left-hand side of the instrument, which normally are shorted by a piece of wire or other conductor. These, as will be seen from the circuit diagram, are interposed between the lower side of the condenser and tuning inductance and the

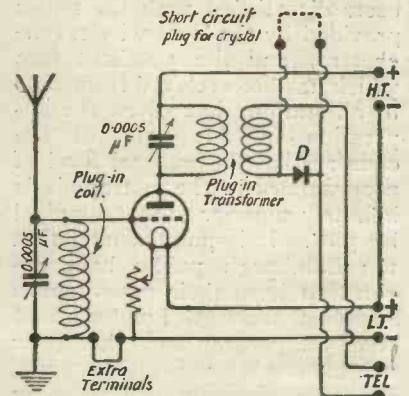

Fig. 2.—The simple circuit used. Extra terminals are for the reflex transformer when fitted.

◆ ◆ ◆

In the following article is described a useful instrument which possesses the novelty of fulfilling many purposes

◆ ◆ ◆

negative filament connection. There is in addition a socket into which a short-circuiting plug can be pushed, arranged to short circuit the crystal detector. The first pair of terminals can be opened, and if necessary the secondary of an intervalve transformer shunted by a condenser, placed between them so as to enable experiments in dual amplification to be conducted.

The short-circuiting plug across the crystal enables this unit to be used as a high-frequency unit in conjunction with an ordinary detector valve, for, as will be seen, the shorting of the detector enables the telephone terminals to be connected to the grid and filament of the detector valve without further change. Equally well a further low-frequency valve can be added in place of the telephones, thus increasing the signal strength.

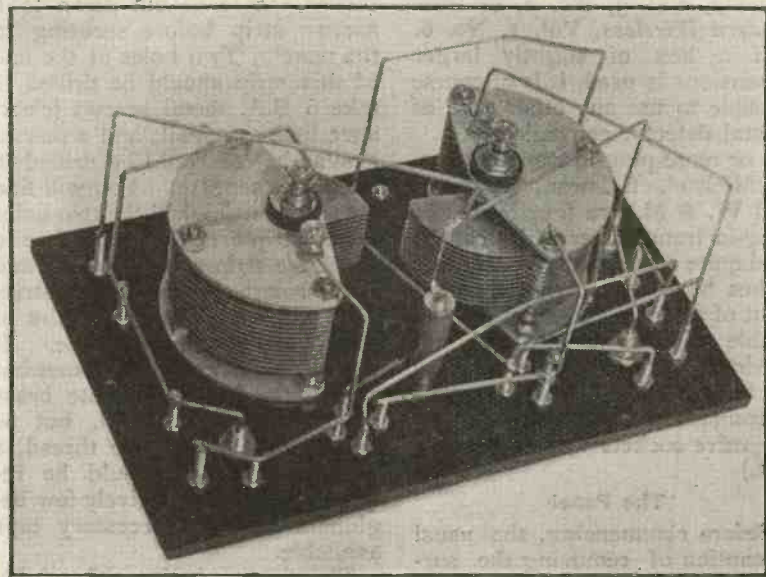

Fig. 4.—Underside wiring. Stiff wire is used throughout.

Components Required

Owing to the small compass into which the instrument is packed, certain precautions have to be taken to enable the components to occupy so small a space. The crystal detector, for example, is of the plug-in type requiring very small base-room. The filament resistance is a Lissenstat Minor, also used because of the small space taken on the panel, whilst the two variable condensers are placed as close together as is possible. There are no fixed condensers, and the following is a complete list of component parts. As usual, I am indicating after these parts the makers of those used,

though obviously any good components will suit here.

1 box with ebonite panel measuring 9 in. by 5½ in. by ¼ in. (This box, complete with panel, is of Bowyer-Lowe manufacture.)

2 variable condensers, which in this case are each of 0.0005 μF. (Those used are of Ormond manufacture and can be commended for having the capacity they are alleged to possess. A 0.0003 μF capacity variable condenser would suit just as well as the high-frequency condenser if only the British Broadcasting band is to be covered. If, however, it is desired to listen to Continental telephony—quite possible on this set when conditions are good—the larger condenser should be used.)

2 sets of valve legs.

10 terminals.

1 filament resistance (Lissenstat Minor).

2 sets of sockets for plug-in coils.

1 short-circuiting plug for same.

1 socket for plug-in detector.

1 plug-in detector (Bowyer-Lowe). The same type of detector is also made by S. A. Cutters. Quantity of No. 16 square tinned copper wire.

1 set of plug-in coils for broadcast wavelengths, or if Continental telephony is required other suitable coils. Guidance in the choice of plug-in coils for the reception of both low and high wavelengths may be gathered from the chart given in *Wireless*

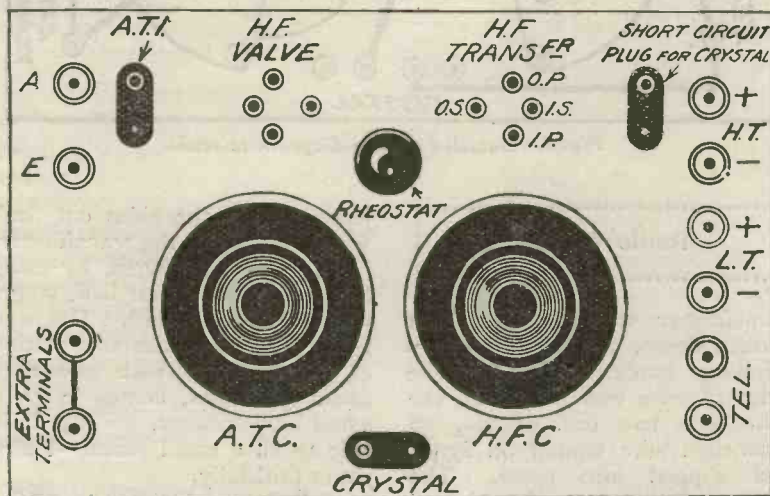

Fig. 3.—Panel layout. For normal use the short-circuiting plug for the crystal should be withdrawn.

Weekly, Vol. 3, No. 6, or from *Modern Wireless*, Vol. 1, No. 6.

If a box of slightly larger dimensions is used, it is of course possible to use any other type of crystal detector conveniently.

1 or more plug-in transformers. (McMichael, Ediswan, Tangent, and W. & M. are four makes of plug-in transformer which can be used quite successfully. All these makes have the same arrangement of primary and secondary to enable them to be interchanged. Obviously if the connections are not the same in the various makes of transformer the connections to the valve sockets will not be correct.)

The Panel

Before commencing, the usual precaution of removing the surface skin of the ebonite should be taken. Measure the thickness of the edges of the box, mark a line around the under side of the panel with a scribe equal to this thickness, and you will then have a guide to enable you to see just how close to the edge you may fit your terminals. The Ormond condensers are fortunately made for "one hole mounting," and therefore one has not the usual trouble of drilling holes accurately to enable one to mount the top plates. A $\frac{3}{8}$ -in. hole is required for these condenser spindles, and the same-sized hole can be used for the Lissenstat, which is also made for such mounting. It is well to use separate valve pins, and if you use a Morris valve template (consisting of a disc of steel from which project four sharp points), you will have no difficulty in obtaining the correct spacing. The Bowyer-Lowe crystal detector is supplied with an ebonite disc carrying the two sockets into which the detector plugs, but owing to the small space in this receiver this latter

socket has to be cut down to a narrow strip before securing to the panel. Two holes at the end of this strip should be drilled to take 6 B.A. metal screws (clearance hole as usual), and a pair of similar holes should be drilled in the panel beneath. You will find it convenient to drill the two holes in the strip first of all and then to stand the strip over the panel and drill through the holes in the strip. This will enable the two pairs of holes exactly to coincide. It would, of course, be somewhat simpler to fit the separate brass sockets into the panel, but as these are of very large thread, a large-tapped hole would be required, and comparatively few beginners have the necessary taps available.

The six terminals on the right-hand side are separated exactly $\frac{3}{4}$ in. from one another, the first hole at the top being 1 in. from the edge. The four terminals on the left are spaced an inch apart, the two extreme terminals being $\frac{3}{4}$ in. from the edge. The centres for the condensers are 3 ins. from each edge on a line $2\frac{1}{4}$ ins. from

the bottom. The central hole for the Lissenstat is $1\frac{1}{2}$ ins. from the top of the panel, whilst the centre line for the two valve sockets is $1\frac{1}{4}$ ins. from the top, the two centres being $2\frac{1}{8}$ ins. from each side. The two valve sockets are as close to the terminals as is permissible—i.e., $\frac{3}{4}$ in. from the terminal centres.

Wiring Up

As stray capacities play a very important part in high-frequency amplification, I recommend the use of stiff wire in this particular case rather than the simpler No. 22 tinned wire covered with sioflex or other tubing. Keep all wires as well spaced as possible and follow as closely as you can the wiring diagram given in Fig. 5.

A final hint: after you have soldered up all connections and the points have cooled, retighten all nuts before connecting your wires to the terminals. The reason for this is that the heat applied to the shanks of the terminals tends to soften the ebonite surrounding them, and loosen them slightly.

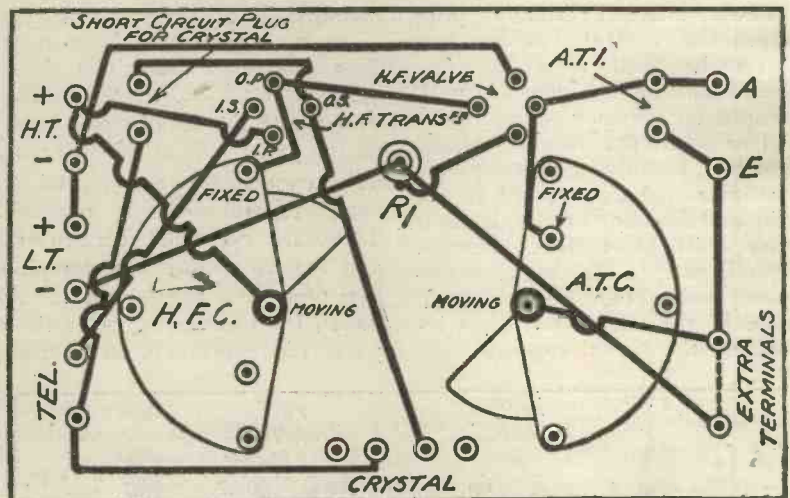

Fig. 5.—Detailed wiring diagram to scale.

Radio Chokes

SIR,—I have just received *Modern Wireless*—January issue—and note with interest the article on "Modern Wireless Choke Circuits." It is mentioned that the writer—yourself—has had no experience with Ford coils. I have just started on this method of amplification, and may mention that a Ford spark transformer is just of the right size for excellent signal strength. I might mention that the original

transformer was not used, but broken down, and the secondary winding made use of. The primary wire was wound off the iron core, two ozs. of No. 36 enamelled wire wound on again and slipped into place. The two windings were then joined in series and the iron wires pro-

jecting from the sides cut flush with the ends of the transformer.

The signal strength, by using this choke as the first L.F. stage, was excellent, as with 1 Det. and 1 L.F. an experimenter's station $4\frac{1}{2}$ miles away, with power of about 50 watts, comes in on a small loud-speaker, so that it is able to fill a small room.—I am, yours faithfully,

"SOUTH AFRICAN EXPERIMENTER."

C.W. and Telephony Transmission Using Valves

No. VIII.

By JOHN SCOTT-TAGGART, F.Inst. P., A.M.I.E.E.

This series of articles began in Vol. 3, No. 6, with a consideration of the theoretical principles underlying valve transmission

FIG. 17 shows a similar kind of circuit in which the negative terminal of the high-tension supply B2 is connected to earth. In both the last two circuits the grid is shown as being at zero potential, but we may generally obtain a greater efficiency by connecting a leaky grid condenser in series with the grid.

Another kind of single-circuit transmitter which has a considerable vogue is that which employs two condensers in series with the middle connection taken to the filament. The oscillatory circuit in Fig. 18 consists of the induct-

side of B2 are connected to earth —always a desirable feature in a transmitter. When oscillations are flowing in the oscillatory cir-

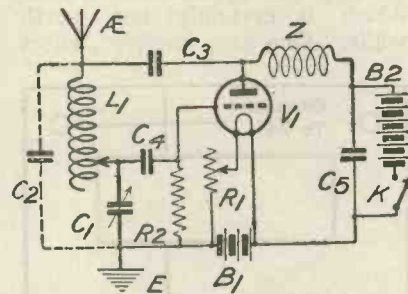

Fig. 18—A single-circuit arrangement involving a pair of condensers in series, a middle connection being taken to the filament.

cuit, potentials will be set up across the condenser C1, which will be communicated to the grid; this will produce changes in the anode current which, in turn, strengthen the oscillations in the aerial circuit; reaction is in this way obtained. The aerial condenser C1 may either be tuned or fixed.

Production of High-tension Voltages

An important problem in medium and high-power valve transmission is the provision of a suitable source of high-tension direct current. In the case of small-power transmitters where the anode voltage does not exceed about 500 volts, batteries and dry cells may be employed, although expensive. For voltages up to about 1,500 the best source of direct current is undoubtedly a motor-generator, or in the case of an aeroplane set, a generator driven from a small air-driven propeller. When higher voltages are required it is usual to use either multi-phase alternating currents or rectified alternating

currents. Several dynamos are sometimes connected in series.

If we are not particular about producing pure continuous waves, we may employ an ordinary induction coil to provide voltages up to 1,000 volts. In Fig. 19 is shown a single-circuit valve transmitter, in which the secondary T2 of an induction coil T1 T2 is connected so that the maximum half-cycles (produced at the break) cause the anode of the valve V1 to become positive. The induction coil is worked from the accumulator B3. The make-and-break shown in the primary circuit should preferably give a clear high note at the receiving

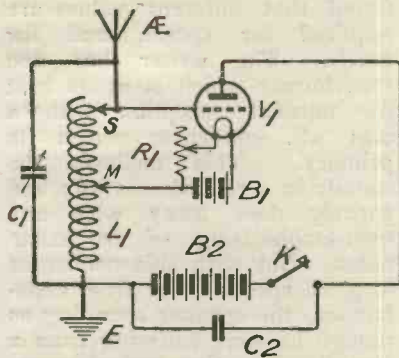

Fig. 17.—A single-circuit transmitter which may be used when the negative side of the H.T. supply is connected to earth.

ance L1, the condenser C1, and the condenser (represented by C2) formed by the aerial and earth. The ends of L1 are connected respectively to the anode and grid of the valve. The condenser C2 acts as a coupling condenser through which the oscillatory circuit is excited, while the condenser C4 is the usual grid condenser. The direct current anode circuit, it will be noticed, is separated from the oscillatory circuit and the usual air-core choke Z is employed. Both the accumulator B1 and the negative

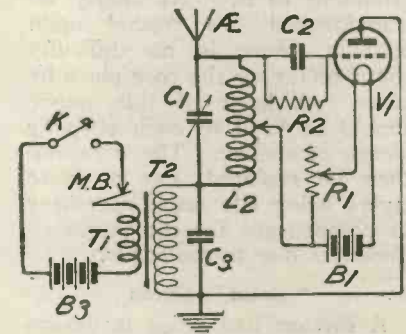

Fig. 19.—A transmitter circuit in which an induction coil is used to supply H.T. voltage for the plate of the oscillating valve.

station so as to be easily readable. The actual note sounds like a mixture between C.W. and spark; signals may be received on a non-oscillating detector, but best results are obtained when using heterodyne reception.

The arrangement of Fig. 19 may be varied in a large number of ways, but it is desirable to connect the secondary T2 in such a position that it will not be at high-frequency potential to earth; moreover, it should always be shunted by a condenser.

Improving Cheap Transformers

MANY who have bought cheap, modern transformers, or instruments designed some time ago which were intended primarily for Morse code reception, will probably be rather dissatisfied with the performance of their sets upon the note-magnifying side. Not everyone realises what an important part the low-frequency transformer plays in reception. It magnifies every noise inherent in the set, and should it be badly put together it will give rise to a great deal of very unpleasant distortion.

Poor Insulation

It is most important that any audio-frequency transformer should have a laminated core and that its sections should be particularly well insulated from one another.

Many transformers of poor quality are most inefficiently insulated, and a great improvement can therefore often be made by attending to it. As nearly all transformers are wound upon bobbins, there is no difficulty about removing the core piece by piece. A layer of thin paper should be fixed to each strip by means of shellac. The core can then be replaced, one or more layers being left out if necessary to compensate for the increased thickness due to the paper.

"Solid" Cores

A further bad point in design frequently met with is that the core is held together by means of bolts passed through it at its corners. It is of little use to insulate layers from one another and then to provide four solid connections between them of this kind! An improvement can be very easily made by removing the bolts and drilling the holes through which they passed to $\frac{1}{4}$ in. Then insert a bush made of $\frac{1}{8}$ in. inside diameter ebonite tube, and clamp the laminations together with $\frac{1}{8}$ in. Whitworth bolts, placing a washer made of ebonite or of shellacked cardboard under the head of each bolt and below each nut. (See Fig. 1.)

Transformer Following Detector

The audio-frequency transformer which immediately follows the rectifier should, for the best results, have a primary, the impedance of which nearly matches that of the valve. If the transformer is of a very small size it will probably not contain sufficient wire to give it a very high impedance. Nothing can, of course, be done to remedy this short of redesigning and re-winding the transformer, a task which is certainly not worth while. One can, however, effect

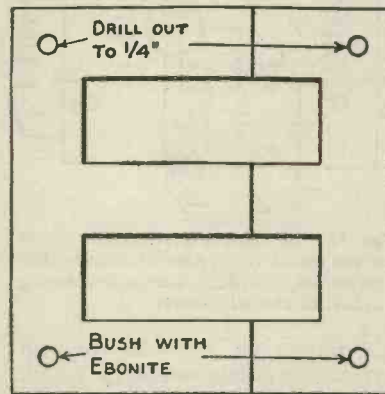

Fig. 1.—Illustrating how the holding bolts should be insulated from the core.

a considerable improvement by selecting a rectifying valve, the plate-filament impedance of which is on the low side, whilst if two stages of note magnification are used the small transformer will do quite well for the second, provided that the first is coupled to the rectifier by a large transformer of good quality.

Natural Resonance Frequency

Low frequency intervalve transformers made by first-class firms are designed by experts able to deal properly with the many problems which present themselves for solution, but there are on the market dozens of instruments which have been designed by mere rule of thumb and without any account being taken of such factors as the transformer's own natural resonance frequency. Every transformer has a frequency to which

it responds much more readily than it does to others. Should this frequency lie within the limits of audibility certain notes will be unduly emphasised whenever they occur with very unpleasant results. The makers' endeavour should be to keep the transformer's resonant frequency below the lower limit of audibility. This may happen to be the case in a cheap-jack transformer, but should it be so it is due, in the majority of cases, to good fortune rather than to good judgment. Luckily, however, this is a thing which can be dealt with fairly satisfactorily by the amateur.

Adding Condensers

By shunting a suitable condenser across the primary of a transformer we can tune it to some extent so that the resonance frequency of the circuit is so low as to be inaudible. If you are anxious to obtain pure and undistorted reception of telephony it will be well worth your while to experiment with condensers of different capacities in order to find that which gives the best results. It will often be found that different values are required for speech and for music. The writer has one transformer which is at its best for musical reception with a $0.01 \mu\text{F}$. condenser across its primary. This mellows the sounds in a remarkable way and entirely does away with any over-emphasising of particular notes. But with this condenser in place speech is far from satisfactory, the speaker sounding as though he were suffering from a sore throat. For perfect reception of speech a condenser of $0.0005 \mu\text{F}$. is required.

Telephone Transformers

It is not, perhaps, generally realised that a good deal of distortion can be produced by the telephone transformer when low resistance 'phones are used. This is again due to an unsuitable resonance frequency which can be dealt with in the manner indicated for intervalve transformers.

R. W. H.

NEXT WEEK: THE TYPE W 2 RECEIVER. An interesting two valve instrument with very selective tuning arrangements.

How to make a 3-Valve Panel Receiver

TYPE W 1.

By HERBERT K. SIMPSON.

Below will be found further constructional details and half-scale layout of the panel for building the receiver.

(Concluded from Vol. 3, No. 12. Page 393).

The Cabinet

THE panel for this receiver is laid out in accordance with the dimensions given in Fig. 7, which is drawn to half scale. From this drawing measurements may be taken by means of dividers and the result multiplied by two. With all drill holes made and the panel squared up, the surface on both sides of the ebonite should be rubbed with fine emery paper

until all evidence of the glossy finish is removed.

Full dimensions of the cabinet are given in Fig. 8, and no difficulty should be experienced by a careful worker. The cabinet could, of course, be obtained from a firm specialising in this form of work. The cost, in this case, should be, at the most, 18s. The panel is secured to the cabinet by means of wood screws, situated near each corner of the panel.

Testing

The set may now be tested. Connect up the H.T., L.T. and grid bias batteries to the terminals indicated in Fig. 3. A suitable voltage for the H.T. battery is 70 volts, and for broadcast reception, a number 50 Igranic coil may be used in each socket.

Starting with one valve, connect the telephones to terminals 1 and 2, leaving 3, 4, 5 and 6 free. Connect the aerial lead to

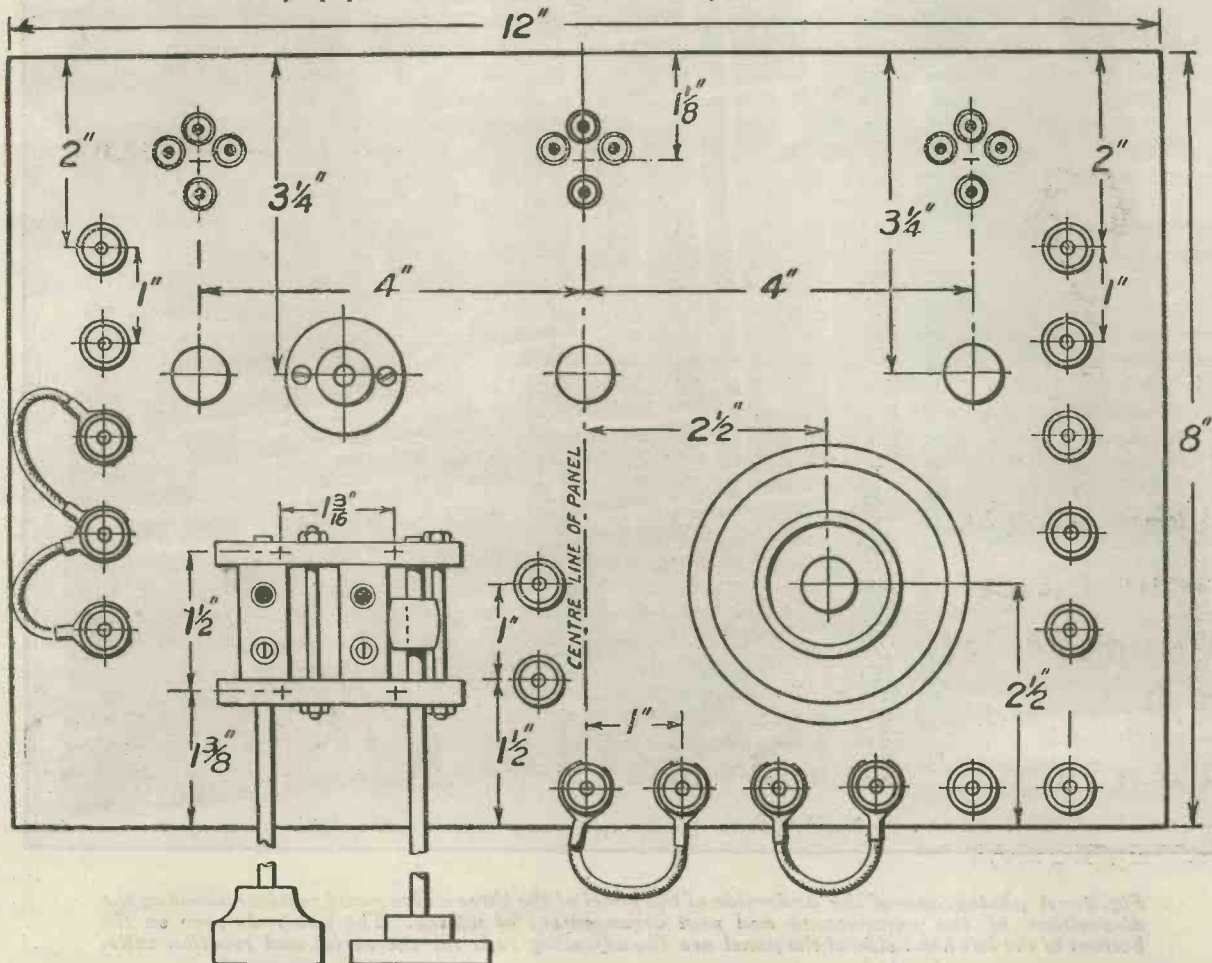

Fig. 7—Layout of the panel. This figure is drawn to half scale therefore all measurements taken from it by means of dividers should be doubled.

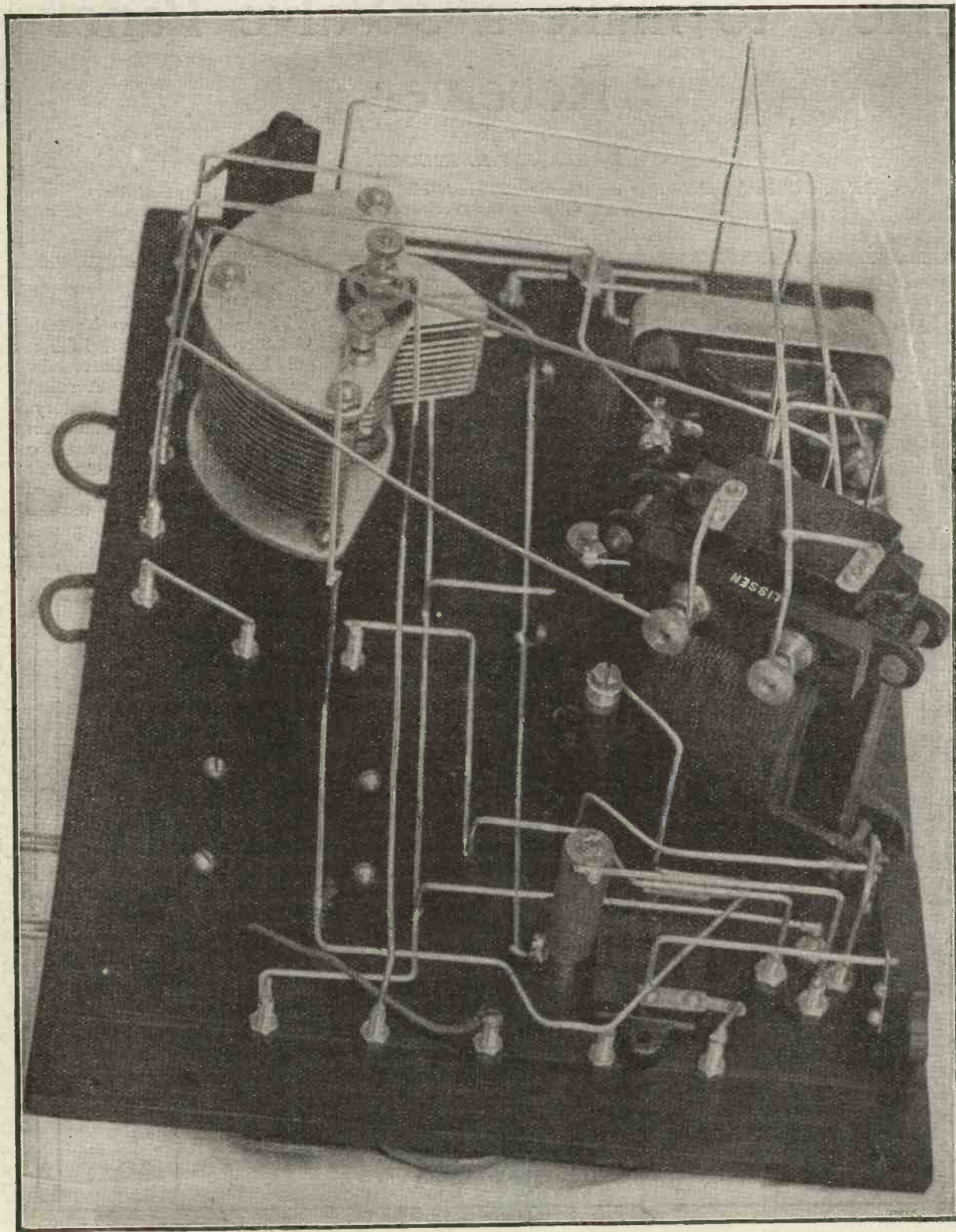

Fig. 8.—A photograph of the underside of the panel of the three-valve panel receiver showing the disposition of the components and neat arrangement of wiring. The two rods seen on the bottom of the left hand side of the panel are the adjusting rods for the aerial and reaction coils.

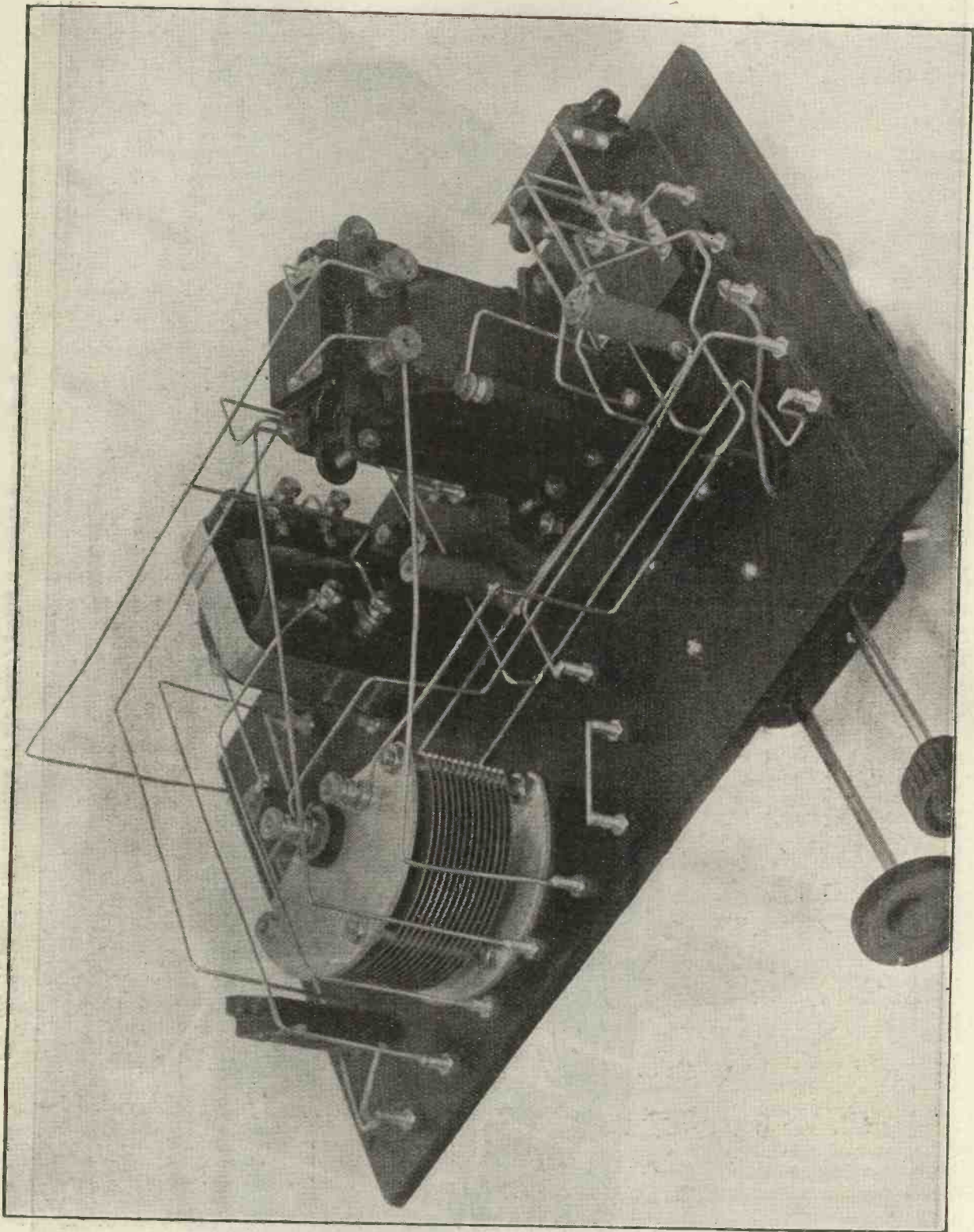
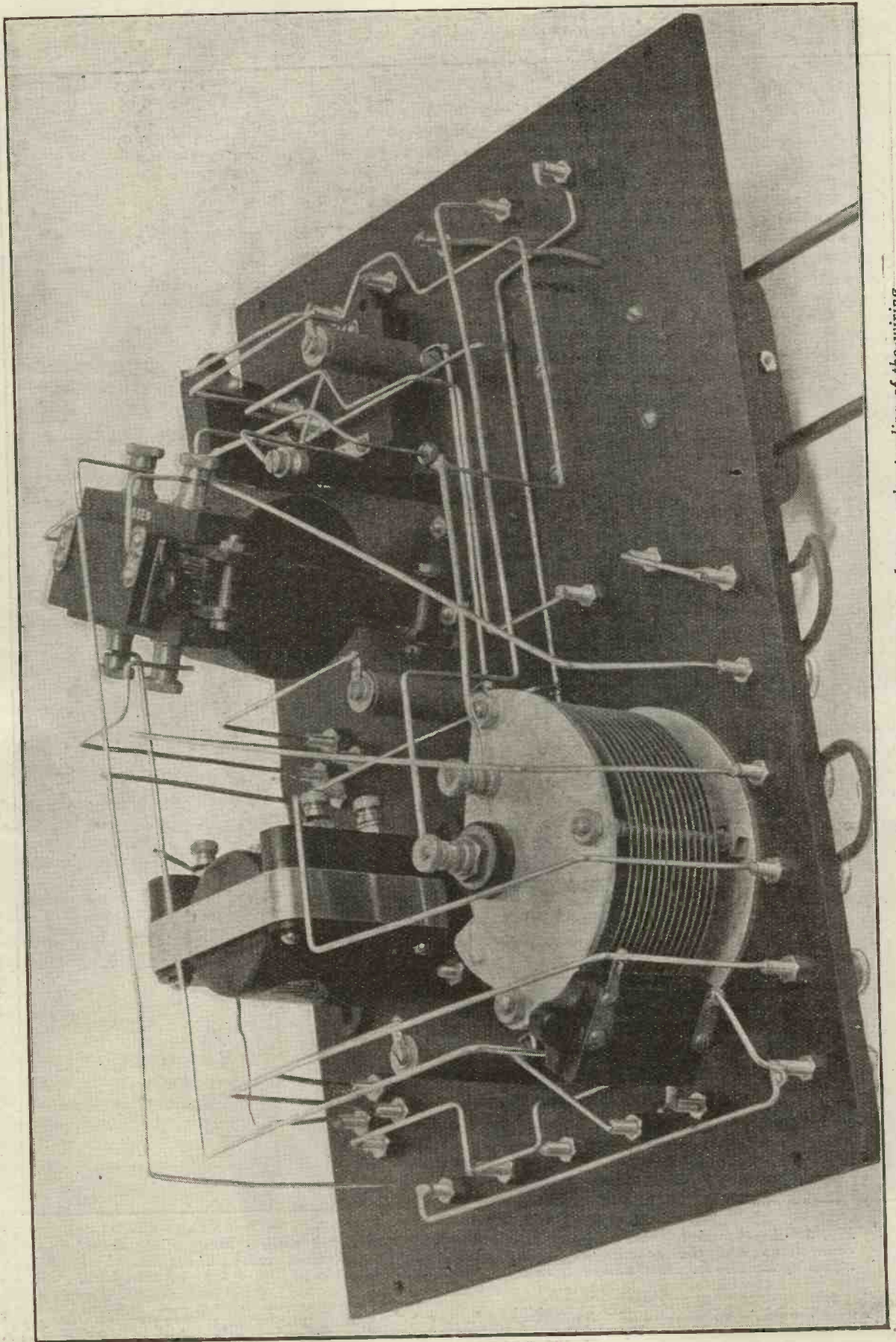

Fig. 9.—Another photograph of the receiver seen from a different angle. Many of the actual connections and the scheme of wiring may be gathered from this illustration. Two adjusting handles for aerial and reaction coils which are not visible in Fig. 8 may be seen here.



• Fig. 10.—A view of the underside of the panel, giving a clearer understanding of the wiring

terminal A, leaving B free, and join C, D, and E. This brings in the constant aerial tuning system, which makes initial tuning child's play. Turn on the filament, and move the variable condenser over its scale to find a signal, keeping the two coils separated. When signals are heard, move the telephones to terminals 3 and 4, and join 1 to 2. Turn on the filament of the second valve, and note that the signal strength has greatly increased. The third valve may now be added in a similar manner, and a further increase noted. Those who are more than 10 miles from a broadcasting station may care to try the full three valves straight away.

Operation of the Receiver

It may again be impressed upon the operator that it is essential to keep the two coils well separated when tuning the set to any station, as the set is easily capable of oscillation if coupling is tight enough, and considerable interference may be caused to neighbours. When a station is heard, the two coils may be brought closer, to increase the

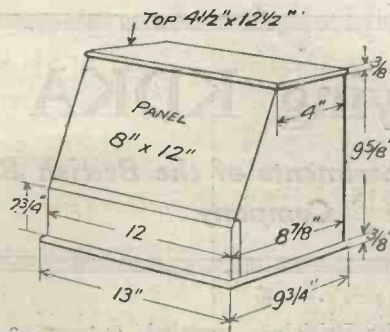

Fig. 8.—Constructional details of the containing box.

signal strength, but it will be noticed that at a certain point the incoming signal is distorted. This is the point where the set commences to oscillate, and the coils must be moved slightly apart. The fact that the set is oscillating may be ascertained by the presence of a hiss when no station is being heard, or a howl when listening to an incoming signal. Another test is by wetting the finger and touching the aerial terminal. If a click is heard on touching the terminal and also when the finger is removed, the set is in a state of oscillation, and the coupling

between the two coils must be loosened. Fine adjustment on the coil-holder being obtainable, it may be utilised to obtain just that degree of coupling between coils where the set is slightly off the point of oscillation.

A little practice will enable signals from distant broadcasting stations to be tuned in, while amateur transmitters may be heard by substituting smaller coils. Longer wave reception will, of course, necessitate the use of larger coils.

Results

The set gave excellent results on quite an ordinary aerial, 2BD, 3ZY and 5IT coming in very well, while 2LO, 12 miles away, was heard with no aerial, the earth lead being connected to terminal A.

Blue prints of the panel layout and of the wiring diagram of this receiver may be obtained from the offices of Radio Press, Ltd., price 1s. 6d. each, post free.

In response to inquiries the Royal Transformer used in the above set may be obtained from Messrs. R. A. Rothermel, 24-26, Maddox Street, Regent Street, W.1.

MAKING LARGE HOLES IN EBONITE

THE amateur constructor is frequently faced by the problem of making a large oblong, square or round hole in the panel of a set under construction. To make these neatly and at the same time fairly quickly is not at all a difficult matter if you know how to set about it.

In the first place, the hole must be carefully marked out, preferably on both sides of the ebonite, with setsquare and scribe, or with dividers if the hole is to be of round shape. The scratched lines should be deep, so that they will not be easily obliterated by ebonite dust.

Two tools are suitable for the operation of cutting out; the first is a fretsaw fitted with a stout blade suitable for cutting metal; the ordinary fine wood-working blade snaps very easily

if it is used upon ebonite. The second is known as a jeweller's hacksaw. This has a rather deep frame with a gap of about 4 1/2 or 5 in. into which miniature hacksaw blades of very fine cut can be fitted. These blades are narrower than the ordinary hacksaw blades, which enables them to be turned a little if one is cutting out a curve. The writer has found that with both types of saw it is best to adopt the Chinaman's method of setting the blade to cut on the draw instead of on the thrust. If they are placed in the handle in the ordinary way one is rather apt to buckle them, which, of course, leads to disaster, when making an outward stroke into thick ebonite.

Having provided a suitable saw, the next process is to drill

holes of a size large enough to allow the blade to be inserted. In the case of a rectangular hole these should be at the corners; for a round hole drill half a dozen holes round the circumference, making all the holes well inside the scribed line. Now cut from one to the next, taking care not to cut into the scribed line.

When the unwanted piece of ebonite has been removed the hole may receive its preliminary trimming with a rasp. This is one of the most useful tools in the constructor's outfit, for it enables a piece of ebonite to be cut roughly in the shortest possible time. Use a D-section rasp, the flat side of which is about 3/4 in. across. This side is, of course, used for straight-edged holes, whilst the curved side is excellent for trimming up round ones. Trim with the rasp until you are within about 1/32 in. of the scribed line, then apply a medium-cut file, exchanging this later for one of fine cut and finishing up the edges with fine emery cloth. R. W. H.

Relaying KDKA

The Biggin Hill Experiments of the British Broadcasting Company

THE experiment conducted by the British Broadcasting Company in picking up and relaying the signals from the American broadcasting station KDKA at Pittsburg are of more than usual interest. The 100-metre wavelength used by KDKA is none too easy to pick up, special apparatus being required for effective reception. In order that the experiment might be as successful as possible, arrangements were made to erect a receiving plant at Biggin Hill Aerodrome, facilities being kindly provided by the Royal Air Force. The two main advantages of this site are, firstly, that the ground is very high and thus free from screening, and, secondly, it is sufficiently far away from inhabited areas to remove possible trouble from amateurs searching for the 100-metre carrier wave with oscillating valves. The three photographs on this page will give readers of *Wireless Weekly* a good idea of the general arrangements. On the right-hand side you see the aerial supported between two masts and led into the building on the left. Actually the aerial is of cage formation, the upper portion being carried on 6-in. hoops. For earth connection either a small counterpoise (seen suspended between the masts) or a metal plate earth can be used. In addition a frame aerial, consisting of two turns of wire around a 4-ft. 6-in. frame, is available, while experiments have also been

carried out on a Beverage aerial specially erected for the purpose.

Inside the cabin a multitude of apparatus will be seen. The super-heterodyne principle has been adopted, but the unusual arrangement is adopted of arranging considerable amplification on the fundamental frequency before the transfer from short- to long-wave magnification is effected. The first valve of the series is fitted with a tuned anode coupling, this

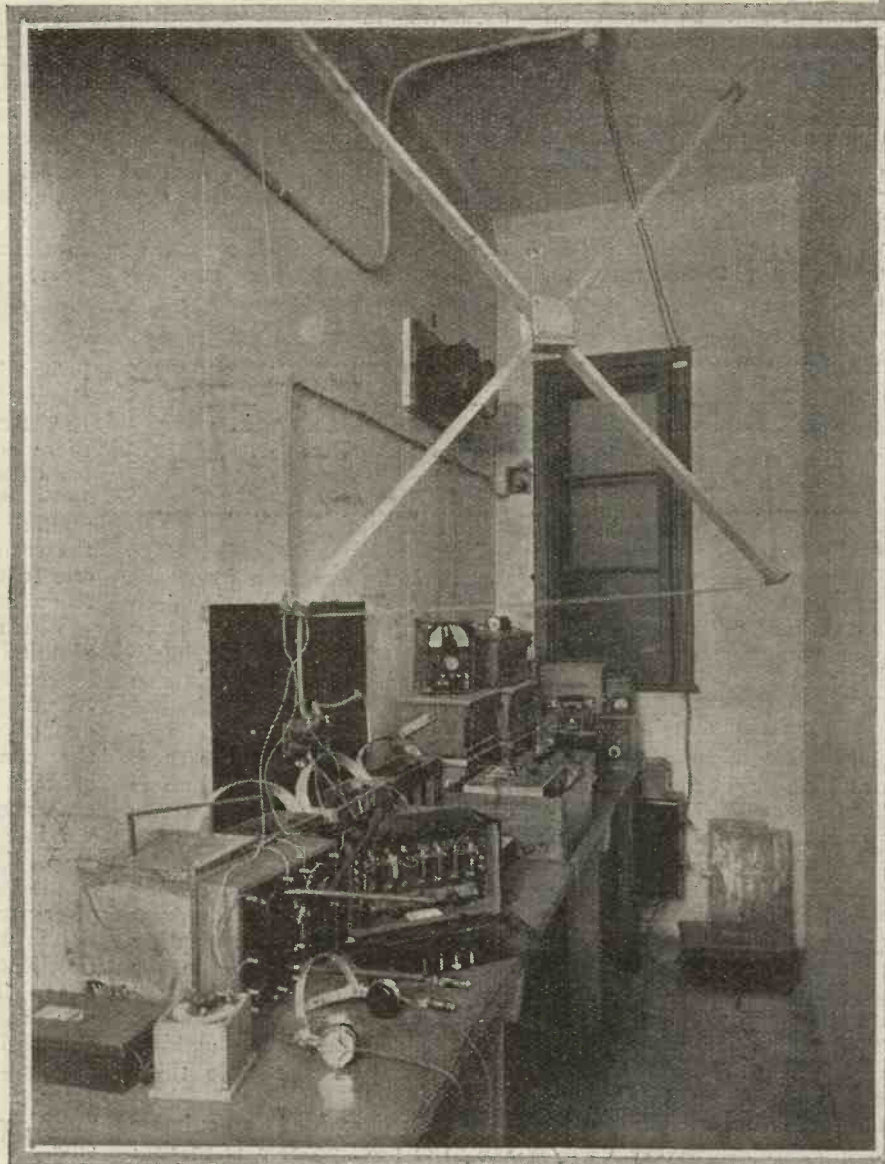

A close-up extension h

method being After magnifi signals are p receiver wou formers havin 100 metres. frequency ca by a rectifyi heterodyne is to give a b a waveleng this wavelen by a resistanc amplifier, con rectification a resistance-cap amplifies sign

It is obvio to be taken example, the to the tuned a

The picture apparatus at is occasional

The picture aerial at Big metal plate

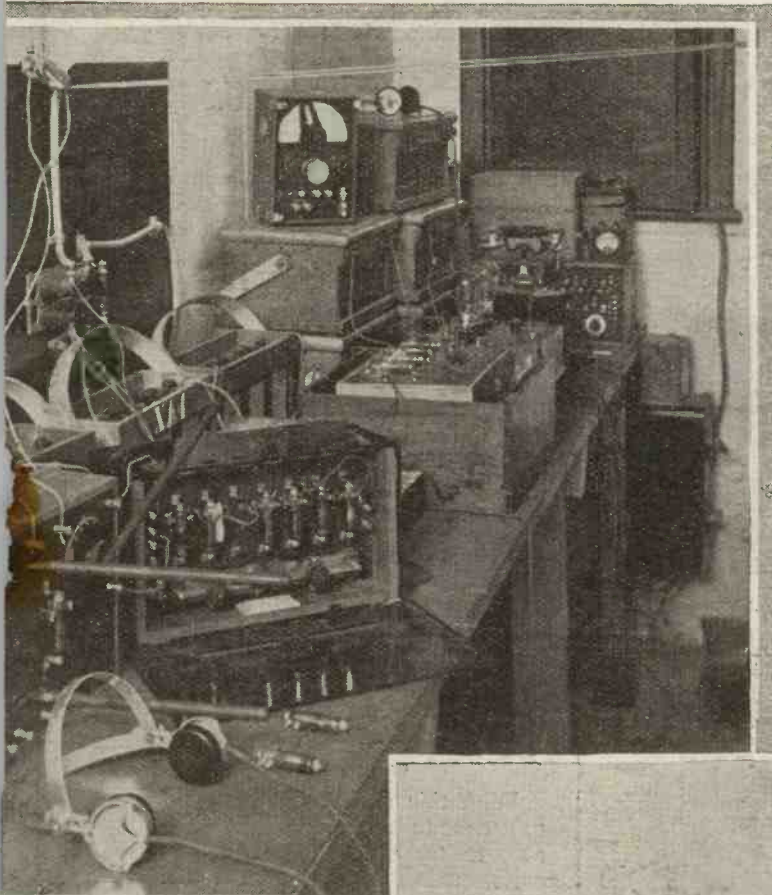

in a tin biscuit box, while the tuned anode panel is shielded with copper foil, this latter being earthed. D.E.V. valves were used throughout the set, except for rectification when D.E.Q.'s were fitted. On the note-magnifying side there were three L.S.5 valves working with 200 volts on the plate. It is of interest to note that the whole of the high-tension supply to this receiver was provided from accumulators. After the signals have been magnified in the manner explained, a step-down transformer passes them to the land line. Two pairs of telephones were shunted across the output side of this transformer, so that the engineers in charge could listen for the signals. In the next room was a two-valve receiver, consisting of a detector valve followed by one-note magnifier, by which, with the help of a small aerial between the huts, it was possible to listen to the actual re-transmission from 2LO. It is hoped to repeat these experiments every Saturday night.

The Westinghouse station, KDKA, is run by the Westinghouse Electrical and Manufacturing Company, of East Pittsburg, Pennsylvania. The concerts have been transmitted for some time on 326 metres and 100 metres simultaneously. The 100 metre transmission operates

with an average aerial energy of 7 kilowatts. The particular short wave transmission was originally planned so as to supply other districts with relayed concerts from the studio at East Pittsburg. In particular, the station at Hastings, Nebraska, picks up the 100 metre signals and relays them on a wavelength just under 300 metres for the benefit of broadcast listeners in this district. A comparison has been made of the results obtained in picking up KDKA on Saturday evening in Manchester and in various parts of London, and the results obtained at all these places are identical with regard to the ratio of atmospherics to signal strength. The reason for making this comparison was that there was a suspicion that the Biggin Hill site might be specially subject to atmospheric disturbances.

of the apparatus showing handles for tuning the first valve circuit.

used to give sharp tuning. Variation by this first valve, the passed to a special Marconi 55 and with semi-aperiodic trans- ing an optimum wavelength of Up to six stages of high- be used in this way, followed valve, after which a separate coupled to the receiver, so as frequency corresponding to of about 2,000 metres. On th the signals are magnified e-capacity coupled long-wave sisting of 4 valves, after which gain takes place, and a 3-valve acity coupled note magnifier alsia audio-frequency. is that many precautions have n, such as screening. For heterodyne which is coupled anode coil is partially screened

on the left is of the receiving Biggin Hill. The frame aerial ly used to receive KDKA.

on the right is of the receiving gin Hill. A counterpoise or earth can be used at will.

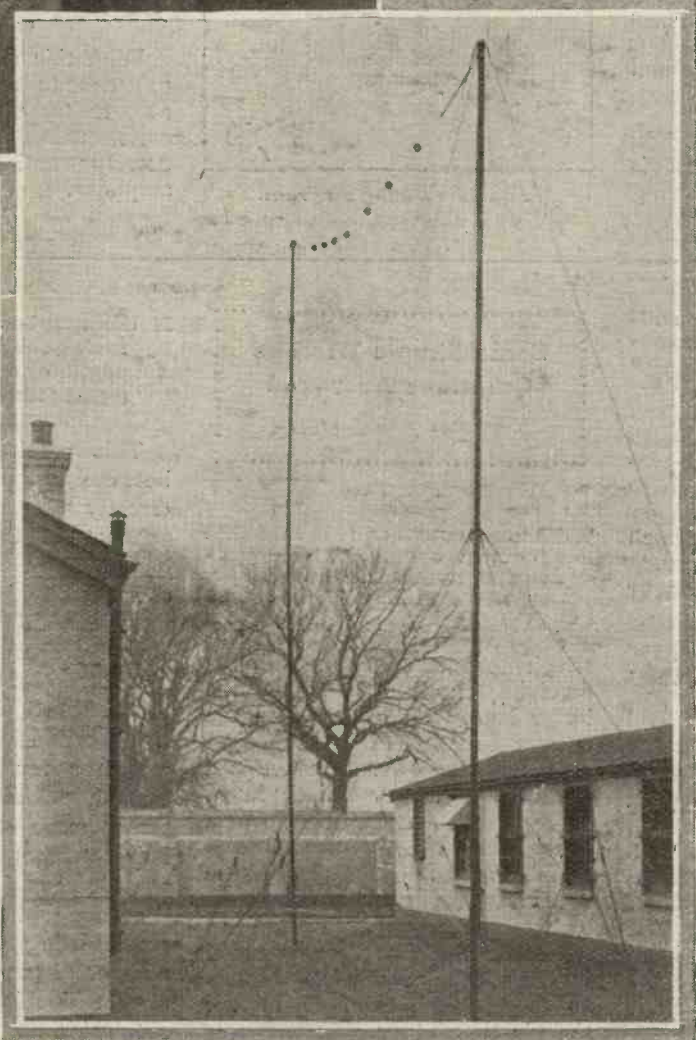

An Experimenter's Unit Receiver

By H. BRAMFORD.

The following is the fifth of a short series of articles which began in Vol. 3—No. 9.

Unit No. 4

This unit takes the form of a low-frequency amplifier, the only components necessary being an ebonite panel measuring 6 in. x 4 in. x $\frac{1}{4}$ in., one intervalve transformer, and four terminals. The transformer, which should be of good make, should be purchased. A photograph of the complete panel is shown in Fig. 21.

Panel Drilling

As in the case of all previous units the panel should, after drilling, be rubbed on both sides with fine emery paper in order to remove its glossy but undesirable surface. The holes should be drilled to clear the terminal screws.

Assembly

The assembly of this unit is best executed in the following

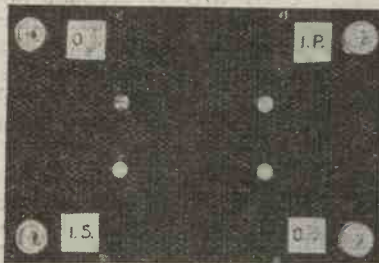

Fig. 21—Photograph of the panel.

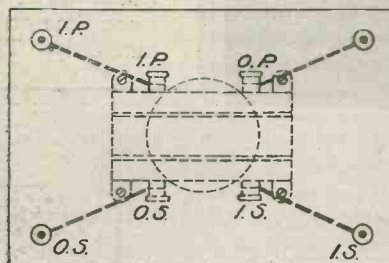

Fig. 22—Wiring diagram.

manner. First mount upon the panel the four terminals marked I.P., O.P., I.S., O.S., as shown in Fig. 21. Next mount the low frequency transformer on the underside of the panel by means of four screws, passing through the four lugs of the transformer.

The connections are made thus. The input primary (I.P.) of the transformer is connected to the terminal marked I.P., and the output primary (O.P.) to the terminal marked O.P. The input secondary (I.S.) is connected to the terminal marked I.S., and the output secondary (O.S.) to the terminal marked O.S.

Operation

With this and the valve panel unit next to be described, we are able to try out single valve circuits, using the crystal as a detector and the valve as an amplifier.

In view of the possibility of accidentally applying the high-tension voltage to the valve filaments of a set, what is the best possible safeguard?

Probably the best precaution of all is to include in the high-tension battery circuit either a high resistance, such as an ordinary high voltage lamp bulb, which will limit the current in the event of an accidental short circuit, or a suitable fuse.

Why is it that stranded copper wires are usually recommended for aërials?

High-frequency currents travel almost entirely on the surface of the conductor, and hence to reduce its resistance it is desirable to let it be composed of several separate strands, since in this way a greater surface is obtained for the current to travel upon. For the best results also, the wires should be separately insulated, as is the case with stranded enamelled copper wire, which is now so frequently used.

Some Simple Wireless Questions Answered

(Continued from page 410)

What is meant when it is said that the waves emitted by a particular transmitter are sharply tuned?

A sharply-tuned wave is one which produces signals in a receiving circuit only when the latter is exactly adjusted to the correct wavelength. The opposite of a sharply-tuned wave is a broadly-tuned, or flatly-tuned wave, which may be heard over a considerable range of adjustments upon the tuning dial of the receiver. The waves from a spark transmitter are a good example of the fairly flatly or broadly-tuned wave; continuous wave signals afford a good example of the sharply-tuned type.

If the number of turns upon a tuning coil is doubled will it be possible to tune to twice the former maximum wavelength?

This result does not follow, because the wavelength varies directly as the square root of the product of the inductance and capacity in circuit. If the capacity remains constant and the inductance is doubled, the wavelength will be increased by the square root of two, namely, 1.414 times. With the ordinary single-layer cylindrical type of tuning coil, however, with turns closely wound, doubling the number of turns more than doubles the inductance, and this compensates considerably for the subsequent "square root," the nett practical result being that doubling the number of turns on a tuning coil almost doubles the wavelength obtainable upon a given aerial.

How to Use the "Wireless Weekly" Omni Receiver

By JOHN SCOTT-TAGGART, F.Inst.P., A.M.I.E.E.

The first of a series of weekly chats dealing with circuits and experiments which may be tried out on the Omni receiver.

ONCE the *Wireless Weekly* Omni receiver is made, the experimenter has an enormous field of experiment open to him. He can, in a moment, try out practically any circuit described in any book or magazine; three minutes is ample to wire up the terminal board in the particular manner desired. Instead of having to arrange a new panel, drill holes, and make or buy a cabinet, or alternatively to arrange a number of straggling wires over the table, the builder of the Omni receiver is able, whenever he sees an interesting-looking circuit, to try it out without the least delay.

The rubber-covered leads for joining the terminals together have, as has already been stated, fishtail lugs soldered to the ends. A selection of different lengths will be required, and the following sizes will be found suitable:—
2½ in., 5 in., 8 in., 12 in.

I would advise anyone starting to make up a dozen 2½ in. connecting links, a dozen 8 in. links, half-a-dozen 5 in., and half-a-dozen 12 in. links.

These links may be purchased from Messrs. Burne-Jones & Co., Ltd., of Montford Place, Kennington Road, London, S.E.11. This firm is prepared to supply any parts for the Omni receiver exactly as described. We have examined, and are thoroughly satisfied with the good workmanship of all the parts, engraved panel, etc. No doubt other manufacturers will desire to supply the necessary parts, but up to now this enterprising firm is the only one which has asked for permission to supply.

A Single-Valve Dual Receiver

Fig. 2 is one of the circuits which may conveniently be tried on the Omni receiver. It will be seen that the valve V1 acts

as a high-frequency amplifier, and that the amplified currents are rectified by the crystal detector D, the low-frequency currents being then fed back into the grid circuit of the valve and amplified by the valve, the amplified currents passing through the telephones T.

The condenser C1 has a capacity of 0.0005 μF, while C2 has a capacity of 0.001 μF. The condenser C4 has a value of 0.002 μF, while C3 has a maximum

This article should be studied by all readers, because a perusal of it will convince all of the peculiar advantages of this type of receiver for experimental work.

capacity of 0.0005 μF. The crystal detector D should be of a good pattern, and the latest Burndopt crystal detector is the

type used on original Omni receiver itself. This detector has a beautiful control and is one of the best types on the market to-day.

Let us first of all wire-up the Omni receiver in accordance with this circuit, and then we can carry out a few experiments which will only take a short time, but which will be of considerable interest.

Having the Omni receiver in front of us, and before connecting the six-volt filament accumulator and the 80-volt high-tension battery to the terminals on the front of the panel, we will proceed to open the lid and join up the necessary terminals on the terminal panel. Nineteen connections are necessary; this may seem a lot, but actually quite as many are made as if you were wiring the underneath of a panel. The actual flexible leads required are as follows:—

- Eight of 2½ in. long.
- Seven of 5 in. long.
- Three of 8 in. long.
- One of 12 in. long.

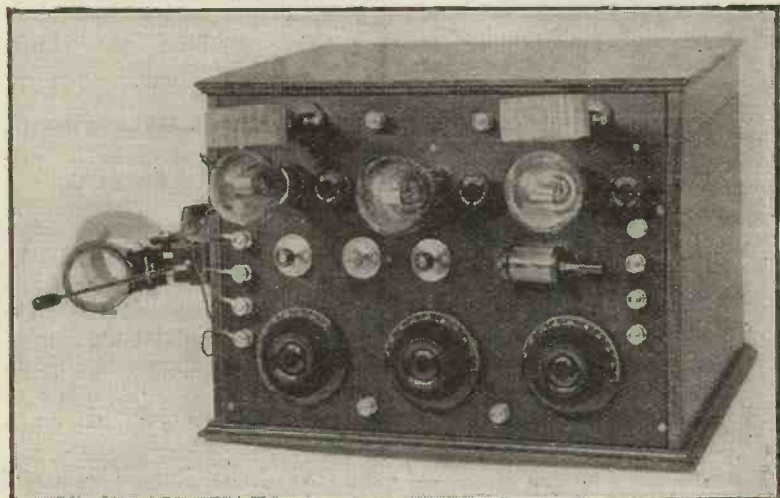

Fig. 1.—A hitherto unpublished photograph of the Omni Receiver.

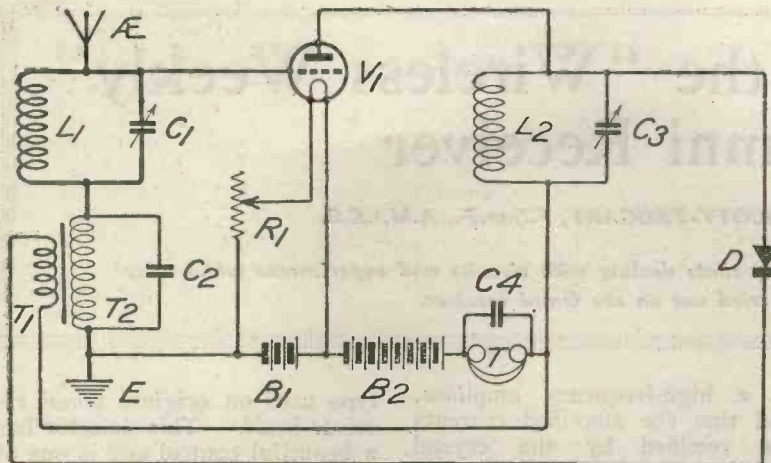

Fig. 2.—A single-valve dual circuit which may be obtained on the Omni Receiver.

The first thing to do is to join the terminal 51, which is on the inside of the front panel of the Omni receiver, to terminal 50, which is one of the terminals of the left-hand coil which is plugged into the front of the panel. The lead between 51 and 50 is 2½ in. long, this length being just about sufficient. Next, join terminal 50 to terminal 42 by means of a 2½-in. link; then join terminal 49 to 34 by a 5-in. link; next, join 42 to terminal 12, which latter is the grid terminal of the first valve which we propose to use; an 8-in. link will be required for this purpose. The next stage in joining up the terminals is to join 34 to 30 by an 8-in. link, and then 29 to 48.

Instead of proceeding in this way, it will be much simpler to give a table, or key, to the wiring of the terminal panel, and this key, starting from the very beginning, is given below. On the right-hand side of the key, the length of the link required is given, but this will not be done in future, because it is a matter of commonsense for the experimenter to pick up a link of suitable size to fit the terminals, and if it is of the wrong size to try another out of his pile.

51-50	2½ in. link.
50-42	2½ in. "
49-34	5 in. "
42-12	8 in. "
34-30	8 in. "
29-48	8 in. "
29-37	2½ in. "
30-38	2½ in. "
4-2	5 in. "
2-1	2½ in. "
9-10	2½ in. "
10-23	12 in. "
31-24	2½ in. "

32-40	2½ in. link.
23-39	5 in. "
31-47	5 in. "
4-20	5 in. "
28-22	5 in. "
21-23	5 in. "

When all these connections have been made, join up the low-tension battery to the lower two terminals on the right-hand side; the terminals are marked L.T. + and L.T. - in Fig. 1, which appeared on page 273, Vol. 3, No. 9, of *Wireless Weekly*, dated February 6, 1924. The size of the accumulator, of course, will depend upon the type of valves used, and six volts is required in the case of ordinary bright emitter valves. The high-tension battery is also connected across the terminals H.T. + and H.T. - in this figure, and the value of the high-tension battery will depend chiefly upon whether phones or a loud-speaker is to be used. As it will be presumed that telephone receivers are being used on this circuit, 60 volts high-tension will be ample.

The aerial is connected to the aerial terminal, which is the left-hand one of the two at the top of the front panel illustrated in Fig. 6 (on page 309); the earth is connected to the terminal to the right of this one. Telephone receivers are connected across the telephone terminals at the foot of the front panel shown in Fig. 6.

The valve is now inserted into the left-hand valve holder when looking at the front of the panel, and the Lissenstat is adjusted until the correct valve brilliancy is obtained. A No. 25, 35 or 50 coil is now plugged into the left-

hand coil holder on the front of the panel, i.e., the one which is connected to the terminals 49 and 50. A No. 50 plug-in coil is now inserted into the coil holder L1 in Fig. 1, on page 273, i.e., the coil holder furthest back on the three-way coil holder at the side of the cabinet. No coils are connected in any of the other sockets.

The set is now ready for operation, and the only adjustments are the condensers C1 and C3 of Fig. 2 of this article.

If you are worried about tuning in to your broadcasting station, try constant aerial tuning, which has been described in these columns. In other words, insert a 0.0001 μF capacity condenser in series with the aerial, and use a No. 50 coil in the coil socket 49-50.

If this is done, only a slight alteration of the wiring key is necessary. The key would now begin:—

51-3
11-50
50-42

and so on from line three of the above key.

Very good telephony could be received over 50 miles on this circuit, and up to about 8 miles good loud-speaker results are obtainable. In the latter case a little more high-tension voltage is desirable.

Some Experiments

Looking at Fig. 2, we can carry out several interesting experiments. Suppose we find that the receiver tends to produce a buzzing noise, which is due to low-frequency reaction. The first thing to do is to try reversing the leads to the primary T1 of the transformer; this reversal is accomplished by reversing the leads going to the terminals 21 and 22; in other words, take the lead going to 22 off 22 and put it on the terminal 21 from which the lead which already goes there has been withdrawn. Then connect the end of the lead which went to 21 to the terminal 22. This may cure the undesirable buzzing; in any case the experiment is worth trying out to see whether any louder results are obtainable by doing this, whether the valve buzzes or not.

If you find the circuit tends to buzz, even after trying out several experiments with it, try connecting a variable 100,000-

ohm resistance across the grid terminal and positive side of the filament accumulator B1. This is done by adding to the above key, by joining 12 and 36 and also 44 and 40. The middle Watmel variable resistance, shown on a line with the crystal detector in Fig. 6, is the one to adjust, and at a certain adjustment it will probably be found that the valve will stop buzzing, and quiet will reign.

Another experiment is to try the effect of removing the condenser C4 across the telephone receivers. In the circuit we have joined up, the condenser C4 has a value of 0.002 μ F, but we can try doing without this condenser by removing the links between 31 and 39. If it is now desired to try a 0.0003 μ F condenser across the telephone receivers, as is sometimes better, connect the terminals 19 and 23, and 27 and 41.

Another experiment which can certainly be carried out on the Fig. 2 circuit, is to try connecting the telephones T, shunted by the condenser C4, next to the anode of the valve instead of in the position shown. If this is done, the telephones should not be touched with the hand, once they have been adjusted on the head, and the less movement of leads, the better, because the telephones will be at a high-frequency potential to earth, which is not very

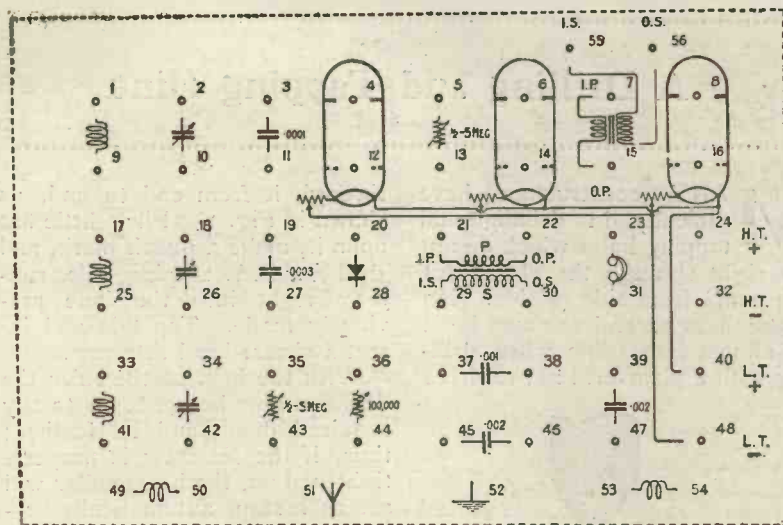

Fig. 3.—The terminal board.

desirable. A loud-speaker, on the other hand, could be placed next to the anode of a valve without any ill effects, because it is stationary and well insulated in nearly every case. The high-frequency oscillations in L2 C3 may not be quite as strong, but the circuit is certainly made more stable. The following changes from the standard key given at the beginning of this article should be made:

Instead of the connection 10-23 in the master key above, join 10 to 24. Instead of the connection 21-23, join 21 to 24. Instead of

the connection 31-24, leave these two terminals unconnected.

Having made these modifications, take the lead out between 2 and 4, and join 4 to 23 and 2 to 41; the remaining connections are left as they were.

This makes a very interesting comparison with the original circuit as given, and many interesting lessons may be learnt from it.

Those who care to try, may like reversing the leads to the crystal detector; in other words, the leads to 20 and 28 are reversed.

- 6th (THURS.).—3.45, Miss Isabel Forsyth's Students' Orchestra. 7.30, Orchestra. Mr. Barnett Cohen, baritone. Mr. G. Hodgson, tenor. Miss Nora Delmar (London), soprano.
- 7th (FRI.).—3.45, Mr. R. Elliott, piano. Mr. E. Hudspeth, tenor. Mr. J. Mackintosh, cornet.
- 8th (SAT.).—3.45, Walker's Band relayed from Tilley's Orchestra. Mr. Kemp Jordan, baritone. Mr. Catcheside Warrington, entertainer. Mr. Babbs, violin. Miss Nora Studley, mezzo-soprano.
- 9th (SUN.).—3, Mr. Oppenheim's String Quartette. Miss Hilda Rood, contralto. Mr. Harry Frater, bass. Mme. Leonora Howe soprano. 8.30, 7th Batt. Durham Light Infantry Band. Mme. Elsie Downing, soprano. Rev. P. Ashton, religious address. Mr. Fred Charlton, baritone.
- 10th (MON.).—3.45, Miss G. Edmondson, piano. Mme. F. Cox and Mr. J. Saul, duets. Mr. W. A. Crosse, piano. 8.30, "Old Favourites" Night. Orchestra.

Broadcasting News

(Concluded from Page 413.)

- Miss Evelyn Wilson, soprano. Mr. Wm. Laws, violin. Mr. Wilson Beveridge, tenor.
- 11th (TUES.).—3.45, Miss Rosina Wall's Trio. 7.30, St. Dominic's Choir. Mr. G. Parker (London), bass. Miss Lilian Coburn, soprano. Mr. W. A. Crosse, piano. Newcastle Players Repertory Theatre Company in "The Lost Silk Hat," by Lord Dunsany.

PLYMOUTH. — The Plymouth Station should be functioning before these notes appear, and the B.B.C. are fortunate in having as a Station Director there Mr. Clarence Shirley Goode. Actively engaged in the theory and practice of wire-

less telegraphy for over ten years, Lieut. Goode is now one of the pioneers of this extremely young science. He was one of the first instructors of the modern phase of wireless in the Royal Engineers. In France and Belgium he controlled some of the most responsible wireless stations including the famous wireless listening posts in Hill 60.

Simultaneous Broadcasting Events.

- MARCH.
- 5th (WED.).—B.B.C. Dramatic Critic.
- 6th (THURS.).—B.B.C. Musical Critic. Talk by Radio Society of Great Britain.
- 7th (FRI.).—B.B.C. Film Critic.
- 8th (SAT.).—Savoy Bands.
- 9th (SUN.).—Big Ben Time Signals.
- 10th (MON.).—B.B.C. Literary Critic.
- 11th (TUES.).—French Talk.

A Drilling and Tapping Hint

MANY constructors have difficulty in drilling and tapping holes which do not go right through the ebonite of the panel from side to side. No matter how careful one may be it is almost impossible when drilling with a plain drill not to drive

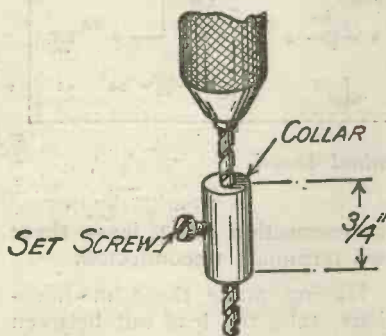

Fig. 1.—Illustrating the drill "stop."

it in a little too far at times, with the result that an unsightly bump appears on the upper surface of the panel. This can be avoided by a very simple expedient. A little gadget will have to be made, but as 4 B.A. screws are the only size used for this purpose, it is unnecessary to construct more than one of them. Obtain a 3/4-in. length of 3/8-in. round brass rod and drill a 4 B.A. clearance hole

through it from end to end, as shown in Fig. 1. File a little flat upon it, make a punch mark, and drill a 4 B.A. tapping hole, running right into the hole previously made. Tap this and insert a cheese-head setscrew.

With the help of the ruler the drill can now be set to go to any required depth and no further; thus, if the setscrew is properly tightened up, the brass collar will act as a stop, automatically suspending operations as soon as the hole is of the proper depth.

Tapping such holes has been a puzzle to many constructors. One should start with an ordinary plug tap with a slightly tapered point. When two or three turns of thread have been put on, this should be exchanged for a square-ended bottoming tap, which is able to go right down to the end of the hole. This seems easy enough, but the difficulty is to feel exactly when the bottom is reached; one is apt to give one turn too many, with the result that the threads are stripped, for one cannot afford to take any liberties with such soft stuff as ebonite.

It is not necessary here to make up a gadget of any kind. One requires no more than a pair of

4 B.A. nuts placed upon the threads of the taps. The ruler is placed against the tap and the lower nut is screwed down until its distance from the end of the tap is exactly equal to that of the depth of the hole to be threaded. The upper nut is then turned down upon it and the two are tightly locked together. Tapping can now be done with a certain amount of confidence, for once the tap is at the bottom of the hole, the nuts will jam against the ebonite and give warning.

In tapping holes of this kind it must be remembered that the dust cut out by the tap cannot escape, as it can when a straight

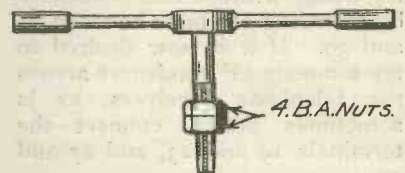

Fig. 2.—Showing how nuts may be used to prevent the tap running too far.

through hole is being threaded. Hence it is necessary to remove the tap altogether and to shake out the dust after each two or three turns have been made. If this precaution is neglected, dust will accumulate upon the bottom of the hole, reducing its depth and so causing the tap to jam and strip the threads before the indicator nuts comes into contact with the surface of the panel.

R. W. H.

Book Review

Tuning Coils and How to Wind Them. By G. P. KENDALL, B.Sc. (Radio Press, Ltd., 1s. 6d.)

Probably no part of a receiving set is so potent for good or ill as the tuning inductances, and, as the author of this book points out in his preface, probably no part is more neglected by most experimenters. Actually, good coils can make all the difference between fair and really good reception, and the author's object in presenting a clear and practical exposition of the whole subject of the design and construction of tuning coils is a most commendable one.

The 1,600 Metre Station

(Concluded from page 408)

condemned to spend long dreary evenings in the country without the possibility of distraction of any sort. The high-powered station is additional to the present service, and will bring in all those not adequately served at present. Must it be said that those who are satisfied at present have for purely theoretical and recondite reason denied to others their right to enjoy broadcasting? Must it also be said that a few manufacturers, traders and others are evidencing shortsightedness in any uneasiness they may have, cutting off their

nose to spite their face. We are opening up to them, if and when this high-powered station gets going, a market greater than they have ever had before.

Remember it is all problematical as to whether the station will be built. We are only going to experiment, and much will still have to be done even if this is successful before the actual scheme is approved.

EDITOR'S NOTE.—A commentary on this article will be found on the Editorial page of this issue.

A Tubular Condenser

ONE does not often see nowadays the tubular variable condenser, which was at one time very popular for wireless work, the reason being that a very much more compact device can be made up by the use of fixed and moving vanes. A tubu-

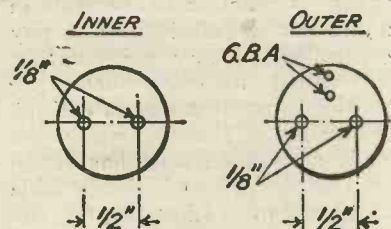

Fig. 1.—Construction of outer and inner tube ends.

lar condenser is, however, very useful indeed where a small variable capacity is required, since it allows very fine adjustments to be made, and it has also the advantage of having a minimum capacity that is practically negligible.

This condenser consists of two metal tubes, one of which is fixed, whilst the other slides inside it like the secondary of a loose coupler.

A useful little condenser with a maximum capacity of about 0.00006 μ F can be made in the following way. It is intended for use as a "vernier" in parallel with larger condensers in aerial or closed circuits:—

Procure two lengths of thin brass tubing, the first with an outside diameter of $1\frac{1}{4}$ in. and a length of $3\frac{1}{4}$ in., the second 3 in. in length and 1 in. outside diameter. If these are made of metal $1/16$ in. thick, the clearance between them when the smaller is placed inside the larger will be $1/16$ in. all round. Prepare plugs for one end of the larger tube and for both ends of the smaller. These may be cut from ebonite rod of appropriate size. They are fixed in place by small countersunk screws, the heads of which, in the case of the smaller tube, are filed down until they do not protrude above the brass. In the plug of the larger tube are drilled and tapped two

6 B.A. holes for the screws, which secure it to the endpiece, and two $\frac{1}{8}$ -in. holes for the guide rods; those of the smaller are drilled as shown in Fig. 1. The $\frac{1}{8}$ -in. holes, which must be made perfectly true, are for the rods upon which the tube slides; those tapped 6 B.A. take the screws which fix in place the handle by means of which the tube is moved.

Ebonite Endpieces

Cut out two endpieces of $\frac{1}{4}$ -in. ebonite 2 in. square. Fix the larger tube to one of these by driving screws into its plug and making the hole in the other large enough for the tube to pass through. The endpieces may now be mounted upon a base 7 in. in length and 3 in. wide. This may be made of hard wood, the two terminals being fixed into ebonite panel bushes such as can be obtained from advertisers; 3 in. beyond the second endpiece fix a piece of ebonite $1\frac{1}{2}$ in. high and 2 in. wide. Obtain two perfectly straight pieces of $\frac{1}{8}$ -in. round brass rod 7 in. long and put a thread on to the ends of each. Fix these parallel and $\frac{1}{2}$ in. apart between the first endpiece and the smaller support, taking care to see that they are

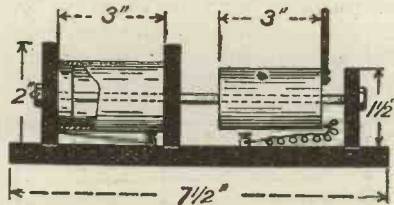

Fig. 2.—Dimensioned arrangement of finished parts.

so placed that when the smaller tube slides upon them it is properly centred in the larger. Solder one end of a piece of flex to the smaller tube and bring the other to one of the terminals. Connect the larger tube to the second terminal by means of a piece of insulated wire. Fasten a short piece of ebonite to the outer plug of the moving tube to act as a handle. The condenser is now complete, except that it is better to cover the inner tube

with a couple of layers of waxed paper, which, besides increasing the capacity, prevents the two tubes from touching in case there should be any play. It is best done by giving the tube a good coating of shellac and wrapping the paper round it whilst the varnish is tacky.

R. W. H.

Use a Separate Heterodyne

Although on short waves a separate heterodyne will not give appreciably stronger C.W. signals than an autodyne receiver, there are yet certain advantages which are well worth having. First of all, of course, our C.W. reception can be carried out in a sportsmanlike way. It cannot be too strongly emphasised that the man who goes hunting round for C.W. signals by swinging his condenser to and fro when the set is oscillating is causing far more irritation to real experimenters who are listening for short-wave signals than a similar procedure would cause on broadcast wavelengths. In broadcast reception the average receiving set is not particularly sensitive, yet even in these cases we all know the worry of the local oscillator. On short-wave reception, however, a large number of experimenters are listening for signals coming from low-power transmitters 3,000 miles away, and unless their sets are adjusted to the utmost sensitiveness they will hear nothing whatever.

An oscillating single-valve set half-a-dozen miles away may give stronger signals than those from an amateur transmitter on the other side of the Atlantic, so that there is a real moral obligation to use a separate heterodyne when endeavouring to pick up C.W. signals on these waves.

A separate heterodyne can be made up in many ways, and as it consists of a single valve in a circuit in which the grid and plate are coupled together to produce oscillation, obviously there are numerous varieties possible. An excellent design for short wave work was published in *Wireless Weekly*, Vol. 3, No. 7 (23rd January).



RECENT comparative tests between the tuned-anode with reaction circuit and a valve detector, followed by a low-frequency amplifier, seem to indicate that the oldest of old circuits is also one of the best.

We have become so used to not using reaction on the aerial that

reaction is introduced from the second valve on to the tuned-anode circuit. The use of a tuned-anode circuit is always accompanied by a violent tendency to oscillate, and this is absent when an aperiodic reaction coil is used. There is a much better control of the reaction,

apply his reaction deliberately in a manner which is very easily controlled. Every experimenter is entitled to one squeak per evening, just as a dog is entitled to one bite. The man who never made a valve oscillate has yet to be discovered, and the trouble about self-oscillation is that you have usually got to get there and come back before you really know that you are near that very sensitive danger zone. The perfect control of reaction which is obtainable on a straightforward circuit of the Fig. 1 type is a great advantage.

Fig. 1 is reproduced here, not for the purpose of reminding readers of the value of the simple reaction detector valve followed by a low-frequency amplifier, but to show a method of obtaining a very fine reaction adjustment. This method, also old, but rarely used, consists in shunting the primary T_1 of an intervalve transformer, by a variable condenser C_2 , having a capacity of $0.001 \mu F$ or $0.0005 \mu F$. Any variable condenser will, in fact, do for this purpose, and by vary-

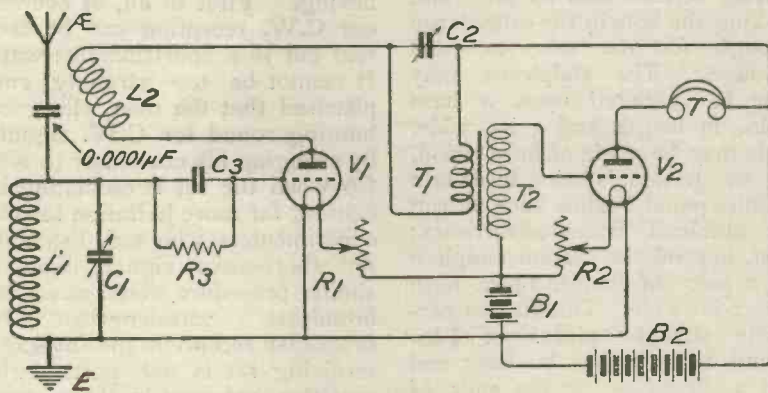

Fig. 1.—A two-valve circuit using direct reaction on the aerial.

we have rather lost sight of the advantages of the kind of circuit illustrated in Fig. 1.

The first valve V_1 acts as a detector using a leaky grid condenser; this circuit also involves constant aerial tuning, a small condenser of $0.0001 \mu F$ capacity being connected in series with the aerial. The inductances L_1 and L_2 may, for a broadcast waveband, be No. 50 coils and the condenser C_2 may be fixed and may have a capacity of $0.002 \mu F$. The circuit will give excellent results, and it is not nearly as likely to produce interference as most people think. There is general apprehension that circuits using reaction on to the aerial cause a great deal of interference, but my own experience is that circuits using an aperiodic reaction coil often give far less interference than those using a tuned-anode circuit, even though, in the latter case, the

and if self-oscillation is set up, it happens, not accidentally, but on purpose, and may easily be stopped by moving the reaction coil away from the grid circuit inductance. Often when using

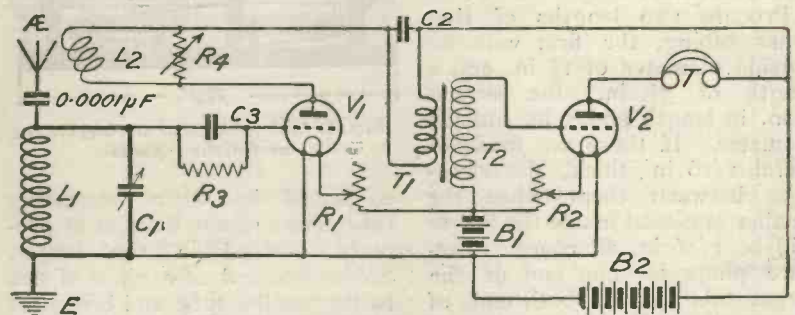

Fig. 2.—A similar circuit to Fig. 1, with the addition of the resistance R_4 . The condenser C_2 is now fixed.

a tuned-anode circuit, even a wide separation of the coils does not stop the oscillation.

I am therefore rather coming round to the opinion that it is better, even for a beginner, to

ing its value, we vary the impedance in the anode circuit of the first valve, and therefore control the strength of the oscillations in L_2 . A finer control of reaction is obtainable in

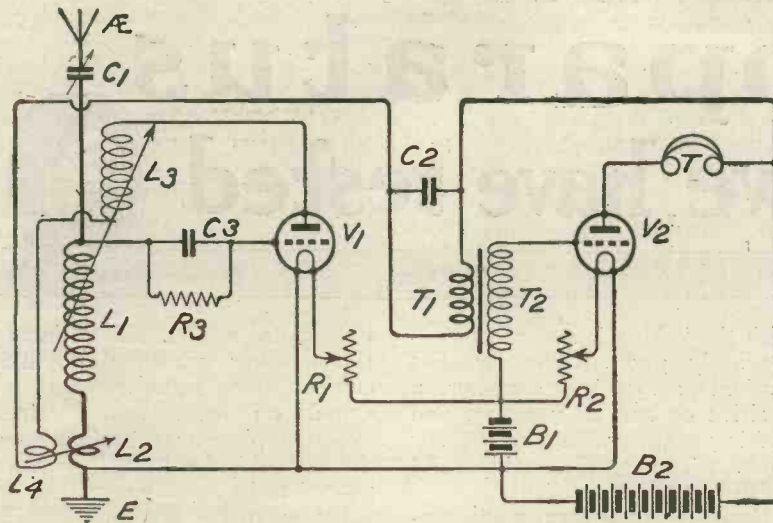

Fig. 3.—A circuit in which fine adjustment of reaction is obtained by varying the coupling between L2 and L4.

this way than is possible when purely mechanical coupling is employed.

Fig. 2 shows a similar sort of circuit in which, however, we now use a fixed condenser C2 of 0.002 μ F capacity, and a variable resistance R4, having a maximum value of about 100,000 ohms. The use of these resistances has been mentioned previously in

connection with tuned-anode circuits, but they are also very useful for obtaining the final adjustment of reaction even when aperiodic reaction coils are used. The advantage of the arrangement is that the final adjustment is obtainable without the necessity for retuning. On the other hand, when the final reaction adjustment is obtained by moving

one coil nearer to the other, capacity values are changed, and a retuning is necessary; this retuning varies the reaction once more, and so some difficulty is experienced in getting the result desired.

Fig. 3 shows a similar circuit to Fig. 2, except that this time fine reaction is obtained by an additional pair of coupling coils L4 and L2, consisting of only one or two turns each. The coil L4 is connected in series with the main reaction coil L3, which is coupled to L1, and the coil L2 is in the aerial circuit. This idea, of course, can be applied to all sorts of reaction circuits and will be found very useful, as varying the coupling between L2 and L4 produces practically no change in the wavelength of the aerial circuit, or other circuit in which one of the coils may be included.

Have you read this month's **DOUBLE** number of *Modern Wireless*? It is the finest constructional number ever published

Ashley Radio

COMPONENTS.

W 352

REGD. TRADE MARK

WATCH THIS SPACE FOR OTHER NOVEL ASHLEY COMPONENTS

PRICES

W No.	£	s.	d.
352	1	0	0
441	2	6	
440	3	6	
385	6	0	
427	2	6	
363	12	6	
509	1	9	
465	8	6	
301	1	0	0
481	3	0	
468	4	6	

No. 7.—ASHLEY UNIT COIL HOLDER.
 Cat. No. W 441—Fixed Coil Holder, . 2/6 each
 " " W 440—Moving " " 3/6 "

- (1) A highly convenient form of adjustable coil mounting.
- (2) Constructed of high-grade ebonite and brass.
- (3) Accommodates all standard Plug-in coils.
- (4) Long extension handle eliminates hand-capacity.
- (5) Should be standardised alike by manufacturers and home-constructors.

Ashley Wireless Telephone Co. Ltd.
 69, Renshaw Street LIVERPOOL



Apparatus we have tested

"Connecticut" Switches

Messrs. S. Smith & Sons, Ltd., have sent for examination a sample of their panel-mounting switches, the "Connecticut."

These are of the push-and-pull design, and are mounted behind a polished metal plate, provided with screw-holes for fastening on the panel. The switch proper is contained in a small barrel about 1 in. long and $\frac{3}{4}$ in. diameter, a clearance hole for which would be required in the panel. The triple switch of the series thus occupies a space of about $2\frac{1}{2}$ in. by $1\frac{1}{2}$ in. on the panel. It has the three switches arranged in parallel for filament control in multiple valve sets.

On test, the insulation resistance, measured on 500 volts D.C.

with the "Meg" tester, was exceedingly good. The switches worked smoothly, showing a positive on and off position, and making contact with a reassuring click. The workmanship and finish appeared excellent.

Small terminal screws are provided for the one connection, and in the case of the multiple switch a common soldering tag is fitted at the end of the bus-bar for the other connection.

"Alembic" Crystal

Mr. J. Millet has submitted for test samples of his "Alembic" crystal, which is of the sensitised galena type, for use with the ordinary cat's whisker. The crystal has a fairly fine granular appearance, and on practical test it showed a multiplicity of sensi-

tive spots, so that the setting of the whisker presented no difficulties. Good signal-strength resulted on local broadcasting. When a piece was broken over the freshly-fractured surface proved to be equally sensitive.

On extensive test in the S.T. 100 circuit, it stood up well to the work, and gave steady and clear signals.

Legal News—King's Bench Division.

G. E. WARD, trading as
CITY ACCUMULATOR CO. Plaintiff

versus

S. G. BROWN, LTD. Defendants.

Judgment was given on the 22nd instant for the plaintiff and he was awarded £800 damages and costs in an action which arose out of the statement made in the Press in August 1922 by the defendants that the plaintiff was selling obsolete headphones of defendants' manufacture and was misleading the public. The defendants applied to the Judge for a stay of execution, which was granted on the usual terms.



Claristal RECEIVING SET

ALL BRITISH MADE. Licence No. 901. Receives Signals and Broadcasting Entertainments loudly and clearly within a radius of 20 to 25 miles. The volume and purity of sound is equal to crystal sets sold at many times the price.

Price complete with the "Sonyte" Crystal 6/6. Plus 1/- extra British Broadcasting Fee.

The "SONYTE" Double Head Receivers. British Made. 4,000 ohms. Complete with cords 17/6.

The "CLARISTAL" Aerial Set.

Comprising 100 feet Stranded Aerial Wire, 6 Insulators, Porcelain leading-in Tube, Leading-in Wire, etc., 3/6. Complete Set, as illustrated, including Telephones and Aerial Set 28/6. Including B.B.C. Fees.

These Lines are stocked by All High Class Radio and Electrical Stores. Write direct if unobtainable. FIRMLY REFUSE SUBSTITUTES.

CRYSTAL DETECTORS

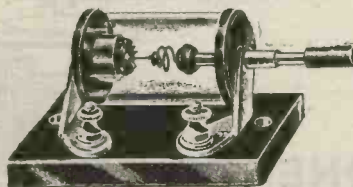

Open Type, mounted on Ebonite Base. No. 380, 1/6 each
Enclosed Type, fitted with Glass Dust Shield No. 400a 2/3 "
Ditto Superior quality No. 400 2/9 "
Ditto Nickel Finish No. 400n 3/- "

VARIABLE CONDENSERS

Suitable for Panel Mounting, one hole fitting.

Fitted with Ebonite Knob and Engraved Dial.

'001	..	10/-
'00075	..	8/9
'0005	..	7/6
'0003	..	6/9
'0002	..	6/-
'0001	..	5/-
'00005	..	5/-



RADIO WIRES

Silk, Cotton and Enamelled Wires, etc. Prompt Deliveries, Competitive Prices. Send your Enquiries.



Fully illustrated Radio Catalogue R/104, free on request. Enclose Business Card or Memo. for Special Trade Terms and Discounts.



Licence No. 315.

High grade set, mounted on substantial Ebonite Panel and enclosed in highly polished Hardwood Cabinet. Fitted with Variometer Tuner covering entire Broadcasting Range and improved type Dustproof Detector. Gives excellent results over a radius of 25 miles.

Price 30/-

We also supply the above Set in polished Hardwood Case without fall-down lid.

Price 21/-

B.B.C. Fee extra on above Sets 1/-

FILAMENT RHEOSTATS.

Complete, ready for mounting. No. 54 54 2/6 each. Fitted with Engraved Ebonite Dial, No. 41. 3/- each.

SPECIAL NEW TYPE suitable for use with the Dull Emitter-Valves. Total resistance 25 ohms. No. 30. 4/- each.



Address all communications to Head Office. Works—PENDLETON, MANCHESTER. Glasgow Depot—95, PITT STREET.

Correspondence

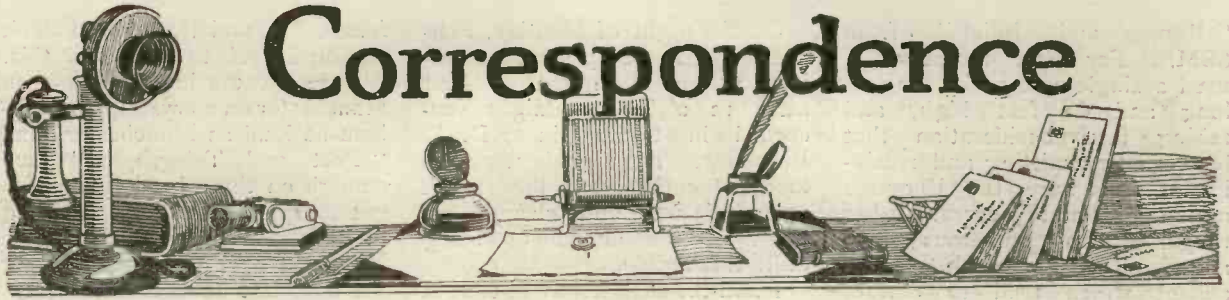

ENVELOPE No. 1

SIR,—Just a line of congratulation on your ST100. I bought a 1s. 6d. envelope of same, and after following the instructions to the letter, have made an instrument which I use in preference to one I bought costing £35. It is selective and no trouble from spark stations is experienced. I have not tried it on U.S.A. yet, but I get France as good as 5IT.—I am etc.,

C. RICE-OXLEY, S.P.B.A.
Shrewsbury.

FLEWELLING SUPER

SIR,—Some time ago I constructed the Flewelling Super Circuit as described in Vol. 2, No. 3.

The aerial coil is No. 35 Igranic and the reaction a No. 75. The aerial coil is shunted by a 0.0005 μ F variable condenser. In Antwerp, using a single-wire aerial, 14 feet long, I received 2LO, 5WA, 6BM, 5SC, and 5IT. For this reception I used 30 volts on the plate.

Shortly after this we went to sea, but owing to bad weather I could not use the set until I arrived in the Mediterranean. Whilst there the circuit had a good try out, for all the receptions were over land and not across sea.

In Barcelona, 710 miles, I received 2LO, and the new Brussels station on two pairs of headphones. At Tarragona, 730 miles, I received 2LO and 6BM

at good strength on two pair of 'phones. At Valencia, 850 miles, with the same results. In Almaria, 1,130 miles, using three pair of 'phones, I received 2LO, 6BM, 5WA, and 5NO so strong that, by adding one stage of L.F., speech was audible at a distance of eight feet from the phones. This reception was remarkably good, no howling being heard save with extreme close coupling of coils; in this case the coils were about one inch apart. In Seville, 1,100 miles, I received 2LO, 6BM, 5WA, and 5NO so strong that I could hear music when a friend was wearing the 'phones. The evening was made particularly interesting by the ballet music from "Faust" and music from

"ATLAS" PATENT PLUG-IN COILS



Maximum Inductance.
Minimum Self-Capacity.

Since High Frequency Currents tend to keep to the surface of a conductor, it follows that the greater the circumferential area, the less the effective resistance, and as the Patent Winding of these coils is comprised of TWIN WIRES with a consequent larger surface area (or skin effect) than is possible with single wire wound coils, the "ATLAS" PATENT PLUG-IN COILS offer the LEAST POSSIBLE RESISTANCE TO HIGH FREQUENCY CURRENTS.

These Coils being wound in true concentric circles, there is an entire absence of sharp bends which are so detrimental to any coil. Furthermore, the special arrangement of "Separators" separating the Layers of the Winding from one another provides the MAXIMUM amount of AIR-SPACING which renders FINE TUNING not only a possibility but an actuality, and which, of course, is the GREAT ESSENTIAL in the CUTTING OUT of UNWANTED STATIONS.

The EFFICIENCY of your Set depends on the QUALITY of the Components. "ATLAS" Components are THE BEST. You get therefore HIGHEST EFFICIENCY by using "ATLAS" SPECIALITIES.

Manufactured only by

H. CLARKE & Co. (Manchester), Ltd.,

Telephone Nos.:
683 & 793
Trafford Park.

Radio Engineers,
"ATLAS" Works,

Telegrams:
PIRTOID,
Manchester.

Old Trafford, Manchester.

The Head 'Phone with tradition behind it:

Write for
Leaflet 74CW.
It gives details.

The
"Tangent" 25/-



Established in 1872, Gent's have manufactured every kind of 'phone for every kind of purpose for the last 30 years.

This fact has, undoubtedly, a bearing on the great and ever-increasing popularity of the "TANGENT" HEAD 'PHONE.

Supreme Efficiency, combined with Comfort to the Wearer, are the outstanding features of this 'phone.

Suitable for Crystal or Valve Sets.

Ask your dealer—if in difficulty, write us to name nearest stockist

GENT & CO., LTD. FARADAY WORKS, LEICESTER.

London:—25, Victoria Street, S.W.1
Newcastle-on-Tyne:—"Tangent House," Blackett Street.

The name "Tangent" or this mark guarantees British make.

"Romeo and Juliet" from 6BM. For these receptions I used a single-wire aerial, 60 feet long and 60 feet high, and taking into consideration that between transmitting and receiving stations were the Pyrenees mountains and several other ranges, also numerous lead mines and other mineral deposits, all of which tend to detract signal strength. The set used to howl and roar when the hand came within a foot of the panel, but by making a few alterations in the circuit and experimenting with shielding, etc., I appear to have made it fairly stable.

Wishing both your papers the success they deserve,—I am, etc.,

V. R. FOWLER.

S.s. _____

KDKA ON ONE VALVE

SIR,—With reference to the one-valve reaction circuit given in "Information Dept.," the January 30th issue, in reply to E.D.M. (Manchester), I thought some of your readers would be interested to hear that it is quite possible to receive America using this circuit.

On the night of Monday, February 4, I made up a set according to the values given, and just after 12 o'clock midnight succeeded in tuning in KDKA, Pittsburg. The signals were not loud, of course, but the speech and music were quite clear, every word of the announcer being quite intelligible.

I find the easiest way to tune in is to short-circuit the series tuning condenser, and adjust the reaction simultaneously with the condenser, and then, when the signal is found, include C1 in the aerial circuit, and finally adjust both condensers.

My aerial is a single strand 60 ft. long and about 40 ft. high.

Wishing your paper every success.—I am, yours faithfully,
J. C. SCOTT.

Leicester.

SINGLE VALVE BROADCAST RECEIVER

SIR,—I have made up the single-valve broadcast receiver described by Mr. E. Redpath in your issue of January 2, 1924, and fitted it into a box which lately housed a crystal set.

I am situated some four miles

from 2ZY, and the most difficult station I had to get was this. Aberdeen came in stronger than Manchester on a crystal, Birmingham as loud as Manchester, and "Post and Telegraphs" loud enough on three head 'phones to get every word without listening intently. All these came in with Manchester at work and during the S.B. late news from London. I think the lower wavelengths will come in better if less wire is used on the inductance tube, my best results being on the higher band of the broadcast. I have today had the Dock Office and Bar Light at Liverpool loud and clear. This reminded me of the old days when we had very little else but these two to test for telephony reception.—Yours faithfully,
H. COOPER.

Stretford.

KENSINGTON RADIO SOCIETY

At the February Meeting Lt.-Col. Hall delivered a most interesting Lecture on his "Neon Tube, Capacity and Resistance Measurer."

After the Lecture he measured several so-called grid leaks and condensers, and results provided an explanation why many Amateurs cannot receive any Station except their own local one.—Hon. Sec., 33, Elm Bank Gardens, Barnes.

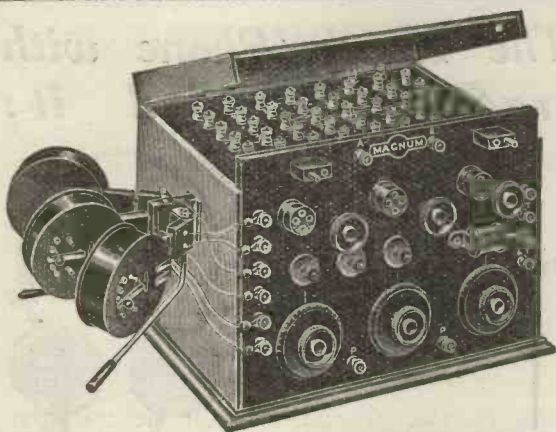

The wonderful OMNI

as described by Mr. J. Scott-Taggart.

As illustrated, including coils, 18 Guineas.

RECEIVES EVERYTHING FROM EVERYWHERE.

TO CONSTRUCTORS.—All Components

:: supplied separately if desired. ::

Send stamp for Illustrated List and set of leaflets dealing with "Twelve Tested Sets" including the OMNI, S.T.100, 4-Valve Family Receiver and all circuits described in "Wireless Weekly,"

"Modern Wireless" and Radio Press Envelopes.

ALWAYS SPECIFY "MAGNUM."

MAGNUM TAPPED COILS—REDUCED PRICES.

No. 1.	180-1000 metres	12/6
No. 2.	600-2600 metres	15/-

BURNE-JONES & Co. Ltd.

Manufacturing Radio Engineers.

MONTFORD PLACE, KENNINGTON, LONDON, S.E.11.

Phone: Hop 6257

Experimental Stations:—2 F.P. New Cross. 2 P.B. Kennington
2 C.T. Lambeth. 6 C.W. Streatham.



CONDENSER & SET CLEANER

Dust is the great enemy of Wireless. Keep your panel and components free from it and ensure stronger and noiseless reception.

9d. each. Postage 2d.

KEEP ONE HANGING BY YOUR SET.

GOSWELL ENGINEERING CO., LTD.

12a, PENTONVILLE ROAD, LONDON, N.1.

Liberal Trade Terms.

'Phone: North 3051.

"ROSEBROS" Guaranteed Crystals.

PACKED IN GLASS TUBES.

"ROSEBROS MARK IV"

Every spot sensitive.

Use any wire contact.

For crystal-valve sets.

Sealed Tubes 1/- each.

From all Wireless Dealers or Trial Tube post free 1/-.

ROSE BROS.

London: 25 Milton Street, E.C.2.

Glasgow: 194a, St. Vincent Street.

Manchester: 25-27, Miller Street.

Bristol: 83a, Redcliffe Street.

Electrical Co., Ltd.

Trade. Liberal Discounts. Ask for Wireless Lists.

London Dealers. We carry large stocks of all wireless goods—call at our Trade Counter for special Cash Discount.

Information Department



J. S. W. (STREATHAM) asks what is a lightning arrester.

This instrument, which may take one of several forms, is designed to protect the tuned circuits of receiving instruments from the effect of lightning or heavy static discharges. One of its most common forms is a small spark gap whose length may be adjusted by means of a slow-motion screw joined across the aerial and earth terminals of the receiver. It is expected that it will do its work by allowing high-voltage discharges to jump across the gap rather than pass through the receiving set itself with consequent damage. Actually, such devices are not recommended as the sole protection against lightning, since they are less effective than a good earthing switch. Their legitimate use is probably as an adjunct to the device.

L. D. F. (BRISTOL) asks what is Litzendraht, to which he has seen references, and what is its use.

Litzendraht is the German name for a conductor composed of a large number of fine strands separately insulated, which is claimed to have a very low high-frequency resistance. Some authorities consider that its use for the winding of tuning inductances is extremely advantageous, but others argue that the dielectric losses in the insulation between the strands are so serious as to completely nullify this advantage. Probably, however, a true statement of the case would reconcile these two opposing views, since upon the longer wavelength the high-frequency resistance remains low and the dielectric losses are much reduced. Upon a very short wavelength, however, the dielectric losses are probably so severe as to make Litzendraht rather inefficient.

D. R. (BIRMINGHAM) asks whether it would not be advantageous to apply a loose coupled tuning system to a reflex receiver of the general type of the ST100 circuit.

The use of a loose-coupled tuner would certainly

E

E

C

The "EEC" "XTRAUDION" VALVE

is being used by the leading Radio Experimenters for detection, high and low frequency amplification, power amplifiers and low power transmission. Price 12/6

USE "RECTARITE," the synthetic crystal that makes Loud speakers talk. 1/6 Large Specimen.



Write to-day for 40 page Radio Catalogue mailed post free, 4d.

Head Office: 10, FITZROY SQUARE, LONDON, W.1.

Showrooms: 303, EUSTON RD., N.W.1.

Branch and Works: TWICKENHAM.

BROWN A. TYPE RADIO HEADPHONES

KING'S BENCH DIVISION.

G. E. WARD, trading as
CITY ACCUMULATOR CO. *Plaintiffs.*

versus

S. G. BROWN, LTD. *Defendants.*

Judgment was given on the 22nd instant for the plaintiff and he was awarded £800 damages and costs in an action which arose out of the statement made in the press in August 1922 by the defendants that the plaintiff was selling obsolete headphones of defendants' manufacture and was misleading the public. The City Accumulator Co. have therefore vindicated their honour and legally re-established their good name. The defendants applied to the Judge for a stay of execution, which was granted on the usual terms.

THE CITY ACCUMULATOR CO.,
10, RANGOON STREET, E.C.3.

BEWARE OF WORTHLESS IMITATIONS, SEE THE TRADE MARK *WatMel* ON EVERY GRID LEAK.

WATMEL VARIABLE GRID LEAK
(Patent No. 206098).

Constantly Variable
Silent in operation.
Constant in any temperature.
Dust and Damp proof.
Each tested and guaranteed.
Neat and well made.

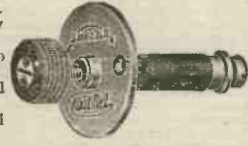

GRID LEAK
.5 to 5 megohms
2/6

ANODE RESISTANCE
50,000 to 100,000 ohms 3/6.

Suitable for S.T. 100 Circuit.

SEND P.C. FOR DESCRIPTIVE FOLDER.

WATMEL WIRELESS CO. Connaught House, 1a, Edgware Road, Marble Arch, W.2. Tel. 4575 Paddington

confers greater selectivity, provided that it does not unduly upset the stability of the reflex set. This, however, is very prone to happen, since the reduced damping in the secondary circuit involves a much greater tendency to self-oscillation and possibly howling. This can customarily be eliminated by the use of a much lower resistance in the stabilising resistance, say 50,000 ohms. Probably the best expedient is to use one of the variable anode resistances for this purpose and adjust it to the required value.

M. E. R. (HALIFAX) states that he has a single-valve set, and asks whether he can add to this a microphone amplifier to operate a loud-speaker from the nearest broadcasting station.

A microphone amplifier is simply a form of mechanical relay adopted for the amplification of speech current by taking advantage of the properties of a form of the ordinary carbon microphone. The varying signal current is passed through an electro-magnet which works a diaphragm or reed of the microphone, thereby causing variations of greater amplitude in a local battery circuit. Such microphone amplifiers require a considerable input to make them work satisfactorily, and we therefore do not think it will be effective after only a single-valve receiver.

M. R. C. (LIVERPOOL) states that he has acquired a Neon lamp, and enquires whether he can make any use of this in his three-valve receiver.

A Neon lamp is similar in appearance to an ordinary metal filament electric lamp of small size, but in place of the usual filament it possesses two electrodes, one often simply a spiral wire and the other a plate. The bulb contains Neon gas at low pressure, and a discharge will take place between the electrodes with any pressure above about 160 volts. A soft glow of very small illuminating power results. The lamps can be used for producing oscillatory current, so that some experimenters have achieved some success in their use for transmitting purposes, and they are also employed for the measurement of high resistances.

The peculiar property of the Neon tube upon which its use as an oscillator depends is that if the discharge is once started by an adequate voltage it continues after the voltage has been reduced considerably below the point at which it started.

W. V. L. (BRADFORD) enquires whether the gauge of wire used for winding inter-valve transformers in a neutrodyne receiver is of any importance to results obtained.

The gauge of wire should be moderately fine, since the slight damping thereby introduced is of some assistance in the circuit. A quite suitable gauge is No. 30 d.c.c., although any gauge between No. 26 and No. 32 may be used with success.

WHAT A CRYING SHAME

If you missed a single word on March 16th because of a loose connection. Such a disaster could not occur if you had Refty Terminals. **DON'T LEAVE IT TOO LATE! GET SOME TO-DAY!**

Type No. 1.
Lacqd. 9d. each.
Ebonite top.



Type No. 2.
Lacqd. 4½d. each.
All brass.

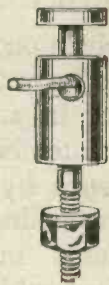

Type No. 4 Lacqd.
10d. each.
Ebonite top.

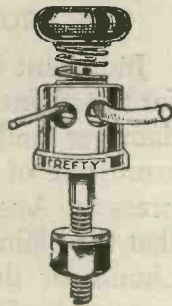

AS
TERMINAL



TYPE
No. 5
3d.
each

AS
WANDER
MIDGE



THE CUP which fixes
the crystal in any
desired position in
less than a second.

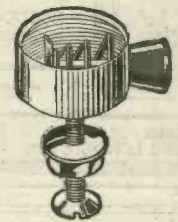

Lacqd 4½d.
Nickel 5½d.

SHOULD YOUR DEALER NOT STOCK THEM SEND TO US DIRECT. SURPLUS POSTAGE RETURNED.

St. Albans.—B. & A. Wireless Co., Verulam Street.
Ashington.—L. W. Shearer & Sons, 5, Station Road.
Bedford.—Bedford Elec. & Radio Co., 22, Campbell Road.
Bexhill-on-Sea.—R. D. Trevor-Roper, 43, Egerton Road.
Bristol.—H. Salanson & Co., 20, High Street.
Cardiff.—South Wales Wireless, Ltd., 19, West Bute Street.
Cambridge.—Bailey, Grundy & Barrett, 2, St. Mary's Passage.
Croydon.—C. W. Brown, 78, Church Street.
Felixstowe.—S. M. Douthwaite, 4, Constable Road.
Glasgow.—E. Bramma & Sons, 5, Copland Road, Govan.
Guildford.—Cole, Ltd., Market Street.

Huddersfield.—J. H. Taylor & Co., Macaulay Street.
Ilford.—Ajax Co., Ltd., 291, High Road.
Kingston.—(Surrey)—Bentall's, Ltd.
Liverpool.—British Radio Co., 8, South Castle Street.
Manchester.
Manchester.—India Rubber Tele. Co., 16, John Dalton.
Newark.—E. Clark, Hawton Road.
Newcastle.—Chase Motor Co., Sandryford Square.
Newport.—Alger & Sons, 160, Dock Street.
Oldham.—Butterfield Bros., 45, Yorkshire Street.
Oxford.—Anderson & Bucknall, Mayfield Road.
Penarth.—C. W. Davies, 98, Globe Street.

Reigate.—Tampin & Makovski, Bell Street.
Redruth.—A. F. Tonkin, Barncoose Terrace.
Redhill.—T. C. Bailey, 7 & 34, London Road.
Sleaford.—E. V. Skinner, 90, Southgate.
Sheffield.—T. A. Ashton, Norfolk Street.
Southsea.—Percy Kinn, Ltd., Elm Grove.
Surbiton.—J. R. Offer & Sons, 72, Victoria Road.
Thornton-Heath.—Scratchley Bros., 111, High Street.
Watford.—Darley's, Ltd., St. Albans Road.
Weymouth.—W. Smith & Son, Esplanade.
Warrington.—Hill & Co., Ltd., 62, Buttermarket Street.
Whitley Bay.—Norman Laws, Front Street, Cullercoats.

REFTY ELECTRICAL APPLIANCES LTD. 2, Featherstone Buildings, High Holborn, London, W.C.1
Phone: Chancery 8264. 'Grams: "Reftinal, Holb. London."

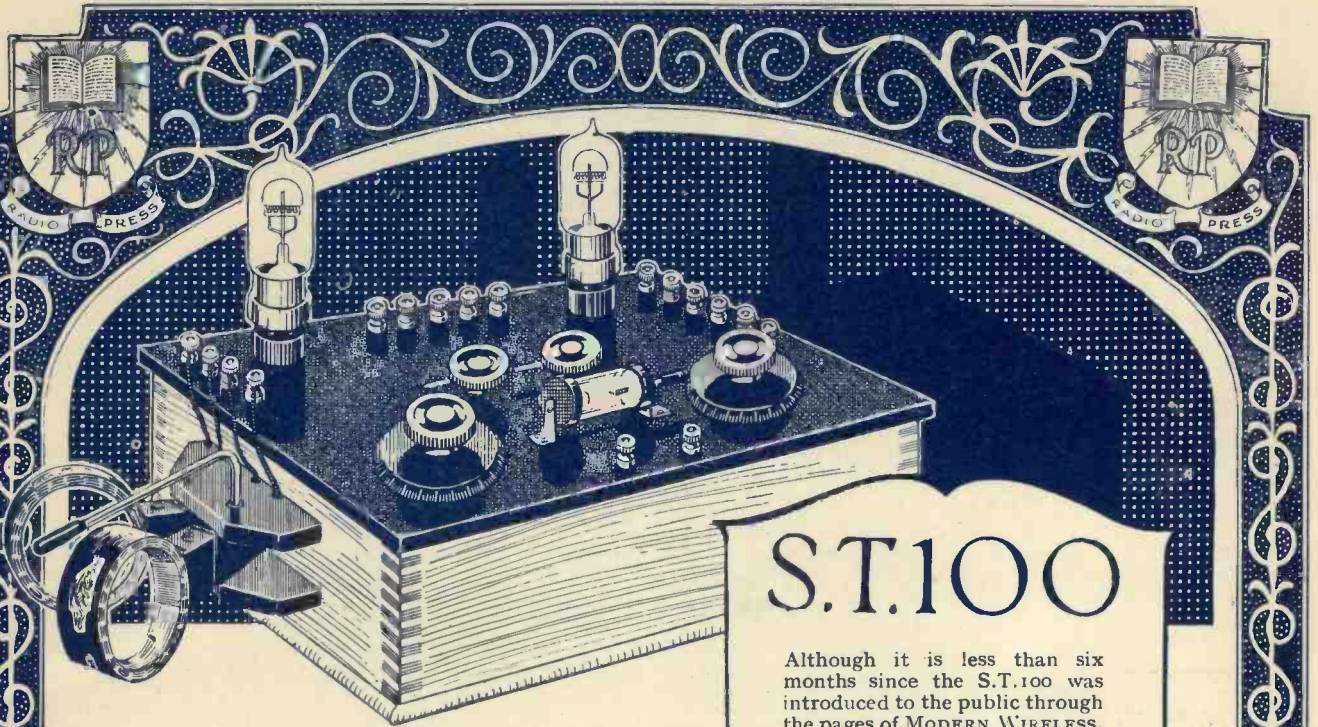

A new system simplifies the home construction of this fine Reflex Set.

WHILE to many enthusiasts who already have some knowledge of Radio the constructional articles in *MODERN WIRELESS* and *Wireless Weekly* are quite sufficient, yet to some beginners and others the elementary details of construction may have been omitted. Obviously exigencies of space in a magazine often render it necessary for an article to be kept brief.

In order to assist the novice and the man who has never built a Set before, however, we have produced a special Series of Envelopes, each dealing with one particular type of Set in a most comprehensive manner.

The first one of the series is devoted to building up the S.T.100 shown above and contains blue prints, wiring diagrams, illustrations of finished instruments taken in various positions, complete working instructions, etc., etc. Absolutely every possible assistance is given so that the novice can follow the instructions and build a first-class Set without possibility of error.

S.T.100

Although it is less than six months since the S.T.100 was introduced to the public through the pages of *MODERN WIRELESS*, yet scores of thousands of Receiving Sets incorporating it are giving complete satisfaction in all parts of the country. For a general purposes, economical Set the S.T.100 would be hard to beat. On an average Aerial all B.B.C. stations can be heard at good strength, while it has a Loud-Speaker range of 30 to 40 miles.

It is particularly economical because it only uses two Valves (a Crystal acting as Rectifier), yet immense amplification is obtained because the first valve acts as a high-frequency and low-frequency amplifier simultaneously.

To build such a Set is within the reach of anyone, the following being practically the only components required; Two variable condensers, two valve-holders, two rheostats, one fixed resistance, one coil-holder, one crystal detector, two L.F. transformers, the necessary terminals, panel and cabinet.

Why not rebuild your present Set into an S.T. 100?

16

Post free
1/9.

RADIO PRESS, LTD., DEVEREUX COURT, STRAND, W.C.2

Radio Press Envelope N°1



"STERLING"

**LIGHTWEIGHT
RADIO HEAD
TELEPHONES**
give perfect results, are of highest finish, handsome appearance, and fitted with polished Duralumin headbands. Easily the best value yet offered.

Resistance the pair in series	Price
120 ohms	£1 2s. 6d.
2000 ohms	£1 4s. od.
4000 ohms	£1 5s. od.

Clear, Light and Comfortable-

Sterling-of Course!

Advt. of **STERLING TELEPHONE and ELECTRIC CO., LTD.**
Manufacturers of Telephones and Radio Apparatus, etc.
210-212 Tottenham Court Road London, W.1
Works: **DAGENHAM, ESSEX**

Your Radio
Dealer can
Supply

Wireless Weekly

and the Wireless Constructor

Vol. 3.
No. 14.

CONTENTS

Imperial W.T. Committee Report.

An Experimenter's Power Amplifier.

The R.S.G.B. Annual Conference.

How to Make a Selective Two-Valve Set.

More Circuits for the Omni Receiver.

Random Technicalities, Broadcasting News, An Experimenter's Unit Receiver, C.W. and Telephony Transmission Using Valves, Some Simple Wireless Questions Answered, etc.

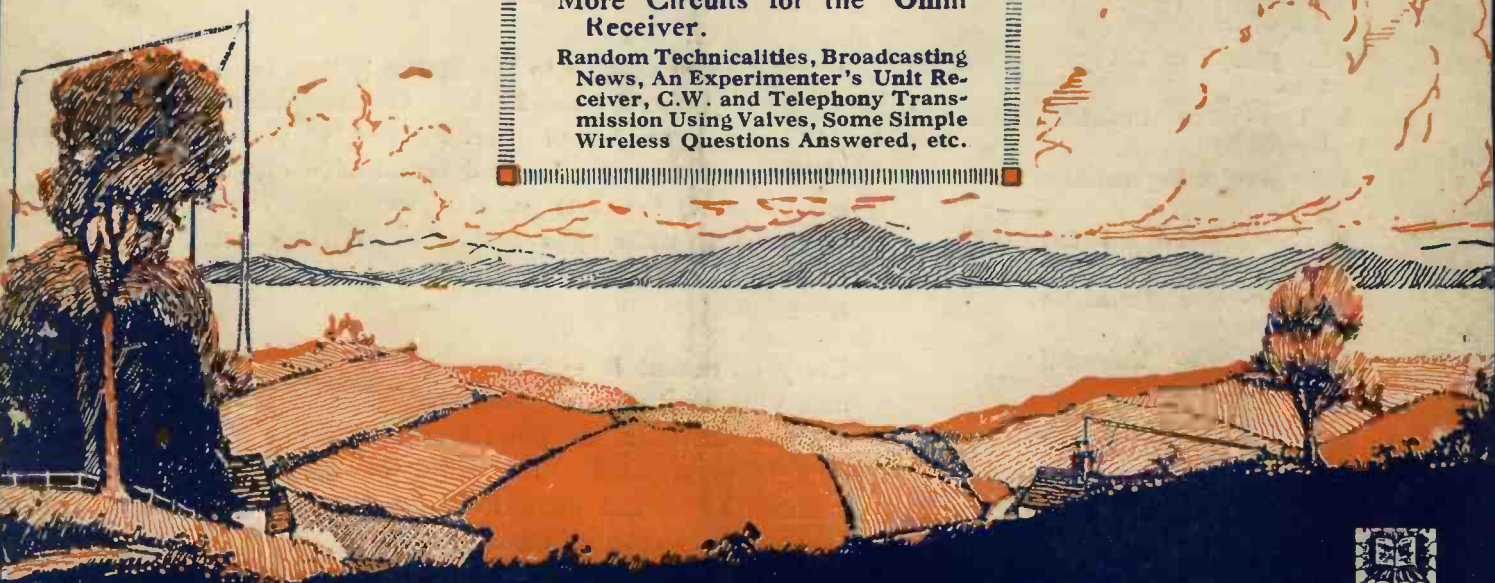

An Extra Selective Two-Valve Receiver

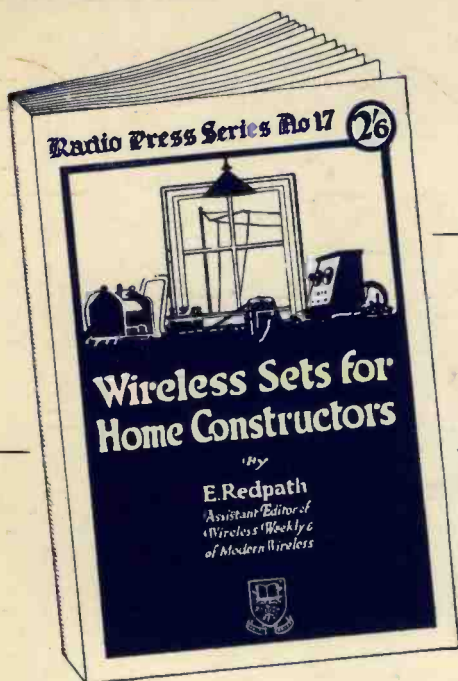
Just Published

A New Radio Press Constructional Book.

NOW ON SALE.RADIO PRESS
SERIES, No. 17.**CONTENTS:**

- Simple Crystal Receivers.
- An Inductively - Coupled
Crystal Receiving Set.
- Testing and Operating Cryst-
al Receiving Sets.
- A Two-valve Low-frequency
Amplifier.
- Adding Amplifiers to Crystal
Sets.
- A Two - valve Broadcast
Receiver.
- A Three-valve Regenerative
Receiver.
- A Single - valve Reflex
Receiver.
- A Three-valve Broadcast
Receiver.
- A Four - valve Universal
Receiver.

2/6

Post Free, 2/8

Wireless Sets for Home Constructors

By **E. REDPATH,***Assistant Editor of
"Modern Wireless" & "Wireless Weekly."*

THE latest addition to the **Radio Press** Series of Constructional Books. Contains designs for a number of Receiving Sets of proved efficiency. The author has had considerable experience in designing Sets suitable for the average enthusiast to make up, and this Book is the direct outcome of experiments carried out during the past few months.

Every instrument is well within the ability of the man who can handle the ordinary household tools, and full particulars are given for making even the components required. The scope of this Book includes Crystal and Valve Receivers with a range from 25 miles up to 3,000 miles on telephony.

RADIO PRESS, LTD.,
DEVEREUX COURT,
STRAND, W.C. 2.

Follow the Instructions and Success is Certain



Wireless Weekly

Vol. 3, No. 14
Mar. 12, 1924.

CONTENTS

	Page
Editorial	440
Imperial Wireless	441
Jottings by the Way	443
The R.S.G.B. and the Affiliated Societies	444
Broadcasting News	445
An Experimenter's Power Amplifier	448
C.W. and Telephony Transmission Using Valves	451
An Experimenter's Unit Receiver	453
Some Simple Wireless Questions Answered	454
A Small Condenser for Neutrodyne Circuits	455
A Soldering Hint	455
R.S.G.B. Conference of the Affiliated Societies	456
A Novel Frame Aerial Pivot	457
How to Make a Selective 2-Valve Panel Receiver	458
Another Circuit on the "Wireless Weekly"	463
Omni-Receiver	463
Using Panel Bushes	465
R.S.G.B. and the Radio Transmitters' Society	465
Valve Notes	466
Apparatus We Have Tested	467
Correspondence	469
Information Department	471



Editor: JOHN SCOTT-TAGGART, F. Inst. P., A. M. I. E. E.

Assistant Editors { E. REDPATH.
P. W. HARRIS.

Radio Press, Ltd.

Publishers of Authoritative Wireless Literature,
DEVEREUX COURT, STRAND, W.C.2

Tel.—Central 3763.

Advertisement Managers: } SCHEFF PUBLICITY ORGANIZATION,
LTD., 125, Pall Mall, London, S.W. 1
Tel.—Regent 2440.

Staff Editors:

E. H. CHAPMAN, M.A., D.Sc.
A. D. COWPER, M.Sc.
G. P. KENDALL, B.Sc.
R. W. HALLOWS, M.A.
S. G. RATTEE.

Scientific Adviser:
Prof. G. W. O. HOWE,
D.Sc., M.I.E.E.
Advisory Editors:
Prof. R. WHEDDINGTON,
M.A., D.Sc.
Prof. C. L. FORTESCUE,
M.A., M.I.E.E.



All correspondence relating to contributions is to be addressed to the Editor of "Wireless Weekly."

Nothing contained herein is to be regarded as permission or encouragement to infringe any patent rights.

Editorial



The Wrong Way.

WHILST the reorganisation of the Radio Society of Great Britain is bound to bring with it considerable improvements, there is obviously much to be done before the Society can be made sufficiently attractive to draw to its meetings the new experimental public which would benefit so greatly by adherence to such a Society. For example, what new blood is likely to be attracted to the Society by the lectures announced in the latest notice of forthcoming meetings? "On February 27 we had a demonstration of the application of the Cathode Ray Oscillograph." Such a lecture, whilst admirable from many points of view, is bound to make only a limited appeal, whilst the very title is sufficient to give the impression that the Radio Society of Great Britain is an institution akin to the Physical Society.

Mr. A. A. Campbell Swinton's lecture announced for March 26 on "The Possibilities of Electrical Television, Both With and Without Wires," should make a wider appeal, but we would have been happier if the Selection Committee could have issued the title in a more attractive form.

For May 28 we are to be given a lecture on "Wireless in British Military Aircraft up to August, 1914." This, presumably, is by arrangement with the Society of Antiquarians. We have every respect for the author, who could give us a much more interesting paper. Why not ask him? No one is *really* thrilled at the thought of aircraft wireless up to August, 1914. In the first place, broadly speaking, there was no aircraft, and, secondly, there was no wireless. So why worry about it?

Everyone who is interested in the Radio Society becoming truly the Radio Society of Great Britain and not the Wireless Club of the Thames Embankment will agree with us that amongst the many burning questions and pressing problems of vital interest to every amateur, there must be at least a few capable

of adequate treatment in lectures before what is alleged to be our leading Radio Society.

To apply the adjective "moth-eaten" to this season's programmes would be a little severe, but really we had hoped the new committee would introduce a little life into things. If the R.S.G.B. tried to run a periodical on these lines, they would fail utterly and miserably. Meanwhile the attendance at their meetings would be a disgrace to the average provincial society. We ourselves do not intend to reproduce the lectures until they become interesting. On the other hand, we are seriously considering running a series of lectures which experimenters *will* attend.

Helping Our Readers.

On another page of this issue we are publishing a list of questions designed to find in what respect our paper appeals to its readers and in what way we can improve it according to their desires. *Wireless Weekly* and *Modern Wireless* have always taken the line that only by close contact with their readers can they give really satisfactory service, and the answers given to questions of this kind are of immense help. Particularly we would like to know the views of readers on the new method of depicting panels from the back, introduced for the first time in *Wireless Weekly* for February 27. Many readers have hailed this full-page reproduction method as one of the greatest advances in wireless explanatory articles, whilst one or two have suggested that it is an easy way for us to fill space! This feature was introduced with no other idea than to facilitate the home construction of sets, and if our readers appreciate the method we shall be pleased to continue it. On the other hand, being always open to modify the journal to meet our readers' wishes, we shall be only too glad to make whatever changes in the method of showing such details as may be indicated on receipt of the question forms. Incidentally, the printing, etc., of whole-page photographs is much more costly.

Imperial Wireless

A Summary of the Committee's Recommendations

THE report of the Imperial Wireless Telegraphy Committee, 1924, appointed by the new Government "to consider and advise on the policy to be adopted as regards the Imperial Wireless Services, so as to protect and facilitate public interests," was issued on February 22 last. The Committee was commendably prompt in making its report, and the following is a Summary of Recommendations:—

Empire Services.

(1) That the State through the Post Office should own all wireless stations in Great Britain for communication with the overseas Dominions, Colonies, Protectorates and Territories.

(2) That the Post Office should operate directly, under an improved business organisation, all the Empire Stations in Great Britain.

(3) That as an alternative an exception be made to the foregoing recommendations in the case of Canada, for the reasons stated in paragraphs 48 to 51, and that competition between the Post Office and private enterprise in the Anglo-Canadian wireless service, which exists at present, be continued, provided that, in any licence granted for the Anglo-Canadian service, public interests are safeguarded as regards conditions of working and terms of expropriation by the State.

(4) That in any licence granted to a private Company, the State must reserve to itself the right to take possession or exercise control over the working of the licensed stations whenever in the opinion of the Government an emergency requires it.

(5) That the Leaffield station should be enlarged as recommended by the Post Office wireless experts and engineers, that the new high-power station, now building at Rugby, should be extended to a 16-mast station, that a second new station of

similar capacity be erected, and that these works should be put in hand without delay.

(6) That each of the high-power stations should be of world range and equipped with the latest apparatus, so that the highest degree of efficiency can be attained.

(7) That, if necessity arises, full advantage be taken of the Patents and Designs Act, 1919

(Section 8), under which the Crown can acquire the use of all patented inventions which may be useful for public utility services such as wireless.

(8) That in order that State management and operation of Empire wireless may be carried out in a way to ensure the greatest efficiency, an improved business organisation should be set up by the Post Office, and

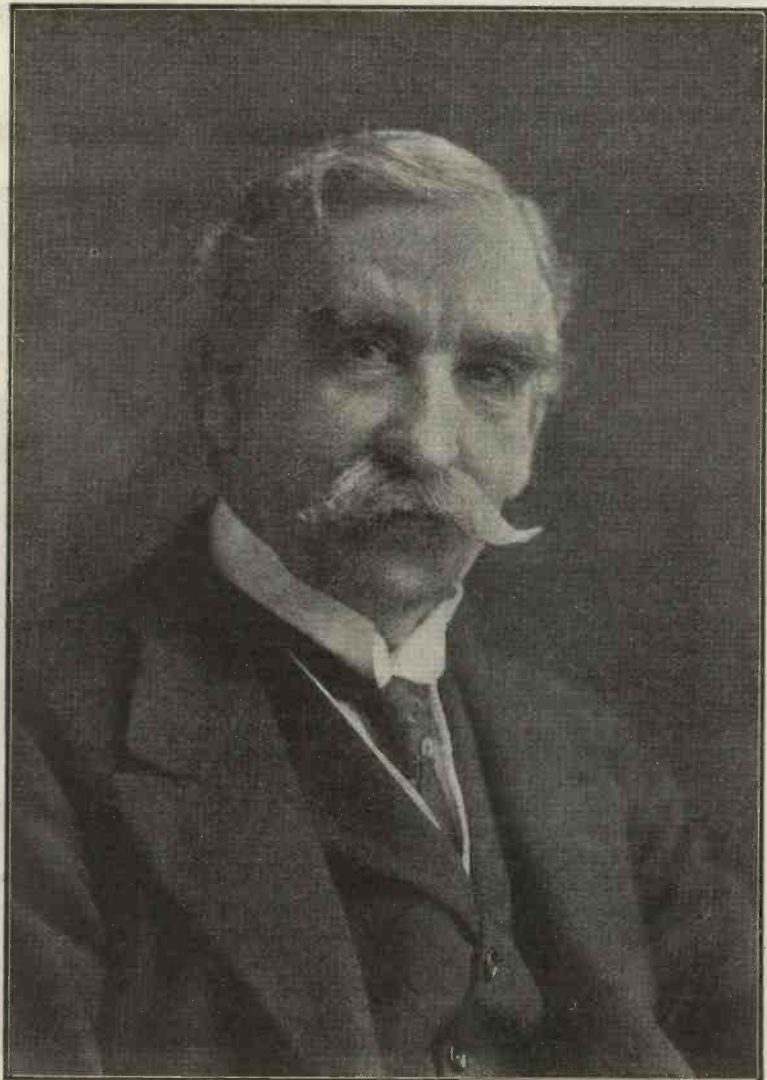

Photo by Elliott & Fry.

Mr. Robert Donald, Chairman of the Imperial Wireless Telegraphy Committee, 1924.

that the Post Office Advisory Council of business men be consulted on this question.

(9) That the present terminal wireless station near Cairo be removed from the Empire system as soon as the requirements of the Admiralty are met by other stations and the proposed new high-power stations in India, South Africa and Australia are in operation.

(10) That the expert Wireless Telegraphy Commission be requested to report on the extent, and cost, of a wireless system for the Colonies necessary to complete the Empire network of wireless communications.

Foreign Services

(11) That private enterprise be given facilities to develop wireless communication with continental Europe, as with the rest of the

world outside the British Empire, subject, in the case of Anglo-Continental services, to suitable terms being arranged for the payment of royalties or otherwise in view of the competition which must exist between wireless and State-owned cables.

(12) That there should be free competition in foreign wireless, subject to the State reserving the right of expropriation and the right to take possession and assume control in case of national emergency.

(13) For the present the existing provisional licences for Continental services should be renewed, and the Post Office should concentrate its Continental traffic as far as possible at Northolt; the station at Stonehaven should be discontinued without avoidable delay; and arrangements should also be made to discontinue the

station at Caister as soon as other provision is made for the traffic.

(14) That telegraphic and telephonic broadcasting to the Continent be carried on by the Northolt station.

85. We wish to record our appreciation of the valuable help rendered to us by our Secretary, Mr. W. E. Weston, and the readiness with which he obtained all the information which we required in the short time which our investigations occupied.

ROBERT DONALD
(Chairman).

F. J. BROWN.

W. H. ECCLES.

D. DRUMMOND FRASER.

HENRY H. SLESSER.

W. E. WESTON (Secretary),
February 22, 1924.

A WELL-DESIGNED AMATEUR STATION.

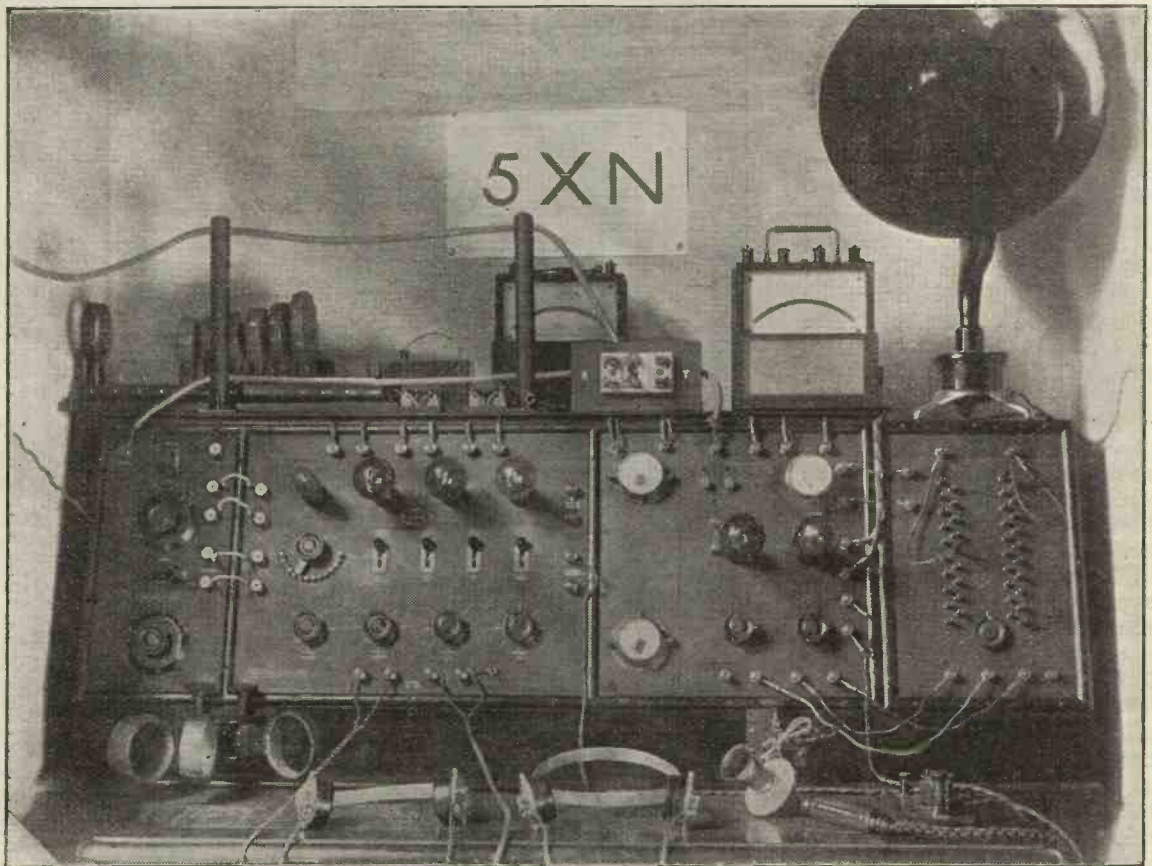

Our photograph shows the transmitting and receiving station of Mr. Everitt, of Eltham, S.E.9. The microphone is seen by the side of the transmitting key. The receiver (on the left) is a standard Burndep instrument.

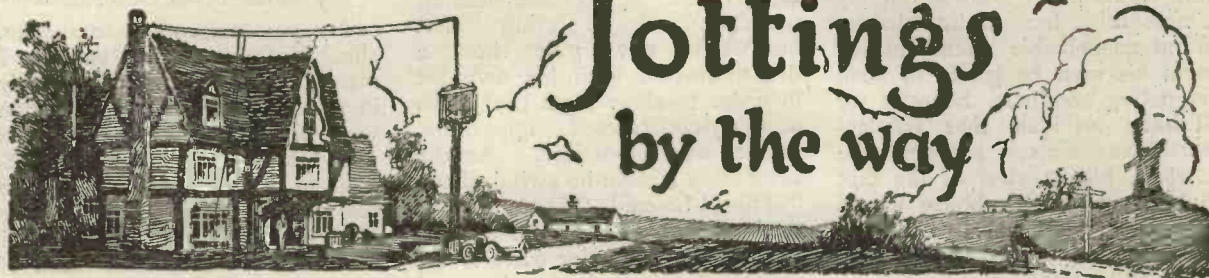

The Practical Joker

THE wireless practical jester, as no doubt you have noted, is coming into existence. He was at work some nights ago at a big radio assembly. Those who essayed to enter the door placed their hands upon its knob and then leapt back several yards with their hair on end. It was not that they had suddenly caught sight of the lecturer or anything of that kind. A fellow of infinite jest had connected up a high tension supply so that anyone touching the aforementioned knob was literally galvanised into performing steps that would have put the most rubber-jointed of Russian dancers to shame. Those who managed to enter despite this shocking rebuff at the door realised that pranks were afoot, and, remembering that where there is one booby-trap there is probably also another, cast their eyes around to see what they could see. Suspended from the ceiling was a bag subsequently found to contain flour which it was evidently the jester's intention to release at a given moment upon the devoted heads of the assembled company. This flour was happily nipped in the bud by the removal of the bag ere it could do any harm.

I am perfectly in sympathy with the noble idea of electrifying the door knob, for such a proceeding is quite in keeping with the atmosphere of a wireless meeting, and would no doubt have the effect of stimulating members of a society as a prelude to the lecture, debate, conference, discussion or whatnot. But I cannot pass the sack of flour business. When at Rome, do as the Romans do. If you want to be funny in a practical way at a wireless meeting, I see no wrong in devising a neat little scheme for causing the chairman's hair to stand on end

whenever he touches his gavel, or for making the loud-speaker emit a scream when he sits down. There would be little harm again in effecting improvements in the wiring of the prize set, so that when the blushing winner of the competition stood forth to give a demonstration of its powers, he was shocked to find that everything worked backwards. These things are forgivable, and they merely conduce to a general atmosphere of cheerfulness. But do not, I beseech you, try the flour trick, however much your local club may be in need of waking up. Let there be a decency above all in your jests and a due regard to their appropriateness. Soot might do, for soot after all is a form of carbon, and it is not a far cry from carbon to electricity. But flour—no.

The Joke Supreme

One of the noblest jests that I have ever come across was that worked in Little Puddleton upon the man Tipplesworth. Tipplesworth, I should say, has a way of being a blot, the kind of blot that cries aloud to be erased, but somehow he usually manages to defy all efforts to do so. For many moons the fellow had been a plague to us at the wireless club owing to his insufferable superiority. It is not that he had much knowledge; but he possesses a final and devastating way of laying down the law which leaves no room for argument, and argument is, of course, the life and soul of a wireless club. For a long time we have sought to discover some means of bringing about his downfall, but it has always been a very difficult business, for, like a rubber ball, the harder he falls the higher Tipplesworth bounces. A shrewd puncture was evidently needed to take the bounce out of him. The opportunity came only a few days ago.

Many heavy-handed neophytes

installed sets at Christmastime, since when they appear to have spent most of their leisure hours in moving the knobs of their reaction condensers gently to and fro. The local ether has been so violently disturbed that on most evenings 2LO's musical programmes sounded more like an imitation of feeding time at the Zoo than anything else. Naturally the society took steps. Several of the chief offenders were clubbed to death by a committee appointed to run oscillators to earth. In fact, at one time a strike of the local dustmen was threatened owing to the weight of the corpse-filled dustbins which they were called upon to handle upon the morning after a raid. But for the confirmed oscillator even death has no terrors, since he would gladly lay down his life rather than give up the cherished right to howl. Stronger measures appeared therefore to be indicated. Someone had a happy inspiration of suggesting that Tipplesworth should be asked to lecture upon the subject. It was felt that if all oscillators were roped in and taken forcibly to the place of meeting the horrors of sitting through Tipplesworth's oration, coupled with the threat that the process would be repeated if necessary once a fortnight, would have the desired results, if anything could.

The Lecture

Tipplesworth's voice, be it noted, had always been the loudest of those that condemn oscillation. He lost no opportunity of telling everyone precisely what he thought of the condenser wangers, referring to them scathingly as bandits, despicable creatures, non-sportsmen, ether hogs and things like that. Equally loud-voiced had been his assertions that his own set was completely above suspicion. He explained to all who would listen that to build a set

that would howl showed merely a lamentable lack of knowledge. In no conceivable circumstances could his own be guilty of such disgusting conduct. Secretly we all have an idea that Tipplesworth was himself amongst the howlers, but in view of the fact that a visit to his house would have been necessary in order to disprove his claims to being a little white lamb, we were content to let the matter pass. An evening at Tipplesworth's house and in his wireless den is not a thing for even strong men to contemplate lightly. Anyhow, he appeared to be qualified in every way to deliver the punitive lecture, which was duly arranged.

On the appointed evening the hall was packed. The oscillators had been brought in willy-nilly, and the rest of us had to be there to see that they did not escape. Tipplesworth plunged at once into the subject. He explained what oscillation was, how he recognised it, how you caused it and how you stopped it. He denounced oscillators in no measured terms, commenting forcibly upon their manners, their habits and their morals.

He wound up a soul-searing peroration by stating that he would now give them a demonstration with his own set in order to show them that, with properly-constructed apparatus, offence was impossible. Amidst breathless silence he switched on. "This," he said, "is the proper way to tune in 2LO; you will observe that the carrier wave is *not* audible." His right hand moved to the A.T.C., his left to the C.C.C. He moved them gently. "QUEAL" remarked the loud-speaker. Tipplesworth, purple in the face, tried again. The result was a howl of even more noble proportions. To cut a long story short, if he touched so much as a rheostat, the thing positively roared at him. His hands fluttered nervously over it, whilst perspiration streamed down his face, and every flutter produced some new variety of squeak, squeal, scream, howl, screech or yell. . . . Who was working that heterodyne wavemeter, I do not know, but it was very skilfully done, and if it has not cured oscillation, it has at all events succeeded in giving Tipplesworth his final squashing.

A Shock-Proof Generation

Are you susceptible to shocks, shocks of the electric variety, I mean? People vary enormously in this respect. I know one man who will calmly wet his fingers and place them across the contacts of a 220-volt light switch to see whether any juice is flowing or not. As for me, should I accidentally touch both leads of even a 60-volt high-tension battery I leap into the air with a wild cry and am a broken man for some moments.

In the interests of the rising generation, I think that the matter ought to be taken up by the Eugenics Society. Every endeavour should, of course, be made to produce a race of shock-proof human beings to become the wireless stalwarts of the future. In days to come, instead of weighing the baby we shall measure his ohmic resistance. We shall read in the papers that Mrs. So-and-So has presented her husband with a fine healthy 50,000 ohms boy. Vaccination will become less important than the new process for thickening the skin of the finger tips.

WIRELESS WAYFARER.

The R.S.G.B. and the Affiliated Societies

ON Tuesday, March 11, at 8 p.m., at the Central Hall (opposite Jones and Higgins), Peckham, the Radio Societies affiliated to the Radio Society of Great Britain will hold a special general meeting to elect representatives for the new General Committee of the Radio Society of Great Britain.

Two delegates from each Society affiliated or applying for affiliation are asked for, to attend the meeting.

Mr. Geo. Sutton, A.M.I.E.E., has been requested by Dr. Eccles, President of the R.S.G.B., to make the arrangements. His letter is given below.

To The Affiliated Radio Societies in the South London Area.

GENTLEMEN,—Since you did me the honour on October the 8th last of electing me to represent you upon the Council of the Radio

Society of Great Britain, I have left no stone unturned in advancing your cause. Particularly have I zealously watched any attempts to curtail your liberty of action, and now call your attention to the new R.S.G.B. regulations relating to Affiliated Societies, in which the fullest individual freedom is guaranteed consistent with that amount of direction which a Parent Society, as such, must exercise.

I have hesitated to call you prematurely to a separate conference, but now that the General Committee of the R.S.G.B. has been decided upon, and the Chairman and Secretary elected, I hope to be able to announce in the immediate future that a meeting-place has been arranged and two delegates invited from each affiliated Society (or Society which is immediately applying for affilia-

tion), so that those Societies may elect members to serve upon the General Committee of the Radio Society of Great Britain. The representation will be on a basis of one member for each six Societies, and it is hoped that the whole South Metropolitan Area will form a united group, in which case there is no doubt that it will be the strongest individual group represented on the General Committee. I hoped that the newly-formed South London League of Radio Societies would have formed the nucleus, but that body has definitely resolved to have nothing whatever to do with the R.S.G.B. I have been requested by the President of the R.S.G.B. to call together the Affiliated Societies in South London so that the election may be proceeded with, and I beg that you will, at your earliest convenience, furnish me with the names and addresses of two delegates from your Society who will attend the meeting.—I am, Dear Sir, Yours faithfully,

GEO. SUTTON, A.M.I.E.E.
18, Melford Road, S.E.22.

Broadcasting News

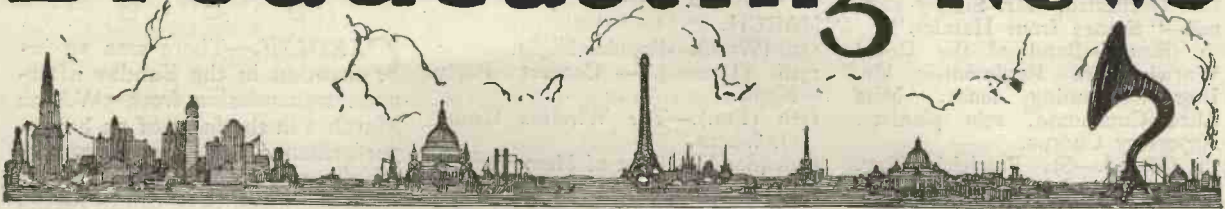

LONDON.—Major Corbett Smith, who has done such excellent work in Cardiff, is being transferred to London. It is difficult to assign any particular office to Major Corbett Smith, but he may be depended upon to strengthen the programmes generally. He has certainly had great experience in miscellaneous entertaining, and has a fund of originality as well as plenty of initiative.

□ □ □

The series of Chamber Concerts devoted to the works of living British composers, which were originally arranged for Thursdays, have been arranged to take place on Mondays, commencing on Monday, April 21. Therefore the dates for these interesting concerts are Thursday, March 13, when Mr. John Ireland will arrange the programme; March 27, when the programme will be arranged by Mr. Martin Shaw; April 10, arrangements by Mr. Frank Bridge. After that date these concerts will be held on Mondays instead of Thursdays, though at the moment the composers have not been decided upon.

□ □ □

Forthcoming Events

- MARCH.**
 12th (WED.).—B.B.C. Dramatic Critic. Wireless Orchestra.
 13th (THURS.).—Talk by Radio Society of Great Britain. Mr. Jack Rickard and Miss Violet Dean. "The Scandalmongers." Miss Daisy Kennedy, solo violin. Mr. George Parker, baritone.
 14th (FRI.).—Mr. Percy A. Scholes "High-Low Programmes."
 15th (SAT.).—Station Orchestra. Savoy Havana Bands.
 16th (SUN.).—Organ Recital. The Rev. W. C. Poole, religious address. Mayfair Singers.
 17th (MON.).—Irish Night.
 18th (TUES.).—Band of H.M. Royal Air Force. H.R.H. Prince of Wales.

ABERDEEN.—The student's night, looked forward to by young and old alike, proved one of the most attractive programmes yet broadcast from 2BD. Wit and humour sparkled throughout, and the fact that the students had the run of the studio for the night ensured a continuity which is not usually easily attainable in wireless transmission.

- 15th (SAT.).—"Another Nicht wi' Mr. McWhackie an' his Freens."
 16th (SUN.).—Organ Recital and Service relayed from St. Andrew's Cathedral.
 17th (MON.).—St. Patrick's Night, including two Plays, "A Tinker's Wedding" and "Shadow of the Glen."
 18th (TUES.).—Scandinavian Night.

□ □ □

BELFAST.—The Belfast Broadcasting Station seems to be making good progress, and one can venture to express the hope that it will be in working order during May; negotiations have been conducted in the most harmonious spirit.

□ □ □

BIRMINGHAM.—The 5IT Radio Circle includes among its members some very versatile and capable little artistes, and a number of them had the privilege recently of entertaining the grown-ups. They contributed songs, piano solos, and recitations for an hour. Listeners were invited to give their opinions on the merits of the young performers by sending a postcard naming the best artiste, to whom a prize of a crystal set was given; a twelve-year-old Birmingham girl, who recited, being the winner.

□ □ □

It is hoped to repeat these competitions in future as a means of fostering youthful talent. The 5IT Radio Circle has now a membership of 6,000—and it is still growing. The "'teens" corner, too, has a good membership.

□ □ □

Forthcoming Events

- MARCH.**
 12th (WED.).—Lozell's Picture House Orchestra. Station Orchestra. "Birmingham Composers' Night." Mr. Sidney Grew—Readings from works of Birmingham poets.
 13th (THURS.).—Piano Quintette. Chamber Music Programme. Mr. Raymond Green, entertainer.

BROADCAST TRANSMISSIONS	
	Call-Sign Wavelength
LONDON	2LO 385 metres
ABERDEEN	2BD 495 ..
BIRMINGHAM	5IT 475 ..
BOURNEMOUTH	6BM 385 ..
CARDIFF	5WA 353 ..
GLASGOW	5SC 420 ..
MANCHESTER	2ZY 375 ..
NEWCASTLE	5NO 400 ..
TIMES OF WORKING	
Weekdays	3.30 to 4.30 p.m. and 5.0 to 10.30 p.m. G.M.T.
Sundays	3.0 p.m. to 5.0 p.m. and 8.30 to 10.30 p.m. G.M.T.

Communal singing has taken the fancy of listeners in the north-east, and following on church experiments, arrangements have been completed for the broadcasting of the joint efforts of a "choir" of 3,000 voices. The Aberdeen Music Hall has been booked for the 27th instant for this purpose, and the requisite number of "artistes" has already been secured.

□ □ □

Forthcoming Events

- MARCH.**
 12th (WED.).—Jazz Night. Mr. Philip Wilson (London), Chat on Music in the reign of Queen Elizabeth and James I, with examples.
 13th (THURS.).—Operatic Night.
 14th (FRI.).—Literary Night, "Duke of Killiecrankie"—a farcical romance in three acts.

- 14th (FRI.).—Lozell's Picture House Orchestra. Mr. Herbert Aldridge, recitation.
- 15th (SAT.).—Kiddies' Concert. Station Orchestra. Mr. Sidney Russell—"Scenes from Hamlet."
- 16th (SUN.).—Band of the Royal Warwickshire Regiment. Mr. Ingram Benning, tenor. Miss Alice Couchman, solo pianiste. Repertory Chorus.
- 17th (MON.).—St. Patrick's Day. Programme of Irish Music.
- 18th (TUES.).—Piano Quintette. Grey's Concert Party.

tioned was undoubtedly the gem of a fine collection.

□ □ □
Forthcoming Events

MARCH.

- 12th (WED.).—Popular Night.
- 13th (THURS.).—Concert Party Night.
- 14th (FRI.).—The Wireless Grand Orchestra.
- 15th (SAT.).—Night of Memories.
- 16th (SUN.).—Organ Recital from Boscombe Arcade. Miss Diana Webster, contralto. Mr. Reginald

- 17th (MON.).—Irish Night.
- 18th (TUES.).—Semi-Classical Night. Miss Carmen Hill, mezzo-soprano. Mr. Bert. Brewin, tenor.

□ □ □
CARDIFF.—There was an innovation in the Sunday afternoon transmission from 5WA on March 2 in the form of an hour's performance of good music, which came as a welcome change from the usual S.B. organ recital from London.

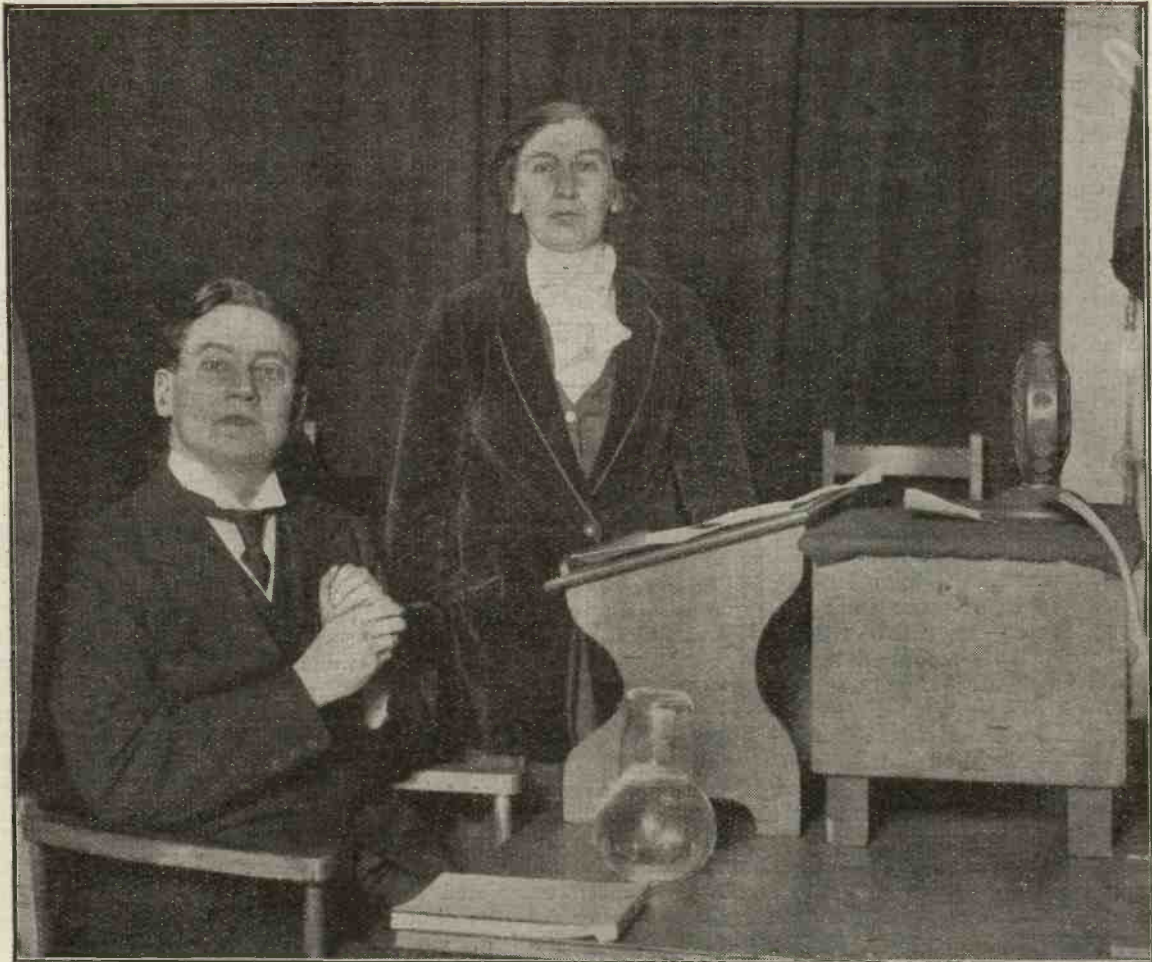

BOURNEMOUTH.—The programme broadcast from 6BM on Wednesday, February 27, resulted in hundreds of letters of appreciation being sent to the Station Director. The idea of broadcasting a picture seems to be quite original. Most folk are familiar with that striking picture "Revolution," by Fred Roe, and its representation by dialogue, music and sound was as striking to the ear as is the original picture to the eye. All the "pictures" were most enjoyable, but the one men-

.....
Mr. Henry Ainley and Miss Cicely Hamilton at the microphone on the occasion of the debate between Sir E. Marshall Hall, K.C., and Miss Hamilton at the London School of Economics. Broadcast from 2LO
.....

Attridge, baritone. The Æolian String Quintette. Rev. W. H. Thompson, religious address. Major Stanley How—Half an hour with Sir Edwin Arnold's works.

The St. David's Day programme, although almost entirely Welsh, was much enjoyed by English and Welsh alike, and "A Happy Evening in a Welsh Farmhouse" met with unusual approval. Many well-known Welsh singers, play-actors and authors took part, and their rendering of the play, "The Poacher," was greatly enjoyed.

□ □ □
Forthcoming Events

MARCH.

- 12th (WED.).—"The Magic Carpet in its First Flight."

- 13th (THURS.).—Orchestral Night.
 14th (FRI.).—Orchestral Night and
 Speeches from the Welsh
 Patronal Dinner.
 15th (SAT.).—Popular Night.
 16th (SUN.).—The Rev. I. C. Jones,
 B.A., religious address. British
 Composers' Night.
 17th (MON.).—St. Patrick's Day.
 18th (TUES.).—Shakespeare Night.
 H.R.H. the Prince of Wales.

GLASGOW.—A new feature in wireless in the city has just been witnessed, when for the first time pupils in school listened-in to an educative programme from 5SC. The experiment was carried out at Garnetbank School, and there were also present members of the Glasgow Education Authority and Dr. J. C. Stewart and Mr. D. D. Anderson, H.M. Inspectors of Schools. The programme consisted of a popular lecture on Scottish poetry by Professor J. R. Peddie, a talk on French by Professor Martin, and a brief lecture on English by Mlle. Pierette Grizel. A crystal and two-valve amplifier set, operating a loud-speaker, were employed for the reception. The majority of those present expressed their satisfaction with the demonstration, although the lesson in French was not quite so clearly heard as the other items.

Forthcoming Events
MARCH.

- 12th (WED.).—Classical Night.
 13th (THURS.).—Motherwell and
 Wishaw Town Band.
 14th (FRI.).—Literary Night.
 15th (SAT.).—Scottish Night.
 16th (SUN.).—The Wilton Select
 Choir. The Rev. W. Newman
 James, religious address.
 17th (MON.).—St. Patrick's Night.
 18th (TUES.).—Competition Night.

MANCHESTER.—The second dramatic production from 2ZY broadcast a few days ago consists of a short curtain-raiser entitled "The Mystery of the B Flat Trombone," by H. Toplis, followed by "Captain Swift," by C. Adam James, both produced by Mr. Victor Smythe. The first piece, a detective story, was too much abbreviated, and events moved too rapidly to follow intelligently. The second play, a delightful mixture of romance and bushrangers, proved very enjoyable. It was a play well suited to broadcasting and was excellently performed. The char-

acters could in almost every case be recognised by their voices alone, and the interest was sustained throughout.

Forthcoming Events
MARCH.

- 12th (WED.).—Miscellaneous Concert. Light Music by 2ZY Orchestra. Mr. T. A. Coward, M.Sc., Talk on "Spring in the Woods." Miss Winnifred Fisher, mezzo-soprano. Mr. Victor Smythe and a little humour.
 13th (THURS.).—2ZY Trio. Boy Scouts and Girl Guides' Bulletin. Garner-Schofield Dance Band. Mr. George Parker, bass. Talk by Prof. T. H. Fish, B.Sc.
 14th (FRI.).—Miscellaneous Concert. 2ZY Orchestra. Mr. H. Daveney, baritone. Miss Rachael Hunt, contralto. Mr. H. B.

We are given to believe by the B.B.C. that an announcement will be made shortly to the effect that a new station is to be erected for 2LO. The proposed site is in the West-end and situated on the roof of a well-known building. At one end of the roof it is proposed to erect a hut for housing the plant, and in order that the public may see the interior of the station without interfering with its working, large plate glass windows are being provided. The aerial, we understand, is to be slung between two steel towers, each 150 ft. high and 150 ft. apart. We await developments!

- Walker, tenor. Mr. G. W. Thompson, Talk on "The Marvels of Water and its Composition."
 15th (SAT.).—Oxford Picture House Orchestra. Organ Recital, Piccadilly Picture House. Keyboard Kitty. Mr. Foden Williams, entertainer. Mr. Stephen Williams, baritone. Mr. Victor Smythe and Algy. Mr. Phillip Wilson, tenor.
 16th (SUN.).—Orchestral and Operatic Concert by 2ZY Augmented Orchestra. Mr. Robt. Chignell, baritone. Miss Edith Ashby, solo pianoforte. Rev. A. L. J. Shields, religious address. Mr. Mikel Arenstein, solo 'cello. Mr. Pat Ryan, solo clarinet.
 17th (MON.).—2ZY Trio. St. Patrick's Day. Programme of Irish Music by 2ZY Orchestra. Mr. Tom Case, baritone.
 18th (TUES.).—Mr. D. Openshaw, baritone. Mr. James Bernard in "Extracts from Hamlet." Prof. F. E. Weiss, D.Sc., F.R.S., Talk "On Trees." H.R.H. Prince of Wales' Speech S.B. from London.

NEWCASTLE.—On Sunday evening monthly a complete service is to be relayed from one of the local churches instead of the usual Sunday evening concert. The first of these transmissions will be on Sunday, March 16, and will be from the Brunswick Wesleyan Church.

Forthcoming Events
MARCH.

- 12th (WED.).—Walker's Band. Orchestra. Mme. Evelyn Longstaffe, contralto. Mr. W. J. Taylor, baritone. Jay Kaye (London), entertainer.
 13th (THURS.).—Mme. Alec Thompson's Quartette Party. Mr. Phillip Wilson (London), tenor. Mr. Ernest Sharp's String Quartette.
 14th (FRI.).—Mr. V. Caygill, piano. Mr. Tom Sherlock, baritone. Mr. T. Brennan, euphonium. Orchestra. Mr. T. Sherlock, baritone. Mr. J. E. Rowell, tenor. Miss Lilian Rowell, contralto.
 15th (SAT.).—Vocal and Piano Recital by Mr. and Mrs. Geo. Dodds, and Mr. Yeanan Dodds. Orchestra. Mr. G. Tindle, baritone. Miss K. Birch, soprano. Mr. G. Van Hee, 'cello. Walker's Band relayed from Assembly Rooms.
 16th (SUN.).—Orchestra. Miss Maud Greener, soprano. Mr. G. Harris, tenor. Mr. John van Zyl (London), bass. Service relayed from Brunswick Chapel.
 17th (MON.).—Miss May Conn, piano. Mr. A. Fraser, baritone. Mr. W. A. Crosse, clarinet. Irish Night. Mme. Dorothy Foster, soprano. Mr. Norman Wright, entertainer. Mr. Vincent Jones, baritone.
 18th (TUES.).—Mr. Wm. Laws' Trio. Orchestra. Mme. Elsie Cochrane (London), soprano. Mr. E. L. Odhams, reading. Mr. Norman Currie, baritone. Miss R. Wall, violin. H.R.H. the Prince of Wales' Speech S.B. from London.

Simultaneous Broadcasting
Events.

MARCH.

- 12th (WED.).—B.B.C. Dramatic Critic.
 13th (THURS.).—B.B.C. Music Critic Talk by R.S.G.B.
 14th (FRI.).—The Prime Minister.
 15th (SAT.).—The Savoy Bands.
 17th (MON.).—B.B.C. Literary Critic. Sir William Bragg.
 18th (TUES.).—Captain P. P. Eckersley. H.R.H. the Prince of Wales

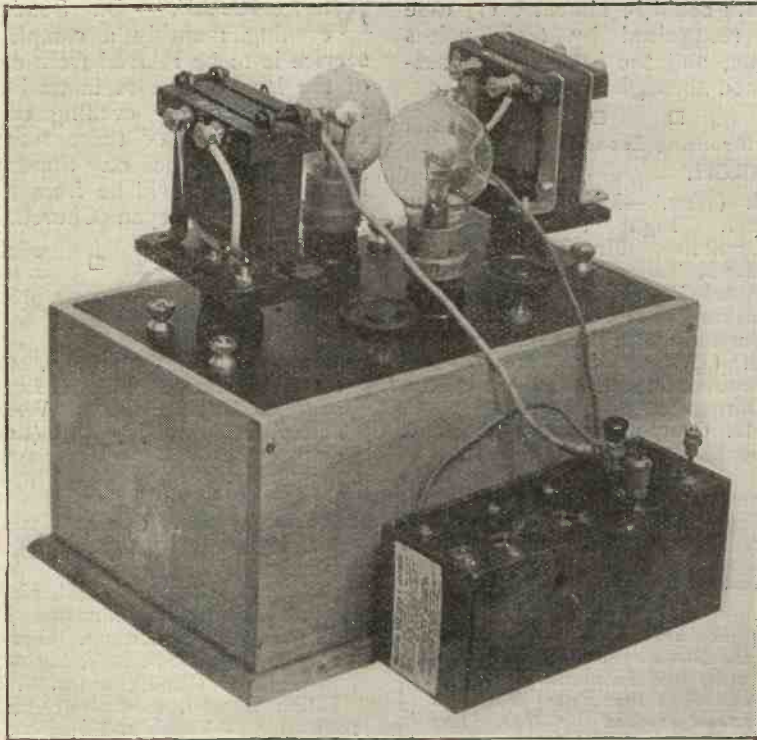

Fig. 1.—Note the method of applying negative bias to the grids of the valves.

Introductory

TO operate a loud-speaker in such a way that it will produce the greatest volume of *undistorted* sound, it is well known that it is desirable to use large valves with a high value of anode voltage and a carefully adjusted grid potential. In other words, a power amplifier is needed, which is simply a note magnifier designed with some care to eliminate interaction between circuits and any consequent tendency to howling, suitable transformers being chosen to carry the fairly heavy currents which may flow in the amplifier and some switching arrangement or other device provided for the adjustment of grid voltage. It must be realised that if a really large output is required the ordinary small receiving valve is quite unable to cope with the energy which will flow in the final circuits and will inevitably introduce a certain amount of distortion if used. Even upon the more moderate volume customary when reproducing broadcast music and speech in a room of ordinary size, a noticeable improvement in quality can usually be obtained by the use of what are known as power valves under

proper conditions of plate and grid potential, and the practice is to be commended to all experimenters who possess a little skill in handling valves.

The reason for the improved quality is to be found in the fact that to obtain distortionless amplification it is essential that the potential of the grid of the valve shall be carried by the varying signal-voltages up and down the *straight* part of the characteristic curve of the valve, and *not* round the top or bottom bends. Now, with an ordinary receiving valve the really straight part of the characteristic may be relatively short, and hence powerful signals, such as are present in the last stage of a low-frequency amplifier, will send the operating point round the bends, with consequent distortion. The only remedy is a valve whose characteristic has a long straight portion, such as the power or "loud-speaker" valves which have been mentioned. These valves are specially made for the purpose and are intended to be used with a high plate voltage, the actual value depending upon the particular type of valve, and a considerable negative "bias" upon the grid.

An Experimenter's Power Amplifier

By G. P. KENDALL, B.Sc.,
Staff Editor.

Grid Bias

The question of grid bias is, of course, vital to the securing of good reproduction, since we are concerned here with another possible source of most serious distortion, namely, grid current. Remember, that if at any moment the grid becomes positive, grid current will flow, and the result will be that the tops of the positive halves of the signal currents will be cut off, with consequent distortion. The remedy for this type of imperfect reproduction is the expedient of applying a steady negative potential to the grid by means of a battery of such a value that the signals carry the operating point above and below this steady potential, but never make the grid actually positive. The actual adjustment of the negative bias must obviously be done with some care, since if the bias is too small it will not be sufficient to prevent strong signals from making the grid positive, while if it is made too great the operating point will be near the bottom bend of the characteristic and strong signals will carry it actually round the bend.

It will be realised that only

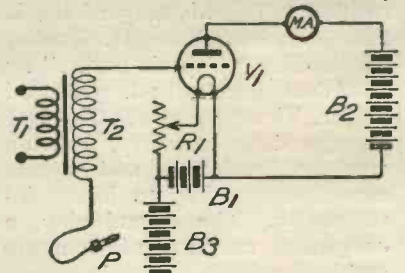

Fig. 2.—Showing how grid cells are used. The milliammeter M.A. indicates the effect of a given grid potential.

Besides the usual constructional details of a very simple but successful amplifier, this article contains a clear outline of the practical side of power amplification, which should prove most helpful to the less experienced reader

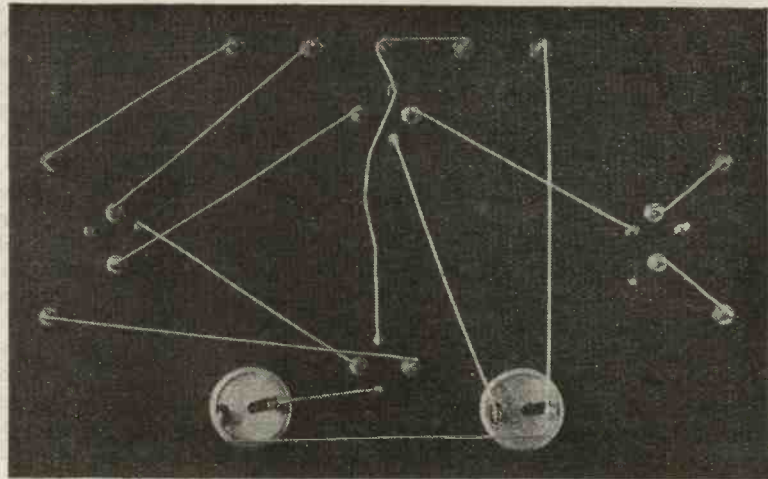

Fig. 3.—A view of the underside. The wires which cross are separated by a space of an inch or more.

that portion of the characteristic curve which lies to the left of the zero grid volts line can be used, and therefore it should be made a rule to keep as much of the curve as possible to the left of the line. This can be achieved by applying a suitably high plate voltage, since the effect of so doing is to shift the whole curve bodily to the left. The actual value to be used will obviously depend upon the type of valve employed, but it may be taken as a rule that nothing less than about 200 volts is much use with a power valve of a size capable of giving the required distortionless amplification of large energies.

How to Adjust Grid Bias

The adjustment of the grid bias is actually not very difficult if a method such as that about to be described is employed, and the operator carries it out with a reasonable amount of care. It should first be explained that the present writer is most strongly of the opinion that the possession of a milliammeter is essential to the successful use of a power amplifier; lacking such a measuring instrument one is simply working

in the dark, and can only proceed by laborious trial and error methods, which may easily be wasteful of high-tension batteries as well as time. A suitable instrument will have a scale reading up to about 50 milliamps and may be obtained for about 30s. (One of the cheaper variety will serve, since very great accuracy is not essential.)

Before detailing the method of adjustment, it may be well to explain briefly how the negative bias is actually applied to the grid of the valve. The simplest expedient is to use a battery of dry cells (a 30-volt H.T. battery with tappings is very convenient) connected into circuit, as shown in Fig. 2. The positive of the battery is connected to the negative terminal of the filament accumulator, while the end of the secondary winding of the intervalve transformer terminates in a piece of flexible lead carrying a wander plug P, which can be inserted in any desired socket in the battery. Any required negative potential can thus be communicated via the transformer secondary to the grid of the valve.

increasing the bias step by step until the anode current drops to one milliamp, whereupon the actual voltage upon the grid should be estimated. The correct normal bias to use is one half of this value. This is perhaps a rather crude and empirical method of adjustment, but it is quite effective in practice, and results in fixing the steady potential of the grid at the correct value without difficulty.

General Constructional Details

The construction of an effective power amplifier is not a matter of great difficulty if a little care is taken to simplify the design so that the transformers are well separated and the wiring is kept short, direct, and spaced out. It is generally best not to attempt to include switches for varying the number of valves in use, since the resulting complication in the wiring is liable to give trouble, although good design and careful wiring-up will reduce it to negligible proportions where switches are for some reason essential.

The instrument illustrated in this article was designed to meet the need for a quite simple power amplifier capable of giving really good results, yet permitting a certain amount of experimental work to be done. Its actual construction is exceedingly simple, so simple, in fact, that little detailed description need be given to enable it to be made.

The necessary parts are given in the following list:—

- 1 ebonite panel, 10 in. x 6 in. x 1/4 in.

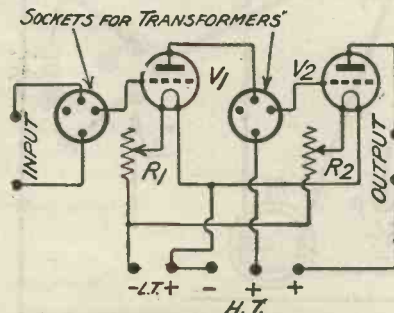

Fig. 4.—A schematic diagram of the connections of the amplifier.

1 wooden box to carry the panel, 3 in. or a little more in depth.

- 8 valve pins.
- 4 valve holders.
- 2 pieces of ebonite, each 3 in. \times $1\frac{1}{2}$ in. \times $\frac{1}{4}$ in.
- 2 filament rheostats.
- 9 terminals.
- 2 L.F. transformers.

Some No. 18 bare tinned copper wire for connections.

Transformer Mountings

A feature of a somewhat unusual nature is the method of mounting the intervalve transformers in this amplifier; as may be seen on referring to the photographs, they are not attached in the ordinary way to the underside of the panel, but are mounted so as to be interchangeable in exactly the same fashion as are high-frequency transformers of the plug-in type. They are attached with screws and nuts to pieces of ebonite measuring 3 in. long by $1\frac{1}{2}$ in. wide, in which are screwed valve pins so that the whole may be plugged into a valve holder. The necessary two valve holders to carry them are placed as far apart as possible at opposite ends of the panel, and wired into circuit in the manner shown in the wiring and circuit diagrams.

It will be noticed that only three of the sockets of each of these valve holders are connected into circuit, and the fourth is left blank. The ends of the primary windings of the transformers are wired to the pins corresponding to the plate and grid sockets of the holders, and one end of the secondary is joined to one of the "filament" pins. The socket corresponding to this pin is connected to the grid of the appropriate amplifying valve. To the other secondary terminal is attached a short flexible lead carrying a plug at its end, which is inserted in one of the sockets of the grid battery.

Grid Cells

The grid battery may be a 36-volt H.T. unit placed alongside the amplifier so that the wander plugs from the transformer secondaries may be conveniently manipulated. The positive terminal of this battery, of course, is connected directly to the negative terminal of the filament battery.

Wiring

The actual connections of the parts on the panel will be best followed from the wiring diagram, but it should perhaps be explained that no attempt has been made to indicate the I.P., O.P., etc., of the transformers, since the correct connections are best found by actual experiment. Connect up the two primary and one secondary terminals as has been explained, and try the effect of reversing the leads to first the primary and then the secondary, noting the results. One arrangement will be found best, and should be made permanent, the testing being done for first one transformer and then the other. If any howling occurs, it is to be noted, the cure is usually to reverse the two leads to the secondary of the first transformer.

Transformers

The type of transformer to use is one of some importance. It must be realised that the small cheap type is quite useless for power amplification, and the only kind which can be successfully employed is the large robust pattern guaranteed to withstand high voltages. It is actually some advantage to use two transformers of different makes, since purer reproduction can be obtained in this way. The object of mounting the transformers so that they are interchangeable, of course, is to enable different types to be very easily compared and tested by plugging them in and noting the strength and purity of a given transmission. The change from one transformer

to one of another make can be made almost instantaneously, and very accurate comparison is therefore possible.

Valves

There are a number of good power amplifying valves upon the market which are quite suitable for use in this instrument, the one usually employed by the writer being the Mullard P.A.2. This valve gives very good and pure reproduction with between two and three hundred volts on the anode and about fifteen volts negative on the grid.

Batteries

A point which is often overlooked concerning power amplifier work is that of the H.T. supply. It must be concluded that the majority of the smaller H.T. batteries are incapable of standing up to the heavy load thrown upon them by a couple of power valves, and it is really essential that some larger type of cell should be used. The accumulator type is no doubt ideal where expense is not a primary consideration, but for the average experimenter the best solution is probably to be found in the larger-sized units made by Messrs. Siemens. A separate battery should *always* be used for the amplifier as distinct from the receiving set proper, and a separate filament accumulator is also a slight advantage. If this latter is used, it should be of fairly large size (power valves consume a good deal of current), and its negative terminal should be connected to earth.

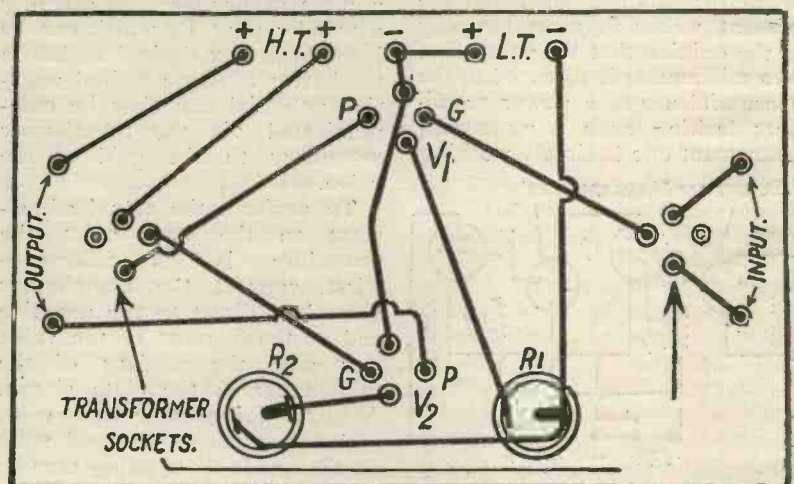

Fig. 5.—Working diagram of the internal connections.

C.W. and Telephony Transmission Using Valves

No. IX.

By JOHN SCOTT-TAGGART, F.Inst. P., A.M.I.E.E.

This series of articles began in Vol. 3, No. 6

Rectification of A.C.

IF we are desirous of transmitting pure continuous waves, we must not use an intermittent anode current supply, nor must we use an alternating source to feed the anode circuit of the valve. Those methods produce interrupted continuous waves, and we must rectify the supply currents if we are to obtain pure continuous waves.

bottom plate of C. Since these electrons cannot leak through C, the potential of the bottom plate becomes very highly negative with respect to the top plate; in other words, the terminal Y will become positive with respect to the terminal Z. The condenser, being of large capacity, acts as a store or reservoir for the rectified electric current, and we can use the terminals Y Z for connecting

frequency equal to the frequency of the alternating current supply which should, therefore, be of as high a frequency as possible (preferably not less than 1,000).

The reservoir condenser C may be compared to a reservoir having a stream running into it and an outlet pipe. If the reservoir were empty, any irregularities in the inflowing water supply would produce irregularities in the flow of water through the outlet pipe. If the reservoir, however, is full of water, a steady outlet supply of water is ensured however irregular the stream may be in its supply of water to the reservoir. In this analogy the stream corresponds to the rectified pulses which charge the condenser.

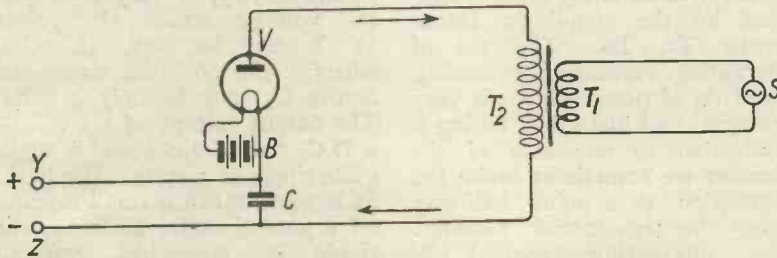

Fig. 20—Illustrating the theory of valve rectification

The theory of alternating current rectification by means of a valve has been considered, but we will briefly re-explain the subject by referring to Fig. 20. A valve has in its anode circuit a secondary T₂ of a transformer, the primary T₁ of which is fed by a source of alternating current; a large condenser, C, of, say, 2 mfd., is also included in the anode circuit. The condenser C allows the high voltage alternating potentials to be communicated through it; the anode is therefore given an alternating voltage which, when it makes the anode potential positive, will cause a flow of electrons from filament to anode, through T₂ to the bottom plate of C. The negative half-cycles which influence the anode, repel electrons, with the result that no current flows round the anode circuit. The effect of supplying alternating current to the two-electrode valve rectifier is to produce a large accumulation of electrons on the

in a valve transmitting circuit just as we would use the terminals of a high voltage dynamo. Since the condenser C is of large capacity and the current drawn from it is small, the current which it will supply to a valve transmitter will be almost pure D.C. There will, however, usually be a slight ripple which will have a

Fig. 21 shows a complete wireless transmitter in which the source of direct current is a rectifier unit consisting of a two-electrode valve, V₂, supplied with alternating current, which may come from an alternator or from the secondary of an induction coil as shown in the figure. The induction coil may be worked off the accumulator B₁ with another accumulator B₃ in series with it

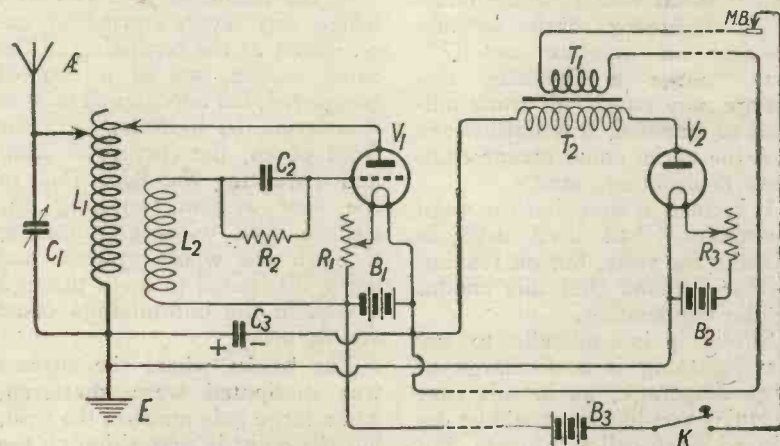

Fig. 21—A complete transmitting circuit using rectified A.C.

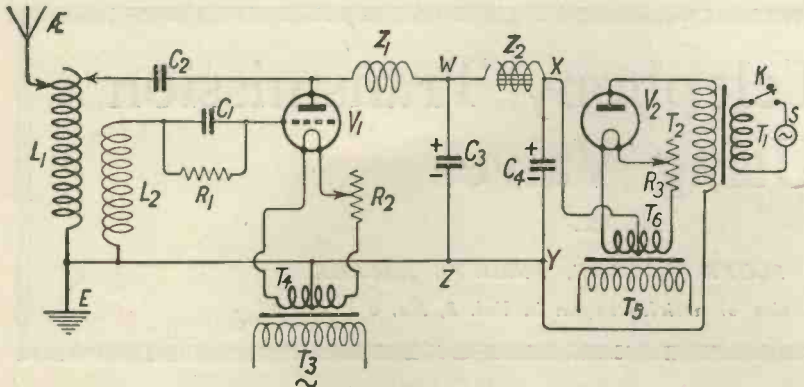

Fig. 22—A circuit for high-power transmission

if the voltage of B₁ is not sufficient. It must be noted that the filament of a rectifier valve, while negative with respect to the anode will be positive with respect to the negative side of the reservoir condenser; consequently we can never heat the filament of the generating and rectifying valves off the same accumulator. One or other of the filament batteries will have to be highly insulated according to its position; in Fig. 21 the accumulator B₁ should be highly insulated.

Fig. 22 shows a high-power valve transmitter using separate D.C. and oscillatory circuits and employing a rectifier. The usual choke coil Z₁ is provided, and also an iron-core choke Z₂. Two condensers, C₃ and C₄, are arranged as shown, and these, together with the choke coil, Z₂,

act as a ripple eliminator, which prevents the slight ripple on the direct high-voltage current supplied by C₄ reaching the anode of the valve. The filament of the valve V₁ is shown heated by the step-down transformer T₃, T₄; the filament of the rectifier valve V₂ is similarly heated by alternating current supplied by the step-down transformer T₅, T₆. The use of alternating currents for heating filaments of power valves is very common, and instead of taking a connection to one side of the filament we sometimes make the connection to a point half-way along the transformer winding. The alternating current is stepped up by the transformer T₁, T₂ before being supplied to the rectifier valve V₂, and the signalling key K may con-

veniently be connected in the position shown.

Great care is always taken to insulate the transformer windings which supply currents to the filaments. The same source of A.C. may be employed both for heating the filaments and for supplying the anode circuit of V₂.

Action of Ripple Eliminator

The action of the ripple eliminator of Fig. 22 is very simple. Let us suppose that the D.C. voltage across C₄ is 2,000, and that superimposed on this is an A.C. ripple of 50 volts. This ripple being of an alternating nature will pass through the choke Z₂, and the condenser C₃. The A.C. voltage across X Y, and therefore across X Z, will be 50, and this will be spread over the choke Z₂ and condenser C₃. As the choke offers a high impedance to the A.C. and the condenser C₃, a very low one, the voltage across the points W X may be, say, 45 volts, whereas the potential variations across C₃ may be only 5 volts. The output voltage of C₃ will be a D.C. one of 2,000 and a negligible ripple of 5 volts. We have, as it were, taken a small tapping off a potentiometer as far as the ripple is concerned, without affecting the D.C. voltage which is unaffected by the low resistance choke Z₂, and which cannot pass through C₃.

DEAR SIR,—In your issue dated February 20, and under the article headed "Some Simple Wireless Questions Answered," you state in answer to the question "What would be the effect of a lightning flash actually striking an amateur aerial?" that "Since a lightning discharge may consist of some millions of amperes, it is hard to see how the aerial could escape complete destruction, etc."

It seemed at first that the word "amperes" had been used in mistake for volts, but on reading further I found that this cannot be the explanation.

Surely it is a mistake to say that lightning is a discharge of large amperage, as in this case lightning conductors would be destroyed when called into use, but we do not find this to be the case.

.....
LIGHTNING

In the Island of Java recently, where very severe storms are experienced at the beginning of the rainy season, one of a row of completed, but unoccupied houses was struck by lightning over the front porch, the current striking and disrupting the King Post of the roof system, entering the electric light wires and passing through the whole system, and being dissipated to earth through a wall in the outbuildings some 100 ft. away.

The bricks where the current was dissipated were shattered, and a large hole made in the wall, but the point is that although the insulation of the electric cable

was destroyed by puncturing, thus necessitating renewal, the cable itself was intact, which would have been impossible had the amperage been as you state.—I am, Yours faithfully,

W. ALAN GIBBINGS.

(A reply to this letter will appear next week.)

.....
RADIO SOCIETY OF GREAT BRITAIN

An Informal Meeting of the Radio Society of Great Britain will be held at the Institution of Electrical Engineers at 6 p.m. on Wednesday, March 12th, at which Mr. F. Phillips will open a discussion upon "Amplifiers for Short Wave Reception."

.....

An Experimenter's Unit Receiver

By H. BRAMFORD

The following is the sixth of a short series of articles which began in Vol. 3, No. 9

Unit No. 5

This unit takes the form of a valve panel, having a filament resistance and a valve adaptor. A photograph of the complete unit is shown in Fig. 25, which illustrates the front of the panel.

Materials Required

- 1 piece of ebonite measuring 6 in. x 4 in. x $\frac{1}{4}$ in.
- 1 valve holder.
- 1 valve.
- 1 filament rheostat.
- 4 terminals.

Panel Drilling

Details of the panel drilling are shown in Fig. 24. Four holes are drilled to clear the terminal screws. A large hole is drilled to

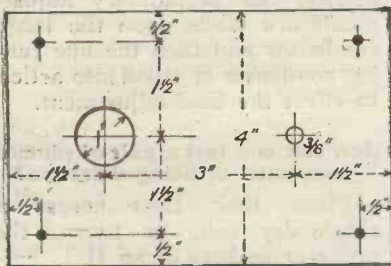

Fig. 24.—Drilling dimensions of the panel.

clear the four pins of the valve holder; or, alternatively, four holes may be drilled to receive four valve sockets. The remaining hole is drilled to clear the spindle of the filament rheostat.

Assembling

First mount upon the panel the four terminals G, P, F -, and F +, as shown in Fig. 26. Next attach the valve holder to the upper side of the panel. The rheostat is mounted on the under

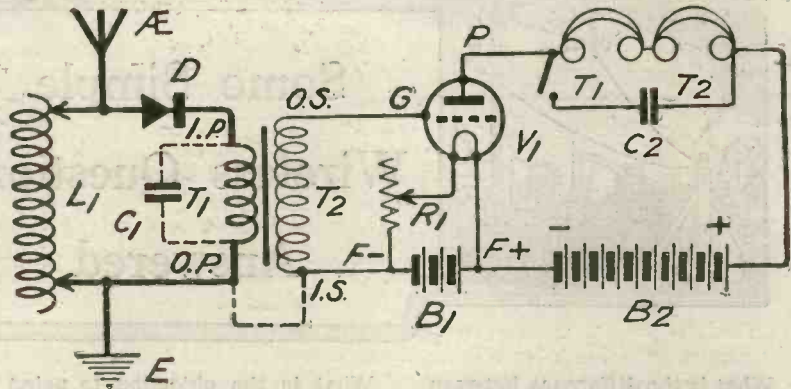

Fig. 27.—A circuit formed by connecting the units already described. The valve V1 acts as a low-frequency amplifier of the signals received on the crystal circuit.

side of the panel, the projecting spindle being fitted with an ebonite knob and pointer. An ivory scale placed centrally with the rheostat completes the assembly.

The connections are made in the following order. The grid leg of the valve holder is connected to the terminal G, and the

an ordinary crystal circuit, using unit No. 1 for the aerial tuning inductance, to which is added the low-frequency amplifying unit No. 4. The connections of the transformer and the valve panel are clearly shown in the circuit diagram. The dotted connection is optional, and some improvement may be obtained by placing a 0.002 μ F fixed condenser across the primary of the transformer. Using this circuit very comfortable volume can be obtained, even when employing several pairs of telephones, over distances of about ten miles or so. With one or two pairs of telephones the circuit may, of course, be expected to give good results over longer distances.

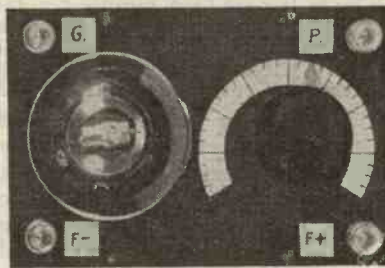

Fig. 25.—Plan view of the front of the panel.

plate leg of the holder is connected to the terminal P. One of the filament legs of the valve holder passes to the rheostat, from which connection is made to the terminal F -. The remaining leg of the valve holder is connected direct to the terminal F +.

Testing

To test the connections made, pass a lead from the negative terminal of the accumulator to the terminal marked F -, and another lead from the positive terminal of the accumulator to the terminal marked F +, using four volts. The filament of the valve should then light up.

Operation

By using this unit in conjunction with the low-frequency transformer, we may operate the circuit shown in Fig. 27. This is

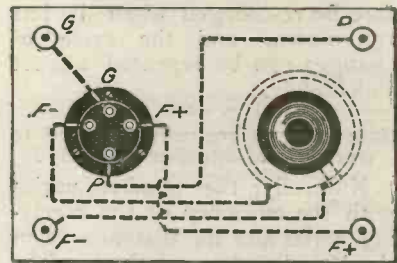
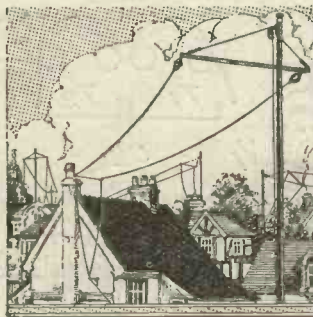

Fig. 26.—The wiring arrangements.

For the experimenter who is just within range of one of the broadcasting stations with his crystal unit, this unit 5 will render his reception an easier and more comfortable amusement. Further circuits will be described in due course, using the valve as a detector.

Have you read this month's "Modern Wireless"?

It is the finest constructional number ever published.



Some Simple Wireless Questions Answered

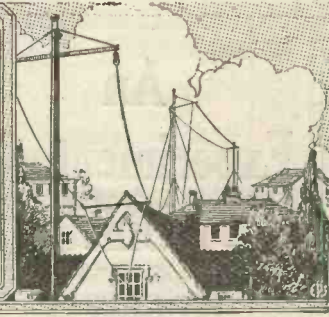

What is the difference between primary and secondary batteries?

A primary battery is one in which the chemical change which produces the electric current is not easily "reversible," that is, the substances which result from the change cannot be re-converted into their original form by passing a charging current through the cell in reverse direction. Hence, when all the active substance has reacted with the exciter, the cell is "run down."

A secondary battery, on the contrary, operates by virtue of a chemical change which can be reversed by passing a current through it in the opposite direction to that given out by the battery. The materials composing the cell are thereby restored to their original form, and will once more react and give out a current from the terminals of the battery. The battery can therefore be re-charged when it has run down, and the cycle of changes can be repeated almost indefinitely.

How many valves must be used to work a loud-speaker properly?

Naturally, the number varies with the efficiency of the receiving aerial and its distance from the broadcasting station. The following figures assume an average-sized outdoor aerial, and should give a general idea of the required amount of amplification:—

Up to 10 miles—Crystal and two low-frequency valves.

10—40 miles—H.F., detector with reaction, and L.F.

40—80 miles—H.F., detector with reaction, and two L.F.

Above 80 miles—Two H.F., detector with reaction, two L.F. These are the minimum numbers of valves for *consistent* reception, and without much skill in manipulation.

What is the objection to using a gas pipe as an earth connection?

Partly because, owing to the number of "red leaded" joints which usually occur in the average household installation, the conductivity may be very poor. A further and perhaps a more important objection, however, is the possibility of a heavy static charge induced in the aerial by a passing thundercloud causing sparks to occur at the bad joints, with the risk of fire.

Why is it that in a simple crystal set the current passes through the high resistance of the crystal and phones instead of through the low-resistance tuning coil?

It must be remembered that although the tuning coil may have a low ohmic resistance, yet it offers a considerable impedance to currents of the frequency to which the circuit is tuned, and hence such currents produce appreciable differences of potential across its ends, which cause currents to flow in the detector circuit.

Is it better to run a long earth lead in order to reach a main water pipe close to the ground or to connect to a water pipe on an upper floor, using only a short wire?

In all probability the best results will be obtained by using a short stout connecting wire to the nearer water pipe. It should not prove a difficult matter, however, to try each arrangement in turn and note the results actually obtained.

Why should the aerial down-lead be kept as far away as possible from an iron rain-water pipe?

If the down-lead is allowed to run parallel with and fairly close to the iron pipe in question, the latter exercises a considerable screening effect, preventing the down-lead from assisting the

aerial proper in the collection or absorption of energy. In addition to this, the pipe being earth connected, forms, along with the down-lead, a condenser and may account for considerable losses due to "capacity leakage" to earth.

What is a vernier condenser, and what is its use?

The word Vernier is being very carelessly used nowadays in connection with almost any piece of wireless apparatus which affords a particularly exact adjustment. A better name altogether would be "fine tuning" condenser. Such a condenser is simply a small variable condenser, comprising only three or at the most five plates, so that a considerable movement of the controlling knob and dial gives only a small change in capacity. By connecting a condenser of this description in parallel with a large variable condenser, the preliminary adjustments are made upon the large condenser and then the fine tuning condenser is called into action to effect the final adjustment.

How can one test a pair of phones suspected of being defective?

Place their tags across a single dry cell, or two of the adjacent sockets of an H.T. battery, and note whether a click is produced at make and break of the circuit. No click indicates a break in either cords or windings. Replace the cords with temporary leads and try again. If there are still no clicks the fault is in one or both of the earpieces. Short-circuit first one and then the other with a piece of wire, and repeat the test. If shorting one earpiece enables clicks to be heard in the other, the shorted one is at fault. If no result is obtained by shorting either, both are faulty.

A Small Condenser for Neutrodyne Circuits

THOSE who make up either the original neutrodyne circuit or any of the modifications appearing from time to time in the pages of *Wireless Weekly* and *Modern Wireless* may have found it rather difficult to construct satisfactorily the tiny variable condensers required for effecting the stabilising coupling. What one wants is an easily made condenser of

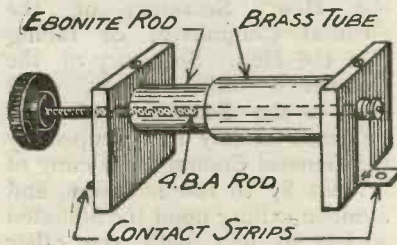

Fig. 1.—Illustrating a simple form of condenser.

very small capacity which will allow adjustments to be made quite simply, and which will stay fixed once the correct setting has been found.

A very simple form of condenser can be made up as shown in Fig. 1, which shows the finished apparatus. It consists of an ebonite rod covered over part of its length with copper foil and mounted between two end-pieces provided with terminals, or connecting strips for soldering. Through a tapped hole drilled along the long axis of the rod passes a piece of 4B.A. studding provided with a small ebonite knob. The metal covering of the tube forms one plate of the condenser; the screwed rod the other. If the knob is turned so that the length of studding is screwed further in, a larger and larger portion of it is brought within the tube, and the capacity is consequently increased. When the knob is turned in the other direction, the rod is withdrawn, and the capacity can be reduced to a negligible amount.

The two end-pieces (Fig. 2) are made from $\frac{1}{2}$ -in. ebonite drilled as shown in the drawing. The large hole is $\frac{1}{4}$ in. in diameter in one end-piece and $\frac{3}{8}$ in.

in the other. The 4B.A. tapped hole running from the top edge into the large hole is for the set-screw which will hold the rod in place; the others in the lower edge are meant to take the screws which will secure the condenser to the panel.

Obtain a piece of $\frac{1}{2}$ -in. diameter round ebonite rod 2 in. in length and a piece of brass tubing $\frac{3}{8}$ in. outside diameter and 1 in. in length. Rub the ebonite rod down a little with emery cloth until it can be forced into the tube; then drive it in until the ends of tube and rod are flush. Solder a strip of brass $\frac{1}{4}$ in. wide and 2 in. long to the tube quite close to its end. Now drill and tap a 4B.A. hole right through the rod from end to end, taking care to see that it runs centrally. Insert the brass-covered end of the rod into the end-piece with the large hole in it, and fix it in place with a set-screw. Place the other end in the second end-piece and fix it in the same way. To the outer face of these end-pieces fix by means of a pair of screws a strip

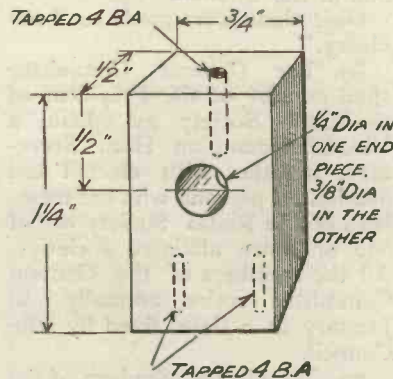

Fig. 2.—Constructional details of the end pieces.

of stout sheet brass in which is drilled and tapped a 4B.A. hole registering exactly with that in the rod. This brass strip is to form a contact for the rod, just as the other will be a contact for the tube. They may be either bent round and fitted with terminals in a convenient fashion, or they may be cut off fairly short and left as soldering tags.

Take a $2\frac{3}{4}$ -in. length of 4B.A. studding, taking care to see that it is straight and that the threads have not been injured in any way. Fix a small ebonite rod to one end of it by making a 4B.A. tapped hole in the ebonite and screwing a lock nut up against it. Place another nut upon the studding and screw it into the hole in the rod. The apparatus may now be mounted upon the panel. To use it, turn the knob in either direction until the correct neutralising capacity has been found. The way in which the correct condenser value may be determined has already been described fully in the pages of this journal. As soon as the correct adjustment has been obtained, tighten down the lock nut which holds the rod firmly fixed and prevents it from being thrown out of adjustment accidentally.

R. W. H.

A Soldering Hint

THOUGH resinous or greasy fluxes are extremely easy to solder with and have the big advantage that they produce no corrosive effect upon metals they have one very great drawback for certain kinds of wireless work. All of them splutter a great deal when a hot soldering iron is applied. As most of these fluxes are comparatively good conductors a panel so splashed loses some of its insulating qualities. The effect is particularly serious when connections are made to the four legs of a valve holder for the presence of the splashes may provide paths from leg to leg.

For work of this kind the writer has found it much better to use Baker's soldering fluid. This is a clear liquid, sold in tins, which is very easy indeed to use. One simply brushes a little over the parts to be joined, and then uses the soldering iron in the ordinary way. No spluttering takes place, and even if it did it would not greatly matter, for the fluid quickly dries off and has no effect at all upon insulation. It is quite non-corrosive in its action, and is therefore most suitable for soldering even the finest leads.

R. W. H.

The Radio Society of Great Britain

Below we publish a very much condensed account of the proceedings of the annual meeting of delegates from the affiliated societies

THE fifth annual meeting of delegates from the Radio Societies affiliated with the R.S.G.B. was held on Saturday, March 1, with the President (Dr. Eccles) in the chair. In his introductory remarks the President explained that the meeting this year consisted solely of delegates and officials of the R.S.G.B., and went on to refer to the recent changes in the constitution of the Radio Society, describing them as a bloodless revolution. He hoped that now that these changes were accomplished complete unity would be restored in the amateur ranks, and conveyed the impression that he felt the need for such unity in the coming year would be greater than ever before.

The meeting then proceeded to consider the items on the agenda paper, the various resolutions passed being outlined below.

(a) A General Committee representing all the affiliated societies to be formed.

(b) The General Committee to be elected *mainly* by the affiliated societies.

(c) The General Committee to make representations to the Council of the R.S.G.B. on matters of national importance.

(d) The affiliated societies to be divided into groups, each group to elect one or more members of the General Committee. The General Committee to have power to co-opt additional members from bodies inadequately represented.

(e) The division of the societies into groups to be in the hands of the General Committee.

(f) The General Committee to be empowered to fix annually the fees of affiliation, these fees not to be reduced below the present figure without the consent of the Council.

A good deal of objection was made to the latter clause, but this resolution was ultimately passed almost unanimously.

The delegates then turned their attention to the memoranda of

association of the R.S.G.B., copies of which had been distributed, and proceeded to vote upon them. Amendments were made to embody the resolutions which had been passed, and the final form of the more important sections was as follows:—

Affiliated Societies

87. The Council may admit societies interested in the science of radio communication to the privileges of affiliation at any meeting of Council upon the recommendation of the General Committee.

88. The General Committee, which shall be advisory to the Council, shall discuss matters affecting the common interests of the Society and the affiliated societies, but shall not communicate in the name of the R.S.G.B. on such affairs of general interest with bodies or persons outside or other than the Society and its affiliated societies and their officers, without the special sanction of the Council.

Objections were made to "advisory."

89. The General Committee shall consist of the President of the Radio Society *ex officio*, a Vice-Chairman, an Hon. Secretary, together with elected and nominated persons who are members of the Radio Society or of one or more affiliated societies. All the members of the General Committee retire annually in January at a date fixed by the Council.

90. The elected members of the General Committee shall be elected annually in January. For this purpose the affiliated societies shall be divided by the General Committee into groups comprising not less than six affiliated societies as a rule. Each group shall have the right to elect to the General Committee one or more persons who shall be members of one or more societies belonging to the group, or, alternatively, a corporate member of the Radio Society. The

nominated members of the General Committee shall be nominated by the Council from their own membership in January of each year and shall be (in addition to the President) the Hon. Secretary, the Hon. Treasurer and three other persons.

91. In December of each year the Hon. Secretary of the General Committee, or failing him the Hon. Secretary of the Council or other officer, shall send to the Secretary of each affiliated society as grouped by the General Committee a copy of articles 87 to 100 inclusive, and a notice calling upon the affiliated society to join with the other societies of its group in nominating an agreed representative on the General Committee. The name of the agreed group representative should reach the Hon. Secretary of the Group Committee before the 20th January. Failing the submission of an agreed name, the General Committee shall take such special steps as they think fit to obtain representation of the group.

92. For the first election of the General Committee the affiliated societies may be divided into groups at a conference of the affiliated societies to be held in March, 1924. Subsequent General Committees shall be elected by groups created by or approved by the preceding General Committee.

93. No member of the General Committee shall be eligible to serve in the same capacity more than three years in succession.

94. Any casual vacancy occurring in the elected members may be filled by the groups affected within two months, failing which it will be filled by the General Committee, and in the nominated members by the Council.

95. The General Committee shall after the annual election forthwith appoint a Vice-Chairman and Hon. Secretary from among their own number, and shall elect three of their members

who are not already members of the Council to serve on the Council.

97. The General Committee shall meet at least twice in each year and at a time and place fixed at the preceding meeting or by the officers. Special meetings shall be held by direction of the Council, the President or the Vice-Chairman; and the President shall call a special meeting on being requested in writing by ten members of the General Committee within 14 days of such requests.

100. The General Committee

has no authority to expend or pledge any part of the income or property of the Society, but the Society shall defray all necessary administrative expenses incurred by the Hon. Secretary of the General Committee in the conduct of the correspondence of the General Committee.

The meeting then proceeded to elect a provisional General Committee from amongst the delegates present, this Committee to serve for either the full year, or until such time as their societies should hold proper elections. This occupied almost the whole

of the remaining time available for the meeting, and it will be interesting to note whether the affiliated societies will accept the representatives who were thus elected for them.

The remaining business comprised a resolution proposed by the representative of Derby that a national research fund be raised (carried *nem. con.*), a report by General Holden of the preliminary work of the Standardisation Committee, and an outline by the President of the present position regarding the issue of transmitting licences.

A Novel Frame Aerial Pivot

THE frame aerial has been coming more and more into general use of late owing largely to its convenience and to the fact that many people much object to erecting an outside aerial in their gardens. The frame is compact and handy; it is markedly directional, which means that by its use a great deal of interference can be cut out; it is also absolutely safe in thundery weather. One does not expect, of course, to obtain the same signal strength with a given set upon the frame as with an outdoor aerial of good height and length. But one can compensate for the loss in strength by adding one or more stages of high-frequency amplification, and full use may be made of reaction for the same purpose without there being any fear of causing interference with other people's reception.

The main drawback to most of the types of frame aerial that have so far been designed lies in the fact that if they are provided with a rotary movement upon a vertical pivot there must be flexible leads which twist round the pillar when the frame is rotated. Here is a very simple little pivot mounting, which entirely does away with this drawback. Provided that the frame is made of light wood and is well balanced it will answer excellently for the purpose, and will be found most useful. Purchase a good-sized plug and jack—these may be bought quite cheaply from shops which deal in disposals goods—

and see that they are a good fit, so that there is little or no wobble when the plug is pushed home. Mount the jack in the top of a box about 12 inches square by 4 inches deep, as shown in the illustration. Two terminals should be fitted to the box to take the leads from the receiving set.

The jack is mounted, as shown in the upper part of the drawing,

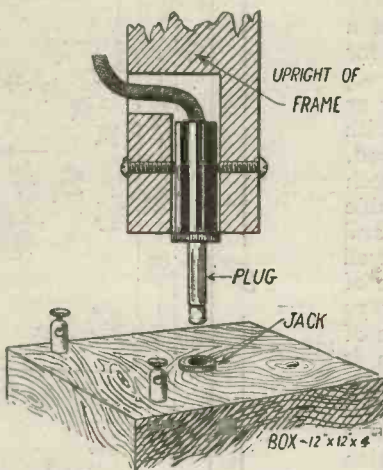

Fig. 1.—Details of the pivot.

in the upright of the frame. A hole into which it will just fit is drilled in the wood and another is made at right angles to this and running into it for the leads. The plug is held in place by means of a couple of wood screws, whose rounded points fit into little hollows made with a drill in the ebonite case. When mounting the plug the leads should first of all be pushed into

the hole at the side of the upright and brought out at its end. They are now fixed in the ordinary way to the plug, after which they are drawn up whilst the plug is being pushed home into its seating.

R. W. H.

SINGLE-VALVE COMPONENT SET

SIR,—I would just like to let you know what excellent results I get with the single valve component set described in *Wireless Weekly* of February 13, 1924. Using an R valve in this set and with Ducon plug, I get all B.B.C. stations, Brussels and L'ecole des Postes. This place is forty miles from Manchester and sixty miles from Birmingham. I have added an amplifier panel as described for the "All Concert" set. With this Manchester and Birmingham are comfortably loud on a loud-speaker, all the other stations just right on the 'phones.

R. A. GROSVENOR.

Chester.

636,000 WIRELESS RECEIVING LICENCES.

In a written reply to Sir Frederic Wise, the Postmaster-General states: On January 31 about 636,000 wireless receiving licences were in force; figures for February are not yet available. The total amount actually paid to the British Broadcasting Company by the Post Office up to date is £71,450; but subject to Parliamentary sanction, and to their obligation to return any ultimate surplus, as provided in their last agreement with the Post Office, the total amount which the Company will be entitled to receive in respect of the fees on these licences will be about £348,000.

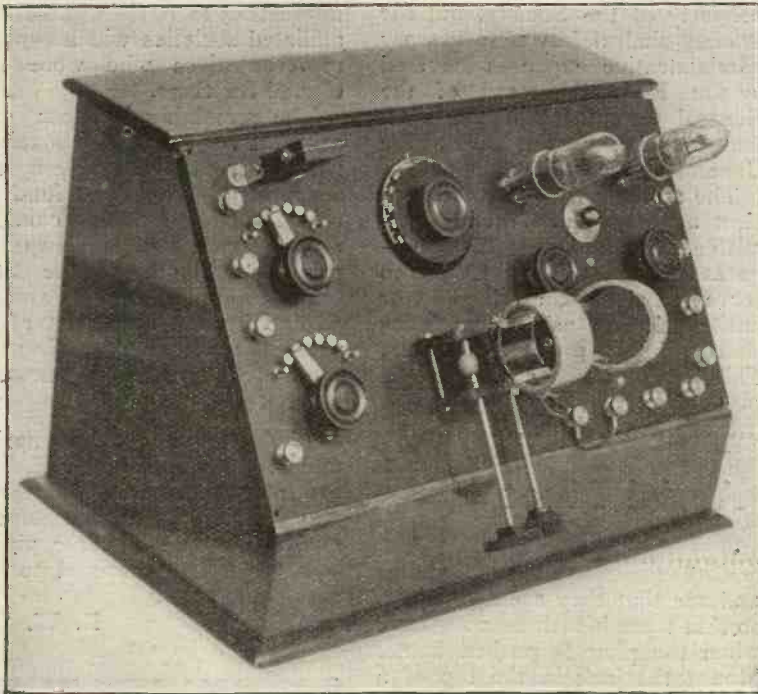

Fig. 1.—A view of the complete instrument.

How to Make a Se Panel R

TYPE

By HERBERT

A description of a two-valve set, in which the A giving goo

inductance and grid-tuning coil, which are wound upon a cardboard tube mounted behind the panel. Next, are the coil holder and variable condenser, while on the right of the panel are the valve sockets, filament resistances, and variable grid leak.

The circuit diagram is shown in Fig. 5, and it will be seen that, by connecting the aerial to terminal A, and earth to E, leaving A1 and A2 free, a circuit

of special de aerial port Li is contr and is coup and is coup portion, wh the switch the aerial is the aerial coil and this, whi ing signal selectivity. tuned by the condenser,

THOSE who favour a two-valve set will find the instrument described very efficient for the reception of broadcasting, while longer wave stations may be tuned in by the addition of a plug-in loading coil, provision for which is made on the panel.

The set may be used either as a single-valve detector, or with a note magnifier, as desired, while reaction is possible in both cases. The set is thus suitable for the reception of spark and continuous wave signals, as well as telephony, although the use of a separate heterodyne is always recommended for the reception of continuous waves. Provision is made for reversing the reaction coil by means of two terminals on the panel, from which two flexible leads go to the reaction coil socket on the two-coil holder, which is of the Cam-Vernier type sold by the Goswell Engineering Co. It may be remarked that this firm now supply a coil holder of this type, in which a special reversing device is incorporated, thus obviating the necessity for terminals on the panel.

A photograph of the finished set is shown in Fig. 1. On the left are seen the two six-point switches, controlling the aerial

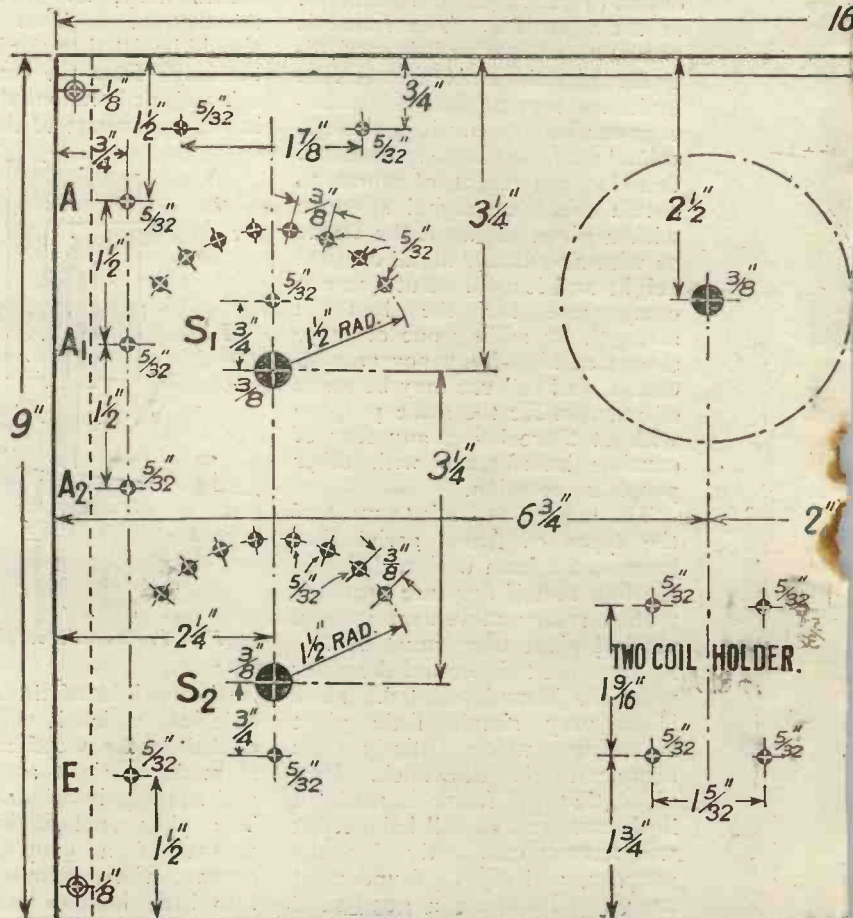

Fig. 3.—A half-size drilling diagram. Distances mea

Selective Two-Valve Receiver

W. 2.
K. SIMPSON.

American Haynes Circuit may be used if desired, and selectivity.

Design is obtained. The of the inductance by the switch S_1 , to the grid circuit is controlled by Thus, although periodic, portions of may be tapped off, there is no wise reduction in strength, increases The grid circuit is switch and variable while reaction is

applied by coupling the reaction coil L_4 to the coil L_3 in the grid circuit. The first valve acts as a detector, with the usual grid leak and condenser, and the second is a low-frequency amplifier. A simple circuit with a parallel condenser is obtained by joining the aerial to A_1 , leaving A and A_2 free. This incorporates the constant aerial tuning system, which makes initial tuning very easy; if it is not desired to use

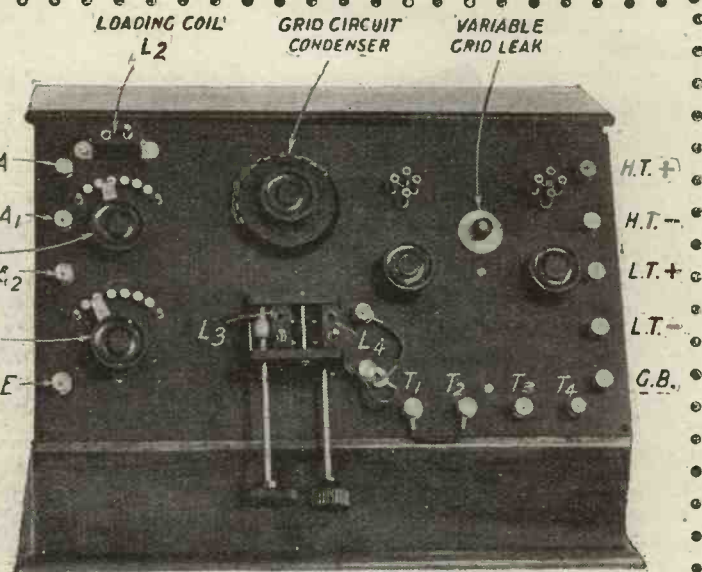

Fig. 2.—Another view of the set, with terminals marked.

this method of tuning, the aerial is connected to A_2 , leaving A and A_1 free. In this case the only tuning that has to be done is effected by means of S_2 , and the variable condenser, using the reaction coil as before.

One valve may be used alone by joining the telephones to terminals T_1 and T_2 , and if both are required, T_3 and T_4 become the telephone terminals while T_1 and T_2 are joined together.

The loading coil is represented in the circuit diagram at L_2 , which is shown dotted, with a dotted line shorting it. This is the coil, the socket for which is seen at the top left-hand corner of the set in Fig. 1, where a plug with its contacts joined together is shown plugged into the socket.

Component Parts

A list of the components required is given below, together with the price:—

Article.	£	s.	d.
Cabinet	0	18	0
Panel, 16 in. x 9 in.	0	6	0
15 4 B.A. W.O. type Terminals	0	2	6
1 Coil Plug for panel mounting	0	1	0
1 Coil Plug for shorting the above	0	1	0
2 Rotary Switch Arms, 1 1/2 in. radius	0	2	0
12 Studs	0	0	7
4 Stops	0	0	3
1 0.0003 Variable Condenser	0	5	0

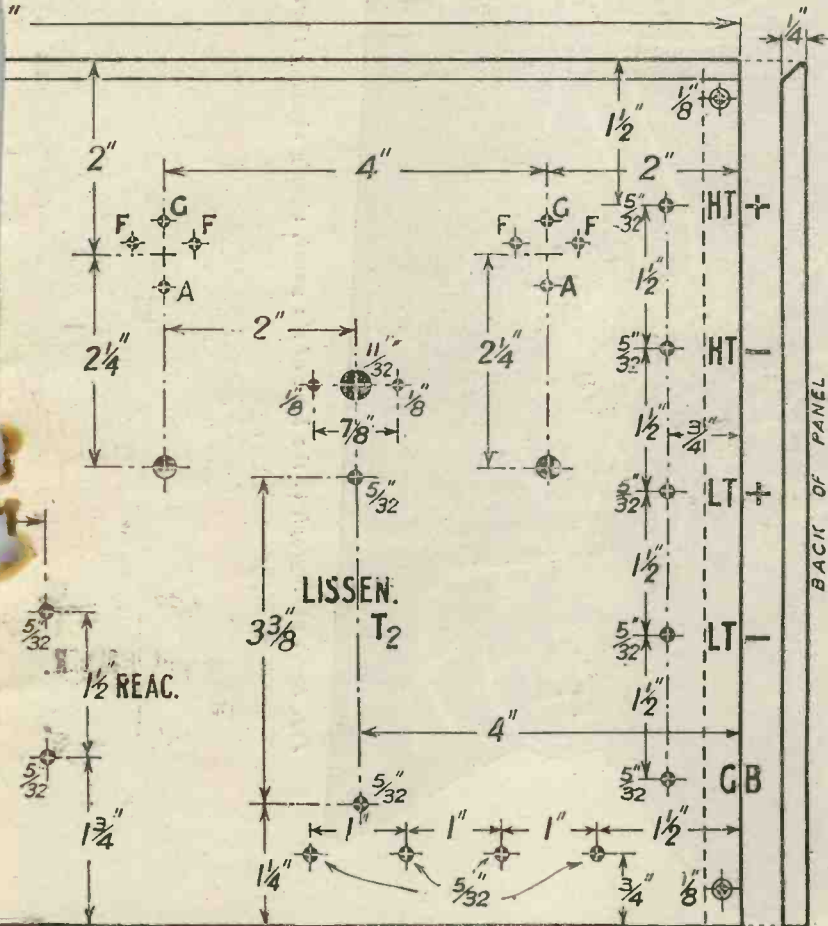

Measured off this figure with dividers should be doubled.

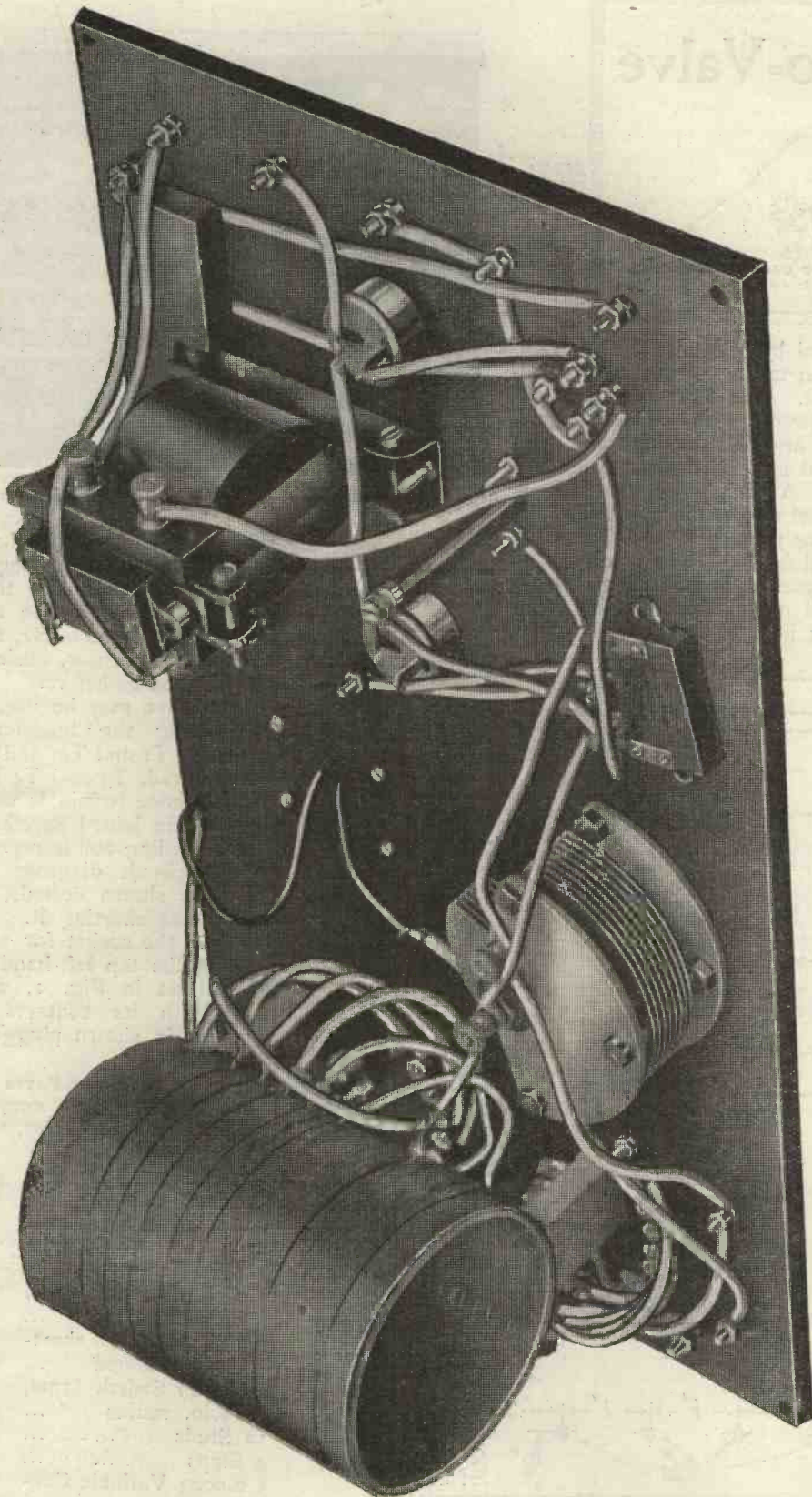

Fig. 4.—A photograph of the back of the panel, clearly showing the wiring and method of mounting the inductance.

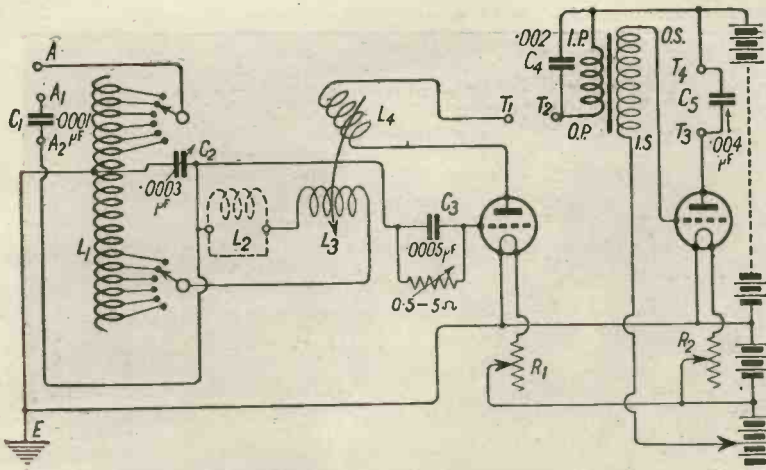

Fig. 5.—The circuit arrangement.

1 Two-coil Holder (Goswell Eng. Co.)	£	s.	d.
8 Valve Sockets (1s. per doz.)	0	7	6
2 "Microstat" Filament Resistances	0	0	8
1 Lissen T2 L.F. Transformer	0	5	6
1 Dubilier 0.0001 μF Condenser	1	5	0
1 Dubilier 0.0003 μF Condenser	0	2	6
1 Dubilier 0.002 μF Condenser	0	2	6
1 Dubilier 0.004 μF Condenser	0	3	0
1 0.5 to 5 megohm Watmel Grid Leak	0	3	0
Screws, etc.	0	2	6
	£	4	9
		0	

It is not essential that the components should be of the make specified, and the constructor may employ such parts as he may already possess, but if new components are to be purchased, it is always advisable to favour those of good repute.

The ebonite panel measures 16 in. x 9 in. x 1/4 in., but should be obtained slightly oversize, and filed square and to the exact dimensions. The surface should also be removed by rubbing with fine emery cloth, as this improves the insulation. A diagram showing the lay-out of the component parts on the panel is given in Fig. 7, and a dimensioned drilling diagram in Fig. 3. All the holes should be carefully marked with a centre punch to ensure the holes being in the correct place, and this is especially necessary in the case of the holes for the studs of the switches. A semicircle should be marked out, with the

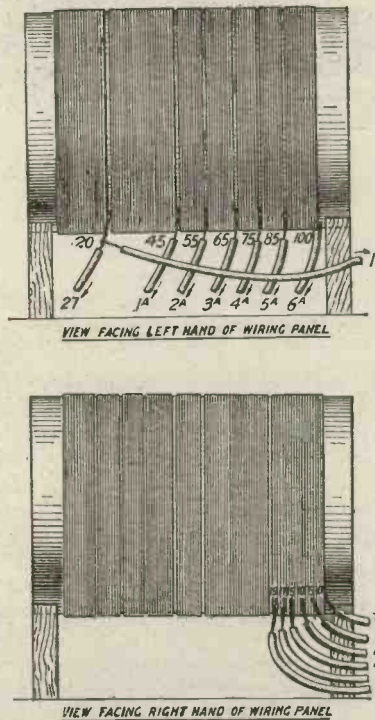

Fig. 6.—A close-up view of each side of the coil, showing the windings and the tapping points.

same radius as the switch arm, and the positions of the studs marked on this.

All holes may then be drilled, and the various components mounted. The inductance must now be made, of 100 turns of No. 22 d.c.c. wire, upon a 3 1/2 in. diameter cardboard tube, 5 1/4 in. long. This is tapped at 5, 10, 15, 17, 19, and 20 turns (making in all seven ends here, including the beginning of the winding); continue winding and take tapings at 45, 55, 65, 75, 85, and 100. To make these tapings, make a loop in the wire at the point where the tapping is to be made, and twist the wire round itself, thus making a permanent loop, and continue winding. Wires are then soldered on to each loop, after scraping off the insulation.

Looking at the underside of the panel, shown in the photograph, Fig. 4, it will be seen that the inductance is secured to the panel by two pieces of wood, 1 3/8 in. x 1 in. x 3/8 in., shaped to the curve of the cardboard tube, by means of two wood screws. The pieces of wood are screwed to the panel by one screw in each, the holes for which are seen in the drilling figure.

Connect the set of six tapings, 0 to 19, to the top switch, as follows:—(0-6), (5-5), (10-4), (15-3), (17-2), (19-1). Leave the tapping of the 20th turn free, and connect the next six tapings to the bottom selector switch in the following manner:—(45-1A), (55-2A), (65-3A), (75-4A), (85-5A), (100-6A).

Views of the coil, showing tapings, are given in Fig. 6. (To be concluded next week.)

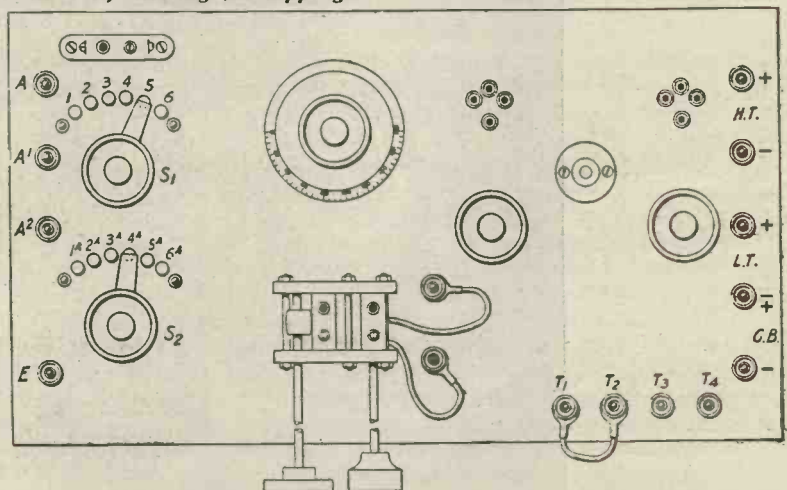

Fig. 7.—Showing the lay out of the parts upon the panel.

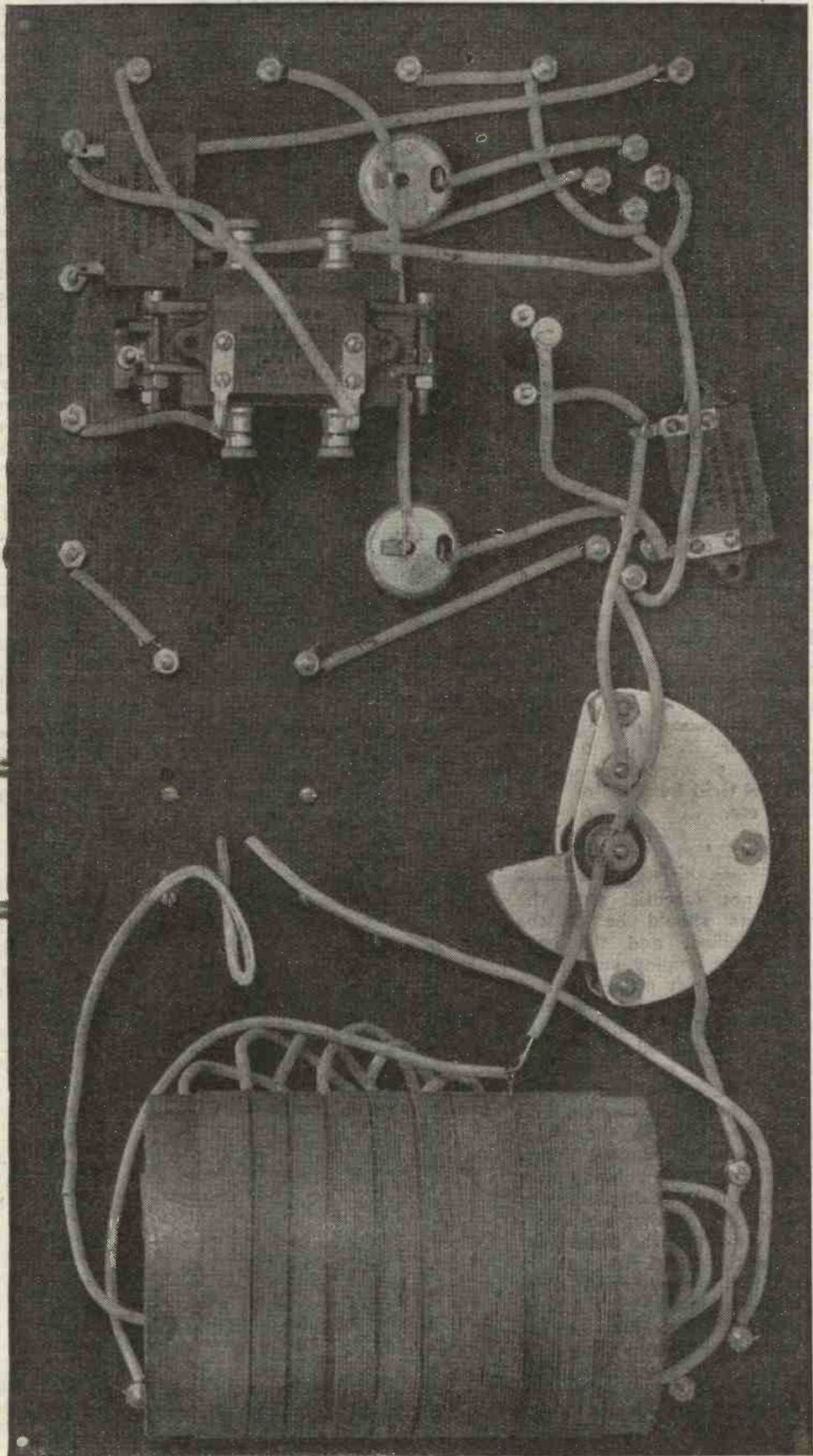

Fig. 8.—A plan photograph of the underside of the panel, showing relative positions and general layout of the wiring.

Another Circuit on the "Wireless Weekly" Omni Receiver

By JOHN SCOTT-TAGGART, F.Inst.P., A.M.I.E.E.

The second of a series of weekly chats dealing with circuits and experiments which may be tried out on the Omni Receiver.

A Correction

IN last week's circuit, which was a single-valve dual, the wiring key omitted to include a connection between terminals 52 and 48. This error would be an obvious one to most, but a special method of checking the wiring key has been introduced to prevent such an error occurring again.

The ST34 Circuit on the Omni Receiver

Fig. 1 shows the highly popular ST34 circuit, which so many experimenters have used for the reception of broadcasting.

The addition of a fixed condenser C₁, of 0.0001 μF capacity, is optional, and is for the purpose of constant aerial tuning. For broadcast reception the coils L₁ and L₂ are No. 50, while L₃ is a No. 75. For the longer wave broadcast stations a No. 75 may be used for L₁, L₂ and L₃.

The condensers C₂ and C₃ are of 0.0005 μF capacity. The following is the wiring key for this circuit on the Omni receiver terminal board, which is reproduced in Fig. 2:—

51 - 3	8 in. link.
11 - 50	8 in. "
10 - 11	2½ in. "
11 - 12	2½ in. "
2 - 49	8 in. "
49 - 52	8 in. "
52 - 48	5 in. "
4 - 26	8 in. "
26 - 25	2½ in. "
17 - 18	2½ in. "
18 - 24	12 in. "
26 - 27	2½ in. "
19 - 5	5 in. "
5 - 14	2½ in. "
13 - 40	8 in. "
6 - 1	12 in. "
9 - 23	12 in. "
23 - 45	8 in. "
46 - 31	5 in. "
31 - 24	2½ in. "
32 - 40	2½ in. "

The coils to use, in this case, are No. 50 for L₁, No. 50 for L₂ and No. 75 for L₃, as stated above. The coil in the aerial circuit, marked L₁ in Fig. 1, is a No. 50 plugged into the coil holder, 49-50, which is at the left on the front of the panel of the receiver. The tuned-anode coil L₂ is a No. 50, which is plugged into the middle coil holder on the side of the box, i.e., the one which goes to the terminals 17-25. The reaction coil L₃, in Fig. 1, is the coil at the rear of the three coil holders on the side of the box; the connections to this go to 1-9 on the terminal board. No coils are fitted into 33-41 or 53-54.

Operation of the Set

The first and second valves are used in this circuit, and the appropriate rheostats are adjusted. The high-tension voltage may be about 60 volts, or even 80 volts, in the case of ordinary valves, but in the case of dull emitters, 60 volts should be ample. There is no point in using 100 volts on this circuit, because no low-frequency amplification is employed.

The coils L₂ and L₃ of Fig. 1, i.e., the coils connected to the

terminals 1-9, and 17-25, should be kept well away first. The two variable condensers, C₂ and C₃ of Fig. 1, are adjusted until the signals desired are received. The condenser C₂ is the variable condenser connected to 2-10 on the terminal board, and this is the right-hand condenser of the three shown in Fig. 6 on page 309 of *Wireless Weekly* (February 13, 1924 issue). The condenser which tunes the tuned-anode circuit, i.e., the condenser C₃ of Fig. 1, is the condenser 18-26 on the terminal board of Fig 2; this is the middle terminal of the three on the front of the panel. For intelligent working of the circuit it is important to remember which of these variable condensers controls which circuit.

Having tuned in on the two condensers, the reaction coil should be brought closer to the tuned-anode inductance L₂, and the condensers C₂ and C₃ being slightly readjusted. The reaction coil is now brought closer still, and the final readjustments of the two condensers made. While this process is in progress, the signal strength should be increasing; if there is no increase, or if there is an actual decrease, the connections to the reaction coil

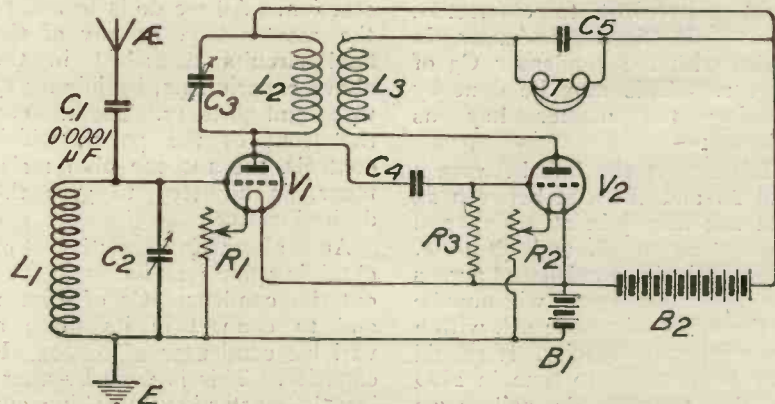

Fig. 1.—The circuit arrangement of ST34.

should be reversed. This is done by disconnecting the leads going to terminal 1, and placing it on terminal 9, while the lead on terminal 9 is taken off and placed on terminal 1. The process of adjusting the reaction is now recommenced, and an increase in signal strength should be obtained.

Experiments with the Circuit

The use of a constant aerial tuning condenser is not recommended for wavelengths above 600 metres, as there is some small falling off in signal strength which increases as the wavelength increases. For the reception of longer wavelengths it is desirable to cut out the condenser C₁, and this is done by taking out the link between 51 and 3, and connecting a link between 50 and 51; the other connections are not altered.

If it is desired to tune the aerial circuit by means of a series variable condenser, the coil in the front of the panel may be altered to a No. 75, and the following alterations made. The link between 3 and 51, in the master key table, is taken out, as also is the link between 2 and 49; a connection is now taken between 51 and 2, and this places the variable condenser in the aerial lead.

If it is desired to try a larger coil in place of L₂, a No. 75 coil may be used, but in the case of 2LO, for example, it will not be possible with the ordinary 0.0005 μF condenser to tune down to the required wavelength. What we can do, however, is to change the variable condenser C₃, of 0.0005 μF capacity, into one of small capacity, in which case a lower minimum capacity is obtained. It will be found most convenient to connect a 0.001 μF fixed condenser in series with the condenser C₃ of Fig. 1. This may be done by altering the master key as follows:—

Disconnect the link between 4 and 26 and the one between 25 and 26; now join 26 to 37 and connect 25 to 38, and 38 to 4. The variable condenser across the inductance 17-25, will now be of the order of 0.0003 μF, with a low minimum capacity. It should now be possible to tune in 2LO on the tuned-anode coil, even when a No. 75 coil is used. Sig-

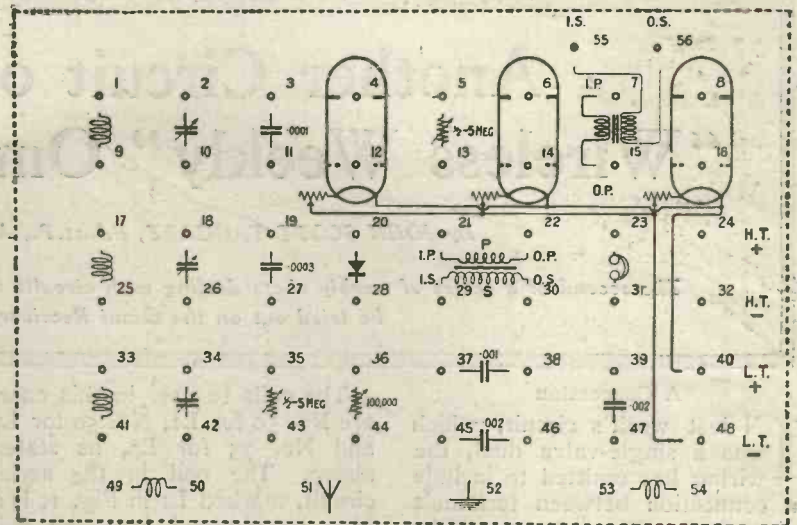

Fig. 2.—The Terminal Board.

nals should be rather stronger, and it will be found that the reaction need not be so tight between L₃ and L₂; in fact a No. 50 coil may be tried instead of L₃.

The value of the reaction coil may always be altered as an experiment; the smaller the coil, the better, provided sufficient reaction can be obtained. A No. 50 should always be tried as well as a No. 75.

There may be a tendency for the first valve to oscillate, in which case the reader may care to try a positive potential on the grid of the first valve. This should considerably stabilise the circuit. This variation is made from the master key by taking out the link 52 to 48, and joining 52 to 40.

A very distinct refinement to this circuit is to connect a variable 100,000 ohm resistance across L₂. This will give an extremely fine adjustment of reaction. All we do is to add to the master key, or any of the final circuits described in the above experiments, by joining 25 to 44 and 36 to 17. The knob on the front of the panel, which controls the 100,000 ohm resistance, is adjusted to give the desired control.

An alternative method of obtaining fine reaction is to take out the condenser C₅ of Fig. 1 and to connect in its place a variable condenser of 0.0005 μF capacity. This is done by altering the master key by taking out the leads between 45 and 23, and

between 46 and 31. A new link is made to join 34 to 23 and 42 to 31. The left-hand variable condenser on the front of the panel, by being adjusted, will vary the reaction between the two coils, which should be sufficiently close to enable the variable condenser to change the magnitude of the reaction within the desired limit.

**WIRELESS AND
OTHER PATENTEES.**

SIR,—A new Canadian Patent Act has recently come into force under which inventors, who own a patent in any country foreign to Canada, can still apply for a Canadian patent on the same invention up to one year from the passing of the Canadian Act, that is, up to June 13, 1924, provided that no patent has been issued on an application filed outside Canada for the same invention for more than one year.

Therefore, patentees who wish to apply for Canadian patents, and who come within the terms of the Act above-mentioned, should give the matter their immediate attention.—Yours faithfully,

H. T. P. GEE,
Patent Agent and Regd.
Canadian Patent Attorney,
51 and 52, Chancery Lane,
London, W.C.2.

Using Panel Bushes

SEVERAL writers in *Wireless Weekly* have recommended recently the use of the insulating panel bushes, which can be obtained from advertisers; there are, however, one or two tips about using them which readers may find of service.

They are designed really for use with panels that are not less than $\frac{1}{4}$ in. thick; that is to say, the little boss below the flange is $\frac{1}{8}$ in. deep. The best way of using them, of course, is that shown in Fig. 1, in which case they can be inserted into wood up to $\frac{1}{2}$ in. in thickness, and, thanks to the flanges both above and below the panel, terminals and so on can be made absolutely tight and secure.

A difficulty arises, however, if one is using thinner wood. The writer frequently employs plywood for his panels. Besides

being exceedingly cheap, this material is very strong and is not at all difficult to work. Ply-wood is usually $\frac{3}{16}$ in. thick. Now

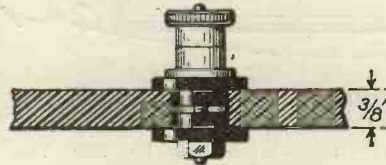

Fig. 1.—The usual method of using ebonite bushes for wood panels.

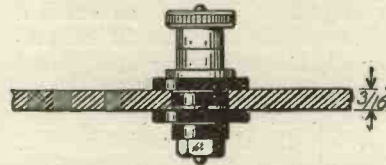

Fig. 2.—Method adopted when using bushes on panels of less than $\frac{1}{8}$ -in. thickness.

if one tries to insert two bushes into each hole in the ordinary

way, the terminals cannot be tightened up, since the distance between the flanges is greater than the thickness of the wood. Fig. 2 shows how this may be overcome by reversing the lower bush, so that its flange lies against the wood.

Yet another way which results in a further economy is to use only one bush instead of a pair for each terminal. If this is done, the bushes must be cemented into their holes so that they are quite firm. The writer has found that seccotine answers admirably for the purpose, provided that the holes are not made too large. The best way of boring them is to use a $\frac{1}{2}$ -in. auger bit with sharp cutting edges. If an attempt is made to bore straight through plywood, even with this kind of bit, the bottom layer is sure to split. To prevent this, cut away only one layer on the upper side of the panel; then turn it over and drive the bit right through. This will ensure the cutting of perfectly clean holes with no splitting of the wood.

R. W. H.

ON Tuesday, February 26, at the Headquarters of the R.S.G.B., at 53, Victoria Street, London, S.W., a joint meeting between members of the Committees of the Radio Transmitters' Society and of the Transmitting and Relay Section of the R.S.G.B. was held. This meeting arose out of the resolution recently passed by the members of the Radio Transmitters' Society in general meeting, when the principle of amalgamation with the Transmitting and Relay Section was approved. The business done at the meeting was of a preliminary nature, the main object being to settle the officers and devise the machinery for the carrying on jointly of the work which hitherto had been done by the two bodies.

On the proposition of Dr. W. H. Eccles, Captain Ian Fraser was appointed chairman of the Amalgamated Committee, and Mr. Gerald Marcuse was appointed honorary secretary. Mr. W. Corsham and Mr. D. K. Alford accepted the office of joint traffic managers, and were asked to prepare a scheme for consideration at the next committee

The Radio Society of Great Britain and The Radio Transmitters' Society

meeting to be held on Tuesday, March 11, for the carrying on and development of transmission tests, calibration signals, etc. It was agreed that the committee should continue the series of successful lectures which, under the auspices of the Radio Transmitters' Society, had been regularly held, and the secretary was asked to book a room at the Institute of Electrical Engineers for March 14 and 28 and April 25. It is not possible to announce in time for publication the names of the lecturers on these occasions, but notices will be served upon the members in due course.

As regards finance, it was re-

An interesting "Question Form" is published on page v, and we shall much appreciate candid answers to all questions.

ported that the Radio Transmitters' Society had a substantial balance to hand over for the use of the new committee, and a sub-committee, consisting of Messrs. Maurice Child, E. J. Simmonds, and H. S. Walker (honorary treasurer of the R.T.S.) was appointed to advise the committee as to the best method of adjusting all outstanding matters relating to subscriptions, etc.

General satisfaction was expressed at the prospect of future harmonious working under the auspices of the R.S.G.B., and the committee were confident that, after a brief delay to allow all matters under negotiation to be properly settled, the new and enlarged Transmitting and Relay Section of the R.S.G.B. would be able to offer its members more adequate facilities and stronger representation than had hitherto been available.



Aerial Tuning

OWING to the facilities thereby afforded for experimental work, I am beginning to provide three or four terminals on every set to facilitate different combinations of inductance and capacity in the aerial circuit. There are altogether four distinct methods of arranging the aerial circuit. These methods are:—

1. Shunting the aerial tuning inductance by a variable condenser.
2. The constant aerial tuning system, which I recently advocated.
3. Tuning the aerial circuit by means of a variable series condenser, the potentials across the inductance being communicated to the grid of the first valve.
4. The use of a series tuning variable condenser, the potentials across this condenser being communicated to the grid of the first valve.

Each of these methods possesses distinctive features. The great advantage of the constant aerial tuning system is that you always know exactly where you are on any aerial. The insertion of a $0.0001 \mu\text{F}$ fixed condenser in series with the aerial lead makes the receiver almost entirely independent of the aerial capacity, and tuning is accomplished by a parallel variable condenser across the aerial inductance. This enables a wider range of wavelengths to be obtained with a given condenser than is ordinarily the case.

The parallel tuning arrangement is probably best in all cases for wavelengths above 600 metres. Below 600 metres there are two schools; one in favour of a series tuning condenser and one in favour of a parallel tuning condenser. There

is very little to choose between the two methods, but my own recommendation is to use the series variable condenser when a large capacity aerial is employed. When the parallel condenser arrangement is used, as small a value as possible should be employed, the condenser being used rather for obtaining fine adjustment than for increasing the wavelength of the aerial circuit. The greatest disadvantage of the parallel variable condenser tuning method is that only a narrow range of wavelength is obtained with the condenser in this position, because the condenser always has in parallel with it the capacity of the aerial.

The least used of all circuits is the series tuning arrangement in which the potentials applied to the grid of the first valve are taken from across the variable condenser, instead of across the inductance, as is usually the case. The accompanying figure shows not only various terminal arrangements, but also useful circuits for short-wave reception. The variable condenser C_1 of $0.0005 \mu\text{F}$ capacity is connected in series with the aerial inductance L_1 , and one side of the con-

denser C_1 is connected to the grid of the first valve, and the other side is connected (the terminals T_3 and T_4 being short-circuited) to the negative terminal of the filament accumulator.

In the anode circuit of the first valve we have the inductance L_2 shunted by the condenser C_2 , which latter has a value of $0.0003 \mu\text{F}$ capacity. The condenser C_3 is the usual grid condenser of $0.0003 \mu\text{F}$, and R_5 is the usual gridleak. Telephones are in the anode circuit of the second valve. Reaction is obtained by coupling L_2 to L_1 , although frequently sufficient capacity reaction is obtainable without the need for any magnetic effect. A variable 100,000 ohm resistance is connected across the inductance L_2 , and is shown as R_4 . The use of this for adjusting the reaction was advocated in these columns recently, and a very large number of experimenters are using this very successful method of obtaining extremely fine reaction adjustments on weak signals without altering the tuning of the circuit.

(Concluded on page 468)

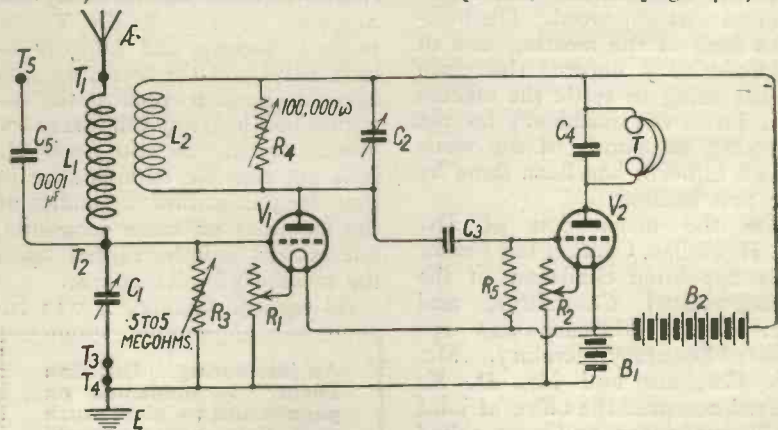

Fig. 1.—A useful circuit for short wave reception in which are incorporated terminal arrangements for varying the methods of aerial tuning.



Conducted by A. D. COWPER, M.Sc., Staff Editor.

"Bretwood" Variable Gridleak.

A curious type of variable grid-leak is the "Bretwood," a sample of which has recently been sent to us for test and report.

In this, the variable resistance is that offered between a plastic resistance material contained in a tube and a plunger which is advanced or withdrawn from this tube by a screw.

The instrument takes the form of a small tube $2\frac{1}{2}$ in. long and a little under $\frac{3}{8}$ in. diam., and is fixed to the panel by the ordinary one-hole-fixing method. The lower end of this tube (which is of insulating material) carries a terminal, and the second connection is made to a spade-terminal under the top nut. Only the

small control knob and a circular scale are visible above the panel.

Owing to a disappointing experience with an early pattern of this grid-leak, purchased some time previously, the writer was particularly interested to find a much more satisfactory performance in the sample submitted here. On actual trial in reception, it was found possible to make a fine adjustment of the leak-resistance value, without noises or other erratic symptoms. Some "backlash" of resistance values was observed, but not of a serious order.

On careful measurement with 100 volts D.C. and microammeter, and with the "Meg" tester at moderate voltage, the

available range, in some dozen complete revolutions of the knob, was from about 200,000 ohms to 10 megohms or more. In this pattern it was possible to re-establish a desired value of resistance, with sufficient accuracy, by screwing back the same number of turns, in repeated trials, and over the range mentioned. The markings on the scale attached did not appear to have much relation to the resistance values given.

About five complete revolutions of the knob were found to cover the most useful range of leak-resistances, starting about 5 turns out from the minimum position (which latter gave almost a short-circuit).

If you have the good GOODS, then

Wireless Weekly

is the GOOD medium through which to **SELL THEM**

GIVE IT A TRIAL!

Advertisement Managers:
SCHEFF PUBLICITY ORGANISATION, LTD.,
125, Pall Mall, London, S.W.1.
Phone—Regent 2440. Telegrams—"Advertiras, Piccy, London."



M. H. The Mark of Merit on any Wireless Set or component is a guarantee of efficiency, reasonable price and sound British manufacture. **BUY BRITISH GOODS ONLY**

We are exhibiting in the Electrical and Allied Engineering Section of the British Empire Exhibition, 1924.

Complete Catalogue, over 60 profusely illustrated pages, Post Free 1/8.

HOME ASSEMBLY UNITS

A Six-Valve Set starting with one valve and available for use all the time.

Only one fixing for each component. No soldering. Wiring simple and by screw-driver only.

Polished and engraved ebonite panel Oak Cabinet, Standard M.H. Unit Components.



Radio-Frequency Amplifier.

- Radio-Frequency Amplifier £3 17 6
- Tuner £3 7 6
- Audio Frequency Amplifier £3 12 6

Send for list of **SHOP SOILED** goods at reduced prices. Genuine Bargains of high class apparatus.

L.M. MICHAEL LTD

IN CONJUNCTION WITH B. HESKETH LTD
SHOWROOMS: Radio Corner, 179, Strand, London, W.C.2
5, Yelverton Road, Bournemouth All correspondence to Head Office.
HASTINGS HOUSE, NORFOLK STREET STRAND LONDON, W.C.2

A Geared Vernier Adjustment for Dials

The "Torvic" vernier-adjustment dial, supplied by Messrs. Autogears (Leeds), Ltd., has been submitted to us for test.

This dial has a large aluminium gear-wheel fitted below it, into which gears a small pinion, the latter being rotated at will by a small knob above it, the bearing for its short spindle being fixed on the panel by two small bolts.

The main knob (carrying its gear-wheel) can be rotated as usual for rough tuning (the small knob spinning idly meanwhile). The small knob is then brought into use for fine adjustment. This is naturally facilitated by the considerable gear-down ratio. At the same time it is claimed that the large wheel acts as a capacity screen, and the hand can be kept further away during the last adjustments.

The sample submitted was of sound mechanical design and construction, and worked in a satisfactory manner, extremely fine adjustment of the position of the main spindle being readily pos-

sible. It was noticed that the friction in the device made the main knob rather stiff to turn, but no doubt one would soon become accustomed to it. It is of small moment when, as in this case, a positive fine adjustment is also available.

Valve Notes

(Concluded from page 464.)

The arrangement works perfectly well on the broadcast wave-band, and tests the other day gave as good results as if the grid and filament of the first valve were connected across the aerial inductance, and a variable condenser C₁ connected in the aerial lead. A variable gridleak R₃ is connected across the variable condenser C₁ to prevent a charge accumulating on the grid of the valve.

In the circuit five terminals are provided which enable any of the above four methods of tuning the aerial circuit to be tried. We have the terminal T₁, the ter-

minial T₅ for constant aerial tuning, and the terminal T₂ for parallel condenser tuning. T₃ and T₄ may be short circuited when required.

For series tuning, as shown in the illustration, the aerial is connected to the terminal T₁, and T₃ and T₄ are short circuited. For constant aerial tuning the aerial is connected to the terminal T₅, while the terminal T₁ is connected to T₃, the terminals T₃ and T₄ being short-circuited. If the ordinary series tuning arrangement is desired, with the variable condenser in the aerial lead, the potentials across the inductance being communicated to the grid and filament of the valve, we connect the aerial to the terminal T₃, which is now no longer joined to T₄. The terminal T₁ is connected to the terminal T₄. In all cases the terminal T₄ is connected to earth.

NEXT WEEK.

In our next issue will appear full constructional details of a novel type of two valve low frequency amplifier.

CAM-OPERATED VERNIER COIL HOLDER.

Quality RADIC



This is the last word in accurate tuning devices. Similar to our standard coil holder, but the usual fixed socket has a very slow movement giving a micrometric adjustment in both directions through 10°. This is effected by a cam operated by a separate knob.

Price, 2 way (only) 7/6, on base 1/- extra. Postage 3d.

GOSWELL ENGINEERING CO., LTD.,
12a, PENTONVILLE ROAD, LONDON, N.1.
Liberal Trade Terms. Phone: North 3051.

BEWARE OF WORTHLESS IMITATIONS, SEE THE TRADE MARK **WatMel** ON EVERY GRID LEAK.

WATMEL VARIABLE GRID LEAK
(Patent No. 206098).



Constantly Variable
Silent in operation.
Constant in any temperature.
Dust and Damp proof.
Each tested and guaranteed.
Neat and well made.

GRID LEAK
.5 to 5 megohms
2/6

ANODE RESISTANCE
50,000 to 100,000 ohms 3/6.
Suitable for S.T. 100 Circuit.

SEND P.C. FOR DESCRIPTIVE FOLDER.

WATMEL WIRELESS CO., Cornaught House, 1a, Edgware Road
Marble Arch, W.2. Tel. 4575 Paddington

Terminal Troubles Terminated!!!

MOUSLEY'S PATENT TERMINAL
(P/Pat. No. 25765/23).

For Wireless Sets, Accumulators, Batteries, etc.

Makes Direct Contact.
Is Cleaned in a Second.
Makes Instant Connection.
Requires One Hand Only.
Makes Awkward Connections Readily Accessible.

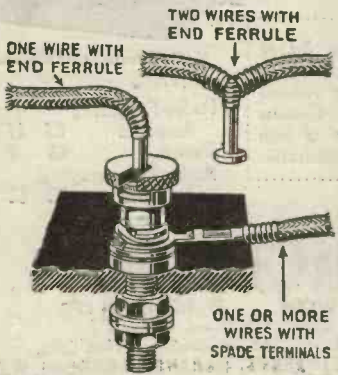

ONE WIRE WITH END FERRULE
TWO WIRES WITH END FERRULE
ONE OR MORE WIRES WITH SPADE TERMINALS
COMPLETE TERMINAL - TYPE A

Will fit on to ALL TERMINAL SCREWS OF EXISTING SETS AND BATTERIES.

THE TERMINAL for the OMNI RECEIVER and all other Experimenters' and Constructors' Sets.

Prices of 2, 3 and 4BA Terminals:
Heads only 2/6 doz.
Complete Terminals (A) 4/8 doz.
Wire End Ferrules . . . -/6 doz.

Postage:
Heads 2d. doz., Trms. 3d. doz.

Of all High-class Wireless Dealers or direct from
Sole Concessionaire:
N. K. MOUSLEY,
22, Queen's Road,
Edington, BIRMINGHAM.

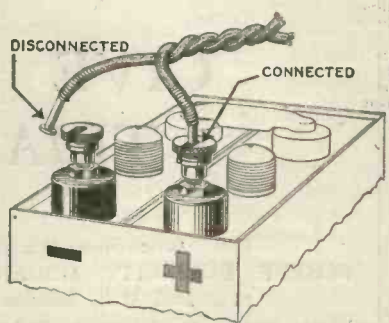

DISCONNECTED
CONNECTED
TERMINAL HEADS ON ACCUMULATOR

Correspondence



ACCUMULATOR RATING

SIR,—I was interested to read Earl Russell's letter in your issue of 27th inst. regarding the above, and while thoroughly agreeing with him that "Ignition" rating is liable to give an utterly false impression as to the capacity of a cell when used for lighting or valve operation, I must point out that the capacity on continuous discharge *does* depend on the *rate of discharge*. For example, a cell capable of giving 10 amperes for 10 hours continuously is said to have a capacity of 100 amp. hours at the 10-hour rate of discharge, but this same cell, if discharged in five hours, will only give 17 amps. continuously or 24 amps. for three hours, before

reaching the safe limit of, say, 1.83 volts. I suggest that all portable accumulators should be rated on the 10-hour rate, which is a reasonable one, and which would obviate disappointment to the purchaser. A cheap accumulator is usually a very dear one in the long run, and it pays every time to buy the best possible.—
Yours faithfully,

STANLEY H. FREEMAN.

Alford.

LONG-DISTANCE RECEPTION

SIR,—Your readers may be interested to hear that with a three-valve set employing 2 H.F. and Det., and on an aerial but

very little superior to a good amateur's aerial, the B.B.C.'s transmissions from London and Bournemouth were received regularly every night during a trip between Malta and Gibraltar.

When off Algiers on February 16 the Covent Garden opera was received at a signal strength of 10, using two pairs of headphones.

2BD (Aberdeen) was also received at a signal strength of 9 after the conclusion of the London transmission the same evening. 2BD's speech was the acme of clearness, and every word was well defined. This was when Aberdeen announced that he was testing preparatory to a simultaneous broadcast from all stations the following evening.

Last Few Days—Final Bargains from GAMAGES SALE

Upon the reliability of your apparatus depends the success of your experiments. With Gamage accessories you are assured of the *utmost results*. Customers are urged to anticipate their requirements and order NOW at these greatly reduced Sale Prices.

Make your order up to £1.
It is then sent post free.

Post your order now or pay us a visit.

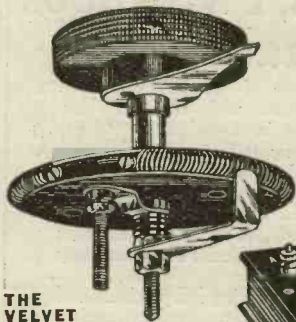

THE VELVET

FILAMENT RESISTANCE

A high-class Variable Resistance for one or two valves, with a perfect movement. Similar to illustration, but with many improvements in the details. Reduced during the Sale to Each **2/6**

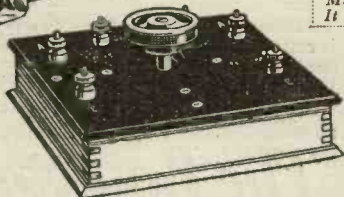

Series PARALLEL SWITCHES Best quality and beautifully made throughout. A very useful accessory for the serious experimenter. Postage 6d. Price **5/-**

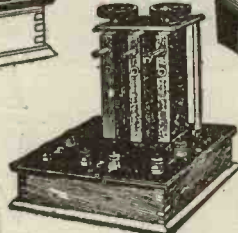

THREE COIL HOLDERS

Beautifully finished throughout. Suitable for Honeycomb and Burndept Coils. Simple in construction and most practical in use.

SALE PRICE **9/6**
Usual Price 10/6.



The Super 'Phone DISTRIBUTOR BOARD

A beautifully finished component with lacquered terminals. To take 4 pairs of 'phones. Sizes: 5x2 x 1 1/2 ins. Postage 4d. Sale Price **3/6**
A most useful and practical accessory. Price with Crystal **3/9**

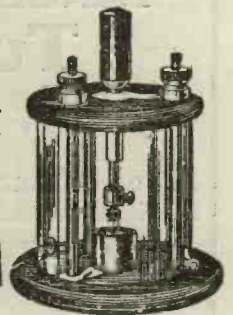

DUSTPROOF DETECTOR with "Permanite" Crystal

A beautifully made piece of apparatus, very efficient in use. Transparent cover protects the Permanite Crystal from dust. Post 4d. Price with Crystal **3/9**

ORDER BY POST from this announcement with every confidence. Money refunded in full if goods are not approved.

SALE CATALOGUE post free on request. Every page crammed with bargains from all departments. Send for a copy.

For Utmost Results Use **"PERMANITE CRYSTAL"** Reg. No. 438341.

Clear, powerful results. Remains in adjustment longest. Testimonials from all over the country have been received. **1/6** Post Free. Price per large specimen

A. W. GAMAGE, LTD. — **HOLBORN, LONDON, E.C.1**
CHEAPSIDE HOUSE, BENETFINKS.

I may say that although London, Cardiff, and Aberdeen came in very well Bournemouth was the best of all.

To conclude, I should like to say that it was really surprising how well these stations came in.

Wishing your two journals, *Wireless Weekly* and *Modern Wireless*, the success they deserve.—I am, etc.,

London. A. W. W.

THE OMNI RECEIVER

SIR,—I have been trying out your Omni circuit, which I finished wiring up last Sunday, and connected up as ST45. It is absolutely wonderful. I cannot praise it too much. I thought when I made ST100 that I had got something great. But good as it is, the Omni is the real thing. I feel I could live by it. The strength and volume of sound, wired up as it is at present, beats a 4-valve set I know, good and hard. I simply can't praise it or your papers, *W. W.* and *M. W.*, enough. I have put in everything as far as possible as shown in your illustrations, including bus bar, which I consider the only real way of wiring. I

must conclude now, as I can only think of praise for it.—Yours faithfully,

THOMAS W. THACKER.
Adderbury.

NOVEL SINGLE-VALVE RECEIVER

SIR,—Having constructed the "Novel Single-valve Receiver" described by Mr. Stanley G. Rattee in the January 23 issue, using a dull emitter valve with 52 volts H.T., and on an aerial 45 ft. long and 25 ft. high, the following stations came in at reasonable strength:—2ZY, 5NO, 2LO, 6BM, 2BD, 5SC, and 5WA. Also the School of Posts and Telegraphs, Paris. Hoping these results will interest your readers.—I am, etc.,

Blackburn. A. MARSDEN.

ST CIRCUITS

SIR,—Here are some notes on ST107 and ST110 which you may care to publish.

These circuits are certainly well described in "More Practical Valve Circuits" as suitable for long-distance reception.

I mentioned before that with the ST74 or 77 circuits some of the southern stations could be

heard here; but, with the two valves they can be enjoyed.

When using ST107, however, it is not so much the louder signals that one notices. The value is more in not having to bother about critical settings of reaction and crystal.

With the ST110 both loudness of signals and ease of tuning are much more marked.

For the means of fixing up this circuit I am indebted to articles in the February *Modern Wireless* and in *Wireless Weekly*. A three-coil holder is used, two of the coils being the H.F. transformer. The centre coil is the tuned secondary; one of the outside coils is the plate coil of the second valve, and can be swung up for reaction; the other outside coil is the untuned primary. Ordinary Ingranic coils are used.

Comparing this with a five-valve straight circuit commercial receiver, the five-valve receiver gives clearer signals, and on some stations they are louder; whilst the ST110 has a better range of stations and brings in less miscellaneous interference. On the whole I prefer the dual circuit.—Yours faithfully,

Orkney. E. P. H.

**"TANGENT"
Tuning Coils**

TESTED and TRIED

Set of 4 Concert Coils
covering all British Broadcasting.

On firm frames—robust and substantial.

Their efficiency—which is second to none—is not impaired by the special material of the frames.

No self-supporting coil excels them.



Ask your dealer or send for

Leaflet 97W

GENT & Co., Ltd.

Established 1872
Manufacturing Electrical Engineers,
FARADAY WORKS,

LEICESTER.

LONDON: 25, VICTORIA STREET, S.W.1.
NEWCASTLE-ON-TYNE: TANGENT HOUSE, BLACKETT ST.

**Two Switches, Two Knobs
— and that's all**

A PERSON knowing nothing of Wireless can tune and obtain perfect reception with the new Vox Populi Wireless Installation in one minute.

By turning the two switches he lights his valves. Turning the left hand knob brings him in tune with the station he wants; turning the right hand knob gives him a suitable volume of sound. That's all he needs to know.

Yet this is the most efficient Two Valve Receiver obtainable; it costs less than most and its price includes every accessory from Aerial to Earth.

Drop us a line NOW for Brochure giving full particulars of this remarkably efficient, economical set. Enquiry involves no obligation.

The Bowyer-Lowe
Vox Populi
Wireless Receiving Set

Price includes Valves, Telephones, Batteries and all indoor and outdoor accessories, all

£16

Royalties and Tariffs. Instrument only £9 5s. od. plus 15s. B.B.C. Tariff.

A postcard brings full particulars.

BOWYER-LOWE CO. LTD., LETCHWORTH, HERTS.

Information Department



C. J. R. (ISLINGTON) states that he is getting only poor results from his ST100 receiver, reporting that lifting the cat-whisker from the crystal makes no difference to the loudness of signals, and that he finds he cannot use more than 36 volts upon the plates of his valves. He adds that these valves are of the soft Dutch type.

The symptoms reported indicate clearly that the source of trouble lies in the fact that the valves are not being operated under correct conditions. It is plain that the first valve at least is performing the function of rectification, instead of simply amplifying the signals so that they could be later rectified by the crystal. We are a little doubtful whether this can be remedied with a soft valve without a good deal of experiment, and since soft valves are in any case unsuitable for the ST100, we would suggest that these be replaced by good hard valves of the standard English type. When this has been done it will be found that a suitable

adjustment of high-tension voltage, filament current, and grid potential will give good results when the cat-whisker is in contact with the crystal only. Suitable values for the various constants just mentioned are 100 volts for the anode, about 6 volts negative upon the grids of the valves, and rather more filament current than would be necessary in a straight circuit. Pains should be taken also to make certain that the specimen of crystal being used is a good one, and it is worth while to have a selection of crystals mounted in cups so that they can be readily interchanged.

W. L. B. (SELBY) asks for the correct sizes of coils to use in the simple reflex receiver described recently in "Modern Wireless."

For reception of broadcasting the following coils should be used:—

Aerial circuit (left-hand socket)—No. 35 or 50,

THERE'S TIME YET TO AVOID DISASTER.

Suppose that on March 16th you make special preparations to "Listen-In" for a certain beloved voice—perhaps invite friends, who will be as eager as yourself—well! suppose that that is the night of all nights when something goes wrong, and for all your hot fury you hear nothing at all, or, at the best, only a word here and there. You would rightly regard that as a disaster. Then suppose you find afterwards that all the trouble occurred because of a loose connection. These things *do* happen. But *never* to the man who uses Refty Terminals. They not only *cannot* shake loose, but the contact is as good as a soldered joint. At the same time, a wire can be attached or detached in a fraction of the time it takes to do with the old screw, shake loose, never certain, temper-testing torment.

IF YOUR DEALER DOESN'T STOCK THEM SEND DIRECT. SURPLUS POSTAGE RETURNED.

No. 1 Type.
Insulated Top,
in 5 Colours,
9d. each.

No. 2 Type.
All Brass,
4½d. each.

No. 4 Type.
Black, Red, Blue,
Green or Cream.
10d. each.

THE BIGGEST VALUE FOR MONEY
IN THE WIRELESS WORLD.

THE CUP.

"They're Great!
All my friends want
one. Send 12 more,"
Yorkshire.



PRESS
KNOB!



INSERT
WIRE!



LET
GO!

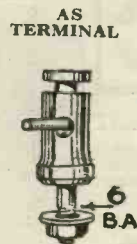

TYPE
No. 5.
3d.
each

VOILA!

AS
WANDER
MIDGE

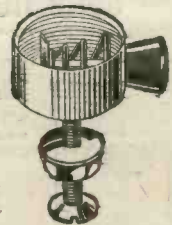

Lacqd. 4½d.
Nickel 5½d.

REFTY ELECTRICAL LTD. 2, Featherstone Buildings, High Holborn, London, W.C.1
Phone: Chancery 8234. Grams: "Reftinal, Holb. London."

according to the size of the aerial employed.

Tuned-anode (right-hand socket)—No. 75.

R. S. (ANERLEY) reports trouble with the Transatlantic receiver, and states that his results are exceedingly erratic, and that moving the valves in their clips will often make 100 per cent. difference to the signal strength.

We should diagnose the trouble here as being due to a fault which a number of correspondents have reported, namely, that the valve clips have been lacquered with a colourless lacquer over their whole surface. This type of lacquer is often quite invisible, but effectively prevents the valves from making proper contact with their clips. A little attention with emery paper will probably make all the difference. At the same time, it would be well worth while to test the windings of the high-frequency transformers with a dry cell and a pair of telephones, and make certain that there are no intermittent or poor contacts therein.

M. I. W. (GOLDERS GREEN) states that he has just bought a loud-speaker of a good and well-known make, and asks what precaution should be taken to ensure the clearest reproduction.

Assuming that distortion has been eliminated as far as possible in the circuits of the receiver itself, first firmly adjust the screw of the

loud-speaker until the best result is obtained, and then experiment with various sizes of fixed condenser across its windings. In the case of a low resistance loud-speaker the best capacity will be quite large, an average value being $\frac{1}{4}$ μ F. The effect is less marked with the high resistance type, but is nevertheless present, and a noticeable improvement will often be effected by the use of a condenser of about .005 μ F in parallel with the windings.

It should not be overlooked that to obtain satisfactory reproduction with any loud-speaker the volume of the signals must be adjusted with some care. It is useless to apply an input power large enough to work one of the largest types of loud-speaker, such as those used for open-air demonstration, to one of the baby types, for the inevitable result is severe distortion from overloading. Always adjust the strength of signals to such a point that the loud-speaker is taking just as much as it will carry without beginning to distort seriously, and never give it more. It is a common but most objectionable practice to pile on valve after valve until the diaphragm is rattling against the pole pieces and the horn is ringing with all sorts of notes and their harmonics, and this practice accounts for a good deal of the popular prejudice against the loud-speaker. If it is necessary to reduce the signal strength even when a moderate number of valves are in use, it should be done by slightly detuning the receiving circuit, rather than by turning down the filament current.

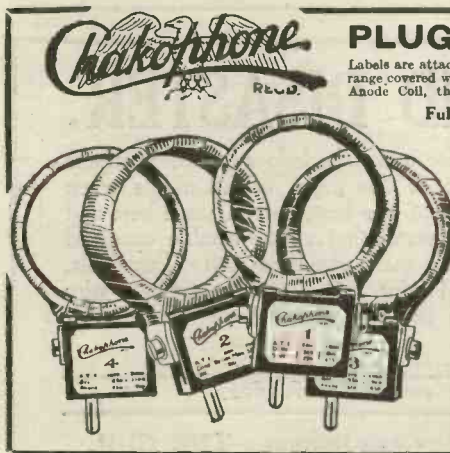

PLUG-IN COILS

Labels are attached to each coil giving details of range covered when using as A.T.L. Secondary or Anode Coil, thus dispensing with Wave-meter.

Full instructions given with each set of Coils.

Price. Set of 3 Coils 12/-
" " " " 15/-

Fitted with "best plugs and bound up.

Coil No.	With As.	Range Cond.	Metres.	Price.
1. A.T.L.	'001	290 to 435	4/6	
2. A.T.L.	'001	400 to 700	4/9	
2. Sec.	'0005	200 to 450	4/9	
3. A.T.L.	'001	700 to 1400	5/-	
3. Sec.	'0005	330 to 900	5/-	
3. Anode	'0001	280 to 450	5/-	
4. A.T.L.	'001	1000 to 2000	5/3	
4. Sec.	'0005	450 to 1100	5/3	
4. Anode	'0001	450 to 700	5/3	

Write for specifications of our Crystal Sets and Valve Sets
THE EAGLE ENGINEERING Co., Ltd. London Showrooms,
 8, St. Russell St., W.C.1.
 Head Office and Works—
EAGLE WORKS, WARWICK.

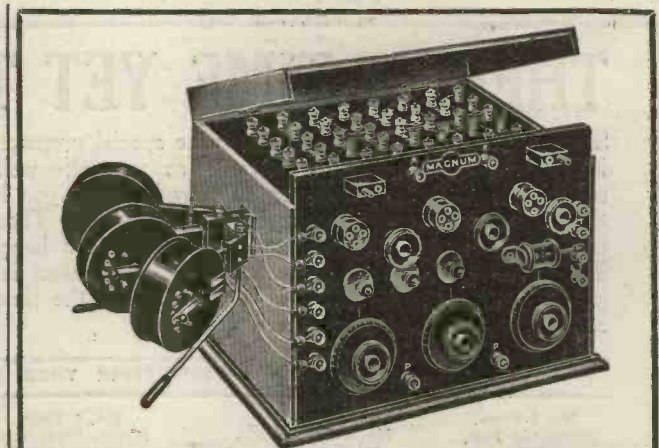

The Wonderful OMNI

as described by Mr. J. Scott-Taggart.
 As illustrated, including coils, 18 Guineas.

RECEIVES EVERYTHING FROM EVERYWHERE.
 TO CONSTRUCTORS.—All Components supplied separately if desired.
 Send stamp for Illustrated List and set of leaflets dealing with "Twelve Tested Sets," also the OMNI, S.T.100, 4-Valve Family Receiver and all circuits described in "Wireless Weekly," "Modern Wireless" and Radio Press Envelopes.
 ALWAYS SPECIFY "MAGNUM."

MAGNUM TAPPED COILS—REDUCED PRICES.
 No. 1. 180-1000 metres 12/6
 No. 2. 600-2600 metres 15/-

BURNE-JONES & Co. Ltd.
 Manufacturing Radio Engineers,
 MONTFORD PLACE, KENNINGTON, LONDON, S.E.11.
 Phone: Hop 6257
 Experimental Stations:—2 F.P. New Cross. 2 P.B. Kennington
 2 C.T. Lambeth. 6 C.W. Streatham.

ECONOMIC ELECTRIC L.D.



The "EEC" "XTRAUDION" VALVE is being used by the leading Radio Experimenters for detection, high and low frequency amplification, power amplifiers and low power transmission. Price 12/6

USE "RECTARITE," the synthetic crystal that makes Loud speakers talk. 1/6 Large Specimen.

Write to-day for 40 page Radio Catalogue mailed post free, 4d.

Head Office: 10, FITZROY SQUARE, LONDON, W.1. Showrooms: 303, EUSTON RD., N.W.1. Branch and Works: TWICKENHAM.

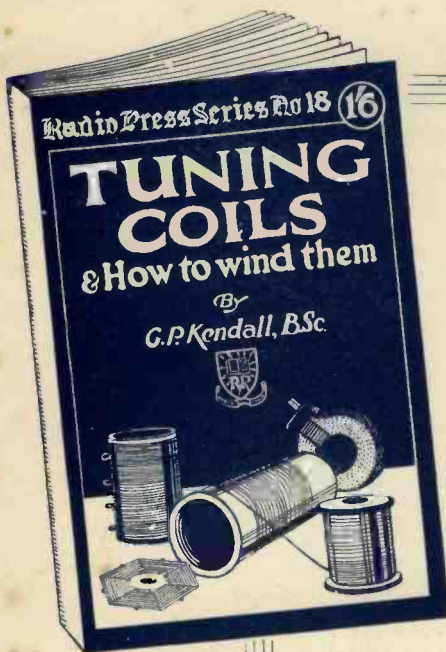

Tuning Coils

and how to wind them.

By G. P. Kendall, B.Sc.

Just
Published.

THERE is probably no single Component in any Receiving Set able to exert so much influence as an Inductance Coil. A highly efficient Coil (or Coils) will often make all the difference between mediocre results and really good loud reception.

Even if you feel that your present Set is giving tolerably good results, the chances are that it will be worth your while—presuming that you are using plug-in coils—for short-wave lengths to use a set of home-made basket coils. Such coils as these have particularly low self-capacity.

This new book by G. P. Kendall, B.Sc. (staff editor) contains concise details for making every type of Coil used in Wireless to-day. Further, the advantages and disadvantages of each type

are discussed in such a manner that the reader is able to make an immediate decision as to the actual coils suitable for his requirements.

All necessary data, such as diameter of tubes, gauge of wire, number of turns, etc., are given—the results of the author's own experiments.

No experimenter can afford to be without such a comprehensive guide as this.

Published by
Radio Press, Ltd.,
Devereux Court, Strand, W.C.2.

1/6

Sold by all Booksellers,
or sent Post Free direct, 1/8.

RADIO PRESS
SERIES, No. 18.

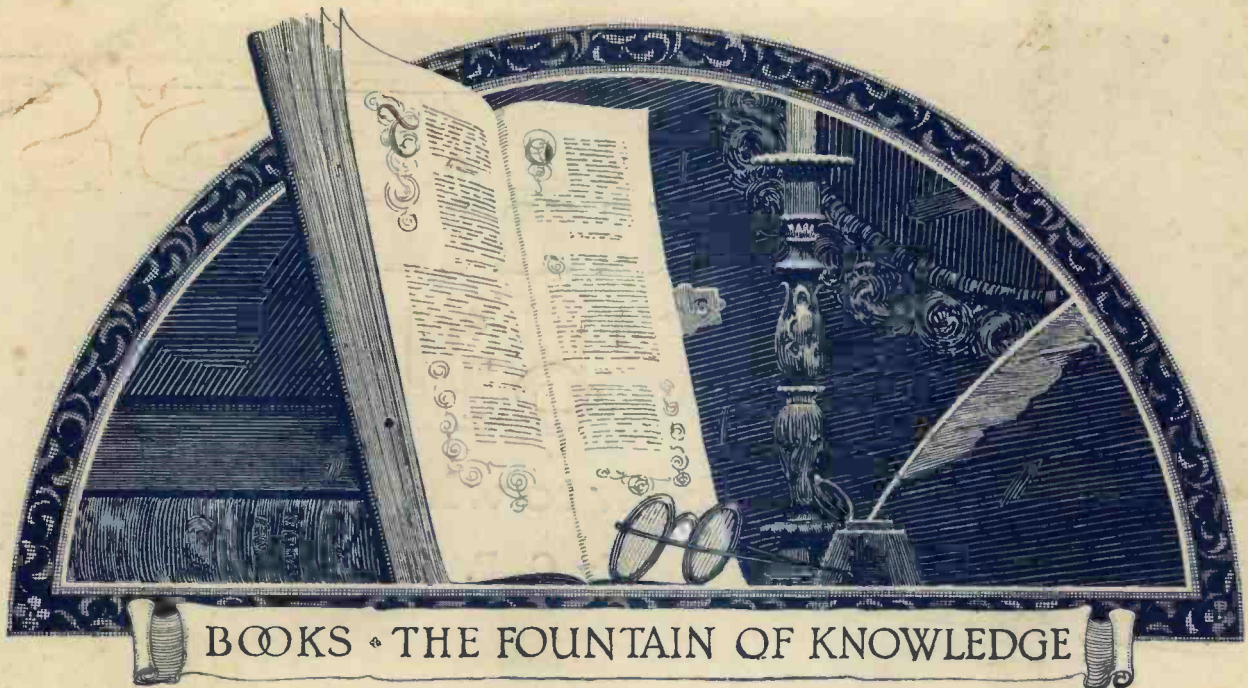

BOOKS • THE FOUNTAIN OF KNOWLEDGE

Let Radio Press Books help you along the road to success.

COMPLETE LIST.

	Price
1 Wireless for All ..	9d.
By JOHN SCOTT-TAGGART, F.Inst.P.	
2 Simplified Wireless ..	1/-
By JOHN SCOTT-TAGGART, F.Inst.P.	
3 How to Make Your Own Broadcast Receiver ..	1/6
By JOHN SCOTT-TAGGART, F.Inst.P.	
4 How to Erect Your Wireless Aerial ..	1/-
By B. MITTELL, A.M.I.E.E.	
5 The Construction of Wireless Receiving Apparatus ..	1/6
By P. D. TYERS.	
6 The Construction of Crystal Receivers ..	1/6
By ALAN L. M. DOUGLAS.	
7 How to Make a "Unit" Wireless Receiver ..	2/6
By E. REDPATH.	
8 Pictorial Wireless Circuits ..	1/6
By OSWALD J. RANKIN.	
9 Wireless Valves Simply Explained ..	2/6
By JOHN SCOTT-TAGGART, F.Inst.P.	
10 Practical Wireless Valve Circuits ..	2/6
By JOHN SCOTT-TAGGART, F.Inst.P.	
12 Radio Valves & How to Use Them ..	2/6
By JOHN SCOTT-TAGGART, F.Inst.P.	
13 500 Wireless Questions Answered ..	2/6
By G. P. KENDALL & E. REDPATH.	
14 12 Tested Wireless Sets ..	2/6
By P. W. HARRIS.	
15 More Practical Valve Circuits ..	3/6
By JOHN SCOTT-TAGGART, F.Inst.P.	
16 Home-Built Wireless Components ..	2/6
*17 Wireless Sets for Home Construction ..	2/6
By E. REDPATH.	
*18 Tuning Coils and How to Wind Them ..	1/6
By G. P. KENDALL.	
*Broadcast Listeners' Year Book, 1924 ..	1/6
Elementary Text-Book on Wireless Vacuum Tubes ..	10/-
By JOHN SCOTT-TAGGART, F.Inst.P.	

Books marked with an asterisk have been recently published.

THE difference between success and failure in Radio is often only quite a narrow margin. A misplaced component causing an unwanted capacity—two transformers placed so that their fields interact—condensers of incorrect capacity—these are the finer points which, perhaps, on the surface are not apparent to the experimenter yet can make all the difference between a good result and a disappointing one.

Such expert knowledge as this can be obtained by anyone at small cost—it is all contained in the comprehensive series of authoritative books shown here.

Radio Press Books can be obtained from all Booksellers or sent direct (postage 2d per volume extra) by Publishers.

Radio Press, Ltd.
Devereux Court, Strand, W.C.2

Gilbert Ad. 617.

Wireless Weekly

and the Wireless Constructor.

Vol. 3.
No. 15.

CONTENTS

A Novel Two Valve Amplifier.

A Two Valve Panel Receiver—Further Details.

Telephony Transmission with Valves.

A Rheostat for Dull Emitters. Amplifiers for Short-Wave Reception.

An Experimental Unit Receiver. Random Technicalities, Jottings by the Way, Broadcasting News, Valve Notes, Apparatus We Have Tested, Correspondence, Information Dept., etc.

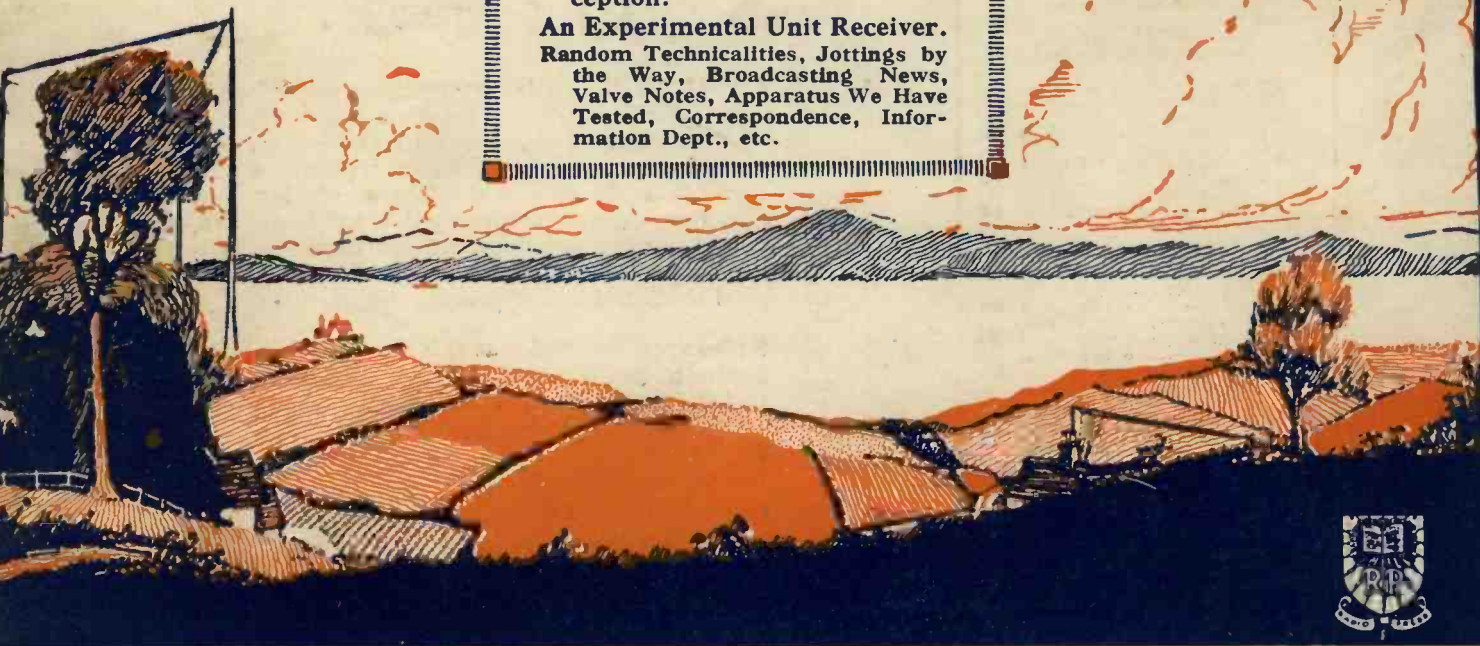

A 100-metre Receiver for KDKA

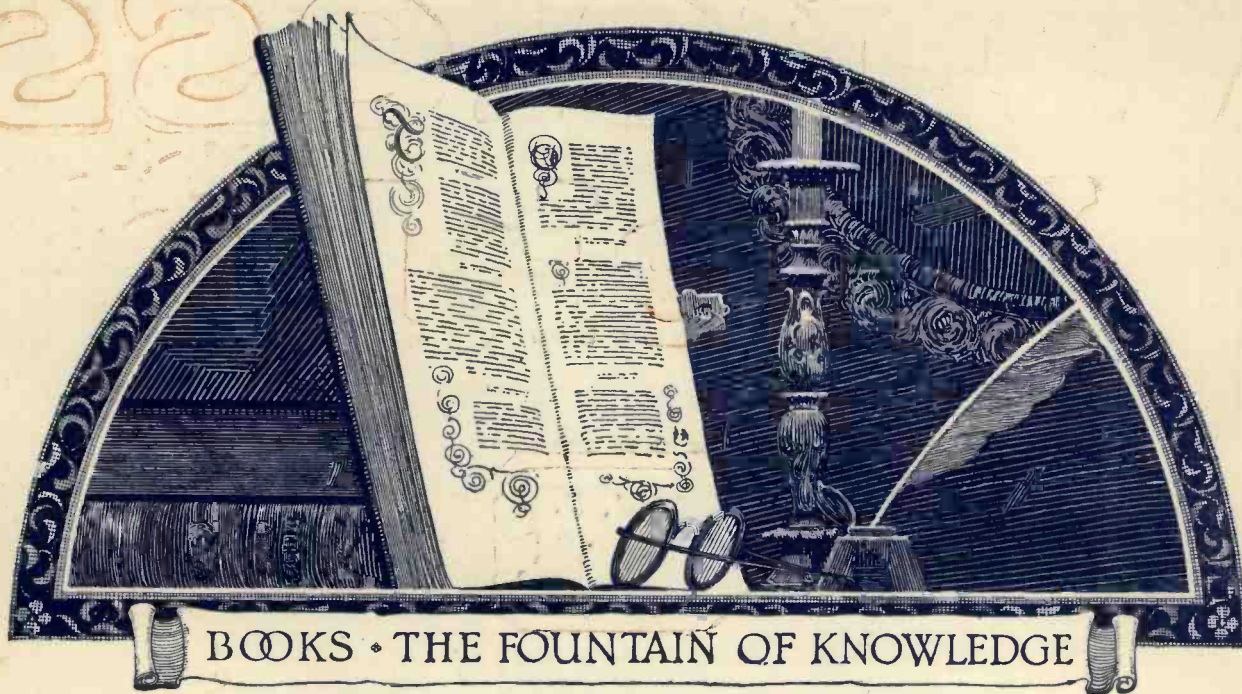

Let Radio Press Books help you along the road to success.

COMPLETE LIST.

	Price
1 Wireless for All	9d.
By JOHN SCOTT-TAGGART, F.Inst.P.	
2 Simplified Wireless	1/-
By JOHN SCOTT-TAGGART, F.Inst.P.	
3 How to Make Your Own Broad- cast Receiver	1/6
By JOHN SCOTT-TAGGART, F.Inst.P.	
4 How to Erect Your Wireless Aerial By B. MITCHELL, A.M.I.E.E.	1/-
5 The Construction of Wireless Re- ceiving Apparatus	1/6
By P. D. TYERS.	
6 Construction of Crystal Receivers By ALAN L. M. DOUGLAS.	1/6
7 How to Make a "Unit" Wireless Receiver	2/6
By E. REDPATH.	
8 Pictorial Wireless Circuits	1/6
By OSWALD J. RANKIN.	
9 Wireless Valves Simply Explained By JOHN SCOTT-TAGGART, F.Inst.P.	2/6
10 Practical Wireless Valve Circuits By JOHN SCOTT-TAGGART, F.Inst.P.	2/6
11 Radio Valves & How to Use Them By JOHN SCOTT-TAGGART, F.Inst.P.	2/6
12 500 Wireless Questions Answered By G. P. KENDALL & E. REDPATH.	2/6
13 12 Tested Wireless Sets	2/6
By P. W. HARRIS.	
14 More Practical Valve Circuits	3/6
By JOHN SCOTT-TAGGART, F.Inst.P.	
15 Home-Built Wireless Components *16 Wireless Sets for Home Construc- tion	2/6
By E. REDPATH.	
*17 Tuning Coils and How to Wind Them	1/6
By G. P. KENDALL.	
*18 Broadcast Listeners' Year Book, 1924 Elementary Text-Book on Wireless Vacuum Tubes	10/-
By JOHN SCOTT-TAGGART, F.Inst.P.	

g Books marked with an asterisk have
been recently published.

THE difference between success and failure in Radio is often only quite a narrow margin. A misplaced component causing an unwanted capacity—two transformers placed so that their fields interact—condensers of incorrect capacity—these are the finer points which, perhaps, on the surface are not apparent to the experimenter yet can make all the difference between a good result and a disappointing one.

Such expert knowledge as this can be obtained by anyone at small cost—it is all contained in the comprehensive series of authoritative books shown here.

Radio Press Books can be obtained from all Booksellers or sent direct (postage 2d per volume extra) by Publishers.

Radio Press, Ltd.
Devereux Court, Strand, W.C.2



Wireless Weekly

Vol. 3, No. 15
Mar. 19, 1924.

CONTENTS

	Page
Editorial	474
High-Frequency Amplification on Short Waves	475
Jottings by the Way	478
A 100-Metre Receiver for KDKA	480
Making Fixed Condensers	482
An Experimenter's Unit Receiver	483
C.W. and Telephony Transmission Using Valves No. X	484
Is a Telephone Condenser Necessary?	485
Broadcasting News	486
Saved From the Scrap Box	489
Some Useful Soldering Tips	491
An Amplifier with New Features	492
How to Make a Selective 2-Valve Panel Receiver	495
A Rheostat for Dull Emitters	498
Valve Notes	499
Apparatus We Have Tested	501
Correspondence	503
Information Department	505



Editor: JOHN SCOTT-TAGGART, F.Inst. p., A.M.I.E.E.
Assistant Editors { E. REDPATH.
P. W. HARRIS.

Radio Press, Ltd.

Publishers of Authoritative Wireless Literature.
DEVEREUX COURT, STRAND, W.C.2

Tel.—Central 3763.

Advertisement Managers: } SCHEFF PUBLICITY ORGANIZATION,
LTD., 125, Pall Mall, London, S.W.1
Tel.—Regent 2440.

Staff Editors:
E. H. CHAPMAN, M.A., D.Sc.
A. D. COWPER, M.Sc.
G. P. KENDALL, B.Sc.
R. W. HALLOWS, M.A.
S. G. RATTEE.

Scientific Adviser:
Prof. G. W. O. HOWE,
D.Sc., M.I.E.E.
Advisory Editors:
Prof. R. WHIDDINGTON,
M.A., D.Sc.
Prof. C. L. FORTESCUE,
M.A., M.I.E.E.



All correspondence relating to contributions is to be addressed to the Editor of "Wireless Weekly."

Nothing contained herein is to be regarded as permission or encouragement to infringe any patent rights.



Standard Parts

THERE is no question that the need for standardisation of component parts is becoming more and more pressing every day. By "standardisation" we do not mean the production of uniform designs, for this of course would be disastrous, and would remove all initiative on the part of the manufacturers. There are, however, a large number of points on which it would be possible for the producers to agree without in any way sacrificing the originality which characterises their products. Take for example the popular form of filament resistance, consisting of a disc or boss, round the edge of which the resistance element is secured. In practically every case we have to drill three holes in a panel—a centre large hole for the spindle, and two others for the screws which pass through the panel into the disc beneath. Almost invariably the holes in the disc are tapped 4 B.A. yet there is no agreement between manufacturers as to the spacing of these holes. Again, take the case of the variable condensers for panel mounting. Here once more 4 B.A. tapped holes are customary, yet again we have no uniformity. In the case of interval transformers there would appear to be more difficulty in standardising the holes used for mounting, yet there are numerous patterns of transformer on the market in which there is very little difference in the spacing of these holes in the frame. Every experimenter who has had reason to change his interval transformers knows the way in which the appearance of a panel can be completely spoiled by the necessity of re-drilling for the new transformer.

A Suggestion

A "round-table" meeting of the component manufacturers would soon settle these points to the benefit of the whole industry. The experimenter would be greatly helped in being able to drill his panel accurately, using for the purpose templates, which could be sold quite cheaply. Already we have templates for marking out the position of valve legs, and we are pleased to see that more and

more manufacturers are issuing templates with their particular components. We look forward to the time when measurements will be sufficiently standardised for standard templates to be used for the panel mounting of all kinds of components, and the facility of interchange of various parts should greatly increase sales of the various condensers, transformers, resistances, etc. It stands to reason that the experimenter who can easily change from one kind of component to another will want to do so quite frequently.

Faulty Ebonite

Ebonite, which is used in such large quantities in the making of wireless instruments, is still sold as an unbranded article, with no indication whatever to the inexperienced customer as to whether it is suitable for his particular purpose. This journal was the first to advocate the placing of some distinguishing mark upon ebonite to indicate that it came from a reputable manufacturer, whose product could be relied upon. The quality of the material sold by the leading firms is unexceptionable, but a great deal of the alleged ebonite will be found to be almost worthless when tested. The only real safeguard is, of course, to buy from a recognised dealer, whose reputation is at stake. We believe one or two firms are now branding their ebonite with transfers or labels, which are easily removed. The method should certainly be extended. But why should even these firms sell ebonite from which it is necessary to remove the surface skin? Surely it is possible to manufacture a good grade which can be used without such laborious preliminary rubbing.

An Unlucky Number

On another page we publish a report of one of the most interesting discussions yet held by the Radio Society of Great Britain. The mere announcement of a discussion on the subject would have packed the meeting of any live suburban or provincial society. When Dr. Eccles rose to introduce the first speaker, there were just thirteen members present. Need we say more?

High-Frequency Amplification on Short Waves

Interesting informal discussion at the Radio Society of Great Britain.

ON Wednesday, March 12, at an informal meeting held at the Institution of Electrical Engineers, Mr. Frank Phillips delivered before the Radio Society of Great Britain a most interesting paper, which served to open a discussion on radio-frequency amplification on short wavelengths.

Two Methods

Radio-frequency amplification on short waves, said Mr. Phillips, could be classified under the two main headings of "straight circuits" and special circuits of the super-heterodyne type. He proposed to deal with straight circuits in his short talk, leaving a discussion of the merits, or demerits, of the Armstrong super-heterodyne method to those who had more experience of this method than he had. Those people who had worked on "100-metre" signals, such as those received from KDKA (which worked on 102 metres) and WGY (which, in addition to its ordinary broadcasting wavelength, also sent out transmissions on about 108 metres), were acquainted with the difficulties which arose through shunting capacities, and by experience had learned to make allowances for them.

An Erroneous Idea

It was assumed that on these very short waves it was impossible to get any radio-frequency amplification, but he would show them that it was quite possible to get excellent amplification in this manner, quoting as an example that, using two high-frequency valves, a detector and two note magnifying valves, he was able to get full loud-speaker strength from KDKA, the volume at the best being at least equal to that obtainable from the broadcasting station at Bournemouth. (Mr. Phillips' house is situated at

Blackheath, some 9 miles south-east of London.)

The amplification on this wavelength, however, was not so great as that obtainable with a similar circuit on longer waves, and as a rough indication could be taken as being just about as great with two high-frequency valves (using a tuned-anode circuit for coupling) as is normally obtainable with one high-frequency valve with the same circuit.

Losses Inevitable

When setting out to obtain radio-frequency amplification on this wavelength, said the speaker, we must make up our minds that we are bound to put up with certain losses. Stability could only be obtained in this way. However, there were a number of ways of introducing such losses, some being much preferable to others. The common, and very bad, way of stabilising a circuit was to use the usual potentiometer control on the grids, these being made more or less positive, grid currents being set up which prevented the valve oscillating. He was very much against this method, which only obtained stability at the expense of efficiency. He had given a good deal of thought to a method of obtaining stability without

such losses. Finally he had discovered a method which gave all the stability required without any very considerable losses and possessed the great advantage of enabling him to keep the grids fully negative, enabling the valves to work in the most efficient way for amplification.

The Method

The method adopted, for which he did not claim originality, was to introduce, in series with the rejector circuit of the tuned-anode coupling, a non-inductive resistance of a value of 3,000 or 4,000 ohms. It was essential that this resistance should be as non-inductive as possible. Fortunately, he had succeeded in producing such a resistance in a form which was both cheap and simple to make. It consisted simply of a short tube of brass on which was wound as a single-layer coil the necessary length of resistance wire to give the figure mentioned. At first sight, such a winding might appear to be highly inductive, but Mr. Phillips went on to explain in detail how the non-inductive effect was secured, owing to the capacity effect between the turns and the brass core. Such a coil could be wound with relatively few turns of very thin wire, or a much

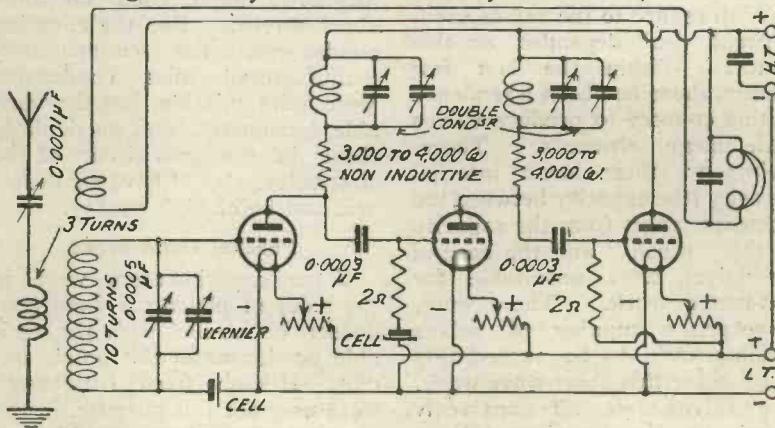

Fig. 1.—The circuit described by Mr. Phillips.

larger number of turns of thicker resistance wire. Experience had shown that it was possible so to proportion the number of turns and the thickness of wire to get a resistance which had so little inductivity that its introduction into the circuit on a 100-metre wave adjustment did not alter the wavelength of the circuit more than half of one per cent.

Values Used

The circuit, otherwise, was quite normal. The speaker said he had found it preferable to loosely couple the aerial to the grid inductance. He found the best results to be obtained with an aerial coil consisting of three or four turns on a 2½-in. former, with a series condenser of a maximum value of about .0001 μF, the secondary inductance (quite loosely coupled to the aerial coil) consisting of 10 turns, which, shunted with a .0005 mfd. variable condenser, covered a considerable band of wavelengths. Using two tuned-anodes with the 3,000- or 4,000-ohm resistances in circuit between the acceptor circuits and the plates, stability was so great that, although the grids were made fully negative, it was still necessary to use reaction before the set could be made to oscillate.

Delicate Reaction Control

Reaction control was delicate, and it was possible to build up very gradually by the application of the reaction coupling until a point was reached when it was possible to hang on the verge of oscillation without trouble.

Valves

With regard to the valves used, a great deal depended on this factor. Within the last few months there has been a tendency in this country to produce valves with large elements. These, owing to their large internal capacity (the capacity between the elements, apart from the capacity in the "pinch" and the base of the valve), were unsuitable for 100-metre work. There were, however, a number of valves which proved to be exceedingly suitable for this short-wave work. The valves were all apparently based on the American UV199 pattern, and were made in this

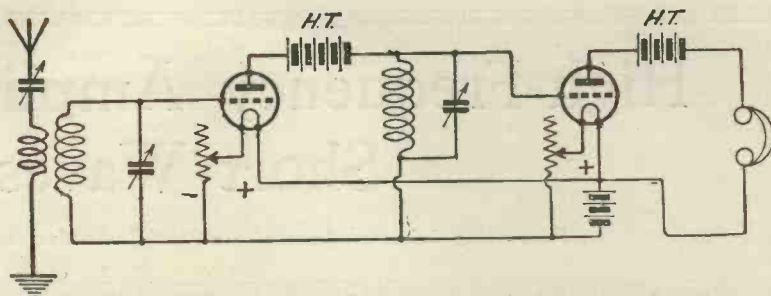

Fig. 2.—Mr. Maurice Child's arrangement.

country as the DE3 (Marconi Osram), the B5 (British Thomson-Houston Company), the AR06 (Ediswan), and the Mullard D.F. Ora. All these valves were closely similar and had very low inter-electrode capacity. He had found these far better than any others for this work, with the possible exception of the V24 type, which, owing to the leads being brought out through the sides of the valve, and not through the base, also had low capacity.

Filament Resistances

He also counselled users to arrange for the filament resistances to be in the positive legs of the valves, and to arrange any grid bias necessary by means of dry cells in the grid circuit. The reason for this was, that sooner or later it might be desired to run these valves off dry cells, and, owing to the falling discharge characteristic of dry cells, no constancy of grid bias could be obtained by the usual method of utilising the drop through the filament resistance.

Importance of Condensers

Considerable importance was attached to the condensers, variable and fixed, used on these short waves. For the coupling condensers, the commercially manufactured mica condensers were quite suitable, but the variable condensers, and particularly those in the grid circuit of the first valve, should have air dielectric and be of high quality.

Parallel Condensers

Some experimenters were in the habit of placing a fixed condenser in parallel with the variable condenser in the anode circuit. If such fixed condensers were used for this purpose, it was essential that they should have an air dielectric, and not mica.

The grids of the H.F. valves should be connected to the negative side of the biasing battery, the positive of this being, of course, connected to the negative L.T., whilst the gridleak of the detector valve should be connected to the positive L.T., this giving, when about 45 volts were used on the plate and the correct filament temperature, just the requisite bias to give good rectification with these valves. Valves of the UV199 type, said Mr. Phillips, were particularly efficient rectifiers.

With these resistors in circuit, he had found it quite possible, and indeed most convenient, to use double condensers for simultaneously tuning the two high-frequency circuits. A single-plate vernier was found of value in balancing the two condensers. He sketched an ingenious form of such vernier on the blackboard.

Distortion of KDKA

The speaker also dealt with the distortion of signals found to be present on 100 metres. It was undoubtedly a fact that the KDKA and WGY 100-metre transmissions were often accompanied by such considerable distortion of the speech as to make the words practically unrecognisable. There was still a mystery as to the cause of this, but it had been noticed, not only by the B.B.C., but by the Metropolitan-Vickers people and many private experimenters. Speaking of the distortion obtained in the Biggin Hill reproduction, Mr. Phillips said that he was of the opinion that much of it was due to the use of too many valves, which were possibly stabilised in such a way as to have grid currents, and gave distortion for this reason. Every valve can produce a certain amount of distortion, and in multi-valve sets of this nature a great deal can be pro-

duced. His experience was that, for this 100-metre long-distance reception, it was advisable to use the smallest possible number of valves.

The Discussion

The discussion which followed was of considerable interest, and Mr. Phillips made a point of answering most of the questions as they were put. Mr. Maurice Child, Mr. Reeves, Captain Ainslie, Mr. Philip R. Coursey, Mr. H. Andrewes, Mr. Percy W. Harris and others contributed and one member took the opportunity of pointing out that the Eiffel Tower were now sending out, on Monday, Wednesday and Friday, C.W. transmissions on about 100 metres, and would be glad to receive reports from listeners.

Mr. Maurice Child described a circuit which he had used very successfully. This differed from the usual form of tuned anode circuit in having between the plate and the acceptor circuit a small high-tension battery. By placing the high-tension batteries in this position he was able to dispense with the coupling condensers, tuning being apparently facilitated, the tuning of one circuit not upsetting the adjustment of the other.

Captain Ainslie stated that he had been able to receive excellent results from KDKA using a circuit consisting of an acceptor circuit, connected straight to the grid of the first valve, which was coupled by the tuned anode method to the detector valve; no earth whatever was used, the grid being quite free.

Mr. Harris sketched a very similar circuit due to D. H. MacDonald, which he had been using for some time for broadcast wavelengths, the difference being

that between the grid and the filament a condenser of about .0001 mfd. was introduced, the usual earth connection being used.

Unfortunately, there were no super-heterodyne enthusiasts present to state the case for this form of amplification.

The Grebe Circuit

Mr. H. Andrewes said he had been experimenting with the Grebe C.R. 13 circuit and had been very successful with it. A point of interest in this circuit was the method of stabilising by using a non-inductive resistance between the earth connection and the negative filament. A suitable non-inductive resistance was rather difficult to obtain, but he had found the Lissenstat used, not as a filament resistance, but as this series resistance, very successful. Used in this way he was able to control reaction by its means, and in his opinion this method possessed considerable advantages over the reaction coil method for controlling oscillation. With the use of a reaction coil on these short wavelengths, any change of reaction coupling rather upsets the tuning and necessitated further attention to controls. By altering this non-inductive resistance, however, tuning was not upset, and therefore the set was much easier to handle.

"Patchy" Reception

One speaker, dealing with the question of distortion, said that he had noticed on several occasions whole sentences would come through with remarkable purity and clarity, yet immediately afterwards they would again become violently distorted. There were, it seemed, good patches of a few moments duration; other mem-

bers confirmed this from their experience.

Spaced Windings

Answering a question on the subject, Mr. Phillips said he had not found any appreciable improvement in using spaced windings for his coils, although theoretically it might appear to be an advantage to use such a method. Several members attempted to find an explanation of the peculiar distortion experienced, which in one aspect could be said to resemble a fluctuation of a periodicity of about 120 per second. This was possibly due to difficulties in getting good smoothing of the supply at the transmitting station.

In the initial experiments KDKA had used one or two kilowatts, but now they were endeavouring to use about 28 kw. and had not yet succeeded in producing a reliable master oscillator to handle this energy on that wavelength.

Weaker Signals

Comparison of results by members indicated that results were not so good within the last few weeks. From day to day, observing at a given hour, there seemed to be a steady diminution of signal strength as time went on, possibly due to the daylight effects. If, however, one sits up late enough, the original strength was still obtainable; at the present time, apparently, the optimum strength occurring at about 1 a.m. Several weeks ago it was possible to get the Sunday evening Church service quite well, but now observations seemed to show that it was practically impossible to receive KDKA on Sunday evenings before the finish of the Church service.

Although the meeting was sparsely attended, the subject proved so interesting that it was well after 8 p.m. before proceedings terminated. The chair was initially taken by Dr. W. H. Eccles, the President, who, owing to an engagement, had to vacate the chair after a short period, his place being taken by Mr. Reeves.

A hearty vote of thanks was accorded to Mr. Phillips for his remarkably illuminating paper, one of the most interesting which has been delivered before the Society.

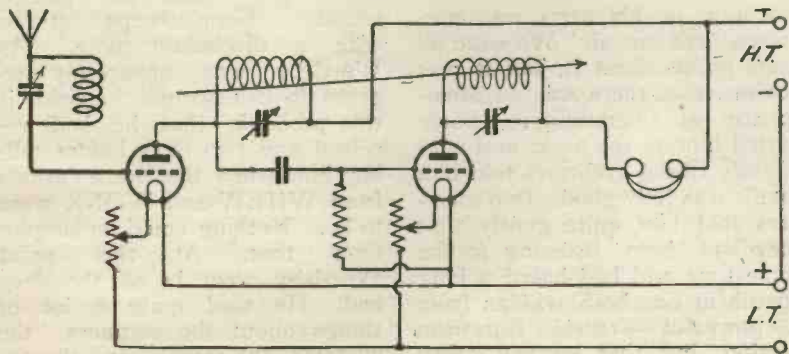

Fig. 3.—Captain Ainslie's receiver for 100 metres.



What Happened to Wortleby

IN Little Puddleton the man Wortleby has been rather going through it of late since he has been the target for the sling-and-arrow practice of those who class all real wireless men as careless handlers of the truth. Long ago Wortleby set himself the task of being able to receive American broadcasting with comparative ease and regularity. For months the man spent his whole time in making up wondrous sets and his whole income in acquiring the necessary bits and pieces for their construction. His workshop was so choc-a-bloc with Armstrongs, Flewellings, Neutrodynes, Reflexes and Super-Heterodynes that you would have found it hard to swing the proverbial cat had you been minded to do so—I have never quite understood why space for cat swinging should be regarded as such an essential quality of rooms, for it is a hobby to which comparatively few people seem to be given. Though I have made a careful search for one for years I have never yet succeeded in running to earth a confirmed cat-swinger. It was calculated at the Wireless Club that Wortleby had purchased during the previous twelve months sufficient ebonite to pave the streets of our small but important town, that the joint capacity of his condensers ran into kilofarads, and that had he devoted himself to drilling through the solid earth instead of through ebonite he might have made a 4B.A. hole from Little Puddleton to a spot in the neighbourhood of Brisbane. We did not often see him during this time, for he spent all his days behind the locked door of his workshop and his nights in his wireless den, ingeniously padded so that no sound from outside could reach him except through the 'phones, whose continual pressure was

known to have given him rather painful corns upon the ears. But when his labours had endured for the better part of twelve months he began to make rare appearances at the Wireless Club, and we gathered from the hints that he threw out that he would shortly accomplish something that was really worth doing.

The Great News

One evening he rushed in, a pale, wan figure, but with the fires of excitement burning in his eyes, speaking in a voice all wobbly with emotion. So bad in fact was the oscillation of his vocal chords that the sounds which issued in a torrent from his lips were like those of the carrier wave which you just cannot tune in. It is obvious that there was modulation, but our ears were unable to resolve it into comprehensible speech. At length, however, his transports were somewhat moderated, and we gathered that in the small hours on the previous night he had succeeded in hearing portions of a discourse upon Modesty by the President of the Dudville Boosters' Club broadcast from WHEW. When this was over, he informed us, he had made further adjustments and had listened entranced to a lecture upon the Feeding of Babies from WONK. Both, he assured us, were beautiful. The reception of his news was perhaps a little mixed. We were all quite polite about it, but it was obvious that there was an atmosphere of incredulity. Some patted him on the back, and with slightly raised eyebrows told him that it was jolly good. Two members told him quite gently that they had been listening at the same time and had heard a long speech in Czecho-Slovakian from a powerful Central European station, but that he had every excuse for mistaking the words

for good American, since atmospherics were quite up to the B.B.C. standard. Gupplethorpe, a hard, cynical fellow, said that he knew for a fact that both WHEW and WONK had been dismantled about six weeks before. Poor Wortleby strove manfully to keep his end up, but whether he protested too much, or whether it was that jealousy and wounded pride prevented our better feelings from doing themselves justice, he had not succeeded in carrying the meeting with him. His agitation was pitiful to behold when he saw that despite the polite assurance of many of us, we were all in our heart of hearts admiring his skill in the drawing of long bows rather than his prowess as a wireless man.

Proof Positive

The next night he turned up again with an expression of subdued triumph upon his face. Quietly he drew from his pocket an orange-coloured envelope, from which he took a folded paper. Without a word he handed round a cablegram from the Director of WHEW: "Speech was made on Modesty, as you stated. Congratulations." This was followed by the production of a second envelope, and another cablegram from WONK also confirming Wortleby's report was passed round. Gupplethorpe struck with a discordant note. As Wortleby was apparently so given to cablegrams, he said, it was probable that he had received one two days before telling him when the transmissions from WHEW and WONK were to be. Nothing could be simpler than that. At this point Wortleby went in off the deep end. He said quite a lot of things about the manners, the customs, the morals, and the ancestry of the members of the

Wireless Club. The Club, he told us, was originally formed to encourage wireless. Now it appeared to exist solely for the discouragement of those who were in any way keen. We still did not believe him. Very well, he would show us that he was capable of getting not only these stations, but others even less generally known on any night he liked.

The Acid Test

Lesser men would have retired at this point shaking the dust from off their feet and acknowledged themselves beaten. Not so Wortleby. As we refused to listen, he said he would do more than give a demonstration. He would make a gramophone record of his reception and would turn it on for all to hear. It appeared that he had recently acquired one of those machines

which you see in most efficient business offices. You dictate things into a kind of spout, and the words which fall from your lips are recorded upon a waxen cylinder. When the cylinder is full, a damsel takes it away and puts it upon her machine, clamps a neat little pair of phones upon her head, turns the thing on and types whilst it talks to her. Wortleby says he hates writing letters; that is why he bought the thing, I suppose. His idea was to affix the spout of the machine to one of his receivers after tuning in one of the desired stations and to obtain a record of the programme, in which, of course, the call sign would appear. He invited three of us to spend the night with him, saying sarcastically that we could wallow in sleep in our beds whilst he worked, and that he would let us

hear the proof of his achievements after breakfast the next morning. We went, we slept well, we breakfasted satisfactorily. Wortleby placed the little cylinder upon the machine with a quiet smile of triumph, and handed each of us a pair of phones. He turned it on; we listened. There was the gentle scratching as the needle made its way over the record—just that and nothing more from end to end. . . . These arrangements are all very well so long as you remember to press down a little catch as a signal to the machine to begin recording. This Wortleby had omitted to do, with the result that the record was as unscathed as upon the day when it left the factory.

WIRELESS WAYFARER.



From 1 a.m. until 4.30 a.m. on Thursday, 13th March, the R.S.G.B's Experimental Station 6XX made an interesting attempt to transmit telephony to the United States. Calls were made in C.W. to station 1XW (operated by Kenneth Warner and F. M. Schnell, of the American Radio Relay League), and immediately a change over was made to telephony. After a few trials of speech, an attempt was made to relay dance music from the Hotel Cecil, the microphone being situated in the Ballroom, as shown in our photograph, and the modulated currents being taken by landline to the transmitting station at Messrs. Dubilier's Works, Hammersmith. At the time of going to press no reports of successful reception have been received. During the morning of March 14th, the B.B.C. transmitted the Savoy Orpheans Band to America, with marked success.

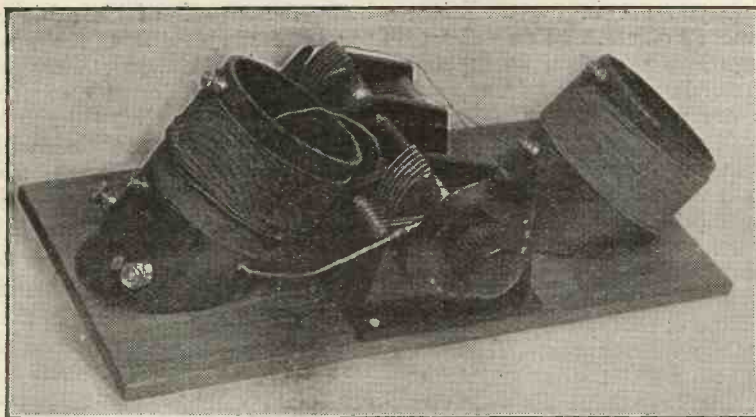

Fig. 1.—The complete tuner.

THERE is no real difficulty in receiving transmissions on the lowest wavelength range in every-day use, i.e., around 100 metres, with an ordinary suburban P.M.G. aerial, provided that suitable inductances are used, and the natural wavelength of the aerial (which will probably be above 100 metres) is reduced by a series or "shortening" condenser of small capacity.

Semi-Aperiodic Coupling

The form of semi-aperiodic aerial coupling described recently by the writer in several circuits offers particular advantages in this connection. This modification of a well-known device, the "auto-transformer" coupling, with a coil tapped for the aerial connection so as to include only a few turns (the whole of the coil being included in the grid circuit), gives excellent selectivity together with undiminished signal-strength when reaction is skilfully applied. It has also the advantage of being largely independent, both for wavelength and reaction effects of the aerial used, hence is particularly adapted for working down at the lower limit of available wavelengths.

Easily-controlled H.F. Stage

An effective and easily-controlled H.F. stage can be arranged by using a coil of similar dimensions to the A.T.I., but without the aerial tap, as the tuning inductance in a "series-tuned anode" (inductance in series with both valve capacities, instead of in parallel with them), as described by the writer recently. Since both aerial-

secondary and anode inductances are of approximately the same value, the tuning capacities associated with them will not be very different, as the proportion of the variable tuning condensers (.0001 μ F maximum) used across them is fairly large compared with the casual and valve capacities. Accordingly, it becomes possible to tune these simultaneously by a double condenser actuated by one handle, with very great simplification of control. The ordinary type of double condenser on the market is not available here, as the two must be wholly insulated from one another, and, if possible, fairly well isolated as well. However, it is not difficult to couple two ordinary .0001 μ F variable condensers by an insulating sleeve, so that they are actuated simultaneously by one handle. The writer illustrated one such arrangement in the account of the "C. Q." receiver in *Wireless Weekly*, Vol. 3, No. 5, pp. 155-156. In the tuning unit described here, a double .0001 μ F variable condenser kindly constructed to the writer's specification by Messrs. Peto-Scott was used. This has the two condensers mounted on the same ebonite base-plate, a single knob controlling them. A 1½ in. long sleeve of ebonite tubing connects the two spindles which are, of course, co-axial.

Balancing Circuits

Any slight difference in the inductance and capacity in the two circuits due principally to the slight effect of the aerial-lead is compensated for by a vernier or three-plate condenser in parallel with the anode-tuning condenser.

A 100-METRE RECEIVER FOR KDKA

By A. D. COWPER, M.Sc.,
Staff Editor.

The setting of this does not have to be altered materially for quite a broad band of wavelengths whilst searching—although it incidentally gives a delicate control of the heterodyne note in reception of C.W. Morse. Accordingly, the one-handle tuning feature is not sacrificed by the introduction of this condenser, and the operation and adjustment of the circuit are rendered far easier by its presence.

Radio Chokes

The rest of the circuit follows very much the type of two-valve H.F. and detector circuits described recently by the writer. The radio-chokes required for the H.F. coupling and Reinartz type of reaction indicated can be the usual plug-in coils of fairly high number of turns, though the 250 turns required on the broadcast belt are needlessly high on this low range. Actually the writer used a plug-in coil of 250 turns and a small "frame-aerial" coil of the same number, as these happened to be handy. A couple of hundred turns of No. 32 S.W.G. enamel-insulated wire on a three-inch former would be adequate. The reaction condenser must have a low minimum. Sometimes, if the two oscillating circuits are very closely tuned, and the aerial-condenser is small, a three-plate will suffice here.

Mounting Inductances

The principal point of the receiver is, of course, the actual type of tuning inductances used for this short-wave reception. These are indicated in the figures. As they must be mounted at an angle of 60 degrees to the horizontal, to minimise the very serious stray coupling experi-

Provided you have a suitable tuner, the reception of KDKA is usually more regular than that of any other American broadcasting Station

enced on extremely short waves, they are made of 3 1/4 in. waxed cardboard formers cut so as to stand approximately at this angle. As the H.F. resistance of wire increases extremely rapidly on the shorter waves, thick wire must be used throughout. For favourable results and good selectivity, the resistance in particular of the portion of the first grid inductance which is included in the aerial circuit must be extremely low, and must be made of the thickest conductor available. No. 18 S.W.G. d.c.c. wire is used elsewhere, except for the reaction coil, where No. 26 is indicated.

Double Turns

To save using a few feet of, say, No. 14 wire, the five turns between the aerial-tap and the earth connection are wound in this unit with doubled No. 18, one layer on top of the other. Thus, starting at the top of the A.T.I. former, which should have a length on the shorter side of about 2 1/2 in., 20 turns (single layer) of No. 18 are wound on, the beginning of the wire being secured to a terminal pushed through the waxed cardboard former at the top. The end of the wire is then passed inside through a small hole, and secured to the lower end of another terminal (the aerial-tap terminal), arranged lower down the former, as shown in the figure. Two lengths of No. 18 are now secured to the same terminal and brought through small holes in the former close to the termination of the 20 turns. One wire is then wound on closely for five turns, passed through a small hole, and secured to the "earth" terminal, which is also mounted in the cardboard

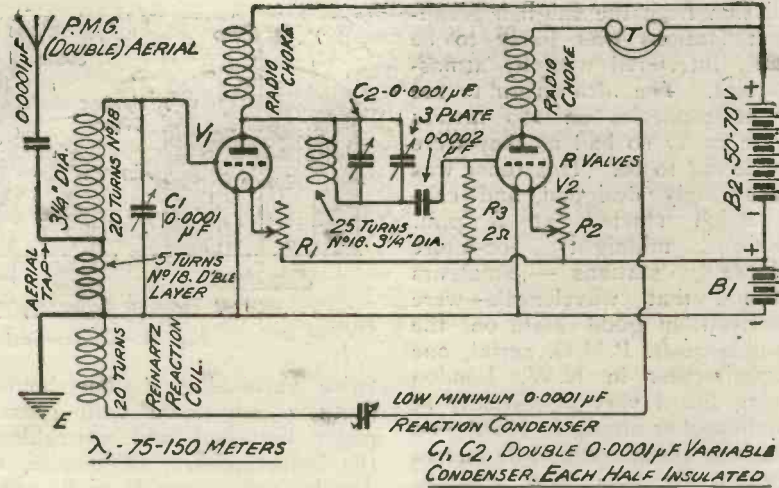

Fig. 2.—The circuit arrangement.

former. A row of thin nails or pins is then driven temporarily into the former to hold the last turns from side-slipping; and the other No. 18 wire is wound for five turns in the grooves between the first five. The wire is passed through a small hole close to the first, and similarly made fast to the same earth terminal. Thus we have two coils of five turns each in parallel, equivalent to a single coil of much thicker wire, but occupying no more space of the former than one. The reaction coil is then wound (starting from the same "earth" terminal, and winding in the same direction), 20 turns of No. 26 S.W.G. d.c.c. wire being wound on as closely as possible. The beginning and end are brought through small holes in the former to the lower ends of the corresponding terminals as before. The coil is then given a good coat of shellac varnish, thoroughly baked, and the pins or small nails withdrawn. It is fixed down to the base-board—measuring 14 in. by 7 in. (it is made of 3/8 in. wood in the tuning unit illustrated)—by wood screws passed through the end.

Anode Inductance

The anode inductance is wound with 25 turns of the same No. 18 wire on a 3 1/4 in. former (which should be about 2 in. long on the shorter side), the ends being similarly brought to terminals. The coils are screwed down, as indicated, at a distance of at least a foot. It would have been preferable, in fact, to have made the base-board rather longer, as

the A.T.I. is brought too close to the tuning condenser with its mass of metal in the arrangement shown, to give the very best results. Thus the tuning in this is not symmetrical on the two sides at the minimum position. This illustrates one of the principal difficulties in extremely short-wave work.

If it is actually thought worth while to incorporate so highly specialised a unit as a 100-metre receiver in permanent cabinet form, this base-board mounting can be made the basis of a long low American type of cabinet, with a vertical panel in front to carry the condenser scales of the double tuning condenser; the vernier and the reaction condensers. The vernier should be arranged to the right of the anode inductance at the same level, with the reaction condenser beyond or above. The reaction lead from the latter to the reaction coil on the A.T.I. should be kept well away from the others. The valves could well be placed on a shelf inside the cabinet above the inductances, giving short leads to the grids. The radio-choke should be well away from the other inductances and at right angles to one another.

Constructional Notes

Actually, the construction of tuning-unit shown is not by any means a formidable task. Thus the one illustrated was constructed by the writer, after seeing a paragraph in the evening paper to the effect that an attempt that night to relay an American trans-

mission from the English broadcast stations was likely to be sadly interfered with by atmospherics. The idea arose to see if atmospherics on 100 metres were really so bad as they were made out to be. This tuner was accordingly designed, and construction started at 8 p.m. Before midnight 100-metre Morse stations — amateurs around that wavelength—were received in good style on the double 40-ft. P.M.G. aerial, one experimenter in N.W. London being heard very persistently at loud-speaker strength. Northolt's mush at about 108 and 81 metres respectively was loud enough, but was readily tuned out a short distance on each side. Almost perfect silence reigned elsewhere, only an occasional rattle of mild atmospherics. Yet shortly before we were being treated to a symposium of American X's which sounded like a gale on a pebbly beach at times, with some interference by KDKA. The effect of real selectivity and tuned H.F. amplification is shown here.

The time indicated included that for cutting, planing, and

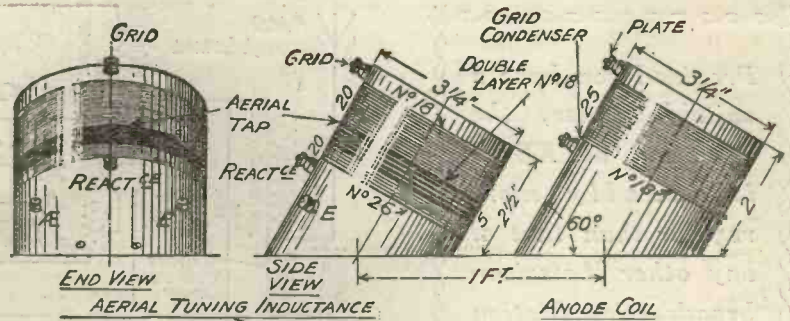

Fig. 3.—Constructional details of the coils.

twice varnishing the base-board (with a rub down with glass-paper between) and varnishing the inductances. Of course, a double valve panel with convenient terminals for experimental connections was available, also the necessary condensers.

Operation

In operation, with the tuning condenser spindle at the knob end made the earthed point, hand-capacity effects (the bug-bear of short-wave work) were practically absent, and with .0001 μ F tuning condensers no difficulty was found in tuning to

C.W. stations, though they were very easily overlooked if the condenser-handle were twirled quickly. The reaction control was delightfully smooth and free from most of that tuning difficulty which swinging coils are apt to give. By proper balancing with the vernier condenser, the circuit oscillated smoothly and perfectly quietly—so quietly that a plate milleameter was needed to tell if it was actually oscillating—from about 75 to 150 metres wavelength. The aerial series condenser could be anywhere between .0001 and .0002 μ F, preferably the former. Ordinary R valves were used, with 60 volts H.T.

MAKING FIXED CONDENSERS

A FIXED condenser consists in its essentials of three parts:—1. A double set of thin metal plates. 2. A set of mica or waxed paper sheets forming the dielectric which separates the two sets of metal plates. 3. Two sheets of ebonite or other insulating material between which the whole assembly is clamped.

The question of the kind of dielectric to use depends largely for its answer upon the purpose to which the finished condenser is to be put. If it is of the large-capacity type and is to be used as a reservoir across a high-tension battery, or in some other position where extreme efficiency is not necessary, the dielectric can conveniently be thin paper soaked in melted paraffin wax of good quality. If, however, the condenser is to be used in a position where losses must be kept down (e.g., as a grid condenser)

mica of the best quality should be used.

The details of assembling the condenser between clamping plates are best left to the taste of the individual constructor, but it seems desirable to recommend that ebonite rather than fibre should be used for these clamping plates, and that the method of clamping adopted should be the passing of brass screws through the corners of the clamping plates. These plates should therefore be made larger than the plates of the condenser itself, so that the screws may not foul the copper foil plates.

The condenser itself consists, of course, of interleaved sheets of mica and copper foil, alternating mica and foil, until the required number of plates has been built up. Alternate foils are soldered together where they project at one end of the assembly, the remaining foils being soldered together at the other end, and a wire being soldered to each of these points to provide means of connecting the condenser in circuit. The

foils may be cut with a lug at one end to facilitate this joining together, or alternatively they may be cut longer than is necessary and the projecting ends soldered up solid.

The actual assembly of the condenser is best done with shellac varnish, and care is necessary here to ensure that the varnish is properly dried in between the plates when the job is finished. Probably the best method is to shellac the mica sheets fairly heavily and dry them thoroughly (with heat) before assembly. If the condenser is then assembled loosely and placed in a fairly hot oven, the dried shellac will melt, and the whole can be clamped up tight. On cooling, the complete assembly will set into a solid damp-proof mass.

Since the thickness of different samples of mica varies within quite wide limits, it is not possible to give dimensions for condensers of any given capacity, with any accuracy.

G. P. K.

An Experimenter's Unit Receiver

By H. BRAMFORD

The following is the seventh of a short series of articles which began in Vol. 3, No. 9

Unit No. 6

This unit takes the form of a grid leak and condenser, the only components necessary being an ebonite panel measuring 6 in. x 4 in. x $\frac{1}{4}$ in., one grid leak having a value of 2 megohms, one Dubilier condenser, 3 clips, and 3 terminals. The grid leak and condenser should be purchased. A photograph of the complete unit is shown in Fig. 29.

Panel Drilling

The panel is drilled as shown in Fig. 28. The securing holes for the grid leak clips should be drilled to clear 4 B.A. screws,

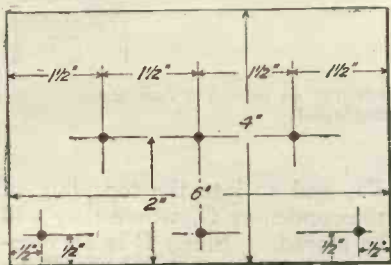

Fig. 28.—Layout of the panel and drilling dimensions.

and the remaining three holes should clear the terminal screws.

Assembly

The assembly of this unit is executed in the following manner:—First mount upon the panel the three grid leak clips, by means of three 4 B.A. screws and nuts. The nuts which are secured on the underside of the panel act also as securing nuts for the condenser, which should be of the Dubilier type, the soldering tags of the condenser being placed between the nuts and the panel. Next mount upon the panel the three terminals—T₁, T₂ and T₃.

Operation

With the use of this unit we are now able to try out single-valve circuits, using the valve as

a Detector. A suitable circuit is shown in Fig. 31. Unit No. 1 (a tapped inductance) is used for the aerial tuning inductance. In this circuit the grid leak and con-

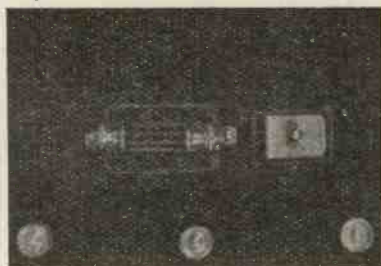

Fig. 29.—A plan view of the top of the panel.

denser are in parallel, the grid leak being inserted between clips A and B. To use the grid leak in series with the condenser the grid leak is inserted between clips B and C. The earth connection may be taken to the positive side of B₁, as shown in the circuit (Fig. 31), or alternatively it may

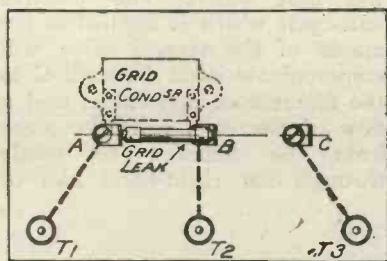

Fig. 30.—The connections of the unit.

be taken to the negative connection. The condenser shown across the phones is optional.

The connections are made in the following order. The terminal T₁ is connected to the clip A, terminal T₂ is connected to clip B, and terminal T₃ is connected to clip C.

The circuit described gives good results as regards signal strength on local broadcasting; but since

there is no reaction effect with this arrangement, the sensitivity of the circuit is not very much greater than that obtaining with a crystal receiver.

The experimenter who is within range of one of the broadcasting stations with the crystal unit will find that this unit is more reliable in its adjustment.

Further units will be described in due course, which will enable the experimenter to get a wider range of wavelengths.

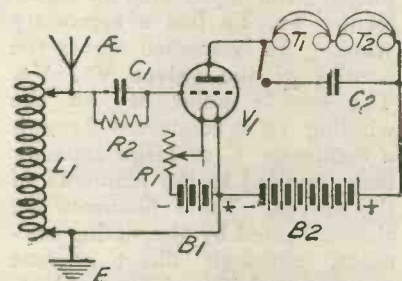

Fig. 31.—A suggested circuit using the already completed units.

Single-Valve Loud Speaking

SIR,—I have constructed the "single-valve loud-speaker circuit" recently published by you and thought you would be interested to know that it works an "Amplion" with extraordinary strength for a single valve. The set at first howled considerably, but by shielding the transformer coil with tin foil it now works silently. After trying several valves, the Ediswan proves most satisfactory, with about 80 v. H.T. My best results so far have been obtained by using Zincite pressing against Hertzite. I find carborundum does not give such purity of tone on the musical items.

N. B. REEVE.

E.I.

C.W. and Telephony Transmission Using Valves

No. X.

By JOHN SCOTT-TAGGART, F.Inst.P., A.M.I.E.E.

This series of articles began in Vol. 3, No. 6

Full-Wave Rectification

IN the method of rectifying A.C., so far discussed, we only use the positive half-cycles of the alternating current. By using two valves, however, we may cause both half-cycles to produce a direct current of high voltage. Fig. 23 shows the usual kind of apparatus employed; the input step-up transformer T_1 , T_2 has a secondary winding T_2 connected across the anodes of the valves V_1 , V_2 . The middle point M on the winding T_2 is connected through a condenser C of large capacity (say 2mfds.) to the filaments of the valves. These filaments are shown heated by alternating currents, although direct current may be used if more convenient. In this circuit each valve operates as a rectifier, the current through each charging up the top end of C to a negative potential.

Let us suppose that at a given moment the extreme right-hand side of T_2 is positive with respect to the left-hand side; the anode of the valve V_2 will be positive with respect to M , and therefore to the filament of the second valve, but since the point

M will be positive with respect to the left-hand side of T_2 , the anode of V_1 will be negative with respect to the filament of the first valve. The positive half-cycle which is applied to the anode of the second valve will communicate itself through C to the filament of this valve, and a flow of electrons will take place from the filament to anode through the right-hand half of

T_2 , and so into the top plate of the condenser C , where they will be stored. Since C is an insulator, the stored electrons will be unable to pass through it. Meanwhile, the anode of the first valve is negative and no current will flow through V_1 .

When the direction of the alternating current in T_2 changes the anode of V_1 will be made positive with respect to the filament of V_1 , and an electron current will flow from filament to anode through the left-hand half of T_2 into the top plate of the reservoir condenser C . Meanwhile, the anode of V_2 is at a negative potential with respect to its filament, and the valve V_2 is not in operation. We thus see that, in whichever direction the current in T_2 may be flowing, the condenser C will be charged up at each half-cycle by a downward flow of electrons, which will make the terminal Y negative with respect to the terminal Z . The terminals YZ may be used as the high-tension source for a valve

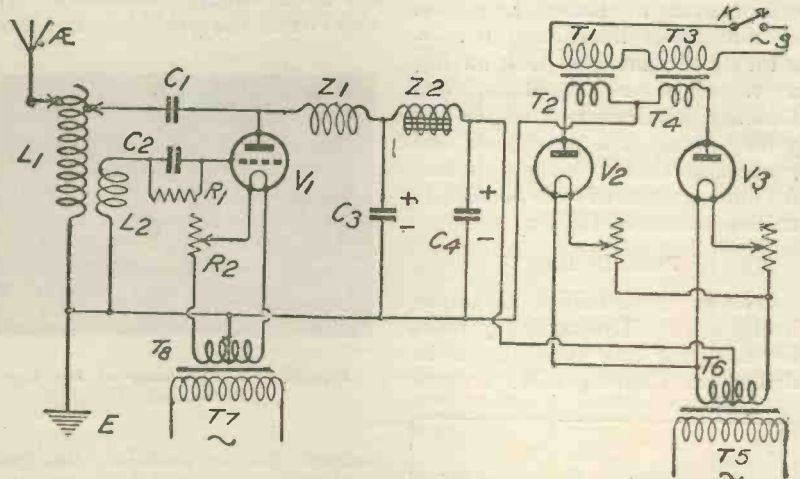

Fig. 24.—A complete valve transmitter in which a full wave rectifier is employed.

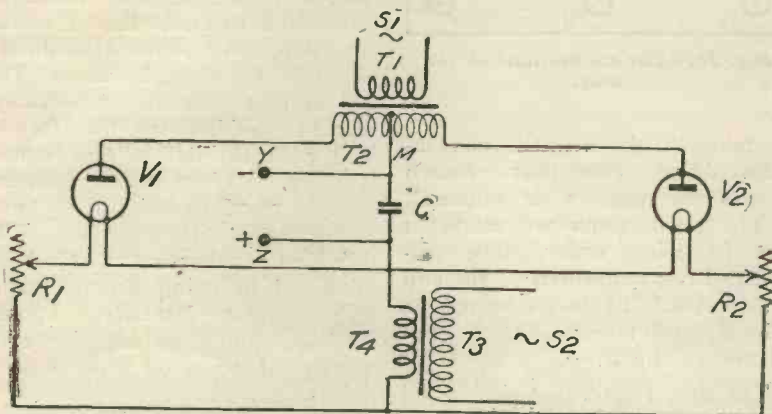

Fig. 23.—A full wave rectifier employing two 2-electrode valves.

transmitter. If no current is absorbed from the terminals YZ the condenser C will rapidly charge up until the voltage across it is equal to the maximum voltage across half the winding T₂; the potential across C cannot rise above this value because the anodes will never become positive with respect to the filaments.

It is frequently convenient to use ordinary three-electrode valves in a circuit of the kind shown in Fig. 23, or, in fact, in any other rectifier circuit, instead of using proper two-electrode valves; when three-electrode valves are used, the grids are usually connected directly to the anodes.

It is certainly a little confusing to the beginner to note how his more expert friends dash off circuit diagrams of all sorts and sizes, in some of which a telephone condenser is shown, others being destitute of fixed condensers of any kind. Now, the use or omission of the telephone condenser becomes a simple matter if we once understand its function.

Originally, of course, a fixed condenser was connected across the 'phones in crystal sets to improve the clarity of signals, but this function of the telephone condenser has now become relatively unimportant by comparison with its other service of by-passing high-frequency currents.

Remembering that the "impedance" of a pair of 'phones is so high that they effectually block the passage of H.F. currents, it will be realised that it is sometimes necessary to provide an alternative path for

Transmitter Using Full-Wave Rectification.

Fig. 24 shows a complete transmitter working off alternating current and using full-wave rectification. The rectifier unit is similar to that shown in Fig. 23, except that instead of using a single transformer with the half-way tapping taken from its secondary, we use two step-up transformers T₁, T₂ and T₃, T₄; this alternative arrangement operates in exactly the same manner. The condensers C₃, C₄ and the low-frequency choke Z₂ constitute a ripple eliminator. The ripple from a full-wave rectifier has twice the frequency

of that produced by a half-wave rectifier, because in the former case the reservoir condenser receives two charges at every cycle; naturally, the higher the frequency of the ripple, the purer will be the note of the transmitting station when received by the heterodyne system.

The left-hand half of Fig. 24 is an ordinary transmitting arrangement. Both transmitting and rectifying valves have their filaments heated by alternating current, and connection to the filaments is preferably made by taking half-way tappings from the low-voltage windings of the filament current transformers, as shown.

Is a Telephone Condenser Necessary?

such currents, whereby they may get past the 'phones. For example, when reaction is used and the 'phones are connected in the anode circuit of the rectifying valve, it is necessary to shunt them with a fixed condenser of about 0.002 μ F in order that the H.F. pulses, which are needed to provide the reaction effects, may get past the 'phones. If the rectifying valve were followed by a low-frequency amplifier, the shunting condenser would be connected across the primary of the first intervalve transformer.

To sum up: When the 'phones (or a low-frequency transformer) are connected in the anode circuit of a rectifying valve which is being used to provide reaction, it is advisable (though not invariably necessary) to provide

a by-pass condenser. When, on the other hand, no reaction is being used, or the 'phones are placed in the anode circuit of an L.F. amplifier, a telephone condenser is unnecessary. It may sometimes, however, be found to improve the clarity of tone of the signals, and for this reason it is usually provided in crystal receivers, although the actual improvement is often negligible.

Since the thickness of different samples of mica varies within quite wide limits, it is not possible to give dimensions for condensers of any given capacity with any accuracy, but it may be useful to indicate suitable sizes for a telephone condenser.

The condenser should have two sets of plates, five in each. Dimensions of the copper plates should be 2 x 1 in. and the mica dielectrics 2 1/2 x 1 1/2 in. This will give a condenser of a good average value.

P. K. G.

"Lightning"

SIR,—The letter on this subject, which appeared in last week's issue under this title, would seem to call for some comment, since it appears that your correspondent, Mr. W. A. Gibbings, has not quite appreciated the reservation in the answer to the question, "What would be the effect of a lightning

flash actually striking an amateur aerial?" It will be remembered that the answer was worded: "Since a lightning discharge may consist of some millions of amperes, it is hard to see how the aerial could escape complete destruction," etc.

Note the use of the word "may." Naturally, the actual volume of a lightning flash must be an exceedingly variable quantity, and such cases as have been recorded show that whereas on

some occasions the discharge has been a mere attenuated spark, on others it has been of such enormous volume as to destroy quite heavy conductors. An example of the latter type of discharge was described by Mr. S. G. Rattee in one of the past issues of this Journal under the title of "Struck by Lightning," the episode in question having occurred at the Cap D'Aguilar Station.—I am, etc.,

G. P. KENDALL.

Broadcasting News



LONDON. — The following figures relative to the number of sets sold in February, give an indication of the proportion of crystal to valve receivers:—

- 28,831 crystal sets.
- 346 crystal sets with one valve.
- 52 crystal sets with two valves.
- 385 one-valve sets.
- 3,418 two-valve sets.
- 622 three-valve sets.
- 1,008 four, five and over valve sets.
- 3,879 microphone amplifiers.
- 4,016 valve amplifiers.

With regard to the hint published in last week's issue, of the new transmitting station for 2LO, the following particulars are of interest:—

The object of the B.B.C. is to erect a station on fairly high ground, on such designs that the public may be able to see over the station without interfering with the progress of the work. The site for this has already been chosen, and in addition to being high, it is not very far from the studio in Savoy Hill. The power of the new station will be double that used at present, but since doubling the power does not necessarily mean that the signal strength will also be doubled, the public are warned that they must not expect a tremendous increase in signal strength. If this new station comes into force, it will be used for a second programme until the new high power station is disposed of either one way or the other.

Sunday, March 9, afforded us a remarkably fine programme; particularly good were the Puccini items, especially "La Tosca" selection by the Orchestra, and Grieg's morceau "Spring's Awakening." Mr. Tom Kinniburgh's rendition of "Within These Sacred Bower's"

from Mozart's "Magic Flute," was approaching perfection.

On Monday, March 10, we had the unalloyed pleasure of listening to Verdi's ever lovable "Rigoletto" broadcast from the studio, and while we miss the applause of the Opera House, we were also spared the incidental noises and other effects and defects, due to the singers (when performing at the Opera House) having continually to change their positions, relative to the transmitting microphones; on the

- 22nd (SAT.).—The Roosters' Request Programme. Savoy Bands.
- 23rd (SUN.).—The Rev. Doctor John G. Vance, religious address. Light Symphony Concert.
- 24th (MON.).—B.B.C. Literary Critic. Musical Comedy Night.
- 25th (TUES.).—The Georgians. The Savoy Bands.

ABERDEEN.—The decision of the director of 2BD to substitute a local programme for the customary London afternoon transmissions on Sundays, has been on the whole, popular, and if the high standard set at the outset is maintained, there can be little ground for complaint. One of the outstanding advantages is the absence of the all too frequent distortion which usually accompanies land line transmissions.

As predicted in these notes, the demand for another student's night was immediate and insistent, and listeners to 2BD will be pleased to learn that arrangements have been completed for the broadcasting by the students of a burlesque play. The date has been provisionally fixed for the 31st instant.

BROADCAST TRANSMISSIONS	
Call-Sign Wavelength	
LONDON	2LO 365 metres
ABERDEEN	2BD 495 ..
BIRMINGHAM	5IT 475 ..
BOURNEMOUTH	6BM 385 ..
CARDIFF	5WA 363 ..
GLASGOW	5GC 420 ..
MANCHESTER	2ZY 375 ..
NEWCASTLE	5NO 400 ..
TIMES OF WORKING	
Weekdays 3.30 to 4.30 p.m. and 5.0 to 10.30 p.m. G.M.T.
Sundays 3.0 p.m. to 5.0 p.m. and 8.30 to 10.30 p.m. G.M.T.

whole, we think we prefer these operas broadcast from the studio, where the balance of the singers and musicians can be regulated to a nicety. The singing of Gilda and Rigoletto was superb, for that matter so was that of the other artists; the orchestra was up to its usual mark of excellence.

Forthcoming Events
MARCH.

- 19th (WED.).—B.B.C. Dramatic Critic. The Magic Carpet.
- 20th (THURS.).—The Kendall String Quartet. Miss Ethel Dixon, piano. Savoy Orpheans.
- 21st (FRI.).—The Third Symphony Concert, given by B.B.C. at Central Hall, Westminster.

Forthcoming Events
MARCH.

- 19th (WED.).—Dance Night. Mrs. Shand's Dance Orchestra. Mr. Fred. Spencer, "Humorous Sketches of Mrs. 'Arris."
- 20th (THURS.).—Operatic Night. Miss Elsie Cochrane, soprano. Mr. A. B. Duncan, baritone.
- 21st (FRI.).—S.B of Symphony Concert from London.
- 22nd (SAT.).—Special Band Night. Band of British Legion. Wireless Orchestra.
- 23rd (SUN.).—Greyfriars Church Choir. Miss Carma Daah, soprano. Rev. J. M. Gladstone, religious address.
- 24th (MON.).—"Everybody's Programme. Miss Nan Stenhouse, soprano. Mr. Robert Anderson, baritone. Mr. Gus Stratton, entertainer. 2BD Repertory Players.

25th (TUES.).—Classical Night. Early Italian music and songs. Miss Elsie Cochrane, soprano.

□ □ □

BELFAST.—One of the difficulties experienced by the B.B.C. in establishing Belfast's broadcasting station was providing a distinctive wavelength in the already crowded compass between Cardiff's 353 and Aberdeen's 495. At the time of going to Press, 435 metres has been allotted to 2BE, to give Belfast its new call sign. The announcement is naturally evoking much discussion among Northern Irish listeners, but since 435 is sufficiently distinct from its neighbour wavelengths of 420 for Glasgow and 475 for Birmingham there are general expectations that the decision of 435 will obviate any confusion due to interference from either of these towns.

□ □ □

BIRMINGHAM.—The 5IT staff are ever endeavouring to give their audience something new and delightful, and they succeeded conspicuously a few nights ago when "The Mystery Singer"—Miss Ursula Greville—gave a number of songs and a demonstration of what she considers are the essential qualities of the "radio voice." Mindful of the fact that some eminent singers have very nearly shattered their reputation—and the microphone also!—when they have contributed to a radio programme, Miss Greville, who is one of the finest *colloratura* singers, has made a special study of the "radio voice." The essential features, she believes, are chiefly a carefulness to avoid full resonance in the vowel parts of enunciation, with, on the other hand, a slight over-emphasising of the consonants; the maintenance of perfectly true poise in long-drawn notes, particularly those in the higher registers; and the correct projection of the voice towards the microphone. Miss Greville's identity was not revealed to listeners until the following day, the object of the "mystery" being to secure unbiassed opinions of her singing. These almost wholly agreed that her voice "came over" with exceptional sonority and clearness.

Forthcoming Events

MARCH.

- 19th (WED.).—Classical Programme.
- 20th (THURS.).—Piano Quintette. Popular Classics. Programme by the Orchestra. Dance Music.
- 21st (FRI.).—Lozell's Orchestra. London Symphony Concert.
- 22nd (SAT.).—Kiddies' Concert. The Court Company of Players will produce "The Chinese Puzzle," a drama in four acts.
- 23rd (SUN.).—Station Orchestra. Repertory Choir. Address by Canon F. E. Belton.
- 24th (MON.).—Lozell's Orchestra. Miscellaneous Programme by Orchestra and Soloists.
- 25th (TUES.).—Piano Quintette. Philip Wilson: Talk and Recital on Music in the Reigns of Queen Elizabeth and James I. Colin Gardner: Wireless Hints.

□ □ □

BOURNEMOUTH.—The week ending March 8. was an exceedingly interesting one, and local listeners have voiced their approbation in no uncertain manner.

□ □ □

The Sullivan evening was a great success. The most striking feature was the singing of Mr. Sydney Coltham, and was a treat not to be missed. Conditions the night he sang were ideal. There was a complete absence of interference in any shape or form. As a consequence his voice was heard against a background of absolute silence. Listeners, however,

must have caused some "noise" themselves for it was announced that the telephone bell was ringing practically the whole evening, asking for encores, to which Mr. Coltham generously responded. Mr. Roland Gourley was also in Bournemouth, and gave one of his inimitable entertainments, which was thoroughly enjoyed.

□ □ □

Mr. Harry Pouncey and the Wessex Glee Singers, also provided an excellent evening. Mr. Pouncey's knowledge of the Wessex dialect and folk-songs is very profound, so that more need hardly be said.

□ □ □

Forthcoming Events

MARCH.

- 19th (WED.).—Musical Comedy Night.
- 20th (THURS.).—Chamber Music Night.
- 21st (FRI.).—S.B. from London of the Symphony Concert.
- 22nd (SAT.).—Request Night.
- 23rd (SUN.).—Organ Recital. The Rev. Father Triggs: Religious Address.
- 24th (MON.).—Aldershot Silver Prize Band.
- 25th (TUES.).—Mozart Night.

□ □ □

CARDIFF.—Much regret is manifest in this district at the forthcoming departure from the Cardiff Station of the station director, Major Corbett Smith, who is being transferred to the programme staff at London. The



Our photograph shows a workman climbing up the inside of one of the masts at the Nauen Station. By holding the picture above the head and looking upwards, some idea of height is conveyed.

"Major" has endeared himself in the hearts of "Comrados" since his coming to Cardiff, and his "Everyman" talks, which were such a feature, will be missed very much. The "Major" was a "one-man band" in the true sense of the word, and it will, indeed, be difficult to find a successor to fill the position as he has.

□ □ □

Forthcoming Events

MARCH.

- 19th (WED.).—S.B. from London.
- 20th (THURS.).—A Programme of Variety.
- 21st (FRI.).—S.B. from London of Symphony Concert.
- 22nd (SAT.).—Popular Night.
- 23rd (SUN.).—An Hour of Good Music. Rev. J. Willis Bennetworth: Religious Address. Spanish Night.
- 24th (MON.).—S.B. from London.
- 25th (TUES.).—Shakespeare Night.

□ □ □

GLASGOW.—On Thursday, March 6, 5SC celebrated its first birthday, and for the occasion a birthday programme was broadcast in the evening. In addition to the musical side of the programme, congratulatory speeches were transmitted by Mr. Baillie Geo. Kerr, the Senior Magistrate, and Sir Charles Cleland, Chairman of Glasgow Education Authority. Sir Charles said that from the educational standpoint, interest had recently been awakened in Glasgow as to the possibility of wireless in schools as an aid to the children in their lessons. Baillie Kerr observed that far from interfering with the attendances at theatres and music-halls, as some people suggested, broadcasting was, in his opinion, a most useful and valuable auxiliary to them. Mr. H. A. Carruthers, the station director, responding, said they welcomed the pointing out of faults in the programmes. No week had passed, however, without hundreds of letters being received, and he estimated that about 70 to 80 per cent. of them were letters of appreciation. They were out to be as enterprising as they could, and the more novel the suggestions the more they would be welcomed. An interesting item on the programme for the evening was a "Birthday Sketch," specially written in honour of 5SC's birthday by Mr.

George Woden, the author and playwright.

□ □ □

Forthcoming Events

MARCH.

- 19th (WED.).—Classical Night.
- 20th (THURS.).—Special Request Night.
- 21st (FRI.).—S.B. from London of Symphony Concert.
- 22nd (SAT.).—Dance Night.
- 23rd (SUN.).—Band of the City of Glasgow Police. The Rev. D. Forfar: Religious Address.
- 24th (MON.).—Orchestral Night.
- 25th (TUES.).—Music and Humour Night.

□ □ □

MANCHESTER.—Wireless figured prominently in the revels of the Manchester University students at their annual "Rag." A tableaux in the procession portrayed the "2BAD" Broadcasting Station, the staff of which was easily identified as that of 2ZY, including the station director in "plus fours" and a football jersey, conducting an unruly orchestra. During the evening some of the students invaded the 2ZY studio and took possession of the programme for the time, entertaining the unseen, and possibly mystified, audience to some witty caricatures of the uncles and aunts. Every phase of broadcasting seemed to receive attention—there were the Savoy "orphans," unusual and original time signals, startling cotton reports, a switch-over to "Ki-dee-ki-hi, Pennsylvucky," complete with trans-Atlantic atmospherics to order.

□ □ □

Forthcoming Events

MARCH.

- 19th (WED.).—Concert. Ashton-under-Lyne Concertina Band. Mr. T. A. Coward, M.Sc.: Talk on "The First Migration." Miss Phyllis Gatenby, elocutionist.
- 20th (THURS.).—2ZY Orchestra. Carlton Main Colliery Band. Mr. Tom Sherlock, baritone. Mr. Edward Brock, solo piano. Prof. T. H. Pear: Talk on "How to Use the Memory."
- 21st (FRI.).—Concert. S.B. from London of Symphony Concert.
- 22nd (SAT.).—Concert. Popular Concert by 2ZY Orchestra. Miss Selma Whitehead, soprano. Mr. E. N. Butterworth, humorist. Talk by Mr. G. W. Thompson on the "Marvels of Water"; (2) "Dew and Mist."
- 23rd (SUN.).—Radio Military Band. Miss Jennie Copeland, soprano. Rev. R. W. Thompson, M.A.,

B.D. Mr. Pat Ryan, solo clarinet. Miss Molly Gray, soprano. Mr. Norman Fawcett, solo piano.

- 24th (MON.).—2ZY Quartette. Mr. Leonard Busfield, solo violin. Mr. Laurence Wildgoose, tenor. Mme. Muriel Bradburn, soprano. Persiflage, by Percy Phlage. Mr. R. M. Lowe, bass-baritone.
- 25th (TUES.).—Concert. 2ZY Orchestra. Operatic Music. Miss Ethel Wynn-Jones, contralto. Prof. F. E. Weiss, D.Sc., F.R.S., "More About Trees." Savoy Bands.

□ □ □

NEWCASTLE-ON-TYNE.—It is the ambition of the Newcastle Player's Repertory Theatre Company to do for Newcastle what Mr. John Drinkwater and his associates did for Birmingham, and we understand that their efforts have been so successful that there is now definitely a scheme in hand for the establishment of a repertory theatre in the city. The members of the company made their debut before the 5NO microphone during the past week in the sketch "Elegant Edward," which is very well adapted for broadcasting.

□ □ □

Forthcoming Events

MARCH.

- 19th (WED.).—Walker's Band relayed from Tilley's. Modern French Composers. Orchestra. Miss Margaret Thackeray, contralto. Mr. David Openshaw, baritone. Miss Beatrice Paramor, soprano.
- 20th (THURS.).—Miss L. Storm, piano. Mr. and Miss Golightly, duets. Mr. T. Golder, cornet. Orchestra. Mr. D. McFadzean, baritone. Mr. Fred Spencer, entertainer. Mme. Mable Offer, mezzo-soprano.
- 21st (FRI.).—Mme. Nicholson's Quartette Party.
- 22nd (SAT.).—Walker's Band relayed from Tilley's. Musical Comedy Night. Orchestra. Miss Nora Wiggins, soprano. Mr. Rowland Yates, baritone. Mr. G. Wealans, violin.
- 23rd (SUN.).—Orchestra. Miss Lily Adams, contralto. Mr. Jack Todd, tenor. Mr. Alfred Seabridge, violin. Rev. W. G. Peck, Religious Address. Durham City West End Male Voice Choir. Mr. Ralph Jacobson, 'cello.
- 24th (MON.).—Miss Peggy Campbell, piano. Miss J. Hitchins, soprano. Mr. M. Henderson.
- 25th (TUES.).—Novo Instrumental Trio. Orchestra. Mr. Hudson Barnsley, baritone. Miss Winifred Fisher, soprano.

Saved from the Scrap Box

By R. W. HALLOWS, M.A., Staff Editor

EVERY wireless man's workshop contains a box or a drawer which houses the weirdest collection of odds and ends. In addition to pieces of ebonite small and large, lengths of rod round and square, plain and screwed, odd terminals, plugs, and so on, there is usually to be found in it a certain amount of discarded apparatus. Most of us in our early days as wireless enthusiasts purchased components without the nice discrimination which we now exercise, with the result that a good deal of what we bought was later consigned to the scrap box. Some of these things were useless from the beginning, but many have come to their present resting-place because we subjected them

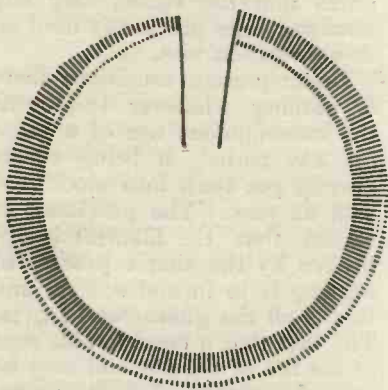

Fig. 1.—An open coil resistance.

to rather harder usage than they could stand.

In my own box the other day I came across two rheostats which must have been there for a very long time. To-day I would not buy a filament resistance whose windings were not made upon a former of ebonite or some other insulating and protecting material. But in times past it was a different matter altogether and one did acquire as a rule rheostats in which the resistance element was simply an open coil of wire. Sooner or later an unsupported coil receives blows or squeezes which put it out of shape and eventually renders the rheostat pretty well useless. With careful handling, however, these open coil rheostats do quite well and it is handy to have a few

spare ones for wiring up emergency circuits. I resolved, therefore, to repair these two, and they are now at work once more. It is not perhaps generally known that ready-made resistance coils with a value of five ohms can be purchased from advertisers in this journal for sixpence apiece.

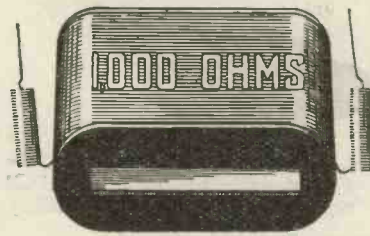

Fig. 2.—A typical 1,000 ohm bobbin.

These are extremely well made, the turns being gradually tapered off to one end. It is the easiest thing to replace worn-out spirals by their use.

A similar piece of doctoring can be done in the case of telephones which have been burnt out through the passage of too heavy a current. The rewinding of one's own bobbins is rather a terrifying job and one that most people would shy at tackling. Ready-wound bobbins can, however, be purchased with resistances of either 1,000 or 2,000 ohms from 1s. to 1s. 6d. each. These can be made to fit most standard types of metal diaphragm telephones, and if one uses them a repair can be made with no great difficulty.

Low resistance bobbins are also obtainable; in fact, one can buy the complete magnet inset with two 120-ohm bobbins ready mounted for 2s. 6d. With the help of these or the bobbins previously mentioned high resistance 'phones can be converted into low or vice-versa. 'Phones which are out of action because their diaphragms are bent can be brought into service again by fitting new diaphragms, which can be obtained in all sizes from $1\frac{1}{8}$ in. to $3\frac{1}{2}$ in. in diameter at very reasonable prices.

There is a use even for the burnt-out low-frequency interval transformer. As a rule, only one of the windings goes

when the accident takes place, the other remaining intact. The winding that is still good can be used quite well as a choke coil in such circuits as those which have been recently described in *Wireless Weekly*. Its approximate resistance can easily be ascertained by the use, as in Fig. 3, of a battery of known voltage and of a milliammeter. By Ohm's Law the resistance in ohms equals volts multiplied by a thousand and divided by milliamperes. Hence, windings whose resistance was 1,000 ohms would show six milliamperes if the current from a fully-charged 6-volt accumulator was passed through them.

A great deal can be done to components whose ebonite portions have been cracked or broken. Not long ago, whilst fixing a Dubilier-type 600 condenser to the underside of the panel, I had the misfortune to break off one of the lugs by turning the screw down rather too hard. Here, a very satisfactory repair was effected in the following simple way:—The two pieces were first of all stuck together with secotine, so as to keep

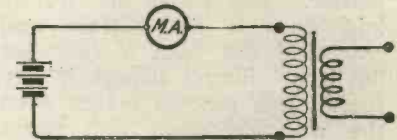

Fig. 3.—Circuit used for calculating resistance of choke oil.

them in position whilst the final operation was in progress. A soldering iron was then made very hot and its point was run rather quickly over the crack between the two portions. The ebonite was fused, so that quite a good joint resulted. After being finished up with emery paper it was hardly noticeable, and the condenser was as useful as ever. The same method may be applied successfully to cracked rheostat formers, broken knobs, and even to thin panels that have split whilst being drilled. It cannot, of course, be claimed that ebonite repaired in this way is as strong as ever, since fusing takes place only to a small depth below the surface. Still, it does render unsound articles useful, and with careful handling they will last for a long time after they have been treated in this way.

Ebonite which has become

warped—a thing which occasionally happens to old panels and to the mountings of components—can be straightened out again without much labour. All that is necessary is to immerse it for some time in boiling water, which causes it to become about as pliable as sheet lead of the same thickness. The warped part can then be placed between two flat surfaces under a heavy weight and left to cool. After this treatment it will become as hard as ever on cooling and all bends will be removed. The time of immersion required to soften it depends upon the thickness of the ebonite and upon its make. Some kinds soften almost at once, whilst others may require to be boiled for several minutes before they show signs of yielding.

Few scrap boxes do not contain one or two condensers of the rotary vane type, which have been thrown aside either because their plates were bent or because contact with the spindle had become so faulty that the instrument could not be used in any circuit. If the condensers are very old ones, with zinc plates, straightening is a very easy matter. The plates are merely laid upon a flat surface and smoothed out with a very hot flat iron. Simple though it may sound, this process makes even the worst-deformed zinc plates as good as new in a few moments. Aluminium plates, such as are now used almost universally, are not quite so tractable, since they require a fairly high temperature to soften the metal at all. A process that is sometimes successful, though results cannot be guaranteed in every case, is to heat the vanes in a bunsen flame and then to place them between two perfectly flat metal plates, hammering the upper one with a fairly heavy hammer until the aluminium cools. Aluminium vanes can, however, be bought so cheaply nowadays that it is really not worth while to bother about straightening those which have become bent. The best way is simply to remove them, replacing them with new ones.

Faulty spindle contacts occur very frequently in rotary vane condensers that are not well designed, when they have been in use for some time. One quite good way of curing this fault, and so of bringing discarded con-

densers back again into service, is as follows:—It will usually be found that a shoulder is cut at the lower end of the spindle, a tip of small diameter passing into the bush for a depth of about $\frac{1}{4}$ in. Shorten this tip until there is at least $\frac{3}{16}$ in. clearance between its end and the bottom of the bush. File it to a round point. Now tap the lower end of the bush and insert a small screw, first flattening its point

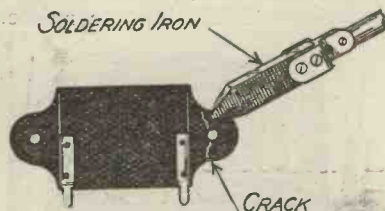

Fig. 4.—Illustrating method of repairing the broken moulding of condensers.

and making a cup in it with a drill of appropriate size. The screw may be turned in until the tip of the spindle is seated in this cup. This will ensure a good contact, and future wear can be taken up by means of the screw. Should this method not be possible owing to the design of the particular condenser, here is another which will answer very well indeed. In this case it is necessary that the lower end of the spindle should protrude for a $\frac{1}{4}$ in. or so below the bush in the bottom plate. If it does not

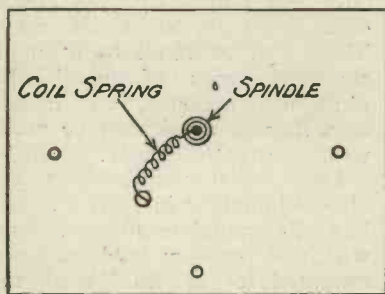
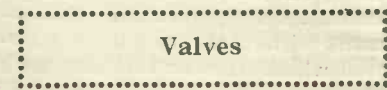

Fig. 5.—How to fit a spring contact to a condenser spindle.

already do so, the tip should be cut off and replaced by a short length of studding, screwed into a hole tapped in the end of the spindle. About 6 in. of thin copper wire are now wound round a knitting needle, so as to form a spiral spring. One end of this is soldered to the protruding end of the spindle, whilst the other is fixed to a screw in the bottom plate, as shown in Fig. 5. A

perfectly positive contact with the moving plates is thus obtained.

In addition to actual apparatus the scrap box will often contain numbers of B.A. nuts and screws which have been thrown away on account of injured threads. Every workshop should contain 2, 4, 5 and 6 B.A. taps and a 4 B.A. die. With these, damaged threads can usually be made quite good again. Stripped nuts cannot be restored to their original use; there is, however, one very handy use for them: they may be tapped out one or two sizes larger than they originally were.



SIR,—I should like to call your attention to a much-needed protection for wireless experimenters, owners of broadcast receivers and all users of radio valves in the shape of some guarantee that the valves they buy have not been previously used on demonstration sets.

Under present conditions there is nothing whatever to prevent the unscrupulous use of a valve for any period, it being subsequently put back into stock and sold as new. The purchaser is shown that the filament is unbroken by the simple process of heating it to incandescence, and this is all the guarantee he gets. The fact that a considerable part of the life of the filament may be spent by reason of such unscrupulous use is entirely overlooked.

I would suggest that the desired protection be afforded by the manufacturers placing a seal, in the form of an adhesive strip, across the grid and anode legs of a valve. This would effectively prevent its use in a holder, and at the same time would not hamper the very necessary operation of testing the continuity of the filament.

Copies of this letter are being sent to the Radio Society of Great Britain, the principal technical magazines and the various valve-manufacturing companies.

—Yours faithfully,
J. W. HADFIELD CRAVEN.
Nuneaton.

[Our correspondent is referred to the Editorial which appeared in our issue of September 12, 1923.—EDITOR.]

Some Useful Soldering Tips

MOST readers of *Wireless Weekly*, who devote part of their energies to constructional work in wireless, are bound, at times, to come up against small soldering jobs of considerable difficulty. When one is wiring up a panel in the first instance, soldering is always a fairly straightforward business, especially if one thinks out the work before undertaking it. It is best to so plan things that the most difficult joints are made before too many wires have been added, so that there is little room left for work in cramped places. The trouble begins when, as is usually the case, one has to make certain alterations after trying out the apparatus. Fate is generally perverse enough to see that these changes in wiring have to be made in the most inaccessible spots. Hence the choice seems at first sight to lie between either the dismantling of

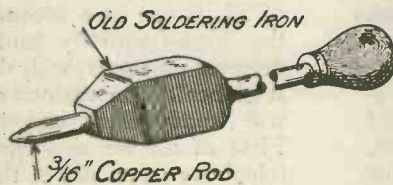

Fig. 1.—A useful iron for fine work.

most of the wiring or being content with a rather ugly job. Matters are made somewhat easier by the use of a very small soldering iron made from a copper rod; but there is one very serious drawback to its use, which is that, owing to its small size it cools so rapidly that one spends most of one's time in heating it up.

The writer has recently made up an "awkward job iron" which is most satisfactory to use, for it combines both the heat-retaining properties of the large tool and the handiness of the small one. The point of an old soldering iron of fair size is cut off with a hacksaw. A 3/16 in. hole is then drilled and tapped in the end. A short length of 3/16 in. round copper rod is threaded at one end and tapered at the other to a fairly sharp point. The rod is then screwed tightly into

the iron, a few punch marks made at the junction, serving to keep it securely fixed. If the workshop does not contain a 3/16 in. tap and die, any garage or cycle shop will do the job quite cheaply. The length of the small rod can

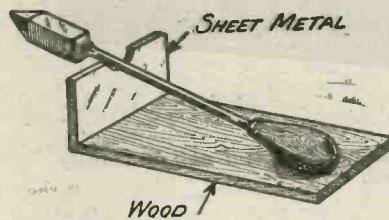

Fig. 2.—A convenient form of iron rest.

be made to suit individual requirements. The writer generally uses one of about 1 1/4 ins. in length. This tool retains the heat very well indeed, owing to the large bulk of copper behind its point, and there are few places which cannot be reached by it.

A very useful little accessory, whilst one is soldering, is a rest of some kind for the iron. When one is in the workshop one can do without it, for the iron can be put down almost anywhere. But many amateur constructors are forced to do their work in their sitting-rooms, where a hot soldering iron thoughtlessly laid down may do a good deal of damage! A very simple little device is shown in Fig. 2. This consists

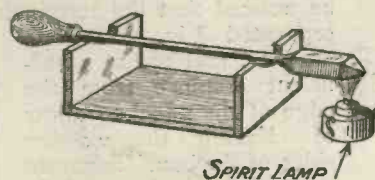

Fig. 3.—Another form of rest for the soldering iron.

simply of a piece of sheet metal with a hollow cut in its top edge screwed to the end of a small board. Placed in this the iron cannot do any damage and is always at hand when wanted. A still better rest is shown in Fig. 3. Here the iron is supported in a horizontal position, so that the copper portion can be kept in the flame of a spirit lamp. This con-

trivance will be found most useful when one is wiring up panels, for the iron is constantly hot and no time is wasted. R. W. H.

International Broadcasting

Broadcasting has developed rapidly during the last few months in all parts of the world, and several of the more powerful stations have international audiences, who, although keenly appreciative of the musical portions of the programmes, are naturally disappointed when "talking" starts. To make international broadcasting really effective, something will have to be done in the way of transmitting lectures, news items, and other matters of special interest to foreign listeners in an auxiliary language, such as Esperanto.

Quite a number of lectures have already been broadcast from British and foreign stations in Esperanto, and have been heard and understood by many thousands of radio-enthusiasts. As an instance of the practical value of such talks, a lecture was broadcast a few weeks ago from the Prague Station on the attractions of Czechoslovakia for the foreign tourists.

Further talks from this station (1,150 metres) took place on March 17, 9 p.m., on "The Sample Fair of Prague." This talk had been arranged at the special request of the Fair authorities; and some time in May (date to be announced later) a special international Esperanto concert will be transmitted.

On March 31 a talk will be broadcast by Dr. Priyat, of the Institut Jean Jacques Rousseau, from the Geneva Station, 1,100 metres, 9 p.m., in French and Esperanto.

On April 5 Mr. J. D. Sayers, of the *New York Evening Post*, will talk in Esperanto from the W.O.R. Station, Newark, N.J., U.S.A.

On June 23 Mr. J. Boyd Anderson will talk from the Glasgow B.B.C. Station.

Reports of reception will be welcomed by Mr. H. A. Epton, 17, Chatsworth Road, Clapton Park, E.5.

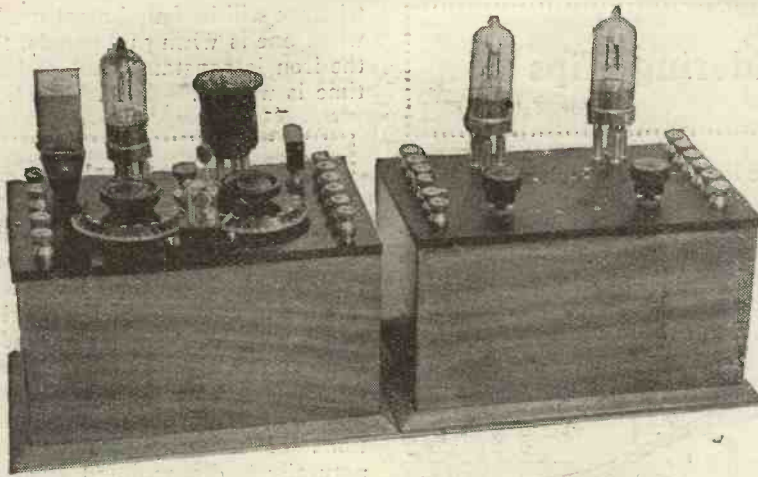

The new amplifier, used with the H.F. and crystal unit previously described.

An Amplifier with

By PERCY W. HALL

This article describes a two-valve low-frequency transformer.

In this particular instrument I strongly advise you to use a separate filament resistance for each valve, for as you will see a little later, the valves may occasionally perform different functions. Notice that the filament connection of the first valve is made to the negative side of the valve above the filament resistance. The filament connection of the second valve is made to the negative lead below the filament resistance. This is done deliberately.

A Unit of Many Uses

When finished, the unit may be connected up in a number of different ways. Let us take first of all its use as a second unit to the high-frequency and crystal detector unit previously described. A glance at the various diagrams will show what can be done. First of all we can connect the telephone terminals of the crystal unit to the two lower terminals with the first valve extinguished, whereupon we shall have a high-frequency valve, a crystal detector, and one note magnifier. Alternatively we can short-circuit the middle two terminals on the

THIS detector and amplifier unit, primarily designed to work with the H.F. and crystal unit, described in our issue of March 5, is nevertheless suitable for many other purposes.

A single- or two-valve amplifier for low frequencies is one of the simplest instruments to make. We have only to provide two valve sockets, two filament resistances (even one for both valves will do) and a couple of intervalve transformers. These, mounted on the necessary panel, or box, with a few terminals constitute very efficient instruments, and it might be thought there was very little new to say on the subject.

In this article, however, I hope to show you how to make a very simple and useful two-valve amplifier, which has more uses than can be obtained from a similar instrument of the usual design. Primarily it is built to combine with the valve and crystal unit described in *Wireless Weekly* for March 5; and when used with this latter unit, enables a number of most interesting combinations to be tried. Before giving details of how to connect it to other instruments, let us consider for a moment the actual construction.

Components Needed

The finished unit consists of a box of exactly the same dimensions as that used for the valve and crystal unit (9 in. x 5 3/4 in.), an ebonite top panel provided with 12 terminals, two valve sockets, two Lissenstats (or any

other suitable filament resistances), a fixed condenser of .0003 μ F fitted with a grid leak of 2 megohms, a fixed condenser of .002 μ F, and a further fixed condenser of 1 μ F shunted across the high tension terminals. Finally, we have one intervalve transformer. That shown is a "Magnum."

Wiring is carried out with No. 16 gauge square-section tinned copper wire, in the manner shown in the detailed wiring diagram, a blue print of which is obtainable as usual at the price of 1s. 6d., post free. In ordering, you should ask for Blue Print No. 22. After the ebonite panel has been thoroughly rubbed down on both sides with fine emery paper to remove the surface skin, the positions of the various components are marked off. It will be noticed that the terminals are separated 3/4 in. from one another, and are at a sufficient distance from the edge of the panel to allow of clearing the wooden sides of the box. Separate valve legs can be used, in which case it is wise to utilise one of the many valve templates sold, so that the holes can be accurately marked out, or if desired, the ebonite sockets with embedded legs can be used. The transformer should be placed so that the secondary terminals come in the position shown so that the grid lead can be kept short.

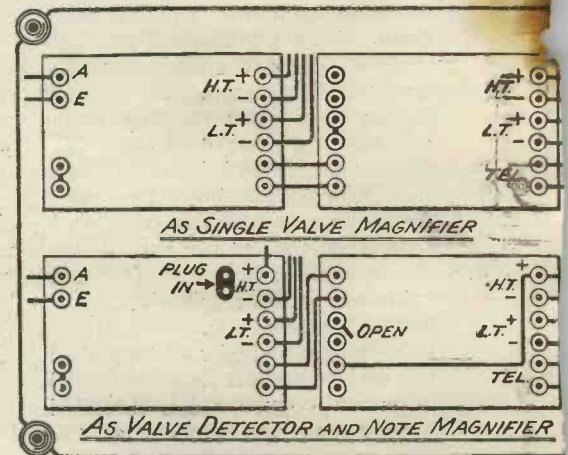

How the amplifier can be used with the H.F. a

With New Features

ARRIS, Assistant Editor

frequency unit in which one intervalve transformer is used.

is left (thus short-circuiting the grid condenser and leak), and if then we connect the positive H.T. to the second terminal from the bottom on the left, we can utilise the first valve of the new unit as a valve amplifier for the rectified current from the crystal detector, there being no need when the signals are fairly weak to use any intervalve transformer here. Of course if we were using a valve detector it would be necessary to have some kind of special coupling as would be the case if the crystal were shunted across a tuned anode coil and not across a transformer, as in the unit mentioned. When so connected we have a high-frequency valve, a crystal detector and two note magnifiers; a very useful and sensitive combination, which, whilst not quite so efficient on strong signals as a set with two inter-valve transformers, is yet a thoroughly reliable combination. For example, with the apparatus connected as shown, it is easy to listen to some of the distant broadcasting stations on a loud-speaker when conditions are favourable, whereas using the combination with a high-fre-

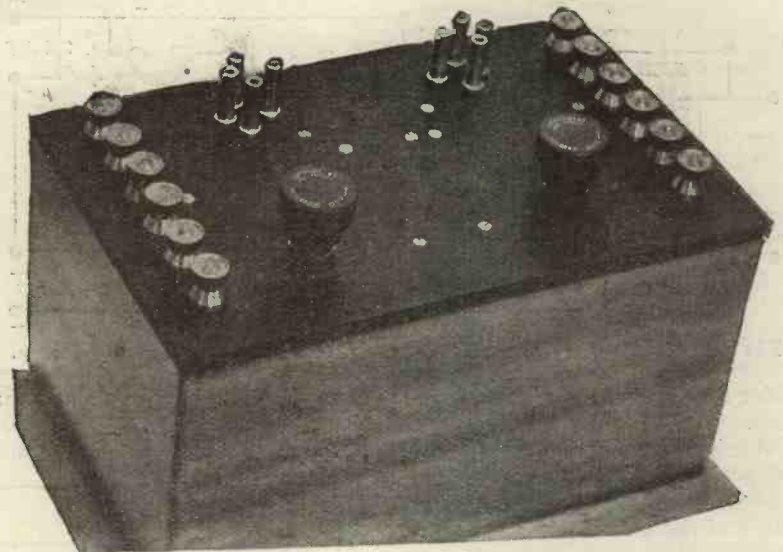

Simplicity is the keynote of the panel layout.

quency valve, a crystal detector and one note magnifier only (coupled by an intervalve transformer), such signals do not come up to loud-speaker strength save in exceptional circumstances.

As Valve Detector Unit

By plugging in the special short-circuiting plug, which short-circuits the crystal in a previous unit, and by opening the link between the middle pair of terminals on the left-hand side of the second unit, and by leaving the positive connection as shown in the figure, we can use the set as a high-frequency valve, a detector valve, and one-note magnifier—another useful and stable combination. Finally, by removing both valves from the second unit, opening the link on the left-hand side of the first unit, and connecting a Wander plug from the lower left-hand terminal of the first unit to the grid socket of the second valve socket, and by joining the telephone terminals of the first unit to the transformer terminals of the second, with the telephones now connected between the positive H.T. and the positive H.T. terminal of the first unit, we can listen on the first set as a single-valve dual amplification receiver. In this case, of course, we must remove the short-circuiting plug from the socket on the first unit and

adjust the crystal carefully. Used in this way the receiver is quite good enough for loud-speaker working at four to six miles from a broadcasting station with a reasonable aerial. Even greater distances will occasionally yield good results in this way.

Two Transformers

If it is desired to use both valves in the second unit as transformer coupled note magnifiers all we need do is to connect the secondary of an intervalve transformer to the upper left-hand terminals (short-circuiting the grid condenser, of course), the primary of this transformer being connected to the telephone terminals of the first unit. In this case OS should go to the grid, IS to the filament terminal with IP to the lower and OP to the upper of the two telephone terminals of the first unit. In some cases it may possibly be found that slightly better results are obtained by reversing the IP and OP connections.

Even if the reader has not built the previously-described unit he will still find the present instrument of general utility. For example, a variometer, a coil shunted by a variable condenser or other tuning device can be rapidly put together and connected across the grid and filament terminal of the first valve with the short-circuiting link open. We then have a simple two-valve set, consisting of a detector followed by one-note mag-

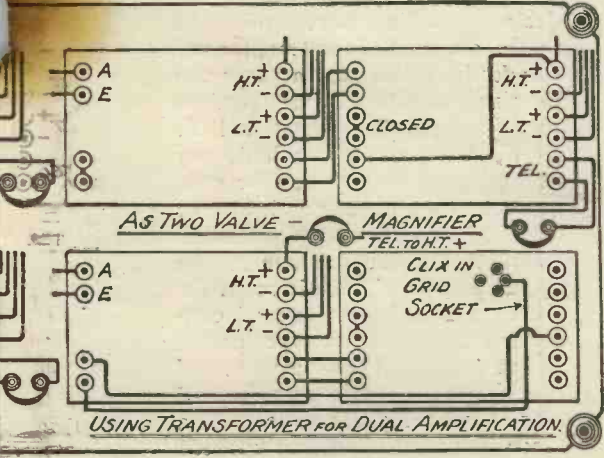

nd crystal receiver described in "Wireless Weekly."

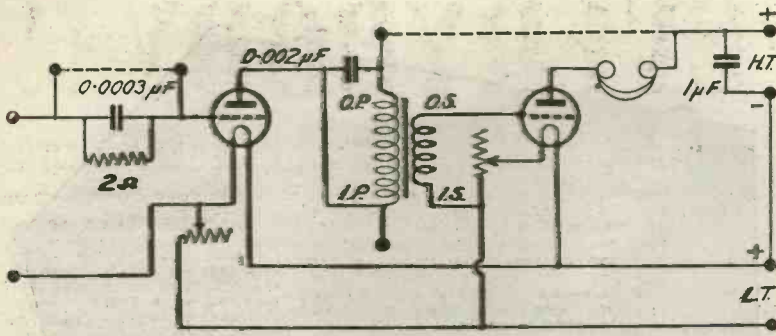

The Circuit used. Note additional terminals for transformer primary.

nifier for general broadcast reception.

Again, whenever required, the IP and OP terminals of the set can be connected to some other set, and the unit used as a single-

ance, it should be explained that this valve sometimes serves the purpose of a detector, and some-

the negative L.T. below the filament resistance the grid would have, when used as a detector, a negative bias upon it—not a desirable characteristic. If we were to connect the grid connection to the positive leg of the valve this would give slightly improved results when the valve was used as a detector, but would cause distortion when it was used as a note magnifier. The connection actually made is thus a compromise. As the second valve is always used as a note magnifier, connection is made to the negative L.T. below the filament resistance so as to place a slight

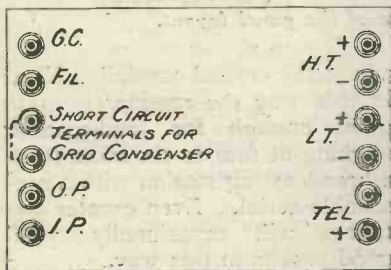

valve note magnifier. Other uses will doubtless suggest themselves.

A Reason

In case the reader may be curious as to why the filament connection of the first valve in this unit is made to the negative leg of the valve above the filament resist-

times as a note magnifier. If the filament connections were made to

negative bias upon the grid. Using a 4-volt valve with a 6-volt accumulator and the filament resistance suitably adjusted, we shall have approximately 2 volts negative bias upon the grid. Unless signals are very strong this will generally be found about correct. If, however, the reader desires to give more grid bias the IS terminal of the transformer should be taken to a separate terminal connected to the negative L.T. Between these two terminals any desired grid battery can be connected, the negative lead, of course, being connected to the IS terminal and the positive to the negative L.T. There is room for these terminals in several convenient positions on the panel. When using dull emitter valves of the single-cell variety such grid bias is generally desirable. The reader is recommended to fit these terminals in such cases.

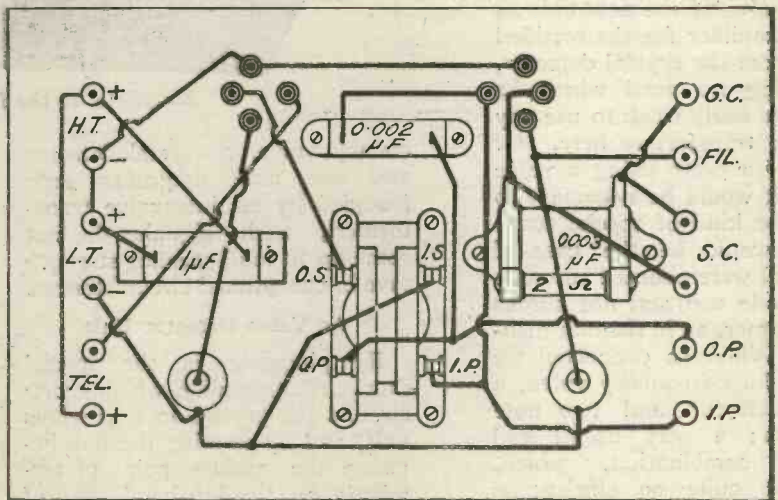

Back of panel wiring.

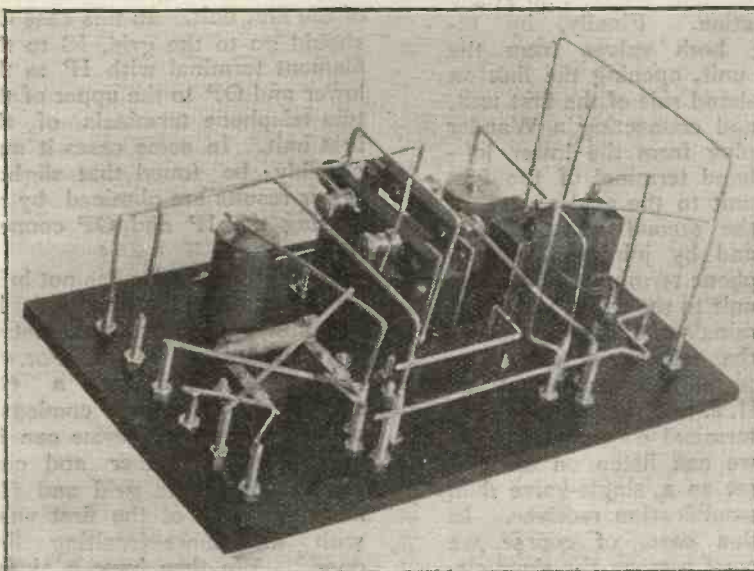

This underside of panel view shows the method of wiring up with No. 16 gauge square section wire.

How to Make a Selective Two-Valve Panel Receiver

TYPE W 2

By HERBERT K. SIMPSON

Further constructional details of the instrument will be found below, together with the result of the Editor's tests upon the W 2 Receiver.

THE wiring diagram is seen in Fig. 9, and all points to which connection has to be made are numbered, omitting the numbers which correspond to various tapping points on the coil. A table is given below of the components and the numbers allotted to them, and a list of points to be joined makes wiring-up very easy.

List of Numbers

- Selector switch, S1, studs, 1 to 6.
- Selector switch, S2, studs, 1A to 6A.
- A, 7; A1, 8; A2, 9; E, 11.
- HT+, 12; HT-, 13; LT+, 14; LT-GB+, 16; GB-, 18.
- Inductances, L2, 21, 22; L3-23, 24; L4-25, 26.
- Aerial tuning condenser, 27, 28.
- Switch arm, S1, 29.
- Switch arm, S2, 30.
- Transformer, IP, 31; OP, 32; IS, 33; OS, 34.

- Fil. resistance, R1, 35, 36.
- Fil. resistance, R2, 46, 47.
- V1, P 37; G 38; Fil. 39, 40.
- V2, P 41; G 42; Fil. 43, 44.
- Variable grid leak, 48-49.
- Grid condenser, 50-51.
- Const. aerial condenser, 52, 53.
- Transfr. bypath condenser, 54, 56.
- Telephone bypath condenser, 57, 58.

Connections

The inductance. The first figure in each bracket is the turn-number on the coil where a tapping is taken.

(0-6), (5-5), (10-4), (15-3), (17-2), (19-1). No. 20 will be found below.

(45-1A), (55-2A), (65-3A), (75-4A), (85-5A), (100-6A).

The Rest of the Set

(7-29), (8-53), (9-52-22-28-51-48), (11-13-14-44-39-27-20).

(12-T4-58-54-31), (16-47-36), (18-33), (21-23), (24-

30), (25-37), (26-T1), (32-T2-56), (34-42), (35-40), (38-49-50), (41-57-T3), (43-46).

Full dimensions of the cabinet are given in the drawing, Fig. 10, and no difficulty should be experienced by a careful worker. If desired, the cabinet may be purchased from a firm specialising in this form of work, and in this case the cost should not exceed 18s.

In the drilling figure, Fig. 3, it will be seen that the panel is slightly bevelled at the top, to permit it to fit properly into the cabinet; thus, in fitting the panel into its place, the bottom is first lodged in position, and the panel lowered into its place in the cabinet. Conversely, in removing the panel from the cabinet, the top must be raised first.

For broadcast wavelengths the coil L2 in Fig. 2 is not required, and its socket, near the top of

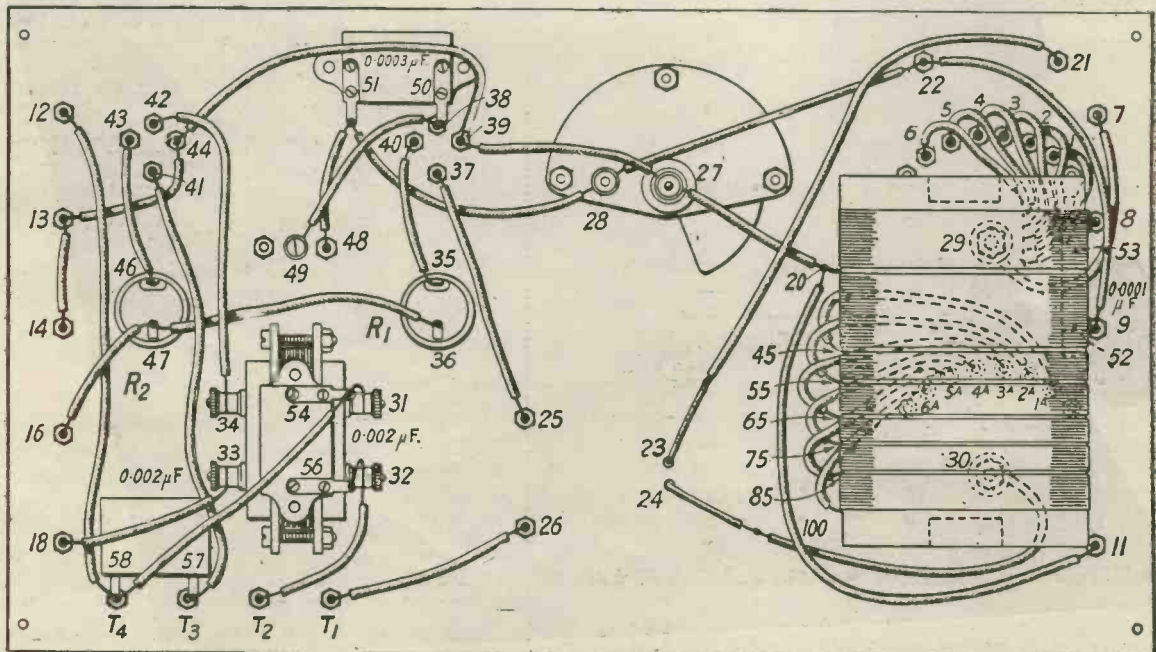

Fig. 9.—Wiring diagram of the receiver.

the panel, is shorted by inserting a coil plug provided for the purpose, the latter having plug and socket connected together by a piece of wire. In Fig. 1 this shorting plug is seen in the socket. L3, the left-hand coil in the two-coil holder, should be a No. 25 for broadcasting, while the reaction coil L4, which is the right-hand coil, should be a No. 50.

The 0.0003 μ F variable condenser is adjusted for fine tuning, while a rough adjustment is obtained by the inductance switch S2 and the plug-in coil L3.

For longer wavelengths, a coil will have to be inserted in the socket L2, and larger coils L3 and L4 may have to be used in the two-coil holder. A high-tension battery of at least 70 volts should be employed, and a 6-volt accumulator for bright emitter valves. If dull emitter valves are employed, dry cells may replace the accumulator, but it is recommended that a 2- or 4-volt accumulator be used, according to the voltage required by the valves, as the voltage of a dry cell is less steady on discharge than is that of an accumulator.

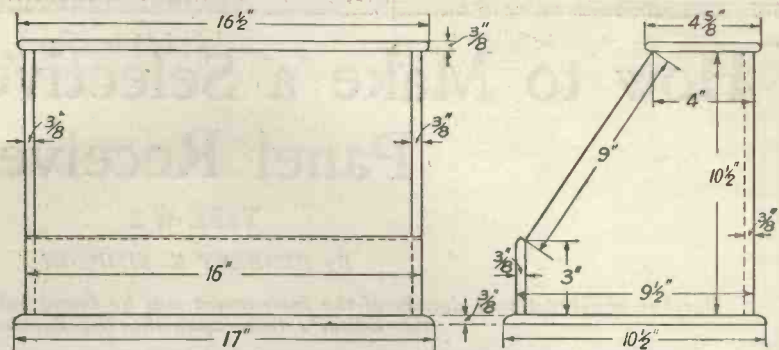

Fig. 10.—Two views of the cabinet, giving all dimensions.

Testing the Set

Connect up the batteries to the terminals indicated in Fig. 2, and join the aerial and earth leads to terminals A1 and E respectively. This brings in the constant aerial tuning system, thus greatly simplifying the matter of tuning. Put a 25 coil in the left-hand socket,

a 50 in the right, and short the socket at the top left corner of the panel by means of the plug. Place the valves in their sockets, and join up the telephones to T3 and T4, while T1 must be joined to T2. Both valves are now in circuit, but if only one is required the telephones are connected to T1 and T2, leaving T3 and T4 free.

Tuning is now effected by

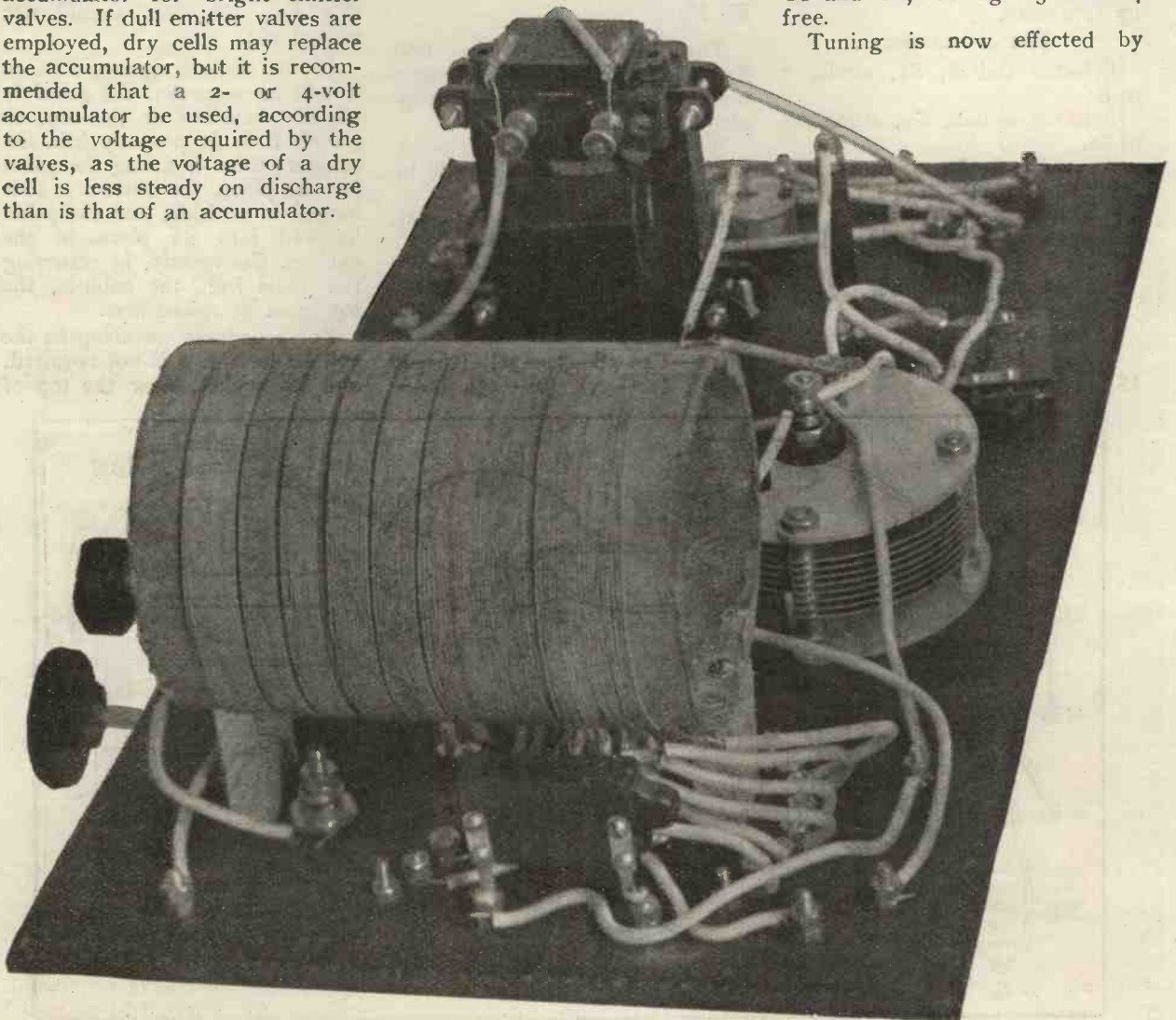

Fig. 11.—A photograph of the underside of the panel.

putting the switch S₂ on stud 1A and moving the condenser over its scale, listening for a signal while doing so. If no signal is heard, try with the switch on stud 2A, and so on, until signals are heard at their best. The reaction coil may be swung up closer to the grid coil L₃, but care must be taken not to couple them too tightly, as if this is done, the set will oscillate and cause interference to other listeners in the neighbourhood. With the aerial and earth connected as above, the switch S₁ is inoperative. If the aerial is joined to A₂, the same circuit is in use, without the constant aerial tuning.

The specially-selective circuit is obtained by joining aerial to A, leaving A₁ and A₂ free, and earth to E, using the same arrangement of coils as before. In this case the circuit is tuned exactly as before, but with the switch S₁ on stud 1. When signals are heard, an adjustment of S₁ may result in better signals, but in cases of interference, this switch will prove its value. It will be found that by an adjustment of this selector switch the interfering station can be almost entirely cut out, provided that its wavelength is not exactly the same as that of the required signals, with no loss in signal strength of the station to which it is desired to listen. Reaction being possible with this circuit, it may again be mentioned that the coils in the two-coil holder must not be brought too close together, on account of oscillation.

When listening for distant stations, however, the set must be made to oscillate slightly, by coupling-up the coils until oscillation starts. Move the condenser until a "carrier wave" is picked up, and tune to the "silent point" of this; now loosen the coupling by drawing one coil way from the other very slightly, keeping on the silent point by adjusting the condenser. Speech will be heard when the set just stops oscillating when tuned to this point.

A little practice will enable the operator to obtain the best results from this set, which is very efficient, bringing in distant stations at good strength, with a minimum of difficulty, owing to the selective properties of the circuit.

HIGH SELECTIVITY

Test Criticism of the W 2 Receiver

In accordance with our policy explained in Vol. 3, No. 12, we publish below the results of tests made by Mr. John Scott-Taggart, F. Inst. P., using the W 2 Receiver

This set gave very good average results on broadcasting. The results were a trifle disappointing on distant broadcasting, but not much is to be expected in this direction on two valves, especially when no high-frequency amplification is employed.

Results from 2LO

At 12 miles from 2LO, where my station is, 2LO signals come in very loud for a straight circuit, and, for the reception of local broadcasting, the set gives excellent loud-speaker signals. The loud-speaker signals on 2LO were amply sufficient on a single-wire aerial 75 feet long (including down lead) and 12 feet high. The results are much louder than with a tuned anode and reaction (ST34) circuit. The reception was equally good on all the broadcast wavelengths, when tested with a wave-meter, and on spark stations (450 and 600 metres). The full range of wavelengths was more than covered when a No. 50 coil was plugged into the left-hand (fixed) coil-holder. The tapped coil enabled a minimum of capacity of the variable condenser to be used with resulting efficiency, and this advantage is important on longer wavelengths, e.g., Radiola (1,780 metres) and Paris FL, where gaps between coils are usually rather larger.

Constant Aerial Tuning

The constant aerial tuning arrangement gave as good results as the "Haynes" circuit, and was easier to work, but the latter gave beautifully selective results without loss of signal strength. Any degree of selectivity could be obtained by means of the "aerial tap" switch (the upper arc), but signal strength fell off rapidly if too few turns were included in the aerial circuit. With only one turn in the aerial circuit, no signals on the loud-speaker were obtained on the 75-ft. aerial, but on a 35-ft. high, 100-ft. twin-wire aerial good signals were

still received with extraordinary selectivity.

The Haynes circuit arrangement should greatly appeal to all who suffer from spark or other jamming.

The reaction should be looser when using the Haynes circuit than when employing C.A.T. (constant aerial tuning), and while a No. 75 reaction coil is advised for C.A.T., a No. 50 is better for the Haynes arrangement, except when working over 400 metres, when a No. 75 may be employed.

Using C.A.T., 2LO came in on the left-hand stud of the lower inductance switch, a No. 50 in the left-hand coil-holder, a No. 75 as reaction coil, and 20 deg. on the variable condenser. Aberdeen came in only faintly on the loud-speaker on the fourth stud from the left of the lower switch (using C.A.T.), a No. 50 grid coil and 75 reaction, and 30 deg. on the variable condenser. It also came in on the second stud from the left, a No. 75 grid coil, No. 75 reaction, and 15 deg. on the variable condenser.

Distant Stations

Newcastle came in fairly well, and was better than Aberdeen and Birmingham, which were both unsatisfactory.

2LO on the Haynes circuit came in on the first left-hand stud of the lower switch, a No. 50 grid coil and No. 50 reaction, the aerial tap switch (the upper arc) being on the 4th, 5th or 6th stud from the left; the variable condenser was at 40 deg.

Aberdeen's adjustments on the Haynes circuit were the same, except that the sixth stud on the lower switch was used and 25 deg. on the condenser.

Experimenters near any of the other B.B.C. stations should get as good results from their own station as I did from 2LO.

The general performance of the set was well above the average, and the alternative circuits are an added advantage.

A Rheostat for Dull Emitters

THE newest type of dull emitter valves have such an extremely low current consumption that a rheostat built upon the lines of a potentiometer is necessary for controlling their filaments if they are worked off a 6-volt accumulator. To cut down the current of a 6-volt battery to .06 ampere we require, as Ohm's Law shows us, a total resistance of 100 ohms. The filaments of the M.O. DE₃ and the B.T.H. B₅ have each a resistance of about 50 ohms; that of the Ediswan A.R. .06, which passes .06 ampere at a potential of 2.5 volts, has a resistance of a little over 40 ohms. As all these valves are apt to vary a little in their requirements, particularly when they are used either as high-frequency amplifiers or as rectifiers, it is as well to make the resistance of the rheostat about 80 ohms so that one has plenty in hand. First-rate accumulators often maintain an E.M.F. of between 6.2 and 6.5 volts for some considerable time after they have

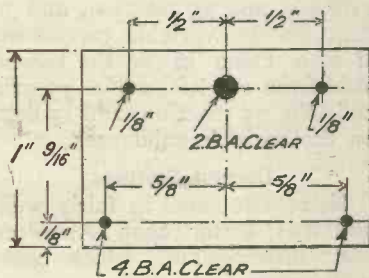

Fig. 1.—Details of the end pieces

been charged. The writer's, an Exide, though it was charged a week ago and has been used on an average three hours a day for working a set fitted with three DEQs and one DEV, shows at the moment of writing 6.5 volts. As these four valves have a total consumption of .7 ampere, the discharge has already been 16.8 ampere hours with no falling off in the original E.M.F. Those who use similar accumulators will find it necessary to have the little extra resistance mentioned in order properly to control the filament potential.

A very satisfactory high resistance rheostat can be made up in the home workshop, chiefly from

such odds and ends as are to be found in every wireless man's scrapbox. The former is a piece of 1/4-in. ebonite 3 in. in length and 1 1/2 in. wide. The corners should be rounded off with a file in order to make it easy to place the windings evenly and tightly upon it. It is wound with 14 yards of No. 30 enamelled Eureka wire. As this wire makes 73 turns to the inch if closely wound, the windings will occupy just over 2 in., so that a space of rather less than 1/2 in. may be left clear at each end of the former. Each end of the wire is anchored to a 4 B.A. screw driven into the ebonite. The heads of these

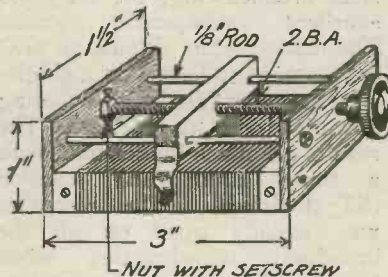

Fig. 2.—Showing the end pieces in position and method of mounting the runners.

screws also serve as stops for the slider. The wire once put on should be given a dressing of shellac to keep it in place, and should be allowed to dry hard.

The detail of the end pieces, which are cut from stout sheet brass, is seen in Fig. 1. They are 1 in. in height and 1 1/2 in. wide, 1/8 in. from the lower edge are drilled two 4 B.A. clearance holes for the screws which will attach them to the ebonite, 13/16 in. from the lower edge are three holes, the middle one 2 B.A. clearance, the others 1/8 in. in diameter. The end pieces are attached to the former, as seen in Fig. 2, the two lengths of 1/2-in. round brass rod being threaded at the ends for a short distance and held in place by nuts. It is most important that these two rods should be absolutely straight and parallel, and that they should be well polished with fine emery paper.

The same drawing also shows the way in which the length of 2 B.A. brass studding which

works the slider is mounted. The 2 B.A. clearance holes in the end pieces act as bearings for it, and it is kept in place by nuts provided with setscrews which must be so adjusted that the rod can be moved quite easily by means of its knob but has no end-play. This rod again must be absolutely straight, and one must be careful to see that the threads have not been damaged in any way.

Fig. 3 shows the detail of the slider, which is made from a 1 1/2-in. length of 3/8-in. square brass rod. Three holes whose positions correspond exactly with those in the end pieces are drilled in this, the only difference being that the middle one of the trio is threaded and not made to pass the studding clear. To either end of the slider is soldered a contact arm made from springy sheet metal. The drawing shows the way in which these are bent. The slider is now mounted upon the guide rods, the 2 B.A. screwed rod being passed through its middle hole. It is then run up and down two or three times for the whole length of its travel and the enamel is cleared off the wire along the path which its arms follow.

As each turn of wire has a resistance of only about 1/2 ohm, this

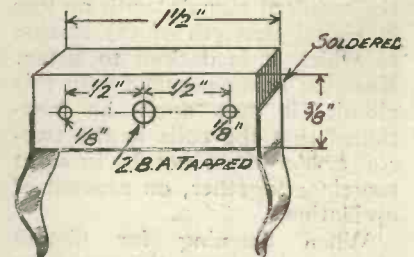

Fig. 3.—Constructional details of the slider.

rheostat can be used by itself for most ordinary purposes. If, however, it is found that a finer adjustment is desirable it can be wired in series with an ordinary 5 or 6 ohm rheostat which will serve as a "vernier." It can be attached to the underside of the panel by means of a couple of 4 B.A. bolts passed through holes drilled for them in the endpiece nearest the knob. When it is mounted in this way it makes a very neat fitting, for nothing but the knob appears above the panel; nor does it require much depth, the total length below the panel being only about 3 1/4 in.

R. W. H.



Notes on the Use of Variable Condensers

MANY experimenters are not making the most of their variable condensers. The different commercial types often have widely differing characteristics; in the first place, some manufacturers are not supplying genuine capacities, and are selling to the public 0.0004 μF variable condensers for 0.0005 μF . We have drawn attention to this state of affairs, and propose to go further in the near future unless standard capacities are adhered to.

Quite apart from this, however, different makes of condensers have different minimum capacities; that is to say, when the condenser is adjusted to zero there is a very appreciable capacity still in circuit, which, when shunted across a plug-in coil, will give a certain minimum wavelength which will vary with different types of condensers. If then, the full range of wavelengths expected from a coil is not obtained, the fault is probably that the minimum capacity of the condenser is too high. Unfortunately, this is a matter which cannot be directly rectified, and it would be a good thing if condenser manufacturers paid a little more attention to what is really an important matter. The coil manufacturers, on their side, have done what they can to reduce the self-capacity of the coil which, if too high, also limits the range of wavelength obtainable with a given inductance.

What the average experimenter does is to use a small capacity condenser, such as a 0.0003 μF . He will generally find that he gets as wide a wavelength variation as with a 0.0005 μF , for the simple reason that the minimum capacity is

lower. Because of this lower minimum self-capacity a larger coil is employed. For example, when using a tuned anode circuit the ordinary 0.0005 μF variable condenser will not get down to 2LO (365 metres) when using a No. 75 coil; a No. 50 is necessary. If, on the other hand, we have a 0.0003 μF variable condenser, 2LO can usually be tuned in on a No. 75 coil with an increase in signal strength. For long distance work, a small capa-

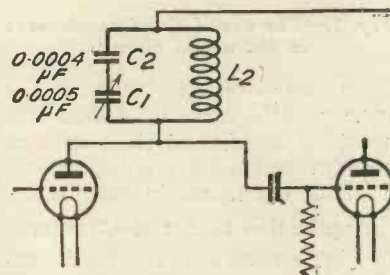

Fig. 1.— Method of reducing the apparent minimum of a tuned anode condenser.

city and a large inductance in a tuned anode circuit is very desirable.

Those who do not desire to buy a new variable condenser will find it most convenient to connect a fixed condenser in series with their variable one; this will result in a sort of composite variable condenser having a much lower minimum capacity, and also, of course, a lower maximum capacity. For example, if we connect a fixed condenser of 0.0005 μF in series with a 0.0005 μF variable condenser we will have a variable capacity ranging from nearly zero to 0.00025 μF , the minimum capacity in this case being very much smaller than in the case of the 0.0005 μF variable condenser. Any existing variable condenser may therefore be turned into one

of much smaller capacity and smaller minimum capacity, by the use of a series condenser, and I have employed this method frequently in designing receivers. It saves the cost of buying a separate variable condenser for each new set, and a variable condenser may be readily changed into one of smaller maximum capacity by the series insertion of a fixed condenser whose capacity is given by simple calculation.

Let us suppose that:

C_1 = maximum capacity of present variable condenser.

C_2 = maximum capacity desired.

C_3 = capacity of the series fixed condenser.

Then:

$$C_3 = \frac{C_1 \times C_2}{C_1 - C_2}$$

If, for example, your present condenser has a capacity of 0.0005 μF , and you want to obtain the effect of a 0.0003 μF variable condenser, multiply 0.0005 by 0.0003 and divide this by the difference between 0.0005 and 0.0003 (i.e., 0.0002). The result will give you the capacity of the fixed condenser necessary, and a little arithmetic will show that to change a 0.0005 μF variable condenser into a 0.0003 μF variable condenser, having a small minimum capacity, it is only necessary to connect a 0.00075 μF fixed condenser in series with the variable one.

The problem may arise in rather a different way. For example, you may have a 0.0005 μF variable condenser and you want to know what will happen if you connect in series with it a 0.0004 μF fixed condenser. The simple formulæ is as follows:—

$$C_3 = \frac{C_1 \times C_2}{C_1 + C_2}$$

In other words, multiply the two

capacities together and divide by the sum of the two capacities. In the case given above, where a 0.0004 μF fixed condenser is connected in series with a 0.0005 μF variable condenser, the maximum capacity of the combination will be 0.00022 μF , while the minimum capacity will be very much smaller than the minimum capacity of the 0.0005 μF variable condenser.

Practical Applications

Fig. 1 shows a tuned anode circuit in which the inductance L_2 is shunted by two condensers, one of them being marked C_2 and the other C_1 , the latter being a variable one having a maximum capacity of 0.0005 μF . The fixed condenser C_2 has a capacity of 0.0004 μF , so that we have across the inductance L_2 what is equivalent to a 0.00022 μF variable condenser, having a very low minimum capacity. I recommend the use of a fixed condenser of this value in the position shown. A No. 75 plug-in coil may be used for the reception of the different broadcasting stations. On weak signals there is a marked advantage in using a large inductance and a small condenser, but the tendency of self-oscillation is somewhat increased, and if reaction is being used in any part of the circuit less will be required. The terminals of the fixed condenser C_2 may be brought out on the front of the panel, and a shorting strap or wire may be used when it is desired to use the 0.0005 μF as an ordinary variable condenser across the anode coil.

By this means the experimenter has produced what is virtually two variable condensers of different capacities, each of which may be used to suit the particular circumstances.

By a simple arrangement of terminals the fixed condenser may also be connected in parallel with the 0.0005 μF variable condenser. This will enable the experimenter to have what is equivalent to three variable condensers; the first is the 0.00022 μF , obtained by connecting C_1 and C_2 in series, as shown in Fig. 1; the second is of 0.0005 μF capacity, and is obtained simply by short-circuiting C_2 , the fixed condenser; and the third is obtained by putting C_2 in parallel with

C_1 ; this gives the effect of a variable condenser having a capacity of from 0.0004 μF to 0.0009 μF . By the use, therefore, of a 0.0005 μF variable and a 0.0004 μF fixed condenser it is possible to obtain a smooth variation of capacity from nearly zero to nearly 0.001 μF . The reason why 0.0004 μF has been chosen for the fixed condenser is partly because a 0.00022 μF variable condenser is very useful for general work, and to ensure an absolutely unbroken variation of capacity up to the highest value. If we had chosen a 0.0005 μF fixed condenser there would have

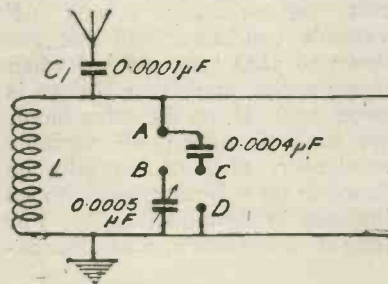

Fig. 2.—The use of fixed condensers in the aerial circuit.

been no overlap between the 0.0005 μF variable condenser, used by itself, and the combination of the fixed condenser and variable condenser in parallel.

Application to Aerial Circuits

Fig. 2 shows how a fixed condenser of 0.0004 μF and a variable condenser of 0.0005 μF may be arranged for tuning the aerial circuit. In the figure, constant aerial tuning by means of a fixed condenser C_1 is shown, but this is no part of the present idea. In Fig. 2, if the 0.0005 μF variable condenser is to be used alone, join the terminals A and B . If, however, it is desired to shunt the inductance L by a small capacity variable condenser, join B and C only, in which case L will be shunted by a 0.00022 μF variable condenser. If longer waves are to be received and a higher capacity than 0.0005 μF is desired, join A B and C D .

Vernier Adjustments

The use of a fixed series condenser has the additional advantage of giving almost a vernier adjustment. If, for example, a station were being received on, say, 10° of a 0.0005 μF variable condenser, the tuning would be very much more critical than if a

series fixed condenser of 0.0004 μF were employed, because in the latter case a much greater portion of the scale would be available.

It must, however, not be imagined that by using a large inductance and a small variable condenser a better vernier adjustment is obtained than with a smaller coil and a larger variable condenser. When working with small variable condensers the tuning, in fact, becomes more critical, and although one might at first imagine that the use of a 0.0002 μF variable condenser and a large inductance would give very fine tuning, yet this is not, in fact, so, although, of course, the tuning is much simpler than if a large size variable condenser is used with the same size coil.

BOOKS WHICH SOLVE YOUR PROBLEMS

WHETHER you are erecting an Aerial, building a Set, or endeavouring to find out how one works, there is a wide choice of Radio Press Books ready to help you. Don't attempt to struggle along in the dark by yourself, but make use of the assistance freely offered you by the authors of these Books. Remember each is written by an expert in his own particular branch of Radio and every author is a man of note.

Choose your Books from this List:

	Price
1. Wireless for All	9d.
By JOHN SCOTT-TAGGART, F.Inst.P.	
2. Simplified Wireless	1/-
By JOHN SCOTT-TAGGART, F.Inst.P.	
3. How to Make Your Own Broadcast Receiver	1/8
By JOHN SCOTT-TAGGART, F.Inst.P.	
4. How to Erect Your Wireless Aerial	1/-
By B. MITTELL, A.M.I.E.E.	
5. The Construction of Wireless Receiving Apparatus	1/8
By P. D. TYERS.	
6. The Construction of Crystal Receivers	1/8
By ALAN L. M. DOUGLAS.	
7. How to Make a "Unit" Wireless Receiver	2/8
By E. REDPATH.	
8. Pictorial Wireless Circuits	1/6
By OSWALD J. RANKIN.	
9. Wireless Valves Simply Explained	2/6
By JOHN SCOTT-TAGGART, F.Inst.P.	
10. Practical Wireless Valve Circuits	2/6
By JOHN SCOTT-TAGGART, F.Inst.P.	
11. Wireless Licences and How to obtain Them	1/-
By E. REDPATH.	
12. Radio Valves and How to Use Them	2/6
By JOHN SCOTT-TAGGART, F.Inst.P.	
13. 500 Wireless Questions Answered	2/8
By G. P. KENDALL & E. REDPATH	
14. 12 Tested Wireless Sets	2/0
By PERCY W. HARRIS.	
15. More Practical Valve Circuits (Cloth Bound)	3/0
By JOHN SCOTT-TAGGART, F.Inst.P.	
16. Home-Built Wireless Components	2/6
17. Wireless Sets for Home Constructors	2/6
By E. REDPATH.	
18. Tuning Coils and How to Wind Them	1/6
By G. P. KENDALL, B.Sc.	
Elementary Text-book on Wireless Vacuum Tubes	10/-
By JOHN SCOTT-TAGGART, F.Inst.P.	
The Broadcast Listeners' Year-book	1/0



Apparatus we have tested

Conducted by A. D. COWPER, M.Sc., Staff Editor.

Griffin Hedgehog Transformer

Messrs. Ernest Griffin & Co. have sent for test two examples of their "Hedgehog" L.F. interval transformers.

These are of a pattern that may not appeal to the æsthetic sense, but which is, nevertheless, quite sound electrically. A core of iron wire is used, brought round the finished coils so as wholly to enclose the latter and give a compact and continuous magnetic circuit. The appearance thus presented somewhat recalls the hedgehog.

The transformer is mounted in a brass frame, with legs for fixing on base-board or panel. At the top an ebonite terminal-strip carries four terminals.

The insulation-resistance between coils and from each coil to earth, when tested on 500 volts D.C. from the "Meg," was exceptionally good in both instruments. Mechanically the construction of the transformers appeared to be sound, and the finish satisfactory.

On practical trial these transformers comported themselves in a manner which compared distinctly favourably with standards, giving excellent amplification and a good tone. In the ST100 circuit, later form, with a .0002 μ F. condenser across the secondary and in series with the A.T.I. above the earth-lead, very good results were obtained. In the other position in this circuit,

before the second valve, the results were also good.

A Panel Material

Messrs. A. C. R. Greene & Co., Ltd., have sent us a sample of their "Moulded Ebony" insulating material, in the form of a $\frac{1}{4}$ -in. panel.

This is a dull black material, rather heavy, and with a slightly roughened surface. On trial, a smooth matt surface, strongly suggestive of a black slate, was obtained with fine emery. The material could be given a sharp-cornered, smooth edge with the file. It cut rapidly with a twist drill without any binding, but rather grittily. There was a distinct tendency to crumble away at

Nothing old—Nothing new!

Just a bargain in

Variable Condensers.

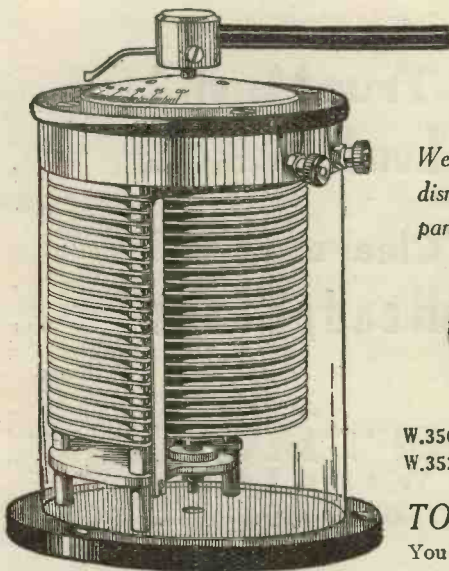

Well worth dismantling for panel mounting.



W.350 .0005 m.f. 8/6
W.352 .001 m.f. 10/6

An instrument remarkably fine in more than one respect; designed for service where a high degree of accuracy has to be obtained.

Dust is excluded from the vanes by total enclosure, and hand capacity effects are eliminated by an extension handle which together with an accurately graduated scale and fine index pointer facilitates exact reading.

Applicable to varied requirements, e.g. wavemeters, standards of comparison for ordinary condensers or as actual tuning condensers.

The insulation throughout is the finest obtainable; the distance between vanes is accurately gauged, whilst the thick metal plate shown in the illustration prevents variation.

TO BE SOLD CHEAP—MORE THAN 60% REDUCTION

You are strongly advised to secure one whilst the stock lasts. We pay postage.

ASHLEY WIRELESS TELEPHONE COMPANY,

LIMITED,

69, RENSRAW STREET, LIVERPOOL.

AGENTS IN ALL LARGE TOWNS.

Manufactured in the same Factory as the famous Claritone Loud Speaker and embodies the same quality of workmanship.

the back edge of a hole even when supported on wood whilst drilling. For tapping, not too large a size of drill must be used at first, or else the thread will be loose. It took, however, a sharp and strong thread with a No. 4 B.A. tap. As the material has, we are informed, an asbestos base, it was not surprising to find that the heat of a hot soldering iron did not affect it when used in the ordinary way. Even direct heating of drillings showed little effect until a fairly high temperature was reached, so that there should be little fear of a large panel warping in the sun.

Electrical tests, carried out with a "Meg" tester with 500 volts D.C. between valve-sockets at the usual distance, showed an unexceptionable insulation resistance, far over 100 megohms.

A Variometer

A small variometer of good mechanical design is the No. 1 Woodhall, a sample of which has been submitted for test by the makers. The variometer is only 3 in. in diameter, and has a moulded composition stator (internally wound) and a ball rotor. The clearance between the wind-

ings is but an eighth of an inch, so that the inductance ratio is fairly large. The device is arranged for panel mounting, requiring a single hole only. Four brass brackets for board-mounting are also provided.

The knob and scale are of a novel and convenient type, as the large (2½-in.) knob has the scale engraved around its periphery, giving a neat appearance and facilitating fine adjustment. Contact is made to the moving spindle and rotor windings by enclosed spring plungers. Two accessible and reasonably large terminals are fitted.

On actual trial, the wavelength range on a P.M.G. aerial was from below 300 to above 700 metres, which implies, of course, careful setting for tuning to any one station. In so small an instrument, with fairly fine windings and the appreciable distributed capacity characteristic of this type of variometer, neither great selectivity nor remarkable signal-strength were to be expected, and were not found.

For inter-valve coupling, the instrument covered the broadcast band with a .0002 µF fixed condenser in parallel.

It was noticed that the screws on which the board-mounting legs were to be fixed were decidedly short for this purpose.

A Radio Bell-Push

A simple little device which has several uses in connection with a radio installation in a large house is the "Ktol" Radio Bell-Push, a sample of which has been submitted by the Ktol Company.

By fitting these in each room of a house wired for bells, after disconnecting the ordinary bell battery, the house wiring becomes available for head-phone or loud-speaker extensions from any room to any other. Either wire can even be used as a form of indoor aerial; the makers claim also that it is possible to use the house wires for lead-in to a distant room when using an outside aerial.

The fitting appeared, on examination, to be suitably made for the purpose intended. But for the trouble of disconnecting the bell battery there seems to be no reason why the electric bell wiring should not be used for phone extensions as indicated.

True Music Loud Speakers

Clear as Crystal Headphones

TMC Wireless

If unable to obtain locally, write to us direct.

THE TELEPHONE MANUFACTURING CO., LTD., HOLLINGSWORTH WORKS. DULWICH, LONDON.
 BRITISH EMPIRE EXHIBITION, WEMBLEY, 1924.

(E.P.S. 171)

Correspondence



ACCUMULATOR RATING

SIR,—Our attention has been called to a letter sent you by Earl Russell commenting upon a remark in your issue of February 5 on the subject of the capacity of wireless accumulators.

Possibly Earl Russell is unaware that the standard motor-car ignition accumulator, which has been adopted by the wireless trade, is rated according to standards laid down by the Society of Motor Manufacturers and Traders, and according to these rules, which are followed by all reputable firms, both the so-called ignition capacity and the actual ampere hours are stated, both on the label on the accumulator and in catalogues.

If you will permit us for a

moment to delve into ancient history we will explain how the term "Ignition capacity" arose. In the very early days of motor-ing, when most of the cars in use over here were French, the accumulators which came over with them were also French, and these were rated for ignition purposes at about double their actual capacity, the French argument being that when used in connection with an ignition coil or interrupter with an ammeter in circuit, owing to the current being intermittent, the actual time that the battery would last in action was approximately double what it would give at continuous discharge. I think that firms like ourselves and Messrs. Peto & Radford were among the most strenuous opponents of this

rating, but it was found that the French rating for a given size of battery was so firmly established that it was no use trying to convince the non-technical user or garage man that an English accumulator rated at its true capacity of 30 ampere hours was exactly the same as the French one called 60, and the Society therefore established the rating as mentioned above. When, however, accumulators began to be used for lighting, and later on for starting, we ourselves reverted to the continuous discharge rating, as will be seen by a perusal of our folders "C" and "D," where you will see that only those accumulators specifically listed for ignition purposes have both the so-called ignition and the actual capacity stated.

USE "IGRANIC" RADIO DEVICES

HIGHEST IN QUALITY

ECONOMICAL IN PRICE

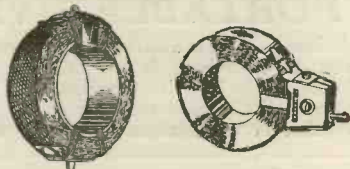

HONEYCOMB INDUCTANCES.
(De Forest Patent No. 147,344.)

These world-famous coils are renowned for their high efficiency, low self capacity, small absorption factor and minimum high-frequency resistance. No dead-end losses. Each turn surrounded by air pocket. Made in two types, gimbal and plug mounted. Wavelengths approximately 100 to 25,000 metres. The only coils that uphold their claims for negligible losses. Prices vary with sizes.



INTERVAL TRANSFORMERS.
(Patent No. 205,013.)

Designed for the distortionless reproduction of speech and music. The steel shroud effectively shields from external interference. Recent improvements in design render it the finest amplifying transformer obtainable. Prices: Shrouded, 21/- Open, 20/-

Obtainable from all Dealers.
Write for Lists Y.22.



FILAMENT RHEOSTATS.
(Patent No. 195,903.)

A splendid instrument for filament control under all conditions. Novel method of construction ensures smooth and silent operation. Designed for individual valve control. Adjustable contact finger permits of resistance values from zero to four ohms by fine variation. Supplied in two types, plain and vernier.

Prices: Plain, 4/6 Vernier, 7/-

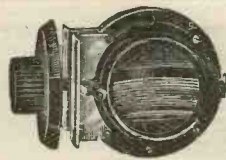

VARIOMETER, TYPE "H."

Recommended for use in the aerial circuit of crystal and valve sets. Wave-length range approximately 150-600 metres, with P.M.C. standard aerial. Stator and rotor best quality mouldings, windings self supporting and impregnated solid. Price, with knob, dial and fixing bracket, 15/-

Manchester.
Glasgow.
Bradford.



149, Queen Victoria Street,
LONDON.
Works: BEDFORD.

BATTERY POTENTIOMETER.

An Igranic Potentiometer is a necessity where one or more stages of high-frequency amplification is used. Stabilises grid and eliminates noises and self-oscillation. Resistance 300 ohms. Current consumption negligible. Nickelled finish, complete with fixing screws, knob and pointer. Price 7/-

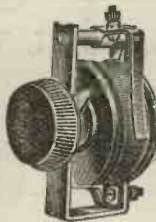

Newcastle.
Cardiff.
Birmingham.

We do not quite see why this rating should have been adopted by the wireless world, unless it was that only these ignition accumulators were made up in the precise form and voltage required; and in view of the fact that wireless work could hardly be called intermittent we do not think it is too late for a standard to be laid down and the rating altered.—Yours faithfully,

C. A. VANDERVELL & Co., LTD.,
Acton,
London, W.3.

REFLEX CIRCUITS

SIR,—I am writing to let you know my appreciation of your two papers. I have been a reader since the first number and I should say that more than half my wireless knowledge has been obtained from them.

Of late I have been experimenting with Reflex circuits and a frame aerial of 1 ft. 6 in. side. On a single-valve reflex, I can often get distinct speech from 2ZY, 5NO and 6BM. Glasgow, about a mile away, gives fair results on a large loud-speaker. On your ST100, 5SC comes in

comfortably without any aerial or earth, and on the small frame requires to be detuned considerably. I also make use of the hint in your papers, namely putting a resistance across the secondaries of both transformers. On the same frame and ST100, I can count on getting a comfortably audible transmission from at least one B.B.C. station, other than 5SC. Generally speaking, 5WA, 2ZY, 5NO and 6BM are quite good.

I would also like to express my appreciation of Mr. Cowper's short-wave receiver. I assembled it roughly one night, using just one valve, finishing about 1 a.m. I had no sooner connected up to a small indoor aerial about 15 ft. long and 10 ft. high, than I heard KDKA calling. The addition of an L.F. valve brought it in quite comfortably, and on one occasion, I had it on loud-speaker by using a microphone amplifier.

Trusting that the above has been of interest to you, and with best wishes for your papers, I am, Yours truly,

ALEX. A. M. TURNBULL,
Glasgow.

OMNI RECEIVER

SIR,—Having completed the "Omni Circuit" receiver, I tried out the circuit described in last week's issue of *Wireless Weekly* with excellent results, being able to obtain 2LO with sufficient strength to be comfortably audible in a loud-speaker. My aerial is only a moderate one. I thank you for this excellent receiver which enables one to try out various circuits in a very short time. I am 12 miles from 2LO.—Yours faithfully,

GEORGE S. V. HARRIS.

**THE
"WIRELESS WEEKLY"
OMNI RECEIVER.**

Owing to the demands upon our space a further circuit for the OMNI RECEIVER is unavoidably held over until next week.

In connection with the Ormond Condensers contained in this receiver we are advised that the sole stockist of these components for the West End is K. Raymond, of 27, Lisle Street, London, W.

E

ELECTRIC

L.D.



The "EEC" "XTRAUDION" VALVE is being used by the leading Radio Experimenters for detection, high and low frequency amplification, power amplifiers and low power transmission. Price 12/6

USE "RECTARITE," the synthetic crystal that makes Loud speakers talk. 1/6 Large Specimen.



Write to-day for 40 page Radio Catalogue mailed post free, 4d.

Head Office: 10, FITZROY SQUARE, LONDON, W.1.

Showrooms: 303, EUSTON RD., N.W.1.

Branch and Works: TWICKENHAM.

BEWARE OF WORTHLESS IMITATIONS, SEE THE TRADE MARK *Watmel* ON EVERY GRID LEAK.

WATMEL VARIABLE GRID LEAK
(Patent No. 206098).

Constantly Variable Silent in operation. Constant in any temperature. Dust and Damp proof. Each tested and guaranteed. Neat and well made.



GRID LEAK
.5 to 5 megohms 2/6

ANODE RESISTANCE
50,000 to 100,000 ohms 3/6.

Suitable for S.T. 100 Circuit.

SEND P.C. FOR DESCRIPTIVE FOLDER.

WATMEL WIRELESS CO., Connaught House, 1a, Edgware Road, Marble Arch, W.2. Tel. 4575 Paddington

Two Outstanding Achievements.

THE PORTABLE-FIVE

The only Portable Receiving Set in a leather suitcase, requiring no Aerial and no Earth. It is entirely self-contained, including valves, batteries, invisible loop aerial, and Loud Speaker. Really good reception on the Loud Speaker at 25 miles or on Headphones at 500 miles.

THE SUPERFIVE

A Five-Valve Cabinet Receiver for use with either Dull or Bright emitter valves—owing to its many Special and Exclusive features really good Loud Speaker reception may be easily obtained at 500 Miles under normal conditions—under reasonably favourable circumstances good Loud Speaker reception at 3,000 Miles has been frequently obtained by private users.

Write for special illustrated catalogues describing the above to—



Offices & Showrooms (Open 8 to 7; Saturdays 8 to 1) —
92, QUEEN ST., HAMMERSMITH, LONDON, W.6.
'Phone: Hammersmith 1916. Grams: "Tingoldar, London."

FEW AGENCIES STILL OPEN.

Information Department



J. W. C. (ABERDEEN) asks how he can tell when his set is oscillating.

Probably the best test for self-oscillation is that known as the finger test. This simply consists in touching with a moist forefinger either the aerial terminal of the set or the grid end of the grid circuit of the rectifying valve. If reaction is taken into the aerial circuit, touching the aerial terminal will provide the necessary indication, but if reaction is introduced into the tuned-anode circuit, this is the circuit to which the finger test should be applied. When the set is oscillating the test produces a sharp click in the 'phones when the finger is placed upon the terminal and when it is removed.

To ascertain whether oscillation is taking place to an extent which will cause interference with neighbouring listeners, the proper test is to vary the tuning of the aerial condenser when listening

to broadcasting. If this produces howls and squeals in the 'phones of varying pitch radiation is taking place.

T. R. (GRIMSBY) asks what is the difference in sound between spark and continuous wave Morse signals.

Spark signals do not as a rule possess a very musical sound, but may range between a harsh buzzing sound and a fairly clear note. Their pitch is not altered by varying the tuning of the receiver, and when the set oscillates they are all heard with a rough scratchy sound. Continuous wave signals, on the other hand, cannot be heard at all until the set oscillates or a local heterodyne is used, and have clear musical notes which can be adjusted to any pitch between the highest and lowest audible by varying the tuning of the receiver or the frequency of the oscillations generated by the separate heterodyne.

Every Part Sensitive
No 'Blind Spots'

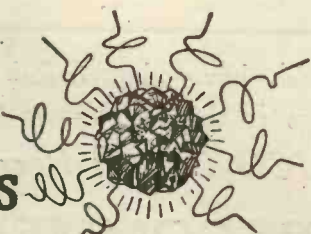

YET ANOTHER CRYSTAL—BUT DIFFERENT. After 16 months of research under the supervision of W. Bennison, F.C.S., and T. Hadley, B.Sc., at our Cale Street, Chelsea, Laboratories, we have produced a **SCIENTIFIC CRYSTAL**.

Neutron

the new CRYSTAL

Before despatch, each piece is tested for **COMPLETE SENSITIVITY** and **STRENGTH OF RECEPTION**. On distance tests, clear signals were received where *all other* crystals had failed. Packed in airtight boxes, complete with Silver Cat's Whisker and full instructions.

If your dealer does not stock it, Neutron will be mailed direct, Post Free on receipt of 1/6, by the Neutron Co., Dept. C., Sicilian House, Southampton Row, W.C.1.



"TANGENT" Tuning Coils

TESTED and TRIED

Set of 4 Concert Coils covering all British Broadcasting.

On firm frames—robust and substantial.

Their efficiency—which is second to none—is not impaired by the special material of the frames.

No self-supporting coil excels them.

Ask your dealer. Say "TANGENT" and refuse substitutes, or send for

Leaflet 97W

GENT & Co., Ltd.

Established 1872
Manufacturing Electrical Engineers,
FARADAY WORKS,

LEICESTER.

LONDON: 25, VICTORIA STREET, S.W.1.
NEWCASTLE-ON-TYNE: TANGENT HOUSE, BLACKETT ST.

HEAR THE BARNES FIRST

The BARNES MINORPHONE LOUD SPEAKER

This excellent BARNES MINORPHONE Loud Speaker is of robust construction. It gives splendid volume with great purity of tone, has adjustable diaphragm, detachable horn. Size 12" x 8" (dull black finish), the well-designed base is dull black with polished aluminium top.



BRITISH MADE.

—appeals to you as the Loud Speaker you can easily afford. You will not hesitate to purchase one from your dealer after you have heard the BARNES MINORPHONE ONCE. Your friends—who have their own ideas about Loud Speaker reproduction will envy your choice. The BARNES MINORPHONE has a tone which is undeniably mellow; it is free from all harshness. Its value makes it undoubtedly the most popular Loud Speaker of to-day. Tomorrow will see it in the homes of all who appreciate faithful reproduction of the human voice and the many musical instruments broadcast.

The BARNES MINORPHONE is within the reach of every man.

Ask your dealer for a demonstration — you will be satisfied.

If he does not stock the Barnes Minorphone write us direct sending his name.

Take one home to-night, they will be pleased with the tone.

Price £1 - 17 - 6

L. B. TICKLE & CO.

— Government Contractors —

61, BOROUGH ROAD, LONDON, S. E. 1.

Phone - H-p 3874. Trade Enquiries Invited. Grams: "Elbeetickle, Sedist."

DECIDE UPON THE BARNES

WHY NOT EXTEND THE SCOPE of YOUR "SET"?

Write to the Service Co.'s Wireless Dept. for particulars as to how this can be done in the simplest way and at a minimum of cost. You can pay as you build and extend and get more out of Wireless. **Write or call NOW!**



For 2d. stamp for postage we will send any reader our 26 page book on Wireless. It's well worth getting and reading.

THE SERVICE CO., Ltd.
292, HIGH HOLBORN, LONDON, W.C.1
Tel.: Holborn 666 (3 lines).
Telegrams: "Admittedly," London.

THE "OMNI-CIRCUIT" PANELS

CUT TO SIZE, DRILLED AND ENGRAVED.

Best Ebonite and Workmanship.

Size of Panels: — 14 x 10 x 1/4 14 x 9 1/4 x 1/4

£1 : 10 : 0 Per Pair.

ANY SIZE PANELS SUPPLIED AND ENGRAVED TO CUSTOMERS' SKETCHES

S. MARKS & SON,
7 & 8, CARTHUSIAN STREET, E.C.1.

Telephone: Clerkenwell 6318.



TYPE No. 2. Lacqd. 4½d. each. Nickel 5½d. each. TYPE No. 4. Lacqd. 10d. each. Nickel 11d. each. Knobs in Black, Red, Blue, Green, or Cream.

Among the Sets which have adopted Refty Cups and Terminals as standard fittings is the well known and highly efficient **JEJCO Crystal Receiver.**

— WE RECOMMEND IT —

For those who appreciate Refty fittings, but have not the time to build their own sets, this Popular Instrument has no equal for good Reception and high-class finish at a moderate price. There is nothing to learn. Make the four connections, Aerial, Earth and Phones, in less than one minute, and you can be certain of good results.

Fitted with No. 2a Nickel Phone Terminals **35/- post and tax free.**

Fitted with No. 4a Nickel Phone Terminals **36/- post and tax free.**

REFTY ELECTRICAL APPLIANCES LTD.

2, Featherstone Buildings, High Holborn, London, W.C.1

'Phone: Chancery 8264.

'Grams: "Reftinal, Holb. London."

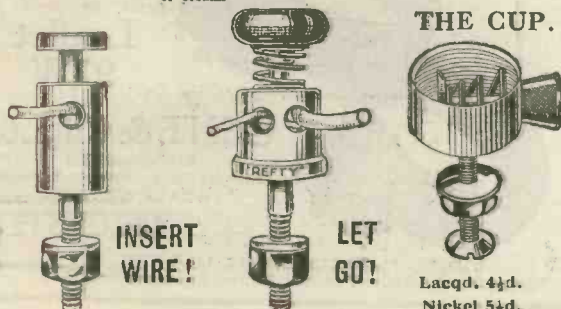

PRESS KNOB!

INSERT WIRE!

LET GO!

THE CUP.

Lacqd. 4½d. Nickel 5½d.

PARTS, COMPONENTS, SETS—they all sell equally well in WIRELESS WEEKLY.

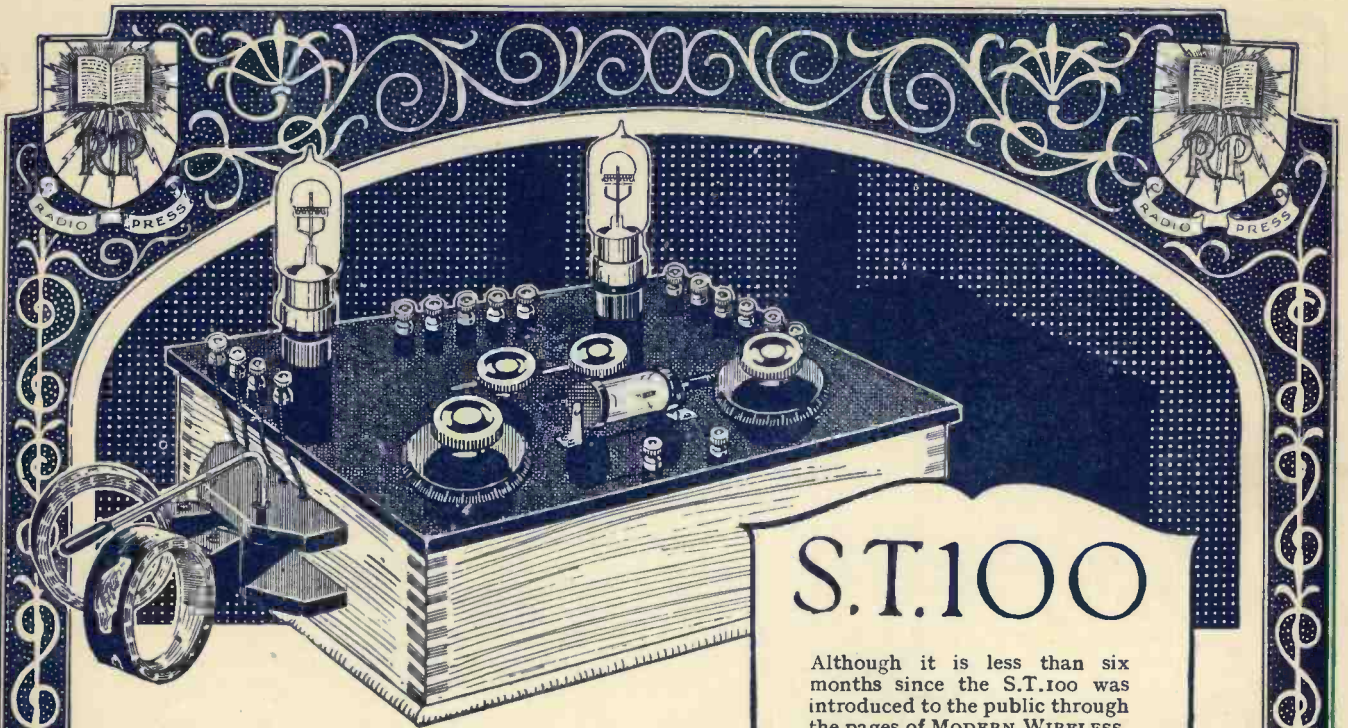

A new system simplifies the home construction of this fine Reflex Set.

WHILE to many enthusiasts who already have some knowledge of Radio the constructional articles in *MODERN WIRELESS* and *Wireless Weekly* are quite sufficient, yet to some beginners and others the elementary details of construction may have been omitted. Obviously exigencies of space in a magazine often render it necessary for an article to be kept brief.

In order to assist the novice and the man who has never built a Set before, however, we have produced a special Series of Envelopes, each dealing with one particular type of Set in a most comprehensive manner.

The first one of the series is devoted to building up the S.T.100 shown above and contains blue prints, wiring diagrams, illustrations of finished instruments taken in various positions, complete working instructions, etc., etc. Absolutely every possible assistance is given so that the novice can follow the instructions and build a first-class Set without possibility of error.

S.T.100

Although it is less than six months since the S.T.100 was introduced to the public through the pages of *MODERN WIRELESS*, yet scores of thousands of Receiving Sets incorporating it are giving complete satisfaction in all parts of the country. For a general purposes, economical Set the S.T.100 would be hard to beat. On an average Aerial all B.B.C. stations can be heard at good strength, while it has a Loud-Speaker range of 30 to 40 miles.

It is particularly economical because it only uses two Valves (a Crystal acting as Rectifier), yet immense amplification is obtained because the first valve acts as a high-frequency and low-frequency amplifier simultaneously.

To build such a Set is within the reach of anyone, the following being practically the only components required; Two variable condensers, two valve-holders, two rheostats, one fixed resistance, one coil-holder, one crystal detector, two L.F. transformers, the necessary terminals, panel and cabinet.

¶ Why not rebuild
your present Set
into an S.T. 100?

16

Post free
1/9.

RADIO PRESS, LTD., DEVEREUX COURT, STRAND, W.C.2

Radio Press Envelope N°1



"Sterling" Lightweight Radio Head Telephones are British made throughout at Sterling works. They are fitted with polished Duralumin headbands and supplied in the following resistances:

120 ohms the pair	£1 : 2 : 6
2000 ohms the pair	£1 : 4 : 0
4000 ohms the pair	£1 : 5 : 0

The friends of your leisure time!

"Sterling" Lightweight Radio Head Telephones—*trustworthy* day in and day out. Supreme in tone, volume and quality. As light as *good* headphones can be and as comfortable as *good* headphones should be.

Never a complaint yet. And why? Simply because the secret of their absolute satisfaction lies firstly in design, secondly in material, thirdly in workmanship, fourthly, lastly and all the time, in *performance*. They never vary—music or speech is rendered with fidelity and clarity beyond comparison. And as for value? Inspect them, compare them, test them at your dealers—do what you will. Then note the *price*. Do that and you will buy them.

Buy STERLING LIGHTWEIGHT RADIO HEAD TELEPHONES—Your Dealer can Supply!

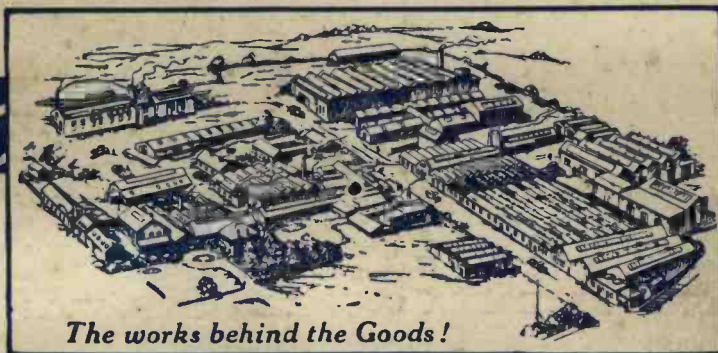

The works behind the Goods!

Buy
British
Goods
Only

Advt. of STERLING TELEPHONE & ELECTRIC CO. LTD.

Manufacturers of Telephones and Radio Apparatus, etc.
210-212 Tottenham Court Road,
London W.1

Works: DAGENHAM, ESSEX.

Wireless Weekly

and the Wireless Constructor.

Vol. 3.
No. 16.

CONTENTS

Eliminating Hum from A.C. Mains.

A Capacity Reaction 3-Valve Receiver.

Getting the Most from Dry Cells.

German Broadcasting Times.

Fitting Vernier Attachments to Rheostats.

An Experimenter's Unit Receiver, Random Technicalities, Jottings By the Way, Valve Notes, Apparatus We Have Tested, Correspondence, Information Dept., etc.

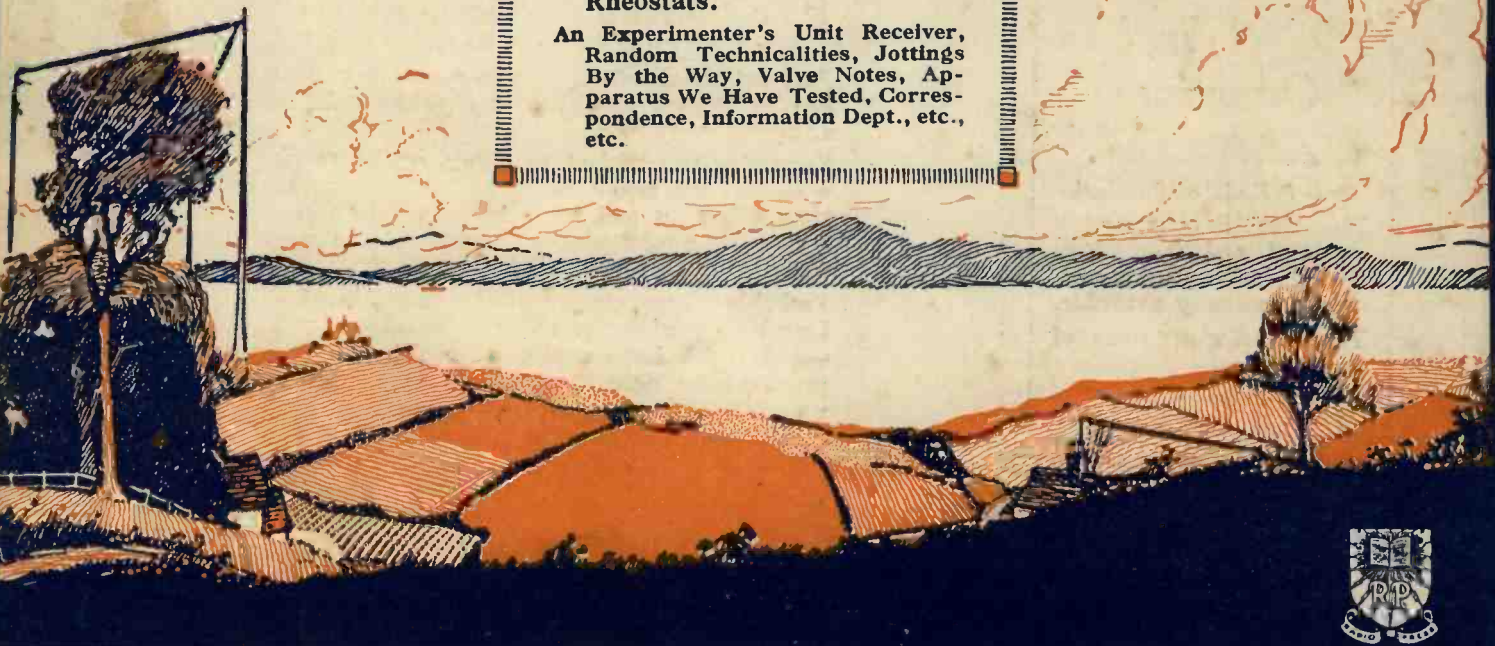

A Transformer Coupled Dual Receiver

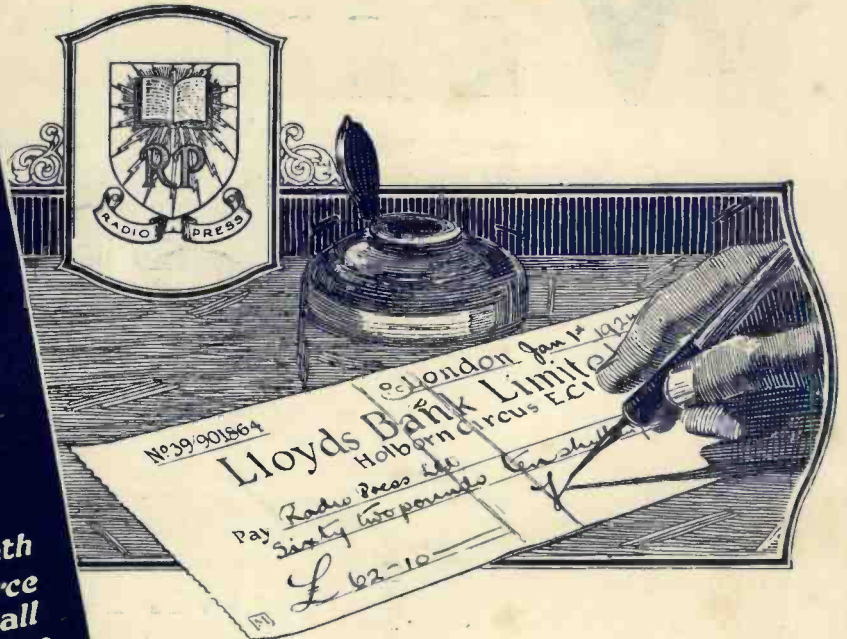
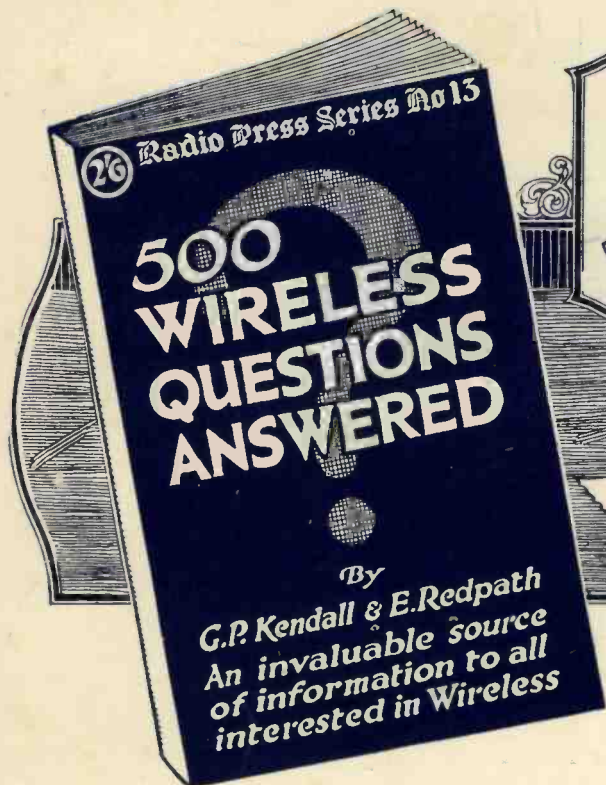

Over £60 worth of Radio information for half-a-crown

500 Wireless Questions Answered.

By G. P. Kendall and E. Redpath.

This Book is conveniently arranged and indexed so that the necessary information is instantly available.

The following are some of the sections :—

Aerials, Earths, Waves, Tuning Coils and Condensers, Valves, Reaction, Batteries of all kinds, Crystal Sets and Amplifiers, Grid Leaks and Condensers, Loud Speakers, Wire, Interference, Morse Signals, Telephone Receivers, etc.

2/6

Post free 2/8

FOR a reader of *Wireless Weekly* to enlist the services of its technical staff costs him 2/6 for every question he wishes answered

And yet—because the accuracy of every reply can be trusted implicitly—many hundreds are answered every week.

Supposing you wished to obtain replies to 500 questions you would run up a little bill of no less than £62 10 0 and yet you can obtain a book giving the replies to five hundred of the most useful Radio questions for half-a-crown.

Probably a large number of the questions which have been troubling you for the past few months—and which have consequently retarded your progress—are actually answered in this Book. Why not get a copy to-day? Its information is wonderfully complete and as will be seen from the synopsis, embraces every possible phase of wireless.

RADIO Press Ltd.

Devereux Court, Strand, W.C.2.

RADIO PRESS SERIES No. 13



Wireless Weekly

Vol. 3, No. 16
Mar. 26, 1924.

CONTENTS

	Page
Editorial	508
Interference from Electric Mains ..	509
Jottings by the Way ..	511
German Broadcasting Programmes ..	512
Random Technicalities ..	513
A Capacity Reaction Three-Valve Receiver ..	514
C.W. & Telephony Transmission Using Valves	517
Getting the Most from Dry Cells ..	519
Rheostats with Vernier Attachment ..	520
An Experimenter's Unit Receiver ..	521
A Three-Valve Circuit on the "Wireless Weekly" Omni Receiver ..	522
Useful Panel Material ..	523
Theory of the Rejactor Circuit ..	524
How to Make a Two-Valve Dual Receiver ..	526
Valve Notes ..	533
Formers for Basket Coils ..	534
Apparatus We Have Tested ..	535
Correspondence ..	537
Information Department ..	539



Editor: JOHN SCOTT-TAGGART, F. Inst. P., A. M. I. E. E.
Assistant Editors } E. REDPATH.
 P. W. HARRIS.

Radio Press, Ltd.

Publishers of Authoritative Wireless Literature.
DEVEREUX COURT, STRAND, W.C.2
Tel.—Central 3763.
Advertisement } SCHEFF PUBLICITY ORGANIZATION,
Managers: } LTD., 125, Pall Mall, London, S.W.1
Tel.—Regent 2440.

Scientific Adviser
Prof. G. W. O. HOWE,
D.Sc., M.I.E.E.
Advisory Editors:
Prof. R. WHIDDINGTON,
M.A., D.Sc.
Prof. C. L. FORTESCUE,
M.A., M.I.E.E.

Staff Editors
E. H. CHAPMAN, M.A., D.Sc.
A. D. COWPER, M.Sc.
G. P. KENDALL, B.Sc.
R. W. HALLOWS, M.A.
S. G. RATTEE.

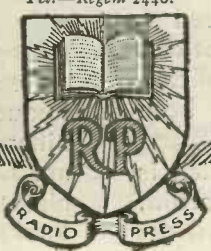

All correspondence relating to contributions is to be addressed to the Editor of "Wireless Weekly."

Nothing contained herein is to be regarded as permission or encouragement to infringe any patent rights.



Cardiff Announcing

LISTENING to the items sent to London from Cardiff, last Wednesday, we were much surprised to note the method of announcing, which, apparently, is being adopted. We have, on previous occasions, felt that there was much to be desired in this respect from this station, but when it comes to what was apparently considered an important item, we did at least think that a special effort would be made, since the programme was being sent broadcast to another station.

The method of announcing was rather reminiscent of a dear old gentleman of the "old woman" type addressing a village meeting to which a lecturer has been invited. "Magic carpet" talks are, no doubt, interesting, and it is a pity that the effect should be spoilt by an announcer who apparently considers himself the chief attraction. The feeble attempts at humour, the asides, and the general nature of the introduction amazed us. Instead of the healthy, business-like, and yet sympathetic tones of the 2LO type of announcer, we were treated to a simpering performance which verged, every now and again, on to the fatuous. We do not wish to be unkind, but we can only say that this type of announcer would not find favour in the London area. Cultivate a friendly atmosphere by all means, but the atmosphere of unctuous self-satisfaction jarred. After all, announcers are announcers, and should learn to avoid putting themselves too much to the fore.

Apart from these matters, the final remarks of the announcer, before continuing with the ordinary Cardiff programme, were calculated to offend London listeners, and it occurred to us while listening that a little subsequent disciplinary action might have been beneficial, if the Director of Programmes had been listening.

Finally, the word "comrados," which is the form of address regularly used by Cardiff, strikes us as being original on hearing it the first time, puerile after a few weeks and fatuous after a few months.

Wireless in Springtime

The spirit of springtime seems to be permeating the B.B.C., for we notice that arrangements are being made to broadcast the song of the nightingale. We understand there are certain difficulties in persuading a nightingale to adhere to a programme announced in the *Radio Times*, and it will indeed be disappointing if after millions have waited anxious hours to hear these thrilling notes an announcement should be made that atmospheric prevent satisfactory reception. However, the British Broadcasting Company have conquered greater difficulties than this before now, and we wish them all success.

His Majesty's Wireless Set

Great interest has been aroused by the announcement that His Majesty the King has been pleased to accept from the British Broadcasting Company a cabinet wireless receiver which is illustrated on another page, arranged so as to be self-contained with batteries and loud-speaker complete. Captain Eckersley, the Chief Engineer of the British Broadcasting Company, is the designer, and naturally every endeavour has been made to obtain the purest possible reproduction. No aerial is used—even the conventional frame associated with elaborate cabinet sets is absent. Instead, a special capacity aerial is used consisting of two copper plates, one at the top and the other at the bottom of the instrument, forming, strangely enough, practically the modern equivalent of the old Hertzian oscillator. There are two stages of high-frequency, a detector valve, and three note magnifying valves. Reaction is used and is controlled by a knob on the front of the instrument, the only other tuning control being the aerial tuning, which is of conventional pattern. Three tubular valves are used for the high-frequency and detector, whilst the note magnifiers (which are resistance capacity coupled), are LS5 valves, with about 200 volts on the plates, and 15 volts negative on the grids. The loud speaker is incorporated in the cabinet on the right-hand side and two doors enclose the whole instrument.

Interference from Electric Mains

By G. P. KENDALL, B.Sc., Staff Editor

Some practical suggestions for the reduction of a very prevalent nuisance, by a writer who has made a special study of the subject

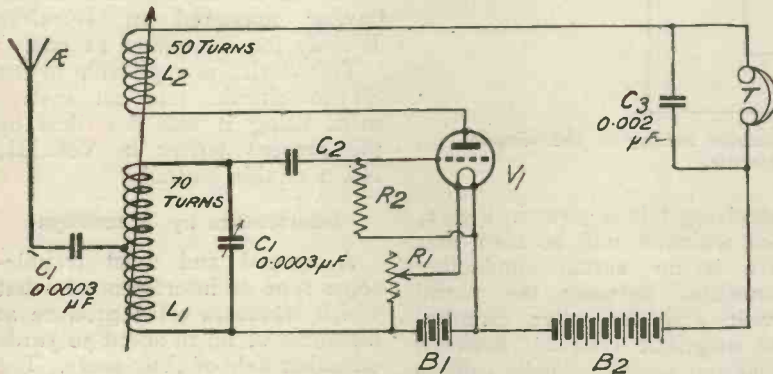

Fig. 1.—A specially useful circuit where interference is troublesome.

THE increasing popularity of reflex circuits has led great numbers of listeners to realise what a most insufferable nuisance neighbouring power and lighting mains can be under some conditions. The nature of the interference which results is always the same, namely, a continuous buzzing or humming noise in the 'phones, but its occurrence is exceedingly erratic; a set may be installed in a room surrounded by a network of wiring carrying alternating current, and yet little trouble will be experienced, whereas a next door neighbour without a wire in his house may hear such a roar that reception is almost impossible. The deciding factor would appear to be induced earth currents, and these are, of course, quite incalculable, so that it is almost impossible to predict whether trouble of this sort will be met with in any given situation.

The trouble is, on the whole, more liable to occur with reflex circuits than with the straight-forward type, since in many of the former a low-frequency amplifying valve is connected directly to the aerial circuit, so that any induced audio-frequency currents flowing therein will be picked up and amplified. Interference of this sort, however, is not by any means confined to

dual amplification circuits, and I have met many acute cases where a perfectly simple set was employed.

Methods of Elimination

Interference by induction from lighting and power mains may be brought about in two principal ways; the interfering currents may be picked up by the aerial-earth circuit and so applied to the valves, or the set itself may pick them up by direct electro-magnetic induction from stray fields. Fully 90 per cent. of the cases which I have investigated have been of the former type, and it is to these that I shall devote the greater part of the space available for this article.

The first step when confronted by a case of interference from lighting mains is to decide which type of trouble is present, and to do this all that is necessary is to

remove the aerial and earth wires from the respective terminals of the receiver. If the noise stops, the trouble is of the first type. If it continues it is of the second.

Trouble of the second sort is very rare, and practically the only remedy is to abandon low-frequency amplification and enclose the whole receiver in a sheet-iron box.

The sort in which the trouble is located in the aerial-earth circuit can be dealt with in a great variety of ways, the correct one to use in any given case obviously depending upon the particular conditions. Having decided that interference of this kind is occurring, the first step should be to ascertain whether the aerial or the earth is the real source of disturbance. Remove the aerial wire from the set, leaving the earth connected. If the noise continues it indicates that the interfering currents probably emanate from the earth connection. Replace the aerial and remove the earth wire. If the humming now ceases the previous surmise is confirmed, but if it continues a clear indication is provided that both aerial and earth are picking up the interference.

We are now in a position to consider some of the special methods of elimination.

Filter Devices

Where the foregoing tests have indicated that the interfer-

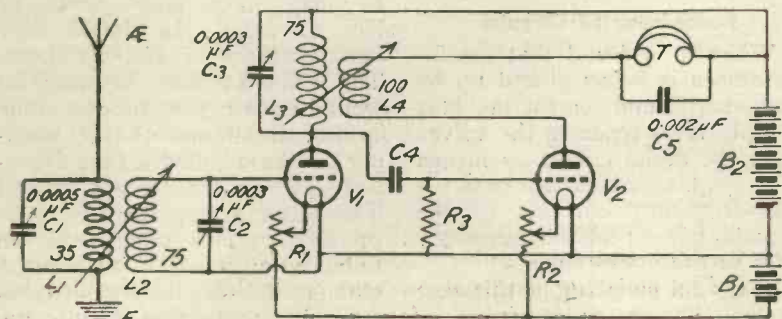

Fig. 2.—One of the best methods of eliminating A.C. hum.

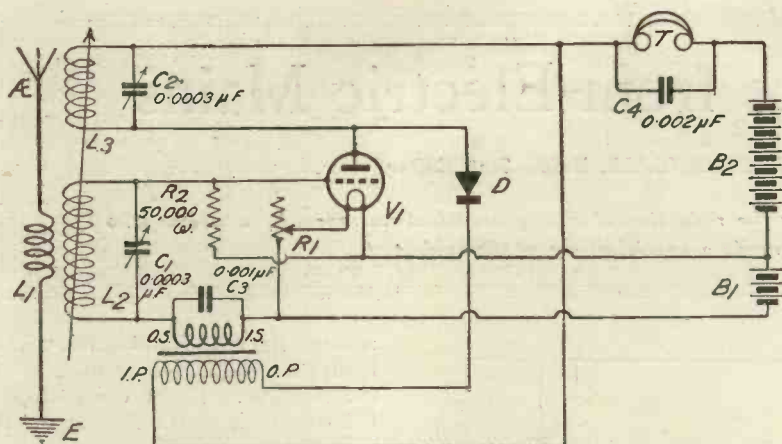

Fig. 3.—The application of aperiodic aerial tuning to the simple type of reflex circuit.

ing currents originate in either the aerial or the earth a simple remedy which is usually successful is to insert a filtering arrangement between the aerial or earth as the case may be, and the appropriate terminal on the set. The simplest filter, of course, is a small fixed condenser, which will allow the high-frequency currents of the signals to pass fairly freely, but will almost completely stop the low-frequency interfering currents. A suitable capacity for such a condenser is 0.0001 μ F, and it must be remembered that when this is inserted in series in the aerial circuit a larger coil will probably be needed to tune to a given wavelength.

Counterpoise Earths

Where the trouble is traced to the earth connection relief can usually be obtained by the use of what is known as a counterpoise earth. This is simply a sort of dummy aerial suspended a few feet above the ground immediately beneath the aerial itself, carefully insulated, and connected to the earth terminal of the set instead of the usual earth wire.

Loose-coupled Circuits

When it is found that the interference is being picked up by both aerial and earth, the best remedy is to separate the valves from the aerial circuit by means of a coupling which will pass the high-frequency currents of the signals, but not the low-frequency ones of the interference.

A typical coupling of this sort is that known as inductive or "loose" coupling. A circuit

embodying this is given in Fig. 2, from which it will be seen that there is no actual conductive connection between the aerial circuit and the valve circuits. The magnetic coupling between aerial and secondary coils suffices to transfer the signals from one circuit to another, but does not similarly transfer the low-frequency interfering currents to any appreciable extent.

This method is very effective, and materially improves the selectivity of the receiver, but, of course, it involves an additional circuit to tune.

Special Circuits

In the case of reflex circuits the adoption of a loose-coupled tuning arrangement is somewhat liable to impair the stability of the receiver, and I have found that in the case of the simple single valve reflex now so widely used it is better to use the aperiodic aerial system of tuning. A circuit on these lines is given in Fig. 3, and it may be of interest to give the necessary practical data for this arrangement.

The coil L_1 should consist of twelve turns of No. 18 d.c.c., and L_2 may have sixty turns of No. 22 d.c.c. L_3 should have seventy turns of No. 24 d.c.c. The coils L_1 and L_2 may be wound upon a 3 in. tube or some form of simultaneous basket winding can be adopted. (See *Wireless Weekly* for Dec. 5, 1923.) This latter arrangement is to be preferred. This circuit will be found very stable if the 50,000 ohm resistance is provided, remarkably selective, and unusually free from disturbances.

Another type of circuit which I have found valuable for the elimination of the kind of interference under discussion is the form in which a centre tapping is taken from the tuning coil through a small fixed condenser (0.0001 to 0.0003 μ F) to either an earth connection or an aerial.

A single valve circuit using this arrangement is illustrated in Fig. 1, full constructional details of a set embodying this circuit having appeared in *Wireless Weekly* for November 21 last.

This device is applicable to the ST100 circuit, and an instrument using it was described by the present writer in Vol. III, No. 1 of this journal.

Interference by Tramways

A special and most troublesome type of interference is that which tramcars often produce at distances of up to about 50 yards on either side of their route. The sparking at their switch contacts, trolley runners, and motor commutators seems to produce an actual radiation of wireless waves exceedingly difficult to get rid of.

A counterpoise is usually helpful, and a loose coupled tuner has some effect, but the only real remedy is to get the aerial as far as possible from the overhead wires, and, if possible, at right angles to them.

It should perhaps be explained that interference of this variety causes crackling and sizzling noises closely resembling atmospheric, but of greater loudness.

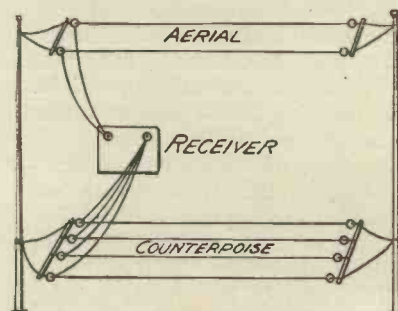

Fig. 4.—Diagrammatic representation of a counterpoise earth.

INSTITUTION OF ELECTRICAL ENGINEERS. Wireless Section Meeting. Wednesday, April 2nd, 1924, at 6 p.m. "Thermionic Valves with Dull-Emitting Filaments," by the Research Staff of the G.E.C. (work conducted by Messrs. M. Thompson and A. C. Bartlett.)



Still Growing

THE great family of wireless enthusiasts continues to increase at a very satisfactory rate. During the month of February there were between fifty and sixty thousand additions to its strength, bringing it up to a total of well over 600,000. It looks as if the B.B.C. will have a pretty profitable year with its share of the licence fees. I often wonder why people are inclined to grumble at the amounts paid for the licences. Surely ten shillings or even fifteen shillings is a pretty small subscription to pay for a whole year's entertainment with eight different programmes every night, if your set is big enough to bring in all stations. The trouble is that so many people want something for nothing and therefore do not like the idea of even the half-quid *pro quo*. Grousing is one of our most popular national pastimes, though we very rarely mean it to be taken seriously.

I expect that before long we shall be approaching American programmes in the size and length of our own, which is a wonderful thought, but at the same time rather a terrible one. I often wonder how Americans ever get any work done at all nowadays, for with them broadcasting is apt to begin at breakfast time and to continue almost without intermission until it is time to creep between the sheets. Possibly Americans are of a more sunny nature than we; certainly the average Englishman is not at his brightest and best either as a talker or listener at breakfast time. What he wants then is to read his papers in comfort and afterwards to smoke the best pipe of the day in peace and quiet. If the young members of his family insist upon having wireless as an accompaniment to the eggs and bacon, I foresee that there

will be trouble in many hitherto united families. Then there is the question of the lady of the house. In America she is catered for by musical and other programmes right through the morning. Should this kind of thing become established here, you and I, I fancy, would be forever thrusting our feet into socks which offer no proper covering for our tender big toes and putting on clean shirts that have not a button to bless themselves with. No, if all-day wireless comes, I think that I shall have to take certain protective steps. I shall burn my present set and design something terribly complicated which does all sorts of horrible things unless you turn the right knobs the right way. It will have booby-traps in the shape of innocent-looking terminals that give you shocks, and other little things of that kind. On second thoughts, I do not think that even that would work, for as it is the rest of the family is becoming far too proficient in the handling of wireless sets. They will probably retaliate by making sets of their own which work a jolly sight better than mine does.

The Pottlesdown Pair

It is just this wireless rivalry that has been responsible for bringing about a sad state of affairs in one household in Little Puddleton. Until recently the country could have shown no happier pair than Horace Pottlesdown and Amelia, his spouse. They had the most perfect understanding of one another, and it was wonderful to behold the way in which they humoured each other's little foibles. She, for example, though she has never wielded a golf club save on the occasion when she borrowed Horace's pet driver to dislodge a sparrow's nest from the gutter

spout, would listen with rapt attention to his evening post-mortems when he told her the tale of the stymie at the ninth or the dreadful business of his fozzled approach at the sixteenth. He, though by no means musical, would sit apparently enraptured whilst she told him of a concert to which she had been, using those wonderful technical terms of the art of music which are apt to make the wireless men green with envy at times when he considers his own small vocabulary of jaw-breakers. They were then a very happy couple, and when Horace began to dabble in wireless things appeared to be going even better than ever. He served his apprenticeship with crystal sets then, sighing like Alexander for more worlds to conquer, went on from valve to valve until he had constructed a set that was really worth lying about. Mrs. Pottlesdown knew nothing whatever about wireless and appeared to care even less about its technical side. But she played up beautifully to her Horace. Whenever friends dropped in to hear what the set could do she would ask if they understood how wireless worked. This was a safe question, for in those early days of the art knowledge was confined to a very few. When they replied in the negative she would say, "Oh, well, I am sure Horace will tell you. You cannot help understanding because he makes things so plain." This gave Pottlesdown his opening, and he thoroughly enjoyed himself for the space of half an hour or so, afterwards beaming with just pride at the compliments he received upon his skill as an expounder.

How the Trouble Started

Now, as I have said, Mrs. Pottlesdown had a musical soul, and when programmes began to contain things that really mat-

tered, she was fired with a mighty yearning to listen in from the word go until the final syllable of the announcer's good-night speech. Horace, though the best of husbands, could not always be there when he was wanted to switch on and tune in. There were times, then, when she had perforce to sit in agony of soul because, though some much-to-be-desired item was at that moment being rendered, she could not turn it on. Bitterly she told Horace of her secret sorrow, and he, rising to the occasion, forthwith gave her practical instruction in the art of twiddling knobs. All went merrily for a time, but unrealised by either of them, a new development was slowly taking place. Amelia had listened so often to Horace making everything wireless perfectly plain that it dawned upon

her at length that she was really beginning to understand things. She bought a wireless book. She read it. She bought another and yet another. When Horace was away at the office she read through his little library volume by volume, but she kept her knowledge concealed until one day the secret was quite unintentionally disclosed. She had been listening during the afternoon to what you and I would call a pretty ghastly noise, but what your real highbrow calls a perfect tone poem by the great master Sloshitoff. As she listened she became aware that things were not quite perfect. There was a little edginess here and a little over-emphasis there.

When Horace returned she told him how much she had enjoyed the programme, and then unthinkingly blurted out, "Don't

you think you could reduce the distortion on the LF side of the set if you shunted the transformer secondaries with resistances?" She also said quite a lot about biasing batteries, and then warmed to her work, giving a little disquisition on the evils of grid current. When she had finished Horace's jaw was hanging open with amazement, and his eyes bulged out of his head. Then she realised what she had been saying, and blushed furiously. It was, so Horace told me, the happiest moment of his life. Here was a perfect partner now showing a thorough knowledge of his greatest hobby and a keenness upon it which outran even his own. Neither of them recognised the entry of the serpent into their garden of bliss and the trouble to come.

WIRELESS WAYFARER.

German Broadcasting Programmes

In response to many requests, we give below details of the daily programmes from the various German stations. Practically all can be heard well in this country.

Berlin, Vox Haus (Radio Stunde A.G., Potsdamer Str. 4).

Wavelength. — About 420 metres, varying between 415-435.

09.00. G.M.T.—Market prices (foodstuffs, etc.).

09.15. G.M.T. — First news report.

11.15 G.M.T.—Exchange quotations.

11.55 G.M.T.—Time signal (relayed from Nauen).

12.05. G.M.T.—Second news report.

13.15. G.M.T.—Exchange quotations.

15.00-17.00 G.M.T.—Concert (small orchestra).

18.30 G.M.T.—Lectures (not daily).

19.30 G.M.T.—Concert. (Sundays and holidays, 18.00-19.00 G.M.T.)

20.45 G.M.T.—Last news report. Weather forecast.

21.50 G.M.T.—Dance music (not daily—usually Thursdays).

The power of above station is said to be 1½ kw., but rarely exceeds 1 kw.

Berlin Vox Haus also broadcasts gramophone records from 7 a.m. to 8 a.m. G.M.T. on 420 metres for the entertainment of passengers flying on Junker 'planes between Berlin and Leipzig at that hour.

Leipzig — Mitteldeutsche Rundfunk A.G.

Wavelength, about 400 metres.

09.00. G.M.T.—Market prices.

11.45 G.M.T.—Exchange quotations, etc.

11.55. G.M.T.—Time signal (from Nauen).

15.30-17.00 G.M.T.—Concert (the Radio Orchestra).

18.30 G.M.T.—Lectures (almost daily during Leipzig Fair week).

20.15 G.M.T.—Concert and news.

(Sundays and holidays, 16.00 to 17.00.)

21.00 G.M.T.—Dance music (not daily).

Königswusterhausen L.P. 4,000 metres.

06.00-07.00 G.M.T. News. Daily.

11.00 to 12.30, Exchange (on 2,700 metres).

15.00 to 16.30, Exchange and news (on 4,000 metres).

This station also relays on 635 metres the evening concert from Vox Haus daily.

On 2,800 metres, concerts are frequently given by Dr. Erich Huth from 18.30 to 19.00.

On Sundays, from 10.50 to 11.50 G.M.T. Königswusterhausen broadcasts a concert given by the Homophone (Record) Orchestra.

Eberswalde is very irregular, but now and again gives out a concert on 2,700 metres, at 20.00 to 20.45 German time.

Dr. Erich Huth Berlin. — Experimental transmissions — mostly gramophone records — are broadcast on 550 metres, almost daily at 18.20 to 18.45 G.M.T.

The Telefunken Company experiments on about 550 metres at irregular intervals, but on one or two occasions have broadcast operas from the Volks Opernhaus — wavelength usually about 550, but on occasions much higher.

Random Technicalities

By PERCY W. HARRIS, Assistant Editor

Improving Loud-Speakers—The Home Worker and his Workshop.

IT is now fairly generally known that most loud-speakers work best with a small fixed condenser shunted across the terminals. Most commercial receiving sets are provided with some form of condenser across the telephone or loud-speaker terminals, the value generally being about 0.002 μ F. If, however, you have a receiver in which you have not troubled to incorporate such a condenser (there is no real need for it with most modern telephones) and you should use this receiver for operating a loud-speaker, try shunting one or two different capacities across the terminals to see whether a better result is obtained. I have two loud-speakers at the moment, one working excellent with .002 μ F across it and the other requiring nearly .01 μ F before the best is obtainable. McMichaels, the Grafton Electric and, I believe, one or two other firms sell condensers which slip into spring clips, allowing various values to be tried at will. A pair of such clips behind the panel where the telephone or loud-speaker terminals are situated will enable you to try a few differing values.

□ □ □

It is surprising how many experimenters make up one set after another, quite regardless of whether or not they are obtaining good results. This week I would like to give a few hints to those who make up a number of sets, as considerable economies can be effected if you know the right way.

□ □ □

First of all, keep two large boxes or, if you like, trays, one for odd lengths of wire and the other for odd lengths of insulating tubing. Whenever you pull a set to pieces do not throw away the odd lengths of wire—even the short lengths—for such wires

can be used over and over again and will keep your wire bill down to a very small figure. The odd pieces of insulating tubing come in very useful, too. The object of having the boxes or trays large is that you can see at a glance what lengths you have available.

□ □ □

Secondly, in regard to solder. Whenever you apply the solder

purpose than occasionally cleaning the soldering iron.

□ □ □

An extremely useful tool for the rapid dissembling of sets is the American automatic screw-driver, which is fitted with a rapid thread so that on pushing down the handle the blade of the screw-driver turns. A small catch enables you to reverse this motion when necessary, so that a few pushes with this will release any wood or metal screw in a fraction of the time usually required.

□ □ □

I always keep handy on the bench a wooden box divided into seven partitions, six being of equal size and the seventh three times as big as the others. In the largest of all are kept wood screws, whilst in the others are kept respectively 6 B.A. metal screws, 4 B.A. metal screws, 2 B.A. and larger metal screws, 6, 4 and 2 B.A. nuts (the nuts are all kept together), washers and soldering lugs, and lastly various oddments, such as wander plugs, special terminals, and the like. When dissembling a set the nuts and screws can be put into their places without any effort, and are ready at hand when the next set is made.

□ □ □

Old cigar boxes are very handy on the work table. In one you can keep assorted drills, in another mica and copper foil for making condensers, whilst in the third can be placed small scraps of ebonite which are very useful in mounting odd parts. An ebonite scrap box is also an essential in every well-ordered workroom, and, of course, a tool rack will save a great deal of time. It is the saving of odd moments that enables some of us to get through a great deal of work in comparatively little time.

WOOD TELEPHONE CAPS

The following letter is self-explanatory:—

Sir,—I am enclosing here-with an Earcap which I think will interest you. One of our friends bought a set of Ear-phones retail at 16/—, and when he tried to remove the earcap it broke.

You will note it is made of wood; surely your readers should be warned about this sort of thing being done.

Our employee, although working in a rubber factory, was quite under the impression that the Earcap was made of ebonite.

Yours faithfully,

THE..... RUBBER MANFG. CO., LTD.

to the soldering iron do so above an old tin lid, and see that the odd drops fall into this lid. A little flux may be kept in the lid with these odd pieces, and will help you to tin the bolt rapidly whenever necessary. It is well to keep an old file for no other

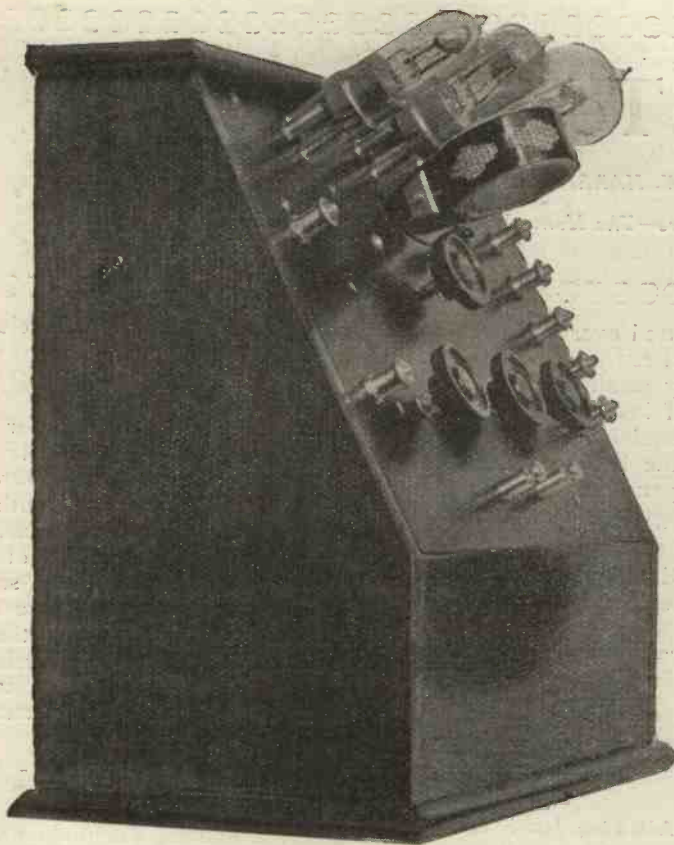

Fig. 1.—The appearance of the receiver may be gathered from this photograph.

As is well known, there are two most common methods of obtaining reaction effects, namely, electro-magnetic and electro-static coupling, and of the two probably the less familiar is the electro-static or "capacity" reaction. There seems to be no apparent reason why this form of reaction has not become as universally used as the electro-magnetic type, though it is admittedly somewhat more difficult to introduce into a circuit without preliminary experiment; nevertheless, when once successfully applied the results obtained and the extreme fineness in reaction control more than justify the little experiment necessarily preceding its application.

In the receiver to be described this form of reaction is employed as an alternative to the more commonplace method of using a two-coil holder with the reaction coil coupled to that in the aerial circuit, and many interesting as well as peculiar effects can be observed when experimenting with the circuit.

Considerations in Design

A general conception of the finished receiver may be gathered from the photograph Fig. 1, whilst the wiring beneath the panel may be seen in the third photograph, Fig. 6. The receiver which constitutes a detector and two low-frequency valves is intended primarily for the reception of British broadcasting only, and for that reason the

A Capacity Reaction Three-Valve Receiver

By *STANLEY G. RATTEE*,
Staff Editor.

aerial tuning is simplified by the use of a variometer, though readers may, if they prefer, substitute a No. 35 or 50 (according to the station desired) plug-in coil and 0.0005 μ F condenser for this component. In order that either two or three valves may be used, a simple form of switching is introduced by means of Clix plugs, and to permit the last low-frequency valve being used as a power amplifier, if required, a special arrangement of H.T. terminal connections is incorporated.

Components and Materials

The materials and components necessary for the construction of the receiver to the specification given herein are:—

- 1 ebonite panel measuring 12 in. by 9 in. by $\frac{1}{4}$ in.
 - 2 filament resistances.
 - 1 variable air condenser of 0.0003 μ F capacity.
 - 1 variometer.
 - 2 low-frequency transformers.
- Those incorporated in the receiver illustrated are the Fuller "Iron-clad" and "Royal."
- 1 coil mount.

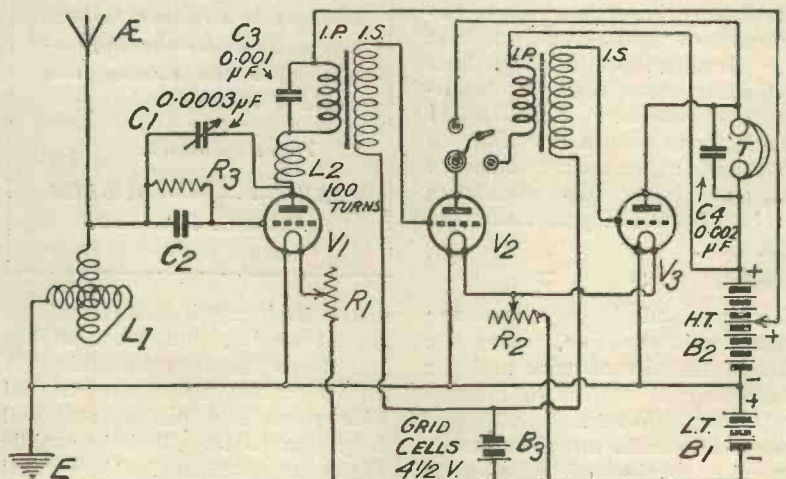

Fig. 3.—The circuit employed in the receiver.

Full constructional details of a receiver possessing several points of novel design and fine adjustment of reaction

- 2 Clix sockets.
 - 1 Clix plug.
 - 1 grid condenser of $0.0003 \mu\text{F}$ capacity.
 - 1 grid leak of 2 megohms resistance.
 - 1 fixed condenser of $0.001 \mu\text{F}$ capacity.
 - 1 similar condenser of $0.002 \mu\text{F}$ capacity.
 - 1 $4\frac{1}{2}$ -volt dry-cell battery, such as those used for flash-lamps.
 - 12 valve legs or, alternatively, 3 valve-holders.
 - 1 No. 100 Igranic or other make plug-in coil.
 - 9 terminals.
- Quantity of No. 18 tinned copper wire and Systoflex for connecting purposes.

The Circuit

The circuit used in the receiver is shown in Fig. 3, and before connecting the components in the final construction of the receiver, readers are advised to thoroughly acquaint themselves with the arrangement of the circuit.

The choke coil L_2 , which is, in fact, a No. 100 plug-in coil connected between the anode of the

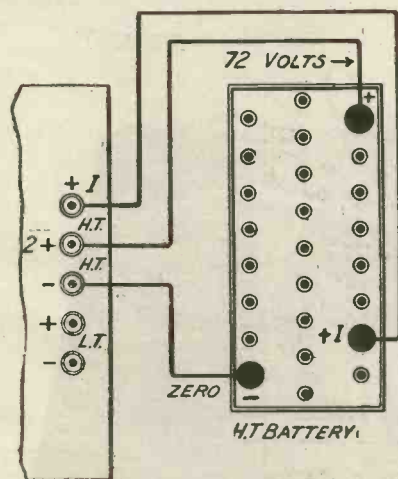

Fig. 4.—The H.T. terminal arrangement.

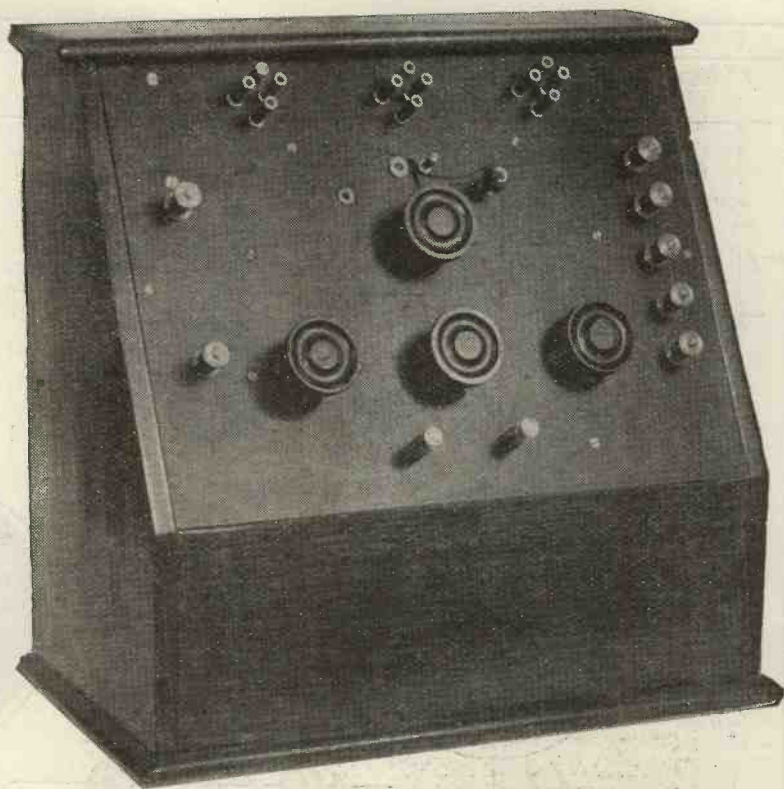

Fig. 2.—A full face view of the instrument, showing the layout of the panel.

detecting valve and the O.P. of the first intervalve transformer, bears very considerable relation to the condenser C_1 . For instance, using a No. 75 coil as a choke, the value of C_1 needs to be increased from $0.0003 \mu\text{F}$ to 0.0005 , whereas if C_1 is 0.001 then L_2 may be a No. 50 coil.

For the best results, giving a fine control of reaction, a control equal to that associated with the well-known Reinartz receiver, a No. 100 coil as L_2 , and the value of C_1 $0.0003 \mu\text{F}$ will be found the most satisfactory.

The Variometer

As previously stated, the aerial tuning is carried out by means of a variometer, the details of which are as follows:—

The stator consists of a cardboard tube $2\frac{1}{2}$ in. long and 3 in. in diameter, which after being gently baked in order to drive out any moisture and then shellacked, has wound upon it 40 turns of No. 22 S.W.G. d.c.c. wire.

The rotor consists of a cardboard tube measuring $1\frac{3}{4}$ in. long and $2\frac{1}{2}$ in. diameter, which also, after being dried and shellacked, has wound on it 36 turns of No. 22 S.W.G. d.c.c. wire. The

wavelength range of this variometer, when used to tune the average P.M.G. aerial, is from about 250 metres to 500 metres.

Those readers who prefer to substitute this component for a plug-in coil arrangement may do so by connecting across the aerial and earth terminals a single-coil socket with a $0.0005 \mu\text{F}$ variable condenser in parallel. With this arrangement it will be found necessary, when tuning to the lower broadcast wave band, to use a No. 35 coil, and when tuning to the higher waves, to plug in a No. 50 coil; in both cases making final adjustment with the $0.0005 \mu\text{F}$ aerial tuning condenser and $0.0003 \mu\text{F}$ reaction condenser.

The Panel

A general idea of the layout of the panel may be gathered from the photograph Fig. 4, and also from Fig. 5. Since the dimensions for condensers and transformers must vary with each make, the drilling dimensions of these are omitted. The disposition of these components beneath the panel may, however, be gathered from Figs. 6 and 7.

After the drilling measure-

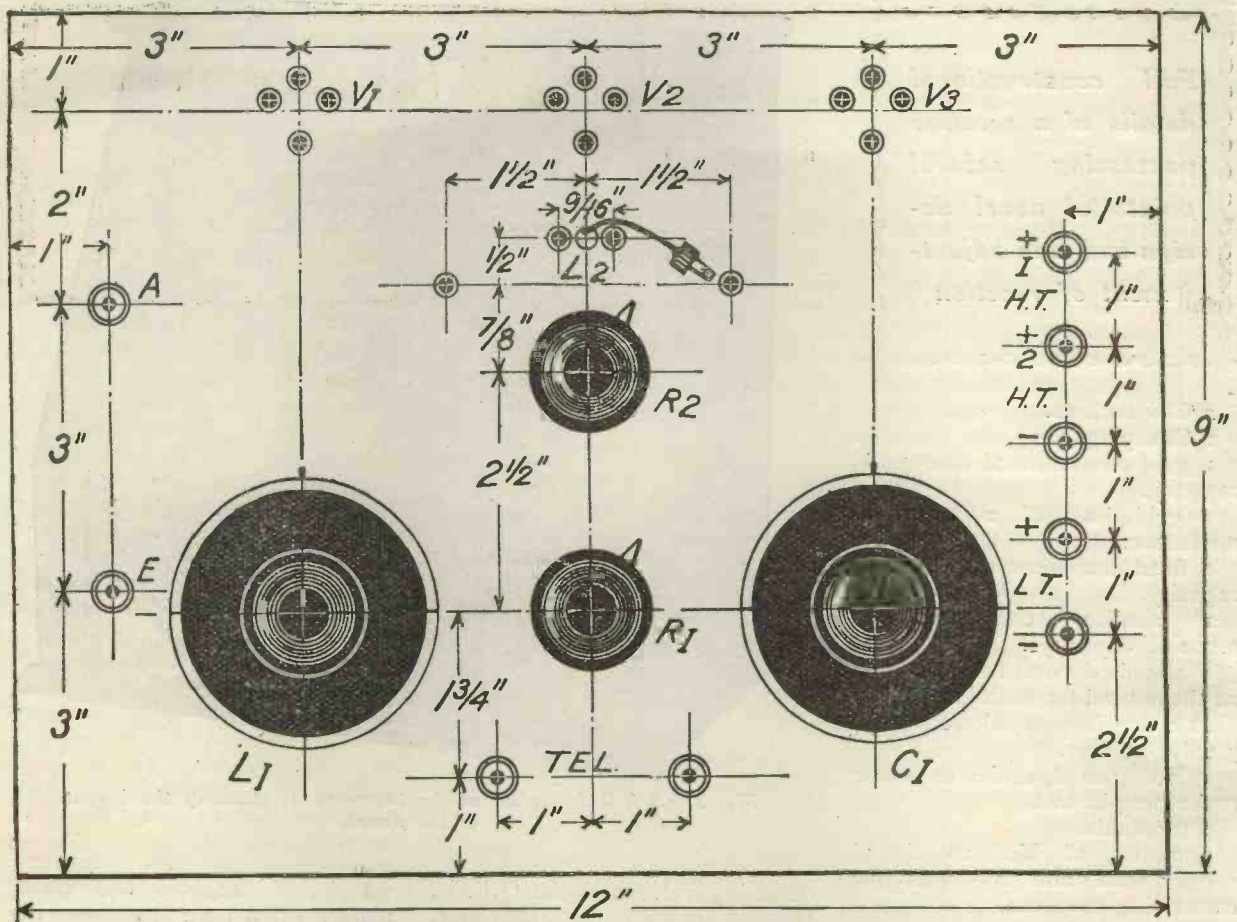

Fig. 5.—The layout of the panel, transformer and condenser drill holes being omitted, these being decided by the makes chosen. This figure is exactly half-size.

ments have been decided upon and the required holes made, the ebonite should be treated upon both sides to a very severe rubbing with fine emery paper or pumice powder in order that the constructor may assure himself that the "glossy" finish may not ultimately nullify his results.

Grid Bias

In order that the results may be as clear as possible when high H.T. voltages are applied to the plates, a small flash-lamp battery of 4½ volts is introduced between the secondaries of the low-frequency transformers and the L.T. negative, the connections for this battery being L.T. negative to positive of battery and negative of battery to O.S. of secondary of transformers.

Wiring Up

With the various components mounted in the positions indicated in the photograph Fig. 6 and the wiring diagram Fig. 7, the various connections may be

made, strictly adhering to the details given in this latter figure. All connections should be soldered and must be kept as short as possible, otherwise "howling" and general inefficiency is likely to result.

It will be observed that the usual condenser of 0.05 µF to 1 µF capacity across the H.T. terminals is omitted in this

receiver, and the reason for the omission is that in some cases it is not found necessary, and when necessary can be connected externally; should the H.T. battery be an old one or should H.T. noises prove irksome, then the inclusion of the condenser across the H.T. terminals is indicated.

(Concluded on page 532.)

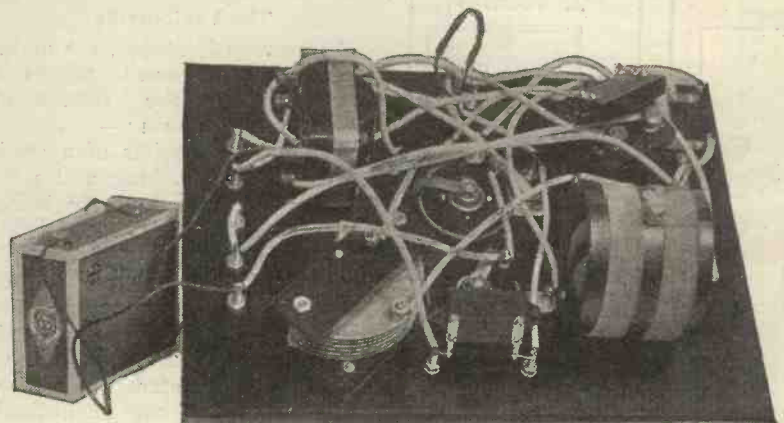

Fig. 6.—A view of the underside of panel, showing wiring and grid battery.

C.W. and Telephony Transmission Using Valves

No. XI.

By JOHN SCOTT-TAGGART, F.Inst.P., A.M.I.E.E.

Use of A.C. without Rectification

A USEFUL method of generating continuous waves is shown in Fig. 25. Alternating current is now used to supply the anode circuits of two three-electrode valves, V_1, V_2 . Each of these valves oscillates while its anode is made positive during a positive half-cycle of alternating current. The low-frequency alternator L.F.A. supplies current to the transformer T_1, T_2 , and the middle point of T_2 is connected through the inductance L_1 to the filament battery B_1 . The ends of T_2 are connected to the anodes. A single grid circuit coil L_2 is connected in the position shown, and is magnetically coupled to the inductance L_1 . When the top end of T_2 is positive with respect to the middle point, and therefore positive with respect to the filament of the first valve, the anode current flows from filament to anode, through the top half of T_2 , through L_1 to the filament; due to the coupling between L_2 and L_1 , the valve V_1 oscillates and produces semi-continuous waves, while the valve V_2 is inoperative, as the anode of the second valve is temporarily negative with respect to the filament.

When the current in T_2

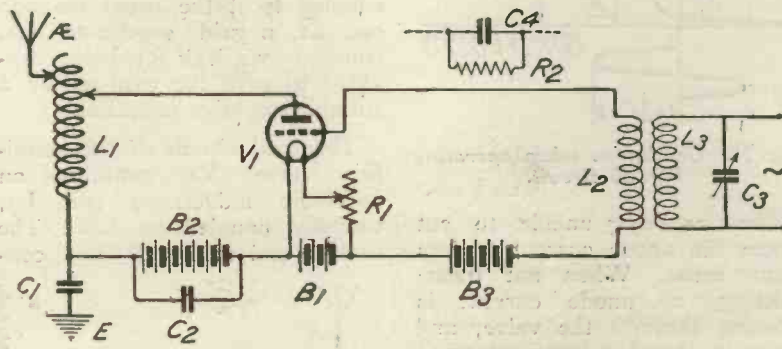

Fig. 26.—Separate excitation circuit.

changes direction, the lower valve produces the oscillations. We thus obtain an aerial current which varies in amplitude at every half-cycle, but which is otherwise similar to that produced by a pure continuous wave transmitter. The signals may be received without the use of an oscillating valve, but if the frequency of the alternations supplied by L.F.A. is, say, 1,000, the ripple produced will not prevent a pure note being received on a heterodyne receiver. To produce a purer note, 3- and 6-phase currents have been used with success.

Separately Excited Valve Transmitters

Instead of employing a powerful generating circuit, we can start with a low-power oscillator

and amplify the radio-frequency current by high-power amplifying valves. Fig. 26 shows a valve V_1 having a grid circuit containing an inductance L_2 , which is coupled to the oscillatory circuit L_3, C_3 , which supplies the radio-frequency current to be amplified. In the anode circuit of V_1 is an inductance L_1 . The valve V_1 acts in exactly the same way as a receiving amplifier valve, the only difference being that the aerial circuit is the one in which amplified oscillations take place. We can operate the valve so that when the grid is at zero potential we are working along the steep straight portion of the curve; in transmitting arrangements, however, it is more efficient to operate lower down on the curve and to use only the positive half-cycles of radio-frequency current supplied by L_3, C_3 .

Fig. 27 shows the characteristic curve of the amplifier valve V_1 working under the most efficient conditions. The normal operating point is A in preference to B. In both cases the grid potential should be negative so as to prevent damping in the grid circuit.

It will be seen from Fig. 27 that only the positive half-cycles produce any output oscillatory current in the aerial, the negative

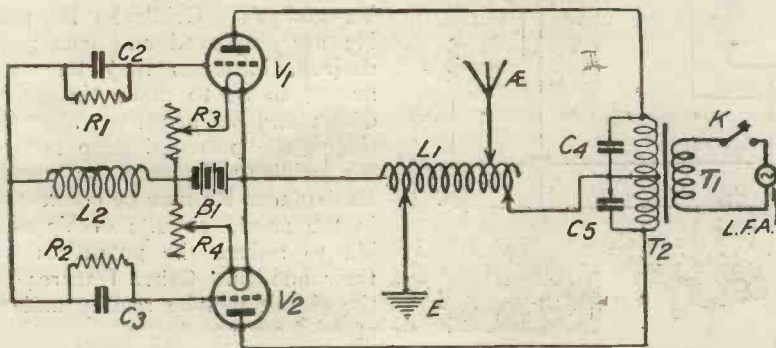

Fig. 25.—Use of A.C. for transmission employing both half-cycles.

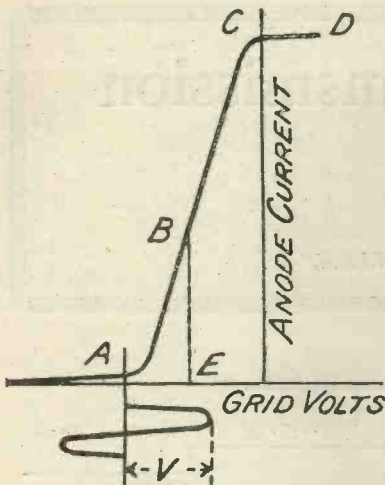

Fig. 27.—Conditions when operating Fig. 26 circuit.

half-cycles being unable to cut down the anode current to less than zero. When not transmitting, no anode current is flowing through the valve, and there is, therefore, no wastage of energy. A key may be used to control either the anode circuit of V₁ or the grid circuit, or the source of oscillations; the latter method is usually preferable.

In Fig. 26 the grid may be given a negative potential by means of a battery B₃, but if a leaky grid condenser be connected in the position shown by the dotted line (the battery B₃ being omitted) the grid will automatically assume a negative potential which, however, will not remain when the supplied oscillations are cut off.

A more practical arrangement consists in using a valve oscillator and using the potential drop

across its gridleak to supply the grid with a suitable negative potential.

Fig. 28 shows an essentially practical form of a separately excited generator employing a three-electrode valve V₂ as a master oscillator. It must be understood that any source of radio-frequency current may be employed instead of an oscillating three-electrode valve. The oscillating circuit L₁, C₁ has coupled to it the usual reaction coil L₂, a grid condenser C₂, shunted by a leak R₃, being provided to give the grid of V₂ a suitable negative potential.

The grid circuit of the amplifier valve V₁ contains an aperiodic inductance coil L₃, variably coupled to L₁. The bottom end of L₃ is not con-

V₂ negative with respect to the filament, but also makes the grid of V₁ negative, and this negative potential may be adjusted by varying the tapping on R₃. The coupling between L₁ and L₃ is generally such that the positive half-cycles on the grid of V₁ sweep over the whole of the characteristic curve of this valve. The generator B₂ supplies the anode current both for the amplifier valve V₁ and the oscillating valve V₂.

Since V₁ will usually be a larger valve than V₂, and will be required to develop higher powers, a resistance R₄ is frequently employed to cut down the anode voltage of V₂, a condenser C₅ being preferably shunted across this resistance. The key K may be included in the position shown, the advantage of

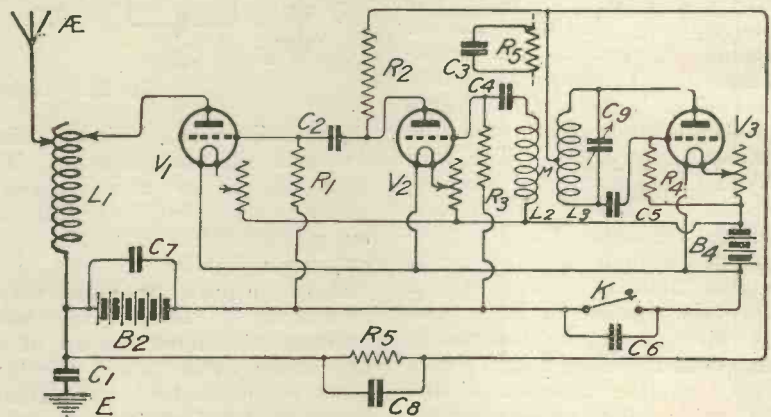

Fig. 29.—Another separately excited transmitter.

nected through a battery to the filament, but is connected to a point on the gridleak R₃ of the oscillating valve V₂. The potential drop across R₃ results in making not only the grid of

this arrangement being that on opening the key the potential of the grid of V₁ falls and no current flows through V₁ when the anode circuit is being broken.

Fig. 29 shows a separately excited power amplifier in which two stages of amplification are employed. In this case we use resistance amplifier connections, the anode circuit resistance R₂ being used to couple the valves V₂ and V₁. Gridleaks R₁ and R₃ are employed as usual; if desired, batteries may be connected so as to make the grids of V₁ and V₂ negative; alternatively, the potential drop across the gridleak R₄ may be used. Resistances R₅ may be connected in the anode circuits of V₃ and V₂ to reduce the potentials on their anodes. Other features of the circuit will be readily understood from the figure.

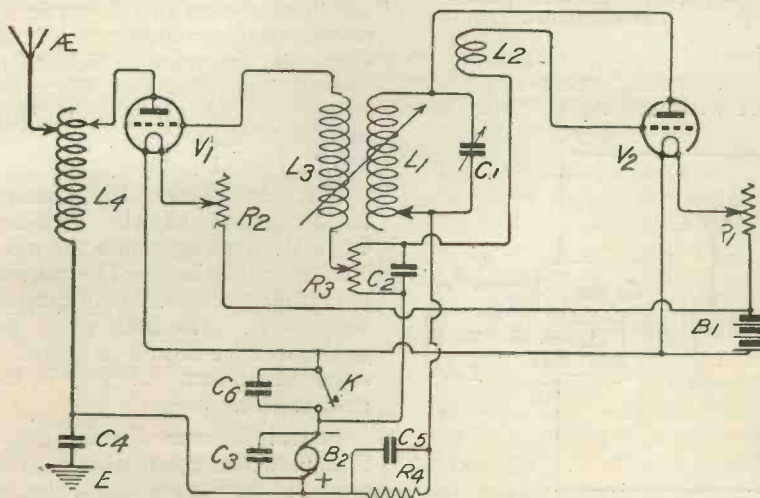

Fig. 28.—A really practical separately excited C.W. transmitter.

(To be continued)

Getting the Most from Dry Cells

By R. W. HALLOWS, M.A., Staff Editor

WITH the advent of the new low consumption dull emitters the dry cell is becoming immensely popular amongst amateurs for filament heating purposes. Those who can use accumulators for the purpose—that is to say, those wireless men who have no difficulty in getting charging done—would be well advised to do so, for better results are to be anticipated from the steady delivery of a secondary battery than from that of a dry cell, which must inevitably be of a somewhat fluctuating order. Still, dry cells answer very well indeed, especially if they are well used, and they are a heaven-sent boon to the man who lives in some remote part of the country far from any charging station. They bring the valve set, and therefore the reception of broadcasting, within his power, whereas but a few months ago he was limited to the crystal, which did not give him the necessary range.

It is as well when buying dry cells to specify a make which has been designed particularly for filament illumination work, for this will have a much longer life than the ordinary bell cell. The filament cell and the bell cell have two quite different tasks to perform. The latter is called upon to deliver a moderate amount of current for perhaps three seconds at a time when the push button is pressed. It then has a rest, which at the worst will be hundreds of times longer than the period during which it is required to deliver current. It has therefore ample opportunities of recuperating between whiles. The filament cell has to work for long periods on end, delivering up to .25 of an ampere, and being rested on the average perhaps ten times as long as it is worked. For dull emitter work, therefore, we require a cell able to stand up to a fairly heavy discharge for a couple of hours or so without an undue drop in its voltage, and capable of recuperating properly during the periods of rest which are allowed to it.

An important point to note is that the probable life of a cell depends very greatly upon its weight. Thus if we procure two cells, one weighing about 2½ lbs. (this is about the weight of an average 6-inch cylindrical cell) and the other rather more than 5 lbs., the life of the larger, if both have the same current load, will be very much more than two-and-a-half times that of the smaller. For example, if it is used to work a Wecovalve on an

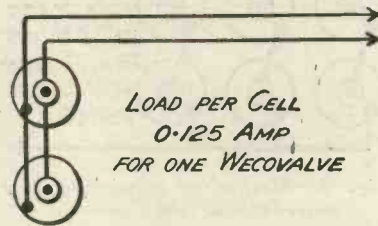

Fig. 1.—Dry cells connected in parallel for use with one Wecovalve.

average of two hours a day the life that could be reasonably expected of the smaller cell would be about 90 hours; the larger, on the other hand, should last between 300 and 350 hours. If cells of the smaller type are used it is very much more economical to wire two of them in parallel, as shown in Fig. 1, for working a single valve. If this

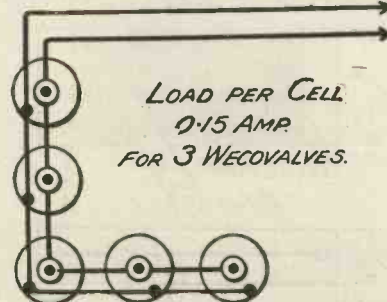

Fig. 2.—Cells connected in parallel for supplying current for three Wecovalves.

is done the load for each cell is halved. This reduces it to .125 ampere, a current which the cell will give for considerably more than double the number of hours that it would deliver .25 ampere. With two cells in parallel we might reasonably expect a working life of 250 hours. Therefore, though the initial expense is doubled, the two cells will last

very nearly as long as three put into use singly. The use of three cells in parallel has again a very marked effect upon the life of the battery, and effects a further ultimate reduction in the running costs.

To get the best from small cells the current taken from each should not exceed .15 ampere, and even this should be reduced if possible. Never attempt to run more than one Wecovalve off a cell of this size. The absolute minimum allowance is one cell per valve, and to keep within the figures given above the number of cells should be as under:—

No. of Wecovalves.	No. of cells in parallel.
1	2
2	4
3	5
4	7

When cells are placed in parallel in the way mentioned so as to reduce the load, a very important result is that the E.M.F. of the battery does not fall off anything like so quickly as is the case when the discharge rate is at .25 ampere per cell. This means not only that the filament potential is kept more steady, but also that the grid bias, whether it be positive on the high-frequency side of the set or negative for the note magnifiers, is also less subjected to variations; hence the set is more stable and is easier to handle. There is, further, less risk of damaging valves when they are switched on after a period of rest. As the potential will not have fallen off so much during the previous period of work, there will not be such a marked increase when the batteries are rested; hence there is not the same danger of subjecting the filaments suddenly to a potential far higher than that which obtained at the end of the previous reception.

When we come to the “.06” type of dull emitter, conditions are slightly different. We have here a valve whose filament current requirements are well within the powers of a single dry cell of moderate size. Sixty milliamperes is a small load even if the drain is continuous, and any well-designed cell should be able to stand up to it for several hours on end without showing a

marked falling off in E.M.F. The trouble is that wireless folk are rather prone to take too rosy a view of the valve's current consumption, and to forget that four valves which take .06 ampere make a total drain upon the battery of .24 ampere. One often sees four- or even five-valve sets being worked from a single group of three cells wired in series, as shown in Fig. 3. Bearing in mind our rule that the load per cell is not to exceed .15 ampere, we find that three cells in series cannot cope properly with more than two ".06" valves. The table below shows that the number of cells in parallel-series (Fig. 4) required by following sets:—

No. of ".06" valves.	No. of trios of cells.
1	1
2	1
3	2
4	2
5	3

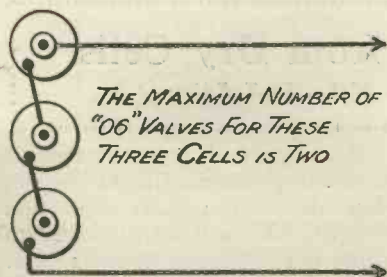

Fig. 3.—Arrangement of dry cells for two ".06" valves.

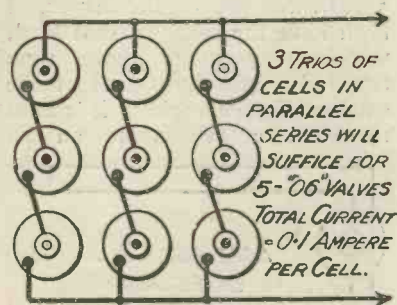

Fig. 4.—Method of connecting dry cells for five ".06" valves.

We have considered so far the best course to take with small cells, that is, those weighing about 2½ lbs., are used for filament heating. The safe load of a 5½-lb. cell may be put down at about .3 ampere. Hence a single cell of this kind will suffice for one Wecovalve and three in parallel will be sufficient for four. For ".06" valves three large cells in series should provide for the needs of a five-valve set.

The conclusions we come to are that it pays in the long run to buy big cells, but if small ones are purchased it is a good investment to use them in parallel. In no case should the load exceed .15 ampere per small cell, or .3 ampere per large cell. By keeping down the current demands of the set within these limits we very much increase the lives of the batteries, at the same time adding to the efficiency and to the stability of the set.

MANY valves are very critical as regards the adjustment of their filament potential when used either as high-frequency amplifiers or as rectifiers. In the former case considerable selectivity may be obtained by having some means of making very fine adjustments, in fact on short waves when the set is near the oscillating point a certain amount of what may almost be described as tuning may be done with the filament resistances of the radio frequency valves. A finely adjustable rheostat fitted to a detector valve enables one to get it working on exactly the right point of the characteristic curve and so to obtain clean and efficient rectification. When a soft valve is used as a rectifier a vernier attachment is almost essential since in this case the filament potential is particularly critical, especially if the valve is used with no high frequency stage in front of it. In the present note three simple ways of obtaining these highly desirable fine adjustments will be described.

The first is extremely simple, but at the same time it works very well indeed. The rheostat proper consists of 2½ yards of No. 26 s.w.g. enamelled Eureka resistance wire wound upon a

Rheostats with Vernier Attachment

former made of ¼-inch ebonite 1 inch wide and 2½ inches in length. This is fixed to the underside of the panel by means of screws, as shown in Fig. 1, contact being made by a selector

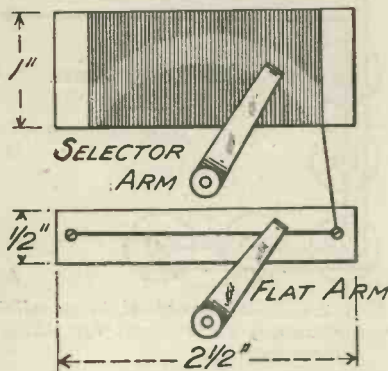

Fig. 1.—Showing method of mounting the vernier attachment.

arm which travels along a path bared of enamel. The fine adjustment is made as follows: On a second piece of ¼-inch ebonite 2½ inches long and ½ inch wide, a piece of the same resistance wire bared of its enamel is stretched between the two screws

which serve as attachments to the panel. Contact in this case is made by a flat arm mounted upon an ordinary spindle. Fig. 2 shows the way in which the wiring is done. The two resistances are placed in series, connections to the filament and to LT negative being taken from the bushes of the spindle.

The spindle of the fine adjustment is placed immediately behind that of the main rheostat in the place of the filament stop pins so that pointers cannot foul. Its knob should be lower and rather smaller than that of the main resistance.

In operating the set one places the pointer of the fine adjustment in the middle of its travel and then obtains the best possible adjustment with the main resistance. When this has been done the fine part of the work is accomplished with the smaller knob.

A rather more elaborate rheostat is seen in Fig. 3. The former consists of a 5-inch length of 3/16-inch ebonite ½ inch
(Concluded on page 531.)

An Experimenter's Unit Receiver

By H. BRAMFORD

The following is the eighth of a series of short articles, which began in Vol. 3, No. 9

Unit No. 7

This unit takes the form of a loading coil to be used when required in conjunction with Unit No. 1. A photograph of the complete unit is shown in Fig. 33, which illustrates the back of the panel. The only components necessary are one piece of ebonite measuring 6 in. x 4 in. x 1/4 in., one cardboard former 2 in. dia. x 5 1/2 in. long, 2 terminals, and a quantity of No. 22 S.W.G. d.c.c.

Panel Drilling

The panel is drilled in accordance with the details shown in Fig. 32. The holes for the two

terminals T1 and T2 are clearance holes. Two further holes are drilled to clear 4 B.A. screws which act as securing supports for the wound former.

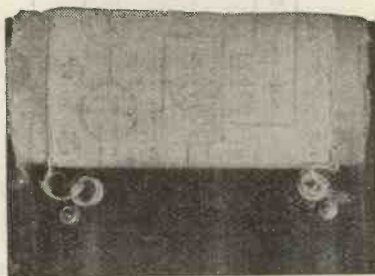

Fig. 33.—A photograph of the underside of the actual unit.

Assembling

First mount upon the panel terminals T1 and T2. Next wind 100 turns of No. 22 S.W.G.d.c.c. on the cardboard former and secure the beginning and finish of the winding by making holes in the former and threading the ends of the wire through, leaving sufficient length at each end for connection. Secure the former on the underside of the panel in the position

shown, and connect the beginning of the winding to T1 and the finish of the winding to T2.

Operation

A simple crystal circuit employing the use of this unit in conjunction with Unit No. 1 is shown in Fig. 34, in which circuit the aerial tuning range is increased by virtue of the added inductance.

In next week's issue will be given the description of a condenser unit by means of which the loading coil may be used as a wave trap.

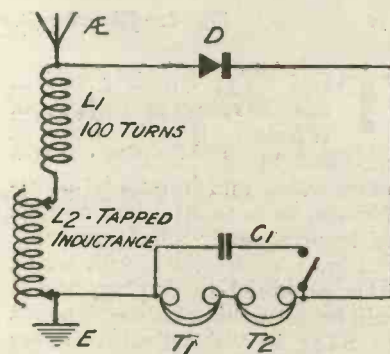

Fig. 34.—A circuit which may be tried, using the units already described.

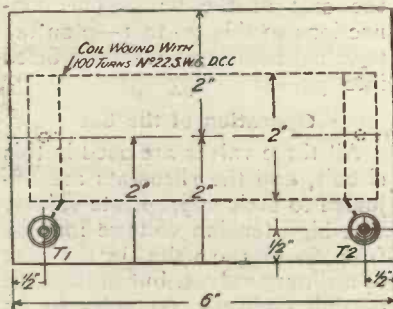
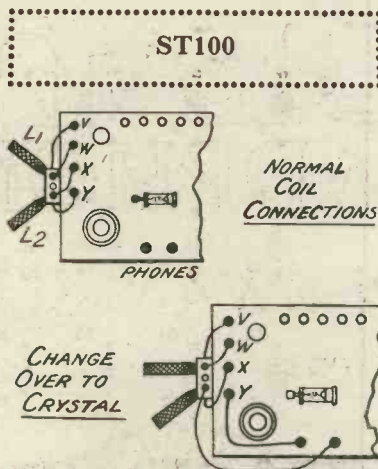

Fig. 32.—Panel dimensions.

SIR,—Your ST100 circuit is without doubt becoming increasingly popular, and deservedly so. I have read from time to time numerous letters of appreciation which have been published by you in your two periodicals. I wonder how many constructors of this set know that it can also be used as a plain crystal detector? This is a very useful thing to know in view of the fact that accumulators, etc., become exhausted at inconvenient times. The change over to crystal is simplicity itself. Disconnect the coil L2 from the terminals x y. Connect the wire which went to x to the right-hand 'phone terminal. Change the y (secondary coil) lead to x. Now



Illustrating Mr. Worthington's connections.

join the left-hand 'phone terminal to y, and the change over is complete.

Tuning is performed on the two polar condensers as before.

I have not tried the effect of leaving the secondary coil lead x in its normal position, and simply changing over lead y, therefore I cannot say whether any result would be obtained, but changing over the leads as explained has enabled me to "listen-in" on the crystal circuit alone. The change over is worth trying, if only for the sake of experiment.—

Yours faithfully,
JAS. WORTHINGTON.
Manchester.

A Three-Valve Circuit on the "Wireless Weekly" Omni Receiver

By JOHN SCOTT-TAGGART, F.Inst.P., A.M.I.E.E.

The third of a series of chats dealing with circuits and experiments which may be tried out on the Omni Receiver.

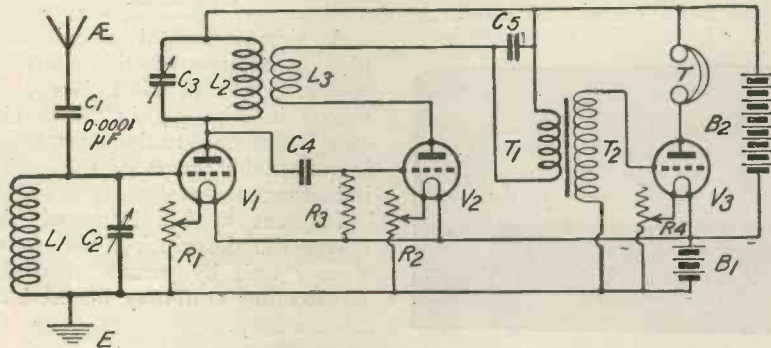

Fig. 1.—The circuit arrangement of ST 45.

THE ST₃₄ circuit given in the March 12 issue of *Wireless Weekly* may be modified by the addition of an extra valve and intervalve transformer, so as to introduce a stage of low-frequency amplification.

Fig. 1 shows the circuit which it is proposed to employ, and it will be seen that this corresponds to ST₄₅ in "Practical Wireless Valve Circuits." Constant aerial tuning has, however, been introduced, a condenser C₁ of 0.0001 μF being included in the aerial circuit, for reasons which have previously been given in these pages.

For broadcast reception, the coils L₁ and L₂ are No. 50, while L₃ is a No. 75. For the longer wave broadcast stations, a No. 75 may be used for L₁, L₂ and L₃. The condensers C₂ and C₃ are of 0.0005 μF capacity. The following is the wiring key for this circuit on the Omni receiver terminal board, which is reproduced in Fig. 2:—

- 51—3
- 11—50
- 10—11
- 11—12
- 2—49
- 49—52
- 52—48
- 4—26
- 26—25

- 17—18
- 18—24
- 26—27
- 19—5
- 5—14
- 13—40
- 6—1
- 9—22
- 21—24
- 21—45
- 22—46
- 30—16
- 29—48
- 8—23
- 31—24
- 32—40

The coils to use in this case are No. 50 for L₁, No. 50 for L₂, and No. 75 for L₃, as stated above. The coil in the aerial circuit, marked L₁ in Fig. 1, is a No. 50 plugged into the coil holder 49—50, which is at the left of the front of the panel of the receiver. The tuned-anode coil L₂ is a No. 50, which is plugged into the middle coil holder on the side of the box, i.e., the one which goes to the terminals 17—25. The reaction coil L₃, in Fig. 1, is the coil at the rear of the three coil holders on the side of the box. The connections to this go to 1—9 on the terminal board; no coils are fitted into 33—41 or 53—54.

Operation of the Set

All three valves are used in this circuit, and the rheostats are adjusted to their appropriate values. The high-tension voltage may be from 60 to 100 volts, in the case of ordinary valves, but in the case of dull emitters, 60 volts to 75 volts is ample. The coils L₂ and L₃ of Fig. 1, i.e., the coils connected to the terminals 1—9 and

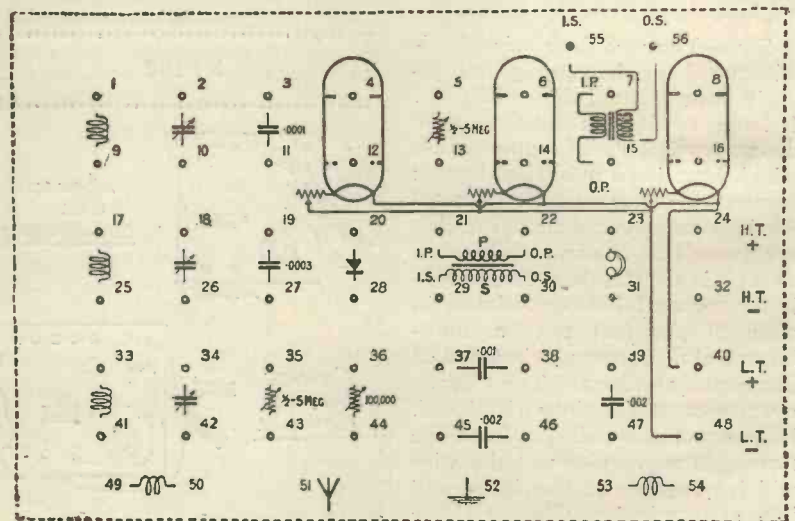

Fig. 2.—The terminal board.

17—25, should be kept well away first; the two variable condensers C₂ and C₃ of Fig. 1 are adjusted until the signals desired are received. The condenser C₂ is the variable condenser connected to 2—10 on the terminal board, and this is the right-hand condenser of the three shown in Fig. 6 on page 309 of *Wireless Weekly* (February 13, 1924, issue). The condenser which tunes the tuned-anode circuit, i.e., the condenser C₃ of Fig. 1, is the condenser 18—26 on the

terminal board of Fig. 2. This is the middle terminal of the three in the front of the panel.

Further details as to the operation of this circuit should be obtained from the issue of *Wireless Weekly* of March 12, 1924. The addition of the low-frequency transformer does not affect the methods of tuning.

Experiments with the Circuit

The experiments with this circuit may be the same as those described in the case of the pre-

ceding circuit. The experiment in the last paragraph of the chat appearing in the March 12 issue cannot be carried out in the case of the present circuit, but the equivalent may be tried by modifying the master key given above by disconnecting the leads 21 to 45 and 22 to 46, and joining 21 to 34 and 22 to 42. In other words, a variable condenser has been substituted for the fixed condenser C₅ of Fig. 1; this enables a specially fine adjustment of reaction to be obtained.

Useful Panel Material

ONE of the most expensive items when one is constantly engaged, as so many wireless enthusiasts are, in making up either small pieces of apparatus or complete sets is the ebonite used for panels. One always seems to be buying pieces of this material and the cost at the end of the year mounts up considerably. For small devices, such as variable gridleaks of the selector switch pattern, anode resistances of the same kind, banks of fixed condensers, and the like, the writer has found that the material used for making gramophone records answers very well indeed as an insulating substance upon which to mount the parts. Gramophone records are made of a compound into the make-up of which shellac enters very largely, and shellac is one of the best insulators. Though the writer has always found this material quite satisfactory, he was rather alarmed to hear from a friend that lamp-black, which is a conductor, was used in the composition of records. It was resolved therefore to test the resistance with a megger. Several holes, each 2 in. from its neighbour, were made in various parts of an old record, each being fitted with a terminal. Megger tests were then taken across the pairs of terminals. The only instrument available was a 500-volt megger reading up to 20 megohms. This gave an "infinity" reading between each set of terminals. Twenty megohms is admittedly an insufficient resist-

ance factor for high-frequency insulators, but it is probable that the insulation of gramophone record material is very much higher. The writer certainly has never traced any fault in his apparatus to the use of it as a substitute for ebonite. One point, however, is important; before the record is used, it should be thoroughly scrubbed in order to remove from it any tiny fragments of metal that may have been deposited by the wearing away of needles.

As it is comparatively brittle the material is not too easy to work in, but if one exercises a little care, it can be drilled and even tapped without mishap. It will be found that from a 12-in. record a square with 8½-in. sides can be cut. Cutting is best done by placing the record between two strips of wood held in the vice and using a hacksaw. As a further precaution it is as well to cover the material with a folded newspaper before placing it between the pieces of wood. Matters are made much easier if two or three thicknesses are cut at the same time. It is not recommended that old records should be used for anything like large panels. The writer cuts them up into slabs 4 in. square, of which a stock is kept so as to be at hand when small pieces of apparatus are to be made up. Two of these cemented together are generally used for panels.

In drilling one must be careful not to apply too much pressure, otherwise the material will split

rather easily. It is essential to place it upon a flat surface when drilling, and a folded newspaper should be used to act as a cushion.

One of the most useful points about this material is that it can be moulded readily into any shape by heating it in hot water. Thus an old record which is badly warped need not be discarded as useless for wireless purposes. It can be made perfectly flat by being warmed, and afterwards placed under pressure between two flat surfaces. The material is most useful for making ring-shaped formers to take the windings of dull-emitter rheostats or of rotary potentiometers. One simply cuts out a strip of the required width, puts on the necessary number of turns and then moulds the strip into shape, after warming it, round a lamp glass or some other round object of suitable diameter.

R. W. H.

BOOKS WHICH SOLVE YOUR PROBLEMS.

WHETHER you are erecting an Aerial, building a Set, or endeavouring to find out how one works, there is a wide choice of RADIO PRESS Books ready to help you.

Don't attempt to struggle along in the dark by yourself, but make use of the assistance freely offered you by the authors of these Books. Remember each is written by an expert in his own particular branch of Radio and every author is a man of note.

The Theory of the Rejector Circuit

By J. P. DAWSON.

An interesting and lucid explanation of a principle employed in tuned-anode circuits, wave-traps, etc.

AT the present time a good deal of attention is being directed to the subject of rejector circuits, and no doubt the reason for their acting as they do is by no means clear, even to many well versed in general wireless theory. That an oscillatory circuit, connected in a certain way, should offer a very high impedance to currents of the frequency to which it is tuned, and a much lower impedance to currents of other frequencies, appears something of a paradox. Yet the principle of the action is really very simple, and can be explained with the help of only the most elementary mathematics; indeed, it can be made sufficiently clear without the use of mathematics at all.

Principle explained

Suppose an alternating potential of any frequency to be applied across a simple coil of wire, as in Fig. 1, in which L represents the coil, and A and B its terminals, which are connected to an alternator or other source of A.C. of any frequency. Now, because the coil L has inductance, the current in it will lag behind the potential applied across A B: and the greater the inductance of L in proportion to its resistance, the greater will be the "angle of lag." If the inductance be small, and the resistance very great, the current and E.M.F. will be nearly in phase. If, however, the resistance be negligible as compared with the inductance, the lag will be very great; in the ideal case of zero resistance the angle of lag would be 90 deg. whatever the value of the inductance. Put mathematically, the tangent of the angle of lag = $\frac{2\pi nL}{R}$, n representing frequency, L inductance, and R resistance.

Case of the condenser

Now consider the case of a condenser (see Fig. 2). Here

the current *leads* the E.M.F. in phase, the mathematical expression being - the tangent of the angle of lead = $\frac{I}{2\pi nC}$, where C is the capacity of the condenser. This simply means that the *smaller* the capacity the greater the impedance, and that, with given capacity, the more we reduce the resistance, the greater becomes the angle of lead. If we could make the resistance zero, then the angle of lead would be 90 deg.

(impedance due to inductance), its value is $2\pi nL$. The impedance in the C branch is made up simply of capacitance, and has the value $\frac{I}{2\pi nC}$.

Suppose, now, we start with an E.M.F. of very low frequency, which is gradually increased. Obviously, since 'n' in the formulæ stands for frequency, the value of the reactance of the L branch steadily increases; that of the capacitance of the C branch diminishes. Thus a point will be reached where the two im-

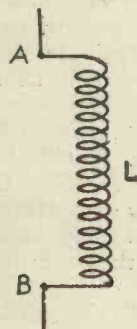

Fig. 1.

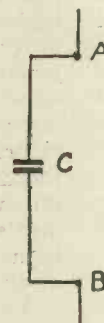

Fig. 2.

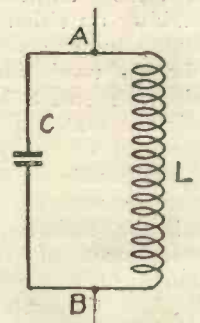

Fig. 3.

An analysis of a rejector circuit.

Now let us join our inductance and condenser in parallel, as shown in Fig. 3, and let us suppose that the resistance of both branches of the circuit is really zero. Next let us apply an alternating E.M.F. across the points A, B. Alternating currents will flow through both L and C. The current in L lags behind the applied E.M.F. by 90 deg.; that in C leads it by the same amount. Therefore, the currents in these two branches are 180 deg. out of phase, i.e., they are exactly opposite in phase.

How current divides

The proportion in which the current divides itself between the two branches depends on their respective impedances to the particular frequency applied. Since the impedance in the L branch consists entirely of reactance

pedances are equal; i.e., where $2\pi nL = \frac{I}{2\pi nC}$. The combined circuit, consisting of L and C, is now *in resonance*, with the frequency of the applied E.M.F.

Equal impedances

But notice that the impedances of the two branches now equal one another, and hence that the currents flowing in these two branches are equal in magnitude. As we have seen above, they are also exactly opposite in phase. Therefore, in the external circuit—the leads from A and B to the generator or other source of alternating E.M.F.—they cancel each other out, so to speak; or, to put it more precisely, the current in the external circuit at any instant is the algebraic sum of the currents in the two branches, and hence, in the case we are considering, it is at each instant

zero. So we see that while a strong current will flow in circuit L C, no current whatever flows in the external circuit, although an alternating E.M.F. exists across A B.

It should be noted that, supposing the resistance of the LC circuit to be zero, but the circuit not tuned to the impressed frequency, we should still have the currents in the two branch circuits opposite in phase; but they would differ in magnitude, since

the impedances would be unequal. Hence a current would flow in the generator leads. If, on the other hand, LC be correctly tuned to the applied frequency, but the resistance be not zero, the currents would be equal in magnitude, but would not differ in phase by 180 deg., because the angles of lag and lead respectively would not be 90 deg. By making the resistance as low as possible, we make these angles nearly 90 deg., but still,

since the currents in the L and C branches are not exactly opposed in phase, a small current will flow in the external circuit. Mr. Hinton's invention, described in the February number of *Modern Wireless*, takes advantage of the "negative resistance" properties of the valve to cancel out nearly all the positive resistance in the circuit, and hence produces a rejector circuit much nearer to the ideal than any previously constructed.

HIS MAJESTY'S WIRELESS RECEIVER



Our photograph shows the cabinet wireless receiver just installed at Buckingham Palace for the use of His Majesty the King. It is self-contained, with batteries, loud speaker, and aerial in one cabinet. Fuller particulars are given on our editorial page.

A Two-Valve

By HERBER

A description of a two-valve set
a straight or dual

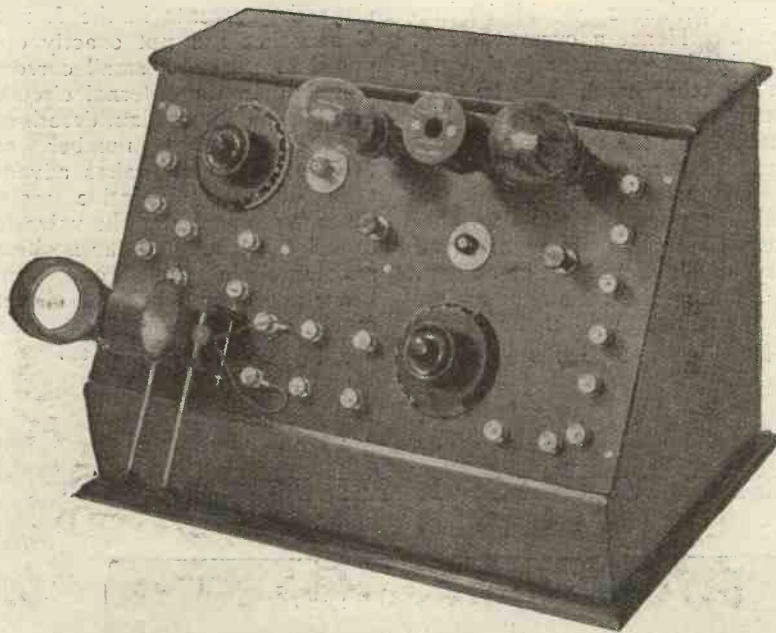

Fig. 1.—A photograph of the complete set, with valves, coils, and transformer in position.

THE increasing popularity of dual amplification circuits has prompted the description of the present set, and as the set may also be used as a "straight" high-frequency amplifier and detector, the advantages of dual amplification may be easily observed. A photograph of the finished set is given in Fig. 1, and it will be seen that the set is by no means complicated.

The variable condenser on the left hand side of the panel is in the aerial circuit, while the other tunes the primary of the high-frequency transformer. The rheostats and valve holders are clearly seen, and it should be noted that the centre valve holder is the socket for the high-frequency transformer. The left hand socket of the two-coil holder is for the aerial coil L₁, while the reaction coil L₂ may be easily reversed by means of the two terminals provided for this purpose.

The Circuit

The circuit diagram of the receiver is seen in Fig. 5, and a careful study of this will enable the circuit arrangements to be clearly followed.

By connecting the aerial to A and earth to E, joining B, C and E, and connecting T₁₁ to T₁₂, with the telephones across T₁ and T₂, we obtain a straight-forward circuit in which the first

valve acts as a high-frequency amplifier, and the second as a detector, with reaction applied by means of the reaction coil L₂. The constant aerial tuning system is also applied, thus simplifying the tuning; if it is not desired to use this form of tuning, the aerial connection is moved to A₁, leaving the rest as before. A series aerial condenser may be used by connecting the aerial to C, earth to E, and joining B to E.

When the dual circuit is used, these aerial circuit connections must be slightly modified, and a table of connections is given, which will make these clear.

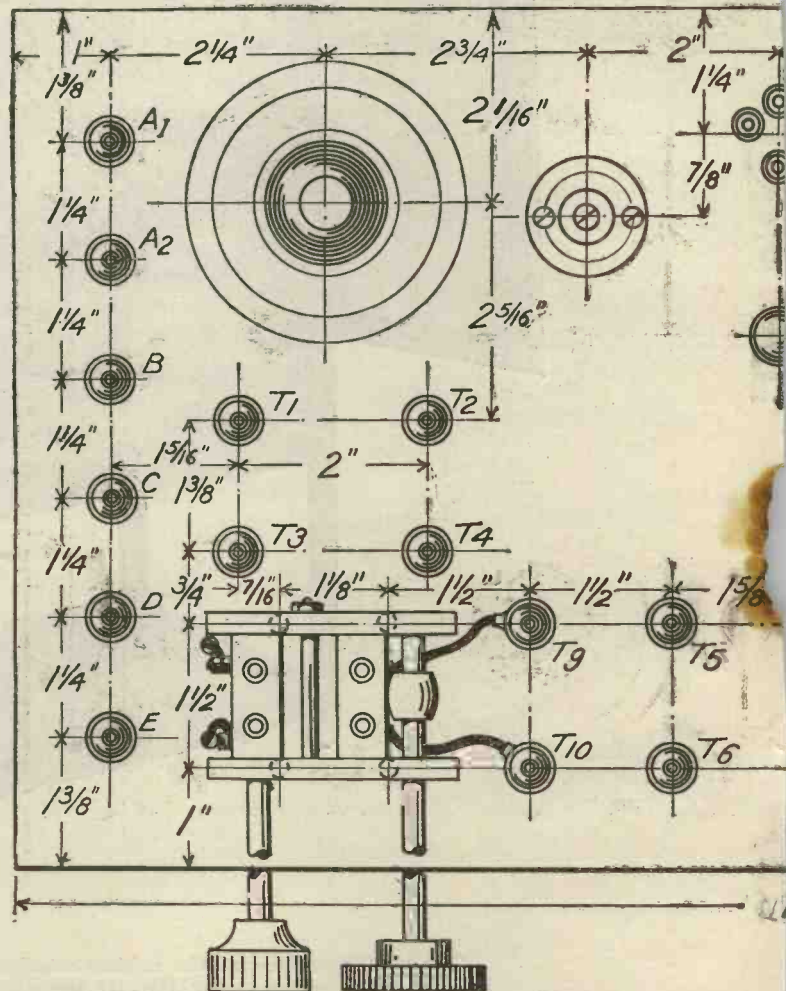

Fig. 3.—A half-size drawing, showing the layout of the parts on the

Dual Receiver

by W 3
T. K. SIMPSON.

set which may be used either with
amplification circuit

A frame aerial may be used with either circuit, and may be used either alone or in conjunction with the aerial tuning coil. Using a frame alone, connect the ends to A₁ and C₁, and for a straight circuit join C to E, while if a dual circuit is used C must be joined to D, and in each case the aerial inductance must be withdrawn from the coil holder.

If, however, the frame is to be used in conjunction with the aerial tuning inductance, the ends of the frame are joined to B and C, joining C and E for a straight circuit, and C and D for a dual.

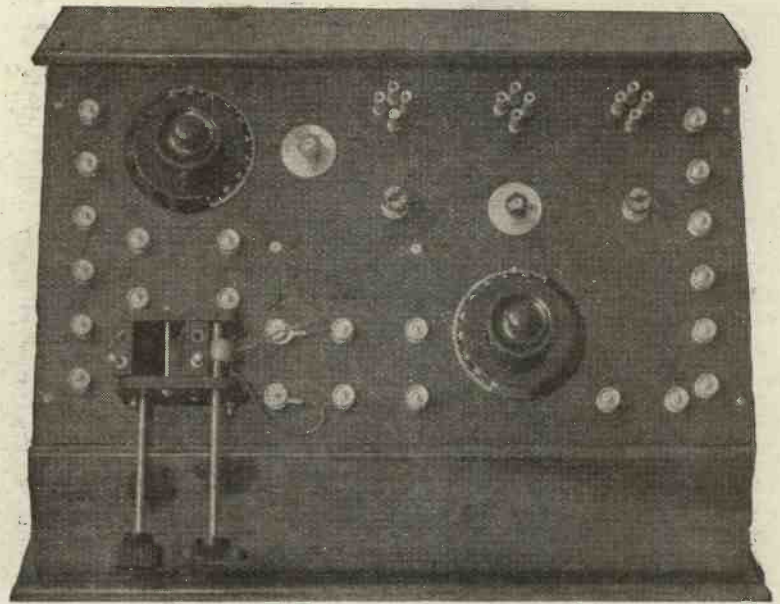
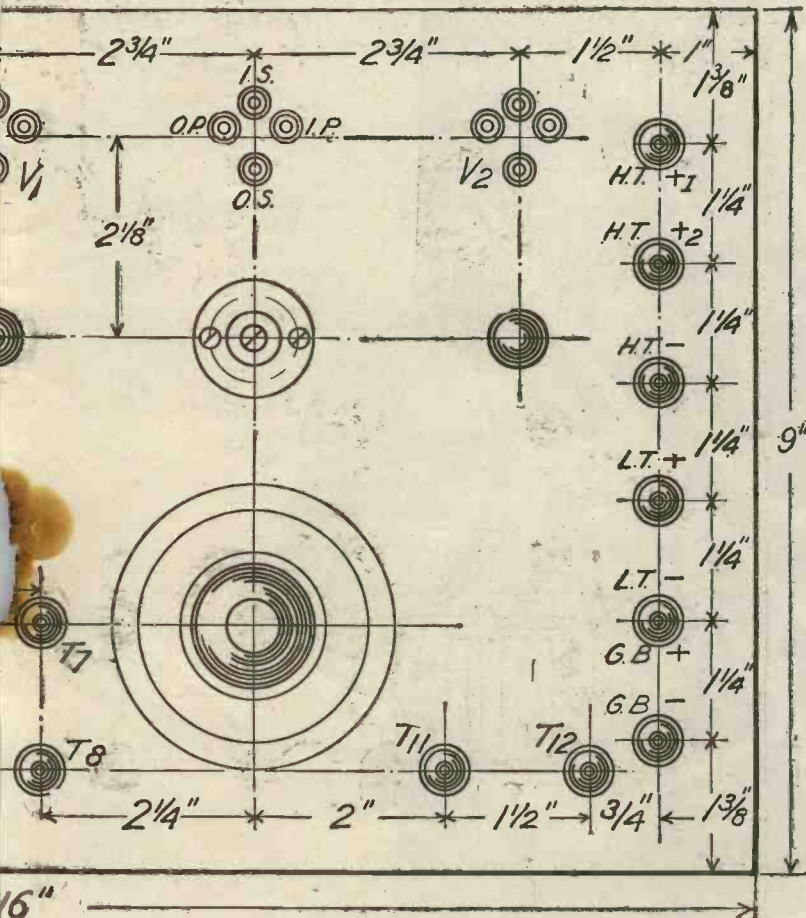

Fig. 2.—Another view of the finished receiver, showing the disposition of the parts upon the panel.



Circuit Arrangements

Circuit	Connect	'Phones	Aerial	Earth
H.F. and Det. Const. Aerial	B. C. E. T ₁₁ -T ₁₂	T ₁ -T ₃ see fig. 6.	A	E
HF Det. Series Cond.	B. E. T ₁₁ -T ₁₂	T ₁ -T ₃	C	E
HF and D. Par'll. tuning	B. C. E. T ₁₁ -T ₁₂	T ₁ -T ₃	A ₁	E
Dual. Const. aerial	B. C. D. T ₁ -T ₂ T ₃ -T ₄	T ₁₁ -T ₁₂ see fig. 7.	A	E
Dual Series Cond.	B. D. T ₁ -T ₃ T ₃ -T ₄	T ₁₁ -T ₁₂	C	E
Dual Par'll. Cond.	B. C. D. T ₁ -T ₂ T ₃ -T ₄	T ₁₁ -T ₁₂	A ₁	E

List of Parts

A list of the parts required, together with the retail cost, is given overleaf, and it will be seen that quite ordinary components are used, many of which the constructor may already possess.

It is not essential that the components should be of the make specified, but special note must be made of the connections to the high-frequency transformer. In

panel, with the necessary dimensions for drilling all the necessary holes;

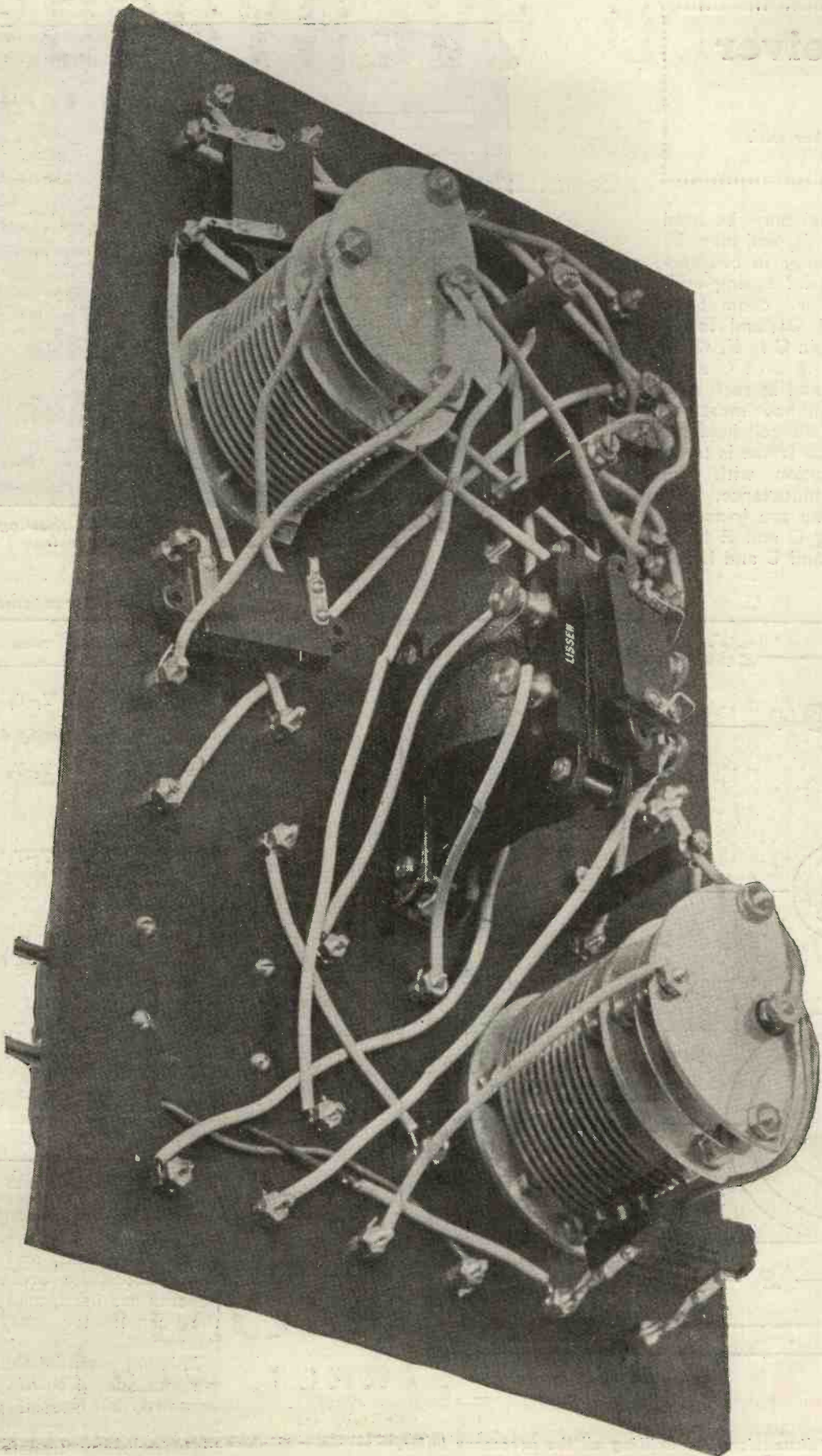

Fig. 4.—A photograph of the back of the panel showing the wiring.

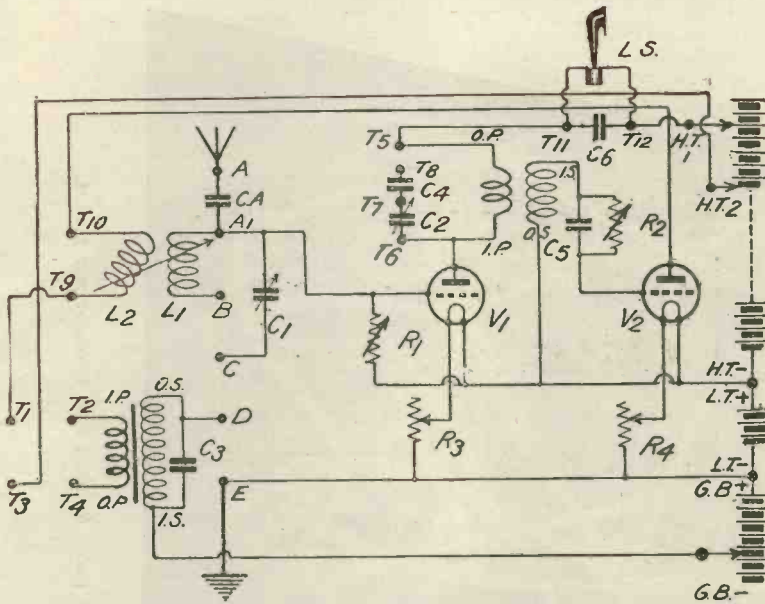

Fig. 5.—The circuit of the receiver, showing all the terminals used for changing the circuit.

Article.	£	s.	d.
12 Valve sockets, with two nuts, at 2d. ...	0	2	0
24 4 B.A. W.O. type Terminals ...	0	4	0
2 Filament Resistances (Lissenstat Minor) ...	0	7	0
Dubilier Condenser—one 0.0001 CA ...	0	2	6
Dubilier Condenser—one 0.0003 C5 ...	0	2	6
Dubilier Condenser—one 0.0004 C4 ...	0	2	6
Dubilier Condenser—one 0.001 C3 ...	0	3	0
Dubilier Condenser—one 0.004 C6 ...	0	3	0
Wire Covering, screws, etc.	0	1	0
	£6	10	6

A diagram showing the layout of the components on the panel is given in Fig. 3, and the positions of all the necessary holes are clearly dimensioned. The ebonite panel measures 16 ins. × 9 ins. × 1/4 in., and should have

some cases the primary winding is connected across the filament legs, while in others the secondary winding is in this position. In the present case the primary is across the filament, as indicated in the wiring diagram.

Article.	£	s.	d.
Cabinet (Wright and Palmer, Forest Gate)...	1	2	6
Panel, 16 in. × 9 in. × 1/4 in.	0	6	0
2 0.0005 variable Condensers, with Vernier (L. McMichael, Ltd.) ...	1	9	0
1 Two-coil holder (Goswell Eng. Co., Ltd.)...	0	7	6
1 H.F. plug-in Transformer 300—600m. (L. McMichael, Ltd.) ...	0	7	0
1 Lissen T ₂ L.F. Transformer ...	1	5	0
1 Watmel 50,000-100,000 ohm Resistance ...	0	3	6
1 Watmel 0.5—5 megohm Grid Leak ...	0	2	6

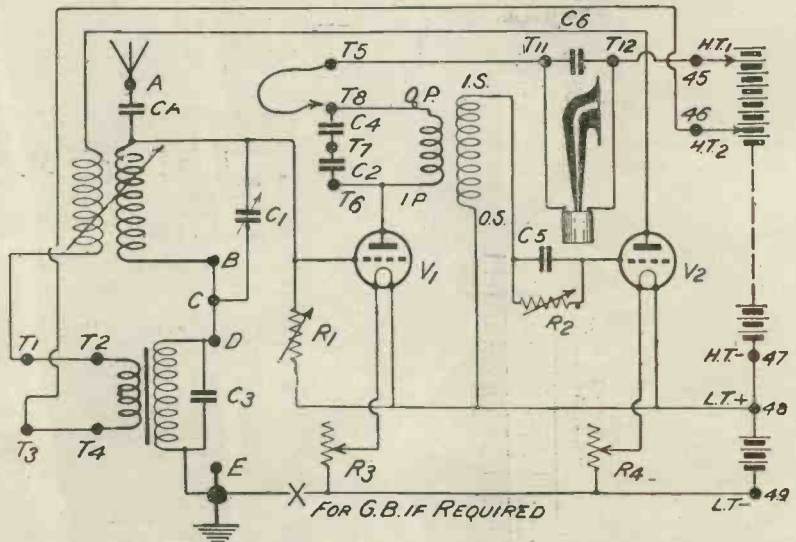

Fig. 7.—How to connect up the terminals for a dual amplification circuit, using constant aerial tuning.

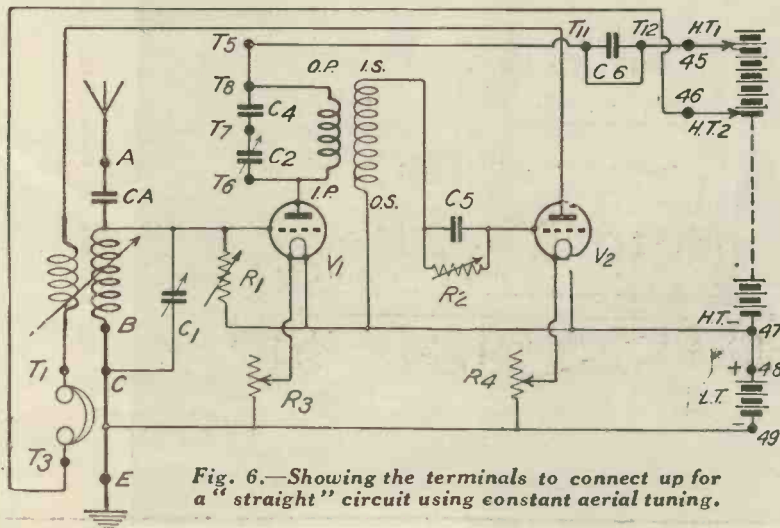

Fig. 6.—Showing the terminals to connect up for a "straight" circuit using constant aerial tuning.

the surface removed by rubbing with emery cloth until all evidence of the glossy finish has disappeared. This is done on both sides, and helps to improve the efficiency of the set, by reducing surface leakage. The holes should then be drilled, to the sizes given, and the component parts mounted in their respective positions.

Photographs of the back of the panel are given in Figs. 4 and 8, from which the disposition of the parts and wiring can be followed.

In next week's issue will be given constructional details together with half-size wiring diagram.

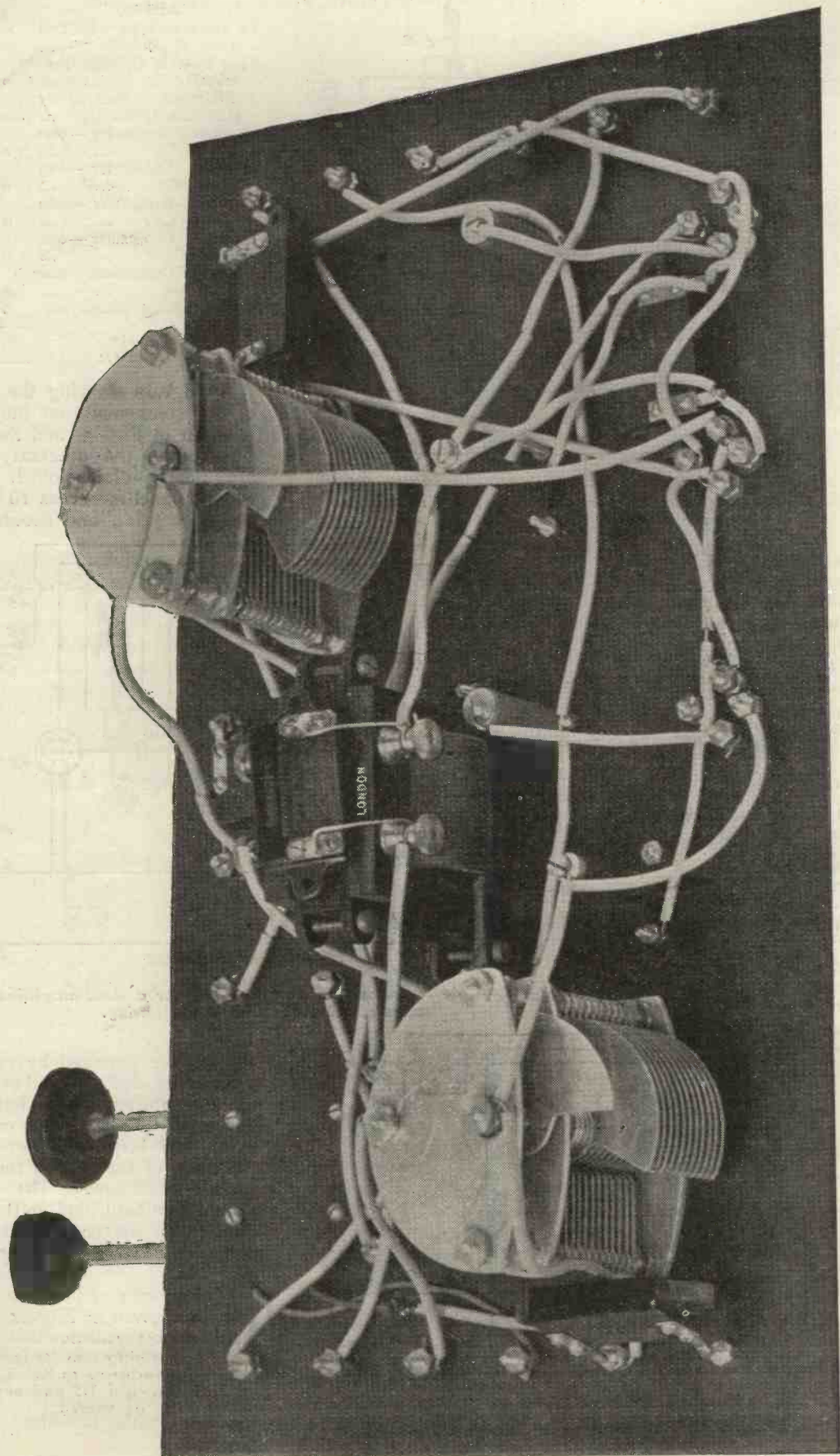

Fig. 8.—Another view of the back of the panel, showing more clearly the connections to the valve holders and transformer socket.

RHEOSTATS WITH VERNIER ATTACHMENT—concluded from page 520.

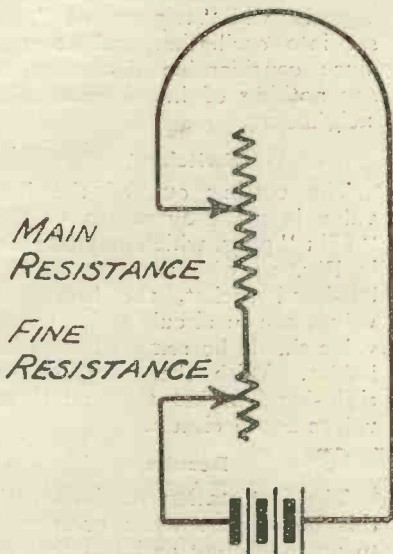

Fig. 2.—Illustrating the connections.

thick which is immersed in boiling water until it is soft, and is then bent round a lamp glass or some similar object with a diameter of 2 inches to a horseshoe shape. Ebonite varies a little in consistency. As a rule it becomes soft after a few moments' immersion in hot water; some kinds, however, may require even a little boiling before they become sufficiently plastic. Drill a 6B.A. clearance hole close to either end of the horseshoe and wind it with 65 turns of No. 26 bare Eureka wire, spacing the turns with string. The edges of the former should be rounded off with a file so that the turns may lie evenly and tightly together.

Mount the former as shown in Fig. 3 upon a piece of $\frac{1}{4}$ -inch ebonite of the dimensions and shape seen in the drawing. Drill a hole for the main spindle and

another for the auxiliary spindle. Contact with the main spiral is made by a flat arm. Round the edge of the curved portion of the ebonite and stretch a 3-inch length of the same resistance wire between two screws. If the wire is made quite tight there will be no fear of its slipping off. Contact in this case is made by an L-shaped arm made of springy sheet metal. The two spindles are arranged as before, and the operation of the rheostat is precisely the same. Fig. 4 shows how an attachment for making fine adjustment possible may be added to an ordinary rheostat. A piece of ebonite of the same shape and size as that shown in Fig. 3 is cut and the rheostat is attached to it by screws. The fine adjustment is made up in the same way as shown in that drawing, and the whole is then mounted upon the underside of the panel.

In each case the knob con-

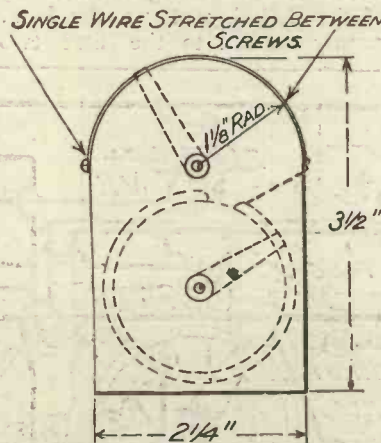

Fig. 3.—An alternative method of mounting the vernier attachment.

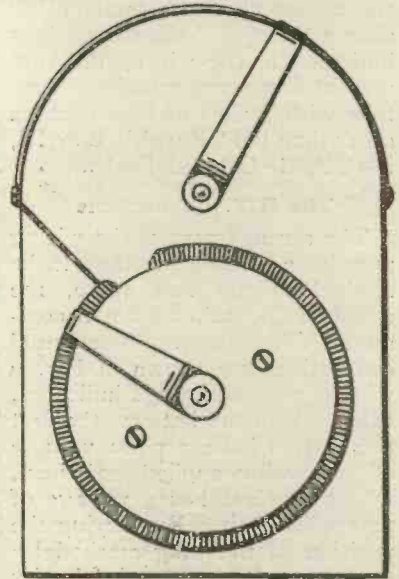

Fig. 4.—Showing how a vernier attachment may be added to a rheostat of the ordinary type.

trolling the fine resistance should be provided with a small pointer cut from sheet metal. It will not as a rule be necessary to use a scale, but it is desirable to have a rough idea of the position of the arm when one is using the rheostat. The best way of making connections is not to pinch the wire between the bush of the spindle and the ebonite as one frequently sees done, but to solder a lead directly to each bush. This can be done very easily if a small hole is made in the rim of the bush, a blob of solder being placed over it. The solder is then softened with a hot iron and the wire is pushed into the hole and held there until the solder has set.

Wireless News

According to the *Daily Chronicle*, listening-in has become a craze throughout the length and breadth of Germany, and "Radio" is the word of the moment. There has been a tremendous rush in Berlin to appropriate it for all sorts of things. Already there is the "Radio Cigarette," and a place of even-

ing entertainment has suddenly changed its name to the "Radio Cabaret." "The Radio Marriage" is one of the latest films. ("The Radio leitmotif is well preserved throughout," says the up-to-date critic.) A musical comedy, entitled "The Radio Maid," has been running successfully for several weeks, and at one of the

music-halls "The Radio Girls" are to be seen. The newspapers radiate "Radio," and a "Radio Exhibition" is to be held in Berlin at an early date. We publish on page 512 particulars of German broadcasting programmes.

We have been asked to call attention to the fact that the price of the Amplifier advertised by Mr. W. Matthews in Vol. 3, No. 15, should read 1/3 and not 6/3 as quoted.

In connection with the low-frequency transformers, should the reader choose a make other than a "Royal" the connections indicated in the wiring diagram may at first prove puzzling therefore with makes of transformers other than the "Royal," B+=IP, P=OP, G=OS and F=IS.

The H.T. Connections

The arrangement of the wiring permits a varying voltage to be applied to the last valve, the supply being taken from a common H.T. battery. The actual connections are shown in Fig. 4 where, with the plugs indicated, using a Siemens battery, the first two valves have a plate voltage of 54 volts applied to them, whilst the last has a voltage of 72 applied to it. By varying the position of the plug marked I+ signals may be made louder or softer, and varying degrees of reaction may also be obtained by the same means.

Operation

A receiver of this type is particularly easy to operate, the only adjustments being made

A CAPACITY REACTION THREE VALVE RECEIVER.

(Concluded from page 516.)

upon the variometer and reaction condenser. For general use about 54 volts H.T. on the first two valves will be found to give the best results, but should the set show any tendency to burst into oscillation, then this voltage must be reduced until a value is reached when the condenser may be used without difficulty.

For the reception of weak signals an extremely fine control of reaction may be obtained by reducing the H.T. supply to the first two valves until a point is reached when the set will not oscillate beyond a very mild degree, and for the work of searching this feature has much to commend it.

For the reception of local broadcasting, that is, reception within a radius of 15 miles of any of the B.B.C. stations, the H.T. supply applied to the first two

valves should be kept as low as possible, otherwise the incoming signals will "trigger off" the set into oscillation, and so produce considerable distortion, to say nothing of interference with neighbours.

Switching

The cutting out of the last valve is made by means of the "Clix" plug, which may be seen in Fig. 2; with the plug in the left-hand socket, the first two valves are in circuit and the last valve should be removed from its holder. With the plug in the right-hand socket then all three valves are in circuit.

Results

The first station received with this instrument when connected to an indifferent aerial at Sydenham, London, S.E., was Bournemouth, other stations subsequently heard, exclusive of London, being Newcastle, Cardiff, Glasgow, Birmingham and Aberdeen; these stations, with the exceptions of Glasgow and Aberdeen, being audible on a loud-speaker.

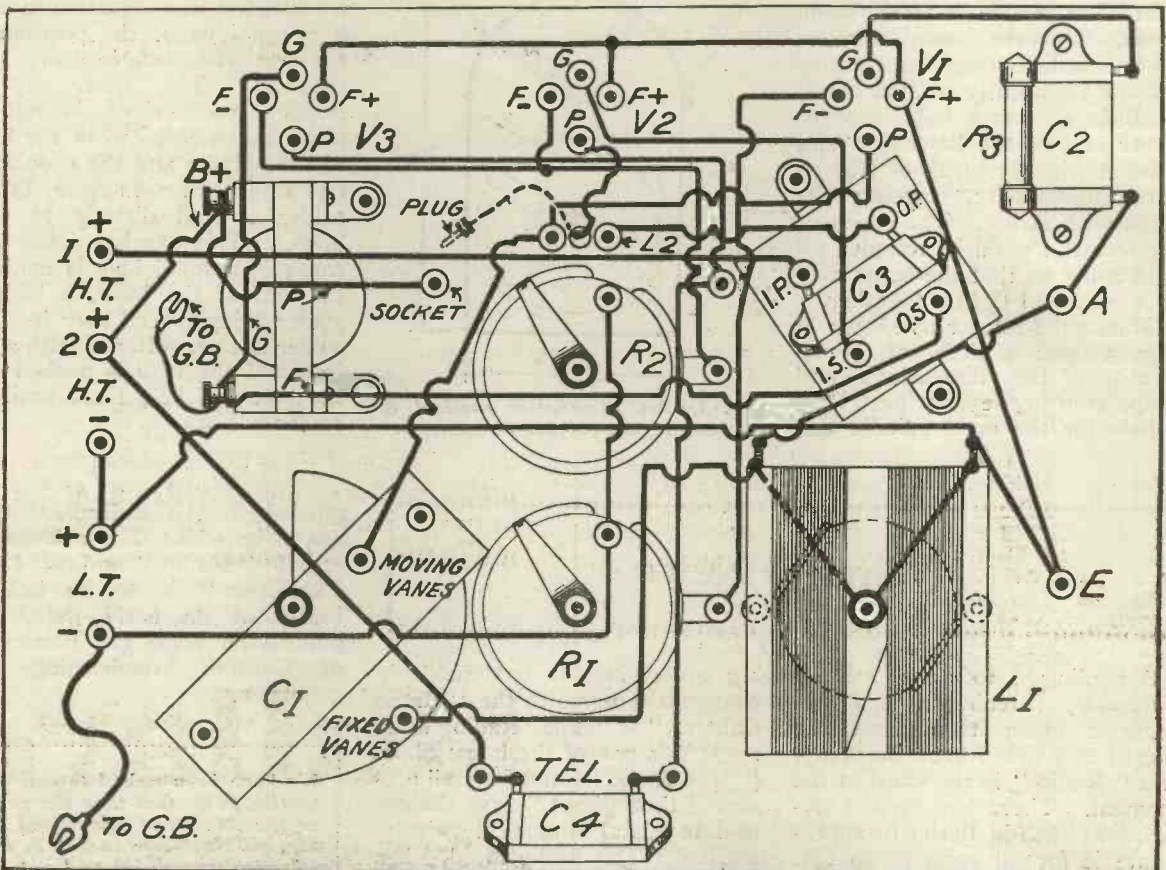

Fig. 7.—This illustration shows the actual connections to the various components and is a practical wiring diagram drawn exactly half size.



More about Condensers

IN last week's issue I explained how important the minimum capacity of a variable condenser is, and indicated that a $0.0005 \mu\text{F}$ variable condenser, connected in series with a $0.0004 \mu\text{F}$ fixed condenser, proved an excellent combination for tuning purposes, especially in tuned anode circuits.

This brings me to my second point, which is that the use of a small size variable condenser, or the use of the series fixed condenser in connection with a larger variable condenser, does not make a vernier condenser un-

are shorted, but if the inductance L is to have a larger value, then simply join B to C. For long wavelengths join A to B and C to D. In each of these three cases the vernier condenser C_3 will be found useful.

An Additional Advantage

An additional advantage of the use of a fixed condenser in series with a variable one is that hand capacity effects are less, because the presence of the hand

condenser in series with one of $0.00001 \mu\text{F}$, placing the hand near to the 1 mfd. condenser would obviously make no appreciable percentage change in its capacity, and consequently in the joint capacity of the two condensers in series. The opposite would be the case if the hand were placed near the small condenser.

A Useful Two-Coil Holder

I have been using a very useful two-coil holder, which is now on the market and possesses distinctive features not present in

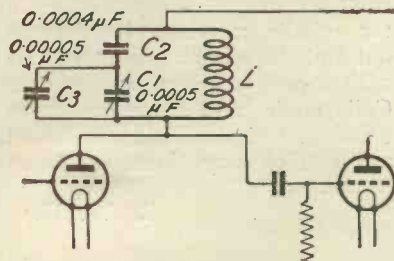

Fig. 1.—A useful vernier arrangement.

necessary. A vernier is extremely useful at all times if weak signals are to be received, and is practically a necessity. A three-plate vernier, consisting of two fixed plates and one moving, is desirable, and this usually has a maximum capacity of $0.00005 \mu\text{F}$.

Fig. 1 shows how the vernier C_3 may be used in combination with C_1 , a fixed condenser C_2 being provided when necessary, to give the effect of a small variable condenser across the inductance L .

Fig. 2 shows a four-terminal switching arrangement which has many advantages, and may be applied to grid or anode circuits. For ordinary use, A and B only

MODERN WIRELESS

Readers in the London Area who are prepared to sell back their March copies of Modern Wireless (Spring Double Number) are invited to send a postcard addressed to Radio Press, Ltd., Devereux Court, Strand, W.C.2, stating the price they want for their copies. These cards will not be acknowledged but the Publishers will buy back such copies as they require. These copies should of course be in perfect condition.

This step has become necessary in view of the unprecedented demand for the March issue. The demand has exceeded the supply by nearly 20,000 copies.

near, say, an ordinary condenser of $0.0002 \mu\text{F}$ maximum capacity, would greatly alter its value, but when we are using a much larger condenser with a fixed condenser in series with it, placing the hand near the variable condenser, while altering its capacity slightly, will not make much difference to the resultant capacity with which we are concerned, and which depends upon the fixed and variable condensers in series. To take an extreme case, supposing we had a 1 microfarad

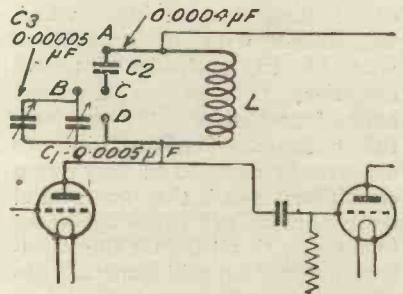

Fig. 2.—An arrangement of terminals which may be applied to both grid and anode circuits.

the ordinary coil holder, while the price is within reach of all. The movable coil has a rough adjustment by the rotation of a knob, and the vernier adjustment is carried out on the fixed coil, which, although so-called, is movable through an arc of 10 degrees. It is possible to move the fixed coil closer to, or further away from, the movable, and the adjustment is very smooth and neat. The principle on which the coil is moved is very simple, but ingenious, and consists of a cam. The whole coil holder is ideal for valve circuits where a delicate final adjustment of reaction is desirable.

Formers for Basket Coils

THE basket coil makes a special appeal to amateurs since it is about the easiest of the compact low-capacity coils to wind. Those who make them at home generally employ cardboard for the former, but this is not a very satisfactory material since unless the coil is small and the cardboard thick the finished product will be a rather flimsy affair. The writer has tried several kinds of material for the purpose, and has found that three of them answer very well indeed. These are ply-wood, celluloid and fibre. All of these are quite cheap and easy to work. Both ply-wood and fibre have the disadvantage of being hygroscopic. In the case of the former material this quality can be minimised by a preliminary dressing of shellac; fibre, however, seems to defy all attempts at rendering it non-hygroscopic. Though many chemists have assayed the task of finding something which will blend with it in such a way as to neutralise its bad qualities, nothing so far has been found that fully answers the purpose. Basket coils are not usually exposed to very damp conditions, and if they are wound upon fibre a light dressing of the formers with oil before the windings are put on will generally do all that is necessary. Celluloid has not this disadvantage, and ready-made celluloid formers can be bought quite cheaply from advertisers.

If coils are wound upon thin formers the turns will not cross each other at anything like right

angles in the spaces between the spokes. It is desirable that the angle should be as near 90 degrees as possible since this minimises the self-capacity of the coil. Obviously, the best method of ensuring that the crossing angle shall be large is to make the formers thick. This can be done quite easily by using two

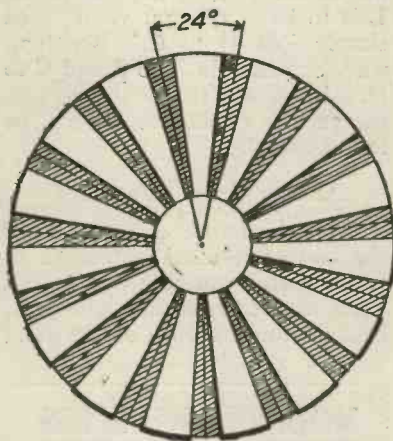

Fig. 1.—Details of the former upon which to wind basket coils.

layers of the material, whichever it may be.

Cut out two discs of fibre, ply-wood, or celluloid of the size required, clamp the two together and mark them out, as shown in Fig. 1. The portions seen

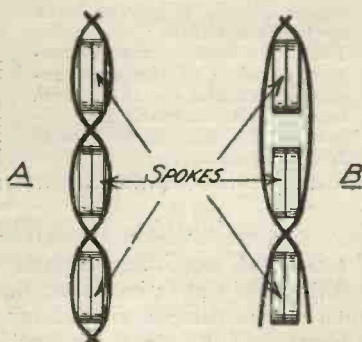

Fig. 2.—Illustrating two methods of winding the wire between the spokes.

shaded in the drawing are to be cut away altogether, leaving 15 spokes tapering from top to bottom. When this has been done the two discs may be secured in position by means of a couple of bolts passed through

the portion left solid in the middle of each. Winding may be done in the ordinary criss-cross way (Fig. 2, A), or if it is desired to get more turns on to a former of given size the form of winding shown in Fig. 2, B may be used. Here, instead of crossing between each pair of spokes, the wire is lead round two spokes and then taken across to the other side. This latter method of winding gives a very neat-looking coil with a very low self-capacity.

Should it be desired to make coils from which the former is removed after winding is completed, this can be done very simply without any necessity for making or purchasing a metal "spider." Place two discs of cardboard together, marking and cutting them out as previously described. Wind by either of the methods referred to above, and when all the turns are on take a needle threaded with silk and pass it under the turns on one of the spokes. Tie the ends of the silk together and do the same thing on both sides of each spoke. Now take a sharp knife and cut through the base of each spoke. The solid disc in the middle can now be pressed out and the spokes are pulled out with a pair of pliers one by one. Coils made in this way are very efficient, but they will not stand any sort of rough handling when in use.

R. W. H.

A Lord of the Ether

There is much perturbation amongst the operators of the high-power long wave station owing to the advent of LPZ, the new high-power transatlantic station at Buenos Aires. This powerful transmitter, which uses a high-frequency alternator, has a wavelength of about 17,000 metres and heterodynes the transmissions from Annapolis, Radio Central, and other busy stations, making operation exceedingly difficult. Longwave listeners can hear the new transmitter practically any evening about 11 p.m., working to POZ (Naven) and can judge for themselves the disturbance caused.

CITY ACCUMULATOR CO. 2nd ANNUAL DINNER.

On the evening of March 8, at Frascatt's Restaurant, London, Mr. G. E. Ward and Mrs. Ward entertained some forty members of their staff and guests to dinner, the occasion being the second Annual event of this kind. In welcoming the company, Mr. Ward alluded to the progress which had been made since the last dinner, branches having been opened in the West End of London and at Bournemouth; in addition, the Headquarters had been moved to larger premises in the City, the original Mark Lane address being now made a branch.



Apparatus we have tested

Conducted by A. D. COWPER, M.Sc., Staff Editor.

"Kenite" Panel Material

A new insulating material for radio panels, known as "Kenite," is being marketed by Messrs. H. D. Douglas & Co., and a sample panel has been handed to us for practical test.

"Kenite" is a dullish black material closely resembling ordinary black fibre in appearance, but with a surface very slightly marked in a manner that suggests a smooth canvas. It can be given a matt finish with fine emery-paper, though this is quite needless.

On workshop trial, in the ordinary operations and with the tools that make up an average amateur constructor's outfit, it was found to be markedly

superior to fibre in ease and cleanness of cutting; and less treacherous than ebonite. It cut readily with a hand-saw, while with a very sharp plane the edges could be trimmed square and smooth, and the file worked well on it. It was easier to drill than fibre of the ordinary type, as less jamming was experienced. A plug tap entered readily for No. 4 B.A. tapped holes, and gave a good thread; the material was soft enough, however, to insert small screws directly without previously tapping the hole, and without breaking the neck of the screw, while the mechanical strength seemed to be adequate.

A little care was needed in drilling holes if the panel was not

backed up by a piece of wood, on account of possible breaking away at the back edge of the hole. The general impression in working the material was that it resembled some fairly hard uniform wood without any grain, and appeared to be eminently suited to the amateur constructor's requirements and average skill. Of course, the same high finish possible with ebonite of good grade (hand-finishing and buffing) must not be looked for with this material.

In electrical tests, with the "Meg" tester applying 500 volts D.C., the insulation between grid and filament sockets in the ordinary valve-socket fitting mounted on a 1/4-in. panel of

GAMAGES of Holborn

Vast Experience (spread over many years) and a Genuine Desire to Help the Amateur have established us to-day as the Premier Wireless Supply House. You'll always find prices lower at Gamages, though the quality is of the usual high standard.

THIS WEEK'S MONEY-SAVING OFFERS

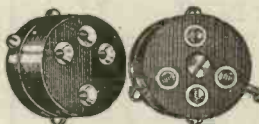

Legless VALVE HOLDER
The easiest valve holder to fit on the market. It presents no difficulties even to the mere novice, as it is its own template. Front 1/3 and Back views are shown in sketch. Post 3d.

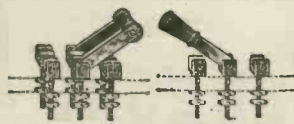

UNMOUNTED SWITCHES.
Switch parts nickel plated and consist of double switch arm with small black handle, together with necessary contact parts, complete with fixing nuts
Single Pole 1/6 Double Pole 2/-
Price 2/-



TERMINALS
Very handy for Aerial, Earth, Battery Wires, etc. Beautifully finished and obtainable in two shapes as sketch. Price per doz., either type 1/6 Post 2d.



The Super 'Phone DISTRIBUTOR BOARD
A beautifully made component with lacquered terminals. To take four pairs of 'phones. Size 5 ins. x 2 ins. x 1 1/2 ins. Price 3/6 Post 4d.

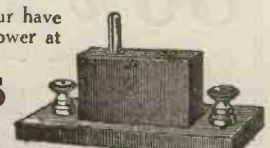

HANDY COIL HOLDER
A most useful accessory for the amateur and experimenter. Made in best ebonite. Terminals are lacquered and the socket is a perfect fit. Price 2/3 Post 3d.



VELVET High Class Variable Resistance
Similar to illustration but with many improvements. Perfect movement. Price 2/6 Post 4d.



Fuller's Block Wireless Accumulators.
Ex-Govt. Stock but absolutely unused. Exceptional Value. 2 volts 10/6 Postage 1/-
40 amps. 21/- Postage 1/-
4 volts 31/6 Postage 1/6
6 volts 1/6 Postage 1/6
40 amps. 5 Accumulators sent Carr. Free.

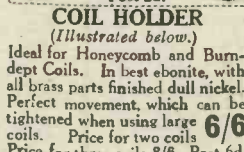

COIL HOLDER
(Illustrated below.)
Ideal for Honeycomb and Burn-dept Coils. In best ebonite, with all brass parts finished dull nickel. Perfect movement, which can be tightened when using large coils. Price for two coils 6/6 Price for three coils 8/6. Post 6d.



DUSTPROOF DETECTOR
A beautifully made piece of apparatus, very efficient in use. Transparent Cover protects the "Permanite" Crystal from dust. Price complete with "Permanite" Crystal 3/9 Post 4d.

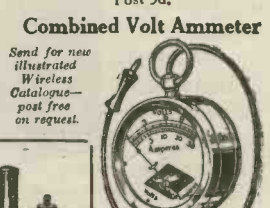

Combined Volt Ammeter
A most useful and essential component for the experimenter readings. 0-15 volts 0-30 amp. Price 7/6 Post 6d. Send your Order now.

A. W. GAMAGE, Ltd., Wireless Experts, HOLBORN, LONDON, E.C.1

Cheapside House: Benetfinks.

this substance, and also between two terminals at 1 in. apart, was too high to indicate—well over 100 megohms. Accordingly the insulation is unexceptionable for any ordinary reception conditions.

In the proximity of a hot soldering-iron, the material softened, and showed some slight tendency towards local crumbling. Ordinary care is thus called for in making soldered connections, as with most panel materials.

From these tests we can certainly recommend this material, whose price, we learn, is to compare favourably with that of ebonite, for general constructional and experimental work. It is obviously not to be classed with the ordinary type of fibre.

A Vernier Adjustment Fitting

Messrs. Sparks Radio have submitted for inspection samples of their fine-adjustment device for tuning condensers which have a bevel scale. This has a small rubber friction wheel, which engages with the edge of the scale, and is itself driven frictionally by a smaller friction-spindle, thus

giving a high gear-ratio for extremely fine adjustment.

The fitting is to be mounted on the panel by a single small screw, so that it evidently can be readily adapted to existing instruments. A two-inch long spindle with a small knob for actuating the device removes the hand far enough away when making fine adjustments to eliminate to a large extent troublesome capacity effects.

On trial, the mechanism worked as it should, with surprisingly little back-lash or slip, in spite of the double friction drive, and was capable of extremely close adjustment. It appeared to be strongly made.

Crystal and Cat's-Whisker

A sample of the "Neutron" crystal and special cat's-whisker, enclosed in a small box in which it is retailed, has been sent for comment by Messrs. Bennison & de Vries. This is of the sensitised galena type, coarsely crystalline in appearance. The cat's whisker was of white metal, and was found to be of the right degree of springiness and of convenient form.

On test, a large number of sensitive spots were readily

found on each side of the crystal, and also on a newly-broken surface. The signal-strength in actual reception, observed aurally in broadcast reception and measured quantitatively in comparison with reliable standards in rectification of the broadcast station's carrier wave, was of the order that one expects in a really good crystal. The combination should give every satisfaction if used in accordance with the careful instructions of the makers.

"Wireless Weekly"

Our attention has been drawn to an error in the copy which was sent us for the Mullard Radio Valve Co.'s advertisement appearing in our February 27th issue. The phrase "The First amateur 'just across' the Atlantic working both ways" should obviously read "The First amateur 'first across' the Atlantic working both ways."

80% of the Howling in L.F. Amplification

CAN BE OBVIATED BY USING:

DESIGNED FOR USE WITH "R" TYPE OR DULL EMITTER VALVES ALSO VALVE AMPLIFIERS USING CRYSTAL DETECTORS



PRICE 18/- EACH
MADE LIKE AN INSTRUMENT INSIDE AND OUT.

SHROUDED POWQUIP TRANSFORMERS.

They are remarkable for their robust construction, and incorporate sound technical principles, embodying features vastly in advance of accepted standards. The shroud is made from a special low resistance alloy which entirely eliminates stray fields, rendering side-by-side mounting possible without mutual interference. By installing these transformers and carefully spacing the grid and plate leads, the remaining 20% of howling and distortion will disappear, resulting in ideal and maximum amplification.

The POWER EQUIPMENT Co., Ltd., CROWN WORKS, CRICKLEWOOD, N.W.2.

If unable to obtain locally, please send us your retailer's address.

The Head 'Phone with tradition behind it:

Write for Leaflet 74CW. It gives details.

The "Tangent"

25/-



Established in 1872, Gent's have manufactured every kind of 'phone for every kind of purpose for the last 30 years.

This fact has, undoubtedly, a bearing on the great and ever-increasing popularity of the "TANGENT" HEAD 'PHONE.

Supreme Efficiency, combined with Comfort to the Wearer, are the outstanding features of this 'phone.

Suitable for Crystal or Valve Sets.

Ask your dealer—if in difficulty, write us to name nearest stockist
GENT & CO., LTD. FARADAY WORKS, LEICESTER.
London:—25, Victoria Street, S.W.1.
Newcastle-on-Tyne: "Tangent House," Blackett Street.

The name "Tangent" or this mark guarantees British make.

Correspondence

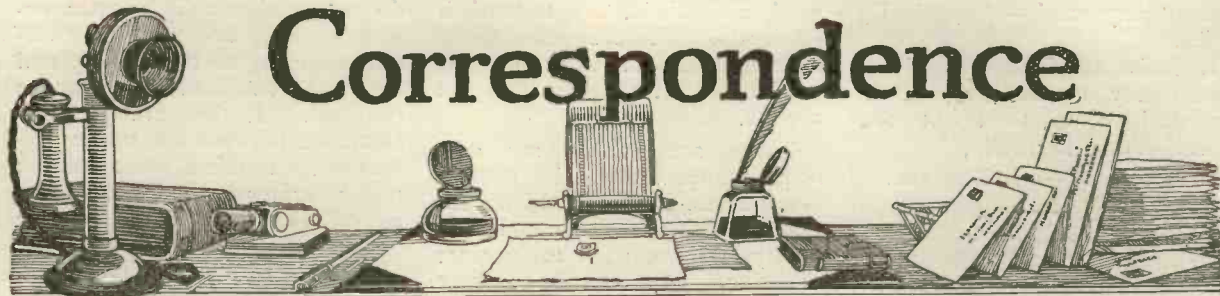

UNCONVENTIONAL AERIALS

FROM THE EARL RUSSELL.

SIR,—I am comparatively a new-comer to wireless, and therefore speak with bated breath in the presence of my superiors, but I think one or two experiences may be of interest. Of course, all that we are told about aerials is quite true, viz., that they should not be screened, that the earth should be short, and so on, but wireless in practice sometimes laughs at its exponents. Last week-end I was using a three-valve set (tuned-anode of quite normal design) on a rather peculiar aerial. The aerial itself consisted of old telephone wire,

a single strand of silicium bronze about No. 16, about 200 ft. long and about 15 ft. above the ground, alongside a beech hedge, screened by trees, passing near a stable and continued by insulated wire round the house into a bedroom window, where there was about 20 ft. of it mixed up with the earth, and then out of the window and down again to a lower room. The earth lead, besides running alongside the aerial in festoons in the bedroom and round the house wall, was also insulated, and was altogether some 50 or 60 ft. long. In fact, both the aerial and the earth had every conceivable fault, but Bournemouth, Cardiff and New-

castle were all received with 48 volts H.T. at strength about R6 to R7. London suffered from the heavy screening of the trees and the house on the London side, and was not more than about R3 to R4. Of course, the total capacity was heavy and tuning not specially selective. I was so much struck by the impropriety of this aerial's behaviour that I tried some other experiments and received Bournemouth on the earth alone with scarcely any diminution of strength. On the aerial alone without any earth reception was also possible, but not quite so loud. I then received on a 15 ft. length of wire flung on the floor of the room

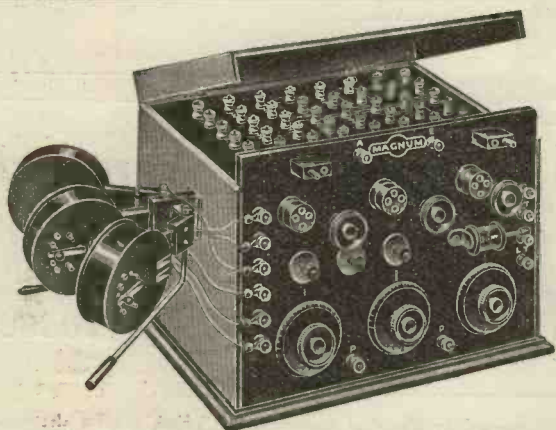

The Wonderful OMNI

as described by Mr. J. Scott-Taggart.

As illustrated, including coils, 18 Guineas.

RECEIVES EVERYTHING FROM EVERYWHERE.

TO CONSTRUCTORS.—All components supplied separately if desired. Send stamp for illustrated List and set of leaflets dealing with "Tested Sets," also the OMNI, S.T.100, 4-Valve Family Receiver and all circuits described in "Wireless Weekly," "Modern Wireless" and Radio Press Envelopes.

Connecting Links, per set of 50, 8/- Carr. paid on Retail Orders value £2 and over, ALWAYS SPECIFY "MAGNUM."

MAGNUM TAPPED COILS—REDUCED PRICES.

- No. 1. 180-1000 metres 12/6
- No. 2. 600-2600 metres 15/-

BURNE-JONES & Co. Ltd.

Manufacturing Radio Engineers,

MONTFORD PLACE, KENNINGTON, LONDON, S.E.11.

Phone: Hop 6257

Experimental Stations:—2 F.P. New Cross. 2 P.B. Kennington: 2 C.T. Lambeth. 6 C.W. Streatham.

FOUR-VALVE BROADCAST RECEIVER



M. H. B. R. 4 D. E.

No accumulators, no external wires. All self-contained, aerial and earth and loud speaker connections by means of neat plugs. Will receive all British and most Continental Broadcast. Write for particulars.

L.M. MICHAEL LTD

IN CONJUNCTION WITH B. HESKETH LTD
SHOWROOMS: Radio Corner, 179, Strand, London, W.C.2.

5, Yelverton Road, Bournemouth. All correspondence to Head Office.
HASTINGS HOUSE, NORFOLK STREET, STRAND, LONDON, W.C.2

without any earth—strength R3 to R4.

It looks as if on a good set almost any connection will do for stations up to about 200 miles.—Yours faithfully,

Chichester. RUSSELL.

ST76

SIR,—The writer would like to thank you for the circuit ST76 + one L.F. (October 10, Information Department), and regrets to find that this valuable circuit is omitted from "More Practical Valve Circuits." This circuit gives such powerful loud-speaker results that under normal conditions all stations, except 2BD and 5IT, have to be detuned.—Yours faithfully,

Lurgan. V. W. ALLEN.

VALVES

SIR,—I wonder if manufacturers realise the great demand that exists for bright-emitter valves, two of which would be well within the capacity of a good 4-volt accumulator. We are constantly told that the valve whose filament voltage is given as 4

needs a 6-volt battery to work it efficiently. There appears to be nothing between this and the semi-dull-emitter type working at 2 volts.

There are within my own acquaintance many who possess 4-volt accumulators, and who, for reasons both of expense and portability, do not wish to increase the size. My own 60 ampere hour battery is heavy enough as it stands, and another cell would increase the weight to about 20 lbs. Smaller batteries are constantly in the charger's hands, and many will appreciate the double meaning of the word.—Yours faithfully,

Birmingham. F. S.

OMNI RECEIVER

SIR,—I have been using an "Omni Circuit" receiver for over a month, and congratulate you on having designed an instrument which supplies a long-felt want. One or two small points may be of interest to you.

I can strongly recommend the use of "Clix" terminals and sockets to those constructors who

do not grudge a little extra expense. They are worth the difference owing to the rapidity and ease with which circuits may be changed. If they are used the clearance between the upper surface of the terminal board and the under surface of the lid should be a full 1½ in. to allow of one "Clix" being placed vertically on the top of another and the lid closed.—Yours faithfully,

London. "READER."

CO-OPERATION WANTED

SIR,—Being interested in short-wave transmission on 5 to 25 metres, and finding a difficulty in getting into touch with other transmitters holding a licence for these wavelengths, I should be greatly obliged if you will publish an appeal for names and addresses of other fellow-workers on these extremely short wavelengths, with a view to co-operating in experiments.—Wishing your publications all success, I beg to remain, Yours faithfully,

GEO. WILMOT JONES (2-WB).
8, Rosebery Street,
Wolverhampton.

PUT this little Gadget on your Panel and get the distant stations.

Tunetune
MICRO-ADJUSTER

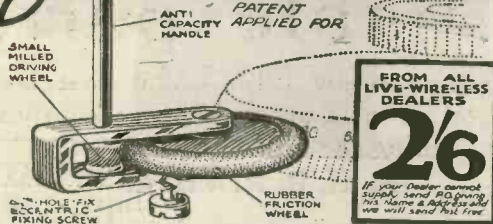

A simple and effective device for condensers, variometers, etc., where critical adjustment is required. Hand capacity eliminated. Will enable you to find—and hold—the distant stations. Gives the finest possible control; can be fitted to any existing condenser.

FROM ALL LIVE-WIRELESS DEALERS
2/6
If your Dealer cannot supply, send this coupon to us and we will send you free.

TRADE ENQUIRIES INVITED. SOLE DISTRIBUTORS:
SPARKS RADIO SUPPLIES (Dept. W.)
43, GREAT PORTLAND STREET, LONDON, W.1.
Telephone: LANGHAM 2463.

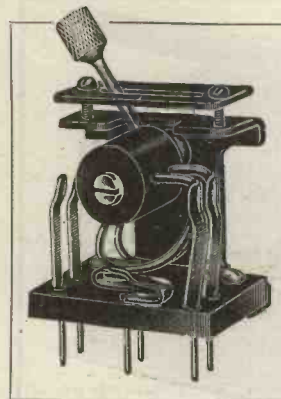

This switch eliminates capacity losses

Specially designed by Electrical Engineers, this switch reduces electrostatic capacity, one of the greatest sources of signal strength loss, to the absolute minimum. The contacts have a rubbing action and are therefore self-cleaning. Made in four standard sizes to change over 2, 3, 4 and 6 contacts, every switch is sold under the "Utility" guarantee—replacement or repair if faulty.

The Lever Pattern "Utility" Change-over Switch.

PRICES:

No. W. 147/2.	(2-pole change-over)	...	5/- each
No. W. 147/3.	(3-pole ")	...	6/- "
No. W. 147/4.	(4-pole ")	...	7/6 "
No. W. 147/5.	(6-pole ")	...	10/- "

Ask your Dealer to show you these and other "Utility" products.

WILKINS and WRIGHT Ltd.
"Utility" Works, Kenyon Street, Birmingham.

Information Department



J. P. (CLAPHAM) states that he is shortly moving to an address in Cornwall, and asks whether we consider that his ST100 receiver will still serve to give him loud-speaker reproduction of one or more of the broadcasting stations.

Since Cornwall is a notoriously bad spot for reception, we think that our correspondent will probably need to use a decidedly more sensitive set than the ST100. Many of our readers have reported that they can obtain only the poorest of results with anything less than a set employing two high-frequency valves, and therefore probably the best set to recommend is the "Transatlantic," described in the November and December numbers of *Modern Wireless*. However, the conditions in Cornwall seem to be exceedingly patchy, and in one or two places quite remarkably good results have been obtained with simple sets, and therefore we would suggest

that the ST100 receiver should be taken down there and tested upon the best aerial which it is possible to erect.

R. S. (DURHAM) asks: Is it better to use high or low-resistance telephones?

This is one of the debatable points in wireless, and different experimenters give different answers to the question. The fact appears to be that high-resistance phones are slightly more sensitive than low-resistance ones, the latter, of course, being used in conjunction with a step-down (telephone) transformer, but they are also considerably less robust. They are wound with a very large number of turns of fine wire, and this wire is very prone to burn out, or have its fragile insulation destroyed by any undue strain, such as an excessive voltage from an H.T. battery or even by the steady anode current of a valve. They may also be damaged by the anode current weakening their permanent magnets, if it happens

BEWARE OF WORTHLESS IMITATIONS, SEE THE TRADE MARK **WatMel** ON EVERY GRID LEAK.

WATMEL VARIABLE GRID LEAK

(Patent No. 206098).

Constantly Variable
Silent in operation.
Constant in any
temperature.
Dust and Damp
proof.
Each tested and
guaranteed.
Neat and well
made.



GRID LEAK
.5 to 5 megohms
2/6

ANODE
RESISTANCE
50,000 to 100,000
ohms 3/6.
Suitable for S.T.
100 Circuit.

SEND P.C. FOR DESCRIPTIVE FOLDER.

WATMEL WIRELESS CO., Comaught House, 1a, Edgware Road
Marble Arch, W.2, Tel. 4575 Paddington

ECONOMIC ELECTRIC LD.



The "EEC" "XTRAUDION" VALVE is being used by the leading Radio Experimenters for detection, high and low frequency amplification, power amplifiers and low power transmission. Price 12/6

USE "RECTARITE," the synthetic crystal that makes Loud speakers talk. 1/6 Large Specimen.



Write to-day for 40 page Radio Catalogue mailed post free, 4d.

Head Office: 10, FITZROY SQUARE, LONDON, W.1.

Showrooms: 303, EUSTON RD., N.W.1.

Branch and Works: TWICKENHAM.

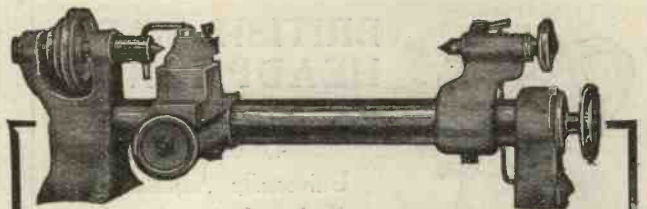

Ideal for making reliable parts

A handy, strong little Lathe that takes material up to 12 ins. by 4 ins., for turning, facing, boring and drilling.

The

WADE LATHE

Slide rest travels whole length of bed and is fitted with cross feed. All parts standardised.

Price as illustrated

£2-10-0

Send for List W.12.

C.A.V. SMALL TOOLS Ltd.,
181 Queen Victoria Street,
LONDON, E.C.4

to be flowing in such a direction as to tend to neutralise instead of strengthen them.

Low-resistance 'phones, of course, do not have to carry the steady anode current, since they are separated from the anode circuit by the telephone transformer, and are protected from high pressures from the anode battery in the same way. Also, they remove the risks of shock to the user, which are present with the high-resistance type used directly in the anode circuit.

It would seem advisable, then, to use low-resistance 'phones and the transformer with valve sets, and in crystal sets where the utmost sensitivity is requisite to employ high-resistance ones.

P. R. W. (HORNSEY) states that he has heard various transmitters referring to the packing of their microphones, and asks the meaning of this expression. He states that he is using one of the Post Office microphones himself and has never experienced any trouble of this sort.

With a microphone which contains a number of loosely-packed carbon granules or dust there is a tendency for the granules to settle into a compact mass. This tendency to "pack," as it is called, causes trouble at times, since it makes the microphone insensitive to certain frequencies. A sharp tap will frequently make the instrument sensitive again. Many experimenters consider that "packing" is particularly liable to occur in

microphones containing granules of mixed sizes, since the smaller ones may work their way into the spaces between the large ones and form a compact mass. Moisture may also contribute to the process.

J. R. C. (WANDSWORTH) asks whether greater efficiency is obtained with a slider coil or a tapped one.

Provided that the tapping is carried out on the multiple and sub-multiple system, thus enabling tuning to be effected to the nearest single turn, there is very little to choose between the two types of coil. The tuning switch, moving over a semi-circle of studs, probably gives more certain and reliable contact, whilst, at the same time, avoiding the usual clicking noises associated with the movement of a slider along a tuning coil.

W. R. (CAMBERWELL) asks what is the object of using a counterpoise earth with a transmitter.

A counterpoise earth simply consists of a dummy aerial erected a few feet off the ground beneath the true aerial, and is used as a balancing capacity connected to the earth terminal of the transmitting set. It is usually found that the high-frequency resistance of a system of this nature is much lower than that obtained with a direct conducted earth, and therefore it is considered that much higher efficiency is obtained.



BRITISH-MADE HEADPHONES.

Complete with Cords, 4,000 ohms.

Universally Adjustable.

Each pair tested and packed in box.

16/6 PER PAIR

Manufactured by:
Auckland's Wireless, Ltd.,
395, St. John Street, London, E.C.1.

CAM-OPERATED VERNIER COIL HOLDER.



The usual fixed socket has a very slow movement giving a micrometric adjustment in both directions through 10°. This is effected by a cam operated by a separate knob.

Price, 2 way (only) 7/6, on base 1/- extra. Post 3d.

With Reaction Reverse and Short-Circuiting Switch, 12/6.

GOSWELL ENGINEERING CO., LTD.,
12a, PENTONVILLE ROAD, LONDON, N.1.

Liberal Trade Terms.

Phone: North 3051.

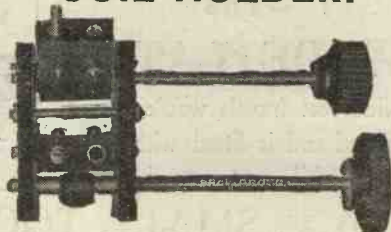

"The Heart of your Set is the Crystal."

For PERFECT RECEPTION use

HARMOTONE

TRADE MARK
the new detector and amplifying crystal.

GUARANTEED STABLE: being selected for reflex circuits.

Post Free 1/1½ and 2/- (complete with whisker).

THE FLEET RADIO STORES 143-144, Fleet St., London, E.C.4

Trade Enquiries:
THE SCLERINE CRYSTAL COMPANY, 4, Byron Road, London, E.17

IRISH

Experimenters and Constructors can obtain all types of complete sets, and component parts by best makers at lowest English Prices.

Send for List of Apparatus and Parts to

THE IRISH RADIO STOCKISTS

3, CROW STREET,

(Opposite Hely's, Dame Street), DUBLIN.

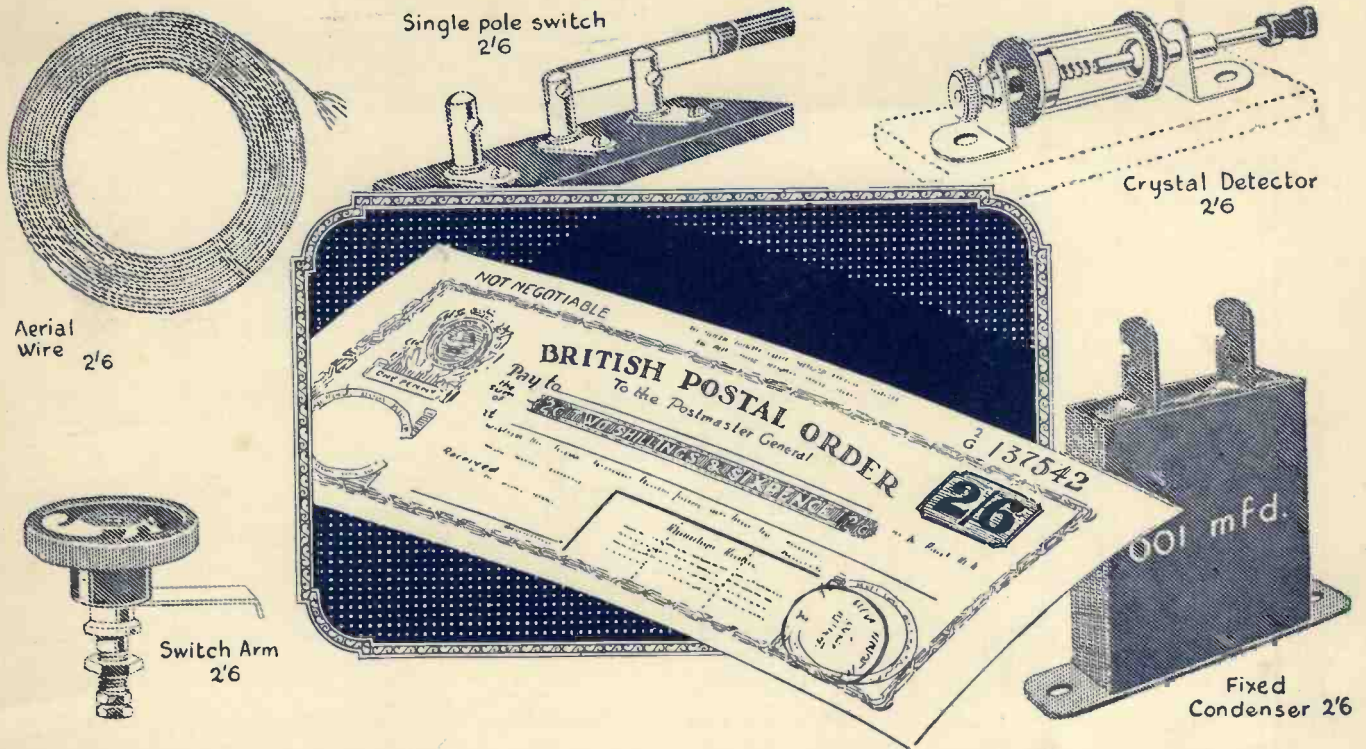

What will half-a-crown buy?

—one small Component or a comprehensive Book on the Valve.

WHICH is preferable—one small wireless component or a complete and comprehensive Book on the Valve? Such a Book as *Radio Valves and How to Use Them* by John Scott-Taggart, F.Inst.P., must be of infinitely greater assistance to the experimenter because it readily points the way to a better understanding of the practical working of Radio.

While two enthusiasts start out, perhaps, to build exactly the same Receiver, one will get consistently good results and the other will meet with nothing but difficulties. Why? Because he has not grasped the underlying principles of Radio. Don't imagine that the theory of the Valve is difficult to understand or that you must assimilate a "dry-as-dust" text book before you can get an understanding as to how it works. This new Book is probably the most interesting and illuminating Book on the Valve yet

written and everyone with a Valve Set, without exception, ought to get a copy. If your Set is difficult to control—if it oscillates too readily—if long distance stations are difficult to pick up—perhaps the Set is quite in order and the fault may lie with you. Buy a copy of this Book to-day and make up your mind that you will gain a working knowledge of the valve—your progress in Radio will date from the day you commence reading *Radio Valves and How to Use Them*, post free 2/8.



RADIO PRESS, LTD.,
Devereux Court, Strand, W.C.2.

Radio Valves and how to use them.

By *John Scott-Taggart, F.Inst.P.* A.M.I.E.E.





Five valve set in case, with cover not interfering with valves or leads. Wavelength range 300-4,000 metres. PRICE £31:5:0
B.B.C. Tax £1:10:0



Four valve set in case, with cover not interfering with valves or leads. Wave-length range 300-4,000 metres. PRICE £26:0:0
B.B.C. Tax £1:5:0

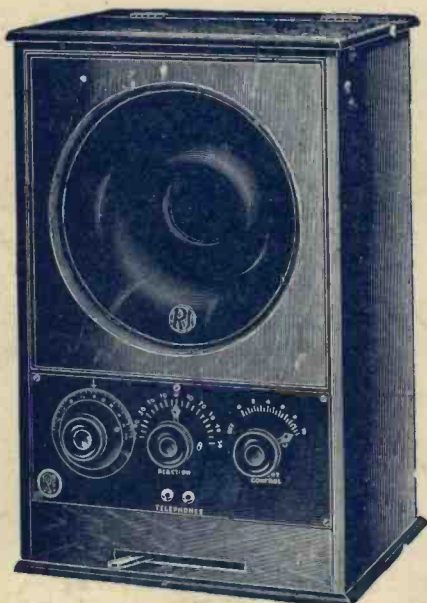

The Lyriannette Receiver for B.B.C. Wave-lengths. Complete portable Wireless Receiver, Standard Loud Speaker, D.E. Valves, Batteries. 2 Valve. PRICE Complete 19 Gns. B.B.C. Tax 15/-
3 Valve. PRICE Complete £25:18:0
B.B.C. Tax £1



Crystal Receiver
B.B.C. Wave-lengths. Price 2 Gns.
B.B.C. Tax 1/-
Phones extra.

BRITISH and BEST

Tell the whole story, right from the time when the first R.I. set was made, on a foundation of 25 years' concentrated wireless experience.

The best British labour and the best British materials. Continuous research and testing of a most searching character. The appreciation of the British Public.

R.I. sets include in their construction more improvements than any other sets on the market. The design of each type has been graded to a particular need. The reproduction of speech and music has attained a degree of perfection never before equalled.

All our high power sets have a wave-length range 300-4,000 metres without extra accessories, and are suitable for the proposed alterations by the B.B.C.

Write now for our 50-Page Catalogue sent free on application.

RADIO INSTRUMENTS, Ltd.

Managing Director: J. JOSEPH, M.I.E.E.

Chief Designer: W. A. APPLETON, M.B.E., M.I.R.E., late Admiralty Technical Research Officer

Works, Offices and Showrooms:

12, Hyde Street, New Oxford Street, W.C.1

Telephone: Regent 6214-6215-6216.

Telegrams: "Instradio, London."

NORTHERN DEPOTS: 19 Hopwood Avenue, MANCHESTER, and Trinity House, Commercial Street, LEEDS