

The WIRELESS CONSTRUCTOR

— Edited by Percy W. Harris —

Vol. II. No. 6 **CONTENTS** APRIL

Three Valves—One Dial .. 543	By STANLEY G. RATTEE, M.I.R.E.	Spring-cleaning Your Set! .. 574	Distance or Volume? .. 580
Talks to Beginners .. 548	By PERCY W. HARRIS, M.I.R.E.	By A. V. D. HORT, B.A.	Keeping Reaction in Check .. 589
Your Aerial System .. 552	By H. I. BARTON-CHAPPLE, Wh.Sch., B.Sc., A.C.G.I., D.I.C., A.M.I.E.E.	By Major J. ROBINSON, D.Sc., Ph.D., F.Inst.P.	A Vernier Coil-Holder .. 598
An H.F. Amplifier for the "Midget" Set .. 558	By A. S. CLARK.	More Practical Workshop Hints .. 600	Four Circuits in a Crystal Set .. 608
Our New Free Blueprint Scheme .. 582	Erecting Bamboo Masts .. 583	Oscillation in H.F. Amplifiers .. 613	By J. H. REYNER, B.Sc., A.C.G.I., D.I.C., A.M.I.E.E.
How Radio Records Bridged the Atlantic .. 588	By S. McCLATCHIE.	Apparatus Tested .. 621	



The Famous Gambrell Coils

AT REDUCED PRICES

AT THESE PRICES Maximum Efficiency is within reach of everybody.

DO YOU KNOW that Gambrell Coils can be used for many purposes such as H.F. Transformers, Neutrodyne Units, etc., etc., with much better results, thus doing away with the necessity of purchasing special gadgets which may have to be discarded when altering your circuit.

GAMBRELL COILS							
Size	Nearest size in ordinary coils	Old Price	NEW PRICE	Size	Nearest size in ordinary coils	Old Price	NEW PRICE
a/2	18	5/9	4/10	E1	150	8/9	6/9
a	25	5/9	4/10	E	200	9/6	7/9
A	30	5/9	5/-	F	300	10/3	8/6
B1	40	6/-	5/3	G	500	12/-	10/-
B	50	6/-	5/6	H	750	14/-	12/6
C	75	6/9	5/9	I	1000	16/-	14/-
D	100	8/-	6/3	J	1500	19/-	17/6

Any Gambrell Coil can be supplied tapped at its electrical centre for 6d. extra

WRITE FOR PARTICULARS OF ALL PRICE REDUCTIONS TO:—
GAMBRELL BROS., LTD. 76, VICTORIA STREET, LONDON, S.W.1.
 Telephone: VICTORIA 9938

18-5-26

A Need Supplied!

2-VOLT VALVES

Giving a 6-Volt Result

Osram D.E.2

Only 12amp. Filament Current Consumption at 1.8 Volts

The introduction of D.E.2 H.F. and L.F. OSRAM VALVES marks another big step in radio progress, and one which will be welcomed by every wireless user. The most severe practical tests have proved conclusively that it is possible to get the same volume and tone from these new 2-volt OSRAM VALVES as from many valves requiring 4 or 6-volt accumulators. *The use of D.E.2 OSRAM VALVES means that accumulator expenses are halved or reduced by one-third for the same, if not better, results.*

D.E.2 H.F. and L.F. OSRAM VALVES are developments from the well-known and popular D.E.R. class, but possessing better characteristics, a third of the current consumption and the same immunity from possible destruction by over-running. You cannot over-run the D.E.2 with a 2-volt accumulator and a standard 5 ohms filament resistance.

Users of 4 or 6-volt accumulators can, by arranging the cells in parallel, make their accumulators last two or three times as long on one charge and still get the same volume and purity.

D.E.2 H.F. and L.F. OSRAM VALVES employ the latest form of thoriated tungsten filament, which ensures a steady and lasting emission throughout a long, useful life.

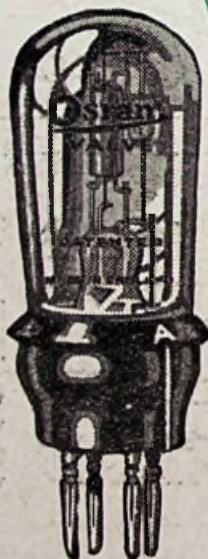

The electron emission of the D.E.2 L.F. OSRAM VALVE is exceedingly liberal, and, as the internal resistance is markedly low, the D.E.2 L.F. proves a most sensitive *Detector* for picking up distant stations. The anode current it passes also makes this type excellent as an L.F. amplifier for providing full mellow tone and plenty of volume.

The D.E.2 H.F. OSRAM VALVE is specially designed to provide the utmost sensitivity to weak signals when used in the H.F. stage; and in addition gives surprisingly increased volume in a choke or resistance-coupled amplifier. *Use a D.E.6 OSRAM VALVE in the last stage.*

For 2-volt accumulators an ideal combination is the D.E.2 H.F. as H.F. Amplifier, and D.E.2 L.F. as Detector and L.F. Amplifier, with the D.E.6 OSRAM VALVE as Power Valve

Characteristics
H.F. Type

Filament Volts ..	1.8
Filament Current ..	0.12
Anode Volts ..	40/120
Impedance ..	45,000 ohms
Amplification Factor ..	12

Price 15/6 each

Osram Valves

for Broadcasting

THE G.E.C.—YOUR GUARANTEE.

Characteristics
L.F. Type

Filament Volts ..	1.8
Filament Current ..	0.12
Anode Volts ..	20/80
Impedance ..	22,000 ohms
Amplification Factor ..	7

Price 15/6 each

Advt. of The General Electric Co. Ltd., Magna House, Kingsway, London, W.C.2.

Editor-in-Chief:

JOHN SCOTT-TAGGART,
F.Inst.P., A.M.I.E.E.

Editor:

PERCY W. HARRIS,
M.I.R.E.

The : WIRELESS : CONSTRUCTOR

RADIO PRESS, LTD.,
Bush House, Strand,
W.C.2

'Phone:
City 9911 (7 lines)

Telegrams:
"Radbooks, Estrand,
London"

Vol. II. APRIL, 1926. No. 6.

Three Valves—One Tuning Control

A General Purpose Receiver with an Untuned H.F. Stage

By **STANLEY G. RATTEE, M.I.R.E.**

In most receivers which incorporate high-frequency amplification the tuning controls number at least two. From the point of view of the beginner in wireless, this is sometimes a disadvantage in that, unless the two or more tuned circuits are properly adjusted, very little, if anything at all, will be heard.

Simplicity of Operation

It may, of course, be argued that the beginner in radio should not attempt at first to operate a set using two variable condensers, but there are nevertheless many people, including beginners and "experts," who must, for reasons of distance or local conditions, use a receiver incorporating H.F. amplification. This necessity, as previously stated, usually means that at least two variable condensers must be operated.

There are, of course, methods of coupling H.F. valves which do not necessitate tuning of the anode circuit, such as "aperiodic" coupling, to give a well-known example, and in receivers so designed the operation of tuning is greatly simplified. The amount of amplification is

possibly a little less than that which the average listener would obtain with a tuned stage, but, from the point of view of easy operation, it has much to commend it.

Since the inclusion of an H.F. valve in any receiver infers that the set may be used for distance work, it is necessary that a certain amount of selectivity be also allowed for, and for this reason auto-coupling by means of "X" plug-in coils is used in the present case.

Notes on Design

The vertical panel and baseboard design has been used in order that valves and coils may be completely enclosed within the cabinet. The method of construction also permits of easy wiring of the components, at the same time allowing the panel to be kept reasonably free from terminals, only those for the aerial, earth and telephones appearing on the front of the instrument.

In order that there may be no difficulty in stabilising the high-frequency valve, the receiver is fitted with a potentiometer, while a high value of high-tension voltage may be given to the note-magnifying valve if desired, a separate terminal being provided for the H.T. tapping for this valve, together with facilities for using a suitable grid-bias voltage.

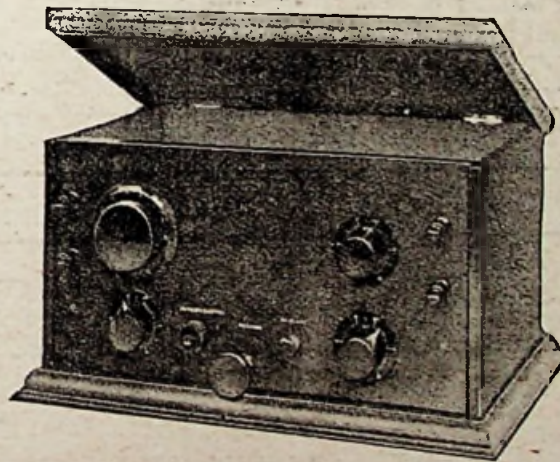

Coupling System Employed

In the receiver to be described, the system of coupling used is that of an "aperiodic" transformer, while the controls are practically the same as those of a single-valve reaction receiver. Tuning is carried out by means of one variable condenser, while reaction is controlled by means of variable coupling between two coils.



The Circuit

Each valve is controlled by a separate filament resistance, while the detector valve is provided with a variable grid-leak, the adjusting knob of which appears on the front of the panel. The circuit of the receiver is given in Fig. 1, and it will be seen that three valves in all are used. The aerial is tapped at a suitable point upon the grid coil L_1 , this latter being tuned by a $.0005\mu\text{F}$ variable condenser C_1 . The two coils L_2 and L_3 constitute the "aperiodic" transformer windings and are wound in the manner of the usual barrel type of plug-in transformer. The sizes of the coil L_1 and of the H.F. transformer L_2 , L_3 may be changed according to the wavelength which it is desired to receive, the set being suitable for use upon the broadcasting wave-

shunted by a fixed condenser of $.001\mu\text{F}$, while the phones, or loud-speaker, are connected in the anode circuit of the low-frequency valve V_3 .

Components and Materials

Those readers who are desirous of building this simple set should first collect together the following components and materials. It will be noticed that following the components mentioned the name of the manufacturer or his trade mark is given; this information is intended for the benefit of those readers who wish to duplicate the receiver as illustrated, though it must, of course, be understood that other goods appearing in the advertisement pages will do equally well, so long as the values are as given.

formers, No. 1 and No. 3 (Burne-Jones & Co., Ltd.).

Four "Antipong" valve-holders (Bowyer-Lowe Co., Ltd.).

One variable square-law condenser, $.0005\mu\text{F}$, Polar cam-vernier type (Radio Communication Co., Ltd.).

Three filament rheostats, 30 ohm type (British L.M. Ericsson Mfg. Co.).

One Peerless potentiometer, 300 ohms (Bedford Electrical & Radio Co.).

One low-frequency transformer (Brandes, Ltd.).

One Newey two-coil holder (behind-panel type) (Pettigrew & Merriman, Ltd.).

One fixed condenser, $.0003\mu\text{F}$ (Watmel Wireless Co.).

One fixed condenser, $.001\mu\text{F}$ (Dubilier Condenser Co., Ltd.).

One terminal strip with seven terminals.

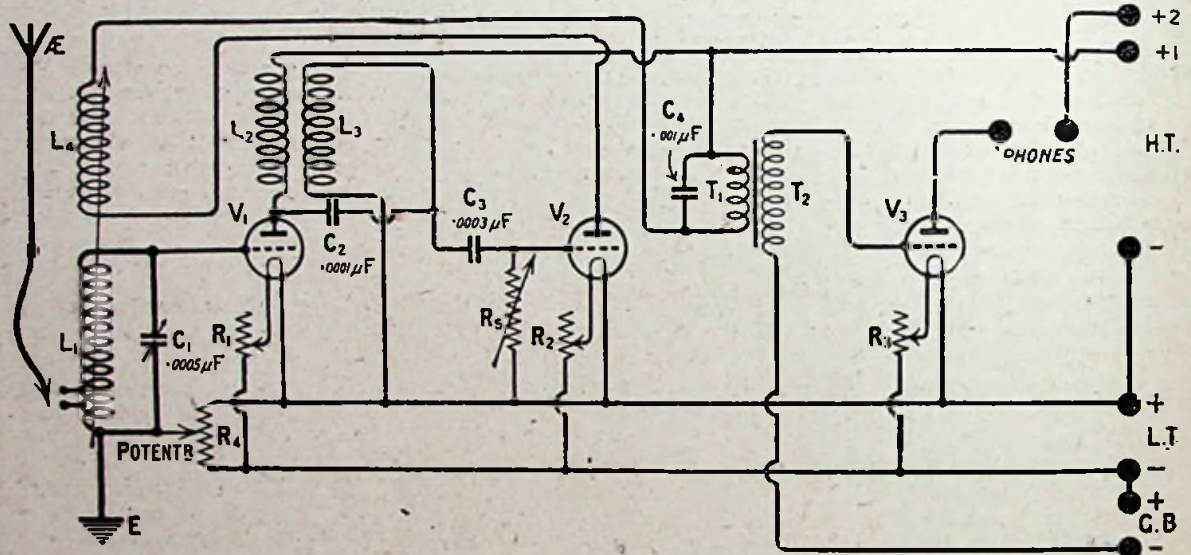

Fig. 1.—The circuit diagram, which will provide an additional check when the wiring is finished. L_2 , L_3 is the "aperiodic" transformer.

band or upon the long wavelength of 5XX.

Reaction Coupling

The $.0001\mu\text{F}$ fixed condenser shown connected between the anode of V_1 and the grid of V_2 is optional, and in the present set is of the clip-in type so that different values may be tried. Its purpose is to tighten coupling somewhat, and, from personal experience, $.0001\mu\text{F}$ would seem to be a good average value; if possible, various values should be tried by readers and the results noted for any improvement upon different wavelengths.

It will be seen that reaction is obtained in the popular manner by coupling the grid coil L_1 to a coil connected in the anode circuit of the detector valve V_1 . The primary of the low-frequency transformer is

This latter point is one of some importance, for the final design of a receiver is the outcome of careful experiment upon the part of the designer, all the values and so on being especially chosen for the best results, and any departure therefrom may quite possibly mean that the set will either not work as well as it would otherwise, or that its tuning range is not as it is intended to be.

What You will Require

One ebonite panel, 16 in. by 8 in. by $\frac{1}{4}$ in. (Red Triangle, Peto-Scott Co., Ltd.).

One cabinet to take above panel, and baseboard, 16 in. by 8 in. by $\frac{3}{8}$ in. (W. H. Agar).

Two small type right-angle brackets (Burne-Jones & Co., Ltd.).

Two "aperiodic" H.F. trans-

Four terminals, "Aerial," "Earth," "Phones +," "Phones -" (Belling & Lee, Ltd.).

One "Success" variable grid-leak (Beard & Fitch, Ltd.).

One clip-in condenser, with base, $.0001\mu\text{F}$ (L. McMichael, Ltd.).

Radio Press panel transfers.

No. 16 "Glazite" connecting wire.

Length of rubber-covered flexible wire.

The Panel and Baseboard

If the components mentioned above are used, then the drilling of the panel may be proceeded with as shown in Fig. 2; should any of the components be of other manufacture, then the reader should assure himself that these dimensions will give sufficient clearance.

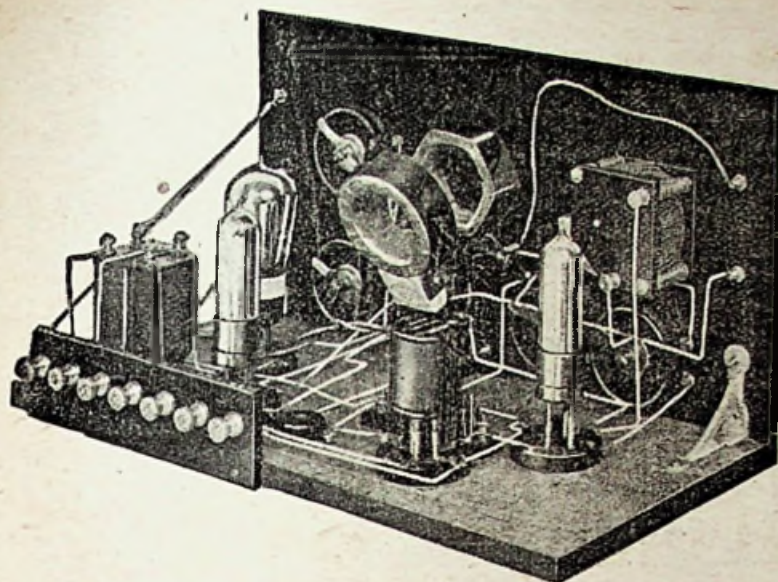

As will be seen from this photograph, the components are not unduly crowded.

After all the holes have been drilled, secure the panel to the baseboard and ascertain that both panel and board are a good fit in the cabinet, filing the latter or both if need be. Next, mount the components upon the panel, as is indicated in Fig. 2, and, with a good-size plug-in coil in the moving block of the two-coil holder, arrange the components upon the baseboard.

Before securing these by means of wood screws, move the plug-in coil well down towards the baseboard, making sure that there is no possibility of the moving coil fouling any component or valve

when the former is moved away from the fixed coil. When placing the L.F. transformer, make certain that this is not fixed too near the edge of the baseboard, otherwise it will be extremely difficult to make connections to the terminal strip along the back edge.

Wiring the Receiver

All the connections which lie close to the panel and baseboard should be made first, and in this direction the photographs will prove useful. The wiring to the fixed block of the two-coil holder should be carefully noted, and it is essential that the

PIN of the holder should be connected to earth. The aerial terminal is fitted with a flexible lead which will subsequently be connected to one of the tappings on the "X" coil.

When connecting the variable condenser, be sure that the moving vanes are connected to earth and, when wiring up the grid leak, be careful to see that the moving element is connected to low-tension positive.

All leads should be kept as short as possible, and those which complete anode and grid circuits should be kept well apart.

Coils to Use

To use the set for reception upon the broadcast band, a No. 60 "X" coil should be inserted in the fixed block of the two-coil holder, with, say, a No. 50 in the moving (the size of this latter coil is best found by experiment in all cases). A No. 1 "aperiodic" H.F. transformer should be inserted in the holder provided. For the reception of 5XX a No. 250 "X" coil should be used for L₁ with, say, a No. 100 for reaction. In this case a No. 3 "aperiodic" transformer should be used.

Operating the Set

Having satisfied oneself that the wiring of the receiver is correct, insert suitable coils and the appropriate transformer. Connect the flexible lead from the aerial terminal to the larger tapping on the "X" coil, connect the batteries and the telephones to their appropriate terminals, and turn the filament

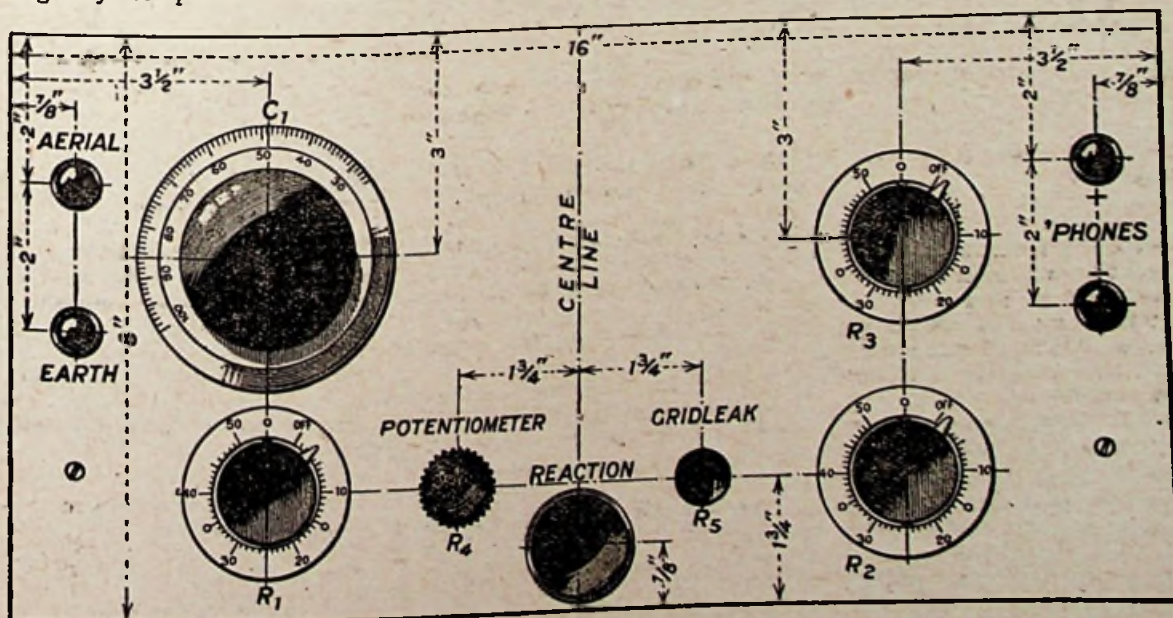

Fig. 2.—All drilling dimensions are given here. Readers may obtain the full-size blueprint, C1035A.

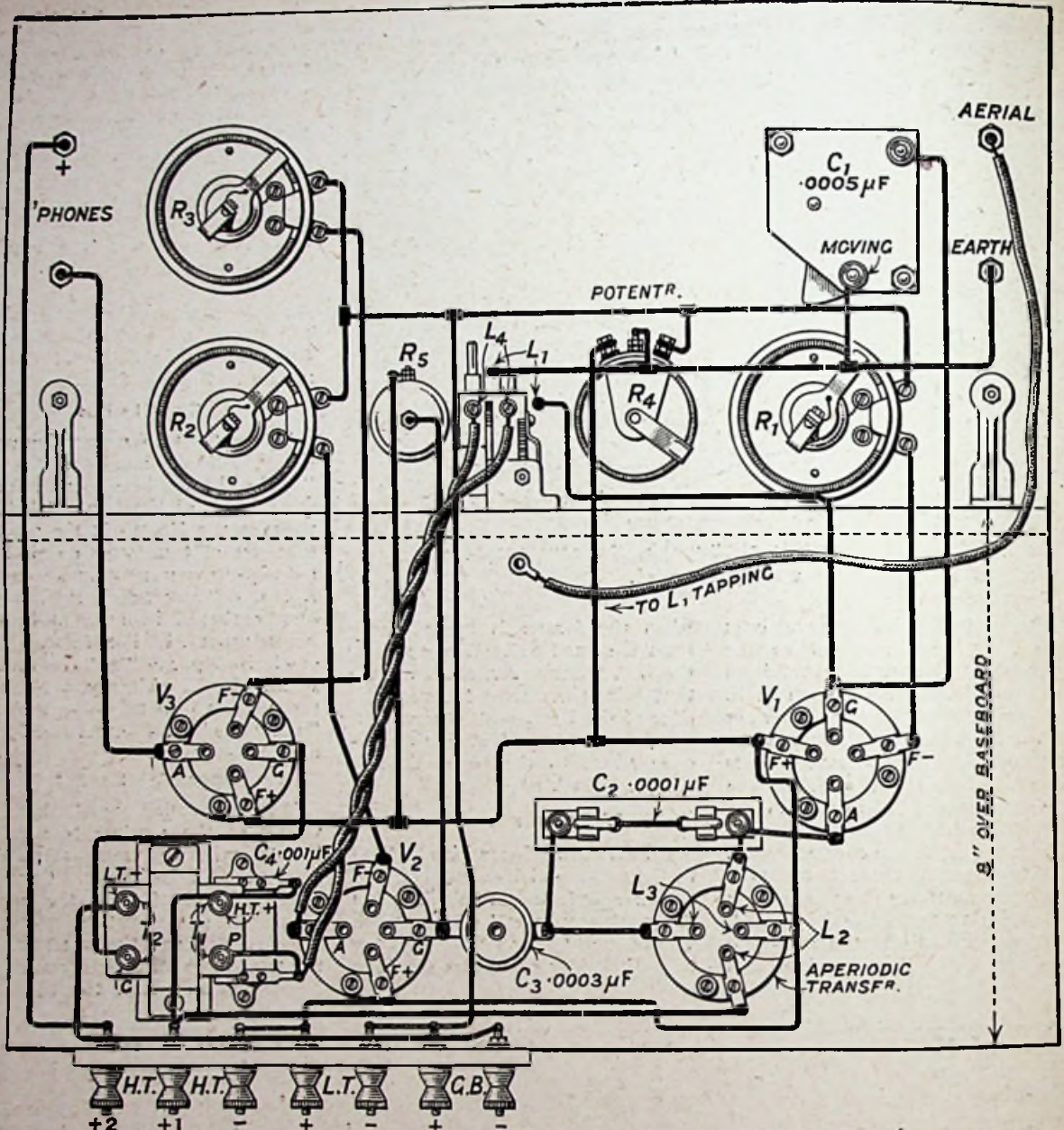

Fig. 3.—Under the new scheme a full-size blueprint of this wiring diagram may be obtained free. Ask for C1035B.

resistances to the "off" position. Connect the aerial and the earth.

Insert the valves in their holders, move the reaction coil well away from the fixed coil, set the potentiometer to, say, its mid-point, and adjust the values of H.T. for the three valves.

H.T. Voltages

The wander-plug which is connected to H.T.₁ may be inserted at, say, 45 to 60 volts, while H.T.₂, assuming that a power valve is being used, may be plugged into a higher value (the value to be that recommended by the makers of the particular valve chosen). Now connect the grid-bias battery across

the terminals provided, using the value stated by the makers of the valve for the particular H.T. value in use.

If a "general purpose" valve is used in the last stage, then the values of H.T. and grid-bias recommended by the makers of the valve should again be used.

Tuning the Set

With all the external connections properly made, light the valves to a suitable degree of brilliance and, with the reaction coil well separated from the grid coil, move the potentiometer slowly from positive to negative. As the slider approaches the negative, a point

will possibly be reached where the set begins to oscillate, whereupon the potentiometer should be immediately turned back towards the positive end just enough to stop the oscillation. (It is assumed, of course, that readers will not test this set for the first time during broadcasting hours.) The reaction coil should now be moved slowly towards the fixed coil, whereupon a coupling should soon be reached at which the set oscillates once more. Should this not take place, however, it will be found necessary to reverse the connections to the moving coil holder. The adjustment of the grid leak should be

found experimentally for the best results.

Reaction Adjustments

With the potentiometer properly adjusted for stability and the reaction coil set at a safe distance from L_1 , turning the variable condenser will soon result in a station being heard. Move the potentiometer, if stability will allow of it, a little more towards the negative end, and, if the set is still stable, tighten the reaction coupling,

adjustment of the tuning condenser. It will generally be found that selectivity is improved by connecting the flexible lead to the smaller tapping on the "X" coil.

Valves

Practically any types of valves may be used in this receiver, so long as they are used in the correct positions. Personally, I have used three "general purpose" valves with good results in addition to the following: H.F. or detector, D.E.3,

published in *Wireless*, Vol. II, No. 6, on the subject of "Local Conditions."

Loud-Speaker Work

It must be understood, of course, that the receiver illustrated is not intended for use with a loud-speaker except in those cases where the local station is within a reasonable distance. For loud-speaker work on the more distant stations it is recommended that a further stage of low-frequency amplification be

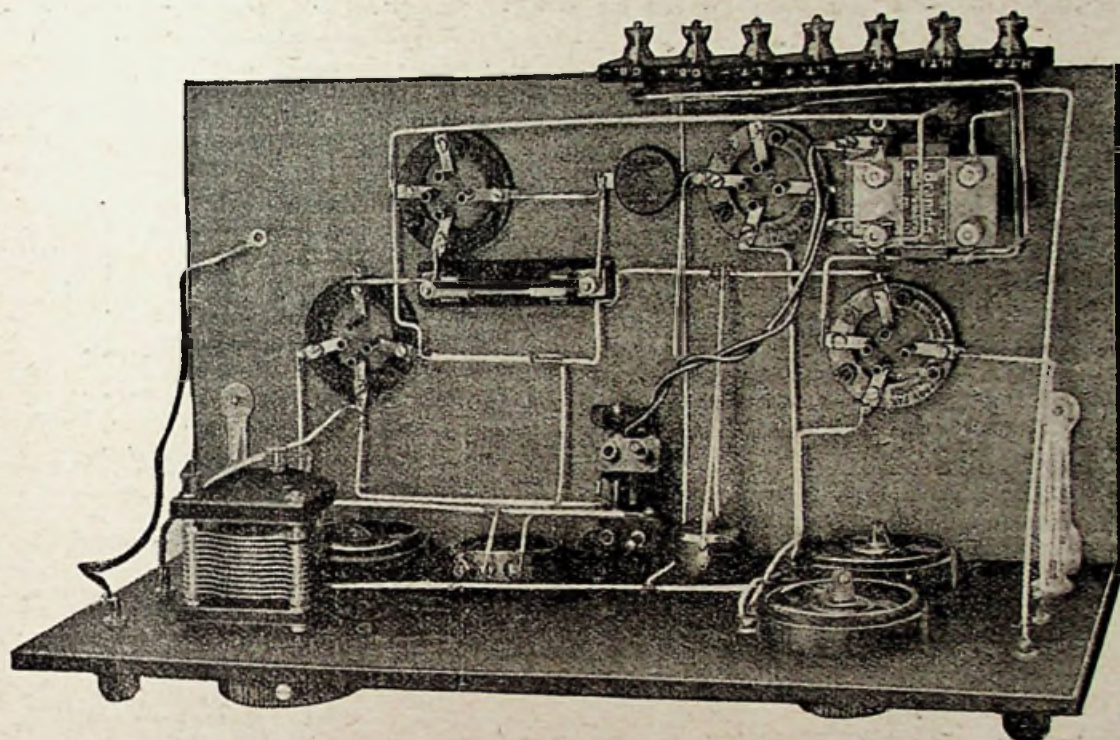

A very good idea of the baseboard layout and wiring arrangements is afforded by this back-of-panel view.

taking care that the set is not made to oscillate. This latter operation of tightening the reaction coupling will result in an increase in signal strength, whereupon the variable condenser should be again adjusted for the loudest signals. The value of H.T. applicable to H.T.₁ should also be experimented with.

Broadcasting

After some little practice in operating the set, you may with confidence attempt the reception of telephony from either your local station or one more distant. The operation of the set is the same in either case, though it must be understood that any alteration of the reaction coupling will necessitate resetting the variable condenser. For this reason, when the best reaction coupling has been found, the potentiometer may be then utilised as a fine control without any appreciable effect upon the

Mullard "Red Ring" Cossor P.2, D.E.8, "6-60"; L.F. stage, P.M.4, D.E.4, B.4, and Mullard "Green Ring."

Results

Using the receiver in south-east London, good loud-speaker results are obtained from 2LO when using an "Ultra" hornless-type of loud-speaker. The aerial used is undoubtedly poor, and also reception conditions are distinctly unfavourable in that the aerial is within a quarter of a mile of one of the 220 ft. steel towers of the Crystal Palace. In distant reception good signals are obtainable from Radio-Paris, Radio-Belgique, Daventry, Birmingham and numerous German stations.

In connection with results obtainable at any time on any set in the district mentioned, it may interest readers to read an article by the present author which was

added, when it will generally be found that ample volume will result. For receiving the local station, however, within distances up to, say, 10 miles or so, the three valves should prove sufficient.

Conclusion

The receiver just described should prove very popular as a "family set" in that the simple control brings its operation within the understanding of the least technical member of the family; further, with the reaction socket short-circuited for local work, the possibility of accidental oscillation is somewhat reduced by confining such possibility to the adjustment of the potentiometer.

Since the grid-tuning condenser is fitted with a "cam-vernier" device, the operation of tuning is greatly simplified, in that the desired station is not so likely to be missed.

Talks to Beginners

By PERCY W. HARRIS, M.I.R.E., Editor

I.—Making a Start

This new series of articles, beginning in the present issue, is designed for those who are just taking up the hobby of wireless, have had a set in use for some time, and are now anxious to understand more about the whys and wherefores of it. The first article, entitled "Making a Start," is a general talk about wireless reception at home. Subsequent articles will deal in more detail with the functions of various parts and accessories

IT is interesting to draw a parallel between wireless and motor cars. A few years ago motor cars were regarded by the average man and woman as complex, intricate pieces of machinery, needing considerable training and a real mechanical aptitude to operate. They were troublesome to operate, erratic in their action, and an outing in one of them was something akin to an adventure. Now motor cars are simple and reliable, the price has come down to a figure accessible to a considerable proportion of the population, and they can be operated quite successfully and reliably by people who have no mechanical knowledge and are quite content with results without wishing to know just how the mechanism works.

An Everyday Affair

Similarly, a few years ago wireless receivers were elaborate and intricate, as well as expensive. Their operation was complex and needed special electrical aptitude, and their operation was only mastered by those possessing a keen interest in the scientific side of wireless. Nowadays, wireless sets have become simple, reliable and inexpensive, and thousands, if not millions, of people are operating them as a regular part of their daily routine.

Catering for the Uninitiated

Unfortunately, there are still a number of people who think that the hobby of wireless is only for those who have special electrical knowledge or are of a scientific turn of mind. While such people do find the hobby of absorbing interest, a tremendous amount of pleasure can be obtained from the very start by the uninitiated. For, even if he does not wish to build his own set (and the home-constructed set is now within the reach of practically everybody), he has a wide range of choice in the

commercial sets, which can be obtained at prices varying from a few shillings to well over a hundred pounds.

In this series of articles I am not assuming that you wish immediately to build your own set. Possibly you already have one and, before proceeding to construct one for yourself, you are anxious to know a little of the whys and wherefores of it. You have, perhaps, a crystal set which operates simply and reliably and gives you and your family amusement and instruction for many hours of the day. The first question you will naturally ask is just how are you able to obtain such faithful reproduction of the sounds and music which take place in the studio.

The First Link in the Chain

In the more important wireless stations there are generally two or three studios—London has even more than this—and, while they vary in size and in the elegance of their decoration, they all have certain points in common. For example, they are carefully shielded so that noises made outside the room cannot penetrate into the interior of the studio, the rooms themselves are draped to avoid irritating and disturbing echoes, and the floors are padded with thick carpet so that movements of announcers and others in the

studio may not set up disturbances which will be transmitted.

The Mystery Box

At some convenient spot in the studio is placed the microphone. The microphone is essentially a piece of wireless apparatus. You speak into a microphone every time you use the telephone. What wireless has done is so to improve the old telephone microphone that, instead of giving a rough and distorted reproduction of the human voice and other sounds, it is able to reproduce them with amazing fidelity.

The microphone we use when we speak into a telephone contains a small chamber packed with carbon granules. The carbon is so packed that its resistance varies with pressure. This means in effect that, if we pass an electric current through a microphone, any pressure upon it will cause variation in the strength of the electric current. Actually the sound waves set up by our voices, falling upon the front plate of the microphone,

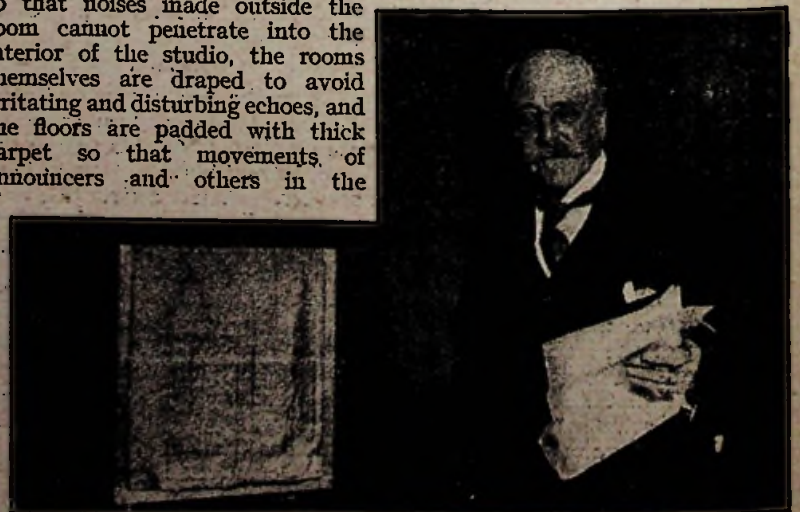

We receive evidence of the microphone's great sensitivity every night. Who has not heard the rustle of the announcer's papers?

do compress the carbon in varying degrees, and this varying compression sets up in this way a varying electric current which operates the receiving mechanism at the other end.

Two Common Types

The first broadcasting microphone operated by means of carbon granules, and indeed many of those in use to-day still make use of carbon. The Western Electric microphone, which is almost universally used in America, is a carbon granule microphone. The British Broadcasting Company have made use, however, of a type of microphone operating in a different manner, known as the Magnetophone. In this a very fine coil of wire is made to move in a magnetic field, and this movement causes a variation in the electric current passing through the microphone.

Whatever form of microphone we use, its purpose is always the same, i.e., to vary an electric current in accordance with the varying sound waves falling upon it.

Even a Whisper!

Broadcasting microphones are astonishingly sensitive, particularly when we compare them with the ordinary telephone microphones. In order that satisfactory reproduction can be obtained with a Post Office telephone, we are instructed to speak close to the mouthpiece. A broadcasting microphone will pick up and faithfully reproduce sounds made yards away from it, and one of the difficulties that announcers at a broadcasting station have to overcome is the inability of new broadcasters to understand that every little sound, even a whisper, is picked up and "put on the air."

Amplifying the Sound

At public dinners and other functions which are broadcast from outside the regular studio, the microphone is often skilfully hidden in a bank of flowers, or it may even be suspended from the ceiling above the heads of the people, as occurs at such places as the Savoy Hotel ballroom. From the microphone, the varying electric currents are led to valve magnifiers which, while faithfully preserving the variations of electric currents, increase their strength enormously. From the magnifiers, or amplifiers, as they are called, the currents are taken to the transmitting station, about which I shall now try to give you a brief idea.

Using Electricity in a New Way

Before the coming of wireless we were all apt to look upon electric current as something which was confined to a wire, and which could be made to perform a number of useful functions, such as giving us light, heat and power. Wireless has not really brought in any different kind of electricity, but it has used electricity in rather a new way, and in using it in this fashion we have been able, so to speak, to send it over the air away from the confines of a wire.

Sometimes when two telephone lines run close to and parallel with one another, the listener on one of the lines may hear conversations taking place on the other, although there is no direct connection between. This is due to what is known

A current which changes its direction at the most a few hundred times per second is known as an alternating current, so that an oscillatory current is really nothing more than a high-speed alternating current, if we may use the term. Alternating currents are used a great deal by electric lighting and power companies for the distribution of energy for lighting, heating and cooking.

What Happens at the Broadcasting Station

A broadcasting station consists first of all of apparatus which will send out into the surrounding space a continuous stream of electric waves, for which purpose there is generated in its aerial a very powerful oscillatory current. When such an oscillatory current is occurring



Engineers in the modulating room at 5IT's new studio.

as "induction." Someone found that a changing current in one wire can be made to set up current in another wire near by, and it was found much later that if an electric current in a wire could be made to change its direction with a very great rapidity (hundreds of thousands of times per second) waves of free electricity would be radiated from this wire into space, and would be spread out in great, ever-widening circles, until finally they dissipated themselves ever so many miles away.

Those Changing Currents

A current which changes its direction with very great frequency is known as an oscillatory current.

in the aerial, waves will radiate approximately equally in all directions from the aerial, and their influence will be felt over a wide area on suitable receivers. Just as oscillatory currents will set up waves of free electricity in the surrounding space, so, conversely, waves of free electricity falling upon an aerial wire will set up in it oscillatory currents.

The closer to the broadcasting station is situated the receiving aerial, the stronger will be the oscillatory currents set up in it by the waves from the broadcasting station. So long as a steady stream of energy is sent out from the broadcasting aerial, so will a uniform oscillatory current be set

up in the receiving aerial (provided the latter is tuned to it).

Not Sound, but Electricity

By means of special apparatus at the broadcasting station, the magnified currents from the microphone (varying, as you will remember, in accordance with the speech and music waves falling upon the microphone) are made to impress these variations upon the oscillatory current in the aerial, and so the waves radiated vary in strength in accordance with the sound waves in the studio. Remember, it is not sound waves that are radiated from the broadcasting station, but electric waves. Similarly, sound does not pass along a telephone wire, but electric current varying with the variations of the sound waves.

There is no need at present to examine in detail the apparatus at the broadcasting station which performs the functions referred to. At the moment it is only necessary to understand that sound waves occurring in the studio modulate electric currents and cause varying electric waves to be radiated from the station.

OUR NEW FREE BLUEPRINT SERVICE

The extended free blueprint scheme, which first came into operation last month, is already proving of immense benefit to readers.

Instead of enclosing a blueprint of one particular set in each issue of THE WIRELESS CONSTRUCTOR, we have now made arrangements whereby each reader can obtain free of all charge a back-of-panel blueprint of any one set in this and future issues.

Thus each reader can have a full-size wiring guide to any set which takes his fancy or suits his particular needs. Further particulars of this service will be found on page 562, while the coupon is on page 624.

A BLUEPRINT OF ANY SET FREE

A Simple Indoor Aerial

By H. Bramford

A VERY simple indoor aerial for erection in the same room as the receiver itself may be made for a few pence and with little trouble by the method described in this article. In some respects it is rather unique in design, and differs from many commercial types, inasmuch as it is constructed from soft copper wire, and not phosphor-bronze or spring brass.

Materials Required

First procure a quantity of No. 16 S.W.G. copper wire (approximately 80 ft. will be required) and a cardboard former 18 in. long and 1½ in. in diameter. Secure one end of the copper wire in any manner to an end of the former, and, having done this, proceed to wind the wire tightly and closely round the former until the whole length has been used. Now loosen the end of the wire which was previously secured and let the winding slacken. It will then be easy to slide it off the former, and it will be seen that we have now a spiral copper spring.

To one end of this "spring" tie a piece of tape of sufficient length to pass right across the room where it is desired to erect the aerial. Secure the same end of the tape also to an insulated hook previously placed in the wall of the room. Next thread the other end of the tape through the spring and secure it to a further hook in the opposite wall, or wherever the aerial is to be placed. Now take the loose end of the spring and slide it along the tape to the farther side of the room. To prevent it springing back, secure this end to the tape by means of a piece of string.

The Down Lead

The down lead is made as follows: Procure a piece of flexible insulated wire of suitable length, and to one end attach a spring clip. To the other end attach a spade tag. The clip is then attached to one end of the spiral aerial and the spade terminal is taken in the usual way to the aerial terminal of the set. The diagram shows the general details of construction and erection.

Advantages Claimed

Some of the particular advan-

tages of this simple aerial are as follows: It may be put up in a few moments in any room, erection is simple, it may easily be taken down and erected elsewhere, and it is extensible to any desired length. Furthermore, the clip on the down lead may be secured on any point of the aerial itself, thus enabling one to experiment with either an "I," type aerial or a "T" type aerial. The idea may, of course, also be applied to a multiple aerial, embodying, say,

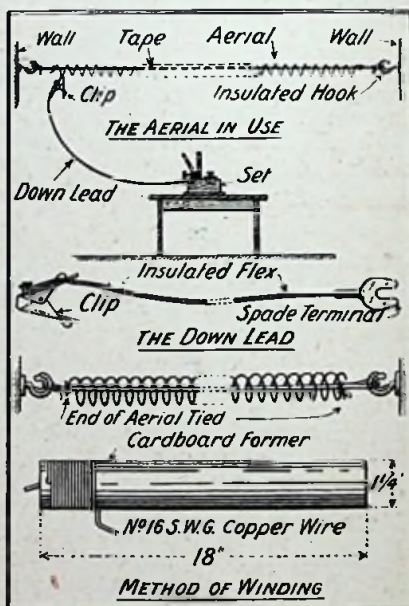

Details of the construction and erection of the aerial.

two such spiral springs in parallel, or to a radial arrangement, which would probably give even better results.

Insulation Necessary

For an indoor aerial results are exceedingly good, although no claim is made that it is as good as an efficient outdoor aerial. It should, however, be found to be efficient when used in conjunction with crystal sets, provided that a good earth is made. It should be mentioned that as bare wire is used for the construction, this kind of aerial should be carefully insulated from the walls—that is to say, the wire should not touch the walls at any point.

THE PIRATE BOLD!

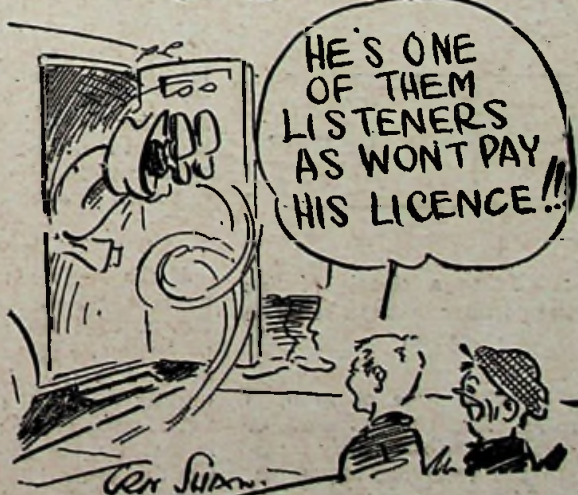

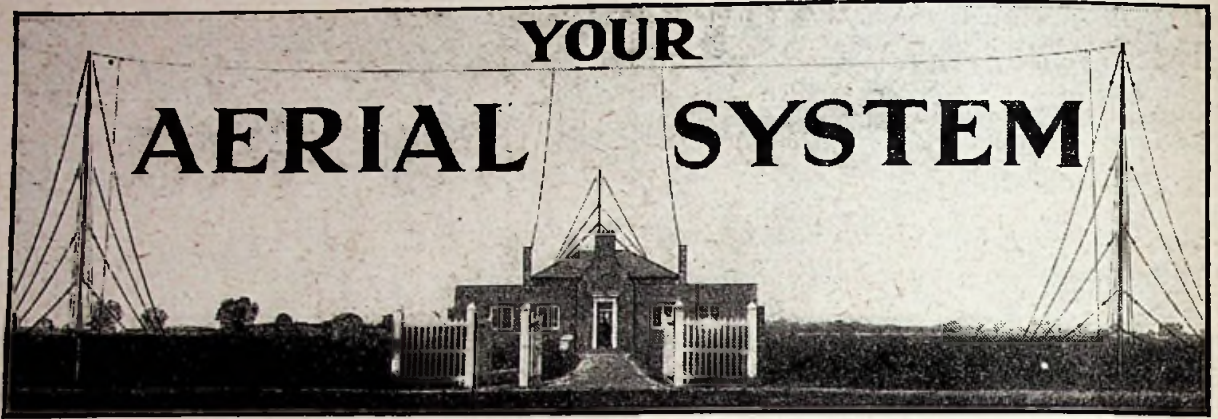

Some suggestions regarding aerial and earth arrangements, by H. J. BARTON-CHAPPLE, Wh. Sch., B.Sc.(Hons.), A.C.G.I., D.I.C., A.M.I.E.E.

THE function of a receiving aerial system is to absorb some of the electro-magnetic energy propagated into space from the wireless transmitting station. This energy is evidenced as a minute high-frequency alternating voltage across the ends of the aerial tuning coil, which voltage is subsequently transferred to the rectifying apparatus (valve or crystal), either directly or, in some cases, after being amplified at the high frequencies before passing on to the rectifying unit. It is often found that wireless experimenters and constructors are prone to devote a great deal of thought and care to the construction and manipulation of their particular receiving set, but the aerial system is neglected.

The Orthodox Aerial

This, of course, is a wrong state of affairs, for the aerial system, no

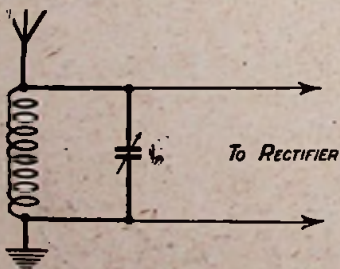

Fig. 1.—Using a circuit of this type, the aerial capacity should be small.

matter in what type or form, is responsible for the amount of energy which is subsequently transferred to the receiving apparatus, so that if the former is inefficient the labours spent on the set are, to a large extent, nullified. Under these circumstances it would appear opportune to consider the salient

features of an aerial system so that due regard can be paid to the close relationship which should exist between all parts of the system in order to avoid undue losses.

In this article we shall confine our attention to the orthodox aerial, leaving considerations of the others, such as frame aerials, indoor aerials, tree aerials, etc., for a future date. There are certain fundamental principles which should be borne in mind when contemplating the erection of an aerial, while, if an aerial is already in position, it is useful to know how certain small improvements may be effected which will do much towards improving reception.

Type of Aerial

The length of the aerial and down lead is limited, but it is left to the judgment of the experimenter when the question of type has to be settled. Now, for the majority of conditions, a "straight" aerial will generally meet all requirements, without the necessity for recourse to the fancy types. There is one point, however, which is worth attention, and that is the choice between a single-wire aerial and a twin or multiple-wire aerial. This can often be settled on these lines.

Coupling Arrangements

If the receiver is to be direct or auto-coupled to the aerial, as in Fig. 1, then the provision of an adequate size of aerial-loading coil becomes a necessity, and consequently the aerial capacity should not be unduly large; this condition is met by the single-wire aerial. On the other hand, if inductive coupling is resorted to, as in Fig. 2, then a larger aerial capacity is permissible, since the tuning of the coupled circuit will give the necessary condition for good

reception. A twin or multiple-wire aerial may then be erected, with the resultant larger capacity.

Apart from these considerations, however, it will generally be found that a well-erected single-wire aerial will meet most contingencies and, being quite straightforward, will be less likely to cause trouble.

Environment

The question of environment probably imposes the greatest restrictions, but where possible an open situation free from screening is the most desirable feature. Under these circumstances about 20 to 30 ft. will probably be sufficient for the height of the aerial wire, but when the aerial is screened the height should be increased, as the effective height will not then be equal to the height above the ground. A pole such as that described in last month's issue of this journal by Mr. A. V. D. Hort will be quite suitable for supporting

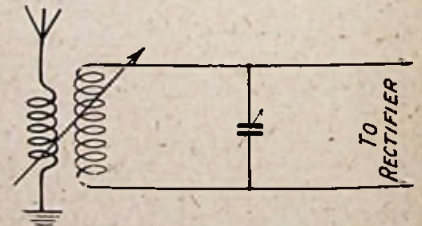

Fig. 2.—A larger aerial capacity is permissible with inductive coupling.

the "free end" (i.e., the end remote from the lead-in wire), or a tree shorn of some of its branches will meet the need, provided the actual end of the aerial wire is not located in the foliage.

The erected aerial is shown diagrammatically in Fig. 3, and it will generally be found more efficient to have the lengthwise

portion of the aerial (A B) parallel to the ground. If this is not possible, it is preferable to have the lower end of this wire at the lead-in end, *i.e.*, the slope A C is generally better than A D.

The Down Lead

The down lead should be kept as far away from the wall as possible,

Stay Wires

Where rope is employed for the mast stays and the strain lead, the latter being shown as B E in Fig. 3, provision should be made for the continual shrinkage and expansion consequent upon atmospheric changes. The aerial must not be pulled up taut for these reasons. Halyards made from flexible steel

should have a long leakage path, so that when they are damp or covered with soot the amount of energy leaking away will be kept small. Good quality porcelain insulators with a smooth-glazed outside surface and free from flaws are among the best for this purpose.

Ebonite tends to deteriorate when exposed to the weather, especially in sunshine, and, in addition, it is mechanically weak because of its brittleness. When employing porcelain, it should be arranged for the insulators to be in compression and not in tension, as they are then stronger.

Position of the Insulators

When using a single-wire aerial the insulators can be conveniently located in the positions A and E of Fig. 3, two at each end being generally found sufficient. If a double-wire aerial is employed, however, we are given the choice of placing the insulators in the aerial leads themselves or in the ends of the halyards, *i.e.*, A, B, C, D or E, F respectively of Fig. 4.

When the insulators are placed in series with each aerial wire it is clear that the leakage paths over these insulators are in parallel to earth. Thus it is better to insert the insulators at the positions E and F in preference to those of A, B, C, D, so as to reduce the leakage loss. Of course, it is possible to have the insulators located in each arm of the bridge between the spreader and the halyard, but this is not so

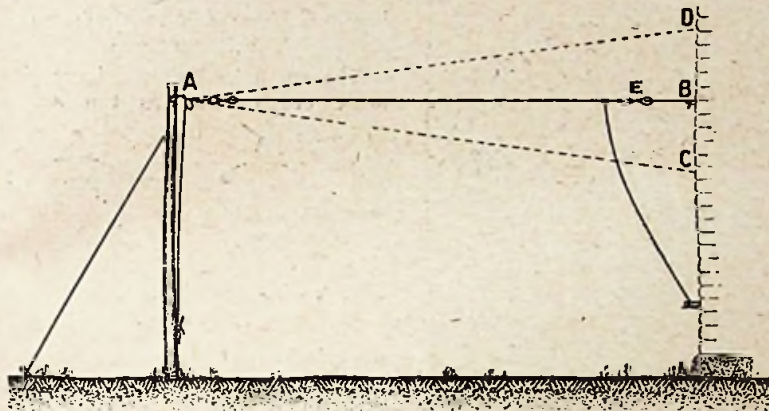

Fig. 3.—It is preferable to make the aerial parallel to the ground, as in position A B.

and under no circumstances must it run close to rain-water pipes, etc. "Eddy currents" are induced in any masses of metal close to the down lead, and this results in losses and a reduction of signal strength when receiving. The house end of the aerial should be clear of any lead roofing and, where possible, should run transverse to the guttering.

wire in lieu of rope will be found very effective, since, in addition to being mechanically strong, they are not appreciably affected by the weather.

Insulation

The provision of efficient insulation for an aerial system is essential. Insulators must be placed at the free end and lead-in end of the horizontal wire. These insulators

Importance of the Down Lead

It is not always appreciated by the wireless experimenter that the portion of the aerial which has the greatest effect in absorbing the propagated electro-magnetic energy of the wireless waves is the vertical portion, *i.e.*, the lead-in wire. It can be proved theoretically that the currents set up in the aerial by the wireless waves are almost directly proportional to the *effective* height of the aerial. It thus follows that the higher the aerial the better will be the results obtained.

Selectivity

Selectivity is improved if the ratio of the horizontal portion to the vertical portion of an aerial is not made unduly large, and where possible, with the normal aerial, the length of the horizontal portion should not exceed 40 to 50 ft., with a corresponding height of 30 to 40 ft. for the down lead. Where screening is present, however, it may be found necessary to increase the length of the horizontal portion compared with the down lead.



This aerial, having a long down-lead and short horizontal portion, gives excellent results.

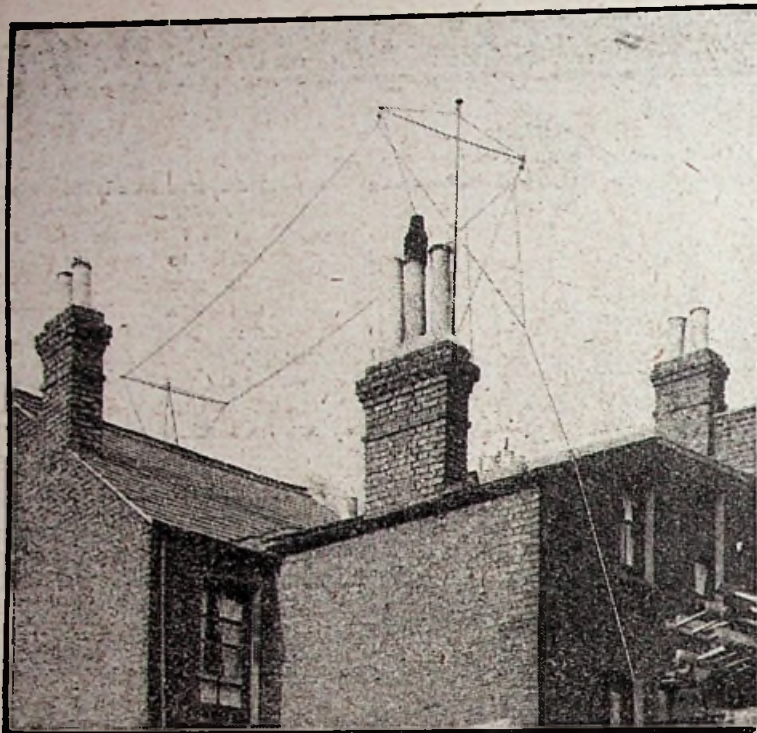

A typical twin-wire aerial. This type has a comparatively large capacity and tends to reduce selectivity.

efficient for the reasons just mentioned.

Attaching the Insulators

When using shell insulators or those of similar pattern, it is always advisable to bring the actual aerial wire under the insulator, as shown in Fig. 5(a), continuing the length of the wire as the down lead without making any break or soldered joint. To prevent slipping, binding wire should be placed in the position indicated. If the aerial wire is looped, as in Fig. 5(b), then the

Lead-in Tube

For this reason, too, it is better to instal a lead-in tube or insulator which will allow the wire to pass through to the aerial terminal of the receiving set without discontinuity. A suitable location for this tube must be chosen depending on circumstances, and a suggested type is indicated in Fig. 6. This may be of porcelain or other good-quality insulating material, and the bell-mouth should point to earth in order to prevent rain or moisture running into the tube and causing leakage.

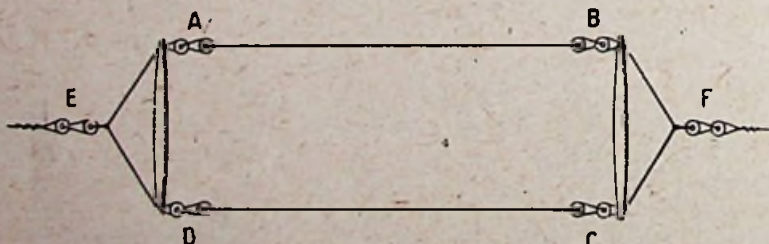

Fig. 4.—Insulators at E and F are more effective than those at A, B, C, D, in reducing leakage loss.

strain and friction caused by one wire bearing down on the other is liable to cause a breakage. It is always preferable to make the down lead and horizontal aerial wire continuous right to the receiving set, as any joints are sources of loss.

Aerial-Earth Switch

If an aerial-earth switch is embodied in the installation, it should really be of a type which permits the earthing of the aerial when not in use to take place outside the building. This precaution is necessary, for if lightning

did happen to strike the aerial, then a path to earth would be provided outside the building and would thus militate against possible danger through the current traversing any wires inside which might be near inflammable material. The provision of this switch, of course, necessitates the lead-in wire being broken before reaching the receiving set, and it should be situated as near the receiver as possible.

The Earth Lead

The earth lead should have the same cross-section as the aerial

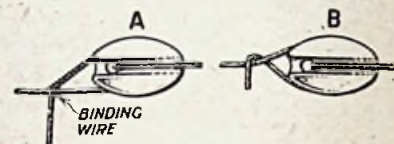

Fig. 5.—Two methods of attaching insulators.

wire, since it has to carry the same high-frequency currents, so that a length of the same wire can conveniently be used. In spite of views to the contrary, *thicker wire is not necessary.*

Although the D.C. resistance of a thick wire is less than the same length of thin wire, we are concerned with high-frequency resistance, and this introduces many modifications. Stranded wires, separately insulated, should be used for aerial, down lead and earth

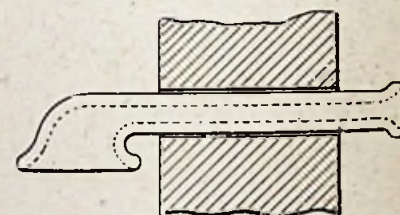

Fig. 6.—A suggested form of lead-in tube.

lead, and soldered joints avoided unless each individual strand is soldered separately to a suitable type of terminal lug.

A Short Length

The earth lead should be as short and as straight as is consistent with environment, and, where a long length is necessary, say, over 10 ft., this lead will function more satisfactorily when insulated and kept away from material likely to cause leakage. The same precautions concerning dielectric losses apply here as in the case of the down lead.

The Earth

As far as the actual earth itself is concerned, this is preferably located
(Continued on page 610.)

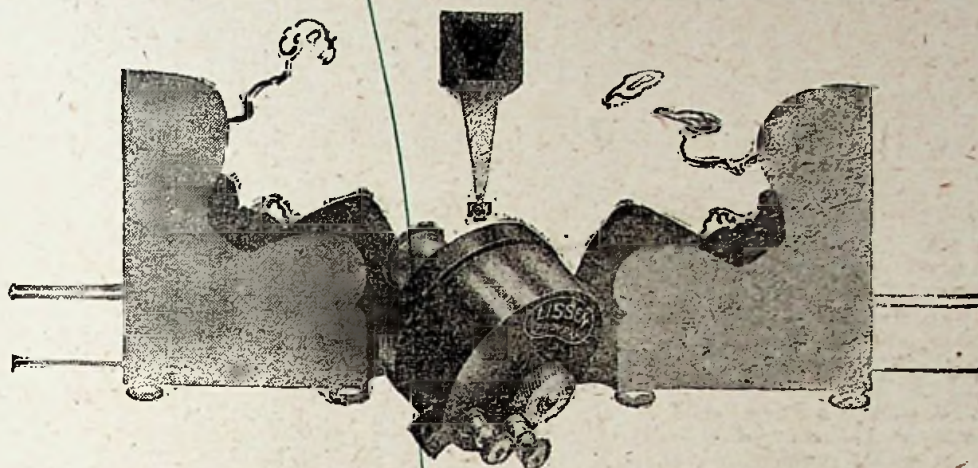

Build your own Loud Speaker and discard your headphones

Gone are the days of troublesome 'phones. The Lissenola brings loud speaker convenience to every home at a record in low price. For 13s. 6d.—less than the cost of headphones—you can buy the Lissenola, which only needs the addition of a horn to make it a powerful, full-sized instrument yielding results equal to an expensive loud speaker.*

Compare the price last. Make this test before buying: Go to your dealer—ask him to put on the best loud speaker he has in stock—then use the same horn on the Lissenola, and see if you can notice any difference.

You can build a horn yourself—with each Lissenola we give you full-size exact patterns and clear instructions how for a few pence you can build a big horn of proved efficiency. The illustration above shows the effective horn you will build. It can be covered with fancy paper or painted so as to resemble a factory-made article.



In addition, the Lissenola will fit the

tone-arm of any gramophone, instantly converting it into a radio loud speaker.

By using the Lissen Reed (sold separately for 1s.) the Lissenola will carry a cone or any other diaphragm working on the reed principle. You can quickly make a paper diaphragm yourself.



*The secret of the Lissenola's remarkable efficiency rests in the effective manner in which the electro-magnetic sound-reproducing system is concentrated.

Your dealer will gladly demonstrate and supply—or post free by return from the makers—price 13/6, or with Lissen Reed 14/6.

BUY THE LISSENOLA and build your own Loud Speaker

Lissen Limited, 26-30, Friars Lane, Richmond, Surrey

'Phone: Richmond 2295 (4 lines).

'Grams: "Lissenium, 'Phone, London."

L.11

"That LEWCOS Coil makes all the difference!"



In the LEWCOS Coil the makers of "Glazite" have achieved another outstanding success.

THIS wireless enthusiast knew that when he found a coil marked LEWCOS it was sure to be better. Coil after coil had been tried and discarded in an endeavour to realise that rare selectivity and fine tuning so essential to complete radio enjoyment.

A LEWCOS coil will make all the difference to *your* set. Try one and prove for yourself.

Each LEWCOS Coil is tested in our laboratory. It is then boxed and sealed up, and reaches you in perfect condition. Ask your radio dealer for a demonstration.

You'll notice the difference with a

LEWCOS

Inductance Coil!

THE LONDON ELECTRIC WIRE CO., & SMITHS LTD.

(Makers of Electric Wire for over 40 years)

PLAYHOUSE YARD, GOLDEN LANE, LONDON, E.C.1

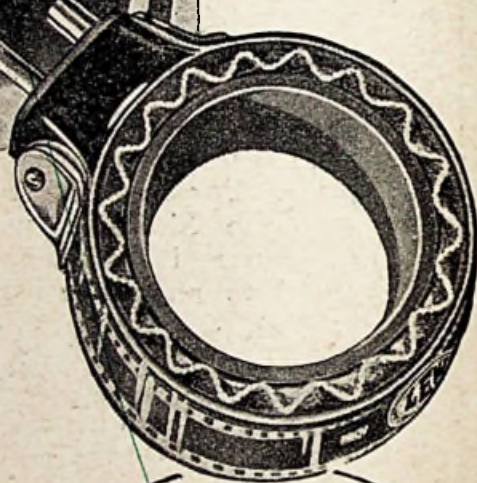

Why

LEWCOS COILS

give better tuning

1. The LEWCOS Coil embodies high electrical efficiency with great mechanical strength.
2. The LEWCOS Coil is very selective, resulting in extremely fine tuning.
3. The LEWCOS Coil has an exceptionally low high frequency resistance with a corresponding increase in signal strength.

All LEWCOS Coils bear the LEW seal

This Mark



Guarantees Quality

An Inexpensive H.T. Battery

By E. Tertius Wilson

How to make a reliable source of high-tension supply at little cost

IT is generally admitted that the maintenance of the efficiency of the high-tension battery is one of the most troublesome problems experienced by the wireless enthusiast, and for this reason the battery described below will probably be of interest to constructors.

The cells are of the Leclanché type, each cell having an E.M.F. of

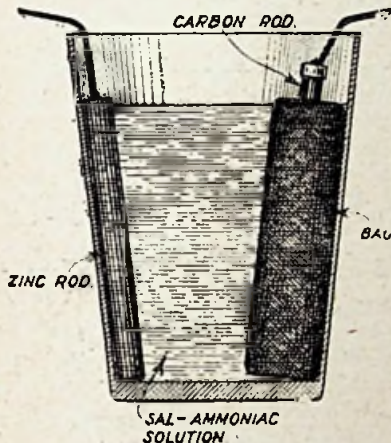

The zinc rod forms the negative pole of the cell, while the carbon is the positive.

1.5 volts, so that for a 60-volt battery 40 cells will be necessary, and so on for any required voltage. Each cell consists of one small bag containing a carbon rod packed round with manganese peroxide, which functions as a repolariser, and also a zinc rod, the whole being immersed in a solution of sal-ammoniac—in fact, a miniature Leclanché cell.

The zinc rods for the cells are made by obtaining a number of zinc rods sold for full-size Leclanché cells and cutting each one up into three sections.

A Use for Old Flash-Lamp Batteries

The small bags containing the carbon rods and depolariser are obtained from old flash-lamp batteries. The cardboard cover of each battery is removed, and the zinc pots cut open and discarded, leaving only the bags with their contents. Care must be taken to

see that the bag is not damaged when cutting open the zinc container. The bags obtained from old flash-lamp batteries are quite suitable for the purpose, as the failure of a flash-lamp battery is usually due either to the drying-up of the paste used as an electrolyte, or to the wasting of the zinc.

A number of small glasses or pots must now be procured to form the outer jars or containers of the cells. Reference to the diagram will show the arrangement of one of the cells.

Connecting Up the Cells

When the required number of cells has been obtained, they are connected together in series by means of copper wire, the zinc rod of one cell being wired to the carbon rod of the next. It will be found that each carbon rod is fitted with a small brass cap, to which the wire can be soldered.

The Containing Box

A suitable box to hold the cells should now be obtained, the dimensions of which will, of course, vary with the number and size of the cells. An ebonite panel should be fitted to one of the sides of the box to carry the sockets for the

wander-plugs connected to the set.

Making Tappings

At one end of the battery of cells will be an unattached zinc rod, and at the other end will be an unattached carbon rod. These are respectively the negative and positive terminals of the battery, and should be connected to the corresponding sockets on the ebonite panel. If the full voltage of the battery will invariably be required, two sockets will be sufficient, but any number of tappings may be made by providing additional sockets on the panel, which are connected by means of rubber-covered flex to those connections between the cells of the battery that will furnish the required voltages.

The Electrolyte

It is now only necessary to pour into the cells a solution of sal-ammoniac to make the battery ready for use, the level of the liquid not being allowed to rise above the tops of the bags.

All that is required to keep the battery in working order is the addition of a little water at intervals, or sal-ammoniac solution at longer intervals.



The orchestra at the Hilversum Wireless Station, HDO, Holland. This station transmits on 1050 metres, and is well known to many British listeners.



An H.F. Amplifier for the "Midget" Receiver

By A. S. CLARK

This little amplifier, shown on the left, is suitable for use with the "Midget" or any other one-valve set.

As will be gathered from its name, the high-frequency amplifier described in this article is intended primarily for use with the "Midget" single-valve receiver described by the author in the May, 1925, issue of THE WIRELESS CONSTRUCTOR. It is, however, so designed that it may be used with any standard straight detector valve circuit, with or without reaction, and this without any alterations whatsoever to the set. It should, therefore, appeal to the many who possess no H.F. stage on their existing receivers and who would like to hear more distant stations without the need of making new sets.

Coupling Employed

The type of high-frequency coupling employed is a form of series tuned anode, and is shown in Fig. 2. The right-hand part of this circuit, it will be seen, is a conventional single valve circuit; the left-hand part being added by means of the H.F. unit. Reaction is normally obtained by means of the potentiometer, which is worked as near the negative end as possible. The use of a reaction coil coupled to L_2 may be tried, and in some cases it will be found desirable to obtain reaction by a combination of the two methods.

The aerial coil of the original set becomes the tuned anode coil L_2 , and the plug-in coil L_1 , which is used in the socket mounted on

the top of the amplifier cabinet, becomes the aerial tuning inductance. A more or less similar design has been followed in this instrument as in the "Midget" single valve set, and in the "Midget" L.F. amplifier, the latter described in the September, 1925, issue of THE WIRELESS CONSTRUCTOR. Although a slightly different style of cabinet has been chosen, the panel is of the same size as that of the original set.

Components for the Amplifier

The components which are required to build this high-frequency amplifier are both few and in-

expensive. They are given in the following list, and the maker's name is given against each part. It is not necessary to keep strictly to these makers, as any others to be found in the advertisement pages should prove suitable. Take care, however, if a different make is

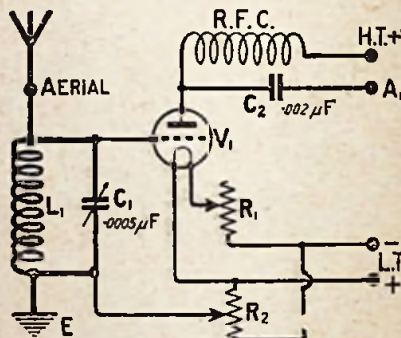
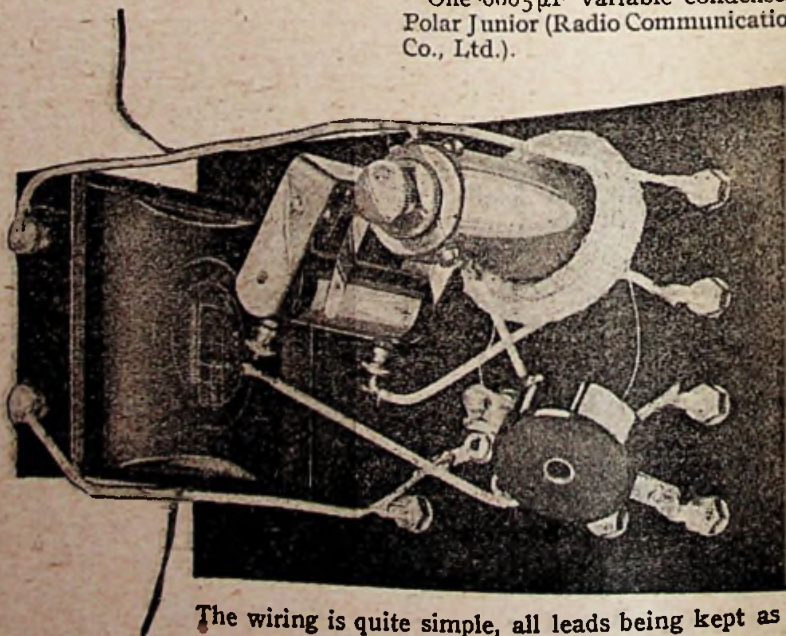

Fig. 1.—The simple circuit of the amplifying unit.

used, that there is ample room for it, since the unit is extremely compact.

Panel 6 by 4 by $\frac{1}{4}$ in. "Paragon" (Paragon Rubber Mfg. Co., Ltd.). Cabinet to take same as illustrated (The Aircraft Company).

One $0.0005 \mu F$ variable condenser, Polar Junior (Radio Communication Co., Ltd.).



The wiring is quite simple, all leads being kept as short as possible.

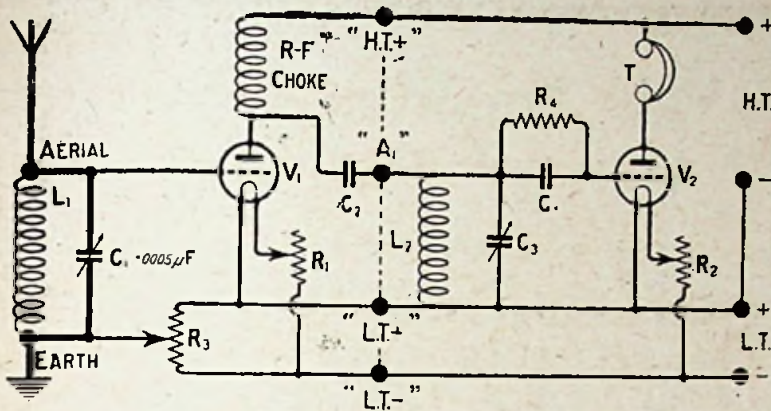

Fig. 2.—The amplifier connected to a simple one-valve set. The potentiometer is now R3.

- Lissenstat Universal filament resistance (Lissen, Ltd.).
- Potentiometer (Norman Radio, Ltd.).
- One "Security" valve holder (Williams, Ellis & Co.).
- Six terminals.
- One board-mounting coil socket.
- .002 μF fixed condenser (Watmel Wireless Co.).
- One ounce No. 30 S.W.G. d.s.c. wire.
- One 2 ft. length of Glazite.
- Packet Radio Press panel transfers.

Constructional Work

Having collected together all the necessary components, the unit may be constructed, and it will not be found to take very long. Commence by marking out the panel, on the side which is to become the back. The positions of all the holes can be seen from Fig. 3.

which is the drilling diagram, and of which a full-size blueprint is obtainable if desired.

Mounting Components

Having marked out the panel and then carefully drilled the holes, the components can be mounted, after the panel transfers have been affixed in accordance with the lettering on the diagram of Fig. 2. The fixed condenser, it will be noted, is not screwed to the panel at all, but is held in place by the wires which make connection to it.

Making the R.F. Choke

It will be seen that a coil of wire

Another back-of-panel photograph.

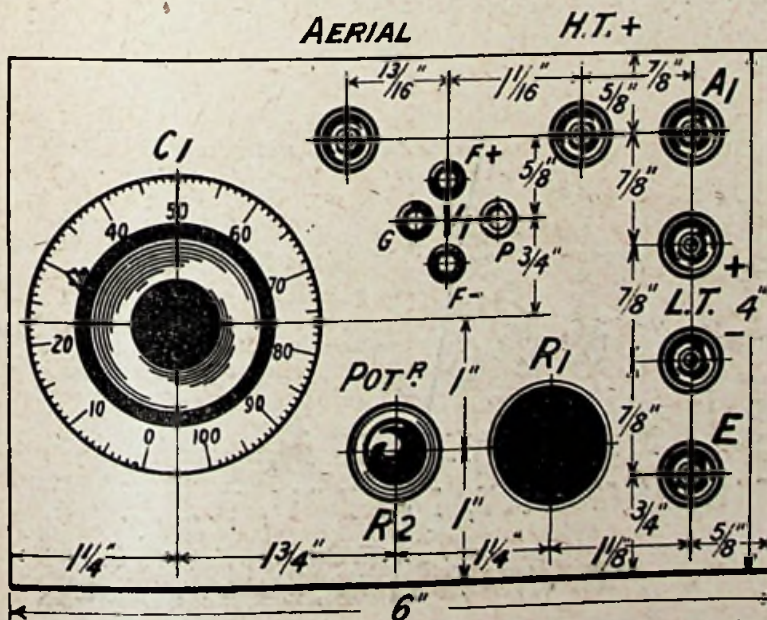
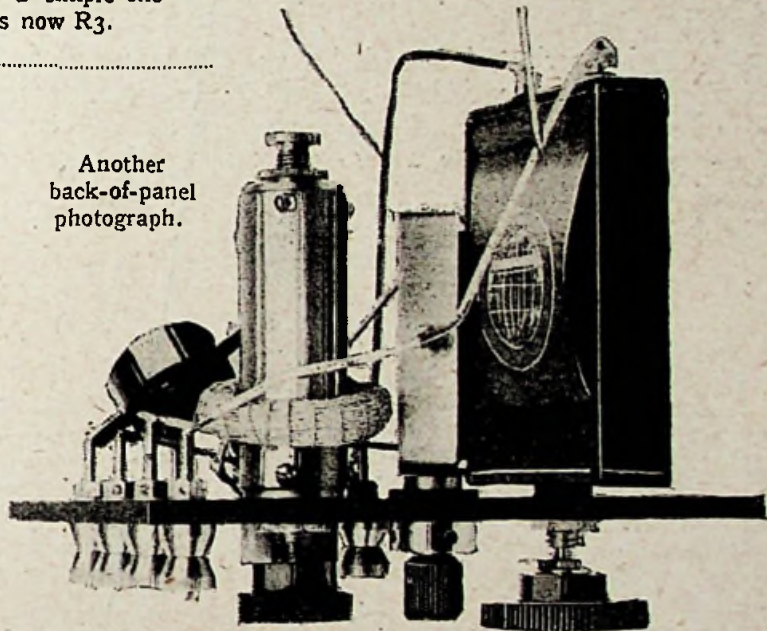

Fig. 3.—The drilling diagram. Blueprint C1037A may be obtained from the publishers.

is placed over the Lissenstat. This is the radio-frequency choke, and, since it has to be put into position before the set is wired, its construction will be dealt with next. A former, such as the wooden handle of a chisel, is obtained and about 200 turns of the 30-g. wire is wound on hank fashion, after placing three lengths of wire along the handle with which to hold the coil together while it is being removed from the former.

After removal it is bound all round with a long length of the same wire, the three small pieces being removed as necessary. This choke is intended for use when the set is to be used on the lower range of broadcast wavelengths. Having completed the choke, it may be slipped over the filament resistance and the wiring may be commenced.

It should present no difficulties whatever if the wiring diagram of Fig. 2 is followed carefully. Two pieces of flexible wire, or, if

2700
18-3-26

FADA Radio

Makes the Neutrodyne E-A-S-Y!



No technical knowledge, no skill necessary to build a Neutrodyne if you use FADA RADIO components. All the expert designing and manufacturing has been done. All you supply is ordinary radio common sense, a few simple tools, and a few hours' time.

And you'll have a Neutrodyne that *works* to perfection—selectivity, distance and volume that will amaze you!

Tens of thousands have built their own Neutrodyne from FADA RADIO parts. Not one of them has been disappointed. The same success awaits you!

FADA RADIO COMPONENTS 165-A

Convert your present 3-valve reaction receiver to a 5-valve Neutrodyne. Simply add the FADA 165-A Neutrodyne Components and the thing's done.

A 70-page instruction book "How to Build a Fada Neutrodyne" with a drilling template for panel, three FADA neutroformers and two Neutrodyne condensers are included in each set of 165-A parts. **£5**

FADA RADIO COMPONENTS 169-A

You never saw a set as easy to construct as this. Every component is provided ready to assemble. A 70-page instruction book describes every operation down to the smallest detail in correct order. A short evening's work with a few simple tools, and you have a set that looks as good and works as well as the most expensive outfit money could buy. **£14**

Manufactured under
Haxline Neutrodyne
Patents granted in
Great Britain.

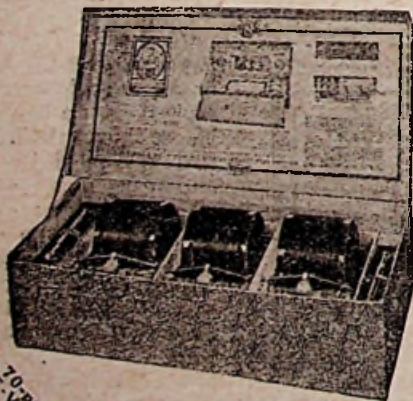

FREE!

Name.....

Address.....

70-page Book—"How to build a 5-Valve Neutrodyne." Send this Coupon TO-DAY!

FADA RADIO LTD.,
31, KINGSWAY, LONDON, W.C.2.



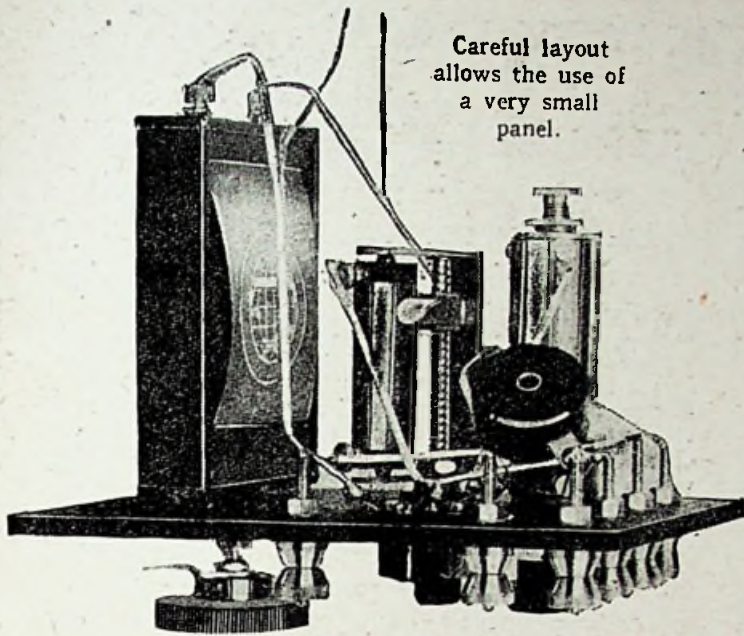

Careful layout allows the use of a very small panel.

usually used in the aerial socket of the ordinary receiver in the H.F.-coil socket, and a coil one or two sizes larger in what used to be the aerial socket. The best size of reaction coil must be found by trial if reaction is used.

Place the potentiometer as near to the negative end as possible without making the set oscillate, and tune simultaneously with the two variable condensers. An off position for the potentiometer is obtained by turning it to the left as far as possible. This should always be done to avoid wasting the I.T. current when the set is not in use.

In Practice

The amplifier was found to be quite satisfactory in practice, the high-frequency amplification effect serving to make stations which were difficult to hear and tune before quite satisfactory.

preferred, two lengths of No. 26-g. D.C.C. wire, are used to connect up the coil-holder and they are taken through two small holes drilled in the top of the cabinet.

How to Connect Up the Amplifier

As soon as the wiring is completed, the set may be put on trial. The L.T. is connected in the usual manner to the two terminals marked for it. The H.T.+ for the H.F. valve is placed on the H.T.+ terminal on the unit, the aerial is put on the terminal marked Aerial, the earth on the Earth terminal, and the terminal marked A₁ is connected to the aerial terminal of the set with which the unit is used.

Operation

The set and H.F. amplifier are now operated in the following manner. Place a coil of the size

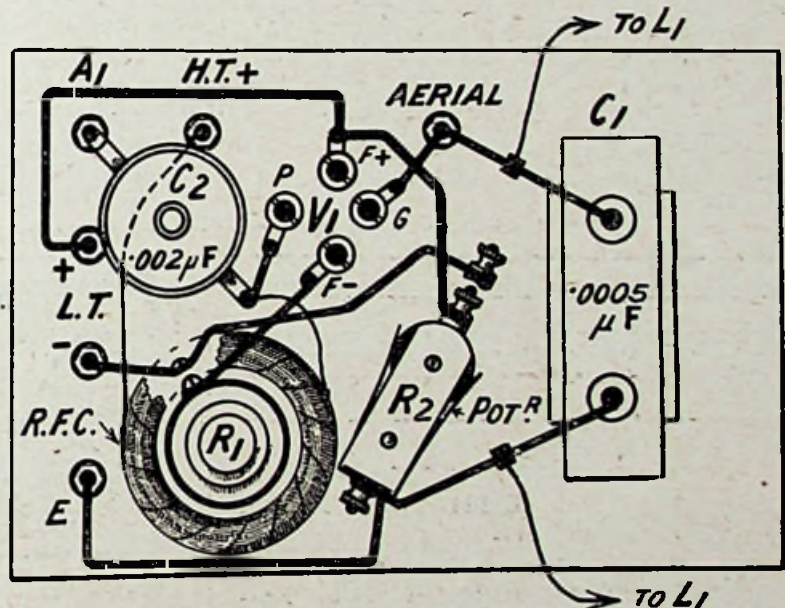
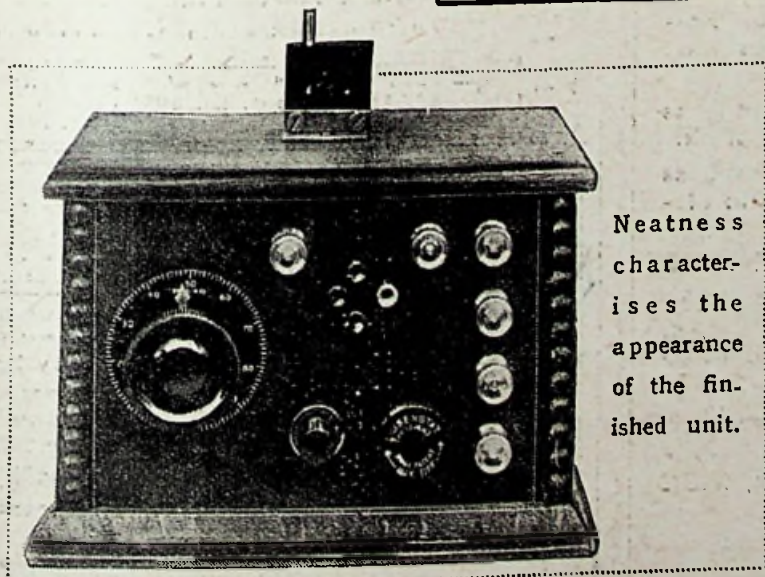

Fig. 4.—A reduced copy of the free wiring blueprint, Cr037B.



Neatness characterises the appearance of the finished unit.

Since it is possible to hear many stations on the "Midget" one-valve set, no purpose would be served in giving a list of stations received when using the amplifier.

It must be noted that the choke described is intended for the ordinary B.B.C. wavelengths, and while it might prove satisfactory on the higher waveband, this will not necessarily be the case. A similar choke suitable for 5XX would need about 350 turns. The actual size of this choke, however, will not be found to be at all critical.

Cutting Threaded Rod

MOST constructors who have attempted to cut threaded brass rod with a hacksaw will have noticed, first, how difficult it is to "get a start," and, secondly, how the threads at the end of the cut portion are torn and broken when the operation is completed.

Use of a File

Both these drawbacks can be avoided if a cut is made with a sharp-edged file all round the circumference of the rod at the required point before commencing work with the saw. This cut gives a smooth edge to the threads and provides a guide for the saw blade.

In the case of fairly thin threaded rod—4 B.A. or smaller—the saw can be dispensed with, as if a deep cut is made round the rod with the file edge, the rod can be snapped off at that point quite easily, any roughness being filed smooth afterwards.

H. M. S.

Free Blueprints for All!

THE SIMPLE CONDITIONS YOU MUST OBSERVE.

It has been decided to supply free a back-of-panel blueprint of any set in this and future issues of THE WIRELESS CONSTRUCTOR. Only one blueprint can be supplied to each reader, and only postal applications (accompanied by the coupon to be found in each issue) will be considered; callers will not be supplied. This offer applies only to THE WIRELESS CONSTRUCTOR, and will obviously be greatly to the advantage of readers.

REMEMBER :—

1. Only one blueprint supplied to each applicant. Extra blueprints are available at 1s. 6d. each.
2. Only a postal application for a blueprint will be considered, and it must be accompanied by the necessary coupon. Callers at our offices will not be supplied.
3. A coupon only covers the sets in the particular issue in which it appears.
4. Only back-of-panel blueprints are included in the free supply offer.

SOME NEW and REMARKABLE ALL-BRITISH PRODUCTS

The New Exide High Tension Accumulators.

All the Igranic Patent Products, Rheostats, Straight Line Frequency Condensers, Plugs and Jacks.

The New Edison Bell Low Loss Coils. Full range now in stock.

The New Ribbed Ebonite Low Loss Formers. 7-in. long, 3½-in. in diameter, 6/- each.

The latest Cossor P.3. Valve now in stock.

Send 6d. for the World's Finest Radio Catalogue (Callers Free), second edition ready shortly; or call and see our great Shop Window Display. (Mention this paper.)

WILL DAY, LTD.

19, Lisle St., Leicester Sq., London, W.C.2

Telephone: Regent 4577.

Telegrams: "Titles, Westrand, London."

SCRAP YOUR H.T. BATTERY!



If your Electric Supply is by DIRECT CURRENT obtain High Tension through the 'EKCO' H.T. UNIT (Pat.) by just attaching adapter to lamp-socket or wall-plug.

USERS' OPINIONS.

"... I may add that under test your Unit was very silent in use; in fact, better than any I have tried of these Units." J. H. (Wireless Dealer), CHESTER.

"... I have tested your 'EKCO' H.T. for the past week and am very pleased with it indeed. In fact, it is altogether superior to my 120 v. accumulator." J. S. (Wireless Dealer), LOVEHIOFT.

"... I am well satisfied with the 'EKCO' Unit—it works my 2 valve set splendidly."—H. H. (ACTON).

"I have tested the Unit very carefully and the results obtained are all that can be desired."—G. F. D. (LONDON).

UNITS TO SUIT ALL SETS from **29/6** PARTICULARS SENT FREE (Dept. D), 505, London Road, WESTCLIFF-ON-SEA

For BETTER RESULTS in Wiring-up, use

"KRISCROS" CONNECTORS

SOLDERING COMPLETELY SUPERSEDED!

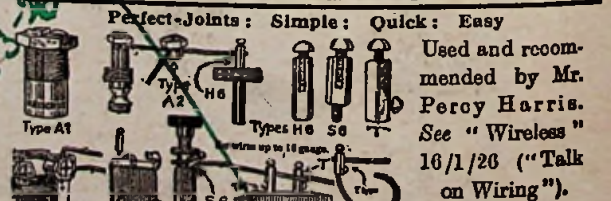

A "Kriscross" for every thread, every component and every purpose. From 1/- doz.

Send for List (Mail Order Dept.) KRISCROS Co., 188, Gray's Inn Road, London, W.C.1



Erecting Bamboo Masts

Hints on the use of bamboo poles for light but strong aerial supports

ALMOST everywhere nowadays one sees "aerials" held up at one or both ends by bamboo poles, but in almost every case these look more like—well, some are not fit to be described, they are a real disfigurement to the neighbourhood. I refer to those poles which are fixed at the bottom, but which bend so that their tops are many feet from the vertical through their bottoms, as in Fig. 1.

Bad Aerials

Again, quite apart from masts themselves, why do so many people lead in from perhaps one-third of the way along the aerial, and why do they take the lead in at such a sharp angle to the aerial? Perhaps worst of all, why does one see so many multi-wire aerials with the wires spaced about 1 ft. apart, when a single wire would be so much better? But I am not supposed to be criticizing aerials, but describing how to erect a fairly good-looking and effective mast for a few shillings.

To begin with, the mast I am going to describe will have a total height of 30 ft., and if put up with care should be able to weather the severest of gales.

The mast itself consists of two 15 ft., or three 10 ft. bamboos; these should be as stout as possible, and without flaws or bends.

How to Connect the Poles Together

The poles are connected together as shown in Fig. 2. A piece of thin walled iron piping, such as curtain rod, with a split down one side, is used. This must be of a slightly smaller diameter than the thick end of one pole. The thin end of another pole is forced into one end of the pipe; if necessary, the "knot" can be sawn off. The thick end of the first pole is then taken, the knot sawn off, and the pole forced into the other end of the pipe. It may be necessary to force the pipe open a little to admit the pole.

Using 15-foot Poles

In the case where two poles are being used to complete the 30 ft. of the mast, see that the poles are, as nearly as possible, of uniform diameter all the way up. As this is not usually possible in the case of 15 ft. poles, it is best to connect the two thick ends together in the middle—a method which will give a better finish and greater rigidity.

If the poles are a tight fit they will hold the pipe without any locking being necessary, if not, drill a small hole through the pipe and slip a piece of wire through.

Having connected the bamboos up, give the mast a coat of paint, and proceed with the construction of the stay wires.

Stay Wires

This type of mast requires at least one set of stay wires every 10 ft., for a single wire aerial, or every 7½ ft. for a cage, or heavier one.

Gauge of Wire Required

Having decided whether to use three or four sets of stays, mark off the positions of these along the mast. Here drill a small hole through the mast, and slip some 12 (or so) S.W.G. copper wire through

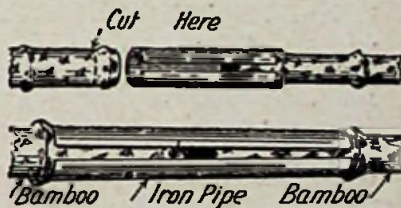

Fig. 2.—An extremely strong joint results if piping is used.

and bend it round to form four eyelets, to which the stay-wires may be attached.

Now fix a piece of 18 gauge galvanized iron wire to each of these (12 or 16 wires in all) and make sure that you don't cut them off too short. Insert a light insulator (shell or egg) about every 5 ft. along each stay.

"Packing" the Stay Wires

The next step is very important and must be carefully observed, or the wires will get in a hopeless tangle. Take the three (or four) stays which will come in one direction, and with the mast lying along the ground, with cotton tie the ends of these stay wires together and bind them all to the mast in several places with cotton, repeating the process with the three other sets of stays. See that the four sets of wires do not cross anywhere. Then tie a piece of string around the whole lot somewhere near the base of the mast. The stays will now be bound to the mast in four

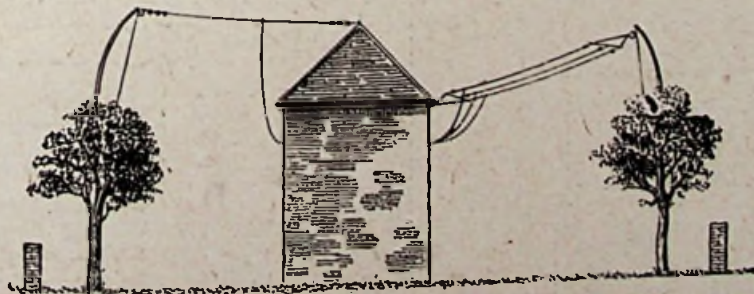

Fig. 1.—Many badly erected masts are ugly, if not dangerous, especially when no stays are employed.

Plot 18.3.26

Praesis ut prositis

Latin motto: "Be first that ye may be of Service"



Brown Type H4

THE success of the Brown Loud Speaker runs parallel with the rapid growth of Broadcasting. Each year has seen the Brown more firmly established in public favour. Its long lead—for the Brown was the first Loud Speaker ever built in this country for wireless use—has never been seriously challenged.

True, the immense wave of popularity it has consistently enjoyed has often made a temporary shortage unavoidable. But S. G. Brown Ltd. have remained steadfast to an ideal—the continued production of a series of Loud Speakers worthy of the great reputation enjoyed by Brown Wireless instruments throughout the world.

Not for one moment would they permit a hair's breadth deviation from this most rigid standard of manufacture. Whether a man pays thirty shillings for a Brown H.4 or fifteen guineas for a Brown Q type, he obtains the same quality of materials, the same careful workmanship—and therefore the same dependable Service.

S. G. Brown Ltd., Western Avenue, N. Acton, W.3

Retail Showrooms:
19 Mortimer Street, W.1
15 Moorfields, Liverpool
67 High Street, Southampton

Depots (Wholesale Only):
2, Lansdown Place West, Bath
Cross House, Westgate Road, Newcastle

Scottish Depot:
120 Wellington Street, Glasgow.



Eight Types of Brown Loud Speakers



Type H.1. 21 ins. high. 120 ohms £5 5 0 2000 ohms £5 8 0 4000 ohms £5 10 0	Type H.2. Height 17 ins. 120 ohms £2 5 0 2000 ohms £2 8 0 4000 ohms £2 10 0	Type H.3. 15 ins. in height and in resistance of 2000 ohms £3 0 0	Type H.4. The smallest Brown Loud Speaker. Only 10 ins. high. 2000 ohms £1 10 0
Type K.Q. 20 ins. high. Resistance: 2000 or 4000 ohms £6 0 0	Type Q. 23 ins. high. In resistances of 120, 2000 or 4000 ohms £15 15 0	Cabinet Type In Mahogany or Oak Cabinet, 2000 or 4000 ohms £6 6 0	Crystavox The only Loud Speaker which works from a Crystal Set. £6 0 0

—three types of Headphones

Type A. As used by the Admiralty 120, 2000 or 4000 ohms £2 10 0 8000 ohms £3 0 0	Type F. Popular Broadcast type. Weight only 6 ozs. 2000 ohms £1 0 0	Type A.2. The New reed-type, unequalled for sensitiveness. 2000 ohms £1 10 0
--	---	--

and two Gramophone Adaptors

For converting your Gramophone into a Loud Speaker	H.1 (2000 ohms) £4 10 0 H.2 (2000 ohms) £2 0 0
--	---

If the Trade have difficulty in obtaining Brown Wireless Instruments they should write to us without delay.



Above: Type HQ
Below: Type H3

separate sets of three or four. Fix a pulley at the top and thread a halyard through it and bring this down the side of the mast and fasten at the end, between two of the sets of wires.

Erecting the Mast

The mast is now carried to the point where it is to be erected, and

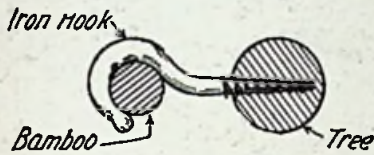

Fig. 3.—The end of the bamboo slips into a hook screwed into the tree.

if this is up a tree, stand the mast vertically against the tree.

It must be borne in mind that a mast like this can be held out horizontally, with the two hands only 4 ft. apart at the base end; it will bend, but should not show any signs of breaking unless faulty bamboos have been used.

Erecting a Mast on a Tree

If the mast is to be erected up a tree, as in the case of 6 LJ's mast (Fig. 5), fix a hook, or eye screw, 4 ft. below the highest point to which you intend to tie the base of the mast, pull the mast up, "hand under hand," and, holding it vertical all the time, slip the end (the knot having been removed) through the eye screw, and bind the mast to the tree 4 ft. above this (see Figs. 3 and 4). No stay-wires will yet have been used; the mast should be quite self-supporting without them when there is no aerial attached. Of course, choose a fine, calm day.

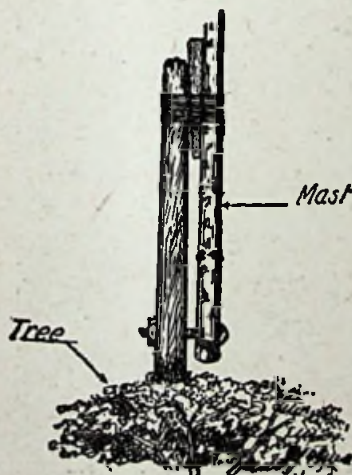

Fig. 4.—A wooden wedge may be forced between mast and tree to tighten the binding.

Anchoring the Stays

Then remove the string holding the sets of stay wires to the mast, and free these four sets. Throw them over the tree in the directions in which they must go. Climb down, and break the cotton by jerking the wires, and attach them to the ground points previously selected. Do not take them down at too sharp an angle to the mast; preferably at least 30° should be allowed

Utilising a Roof

If the mast is to be erected on a roof proceed as follows: First arrange that you yourself can get to the place on the roof where the base of the mast is to be. Then pass a string from here to the four

and from slipping down the roof. The other wires are then threaded through and fastened.

If the stay-wires are to go over the sides of the house, proceed just the same way, having led the four top wires in the correct directions.

A One-Man Job

Don't be afraid if you lose control of the mast; even if it falls while you are trying to erect it, it will do no damage to the slates, being so light.

The masts at the writer's station are entirely a one-man job, so even without assistance at all this type of mast can be easily erected.

Conclusion

With 3 or 4 sets of stay-wires as described it is really amazing

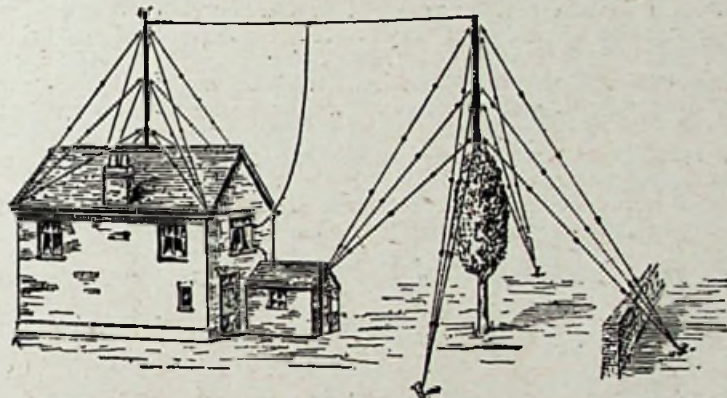

Fig. 5.—The aerial system of 6LJ. Three sets of stays are used for each mast, with insulators at intervals.

sides of the house, by which the stay-wires can subsequently be pulled over.

In the case of the mast at 6 TM the wires go right through the roof, through small holes in the slates. The wires were threaded through by passing a string out through the hole previously drilled through the slate from inside the roof box, fishing this up, attaching the wires, and pulling back the string. No, the roof does not leak; after all is finished, Chatterton's Compound was pushed up the holes, from inside the roof, and a flame was held under it for a moment till the holes were quite sealed off.

Stays through the Slates

The top section wires only are first threaded through, their lengths adjusted, with the mast lying along the roof, till they will be of correct size when the job is finished and the base of the mast stood on the top of the slates where it is finally to remain. It is not tied in any way, but is prevented from moving horizontally,

what large horizontal pulls the mast will sustain without showing signs of buckling.

There is one great advantage about this type of mast, which cannot be overlooked. It can be taken down and re-erected in about five minutes to repair pulleys, halyards, etc. Simply slip the mast off the slates, in the roof case, or untie it in the tree case, and pull it down "hand over hand," till you reach the top, fix the new rope, and push the mast up again. Don't touch the stay-wires at all.

The writer has no hesitation in recommending these masts, even when a heavy aerial is being contemplated.

"Wireless"

The One-Word Weekly

EVERY **2d.** TUESDAY

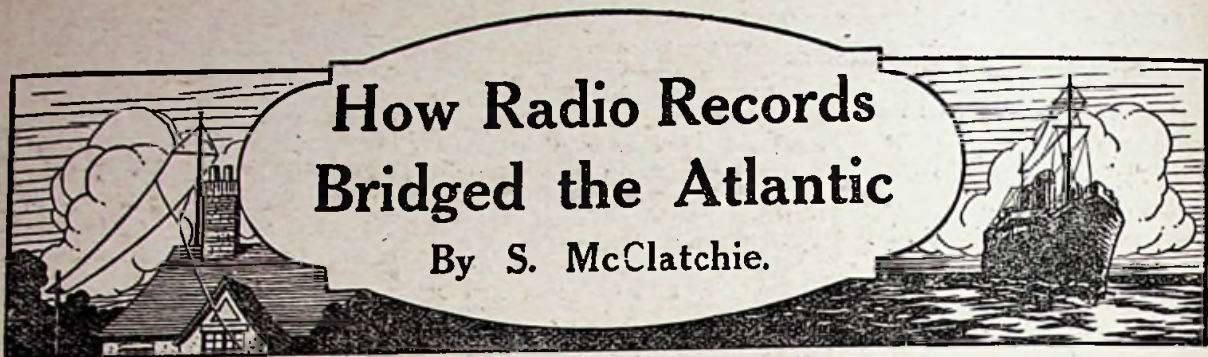

An account of new developments in voice reproduction by wireless

LAST Christmas Day a new means of bridging the ocean through radio was tried for the first time. A programme of official Christmas greetings from the German to the American people was broadcast from records especially prepared in Germany, through stations WRNY (New York), KDKA (Pittsburgh), and WBZ (Springfield, Mass.). To judge from the opinions expressed by the American listeners, the attempt was an unqualified success. Thousands of appreciative letters poured in, a large number of which asked for the transmission of further programmes along the same lines. The possibility of an important new field for radio development has been opened up, and many people have been asking, "Just how was it done?" Consequently a description of the method and its possibilities may be of general interest.

Stuttgart Re-broadcasts

About a year ago the writer was responsible for a number of re-broadcasts of KDKA in Germany, culminating in the sending over of a greeting from America to the German people, which was picked up and re-broadcast by the Stuttgart station. Shortly afterwards there began to be active discussion of plans for bringing German broadcasts to American listeners by means of transatlantic relays. However, in order to make practicable such an attempt, it would have been necessary for Germany to erect a special transatlantic broadcast station. But such a project seemed to the authorities to be of too uncertain and experimental a nature to justify the great expense and effort involved. Static, fading and other difficulties have thus far rendered transatlantic broadcasting very uncertain and imperfect.

A Danish Invention

Not content with waiting until radio engineering completely solves these problems, which may be a matter of many years, the writer began considering a method which would bring European broadcasting to American listeners without delay, with certainty, and with distortion and interference eliminated.

About 28 years ago, a Danish inventor, Poulsen, invented what is known as the telegraphone, by which speech and music may be magnetically recorded on a steel wire. Such a record can be of almost any desired length, and the reproduction given is extremely faithful. Why not apply the idea to broadcasting, by making exact records of European programmes, sending the records across the water just as a moving picture film is sent, and re-broadcasting the original programmes from the records? The idea seemed quite feasible, so the writer set about building a magnetic recorder or telegraphone for the purpose.

Many difficulties were encountered, but finally the machine was brought to a point at which only a trained ear could distinguish between an original broadcast and the reproduction of it given by the wire. Many records of German broadcasts were made on this machine and brought over to America, and an accompanying illustration shows the apparatus as set up in the studio of Station KDKA of the Westinghouse Electric & Manufacturing Company, at East Pittsburgh.

The Telegraphone

The machine carries two spools so arranged that the steel wire is wound from one on to the other and passed in the process over an electromagnet. The picture shows the writer with eyes directed towards the spools. Immediately over them is a speed indicator for checking the speed of rotation, and means are provided for

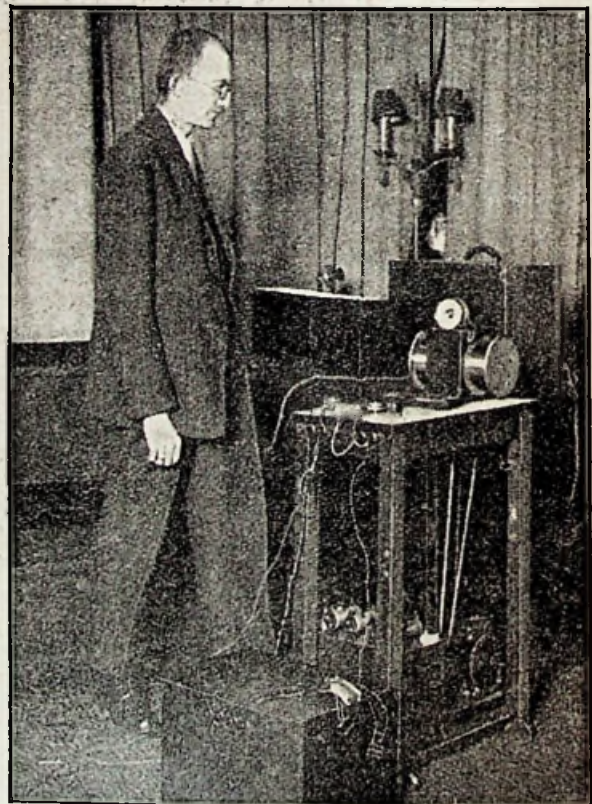

The author with the telegraphone used at KDKA for re-broadcasting German programmes to American listeners.

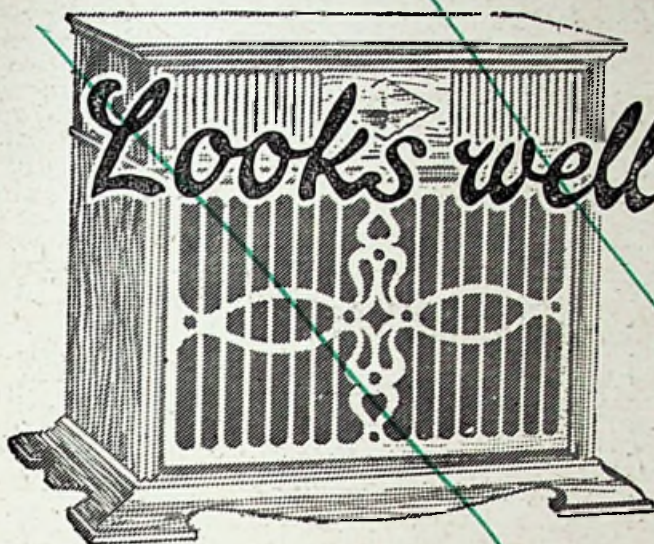

Looks well - Sounds Better!

**CABINET LOUD-SPEAKER
IN MAHOGANY
Price - - £3 : 15 : 0**

THERE are many who prefer cabinet loud-speakers to those of orthodox design. The model illustrated above is of mahogany with a fretted front, and makes a decidedly attractive addition to any room. As reproducing instruments these cabinet loud-speakers are second to none, the tone being exceptionally pure and free from distortion.

As musical reproducers the standard models are in every way as good as the cabinet model shown above, but of course, considerably greater volume is obtained from the standard type. These may be obtained with flares of Mahogany or Oak, and we have no hesitation in suggesting that you should judge for yourself by direct comparison.

Those with metal flares may be obtained Black if desired: Price £4; but the most popular ones have flares hand-painted and grained to resemble various woods: Price £4 5 0.

The Junior Loud-Speaker is not a "Baby" model, but stands 19 inches high, and produces fine round tone, and is free from the usual disadvantages generally associated with small loud-speakers. These may also be obtained Black: £1 15 0; or coloured to match various woods: £1 17 6.

HIRE PURCHASE.

Messrs. H. TAYLOR & Co., Ltd., 49/53, Sussex Place, South Kensington, S.W.7 (near South Kensington Station), are prepared to arrange for the sale of A.J.S. Receivers and Loud-Speakers on easy payments



Models with Wood Flares in Mahogany or Oak Beautiful Reproducers £4 15 0



A. J. STEVENS & Co. (1914) Ltd.
Radio Branch, WOLVERHAMPTON

Telephone: 1748 (7 lines). Telegrams: "RECEPTION, WOLVERHAMPTON"

London Showrooms: 122/124 Charing Cross Rd., W.C.2
Phone: REGENT 7161-2. Grams: "AJAYESCO, WESTCENT, LONDON"

Glasgow Showrooms: 223, St. George's Rd., Glasgow
Telephone: DOUGLAS 5449. Telegrams: "RECEPTION, GLASGOW"

A. J. STEVENS & Co. (1914) Ltd.
Radio Branch, WOLVERHAMPTON

Please send Publication No. 118.

Name

Address

C. April, 1926

Issued by the Publicity Dept. A.J.S.

In replying to advertisers, please mention THE WIRELESS CONSTRUCTOR.

automatically guiding the wire back and forth so as to give even distribution over the winding spool. The wire is led over two "idlers" or pulleys at the front of the apparatus and between these pulleys is mounted the electromagnet. The driving motors are located near the floor, far enough away from the magnet to prevent them from introducing unwanted electromagnetic disturbances through sparking, etc. A motor is connected to each spool separately, in such way that the wire may be run in either direction.

What the Wire Does

On the floor in front of the telegraphone is a box containing the amplifier, for magnifying the very weak currents induced by the magnetic wire to loud-speaker strength. Steel piano wire of about No. 30 gauge is used, the reproducing electromagnet having a diameter and length of about $\frac{3}{8}$ in. and a soft iron core of about $\frac{1}{4}$ in. diameter. This core has a groove in its outer end in which the piano wire runs. The magnet may be wound to a resistance of anything from 100 to 5,000 ohms, depending on the impedance of the circuit in which it is to be placed, and the piano wire is run over it with a speed of about 100 yards a minute. The spools used in the apparatus shown hold five pounds of wire, and give a record of an item lasting about three-quarters of an hour.

How the Record is Made

The voice currents to be recorded are put through the magnet and as the wire passes by it is given a varying magnetization, corresponding to the fluctuations of the voice current. If now the magnet is disconnected from the input circuit, and the wire is again run through with the original velocity, the varying magnetic field of the wire will set up currents in the magnet winding corresponding to the original signals. These currents may be amplified and made to operate a loud-speaker, or the amplifier may be connected to a broadcast transmitter, in which case the original speech and music will be "put on the

air," just as though it were being broadcast for the first time from the microphone. The making of really good records is quite a delicate task, involving many circuit adjustments, but once these have been made it is a simple matter to give a practically perfect reproduction of the original programme at any time or place. Should it be desired to make a new record

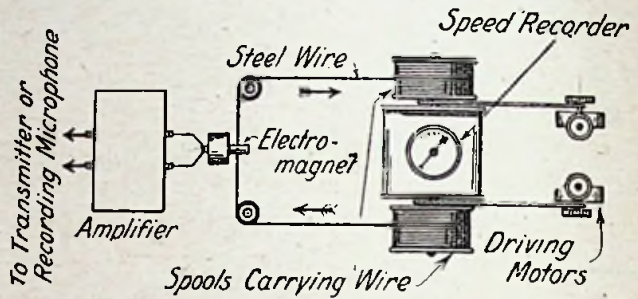

Fig. 1.—A diagrammatic representation of the telegraphone in use.

on this wire, the old one may be readily wiped out by simply passing the wire through a constant magnetic field, such as that of an ordinary permanent magnet.

By means of this apparatus a record of any broadcast programme may be made, and records of a number of programmes of the broadcasting station at Stuttgart, Germany, have been thus made, and used at KDKA.

Wax Recording

While the magnetic method of recording has the great advantage that the record may be quickly made anywhere, it has the disadvantage that the making of duplicate records to be used anywhere and everywhere is not quite a simple matter. Here the gramophone disc has an unquestionable advantage at the present time. Disc records are readily duplicated and may be employed wherever there is a gramophone. However, the quality of reproduction given by the familiar disc record is not always such as to be suitable for broadcasting. Indeed, the use of such records in high-class stations is forbidden in the United States by a ruling of the Department of Commerce, although in this country listeners are familiar with such transmissions. But in the course of the past year radio has come to the rescue of the gramophone and developed new and revolutionary methods of recording and reproduction. These processes have, for some time been kept shrouded in secrecy, and although the writer has been unable to secure photographs of the apparatus used he has seen the process and is in a position to give a general description of it.

The Condenser Microphone

This new method of record making and reproduction is a direct adaptation from the technique of radio broadcasting. The microphone used is of condenser type and consists essentially of nothing more than two metal discs separated from one another by less than $\frac{1}{1,000}$ of an inch, constituting a condenser. One of the discs is so mounted that it will vibrate with sound waves, the capacity of the condenser thus being altered in accordance with the sound vibrations of speech or music. The condenser is charged to a potential of several hundred volts by means of a battery connected to it through a high resistance, and the vibrations of the free condenser plate set up minute changes of potential, which are impressed on a three-stage amplifier and thus greatly magnified. The



Transmitting equipment at the Stuttgart station, which has taken part in the re-broadcasts.

condenser microphone gives very faithful reproduction of the highest and the lowest notes, and has a nearly straight-line frequency characteristic.

Recording Needle

From the amplifier the currents pass through a filter system, to be explained later, and thence to a so-called electric needle. This is the instrument which actually

cuts the record in the wax disc, and consists of nothing more than a gramophone needle actuated by an electro-magnet in such a manner as to cut a record in the soft wax corresponding to the voice currents coming from the amplifier.

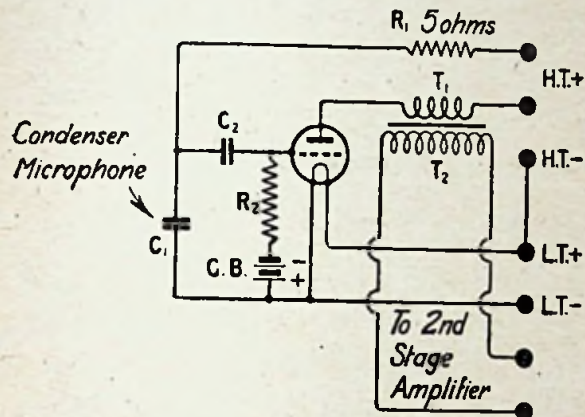

Fig. 2.—The connections in the condenser microphone circuit are shown in this diagram.

cuts the record in the wax disc, and consists of nothing more than a gramophone needle actuated by an electro-magnet in such a manner as to cut a record in the soft wax corresponding to the voice currents coming from the amplifier.

Now, this electric needle would not of itself produce a record in the wax corresponding exactly to the currents from the microphone. This is for the reason

that the needle working on the wax has a natural tendency to record some bands of tone frequencies more strongly than others. The microphone itself also shows the same inclination to a slight degree, and to correct these tendencies, which would otherwise manifest themselves as distortion in reproduction, the filter system is introduced.

The Filter System

This consists of an arrangement of condensers and inductances so proportioned that frequencies which would otherwise be neglected in the record are emphasised, and that other frequencies which the record tends to over-emphasise are cut down in volume. In this way a record with a straight-line frequency characteristic may be produced. That is to say, the record gives a faithful copy of all sounds in their true proportion to one another, instead of greatly over-emphasising a certain small band of frequencies and leaving the very high and low notes out altogether, as is the case with the old acoustic-recording methods.

A Notable Year

The secret of the wonderful reproduction lies, then, in the electrical circuits. This is really one of the greatest achievements of radio engineering of the past year, a year which might almost be characterized as the straight-line frequency characteristic or "S.L.F." year in the calendar of radio history. It has brought us three achievements of far-reaching importance: the S.L.F. microphone, the S.L.F. loud-speaker and the S.L.F. record. This means that practically the whole musical scale, properly proportioned, is brought to the unseen listener's ear, instead of, as heretofore, only a comparatively small portion of this scale. It is the difference between the full, rich tones of real

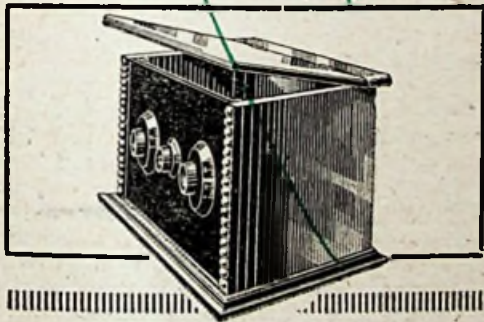

The Artcraft Cabinet for Radio Receivers

Sizes of "Artcraft Popular Type" Cabinets		
Panel Size	Depth	Price
9 x 6	6 x 6	8/0 10/0
10 x 8	8 x 6	8/0 12/0
12 x 8	8 x 0	10/0 14/0
12 x 10	8 x 8	12/0 16/0
14 x 10	8 x 8	14/0 18/0
16 x 8	8 x 8	14/0 18/0
16 x 10	8 x 8	16/0 21/0
18 x 12	8 x 0	21/0 29/0

Hinged Top 1/8 extra

Prices include packing, carriage and insurance to any station in England and Wales. Prompt delivery guaranteed.

ARTCRAFT Cabinets are made in Oak or Mahogany, and are of very attractive and pleasing design. Baseboards included free.

RADION PANELS fitted to all Cabinets at 1d. per sq. inch Black. 1½d. per sq. inch Mahogany.

Cabinets can be supplied for all sets described in Radio Press publications. Quotations sent by return of post.

Write for Illustrated Brochure of Standard "Artcraft" Cabinets

THE ARTCRAFT COMPANY, 154, CHERRY ORCHARD RD. CROYDON. Phone: Croydon 1931

now try choke amplification

Given a good circuit with suitable valves you can demonstrate for yourself that choke amplification is decidedly superior to average transformer coupling. The result depends largely upon the efficiency of the choke, and apart from our claim of the superiority of the Success Super

Choke it is significant that leading constructional experts repeatedly include it in their specifications. This Success product embodies the essential features indicative of a good choke. It is wound with ample turns of large gauge wire upon an effective iron core.

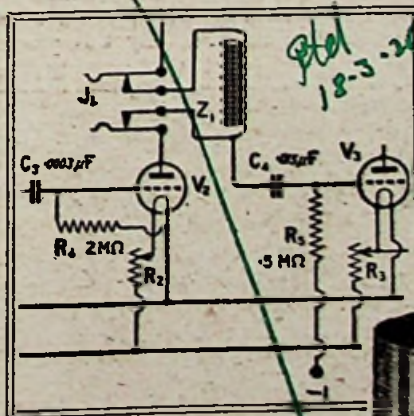

With the Success Super Choke we claim that you can secure consistent amplification over audio frequencies—in fact, the power of reproduction and its remarkable mellow tone will be a revelation and immediately convert you to choke amplification.

In the diagram we indicate the usual method of Choke capacity coupling

SUCCESS SUPER CHOKE. Price 18/6
BEARD & FITCH LTD.

34, AYLESBURY ST., LONDON, E.C.1
And at 1, Dean Street, Piccadilly, Manchester.



music and the cramped imitation which has heretofore passed as good reproduction.

Electrical Reproduction

For reproducing from these electrically cut records, a special reproducer is used. This is simply a phonograph needle attached to an armature or diaphragm mounted before the poles of an electro-magnet, so that vibrations imparted by the record to the needle will set up currents in the magnet by induction. These currents are put through an amplifier connected either to a loud-speaker or to a broadcast transmitter. A filter may also be connected in the circuit to correct any faults introduced by the reproducer, or to reduce the slight ground noise or scratch which is sometimes noticeable.

Excellent Results Achieved

The whole recording and reproducing process from start to finish is accomplished with instruments of radio engineering. By this new means it is possible to produce records which, when put on the air, are practically indistinguishable from the regular studio broadcasting. The British Broadcasting Co. has been using some such records, put on as part of the regular programme. They could not have been distinguished from other features if the announcer had not stated that such a record would be put on. This is simply due to the S.L.F. characteristic. The record is delivering just the same sort of output as the microphone itself, so there is no reason why the two instruments should produce results distinguishable from one another in the transmission.

Pioneer work in developing this new process has been carried on in America by the Westinghouse and General Electric Companies in conjunction with certain gramophone concerns, while in Germany the process is being developed by Dr. Stille, Chief Engineer of the Vox concern, which makes radio apparatus and gramophones. The Vox Co. is the chief stockholder in the broadcasting station of Berlin, and, since the official greetings from Germany to America proceeded from that city, it was natural that the new recording method being developed by the Vox Co. should be used.

The Phono-Film

A third method of recording which offers much promise is the phono-film method. By this process

the currents from the microphone are converted into light pulsations, and the pulsating light beam falls on a rapidly moving film of the motion-picture type. The film records the pulsations as light and shade. In reproducing, a beam of light passes through the film, this time falling on a photo-electric cell. The amount of light which the film allows to pass varies in accordance with the light and shade, and these

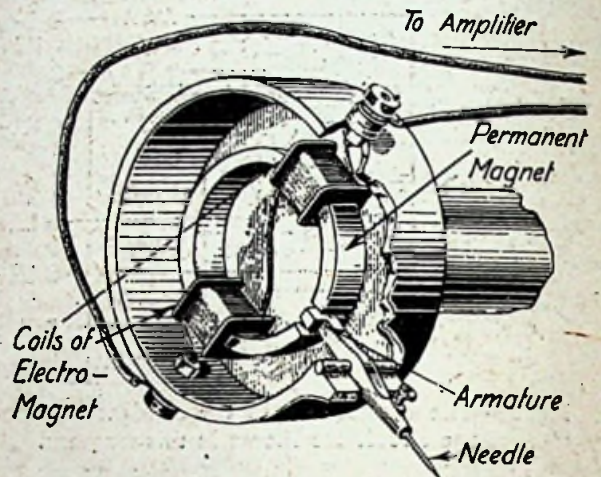

The reproducer is employed in conjunction with a wax record, the resulting currents being used to modulate the station's carrier wave.

variations in the light beam are reconverted into electrical pulsations by the photo-electric cell, the current then being amplified and passed on as in the other methods. The photo-electric process has the advantage over the wax record in that no perceptible scratch whatever is present; but, of course, such film records are quite expensive to make and the process is not as yet fully developed.

Future Possibilities

These recording possibilities open up a new field for broadcast development. The programmes of Moscow, Berlin, New York, Paris, or even Tokio and Peking, may be brought to listeners in Britain just as they were originally given, with no distortion, atmospheric, fading or interference. This is an important step in the direction of international understanding, as well as an extension of the realm of radio enjoyment. But the possibilities by no means end here. It is possible that some day the best numbers on the broadcast programmes of all the B.B.C. stations will be prepared in London, just as to-day American "movies" come from Hollywood.

With the participation of the most famous artists, numbers carefully rehearsed can be recorded, the records distributed to stations throughout the country, and then "released" on a certain day like films and news bulletins. No one can foresee all of the possibilities, but, at any rate, there can be no doubt but that the S.L.F. record is destined to impress its influence on the broadcast art.

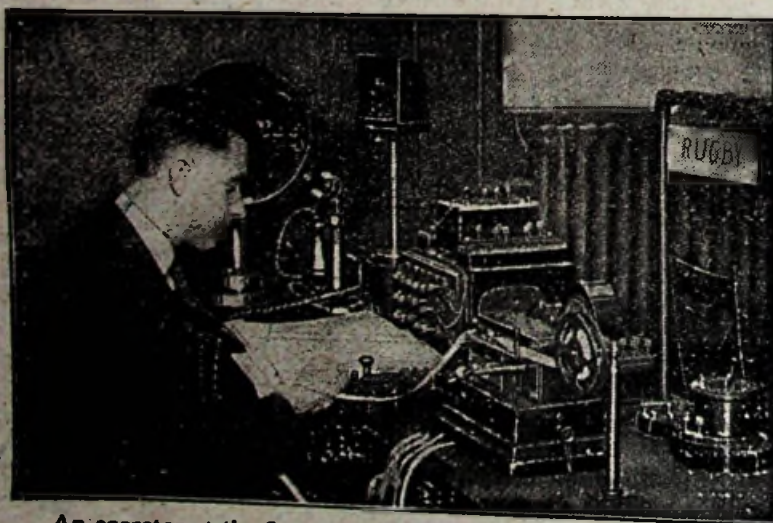

An operator at the Central Telegraph Office, London, sending messages to Rugby for wireless transmission.

TANGENT 2-Valve Radiomatic RECEIVER

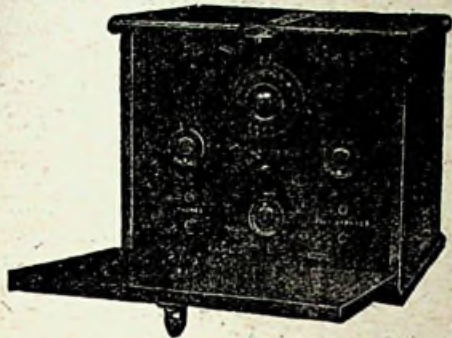

Here is an excellent product—The Tangent Two-Valve Radiomatic Receiver. This is manufactured specially to work with the new Daventry Station, and we claim that—even though it be a bold claim we can substantiate it—the Receiver obtains most satisfactory Loud Speaker strength up to 100 miles.

The whole instrument is designed and constructed according to Gent's best traditions.

Write
for
Leaflet.



London:
25, Victoria
Street,
S.W.1.

Newcastle-
on-Tyne:
Tangent
House,
Blackett
Street.

Free
on
Request

GENT & Co., Ltd, Far day Works, Leicester.

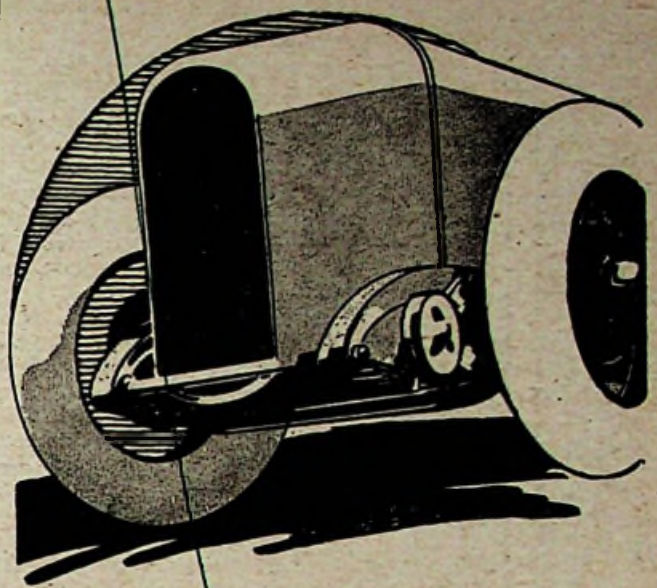

SMOOTHING OUT SHOCKS



The purpose of the Mansbridge Condenser is to smooth out the shocks in your head-phone and loud speaker reception.

Every H.T. battery causes intermittent crackling noises owing to partial polarisation and other internal irregularities which cannot be controlled. A Mansbridge Condenser across the H.T. terminals of your set, however, at once eliminates these noises (which sound very like atmospheric).

Mansbridge Condensers are made in capacities from 0.2 to 2 microfarads, at prices from 2/6 to 5/.

It is important to note that the only condensers made by the Mansbridge Condenser Co., Ltd., carry the words "Mansbridge Condenser" embossed on the case as illustrated above. There are many imitations, but only those bearing this characteristic are the genuine products of the Mansbridge Condenser Co., Ltd., and guaranteed and sold by the Dubilier Condenser Co. (1925) Ltd.

Note that the screw terminals are now also fitted with soldering tags.

MANUFACTURED BY THE
MANSBRIDGE
CONDENSER CO. LTD.
GUARANTEED & SOLD BY THE
DUBILIER
CONDENSER CO. (1925) LTD.

ADVERT. OF THE DUBILIER CONDENSER CO. (1925) LTD., DUCOR WORKS, VICTORIA RD., NORTH ACTON, W.3 TELEPHONE: CHISWICK 2241-24 B.P.S. 6

Henderson
Instruments

Fine Tuning Assured by Fine Movement

This new Henderson "Crescent" Coil Holder, recently put on the market, is of exceptional efficiency and possesses several entirely unique features. Obtainable from all good Dealers—or in case of difficulty by writing direct to the manufacturers.

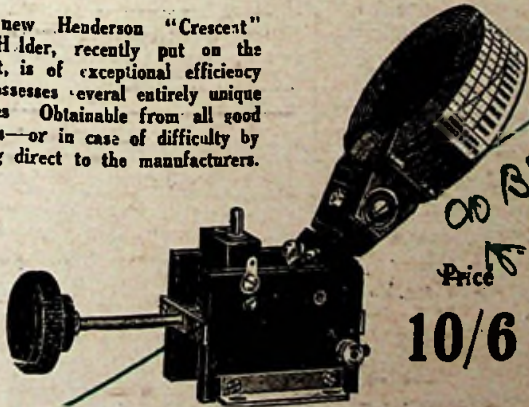

Prov
Pat.

Price
10/6

The New Henderson "Crescent" Coil Holder

The coil moves in same plane as spindle, saving panel and cabinet space. Fine tuning guaranteed by micrometer adjustment at all angles. Rigidity assured in any position and complete freedom from backlash or whip.

Manufacturers:—

W. J. HENDERSON & CO., Ltd.,
351, FULHAM ROAD, LONDON, S.W.10

Phone: Kensington 8983

Sole Distributors for Scotland (except Aberdeen) Kirby, Johnson & Co.,
68, Gordon Street, Glasgow

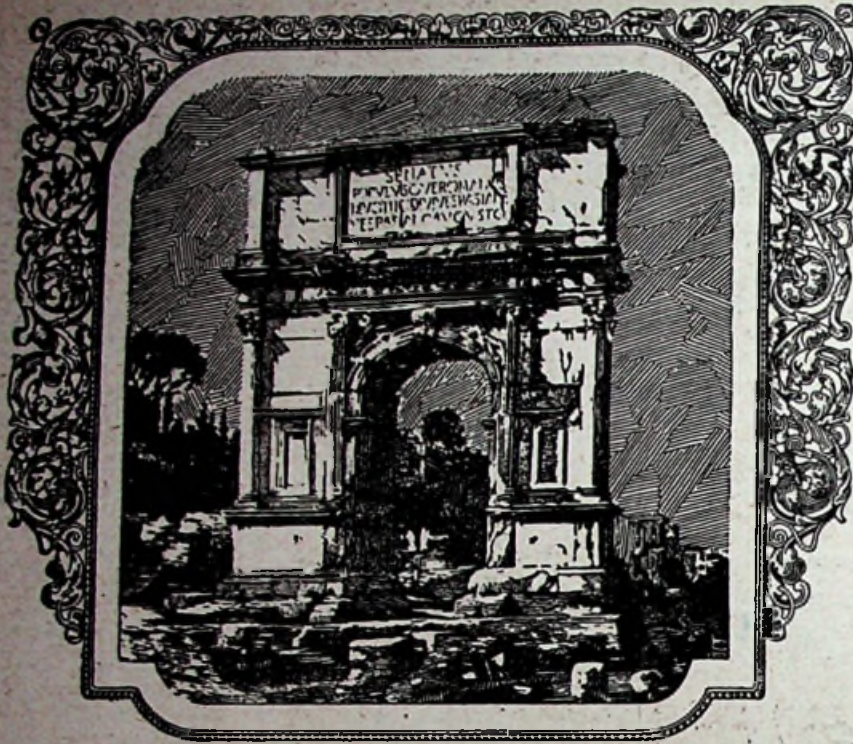

Ageproof and weatherproof

NINETEEN centuries have passed since the erection of the Trajan Column—a monument to perpetuate the first Roman Emperor who was not by birth a true Roman. The hand of Time has faded to dim its lustre. Ageproof and weatherproof, it stands an everlasting memorial to the skill of its craftsmen.

Ageproof and weatherproof, too, is every Eureka Transformer. Snugly sealed within its coppered steel case, even a fourteen-day test of immersion in water failed to break down its exceptional insulation.

But important as these qualities may be, we do not labour them unduly. A Transformer is bought for its ability to produce a generous volume of rich pure

tone. It must amplify equally all the notes of the harmonic scale. In an orchestra the thin piping notes of the clarinet must not be lost at the expense of the deep rolling notes of the double bass.

In setting out to design their Transformer, Eureka engineers struck right at the heart of the problem. They eliminated the laminated core as a possible source of distortion. They vastly increased the size of the windings and reduced the ratio of turns. And finally they wound the primary on the outside of the secondary.

Just as Eureka construction is unique, so Eureka results are unparalleled. Tens of thousands of users in this country and abroad are proud to testify to its ability to "re-create the living artiste."

Eureka Concert Grand - 25/-
Eureka No. 2 (2nd class) - 21/-
Eureka L.F. Choke Unit - 25/-

Eureka Baby Grand - - 15/-
Baby Grand No. 2 - - - 15/-
Eureka Reflex - - - - 15/-



EUREKA

Advertisement of Portable Utilities Co. Ltd. (Eureka Radio Products), Fisher St., W.C.1

Gilber. Ad. 4575 /

In writing to advertisers, please mention THE WIRELESS CONSTRUCTOR.

ELECTRADIX RADIOS

Have a large City Showroom at 218, UPPER THAMES STREET, E.C.4 and are selling an enormous stock of Radio and Electrical Goods of the highest grade—Marconi, Siemens, Sullivan, Brown, Western Electric, at bargain prices. Send 4d. for illustrated catalogue and price list New RB 0, valve sets complete with valve, plugs, etc., 32/6 NEW WESTERN ELECTRIC LOUD SPEAKERS. Complete with Cord in Maker's Sealed Carton, 20/- Cheaper than Asenher's 2,000 ohms, 20/- 70 ohms. 17/3



"The Catalogue that saves you pounds"

Its scope ranges from a 3/6 pair of British Headphones to a 1/2 6d. Milliammeter to a 30,000 volt Generator, and covers all requirements.

If you cannot call and inspect goods in our showrooms between 9 a.m. and 6 p.m. it will pay you to send 4d. for our Catalogue at once. Goods promptly despatched all over the world.

ELECTRADIX RADIOS,

218, Upper Thame Street, London, E.C.4
Phone City 191

Address all Post Orders to City Showroom:

218, Upper Thames Street, London, E.C.4

06 DE'S 10/6

Our Valves are admitted to be the best British made valves on the market 3 Volt 06 L.F. or H.F. only 10/6 2 Volt 34 only 10/6 Power Valves from 12/6 Write at once for our FREE "BOOK and get full particulars. If you order "BOOK" we supply direct. RADION LTD, Radion Works, BOLLINGTON, Macclesfield, England

RADION
Reliable Valves

EBONITE BUSHES

FOR MOUNTING ON WOOD PERFECT INSULATION
Two required for each hole

Orders under 1/- send 1/4d. Postage

NUMBER	1	2	4	8
Size of hole	4BA	2BA	1/4"	5/8"
Price each	1d	1d	1d	2d

DAREX RADIO CO., Standard Works Forest Hill, S.E.25

Liberty Permanent Detec.or

The Original One-Hole Fixing Detector
Stop Fiddling with Cat's Whiskers



Refuse inferior imitations. Insist on seeing the name 'Liberty' to be true.

Technical Reports

Amateur Wireless.
Popular Wireless:
Wireless Weekly:

Every Liberty tests on actual broadcast and fully guaranteed.

50% more efficiency
50% lower price
"THE '100' DETECTOR"

FIXING—One hole only. No need for cat's whiskers. No need for extra connecting wires. No need for extra terminals.

The "Liberty" Detector gives more sensitive reception. Permanently has a cat's whisker gives temporarily. No hunting for the "special spot" lost by the slightest vibration. The "Liberty" is entirely unaffected by vibration sensitive all over, and that loud spot cannot be lost.



From all Dealers or direct
PRICE 2/6
COMPLETE

Radi-Arc Electrical Co., Ltd.
Bennett Street London, W.1

Do You Get the Best from Your Set?

EVERYONE will agree that, in order to obtain the best from a receiver employing reaction, the control over this feature must of necessity be very smooth. It must be possible to make the set "slide," and not "flop," into the oscillatory state. Of the several possible methods for obtaining this smooth control, a number are discussed elsewhere in this book by Major James Robinson, D.Sc., Ph.D., F.Inst.P.

One very satisfactory method is that incorporated by Mr. Percy W. Harris in his novel three-valve receiver "The Melody Three," which he has described in the March double number of *Modern Wireless*. Here a fixed reaction coil is employed, shunted by a variable resistance. "The Melody Three" embodies three valves arranged as H.F. amplifier, detector and L.F. amplifier respectively, the H.F. valve being neutralised in order to obtain stability. This neutralisation, combined with the smooth reaction control mentioned above, results in a most sensitive receiver, capable of bringing in several Continental stations on the loud-speaker under normal conditions.

Two H.F. Stages

Regular readers of Radio Press journals will recollect the articles on the neutrodyne methods which have appeared during the past month or so from the pen of Mr. J. H. Reyner. In the March issue of *Modern Wireless* this author describes a four-valve receiver which embodies several up-to-date improvements. "The Neutrophase Four," as it is named, consists of two H.F. valves, both neutrodyne, detector and one L.F. valve, and combines extreme sensitivity with a high degree of selectivity.

In the same issue, the constructor who for any reason is limited to the use of a frame aerial will find the seven-valve super-het. designed by Mr. C. P. Allinson of great interest. Incorporating an unusual method of coupling the oscillator and detector valves, this receiver has a large number of stations to its credit, 39 separate transmissions having been received by the designer during one test.

Crystal Rectification

The usefulness of the crystal as a detector, and the tonal purity

associated with it, has been borne in mind by Mr. E. J. Marriott in the two-valve-and-crystal receiver described by him in the same issue of *Modern Wireless*. This set will bring in the local station at good loud-speaker strength, whilst several more distant stations can be heard in the telephones.

Alternative Methods

When using the valve as a detector, it has become almost a habit to arrange the circuit for cumulative grid rectification, generally little thought being given to any other method. Mr. A. V. D. Hort, however, has, in a single-valve receiver which he describes

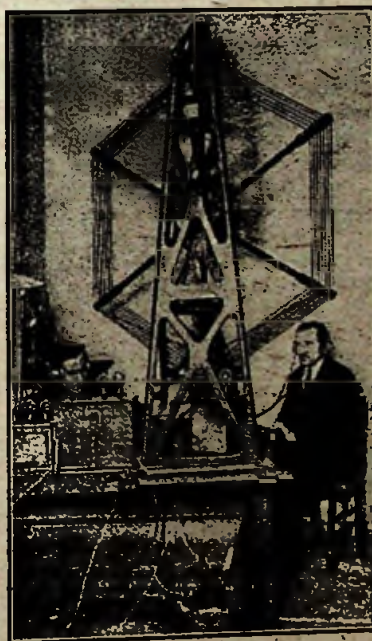

The radio equipment at Le Bourget Aerodrome.

in the current issue of *Modern Wireless*, incorporated an arrangement whereby either cumulative grid or anode current rectification can be obtained at will, and thus a direct comparison between these two methods may be observed.

Problems of Interference

In concentrating on getting the most efficient results from our local station, in many cases, we are satisfied with only moderate signals from the Daventry station. The crystal receiver described in the March issue of *Modern Wireless* by Mr. Stanley G. Rattee, however, has

been designed primarily for the reception of 5XX, although the local station can also be heard.

Besides those mentioned above, a large number of interesting and helpful articles appear in the March double number.

To mention only one or two, "Some Interference Problems in Supersonic Reception," by Capt. H. L. Crowther; "Laying Out Your Receiving Set," by Mr. A. Johnson-Randall; "The Era of Low Loss," by Mr. H. J. Barton-Chapple; "Measurements On Your Receiver," by Mr. D. J. S. Hartt; and a whole host of other articles by eminent authors combine to make this issue an exceptionally fine double number.

Reduced to Half!

Regular readers of Radio Press journals will already be aware of the reduction in the price of *Wireless Weekly* from 6d. to 3d. Its size, however, has in no way been reduced; indeed, the scope of its contents has been considerably broadened.

Of Interest to All

Constructional articles regularly appear, whilst articles by the Editor, Mr. John Scott-Taggart, and by the Technical Editor, Mr. J. H. Reyner, are proving of outstanding interest to all readers. Apart from the well-known writers on the Radio Press staff, a number of outside experts of high reputation are regularly contributing articles to this periodical. Among these might be mentioned Capt. H. J. Round and Capt. A. G. D. West. Without doubt, *Wireless Weekly* is the book for the wireless enthusiast, whether he be a novice or a more advanced experimenter.

Wireless, the one-word weekly, also still holds its high reputation as the leading popular wireless periodical. The soundness of the information contained in *Wireless* and the manner in which it is offered appeal to both amateur and expert alike, and, although the articles contained in it are contributed by well-known experts, its price places it within reach of all.

**Don't Forget the Coupon
on p. 624!**



I HAVE little doubt that many (or perhaps it, would be more modest to say both) of my readers will peruse these lines sitting uncomfortably upon the rim of the bath and toying with a morning, noon or evening meal, as the case may be, which has been tastily laid out upon the wash-handstand. For at this hectic season of the year it is customary, in the first place, to transport the whole of the dining-room furniture, with its accompanying dust, into the drawing-room, whence after a short sojourn it is retransported to its original resting place. The



...sitting upon the rim of the bath....

dining-room having been thus thoroughly cleansed is now filled with the drawing-room furniture plus its 12 months' accumulation of grime. After a day or two the drawing-room furniture goes back to its old place. And there you are! The net result is that the dust, having had a jolly good shaking up, settles down once more for another year of peace and quiet.

A Quotation

As the poet Tennyson once beautifully wrote:

In the spring a dread upheaval devastates each comfy room:

In the spring the sprightly housewife goes and buys a brand new broom:

In the spring each mere man cusses till he's almost fit to bust.

In the spring a woman's fancy lightly turns to thoughts of dust.

I quote from memory, so you must forgive me if I have made any little slips in my rendering of the famous lines from "Locksley Hall."

The Inevitable

So far, we poor fellows, for all that when there is no woman within hearing we call ourselves the stronger sex, have simply surrendered over this question of spring-cleaning. We may grumble a bit, but in the end we bow each year to the inevitable. It is, as you know, a long worm that has no turning, and I feel that the time has now come for the oppressed male to arise in his strength and to retaliate. I feel all the more strongly upon this point because my own household has gone in this year for an extra-early spring-cleaning; you can take it from me that there are much more comfortable seats than a packing case in the boxroom, and much more convenient desks than an ironing-board balanced upon two trunks of unequal height.

"Not So Dusty"

Moved by a burning desire for r-r-r-revenge, I am founding here and now the Society for the Propagation of Spring Cleaning by Wireless Men. I sincerely trust that every reader will help forward the movement by joining the Society forthwith and by taking active steps in his own house. The badge of the Society is a turning worm (the turus having hot-air spacing in order to increase the self-importance) surrounded by the motto, "Not So Dusty." The first ten thousand applicants for membership will receive the badge free of all cost if they send eighteen-pence.

Preparing for Vengeance

The preparations for the act of vengeance are quite simple and straightforward. Having purchased a yard or two of some suitable material and wrapped it round your head, you don an apron, roll up your sleeves and get busy. The first procedure is to remove the

sheets from all the beds in the house except your own. These you place with great care over the contents of your wireless den. Then with a broom and carpet beater you set to work to whack up as much dust as possible. This is obligingly caught by the sheets, which you next shake out on to the floor.

Empty Boxes

You now proceed to stake out a claim in the kitchen and in the drawing-room, pushing the contents of each room into a pile in a corner and covering the floor with accumulators, high-tension batteries, wavemeters, spare coils, tools, loud-speakers, odds and ends of wire and spare parts. When you come to transport your gear from the wireless den to the various rooms of the house which are to be filled with it, you are sure to find that you have dozens of empty boxes of various kinds.

It is one of the peculiarities of wireless men that they all collect empty boxes. No one knows why, but everyone does it. These boxes will probably more or less fill the dining-room and the larder. Should you find that the drawing-room is becoming unduly crowded with your bits and pieces, it is a good thing to move the piano into the potting-shed.

Getting On with It

The real work of spring-cleaning now goes merrily forward. With



...move the piano into the potting shed....

a few masterly strokes with the duster you remove on to the floor a half-inch layer of dust which decorates the tops of your batteries. On no account allow this dust to

774-3-26



Take the SHORTPATH to Better Reception

KEEN constructors are continually seeking fresh methods of obtaining better results from their sets. There is now available one simple method—one SHORTPATH to improved results.

The unique construction of the "Cosmos" SHORTPATH valves, whereby the path between filament, grid and anode is reduced to an absolute minimum, enables results to be obtained unequalled by any other valve of the one cell accumulator class.

Compare their characteristics with published figures of other makers

FOR BEST RESULTS S.P.18 VALVES should be used as follows:

HIGH FREQUENCY STAGES:	
Tuned Anode	Green ●
Transformer Loose Coupling	Red ●
.. Tight Coupling	Green ●
<i>If set oscillates use Red ● for all H.F. stages, especially for dual stage valves.</i>	

OTHER STAGES:		
STAGE	TRANSFORMER COUPLING	RESISTANCE CAPACITY COUPLING
Detector	Green ●	Green ●
L.F. (1st Stage)	Green ●	Green ●
L.F. Intermediate	Red ●	Green ●
L.F. (Last Stage)	Red ●	Red ●

	S.P.18 Red Spot	S.P.18 Green Spot
Voltage Amplification Factor (μ) ..	7	15
Impedance	7,000	17,000
Mutual Conductance (g) micromhos	1,000	850
Figure of Merit $\sqrt{\mu g}$	84	113

Price, Red or Green Spot, **12/6**

"Cosmos" S.P. 18 Valves provide a

SHORTPATH to: **MORE POWER FAITHFUL REPRODUCTION GREATER ECONOMY**

S.P.18 valves consume 0.3 amps., at from 1.6 to 1.8 volts. and require only a single cell 2-volt accumulator. They are recommended for use as shown in adjoining table.

Obtainable from most Wireless Retailers.

METRO-VICK SUPPLIES Ltd.
(Proprietors: Metropolitan Vickers Elec. Co. Ltd.)
4, Central Buildings, Westminster, LONDON, S.W.1.

The "Cosmos" D.E.11 Dull Emitter Valve takes 0.25 amp. at 1.1 Volts. and is a splendid Dry Cell Loud Speaker Valve.
12/6

The "Cosmos" A45 Bright Valve is a highly efficient Valve for all reception purposes.
7/6

Have you got your copy of "A Talk to Valve Users"?

Cosmos

RADIO VALVES

Rtd. 18-3-26

Rtd. 22-3-26

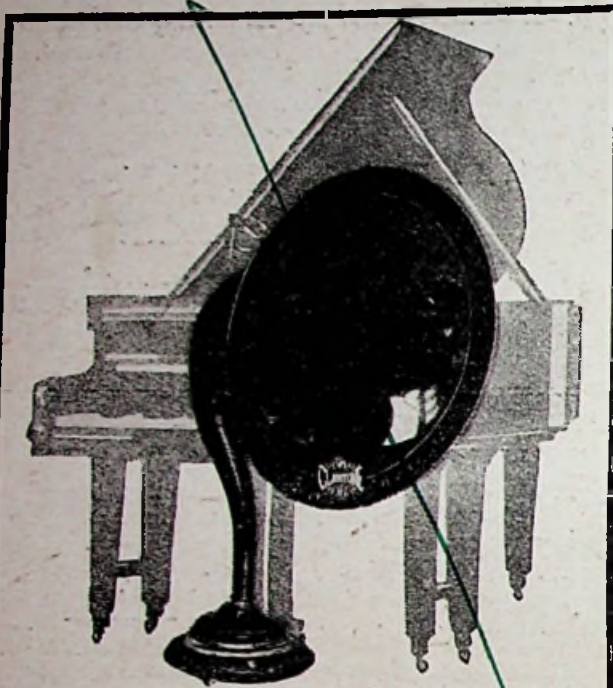

Just as you'd choose a Piano

—so the sweet purity of tone and magnificent volume of the Claritone Loudspeakers will appeal to the music in your nature and influence the choosing of your loudspeaker.

The faithful reproduction and remarkable sensitivity of these instruments has made them favourites wherever they go and the results obtained are equal to many loudspeakers of considerably higher price.

Claritone Loudspeakers

- Senior Model, 2000 ohms, W.290 £5 0 0
- 120 ohms, W.291
- Junior Model, 2000 ohms, W.295 £2 15 0
- 120 ohms, W.296

Claritone Headphones

- W.216 £1 0 0

Sold by all Reputable Dealers

SOLE DISTRIBUTORS:

ASHLEY WIRELESS TELEPHONE COMPY.

(1925 Ltd.)

NOTE OUR NEW ADDRESS:

17 Finch Place, Falkland Street
London Road Liverpool

Get more out of your Set!

LOTUS Coil Holders

are made from Bakelite mouldings with nickel plated fittings; they are an ornament to any set and they give the best results. MOVING BLOCK CANNOT FALL

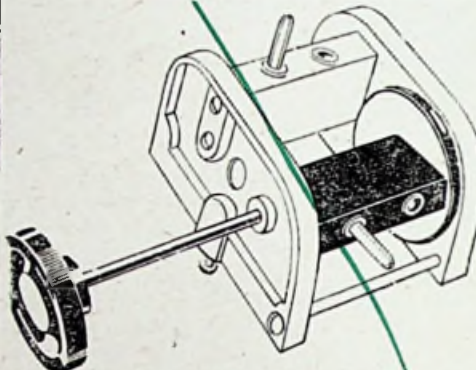

THERE ARE TWO TYPES OF LOTUS COIL HOLDERS.

For Outside Panel Mounting:
Two-Way, 7-3
Three-Way, 10-3
For Inside Breadboard Mounting:
with 6in. handles:
Two-Way, 8-3
Three-Way, 12-6

The Vernier Movement is actuated by three sets of end s.d. Precision Cut Gears, representing a reduction of 8 to 1

TESTIMONIAL

"I should like to take this opportunity of saying how glad I am that I fitted your coil holder. I can now, without any other alteration to my set (Det. L.F.), receive 6 stations with comparative ease, where before, tuning in of 3 was an achievement."

GARNETT, WHITELEY & Co., Ltd.

Lotus Works, Broadgreen Road

LIVERPOOL

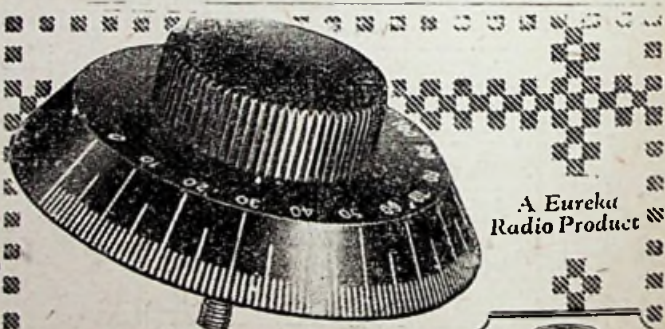

A Eureka Radio Product

Revolutionary in design and performance

MOST Sets fail to obtain selectivity through the use of inferior condensers. Two features are essential—low minimum capacity and the lowest possible losses. The Dialodenser is a multi-plate condenser, but instead of its plates being exposed to the air they are contained within a 2 1/2" dial. Its minimum capacity is the lowest of any condenser.

Its exclusive design ensures a square law reading and permits a wonderfully high standard of efficiency. Smooth movement, one-hole fixing, permanent contact through armoured cable, long service, freedom from damage by dust—here are some exclusive 10/- Dialodenser features. Ask your dealer to show you one to-day, or .0003 mfd's. get further particulars from us. .0005 mfd's.

Portable Utilities Co. Ltd., 8 Fisher Street, W.C. 1

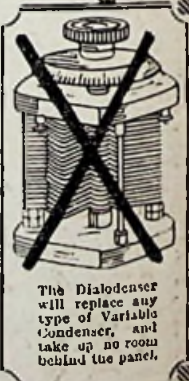

This Dialodenser will replace any type of Variable Condenser, and take up no room behind the panel.

Also .001 mfd's. 12-6

Dialodenser

THE CONDENSER WITHIN THE DIAL

remain undisturbed upon the floor; bustle it up with a few vigorous whacks of the carpet-beater. Should the atmosphere become too thick to be pleasant, the best way of clearing it is to open the door and to fan the dust out into the hall by lustily flapping one of the sheets. Next, we come to the receiving set itself, and here I feel impelled to issue a word of warning. Never use a vacuum cleaner for this.

A Piping Time

My poor friend Mr. Gumplethorpe was one of the earliest members of the S.P.S.C.W.M. It occurred to him that his own spring-cleaning could best be carried out with the help of the vacuum cleaner. He therefore telephoned to the company which provides these things, asking them to come and do the job. On the following morning a donkey-engine thing was chugging away outside his house whilst a squad of men was engaged in draping miles of curly pipes about the place.

By the time that all was in readiness for the cleaner's first cleansing suck, each room was distinctly reminiscent of a macaroni soufflé. Mr. Gumplethorpe, a little bruised through having tripped half a dozen times over the pipes, watched the men with tense interest.

"Ready, Bill," called the man who was holding the spout affair at the business end of the biggest pipe. "Right, Sam!" shouted the donkey-engine operator.

Evacuation

The donkey-engine's rattle became a roar. The spout began to sigh, gently at first and then more



.... thought he was asking for more juice....

deeply. "Boost her up, Bill," bawled Sam. "Right, Sam," came Bill's answering cry. A moment later, Mr. Gumplethorpe leapt into the air, with a scream, as his most cherished power valve was torn from its moorings and disappeared down the spout. The other valves followed in quick succession, and next instant the vanes of his variable condensers filled the air for a moment like a shower of autumn leaves and were then engulfed.

Mr. Gumplethorpe dashed to the

window, calling upon Bill to desist. Unable to hear what he was saying, Bill thought that he was asking for more juice, and proceeded to supply it. By the time that they had succeeded in getting the donkey-engine stopped, Mr. Gumplethorpe's receiving set consisted of nothing more than a panel and a baseboard.

The Problem of the Coil

I would recommend you, then, to banish the vacuum cleaner from your thoughts, and to carry out the spring-cleaning of your set by sheer manual labour. But some pieces of apparatus required for wireless reception are distinctly difficult to spring-clean properly. One of the greatest problems is presented by the honeycomb inductance coil, whose air cells are apt to become so clogged by their gradual accumulation of minute particles that the coil ceases to be air-spaced.

Blow!

Mr. Gumplethorpe attempted to clear the dust accumulation from one of his coils by blowing hard through each cell in turn. When he got to about the eighth, he carelessly drew in his breath instead of expelling it, and was overcome with such a fit of choking and gasping that he all but swallowed the inductance itself. By far the best

GREAT SUCCESS OF THE LOWFORMA

THIS set embodying a LOWFORMA erected by the technical staff of the Wireless Magazine and fully described in the February issue (1926), has received the KDKA (East Pittsburgh) 63 metres transmission, at Loud Speaker strength on a 21 ft. indoor aerial in London.

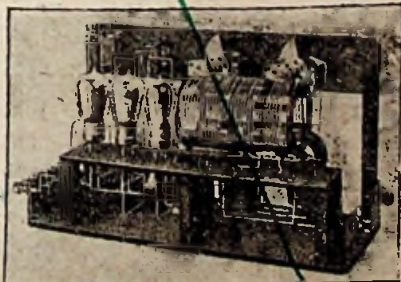

The LOWFORMA is a valuable unit which can be utilized in the erection of numerous Crystal and Valve Sets frequently securing 50 p.c. Better Results.

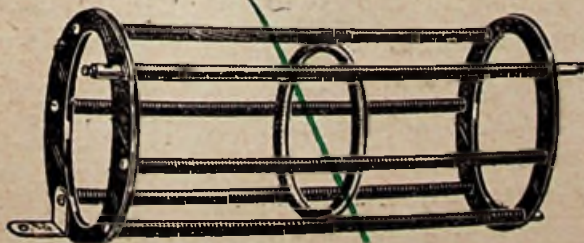

PRICES: 3 1/2 ins. diameter by 5 ins. long, 4/9; 6 ins. 5/0; 7 ins. 5/6 OF ALL DEALERS. In case of difficulty write the makers— A. H. CLACKSON, Ltd. (Dept. C), Head Offices, 119, Fleet St., London, E.C.4

Red 12-5-26



The Valve Saver

Threefold protection for your valves. Fitted in "Antipong" Holders they are safe from accidental shocks, safe from microphonic vibration, safe from interelectrode losses. This triple safety is only found in "Antipong" Holders, which

with their universal fitting can be used in every kind of set. Phosphor bronze springs, heat-proof Bakelite Mounting. Low Loss design, all contribute to your satisfaction with "Antipong." Fit it in every set, for every valve.

BOWYER - LOWE ANTIPONG VALVE HOLDER

From good dealers or direct

3/-

Bowyer-Lowe Co. Ltd., Letenworth

method, I feel, of dealing with dust-clogged coils is to unwind them, pulling the wire through the folds of a tightly-held duster. Replacing the turns upon them will provide pleasant recreation during the long summer evenings. Should you fail yourself in the task of re-making your spring-cleaned coils, you can always enlist the services of your better half to knit them into shape once more.

Cleaning the Cores

And then there is the very difficult question of low-frequency transformers. Dust penetrates with dire effects in between the laminations of which their cores are composed. It is a perfectly simple matter to dismantle the core of your transformer; but the task of re-assembling it is far from attractive, since it seems to consist in solving a crossword puzzle consisting entirely of E's. On the whole, I think that even the most enthusiastic spring-cleaner will be wise, as far as his low-frequency transformers are concerned, to let sleeping dust lie.

Putting the Curls Back

Rheostats, too, are not too easy to deal with. In order to cleanse their resistance coils thoroughly from dust, it is best to straighten

them out and to give them a good polish with "Ososhiny," or some other evil-smelling compound from the housemaid's pantry. To re-



...knit them into shape once more....

wind the spirals is a task that may baffle many. Mr. Gumplethorpe tried to coax his back into shape by using some of Mrs. Gumplethorpe's curling-pins; but, personally, I find it best to send them to the hairdresser to be re-marcelled.

Nor do I advise that valves should be taken to pieces for the purpose of removing dust from their grids and plates. It is so difficult to get anything like a vacuum again with the help of a fountain-pen filler, and I have never had really satisfactory results from sealing off with sealing wax.

Getting Your Own Back

Anyhow, from the brief indications that I have given you will see that it is possible for any wireless man to get a good deal of his own

back if only he has the pluck, the courage, the grit, the heart, the spirit to initiate these retaliatory measures.

finston

LO-LOSS COILS

No. 21 .. 1/3	No. 75 .. 2/0	No. 200 .. 3/6
No. 35 .. 1/6	No. 100 .. 2/6	No. 250 .. 1/3
No. 50 .. 1/9	No. 150 .. 2/9	No. 300 .. 4/0
	No. 175 .. 3/3	

Obtainable from all Dealers
FINSTON MANUFACTURING Co. Ltd.
 45, Horseferry Road, London, S.W.1
 Phone: Victoria 1614

Red 19-0-26

POLAR JUNIOR

A trustworthy Condenser at low cost

Available in 3 capacities: .001, .0005, .0003. All one price

6/6

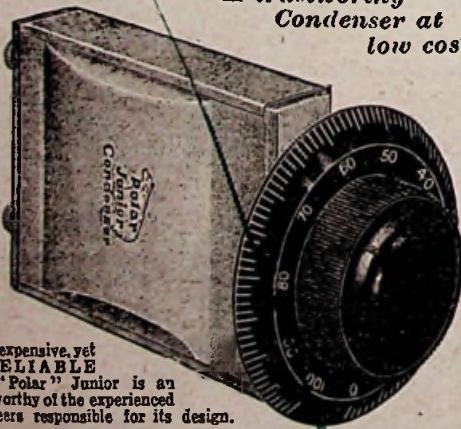

Produced at the low price of 6/6, to meet the demand for an inexpensive, yet thoroughly **RELIABLE** Condenser. "Polar" Junior is an achievement worthy of the experienced Radio Engineers responsible for its design.

It gives definite advantages over cheaply-assembled vane-type Condensers marketed at a popular price. It has a practically straight-line frequency curve, the scale being engraved to allow a movement of 350 degrees. This gives wider dial spacing for Stations tuned-in on the lower portion of the scale, and results in easier, more selective tuning.

High-quality finish and robust construction enable the efficient "Polar" Junior Condenser to carry the unconditional **12 MONTHS' GUARANTEE** (given with all "Polar" Condensers) against original defects and against breakdown in ordinary use.

Radio Communication Co., Ltd.
 34-35, NORFOLK STREET, STRAND, LONDON, W.C.2

The latest model "Polar" Junior has a new hand-some moulded dial and knob. The Condenser itself takes up very little room behind panel, and is completely dustproof. Illustration 2/3 a-tual size

Obtainable from all reputable Radio Dealers. Write to-day for the "Polar" Condenser booklet, giving information on Condensers that no amateur should be without. Sent free on request to Manufacturers:

THE "SECURITY" VALVE HOLDER
 (Prop. Pat. No. 2187/25).

ANTI-CAPACITY

PROTECTS THE VALVE

METAL DRILLING TEMPLATE Included.

OBTAINABLE FROM ALL RETAILERS & FACTORS.

Advert. of Williams, Ellis & Co., London.



CABINETS CAMCO CABINETS

for your set

for the circuits

Described in "MODERN WIRELESS," "WIRELESS WEEKLY" and "THE WIRELESS CONSTRUCTOR," etc., or phone Clerkenwell 6903
WRITE NOW FOR ILLUSTRATED LIST

NAME.....
 ADDRESS.....

Write in Block Letters Please

THERE IS A CAMCO CABINET FOR EVERY CIRCUIT
 TRADE ENQUIRIES ESPECIALLY INVITED
CARRINGTON MANUFACTURING CO., LTD.
 18/20, Normans Buildings, Mitchell St., Central St., E.C.1

Super Economy
B5

THE feature of the B5 Valve is that its current consumption is so small— $\frac{1}{16}$ th. of an ampere—that dry batteries of very small dimensions can be used. It is, therefore, the ideal valve for use in portable receivers, or wherever accumulators are undesirable or impracticable. As an all-round general purpose valve it is unsurpassed. Its electrical characteristics are given below:—

Filament Voltage	-	-	2.8 volts
Filament Current	-	-	0.06 amp
Anode Voltage	-	-	20 to 80 volts
Anode Resistance	-	-	17,000 ohms

The B5 Valve is as good a detector and amplifier as any bright-emitter, but only takes $\frac{1}{16}$ th as much current as the latter.

Price - - - 16/6

B.T.H.
Radio
Valves

General Purpose

R Filament Voltage 4 Volts
Filament Current 0.1 Amp
Max Plate Voltage 100 Volts **8/-**

B3 Filament Voltage 1.8 Volts
Filament Current 0.55 Amp
Max Plate Voltage 80 Volts **14/-**

B5 Filament Voltage 2.8 Volts
Filament Current 0.06 Amp
Max Plate Voltage 80 Volts **16/6**

Power Amplifying

B4 Filament Voltage 6 Volts
Filament Current 0.25 Amp
Max Plate Voltage 120 Volts **22/6**

B6 Filament Voltage 2.8 Volts
Filament Current 0.12 Amp
Max Plate Voltage 120 Volts **22/6**

B7 Filament Voltage 6 Volts
Filament Current 0.06 Amp
Max Plate Voltage 120 Volts **24/6**

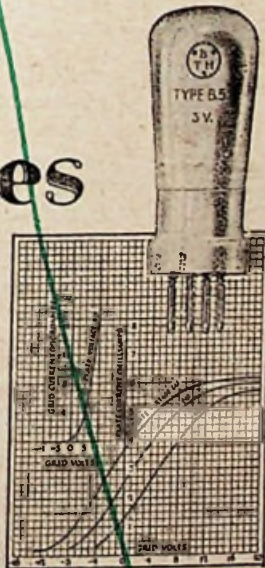

Insist on B.T.H.—the Best of All

Ask your dealer for a demonstration and a copy of Leaflet No. R. 7430

The British Thomson-Houston Co., Ltd., Crown House, Aldwych, London, W.C.2.



1st and 2nd stage

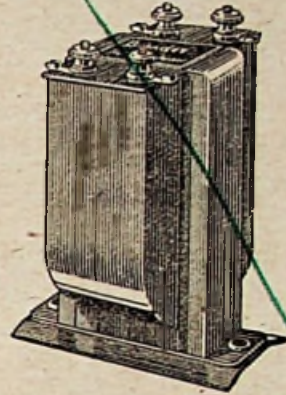

THE AUDIO TRANSFORMER

Ratio 1 to 5. The main objects in view are high amplification of applied voltage, together with a straight line amplification-frequency curve. That is to say, for a given input voltage, the amplification is constant over a wide band of frequencies, thus eliminating resonance. Mechanically protected and shielded so that the transformers may be placed close together without interaction. Terminals and outside soldering tags.

Ratio: 1 to 5 (black finish)

17/6

The 1-3 Transformer has a splendid straight line amplification frequency curve from 300 cycles per second upwards. Over speech, pianoforte and harmonic ranges it amplifies all frequencies equally well. It has a high primary inductance and an ample iron core section and may be worked close to the 1-5 Transformer without interaction. Neither Transformer requires a condenser across the primary or resistance across the secondary.

Ratio: 1 to 3 (brown finish)

17/6

... by ...

Brandes

The name to know in Radio

296 Regent Street : LONDON : W.1

from any good Dealer



Distance or Volume ?

By A. V. D. HORT, B.A.

In this two-valve set you can use either H.F. or L.F. amplification at will, the change-over being effected by a simple switching device

VARIETY adds interest to broadcasting, no less than to other features of our daily life. Many people at present are insistent in their demands that Daventry shall give programmes of its own on every night of the week, so that they may have the opportunity of a change from their local station. Most of these demands probably come from people who have sets which are capable of giving good reception from 5XX and their local station only.

Much greater variety is, of course, available to the man who can choose his programme from two or three of the main B.B.C. stations as well. To bring in distant stations with sufficient volume for a loud-speaker requires perhaps a more elaborate receiver than many listeners can

afford. Anyone who lives within 10 miles or so of a main station, however, can with a suitable receiver put the local station on the loud-speaker for ordinary everyday reception, and occasionally make excursions to greater distances with the aid of headphones.

Economy in Valves

A feature of the set to be described here is its economy in valves and their attendant expense in current consumption. Two valves only are employed, but the circuit is so arranged that they can be utilized either as H. F. amplifier and detector or as detector and L.F. amplifier. By this arrangement one is enabled, when the receiver is in ordinary everyday use, to obtain signals of good strength from the local station

using the detector and L.F. part of the circuit; indeed, it may even be possible to work a small loud-speaker, provided that the local station is reasonably close.

The Question of Selectivity

It is not claimed that the circuit possesses a high degree of selectivity, so that when the H.F. stage of amplification is in use, it will hardly be possible to receive stations very close in wavelength to the local station. Sufficient selectivity is provided, however, to make it possible in most localities to tune in two or three other B.B.C. stations and perhaps one or more Continental stations. Loud-speaker strength is, of course, not to be expected from the more distant stations, but comfortable telephone strength should be attainable.

Two Circuits Employed

Reference to Fig. 1 will show the circuit arrangement. From this it will be seen that the valve V_2 functions always as detector, whether H.F. or L.F. amplification is in use. The change-over from one type of amplification to the other is effected by means of a 3-pole switch S , and by inserting the telephone or loud-speaker plug in the correct jack. It should also be noted that the reaction coil L_2 requires to be reversed when the change is made; this is effected in a simple manner by means of a pair of Clix plugs and sockets. Actually the change-over is a matter of seconds only, so that the signal strength obtainable by each method from any station heard can easily be ascertained.

High-Frequency Amplification

To use the valve V_1 as an H.F. amplifier, the switch is put over to the side marked "H.F." This connects the aerial direct to the grid of V_1 , and connects to its anode the tuned anode coil L_3 , and tuning

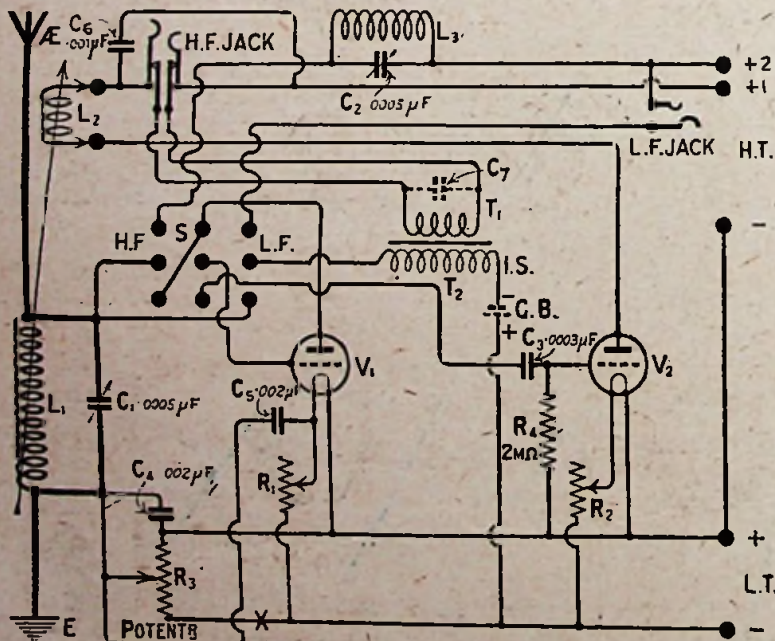

Fig. 1.—The circuit. In the actual set the switch terminals are not in the same relative position as shown here. C_7 is the condenser incorporated in the transformer.

condenser C_2 and the grid lead of the detector valve V_2 . The telephone plug is inserted in the H.F. jack, thus cutting the primary of the L.F. transformer out of circuit. A fixed condenser C_3 across this jack acts as a by-pass across the telephones for H.F. impulses.

Oscillation Control

Control of self-oscillation of the valve V_1 under the above conditions is provided in the potentiometer, R_3 , a sufficient positive bias to check oscillation being applied to the grid of V_1 if instability occurs when the circuits L_1, C_1 and L_3, C_2 are brought into resonance. The fixed condensers C_4 and C_5 by-pass the H.F. impulses which might otherwise be impeded by the potentiometer winding.

The Note-Magnifier Circuit

When it is desired to use L.F. amplification, and so obtain greater volume from strong signals, the switch is put over to "L.F.," and the telephones or loud-speaker are plugged into the L.F. jack.

The aerial is now connected to the side of the grid condenser C_1 remote from the grid of the valve V_2 . The anode of V_1 is connected to H.T. positive through the telephones plugged into the L.F. jack, and the grid of V_1 is placed in circuit with the secondary of the L.F. transformer. The primary of this transformer, by the withdrawal of the telephone plug from the H.F. jack, has been connected in the anode circuit of the detector valve. The reaction coil must also be reversed, by removing the double Clix plug and inserting it the other way round.

The potentiometer may be left at zero, though actually it will have no effect on the operation of the receiver when the L.F. stage is in use. The additional refinement of a switch to cut the potentiometer out of circuit may, if desired, be included at the point marked X in Fig. 1.

How to Fit Grid-Bias
Terminals are provided on the

panel for aerial and earth, and for the H.T. and L.T. batteries, but no terminals are fitted for connecting a grid-bias battery in circuit for the L.F. valve.

If it is desired to get the utmost from the L.F. stage, and if a high value of high-tension is applied to the anode of V_1 under these conditions, a small grid-bias battery may be placed inside the cabinet, wander plugs being taken to it from the L.T. negative terminal and the appropriate terminal on the L.F. transformer.

List of Components

The components required for the construction of the receiver are given in the list below. The makers' names are given for the benefit of those who wish to duplicate the receiver exactly. Other makes of components of good quality may, of course, be used, but in this case some care must be taken in the arrangement of the parts on the panel and baseboard to ensure that they are adequately spaced.

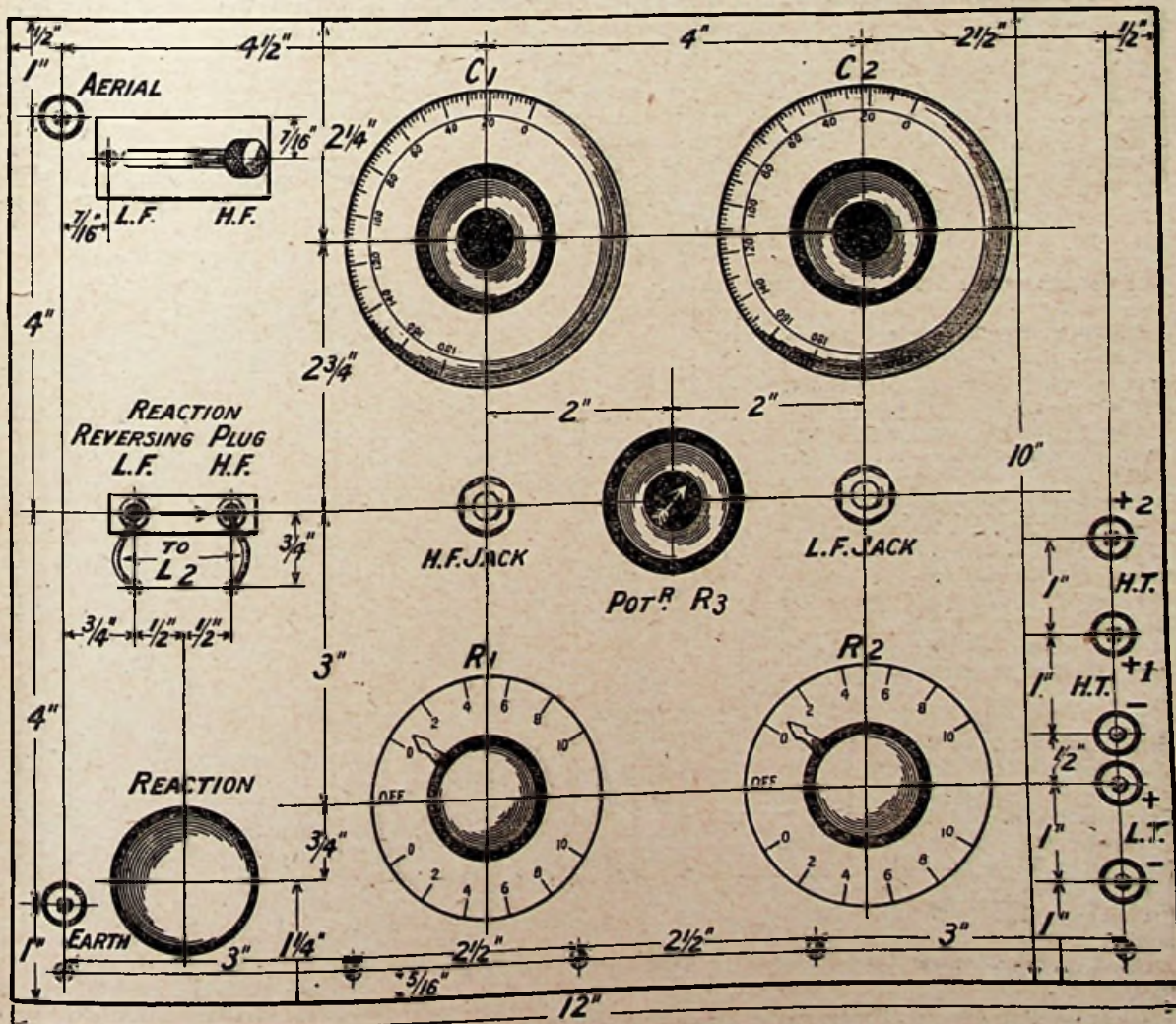
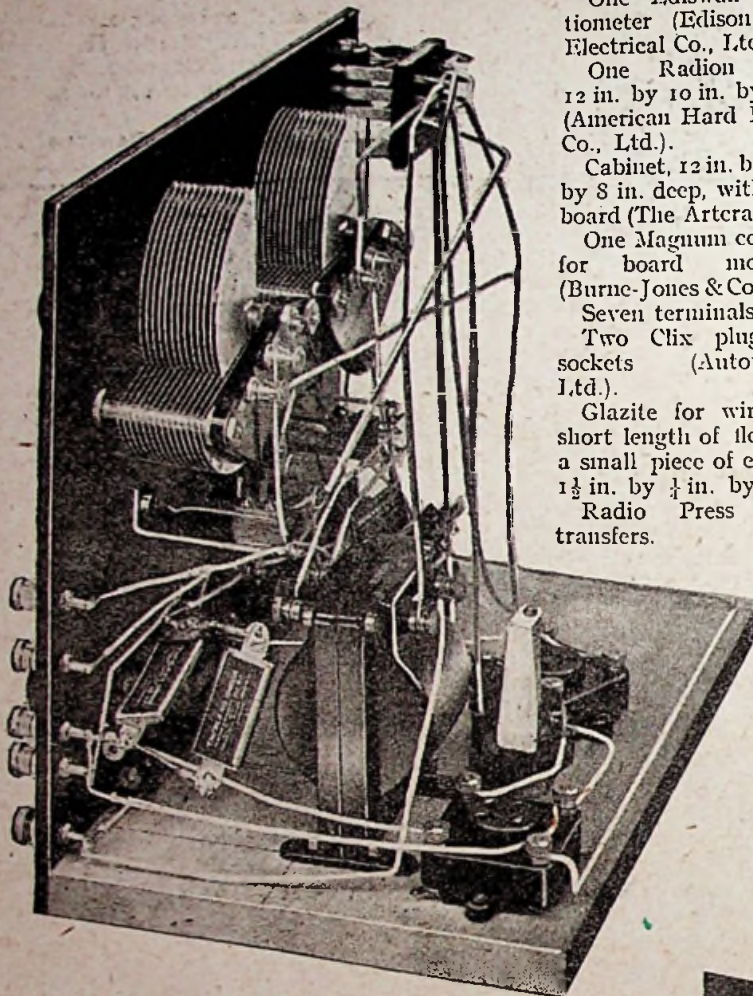

Fig. 2.—The panel drilling diagram. Blueprint C1036A.



The detector valve fits into the nearer socket.

The components required are:—

Two "Efesca" $\cdot 0005\mu\text{F}$ variable condensers, square-law (Falk, Stadelmann & Co., Ltd.).

One "Utility" three-pole change-over switch (Wilkins & Wright, Ltd.).

One single open jack, one double closed jack, and one telephone plug (Rothermel Radio Corporation of Great Britain, Ltd.).

One "Therla" $\cdot 001\mu\text{F}$ condenser (Sel-ezi Wireless Supply Co., Ltd.).

Two "Therla" $\cdot 002\mu\text{F}$ condensers (Sel-ezi Wireless Supply Co., Ltd.).

One "Dorwood" $\cdot 0003\mu\text{F}$ condenser and grid leak mount (Herbert Bowyer & Co., Ltd.).

One $2\text{M}\Omega$ grid leak (Dubilier Condenser Co., Ltd.).

Two Clearertone valve holders (Benjamin Electric, Ltd.).

One two-way coil holder ("Newey," Pettigrew and Merri-man, Ltd.).

One L.F. transformer, type A.F.3 (Ferranti, Ltd.).

Two dual filament resistances (Radio Instruments, Ltd.).

One Edison potentiometer (Edison Swan Electrical Co., Ltd.).

One Radion panel, 12 in. by 10 in. by $\frac{3}{8}$ in. (American Hard Rubber Co., Ltd.).

Cabinet, 12 in. by 10 in. by 8 in. deep, with baseboard (The Aircraft Co.).

One Magnum coil plug for board mounting (Burne-Jones & Co., Ltd.).

Seven terminals.
Two Clix plugs and sockets (Autoveyors, Ltd.).

Glazite for wiring, a short length of flex, and a small piece of ebonite, $1\frac{1}{2}$ in. by $\frac{1}{2}$ in. by $\frac{3}{8}$ in.

Radio Press panel transfers.

Drilling Operations

The first operation to perform in the construction of the receiver is to mark out the panel. If the components given, or others very similar, are to be used, this may be done with the help of the diagram Fig. 2. The two variable condensers, the filament resistances, and the jacks are symmetrically arranged, the potentiometer being placed in the centre between them. Great care should be taken to centre the hole for the coil-holder accurately, as this rests flat on the baseboard, and if the hole is out of position it may be difficult to fit this component in position.

The slot for the switch lever is marked out with a sharp point, using the metal front plate as a guide. A number of holes are then drilled between the lines marked, and the slot is cut out to its proper shape with a small file. The holes for the Clix sockets are centred 1 in. apart.

Mounting the Components

When the drilling is complete the panel should be screwed to the baseboard, with both panel and baseboard in position in the cabinet, so that there is little chance of fixing them together in the wrong position. The L.F. transformer may then be mounted on the baseboard, followed by the filament resistances and potentiometer on the panel.

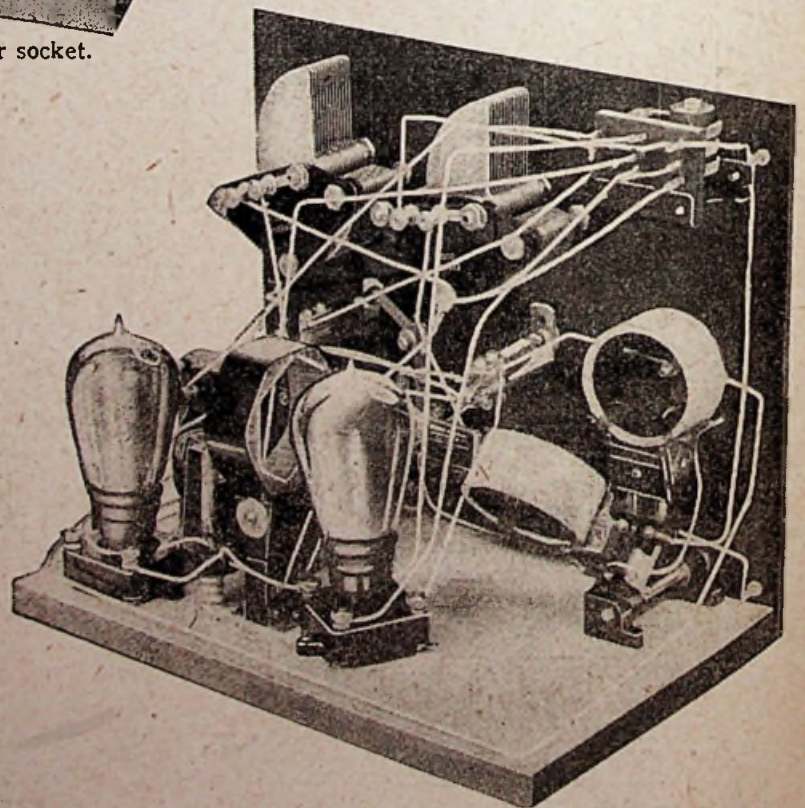

An interior view of the receiver showing coils and valves in position.



COSMOS PERMACONS

- MICA DIELECTRIC
- GUARANTEED ACCURATE CAPACITY
- LOW LOSS
- TESTED AT 500 VOLTS

FIXED CONDENSERS

GIVING FIXED RESULTS

The "Cosmos" Permacon is an ideal fixed condenser, being light in weight of guaranteed accurate capacity, and having the lowest possible losses

The dielectric is mica and each condenser is tested at 500 Volts during inspection. Nickel plated cases give them a particularly neat appearance.

.0001 mfd.	1/6
.0002 "	1/6
.0005 "	1/6
.0003 " (with clip or grid leak)	1/8
.001 "	1/8
.002 "	1/10
.005 "	2/8
.01 "	3/9

"COSMOS" GRID LEAKS are uniform and permanent

1, 1, 2 and 3 megohms . . . each 1/6

Ask for copy of the Cosmos Components Brochure.

METRO-VICK SUPPLIES Ltd.

(Proprietors - Metropolitan-Vickers Elec. Co. Ltd.)

4, Central Building, Westminster LONDON, S.W.1

R.109

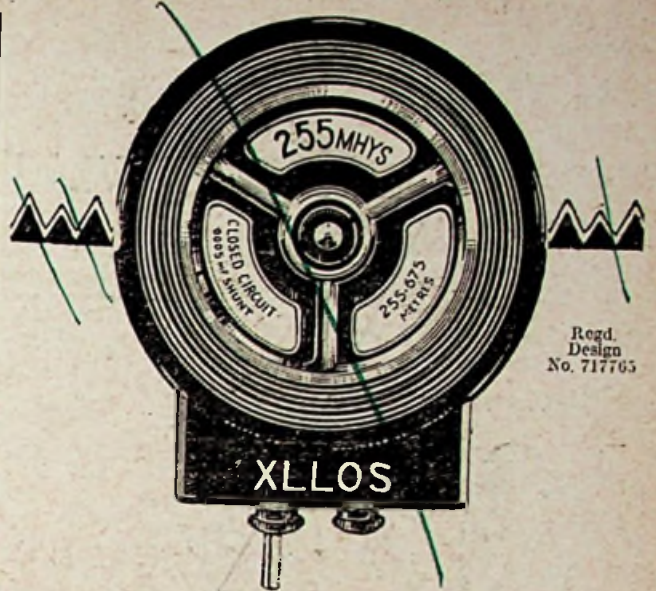

Regd. Design No. 717765

THE NEW IGRANIC "XLLOS" (EXTRA LOW LOSS) COIL

"XLLOS" Coils—the latest IGRANIC achievement—possess electrical and mechanical features which are sought after by all discriminating radio experimenters. They are highly selective and give increased signal strength and greater range of reception. "XLLOS" Coils are extremely adaptable as regards mounting—a feature which is of special value, since it enables them to be used under the most efficient conditions and in many different types of coil-holders. Two pins are supplied with each "XLLOS" Coil, permitting two pin, two socket, or pin and socket mounting.

Sizes and Wavelength Ranges:

No. of Coil	Inductance microhenries	Self-capacity micro-mfd	Natural wave-length metres	Wavelengths in metres when shunted by .0005 mfd, variable condenser		Price
				Aerial circuit using standard P.M.G. aerial	Closed Circuit	
L. 25	29	12	36	220-280	85-225	5/-
L. 30	49	14	50	250-360	110-280	5/-
L. 40	90	16	72	350-490	155-400	5/2
L. 50	150	14	85	435-650	200-520	5/3
L. 75	255	13	109	550-835	255-675	5/6
L. 100	425	12	134	700-1000	325-865	7/-

Write for List No. Z994 and particulars of Igranic Radio Devices



Exclusive manufacturing Licensees of PACENT Radio Essentials

149, Queen Victoria St., London Works: BEDFORD

The IGRANIC Instructional Carton

for constructing a six-valve Supersonic Heterodyne Receiver according to the Igranic design, contains a comprehensive, fully illustrated descriptive handbook, full-size general arrangement drawings, wiring diagrams and drilling template. Obtain a copy from your dealer. PRICE 2/6

Standard VALVES & HEAD RECEIVERS

GIVE BEST RESULTS



The Wecovalve is an ideal valve for all purposes; it is sensitive, free from noise, and exceedingly robust. It has approximately twice the life of any other dull emitter at present on the market.

Try these valves in your pet circuit and note the difference.

Operating characteristics:

- Filament current - - 0.25 amps.
- Filament voltage - - 0.8 to 1.1 volts
- Detector Plate Voltage - - 15 to 30 volts
- Amplifier Plate Voltage - 30 to 60 volts

Wecovalves, each 16/6

P.A.4 Power Valve 45/-

Standard 'phones are the choice of experts who know them to be absolutely reliable.

There is always room for improvement and it is more than probable that the indifferent results you are experiencing are due only to inferior head-receivers.

Ask your dealer to demonstrate a pair of Standard head-receivers to you and note the difference.

Head-receivers, per pair 20/-

Standard Telephones and Cables Limited

Formerly Western Electric

CONNAUGHT HOUSE, ALDWYCH, W.C.2 Central 7245 (10 lines)
 Works: NORTH WOOLWICH, NEW SOUTHGATE, AND HENDON
 Branches: Glasgow, Leeds, Newcastle, Manchester, Birmingham, Cardiff, Southampton, Liverpool, and Dublin



The Grounded Rotor that means fine movement-always

From an experimenter of 14 years' experience:
 "I find that the special knob and dial supplied by you make Geared Dials and Verniers unnecessary in my opinion, and I have been experimenting since 1912."

The first thing you notice about a "Cyldon" is its extraordinary smooth silkiness of action—a smoothness that spells successful tuning. Indeed so gradual is this movement that an additional vernier is unnecessary. The secret lies in the Grounded Rotor, one of the unique features that make the "Cyldon" the best condenser in the world.

CYLDON

(pronounced 'Sil-don')
 Straight Line Wave-Length.

Complete with 4 in. knob dial:

001 mid.	21/-
0005 "	17/6
0003 "	16/6
00025 "	16/-
0002 "	15/6

From all good Dealers or supplied POST FREE.

SYDNEY S. BIRD,
 "Cyldon Works,"
 Sarnesfield Road,
 Enfield Town,
 Middlesex.
 Tel.: Enfield 672.



18.3.26



It will only cost you 6d.

to obtain particulars for building this wonderful Radion 5-Valve Neutrodyne Set. The new Radion Book gives full constructional details of this and three other unique and efficient sets, a 1-Valve Set, a 2-Valve

Amplifier and a handsome self-contained Loud Speaker Receiver. Fully illustrated with photographs and diagrams, it should be in the hands of every wireless enthusiast. From your Dealer, or 6d. post free from

American Hard Rubber Company (Britain) Ltd.
 Head Office: 13a Fore Street, London, E.C. 2
 Depots: 120 Wellington Street, Glasgow, 116 Snow Hill, Birmingham.
 Irish Agents: 8 Corporation St., Belfast.

RADION

the Panel with a Pedigree

Gilbert Ad. 4585

It will be found best to wire up the latter components before proceeding further, as they would not be easy to reach with the other components in position. The terminals may also be fitted at this stage, and the leads from the filament resistances and the potentiometer and its two condensers connected to the low-tension terminals.

The mounting of the variable condensers and jacks calls for no

special comment. The coil-holder has to be mounted a short distance away from the panel, to allow sufficient clearance between the fixed coil and the Clix sockets. This is contrived by placing three or more spacing washers behind the panel on the one-hole fixing bush of the coil-holder. The coil-holder may then be screwed down to the baseboard, care being taken to see that the panel and baseboard are at right angles.

The Reversing Plug

For the reaction reversing plug two holes 1 in. apart are drilled in the 1½ in. strip of ebonite, and Clix plugs are secured in these holes. A pair of flex leads pass from the plugs through small holes in the panel to the soldering tags on the moving block of the coil-holder.

The remaining components may now be mounted on the baseboard. Note that the coil plug for the

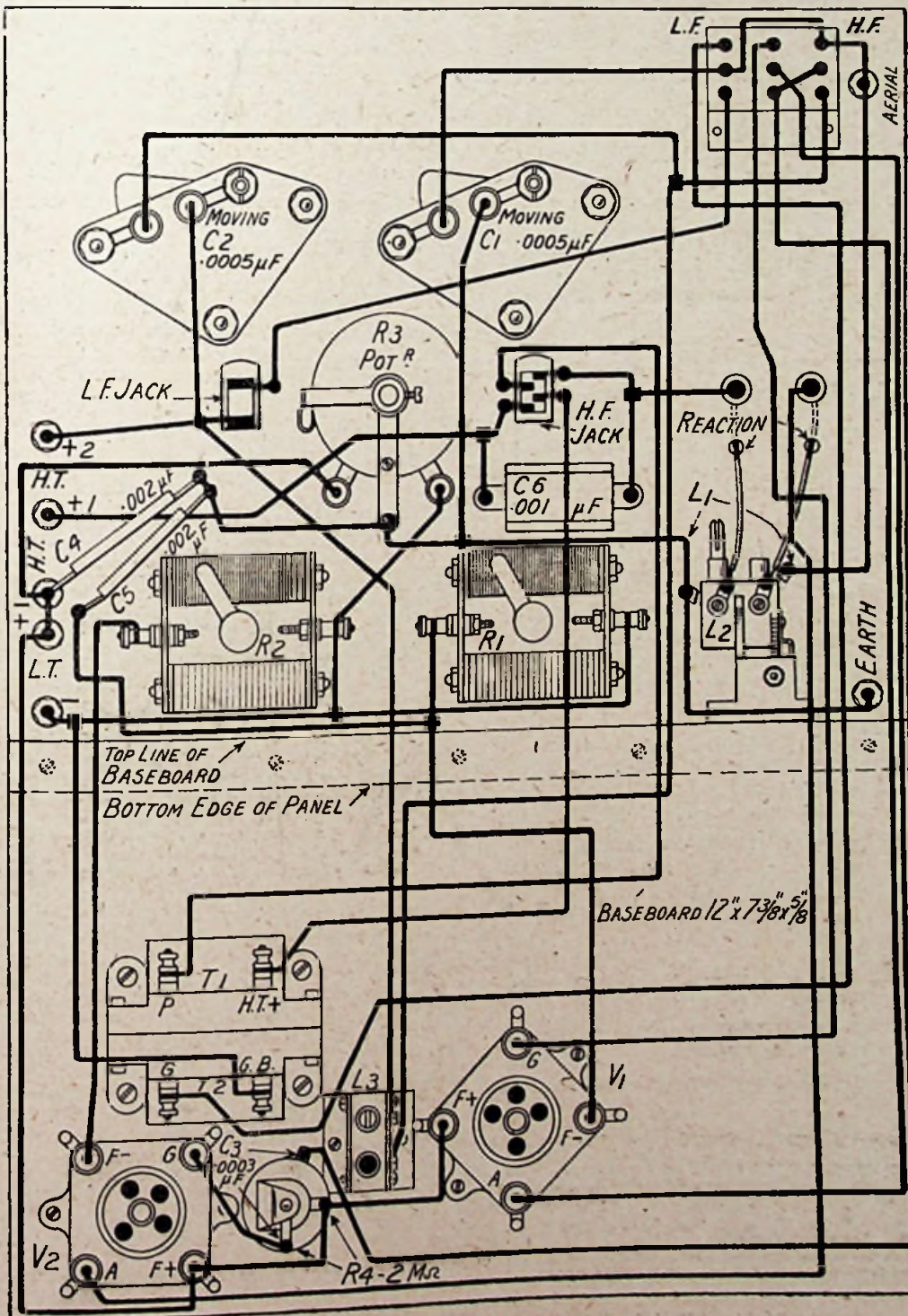

Fig. 3.—This wiring diagram may be obtained as a full-size free blueprint, Cro36B. In order to allow the easy insertion of the aerial coil L₁, the switch must be mounted close to the top of the panel.

tuned anode coil is mounted at right angles to the other coils, and that the valves are placed so that freedom of movement is allowed to the reaction coil.

The grid condenser and leak are secured to the baseboard by means of a $\frac{3}{4}$ in. 4B.A. bolt, which is inserted from the underside of the baseboard, the head of the bolt being counter-sunk in the wood.

Wiring

The arrangement of the wiring may be gathered from the wiring diagram, Fig. 3. The short leads to the valve holders should be completed first. Next will come the leads to the contacts of the jacks, and, finally, the longer leads to the switch and the aerial terminal. Care should be

taken that the switch connections are correctly made; it will be as well to cross off each connecting point in the wiring diagram as it is completed.

Switch Connections

The leads from the six contacts which are "grid leads," are kept fairly close together. The "anode leads," from the lower three contacts, are kept well separated from these, and make as wide angles with them as possible where crossing is necessary. To avoid annoying alterations in the wiring subsequently, it will be found a good plan to place both valves and coils in their respective holders while these leads are being bent to shape, otherwise one or more leads may inadvertently be fixed in such a position that the insertion of a valve or the free movement of the reaction coil is impeded.

A Note on the Cabinet

There is one important point to note in the arrangement of the cabinet. This should be fitted with narrow fillets up the sides or with small square-ended stop-blocks at the top corners, in order to support the panel.

Operation

When the receiver has been wired up and the wiring checked over, the testing of it may be proceeded with. General-purpose valves may be inserted in the valve holders, and in the coil blocks the following coils: aerial, No. 35 or 50; re-



The finished receiver.

plugged in, about 50 or 60 volts being applied to each valve.

With the reaction coil swung well away and the switch to "L.F.," plug the telephones into the L.F. jack. Then tune with the aerial condenser till the local station is heard. The other variable condenser need not be touched, as it is not in circuit. On bringing up the reaction coil and readjusting the variable condenser slightly, the signals should increase in strength. If they decrease in strength or show no decided increase, reverse the reaction plug. The plug may then be marked with an arrow, as shown in the photographs, to indicate its correct positions for L.F. and H.F. If the receiver is wired exactly as shown, the flex leads to the plug will be crossed for L.F. and straight for H.F.

Testing the "DX" Circuit

If everything is satisfactory on the L.F. side, turn down the filaments of the valves slightly and swing the reaction coil well away. Then move over the switch, reverse the reaction plug and insert the telephone plug in the H.F. jack. Do not touch the aerial tuning condenser till the anode tuning condenser has been set, so that the

(Concluded on page 594)

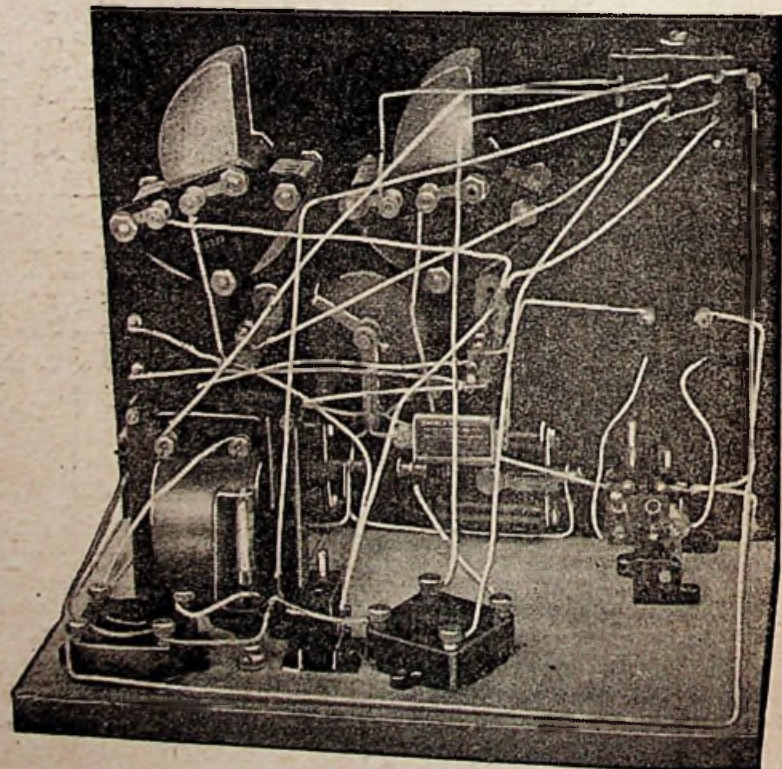

Switch connections are shown clearly in this photograph of the wiring.



**The new
T.C.C. Grid Condenser**

YOU'LL be wise to choose this Grid Condenser. Mica throughout and guaranteed accurate, it is backed by the 20-year-old reputation enjoyed by the Telegraph Condenser Company—pioneers in the building of fixed condensers of all types.

Its upright green moulded case takes up little room on the panel or baseboard. Two flanges facilitate mounting. Observe its special duplex terminals—an exclusive T.C.C. feature—enabling connections to be made either by the milled heads or direct to the soldering tags.

The top of the Condenser is heatproof. There is no possibility that heat from the soldering iron can disturb the internal connections or damage the insulation.

Note also the convenient clips for the grid leak of such generous width as to accommodate practically every make of grid leak. Knowing the reputation of the T.C.C., you'll expect an uncommonly good Grid Condenser—and we can promise you that you will not be disappointed. Made in the same factory and under the same working conditions as the famous T.C.C. Mansbridge Condenser. Each one subjected to the most critical and searching tests it is possible to devise.

Prices of T.C.C. Mica Condensers :

No. 33. All capacities between '004 mfd. and '001 mfd. - - 2/-

No. 34. All capacities between '0009 mfd. and '001 mfd. - - 2/4

Grid leak clips supplied free

Series-Parallel Type: All values between '0009 mfd. and '0001 mfd. 2/10, with two grid leak clips supplied free

**T.C.C. Condensers
[Mansbridge and Mica]**

Advt. of the Telegraph Condenser Co. Ltd., Wals Farm Road, N. Acton, W.3.

Gilbert Ad. 4593

In replying to advertisers, please mention THE WIRELESS CONSTRUCTOR.

Figures to Remember



The Town Crier

OLD times are changed, old manners gone, leaving just the remembrance of perfect service and faithfulness. With quickened feelings of real pleasure you can recollect the service Six Sixty Valves have rendered you—may more, you will always remember the figures 660 as the mark of

PERFECTION OF QUALITY

This is true for every valve in our new range. You say you want a valve suitable for a small or medium-sized Loud-speaker, and which will cost very little to run. You can't do better than get the S.S.3 L.F. (green disc). The filament consumption of this valve is only '06 amps—a remarkable saving not only on Bright Valves but even on the average Dull Emitter on the market to-day. Bear this in mind and effect the maximum economy whilst at the same time ensuring perfect quality of tone. Two good dry cells will operate these valves with entire satisfaction, but a 4-Volt accumulator—in conjunction with a 30-ohm filament rheostat—may be used with the equal success and economy. If you want a Power Valve—you have the S.S.7 to fall back on. This wonderful D.E. is absolutely non-microphonic, has a current consumption of only '1 amps., and is capable of handling output sufficient to work the largest Loud-speaker without distortion.

For long Life, good service, perfect Tone insist on SIX SIXTY VALVES



S.S.3, L.F.

(Green Disc)

Voltage - 3 volts
Consumption '06 amps.

PRICE 16/6

Ask your Dealer for Leaflet S.S.1. 7 for full particulars of complete range



BETTER BY SIX TIMES SIXTY
THE ELECTRON CO., LTD., TRIUMPH HOUSE, 189, REGENT STREET, LONDON, W.1

Ret 18-3-26



Shall I Scrap my
 H.F. Transformer

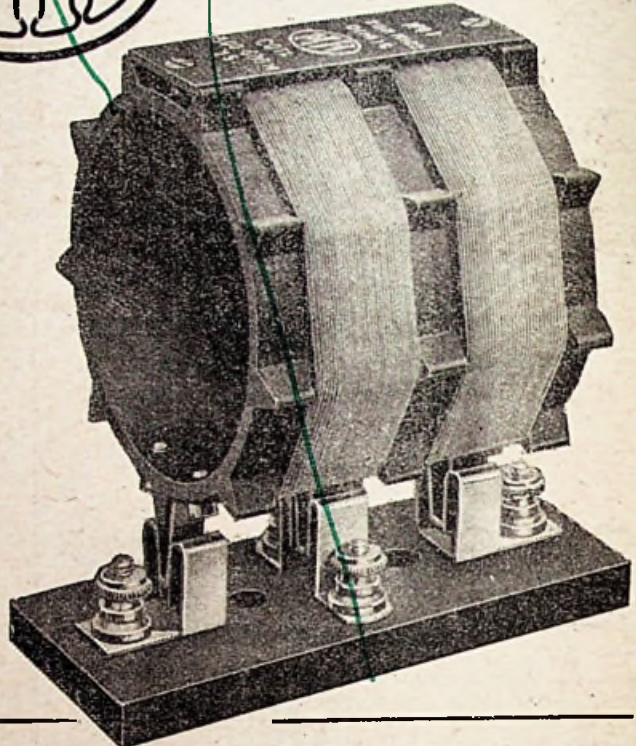
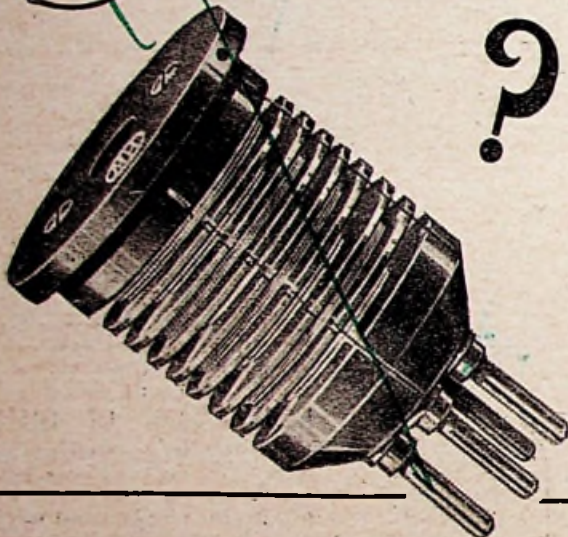



FOLLOWING on the introduction of the "DIMIC" Coil, we have frequently been asked the above question. Our answer is given diagrammatically, from which it will be seen that the H.F. Transformer need not, and we think never will, be scrapped. It is a highly efficient device supplementary to, and not supplanted by, the "DIMIC" COIL.

If you desire a higher performance from your Set, spend a little more money on a further stage of H.F. amplification rather than replace your  H.F. Transformers with "DIMICS." A full diagram for this is shown. It gives extraordinarily good results with very high selectivity. At approximately 18 miles from

2LO we have frequently had Cardiff at Loud Speaker strength without any interference from 2LO when the latter was working — although adjustment for this is naturally very critical. Manchester at the same distance is comparatively easy to obtain and separate from London completely, even with the headphones on.

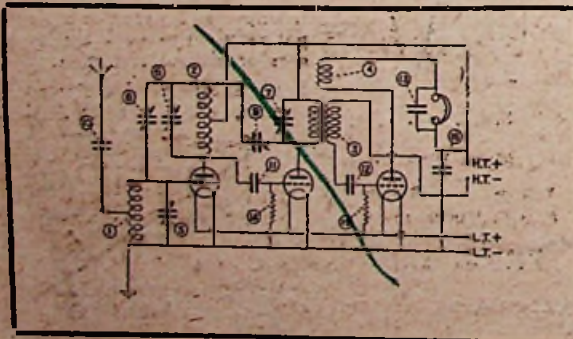
On two stations at a distance, and heterodyning each other, either station has been brought in at full Loud Speaker strength, clear from, but naturally distorted by, the other.



 "DIMIC" COILS

are available in the following sizes:—

- No. 1 300/- 600 M.
- " 1a 450/ 950 M.
- " 2 600/1300 M.
- " 2a 900/2000 M.
- " 3 1100/3000 M.
- " 3a 2000/4500 M.

PRICE 10/- EACH
 BASE EXTRA 2/6

INDEX TO CIRCUIT DIAGRAM		
Item	Each	Base
1 and 2 MH "Dimics" ..	10/-	2/6
3 MH H.F. Barrel Type Transformer ..	10/-	
4 MH Reactor ..	15/-	
5 and 6 .0005 Variable Condenser ..	10/6	
7 .0003 Variable Condenser ..	8/6	
8 and 9 Neutralising Condenser ..	2/10	
10, 11, and 12 .0003 MH Mica Condenser ..	2/8	1/-
13 .001 Mica Condenser ..	3/-	1/-
14 and 15 MH Grid Leak, 1 megohm ..	2/8	1/-
16 .01 MH Mica Condenser ..	4/-	1/-

OUR ADVICE AND OUR PRODUCTS ARE EQUALLY GOOD

TAKE BOTH AND BE SATISFIED.

L.M. MICHAEL LTD

Manufacturers of Wireless and Scientific Apparatus
 WEXHAM ROAD :: SLOUGH :: BUCKS

Telephone:
 Slough 441-442

Telegrams:
 Radiether, Slough

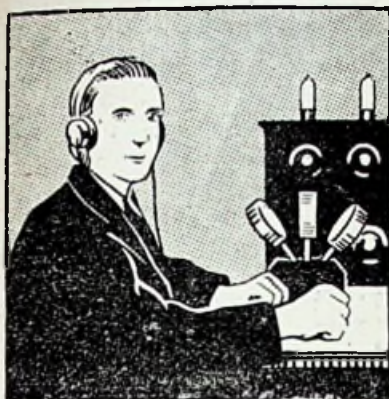

Keeping Reaction in Check

By Major James Robinson, D.Sc.,
Ph.D., F.Inst.P.

Why limit yourself to the coil-holder method? There are many other ways of controlling reaction

THE almost universal use of valves in modern sets has made reaction one of the most powerful agents in wireless reception. With valve circuits reaction is made use of to obtain amplification, and, again, to obtain oscillation, both for transmission purposes and for the reception of continuous waves, and in some cases for telephony, when supersonic reception is employed. Further, it is made use of in order to make a set more selective. Like most powerful agents, however, it can easily get out of hand, and it is therefore in need of strict control. Most of us are familiar with some of the ways in which reaction can get out of hand, but it will be of interest to discuss briefly how this occurs and to give certain methods of obtaining complete control.

The Nature of Reaction

We may indicate in a few words what reaction actually is. A valve inherently causes a certain amount of amplification, which means that when we get an impulse between the grid and the filament of a valve, the current in the anode circuit is changed, and a small change of voltage on the grid produces a considerable change in the anode current. Such amplification occurs, no matter how rapid the impulses on the grid may be.

Obtaining amplification in the anode circuit, it is advisable to throw back a portion of this amplified energy to the grid again for amplification, and this throwing back of energy is what constitutes reaction. We, first of all, obtain some inherent amplification, and then throw back a portion of the amplified energy to the original source for amplification again and again.

A Popular Circuit

One of the commonest methods for obtaining reaction is shown in Fig. 1. In this case we have the

grid coil L_2 with a condenser C_1 across it for tuning purposes. In the anode circuit of the valve we have an inductance L_3 in series with the anode battery and the

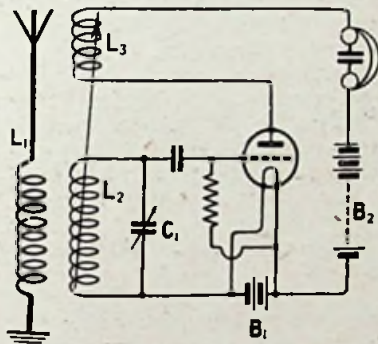

Fig. 1.—The moving coil method is by far the commonest.

telephones. This anode coil L_3 is coupled to the grid coil L_2 in a variable manner so that the amount of energy thrown back can be varied.

Other forms of reaction can also be employed, such as electrostatic reaction.

Distortion and Oscillation

Supposing that we start using the circuit, as shown in Fig. 1, with the reaction coil very far removed from the grid coil, and that signals arrive at the aerial. We shall now obtain a certain signal strength in the telephones. Now we gradually bring the reaction coil close to the grid coil, so that we throw back a small portion of the amplified energy. We shall find that the signals begin to increase in strength, and the nearer we bring the reaction coil to the grid coil the stronger will the signals become, until a point is reached where the signals become distorted. This happens when the reaction has reached a critical point and when the valve commences to oscillate.

With this critical amount of reaction, or with more throw-back than this amount, the valve will be in a continuously oscillating condition, and any impulse, no matter how small, will start the valve oscillating. Thus, as soon as we switch on the high-tension battery, or, again, as soon as we switch on the low-tension battery or complete the circuit, a small change



The valve room at Rugby, showing the power units, control tables and switchboard.

The
**Varley
Constant**



*Wire-wound
Anode
Resistance*

A RESISTANCE wound on the famous Varley Bi-Duplex system, eliminating all inductance between turns.

It is absolutely immune from the effects of heat, damp or any atmospheric change, and therefore perfectly constant in action. The maximum current-carrying capacity is from twelve to fifteen milliamperes.

For inter-valve coupling where freedom from distortion is the first consideration, use the Varley, Wire Wound and Weatherproof.

SEE THAT YOU HAVE A VARLEY
For Silence, Perfect Tone and Efficiency

Complete with
Clips and Base **7/6**

Without Clips and Base 8/-

60,000 ohms, 80,000 ohms, 100,000 ohms
Write for Leaflet.



Constant always

The VARLEY MAGNET CO.

(Proprietors Oliver Pell Control, Ltd.)

Woolwich, S.E.18.

Telephones: Woolwich 888, 889.

is produced which is equivalent to the electrical impulse caused by an incoming signal, and the valve circuit commences to oscillate.

Effects of Excessive Reaction

We thus see that reaction enables us, by tightening the coupling, or throwing back more and more energy, to obtain louder and louder signals, until we get to the point of oscillation when the signals become distorted. It is the intention of all of us to obtain as loud signals as we possibly can by means of reaction without passing the point of critical reaction, and thus getting into oscillation. Making a valve oscillate spoils signals and, in addition, it makes the aerial radiate and annoy the neighbours, because under those circumstances the receiver is converted into a comparatively weak transmitting station which, though of low power, is capable of annoying listeners for miles around.

The condition to be aimed at is that which will make it possible to approach the oscillating condition, and go gradually into oscillation. It is very easy to adjust the receiver so that as the reaction is increased, signals increase in strength until we get a sudden click in the telephones. This occurs as soon as the valve commences to oscillate violently. It is advisable from the point of view of comfort and best signal strength to avoid this violent bursting into oscillation.

Controlling Factors

The factors which control the amount of reaction or oscillation are the type of valve which is used, the amount of reaction, the amount of inherent amplification in the valve, the actual value of H.T. voltage which is employed, the filament current, and the grid potential. By adjusting these it is possible to make the receiver approach the oscillating condition and gradually slide into oscillation without producing a disturbing click.

It can easily be understood why this disturbing noise is obtained, because when the valve is not oscillating and there are no signals arriving there is a constant anode current, and by increasing the amount of reaction until the point of oscillation is reached, a part of the valve energy which previously was in the form of direct current energy is converted into oscillating energy, and thus the direct anode current is changed suddenly. To

avoid the violent clicks, it is essential to get this change of anode current as smooth as possible. We thus see that it is essential to control the reaction adequately, and this can be done by attention to one or more of the factors already mentioned.

Three Methods

One of the most common methods of controlling reaction is the employment of a variable reaction coil, so that the distance between the anode and grid coils can be varied at will. It is absolutely essential to have this control very smooth so that small movements of the reaction control can easily be obtained, and a vital point is that any jerky motion must be avoided. For this purpose many coil-holders now make use of a

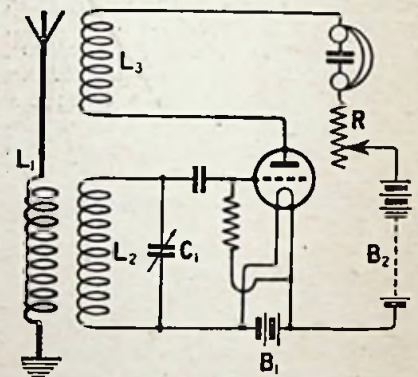

Fig. 2.—Adjustment of the H.T. voltage is one way of control.

double movement, the first being a coarse movement, and the second a very fine movement. With some of the coil-holders constructed on this principle it is possible to obtain very smooth reaction control.

Another way of controlling the reaction is to vary the grid voltage, but this is not always easy, at least, not with the most common form of rectification using a grid leak and grid condenser, under which circumstances the mean potential of the grid is more or less fixed.

A third method of controlling the reaction is by adjustment of the filament current. This, however, is not a very smooth method of control, as filament rheostats are made so that the filament current is changed in small steps, as the arm of the rheostat is moved from layer to layer.

Utilising the H.T.

Again, reaction can be controlled by the value of high-tension voltage which is used. For this purpose

Qta
18.3.26

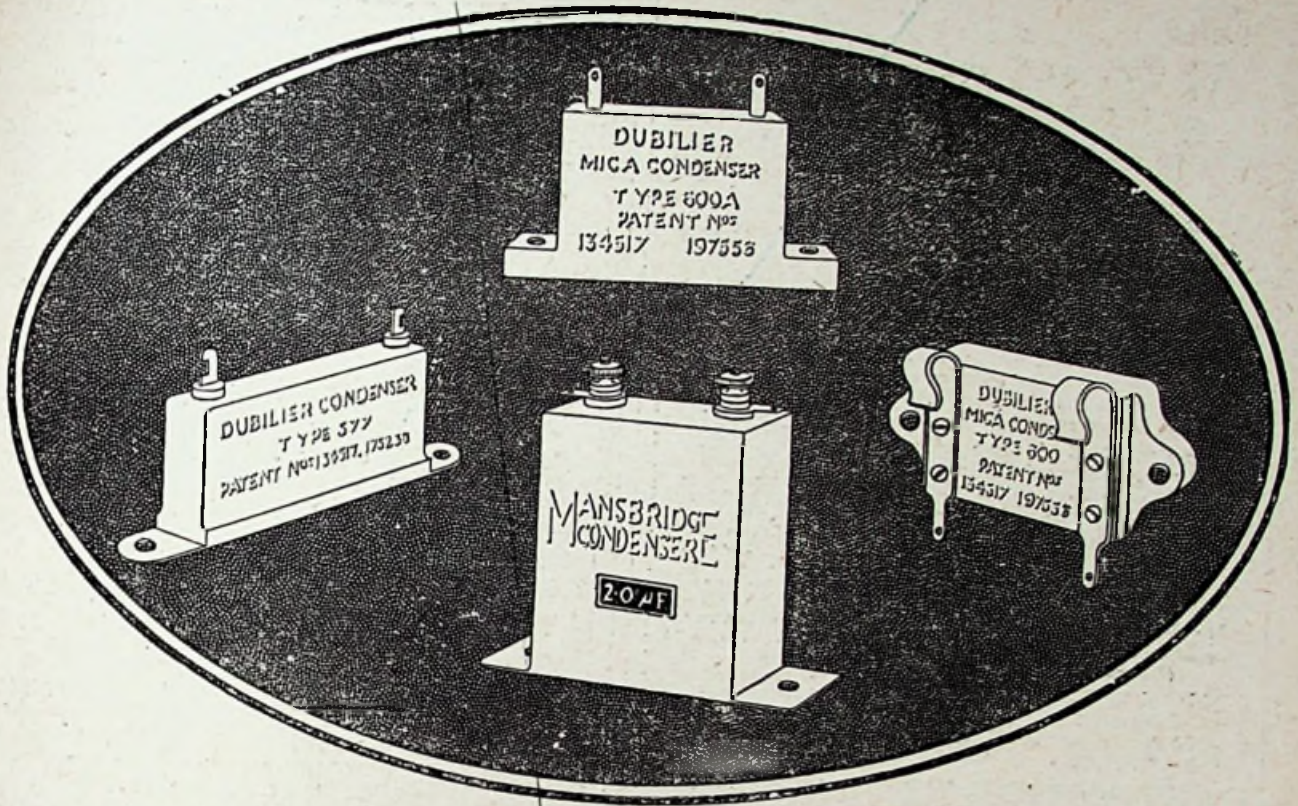

Condensers

For whatever purpose you may require a condenser, Dubilier make it. Type 577, for example, is suitable for all receiving sets, and also for low power transmission. 0.0001 μ F to 0.01 μ F - - - - 7/6

Types 600 and 600A are for general use in radio reception. Absolutely reliable and of guaranteed accuracy, they can be obtained in capacities from 0.0001 μ F to 0.006 μ F - - - - Prices, 2/6 and 3/-.

The Mansbridge Condenser, manufactured by the Mansbridge Condenser Co., Ltd., is made in capacities from 0.02 μ F to 2.0 μ F, at prices from 2/6 to 5/- . It is a genuine Mansbridge as originally designed by Mr. G. F. Mansbridge, and is the only condenser of its type that carries the Dubilier guarantee.

For condensers of all types always

Specify Dubilier

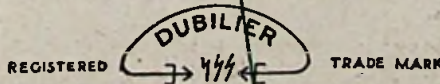

ADVERT. OF THE DUBILIER CONDENSER CO. (1925) LTD., DUCON WORKS, VICTORIA ROAD, NORTH ACTON, LONDON, W.3.

R.P.S. 778
TELEPHONE: CHISWICK 2241 23.

In replying to advertisers, please mention THE WIRELESS CONSTRUCTOR.

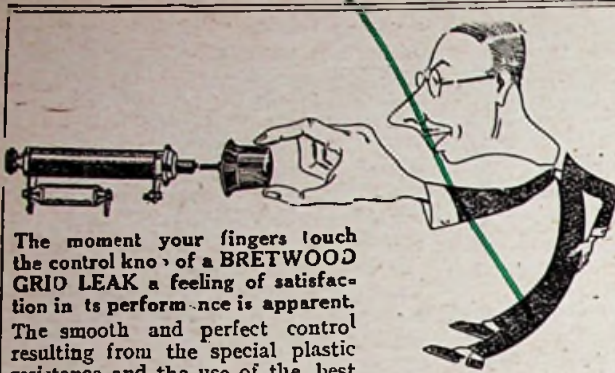

The moment your fingers touch the control knob of a BRETWOOD GRID LEAK a feeling of satisfaction in its performance is apparent. The smooth and perfect control resulting from the special plastic resistance and the use of the best quality materials only in their construction enable us to guarantee them for three years.

The Bretwood Grid Leak gives accurate readings consistently from 50,000 ohms to over 10 megohms. Bretwood Grid Leaks have been used in several sets described in "Radio Press" publications. See page 469 of March issue of "The Wireless Constructor."

The Bretwood Variable Grid Leak and Anode Resistance (Patent No. 224295)

GRID LEAK OR ANODE RESISTANCE With Condenser (as illustrated) 4/-. Postage 3d.

Price 3/-

BRETWOOD LTD. 12-18, London Mews, Maple St., London, W.1

"BRETWOOD" COMPONENTS are guaranteed for three years. They include:

THE "BRETWOOD" FILAMENT RESISTANCE

Price 3/6. Postage 3d.

THE "BRETWOOD" ANTI-CAPACITY VALVE-HOLDER.

Price 1/6. Postage 3d.

THE "BRETWOOD" ANTI-CAPACITY SWITCH.

Price 5/-. Postage 3d.

H.F.A.12

Satisfaction is guaranteed because if you have any cause for complaint, you have only to send the component back to us and we will replace it entirely free of charge. Every "Utility" product is unconditionally guaranteed.

"Utility" No Capacity Change Over Switches



Made to change over any number of contacts. The design ensures that self-capacity is negligible and contacts are rubbing and therefore self-cleaning.

Made in two styles—Knob and Lever Patterns.

Prices—each Knob. Lever.
No. W.C. 130/1 3/8 No. W.C. 147/1 4/6
No. W.C. 130/2 4/- No. W.C. 147/2 5/-
No. W.C. 130/3 5/- No. W.C. 147/3 6/-
No. W.C. 130/4 6/- No. W.C. 147/4 7/6
No. W.C. 130/5 7/- No. W.C. 147/5 10/-
No. W.C. 130/6 8/- No. W.C. 147/6 10/-

*This figure shows the number of poles changed over, e.g., W.C. 130 4 indicates Knob type 4 pole change over.

Nickel plate finish—Knob type 3d., Lever 6d. each extra.

Utility
GUARANTEED
COMPONENTS

Wulkins & Wright, Limited
Utility Works, Kenyon St., Birmingham

E.P.S.7

Single and Multi-valve Sets

Secure a consistent and reliable supply of electrical energy when connected up to

PETO & RADFORD

ACCUMULATORS

The following types meet all requirements

Type	Voltage	Actual capacity in ampere hours	Price complete. Unit without crate (uncharged)
BD 5R	2	32	20 14 0
BD 7R	2	48	0 19 0
BD 9R	2	64	1 3 6
BD 11R	2	80	1 6 9
BD 13R	2	96	1 10 0
GFC 5	2	40	21 6 3
GFC 7	2	60	1 11 3
GFC 9	2	80	1 17 6

For 4 and 6 volt units prices are pro rata and include the requisite number of separate 2-volt cells and the necessary cell-to-cell connectors. Carrying strap for each Type BD 2-volt unit, is. extra.



PETO & RADFORD

Proprietors
Pritchett & Gold AND E.P.S. Co. Ltd.
50, Grosvenor Gardens,
Victoria, London, S.W.1
Telephone: VICTORIA 3667 (5 lines)

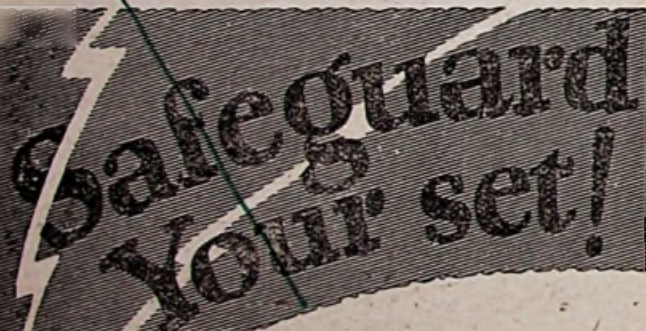

Be prepared in advance against lightning.

Make your aerial a safety conductor instead of a source of danger.

The Etherplus + combined Aerial-earth, lead-in Tube and Switch is a permanent lightning conductor, whether set is off or on.

With every Etherplus + Lightning 'hunt' here is £100 Free insurance against lightning damage



FIXED RETAIL PRICE

3/9 Stock size lead-in tube 6 1/2 in. (9 1/2 in. lead-in tube 6d. extra.)

From your dealer, or direct from
MANDAW

9-15, Whitecross St., London, E.C.1



one can change the actual number of volts applied by the anode battery, but again this is not a smooth adjustment, because we must then change the high-tension voltage not continuously, but in steps of one or two cells at a time. A very convenient way of controlling reaction by means of adjustment of the high-tension voltage is to have a variable resistance in series in the anode circuit. This resistance should be high in value, say, up to 100,000 ohms, and should be continuously variable. In Fig. 2 such a variable resistance is shown at R.

Use of a Variometer

A method which can be conveniently employed and which will give

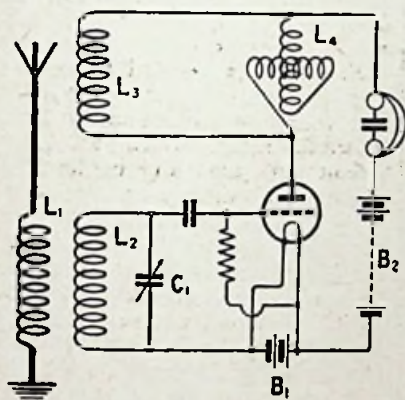

Fig. 3.—Variometer control with L_3 fixed relative to L_2 .

very smooth reaction control is shown in Fig. 3. In this circuit we have the reaction coil L_3 fixed relative to the grid coil L_2 . In parallel with L_3 , however, is another inductance L_4 , which is in the form of a variometer. By varying the amount of inductance in the variometer L_4 we can control the amount of current which flows through the reaction coil L_3 , and thus we can get absolutely smooth control of reaction.

The Electrostatic Method

The electrostatic form of reaction gives a very suitable and simple means of control. A method of applying this is shown in Fig. 4. In this case we have the grid circuit $L_2 C_1$ tuned to the incoming waves. There is no electromagnetic reaction of the type supplied by reaction coils, but in the anode circuit we have a tuned circuit $L_3 C_2$. Tuning this circuit, as well as the circuit $L_2 C_1$, to the incoming waves produces what is called electrostatic reaction,

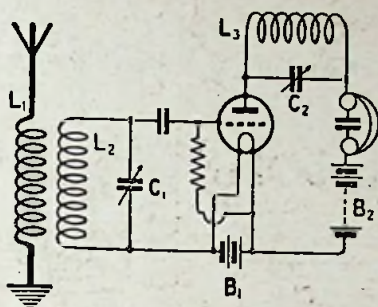

Fig. 4.—A simple means of control is afforded by "electrostatic" reaction.

which is caused by the capacity between the anode and grid of the valve. The reaction can be controlled in this case by varying the condenser C_2 , and we can thus obtain very smooth reaction control.

This electrostatic form of reaction can often be obtained without the use of any deliberate tuning of the circuit $L_3 C_2$. Sometimes, if we use the coil L_3 alone without any parallel condenser, we find that electrostatic reaction is produced and that the circuit will oscillate.

Self-Capacity of the Coil

In such cases it is usually found that the coil L_3 has a certain amount of self-capacity and that the coil with its self-capacity is tuned to something of the same order of wavelength as that of the incoming waves. When this hap-

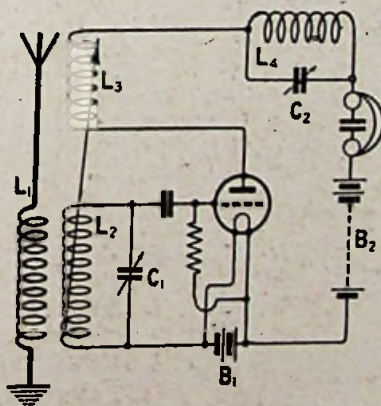

Fig. 5.—Here L_3 produces a reverse reaction effect to counteract the electrostatic reaction provided by L_1 .

pens, it is fairly easy to control the reaction by the use of an added reaction coil, which is shown as L_3 in Fig. 5. This reaction coil is of small dimensions, and it is

wound and adjusted in such a way that it is actually producing reverse reaction—that is, it is tending to stop amplification. In this way it is possible to counteract to some extent the reaction produced by electrostatic means by the coil L_3 , and thus, by varying the amount of coupling between L_3 and L_2 , we can get very smooth control of the reaction. In Fig. 5 we have shown a condenser C_2 in parallel with the coil L_3 , but this is not absolutely essential.

The "Reinartz" Circuit

Another smooth form of reaction control is that shown in Fig. 6, which shows a type of circuit known as the "Reinartz" circuit. In this case we have a tuned grid circuit

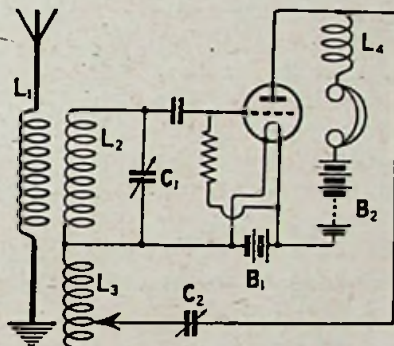

Fig. 6.—In this "Reinartz" circuit L_1 is an R.F. choke.

$L_2 C_1$, and in the anode circuit of the valve we have a high-frequency choke coil L_4 . Reaction is produced by means of a coil L_3 and a condenser C_2 in series from the filament end of the grid coil L_2 to the anode. Variation of the condenser C_2 produces the reaction control that we require.

Stray Fields

The discussion up to the present has related to single-valve circuits, and we have dealt principally with the problems encountered in obtaining and controlling reaction. Under certain circumstances, however, it may be found difficult to avoid reaction. Where multi-valve sets are used, and where high-frequency amplification is employed, it is often found that stray reaction is introduced owing to the various valve capacities, and owing to stray fields. To those who have amplifiers of this type the preceding discussion may be useful in enabling them to understand some of the effects which are likely to be obtained with their high-frequency amplifiers.



Oldham Accumulators save you money



AN accumulator is only part of the price you must pay for running your set. The other part is the cost of keeping it charged. With bright emitters you'll pay more than the original cost of the accumulator in charging fees alone during the first nine months. It is therefore natural that enthusiasts choose the accumulator which will hold its charge longest. This is the secret of the Oldham's popularity—for all Oldham Accumulators are real money savers. Owing to their plates being made under the

Special Activation Process they show a two-fold economy: (1) The plates hold their charge longer. Thus, if your present accumulator lasts you 15 hours on one charge, an Oldham rated at the same capacity will probably last at least 17 hours. (2) An Oldham Accumulator has a longer life, for the S.A. Process ensures a stronger and more energetic plate, resisting sulphation and rendering buckling almost impossible. Yet in spite of these tremendous advantages your Oldham costs you no more. See one at your Dealers to-day.

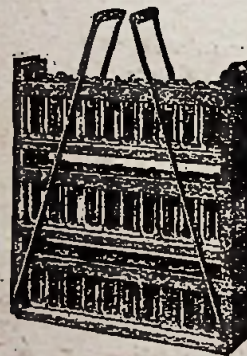

The New C.L.
Supplied in 2 volt units.

10 amp. hours actual	8/9
20 " " "	11/1
30 " " "	13/7
40 " " "	16/1
50 " " "	18/9
60 " " "	21/4

4 volts and 6 volts at proportionate prices.

The Portable Non-Spill

2 volts	10 amp. hours actual	12/6
---------	----------------------	------

The Oldham H.T. Accumulator

In units of 20 volts each.

20 volts	... £1 : 0 : 0
40 " "	... £2 : 0 : 0
60 " "	... £3 : 0 : 0
80 " "	... £4 : 0 : 0

Metal Carriers 1/6 per pair extra.

The .06 Dull-Emitter Cell (Type H.N.)

4 volts	10 amp. hours	10/-
---------	---------------	------

OLDHAM & SON LTD., DENTON, MANCHESTER
 London: Hazlitt House, Southampton Buildings, W.C.2
 London Service Station: 6, Eccleston Place, S.W.1
 Glasgow: 120, Wellington Street

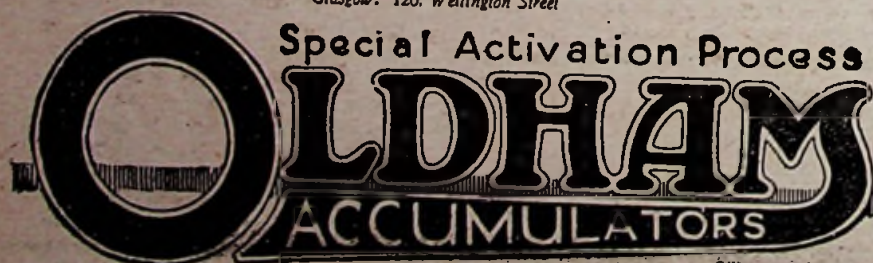

Gilbert Ad: 4580

Distance or Volume?

(Concluded from p. 586)

local station can again be heard. Slight re-adjustments will probably then be necessary.

The object in dimming the filaments is to avoid oscillation on effecting the change-over, since the receiver will probably be found more prone to oscillate when the H.F. circuit is in use. If self-oscillation of the H.F. valve occurs when its tuned circuits are brought into resonance, the potentiometer should be turned towards the positive end till oscillation ceases.

Test Report

On testing this receiver on a short aerial $1\frac{1}{2}$ miles from the London station clear loud-speaker results were obtained with the L.F. circuit, a pleated paper diaphragm loud-speaker being used. The volume was quite sufficient for a small room. With the H.F. circuit in use an unidentified continental station was heard with a background of London, it being practically impossible to eliminate the London transmission altogether at so short a distance. After the B.B.C. stations had closed down, Madrid (EAJ7) was heard at quite good telephone strength.

It should be noted that while general-purpose valves are recommended for use in this receiver, when the change over from H.F. to L.F. and *vice versa* is to be frequently carried out, much better results with each type of circuit will be obtainable if special H.F. and L.F. valves are employed. The use of a small power valve as the L.F. amplifier, with ample high-tension and grid-bias, made a marked difference in the volume obtained from the loud-speaker on London's transmission.

Famous Artists of 1925

With reference to the photograph of Madame Tetrassini in the January issue of THE WIRELESS CONSTRUCTOR, this photograph was provided by Messrs. E. P. SHORT and SON, of Nottingham, who are the holders of the copyright.

MODERN WIRELESS

Spring Double
 :: Number :: 1/6

Notes & Findings

A page of useful information of interest to all constructors

IT is not generally appreciated by the average wireless experimenter that sulphur is an excellent insulator, rivalled only by porcelain and amber. Among its advantages may be mentioned the fact that it does not absorb moisture from the air. In addition, it can be easily melted and cast in position and takes a good polish. Sulphur should have a much wider application than hitherto, one suggestion being for insulating holes when mounting wireless components on a wooden panel in lieu of ebonite. The main disadvantage of sulphur is that it is not as tough as ebonite.

When requiring a temporary earth connection, it will be found that an ordinary garden spade or fork pushed well into the earth is quite suitable. The earth lead from the receiver should be twisted tightly round the metal portion of this garden implement.

Strictly speaking, when the valves of a receiving set are not incandescent no current should flow from the high-tension battery. When the set is not in use, however, it will always be found advisable to disconnect one or both of the high-tension leads from the battery, so

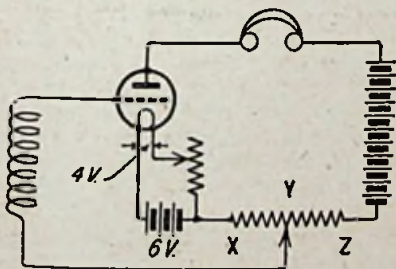

Fig. 1.—When using a 4-volt valve with a 6-volt accumulator, the application of grid-bias is simple.

as to prevent it running down through the possibility of a leak on the panel.

In order to reduce the risk of burning out valves through connecting the high-tension battery across the filaments, it will be found a good plan to connect the low-tension leads from the L.T. accumu-

lator to the set before inserting the plugs of the high-tension battery. A test can then be made to see if the valves light properly, thus ensuring that the low-tension circuit is O.K. The H.T. leads can then be connected without fear of subsequent damage, provided that the internal wiring of the set is correct.

It is often found that the sensitive spot of a crystal is lost through external vibration, if a "perikon" crystal detector is not employed. This objection can be considerably minimised by stretching across the face of the crystal a small piece of silk or muslin. The sensitive spot can still be found with the catwhisker through the fine mesh of this material, and, once located, the wire will keep in place for a long period. This covering also serves the purpose of protecting the crystal surface from the effects of dust.

In order to derive the maximum benefit when employing stranded aerial wire each individual conductor should be insulated from its neighbouring conductor, preferably with enamel. Also each strand should be separately soldered when making joints, etc.

It is not always appreciated that suitable negative grid-bias can be applied to a valve without employing a grid-bias battery. Reference to Fig. 1 will make this clear. Between the negative terminal of the high-tension battery and the negative terminal of the 6-volt L.T. battery is placed a high resistance potentiometer. Due to the fact that an electron current is flowing through the anode circuit of the valve itself from high-tension negative to high-tension positive, it follows that the point shown as X must be at a higher potential than either Y or Z. Now, due to the particular method of connecting the L.T. battery the point X is already at -2 volts with reference to the zero point of the filament. Consequently the point Y, which indicates the movable contact arm of the potentiometer, can be moved

to the right or left so as to give the requisite negative bias voltage to the grid of that particular valve, through the medium of the voltage drop across the resistance of the potentiometer.

If during soldering operations an excess of soldering flux is used, it is possible that some of it will be dropped on to the ebonite panel. If this should happen the panel can always be cleaned with a cloth dampened with methylated spirits, and thus the possibility of objectionable leaks is removed.

When it is desired to rub down ebonite panels to produce a matt surface in lieu of an existing polished surface, many home constructors find that unless extreme care is taken in the operation the result of using the usually recommended emery powder is a scratched surface. This effect is naturally not pleasing to the eye, and an improved finish to the work can be secured if resort is made to the use of "cream grit." This is the material used by monumental

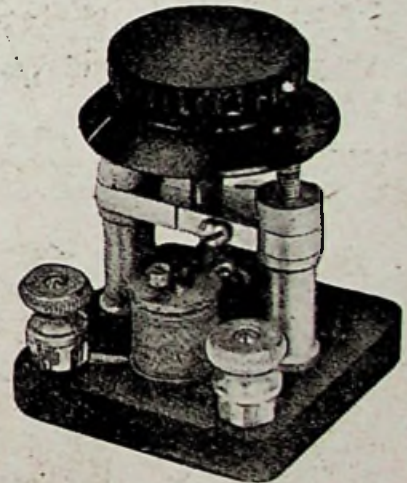

A Bowyer-Lowe buzzer for testing or wavemeter work.

masons when rubbing down lead-lettered inscriptions, and is to be preferred to the usual emery powder.

The two small spring plungers found in any ordinary electric lamp holder are useful accessories for many wireless purposes. They can with advantage be incorporated in many home constructed components as sliding contacts, ensuring a smooth motion together with a positive contact, and are to be preferred to the flexible leads which are often connected to the spindles of switch arms, etc.

H. J. B. C.

Plot
18-3-26

And now the Cossor P.3

Milestones in Valve History

1923—the Cossor P.1

—the valve which eventually became the standard British Bright Emitter.

1925 — the Wuncell

—the dull emitter which set new records for low working temperature.

1926 — the new P.3

—in which is announced for the first time a method of ensuring the true concentric mounting of the elements.

Technical Data

Filament voltage 4-4.5

Current consumption

275 waps.

High Tension voltage

50-150

Negative grid bias 45

volts, if more than 200

volts is used.

Approximate impedance

5000 ohms.

Amplification Factor 8

22/6



Cossor introduces concentric mounting

A. C. Cossor Ltd, Highbury Grove, N. 5

In referring to advertisers, please mention THE WIRELESS CONSTRUCTOR.

Gilbert Ad. 4562

—incorporating new constructional features of paramount importance

THE great fundamental feature originally adopted in the P.1—the arched filament functioning within a hood-shaped Grid, the whole being surrounded by an electron-retaining Anode—has been consistently incorporated in every type of Cossor Valve. After three years it has not been found possible to improve upon this widely accepted principle.

But in the new P.3 Valve there is utilised in addition a constructional feature which is likely to exert a far-reaching influence upon the whole future trend of valve design. We refer to the new method of automatically maintaining the filament, grid and anode in their exact relative positions during the whole life of the valve.

What is this new system of concentric mounting?

Inserted at the top of the hood-shaped anode of the P.3 and projecting also through the top of the hood-shaped grid situated immediately beneath it, is a seonite tube. Through the centre of this seonite tube—which of course is a perfect insulator—runs a fine wire. One end is shaped to form a hook to act as an additional support for the filament, while the other is curved spiralwise into a spring. It will be obvious that the filament, grid and anode—in addition to the usual electrodes rigidly supporting them at the foot of the valve—are now inflexibly held in three distinct positions. Not even the hardest knock can disturb their relative positions.

What are its advantages?

It is well known that any change in the relative position of the filament, grid and anode of any valve during its life will exert a profound effect upon its working characteristics. Let us explain it more fully in another way. Supposing three valves of the ordinary type (with straight tubular anodes) are assembled as follows: No. 1 has its filament, grid and anode mounted concentrically. No. 2 has its filament mounted diagonally through the grid—with-

out, of course, actually touching it. No. 3 has its filament mounted nearer to one side of the grid than to the other. What would be the result? All three valves although assembled from identical elements, would possess entirely different characteristics. Obviously such a lack of uniformity among these three

WITH the rapid development of Radio the announcement of any new valve is of importance, but the first particulars of a new method of concentric mounting is certain to create intense interest among wireless enthusiasts throughout the country. Dating right back to the first Cossor valve in 1923—the famous P.1—each Cossor valve has possessed many exclusive features. It is a Cossor habit not to follow in the well-worn beaten track, but to pioneer improvements which will lead to greater efficiency.

valves would prevent any Receiving Set using them from functioning as it should.

Actually, of course, the valve manufacturer aims to set the filament concentrically within the spiral grid, but after a while the filament sags and imperceptibly the valve begins to change in characteristic. No longer does it give the same good tone—no longer is it so sensitive to weak signals.

The inherent disadvantage of the straight filament has long been known to Cossor—indeed it was the earlier experience gained through the manufacture of R-type valves during the War that led to the introduction in 1923, after more than five years of incessant experimental work, of the now famous arched filament and hood-shaped grid and anode.

What are the uses of the P.3?

Primarily this new P.3 is a power valve. That is to say it should be used in place of a general purposes valve after the Detector in any Receiving Set using bright emitter valves. Provided the set incorporates a good L.F. transformer and that a high tension voltage of from 100 to 150 is employed, an exceptional volume of pure mellow sound will

result. Every note in the harmonic scale will be faithfully reproduced. Even the bass notes—frequently harsh and unnatural—will be heard in their true value.

When the P.3 is used as an L.F. amplifier the Loud Speaker becomes richly endowed with a rare beauty of tone. Gone is the “tinkle tinkle” of the old gramophone, and in its place comes Music—real Music—just as the Old Masters would have us enjoy it.

For Super-Hets., too.

Owing to its enormously greater emission and the new concentric principle of mounting, the P.3 is also eminently suitable for Super-Heterodynes and Neutrodyne. These receivers require, above all, valves which are absolutely uniform in their characteristics. One valve, not up to standard, will disturb the delicate balance of the whole Receiver and destroy not only

its sensitiveness but its selectivity as well.

An economical Power Valve.

If you count the price of your valve in terms of life and maintenance—the business-like way—you'll appreciate that the P.3 is one of the most economical valves you can buy. Because it utilises the new Cossor triple-coated filament it functions at a dull red glow which is practically invisible in daylight. Heat—the culprit which brings most valves to an untimely end—is almost eliminated. The new concentric method of construction is responsible also for protecting the filament from shocks and jars. In fact, in so far as the filament—the only vulnerable part of any valve—is concerned, it is difficult to conceive any improvement.

Finally, the P.3 consumes only 175 amp. at 4 volts—less than one-fourth of the current required by the ordinary bright emitter. Taking into consideration its greater sensitivity and higher rate of emission, you'll agree that this is indeed a notable achievement. Get acquainted with this wonderful new valve and enjoy the pleasures of Broadcasting anew.

Cossor Bright Emitters now 8/- each.

Cossor Valves

Wuncell Dull Emitters from 14/- each.

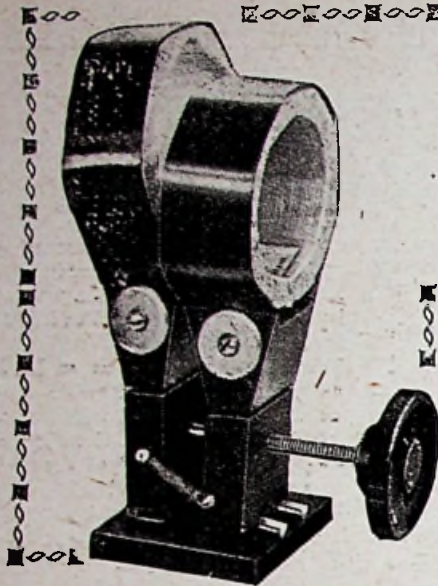

The coil holder ready for use

Fine Control for Your Reaction Coil

A neat and inexpensive coil holder with a "vernier" movement

ON another page of this issue Dr. Robinson emphasises the need for fine control of reaction coupling. There are many excellent types of geared and friction-driven vernier-motion coil holders on the market at the present time, but the majority are fairly expensive. Below is described an inexpensive two-coil holder whose advantages apart from low cost

and simplicity of design, are that it is absolutely free from backlash due to faulty gears, and that an extremely fine motion is imparted to the moving coil block.

Materials Required

The materials required are listed below, but it must be understood that slight variations are permissible as long as they do not seriously affect

the design or dimensions of the finished component:—

Piece of ebonite, 2 in. by 2 in. by ¼ in. (this may be omitted if the holder is to be mounted directly on a panel).

Ebonite knob, threaded 2B.A., with setscrew or locknut.

Small hinge about 1 in. long.

Length of 2B.A. screwed brass rod.

Two ebonite coil plugs, "Quality Radio," one of type B and one of type D were used (Goswell Engineering Co., Ltd.).

Two 4B.A. countersunk head brass screws, ½ in. long.

Four small wood screws, two of which should have countersunk heads.

Two soldering tags and two washers.

One small steel coil spring, ½ in. long when closed.

Fitting the Hinge

The first operation is the fitting of the hinge to the type B coil plug, which is to form the moving block of the coil holder. It is essential that the connecting screws or terminals of this plug should be on one of its flat sides and not protrude through the ends or base. The base is drilled and tapped in two places

from all dealers

Order 19-3-26

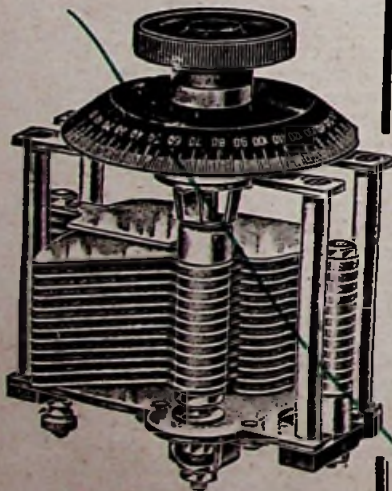

Pat. No. 241805

THE LOWEST LOSSES YET!

THAT'S the claim we make for the new J.B. Condenser. The losses are, in fact, absolutely negligible. For instance, with the '0005 model the total losses measured at a million cycles are '02 ohms.

This is a fact established by an N.P.L. Test, and gives an added point of superiority to the J.B. which, while combining features of mechanical excellence, is logically an instrument for the radio man seeking a precision condenser.

PRICES.

'001	13/-	'00025	8/9
'00075	11/9	'0002	8/6
'0005	10/6	'0001	8/3
			'0003			9/-	

JACKSON BROS
 & POLAND ST- OXFORD ST
 LONDON - W.1
 Telephone - GERRARD 7414

CAXTON 4-VALVE CABINET

Made for Editor of Wireless Magazine for Set "As good as money can buy" described in issue February, 1925.

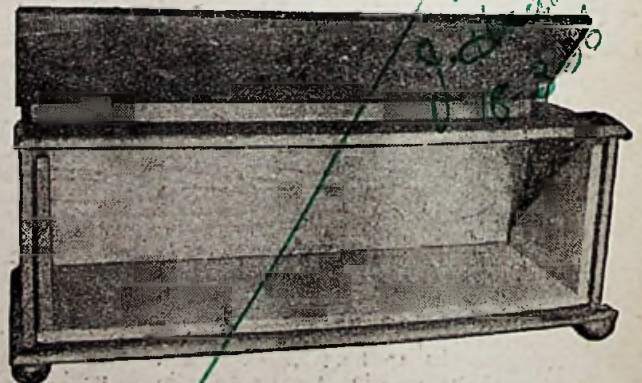

Cash with Order. Fumed Oak ... £1 5 0
 or Real Mahogany polished ... £1 14 0

With detachable recess fitted Base Board to mount 21 in. by 7 in. panel to slide out of Cabinet front.
 Extra 10/- with two beaded front doors totally enclosing fitted panel.
 Cabinet overall length 22½ ins. Width 8½ ins. Height 9 ins.

Polished with the new enamel that gives a glass hard surface that cannot be soiled or scratched.
 SENT FREE.—Catalogue of standard Wireless Cabinets in various sizes and woods. Special Cabinets made to customer's orders.

PACKED AND DELIVERED FREE IN U.K.

CAXTON WOOD TURNERY CO., Market Harborough

to take the short 1/4 B.A. countersunk screws which are used to fix one wing of the hinge to the plug, as shown in the diagram. It is important that these screws should be short, otherwise they may foul the pin and socket of the plug, and thus short-circuit the coil.

The Fixed Block

In the case of the second plug, forming the fixed block of the holder, the design is not so important. A hole is drilled centrally through it 3/8 in. from the top and tapped to take the 2 B.A. screwed rod. The next step is to drill a small hole in each plug to take the small wood-screws for the spring, and it will be noticed that while the screw in the moving block is placed halfway up the end of the plug that in the fixed block is only 1/4 in. from the bottom. This arrangement slightly reduces the amount of extension of the spring when the coils are swung far apart.

Mounting

The fixed block is mounted on the ebonite base (or panel of the set,

as the case may be) by drilling clearance holes for the legs, which are passed through the ebonite. The underside of the panel or base is countersunk to allow the fixing nuts to be screwed up flush with the ebonite. Soldering tags and washers are threaded on to the legs before mounting, but these may be unnecessary if a different type of block is used—e.g., another type B plug.

Moving Block

The free wing of the hinge on the other plug is fastened down by two small woodscrews in such a position that the inner faces of the moving and fixed blocks are about 1/4 in. apart, care being taken that the moving block does swing outwards when the hinge opens.

Length of Handle

A knob is fitted to the 2 B.A. rod and secured in position with a locknut, the other end of the rod being screwed through the tapped hole in the fixed block. The length of the screwed rod depends upon

individual requirements, according to whether panel or back-of-panel mounting is desired.

How the Spring is Used

The short coil spring is fastened as shown, the distance apart of the fixing screws depending on its

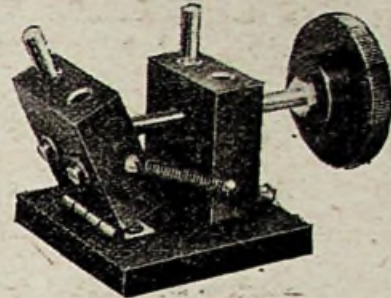

Another view of the finished component.

length, although their heights above the base should be made to conform to the dimensions given. It is important to use a strong steel spring capable of supporting Davenport coils and to see that the spring is just taut when the blocks are at their nearest position. If desired, a second spring can be fixed similarly on the other side of the coil holder to give added strength.

Operation

On turning the knob to the right the threaded rod screws through the fixed block, and pushes the moving block away against the pressure of the spring. When the motion is reversed the pull of the spring causes the moving block to return as the rod screws back. The motion is very regular, and free from backlash, allowing extremely fine control of reaction coupling. The total cost of the coil holder does not exceed half-a-crown, and it will take even the heaviest coils.

P. H. W.

The Powerful Three-Valve Set

SIR,—I have constructed the Powerful Three-valve Set described in the April, 1925, issue of THE WIRELESS CONSTRUCTOR by Percy W. Harris, M.I.R.E. I am using bright-emitter valves, and get very good loud-speaker results. I am very pleased with it, and wish your paper much success.

Yours faithfully,
GEO. SMITH,
Uttoxeter, Staffs.

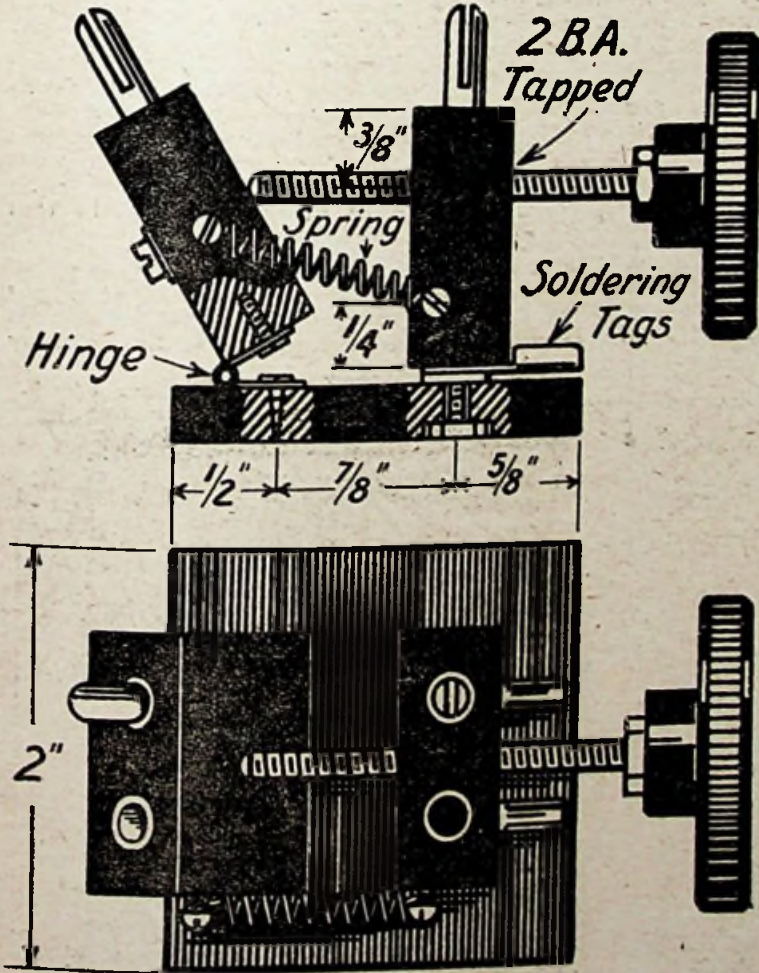

The plan and elevation of the coil holder are given above, together with all the necessary dimensions. Note how the spring is fixed by means of two wood screws.

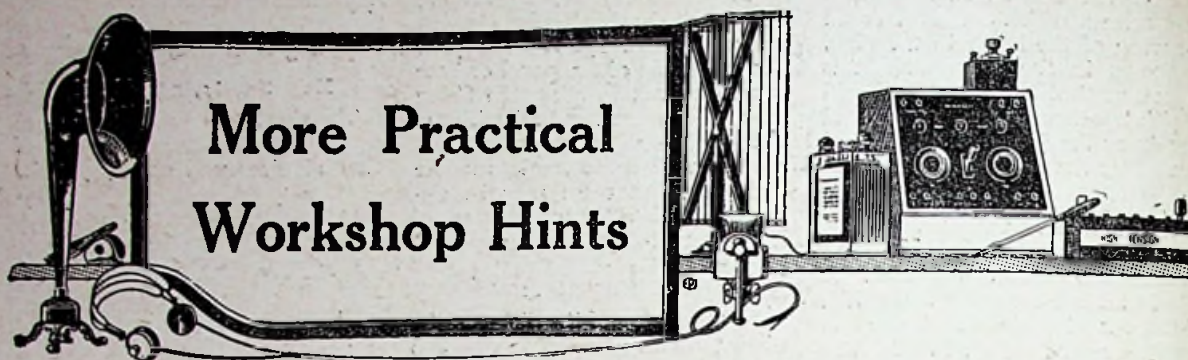

*Emery Grinders—Re-sharpening Drills—Hacksaw Hints—Blade Tension—Saw Handles—
Using Old Emery Cloth*

Finishing Panel Edges

The finishing up of the edges of ebonite panels is a problem that puzzles many constructors. Quite a number of my friends, in fact, have given up the task in despair, and now purchase all their panels accurately cut to size and with trimmed edges. It is, of course, more expensive to buy panels in this way, and the economical man will continue to trim his own.

A Useful Accessory

The best method that I have found so far for accomplishing this is to use a geared emery wheel, which does the work very quickly indeed, and produces edges most pleasing to the eye after they have received the final polish with the finest grade of *used* sandpaper, followed by the application of a little turpentine with a soft rag. Emery grinders are by no means expensive. A large-sized wheel is not required, a diameter of 4 in. being ample. Besides its usefulness for trimming up the edges of panels the emery wheel rapidly repays its original small cost owing to the other tasks which it can be used to perform. With it blunt, burred or misshapen screwdrivers can be ground to the proper form in a very short time, and it helps to maintain tools of many kinds in good working order.

Old Drills

I suppose that most constructors have in their workshops a number of drills of various sizes which have become so blunt owing to prolonged use that they have been discarded. When used for working ebonite drills very rapidly lose their keenness, and become almost useless for cutting brass, which requires a very sharp drill. Comparatively few people know that blunt drills can be re-sharpened and given a new lease of life at very small cost.

It is hardly worth while sending an odd drill to be treated in this

way, but when you have collected half a dozen or so of various kinds they should be sent to a good tool shop, where they will be placed in a special drill grinding machine, which repoints them, and gives them back all their original keenness. Where a large amount of constructional work is done it is best to keep separate drills for ebonite and metal work. As the two kinds of drills become blunt they should be kept in separate boxes, and when they are sent up for re-sharpening each batch should be carefully labelled to indicate the work for which it is intended.

The Cutting Angle

The best cutting angle for ebonite is slightly different from that required for brass, and if the proprietors of the tool shop know the purpose for which the drills are intended they will so grind them

that they are especially suitable for performing their work.

Tips About the Hacksaw

Most beginners at constructional work, and not a few of those who have had a good deal of experience, find the hacksaw a rather difficult tool to handle for doing certain kinds of work. A job which puzzles many people is to keep to the straight scribed lines when cutting out a piece of ebonite; the saw shows a tendency, which has continually to be corrected, to work either into or away from the line. The result is that when the required piece has eventually been cut out it has jagged or wavy edges, which it is rather a business to trim down satisfactorily.

Importance of Tension

The whole secret lies in getting sufficient tension on the blade when it is put into the holder. In nearly

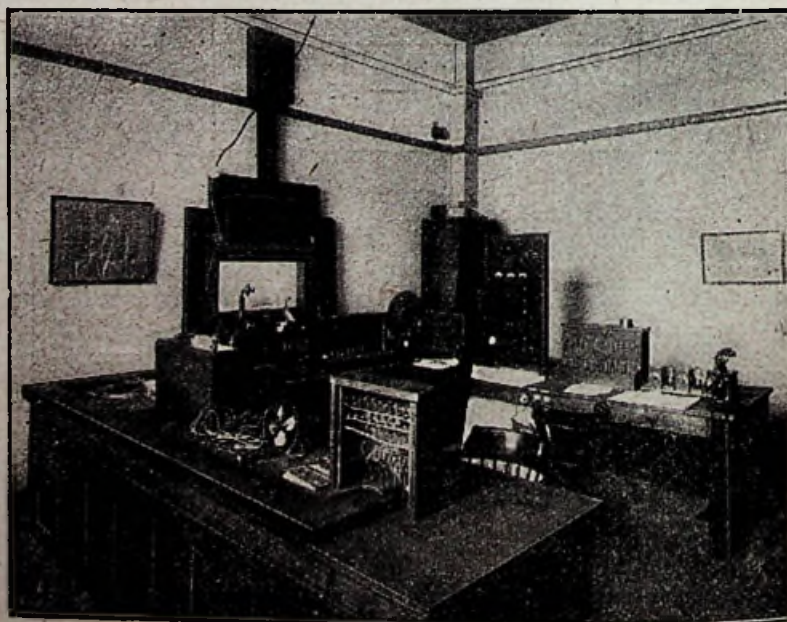

The control room of the new Birmingham B.B.C. station. Note the window to the studio.

every case when you find that a constructor is unable to cut along a straight line you will discover by examining his saw that the blade is far too slack. There is an idea at the back of his mind that if he puts a heavy pull on the blade by means of the tension screw it will be much more liable to snap when in use than it would be if it were left rather slack. This is quite wrong; the slack blade may buckle a little under the pressure of each cutting stroke, and this kind of thing soon leads to a break.

"Sounding" the Blade

The tightly screwed-up blade is kept always quite straight between the points of attachment and is therefore not subjected to unfair bending strains. Further, owing to the fact that it bends whilst cutting is in progress, the slack blade cannot be made to follow a scribed line properly, whilst if the blade is under proper tension it is far from difficult to make it do so. When you insert a blade into your hacksaw frame tune it as you would a banjo string by plucking the smooth edge with your thumb.

When the tension is about correct the blade will give a fairly high-pitched note. A few experiments in cutting along lines scribed

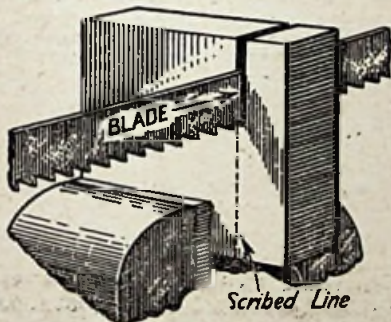

Fig. 1.—A saw blade must be used so that it cuts on the thrust stroke.

upon pieces of scrap ebonite with the blade in various states of tension will soon enable you to recognise the tell-tale note which shows you that your hacksaw blade is properly screwed up.

Another Point

Some beginners, too, make the mistake of putting the blade of a hacksaw into the frame in the wrong way, so that it cuts on the draw—that is, when the saw is pulled towards the body—instead of on the thrust. This is a method adopted by the Chinaman, who is so constituted that his methods of doing things are in a large number of cases the direct opposite to those employed by Europeans. The reason why the blade should

CLEARTRON CHARACTERISTICS



HERE we show you the electrical characteristics of the CLEARTRON Dull Emitter C.T.25; we could talk to you for hours about its general excellence. But charts and talk cannot convince like an actual trial. Give it a "try out" and prove by your experience that CLEARTRON valves in your set mean vastly increased volume and greater distance; operatic purity, keener selectivity and longer life. And unless the C.T.25 produces all these claims and all these advantages it will be replaced without cost or question—our IRONCLAD GUARANTEE sees to this.

Send for Illustrated Catalogue post free

Type	Accumulator or Battery volts	Fil. volts.	Fil. amp	Purpose	Price
C.T.c.8.	Dry Cells	3	0.08	H.F., L.F. Detector	12/6
C.T.15	2 volt Accumulator	1.8	0.15	H.F. L.F. Detector	12/6
C.T.25.	6 volt Accumulator	5	0.25	H.F., L.F. Detector	15/-
C.T.25 B.	6 volt Accumulator	5	0.25	General purpose resistance coupled amplification	15/-

America's foremost valve made in Britain's newest factory

CLEARTRON RADIO LIMITED

1, CHARING CROSS, LONDON; AND BIRMINGHAM
 Telephone: Regent 2231/2 Grams: Cleartron, Westrand, London

British Made



Service Advertising

36/521D

In replying to advertisers, please mention THE WIRELESS CONSTRUCTOR.

cut on the thrust becomes quite clear if you give Fig. 1 a moment's consideration. The scribed line on the work is on the side towards the body; you wish to guide the teeth on to this line; you can do this best if the teeth, when they are making the cut, are moving from the body towards the line. To be able to go straight with the blade set to cut on the draw one would have to make the scribed line on the far side of the work, and to lean right over so that the eye could see both the blade and the line during the cutting stroke.

An Exception to the Rule

When you have placed the blade in the handle of the hacksaw you can make sure, before screwing it up, that it will cut on the thrust by running your thumb lightly along the teeth; these should feel roughest and sharpest as the thumb moves towards the handle. When, however, you are using a fretsaw or a small hacksaw with very fine blades for cutting ebonite, it does sometimes pay to set the tool so that the blade cuts on the draw.

The reason is that with saws of this type it is not possible to put the blade under sufficient tension to keep it perfectly straight during the cutting stroke, and one is less liable to buckle it or break it if the

teeth are arranged to cut whilst the draw stroke is made. One generally uses the thin small saw for awkward little jobs such as cutting a largish hole in a panel. It does not matter greatly here whether one is able to go dead straight or not, since the work often consists in cutting away the webs between a row of holes that have

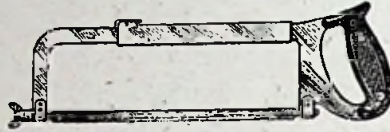

Fig. 2.—A comfortable and steady grip may be obtained with a handle of this type.

been drilled, and in many cases the cut is made well inside the scribed line which marks the final position of the edges of the hole when the work has been finished up with file and emery cloth.

A Handier Handle

To return for a moment to the question of cutting straight with a full-sized hacksaw, some amateur workmen find it difficult to follow a scribed line, even if the blade is properly screwed up, when using a frame of the type most usually seen, which has a round handle in line with the blade, for the wrist is

liable to turn a little in making a cutting stroke. Those who are troubled in this way will probably find that they obtain much better results by using a frame such as that seen in Fig. 2, which is provided with a handle similar to that of the ordinary wood saw.

Economy in Emery Cloth

I suppose that most of us waste a good deal of emery cloth, either by using more than we ought to for various jobs, or by allowing our stock of unused sheets to become damp. Some men will use up two or three sheets in rubbing down and finishing a panel of moderate dimensions, whilst others will get as much work out of a portion of a single sheet.

Are You Wasteful ?

The most uneconomical way of using emery cloth is to tear a strip two or three inches wide from a sheet, to fold this over several times and then to apply it to the surface of the work with the direct pressure of the fingers. This method answers well enough for very small jobs, but when you have a large surface to deal with it is much better not to fold the emery cloth into a pad, but to fix it to a holder of some kind, which will give a flat working surface. One of the best

OK 19-3-26

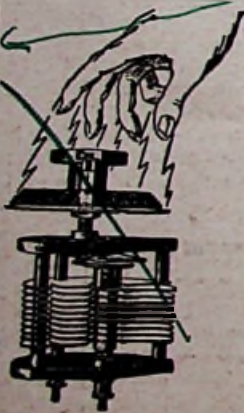

VARIABLE CONDENSERS

Every Fulstop Condenser is unconditionally guaranteed to abolish all hand capacity effects. In addition to being a square law condenser the Fulstop embodies a patent 2-1 gearing, which allows very fine adjustment and accurate tuning. Made in three models from 8/3 to 30/6

H F. NEUTRODYNE UNIT

A combination of a plug-in H.F. Transformer and a Neutrodyne Condenser. It is an invaluable component for Neutrodynes Circuits. Once set it need not be altered, thus assuring better reception and saving time.

It does away with the necessity of drilling a fresh hole in the panel when a set is being converted to Neutrodyne. In cases where several stages of H.F. are used, this unit is the means of matching the transformers perfectly.

Price - - - 12/6

FIXED GRID LEAK (1, 2, & 3 Megs)

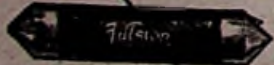

Guaranteed to be accurate and remain so. The element is an entirely new departure, and has distinct advantages over any other. Price - 2/- each

Stocked by most wireless dealers, but if any difficulty write to

J. H. NAYLOR, LTD. WIGAN

Salient "Simplicity Three"

An ultra simple Receiver with only two tuning controls, gives perfect loud-speaker reproduction, all batteries self-contained, automatic switching, covers Wave Band from 175 to 4,000 metres.

Price £22 : 15 : 0 complete with £5 Loud Speaker

Complete set of Components, Cabinet, Blue Prints and Instructions, £10. Marconi Royalty, 37s. 6d.

You will find our List "SALIENT FEATURES" of the utmost interest "S. A. CUTTERS" LTD.

18, Berners Street. LONDON, W.1 Telephone - - - Museum 6273

Price 6d. (Refunded on first purchase)



There are many 'good' Coils - But for Complete Efficiency Use

SLEKTUN

INDUCTANCE COILS

The following National Physical Laboratory Figures constitute a Record:
 COIL OF 200 TURNS INDUCTANCE: 1770 MICRO-HENRIES SELF-CAPACITY: 3 MICRO-MICROFARADS
 Send a p.c. for illustrated booklet—
 SLEKTUN, WELLINGTON HOUSE, BUCKINGHAM GATE, S.W.1

OK 19-3-26

tips that I know is to make use of a large cork bung. A piece of emery cloth of suitable size is wrapped round this, being held in place by the fingers, for which the bung provides a firm and comfortable grip. You will find that a piece of cork used in the way suggested makes your emery cloth go further, and enables you to finish your ebonite surface much more quickly than would be the case if a folded pad were employed.

Use Your Worn Emery

Used emery cloth should never be thrown away until it is completely worn out. Even the finest grade is too keen when new for applying the finishing touches to panels, but pieces that have seen so much use that they are worn almost smooth enable a fine surface free from scratch marks to be

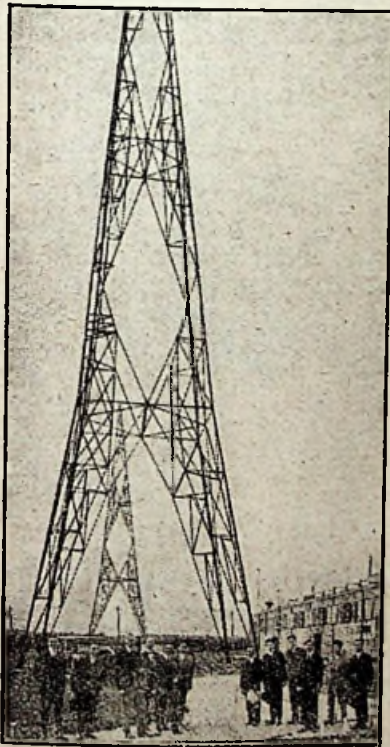

Two huge aerial towers of the Hilversum (HDO) Broadcasting Station.

obtained. Keep your stock of emery cloth, old and new, in a dry place. If it is allowed to become damp and flabby it will not give half the service that it would if hard and dry. It is always a good tip, when sheets have been amongst one's workshop stock for some time, to give them a spell in the oven or in front of a hot fire before they are brought into use.

◆ ◆ ◆
Everybody's Radio
 ◆ ◆ ◆
Reference Book
 ◆ ◆ ◆

It is with much pleasure that we announce that the Radio Press Year Book is now on sale, and our readers will no doubt be interested to learn something of the contents of this invaluable one-and-sixpenny production.

This "Wireless Book of Reference," as it has been very appropriately termed, is divided up into sections, the first being a collection of authoritative articles written by men whose names are well-known to the wireless public because of their expert knowledge of some particular branch of the art.

Following this is the valve section, in which detailed information is given regarding the types of valves to use for different purposes, and in addition a comprehensive list of valve data together with a large number of characteristic curves is included.

Wireless Calculations

Then comes a portion dealing with simple wireless calculations, in which the non-mathematical reader is led, with the aid of numerous examples, to a clear understanding of the methods of finding the inductances of given coils, of dealing with condensers in series or parallel, and of designing resistances. The workshop section contains many tables concerning wire and drill sizes, woodscrews, weights of ebonite, sheet and rod, etc.

For You

Of special interest to readers of THE WIRELESS CONSTRUCTOR in the above section are hints upon set construction; while the experimenter has not been forgotten, inasmuch as he will find a most comprehensive and up-to-date list of amateur call signs, a list of wireless societies, a radio map of Europe, and also the Morse code and the international abbreviations or "Q" signals.

What of the Future ?

Reverting to the general section of the book, we have an enlightening article entitled "Prophecies" from the pen of Mr. J. C. W. Reith, the managing director of the British Broadcasting Company, while Capt.

H. J. Round, M.C., M.I.E.E., chief of the Research Department of Marconi's Wireless Telegraph Co., Ltd., contributes an exceedingly interesting article dealing with low-frequency magnification, in which he elucidates in a simple and practical manner many of the problems involved in the proper understanding of this subject.

Major James Robinson, D.Sc., Ph.D., F.Inst.P., discusses various methods of controlling oscillation in H.F. amplifiers, and Mr. J. H. Reyner, B.Sc. (Hons.), A.C.G.I., D.I.C., A.M.I.E.E. (the Technical Editor of the new *Wireless Weekly*), explains the meaning of coil resistance and describes how the self-capacity of the coil, the spacing of the turns, and the gauge of wire used all affect its general efficiency.

The Re-transmission of U.S. Programmes

Capt. A. G. D. West, M.A., B.Sc., of the B.B.C. Engineering Staff gives many valuable hints to those enthusiasts desirous of receiving American broadcasting. Capt. West's attempts at the re-transmission of American programmes have made his name familiar to listeners in this country, and readers will be obtaining the benefit of much of his practical experience in this work.

American Radio Conditions

In another feature of interest, Mr. Percy W. Harris, M.I.R.E., draws a contrast between American and English radio conditions. Mr. Harris, it will be remembered, has made a thorough investigation of radio in the United States, and is in a position to give first-hand information on the subject.

Three of the Many Other Features

In further articles of technical appeal, Mr. H. J. Barton-Chapple, Wh.Sch., B.Sc. (Hons.), A.C.G.I., D.I.C., A.M.I.E.E., deals with the effects of self-capacity in inductance coils, Capt. H. L. Crowther M.Sc., gives some authoritative facts about valve filaments, while Capt. Jack Frost, of the B.B.C., in his article entitled "Getting the Best from Your Aerial," discusses many points which often escape the attention of the beginner in erecting his aerial.

Rtd 22.3.26
April, 1926

30 ALTERNATIVE PROGRAMMES

Anywhere from anywhere at any time. Guaranteed Loud Speaker Reproduction. No Aerial. No Earth. No Exterior Connections.

DEMONSTRATION AT YOUR HOUSE WITHOUT COST OR OBLIGATION. GENEROUS PRICE ALLOWED FOR YOUR EXISTING INSTRUMENT IF TAKEN IN PART EXCHANGE FOR:

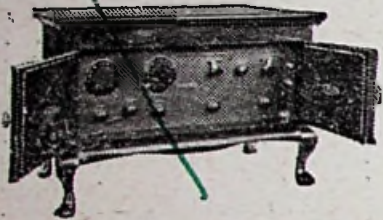

The Curtis
Imperial
Model
Double
Circuit
Super-
Het. 8.

The Curtis DOUBLE-CIRCUIT Super-Het. 8

(Patent's pending)

Two distinct Receivers in one.

A Straight Circuit of 2 or 3 valves for Loud-Speaker Reproduction from the Local Station.

A Super-Heterodyne Circuit of seven or eight valves for Loud-Speaker Reproduction of any Station in the Continent of Europe from anywhere in the United Kingdom. Total consumption of all eight valves, less than that of a single Bright Emitter Valve.

Automatic Tuning. No searching required.

A Correspondent in the Daily Press writes: "12 Stations were tuned in within five minutes - from Barcelona to Bournemouth, it was almost as simple as turning up numbers in the Telephone Directory."

BUILD THE CURTIS SUPER-HET. WITH



The Curtis Intermediate Unit

4 VALVE, 3 IF and 1 FILTER £7 10 0
3 VALVE, 2 IF and 1 FILTER £6 6 0

The Curtis Intermediate Unit is a complete component consisting of the intermediate frequency and filter transformers, with corresponding valve sockets and accessories. Wired up, boxed, tested and matched ready for use in any superionic circuit.

We have built the Super-Het. for you. What is left is of so little consequence that the connecting wires may be run anyhow.

Home Constructors' Treatise, Price 2 6

contains:

1. Circuit diagrams.
2. Simplified lay-out and wiring charts.
3. Instructions for operation.
4. Complete schedule of components.

Write for Catalogues.

Peter Curtis, Ltd.

11, RED LION SQUARE, W.C. 1

Telephone—North 3112-3. Telegrams—"Paracurtex,"

MANCHESTER Telephone—Central 5095 312, DEANSGATE

GLASGOW Telephone—8759 47, CARRICK STREET

EDDYSTONE

LOW LOSS CONDENSER

(Patent No. 240716)

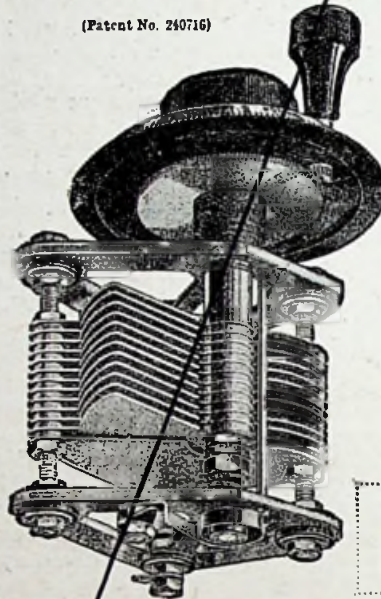

The 10 to 1 patent micro-metric gearing gives hair-splitting tuning, while the fine helical cut gears prevent backlash.

Ordinary brass or aluminium vanes oxidise in time, which causes high frequency resistance. The "Eddystone" brass vanes are specially treated to prevent this.

There are no losses due to insulation or unwanted metal in the magnetic field. It has negligible resistance, since both stator and rotor vanes are soldered to their respective supports.

The fixed aerial vanes are of thinner metal, to reduce high frequency resistance. The moving earth vanes are stout, to prevent buckling.

PRICES:
With Geared Vernier—
0005 :: 17/8
0003 :: 16/6

"Eddystone" Radio Products created a sensation at the British Industries Fair, White City, and for a copy of our latest catalogue

Stocked by most dealers. If any difficulty send direct Supplied on approval for seven days. MONEY RETURNED IMMEDIATELY IF NOT SATISFACTORY

STRATTON & Co., Ltd. - (Dept. C.) - Balmoral Works, BIRMINGHAM

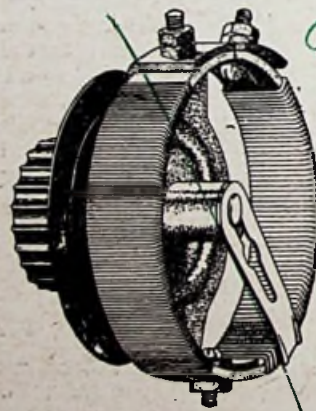

Two in One!

The new Dual Rheostat—a "Peerless" product in every way. Specially designed to meet the demand

for a resistance equally applicable to bright or dull emitters. It has two windings—one offering a resistance of 6 ohms, whilst a continuation of this is of 30 ohms resistance. The resistance element is wound on a hard fibre strip under great tension. One hole fixing is provided, and the terminals are placed in convenient positions. The contact arm has a smooth, silky action, and all metal parts are nickel-plated.

3/9 Retail PEERLESS 3/9 Retail
DUAL RHEOSTAT

Send now for full details

The Bedford Electrical and Radio Co., Ltd.
22, CAMPBELL ROAD BEDFORD

May we send you also details concerning our new "Resicon" Condensers? Precision Instruments—made to an ideal

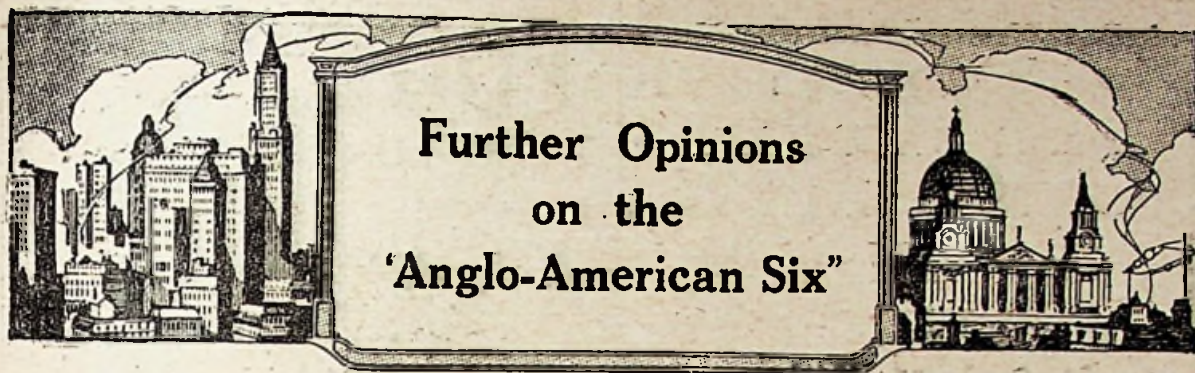

Further Opinions on the 'Anglo-American Six'

FROM A BARNES READER

SIR,—I thought you might care to hear the results obtained at Barnes with the "Anglo-American Six" receiver, designed by P. W. Harris, M.I.R.E. The panel and baseboard layout exactly follows the original, and the finished receiver presents a very handsome appearance.

Whether my aerial earth system is very poor, or Barnes a bad locality I know not, but I can only get very poor results using an efficient crystal set. But on this aerial and earth the "Anglo-American" brings in almost everything. All the main B.B.C. stations and most of the relays come in at good phone strength, using the first four valves, Newcastle and Bournemouth being particularly good. Continental stations come in very well on the same combination of valves. The one evening I sat up, WGY and WJZ came in quite clearly, using in this case the first stage of low frequency amplification.

The set is very simple to operate, and the purity of reproduction on distant stations all that can be desired.

Yours faithfully,

H. L. GROOM.

Barnes, S.W.13.

"AN UNQUALIFIED SUCCESS.."

SIR,—Some two months ago I constructed the "Anglo-American Six" set, described by Percy W. Harris, M.I.R.E., in the January and February, 1925, issues of THE WIRELESS CONSTRUCTOR. I may say that the set has proved to be an unqualified success, and this is the more gratifying to me as it is the first set I have made. I have the advantage of some knowledge of the subject, but I do not think that anyone should have much difficulty in constructing the set and operating it successfully if they follow the very clear instructions given.

I have not bothered much with DX work, but have had excellent concerts from over 30 different

European and British stations, about 25 of these being received at comfortable loud-speaker strength for an ordinary room; many, of course, far louder. In fact, I have heard B.B.C. main stations 50 yards down my garden out of the front door.

The set is extremely selective, easily separating Manchester, Bournemouth and London, but when Oslo (which often is by far the strongest station here) plumped itself between Manchester and Bournemouth I could not cut out the unwanted station *completely*, but quite well enough for all



Boys of the Middlesbrough Juvenile Unemployment School with their "Anglo-American Six."

practical purposes. I have, however, since constructed the "A.A." wavetrap, described in the March, 1925, issue, and can now cut out, and *completely separate*, Bournemouth, Oslo and Manchester. This seems to me extremely good.

I can get *in broad daylight* Manchester and Newcastle always, Glasgow, Belfast, London, and Bournemouth on favourable days, and sometimes others, all at good loud-speaker strength. They are much freer from Morse than at

night, so summer time has no terrors for me; and my selection of programmes is still adequate for any mood. Wishing the Radio Press every success, I beg to sign myself,

Kendal.

IDIOTES.

WIRELESS IN SCHOOL

SIR,—I enclose a photograph of the "Anglo-American Six," described by Percy W. Harris, M.I.R.E., in the January and February, 1925, issues of THE WIRELESS CONSTRUCTOR, which has been built by the boys of the Middlesbrough Juvenile Unemployment School, under the supervision of the headmaster, Mr. A. V. Robinson.

Many Radio Press circuits have been used—*e.g.*, the "Three Valve Simplicity," the "Three Valve Home Receiver," the "Two Valve Neutrodyne," the "Twin Valve Receiver," and the "Long Range One Valve Receiver."

Excellent results have been obtained with all these sets. Perhaps the "Anglo-American Six" and the "Three Valve Simplicity" are the best, and most appreciated by the boys.

For wireless diagrams in school, I have not found any to equal the Radio Press series, which are really simplicity themselves.

The boys have found no difficulty whatever in following the various circuits, and only one set refused to work when it was first tested.

On behalf of our local Education Committee I would be pleased if you could find room in your valuable journal to publish our photograph. It will show other centres and schools in the country what the boys of this school have been able to do with the help of the Radio Press.

Yours faithfully,

A. V. ROBINSON,

Headmaster.

Juvenile Unemployment School,
Middlesbrough.



A novel crystal receiver giving a circuit for every need

PROBABLY the greatest difficulty facing the uninitiated home constructor embarking upon his first crystal set is that of selecting a suitable circuit arrangement to give him the loudest signals in his own particular circumstances. It is true that there is not a very wide range from which to make this choice, but at the same time it is quite likely that one particular arrangement will give louder signals than the others.

With this object in view, the writer designed the set which is shown in the accompanying photographs, and with it, as the heading

suggests, a choice of four circuits is possible. The finished instrument presents quite a handsome appearance, all the metal parts on the front of the panel being nickelled. As will be seen from the photographs, the layout is perfectly symmetrical, and the receiver is very simple to construct.

The Circuits

The first circuit obtainable is a straightforward direct-coupled arrangement using a parallel tuning condenser, and this can very quickly be changed to

a circuit employing a series tuning condenser. By a further com-

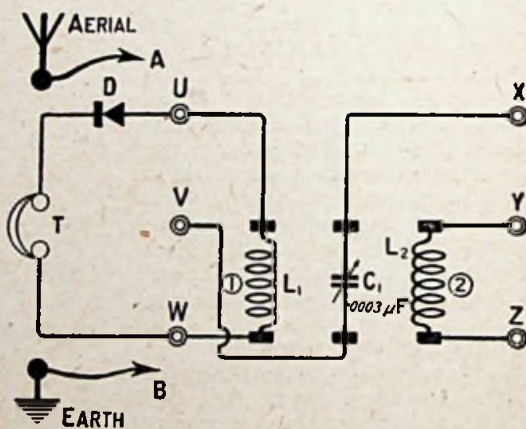
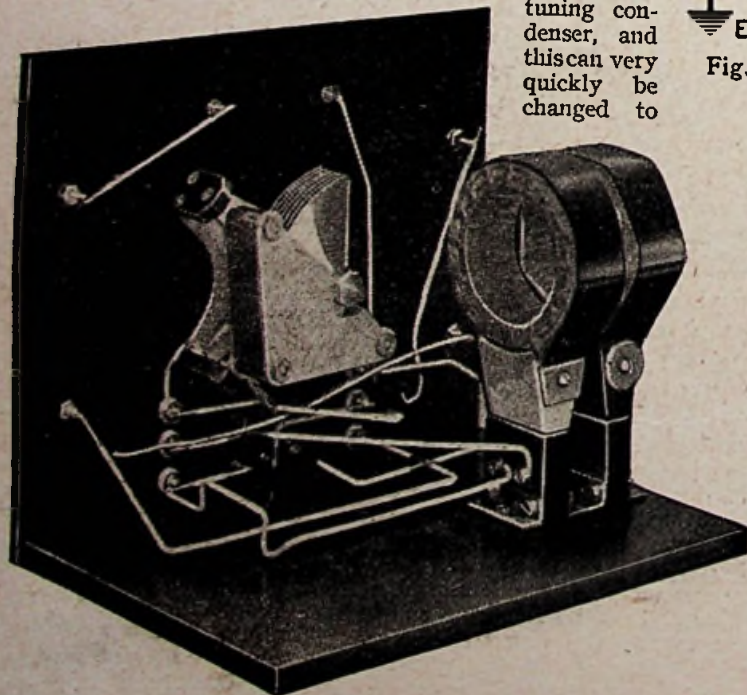

Fig. 1.—The "general" circuit diagram of the receiver described.



A view of the wiring, with the two coils inserted in the sockets.

bination of the switching arrangements it is possible to obtain a tight inductively coupled circuit with a tuned primary and a so-called aperiodic secondary.

Lastly, those readers residing in coastal districts where spark interference is bad may like to try the form of trap circuit which is obtainable on the set. In connection with this latter, although it is practically impossible to eliminate morse interference completely on a crystal set, the use of such a circuit may be found to reduce it considerably. It has one drawback, however, and that is that the signal strength may be much less than with any of the other arrangements.

The Design

The receiver, as will be seen from the photographs, has been designed on the lines of the now popular

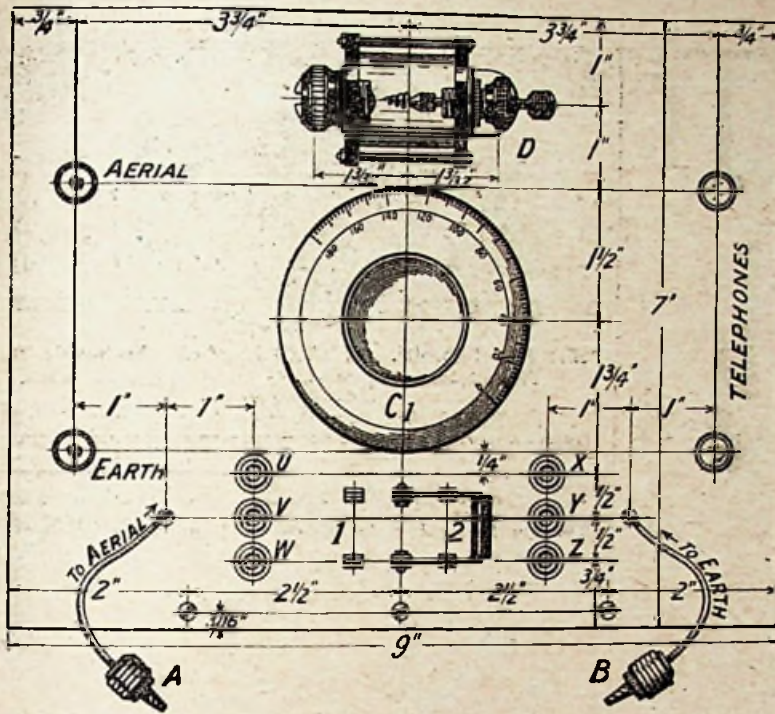

Fig. 2.—Drilling dimensions are shown above. Blueprint C1038A.

American style. The switch which can be seen immediately under the condenser dial, in conjunction with the Clix plugs and sockets, enables the various circuits to be tried. Plug-in coils are employed, and these can be either of commercial types or home constructed.

Components

The components required are not numerous, and in the list below the makers' names are given for the benefit of readers desirous of making an exact replica of the original set. Provided that due allowance is made when drilling and assembling, however, other components of reliable manufacture will suit quite well.

One Radion panel, black, 7 by 9 by 1/8 in. (American Hard Rubber Co.).

One cabinet to take the above, with baseboard (The Artcraft Co.).

One Utility low loss square-law variable condenser, .0003 μF (Wilkins & Wright, Ltd.).

One crystal detector, "Mic-Met" (C. & J. Arrigoni & Co., Ltd.).

One piece crystal ("Neutron").

One nickelled D.P.D.T. switch.

Two nickelled W.O. terminals.

Two nickelled 'phone terminals.

Two Magnum single coil holders (Burne-Jones & Co., Ltd.).

Quantity of No. 16 "Glazite" wire and about a yard of flex wire.

Four Clix plugs and six sockets (Autoveyors, Ltd.).

One packet Radio Press panel transfers.

Marking Out

The reader is recommended to scribe his panel from the layout shown in Fig. 2; and in this process no difficulties should be encountered. As I have previously indicated, if components different from those specified are used, slight modifications may be necessary. Assuming the panel to be scribed, let us turn to the drilling. When doing this the panel should be placed on a piece of soft paper to prevent the front surface from becoming scratched.

All the holes are straightforward with, perhaps, the exception of the

condenser fixing hole, since for the make used on the original set this hole requires to be 5/8 in. in diameter. Given the correct drill, however, readers should encounter no trouble even with this hole.

Supporting the Panel

By glancing at the back-of-panel views it will become apparent that no panel brackets have been employed. These were found to be unnecessary, three large wood screws sufficing to fix the panel to the baseboard. Before actually fixing the panel to the baseboard, it will be found convenient to mount upon the former the switch and the Clix sockets. The remainder of the components can be fitted after the panel has been mounted. To complete the assembly of components ready for connecting up, the two single coil-holders should be mounted, as shown, upon the baseboard.

The Wiring

"Glazite" wire was employed for making the necessary connections, and reference to the back-of-panel photographs and drawing will help readers to overcome any difficulties which may arise at this stage. A piece of flex wire, one end of which is soldered to the aerial terminal, passes through the left-hand hole, as indicated in Fig. 2, and terminates in a Clix plug (A).

Another piece of flex is taken from the earth terminal, and this passes through the other hole in the panel. This lead also terminates in a Clix plug. A further piece of flex,

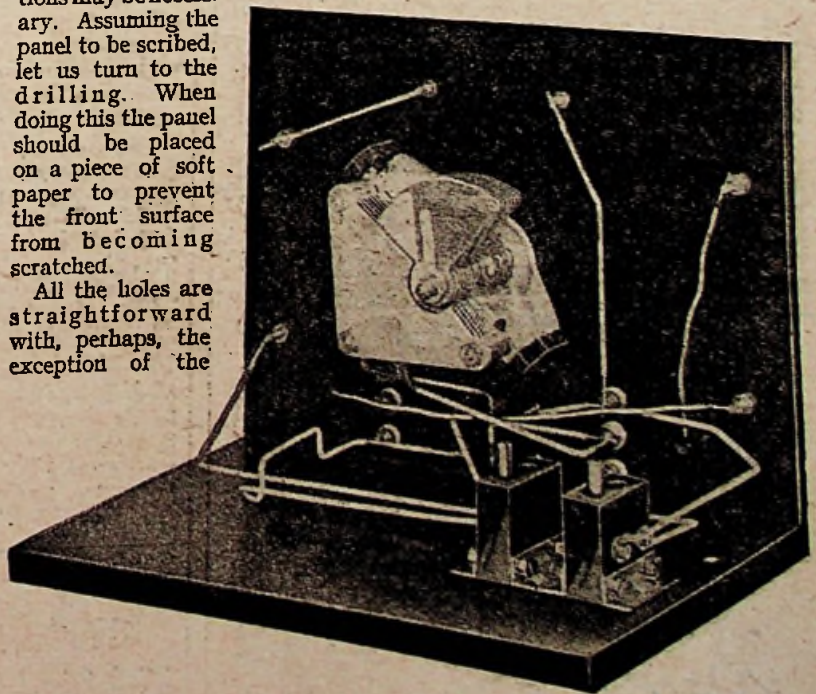

Another back-of-panel photograph which will help the constructor

RT 10-8-26

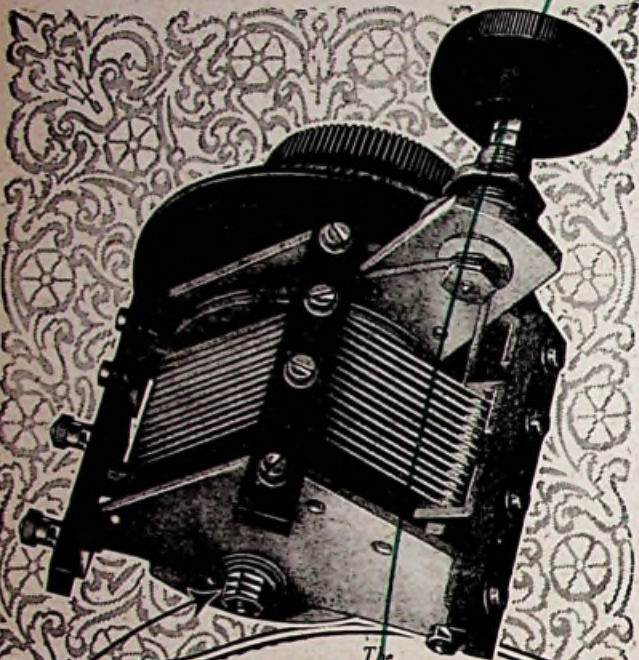

The **"COSMOS"**
SLOW MOTION
CONDENSER

COMPENSATED
SQUARE LAW
EFFECT
LOW LOSS
NO
BACK LASH

with its ratio of 10 to 1 makes it possible to dispense entirely with the customary vernier and its attendant losses. Particular stations can be logged. Backlash is avoided not temporarily but permanently and movement is smooth, permitting fine adjustment. This model can also be arranged for remote control, as shown in the illustration below. Also supplied without slow motion feature when the condenser is one-hole fixed. Both models are constructed to eliminate hand capacity, for low loss, and to give a compensated square law effect. Cone bearings of hardened steel ensure constant calibration and a pigtail connection gives permanent positive contact.

Metro-Vick Supplies Ltd.
4, Central Buildings, S.W.1

Prices:
Ordinary. Slow Motion.
'00025 mfd. '0005 mfd. '00025 mfd. '0005 mfd
15/- 17/6 19/- 21/6

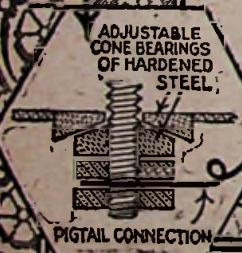

COSMOS



A
NEW
RADIO
SYMBOL

THE
MARK OF
PERFECT
EBONITE

Polished Sheet Ebonite. TESTED Ebonite. No-trouble Ebonite.
From all good dealers, cut from the sheet or in stock size panels.
Matted ready for use.
CLAYTON RUBBER CO. LTD., Progress Works, Croft Street, Clayton, MANCHESTER

RADIAX LOW LOSS COILS

give you improved tuning volume and selectivity

No. 25 - 16	No. 75 - 23	No. 200 - 43
.. 33 - 1/9	.. 109 - 29	.. 253 - 4/9
.. 50 - 2 1/2	.. 150 - 3 1/2	.. 300 - 0/3

SET OF 9, MOUNTED, 26/6

Look for trade mark and number on plug. Each one neatly boxed

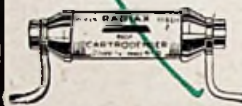

THE
CARTRODENSER

A fixed condenser in most convenient form

No fixing required—damp proof—instantly changed—no panel space required as they fix in run of wiring
'00025 1/7; '0003 1/7; '0005 1/8; '001 1/10; '002 2/-

Also the CARTROLEAK, a grid leak of similar form; any resistance, 1/6

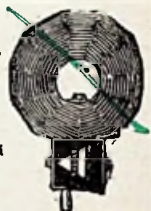

Complete Catalogue of all sets—super het. components and general accessories
Enclose 3d. stamps

RADIAX LTD., 44, Radio House, Palmer Place, Holloway Road, N.7

RT 10-8-26

LONDON'S LARGEST RADIO STORES

Supreme **SELECTIVITY**
Each station has a CLEAR
TUNING SPACE
CROWDING entirely
ELIMINATED
SIMPLIFIED tuning
DISTINCT and DEFINITE
Radio reception
PRECISION workmanship
HEAVY BRASS VANES,
BRITISH MAKE
Rig-tall connection to rotor
gives silent working
Special Spring top Bus's
gives a firm but easy
movement

KAY-RAY
WONDERFUL
LOW LOSS STRAIGHT LINE FREQUENCY
CONDENSERS



In the straight-line frequency condenser was never before possible using the straight-line variable length condenser. Now look at the present-day etc and notice the silent rotation that has taken place. All the new sets have straight-line frequency condensers and many are equipped with vernier dials.

UNSOLICITED TESTIMONIAL
78, Copenhagen Road, Gillingham, Kent.
19/2/26

Messrs Raymond,
While in town a short time ago I purchased 3 of your Low Loss Straight Line, etc., condensers, viz: '0003, '0005 and '0005 with vernier. I did not have an opportunity for testing these until Wednesday evening last, when I banked up a straight one-valve incorporating the '0005 without vernier. The results were absolutely astonishing, because I got a station with almost every degree of the dial. I got as far as Stockholm. The other stations were London (of course), Berlin, Bournemouth, Dresden, Brussels, Hamburg, San Sebastian, Paris, Hilversum and Daventry. I almost forgot to include Dublin. This station is rarely heard in this district but it came in well on two pairs of phones. I have never used a better condenser and I felt that you would like to know. The hook-up was on a piece of board.
(Signed) A. DOWER

Lists Post Free. Any parts quoted for at an inclusive price. Parts you have no use for accepted in part exchange. Post customers write first. Usable valves bought. One burnt out valve accepted as part payment if new British one is purchased.

CALLERS! THOUSANDS OF BARGAINS FOR YOU

K. RAYMOND Phone: GERRARD 4637
TWO SHOPS—so you will ALWAYS find ONE OPEN
27 & 28a, LISLE STREET, LEICESTER SQUARE, W.C.2
Opposite DALY'S GALLERY DOOR (Back of Daly's Theatre).

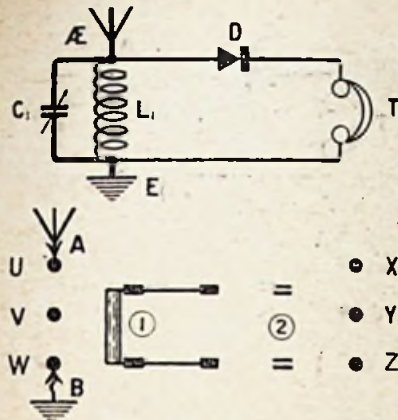

Fig. 4.—The parallel tuning arrangements.

about 6 in. long, should be equipped with a Clix plug at each end. The use of this will be shown later. The application of panel transfers

to the front completes the receiver, and all is now ready for the testing.

Trying Out

To try out the receiver, first insert a No. 35 or 50 coil (depending upon the wavelength of your local station) in the socket marked L_1 , and arrange the switching on the front of your panel to conform with Fig. 4. Adjust the catwhisker on some point of the crystal, and slowly turn the condenser dial from zero to 180 deg, until signals from the local station are heard. The readjustment of the catwhisker should now give the maximum signal strength obtainable with this circuit.

Now rearrange your switching to conform with Fig. 5 and insert a No. 50 or 75 coil in socket L_1 . It is in connection with this circuit that the flex shorting strip is used,

and its purpose is to connect the top Clix sockets on each side. Tune the condenser as before, and signals from the local station should once

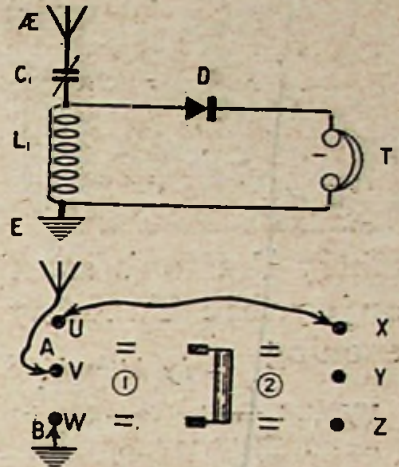

Fig. 5.—The shorting link is employed when using a series condenser.

more be heard. Comparison of strength can now be made with that of the previous circuit.

More Selective Arrangements

The tight-coupled circuit with a tuned primary can be obtained by switching as shown at Fig. 6. For this circuit the exact sizes of coils will have to be found by experiment, but to give some indication, when tested by the writer, a No. 35 was used for coil L_2 , with a No. 60 for coil L_1 .

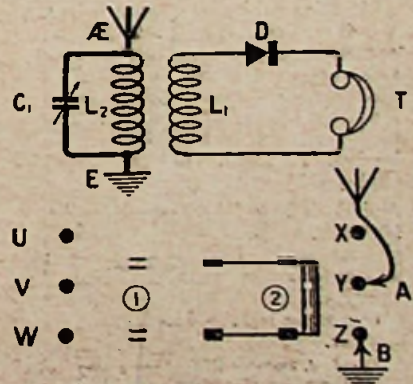

Fig. 6.— L_1 and L_2 are closely coupled for this circuit.

Again, for the trap circuit, shown in Fig. 7, the sizes of coils will best be found by experiment. One point, however, should be mentioned, and that is that L_2 should be kept very small.

If it is desired to receive Daventry, this can be done by using the parallel-tuning circuit

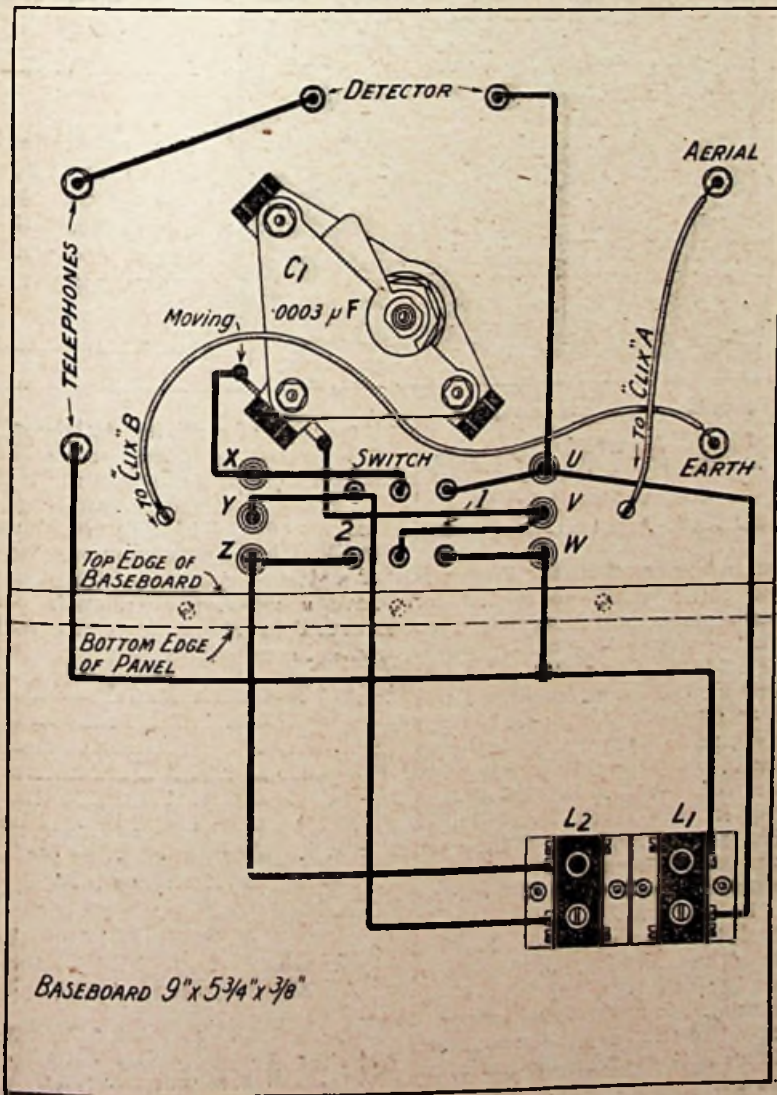

Fig. 3.—The Clix sockets shown are lettered in accordance with the circuit diagrams. Blueprint C1038B.



Harry Preston's most enjoyable Tuesday evening —by himself.

WELL I remember the evening I built up my Pilot 3-Valve Set. Coming home tired and cold, my wife met me in the hall with the words—"There's a parcel from Peto-Scott's for you, Harry." "Good," I replied; "then we'll soon have some wireless music." "Perhaps," she laughed, "but not this week." "You wait," I cautioned; "maybe even to-night."

After tea, I cleared the kitchen table, took off my coat, rolled up my shirt sleeves and commenced work. At 7 o'clock—one hour and a quarter after starting—I had assembled all the components on the panel. At 7.25 the base-board was complete and I had commandeered the family gas-ring for my soldering-iron.

Two hours later I had almost completed the wiring up—the diagram was so easy to follow. At five minutes past ten I had enlisted my wife's help in hitching up a few yards of bell wire around the picture moulding.

At 10.20 p.m. the great moment arrived. Would the Set work? "Bet you a box of State Express to a new hat," said my wife, hopefully, "that it won't." I donned the headphones—there was a moment's silence. Then... "Pay up," I grinned as I handed her the "phones." "Listen to the Savoy Orpheans."

And that's how I built my Pilot Set. No worry, no trouble—just an evening's pleasant work. I shall never regret sending for a copy of the Pilot Manual.* That little book saved me pounds and put me on the right road for building my own Set.

*Send 3d. and we will send you a copy of this splendid 56-page book. Full constructional details, circuit diagrams and many actual photographs.

Pilot Sets for home Constructors

Sole Manufacturers:

PETO-SCOTT, Co., Ltd.,
Head Office: 77, City Rd., E.C.1.

Branches at 62, High Holborn, W.C.1. and at Liverpool, Plymouth and Walsingham. P.S.4589

(Fig. 4). The switching should be carried out as is shown at the bottom of this figure, and a No. 150 or 200 coil inserted in socket L₁. Tuning can be carried out as in the previous cases, when signals from 5XX should be heard.

The receiver, when tested 10 miles west of 2LO, gave very good results, using each circuit in turn. The series-tuning condenser circuit gave the loudest signals in my particular case, whilst when using the trap circuit a distinct decrease in strength was noticeable.

When using this latter circuit, however, the selectivity was found to be good.

It may be of interest to mention,

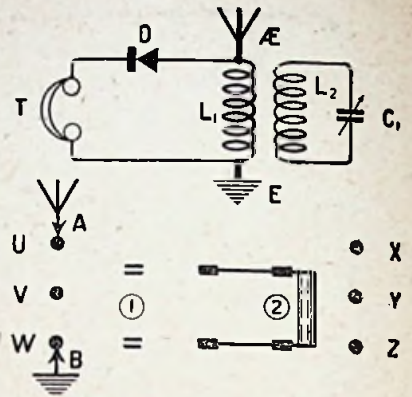
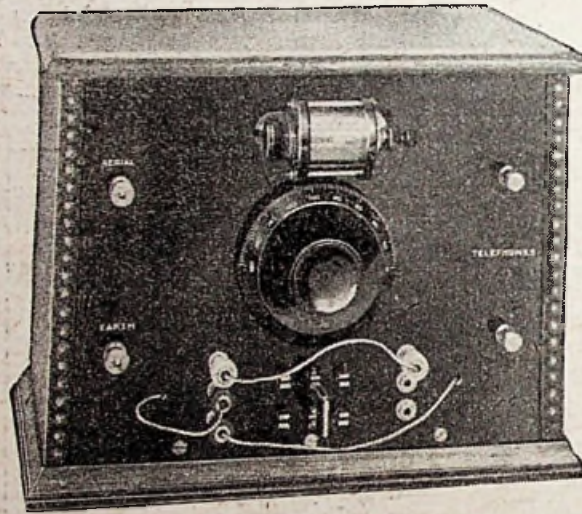

Fig. 7. — Connections are very simple when the trap circuit is used.



in conclusion, that in all the tests mentioned above, home-made coils were employed.

The connections shown in this photograph are those for the series condenser arrangement

Your Aerial System

(Concluded from page 551)

under the aerial itself. Copper is the best material to employ for earth plates or tubes, and, when sinking the earth, provision must be made for keeping the soil damp. One method of accomplishing this is to fill the hole with cinders and coke, packed round the metal with earth, which can then be frequently watered. A few lengths of bare copper wire, such as shown in Fig. 7, running parallel to the aerial and buried beneath the soil make an admirable earth.

If preferred, recourse can be had to a counterpoise. This can take the form of one or more wires, similar to Fig. 7, which are insulated from earth and supported about 10 ft. above the ground level immediately under the horizontal aerial.

General Remarks

A few general remarks concerning

the design of receiving aerials will not be out of place here. The importance of the small ratio of horizontal length to vertical length has already been indicated, and, in addition, for maximum reception of a given signal, the aerial should have a working wavelength not more than about three to four times its natural wavelength. For

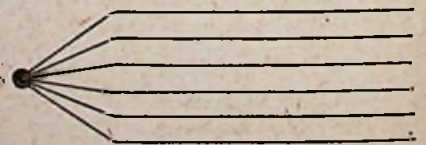

Fig. 7.—How buried wires are arranged for an "earth."

greater selectivity the aerial may be made somewhat smaller than this, but the figure quoted is found to be best in practice.

A large aerial is not generally efficient for short-wave reception, but adequate selectivity is nearly always possible when using a small aerial for long-wave reception and employing suitable loading coils.

*The better grid leak,
It IS silent—always*



Price 4/- each
(post free)

You will need one. Get it NOW. A new principle correctly applied

BELLINGHAM & STANLEY, LTD.
71, Hornsey Rise London, N.19

The New MAXEL Accumulator

Specially designed for Wireless GUARANTEED TWELVE MONTHS. If you live too far away to call and see the Battery Mail your Order to us for the size you want. We will willingly return your money if you are disappointed. Now fitted with NON-CORROSIVE Waulder Plug Terminal

AMPERE HOURS.			
	30	60	110
2 VOLT ..	7/6	9/6	11/9
4 VOLT ..	15/-	19/-	22/6
6 VOLT ..	22/6	27/9	33/8

Packing 1/- extra per battery. 60 volt

H.T. Batteries 7/6 post free.

MAXEL ELECTRICAL CO. 28, Clipstone Street, Great Portland Street, W.1
Telephone: MUSKUM 703.

Read what is said by delighted users of

FERRANTI INTERVALVE TRANSFORMERS

"...There is no doubt your AF3 is ahead of any other at the present time."

"...the deep notes and the roll of drums are splendidly reproduced."

"...have yet to find a transformer which will equal the almost perfect results which yours gives."

"...am so pleased with the great increase in volume, and the perfect purity of reproduction, that I have decided to scrap all my other transformers and replace throughout with Ferranti AF3's."



25/-

Ask your Dealer for Ferranti AF3:
"THE NEARLY PERFECT TRANSFORMER."

FERRANTI LIMITED, HOLLINWOOD, LANCASHIRE

No hand capacity effects!

THE desired station tuned in; carefully it is brought up to maximum volume; you lift your hand from the dial and then—Hand capacity discounts all your patient tuning adjustments.

Just another reason why you should incorporate the Colvern Selector. In addition to the usual earthing plate an insulated spindle reduces hand capacity effects to an absolute minimum.

Using the Colvern you can tune with a degree of accuracy to 1/3,600th part of the variable capacity, and the removal of your hand from the dial will not affect the adjustment a fraction.

The Colvern Selector from every point of view should be your choice if you seek a variable Condenser of more than ordinary efficiency.

Your dealer stocks the Colvern!

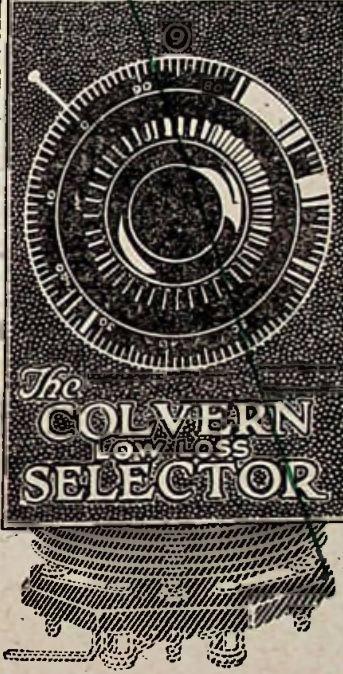

The Colvern Selector Low Loss. Reading to 1/3,600th capacity.
Capacity 7065 mfd. £1 1s. - - - 0003 mfd 11
Type F. without gear attachment.
Capacity 7065 mfd. 15s. 0d. 7065 mfd. 11s. 0d.
One hole fixing. Other capacities if required.
Descriptive folder upon request.
Colvern Independent Vernier - Price 2s. 6d.
Ask your dealer also for the Colvern Low Loss
Coil Former - Price 6s. 0d.

GOLLINSON PRECISION SCREW CO., LTD. Provost Works, Macdonald Rd., Walthamstow, London, E 17
Telephone: Walthamstow 532.

The "PELICAN" UNIVERNIER

Fits any Condenser and makes just that difference in fine tuning that you need to be certain of bringing in the station you really want. Fit Pelican Univerniers in place of your present variable condenser dials and you will secure reliable micro-selective tuning.



Price 6/- Obtainable from all Dealers

CAHILL & CO. LTD. 81, NEWMAN ST. LONDON, W.1

A Wonderful Improvement in VALVE HOLDERS

FOR THE CONSTRUCTOR WHO APPRECIATES QUALITY.

Losses between Valve Legs reduced to the absolute minimum.

The **AERMONIC** Anti-Capacity VALVE HOLDERS

Model D Baseboard
Model E Back of Panel

2/6 each

Distributors:
London & South: James Christie & Sons, Ltd., 245, West St., Sheffield
London Agents: A. F. Bulgin & Co., 10, Curator Street London, E.C.1
British Isles except above: V. R. Pleasance, 35, Fargate, Sheff. Ed.



Super 5-Valve Receiver

for £12

Order 18-5-26

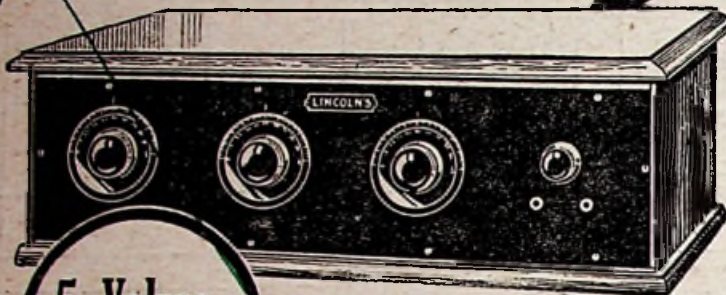

5 Valves FREE

Cabinet Polished Walnut, 30x10x10

BECOME A LINCOLN "SPARE TIME" INSTALLATION ENGINEER. PEOPLE WANT THIS SET IN YOUR TOWN.

Accordingly, we have decided to appoint spare time engineers, one for every principal town in the country. To them we shall send our enquiries and orders, and the resulting commission will actually mean that before long you will have earned back the cost of your sample demonstration set, and be well in pocket.

Keen, enthusiastic wireless men, able to make an installation, having knowledge of ordinary running repairs, and above all of first class character, should at once send for details of this wonderful plan. It may lead to an important staff appointment, and by becoming our local engineer you attain at once practically professional status. Be the recognized local wireless expert; this plan will tell you how. Send no money, but write fully telling us about yourself, your experience, present situation, age, etc. All letters will be treated with strictest confidence; mark envelope "Staff Manager."

LINCOLN "5"

British-built Radio Receiver

LINCOLN RADIO, ABBEY WOOD WORKS, ABBEY WOOD, S.E. 2

Ready to use to-night
Wonderful Offer to Amateur Constructors !!

Turn your Wireless Knowledge into £ s. d.

If you are fortunate you may get one of the famous Lincoln "5" Radio Receivers for only £12, complete with valves, completely assembled and ready to use to-night.

Our extensive national advertising brings us enquiries from all over the country. Our policy is to have our own engineers superintend the installation of these sets, but our staff engineers are unable any longer to cope with the work.

NOTE.—No applications can be considered for districts within 12 miles of Charing Cross. This advertisement is not a general offer to supply the Lincoln "5" at a special price, and sets will only be supplied at the special price, which is by way of deposit, as a condition of a contract for specific services to be performed.

Therla

PRODUCTS

Guaranteed by Faraday House

THAT'S your cue: undoubtedly you must buy Therla Products when requiring Fixed Condensers or Grid Leaks. At no greater cost you obtain a product tested and guaranteed by this famous electrical Laboratory. Each Therla Condenser and Grid Leak is individually tested by Faraday House, and bears their guarantee to be correct to within a very narrow limit of its stated capacity. You can obtain Therla Products from your dealer

Therla Fixed Condensers
PRICES: 0001 to 1015 mfd. 1/3 each. 102 m. d. to 1003 mfd. 2/- ea.
Grid Condenser with Clips, 1/3

Therla G. L. Leaks
Sizes: 250,000, 500,000 ohms. and 1, 2, 3 megohms. Price 1/6.
Grid Condenser and Leak, 3/-

Sole Distributors:
SEL-EZI WIRELESS SUPPLY CO. LTD.
6 CREEK ST., LONDON, W.1, & 20, OLD HAY MARKET, LIVERPOOL
Telephone Regent 1140 LIVERPOOL Royal 1682

Another "LOTUS" Triumph!

The LOTUS

BUOYANCY VALVE HOLDER

Anti-Microphonic Patents Pending

PRICE 2/3
With Terminals 2/6

The delicacy of your Valve filaments is subject to microphonic elements from numerous sources. The LOTUS Buoyancy Valve Holder has been specially designed and constructed to counteract and dissipate these disturbances and will, by its original and unique spring construction, absorb any shock, protect your valves, and eliminate all microphonic noises.

The LOTUS VALVE HOLDER is scientifically designed and made by the manufacturers of **The LOTUS VERNIER COIL HOLDER**
Obtainable from all reliable Radio Dealers

Bakelite Mouldings,
Nickel Silver Springs and
Phosphor Bronze Valve
Sockets,
Nickel Plated.

Valve Sockets and Springs
are locked together by a
mechanical process, making
a definite and permanent
connection.

GARNETT, WHITELEY & Co., Ltd.
Lotus Works, Broadgreen Road, LIVERPOOL

BUY GUARANTEED PRODUCTS & BUY SATISFACTION



Oscillation in High-Frequency Amplifiers

How stability and efficiency have been attained

By J. H. REYNER, B.Sc. (Hons.), A.C.G.I., D.I.C., A.M.I.E.E.

THE high-frequency amplifier is slowly but surely becoming a much more efficient instrument. Not so very long ago persons in authority were able to state that a high-frequency amplifier was a sheer waste of good valves, and that the over-all amplification was almost negligible. Nor were they contradicted with any spirit, principally because their statements were very largely justified.

Satisfaction from Two Stages

He would be a rash man, however, who ventured to make such a statement to-day, for there is little doubt nowadays that by the use of suitable circuits a valve may be made to amplify satisfactorily at radio frequencies. There is a growing tendency towards the production of sets incorporating two stages of high-frequency amplification, and such receivers can be made so satisfactorily that it is possible to pick up far-distant stations with ease and selectivity and yet without the necessity for any critical adjustment. We are gradually tending to eliminate that monstrosity which has been all too prevalent, namely, the inefficient and under-powered receiver in which most of the sensitivity and selectivity depends upon a critical adjustment of the reaction control.

This marked increase in the efficiency of high-frequency amplification is the result of persistent application on the part of the foremost scientists of to-day. Certain troubles were experienced in the early days, and the scientist set out methodically to tackle these difficulties, and to find suitable means for overcoming them. It has been a somewhat lengthy business, but the results are now beginning to justify the expenditure of time and energy.

The Ideal

The biggest trouble experienced with this kind of instrument is that of self-oscillation in the various stages of the amplifier. The ideal amplifier is one in which we introduce a certain amount of energy at the input end, and we take from the output terminals a much-magnified, but otherwise unaltered, edition of the voltages impressed on the input terminals. In practice this ideal is difficult of achievement, because the currents passing through the amplifier do not keep to the straight and narrow path laid down for them, but will persist in exploring other routes, many of which lead back to the starting point. We can thus have a small quantity of energy travelling round in circles, as it were, and this will readily be seen to give rise to various forms of unpleasant effects.

Let us assume that from some cause a certain amount of the energy which should present itself at the output terminals of the amplifier manages to find its way back to the input terminals. This amount

of energy which has returned to the starting point will then be passed through the amplifier and increased in magnitude as were the original signals. Of this increased energy a small portion will again find its way back to the starting point, and will again be amplified.

Energy Circulation

Now, this process will go on indefinitely. There is a continual feeding back of a small quantity of energy from the end to the beginning of the amplifier, and the performance of the amplifier depends almost entirely upon how serious this effect happens to be in the particular circumstances.

Under certain conditions the total effect of this circulation of energy is self-limiting, and does not produce any effect other than that of slightly increasing or decreasing the over-all amplification of the arrangement. A simple example of this would be deliberate reaction introduced from the last valve back to the first valve. It will be appreciated from the ordinary knowledge of reaction that if this coupling is in the right direction the over-all amplification of the arrangement will be increased, whereas if it is in the reverse direction the signal strength will be reduced.

In practice we can obtain reaction from the end of the amplifier back to the beginning without providing deliberate reaction coils. The stray electric and magnetic coupling between the various components of the receiver, including the capacity between the

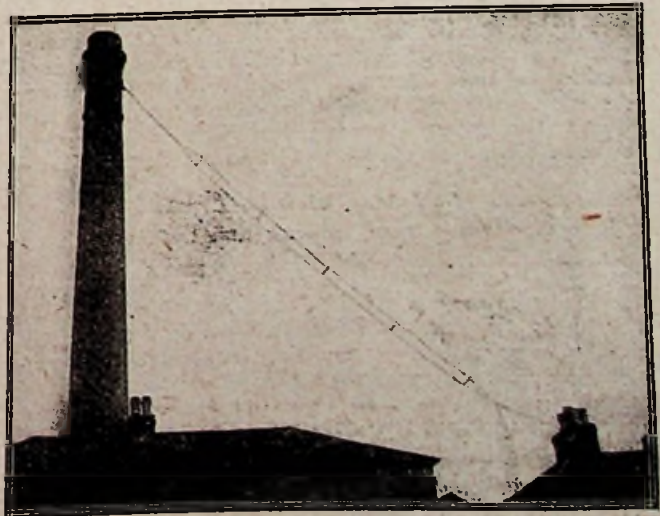

A cage aerial fixed to a tall chimney is employed at the Nottingham Relay Station.

electrodes of the various valves in use, all serve to divert the energy from its normal channel and send it back once more to the starting point. Once there, as we have just seen, it may give rise to an increased or decreased over-all amplification, but if this is all that happens, then the defect is not very serious.

A Cumulative Effect

Unfortunately, there is another condition of affairs, only too common in practice, in which the total effect of the energy circulating in the manner which we have just described is not self-limiting, but is cumulative. That is to say, the arrangement of the various stray couplings is such that an increasing quantity of energy is sent back to the starting point, and the whole amplifier ultimately commences to oscillate of its own accord. Such oscillations may be, and usually are, entirely independent of the signal being received.

In some cases the effect of the stray reaction is to increase the over-all amplification in a progressive manner until the set finally commences to oscillate. It is quite possible, however, to have a state of affairs where the over-all amplification is not affected, or even may be decreased, and the receiver will still burst into oscillation, at quite a different frequency from that of the incoming signal. It is obviously



Fig. 1.—To eliminate stray couplings, coils may be supported in this manner.

impossible to obtain any satisfactory results while such a state of affairs is permitted to exist, and this is the principal problem which has been interesting the scientists of to-day in their efforts to produce stable high-frequency amplifiers.

Reduction of Stray Couplings

We have seen that this short-circuiting of the energy passing through the amplifier is due to stray couplings between the various components. These couplings may be either magnetic or electrostatic. The magnetic couplings may be reduced in a variety of ways. One method, originally designed by Haseltine, consists in placing the coils at an angle with each other. The arrangement is then somewhat similar to that shown in Fig. 1. For any given distance apart (d) there is a certain angle (θ) for which the magnetic coupling between any two adjacent coils is zero, so that no interaction can take place.

Still Another Difficulty

The disadvantage of this method lies in the fact that it is still possible to obtain coupling between the first and third stages even though the coupling between the first and second or the second and third stages is absolutely zero. It follows that if the coils are placed at the correct angle when they are close together, then this angle will no longer be correct when they are placed farther apart, so that the angle which was correct for the first two coils would not be correct for the first and third.

It is not always appreciated that this critical angle is not fixed and definite. It depends upon the distance between the coils, and upon the actual size and shape of the coil itself, to a large extent, and

each receiver must be laid out with due regard to the particular conditions.

How External Fields are Minimised

Another method of overcoming the difficulty is to use coils having negligible external fields. That is to say, the magnetic field produced by the coil is in such a form as to be more or less contained within the confines of the coil. A toroidal winding is one

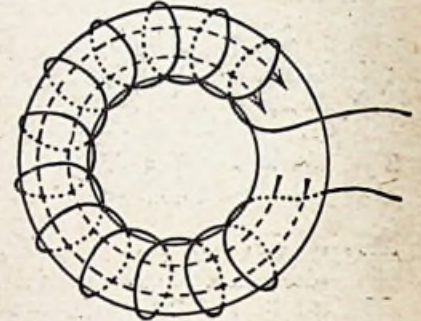

Fig. 2.—A toroidal winding results in a small external field.

method of accomplishing this. A toroid consists essentially of a long single-layer solenoid with the ends bent round to each other, so that the whole thing forms a circular arrangement, and what magnetic field there is fluctuates round the circle, and does not spread itself to any appreciable extent outside the limits of the coil. The disadvantage of toroidal coils is that their high-frequency resistance is considerably higher than that of an equivalent coil of the usual pattern (Fig. 2).

The Binocular Winding

Another type of coil which has a negligible external field is that known as the binocular winding. This has been used to some extent, particularly in America, and the coil is made up in two sections. These two halves are placed side by side somewhat like the cylinders of a pair of binoculars, and the directions of the windings are so arranged that the magnetic field passes down one coil and up the other one, thereby

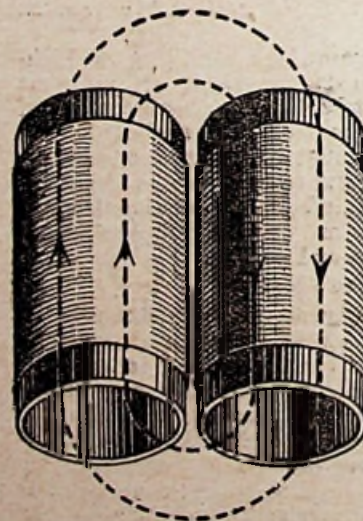

Fig. 3.—The principle of the Grebe "binocular" coils.

forming a more or less complete circuit for itself, and so, again, eliminating the stray magnetic field (Fig. 3).

Screened Coils

Various other types of astatic windings (such as those illustrated in Fig. 4) have been produced which are rather too numerous to mention with any detail in this short article. A method which is coming into favour in this country is that of screening the coil completely. In order to do this the coil is placed

18-3-26

The Inseparables

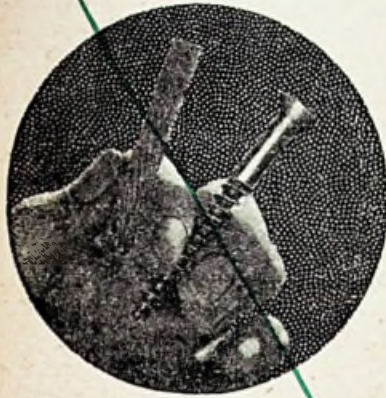

WHEREVER you use screws you need Rawlplugs. Rawlplugs enable you to use screws in any material—brick, plaster, tile, concrete, etc.

The method of use is simplicity itself. You first make a small neat hole with the Rawlplug tool — you insert the Rawlplug and then turn home the screw. The screw makes a perfect thread in the Rawlplug, which exerts a vice-like grip inside the material and holds the fixture permanently in position. Any fixture, from a light bracket to the heaviest bookcase, can be fixed neatly and quickly by means of Rawlplugs.

Buy an Outfit to-day from your Ironmonger, Electrician or Stores. Rawlplugs are made in sizes to suit any size screws from No. 3 to 28

The Rawlplug Co., Ltd., London, S.W.7

HOUSEHOLD OUTFIT (No. 3 size)
50 Rawlplugs, Tool-holder and Bit, supply of screws and books, with full instructions **3/6**

MECHANIC'S OUTFIT (No. 8 size)
100 Rawlplugs, Special Tool-holder and two Bits, supply of screws and hooks with full instructions **5/6**



"I'm going to make more money"

"I am tired of working for a small salary—tired of the strain of endeavouring to keep up appearances—tired of seeing others beat me in the struggle for promotion—tired of the fear of unemployment.

"I've been blind in some ways, but now I see clearly that diligence, integrity, and long service are not enough. To succeed one must have a special vocational training. The men who are going ahead of me have only one advantage—they are trained, while I am not; but I am determined to raise myself to their standard without a day's delay."

Many a man, at last realising the tremendous handicap of being untrained, has thought along those lines and then become an I.C.S. student, greatly to his advantage and happiness.

In every line of business men and women are holding important positions and receiving splendid salaries—because they became I.C.S. students.

The I.C.S. originated spare-time technical training by post 35 years ago, and is by far the largest institution of its kind in the world. It has teaching centres in eleven countries and students in fifty.

Write to-day for full information as to how the I.C.S. can help you in your chosen vocation. There are 300 I.C.S. Courses, of which the following are the most important groups:—

- | | | |
|---------------------|---|---------------------|
| Advertising | Wireless Telegraphy (Elementary and Advanced) | Professional Exams. |
| Architecture | Engineering (all branches) | Salesmanship |
| Building | French and Spanish | Showcard Writing |
| Commercial Art | General Education | Textiles |
| Commercial Training | Market Gardening | Window Dressing |
| Draughtsmanship | Plumbing | Woodworking |

International Correspondence Schools, Ltd.
172, International Buildings, Kingsway, London, W.C.2

18-3-26

THEY LAST LONGER

GENUINE HIGH DRY HELLESEN TENSION BATTERIES



For the first time this season we have a stock of the famous long-life HELLESEN BATTERIES and we are therefore advising customers immediately so that they may know that HELLESEN BATTERIES are available from stock for the first time in three years. Such a demand is in itself the best recommendation possible.

MORE EXPENSIVE THAN SOME OTHERS
THEY SELL ON QUALITY BECAUSE

THEY ARE CHEAPER TO USE!

Delivery from Stock

A. H. HUNT, LTD. (Dept. No. 15), CROYDON, SURREY

18-3-26

SEAGULL

CHOKES COUPLINGS

were the **FIRST**
and are still **BEST**

Choke capacity couplings have replaced the antiquated transformer

PRICE
22/6



Ask your Dealer

You will HAVE TO fit Chokes one day. Why not NOW?

Reasons why Seagull Chokes are unequalled:

- Perfect Reproduction and Tonal Purity
- Ample Power
- Normal Anode Voltage only required
- Long Life; cannot burn out or wear out
- Absolute freedom from undesirable noises
- No Howling

SEAGULL LTD.

Regent House, Kingsway, LONDON, W.C.2
Phone: HOLBORN 6589.

Feb 18.3-

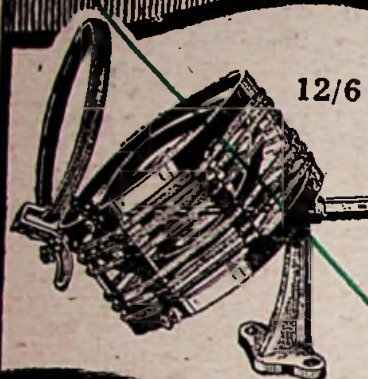

FORMO
CONDENSER PAT. LTD. & CO. LTD.

12/6

ALL FORMO Apparatus is of advanced design and satisfies all requirements of Low Loss and Mechanical and Electrical Efficiency.

New Catalogue Now Ready
Straight line frequency Condensers Squato Law, Low Loss Condensers. I.F. Transformers, Plugs and Jacks. Choke Capacity Couplers. Low Loss, High Efficiency Couplers and Oscillators, etc.

THE FORMO COMPANY
Crown Works, Cricklewood, N.W.2

YOURS FOR 20/-



The 'Tonyphone' G.II. is a two-valve receiver of remarkable selectivity, having a range of well over 1,000 miles. Receives all B.B.C. and most Continental Stations. Will be sent on approval complete with all Accessories on receipt of 20/-. You pay a further £1 each month or 5/- each week afterwards until completed.

The 'Tonyphone' G.II
In handsome Mahogany Cabinet. Complete with Accumulator, H.T. Battery, Aerial, one pair of 4,000 ohms Headphones and two Valves—one High Frequency and one Detector. All Royalties paid

Send to-day and enjoy broadcasting NOW. Illustrated Price list free on application

BRITISH ENGINEERING PRODUCTS CO.
(Battery Dept.), Abbey House, Victoria Street, London, S.W.1

If you are unable to obtain your favourite Wireless Journals from your Newsagent or Bookseller send a subscription

Promptly delivered through the post

MODERN WIRELESS
Twelve months - 15/- Six months - 7/6

WIRELESS WEEKLY
Twelve months - 17/4 Six months - 8/8

THE WIRELESS CONSTRUCTOR
Twelve months - 8/6 Six months - 4/3

WIRELESS (The One-Word Weekly)
Twelve months - 13/- Six months - 6/6

WIRELESS DEALER
(Obtainable by Trade only)
Twelve months (U.K.) 7/6; (Abroad) 10/-

RADIO PRESS LTD.
BUSH HOUSE, STRAND, LONDON, W.C.2

Feb 18.3-26



The Wireless Dealer
AND MANUFACTURER
Edited by John Scott-Taggart, FInstP, AMIEE

February 15th, 1926

Special Features:

- The NARMAT and the SRM.
- Should the B.B.C. interfere in Trade Matters?
- Do We Need Large Coils?
- The Glasgow Wireless
- The S.M. Condenser
- Radio Trade in Sweden

Subscription Rates 7/6 per annum (10/- abroad)

The Industry's Directory

for 7/6 per annum

A P.O. for 7/6 brings to you a monthly résumé of trade conditions, up-to-date financial information, and details of interesting patents.

For this small sum you are kept in close touch with the industry, its development and progress, and are informed of personal movements and changes.

Its business pages carry the news of the leading members of the industry, and are of great assistance to the keen buyer.

Available to the trade only. All subscriptions should be accompanied by Trade card or business letter heading, and should be sent to: The Sales Manager, Radio Press, Ltd., Bush House, Strand, London, W.C.2

THE WIRELESS DEALER
BUSH HOUSE, STRAND, LONDON, W.C.2

inside a suitable metal box, and, with suitable design the stray magnetic field can be reduced absolutely to zero by this method.

Complete screening is difficult of achievement, but sufficiently good results for practical purposes may be obtained fairly simply.

This last method is in some ways the most satisfactory of the three, because it enables the coils to be of an efficient pattern, while, with suitable precautions, the additional inefficiency due to the screen may be kept very small.

Capacity Effects

Stray capacity couplings are another source of trouble. One of the principal requirements in a high-frequency amplifier is that it shall be selective as well as sensitive, and stray capacity couplings do perhaps more than anything else to destroy the selectivity of an amplifier.

It was for this reason that Mr. Harris suggested the use of the special transformers which he employed in his "Special Five" receiver which has been described in *Modern Wireless*. Here the primary winding of the transformer was made very small and

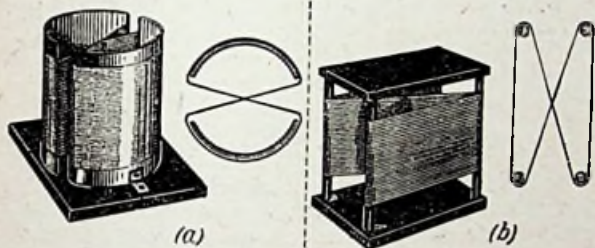

Fig. 4.—Two interesting astatic coils, the right hand one devised by Mr. Percy W. Harris, the Editor.

spaced at one end of the secondary, so reducing very considerably the capacity coupling between the two windings. With the previous forms of high-frequency transformers this aspect of the question had been somewhat neglected.

Inter-Electrode Capacities

With due precautions, however, the stray capacity coupling between the various components may be reduced in magnitude, and its effects may not be so serious, but even then there still remain the inter-electrode capacities of the valves employed.

This is one of the most serious causes of oscillation in an amplifier. Even if the stray coupling between the various components has been entirely eliminated, it is quite possible for sufficient energy to be fed back through a capacity between the anode and the grid of any one valve. Moreover, what is more important, the necessary conditions for this feed back are such as can easily be obtained in a practical case, and, of course, as is well known, such conditions do arise, and unstable amplifiers result.

The Neutrodyne Principle

There are two methods of overcoming this difficulty. They are both very similar in their actions, although the principles upon which they operate are slightly different. The first of these is the neutrodyne principle, first suggested by Prof. Haseltine in America. A simple circuit of this type is shown in Fig. 5, and the action may be explained briefly as follows:—

The point A of the first valve is at a continually varying high-frequency potential due to the presence of signals passing through the amplifier. These varying voltages cause current to flow from the anode

of the valve V_1 to the grid, where they will produce similar variations between the grid and filament of the valve. Under suitable conditions these voltage variations produced may be such as to increase the signals already being received, and they may be sufficient in quantity to cause all the attendant circuits to burst into oscillation. As we have seen, this oscillation may be entirely independent of the signals, and may even be accompanied by a serious decrease in the actual signal current obtained.

An Alternative Feed-Back Path

Coupled to coil L_2 in the anode circuit, however, is a third coil L_3 , and voltages are, of course, set up in this coil due to the coupling between these two. The point to note, however, is that the point B is varying exactly in opposition to point A at each instant. If therefore we connect a small condenser between the point B and the grid of the valve V_1 we shall obtain an alternative path for the feed-back energy, and this will be in the opposite direction to that sent back by the valve itself.

It will be obvious that a suitable adjustment of the condenser C_2 will result in these two circulations of energy cancelling each other out, with the result that a stable condition of affairs is obtained. The condenser C_2 has to be very small, and various forms of neutrodyne condensers have been made up for this purpose.

A "Balance" Method

The other method employed is really a modification of the same principle, except that it employs a modified form of Wheatstone bridge. Here, instead of coupling a coil in the anode circuit to an additional coil, we take a centre tapping from the anode coil and connect this to the high tension. The far end of the coil is then connected to the grid of the previous valve through a neutrodyne condenser. It will be obvious that the variations of voltage at the far end of the coil must be exactly equal and opposite to those at the anode side of the coil with respect to the centre of the coil which is at earth potential. Fig. 6 shows a type of circuit employing this principle.

Various modifications of these several methods may be employed, and readers will be familiar with the various circuits that have been published from time to time in these columns, making use of such neutralising

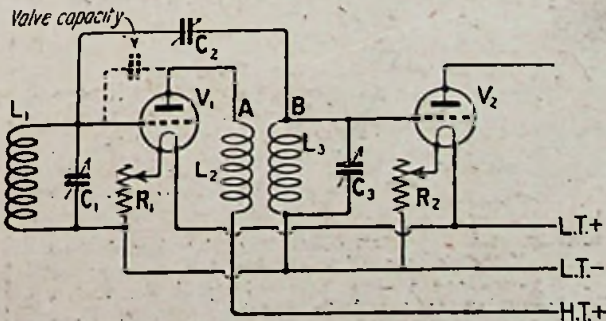

Fig. 5.—A simple "Haseltine" circuit in which C_2 is the neutrodyne condenser.

arrangements. The question must arise as to whether all this complication is necessary. Now, an interesting point arises here. Although it may be possible to obtain an amplifier which is stable and gives reasonably good amplification without resorting to, say, more than one of these devices (usually the neutralising unit), it can be shown that a true cascade effect is not obtained unless attention is paid to all the various points that have been mentioned.

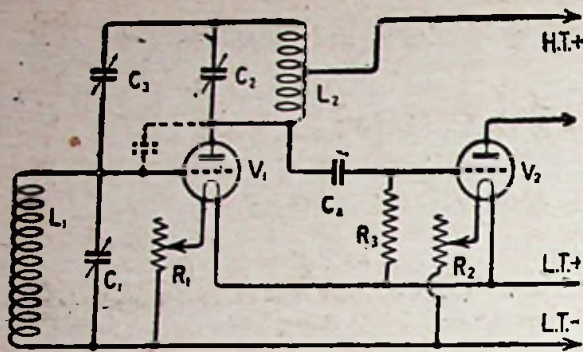

Fig. 6.—A balance circuit for stabilising the H.F. valve.

Loss of Efficiency

If we can obtain an amplification of seven on the first high-frequency stage, then, if we place two such stages in series we should expect to obtain an over-all amplification of $7 \times 7 = 49$. Three stages, of course, would give an over-all amplification of 343. Now, in practice it is found that this true cascading effect is not obtained. If an amplification of seven is obtained for the first stage, then the amplification of the first two stages, instead of being 49, would be something nearer 20, and so on, the effect being cumulative.

Obtaining the True Over-All Amplification

It was recently shown as the result of exhaustive experiment in America that this loss of efficiency was entirely due to stray coupling taking place between the various component parts of the circuit. The only way in which the true over-all amplification could be obtained was by eliminating all possible stray couplings, which were not required.

For this purpose screened coils were employed in order to eliminate the stray magnetic coupling, and careful neutralising arrangements were employed to get rid of the capacity coupling. Actual measurements showed that, if these careful precautions were taken, enormous amplification could be obtained at high frequencies, and the true cascading effect was produced.

A Notable Advance

The tendency in radio design nowadays is towards the production of such true cascading amplifiers with as little complication as possible. Once we have produced a high-frequency amplifier which will behave in practice as it should do on paper, then we shall have made a very great advance in the science of radio. The next development after that will be in the direction

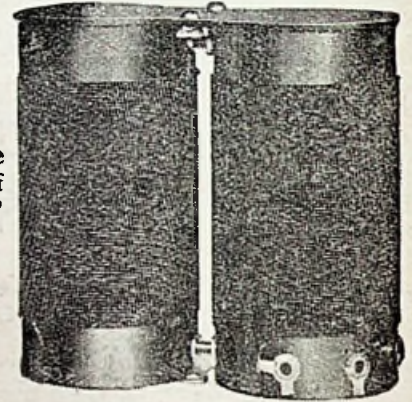

A pair of Grebe astatic coils of the "binocular" type.

of simplifying the arrangement as far as possible, but it is interesting to note that in a comparatively short space of time we have become capable of handling high-frequency amplification with as little compunction as if it were low frequency.

Refd 18-3-26

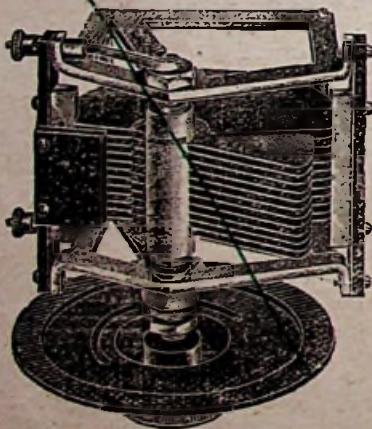

THE NEW
WOOTOPHONE
LOW LOSS
SQUARE LAW
CONDENSER
with improved
dial

Capacity		
'0005	17/6
'0003	16/6
or with Gearing Dial		
'0005	23/6
'0003	22/6

This instrument is a perfect example of low loss design; it has all dielectric material outside the electrostatic field. All vanes are well soldered in position, and a pigtail connection is fitted to moving spindle. The bearings are long and true fitting.

The Ideal Condenser for Short Wave Reception
STOCKED BY PRINCIPAL DEALERS
Goods sent post free. Cash refunded if not satisfied

F. E. Wootten, Ltd.
WIRELESS MANUFACTURERS
56, High Street, Oxford

Refd 18-3-26

EFESCA

Regenerative AERIAL TUNER

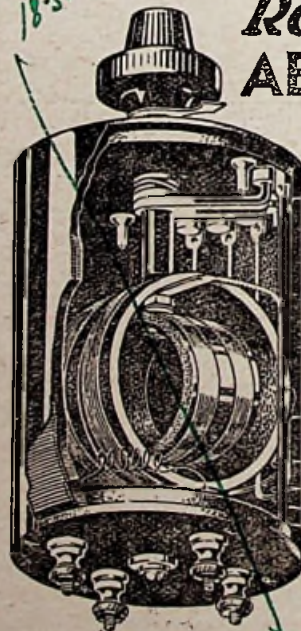

The Efesca Regenerative Aerial Tuner is a specially designed form of Tapped Aerial Coil incorporating Aerial Reaction in a self-contained Unit.

Reaction is effected by means of a rotor revolving in a separately wound section of the Aerial Coil, thereby effecting maximum reaction over the whole wave band covered by the coil. Wavelength range 150 to 2,600 metres in conjunction with a '0005 variable condenser in parallel.

Complete with Knob, Pointer and Scale

Price 32/- each

Ask your Wireless Dealer, or Electrician for



Write for Catalogue No. 559/4, describing and illustrating EFESCA COMPONENTS

FALK STADELMANN & Co., Ltd.
83-93, Farringdon Road, London, E.C.1
ALSO AT GLASGOW, MANCHESTER AND BIRMINGHAM

The Multicap

How to make a useful capacity-bank for the work-bench

THE subject of the present note is a bench instrument which enables a large range of capacities to be obtained by the use of only four fixed condensers. The capacity can be varied by steps of $.0001 \mu\text{F}$ between zero and $.001 \mu\text{F}$, or by steps of $.001 \mu\text{F}$ between zero and $.01 \mu\text{F}$. The component with the smaller maximum capacity is very useful

denser. The other contact of each is taken to a Clix socket.

Capacities Obtainable

By means of a short Clix-fitted wire, connections between the point Y and the Clix sockets A, B, C and D can be made, and the following capacities are obtainable, it being remembered that we add capacities when condensers are connected in parallel.

Capacity μF .	Combination.
$.0001 \dots$	A
$.0002 \dots$	B
$.0003 \dots$	C
$.0004 \dots$	D
$.0005 \dots$	A + D
$.0006 \dots$	B + D
$.0007 \dots$	C + D
$.0008 \dots$	A + C + D
$.0009 \dots$	B + C + D
$.001 \dots$	A + B + C + D

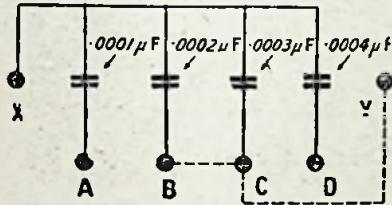

Fig. 1.—The dotted line shows an alternative connection for $.0005 \mu\text{F}$.

for ascertaining the best value for the shunt capacities which are used in various parts of the set. The larger one is particularly useful as a help in discovering the best shunt value for the loud-speaker in large sets.

Condensers Needed

Fig. 1 shows the theoretical wiring diagram of the instrument. It will be seen that the four condensers used in the smaller capacity instrument have values respectively of $.0001$, $.0002$, $.0003$ and $.0004 \mu\text{F}$. From the socket marked X runs a bus-bar connected to one contact of each con-

Design of the Instrument

In Fig. 2 is seen the lay-out diagram of the instrument. Any type of condensers, flat or those of the clip-in pattern, may be employed. The panel is a piece of $\frac{1}{4}$ in. ebonite $7\frac{1}{2}$ in. by $3\frac{1}{2}$ in., and on what is to be the underside scribe a line parallel with one of the long edges and $\frac{1}{8}$ in. from it. On this mark off divisions $1\frac{1}{2}$ in. apart. Make punch marks here for holes to take the upper fixing screws of the condensers. The second set of holes for the fixing screws are spaced in the same way on a line about 2 in. below the

first, depending on the size of condensers used. Scribe a third line $\frac{1}{8}$ in. above the lower edge of the panel, and mark off as before. The punch marks made here will be the centres of 2 B.A. clearance holes to take Clix sockets. Two more Clix sockets (marked X and Y in Fig. 1) are required. These are placed $\frac{1}{2}$ in. from either end of the panel, $1\frac{1}{2}$ in. from its top and $2\frac{1}{4}$ in. from its lower edge.

Wiring Up

Mount the condensers and the six Clix sockets, and wire up as shown in Fig. 3, using bare wire for the purpose and soldering all joints.

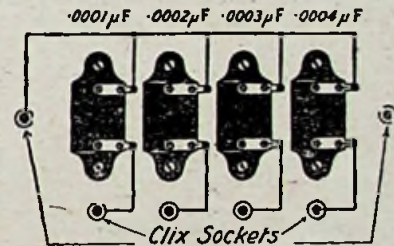

Fig. 3.—The panel layout of the lower capacity Multicap.

When the panel has been mounted upon a wooden box of suitable dimensions the device is ready for use upon the bench.

Make Two of Them!

I have made up two of these devices, one fitted with condensers of $.0001$, $.0002$, $.0003$ and $.0004 \mu\text{F}$, and the other with condensers of $.001$, $.002$, $.003$ and $.004 \mu\text{F}$. With the eight condensers mounted in this way no less than 110 different capacity values between zero and $.011 \mu\text{F}$ are obtainable!

With the two instruments one can advance by steps of $.0001 \mu\text{F}$ from zero to $.011 \mu\text{F}$. This is about as handy a combination as the experimenter could desire, and those who make up either one or two multicaps will find the time and trouble spent in construction very well worth while. The cost of making a multicap is not great, and a pair of them provides one with an invaluable capacity bank.

R. W. H.

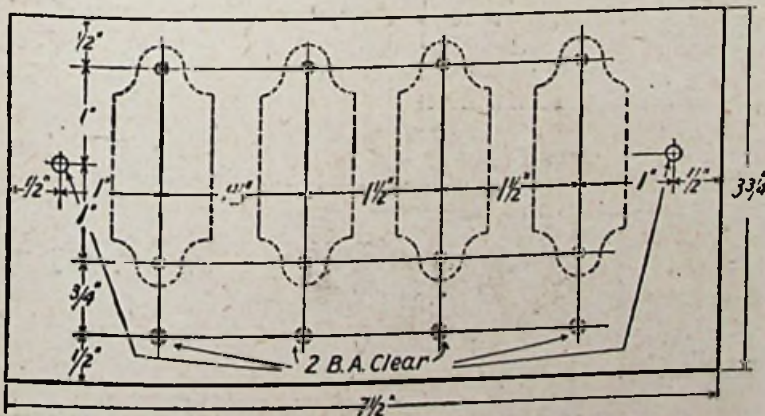

Fig. 2.—The drilling diagram. Slight variations in dimensions may be necessary according to the make of condensers employed.

*Red
1-1-26*



*If Wireless is your hobby you should read MODERN WIRELESS
The contents of this month's issue—a Spring Double Number—will interest and
greatly assist you.*

THEORY.

Developments in Neutrodyne Reception.

A discussion of the fundamental or true Neutrodyne circuit.

Some Interference Problems in Supersonic Heterodyne Reception.

by Capt. H. L. Crowther, M.Sc.

Selectivity in a "Superbet" is not always secured in practice. In this article the author discusses many factors affecting selectivity.

The Curvature of Valve Characteristics,
by Major James R. Binson, D.Sc., Ph.D., F. Inst. P.

An examination of Valve characteristics gives much information. In this article the bottom curve has been singled out for a critical examination.

PRACTICE.

The Neutrophase Four,

by I. H. Reynar, B.Sc. (Hons.), A.C.G.I., D.I.C.

A.M.I.E.E.

A particularly selective receiver, the neutrodyne arrangements being designed on symmetrical lines.

A Seven-Valve Superheterodyne Receiver,

by C. P. Allinson.

An interesting selective receiver. "The set receives Union Radio Madrid, on 373 metres free of all interference from 2 L.O. working within two miles."

A Set for Valve Rectification Experiments,

by A. V. D. Hort B.A.

This set will enable experimenters to compare grid current and anode current rectification and to make comparative tests.

**A FURTHER SELECTION FROM THE
CONTENTS :**

The Melody Three.

By Percy W. Harris M.I.R.E.

The Post Office and Interference.

By Major A. G. Lee M.C. B.Sc. M.I.E.E.

Laying Out your Receiving Set.

By A. Johnson-Randall.

The Era of Low Loss.

By H. J. Barton Chapelle Wh. Sch. B.Sc. (Hons.), A.C.G.I.

D.I.C. A.M.I.E.E.

The Importance of Valve Selection and the effect on Selectivity.

By The Staff of The Radio Press Laboratories.

Which is the Best Aerial Circuit ?

By G. P. Kendall, B.Sc.

Published

1st

of every
month.

1/6

Double
Number.

Modern Wireless



for "The Wireless Constructor" at our Elstree Laboratories

Rheostat

MESSRS. C. A. VANDERVELL & CO., LTD., have submitted to us for test a sample of their rheostat designed for dull or bright emitter valves.

Description of Component.

The interchangeable resistance element of this rheostat consists of resistance wire wound on a cylindrical former about 1 1/2 in. long. This former is supported at its extremities by a bent copper strip, so that it is free to rotate. A length of thin copper rod bent into the form of half a turn of a spiral

The resistance elements of the C.A.V. rheostat are interchangeable.

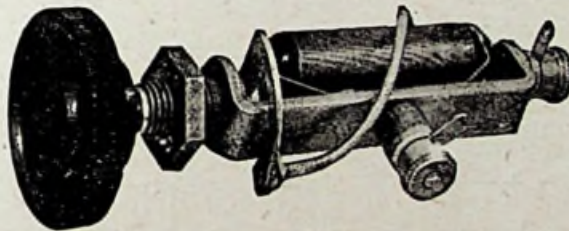

presses against the resistance element, so that when it revolves the resistance element revolves also. One terminal of the rheostat is connected to one end of the resistance element, and the other to the bent copper rod already mentioned.

The bent copper rod can be rotated through half a revolution by means of a milled knob of moulded material. As it revolves it slides along the resistance element, revolving the latter at the same time. The effect of this is that as the knob is rotated through half a revolution the resistance varies continuously between the maximum and zero.

Terminals and soldering tags are provided for this rheostat, and the component can be secured to the panel by means of single-hole fixing.

Laboratory Tests.

On test, it was found that the maximum resistance of this rheostat was 39 ohms. On testing it in a set

it was found that the motion was particularly easy, and the rheostat was almost silent in action. The rheostat was found to be capable of taking 2 of an ampere without overheating.

General Remarks.

This rheostat is a well-made and well-finished article, and can be thoroughly recommended.

Terminals

SAMPLE terminals have been sent by Messrs. Williams, Ellis & Co. to our Elstree Laboratories for examination.

Makers' Claims.

The ring tags are perfect terminators for every kind of wire, and are suitable for use with every type of terminal.

Description of Component.

The ring tag consists of a metal eyelet with a centre hole of approximately 1/4 in. diameter. It is 3/32 in. thick and is pressed into its shape so that a channel round the periphery can accommodate the wire. When a tag is used with flexible wire, the strands can be split and passed round each side of the ring tag, and after twisting the ends together the excess wire can be cut away, making a very neat finish. No solder appears to be necessary, as the wire can be firmly gripped in the ring tag by compression with ordinary pliers and a good joint is ensured.

General Remarks.

These small eyelets appear to be very useful if a neat termination of wire leads is desired. They avoid the possibility of the wire strands coming away from the terminal when screwing the head into position.

Fixed Condensers

SAMPLES of "Micamold" fixed condensers have been submitted for test by Messrs. C. G. Vokes & Co.

Manufacturers' Claims.

It is claimed that the plates and dielectric of these condensers are hermetically sealed under pressure, and so will withstand exposure to different climatic conditions.

Description of Component.

These condensers are apparently hermetically sealed by some brown insulating material. Their shape is square, with 1 1/4 in. sides, while two brass lugs project, each of which is pierced with a hole. These lugs serve as soldering tags, or, alternatively, terminals may be connected to them.

Clx Ring Tags

MESSRS. AUTOVEYORS, LTD., have supplied some sample packets of their Clx ring tags for test at our Elstree Laboratories.



"Micamold" condensers are hermetically sealed to exclude moisture.

The name and capacity are plainly stamped on each condenser.

Laboratory Tests.

On test the insulation resistances of the condensers were found to be infinite, and the insulation did not break down when tested at 180 volts. Exposure all night in the rain, and heat sufficient to render the condensers hot to the touch, did not impair their qualities in any way. The actual capacities are given below:—

Rated capacity in μ F.	Actual capacity in μ F.
·0003 ...	·00031
·002 ...	·00212
·002 ...	·00186

The soldering tags were found to

single-hole fixing by means of a large brass screw which screws directly into the ebonite of the fixed coil holder. This enables front of panel, back of panel or baseboard mounting to be employed. The moving coil plug is fixed to a geared quadrant which engages with a small pinion wheel connected to a 3 in. brass spindle, to the end of which is fixed a fairly large milled knob.

As the knob is rotated the reduction gearing enables a fine motion to be imparted to the moving coil plug, so that as the controlling knob is rotated through a whole revolution the moving coil plug only moves from its position parallel to the fixed coil plug to a position at right-angles. All the metal parts of the coil holder are of brass, brass terminals being provided for fixing connections. A particularly useful feature is that all the terminals are fixed in the ebonite of the fixed coil plug, so that flexible leads are not necessary.

Laboratory Tests.

The motion of this coil holder was found to be particularly smooth, backlash being inappreciable. The setting for several coils was found to be quite good, and the insulation resistance was infinite.

General Remarks.

There are several excellent points in the design of this component. The workmanship and finish are also both excellent, so that the

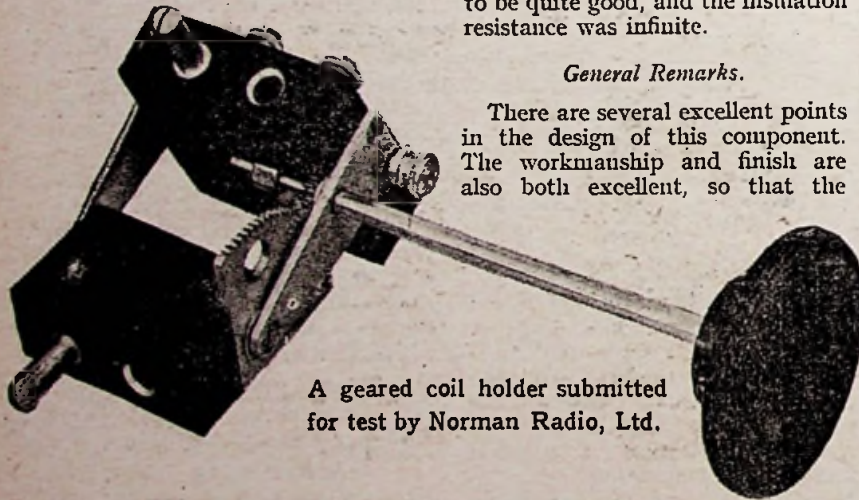

A geared coil holder submitted for test by Norman Radio, Ltd.

be of sufficient size to prevent heat reaching the body of the condenser.

coil holder can be thoroughly recommended.

General Remarks.

These condensers appear to be quite satisfactory mechanically and electrically, and their appearance is quite good.

Two-Way Coil Holder
MESSRS. THE NORMAN RADIO, LTD., have submitted to us for test a sample of their geared two-way coil holder.

Description of Component.

This coil holder is provided with

REPAIRS

Headphones and Loud Speakers rewound to any resistance and remagnetised
EQUAL TO NEW!
 at a trifling cost. Our 27 years' experience of electrical instruments and wire winding is your guarantee. Send direct with instructions to:—
VARLEY MAGNET CO., (Proprietors: Oliver Pell Control Ltd.), WOOLWICH, S.E.18.
 Makers of the famous Varley Anode Resistance.



2-VALVE AMPLIFIER, 35/-
 1-Valve Amplifier, 20/-, both perfect as new; Valves, 4/6 each, smart Headphones, 8/6 pair; new 4-Volt Accumulator, celluloid case, 13/-; new 66-Volt H.T. Battery, guaranteed, 7/-; 2-Valve All-Station Set, £4. Approval with gly.
 Engrs. 57, Studley Rd., Stockwell, London

A WIRELESS "DOCTOR."

If your set is giving trouble or you want advice, an expert will call, anywhere in Greater London, and put you right. No result, no charge.
BLACK, 2a, Woodville Grove, N.16. Clissad 3687.

Make Your Own Electric Light!

These wonderful Dynamos light brilliantly 4-6v. lamps and are very easy to work. 5/6 post free. Will also work as electric motors.
GR. 248 (Dept. E.H.)
 65, Long Acre, LONDON, W.C.2



LITTLE WIRELESS GADGETS

MAP

Small Parts to the Trade

MAP Co. 246 G. 1st St. Birmingham

A HOME FOR YOUR WIRELESS SET

Just Unlock and Tune in



Yes! You can do this for a small outlay. A "Morris 8 anril Cabinet" will keep YOUR receiver DUST-PROOF and FREE from INTERFERENCE. Provision is made for panels up to 30 in. by 8 in. and all accessories are enclosed in this solid oak cabinet in which perfect workmanship is guaranteed.

M-d 1	Solid Oak
A 22 in. inside	£1 15
A 25 in. "	£5 5
C 21 in. "	£5 10
C 25 in. "	£5 15
C 30 in. "	£5 15
	Solid Mahogany
A 22 in. "	£7 5
25 in. by 16 in.	Solid Oak
	Table £1 7 6

(Smaller size sells n.c.)
NO PLYWOOD USED
 Money returned if not satisfied.

Carriage paid and packed free Eng and Wales
Makerimp:rt Co. Dept. 2, Melville Chambers
 60s, Lord St., LIVERPOOL

THE MIRACLE

2-VALVE RECEIVING SET is the world's greatest Wireless Bargain. Start on over 400 miles distant clearly heard on the Loud Speaker. **1 H. P. MADE OF EVERY HOME** Complete with all accessories. D.E. Valves, H.T. Battery, Accumulator, Aerial Equipment, Royal ties mail. Headphones and Sterling Dinkie Loud Speaker. Special reduced cash price £7 10s. Yours for £1 deposit and twelve monthly payments of 10s. Last Payment 10s.
WORLD'S WIRELESS STORES, WALLING

Have you seen the
NEW
Wireless Weekly?
3d.
EVERY WEDNESDAY

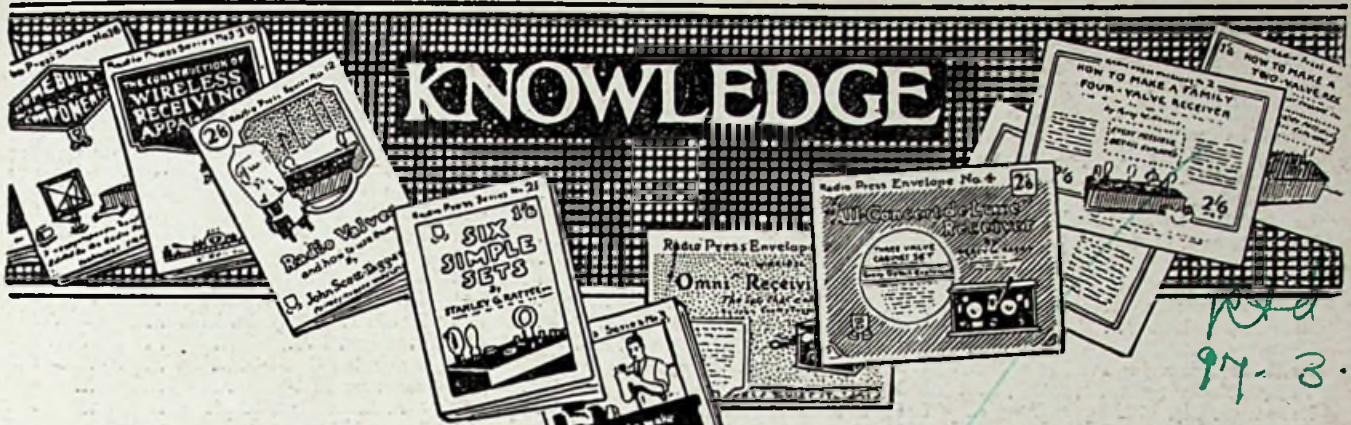

OPERATION

COMPLETE satisfaction from a radio receiver depends upon the operator's knowledge of its fundamentals. The R.P. Books listed here are expressly written for the man who appreciates the convenience of home study.

RADIO PRESS BOOKS

No.	Price	Post Free
1	9d.	11d.
2	1/-	1/8
3	1/8	1/8
4	1/-	1/8
5	1/8	1/8
6	1/8	1/8
7	2/8	2/8
8	1/8	1/8
9	2/8	2/8
10	2/8	2/8
12	2/8	2/8
13	2/8	2/8
14	2/8	2/8
15	3/8	3/10
16	2/8	2/8
17	2/8	2/8
18	1/8	1/8
21	1/8	1/8
22	1/8	1/8
24	1/8	1/8
Elementary Text-Book on Wireless Vacuum Tubes	10/-	10/8
Radio Engineering	15/-	15/9
Modern Radio Communication	5/-	5/0

CONSTRUCTION

THE building of a Radio receiver becomes a most simple job when working from instructions contained in a R.P. Envelope. Every step is explained fully. You cannot go wrong!

RADIO PRESS ENVELOPES

No.	Price	Post Free
1	1/8	1/8
2	2/8	2/3
3	2/3	2/3
4	2/8	2/3
5	2/6	2/9
6	1/8	1/3
7	1/6	1/9
8	1/3	1/9
9	1/8	1/3
10	2/0	2/9
1	1/3	1/9

"MODERN WIRELESS" COIL TABLE.
For Aerial, Anode and Reaction Coils .. 61. 81

SIMPLEX WIRING CHARTS.

1 For 2-Valve Set	1/-	1/3
2 For 3-Valve Set	1/-	1/3
3 For 4-Valve Set	1/-	1/3

RADIO PRESS PANEL CARDS.

1 How to Make the W1 Receiver	1/-	1/3
-------------------------------	-----	-----

RADIO PRESS PANEL TRANSFERS.

Large Packet of 80 Labels	6d.	8d.
---------------------------	-----	-----

Obtainable from all Newsagents and Bookshops or direct from the Publishers,

RADIO PRESS, LTD., Bush House, Strand, London, W.C.2

Index to Advertisers

	PAGE		PAGE		PAGE
American Hard Rubber Co. (Britain), Ltd.	584	Darex Radio	572	Maxel Electrical Co.	611
Artcraft Company (The)	589	Day (Will)	572	Metro-Vick Supplies, Ltd.	575, 583, 608
Ashley Wireless Telephone Co. (1925), Ltd.	576	Dixon (L.) & Co.	572	Mullard Wireless Service Co., Ltd.	Cover ii
Beard & Fitch, Ltd.	569	Dubilier Condenser Co. (1925), Ltd.	571, 591	Naylor (J. H.), Ltd.	602
Bedford Electrical & Radio Co., Ltd.	604	Electron Co., Ltd.	587	Oldham & Son, Ltd.	594
Bellingham & Stanley, Ltd.	611	Fada Radio	560	Peto & Radford	592
Bird (Sydney S.)	584	Falk, Stadelmann & Co.	618	Peto-Scott Co., Ltd.	610
Black (A.)	622	Ferranti, Ltd.	611	Portable Utilities Co., Ltd.	572, 576
Bowyer-Lowe Co.	577	Finston Mfg. Co., Ltd.	578	Radi-Arc	572
Brandes, Ltd.	579	Formo Co.	616	Radiax, Ltd.	608
Bretwood, Ltd.	592	Gambrell Bros.	624	Radio Communication Co., Ltd.	578
British Engineering Products	616	Garnett	612	Radio Instruments, Ltd.	Cover iv
British Thomson-Houston Co., Ltd.	579	Garnett, Whiteley & Co., Ltd.	576, 612	Radions, Ltd.	572, 624
Brown (S. G.), Ltd.	564	General Electric Co., Ltd.	542	Rawplug Co., Ltd.	615
Burne-Jones & Co., Ltd.	624	Gent & Co.	571	Raymond (K.)	608
Cahill & Co., Ltd.	611	Green's	622	"S. A. Cutters," Ltd.	602
Carrington Mfg. Co., Ltd.	578	Henderson (W. J.) & Co., Ltd.	571	Seagull, Ltd.	615
Carton Wood Turnery Co.	598	Hunt (A. H.), Ltd.	615	"Sel-Ezi" Wireless Co.	612
Christie, Jas., & Sons, Ltd.	611	Igranic Electric Co. Ltd.	583	Slektun	602
Clackson (A. H.), Ltd.	577	International Corr. Schools, Ltd.	615	Standard Telephone & Cables, Ltd.	584
Clayton Rubber Co., Ltd.	608	Jackson Bros.	598	Stevens (A. J.) & Co. (1914), Ltd.	567
Cleartron Radio, Ltd.	601	Kriseros Co.	562	Stratton & Co.	604
Cole (E. K.)	582	Lincoln Radio	612	Taylor (C.)	622
Collinson Precision Screw Co.	611	Lissen, Ltd.	555	Telegraph Condenser Co., Ltd.	587
Cossor (A. C.), Ltd.	596, 597	London Electric Wire Co. & Smiths, Ltd.	556	Varley Magnet Co.	590, 622
Curtis (Peter), Ltd.	604	Makerimport Co.	622	Wilkins & Wright, Ltd.	592
Cymbal, Ltd.	624	M.A.P. Co.	622	Williams, Ellis & Co.	678
		McMichael (L.), Ltd.	588	Wootton (F. E.), Ltd.	618
		M. & A. W.	592	World's Wireless Stores	622

VALVES Repaired Quick

Let our valve making plant repair your broken or burnt out valves efficiently & promptly (most makes). Guaranteed equal to new. Bright emitters 5-: "D.E.s" 2 and 3v types) 7/6. Power valves slightly more, see list. Not repairable: 8, Pa WECO v.24, Co-anor D.E.s.

RADION Reliable Repairs

RADIONS Ltd., Bollington, Nr. MACCLESFIELD, Ches.

Largest valve-repairing firm in the world. List Free.

EASY PAYMENTS

We supply ANY MAKE of ACCESSORIES by easy ANY MAKE of SETS payments—ANY MAKE of COMPONENTS

In fact everything Wireless that is on the market 10% down. Balance spread over 12 months Carriage Free. Pr. mpt Delivery

Send list of requirements to

CYMBAL LTD., 11, Oat Lane, London, E.C.2
Phone: City 1877

WIRELESS WAREHOUSE

THE SMALL ADVERTISEMENT WITH A WONDERFUL SERVICE.

Write for Free List.

32 Swan Street, Manchester

Send stamp for La test Lists dealing with 15 Radio Press Sets, and new Illustrated Catalogues.

Note.—Where a complete set of components, together with a drilled panel, is purchased, Royalties at the rate of 12.6 per valve holder are payable.

THE ANGLo-AMERICAN SIX

A highly efficient "Wireless Constructor" Receiver. Complete Set of Components **£17 7 6**. As below ready wired and serial tested. **£22 0 0**. Plus Marconi Royalty **£3 15 0**



AN ANNOUNCEMENT THE NEW MAGNADNYE SUPER-HET

An improved design incorporating several unique features will be ready shortly. Let us register your name for particulars which will be sent when ready.

The 3 Valve Set with 1 Dial, as described in this issue by Mr. S. G. Hattco.

- 1 Ebonite Panel 10x8 1/2 Drilled .. 13 0
- 1 Cabinet and base-board as described .. 1 7 6
- 1 Pair Magnum Aperiodic Br. cets (small size) .. 2 0
- 1 Magnum "Aperiodic" Transformer No. 1 .. 10 0
- 1 Magnum "Aperiodic" Transformer No. 3 .. 10 0
- 4 A Liping V ive Holders .. 12 0
- 1 Polar Variable Sq. Law Condenser '0005 cam-Vernier type .. 12 6
- 3 Erlson Element Rheostat 30 ohms .. 16 0
- 2 Power Potentiometer 2000 ohms .. 4 6
- 1 Branden L.F. Transformer .. 17 6
- 1 Neway 2 Coil Holder (beh nd panel type) .. 6 6
- 1 Wamel Fixed Condenser '0005 .. 2 0
- 2 Dubilier Fixed Condenser '0001 .. 3 0
- 1 Terminal Strip with 7 terminals .. 4 6
- 4 Belling-Lee Terminals as described .. 1 4
- 1 "Success" Variable Grid Leak .. 6 6
- 1 M.H. Clip in Condenser with base '0.01 .. 2 9
- 12 feet of Glaxite .. 1 6
- 1 yard Rubber covered Flex .. 1 6
- 1 Set Radio Press Transfers .. 2 6

7 11 9

BURNE-JONES & CO., LTD.
MAGNUM HOUSE, 296 BROUGH HIGH ST., LONDON, E.1
Telephone: Hop 0251. Telegrams: Burjomaz, Sedist, London.
Cables: Burjomaz, London. Trade Enquiries Invited.

INTRODUCING A NEW MAGNUM PRODUCT

Aperiodic H.F. Transformers.

As used in the 3 Valve set described in this issue by Mr. S. G. Hattco.

H.F. Amplification Simplified. By the use of this Transformer a stage of H.F. may be added to your set without an additional tuning control.



For Super-Het Work.—It is the ideal H.F. stage preceding the first detector. Supplied in the following ranges

No. 1	Aperiodic 300/600 metres
No. 2	550/1200 "
No. 3	1100/3000 "

Price 10/- each.

FREE BLUEPRINT SERVICE COUPON

Wireless Constructor. Vol. II. No. 6. April, 1926

This coupon entitles the reader to one back-of-panel blueprint of any set described in the above issue, and must accompany each postal application.

COUPON

QUESTIONS AND ANSWERS

This Coupon must be accompanied with a 2/6 P.O. and Stamped Addressed Envelope.

"Wireless Constructor,"

APRIL, 1926.

A LONG DISTANCE "PRINCE" RECEIVER.

B.P. No C.1028 B.

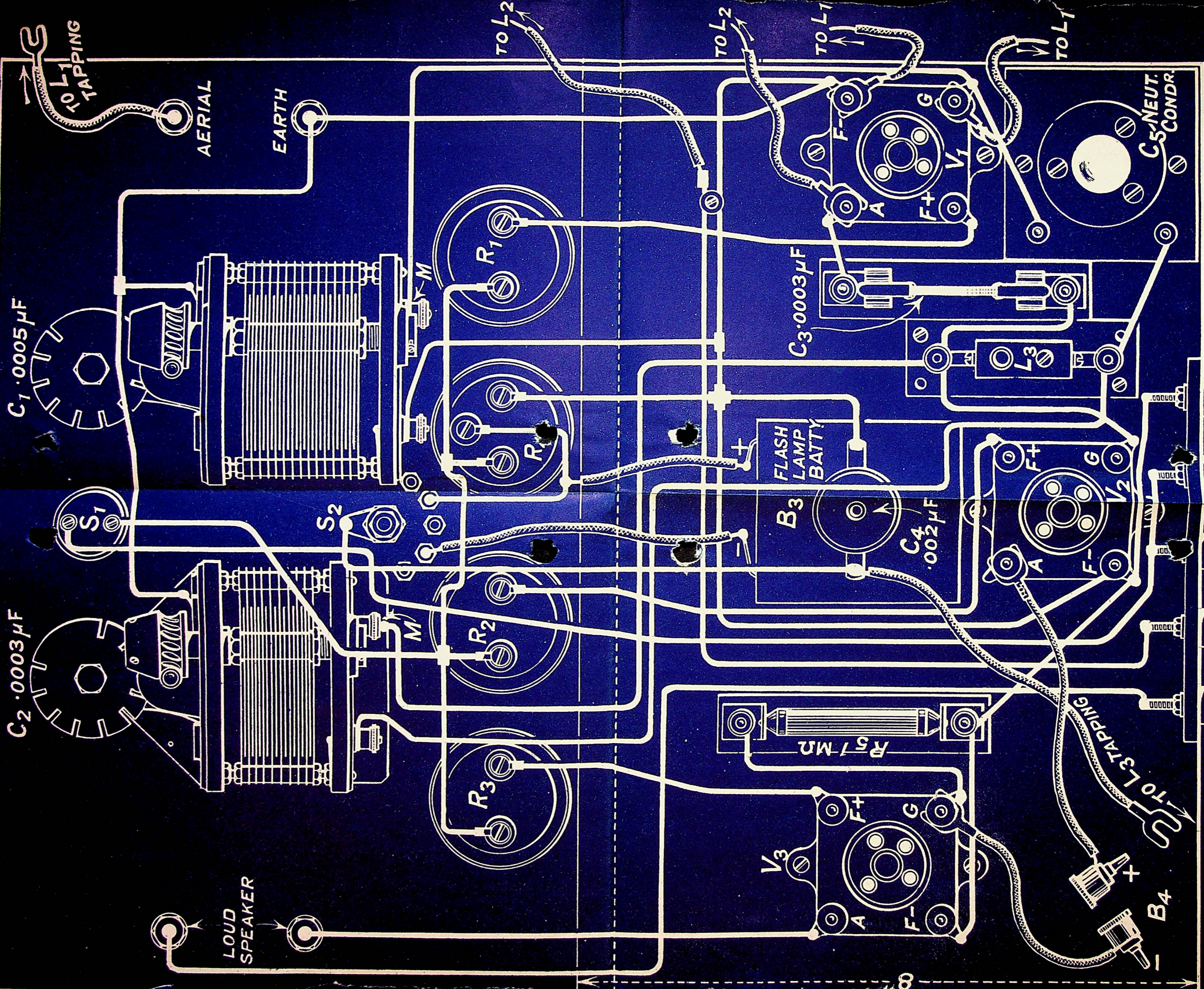

T.W.C. VOL. 2. No 4
PRICE 1/6

H.T. +2
H.T. +1
H.T. -

L.T. +
L.T. -

RADIO PRESS LTD
BUSH HOUSE,
STRAND, W.C.2