

1918

TK
5700
M372
v.5
no.12
c.1

The WIRELESS AGE

ENGI STORAGE

Notice to Reader — When you finish reading this magazine, place a 1-cent stamp on this notice, mail the magazine, and it will be placed in the hands of our soldiers or sailors destined to proceed overseas.

No wrapping. No Address



**Practical Training Courses in
Aviation ~ Wartime Wireless
Military Signaling**

And a Special Feature

Pointers on Teaching Code

By GORDON LATHROP of the Marconi Institute

BUY WAR SAVINGS STAMPS FOR ALL THERE IS IN IT— THIS IS OUR WAR—WE MUST WIN IT!

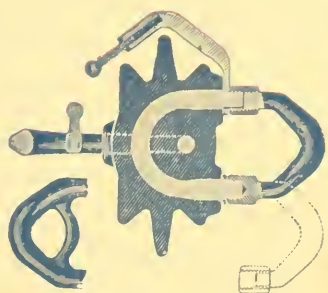

165-A.



LIGHTNING-PROOF INSULATORS
1,000 TO 1,000,000 VOLTS



**Insulators Are Standard in the
United States Navy and Army**

INSULATION
"MADE IN AMERICA"
LOUIS STEINBERGER'S PATENTS



No. 7370



No. 6815

AND WIRELESS TELEGRAPH AND TELEPHONE COMPANIES



No. 4500



No. 4502



No. 4507

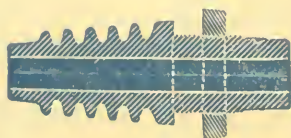

No. 6277



No. 4518



No. 7378

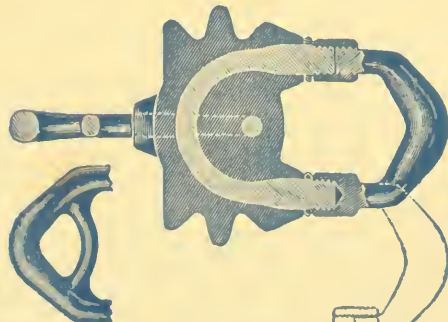

No. 172

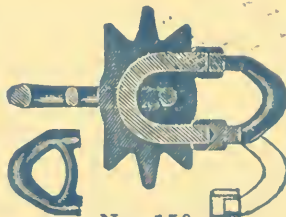

No. 159

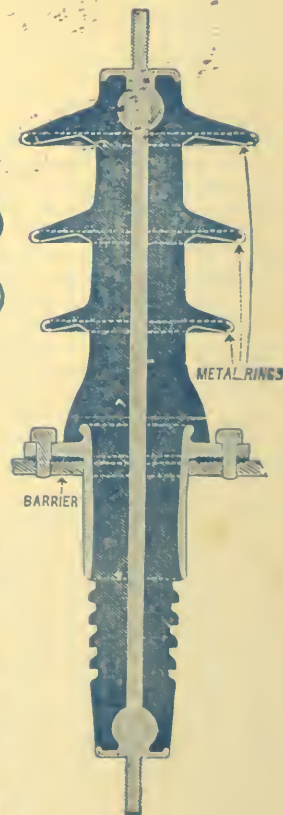

No. 7163

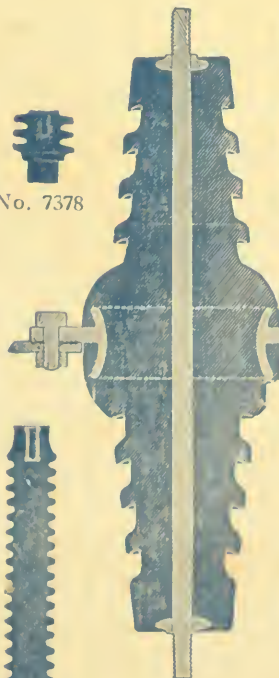

No. 663

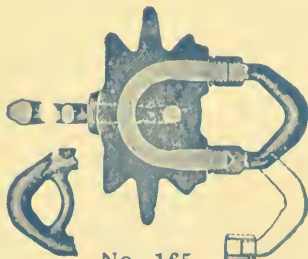

No. 165



No. 7379



No. 7512



No. 7375



No. 6833

SOLE MANUFACTURERS



No. 7487

66-82 Washington St.
66-76 Front St.

27-37 York St.
1-23 Flint St.

Brooklyn, N. Y., America

Study the Instrument Question



Only when you have studied it by direct comparisons will you realize fully what a high degree of efficiency and economy you can effect by selecting

Weston

Indicating Instruments

As soon as you inspect them—even before you subject them to the test of comparison in actual use—the reasons for their acknowledged superiority will be apparent to you. These reasons are revealed in every structural detail.

Weston Electrical Instrument Co.

27 Weston Ave., Newark, N. J.

23 Branch Offices in the Larger Cities



Weston Round Pattern Switchboard Instruments of 7-inch diameter are the standard for use on Wireless Telegraph Panels. As they are of the highest grade and designed for commercial installation, they are not adapted to experiments in wireless work. Write for more specific information.

The Demand in the Army for Men Possessing a Knowledge of Radio is so Great that Officers Urge Men Preparing to Enter the Service to Study at Some Good Radio School

THE MARCONI INSTITUTE stands ready to train you for a responsible position in the Signal Corps, Aviation Corps or Naval Radio station on land or sea.

The man whose patriotism impels him to serve our Government should prepare himself in one of the arts recognized as of supreme value to the successful culmination of the war. Among these the profession of radio stands out foremost. Officers in the Army and Navy are constantly searching for radio trained men.

Commissions come quickly to such men.

The prospective applicant should bear in mind that the Marconi Institute has more than 4,000 graduates to its credit. The majority are now serving in either the Army or the Navy. Thousands of men are still required by our Government.

The Institute gives direct instruction on Submarine, Airplane, Cargo and Passenger Ship apparatus. Vacuum Tubes are especially featured.

The radio laboratory of the Institute is more completely equipped than other training organizations of its kind in the United States.

BAKER PUTS DRAFT AGES AT 18 TO 45

Sends Man-Power Bill to Congress Embodying Step Toward Universal Training

BACKED BY THE PRESIDENT

Measure Gives Him Power to Call Men by Years Either for Army or for Labor

From New York Times of Aug. 4, 1918.

Students are not only taught the theories of the art but they are given the opportunity to manipulate and adjust the most modern types of apparatus in use in the year 1918. Moreover, they receive the benefit of the years of practical experience of the staff of instructors—men who have been identified with the commercial, scientific research and administrative branches of radio communication since its inception.

Students may attend day or evening classes throughout the year. The New York school alone

has facilities for teaching 600 students a day.

The Institute is open daily for inspection and you are cordially invited to visit the school any day from 10 A. M. to 10 P. M. except Saturday on which day the school closes at noon.

Prospective students are always welcome for personal interviews.

A very interesting and instructive, fully illustrated, 96 page manual has been prepared showing the possibilities and opportunities in the radio field and the facilities for training young men at the Marconi Institute. A copy will be gladly forwarded to you upon request.

Address

Director of Instruction, Marconi Institute
25 Elm Street, New York City

BRANCH SCHOOLS:

Room 361-70, Lenox Bldg., Euclid Ave. and E. 9th St., Cleveland, Ohio
New Call Building, New Montgomery Street, San Francisco, Cal.

Addresses of other branch schools to be announced later

LEARN TELEGRAPHY QUICKER—EASIER

WITH
THE
NEW

MORSE OR WIRELESS CODE

ADJUSTABLE BUZZER PRACTICE SET.

NO TOOLS—A TOUCH OF YOUR FINGER ADJUSTS IT.

QUICKLY GIVES YOU SPEED

AS SHOWN
WITHOUT
BATTERY

\$2.90

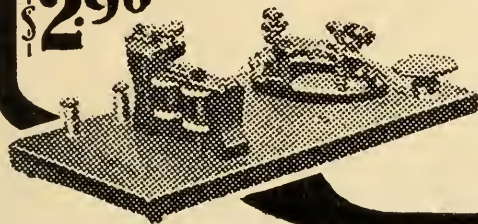

This practice set with its adjustable BUZZER enables you to learn telegraphy, Morse or Wireless Code, in shorter time than ever before thought possible. A touch of your finger to a thumb screw gives any pitch desired to the BUZZER. Especially designed to give very clear sound of exceptionally high pitch even on ONE DRY CELL.

The adjustment of the Buzzer to any pitch is made without the aid of any tools—simply by the thumb screw. The greatest improvement in practice sets ever made—superior to any on the market. Beautifully made; mounted on substantial base.

Price \$3.50
WITH BATTERY
AND WIRE

Complete Ready for Use Immediate Delivery

THE TEWNO CO.

Dept. B 41 Park Row, New York, N. Y.

THE "Exide" BATTERY

FOR WIRELESS AND EMERGENCY LIGHTING

is the product of the oldest and largest manufacturer of storage batteries in the country. It is the battery that has established a standard of storage battery dependability for Wireless service.

Bulletin No. 168 will be mailed upon request

THE ELECTRIC STORAGE BATTERY CO.



New York
St. Louis
Minneapolis

Boston
Cleveland
Washington

PHILADELPHIA, PA.
Atlanta 1888-1918
Pittsburgh

Chicago
Rochester
San Francisco

Denver
Toronto
Kansas City

Service and Quality

Drawing Materials
Surveying Instruments
Sensitized Papers

Quality products delivered when you want them.

Try our Gold Seal blue print paper
—100% pure—100% satisfaction.

Working samples on request.

**New York Blue Print
Paper Co.**

102 Reade St., New York City

Write for Catalog W

SILVER

FOR

Spark Gaps or Contacts

WE CAN FURNISH immediately: Pure silver for sparking purposes on quenched spark gaps. Sterling silver for contacts on sending or relay keys. Pure granulated silver for coatings on Leyden Jars.

Ask for our prices

HANDY AND HARMAN

NEW YORK PLANT

29 GOLD STREET

NEW YORK

The Wireless Age

Edited by J. ANDREW WHITE

Vol. 5

Contents for September, 1918

No. 12

WORLD WIDE WIRELESS

Marconi Medal Lost at Sea.....	971
Wireless to Solve Air Mail Pilots' Problems	971
English Marconi Company Earns Nearly Two Million	971
Advanced Aviation School for Wireless Men	972
S. O. S.—Save or Serve.....	972
A Dane Invents Steel Soldier Animated by Radio	972
Allies Get Hun Map of British Waters	972
German Wireless News Scheme a Failure	973
U. S. Ships Hear Hun Wireless to U-Boats	973
Naval Rookies Climb Skyward to Paint	973
Ernest T. Edwards Dies Suddenly..	973

RADIO SCIENCE

A Rectifying Spark Gap for High Tension A. C. Current.....	979
Spark Discharger for Radio Frequency Oscillation Circuits.....	980
Advance in the Design of X-Ray Tubes	982
Progress of Wireless Telephony—By Elmer E. Bucher	1014

MILITARY PREPAREDNESS

Some Points on Teaching Acquired by a Radio Code Instructor—By Gordon Lathrop	974
Wartime Wireless Instruction—By Elmer E. Bucher (Article XVII)..	986
Signal Officers' Training Course—By Maj. J. Andrew White (Sixteenth Article)	999
Signal Corps News	1003

How to Become an Aviator—By J. Andrew White and Henry Woodhouse (Fourteenth Article)	1005
Aviation News	1013

DIGEST OF ELECTRICAL PROGRESS

Enormous Growth in Sale of Tungsten Lamps	1021
Protection of Battery Charging Circuits	1021
New Research Laboratory in Japan. Electric Welding in the Building of Ships	1022
New Swedish Radio Station.....	1023
An Early Phonograph Concert.....	1023
Recognition to Dr. A. E. Kennelly..	1023
Belated Recognition of Oliver Heavyside	1023
Carty Receives the Edison Medal..	1024

MARINE INSTRUCTION

Navigation News	1026
Finding Your Way Across the Sea.	1026

EXPERIMENTERS' WORLD

N. A. W. A. Monthly Bulletin.....	1027
First Prize—A Simple Regenerative Receiving Set	1029
Second Prize—The Design of a 500-Cycle Transformer	1031
Third Prize—Apparatus for Self Instruction in the Continental Telegraph Code	1032
Construction and Operation of the Field Telephone and Buzzer.....	1033
A Detector Holder for Accurate Adjustment of the Contact Pressure.	1035
A Practical Method of Applying the Marconi-Victor Wireless Records	1037
Linemen's Rubber Gloves Under Test	1038
A Wireless Bungalow	1041
Queries Answered	1043
Book Reviews	1046
Annual Index Vol. V	1050

Index of Equipment

Page	Page	Page
Automatic Transmitters	Miller-Reese-Hutchison, Inc.	Marconi-Victor Records ... 1046
Omnigraph Mfg. Co. VI	Inside Back Cover	National Aero Institute.... 1041
Blue Print Paper	The Continental Fibre Co... VII	Y. M. C. A. Radio School.. 1040
New York Blue Print Paper	The Electric Storage Battery	Motors
Co. III	Co. III	Crocker-Wheeler Co...Back Cover
Books	The Tewno Co..... III	Patents
Wireless Press, Inc., 1034, 1038,	The William B. Duck Co... 1040	Watson E. Coleman..... 1041
1039, 1042, 1043, 1044, 1045,	Weston Electrical Instrument	Printing
1047	Co. I	McConnell Printing Co.... 1036
Bronze and Aluminum Castings	Wireless Press, Inc..... 1035	Silver
Fischer-Sweeny Bronze Co. 1048	Employment	Handy and Harman..... III
Electrical Equipment	United States Employment	Tools and Supplies
Charles F. Campbell..... VI	Service	T. P. Walls Tool & Supply
Dubilier Condenser Co., Inc... V	Instruction	Co., Inc. VI
Electrose Mfg. Co.	Dodge's Telegraph, Ry. &	Wireless Telegraph Service
Inside Front Cover	Wireless Institute	Pan-American Wireless Tele-
Industrial Controller Co. ... 1049	Eagle Aviation School..... 1041	graph and Telephone Co... 1058
Manhattan Electrical Supply	Eastern Radio Institute... 1040	
Co., Inc. 1036	Marconi Institute	
	II, 1037	

RENEWALS—When subscription expires, find a renewal blank enclosed. Return with remittance promptly. CHANGE OF ADDRESS—Notify us of any change in your address, giving both the old and new location.

Published Monthly by Wireless Press, Inc., 25 Elm Street, New York

Edward J. Nally, Pres. Charles J. Ross, Vice-Pres. David Sarnoff, Secy. John Bottomley, Treas.

Yearly Subscription in U. S., \$2.00; Outside U. S., \$2.48; Single Copies, 20 cents

Entered as second class matter at the Post Office, New York.

DUBILIER MICA CONDENSERS

For any voltage and capacity. .004 mf Units to fit all Standard Racks.

Used by the Marconi Company

MICA SELF HEALING

Protective Devices for all size equipments from $\frac{1}{4}$ to 500 K. W.

Protect your Motors and Generators from burning out.

**Up to further notice only U. S. Government Equipments
will be supplied**

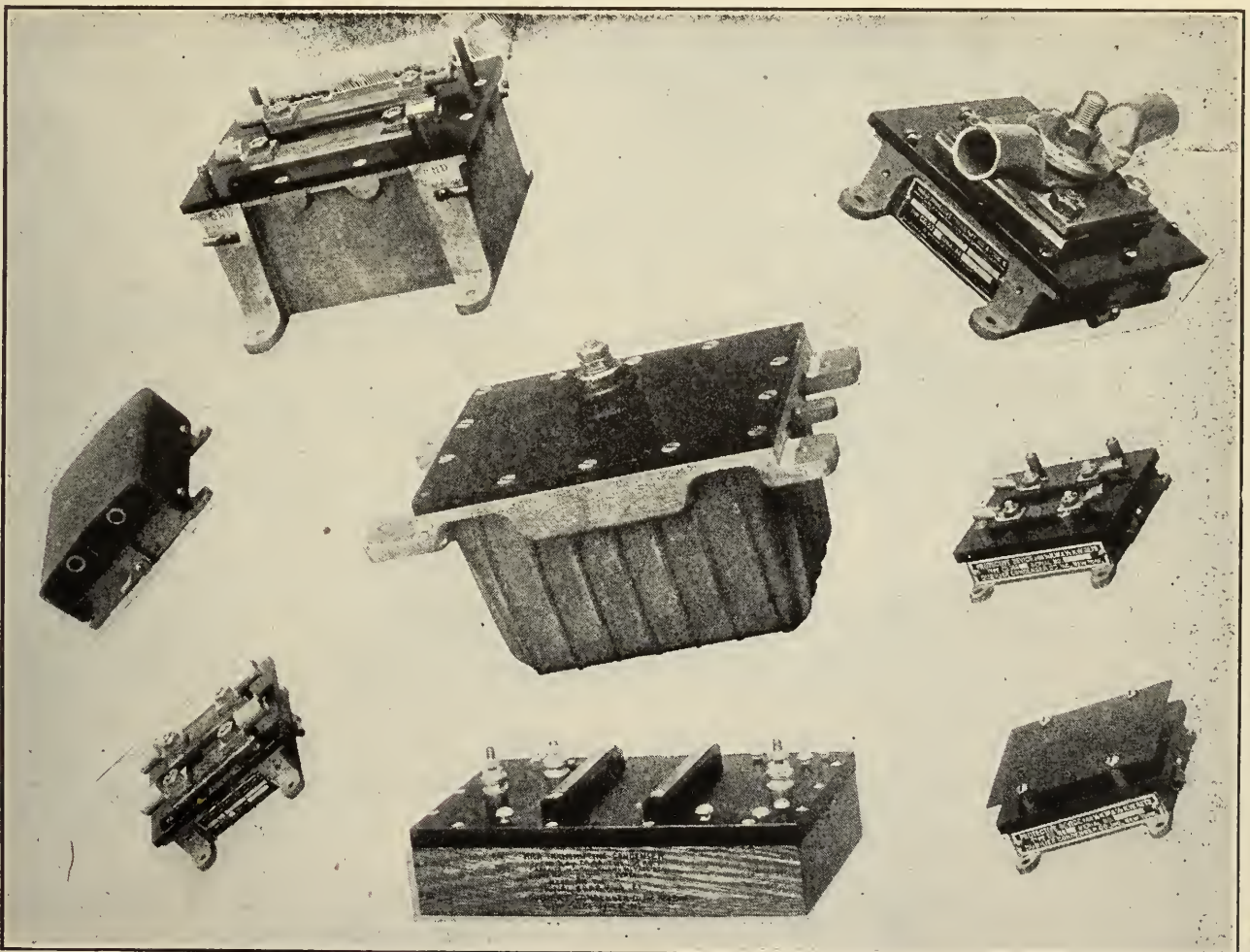

DUBILIER CONDENSER CO., Inc.

217 CENTRE STREET

NEW YORK

When writing to Advertisers please mention THE WIRELESS AGE

LEARN THE CODE WITH THE OMNIGRAPH

The Omnigraph Automatic Transmitter will teach you the Continental and the Morse Codes, at home, in half the usual time and at the least possible expense. The Omnigraph, connected with Buzzer or Sounder, will send you unlimited Wireless or Morse Code messages, by the hour and at any speed you desire. Invaluable also for practice with the Morse Light, allowing you to quickly master the Blinker system as used in the U. S. Navy.

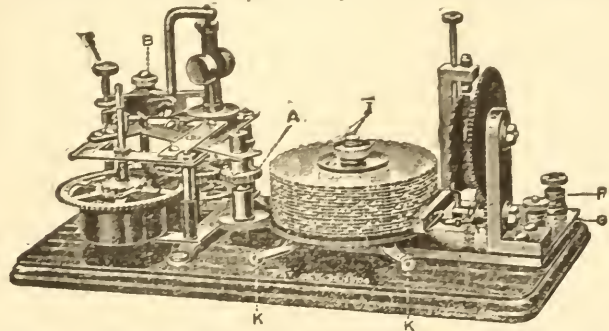

We offer the Omnigraph as a positive success and with the strongest of endorsements. It has been adopted by the U. S. Government, Department of Commerce, and is used to test all operators applying for Radio licenses. Other Departments of the Government use it for instruction purposes and a large number of the leading Universities, Colleges, Technical and Telegraph Schools throughout the U. S. are satisfied purchasers of the Omnigraph. Thousands of individuals have quickly learned with it.

If you expect to enter the Government service, a knowledge of Telegraphy before enlistment will be of invaluable benefit to you, and may mean quick promotion.

Major J. Andrew White, Chief Signal Officer, American Guard, Acting President, National Wireless Association, Editor, THE WIRELESS AGE, says: "The prominent training schools for the past 12 years have found the OMNIGRAPH the one real helper that turns out finished men. The U. S. Government finds the OMNIGRAPH so practical, it places a large number of new machines in use every year." THE MARCONI INSTITUTE says: "Automatic transmitters for code instruction have been successful, the particular advantage being the uniformity of sending which the student imitates and adopts in his own transmitting. Among the prominent Automatic transmitters are the Wheatstone and the OMNIGRAPH." The OMNIGRAPH sells at a popular price and is within the reach of all.

If you are a beginner, it will make you an operator in the shortest possible time.
If you are already an operator, the OMNIGRAPH will make you a better one.

Send for free catalog describing 3 different models—\$8.00 to \$20.00—or order direct through your Electrical Dealer. We sell the Omnigraph under the strongest of guarantees—you must be satisfied or your money back.

THE OMNIGRAPH MFG. CO., 39c Cortlandt Street, New York.
 Immediate Deliveries.
 How did you learn to talk? By listening. JUST LISTEN,—THE OMNIGRAPH WILL DO THE TEACHING

ELECTRICAL SUPPLIES

Wholesale and Retail

Telephone
 Madison Square
 726

Between Broadway
 and Fifth Avenue

CHARLES F. CAMPBELL
 14 WEST 31ST STREET
 NEW YORK CITY

Concentrate Your Buying

It is easier, better and less costly to buy your tools and supplies from one first class, real, live house that knows how to supply your wants at the right prices.

For years we have made a specialty of tools and supplies.

Advise us your needs—We will supply them.

T. P. Walls Tool & Supply Co., Inc.
 75-77 Walker St., New York City

Telephone Connecting all Departments

Radio

Manufacturers
Electricians
Experimenters
Operators

WE know your problems and our men are giving the best that is in them to help you overcome all insulation troubles. According to every known test

BAKELITE-DILECTO

is producing wonderfully successful results on land and sea, on every type of radio instrument and under all kinds of climatic conditions.

Furnished in *Sheets, Rods and Tubes*. You will find it waterproof, permanent and strong.

We also manufacture *Vulcanized Fibre* and *Conite* for special insulating purposes.

Let us show you how our Standard Products can be made to solve your insulating problems.

THE CONTINENTAL FIBRE CO.

NEWARK, DELAWARE

233 Broadway, New York City

332 S. Michigan Ave., Chicago, Ill.

525 Market St., San Francisco, Cal.

411 S. Main St., Los Angeles, Cal.

301 Fifth Ave., Pittsburgh, Pa.



(C) Underwood & Underwood

An interesting freak seen on the Alsatian front is revealed in this photograph of a tree hit by a German shell, leaving the trunk split in such a way that the stump has the appearance of a tropical palm



THE WIRELESS AGE

WORLD WIDE WIRELESS

Marconi Medal Lost at Sea

THE Franklin Medal, the highest token of recognition the Franklin Institute of Philadelphia bestows, that was awarded to Guglielmo Marconi, Italy's great inventive genius, on May 15, has been lost at sea, according to a report from the Quaker City.

The medal was despatched by Ambassador Cellere on a transatlantic liner. The ship was attacked by a German submarine in midocean and sunk, the medal, together with the certificate, going down with it.

The medal, a handsome gold affair, will be duplicated and the duplicate forwarded to Marconi as soon as expediency permits.

Wireless to Solve Air Mail Pilots' Problems

THE air mail pilot is solving the problem of flying in all sorts of weather. Prior to the establishment of the Air Mail Service it was regarded as impracticable to make flights with airplanes during severe storms.

On August 1st Lieut. Stephen Bonsal from Philadelphia to Washington ran into a violent thunderstorm at Laurel, Md., at an altitude of 5,000 feet and proceeded on his way to the landing field in Washington without interruption. It was impossible to distinguish any landmarks in such torrents of rain. When he descended to a lower altitude for observation he was near the wireless towers at Radio, Va. To observers he appeared to drop out of the clouds from nowhere at an angle of 45° to a height of about 300 feet when he leveled the plane and made a perfect landing at Potomac Park in the midst of a torrent of rain. The plane arrived on schedule time, not being delayed by the storm. The propeller was slightly damaged by the pelting rain.

Lieut. Bonsal was not assisted by radio guide but depended entirely upon his compass and his judgment from familiarity with the route. When radio and other systems for determining location, which are being tried out, are installed it will greatly simplify flights of this sort where the landscape is obscured and the velocity of the wind render uncertain the traveling of planes.

English Marconi Company Earns Nearly Two Million

A DISPATCH from London says that the profits of Marconi's Wireless Telegraph Co. in 1917 were £383,000 (\$1,915,000). The directors have recommended a final dividend of 15% on the ordinary stock and 10% on the preference shares and carried £100,000 (\$500,000) to the general reserve fund. The surplus at the end of the year was £376,000 (\$1,880,000). The annual meeting was held in London on July 24.

Advanced Aviation School for Wireless Men

THE latest school to be established is the "Advanced School for Radio Operators" at Ellington Field, Tex.

The purpose of this school is to train men who have taken radio school work elsewhere, for actual duty overseas. The course is divided into three sections of one week each and is almost altogether field work. Both French and British systems of working with the artillery will be taught, and the idea is to make conditions as near like battle front conditions as possible. The first two weeks' work will be conducted in dug-outs, just outside of the post, while the third week's work will be in the open, each man being on his own initiative, the work being done with planes. A number of planes will be assigned especially to this work.

Captain Cook, a British officer assigned to duty in this country, has been here, assisting in getting the work started. Lieut. H. B. Lindsay is in charge of the school, Lieut. Fairman is in charge of the instruction, and Lieut. Worrel is in charge of the supplies and maintenance.

S. O. S.—Save or Serve

IN wireless telegraphy "S. O. S." is the code signal sent out by a ship in distress to summon assistance.

Our ship of state is toiling on a voyage to bear democracy to the peoples on earth and bring back to its own people safety against the violence of brutal autocracy and against cruelty and treachery of the Germany of the Hohenzollerns. Buffeted by the winds and waves of circumstance, it is signaling to its loyal citizens for assistance.

"W. S. S." is the Nation's "S. O. S." The country calls for aid. You can answer that call by buying war savings stamps, which will earn interest for you and aid Uncle Sam.

A Dane Invents Steel Soldier Animated by Radio

AN "automatic soldier" is one of the latest developments in war weapons. A Danish engineer has recently taken out a patent for an apparatus to which he has given this name. It is a steel cylinder normally within a larger cylinder, the whole being sunk into the ground vertically. By means of a mechanism operated by wireless the inner cylinder rises to a height of eighteen inches and an automatic rifle mounted on the inner cylinder fires 400 shots in any given direction.

These "automatic soldiers" can be controlled from a central position four or five miles behind the line of defense, says the inventor. They may be seen by the enemy only when they rise.

From trials already made it has been shown, it is reported, that a few hundred of these steel soldiers can easily defend a position against infantry attacks, however numerous the opposing force may be. In order to overcome the "automatics" they must be destroyed one by one.

Allies Get Hun Map of British Waters

A MAP of the waters around the British Isles, divided into squares and each square numbered, in order to indicate by wireless to German U-boats the location of allied or neutral ships to be attacked, has been discovered by the allies, together with a code by which wireless stations indicated to U-boats

the nationality and type of ships in any given square. The code was so designed that every message seemed to refer to some innocent commercial transaction. Thus a wireless reading, "First quality packing case, Series 4, No. 432," translated meant "British armored cruiser, four smokestacks, in square No. 432."

German Wireless News Scheme a Failure

ALFRID L. BECKER, Deputy State Attorney General, who is investigating the purchase of the N. Y. Evening Mail by Dr. Edward A. Rumely, has made public the fact that shortly after Dr. Rumely bought the Mail negotiations were opened with Dr. Heinrich F. Albert to establish a wireless news service with Germany.

According to the Deputy Attorney General, the scheme was for a limited number of words to be sent through Sayville, or Tuckerton, and Mr. Becker stated that Dr. Albert agreed to furnish 1,000 words daily at a fixed rate for publication in the Mail. But, according to the Deputy Attorney General, the scheme fell through because Dr. Rumely wanted his own representative in Berlin to gather the news and transmit it, while Dr. Albert wanted to do this. Dr. Rumely is said to have expressed the fear that Dr. Albert would "doctor the news."

U. S. Ships Hear Hun Wireless to U-Boats

WIRELESS operators on American and other ships crossing the Atlantic at night frequently "pick up" orders being sent by the German Admiralty to submarines at sea. The messages are in code, of course, and the submarines never acknowledge receipt of the orders, because if they did some warship of the enemy might get a clew as to the location of one or more of the underseas boats.

These messages to the submarines are from Nauen, a small town near Spandau, where Germany has its great wireless station. Electrical waves produced there will reach some 6,000 miles.

Nine towers are in use, the highest being 850 feet. Last year Nauen sent to the outside world almost 5,000,000 words for the German government.

Naval Rookies Climb Skyward to Paint

THE yearly task, just begun, of painting the two giant wireless towers at the Great Lakes Naval Training Station is a difficult one. Five hundred gallons of paint are required, and men engaged in covering the framework are under intense nervous strain, as they have little space on which to stand and are forced to combat a strong wind at dizzy heights. The Great Lakes Bulletin says that "tests have been made to find how long it would take a man to climb to the top of the tower with a ladder and come back down without the ladder. The record is seventeen minutes."

Ernest T. Edwards Dies Suddenly

ERNEST T. EDWARDS, superintendent of the Eastern Division of the Marconi Wireless Company of N. Y., died August 4th at his home in Maple Avenue, Sea Gate. He was born in England thirty-five years ago, and came to this country ten years ago. He had been employed in England as a wireless operator on coast stations and later on the Cunard line between Great Britain and the United States. He entered the American service and for a while was wireless operator on the American Liner New York. He is survived by his widow and two daughters, Betty and Louise. Funeral services held at his late home on August 6th were largely attended by his former associates in the wireless field.

Some Pointers on Teaching Acquired by a Radio Code Instructor

By **Gordon Lathrop**
of the Marconi Institute

THE writer learned to telegraph while working as a messenger boy in a railroad office. As with most novices in an exacting mechanical art, he was mightily impressed by the glittering generalities indulged in by the "old timers" of the craft. One of these was to the effect that the expert telegrapher was never a graduate of a telegraph school.

"What school turned *you* out?" was, and is yet, frequently snapped over the wire by an irate "old timer" when forced to work with a less skillful mate.

After having worked for a half dozen railroads, both of the commercial and land telegraph companies and four press associations, the writer earned the right to consider himself an old timer, telegraphically, and he was wont to hold forth in a like strain. But, fortunately for the art, like so many sweeping statements which pet the vanity of those who so easily voice them, this uncomplimentary dictum about telegraph schools is untrue—untrue in the cold testimony of facts and figures, and fundamentally unsound.

The "old timers" generality however has a degree of justification. Men who, without assistance, have developed sufficient ability in sending and receiving to qualify for their first job, have demonstrated by that very accomplishment their natural aptitude for the art. Further, they have demonstrated persistence and ambition, which, coupled with telegraphic aptitude, produce the skilled worker in the code.



A class receiving advanced code instruction at the Marconi Institute, New York City

The foregoing refers primarily to land line telegraphy and American Morse telegraphers. But the admission of his error concerning telegraph schools in general may serve as a starting point for the writer in telling what he has learned while serving as code instructor to beginners in the New York code room of the Marconi Institute.

There are many and diverse complexities of mental makeup in the Marconi student personnel, but an invariable point to be impressed upon the beginner is that there is but one process of receiving telegraphically, and that deals primarily with "reading by sound."

The writer has learned, however, that the first instruction to be given the beginner is: "Memorize the code in dots and dashes." If he is forbidden the use of code charts, the very first act of the student is to dig up a code chart somewhere to determine for himself what the code actually comprises. In view of the foregoing, the writer submits a code chart for the beginner which outlines a convenient method of memorizing and maintains a progressive relationship between the letters of the alphabet according to the number of dots and dashes employed.

E .	T —	A . —	A . —
I ..	M — —	U .. —	W . — —
S ...	O — — —	V ... —	J . — — —
H	Ch. — — — —		
	N — .	N — .	N — .
	D — ..	K — . —	G — — .
	B — ...	C — . — .	Q — — . —
		X — .. —	
		Y — . — —	Z — — ..
	R — .	U .. —	
	L — ..	F .. — .	
	P . — — .		

This chart has been prepared for the beginner whose mental processes are, say, 60% perceptive and 40% reflective, with a highly developed sense of rhythm. This type of student would instinctively subordinate all tendencies to analyze the sounds into dots and dashes, and would naturally begin to "read by sound." Experience teaches that one who has a natural ear for music will pick up the code work quickly.

In the Marconi Institute we frequently enroll students with the opposite mental makeup; that is, their minds are 40% perceptive and 60% reflective, or analytical. Desire to engage in war service has brought many 40-60 men to the Marconi code rooms. The demand of the period for combination men is unprecedented. Army and Navy aviators must be able to send and receive in the code at a fair rate of speed, in addition to the half dozen other skilled arts in which they must qualify. The Signal Corps of the army and the radio divisions of the navy and marines must have their quotas of combination men—men equally capable in the code and technical operation.

But to return to the writer's purpose of telling what he has learned in the Marconi Institute while instructing others.

Immediately after the beginner has accomplished his first task of memorizing the code in dots and dashes, he is harnessed to the instructor by head telephones and the sending instruction is begun. The student is shown how to hold his hand on the key. The correct "grip" is explained and demonstrated by telling the student to arrange his thumb, index finger and second finger on the key knob in the same manner as he would grasp a pen or pencil to write with a free arm movement. If a pen or pencil were as large as the key knob the relative positions of thumb, index finger and second finger would be



Students receiving laboratory instruction at the Marconi Institute, New York City

practically identical;—thumb against side of key knob as a steadying factor, index finger, convexed preferably, but straight rather than concaved. In this way one makes the correct downward pressure on the knob. The second finger should slip easily in position over the key knob. Just as a hand writing instructor emphasizes the necessity of keeping the hand and wrist relaxed as much as possible, so should the code instructor caution the student about sending. A relaxed wrist precludes “nerve sending,” a common error of beginners.

The writer informs beginners there is one general and three specific rules about sending. The general rule is the Golden Rule paraphrased telegraphically: *Send to others as you would have them send to you.* The three specific rules are these:

Make your dot so short and sharp, though firm, that the receiver cannot mistake it for a dash.

Hold your dash long enough—(three times as long as a dot)—so that receiver cannot mistake it for a dot.

Then, having observed rules 1 and 2, knit together the succession of dot or dash, or combination of dot and dash so closely that receiver cannot mistake it for an unintended combination.

The instructor has insufficient time to send each letter to each student a sufficient number of times to enable the beginner’s mind to register the proper conception of each sound; so use is made of Marconi-Victor Record Number 1 of the series prepared by Harry Chadwick of the Marconi Institute. On this record a voice calls out each letter in alphabetical order, then the letter is reproduced three times in Mr. Chadwick’s perfect style. The beginner, equipped with a head telephone, and sitting before a key, can listen to the first reproduction of each letter in Mr. Chadwick’s style, then he can imitate the second and third reproduction on his telegraph key.

To relieve monotony and register the rhythm of each letter in the beginner’s mind another method is often used. It is the “follow copy” system, advocated by Walter Phillips, originator of the “Phillip’s Code,” used by all

press telegraphers. The instructor distributes cards on which are pasted sheets containing sentences, five letter unpronounceable combinations of letters, such as "GBXTQ," and ten letter code words, such as "GILLIPAXTE." On the margin of each sheet, before the lines, are numbers arranged consecutively in a column.

The instructor distributes the cards to those who have not advanced sufficiently to copy at the rate of five words a minute or more without the copy as reference. Then he sends from the card, line by line, to those who can "read by sound," calling off the number preceding that line before beginning so those who hold copy may follow the sending.

When the opportunity occurs, the writer talks to each beginner. He tries especially to appeal to the 40-60 boy or man—the type whose tendency is to analyze—to break the sounds up in dots and dashes, who by painful reasoning processes tries to detect the letters as they are sent. This, in effect, is the burden of the writer's talk to the beginner:

"You have learned that A, for instance, is composed of a dot and a dash. But so is E, T. The letter C is dot-dash-dot-dash, it is true, but those same components make up the combinations T R, N N, or K E. The letter A in wireless telegraphy is a rhythm; a staccato note and a legato note occurring in quick succession. This principle applies throughout.

"Your job is to tuck away in your mind a correct concept of the sound* of each letter, numeral and punctuation mark, and by practice learn to associate that sound immediately, and without conscious effort, with the letter which it symbolizes."

These, then, in summary, are the instructions which in the writer's opinion, tend to lay the right foundation for the telegraphic aspirant: Memorize the code to learn the arrangement of the elements with which you work; learn the proper grip for sending and model your style after that of an expert telegrapher—one who observes rules one, two and three and the general rule—subordinate from the start the tendency to analyze the sounds by "follow copy" practice, if you can obtain it—by all means at your disposal get yourself as quickly as possible into accord with the first principle of receiving—reading by sound.

In conclusion, let it be said that for the 40-60 student there is no royal road to success in mastering the art of telegraphy. Systems of instruction nor methods such as the phonetic syllable idea will not of themselves bring every student into right accord with the process of reading by sound. The 40-60 boy or man must practice, practice, practice—always on the right basis. After his foundation is properly laid he will progress from table to table and from low speed to high speed with less and less effort. It has occurred, in the writer's observation, that a 40-60 boy or man makes a better code man ultimately than another whose quick perspective faculties gave him such an initial advantage. That is the case if the 40-60 student works hard and persistently to become a 50-50 man while the 60-40 student is content to rely on his instinctive mental processes.

May it not be said to apply in every worthy human activity, as well as in the expert work of the telegraphic craftsman, that it is the frictionless interworking of the instinctive and the cultivated mental machinery which makes for real, satisfying achievement, and produces the evenly balanced, 50-50 man?

If that be true, and the writer firmly believes it to be true, that is the most important lesson learned by him while serving as an instructor to others.

*By pronouncing the syllable "tuh" for the initial dot, the syllable "duh" for other dots and the syllable "dah" for the dash, an oral representation of any letter's rhythm may be produced. So far as the writer has been able to learn, the use of these syllables—for instance, the letter "F" would be pronounced "tuh duh dah duh"—is the most practicable application of the phonetic method of learning the code. The writer would be glad to give credit to the originator of this idea if he could determine to whom the credit is due.

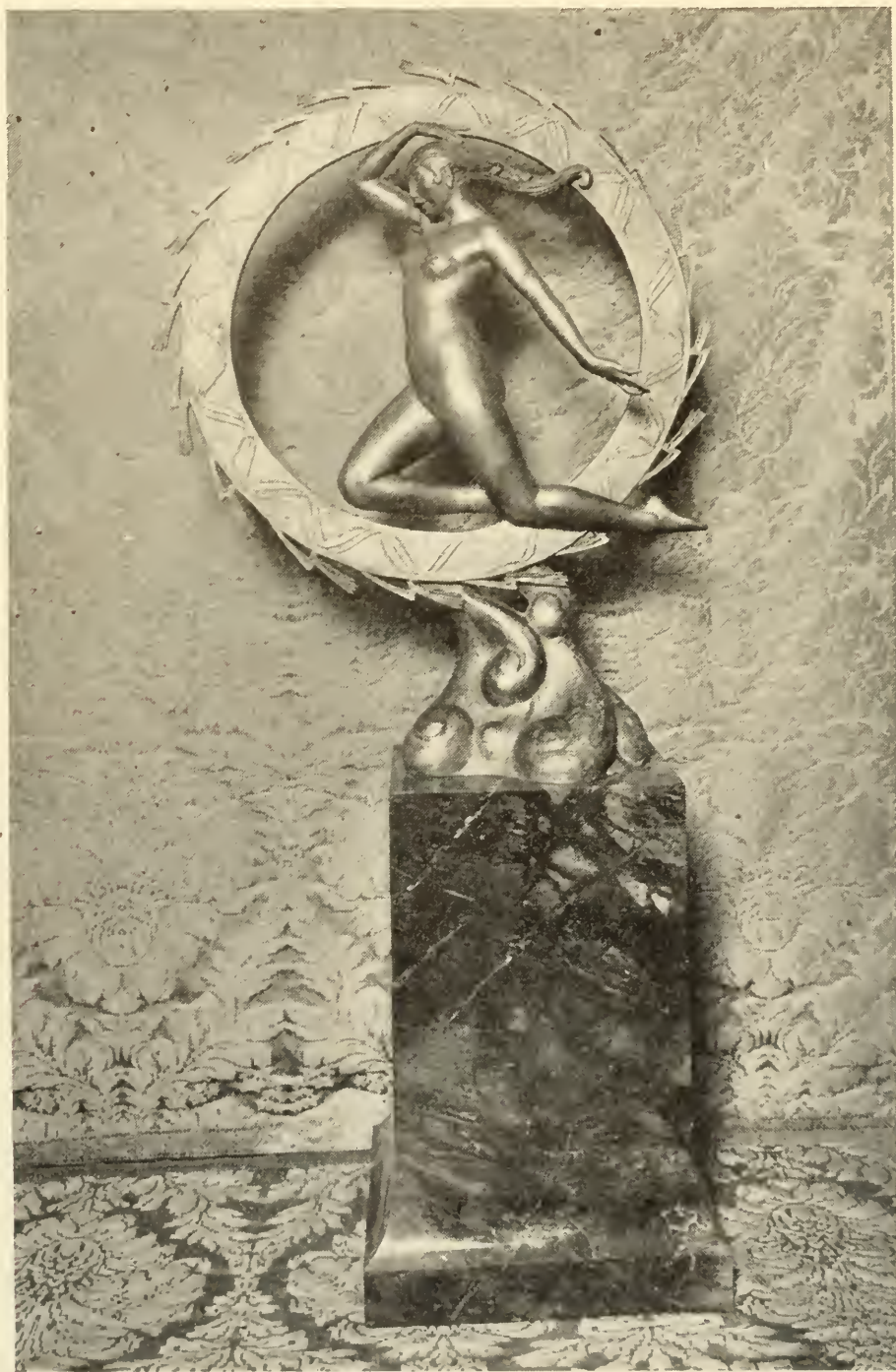

Above is shown a sculptor's conception of "Radio," a subject which the wielders of the scalpel have hitherto evaded with a wholesome respect for the difficulties it presents. Just that much credit is therefore due Edward Field Sanford, Jr., for his expression in bronze of the wildly onward-rushing electric waves. The figure of "Radio," rushing through space with an unearthly wind blowing her hair backward, and with every line eloquent of arrow-like speed, dominates the whole. Surrounding her is a circular halo, or ring, symbol of infinity and suggesting all the circular forms so common in radio apparatus. The coil, the winding, the rotary gap, and the dynamo all contain the circle, and all of these are closely associated with radio methods. The statue was executed for Dr. Alfred N. Goldsmith, for many years a close friend of the sculptor.

Progress in Radio Science

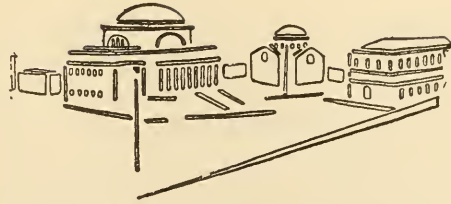

A Rectifying Spark Gap for High Tension Alternating Current

WHEN the condenser charge breaks down in a circuit carrying a powerful current and containing a spark gap of which one electrode is a flat surface and the other electrode a rod with a tapered or rounded end, the discharge across the gap is a plain alternating current arc resembling in appearance a candle flame. This is essentially what takes place when the secondary circuit containing the spark gap is in resonance with the primary power circuit which charges it through an inductive coupling. If the primary circuit and the secondary circuit are not in resonance, the discharge across the gap takes the form of irregular stringy white sparks. In the former case, the gap becomes conductive and current oscillates across it in the same frequency as that of the primary circuit; such oscillations are too low in frequency to be utilized for radiating Hertzian waves. In the latter case, oscillations of current occur in the circuit and internal losses are sustained, diminishing the efficiency of the circuit.

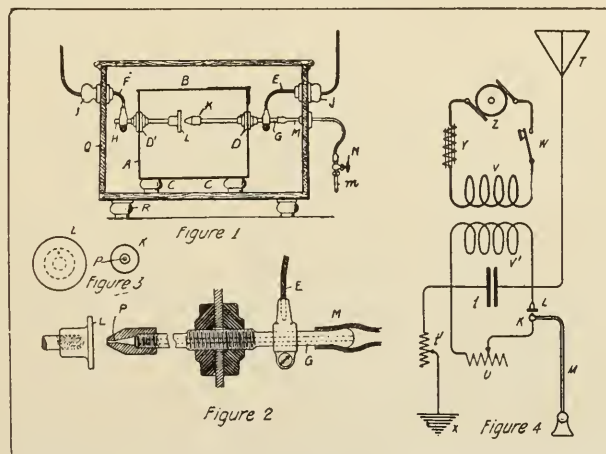

Figure 1—Sectional elevation of spark gap apparatus. Figure 2—Electrodes. Figure 3—Face-end view of electrodes. Figure 4—Diagram of wireless transmitter

An apparatus to change high frequency currents into uni-directional currents has recently been devised by Archibald Shaw, of Sydney, New South Wales, Australia. In his invention, the rod electrode is pierced axially with a fine hole through which gas is forced so as to impinge with considerable velocity upon the opposed face of the other electrode, and if the primary and secondary circuits are in resonance an arc is no longer formed, but the discharge immediately takes the form of a bluish white incandescent blaze of tapered form extending across the gap, and a pulsatory discharge having a very high frequency passes in one direction only.

In practice, a blast of suitable gas under pressure, such as air is used in the gap, the axial jet is made about one sixty-fourth of an inch in diameter at the nozzle, and the pressure is from 50 to 150 lbs. per square inch. With a substantially flat faced electrode of two or more inches in diameter, and a rod electrode of about an inch in diameter formed at the head as a blunt nosed cone, and a gap measuring about three-eighths to a half an inch between the electrodes, as much as 20 kw. can be passed under a pressure of about

28,000 volts. These proportions are highly suitable for the purposes of a high power wireless transmitter.

For this purpose, air pressure at about 110 lbs. per square inch has been found to give very satisfactory results. The length of the gap is varied according to the voltage and the pressure of air employed; for a voltage of approximately 28,000 and an air pressure of 110 lbs. per square inch, the sparking distance is from three-eighths of an inch to one-half an inch. The air pressure should not be increased with the voltage. The best results for wireless transmitters are obtained with voltages approximating 28,000.

The inventor remarks that such voltage, with the quantity of current necessary for long distance wireless transmission, cannot be used with multi-plate gaps of the Lepel type; nor can heavy currents be rectified as may be done with currents of less quantity though high voltage, in point-and-plate gaps such as are frequently used with influence machines.

Experiments have been performed with discharges having a voltage of 60,000, and the length of the gap has been extended to as much as two inches. Flatness of the opposed electrode is desirable, the best economy being obtained with a flat disk upon the face of which the air jet impinges perpendicularly. The electrodes are preferably made of copper or silver; zinc is undesirable as it shows a tendency to pit at the place of impact of the jet. The diameter of the jet should be increased with the power used in the circuit, a diameter of one sixty-fourth of an inch being correct for 2 kw. and slightly more for heavier currents.

In the drawing of figure 1 is a sectional elevation of the spark gap apparatus, figure 2 an enlarged scale sectional elevation of the electrodes, and figure 3 face-end views of the electrodes. Figure 4 is a diagram of a wireless telegraph transmitter in which the spark gap can be employed.

In figure 1 A is a case constructed of micanite or other suitable insulating material and fitted with a lift lid B; it is supported on insulators C, and fitted with leading-in insulators D and D'. E and F are portions of the exciting circuit, their terminals being connected to the stems G and H of the electrodes K and L. The electrode L is fitted with a solid stem H which should be screwed to work in a nut in the leading-in insulator D' to enable the operator to vary the length of the gap readily. The stem G of the flat nosed cone nozzle electrode K is tubular, and it is connected by a rubber hose M to a source m of air or gas under the necessary pressure. N is a valve in the hose M. The forward end of the nozzle electrode K is coned externally.

In the diagram of figure 4 which represents diagrammatically a wireless telegraph transmitter, Z is an alternator delivering current at about 500 cycles per second. Y is an inductance, W a circuit closing key, and V the primary of a step up transformer. The values in the secondary circuit are proportioned so that the condenser t will break down once in every half cycle of the primary current. The radiator T is constructed to radiate freely at the frequency required for transmission, tuning being effected by adjusting the condenser capacity, the length of the spark gap and the variable loading inductance t'.

Spark Discharger for Radio Frequency Oscillation Circuits

A spark discharger more in the nature of an arc gap has been described by Alfred H. Cohen. The object of the device is to provide a gap that will generate constant and persistent oscillating currents and permit the circulation of a liquid having slight conductivity between the faces of the electrodes in the oscillator. Its construction permits visual examination, at any time, of the operation of the spark discharger between the electrodes and permits the length of the discharge gap to be closely regulated. The inventor states that it is adaptable for use under conditions of constant vibration, sudden

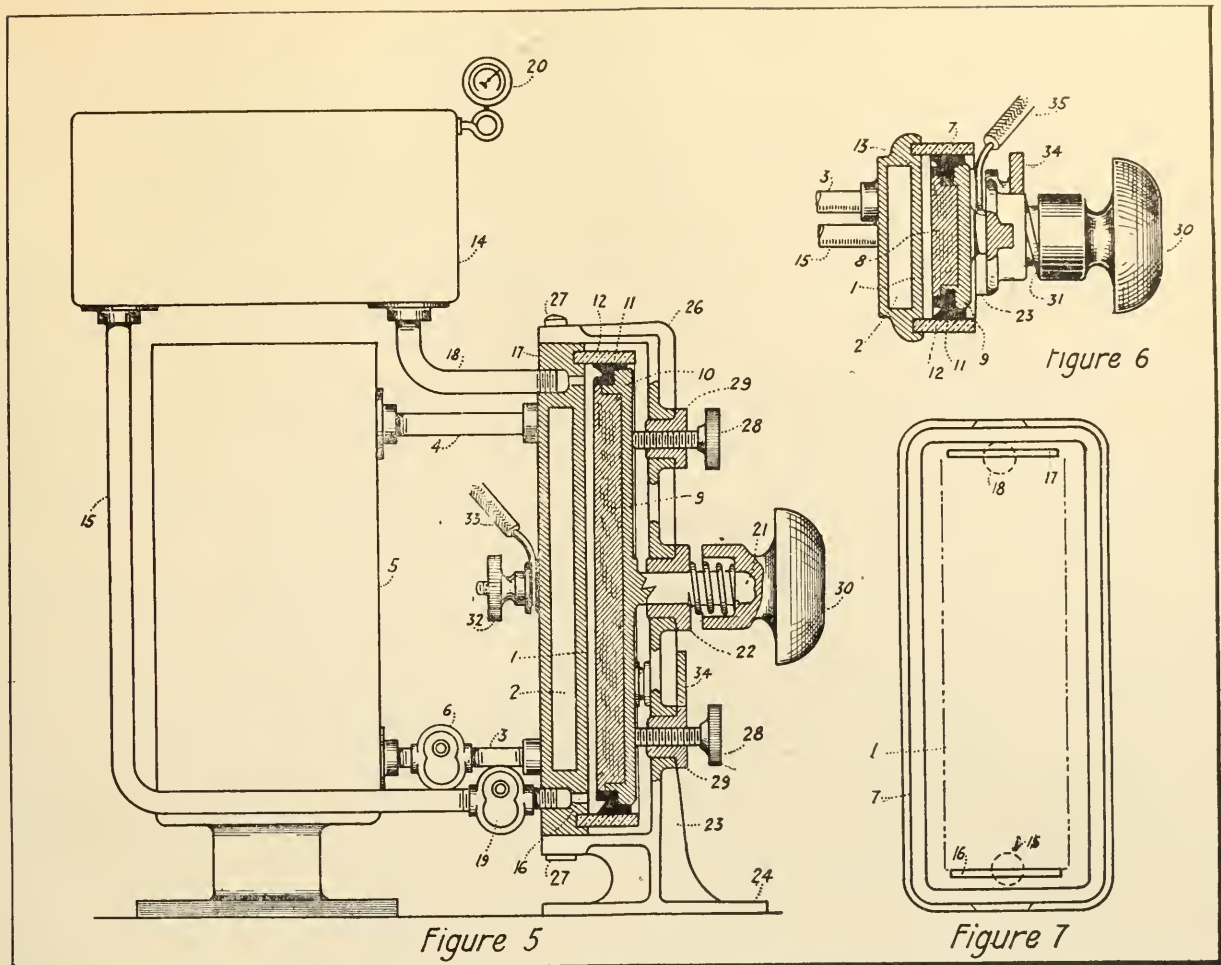

Figure 5—Spark discharger—side elevation and partial cross section view. Figure 6—Cross section of oscillator. Figure 7—Metallic electrodes and ports for circulating liquid between electrodes

shock, change of position and other conditions to be met in marine service, on warships for instance during heavy gun fire.

Figure 5 is a side elevation, partially in cross section, figure 6, of an oscillator constructed in accordance with Cohen's design.

Figure 7 is a detail in front elevation of the metallic electrode, showing the ports for circulating the liquid, between the electrodes.

In detail the construction illustrated in the drawings includes the electrode 1, having a smooth, level plane, sparking surface. This electrode has the hollow chamber 2 cored therein, with which the inlet and outlet pipes 3 and 4 communicate. These pipes are connected with a supply tank 5 filled with a cooling liquid adapted to circulate through the chamber 2 for the purpose of removing the heat created by the spark and radiated by the electrode 1. Thermosiphon circulation is usually sufficient for the circulation of this cooling liquid, but the circulation can be rendered more positive by the addition of the force pump 6. The electrode 1 is surrounded by an annular groove into which the glass ring 7 is cemented.

The electrode 8 is of carbon, coinciding in outline with the active face of the metallic electrode 1. This carbon electrode is embedded in the metallic holder 9, having flanged edges 10 extending to near the sparking surface of the electrode, which has a lateral flange overhanging the thickness of the flange 10. The flange 10 is annularly grooved to receive the packing 11, entirely encircling the electrode 8 and its holder 9, hermetically packing the electrode 8 within the glass ring 7. The attenuated lip 12 of the packing is forced against the wall of the glass ring 7, by the pressure of the liquid confined between the two electrodes and the encircling glass wall of the ring 7.

The space 13 between the electrodes 1 and 8 constitutes the spark gap, which is hermetically surrounded by the glass ring 7. The container 14 is adapted to contain a liquid of slight conductivity such as alcohol, acetic acid, formaldehyde, etc., flowing down through the pipe 15, and through the lower port 16 connected with the space 13, through which the liquid flows upward and out through the port 17, into the pipe 18 connected with the tank 14. The liquid is circulated by the force pump 19, introduced in the pipe 15. To control the pressure of the liquid the tank 14 is pressure tight, and is provided with the pressure gauge 20, properly graduated to disclose the pressure within the tank, or the pressure may be controlled by raising and lowering the tank.

The discharge is started by pressing the knob 30 inward until the electrodes 1 and 8 are brought into contact. This closes the circuit, starting the current flowing through the electrodes, creating a spark as they are separated, the length of the spark increasing as the electrode 8 returns to the normal position fixed by the adjusting screws 28, that regulate the fixed length of the spark for the desired purpose. It is important that this spark travel about, within the confines of the parallel area of the electrodes.

The instant that a spark jumps across the gap 13, the heat generated by the spark creates a bubble in the liquid confined between the electrodes. The point on one electrode from which the spark started, and the point on the opposite electrode to which the spark jumped, are within the bubble for a sufficient period of time to prevent a second spark jumping across between the two exact surfaces isolated or insulated by the presence of the bubble. The succeeding sparks (and they come in succession so rapid as to amount to a practically continuous flow) naturally choose points on the opposite electrodes not occupied by a bubble; therefore, the spark jumps about throughout the area of the opposing faces of the electrodes. The bubbles thus formed very slightly quench each spark as it passes, and prevent the formation of arcs at any point in the spark gap.

The slight conductivity of the liquid allows the sparks to pass between the faces of the electrodes, until it becomes heated at the sparking points, producing the bubbles. The action of the spark is practically continuous, regular and constant throughout the whole parallel surfaces of the electrodes, as is evidenced by the fact that the negative carbon electrode is burned evenly throughout its whole sparking area; this action is facilitated by the constant speed and pressure of the film of liquid passing between the exposed faces of the electrodes. The structure illustrated prevents the forcing of sparks beyond the face of the electrodes, by undue speed in the flow of the liquid, owing to the fact that only the faces of the electrodes are exposed to the liquid. The pressure and the flow of the liquid, therefore, is an important factor in maintaining the correct adjustment.

Advance in the Design of X-Ray Tubes

The Coolidge X-Ray tube, as is well known, operates at extremely high vacua with a pure electron discharge, as contrasted with the Röntgen tubes formerly constructed depending in their action upon the ionization of a residual gas.

In one of the modifications of this tube the cathode rays are focused by means of a static focusing device, such as a ring, tube, or other conductive member surrounding the cathode and establishing a static field radially about the cathode. The focusing member appears to become statically charged by the electron emission of the cathode, and thus modifies the static field in the tube, which is controlling the motion of the cathode rays.

Dr. Langmuir has designed a tube wherein the length of the focus of the cathode rays is varied at the will of the operator, thus controlling the area of the focal spot or surface by adjusting the distribution of potential in the static field directing the cathode rays inwardly to a common point, or outwardly from a virtual focus. For example, by means of a source of po-

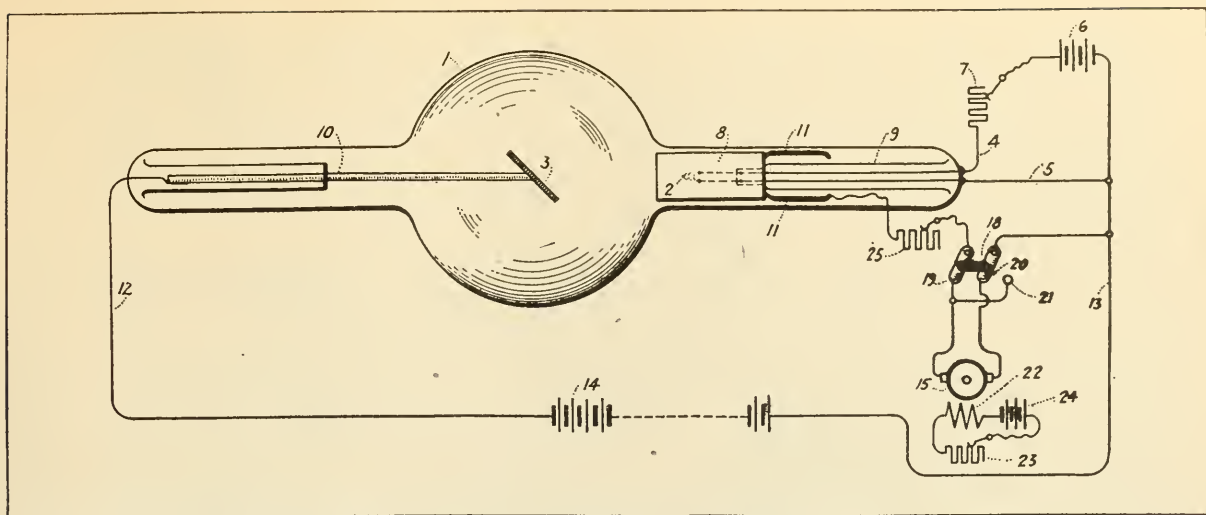

Figure 8—One form of improved Röntgen ray tube

tential between the cathode and the focusing device, the intensity and polarity of the static field may be varied as will now be described:

In the drawings, figure 8 illustrates diagrammatically a Röntgen ray tube provided with a unidirectional source of potential between the cathode and static focusing means; figure 9 shows a Röntgen tube operated from an alternating current source and controlled by a potential which fluctuates in synchronism with the current supply for the tube; and figure 10 shows another means for varying the focus.

Referring to figure 8 it will be noted that the essential parts of the tube comprise an envelop 1 of glass, or quartz, a cathode 2 and an anode 3, located opposite the cathode, and serving also as a focal plate, or focal surface. The cathode, which is a primary source of electrons, consists of a refractory conductor, preferably tungsten. Energy is supplied to incandesce the cathode through leading-in wires 4 and 5 from a battery 6 in series with a variable resistance 7. The anode consists of refractory metal, preferably tungsten. Around the cathode is located a short tube 8 also consisting of metal, for example, nickel, iron or tungsten representing one form of focusing device. The supports for the various parts such as the stem 9 for the cathode, a rod 10 for the anode, and spring anchors 11 for the focusing means have been only diagrammatically indicated. Electrical current is supplied to the tube through conductors 12 and 13 from a source of energy which may be a mechanical rectifier, a high potential battery, or even an alternating current source, such as an induction coil or transformer. The source 14 is symbolic of any of the sources mentioned or their equivalents.

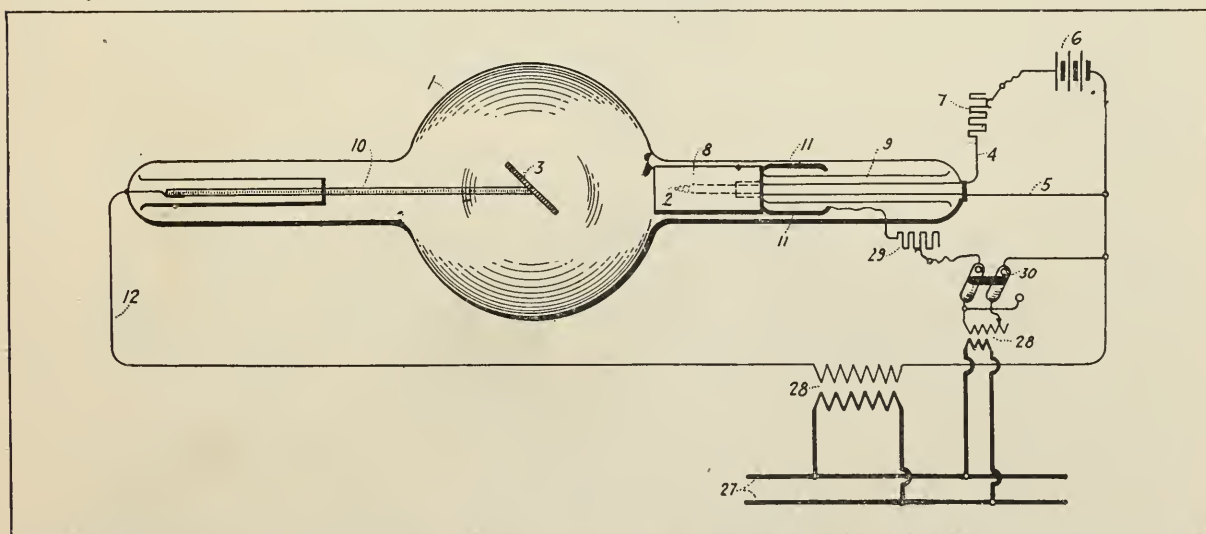
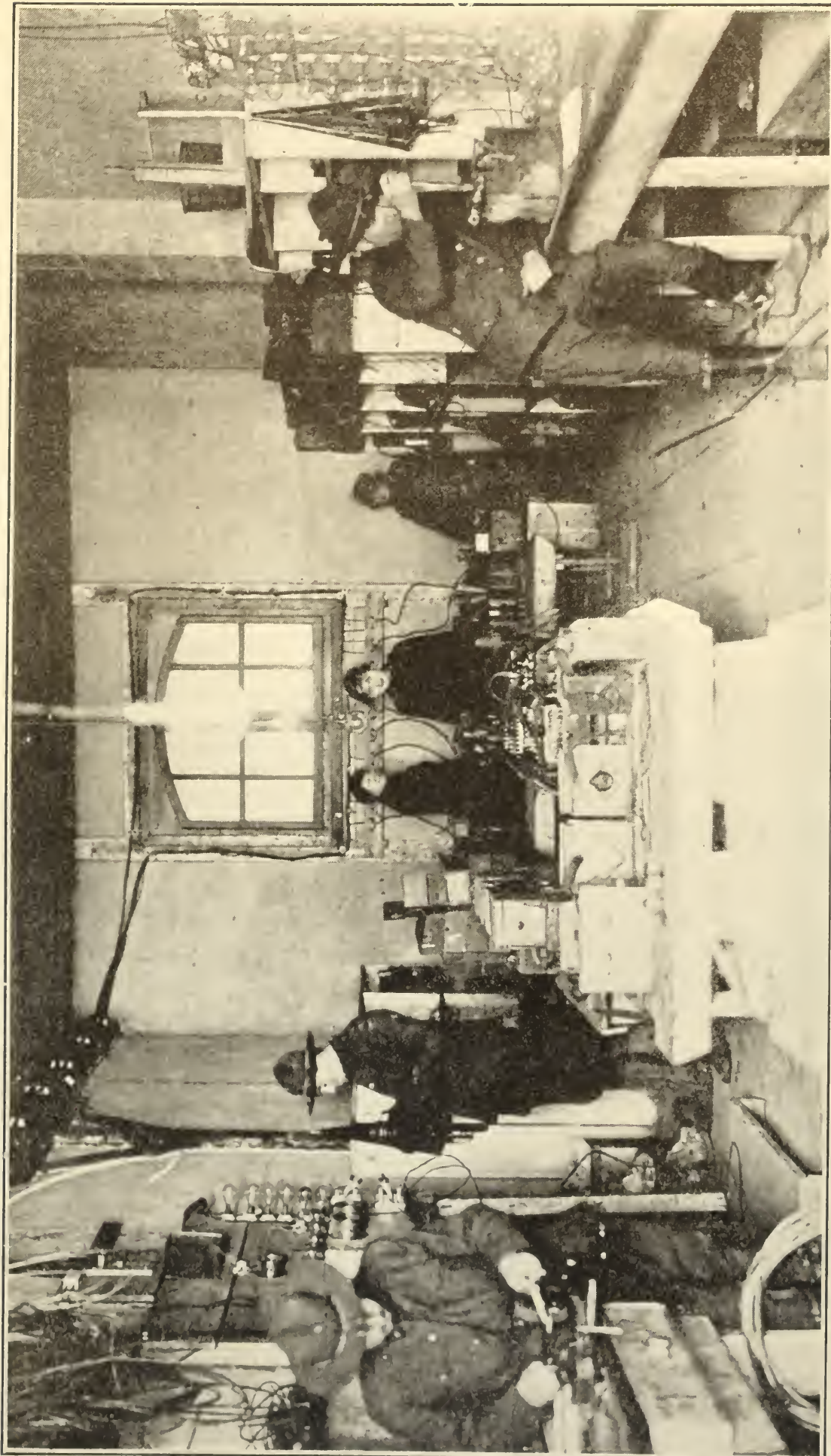

Figure 9—Röntgen tube operated from an alternating current source



(C) Comm. Pub. Info.

How the Signal Corps re-charges its many batteries is disclosed in this view of a charging station for the American Army in France

A source of potential 15 which has been diagrammatically indicated as a direct current dynamo, but may also be a battery, or even a static source of potential such as a glass plate static machine, is connected by means of conductors 16 and 17 and a reversing switch 18 to the cathode and the focusing member. By changing the switch blades from contacts 19 and 20 to contacts 20 and 21, the polarity of the source may be reversed. The degree of potential may be varied in any desired manner, as by varying the excitation of the field coil 22 of the generator, for example, by cutting in or out resistance 23 in the circuit of an energizing battery 24. A resistance 25 is provided in circuit with the source of potential, which may be varied and also entirely short-circuited as indicated.

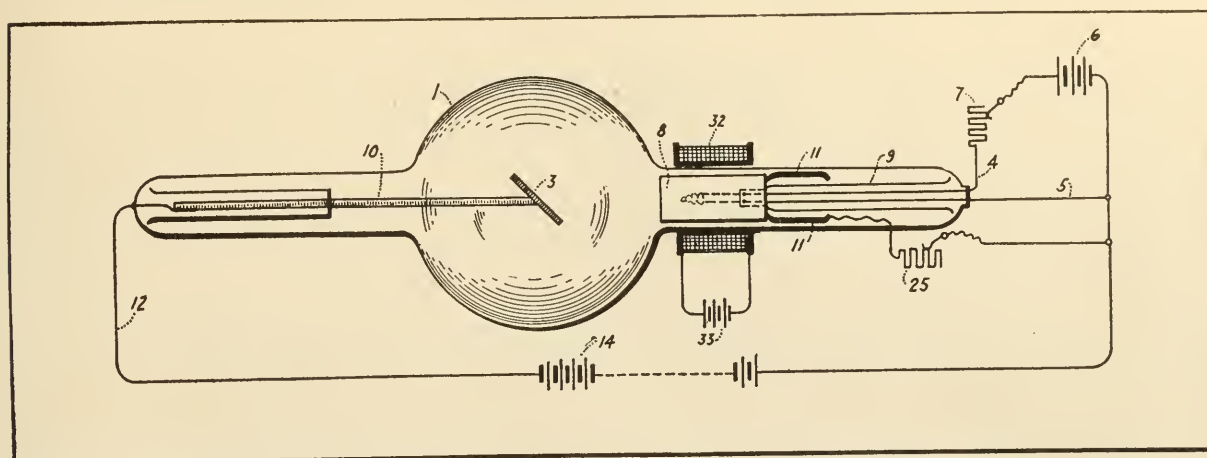

Figure 10—Another form of Röntgen ray tube for varying the focus

When the focusing member 8 is connected to the cathode without interposing any source of potential, one of the surfaces which may be plotted in space to include points of the same potential, will include the tip of the filament and the outer edge of the focusing tube 8. As such equipotential surfaces approach the anode they become less concave. The electrons emitted by the filament when traveling from the cathode to the anode, tend to move perpendicularly to these equipotential surfaces, and are thus directed toward a spot of restricted area upon the anode, called the focal spot.

When the source of potential 15, is introduced into circuit between the cathode and focusing member 8, the positive terminal being connected to the focusing member, the shape of the equipotential surfaces will be changed, as the tip of the filament and the rim of the focusing member no longer are at the same potential. By making the positive potential high enough the focusing of the rays may be entirely prevented, that is, the rays will diverge instead of converge. By making the potential negative with respect to the focusing tube the focal area may be made smaller, or in other words, sharpness of the focusing may be improved. The charge on the focusing member also has an effect on the resistance of the tube and hence on the hardness of the X-rays. A positive charge decreases the hardness and a negative charge increases the hardness in proportion to the potential of the charge.

The structure of the Röntgen ray tube shown in figure 9 is the same as that shown in figure 8, but instead of a direct current source of potential for the focus control, an alternate-source, for example, a transformer 28 is used.

The operation of the system described in figure 9 is similar to that already described in figure 8. Only the half waves of the supply current which are negative with respect to the cathode 2 can pass through the tube. Because of this rectifying property of the tube, the alternating potential between the focusing device 8, and the cathode 2 operates similarly to a direct current source, as it only functionates for waves of like polarity, the set of waves of opposite polarity being suppressed.

Wartime Wireless Instruction

A Practical Course for Radio Operators

ARTICLE XVII

By Elmer E. Bucher

Director of Instruction Marconi Institute

(Copyright, 1918, Wireless Press, Inc.)

EDITOR'S NOTE—This is the seventeenth installment of a condensed course in wireless telegraphy, especially prepared for training young men and women in the technical phases of radio in the shortest possible time. It is written particularly with the view of instructing prospective radio operators whose spirit of patriotism has inspired a desire to join signal branches of the United States reserve forces or the staff of a commercial wireless telegraph company, but who live at points far from wireless telegraph schools. The lessons to be published serially in this magazine are in fact a condensed version of the textbook, "Practical Wireless Telegraphy," and those students who have the opportunity and desire to go more fully into the subject will find the author's textbook a complete exposition of the wireless art in its most up-to-date phases. Where time will permit, its use in conjunction with this course is recommended.

The outstanding feature of the lessons will be the absence of cumbersome detail. Being intended to assist men to qualify for commercial positions in the shortest possible time consistent with a perfect understanding of the duties of operators, the course will contain only the essentials required to obtain a Government commercial first grade license certificate and knowledge of the practical operation of wireless telegraph apparatus.

To aid in an easy grasp of the lessons as they appear, numerous diagrams and drawings will illustrate the text, and, in so far as possible, the material pertaining to a particular diagram or illustration will be placed on the same page.

Because they will only contain the essential instructions for working modern wireless telegraph equipment, the lessons will be presented in such a way that the field telegraphist can use them in action as well as the student at home.

Beginning with the elements of electricity and magnetism, the course will continue through the construction and functioning of dynamos and motors, high voltage transformers into wireless telegraph equipment proper. Complete instruction will be given in the tuning of radio sets, adjustments of transmitting and receiving apparatus and elementary practical measurements.

This series began in the May, 1917, issue of THE WIRELESS AGE. Beginners should secure back copies, as the subject matter presented therein will aid them to grasp the explanations more readily. If possible, the series should be followed consecutively.

ELECTRICAL RESONANCE

(1) In order to secure the maximum range of transmission it is essential that the **open** and **closed circuits** of the radio transmitter be adjusted to substantial **resonance**—that is they must be adjusted to the same nature **oscillation frequency**.

(2) This process of adjustment is called **tuning**.

(3) **Electrical resonance** between circuits of radio frequency is established by resonating circuits which have been calibrated by comparison with a standard or by calculation from knowledge of the inductance and capacity of the circuit.

(4) **Standard resonating circuits** of variable frequency are called **wavemeters**. They should properly be termed **frequency** meters but since a given frequency of oscillation corresponds to a definite wave length in a circuit capable of setting electric waves into motion, the scale of the wavemeter is usually calibrated directly in wave lengths.

(5) The **oscillation frequency** of a circuit containing inductance and capacity can be determined by the following formula:

$$n = \frac{5,033,000}{\sqrt{LC}}$$

where n = frequency in cycles per second,
 L = the inductance expressed in centimeters,
 C = the capacity expressed in microfarads.

(6) The relation between the length of the radiated wave and the frequency of the antenna current in a radio system is expressed as follows:

$$\lambda = \frac{V}{N}$$

where V = velocity of electromagnetic waves in either (186,000 miles per second or 300,000,000 meters),

N = frequency of the antenna current,

λ = wave length in meters.

Hence if the frequency of the antenna current is equal to 500,000 cycles per second and V = 300,000,000 meters, then

$$\lambda = \frac{300,000,000}{500,000} = 600 \text{ meters}$$

THE WAVEMETER

(1) Any circuit containing concentrated inductance and capacity of variable value, if calibrated in wave lengths, may be called a **wavemeter**.

(2) Modern wavemeters generally have **inductance coils** of fixed value and a **variable condenser**. Some types have a variable inductance and a condenser of fixed capacity. It is generally more convenient, however, to employ the condenser as the variable element of the circuit.

(3) If the condenser is the variable element and the wavemeter is to have an extended range of wave lengths, two or more inductance coils may be supplied.

(4) A scale of wave lengths may be imprinted underneath a pointer attached to the movable plates of the variable condenser or the condenser may have a 180° scale and a table of wave lengths may be supplied corresponding to the angular displacement of the movable plates with the stationary plates.

USES OF THE WAVEMETER

The wavemeter may be employed,

- (1) to place two or more radio frequency circuits in electrical resonance;
- (2) to measure the wave length of the closed and open circuits of a transmitting set;
- (3) to determine the coupling of two coupled circuits;
- (4) to measure the decrement of damping;
- (5) to calibrate a receiving set;
- (6) to measure inductance and capacity.

(2) If the inductance coil of a wavemeter is placed near an active oscillation circuit such as the closed and open circuits of a radio transmitter, radio frequency currents will be induced in the wavemeter. **These currents will attain their maximum amplitude when the frequency of the wavemeter coincides with the frequency of the oscillation generator.**

(3) It is therefore essential that some **current or potential indicator** be included in the circuit of the wavemeter in order that the resonance adjustment of the wavemeter may be correctly determined.

(4) A **milliammeter** or a so-called high frequency hot-wire wattmeter are generally employed as current indicators. As a potential indicator, a carborundum rectifier with a head telephone in series, is favored.

AERIAL AMMETERS

(1) Resonance may be established between circuits of radio frequency by means of an ammeter suitable for high frequency currents.

(2) In certain types of transmitting apparatus such as the standard Marconi panel transmitters, the spark gap circuit is calibrated at the Company's laboratory, the contact clips to the primary coil of the oscillation transformer, being soldered fast in position.

(3) To place the closed circuit in resonance with the aerial circuit, in a set so designed, it is only necessary to vary the inductance or the capacity of the antenna circuit until the aerial ammeter indicates a maximum. A wavemeter is required, however, to determine the **purity** and **sharpness** of the radiated wave.

TUNING THE TRANSMITTER

(1) To tune a transmitter to the International standard wave lengths the following measurements must be taken:

- (1) The natural or fundamental wave length of the aerial circuit;
- (2) The wave length of the closed circuit;
- (3) The length of the radiated wave.

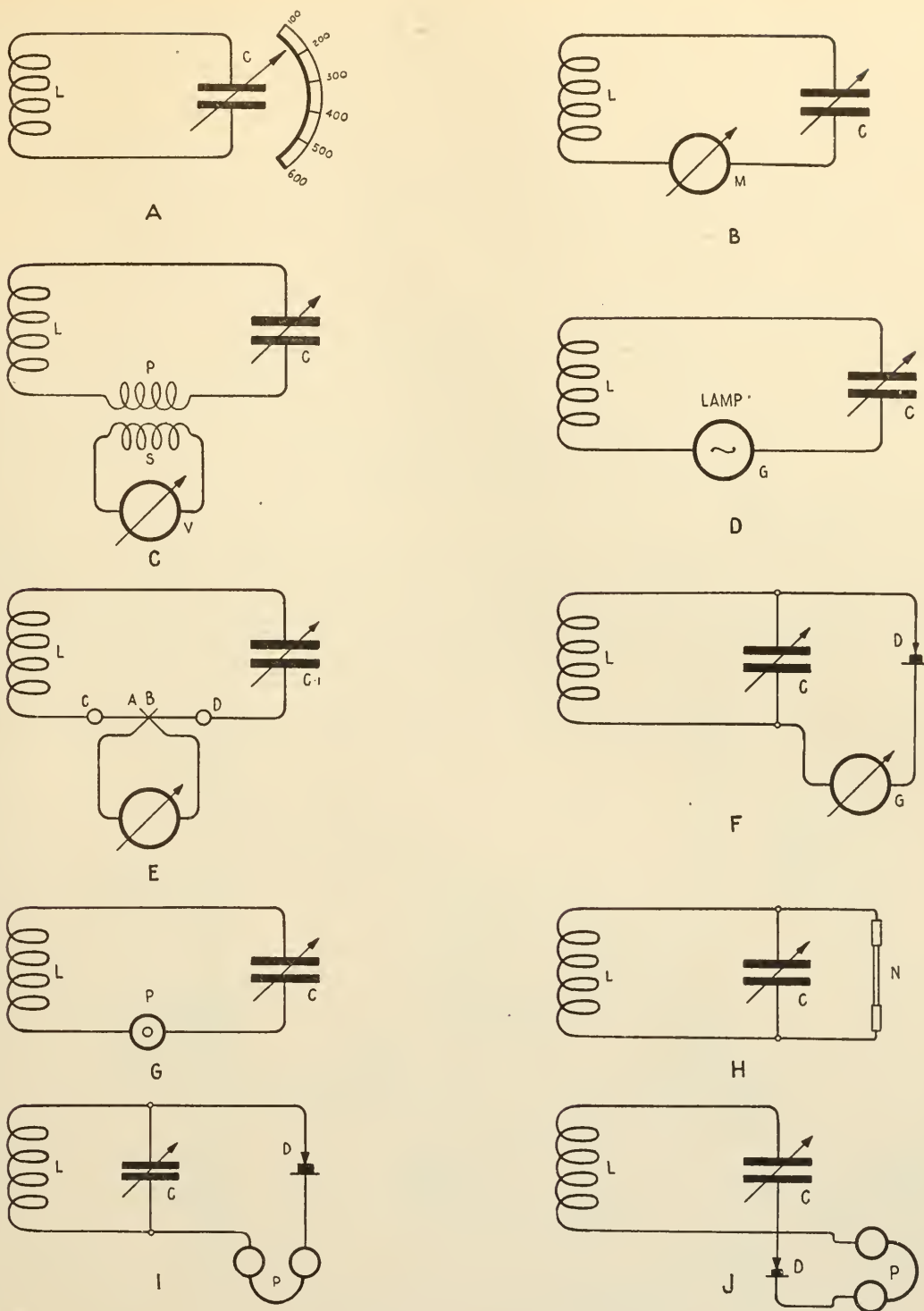

Figure 158 a b c d e f g h i j

OBJECT OF THE DIAGRAMS

To show the various devices employed to indicate that the wavemeter is in resonance with the circuit under measurement.

DESCRIPTION OF THE DRAWINGS

In Fig. 158c a small **hot-wire wattmeter** W—range .01-0.1 watts—is connected to the secondary winding S, of a small step-down transformer, the primary P being con-

In Fig. 158c a small **hot-wire wattmeter** W—range .01-.01 watts—is connected to the secondary winding S, of a small step-down transformer, the primary P being connected in series with a wavemeter.

In Fig. 158d, a small **glow lamp** G (2 or 4 volt battery lamp), is connected in series with the wavemeter, the resonant adjustment being determined when the lamp glows brightest (with the wavemeter in a fixed position).

In Fig. 158e, a **thermo-couple** A, B, is attached to a heating wire C, D, the latter being connected in series with the wavemeter. The terminals of the thermo-couple

are connected to a sensitive milli-voltmeter which may be calibrated in milliamperes.

In Fig. 158f, a **rectifying detector** D is connected in series with a galvanometer G, both being shunted across the condenser C. The currents of radio-frequency are converted by the rectifier to direct current and the resonant adjustment is determined by the maximum deflection of the galvanometer.

In Fig. 158g, an **electrostatic telephone** P is connected in series with the wavemeter, the telephone being an active part of the oscillation circuit. The telephone contains a winding of three or four turns placed underneath a copper diaphragm. The maximum sound is obtained when the wavemeter is in resonance with a given oscillation circuit, the copper diaphragm moving with the group frequency of the transmitter.

In Fig. 158h, a **tube N**, filled with **neon gas**, has sealed-in terminals at either end. When shunted across the terminals of the wavemeter condenser, the tube glows brilliantly at resonance.

In Fig. 158i, a **crystal rectifier** D is connected in series with a 2,000 ohm telephone P, the final two terminals being shunted across the condenser C. The maximum of sound is obtained in the telephone at resonance. The connection of 158j is often preferred because the calibration of the wavemeter is not affected by the presence of a shunt detecting circuit as in 158i. The uni-polar connection of the detector has the disadvantage that the wavemeter must be placed in closer inductive relation to the circuit under test than with the connection of 158i.

SPECIAL REMARKS

(1) The milliammeter or the carborundum rectifier are generally preferred in practice as resonance indicators.

(2) If feeble radio frequency currents flow in the circuit under measurement, a sensitive oscillation detector such as the three-electrode vacuum tube must be connected to the wavemeter.

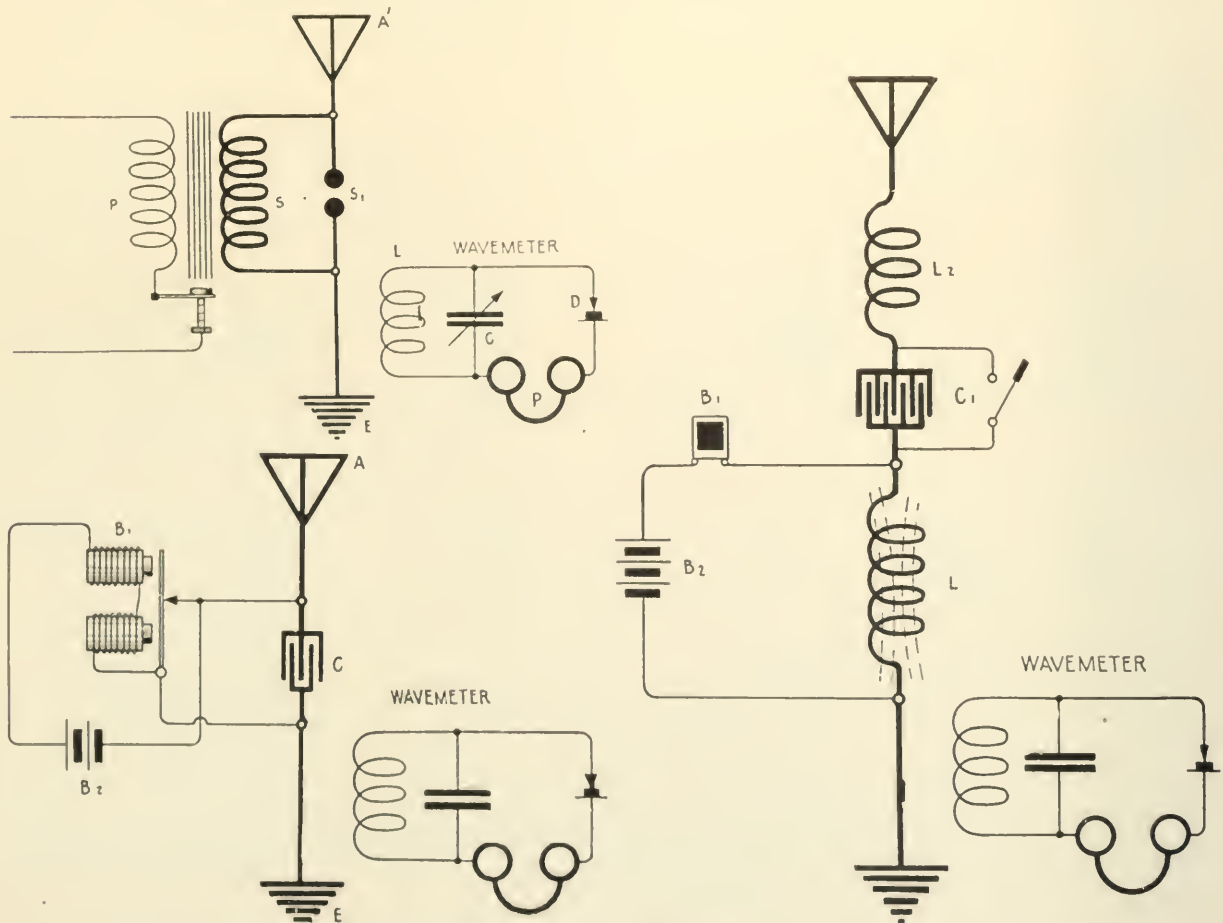

Figures 159, 160, 161

OBJECT OF THE DIAGRAMS

To show the process of measurement of the wave length of the aerial circuit in a radio transmitting system, and means for setting the aerial circuit into oscillation.

PRINCIPLE

In order that resonance adjustment of the wavemeter with the circuit under measurement may be determined, the antenna must be set into electrical oscillation.

DESCRIPTION OF THE DRAWINGS

In Fig. 159 the aerial is set into excitation by a spark coil, the secondary terminals of which are connected to the spark gap S-1 connected in series with the aerial. The coil L of the wavemeter is placed in inductive relation to some part of the aerial circuit preferably near the earth lead.

In Fig. 160 a condenser of large capacity C, is connected in series with the aerial. It is in turn shunted across the interrupter contacts of a vibrating buzzer.

In Fig. 161 a small coil, L-1 is connected in series with the aerial system. This coil is also a part of the circuit from the battery B-2 through the buzzer B-1.

OPERATION

Either the spark coil or the buzzer is set into operation. The wavemeter is placed in inductive relation to the aerial system followed by varying the capacity of the wavemeter condenser until resonance is established as may be indicated by one of the well-known resonance indicators previously mentioned.

SPECIAL REMARKS

(1) In the diagram of figure 159 the natural wave length of the aerial is under measurement, but in figure 161 the wave length of the complete open circuit is being taken. Coil L-1 in this diagram may represent the secondary coil of the transmitting oscillation transformer. Condenser C-1 is the usual short wave condenser. L-2 is the aerial tuning inductance. By change of L-2 or C-1 the serial may be adjusted to radiate waves above and below the fundamental or natural wave length.

(2) In figure 160 the capacity of the condenser C is very large compared to the capacity of the aerial and as a consequence it has but little effect upon the wave length of the circuit; but the charge it receives from the counter E. M. F. of the buzzer, sets the aerial into oscillation at its natural frequency.

(3) A high-voltage alternating current transformer may be employed in figure 159 instead of the induction coil but means must be provided to reduce the current output to prevent arcing at the spark gap.

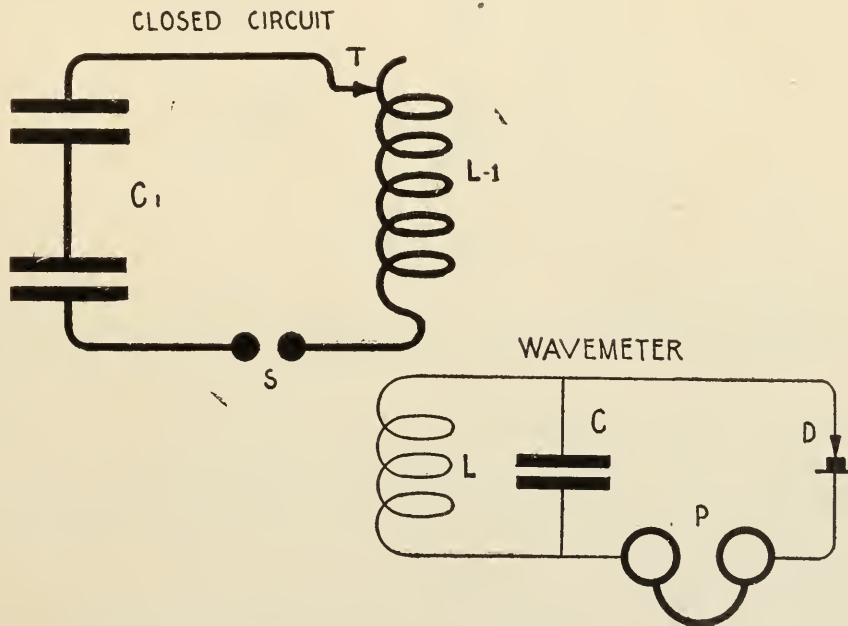

Figure 162

OBJECT OF THE DIAGRAM

To indicate the process of measurement of the wave length of the closed oscillation circuit of a radio transmitter.

DESCRIPTION OF THE DRAWING

The high voltage condenser of the transmitter is indicated at C-1, the primary winding of the oscillation transformer at L-1, and the spark gap at S. The wavemeter is indicated at L, C.

OPERATION

The wavemeter (L, C,) is placed in inductive relation to the primary coil L-1. The spark gap is energized and the wavemeter condenser adjusted until the resonance indicator shows a maximum.

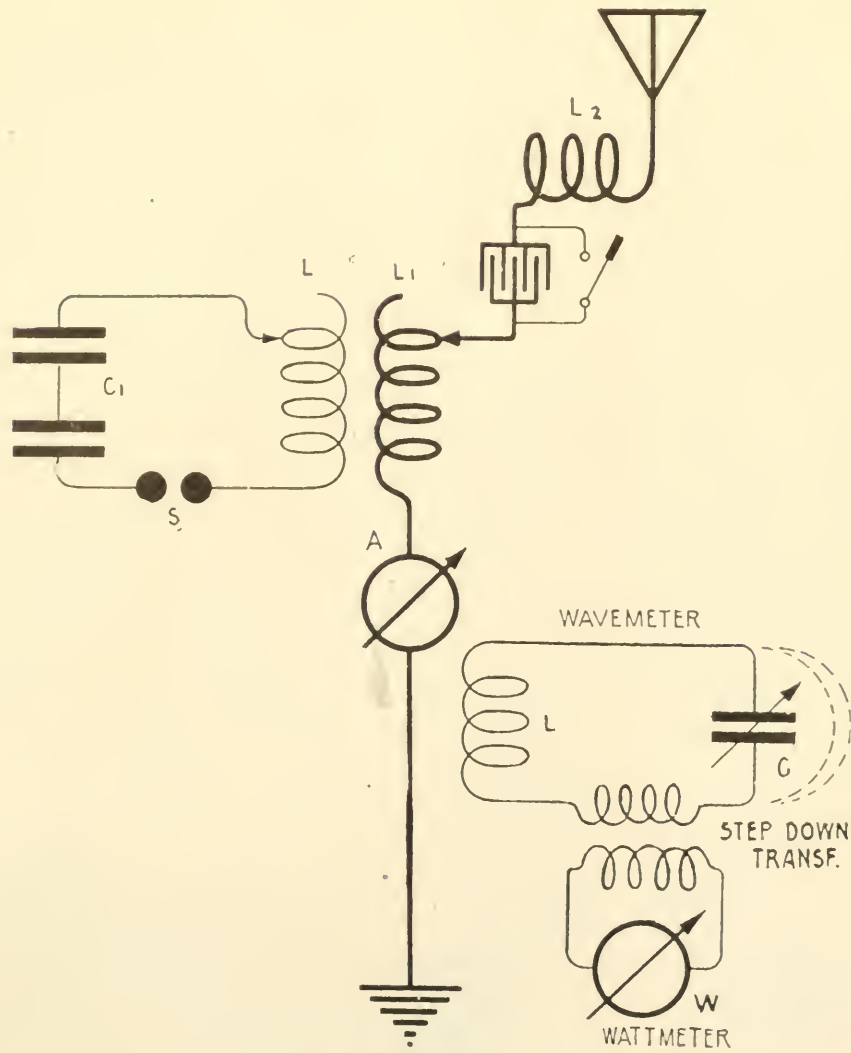

Figure 163

OBJECT OF THE DIAGRAM

To show the connections of the apparatus for the measurement of the radiated wave.

DESCRIPTION OF THE DRAWING

The closed oscillation circuit of the transmitter is indicated by the condenser C, the primary coil L, and the spark gap S. The open circuit or the antenna circuit is represented by the aerial, the aerial tuning inductance L-2, the short wave condenser, the secondary coil L-1 and the aerial ammeter A.

The wavemeter comprises the inductance L and the variable condenser C, and in this particular illustration a low range hot-wire meter W, is inductively coupled to the wavemeter circuits.

OPERATION

It is assumed that the open and closed circuits have been tuned to a definite wave length in accordance with previous instructions. The two circuits are coupled at the oscillation transformer L, L1, the coupling being carefully regulated until the aerial ammeter A indicates a maximum. The coil L of the wavemeter is then placed in inductive relation to the earth lead. The capacity of the condenser C of the wavemeter is then varied until the ammeter W reads a maximum.

If two positions of capacity on the condenser give maximum readings, it indicates that the aerial circuit oscillates at two frequencies. If a single wave emission is desired the coupling of the transformer L, L1, must be reduced until a single resonance position on the condenser C, is obtained. This indicates that the aerial radiates a single wave.

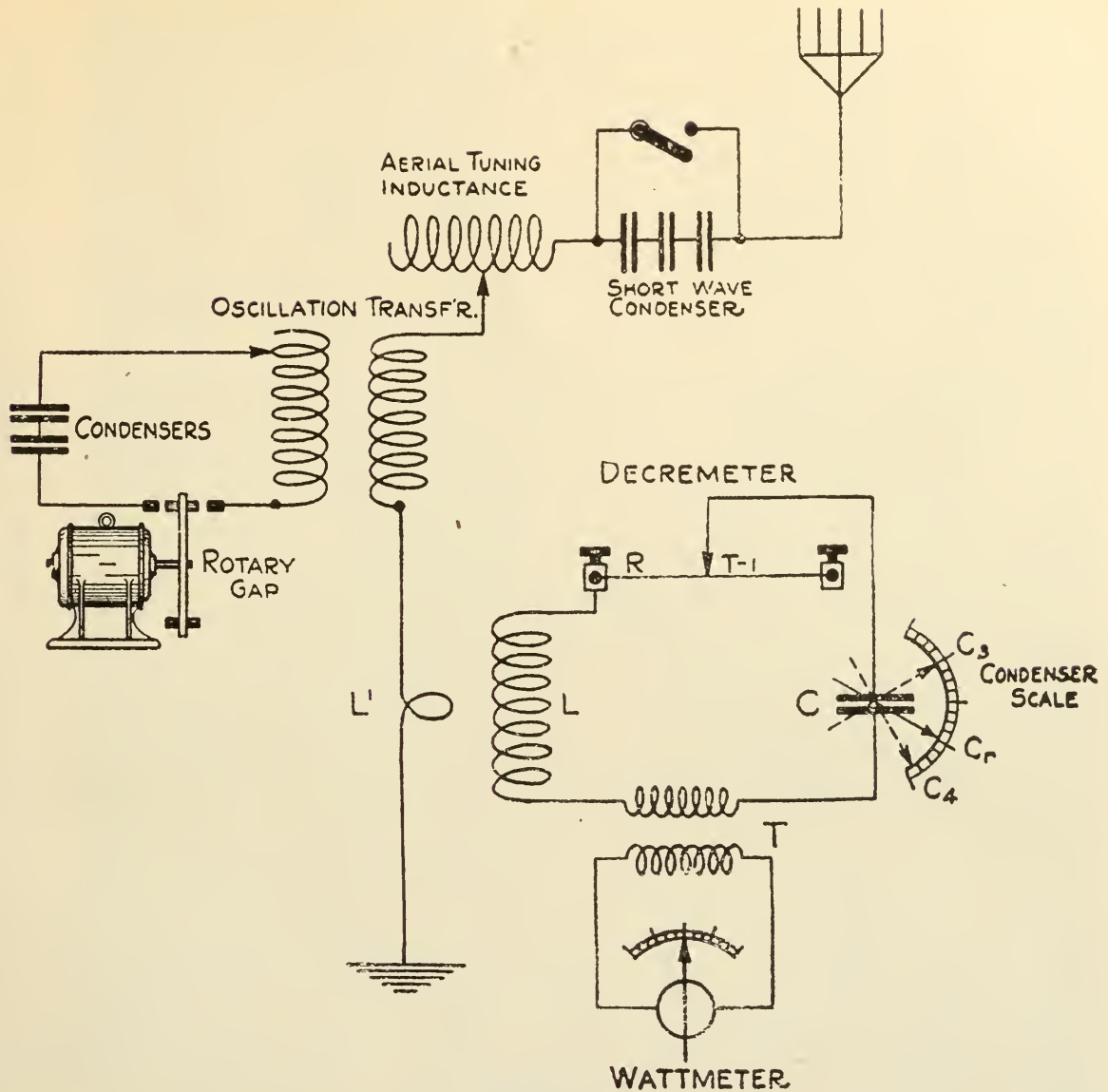

Figure 164

OBJECT OF THE DIAGRAM

To show the fundamental connections of the apparatus for determining the logarithmic decrement of damping.

DESCRIPTION OF THE DRAWING

The open and closed circuits or transmitters are indicated by the usual elements. The coil L of the wavemeter L, C, is inductively coupled in the antenna circuit at the single turn of the wire L1. The circuit of the wave meter includes a small step-down transformer and an I² (current squared) instrument called a wattmeter.

OPERATION

The measurement of the decrement is based upon the following formula. It is a derivation of the original Bjerkes formula:

$$\delta_1 + \delta_2 = \frac{C_2 + C_1}{C_2 - C_1} \times 3.1416$$

Where C₂ = the capacity of the condenser C at values above resonance where the reading of the wattmeter is one-half of that obtained at resonance.

C₁ = the capacity of the condenser C at points below resonance where the reading of the wattmeter is one-half of that obtained at resonance.

The value of the δ₂ is usually indicated on the scale of the decimeter, or in a table supplied with the decimeter. If not, it can be obtained by the following process:

With the wave meter in the identical position as in the previous measurement, a piece of resistance wire R is stretched between the two binding posts indicated in the drawing. (A piece of No. 28 therlo wire approximately 15 inches in length will be found satisfactory).



Press Ill. Svce.

The Italian retreat is known in military annals for the stubbornness with which the ground was contested. This view shows reserve infantrymen going into action in a ravine under heavy fire

With the pointer of the condenser set at resonance, the spark gap of the transmitter is energized and resistance added at R until the reading of the wattmeter is exactly one-half that obtained in the first measurement. The complete process of the measurement of the decrement is gone through as in the first instance. The decrement is then increased by an amount dependent upon the resistance of R. The following formula is then applicable:

$$\delta_1 + \delta_2 + \delta_3 = \frac{C_4 + C_3}{C_4 - C_3} \times 3.1416$$

Where δ_3 = the added decrement due to the resistance R,
 C_4 = capacity of condenser C at a point above resonance where the reading of the wattmeter is one-half of that obtained at resonance;
 C_3 = the capacity of the condenser C at a point below resonance where the reading of the wattmeter is one-half of that obtained at resonance.

The value of $\delta_1 + \delta_2$ is now subtracted from $\delta_1 + \delta_2 + \delta_3$ to obtain the value of δ_3 . Letting V stand for $\delta_1 + \delta_2$ and V-1 for $\delta_1 + \delta_2 + \delta_3$, it has been shown that

$$\delta_2 = \frac{V-1 \times \delta_3}{2V - V-1}$$

If the value of δ_2 is now subtracted from $\delta_1 + \delta_2$ the value of δ_1 is secured.

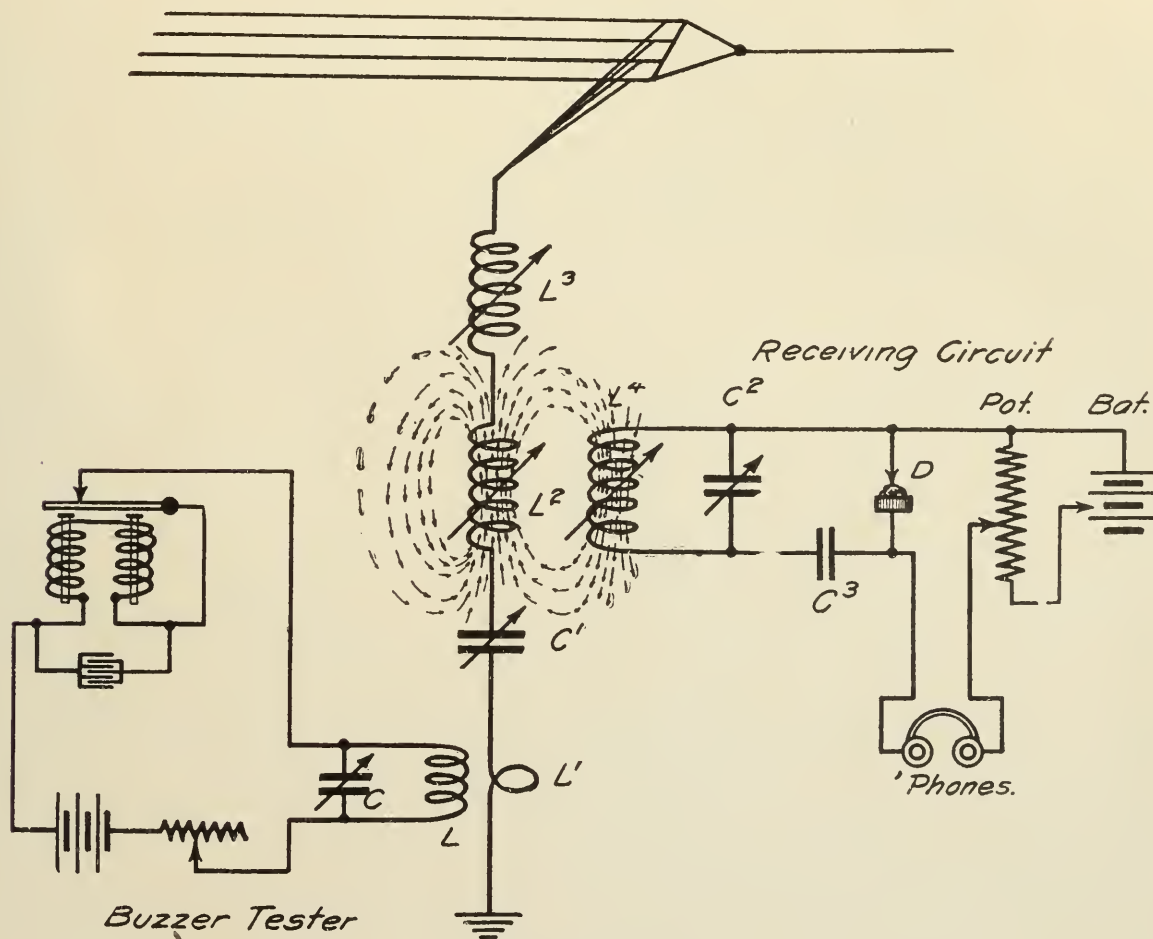

Figure 165

OBJECT OF THE DIAGRAM

To show how the wavemeter can be employed to calibrate a receiving set.

DESCRIPTION OF THE DRAWING

The antenna circuit of the receiving set is indicated by the aerial inductance L-3, the primary winding of transformer L-2, the short wave variable condenser C¹ and the turn of wire L¹ for coupling the aerial circuit to the wavemeter coil L.

The secondary circuit is indicated by the secondary coil L⁴, the short wave condenser C², the stopping condenser C³, the crystal rectifier D, the potentiometer Pot, the local battery Bat. and the head telephone.

The wave meter comprises the coil L and the variable condenser C. This circuit is set into oscillation at its own frequency by a buzzer and battery the circuit of which is completed through the coil L.

OPERATION

When the buzzer is set into vibration, the wave meter L, C oscillates at whatever particular frequency it is adjusted to. The coil L acts inductively on the antenna coil L', inducing therein a small E. M. F. The antenna circuit or receiving set is then set into oscillation at this frequency, but the maximum response will be obtained in the head telephones when the antenna and detector circuits of the receiving set are adjusted to exact resonance with the wave meter.

In this way a receiving operator can properly adjust his apparatus to any definite wave length.

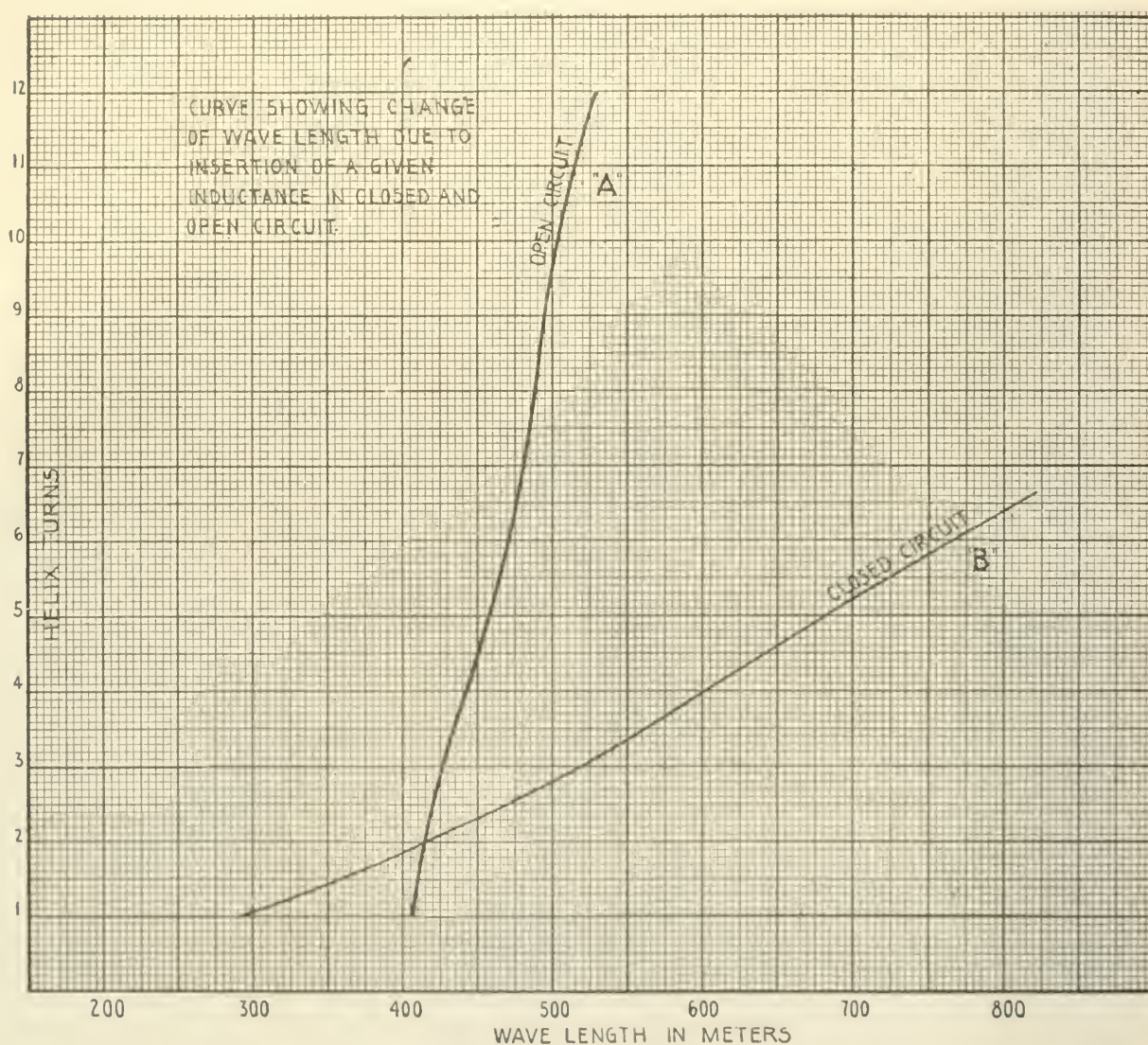

Figure 166—Curves showing the increase of wave length in the open and closed circuits of a transmitting set occasioned by the increase of inductance in either circuit. Curve A shows the increase of wave length in the antenna circuit by the addition of 12 turns of the secondary winding of a standard oscillation transformer. Curve B indicates the increase of wave length in the closed circuit by the addition of $6\frac{1}{2}$ turns at the primary coil. This data is obtained by observing the readings of the wave meter in inductive relation to either circuit as the inductance is increased. The open and closed circuits are generally uncoupled for this determination, the antenna circuit being set into excitation by a spark gap or by a buzzer.

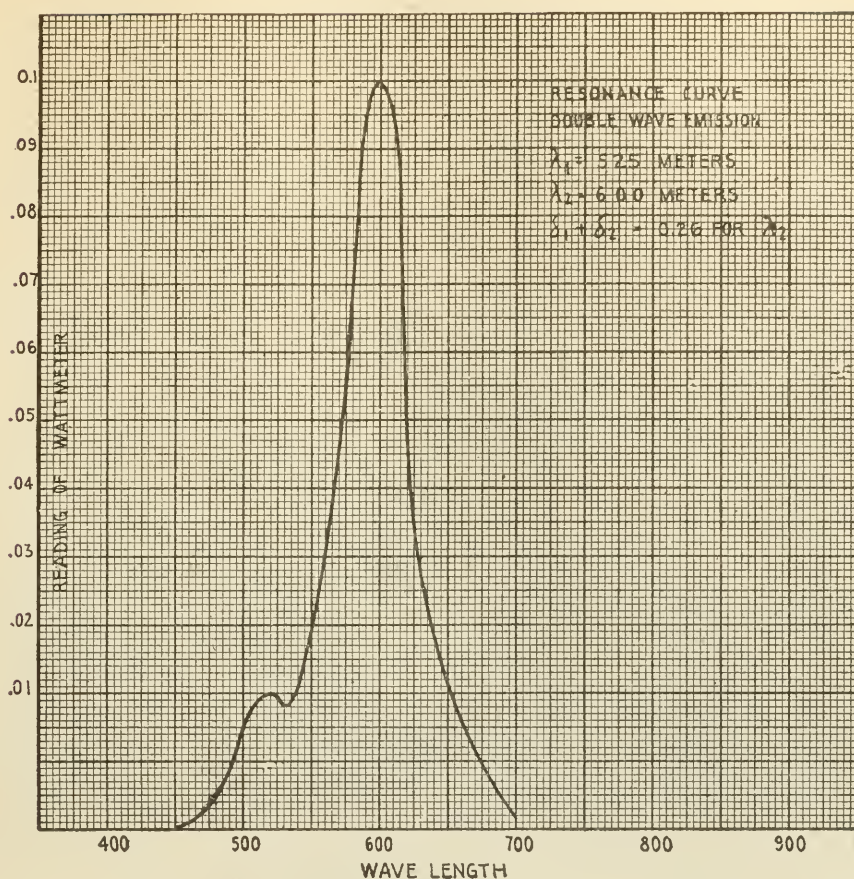

Figure 167—Resonance curve of the radiated wave of a radio transmitter, which complies with the U. S. regulations. The curve indicates that the antenna oscillates at two frequencies, one corresponding to a wave length of 600 meters, and the other to a wave length of 526 meters. The amplitude of the shorter wave is one-tenth of the longer wave and hence it meets the requirements of the U. S. Statute. Modern transmitters are generally adjusted for a single wave emission.

October Features

An article describing the Harvard Radio School where five thousand men are being prepared for the Navy.

An article describing Langmuir's method of constructing gas-free electrodes for Vacuum Tubes and another article on a method of preparing the Three-Electrode Vacuum Tube.

A novel Vapor Arc Generator for the production of radio frequency currents is an additional feature.



(C) Comm. Pub. Info.
Through acres of sun-baked mud these American Signal Corps men daily carry forward coils of new wire for the signaling systems of the trenches. In the view above they are passing from the support to the first line trenches

Signal Officers' Training Course*

A Wartime Instruction Series for Citizen
Soldiers Preparing for U. S. Army Service



By Major J. Andrew White
Chief Signal Officer, American Guard

SIXTEENTH ARTICLE

(Copyright, 1918, Wireless Press, Inc.)

Signal Troops in the Field

IN defining the exact duties of Signal Corps in the field it may be said that it exists for the speedy dissemination of military information. It is the nerve system of the army by which information is transmitted to the brain. Unlike other branches of the service there are no fixed rules for its operation which could be condensed into a tactical manual such as exists for other fighting units.

An official bulletin from the office of the chief of staff, U. S. Army, deals with conditions in field service by stating that the Signal Corps is specially organized, trained, and equipped for the collection and transmission of military information, and only the most general instructions should be given to officers and men as to the manner of performing their duties. It is inadvisable, especially in brief field orders, to attempt detailed instructions; it will suffice in such orders to state the commands to be joined, their location, and a broad statement of the object desired. It is assumed that the signal officer, acting under his general instructions and the orders of his immediate commander, possesses the knowledge, the initiative, and the energy to meet conditions as they arise.

The signal officer at headquarters, in addition to caring for the technical administration and supply of the signal troops, will keep himself informed as to the location of commands, the time and character of projected movements; in short, regarding all actual and probable happenings, so that he may make due provision in advance. He must arrange for the prompt transmission of information received, and for the delivery of all messages. He also makes certain that the military intelligence contained in messages to the commanding general and chief of staff is properly recorded on the map or otherwise graphically so as to be instantly available, and for this purpose

*The articles in this series are abstracted from the complete volume, "Military Signal Corps Manual," by the same author.

should establish a central station at division headquarters, equipped to properly file all messages sent and received, in chronological order and by organizations. This station should also be able to furnish at all times exact information, as to signal stations and location of troops.

The commander, aided by his chief signal officer, must plan and direct, but the signal officers and the men under them must execute; on their energy and ability will depend the value and success of the lines of information.

ESTABLISHING LINES OF INFORMATION—THE DIVISION

Since the Signal Corps is considered as auxiliary troops attached to a division it is best to define its field duties in this connection. While definite rules cannot be laid down for the establishment of lines of information for a division in the field, there are certain fundamental considerations or general principles to be observed.

The division may be considered under three conditions: in camp, on the march, and in contact with the enemy.

When a division is to be assembled in a certain locality and camp established, an officer is sent ahead to select sites for the encampment of the various units of infantry, cavalry and artillery. Quartermaster officers locate their depots and medical officers the field hospitals. It is then the duty of the signal officer to proceed with the installation of lines of information.

A wireless, or radio set, of the cart or tractor type travels with division, corps and army headquarters and is first put in commission. A central station is next established at division headquarters and connected with the most convenient telegraph and telephone offices through which communication may be established with commercial systems or the base.

The Signal Corps camp is then established with a depot for storing all material needed for the service to be required. Corps or army headquarters are connected by wire or radio, telephone lines carried to the chief quartermaster and surgeon and the various hospitals, depots, and corrals.

The object to be attained is the connection of every important point with division headquarters, to link the whole command together and connect with the base by wire or radio. As the various units arrive at their camps, telephone or buzzer lines are run from division central to brigade headquarters, through regimental to battalion headquarters.

Between fixed stations within the limits of the divisional camp the telephone is the ordinary means of communication, telegraph and radio being reserved for more distant work. Telephone and telegraph lines are usually carried by lances. In addition to the more permanent lines, temporary buzzer or field wires are usually laid to changing positions, such as outlying observation points, to the outposts and to aéro stations.

In camp there should be little difficulty in using fully the lines of information, since the extent and direction of the system are known and the stations are easily found. On the march, however, the lines of information become fewer and the stations more difficult to reach. Some general considerations may be noted.

A division on the march must at no time lose electrical connection with its base, through the last station occupied, and for this purpose the pack radio is especially useful. As the advance continues the commanding general designates some position as his own during the day or night and lines are



Sample of telephone dug-out in the front line trenches in which the Signal Corps men maintain the lines of communication at all hazards

extended forward or communication is maintained by radio with this position, it becoming, so far as the lines of information are concerned, the headquarters.

As radio stations, the buzzer, or field wire advance they should be followed, if practical, by the telegraph train with the necessary material for a lance line to replace the field or buzzer wire, which, if exposed, is liable to injury from passing troops and transport. At times, with good roads and open country the advance is so rapid where a lance line is being erected by trained men, that little, if any, cable need be used on the march. Buzzer wire may follow the general line of advance of the commander by extending from one conspicuous station to another designated by him. The field line, or radio, is used only for rapid work. Radio, when used on the march, is advanced by the leap-frog method; that is, three sections are used, the rear station passing the two preceding and thus constantly maintaining two stations in operation.

In the advance the units of a command should, so far as possible, be kept in touch with each other; but as these units frequently move by different routes, and as cross lines are impracticable except at halts, field or buzzer wires must stretch from the last field station maintained at the rear to corps headquarters, and to brigade and to important commands, as the ribs of a fan expand; here, too, the radio must be used. If possible, wire communication between the general and detached commands, or cavalry at the flanks, is also maintained in this way, or communication established by means of visual signaling or radio. Visual signaling may be used to advantage during halts when wire lines can quickly be thrown out; and radio, especially of the wheel type, is particularly useful.

When the day's march is over and the division eats and rests, the work

of the signal men begins anew. Radio stations must be established and buzzer lines run from the advance guard, from the flank, from the corps headquarters, and from the rear to division headquarters, and still others laid out as already described in a preceding paragraph.

When a retiring movement is begun the lines of information are as few as possible and mainly used to connect the rear guard, probably by radio, with the general commander. Provision is made, however, to recall the flanking parties thrown out at intersecting roads when the rear of the marching columns pass. It is well also to connect retreating columns moving by different roads, and this can be done by wire and radio more readily than in the advance, since lines extending to the front of the retreating force will not ordinarily be in danger of interruption. In the retreat, therefore, central stations may be thrown out far ahead and wires led back like the ribs of a fan to the marching column, as in the advance, to be taken up as the columns pass.

As the period of actual contact with the enemy approaches the most serious of the problems of the lines of information arise. The general commanding must know the terrain and the best means of sending messages across it; he must know the probability of success of the attempts of the enemy to cut the wires, or "jam" a radio, and it is when difficulties arise that every possible means of signaling that offers a chance of success is employed.

As the division approaches the enemy, the commander makes as certain as possible that his lines of information with corps and army headquarters, with supporting and reserve troops, and with the rear, are in order and when actual contact comes, buzzer lines will be carried to brigades, to regiments, and sometimes to the outposts. For the troops engaged, buzzer lines are carried forward to the firing line, where trained observers with buzzers or the field telephone are placed to send back important information for control of fire.

It may be practicable at the beginning of the action to maintain touch by radio or even by wire between the smaller reserves, the supports, and the main bodies, but the latter is doubtful, since a great multiplicity of wires on the field of battle is hazardous.

When the division is actually engaged against the enemy the commander extends his field or buzzer line to the positions occupied by the infantry and artillery commands. Radio is in general depended upon to keep him in touch with his cavalry. The artillery, in addition to its other lines of information, establishes between batteries a system of fire control, the information being transmitted from fixed stations, captive balloons or airplanes, by radio, field telephone or buzzer, or by visual signals.

The radio is of greatest importance in the field and especially when used at the larger headquarters. Together with the increasingly greater use of the field telephone in directing the fire of heavy artillery, the large scope of the tactical requirements in modern warfare has enormously increased the work of the Signal Corps.

Communication problems are easier with the smaller bodies of troops, but not less important. When operating in an enemy's country, especially if the movements are connected with a boat expedition or with the navy, somewhat less weight must be given to wire communications, and more reliance be placed upon visual signaling and on the portable radio units. With all such expeditions the field acetylene lantern is extremely useful, for its range under favorable conditions is easily 20 miles, and it can be used by hand from a boat if on quiet water.

Signal Corps News

Urgent calls have been issued by the Signal Corps of the army for twenty production experts for important war work. These places are under the Civil Service, and command salaries ranging from \$2,400 to \$3,600 a year. The duties consist of supervising, distributing, and expediting the manufacture and delivery of materials and equipment.

Written examinations will not be required for these places, but they will be filled under the Civil Service rules on a non-competitive basis. The Signal Corps desires applications from men who have a general knowledge of production and manufacturing problems, experience in preparing and maintaining charts and data of progress, and preferably a thorough knowledge of the manufacture of radio, telephone, or telegraph material and equipment, with all the tools and apparatus pertaining to such equipment and its installation.

Applications will not be received from employes of the Government or of firms or corporations engaged in carrying out contracts for the Government or its allies, unless accompanied by the written assent of the head of the office by which the applicant is employed. Application blanks and full details may be obtained by applying to the Secretary, Second Civil Service District, Room 319, Custom House, New York City.



The Public Relations Committee of the War Department, Committee on Education and Special Training, authorizes the following:

Students' Army Training Corps A trained reserve Army of 100,000 young men volunteers between the ages of 18 and 21 years, to be held in readiness by the universities of the country, is expected as the result of the present "Keep-the-boy-in-college" campaign. This campaign is now being conducted by the schools in co-operation with the War Department.

This national organization is known as the Students' Army Training Corps. It is a recognized unit of the National Army. The college student of the proper age and physically fit is eligible for voluntary enlistment. The student soldier will have the status during the school year of a private in the National Army on furlough without pay. The Government provides uniforms and equipment. During the six weeks of

intensive military instruction during the summer a student soldier will receive the pay of a private.

The members of this student army will hold themselves in readiness to respond at once to a call for service from the President. The policy of the Government in urging the "Keep-the-boy-in-college" campaign is to prepare the Students' Army Training Corps to meet future demands for highly trained specialists and to furnish material for officers' training camps.



The department of military aeronautics, radio section, requires men with some mechanical training, and

An Opportunity for Radio Mechanics thoroughly grounded in electrical work.

Men will be accepted for this service in the army who are of draft age, and in good physical condition. They will be sent to a school for radio mechanics, and afterwards will go overseas at the first opportunity. There will be many opportunities for advancement, and the work is most interesting. About 130 men are required at once, and it is desired to build up a reserve force of several hundred men.



The following men have recently been commissioned:

Weston W. Goodnow, first lieutenant, Aviation Section, Signal Reserve Corps.

Wendell G. Greening, first lieutenant, Aviation Section, Signal Reserve Corps.

Edwyn Johnstone, first lieutenant, Aviation Section, Signal Reserve Corps.

John W. Koontz, first lieutenant, Aviation Section, Signal Reserve Corps.

Charles F. Moore, first lieutenant, Aviation Section, Signal Reserve Corps.

William H. Royle, first lieutenant, Aviation Section, Signal Reserve Corps.

Harry A. Schlotzhauer, jr., first lieutenant, Aviation Section, Signal Reserve Corps.

Robert S. Stewart, first lieutenant, Aviation Section, Signal Reserve Corps.

Frank B. Tyndall, first lieutenant, Aviation Section, Signal Reserve Corps.

Jess B. Wadsworth, first lieutenant, Aviation Section, Signal Reserve Corps.

Frederick L. Walker, first lieutenant, Aviation Section, Signal Reserve Corps.



(C) Comm. Pub. Info.

Men of the Signal Corps are here seen getting ready for an ascension in a giant observation balloon used by Uncle Sam's fighters in France. The type shown is known as a kite balloon, a captive bag which will operate safely under almost any weather conditions. The lower bag which is suspended from the main structure is the air rudder, the smaller one just above it is the ballonnet, an interior air bag open to the rush of the air. Stabilizing bags are attached to the main structure, which is inflated by hydrogen gas before the ascent. The craft is anchored to the ground by cable and windlass, located in friendly territory. These kite balloons serve mainly as fire control stations, but the observers assigned to them are accomplished look-outs and scouts. Protection is afforded by friendly anti-aircraft guns and airplanes, which beat off all hostile attacks

How to Become an Aviator

The Fourteenth Article of a Series for Wireless Men in the Service of the United States Government Giving the Elements of Airplane Design, Power, Equipment and Military Tactics



By **J. Andrew White**
and **Henry Woodhouse**

Copyright, 1918, Wireless Press, Inc.

METEOROLOGY FOR THE AIRMAN

IN many ways the air is comparable to the sea; in fact, in a large portion of the study of the basic principles of aerodynamics the action of the sea is used as an analogy. The professional pilot of water craft who lacks knowledge of the ocean is unheard of; and so must it be with the military aviator's knowledge of the air. Successful flying over long periods is largely due to an aviator's understanding of the air and its vagaries; in fact, where this knowledge does not exist, continued success is entirely a matter of luck. Some grasp of the elementary principles of meteorology is therefore essential. It may be gained by experience, but this method has more than once led to fatal misconceptions. Theoretical instruction, through which ability is acquired to apply the scientific laws of weather forecasting, is a safeguard well worth the time spent in acquiring it.

The best weather for flying is obtainable on a calm, clear day, when eddies or vertical currents are not likely to be encountered. A strong gale is about the only condition that makes flight impossible to the modern airplane, although fog is a considerable handicap to military flying, by reason of the poor chances for proper observation.

A ground haze, low lying clouds, and location of the sun dead ahead, also impede useful military flight, as do detached clouds; but none of these prevent the aviator going aloft. Air eddies and ascending or descending currents, too, are seldom so violent that flying is seriously interfered with. For students engaged in first flights, the early morning and evening are the most suitable times, for it is then that the air is calmest. In the United States, winds from the east and southeast carry with them less "bumps" and are most favorable.

CHARACTERISTICS OF THE AIR

COMPOSITION OF THE ATMOSPHERE

Air is a gaseous body, which, like water, seeks the level where lowest pressure exists. It is 1,600 times lighter than water, but it is at least 50 miles deep, and since one-half of its weight is below 3 miles altitude, its weight or pressure at the earth is considerable. Its constituents are: nitrogen, 70 per cent.; hydrogen, 20 per cent.; argon, 1 per cent.

ATMOSPHERIC PRESSURE

The weight of air on a given spot is atmospheric pressure. The longer the column of air above the place, and the greater the density of the air, the greater will be the pressure at the bottom of the column.

Pressure is variable, however. The temperature of the air usually decreases with height at a rate of about one degree for every 300 feet. This rule is not an absolute one, since temperature varies with locality and season of year, but is useful as a general guide. Density of the air is affected by temperature, due to the expansion of heated air and contraction of cold; density is also affected by pressure, for the higher the air column the greater the air contained in a given space at the bottom.

Air at rest is given motion by change in temperature at the earth. For example, heat from the sun's rays is not absorbed uniformly, bare earth heating more rapidly than portions covered by trees and grass. Over the bare spot the heated column of air will rise by expansion, and as it rises the pressure there will be diminished, whereupon the cooler surrounding air will rush into the vacated space. As the operation is repeated the air motion increases. Thus elevations and depressions are formed, or, as they are termed in meteorology: **HIGH PRESSURE AREAS** and **LOW PRESSURE AREAS**.

MEASURE OF PRESSURE

The barometer is the instrument used to measure air pressure. It is measured by the height, in inches, of a column of mercury necessary to balance it. At a fixed time each day atmospheric pressures taken at various stations scattered over the country are telegraphed to the meteorological office and a weather map is made from those reports. Such a map is illustrated in figure 82.

By joining places which register the same barometric pressure, lines are formed similar to map contour lines and known as *isobars*.

PRESSURE AREAS

All places on any line (*isobar*) have the same atmospheric pressure; where little difference of pressure exists at places close together, the *isobars* will be close together, and vice versa. The air forced from high pressure to an area of lower pressure does not follow a straight line, but takes a spiralling course in a direction more nearly parallel to the *isobars* than at right angles. This is due to the irregularities of the earth's surface and the revolution of the earth on its axis.

Pressure areas, which usually have a diameter of hundreds of miles, do not remain in the same position, examination of U. S. weather maps for successive days showing that they ordinarily move in a general easterly direction and occasionally north and south, but westward only in hurricanes.

An unusually small pressure area indicates a *cyclone area* and sudden violent changes in weather may be looked for. In a high pressure region, or *anti-cyclone*, the weather to be expected and the indications are almost the reverse.

Since the winds flow spirally about the pressure areas, the *isobars* on the weather map furnish the aviator information as to the general direction of the wind, knowledge which is extremely valuable if a cross-country flight is contemplated.

CYCLONE (LOW PRESSURE AREA)

The winds blow anti-clockwise about the center of pressure (clockwise in the southern hemisphere). The barometer falls with the approach of the cyclone, beginning to rise again after the center of the area has passed. The front of the depressed area usually holds rain or cloudiness, the rear cooler weather and clearing.

ANTI-CYCLONE (HIGH PRESSURE AREA)

An anti-cyclone has no general direction of motion, in fact it is frequently stationary for days. The winds spiral clockwise from the center and are very light. Almost any type of weather may be expected except heavy winds. Ordinarily, the weather is fine, but in cold weather fog and low lying clouds are frequent, and rain occasional.

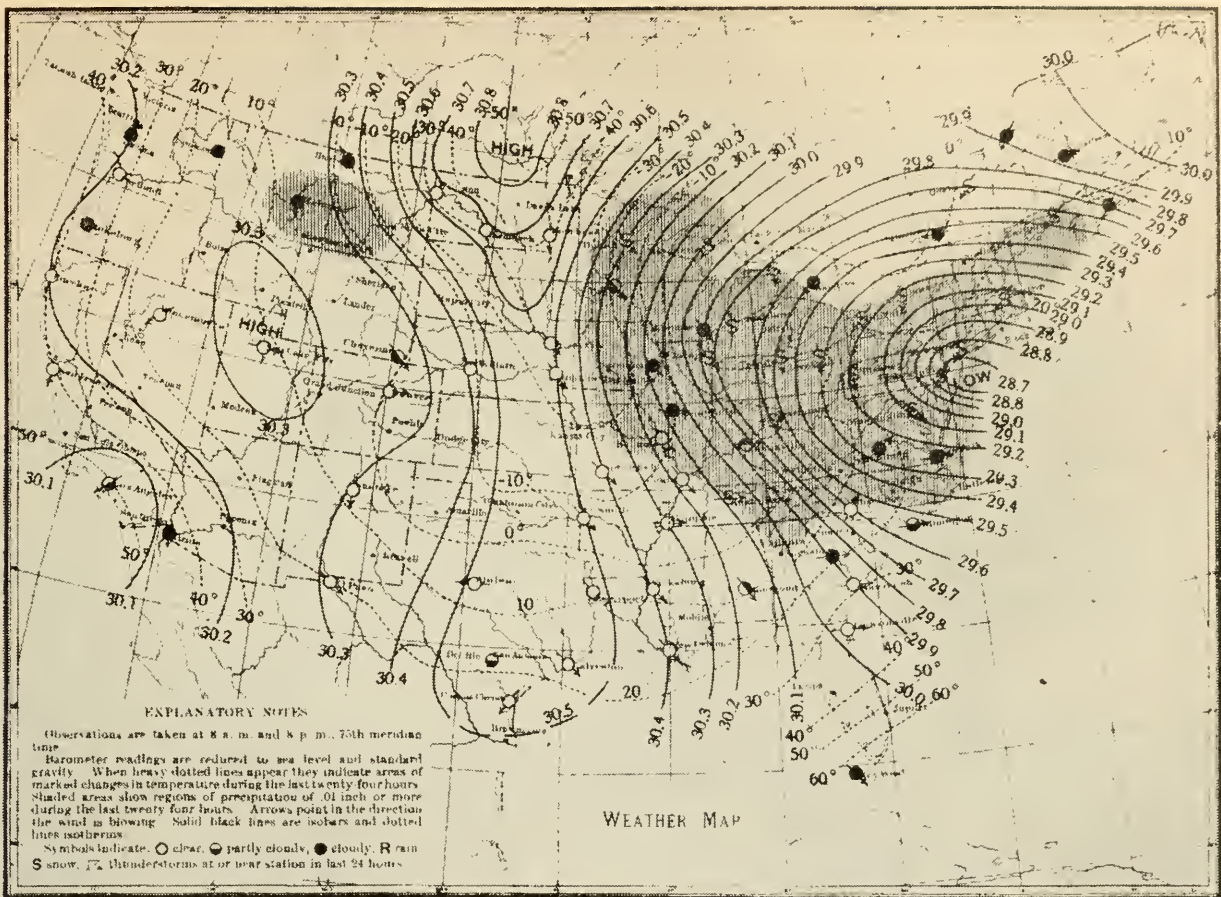

Figure 82—Meteorological map showing atmospheric pressures

SECONDARY DEPRESSIONS

Irregularities in the form of indentations in the isobars frequently appear in a cyclone area. These secondary formations may or may not be well defined; if marked, the winds may become very strong and the weather bad. In front of the secondary the weather is similar to the cyclone, between the secondary and main depression the winds are light, but very strong on the side furthest from the center of the cyclone.

THE WEDGE

When a series of cyclones pass across country in continuous succession, V-shaped isobars appear between cyclones. These indicate fine clear weather, but of short duration, as another cyclone is approaching.

LINE SQUALLS

As the center of a cyclone passes line squalls often appear. They are usually very narrow but often 500 miles in length, are very sudden and violent and, traveling approximately at a right angle to their length, are very dangerous to airmen. The barometer shows a small sudden rise, and a fall in temperature is noticeable; often heavy rain and hail set in, and, occasionally, thunder. These squalls seldom give any warning and are therefore particularly dangerous.

BEAUFORT SCALE

Wind strength is generally expressed as velocity in miles per hour. For convenience winds are divided into 12 groups or classifications, a system known as the Beaufort scale.

BEAUFORT SCALE

Division Number	Nautical m. p. h.	Description of Wind	Division Number	Nautical m. p. h.	Description of Wind
0	Less than 1	Calm	7	28—33	High wind
1	1—3	Light air	8	34—40	Gales
2	4—6	Slight breezes	9	41—47	Strong gales
3	7—10	Gentle breezes	10	48—55	Whole gale
4	11—16	Moderate breezes	11	56—65	Storm
5	17—21	Fresh breezes	12	Above 65	Hurricane
6	22—27	Strong breezes			

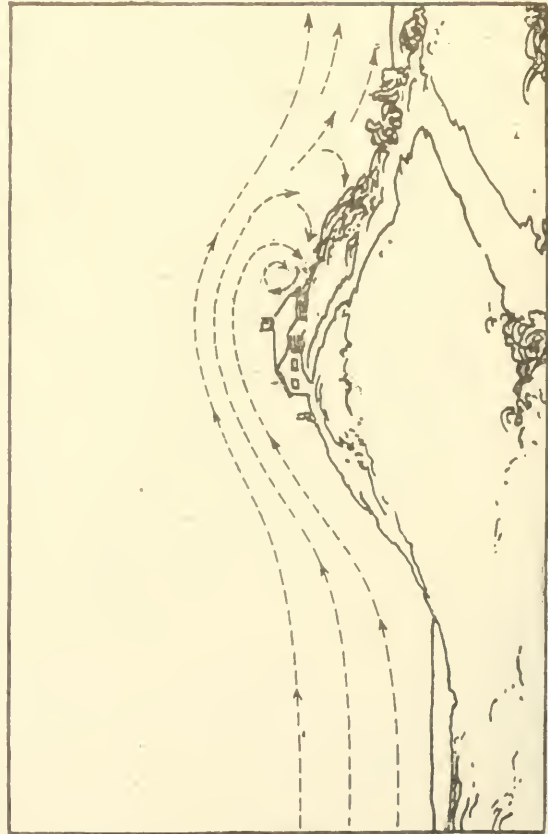
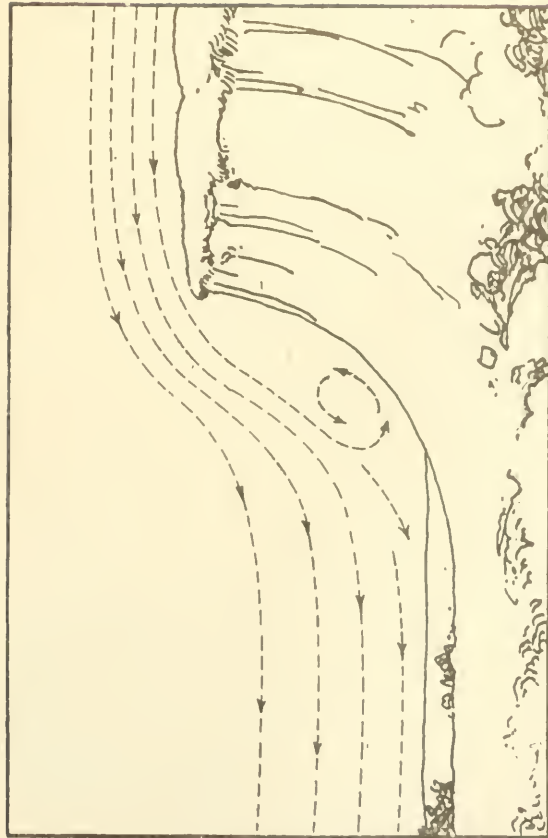

Figure 84 (Upper)—Action of the surface cataract
 Figure 86 (Lower)—Eddies, or bumps, in lee of obstacles

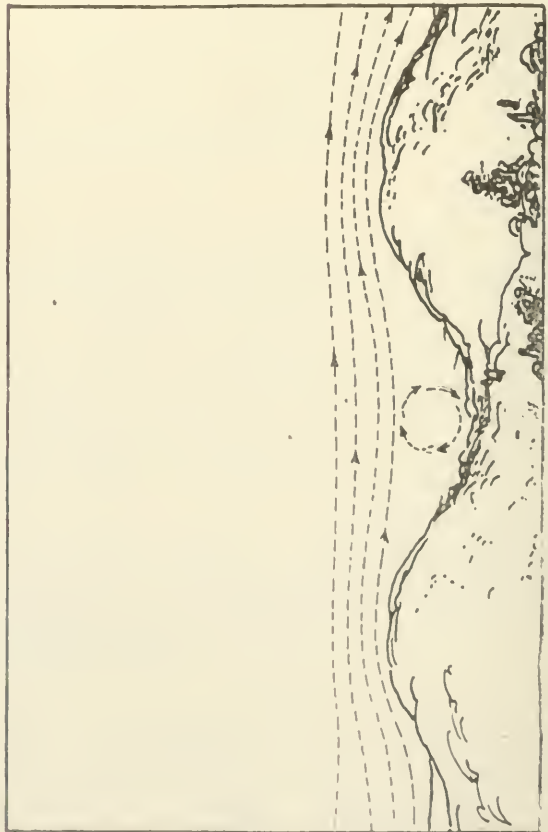
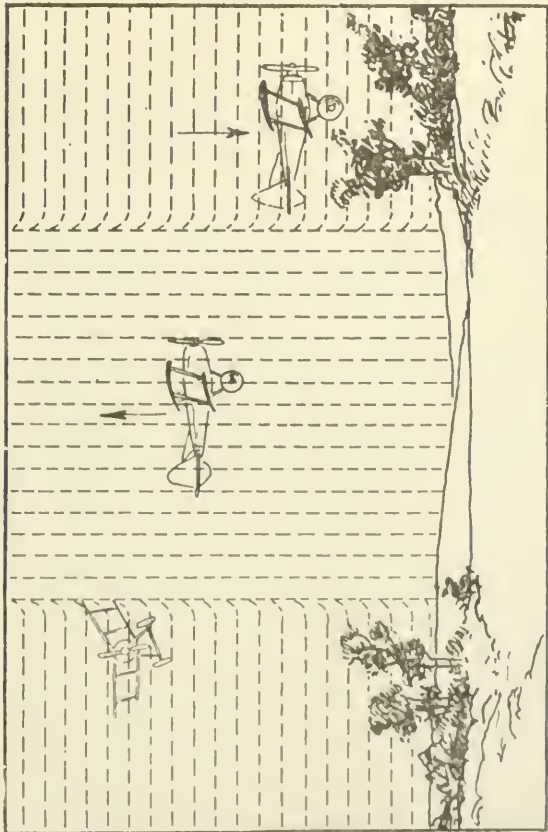

Figure 83 (Upper)—Action of the aerial fountain
 Figure 85 (Lower)—Vertical wind eddies below hill crests

WIND CONDITIONS WHICH AFFECT AVIATION

WIND

The aviator does not need to study the cause of wind, but he should know something of its distribution. Wind is stronger by day than by night at the earth's surface; its average velocity in the United States is 11 miles per hour, normally increasing with altitude up to 1,000 feet, above which height it "veers," or goes round in a clockwise direction.

The following scale is useful for calculating wind problems:

At 1,000 feet wind velocity increases $1\frac{1}{2}$ times, with 10 degree veering

At 2,000 feet velocity doubles and wind veering is 15 degrees

At 3,000 feet or over there is practically no velocity increase and veering is constant at 20 degrees.

AERIAL FOUNTAIN

A rising current of atmosphere encountered over barren land and conical hills in warm weather, the air column rising because it is heated beyond the temperature of the surrounding air. These fountains are not ordinarily dangerous but the rate of ascent has been known to reach a velocity of 25 feet per second. The airplane will rise involuntarily if caught squarely by one of these columns, dropping as it emerges. Wing tips will be tilted if the aerial fountain is grazed. See Figure 83.

AERIAL CATARACT

Descending cold air causes a current which takes two forms (a) the reverse of the aerial fountain with opposite effect on airplanes, and dangerous only in thunder storms; (b) surface cataracts developed by steep barren slopes of earth. The action of the surface cataract is shown in Figure 84. Landing should never be attempted in a surface cataract.

AERIAL CASCADE

The bounding air at the bottom of a steep fall over an earth contour is similar to the result with a water cascade. Eddies of a treacherous character are set up, and counter currents, above which the aviator must remain for safety.

AERIAL BREAKERS

Strong cross currents form choppy winds with action similar to ocean breakers. These are generally heralded by corrugated clouds and are to be noted as difficult of navigation by air pilots.

VERTICAL WIND EDDIES

Below the crest of hills wind eddies form, which describe circles in the vertical plane. See Figure 85. Should the aviator be caught in the pocket under a hill the airplane should be headed in and a landing made parallel to the side of the hill.

WIND LAYERS

Wind will very often be found blowing in different directions and velocities at different heights. Although horizontal, passing from one layer to another of different speed and different direction momentarily changes the buoyancy of the airplane, causing the machine to rise or fall. Turbulent motion and a few bumps will only be experienced, and wind layers are therefore not ordinarily dangerous.

WIND BILLOWS

These are horizontal billows similar to ocean waves and occur at the surface between wind layers; rough going, not necessarily dangerous, results.

WIND GUSTS AND EDDIES

These are generally known in aviation parlance as "bumps." Obstacles in the path of moving air at the surface cause them. They are strongest on the leeward side of hills, buildings, or other elevations, and most noticeable in a strong wind. Figure 86 illustrates the action of the air. If landing is forced, the aviator should select the windward side of the obstruction or a point well away to leeward.

AERIAL TORRENTS

The aerial torrent is caused by air colder than the surrounding air pouring downward. Great velocity is attained on surface slopes or open valleys. The effect on the airplane is exactly opposite that of the aerial fountain illustrated in Figure 83.



Figure 87—Cirrus (Mare's Tails), altitude 30,000 feet or more. Predict wind and cyclonic depression



Figure 90—Nimbus (rain cloud), altitude 300 to 6,500 feet. Steady rain or snow usually falls



Figure 88—Alto-Cumulus; altitude 10,000 to 23,000 feet. Indicate strong cross currents of air

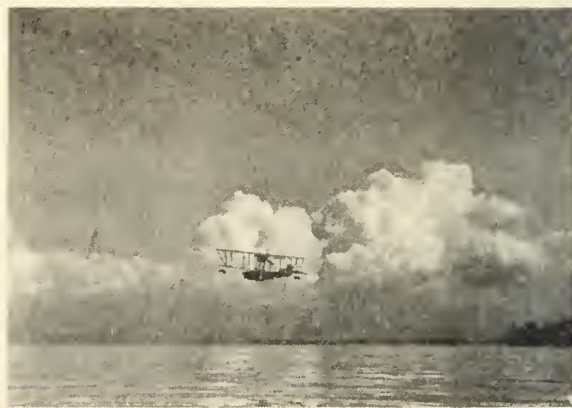

Figure 91—Cumulus (woolpack clouds), altitude 4,500 to 6,000 feet. Cause violent disturbances to the airplane



Figure 89—Strato-Cumulus; altitude 6,500 feet. Predict a change in weather



Figure 92—Cumulo-Nimbus (thunder cloud), altitude 4,000 to 26,000 feet. Dangerous to aviators because of strong currents and electric effects

CLOUDS AND THEIR SIGNIFICANCE

CLOUDS

Clouds are formed, (a) by condensation when an ascending mass of moist air encounters another moist mass of different temperature; (b) by cooling, when an ascending column of vapor, mixed with particles of dust, condenses. Types of clouds and their direction indicate the weather to the observing aviator. Clouds are either in the form of sheets or heaps, and may be so studied.

CLASSIFICATION OF CLOUDS

Cirrus—(Mare's Tails.) Light wisps of whitish cloud, of fibrous appearance with no shadows. These clouds are the highest in the international classification, commonly appearing at an altitude of 30,000 feet or more. They predict wind and a cyclonic depression. Illustrated in Figure 87.

Cirro-Stratus—A thin sheet of tangled web structure, whitish, and sometimes covering the sky completely, giving it a milky appearance. This cloud often creates sun and moon halos. Its average height is 29,500 feet. Forecasts bad weather.

Cirro-Cumulus—(Mackerel Sky.) Small globular masses or white flakes without shadows, or showing very light shadows, arranged in groups and often in lines. Average height between 10,000 and 23,000 feet. Denotes fine weather.

Alto-Stratus—A thick sheet of gray or bluish color, sometimes forming a compact mass of dark gray color and fibrous structure. Often causes brilliant coronae when near sun or moon. Average height 10,000 to 23,000 feet.

Alto-Cumulus—Large globular masses, white or grayish, partially shaded, arranged in groups or lines, and often so closely packed that their edges appear confused. Illustrated in Figure 88. This cloud formation is somewhat similar to the mackerel sky (cirro-cumulus); it has the same elevation, 10,000 to 23,000 feet. The cross lines indicate strong cross currents of air.

Strato-Cumulus—Large globular masses or rolls of dark clouds, frequently covering the whole sky, especially in winter. Altitude 6,500 feet. Illustrated in Figure 89. Predict a change in weather.

Nimbus—A thick layer of dark clouds without shape and with ragged edges from which steady rain or snow usually falls. Shown in Figure 90. Through the openings an upper layer of cirro-stratus or alto-stratus is almost invariably seen. Low elevation, 300 to 6,500 feet.

Cumulus—(Woolpack Clouds.) Thick clouds of which the upper surfaces are dome-shaped with protuberances; base horizontal. Illustrated in Figure 91. They indicate the aerial fountain and are low flying, 4,500 to 6,000 feet. Violent disturbances to the airplane will be experienced when passing through them, or passing above or below.

Cumulo-Nimbus—(Thunder Cloud.) Heavy masses of cloud rising in the form of mountains or turrets or anvils, generally surmounted by a sheet or screen of fibrous appearance (false cirrus) and having at its base a mass similar to nimbus (rain cloud). Illustrated in Figure 92. Apex 10,000 to 26,000 feet; base, 4,000 feet. Dangerous to aviators, because of strong currents and electric effects.

Stratus—A uniform layer of cloud which resembles fog but does not rest on the ground. It usually is stationary or drifting slowly at altitudes of 100 feet to 3,500 feet.

GENERAL OBSERVATION

Aviators may gain valuable knowledge of existing wind currents by observation of clouds. The general rule is that unbroken clouds indicate smooth, even air flow, broken formations the presence of air currents. The behavior of these currents may be anticipated by applying the above classification to the clouds in evidence.



British Official.

Although practically every personal narrative of aviators returned from France contains references of thrilling escapes from anti-aircraft guns, little is known of these weapons or their employment. Anti-aircraft guns are either of high power on fixed mounts, or light guns on movable mounts, such as is illustrated above in a photo from France. The heavy guns are usually set in concrete emplacements but the lighter ones are used with mobile forces and therefore designed to be moved as required. They are usually one or two-pounders, rapid fire and mounted on specially designed motor trucks. In a few instances heavy 6-pounders are employed; these are allotted to army corps and general headquarters, whereas the lighter pieces are generally assigned to brigades and divisions in the field. Explosive and special incendiary, combination time and percussion shells are used. The guns are generally arranged in triangular or square groups of three or four

Aviation News

The Aircraft Board has issued the following statement:—

The arrival in England is announced of delegates from all the allied countries for conference on **Inter-Allied Conference on Standards** international standards, at which a standardization of manufacturing materials as related to the production of machinery, motors, aircraft, etc., will be considered.

The American delegation, headed by F. G. Diffen for the Aircraft Board, includes members from all the prominent engineering societies of the country—the Society of Automotive Engineers, the American Society of Mechanical Engineers, the American Society of Testing Materials, etc. There are also members from the Aircraft Board, the Advisory Committee for Aeronautics, the Signal Corps, the Navy, and the original International Aircraft Standards Board, from which this conference is an outgrowth.

The purpose of this inter-allied meeting, which is the result of the efforts of Mr. Diffen, is to enable better industrial service to be given with less man-hour effort, through relieving plants from carrying in stock unstandard materials, for which there is small call, and concentrating on materials of known performance for the same work.

No attempt will be made by the conference to standardize airplane construction, but rather those materials and units only which are at present causing confusion in purchase and delivery and for which suitable standards can be established.

The following is the list of the American members:—F. G. Diffen (Chairman), Dr. W. F. Durand, Lieut. Commander Benjamin Briscoe, Lieut. W. F. Prentice, Coker Clarkson, E. H. Ehrman, Charles M. Manley, James Hartness, Albert L. Colby, F. G. Ericson, Capt. A. B. Tilt, F. R. Baxter.



Summer and winter flight uniforms only will be required of officers of the Naval Reserve Flying Corps, but they may provide themselves with Navy service uniform as prescribed for Naval Reserve officers, if they so desire, to be worn when not on duty specified below. Summer or winter flight uniforms will be worn by all officers on aviation duty attached to naval air stations and naval aviation detachments, ashore and may be worn on duty in connection with inspection or tests of aircraft and their material, and on such other occasions as may be prescribed by competent authority.



A seaplane which folds its wings while ashore

Progress of Wireless Telephony*

By **Elmer E. Bucher**

Director of Instruction, Marconi Institute

(Continued from July WIRELESS AGE)

Espenschied's Duplex Wireless Telephone System

AMONG the attempts that have been made to secure simultaneous transmission and reception in wireless telephony, the system evolved by Lloyd Espenschied is of interest. A problem of considerable magnitude is encountered in duplex transmitting and receiving systems because of the large amounts of power used for transmitting compared to that flowing in the receiving systems, the ratio being approximately one million to one. This inventor believes he has solved the problem through the use of specially devised balancing out circuits.

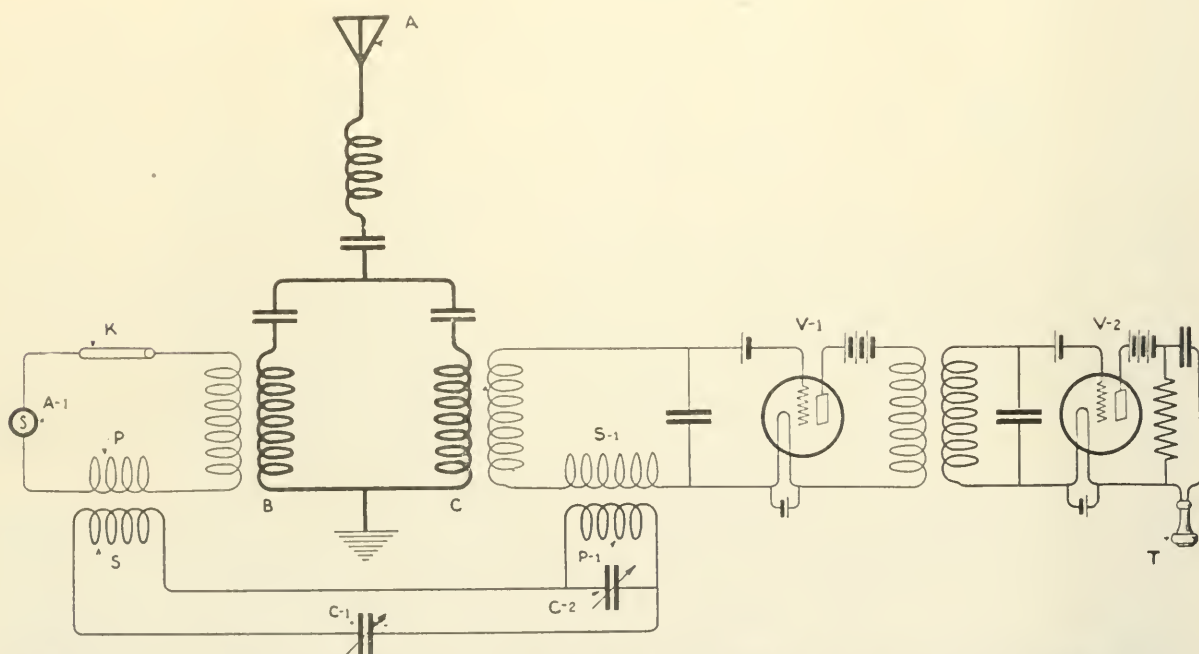

Figure 11—Espenschied's system for simultaneous transmission and reception in wireless telephony

The embodiments of Espenschied's system are shown in the diagram of figure 11, additional circuits being shown in figures 12, 13, and 14. In the systems shown in these diagrams the inventor secures duplex operation by employing different carrier frequencies for transmission and reception. Through the selectivity thus afforded and by the aid of additional balancing out circuits, either the same aerial or two different aeriels may be employed for simultaneous transmission and reception.

In brief, the antenna system shown in figure 11, comprises two parallel branches *B* and *C* which gives the complete system two natural frequencies of oscillation. Branch *B* is coupled to a continuous wave generator *A-1*, and branch *C* is coupled to a valve amplifying system including the tubes *V-1* and *V-2*. The speech signals are translated through the medium of the telephone *T* connected in the output circuit of the tube *V-2*.

Keeping in mind the enormous volume of energy flowing in the transmitting branch compared to that in the receiving branch, it is clear that some means of balancing out the effect of branch *B* upon branch *C* must be employed. This is

*Abstracted from "Vacuum Tubes in Wireless Communication."

accomplished by the balancing out circuit S , $C-1$, $C-2$, $P-1$. S is coupled to the radio frequency generator $A-1$ and to the input side of the three-electrode valve at $P-1$, $S-1$. By proper adjustment of the phase relation of the balancing out current and the current of similar frequency induced in the receiving system, complete annulment is secured in branch C . It must be remembered that the frequency of the balancing out circuit is that of the transmitter. Hence, only currents of this frequency are suppressed in the receiving system, leaving it free to receive waves at a frequency differing from that of the radio frequency alternator $A-1$. Careful adjustments of the couplings P , S , and $P-1$, $S-1$, are essential for successful operation.

The correct phase relation between the balancing currents is obtained by proper adjustment of capacity of the condensers $C-1$ and $C-2$.

The circuit shown in figure 12 is in all respects similar to figure 11 with the exception that the balancing out circuit includes a vacuum tube $V-3$ which ampli-

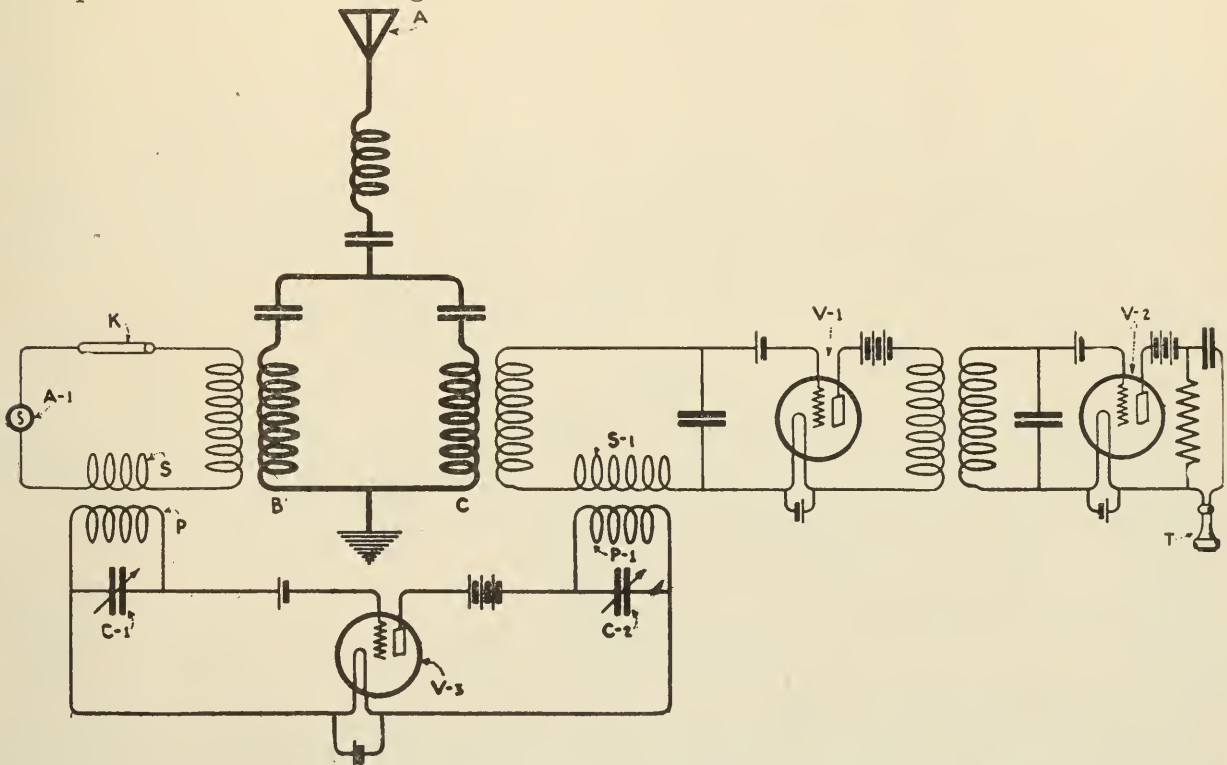

Figure 12—Modified system evolved by Espenschied for simultaneous transmission and reception of wireless telephonic signals. The interfering currents in the receiving system are balanced out by a special circuit P , $C-1$, $P-1$, $C-2$

fies the effect of generator $A-1$. Better balance of the opposing E.M.F.'s is thus secured.

It is thus seen that in a general way the circuits of figures 11 and 12 simulate the circuits of wire telephony, the apparatus always being in a position to transmit and receive.

A system involving the use of separate aerials for transmission and reception of speech signals disclosed by Espenschied is shown in figure 13. The aerial of the transmitter is indicated at W , and of the receiving station at $W-1$. The source of radio frequency for the carrier wave is shown at $A-1$, the output of which is amplified by means of the three-electrode vacuum tubes $V-1$ and $V-2$, the output current of the latter tube being fed to the aerial W at the coupling P , S .

The receiving system embraces the coupling transformer $P-1$, $S-1$, the incoming signal being amplified by the three-electrode tube $V-3$ and detected by the tube $V-4$. The output circuit of $V-4$ includes the receiving telephone T .

Through the transformer M and the microphone $T-1$, currents of vocal frequency are impressed upon the circuit X which also is inductively coupled at $M-1$ to the alternator $A-1$. The output of the alternator is modulated at vocal frequency by $T-1$. The circuit X is coupled to antenna W at $M-3$ through which high frequency current is withdrawn from the antenna circuit to balance out currents of similar frequency in the receiving system. Circuit X is coupled to

$V-3$ at $M-2$. This circuit thus serves to impress currents of speech frequency upon the alternator $A-1$ and to deliver a certain amount of radio frequency to the input circuit of the tube $V-3$ to balance out such energy as may be induced in the aerial $W-1$ by W . The correct phase relation of the opposing radio frequency currents is obtained by careful adjustment of condensers $C-1$ and $C-2$.

In respect to the reception of signals, it is seen that antenna $W-1$ is strongly responsive while antenna W is weakly responsive to the distant transmitter owing to the difference of frequency.

Summarizing the actions of the apparatus disclosed in figure 13, currents of radio frequency generated by the radio frequency alternator $A-1$ are amplified by a battery of vacuum valve tubes the output circuits of which are inductively coupled to the antenna. Circuit X serves to conduct radio frequency current

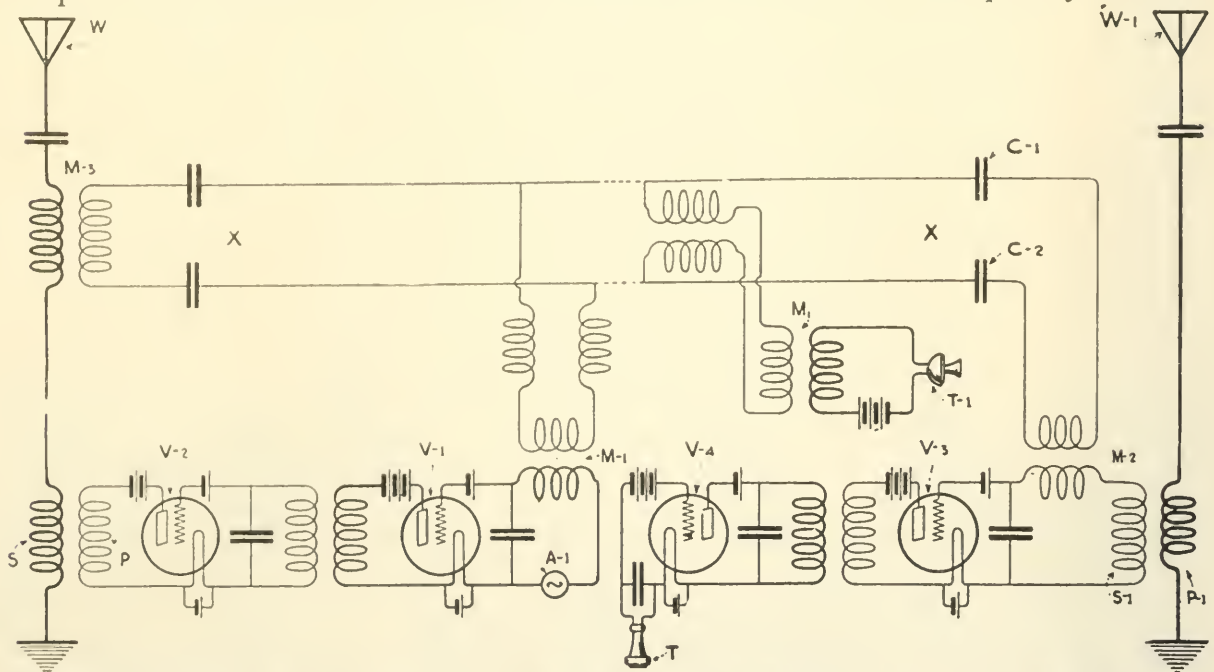

Figure 13—Espenschied's system for simultaneous transmission and reception in wireless telephony from two aerials

from the transmitter for balancing out the effects of the transmitter upon the receiving system. It acts also as a carrier of the vocal currents generated by the microphone $T-1$.

The system shown in figure 14 fundamentally is similar to that of figure 13. The output of the radio frequency alternator $A-1$ is amplified by the bulb $V-1$, the carrier wave being modulated at a radio frequency by the microphone $T-1$ through the coupling M . The output circuit of $V-1$ is coupled to the input circuit of the valve $V-2$, the output circuit of which is inductively coupled to the antenna through the transformer P, S . A balancing out circuit shunted across circuit X including the condenser $C-1$ and the coupling $M-2$ serves to impress a modulated radio frequency wave on the input circuit of the receiving system $V-3, V-4, T$, and thus currents of the transmitter frequency which may be induced in the antenna $W-1$ are balanced out leaving the receiving system free to respond to waves of a frequency differing from that employed in the antenna system W . Correct phase relation of the opposing currents is obtained by means of the condensers $C-1$.

Englund's Duplex Radio Telephone and Radio Telegraph System

We have remarked in the previous article how a vocal wave or current of speech frequency impressed upon a radio frequency or carrier wave sets up three complex waves of frequency $F + f$, F , and $F - f$, in which F is the frequency of the carrier wave and f the vocal wave impressed upon the carrier wave by the human voice through a microphone. Because the wave frequency F does

not contain the signal frequency, f , it represents a waste of power in the antenna system. Means were shown whereby the current of frequency F could be practically eliminated at the transmitter but be supplied at the receiver by a local generator.

Englund has recently disclosed a novel system which not only embodies the foregoing principle, but in which the frequency F is employed for telegraphic signaling. That is, the antenna is used for simultaneous radiation of telephonic and telegraphic messages.

An important feature of the system is the fact that telegraphic and telephonic signals may be dispatched simultaneously at the same wave length from one aerial and may be received upon one aerial at the receiving station. The transmitting circuits of this system are shown in figure 15 and the receiving cir-

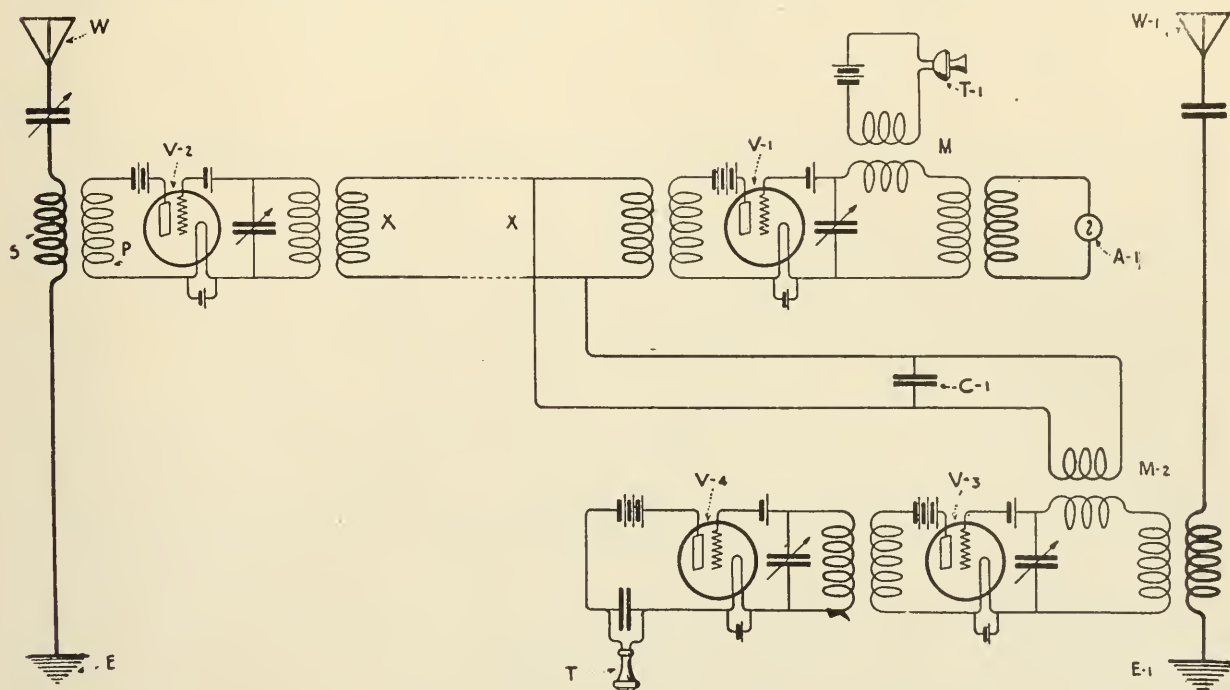

Figure 14—Espenschied's modified system for simultaneous telephonic transmission and reception from two wireless telegraph aerials

cuits in figure 16. Beginning at the left-hand side of the drawing of figure 15, a radio frequency alternator A is coupled to the input circuit B of a modulator bulb. Coupled to the same input circuit is a microphone circuit C including the microphone T , the battery $B-3$, and the transformer $M-2$.

The output circuit of the modulator bulb contains two branch circuits $B-1$ and $B-2$. The branch $B-1$ comprising the inductance and the condenser serves as a short circuit to current of the frequency of the generator A . The parallel circuits of branch $B-2$ are tuned to offer a practically infinite impedance to currents of the generator frequency and a low impedance to currents whose frequencies differ therefrom by a vocal frequency.

Through the transformer M , currents of vocal frequency are impressed upon the input circuit F of the amplifying bulbs $V-1$, the output circuit G being again coupled to a battery of power bulbs $V-2$. The output circuits of the latter are inductively coupled to the antenna at $M-1$. So far the circuit does not differ materially from that described in the July issue, and as already explained, the antenna only radiates when the transmitter T is actuated.

It is to be noted, however, that through the transformer $M-2$, and the telegraph key $K-1$, currents of the frequency of the generator can be impressed upon the input circuit F of the amplifying bulbs $V-1$. Therefore, during the moment that the key $K-1$ is closed, the antenna will radiate at the frequency of the alter-

nator F . The wave motion can be detected at the receiving station by a receiver tuned to that frequency. Thus, the current of the carrier wave is superposed upon the modulated current induced in the antenna circuit by the microphone. Telegraphic and telephonic signaling may then be carried on simultaneously.

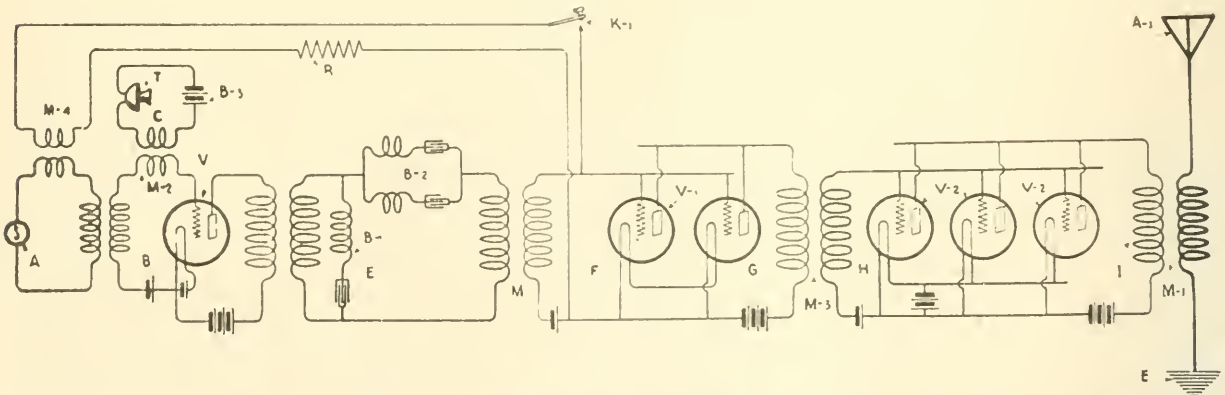

Figure 15—Englund's system for simultaneous transmission of radiotelegraphic and radio-telephonic signals

During the time that the key $K-1$ is closed, the speech distortion ordinarily caused by the presence of the frequency F in the antenna circuit in wireless telephony, is experienced, but at all other times the frequency of the carrier wave F is eliminated. However, it does not interfere seriously with the signals of speech or vocal frequency.

To avoid short-circuiting the amplifiers $V-1$, a resistance R is placed in series with the key circuit.

The circuits of the receiving system whereby telegraphic and telephonic signals may be recorded at the wave length simultaneously is shown in figure 16.

The carrier frequency F which has been eliminated at the transmitting sta-

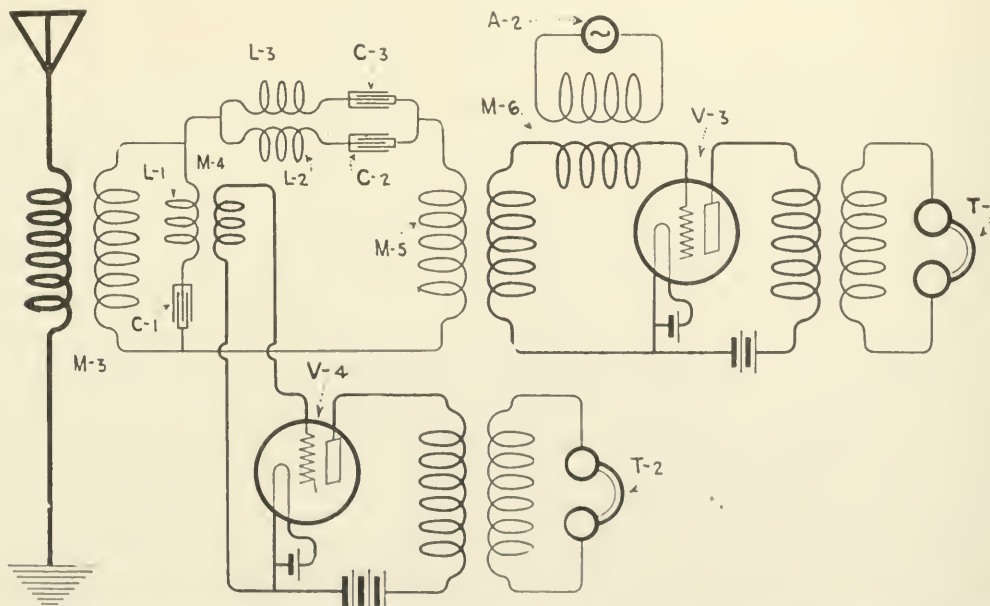

Figure 16—Receiving apparatus in Englund's duplex system. This system will receive telegraphic and telephonic signals simultaneously

tion for wireless telephony, is supplied by a local generator $A-2$ which is coupled to the input side of a three-electrode valve $V-3$, the output circuit of which is connected to a telephone receiver T .

The secondary of the receiving transformer $M-3$ is shunted by an inductance

$L-1$ and a condenser $C-1$, the circuit further containing the inductances $L-2$, $L-3$ and the condensers $C-2$ and $C-3$. This circuit will be found similar to $B-1$, $B-2$ of figure 15, performing similar functions. It is also to be noted that the input side of a vacuum tube $V-4$ is inductively coupled to $L-1$ by transformer $M-4$. It is in this circuit that the telegraphic signals are detected.

Keeping in mind the functions of the branch circuits $B-1$ and $B-2$, in the transmitter, the function of those of the receiver will be readily understood. Thus, oscillations of the carrier frequency will be shunted through $L-1$, $C-1$. Through the coupling $M-4$ they are impressed upon the input circuit of the tube $V-4$ and detected in the telephone $T-2$. Currents of the carrier frequency cannot appear in the transformer $M-5$ which serves to couple the antenna system to the input circuit of the valve $V-3$, but currents of vocal frequency are readily transformed through $M-5$ because of its tuning and thus are detected in the telephone $T-1$.

In summary, the telegraph signals are detected in telephone $T-2$ and tele-

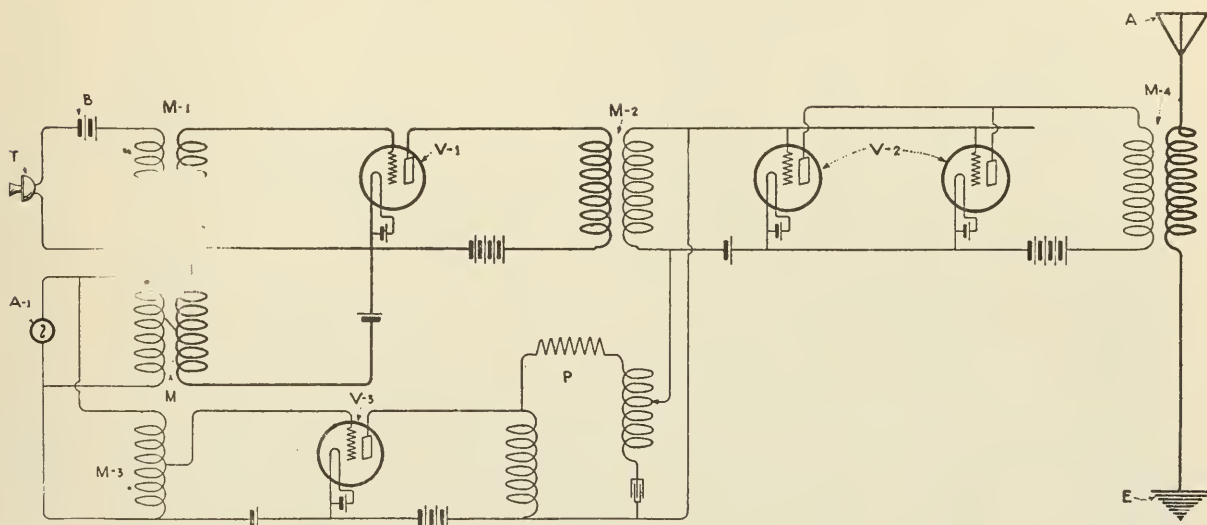

Figure 17—System proposed by Englund for the elimination of the carrier frequency; with the apparatus connected in this way the antenna radiates only when modulated currents of vocal frequency are generated

phonic signals in $T-1$. The alternator $A-2$ supplies the carrier frequency F which has been eliminated in the telephone transmitter circuits.

Englund has disclosed another system for elimination of the carrier frequency at the transmitting station in wireless telephony, it being a modification of the circuits disclosed in the July article. The complete circuits are shown in figure 17. As usual, the radio frequency carrier wave is generated by the source $A-1$, which is inductively coupled to the input side of the three-electrode tube $V-1$, the same circuit being coupled at $M-1$ to the transmitter circuit including the microphone T , and the battery B . The output circuit of $V-1$ is inductively coupled through $M-2$ to the input circuit of the power bulbs $V-2$. The output circuit of the latter is, in turn, inductively coupled to the antenna circuit as usual at $M-4$.

Up to this point, if the transmitter T be spoken into, the antenna would radiate at three frequencies, that is the carrier frequency would not be eliminated. A special balancing-out circuit, however, is provided, which is connected to the alternator $A-1$ in the following way: The input side of a vacuum tube $V-3$ is coupled to the alternator through the auto-transformer $M-3$. The output circuit of $V-3$ is connected to a phase-regulating device P , consisting of inductances, capacity and resistance, as shown. This circuit is in turn tapped across the secondary winding of the transformer $M-2$ so that currents of the carrier frequency F which may be induced in the circuits of $M-2$ are balanced out by opposite phase regulation. The antenna then radiates only during the production of the wave of vocal frequency.



(C) Press Ill. Svce.

The famous 3-inch field artillery gun of the U. S. Army is seen here made ready for action in position exactly duplicating the screened and protected emplacement which these Americans will find abroad

A Digest of Electrical Progress

Enormous Growth in Sale of Tungsten Lamps—Protection of Battery Charging Circuits—New Research Laboratory in Japan—Electric Welding in the Building of Ships—New Swedish Radio Station—An Early Phonograph Concert—Recognition to Dr. A. E. Kennelly—Belated Recognition of Oliver Heaviside—Carty Receives the Edison Medal.

Enormous Growth in Sale of Tungsten Lamps

IT is reported that the total sales of tungsten filament lamps in the United States excluding miniature lamps, for the year 1917, totaled 165,000,000, an increase over the previous year of 14 per cent. It is also declared that more than 75,000,000 miniature lamps were sold during this period. The majority of these are used for flashlights and automobiles, but a considerable number are also employed for candelabra and decorative lighting. The total sales of carbon filament and tungsten filament lamps totaled about 12 per cent out of 100 per cent.

Protection of Battery Charging Circuits

THE importance of including a reverse current circuit breaker in the circuit of a charging generator is shown by the incident described by E. C. Parham in a recent issue of the *Electrical World*. He remarks:

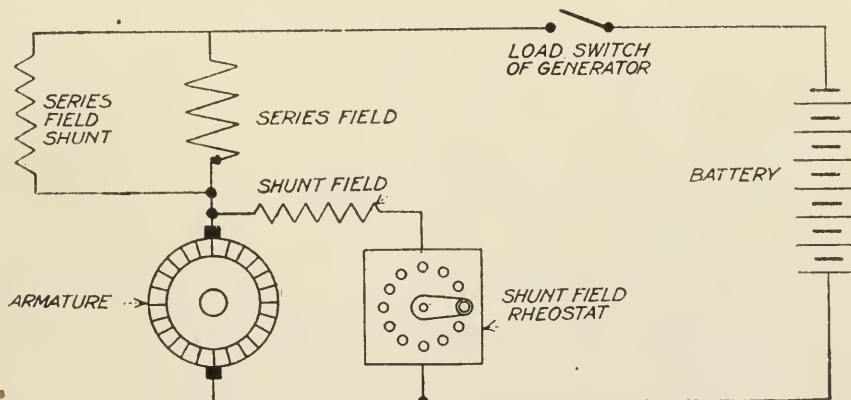

Connections of motor-generator circuit

A motor-generator set after being connected to some batteries all night appeared to be unable to charge the batteries. The set was found to be running at a reduced speed with circuit breaker open. The accompanying diagram indicates the connections.

The set was shut down by pulling the knife switch and the generator was carefully inspected. The series field coil interconnections were of the clamp type and the clamp of the two bottom coils had worked off, thereby opening the series winding and making it necessary for the series-field shunt to carry the total current. Had there been no series-field shunt the loosening of the clamp would have opened the circuit between the generator and the battery and there could have been no motoring action.

As it was, however, the cutting out of the series winding lowered the voltage of the generator to a value that was below that of the battery and the

shunt held intact the circuit that was necessary for the motoring. Up to the time of the opening of the motor breaker the driving motor and the battery had been operating the set in the same direction.

New Research Laboratory in Japan

A NEW physics and chemistry research laboratory has been recently organized in Japan. It is a semi-governmental institution, part of the foundation being furnished by the Government and the rest by private subscribers.

Several young scientists have been nominated as members of the staff, and some of them are at present in the United States studying laboratory methods. The noted physicist, Dr. Nagaoka, is the head of the physics department, and Dr. Ikeda is the head of the chemistry department. The object of this institution is to conduct original investigations in physics and chemistry and to apply the results for the promotion of industry. To accomplish these objects and to make the institution closely related to outsiders, the articles of incorporation contain the following provisions: (1) Private parties may apply for research to be done on specific subjects; (2) Outsiders may obtain permission to utilize the equipment of the institution; (3) Outside investigators may obtain assistance for completing their investigations or inventions; (4) The institution will publish the results of researches conducted in it; (5) The institution will provide public lectures for the dissemination of the results of its research; (6) The institution may confer honorary degrees upon those who have accomplished original research of merit; (7) The institution will conduct correspondence with other similar institutions of the world and co-operate with them; (8) The institute will undertake training of research men.

Electric Welding in the Building of Ships

PROFESSOR Comfort A. Adams, chairman of the standards committee of the American Institute of Electrical Engineers, has appointed a special committee to investigate the possibilities of electric welding in ship building. This committee includes representatives from the manufacturers of welding machinery, the classification societies (Lloyd's and the American Bureau of Shipbuilding), the Bureau of Standards, the Navy Department and shipbuilders. As a result of their investigations, the members of the committee became convinced that time and material could be saved by the introduction of electric welding methods. The committee was re-organized and assigned a definite work by the Emergency Fleet Corporation. An office has been established in room 716, Engineering Societies Building, New York City.

The Emergency Fleet Corporation has authorized the construction of a 50-ft. (15.2-m.) section of a 9,600-ton standard ship at the yards of the Federal Shipbuilding Company, Newark, for the demonstration, development, and application of electric welding to an actual ship structure. The construction of this 50-ft. section will be under the direction of Arthur J. Mason, of the Fleet Corporation, who has been active in advancing the use of electric welding for ship building. The particular ship section is to be sealed up at the ends, filled with water, and tested by hydrostatic pressure. Both spark and arc welding are to be employed. The foundation for this structure is already complete, and the work will be pushed as rapidly as possible.

Large stationary and portable spot welders are being designed for this work, and various arc-welding systems are being studied. An installation will be made in the Hog Island yard at Philadelphia.

The committee is responsible to Daniel H. Cox, manager of steel ship construction of the Emergency Fleet Corporation, who is lending every possible aid to its work.

All available information as to apparatus, tests and applications is being collected. This information, together with that already in hand, will be classified and sent out to all steel shipbuilders and to others interested.

New Swedish Radio Station

THERE has been completed at Karlsborg, Sweden, a wireless station for which is claimed ability to send messages over a distance of 3,150 miles. The masts for the support of the antenna are 684 feet in height, but weigh only 25 tons each. They are insulated at four different places from base to top and are erected with the bases embedded in black granite blocks, impregnated with paraffin. The antenna is 1,476 feet in length, consisting of sixty phosphor-bronze wires hung from steel tubes. The capacity of the station is increased by covering the territory between the masts with a phosphor-bronze wire netting.

An Early Phonograph Concert

H. P. GALLIGHER tells, in the *Telegraph and Telephone Age*, that he first heard phonograph signals in the year 1887 while he was working as night operator at Corry, Pa. It was in the autumn, and he was busy in the telegraph office and a train pulled into the station; a stranger, a young man of perhaps twenty-six or twenty-seven years of age, of slight build, and quiet, studious manner, came into the office. He stated that he was an operator, explaining that he came from Buffalo to see what arrangements could be made for connections through the board on a certain evening on which he was to give a concert in Buffalo, his audience being in Cleveland. The writer remarks:

"The big, button switchboard, three feet square, was at that time more or less a mystery to me. He seemed to be familiar with its operation, however, and explained what it was he wanted done on the evening of the concert. I did not care to take the responsibility, as I might be too busy, and told him to watch out for 'MS' calls and I would go after Will Fox, the day man. Mr. Fox agreed to be on hand the night of the concert and look out for the wires.

"Before leaving, Thomas A. Edison, for he was the stranger, told me to hold my ear down to the magnet of the relay on the night of the concert and I could hear the music. I did so. I could hear the cornet solo very distinctly, but the singing and the orchestra were only a humming sound."

It is interesting to note that the phonograph signals were recorded by the vibrations of an armature relay and not by the familiar telephone receiver. Its vibration was, of course, too crude to record the variations of orchestral music.

Recognition to Dr. A. E. Kennelly

IN addition to the honors which Dr. A. E. Kennelly has received here and abroad for his research work along various electrical lines, he has recently been awarded the Howard N. Potts gold medal by the Franklin Institute, for his invention of the hot wire ammeter and his application of this device to the measurement of convection from small heated wires. Dr. Kennelly at present is acting head of the electrical engineering department of the Massachusetts Institute of Technology. He is well known to radio engineers for his contributions to the Proceedings of the Institute.

Belated Recognition of Oliver Heaviside

THE Board of Directors of the American Institute of Electrical Engineers has elected Oliver Heaviside an honorary member. The recipients of this honor are few in number, comprising Andre Blondel, S.Z. de Ferranti, C. E. L. Brown, and Guglielmo Marconi.

Heaviside is universally recognized as a powerful electrical physicist whose brilliant work on electromagnetic theory laid the foundation upon which the great superstructure of long distance telephony has been reared.

It should be remembered that as early as 1887 he demonstrated theoretically and urged the use of inductance in telephone circuits; but so little was the value of his suggestion recognized that Sir William Preece suggested for a trans-Atlantic telephone cable a cable of special construction in which the electrostatic capacity was increased.

Regardless of the ignorance and prejudice with which he was required to cope, in developing his theories, he continued in his experimental work, and in a series of articles published in the *London Electrician* in 1893, he suggested having "large distributed inductance together with inductance in isolated lumps. This means the insertion of inductance coils at intervals in the main circuit."

Dr. J. J. Carty, of the American Telegraph and Telephone Company, demonstrated the truth of Heaviside's scientific reasoning fully twenty years after the introduction of Heaviside's theories.

Commenting on the latter's accomplishments the *Electrical World* says editorially:

Not alone, however great this work has been, can it be viewed as Heaviside's life work. Besides numerous contributions to the science of mathematics of utmost and revolutionary importance, there are the Heaviside units, called the "rational" units; there is the "rational" current element used throughout his work by Sir Joseph Thomson; there are the fundamental equations of the motion of an electrically charged body, with all the ramifications of mathematical and scientific work, which has culminated in the theory of the electron, and inseparably connected with Heaviside's name is the "distortionless circuit" and its beautiful theory. A busy age may plead preoccupation in extension of its failure to give earlier official recognition. So many are the subjects touched upon in Heaviside's writings, so absorbing and stimulative are these contributions to electrical science, that they have been an inexhaustible source from which lesser men have drawn material for interesting and instructive papers. The theory of the distortionless circuit, the building up of the steady state from a conception of direct and reflected waves, the use of operators—all these are but a few of the contributions made more than a quarter of a century ago, and they are cited at random from the wealth of Heaviside's papers. May this recognition of one of the greatest mathematical physicists the world has ever known convey to Great Britain and her men of science another message from America that in realization of each other's strength must lie the basis of their enduring greatness and invincibility.

Carty Receives the Edison Medal

THE Edison Medal for "meritorious achievement in electrical science or electrical engineering or the electrical arts" was established upon the initiation of a group of friends and associates of Thomas A. Edison, for the purpose of recounting and celebrating the achievements of a quarter of a century in the art of electric lighting. It was decided that the most effective means of accomplishing this object would be to establish a gold medal which during the centuries to come should serve as an honorable incentive to scientists, engineers, and artisans who achieve a high standard of accomplishment. This medal was presented to Colonel Carty at the annual meeting of the Institute to be held in the auditorium of the Engineering Societies Building. The meeting was presided over by President E. W. Rice, Jr. An address was given by Dr. A. E. Kennelly. Another address given by Michael I. Pupin gave the history of Colonel Carty's work in regard to telephone engineering. The medal was presented to Colonel Carty by President E. W. Rice, Jr.

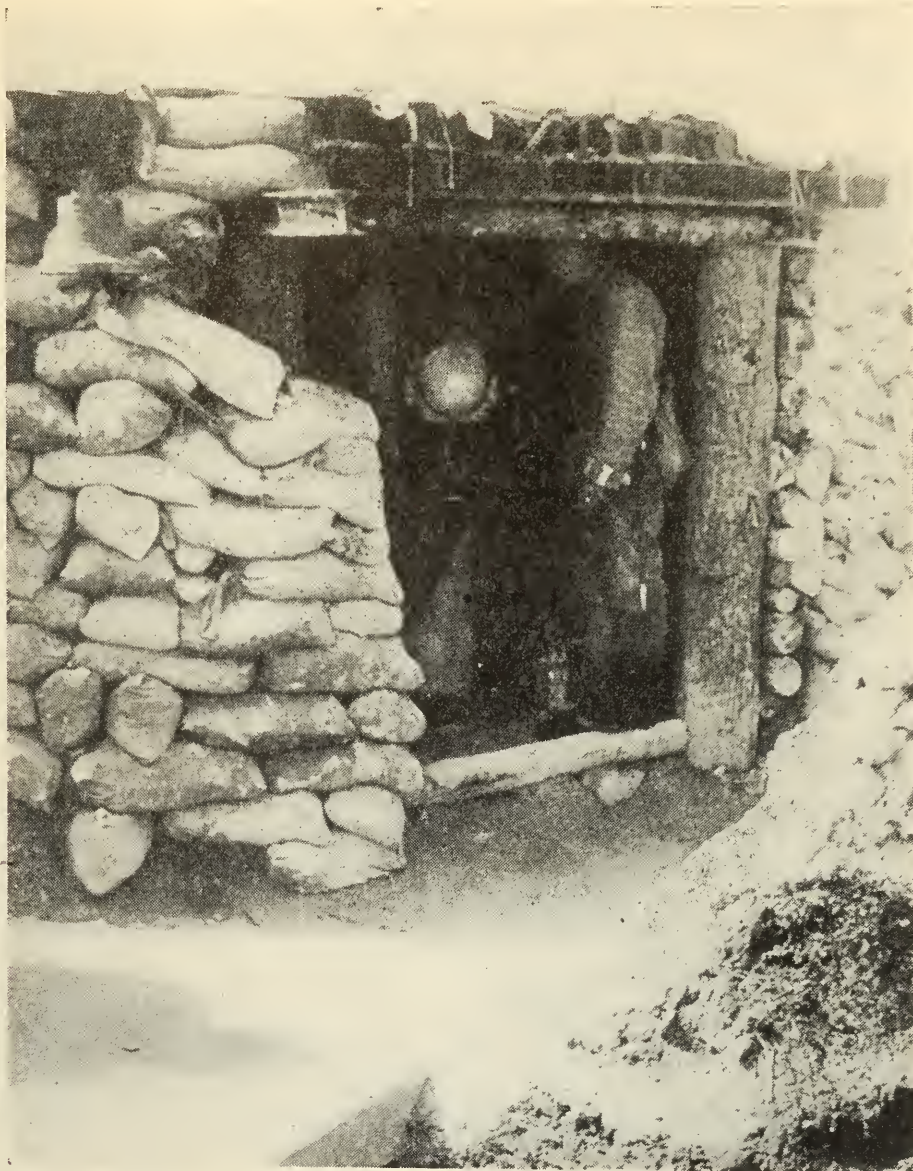

Press Ill. Svce.

The construction of a gun emplacement for light pieces is revealed in detail in this trench view of a well defended position. Atop the sand bags to the left is the bell which is rung to warn of an enemy advance. These bells were formerly used by the allies to sound the "gas alert," but have since been replaced by Strombos horns, which can be distinctly heard above the roar and rattle of gun fire

Navigation News

The Shipping Board authorizes the following:

How a Ship's Tonnage Is Figured Four Ways To many persons who are not experienced shipbuilders the various uses of the term "tonnage" in relation to the size of a ship may be confusing. The following article from the "Pusey & Jones Shipbuilder" explains the terms well and makes a clean distinction between the various ways in which they are used:

There are four kinds of tonnage in use in shipping circles. They are gross tonnage, net registered tonnage, dead-weight carrying capacity, and displacement.

Dead-weight tonnage is what the vessel actually can carry in tons of heavy cargo, plus stores and bunker coal.

Gross tonnage is based on the cubic contents of the hull, with certain arbitrary spaces deducted, and has little bearing on the cargo-carrying capacity of the vessel.

Net registered tonnage is gross tonnage, with certain allowances for crew space and machinery space deducted, and has little bearing on the dead-weight carrying capacity of the vessel.

Displacement is the total weight of the vessel when full of cargo—that is, the weight of her hull plus her dead-weight tonnage.

In round numbers a ship of 9,000 tons dead-weight would stand about as follows:

Dead-weight carrying capacity.....	9,000
Gross tonnage	5,000
Net registered	3,000
Displacement	12,000



Director General Charles M. Schwab has announced the creation of a requirement section for the **New Section is Created For Fleet Corporation** Emergency Fleet Corporation with Mr. George M.

Brill as its head.

Mr. Schwab in creating this new section said:

"It will be the purpose of this section to keep in touch with the shipyards and learn from them in a general way the amount of materials, supplies, and equipment required for extensions, so that a proper schedule

may be placed before the War Industries Board for survey, and, if necessary, for allocation. I think you will appreciate that during this time, when the demand for many materials is so far in excess of the supply, it is most essential that a clearing house be provided so that the needs of different Government agencies may not conflict.



The State Department has transmitted to the Chinese Government the following message from **China to Build Merchant Ships** Edward N. Hurley, chairman of the United States Shipping Board:

"The United States Shipping Board has completed negotiations for the construction of a number of merchant vessels at the Chinese Government's shipyard at Shanghai. This happy arrangement enables Chinese industry to become still more effective in support of our splendid armies who are now advancing toward their assured victory. By making ships, China will be directly making war upon the common enemy."



Following the conclusion of an arrangement with the Kiangnan Dock & Engine Co. of Shanghai,

Contracts for 30 Steel Cargo Ships Awarded to Japanese Yards whereby that company is to build 120,000 tons of steel steamships for the

United States Shipping Board, it is announced that contracts for 30 additional steel cargo steamships have been awarded to Japanese shipyards.

Total contracts now let to Japanese shipbuilders provide for 380,000 tons of shipping, including 50 cargo carriers. These will cost approximately \$78,000,000, of which about \$20,000,000 has been expended. The estimate of the Shipping Board, which was submitted to the Appropriations Committee of the House, asked for an additional \$55,000,000 for this purpose. The Shipping Board had also permitted Japan to obtain 100,000 tons of steel plates, and will now provide 35,000 tons for this new construction.

Finding Your Way Across the Sea

Capt. Uttmark's work has taxed his health to such an extent that he has been compelled to temporarily suspend his writing. His department will be resumed in October.

The Monthly Service Bulletin of the NATIONAL AMATEUR WIRELESS ASSOCIATION

Founded to promote the best interests of radio communication among wireless amateurs in America
J. ANDREW WHITE, Acting President GUGLIELMO MARCONI, President ALONZO FOGAL, JR., Secretary

NATIONAL ADVISORY BOARD OF VICE-PRESIDENTS

Prof. A. E. KENNELLY
Harvard University

Maj. Gen. GEORGE O. SQUIER
Chief Signal Officer, U. S.
Army

Commander D. W. TODD, U.S.N.
Director Naval Communica-
tions

Major WILLIAM H. ELLIOTT
American Guard

Prof. ALFRED N. GOLDSMITH
College of the City of New
York

Capt. W. H. G. BULLARD,
U. S. N.

E. E. BUCHER
Instructing Engineer

Prof. SAMUEL SHELDON
Brooklyn Polytechnic Insti-
tute

Prof. CHARLES R. CROSS
Massachusetts Institute of
Technology

Colonel SAMUEL REBER
Signal Corps, U. S. Army

WILLIAM H. KIRWIN
Chief of Relay Communica-
tions

Headquarters, 25 Elm St., New York

WE are reliably informed by the Federal Board for Vocational Education, through their Vocational Summary, that a great demand still exists for the services of expert radio telegraphers. Members of the association approaching the draft age should devote their spare time to thorough study of the wireless art in order that they may serve their country most effectively when called.

A considerable amount of self education can be effected through the wireless literature now available. There are also a number of first class schools throughout the United States in which for a nominal fee the applicant can receive advanced instruction. The education so obtained is bound to lead to rapid promotion because obviously the more one knows of a certain art, the more valuable his services become to the government.

The association headquarters stands ready to assist each one to complete their education in every possible way. Advice will be given on all problems which may arise in connection with the work. Members are urged to use these columns freely.

The interchange of ideas between French and American Engineers at the battle front is resulting in widespread

progress in the practical applications of wireless telegraphy. It is reported that French engineers were amazed at the completeness of the wireless telegraph equipment furnished by the United States to its fighting men for war purposes. Many other electrical devices of great utility have been supplied to our fighting forces. Fritz must be careful these days, for his conversations in the trenches 1000 ft. distant are readily picked up.

We regret that we cannot publish more details as to how this detective work is carried on.

Have you heard of any new discovery in radio since the war? If so, keep it under your hat for there may be enemy ears nearby. Radio students should not talk too freely these days. Notebooks used in the classroom should not be allowed to lie around promiscuously. Any information which may be of aid to the enemy should be zealously guarded. It is a foregone conclusion that the members of the N. A. W. A. are living up to this necessity.

J. K. D., of Kansas City, Mo., writes as follows: "As a former member of the association I write to ask you what should be done in a predicament

such as the following: After careful consideration of fundamental wireless principles, I have developed an idea, which I think would be of ultimate value to the art, but not being permitted to conduct wireless experiments, I have no opportunity to test my invention.

"I write to ask if you believe it possible that the government will grant me authority to conduct experiments to determine the usefulness of this device?"

We doubt very much if the government will grant this permission unless the experiments are conducted under the supervision of a government officer.

If our correspondent believes his apparatus of sufficient value to be of aid to the government, he can arrange either with a wireless manufacturing company, or with the government officials to conduct experiments under their supervision.

Kenneth Sutherland, age 19 years, a Topeka, Kansas, boy, has given his life on the fields of France for his country and the principles of democracy.

Sutherland, whose call letters were 9 D Q, is officially reported killed in action on July 17.

Many amateur wireless friends will regret the death of Kenneth Sutherland, the young Topeka wireless operator, who at the age of 18 years enlisted in Company A, Signal Corps, and began his trip to give his life for America. He was born in Topeka and lived there all of his life. He graduated from the Topeka high school just before his departure with the company to Camp Doniphan. He sailed on May 19 for France.

Young Sutherland had as his hobby the operation of wireless outfits. He was known as one of the foremost radio men in Kansas and was president of the Kaw Valley Radio Association.

"He was wild to go when war was declared," his father stated, "and we did not have the heart to break the

boy's spirit." Today Kenneth is remembered as one of America's sacrifices for liberty.

The word of young Sutherland's death was the first information received that his radio company had gone into active service. Numerous letters have been received by Topeka friends and relatives of the men, telling of the training in France, but the latest letters received said nothing about active service.

HEARD IN THE CORRIDOR AT MARCONI INSTITUTE

(Reported Verbatim)

"Oh boy! you remember the night that Larney tried to reach Denver from Boston?"

"Yeh? Did he do it?"

"Sure, after calling for half an hour, Denver came right back."

"Some work!"

"You said it. When Larney signed off a faint murmur slipped through the ether."

"Yeh? Wha'd'd he say?"

"He said, 'Hey Larney!—mind taking your bloomin' aerial off mine? It's been down two days.'"

"Gee crickets! Any casualties?"

"Few. One burned-up bulb, one pair of 'phones, and a scared-stiff bean-eater."

"Must 'a been an apartment house."

"Sure! Six aerials on one roof."

"Make good clotheslines!"

"Sure, six dead niggers up to April, 1917."

Major F. Reichenbach, signal corps, U. S. A., has sent out a call for cable operators, radio operators, telephone men who have had actual experience in construction, engineering, operation and maintenance of commercial companies, telephone and telegraph wire chiefs, cable splicers, machinists and gasoline engine men.

The age limits are from 18 to 55 years. Applicants must be American citizens or must have made legal declaration of intention.

Experimenters' World

FIRST PRIZE, TEN DOLLARS

A Simple Regenerative Receiving Set

IF amateur experimenters are permitted to use their apparatus when this war is over, there will be a greater demand than ever for a first grade equipment. One type of apparatus that will be particularly required is a receiving set which responds to both damped and undamped oscillations. Many amateurs prefer a receiving set of great simplicity—one which does not require complicated multipoint switches, and a number of soldered connections. I have therefore, shown the construction in the second diagram of a receiving panel that will be suitable for their requirements.

The cabinet may be of any wood properly finished. It should have over all dimensions of approximately 15" x 10" x 7".

As will be noted from the diagram, the set proper consists of 3 variometers, one condenser, and a three-electrode vacuum tube.

The antenna variometer consists of two cardboard tubes $3\frac{1}{2}$ " and 3" in diameter, respectively. The $3\frac{1}{2}$ " tube is wound with 45 turns of No. 32 single

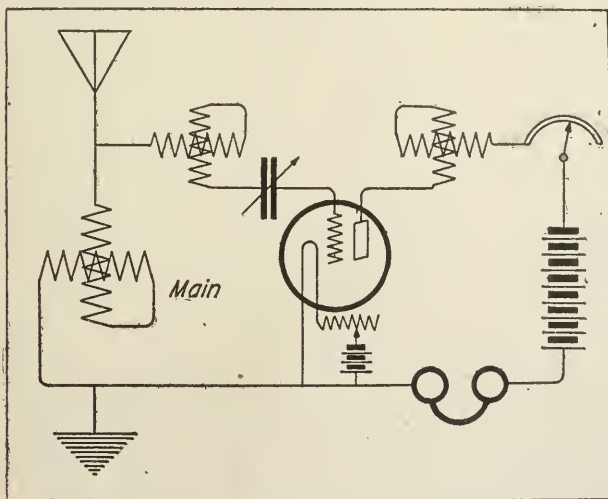

Figure 1—First prize article

silk wire, and the other tube with 50 turns of No. 32 single silk wire.

The grid and plate variometers are identical. They have the same dimensions as the antenna variometer except that they are wound with 30

turns on the outside tube, and 35 turns on the inside tube.

The variable condenser has a capacity of .0005 mfd.

Referring to the drawing of the panel, the lower left hand knob con-

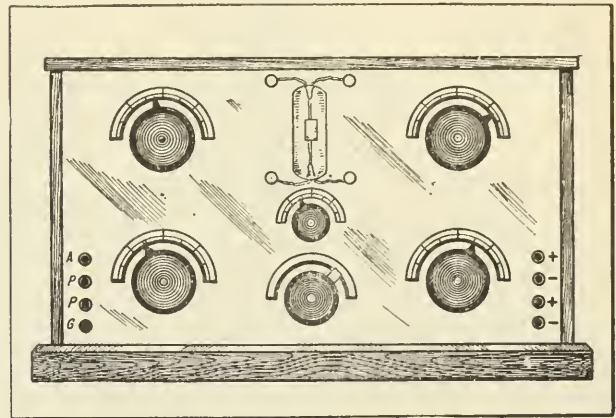

Figure 2—First prize article

trols the antenna variometer, the upper left hand knob the grid variometer, and the upper and lower right hand knob controls the condenser and the variometer in the plate circuit, respectively.

The control knob directly under the vacuum tube is attached to the filament rheostat within the box. The remainder of the diagram, and construction of the panel is self explanatory.

It is to be noted that by this method of connection, the plate circuit is tuned to the frequency of the incoming oscillations, and that the required regenerative coupling is furnished by the tube itself. If, however, greater amplifications are required, inductive coupling can be provided between the grid plate circuit by placing the grid variometer and the plate variometer in proximity.

The advantage of this apparatus lies in the fact that there are no variable contacts or multipoint switches, the necessary tuning being done simply by turning the variometer.

In some cases it may be of advantage to shunt the plate battery and the head telephone by a variable condenser.

JOSEPH LIGMOND,
New York City.



Specialists in camouflage for the U. S. Army developing new methods of battery concealment on a model

SECOND PRIZE, FIVE DOLLARS

The Design of a 500-Cycle Transformer

IT has been shown that for maximum efficiency the iron losses in transformers should be approximately equal to the copper losses.

Assume for example that the design of a 3/4 K. W. transformer is under consideration; with a loss of 6% and efficiency of 94%, the total loss will be 45 watts; one-half of this or 22 1/2 watts will then be the iron loss.

The watt loss per lb. for good silicon steel .014" thick at 500 cycles is approximately 1.2 watts. Dividing this into 22 1/2 gives 19 lb. as the weight of iron. Dividing 19 by .276 gives 68 cu. in. for the total amount of metal. For economy of copper, and to facilitate the cutting of the metal, the transformer should be square in form and in cross section.

Assume 1.7" for the side and 2.89" for the cross section; their product divided into 68 gives 23.5" as the mean length of the path. Dividing the result by 4 gives approximately 5.87" or 7.25" outside and 4" inside length.

With steel of the above dimensions we shall require about 59 pieces to the inch, or totally 400 pieces 1.7" wide by 5.9" long.

We may assume a primary voltage of 100 volts, current of 7.5 amperes; also a secondary voltage of 10,000 volts current of .075 ampere and the ratio of transformation to be 100. The formula,

$$V = \frac{4.44 \times a \times b \times n \times t}{10^8}$$

can be changed to

$$t = \frac{v \times 10^8}{4.44 \times a \times b \times n}$$

where,

v=voltage,

a=cross sectional area,

b=density in lines of force per sq. in.,

t=number turns of wire.

Allowing 15000 lines per sq. in. and solving for

$$100 \times 100 \ 000 \ 000$$

$$t = \frac{100 \times 100 \ 000 \ 000}{4.44 \times 2.9 \times 15,000 \times 500} = 112 \text{ turns}$$

for primary, and since the ratio of

transformation is 100 there will be 11,200 turns in the secondary.

For radio work 1000 circular mils should be allowed for current of 1 ampere. This calls for a conductor of 5700 cir. mils. for the primary coil and 75 cir. mils for the secondary coil. Using the next larger size wire we employ No. 11 (8234 cir. mils) for the primary, and No. 31 (75 cir. mils) for the secondary.

If we use .25" Empire cloth to insulate the primary between the ends of the coil, and allow for the yoke between the coil and the core, the winding length will be 3.5". In this space we can wind 3 layers of 35 turns each. An additional 7 turns can be placed in the middle of the coil to make up the 112 turns.

The secondary should be divided into 10 sections of 1000 volts, and 1120 turns each. Allowing the same thickness of insulation for the secondary as the primary, and 1/32" between coils, we can wind 10 coils consisting of 59 layers of 19 turns per layer, for the secondary.

The overall efficiency may be determined as follows: The mean length of a primary turn is 8.5" and for 112 turns this equals 80 ft. At 1.3 ohms resistance per thousand ft.

$$R = .1 \text{ ohm}$$

$$1^2 R = 7.5^2 \times .1 = 5.6 \text{ watts for the copper losses in the primary coil.}$$

The mean length of the secondary turn is 10.6", total 9900 ft. At 131 ohms per 1000 ft.

$$R = 1257 \text{ ohms}$$

$$1^2 R \text{ loss} = .075^2 \times 1297 = 7.2 \text{ watts for the secondary losses. The total copper loss therefore equals 13 watts, the iron loss} = 22.5 \text{ watts, and the efficiency} = \frac{750}{750 + 13 + 22.5} = 95\%$$

$$750 + 13 + 22.5 = 95\%$$

The primary and secondary inductances may be determined by a modification of the formula given by Messrs. Franklin and Williamson in their work on Alternating Currents as follows:

$$L = \frac{4 \times n^2 \times \lambda}{1} \left(\frac{X}{3} + \frac{Y}{3} + g \right) 10^{-9}$$

Where L =Inductance in Henries,
 n =number turns
 l =2 times the height of the transformer window
 λ =thickness of core,
 X =thickness of pri. coil,
 Y =thickness of sec. coil,
 g =distance between coils,

The above dimensions are in centimeters.

For this example

$$\frac{4 \times 3.14 \times 12,544 \times 4.3}{20.3} (3.3 + 7 + 6.9)$$

10^{-9} = .00069 Hy. pri. reactance.

This may or may not be the correct value required. If not, the dimensions of the transformer will have to be changed.

J. J. HOLAHAN,
Virginia.

THIRD PRIZE, THREE DOLLARS Apparatus for Self Instruction in the Continental Telegraph Code

ALTHOUGH the Government has caused all amateur stations to be closed for the period of the war, they

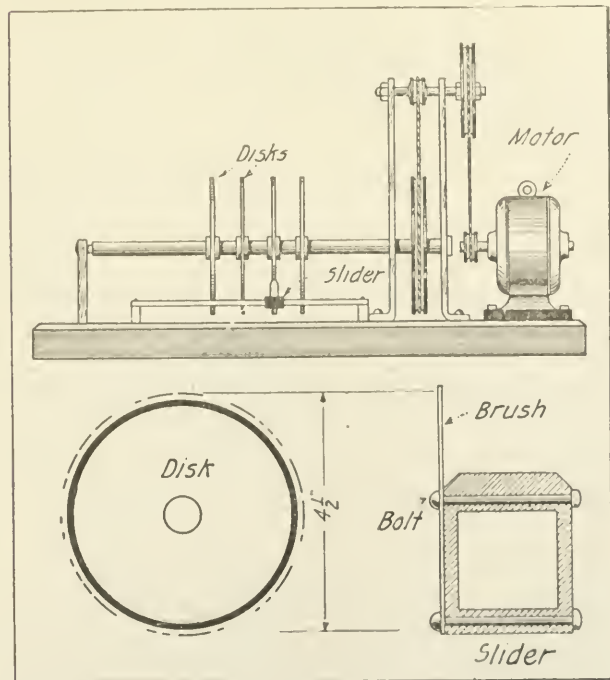

Figures 1 and 2—Third prize article

should not neglect to keep up their code practice. The ordinary buzzer gives only sending practice, but the device described

herewith will give receiving practice, which as is well known, is the harder of the two to master.

The apparatus which I am about to

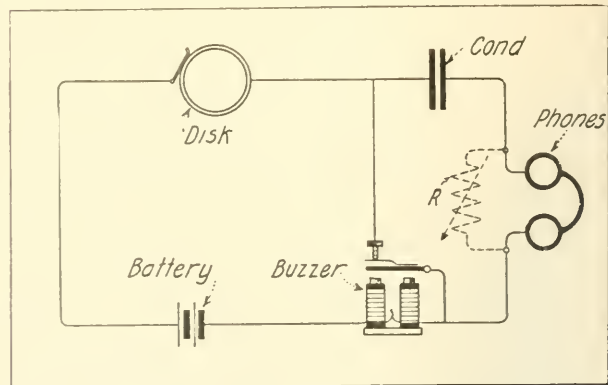

Figure 3—Third prize article

describe can be cheaply constructed. The necessary parts can usually be found around the amateur's laboratory.

The assembled instrument is shown in figure 1, and the details of the cardboard discs are shown in figure 2. Figure 3 is a wiring diagram of the apparatus.

The disc shown in figure 2 is 4 1/2" in diameter. Pieces are cut out of the circumference to form the dots and dashes of the International Code. The discs are then thoroughly shellacked and baked in an oven.

Strips of tin foil which are shown by the dotted lines in figure 2 are pasted on the cardboard disc, and connected to a copper washer in the middle. Care should be taken to cut the tinfoil exactly the same size as the dot or dash on which it is pasted, for otherwise, some dots and dashes will be longer than others. After this is done, the discs are clamped by means of bolts on a threaded shaft which is revolved by an electric motor as shown in figure 1.

The brush shown in figure 2 is made out of sheet brass and screwed on to an ordinary tuning coil slider. The brush may be pushed up and down the slider rod in contact with whatever disc the student desires to use. In this way he may receive practice from a large number of messages.

This device will work well as a flasher of lights on a 110-volt circuit, but a telegraphic relay must be employed because the high voltage would fuse the tinfoil.

J. WISEMAN, JR., *California.*

Construction and Operation of the Field Telephone and Buzzer

THE importance of the work of the Signal Corps in the present war cannot be overestimated, for it is this branch of the service that makes it possible for officers commanding units to keep in touch with the trenches and headquarters of the field troops.

Among the various means of communication are the telephone, buzzer, telegraph, wireless, semaphore, and numerous other methods. The telephone and buzzer are mostly used on the battlefield. The Signal Corps of the U. S. Army have a set which combines both instruments.

Taking this into consideration the writer has made a careful study of the various instruments now on the market, and has designed a set along approved lines, suitable for junior military organizations. He also originated the circuit, his sole object being to make it as simple as possible and to give young men a standard set from which they could use parts for other branches of signaling.

This outfit will not cover 27 miles as the army set, but it will work up to 4000 feet as a telephone set and a great deal further with the buzzer.

It has always been my desire to pick up a book or magazine and find a description of just what was needed for field signaling and no more, but so far I have seen nothing suitable for such service. Now that I am familiar with electricity in its various branches, I decided to give young men an opportunity to benefit by my experience.

The complete circuit is shown in figure 1. It permits the use of either the telephone or the buzzer. Several advantages result from this combination. For instance, if interference makes it difficult to hear the party's voice, the buzzer may be used instead.

We will first consider the buzzer connections. In the drawing they are shown ready for use. Starting at the positive pole of the battery, a wire leads to the lower contact of the key, also to contact No. 5. Contact No. 5 is not connected. Depress the key and

the current flows into the buzzer through contact No. 12, out through No. 10 and back to the negative pole of the battery. The middle contact, No. 11, is connected to the binding post marked G. From the upper contact of the key, a wire leads to contact No. 4 on the T. P. D. T. switch. The current flows through this wire, into the arm No. 1, which is connected to the binding post marked P-1, through the 'phones back to the binding post P-2 to the arm No. 1 and into the wire leading to the binding post L-2, to which the line is connected. The line connected to binding post L-1, which in turn is connected to the negative

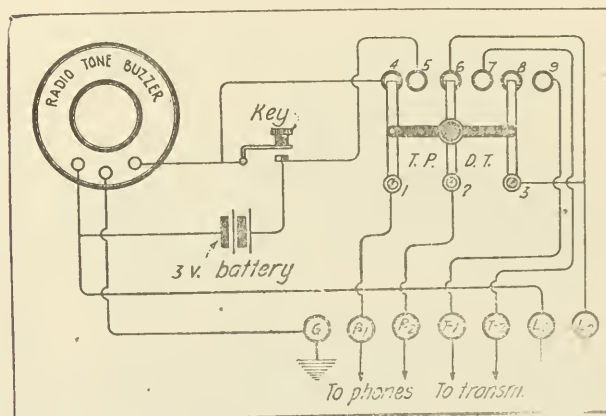

Figure 1—Circuit of field telephone and buzzer

pole of the battery, is in use only when the telephone is employed.

Consider now the telephone connections. Throw the T. P. D. T. switch over on to the other three contacts, Nos. 5, 7, and 9. The transmitter is then connected to the binding posts T-1 and T-2—T-1 being the lower contact on the transmitter and T-2 the upper contact.

Starting at the positive pole of the battery a wire leads to the lower contact of the key also to contact No. 5 on the T. P. D. T. switch. The circuit continues through arm No. 1 into the telephones through P-1, out through P-2 into arm No. 2, through contact No. 7 to binding post T-2 to the upper contact of the transmitter. When you speak into the transmitter, it causes the current to flow through T-1 through No. 9 and arm No. 3 connected to L-2, which is part of

MARCONI SERIES OF STANDARD WAR TEXT BOOKS

Practical Aviation for Military Airmen

A complete text for intensive study. It provides all fundamental information required to prepare an aviator for actual flying.

By

Major J. Andrew White

*Author of "Military Signal Corps Manual."
Chief Signal Officer, American Guard.*

Each component part of the airplane is shown by diagram and principles and methods of operation are concisely stated in detail therewith. It treats broadly many subjects not covered in general aeronautic text books.

Contents

Principles of flight; construction of the airplane; rigging; directions for first flights, cross-country and night flying; construction, operation and care of engines; reconnaissance, map reading, signaling and co-operation with military bodies; radio and its uses; machine gunnery and bombing from airplanes, etc.

Cloth, Price \$1.75

Postage 15 cents

Ready About September First

RADIO INSTRUMENTS AND MEASUREMENTS

*Prepared by the
BUREAU OF STANDARDS
Washington, D. C.*

Every instructor and teacher of radio, whether teaching in college or Government training school will find it a valuable reference book for every day use.

Contents

Part I. Theoretical basis of radio measurements. The fundamentals of electromagnetism. The principles of alternating currents. Radio circuits. Damping.

Part II. Instruments and methods of radio measurement. Wave meters. Condensers. Coils. Current measurement. Resistance measurement. Sources of high-frequency current.

Part III. Formulas and Data. Calculation of capacity. Calculation of inductance. Design of inductance coils. High-frequency resistance. Miscellaneous formulas and data.

In Press,

Full cloth binding, 320 pp. Price \$1.25 in advance of publication

Wireless Press, Inc.

25 Elm Street

New York City

the main line. The negative side of the circuit extends to one binding post of the buzzer, while the other side connects with binding post L-1 which completes the circuit. Therefore the operator may use whichever circuit he desires.

The required articles for this set are listed below:

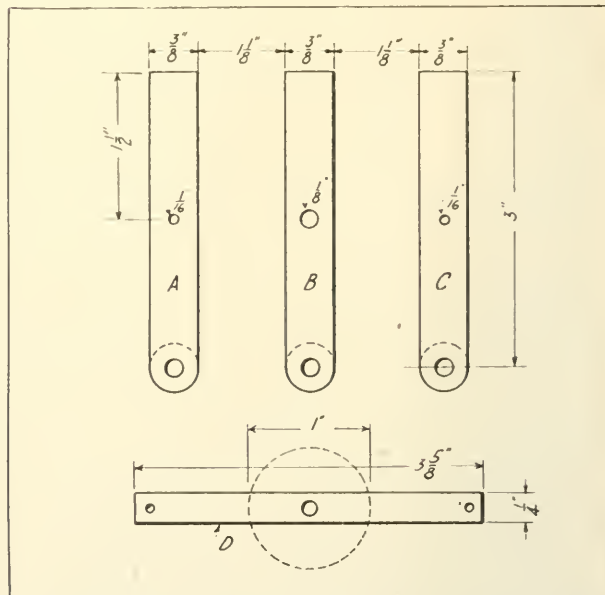

Figure 2—Showing position of cross arm

1 Radiotone buzzer (Electro Imp. Co. Nr. 1K 1800).

1 Strap key (Electro Imp. Co. Nr. C. E. 1118).

Telephones—single one or pair (E. I. Co. Nr. AX1024a).

1 transmitter (E. I. Co. Nr. A. G. E. 6080) or any other make of low voltage (3 volts) transmitter.

7 binding posts, any make or style T. P. D. T. switch.

The construction of this switch is described further on.

The buzzer I have adopted is well suited for this service. The telephones are of the correct resistance for good response. As the receivers and transmitters are to be used in combination, there must be a way to support the transmitter.

Any style of strap key may be used, as they are all built in the same way, but I recommend the E. I. Co.'s as the composition base is waterproof and not as easily broken as a wooden base. This must be taken into consideration

in constructing a portable set, subjected to a great amount of rough handling.

The triple pole, double throw switch consists of the following parts:

3 metal arms A, B and C.

1 cross arm D.

3 flat headed machine screws $\frac{1}{8}$ in. diameter.

1 flat headed machine screw $\frac{1}{8}$ in. diameter for knob.

1 knob drilled and tapped for a $\frac{1}{8}$ in. machine screw.

2 small $\frac{1}{16}$ in. diameter copper rivets.

6 switch points.

Washers and nuts.

The three metal arms have the same dimensions, 3 in. in length, $\frac{3}{8}$ in. in width and $\frac{1}{16}$ in. thick. Arms A and C each have a $\frac{1}{8}$ in. hole $\frac{3}{16}$ of an inch from the end properly centered; also two $\frac{1}{16}$ in. holes $\frac{3}{16}$ in. from the sides and $1\frac{1}{2}$ in. from the end. Arm B has a $\frac{1}{8}$ in. hole $\frac{3}{16}$ in. from the end and a $\frac{1}{8}$ in. hole $\frac{3}{16}$ in. from both sides and $1\frac{1}{2}$ in. from the end.

The cross arm is $3\frac{3}{8}$ in. in length and $\frac{1}{4}$ in. in width. There are two $\frac{1}{16}$ in. holes, $\frac{3}{16}$ in. from each end and $\frac{1}{8}$ in. from the sides. The center hole is $\frac{1}{8}$ in. diameter and is $\frac{11}{16}$ in. from the end. This cross arm is placed across the three main arms as shown by dotted lines in figure 2, and riveted (not tight) so that each arm is able to turn in its place. A $\frac{1}{8}$ in. $\frac{8}{32}$ machine screw is then placed through the center hole and a typewriter knob is screwed on.

In a forthcoming issue, the construction and mounting of the set will be described.

Lieut. R. D. GREENMAN, *New York City*

A Detector Holder for Accurate Adjustment of the Contact Pressure

SOME two or three years ago I constructed a detector holder as per the accompanying drawing, and it occurred to me that it might interest the readers of "THE WIRELESS AGE."

It will be noted finally that my holder not only shows the pressure on the crystal, but also indicates the par-

EQUIP YOURSELF WITH A RELIABLE BUZZER SET FOR CODE PRACTICE

Here Is a Set That Will Give You Excellent Results

The main object of this Practice Set is to enable the beginner to learn the Continental Code, which is easily mastered as the buzzer reproduces the sound of the signals of the most modern wireless stations perfectly.

It comprises a regular telegraph key, without circuit breaker, a special high pitch buzzer, one cell Red Seal Dry Battery, and four feet of green silk covered flexible cord.

The key and buzzer are mounted on a highly finished wood base; three nickel plated binding posts are also mounted on the base and so connected that the set may be used for individual code practice or for operation of a two party line, an excellent method of quickly learning the code. After the beginner has mastered the code, the set may be used in his wireless outfit for setting the detector in adjustment, and also the key may be used to control the spark coil.

Recommended for private use and for schools, as it gives excellent service for class instruction in code work. Full directions with each set.

When used in connection with Marconi-Victor Records this set enables the student to make exceedingly rapid progress.

Wireless Practice Set, with Red Seal Dry Battery and cord.....\$2.70

WIRELESS PRESS, Inc.

25 ELM STREET

NEW YORK CITY

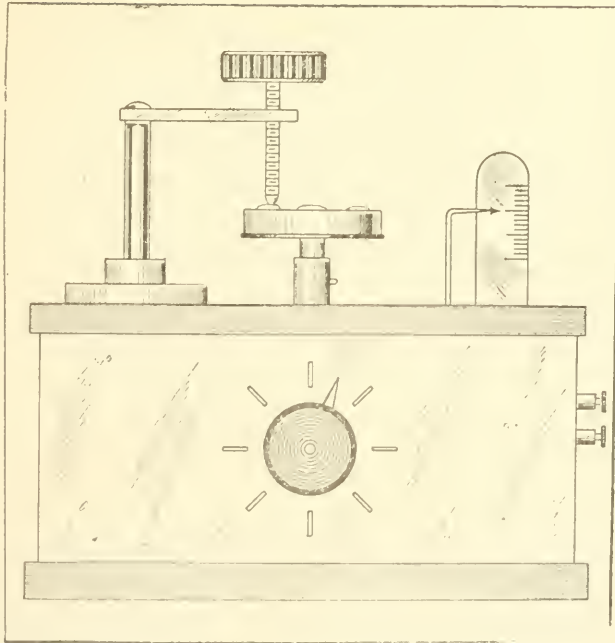

Figure 1—Front view of the detector holder

particular mineral being used at the time that the test is taken.

I have given no direct measurements for this apparatus first, because the essential parts may differ in construction and material, and second, because different size gear wheels may be used.

The advantages of this detector are as follows: The pressure each mineral

requires can be determined accurately, thereby affording a better idea of the correct adjustments of the various types of crystals.

It will be noted that each mineral is so arranged in conjunction with the calibrated pointer and scale, that the

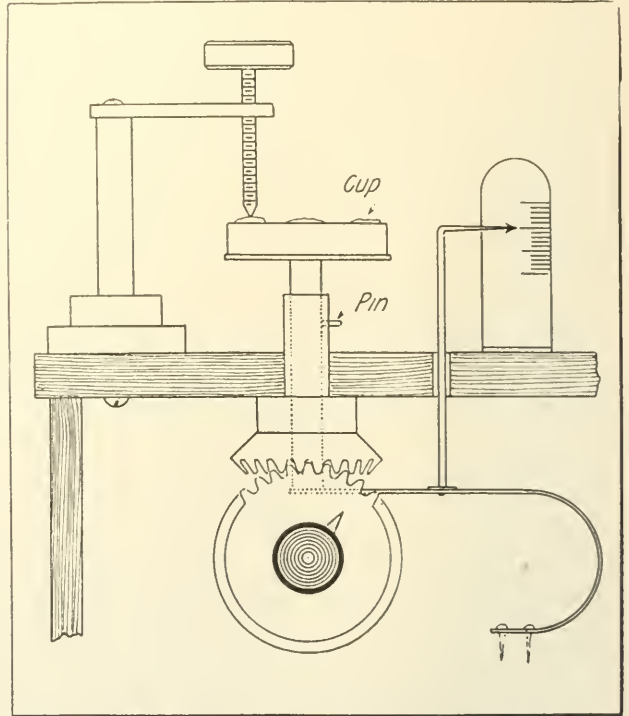

Figure 2—Showing construction plan of the detector holder



Red Seal Dry Batteries Are Guaranteed

to give absolute satisfaction for Automobiles, Motor Boats, Gas or Gasoline Engine Ignition, Medical Batteries, Telephone, Door Bells, Annunciators, Wireless Apparatus or any other open circuit work.

ASK YOUR DEALER

Send for Our New Edition of Our Catalog N28 Now on the Press—
Ready for Distribution At An Early Date

It will be pocket size, 8x4½ and will contain 248 pages with over 1,100 illustrations, describing in plain, clear language all about Bells, Push Buttons, Batteries, Telephone and Telegraph Material, Electric Toys, Burglar and Fire Alarm Contrivances, Electric Call Bells, Electric Alarm Clocks, Medical Batteries, Motor Boat Horns, Electrically Heated Apparatus, Battery Connectors, Switches, Battery Gauges, Wireless Telegraph Instruments, Ignition Supplies, etc.

SEND FOR A COPY NOW

MANHATTAN ELECTRICAL SUPPLY COMPANY, Inc.

NEW YORK, 17 Park Place CHICAGO, 114 S. Wells St. ST. LOUIS, 1106 Pine St. SAN FRANCISCO, 604 Mission St.

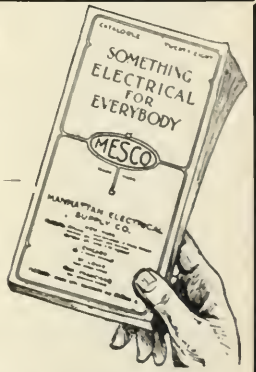

<p>THE WORK WE DO</p> <p>Publications Catalogues Direct Mail Pieces <i>such as</i> Booklets, Folders, Mailing Cards Etc.. Advertising Composition Commercial Stationery Office and Factory Forms</p>	<p>House Organs Street Car Signs</p>	<p>THE CUSTOMERS WE SERVE</p> <p>International Magazine Good Housekeeping Magazine Cosmopolitan Magazine International Film Service Inc. Wireless Press American Weekly Magazine B'way Subways & Home Boroughs Car Ad. Co. Humanitarian Publishing Co.</p>	<p>Hearst's Magazine Harper's Bazar Towse Publishing Co.</p>
<p>THE McCONNELL PRINTING COMPANY</p> <p>226-242 WILLIAM ST. NEW YORK CITY</p> <p>E.E. WONDERLY Manager Phone: Beekman 2980, 8182 WRITE OR PHONE OUR SERVICE DEPARTMENT.</p>			

particular mineral under test is indicated.

As is clearly shown in the drawings, the detector cup is movable by means of the cog wheel. A graduated scale on the front of the box shows the mineral under test at each change. It will be noted also, that even though the cup is allowed to revolve, this does not in any way interfere with the contact pressure of the mineral under test.

E. T. JONES, *Louisiana.*

A Practical Method of Applying the Marconi-Victor Wireless Records

I have devised a method through which I believe the Marconi-Victor records can be used to advantage in training a large class of men.

As shown in the accompanying drawing, a standard phonograph is used for

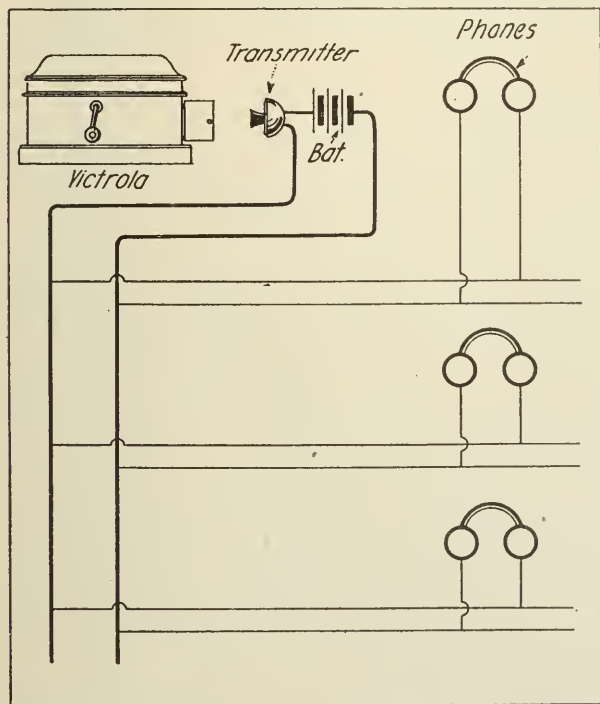

Figure 1—Arrangement to use Marconi-Victor records in class work

the purpose of reproducing the records, but since experience seems to indicate that radio beginners can learn more rapidly by making use of a headphone set, I have shown means whereby the headphones can be used even with the records.

It will be noted that an ordinary transmitter is mounted to pick up the signals produced by the phonograph and at any point along a code practice table these signals can be detected in a headset. This

YOUR Opportunity to Secure a Practical Home Study Course in Wireless

Of Special Interest to Men Who Expect to Enter the Army or Navy.

THE Marconi Institute Extension Training Course and Service is a systematic, time-saving means of furnishing to students in the war camps, homes or local radio clubs, orderly and scientific training through literature prepared by the leading exponents of the art.

It is indispensable to experimenters or students who desire a thorough working knowledge of *wireless*. This service already has been subscribed to by 8,000 men.

It is not essential that students have a college or technical education, but one thing is necessary: they must have a serious purpose and be willing to devote a reasonable portion of their spare time to study and practice.

The Institute Training Service for Schools and individuals comprises the following publications:

<i>Wireless Age</i> , yearly subscription	\$2.00
<i>Practical Wireless Telegraphy</i> ...	1.75
<i>Vacuum Tubes in Wireless Communication</i>	1.75
<i>Elementary Principles of Wireless</i>	1.00
<i>How to Pass U. S. Government Wireless License Examination</i>	.50
<i>Radio Instruments and Measurements (Advance Sale)</i>	1.25
<i>Radio Telephony</i>	2.00
<i>Practical Aviation for Military Airmen (In Press)</i>	1.75
<i>Military Signal Corps Manual</i> ...	1.75
<i>Victor Records for Code Practice (12 lessons)</i>	6.00
<i>Key, Buzzer and Red Seal Battery</i>	2.70

These items may be ordered *separately*, as required, or *in combination* at a discount of 10 per cent. on the magazine and text books, but not on the Records and Apparatus.

Extension Service Department

MARCONI INSTITUTE
25 Elm St. - - New York City

Local and County Representatives Wanted

to present this course to wireless amateurs and others looking forward to enlistment in the Signal Corps or Naval Radio service. Liberal terms.

Slip a Copy in Your Pocket or Kit

You'll find it a faithful friend when you want to get out of some tight place

"What You Want to Say and How to Say It"

In French . . . 25c
 In Spanish . . . 25c
 In Russian . . . 50c

By W. J. HERNAN

The author of these books has been associated with international press associations in all parts of the world and knows what the foreigner in a strange land needs most to help him find his way about and be able to ask for necessities and comforts. These three little books are practical from cover to cover and are extensively used by Army and Navy men, travelers and foreign correspondents all over the world.

Wireless Press, Inc.

25 Elm Street

New York City

Do You Read the Wireless World?

In it you will find articles relating to the PRACTICE of Radiotelegraphy as well as to the THEORY.

The QUESTIONS and ANSWERS SECTION is open to YOU for the SOLUTION OF YOUR DIFFICULTIES.

INSTRUCTIONAL ARTICLES for Home Study WRITTEN BY EXPERTS.

REVIEWS OF BOOKS useful to Wireless Students. The interests of Operators are well catered for.

WRITE for a Specimen Copy, post free to

THE WIRELESS PRESS, Ltd.

Marconi House, Strand, London, England

"WIRELESS WORLD," \$2.25 per annum for America. Single Copies, 25c Post Paid

trains the beginner or student along the lines of everyday practice.

The phonograph-transmitter can be easily muffled so that at a reasonable distance away the signals can only be heard in the head telephones.

While the appearance on the market of these records has been met and welcomed by every student today, with appreciation of the highest kind, it is believed that this suggestion will help to train those desirous of becoming wireless operators for the government in a more radio-like way. The student should be made to use the headset, as it is generally found that the majority of men can copy at a greater rate of speed when making use of the telephone receivers.

E. T. JONES, Louisiana.

Linemen's Rubber Gloves Under Test

THE accompanying illustrations show how the Duquesne Light Company of Pittsburgh, Pa., test the insulating qualities of linemen's gloves.

The gloves shown in the photograph are made of pure rubber varying in thickness from 0.038 in. to 0.040 in. (0.97 mm. to 1.02 mm.), having a guaranteed dielectric strength of 10,000 volts and will actually withstand 18,000 volts. The glove is further protected by a horsehide glove, which prevents mechanical abrasion.

To insure the safety of their employees, this company has installed a special laboratory equipment to test gloves immediately upon their arrival from the manufacturer. Those in daily use are tested bi-monthly and must withstand the same test as when new. Linemen, operators and others are compelled to exchange the pair they have in their possession for a new or tested pair on each semi-monthly pay day before their pay vouchers are given them.

The gloves to be tested are transported from the various districts to the laboratory by the general storeroom truck on its delivery days. For this purpose each district has a rugged box in which are two or more trays, one above the other, each divided into a dozen spaces 15 in. long by 2 in. wide

and 5 in. deep (38.1 cm. by 1 cm. by 12.7 cm.). A pair of rubber gloves fits snugly on edge in each space. The hinged cover is provided with a hasp and padlock, while inside on the cover are two spring clips under which the tester at the laboratory slips his report of the tests on a particular quantity of gloves.

Each pair of gloves successfully passing the test is placed in a specially

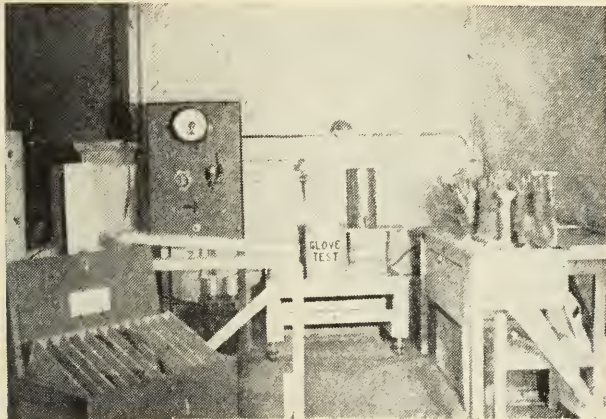

Figure 1—Testing rubber gloves

made envelope 14½ in. long by 4 in. wide (36.8 cm. by 10.2 cm.). When thus enclosed they are placed on edge in the trays, one in a space. The lineman or operator receiving a pair of gloves, sealed in an envelope is assured that they have been properly tested.

The apparatus for making the insulation test is simple, but complete. One pair of gloves is tested at a time being slipped into a specially constructed holder made of copper. This permits the glove to stand with the wrist or gauntlet end open, so that it can be readily filled with water to within 1 in. (25.4 cm.) of the top. For convenience in filling, a spigot is attached to the tank.

The glove holder is immersed to within one inch of its top in an iron bucket of water. Ten thousand volts are applied between the water inside the gloves and that on the outside. The transformer is located on the floor behind the switchboard, its high-tension insulators being visible in the photograph. The volt-meter on the switchboard is connected to the 110 volt or low-tension side of the transformer, but its scale is calibrated to indicate

MARCONI SERIES OF STANDARD WAR TEXT BOOKS

Vacuum Tubes In Wireless Communication

By ELMER E. BUCHER

Director of Instruction, Marconi Institute, New York

Can you adjust a Regenerative Beat Receiver to its maximum degree of Amplification?

Do you understand the circuits of a Cascade Radio or Audio Frequency Amplifier?

Do you understand the difference between the adjustments of the Vacuum Tube as a Detector or as an Amplifier?

These questions and many others pertaining to Oscillation valves are answered in this text book for students and operators.

Tells in understandable language the fundamental operating principle of the vacuum tube.

Shows over 100 different circuits for its practical use as a Detector, Radio or Audio Frequency Amplifier, Regenerative Receiver, Beat Receiver, and Generator of Radio Frequency Currents.

More than 100 diagrams reveal, step by step, in simple and direct form, every possible use of the vacuum tube.

The only text book on the market devoted solely to the various applications of the Oscillation Valve.

Part I—The Oscillation Valve

Part II—Practical Applications of the Valve

Part III—Cascade Amplification by the Vacuum Valve

Part IV—The Regenerative Vacuum Valve Amplifier

Part V—Combined Regenerative and Cascade Amplification Systems

Part VI—The Vacuum Valve as a Detector of Continuous Waves—Audio Frequency Tuning Circuits—Special Circuits for the Vacuum Tube

Part VII—Wireless Telephony

Part VIII—The Dynatron Detector and Oscillator

Every important circuit that has so far been used in connection with the vacuum tube is given. A series of graphic charts in the Appendix reviews the functioning of the vacuum tube in a most elementary manner. The technical introduction reviews the general problems of the continuous and discontinuous transmitters and receivers.

Postage 12 cents extra.

Cloth, Octavo. PRICE \$1.75 net.

WIRELESS PRESS, INC.,
25 ELM STREET, NEW YORK CITY

DUCK'S

BIG 300pp. ELECTRICAL and WIRELESS CATALOG



Mailed upon receipt of 8c, in stamps or coin which may be deducted on first dollar purchase. Catalog contains 160 pages of wireless instruments and 140 pages of electrical supplies. No bigger or better values are obtainable elsewhere. We have a complete stock of everything listed in this catalog. Wireless orders promptly filled.

Blinker Sets, \$2.50

THE WILLIAM B. DUCK CO.

239-241 Superior St. TOLEDO, OHIO



TELEGRAPHY and RADIO FOR MEN IN DRAFT

Send for our latest folder on LAND WIRE Telegraphy. Day and Evening classes. Prepares for all branches. Particularly attractive work.

DAY and EVENING classes in RADIO for Naval Reserve, Aviation, Tank Service, Signal Corps and Merchant Marine.

Beginners every Monday in both branches. Send for prospectus.

Eastern Radio Institute

899C Boylston St., Boston, Mass.



SIGNAL CORPS NAVY AVIATION

still need great numbers of

RADIO OPERATORS

Important and pleasant work

Special Courses for Men Subject to Draft

Hundreds have been trained HERE—Modern Equipment
Low Rates—Gymnasium—Dormitory

START TRAINING TODAY

Write or call for
illustrated booklet

Y.M.C.A. Radio School

161 E. 86th St., N. Y. Phone Lenox 6051

BEST RADIO SCHOOL IN NEW YORK

\$37.50 Profit for 3 Days Work

At one of the War Camps between June 4th and 7th one of our men earned \$37.50 selling SIGNAL CORPS MANUALS. We need more men like him. Our books are what the Army and Navy men want and need to help them improve their rating. Write for particulars

WIRELESS PRESS, Inc. 25 Elm St., New York City

Military Books For Ambitious Men in Army and Navy

Tell us what books you need and we will gladly recommend the best books on each subject. We study the needs of Army and Navy men and supply only the most helpful text books. Let us know your needs.

WIRELESS PRESS, Inc. 25 Elm St., New York City

the corresponding high-tension voltage.

A rheostat is connected directly across the 110 volt line and arranged to give an unbroken range of voltages from zero to full rated potential of the primary windings. When the testing

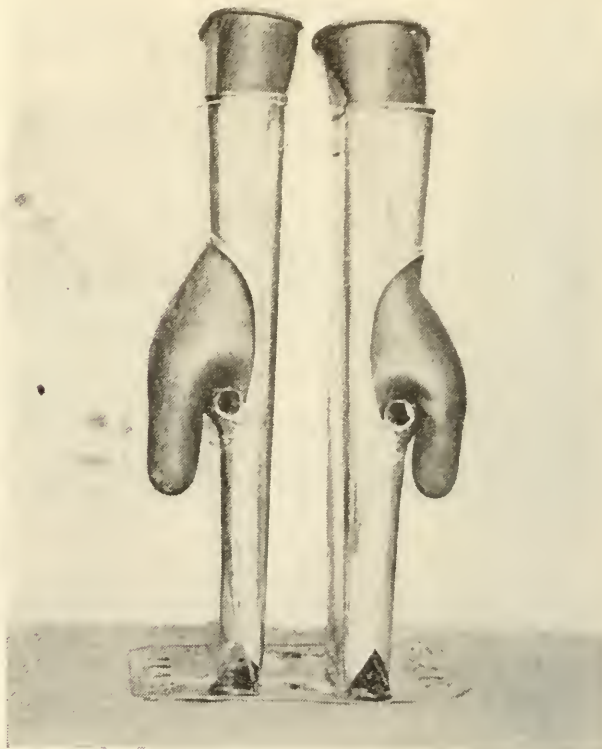

Figure 2—Rubber glove holders for tests

of rubber gloves was first begun on a large scale, investigations were conducted to determine both the charging and the leakage currents of the gloves. It was recognized that the water inside the glove separated from that outside the glove by the rubber wall, constituted a condenser, and that the charging current together with the leakage current could be indicated on a milliammeter in the high-tension circuit. The instruments used for these tests include a very delicate pivot-type milliammeter and watt-meter.

The watt-meter does not indicate the charging component of the current, for the reason that this component is in quadrature with the voltage. From tests made on a dozen pairs of gloves the average total milliamperes per pair was found to be 17.13 and the average total leakage per pair

only 0.25 milliampere. The average energy leakage of a pair was 2.51 watts.

These tests were made at 11,000 volts at the frequency of 60 cycles. At 25 cycles the total current per glove, including charging and leakage, would be 7.14 milliamperes, and at 133 cycles it would be 37.01 milliamperes. The leakage current was the same proportion of the total current as with the 60-cycle tests. The leakage currents have been found so negligible that it was decided that any glove which would stand the 10,000 volt test for one minute is a safe one to use.

Attention is called to the fact that when a glove breaks down under this test a quick acting circuit breaker in the low-tension circuit of the transformer gives the necessary protection to the equipment.

The writer is indebted to Mr. C. W. Ward, Supt. of the Laboratory of the Duquesne Light Co., for the accompanying photographs and data, which should be of special interest to electrical engineers dealing with high tension currents.

FRANK C. PERKINS.

A Wireless Bungalow

ALTHOUGH amateurs cannot use their wireless apparatus at the present time, there is no reason why they cannot make preparations for the future.

One matter which might receive the amateur's attention, is the design of a wireless bungalow for housing his apparatus. The plans of a shack which I constructed are shown in figures 1 to 4 inclusive. This building was erected at a comparatively small cost and afforded a neat wireless room which was away from noises of the house and yet was very comfortable. The best location for the building is directly underneath the lead-in wire from the aerial.

The foundation for the floor is made from six two by fours arranged as in figure 1. The necessary dimensions are shown in the illustration. The foundation is then covered with three-quarter inch matchboards.



LEARN AVIATION

SEND FOR THIS FREE BOOK!

OPPORTUNITY is hammering at your door. The world is calling for millions of men, trained in the science of Aviation, Designers, Builders, Assemblers, Repairmen, Instructors, as well as "Flyers," and offering to pay them big wages! The first step is to send for our BIG FREE BOOK, THE SCIENCE OF AVIATION. It tells how you can learn the basic principles, the "ground work" of this great profession at home under our corps of eminent instructors, among them, Walter L. Brock, winner of the Great London-Paris Race, and others equally famous in aeronautics. The course is prepared so the layman can easily master it—QUICKLY TOO. THERE'S NO TIME TO LOSE. WRITE TODAY.

NATIONAL AERO INSTITUTE
Dept 1216 Morton Building, Chicago, Ill.

LEARN AVIATION MECHANICS

Train Yourself for the Aviation Service and the Aircraft Industry by taking advantage of **Our Ground Course in Aviation Mechanics**

Affording preparation prior to entering Government Ground School, covering aero-dynamics, aero-engines, rigging and Lewis gunnery. Previous experience unnecessary.

Aviation Mechanics Course (6 weeks).....\$60
Aero-Engine Course (3 weeks)..... 35
Wireless Course (4 weeks)..... 25

Write for Illustrated Booklet "W." "A Message to You on Aviation."



EAGLE AVIATION SCHOOL

110-114 West 42nd Street, New York

Books for Men

Wireless, Signal Corps, Aviation, Navigation. Best books on these subjects. Let us know your book needs. We are in close touch with all publishers. Our own publications are authoritative in their field. Orders promptly shipped.

WIRELESS PRESS, INC.
25 Elm Street New York City

PATENTS

THAT PROTECT AND PAY
Books and Advice Free

If you want to sell your patent, take it out through my office. HIGHEST REFERENCES. BEST RESULTS.
WATSON E. COLEMAN, Patent Lawyer
624 F. Street, N. W. Washington, D. C.

Earn Spare Time Money

Represent us in your community. Complete line of wireless literature for amateurs and professional operators, Signal Corps men, Naval Radio operators and men who expect to enter the Service. Liberal commissions. Active agents wanted.

WIRELESS PRESS, INC.
25 Elm Street New York City

Best Text Books for Military Training

Newest editions—with all changes to date. Prompt shipments.

- Military Signal Corps Manual.
Maj. J. Andrew White.....\$1.75
- Vacuum Tubes in Wireless Communication. Elmer E. Bucher.. 1.75
- Radio Telephony. Alfred N. Goldsmith 2.00
- Practical Wireless Telegraphy. Elmer E. Bucher..... 1.75
- Radio Instruments and Measurements (Advance Sale) 1.25
- Elementary Principles of Wireless. R. D. Bangay 1.00
- Practical Aviation for Military Airmen. Major J. Andrew White... 1.75
- How to Pass U. S. Government Wireless License Examinations.. .50
- How to Conduct a Radio Club.... .50
- What You Want to Say and How to Say It in French..... .25
- What You Want to Say and How to Say It in Russian..... .50
- What You Want to Say and How to Say It in Spanish..... .25
- Regimental and Company Forms..... .85
- Infantry Drill Regulations..... .50
- Field Service Regulations..... .75
- Army Transport Regulations..... .50
- Rules of Land Warfare..... .75
- Engineers' Field Manual..... 1.25
- Manual for Non-Com. Officers and Privates50
- Blue Jacket's Manual..... 1.00
- Deck and Boat Book, U. S. Navy.... .60
- Sanitary Troops, Manual and Drill Regulations75
- Manual for Army Bakers..... .50
- Ship and Gun Drill, U. S. N..... .60
- Manual of Military Court Martial.... 1.10
- Gunnery and Explosives for Artillery Officers40
- Provisional Machine Gun Firing Manual, 191750
- Army Field Note Book, by Maj. H. R. Smalley 2.00
- Now ready—New 1918 Edition—Military Aeroplanes, by Grover C. Loening; Revised, Simplified, Enlarged.. 4.75

When ordering please add book postage to above prices.

WIRELESS PRESS, Inc.,
25 ELM STREET, NEW YORK CITY.

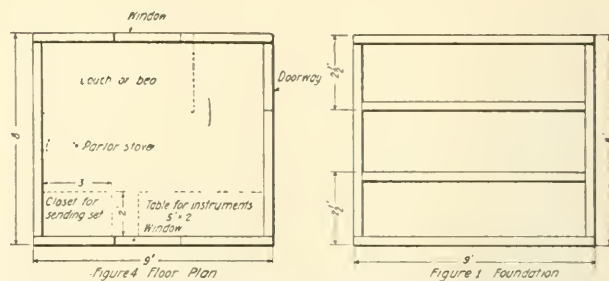
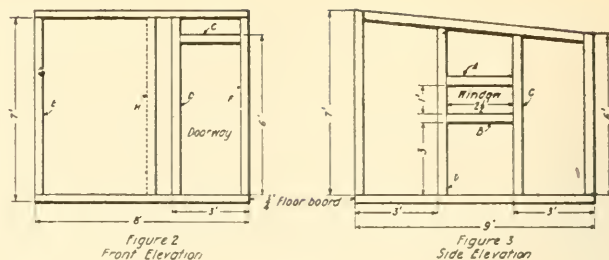

Diagram of building plans for a wireless bungalow

When the floor is completed, the framework should be started.

Figure 2 shows the necessary dimensions for the front frame. The frame for the back is similar except that pieces E and F are six feet high instead of seven. Also in the back frame, piece C should be left out and piece D moved to the position shown by the dotted lines H, figure 2.

The sides are constructed as in figure 3. A space is left on both sides for a window. If the dimensions of the window need to be altered, they can be changed by moving any of the pieces A-B-C-D. I found that two windows of the size shown afforded plenty of light.

The framework for the roof can be made very similar to the floor. As soon as the framework is completed, the building is covered with matchboards and the roof with tar-paper to make it waterproof. If the owner so desires, he can cover the whole outside with tar-paper, and this will keep out much of the wind and cold. After the wireless cabin is finished, it is an easy matter to fix up the inside and lay out the instruments. In one corner I made a closet, or silence cabin, in which I placed my sending set only. Figure 4 shows the exact layout. This left plenty of room for the instrument table, a bed, three chairs, and a stove to drive away the cold on winter evenings.

WESLEY BRADSHAW, Connecticut.

Queries Answered

Answers will be given in this department to questions of subscribers, covering the full range of wireless subjects, but only those which relate to the technical phases of the art and which are of general interest to readers will be published here. The subscriber's name and address must be given in all letters and only one side of the paper written on; where diagrams are necessary they must be on a separate sheet and drawn with India ink. Not more than five questions of one reader can be answered in the same issue. To receive attention these rules must be rigidly observed.

Positively no Questions Answered by Mail.

A. R. L., Nashville, Tenn., inquires:

Ques.—(1) I am acting as a guardian for a young man who contemplates taking up radio work in the government service. He desires to educate himself along wireless lines by home study.

Ans.—(1) He should make a thorough study of the quenched spark discharger transmitting apparatus, and the wave length changing switches. He should also study the processes of tuning transmitters and receivers by means of the wave meter. Another subject of vital importance is the practical use and operation of vacuum tubes. The fundamental principles of the undamped wave transmitters should receive consideration, particularly the arc system.

* * *

D. R. A., Portsmouth, Va.:

We cannot and will not publish during the life of the war, diagrams of radio apparatus employed by the government. Such equipment as was generally known previous to the war period can be discussed through these columns.

* * *

B. D. R., Boston, Mass.:

The resistance of the spark gap in radio transmitters ranges from a fraction of an ohm up to 8 or 10 ohms. The actual value depends on the materials of the electrodes and upon the capacity in the circuit and the damping.

* * *

R. A. N., Chicago, Ill.:

The following formula can be employed to determine the pull in pounds of a magnet upon its armature. This is a fundamental formula:

$$F = \frac{B^2 A^1}{11,183,000}$$

While F = the pull in pounds,

B = the magnetic density in lines per square centimeter,

A = polar area in square centimeters.

* * *

B. A. L., Fort Leavenworth, Kan., inquires:

Ques.—(1) Will you inform me and my associates why it is necessary to advance or retard the spark on a gasoline engine in order to secure the maximum power?

Ans.—(1) It requires an appreciable fraction of time from the instant the spark discharges across the spark plug until com-

SEND HIM A BOOK

Select one of the

MARCONI SERIES OF STANDARD WAR TEXT BOOKS

and he will thank you

WIRELESS PRESS, Inc., 25 Elm St., New York City

EARN TELEGRAPH

Morse and Wireless—R. R. Accounting (Station Agency) also taught. Tremendous Demand—much greater than supply—Permanent Positions Secured. Big Salaries—recently raised. Ideal Working Conditions—short hours, vacations with pay sick and death benefits, etc.—prevailing. Great Opportunities for Advancement. Women Operators also greatly desired by Railways and Western Union. Tuition reasonable. Cheap living expenses—can be earned. Oldest and largest school—two large school buildings, investment exceeds \$25,000.00—established 43 years. Endorsed by railway, Western Union and Marconi Telegraph officials. Large illustrated catalogue free. Correspondence courses also. Write today. Enroll immediately.

Dodge's Telegraph, Ry. & Wireless Institute
Green Street, Valparaiso, Ind.

MARCONI SERIES OF STANDARD WAR TEXT BOOKS

ELEMENTARY PRINCIPLES OF WIRELESS TELEGRAPHY

BY R. D. BANGAY

With the object of increasing the usefulness of this Handbook, the author has extended its scope without going any more deeply into the technical side of the subject.

Since the book has been used largely in the training of Telegraphists who are frequently called upon to take sole charge of complete Wireless Telegraph Installations, the author has endeavored to cover all parts of the transmitting and receiving apparatus in such a way as to give the student a sound working knowledge of the apparatus entrusted to his care.

CONTENTS

Continental Code—Symbols used in Diagrams—Electricity and Magnetism—Magnetism—The Principles of Wave Motion—Pressure Waves—Production of Waves—Production of High-Frequency Oscillations—Production of Oscillating Currents in an Aerial—Coupled Oscillatory Circuits—The Wavemeter—Wireless Telegraph Receivers—The Tuning Buzzer—The Electrolytic Detector—The Magnetic Detector—"Atmospherics"—Aerials—Distribution of Potential and Current Along Aerials—Masts—The Insulation of Aerials—INDEX.

PRICE, \$1.00

Add 10c book postage to above price

WIRELESS PRESS, Inc.
25 Elm Street New York City

Man Wanted

in your community to earn money. Men about to enter the Signal Corps or Naval Radio divisions need our magazine and books. Big sellers wherever shown. Represent us and earn liberal commissions.

WIRELESS PRESS, INC.

25 Elm Street

New York City

MARCONI SERIES OF STANDARD WAR TEXT BOOKS

Practical Wireless Telegraphy

BY ELMER E. BUCHER

Director of Instruction Marconi Institute

Revised Edition, enlarged, with new chapter on Location of Trouble—Maintenance—Repairs

More than 30,000 copies of this book have been sold up to date. It is now used by practically every school, college and training camp in this country. Army and Navy men find this book invaluable.

PRACTICAL WIRELESS TELEGRAPHY is the last word in wireless text books. It furnishes much information of utmost value in regard to the very latest styles of wireless sets now in use, and which has not appeared in print before.

This is the first wireless text book to treat each topic separately and completely, furnishing a progressive study from first principles to expert practice. Starting with elementary data, it progresses, chapter by chapter, over the entire field of wireless—fundamentals, construction and practical operation.

CONTENTS

- Part I. Magnetism.**
The Magnetic Circuit.
- Part II. The Production of Electromotive Force.** Electric Current and Circuits.
- Part III. Electromagnetic Induction.**
The Dynamo—The Flow of Alternating Current.
- Part IV. Motor Generators.**
Hand and Automatic Motor Starters.
- Part V. Storage Batteries and Charging Circuits.**
- Part VI. The Radio Transmitter.**
Condensers—Oscillation Generators—Radiation of Electrical Waves—Damping of Oscillations.
- Part VII. Appliances for a Radio Transmitter.** Spark Dischargers—Oscillation Transformers—Condensers—Transformers.
- Part VIII. Aerials or Antennae.**
- Part IX. Receiving Circuits, Detectors and Tuning Apparatus.** Standard Marconi Receiving Sets.
- Part X. Auxiliary Apparatus or Emergency Transmitters.**
- Part XI. Practical Radio Measurements.** Measurement of Wave Length—Decrement—Calibration—Transmitting and Receiving Apparatus.
- Part XII. Standard Marine Sets of the American Marconi Company.** Panel Transmitters—Composite Transmitters.
- Part XIII. Marconi Direction Finder or Wireless Compass and its Application.**
- Part XIV. Transmitters of Undamped Oscillations.** Arc Generators—Radio Frequency Alternators—Pilotron Oscillator.
- Part XV. Receivers for Undamped Oscillations or Continuous Waves.**
- Part XVI. Marconi Transoceanic Radio Telegraphy.**
- Part XVII. Location of Trouble. Maintenance—Repairs.**

The 340 illustrations alone, specially drawn, form a complete diagrammatic study and impress upon the reader's mind a pictorial outline of the entire subject.

PRACTICAL WIRELESS TELEGRAPHY is a practical man's book from cover to cover and up to the minute. Size 330 pp. 6x9 inches.

Cloth. Price \$1.75 net.

Postage 15 cents

WIRELESS PRESS, Inc.,
25 ELM STREET, NEW YORK, N.Y.

plete ignition of the mixture drawn on at the intake stroke is obtained. Since the most effective results are obtained from an explosion when the piston of the engine just begins the downward stroke, the spark must be set to occur so that the full force of the explosion is obtained when the piston is in this position. At higher engine speeds, the spark is made to occur earlier than at lower speeds in order that combustion may take place at the proper moment on the downward stroke of the piston.

Ques.—(2) What is the function of the distributor in a gas engine ignition system?

Ans.—(2) This device is a mechanically operated high voltage switch which supplies high voltage current to the proper spark plug in the firing sequence.

Ques.—(3) How is the high voltage current for firing the mixture obtained?

Ans.—(3) It may be obtained from an induction coil fitted with a magnetic interrupter, the coil being fed by a storage battery or dry cells, or the current of a low voltage alternating current magneto may be sent through the primary of the induction coil instead of direct current. High voltage currents also may be generated directly in the armature of a high tension magneto. One type is of novel construction. The induction coil is in reality mounted on the revolving armature. As the armature poles pass between the poles of a permanent or horseshoe magnet, a low voltage alternating current is induced in the heavy current coil. This is interrupted by a circuit breaker at the end of the armature. A high voltage current is then induced in the secondary or fine wire winding, which is wound directly over the primary coil. Such magnetos generate potentials from 10,000 to 15,000 volts. * * *

E. V. A., Fort Worth, Tex.:

A simple repulsion motor for alternating current consists of an armature, field poles and a commutator. The windings of the armature are similar to those of a direct current motor, the coils being connected to commutator segments upon which rests carbon brushes. These brushes are short circuited by an external conductor. The field winding is similar to the usual type of induction motor.

When the current is turned on the field winding, the armature is set in rotation, and when it attains a certain speed, a governor mounted on the armature short circuits the windings, at the same time lifting the brushes off the commutator to prevent wear. The motor then runs as a squirrel cage induction motor. * * *

E. R. B., Providence, R. I., inquires:

Ques.—(1) My friend and I have had an argument concerning the effect of taking out a leyden jar in a transmitting set where two banks of condensers connected in a series-parallel are employed. In the example under argument, we considered a condenser, which consisted of 12 leyden jars, 6 in parallel in each bank, and the two banks connected in series.

My friend argues that if we remove one condenser from the six on one side, we should take out another condenser from the opposite side in order to effect a balance. I told him that this was unnecessary. I also held that by making this change the capacity of the condenser battery is increased. Can you help us in this matter?

Ans.—(1) The removal of the one jar from one bank of the condenser will place a slight additional strain on the bank having the smallest number. This will reduce the capacity of the complete condenser. The added strain imposed upon the jars by the removal of one jar, need not be given consideration, but if two or three jars were removed from the bank, then, the banks should be equalized. You should keep in mind that when two or more condensers are connected in series the resultant capacity will always be less than the capacity of the smallest condenser in the group.

Ques.—(2) If a wireless set will work as well with a simple parallel connection of condensers as with a series-parallel connection, why is the latter connection employed in view of the fact that a greater number of leyden jars are required?

Ans.—(1) In the earlier wireless systems it was thought desirable to employ high transformer voltages, but it has been demonstrated by later experiments that as effective results are obtained from transformers giving secondary potentials from 8,000 to 15,000 volts. In earlier systems it was necessary to split the condenser into two banks to protect the dielectric. The commercial leyden jar of today will withstand potentials up to 15,000 volts without puncture. Hence when the secondary potential is less than 15,000 volts a parallel connection is invariably employed.

You must also take into consideration that with the high frequencies employed in modern wireless sets such as 500 cycles, if the condenser capacity is to remain the same as in the old time sets, the voltage of the transformer must necessarily be reduced.

Ques.—(3) Does the Marconi magnetic detector rectify incoming oscillations?

Ans.—(3) The exact functioning of this detector is a matter of much argument, but it is certain that it converts a group of incoming oscillations into audio frequency pulses which actuate the telephone diaphragm.

* * *

P. R. A., New London, Ct.:

Details concerning the construction of the thermo-couple type of aerial ammeters in use by the Marconi Company are not open for publication.

* * *

V. D. A., St. Louis, Mo.:

If one electrode of the electrolytic valve consists of a plate of platinum and the other a plate of lead, the results obtained during the flow of current vary with the direction of the flow. If the aluminum plate is the anode, a film of oxide of aluminum is

**MARCONI SERIES
OF STANDARD
WAR TEXT BOOKS**

RADIO TELEPHONY

By Alfred N. Goldsmith, Ph. D.

Fellow of the Institute of Radio Engineers
Member of the American Institute of Electrical Engineers
Director of the Radio Telegraphic and Telephonic Laboratory of the College of the City of New York

This complete text on radio telephony is intended for radio engineers, radio electricians in the Navy, men in the Signal Corps and especially men in the Aviation Service who handle radio equipment. Amateurs and others who desire to be clearly informed concerning this newest and most interesting branch of electric communication will want this book.

It is written in clear style, and presupposes very little knowledge of radio. The text deals largely with the practical aspects of radio telephony and its future. It is copiously illustrated with wiring diagrams and previously unpublished photographs of "wireless telephone" apparatus.

**IT IS THE ONLY BOOK TREATING THE
SUBJECT OF RADIO TELEPHONY IN
ALL ITS ASPECTS**

Among the unusual features of the book are a description of how radio telephony was carried on over a distance of more than 5,000 miles; an illustrated description of an airplane radio telephone set; an illustrated description of a large ship radio-telephone set; numerous illustrated sections on smaller ship "wireless telephone" transmitters; land station radio telephone sets of all sizes.

Another noteworthy feature is a description of the method of transmitting a radio telephone message to a ship at sea, or across continent or ocean, including the number of persons involved. This material is in dialogue form and so worded as to require no previous knowledge of the subject.

Among the topics treated are: the construction and operation of the Armstrong oscillating audion circuits; the construction and use of bulb amplifiers; the construction of the great alternators of the Alexander and Goldschmidt systems and how they are controlled, especially for radio telephony.

**8vo. 256 pages. 226 illustrations.
Full cloth, stamped in gold. Price \$2.00 net**

Add 15c book postage

WIRELESS PRESS, INC.,

25 ELM STREET, NEW YORK, N.Y.

Learn the Code by the Easy Natural Method

You Just Listen and Learn

These records for the teaching of the wireless code are proving remarkably popular and effective. Men are using them for individual instruction at home, in schools, camps and training stations.

Many of the leading institutes where wireless is being taught are using the **MARCONI-VICTOR RECORDS** for the rapid and efficient training of men.

The instructors in these schools are using these records in the beginners classes in order to make them familiar with the perfect reproduction of code sounds. As the student advances and reaches the intermediate class he finds these records wonderfully valuable in gaining speed. The advanced student is helped by training him how to concentrate and by making him thoroughly familiar with code words and figures.

Not only are these records proving popular in America but are being ordered in Japan and other foreign countries.

The new **MARCONI-VICTOR WIRELESS CODE INSTRUCTION RECORDS** were prepared by the Marconi Institute in collaboration with the Victor Talking Machine Company and are officially approved by the Marconi Wireless Telegraph Company of America.

The set consists of six double faced records each prepared by a code expert of years of practical experience.

These records provide a series of progressive lessons in elementary and advanced instruction for men in all divisions of Government and commercial service.

Order Your Set Today

BRIEF SUMMARY OF RECORDS

Lesson No.	Title
1	International Morse Code and Conventional signals.
2	International Morse Code, etc., continued.
3	Easy sentences and periods.
4	Easy sentences and periods.
5	Marconi Press, South Wellfleet station.
6	Messages with static interference.
7	Press with static.
8	Messages with erasures, etc.
9	Press with interference from second station.
10	Groups of figures.
11	Ten-letter dictionary words.
12	Ten-letter code words.

A set of six double-faced Marconi-Victor Records, complete in a container with instruction manual, specially priced at \$6.00.

WIRELESS PRESS, Inc.
25 Elm Street New York City

formed on its surface which stops the current. But when the aluminum becomes a cathode the film disappears. When an alternating E. M. F. is applied to the electrolyte the current can travel freely in one direction, i.e., from the lead through the liquid to the aluminum, but it is opposed in the opposite direction.

Book Reviews

Leadership and Military Training. By Lieut. Col. Lincoln C. Andrews, U. S. A. Cloth binding, 4¼ x 6 inches; 191 pages. Lippincott. Price \$1.00 net.

Colonel Andrews' text deals almost entirely with the psychology of successful handling of soldiers. The volume is intended to guide inexperienced officers placed in command of men for the first time and to make clear to recruits the problems of the commissioned officer and some of the responsibilities not covered by drill regulations. Pointed observations are included on maintenance of discipline and morale of raw troops and control of men on the battlefield. The material which points the way to best results in the conduct of drills classifies the instruction as disciplinary and instructional and covers both close and extended order, battle exercises and maneuvers. Many phases of practical instruction are commented upon and rules given to co-ordinate the efforts of the whole command. An officer of limited experience will find this work of special value to him, for the volume contains hitherto unpublished advice on the elements of leadership, rarely analyzed and seldom reduced to printed form.

Obtainable through the Book Dept., The Wireless Age.

Military Instructors Manual. By Capt. James P. Cole and Major Oliver Schoonmaker. Cloth binding. 4½ x 7½ inches; 494 pages. E. N. Appleton. Price \$2.00 net.

A real service has been done officers of our new army by the preparation of this book. It is a condensation of the instruction given at Plattsburg by the men who conducted the training, its particular value resting in the fact that the text covers the new warfare, in which the platoon leader for the first time has virtually assumed the role of a company captain. Besides the usual chapters found in works of this nature, covering drill regulations and field work, trench warfare of modern aspect is broadly treated, from formations and construction of trenches, through occupation, defense and attack, the latter subject covering raids, consolidation of mine craters and platoon advances. Genuine assistance to prospective officers is represented in this work, as the material contained between the covers of the book is not easily accessible and would require considerable labor to reduce to the same useful form.

Obtainable through the Book Dept., The Wireless Age.

Hawkins Electrical Guide. Second Edition. By Hawkins and Staff. Cloth binding. 4¾ x 6½ inches; 10 volumes; 3,368 pages. Audel. Price \$1.00 per volume, net.

At a time when the fate of the United States seems to hang on its sons' knowledge of scientific subjects, the value of these instructive books cannot be overestimated. It is certain that only a small proportion of the

men required for war service in electrical branches can be obtained, and by intensive study students must be prepared to fill the gap. A grasp of electrical fundamentals may be quickly acquired by the Hawkins Guides, for the arrangement of the text is unique. Facts and problems are stated simply and concisely and visualized by numerous illustrations. The statements are then emphasized by questions and answers, fixing the principle firmly in the reader's mind. Special care has evidently been exercised to condense the answers, so memorizing is not laborious. Exhaustive captions, descriptive of apparatus illustrated, are a further aid to impressing construction details on the student mind.

The full set of guides, carefully studied, equip the layman with a practical fund of why and wherefore electrical information, covering consecutively: magnetism, induction, dynamos and armature windings, management of dynamos and motors, instruments, testing, wiring and distribution systems and storage batteries. Alternating currents are then discussed and alternators, A.C. motors, transformers, converters and rectifiers described. Switch boards, circuit breakers, measuring instruments and A. C. wiring are presented in detail and power stations and telephone work explained. Railways, motion pictures and automobile ignition are additional subjects, followed by the telegraph, wireless, bells and lighting. The final volume deals with modern applications of electricity, concluding with the X-ray. Obtainable through the Book Dept., The Wireless Age.

Manual of Military Aviation. By Major H. L. Muller, U. S. A. Cloth binding. 4¾x7¾ inches; 308 pages. Banta. Price \$2.50.

Into this compact volume the author has crowded a very considerable amount of valuable information for those new in aviation service. Basing the manual on American and foreign rules, regulations and practices, perhaps the most complete arrangement of theoretical instruction material has here been assembled for the development of skilled personnel. The author divides his subject into five parts and an introduction. Historical matters are first disposed of and the body of the text then takes up the service of aviation by classifying aircraft and defining the various parts. Training is the succeeding subject, covering personnel and schools, with rules for selection and operation of the latter; duties and care of matériel made clear. A chapter and care of material made clear. A chapter is then devoted to aeronautic motors followed by one on instruments. The science of aviation is then discussed, the subjects being meteorology, navigation of the air and flying. The reader is then invited to view military aviation as an art, being instructed in the fundamentals of war service in the air, organization and operation of units and the principles of combat, reconnaissance, coast defense and naval air service, and anti-aircraft defenses.

There is a distinct place for Major Müller's book in the literature of aviation and the method of presentation of his subject is to be highly commended. So well has the task

**MARCONI SERIES
OF STANDARD
WAR TEXT BOOKS**

**Military Signal Corps
Manual**

By Major J. Andrew White

Chief Signal Officer of the American Guard, Member Institute of Radio Engineers, Acting President Nat'l Wireless Association

This manual, the first of its kind and the only complete work on the broad subject of army signaling, is indispensable to those responding to the call to the colors. Primarily prepared for Signal Corps men, it is a necessity for the proper understanding of apparatus and the tactical employment of troops and equipment.

Officers of infantry and artillery will find the volume of great utility, a proper conception of the enormously enlarged Service of Information being indispensable to all commissioned men.

Prepared with the full co-operation and approval of the Chief Signal Officer, U. S. Army.

CONTENTS

Part I.—Organization

The Signal Corps, An Auxiliary Branch of the Army. The Signal Corps' Relation to the Line of the Army. Aircraft. Government and Administration. Military Courtesy. Personnel. Proficiency Test for Companies of Signal Troops.

Part II.—Drill Instruction

General Principles. Definitions. Commands and Signals. School of the Soldier. Physical Training. School of the Squad. Instruction with Arms. The Company Dismounted. The Soldier Mounted. Elementary Collective Instruction Mounted. Field Signal Troops. The Wire Company. The Radio Company. The Outpost Company. The Field Battalion. Telegraph Signal Troops. The Telegraph Company. The Telegraph Battalion. Base Line Signal Troops. Depot Signal Troops. Ceremonies. Reviews. Inspections. Funeral Escort. The Standard. The Guidon. Manual of the Saber.

Part III.—Technical Instruction and Apparatus

Telegraphy and Telephony. The Voltaic Cell. Ohm's Law, and Primary and Secondary Batteries. The Camp Telephone and the Buzzer. Induction Telegraph Set. Radio-telegraphy. Radio Apparatus of the Signal Corps. Visual Signaling Equipment. Flag Kits. The Heliograph. The Acetylene Lantern. Technical Equipment of Personnel.

Part IV.—Transmission

Transmission of Military Information. General Instructions for Army Signaling. The American Morse Code. The International Morse or General Service Code. Instruction in Garrison. Visual Stations. Telegraphy. Visual Signaling in General. Signaling by Flag, Torch and Lantern, or Beam or Searchlight (without Shutter). Signaling with Heliograph, Flash Lantern, or Searchlight, (with Shutter). The Ardois System. Signaling by Two-Arm Semaphore. Signaling by Hand Flags. General Instructions for Locating and Operating Visual Stations. Letter Codes. Telegraph Code Books and Ciphers. Conventional and Preconcerted Signals with Rockets, Bombs, Small Arms and Guns. Flag Signals by Permanent Hoist. Emergency Signals. Conventional Telephone Signals.

Part V.—Field Service

Signal Troops in the Field. Reconnaissance, Patrolling and Scouting. Military Map Reading. Signal Troops in Field Service. Field Lines. Camps. Company Guard Mounting. The Signal Corps and General Coast Defense. Coast Defense Information in War.

Cloth. 588 pages. 260 illustrations.

Price \$1.75 net.

Add 15c postage to above price

WIRELESS PRESS, INC.
25 ELM STREET NEW YORK, N. Y.

been accomplished, in fact, that it seems particularly unfortunate that illustrations are so few and index and contents page references omitted, the volume thus losing much of its value as a reference work. For the prospective aviator and the one in training, however, the book will be found of real value.

Obtainable through the Book Dept., The Wireless Age.

The Flyer's Guide. By Capt. N. J. Gill, R. A. Cloth binding. 5¼x8½ inches; 153 pages. Dutton. Price \$2.00 net.

This volume is a handbook of elementary character. The author relates from a British viewpoint the steps necessary to become an aviator. He then covers in outline the theory of flight and engine principles. Lack of illustrations and brevity of text take this work entirely out of the textbook class, but as preliminary reading matter for the prospective student it will find favor.

Obtainable through the Book Dept., The Wireless Age.

Aircraft Mechanics Handbook. By Fred H. Colvin. Cloth binding. 5x7½ inches; 402 pages. McGraw-Hill. Price \$3.00 net.

In the preparation of this volume the compiler evidently had in mind assembling various items of established practice and setting them down in convenient reference form. In this he succeeded beyond question of a doubt, for the work includes sufficient valuable data on the various parts and auxiliaries of aircraft to find a place of ready usefulness with mechanics and inspectors. No attempt has been made to prepare the volume for the student,

the text is of a character valuable, however, to mechanics in kindred lines who are engaging in airplane work for the first time. The subjects have been intelligently illustrated and carefully selected and the book should become popular in the broad field for which it has been designed.

Obtainable through the Book Dept., The Wireless Age.

Offensive Fighting. By Major Donald M. McRae. Cloth binding. 4¼x6 inches; 196 pages. Lippincott. Price \$2.00 net.

The junior officer, upon whom falls a large share of the responsibility for successful scouting and raiding in No Man's Land, has in this volume a text specially designed to carry him through his tasks. The author's knowledge of his subject is not theoretical; he has been over there with the Canadians and the problems he solves for our new lieutenants are based on his personal experience. Mine crater consolidation is explained and discussed; trench raids and their various objects and methods of execution are explained and practical instruction is given on the subject of patrols and the control of No Man's Land. The concluding half of the book discusses the fine points of co-operation between infantry and artillery, the infantry in attack, and what trench routine comprises, including the duties of officers and the employment of men. The text is well illustrated and written in a manner which aids quick assimilation of the very valuable suggestions it contains.

Obtainable through the Book Dept., The Wireless Age.



*Quick Service
Fine Quality*

Bronze and Aluminum Castings of the Better Grade

Our facilities enable us to make prompt shipments of quality castings in large quantities at attractive prices.

Castings guaranteed true to pattern.

Let us quote on your requirements.

Bronze Rods and Bushing Castings

Fischer-Sweeny Bronze Company
HOBOKEN, NEW JERSEY

Aircraft in War and Commerce. By W. H. Berry. Cloth binding. $5\frac{1}{4} \times 8$ inches; 292 pages. Doran. Price \$1.50 net.

The case for the airplane during the war, and after, is interestingly set forth in this book. Germany's leadership in the air at the beginning of war is told in a review of European development prior to 1914. The progress of the Allied nations since is covered and the air future of these nations predicted. The book is rather a series of non-technical essays, of great interest to the general reading public that seeks information on the newest of arts but is not concerned with the mechanics of aviation.

Obtainable through the Book Dept., The Wireless Age.

Winged Warfare. By Major W. A. Bishop. Cloth binding. $5\frac{1}{4} \times 7\frac{3}{4}$ inches; 272 pages. Doran. Price \$1.50 net.

If any special distinction was to be awarded to the author of the best personal narrative on his career as an aviator, first honors would easily go to Major Bishop. His book is not only well written, but carefully planned to convey a considerable amount of knowledge to the layman without mental burden. This flyer possesses a sense of humor and proportion, in addition to which he has lived through a remarkable series of experiences. The reader who seeks a broad-gauged view of what the military airman does, and is required to do, need go no further than this book; the author in telling his experiences has covered very completely the subject of aerial warfare in bang-up story-telling style.

Obtainable through the Book Dept., The Wireless Age.

Navigation. By George L. Hosmer. Cloth binding. $4\frac{1}{4} \times 6\frac{1}{4}$ inches; 214 pages. Wiley. Price \$1.25 net.

Professor Hosmer's work on navigation is timely and sensible. Many officers will be needed for the new marine fleets of the United States and this volume has been carefully designed to present the study of navigation so aspirants may successfully pass the examinations for navigators. A noteworthy departure from usual practices has been made in this textbook. Algebraic formulae have been omitted and theory replaced by working rules, thus offering a splendid chance for the man whose education includes only simply arithmetic. Another valuable feature is the series of unsolved navigation problems to be worked out by the reader; these follow careful explanations and practical application of methods of computation which point the way for the novice.

In all respects the book is well planned and may be unreservedly recommended to those who are anxious to master the art of navigation.

Obtainable through the Book Dept., The Wireless Age.

On Navigation Simplified. By C. E. MacArthur. Cloth binding. $4\frac{1}{2} \times 6$ inches; 121 pages. Rudder Pub. Co. Price \$1.00 net.

Prospective masters and mates of sea-going vessels are catered to in this little handbook of practical navigation. Clear understanding of the various problems is arrived at through full explanations and illustrations of all the rules used in the solution.

Obtainable through the Book Dept., The Wireless Age.



¶ Automatic and hand operated controllers, magnetic switches, transfer switches and other controller accessories, have been especially designed and are being manufactured in large quantities, to meet Navy Specifications, No. RE 13A 111D.

¶ This I-C equipment is being used by the largest and most discriminating manufacturers of radio apparatus.

Industrial Controller Co.

Milwaukee

Wisconsin

WALKER BROTHERS & HAVILAND

Eastern Sales Agents

New York

Philadelphia

Index—Vol. V

October, 1917 to September, 1918

	PAGE		PAGE
A			
Actaeon, The Torpedoing of the.....	761	Article VIII	474
Aerial Mast, Building and Erecting a Steel	505	Article IX	573
Aerial Ropes, Preserving	601	Article X	661
Aerials, A Home-Made Insulator for...	689	Article XI	741
Aero Motors, Gas Used for Testing....	824	Article XII	814
Aero Repair Work, New York Trains Draft Men in	671	Article XIII	919
Squadron Organization in U. S. Army	671	Article XIV	1005
Air Licenses, Board to Grant.....	824	Aviators, Steel Airplane Traps for Allied To France, Will Send No More Un- trained	750 751
Messages, The World Scope of Gov- ernmental	624	B	
Airplane to Be Under Wireless Control, Unmanned	883	Battery Charging Circuits, Protection of Before We Go Overseas.....	1021 811
Wireless, A Novel Generator for...	871	Book Reviews	527, 606, 1046
Airplanes, Wireless Signaling From Mili- tary	2	Bottomley, John	794
Alamance Went Under, When the.....	762	Brant Rock Station Demolished, Histor- ical	268
Albany Signal Corps Ready for Instruc- tion Work, The	251	Braun Famous German Scientist Dead, Dr.	709
Allies Get Hun Map of British Waters..	972	Brazil to Have New Link to Rubber Section	622 536
Alternators, Checking Up Synchrosopes for the Paralleling of.....	683	to Have New Station	536
Amateur Stations, Keeping the Govern- mental Eye on	160	British Imperial Chain Admitted, Mar- coni Damage Claim for.....	708
Amateur Station, A Model	512	Ship Regulations More Stringent.....	531
Workshop, A Hint for the	881	Bunnell Straight Line Radio-Key (Ghe- gan Patent)	788
Amateurs for Espionage	5	Buzzer, Signal Corps Model High Fre- quency	701
America by Wireless, Linking North and South	184	Telegraph, Construction of a.....	421
American Academy of Engineers, The..	75	to Operate on 110 Volts, Changing a Low Voltage	511
Marconi Company's Profitable Year	269	Work, A Call for Instructors in Wireless and	95
Marconi Company's Service in Year of War	619	C	
Propaganda from the Sayville Sta- tion, Sending	181	Cables, A Suggestion for Relieving the Congested	94
Ammeter, A Novel	448	Calibration of the Receiving Tuner, Prac- tical	428
Amplifying Circuit for Tubular Vacuum Valve Detectors, An	241	California, Naval Operator Under Fire in Naval Radio School Extended.....	357 624
Receiving System, An	628	Cantonment With Wireless Fire Alarm, A	270
Antenna Control for Radio-Telephony..	537	Captured by the Germans.....	542
Current in Wireless Telephony, Modulation of	526	Cardboard Tubes for Tuning Coils, A Method of Making.....	878
Appeal and Warning, A Mysterious	5	Carolina's Wireless Man Tells Expe- riences in Submarine Raid.....	797
Appointments in the Officers' Reserve Corps	739	Carty Receives the Edison Medal.....	1024
Arc of Novel Characteristics, An In- closed	453	Cathode for Pure Electron Discharge Apparatus, Preparation of the....	539
Army, Aero Squadron Organization in U. S.	671	Cavite Opening, The Significance of the Censorship Board, The Members of the New	355 95
Record Observations, How the Eyes of the	822, 823	Chart in Making Wireless Calculations, Convenient	958
Training Corps, Students'	1003	Chicago, Suspected Spy Stations Raided in	884
Units, Fitting Men to.....	918	China, The Frustration of German Plans in	182
Visual Signaling for the.....	929	to Build Merchant Ships.....	1026
Automatic Code Sender for Beginners, An	598	Chinese Naval Radio Station Proposed..	710
Automobiles, Automatic Headlight-Dim- mer for	681	Code Practice Apparatus, "Howler"....	861
Aviation Section, 10,000 Skilled Men Needed by the	671	An Instrument for Daily.....	510
School for Wireless Men, Advanced	972	Set for Continuous Service, A.....	698
4,500 Men to be Drafted for.....	751	Concrete Ships, Forty-two New.....	939
Aviator, How to Become An:		Ordered, More	842
Article III	45	Vessel, A Huge New.....	647
Article IV	129	Condenser, A Useful High Voltage.....	602
Article V	200		
Article VI	301		
Article VII	377		

	PAGE		PAGE
Condenser, The Construction of an Adjustable Fixed	583	Enemy Station Near New York, Search for	535
Conductors, Computing the Weights of..	767	Engineer and the War, The.....	156
Construction of an Amateur Telephone Cabinet, The	866	Engineers, The American Academy of..	75
Contact Point, An Economical.....	877	English Marconi Maintains Dividends...	447
Continuous Waves by Spark Discharges, The Production of	277	Marconi Company Earns Nearly Two Million	971
Constant Pressure Solid Rectifier.....	630	Enlistment of Students of Electrical Engineering	739
Commerce Destroyers, Wireless as an Aid to	92	Espionage, Amateurs for	5
Communication Opened Between Java and Corregidor Island	94	Experimenters, A Short Cut for.....	336
Complaints, The Futility of Idle.....	2	Experimenter's Laboratory, A Serviceable Switchboard for the.....	509
Computing the Weights of Conductors..	767	F	
Continental Telegraph Code, Apparatus for Self Instruction in the.....	1032	Fahrenheit to Degrees Centigrade or Vice Versa, A Novel Method of Changing Degrees	962
Cotton Approved for Wings.....	672	Farm Wireless News	964
Coupling, New Type of.....	672	Field Telephone and Buzzer, Construction and Operation of the.....	1033
Crystal Detector, Changing From the Vacuum Tube to the.....	960	Fleet Corporation, New Section Is Created for	1026
Detectors, A Current Reverser for..	419	Florizel Struck Horn Reef, When the...	886
Cuban Station in Isle of Pines, A New..	623	Florizel's S O S Means of Rescuing Forty-four	533
Current Reverser for Crystal Detectors, A	419	Foulois, Bridgadier General Benjamin D.	136
D		France and America to Perfect Overseas Communication	445
Damped and Undamped Wave Receiver for Long and Short Waves.....	334	by New U. S. Station, Direct Communication With	796
Dane Invents Steel Soldier Animated by Radio, A	972	Will Send No More Untrained Aviators to,	751
Detailed Temporarily as Majors.....	739	250 Telephone Girls Go to,.....	829
Detecting Breaks in Transmission Lines by Wireless Telegraphy.....	488	Franklin Medal, Marconi Awarded.....	797
Detector, A Multi	426	Fuel, Hydrogen Gas as.....	873
An Efficient Receiving	702	G	
Holder for Accurate Adjustment of the Contact Pressure, A.....	1035	Galvanometer and Photographic Device, Adapting the Vacuum Valve for Use With the Einthoven.....	11
of Simple Design, A Dust-Proof....	348	Gas Used for Testing Aero Motors.....	824
Direct Current Meters, The Testing of..	766	Generator for Airplane Wireless, A Novel	871
Doherty Dies as Hero of the Key, Operator	798	of Sustained Oscillations, A.....	843
Drafted for Aviation, 4,500 Men to Be...	751	The Uni-Polar,	767
Draftsmen, Signal Corps Requires.....	824	German Apparatus Unearthed by Dog, Hidden	357
Dreamin' O' Seventeen.....	778	Aviators on Wireless, The Dependence of	183
Dynatron, The	634, 717, 941	Is Interned, Station Near Where... ..	356
E		Plans in China, The Frustration of. .	182
Edison Medal, Carty Receives the.....	1024	Plant, Mexicans Foil Plans for Secret Raider Foiled by Operator.....	532
Education in War Time.....	487	Raiders, Use of Radio by.....	511
Edwards Dies Suddenly, Ernest T.....	973	Ships Improved, Seized.....	939
Electrical Engineering, Enlistment of Students of	739	Station in South America No Myth Trenches, Numerous Short-Wave Sets in	267
Industries Abroad, The Effect of the War Upon	486	Wireless News Scheme a Failure....	973
Industry During 1917, Developments in the	412	Wireless Plants in Mexico, Six....	624
Men, Signal Corps Has Opening for Many	581	Germans, Captured by the.....	542
Vehicle Coming Into Its Own, The..	489	Germany in South America, Curtailing the Activities of	93
Electrically Controlled Boat, Speculation Concerning the	179	Germany's Abuse of the S O S Call....	4
Electric Inspection Lamp and Magnet, A Novel	963	Attempt to Establish a Station in Mexico	270
Propulsion for New Vessels.....	939	Governmental Air Messages, The World Scope of	624
Relay, Heterodyne Amplification by the	115	Government Schools, Novel Buzzer Practice Set for	418
Welding in the Building of Ships....	1022	Wireless, From Washington to Hawaii by	94
Electrolysis Apparatus	878	Government's Searchlight Regiment, The	588
Electron-Discharge Apparatus	279	Great Britain's Use of Women Telegraphists	710
Discharge Apparatus, Preparation of the Cathode for Pure.....	539		
Electrons, A Valve Which Restricts the Flow of	185		
Electrostatic Voltmeter, An.....	769		

	PAGE		PAGE
Growing Need for Hydro-Electric Power, The	766	Low Voltage Buzzer to Operate on 110 Volts, Changing a	511
Guatemala Acts to Prevent Secret Stations	795	Lusitania's Doom, The Cipher Message Which Foretold	446
H			
Halifax Disaster, The Employment of Wireless in the	181	McCoy, Capt. James C.	670
Hawaii by Government Wireless, From Washington to	94	Magnetic Rectifier, A Full Wave	875
Headlight-Dimmer for Automobiles, Automatic	681	Majors, Detailed Temporarily as	739
Heaviside, Belated Recognition of	1023	Marine Radio, Western Railroad Operation Largely Governed by	796
Hero of the Key, A	183	Maritime Nation, The Greatest	729
Heterodyne Amplification by the Electric Relay	115	Marconi an Advocate of Allied Scientific Board	443
Higl. Frequency Buzzer, Signal Corps Model	701	Awarded Franklin Medal	797
High Power Station for Japan, New	710	Company's Profitable Year, American	269
High Power Stations	711, 831, 931	Company's Service in Year of War, American	619
High Tension Insulator, A Remarkable ..	420	Damage Claim for British Imperial Chain Admitted	708
High Voltage Condenser, A Useful	602	Maintains Dividends, English	447
for Radio Transmitters	448	on the Advantages of Closer Co-operation by the United States With Her Allies	179
Holland Has Long-Range Station	444	to Be High Commissioner to United States	268
How the Eyes of the Army Record Observations	822, 823	Medal Lost at Sea	971
How to Remove Moisture From Transil Oil	768	Victor Wireless Records, A Practical Method of Applying the	1037
Hun Attempt to Destroy Liberian Wireless Plant	885	Marconi's Belief in Our Inventors	25
Humor in Wireless Defiance	444	Measurements of the Intensity of Wireless Telegraph Signals with the Oscillating Vacuum Valve	7
Ships for U. S., Hundred	729	Mercury Vapor Pump for the Production of High Vacuum, A	684
Victim, On the Schuykill	763	Meters, The Testing of Direct Current ..	766
Hydro-Electric Power, The Growing Need for	766	Metric System, The Merits of the	589
Hydrogen Gas as Fuel	873	Mexican Link Established for Shipping Aid	795
I			
Improved Equipment for Nauen	622	Mexicans Foil Plans for Secret German Plant	532
Induction Motor, A New Small Squirrel-Cage	789	Mexico, Germany's Attempt to Establish a Station in	270
Insulator, A Remarkable High Tension for Aerials, A Home-Made	689	Six German Wireless Plants in	624
Inter-Allied Conference on Standards ..	1013	Micropho-Detectograph, A Unique	699
International Strafing a Wireless Possibility	447	Military Airplanes, Wireless Signaling From	2
Inventors, Marconi's Belief in Our	25	Signal Codes	395
Iron Wire Transmission, The Problems of	682	Moewe as Seen by the Enemy, An Exploit of the	183
Isle of Pines, A New Cuban Station in ..	623	Motor-Generator and a one-half kw. 500 Cycle High Voltage Transformer, A one-half kw. 500 Cycle	244
Italian Link With U. S., Remarkable Achievement in	619	Motor, The Regulation of a Series Single Phase	685
Italy's Wireless Link With U. S. Established	446	Multi-layered Tuning Coil, A	961
J			
Japan, New High Power Station for	710	N	
Java and Corregidor Island, Communication Opened Between	94	National Amateur Wireless Assn.:	
Japan, New Research Laboratory in	1022	Monthly Bulletin for October	82
Japanese Yards, Contracts for 30 Steel Cargo Ships Awarded to	1026	Monthly Bulletin for November	168
K			
Kennelly, Recognition to Dr. A. E.	1023	Monthly Bulletin for December	252
Kilner U. S. A., Major Walter Glenn	208	Monthly Bulletin for January	342
L			
Lag on Wireless Time Signals	490	Monthly Bulletin for February	427
Lahm, Major Frank Purdy	580	Monthly Bulletin for March	512
Liberian Wireless Plant, Hun Attempt to Destroy	885	Monthly Bulletin for April	594
Liberty Must Fight	649	Monthly Bulletin for May	690
Linemen's Rubber Gloves Under Test ..	1038	Monthly Bulletin for June	778
Lock Nut, A Simple	875	Monthly Bulletin for July	869
Longest Power Transmission Span in the World, The	489	Monthly Bulletin for September	1027
		Nauen, Improved Equipment for	622
		Naval Operator Under Fire in California	357
		Radio in a Year of War	707
		Radio School Extended, California ..	624

	PAGE		PAGE
Naval Radio Station Proposed, Chinese..	710	Radio Code Instructor, Some Pointers	
Rookies Climb Skyward to Paint....	973	on Teaching Acquired by a.....	974
Navigation Plotting Chart, New.....	644	Frequencies, A Pliotron Oscillator for	
Navy Flying Uniform.....	926	the Production of Large Currents	
Has No Room for Radio Women....	623	at	72
Radio in the,	591	in a Year of War, Naval.....	707
Training Operators for the,.....	6	in the Navy.....	591
Negroes for Army Signalmen.....	625	Key (Ghegan Patent), Bunnell	
News Photographers Needed, Expert....	829	Straight Line	788
New Type of Coupling.....	672	Mechanics, An Opportunity for....	1003
of Receiving Set With Desirable Fea-		Phenomenon, A	787
tures	596	Phone Fog Warning Device, The... 94	
New York Police, Wireless and the....	365	School Extended, California Naval..	624
Search for Enemy Station Near,...	535	Sergeants Needed	829
Nitrate by the Electric Arc, The Produc-		Telegraphy, An Oscillation Generator	
tion of	415	for	188
O			
Officers' Reserve Corps, Appointments in		Telephony, Antenna Control for....	537
the	739	Transmitters, High Voltage Conden-	
One Inch Spark Coil, The Construction		ser for	448
of a	872	Women, Navy has No Room for....	623
Open Circuit Oscillators in Receiving		Receiver, A Short Wave Regenerative..	422
Tuners	452	for Long and Short Waves, Damped	
Operator, German Raider Foiled by....	532	and Undamped Wave	334
Operators for the Navy, Training.....	6	for the Elimination of Static Signals	
Oscillation Circuit for the Reception of		and Harmonics, A.....	362
Damped and Undamped Waves, An	774	for Undamped Oscillations, A.....	451
Generator for Radio Telegraphy, An	188	for Wireless Signals, The Valve... 360	
Oscillations, A Generator of Sustained..	843	Receivers, Open Circuit Oscillators as... 279	
Oscillators as Receivers, Open Circuit..	279	Receiving Apparatus for the Production	
Our New Troop Ship.....	547	of Sinusoidal Alternating Currents	359
Overseas, Before We Go.....	811	Circuit, A Variable Condenser and In-	
P			
Palestine, Swedish Radio Reaches.....	795	ductance for a	844
Pan-American Wireless Chain, The....	891	Detector, An Efficient	702
Wireless Project	358	Phenomena, Comments on	786
Wireless Project, Enormous Benefits		Set, A Design for a Combination Va-	
Seen in	620	cuum Valve	165
Paris by Relay From New Station at		Set Applicable to the Reception of	
Guadeloupe, To	622	Damped or Undamped Waves.... 773	
Patent Litigation, War Calls Off.....	796	Set, A Simple Regenerative.....	1029
Patriotic Operators, An Inland Tribute to		Set, A Small Portable	690
Service for Stay-at-Homes, An Op-	884	Set, A Supersensitive	863
portunity for	795	Set for a Wide Range of Wave	
Phonograph Concert, An Early.....	1023	Lengths, A	953
Photographers Needed, Expert News ...	829	Set With Desirable Features, New	
Photographic Device, Adapting the Vac-		Type of	596
uum Valve for Use With the Ein-		System, An Amplifying	628
hoven Galvanometer and.....	11	Transformer, An Inductively Coupled	
Pliotron Oscillator for the Production of		Transformers, The Elimination of	
Large Currents at Radio Frequen-		End Turns in	247
cies, A	72	Tuner of Neat Appearance, A Com-	
Portable Receiving Set, A Small.....	690	pact	164
Power Companies, Union of.....	587	Tuners, Open Circuit Oscillators in..	452
Transmission Span in the World,		Tuner, Practical Calibration of the..	428
The Longest	489	Reception of Damped and Undamped	
Preserving Aerial Ropes.....	601	Waves, An Oscillation Circuit for	
President's Master Message Speeded by		the	774
Wireless	268	of Damped or Undamped Waves, Re-	
Production Experts Wanted.....	1003	ceiving Set Applicable to the.... 773	
Pump for the Production of High Va-		of Undamped Oscillations, Tikker	
cuum, A Mercury Vapor	684	for the	772
Q			
Quenched-Spark Gap, Novelty in the Con-		Rectifier, A Full Wave Magnetic.....	875
struction of	631	A Low Frequency	118
Queries Answered	86	Constant Pressure Solid.....	630
170, 260, 350, 436, 514, 603, 692,		for High Tension Alternating Cur-	
783, 879, 967, 1043		rent, Air Blast	490
R			
Radio "Bug," Unique Buzz of the Fam-		Red Cross Asks for Old Tracing Cloth,	
iliar	623	The	333
by German Raiders, Use of.....	511	Red, White and Blue Circles on U. S.	
		Machines	824
		Remarkable Achievement in Italian Link	
		With U. S.	619
		Rotary Spark Gap, A Compact and Ef-	
		ficient	686

	PAGE		PAGE
Rubber Section, Brazil to Have New Link to	622	Spark Coil, The Construction of a One-Inch	872
S			
Salvador-Mexico Wireless Opens	531	Design, Novelty in	897
Sayville Disclosure, Another	534	Discharger for Radio Frequency Oscillation Circuits	980
Station, Sending American Propaganda from the	181	Discharges, The Production of Continuous Waves	277
Schuylkill Hun Victim, On the	763	Gap, A Compact and Efficient Rotary Gap Designed to Reduce Resistance, A	686
Sea, Americans Under Fire at	761	Gap for High Tension Alternating Current, A Rectifying	979
Distances, Using Wireless to Measure Finding your Way Across the,	622	Spies, Wireless Stations and Spies	4
Article I	27	Spy Stations Raided in Chicago, Suspected	884
Article II	28, 97	Squirrel-Cage Induction Motor, A New Small	789
Article III	221	Static Signals and Harmonics, A Receiver for the Elimination of	362
Article IV	283	Station, A Model Amateur	512
Article V	483, 566	at Guadeloupe, To Paris by Relay From New	622
Article VI	640	Brazil to Have New	536
Article VII	724	Demolished, Historical Brant Rock.. in Mexico, Germany's Attempt to Establish a	268
Article VIII	837, 937	in South America No Myth, German in the North, An Efficient	270
Seaplane Minus Wings, A	488	Holland Has Long-Range	267
Seaplanes Destroy U-Boats in Face of Odds	751	Near Where German Is Interned	242
Searchlight Regiment, The Government's	588	Stations and Spies, Wireless	4
Seadler Heard of Again, The	181	Guatemala Acts to Prevent Secret.. High Power	795
Series Single-Phase Motor, The Regulation of a	685	Steel Aerial Mast, Building and Erecting a	711, 831, 931
Service, In the	119	Airplane Traps for Allied Aviators	505
Set, A Combination	582	Step-Down Transformer, The Design of a 150 Watt	750
Shipbuilder, Song of the	842	Stevens, A. Leo	249
Shipbuilding Primer for Beginners	647	Storage Batteries, Vacuum Valve Rectifiers for Charging	482
Ship Day, Fourth of July a	842	Submarine Attacks, A Convoy to Ward Off	417
Shipping Aid, Mexican Link Established for	795	How an American Steamship Was Saved From a	23
Ships' Tonnage Is Figured Four Ways, How a	1026	Raid, Carolina's Wireless Man Tells Experiences in	93
Shipyards Employed, 300,000	842	Raids Sent in Advance, Wireless Warnings of	797
Short Wave Regenerative Receiver, A.. Sets in German Trenches, Numerous	422	Under the Sea in a	797
Signal Codes, Military	395	Wireless Company Seized, Count Szechenyi's	271
Corps Has Opening for Many Electrical Men	581	Zone, Protection for Wireless Aerial in the	710
Corps Men at Pratt Institute, Training	55	Supersensitive Receiving Set, A	904
Requires Draftsmen	824	Swanson's Work in the Tropics, Mr.	863
Signaling for the Army, Visual	929	Swedish Radio Reaches Palestine	6
System, A Night	162	Radio Station, New	795
Signalmen, Negroes for Army	625	Switch, A Simple Dead-End	1023
Signal Officers' Training Course:		Switchboard for the Experimenter's Laboratory, A Serviceable	424
Article V	38	Switzerland, Telephonic Time Service in	509
Article VI	120	Szechenyi's Submarine Wireless Company Seized, Count	488
Article VII	190	T	
Article VIII	289	Technical Men Needed	918
Article IX	370	Technically-Trained Man, The Demand for the	95
Article X	455	Technical Men to Serve at Home, A Call for	161
Article XI	559	Telegraph and Telephone Industries, Effect of the War Upon	585
Article XII	651	Telegraph and Telephone Lines, The Use of	897
Article XIII	732	Communication, Wireless and Early Systems of	71
Article XIV	825		
Article XV	913		
Article XVI	999		
Simple Way to Make a Good Variometer, A	595		
Socket for a Tubular Vacuum Valve Bulb, A	584		
Soldiers, Wireless Music for Wounded	590		
Song of the Shipbuilder	842		
S O S Call, Germany's Abuse of the ... Means of Rescuing Forty-four, Florizel's	4		
Save or Serve	972		
South America, Curtailing the Activities of Germany in	93		
No Myth, German Station in	267		

	PAGE		PAGE
Telegraph Equipment, An Under-Sea....	10	United States With Her Allies, Marconi	
Telegraphists, Great Britain's Use of		on the Advantages of Closer Co-	
Women	710	operation by the	179
Telephone, A Convenient	874	U. S., Hundred Hun Ships for.....	729
and the World War, The.....	589	Machines, Red White and Blue Cir-	
Cabinet, The Construction of an Am-		cles on	824
ateur	866	Station, Direct Communication With	
Girls Go to France, 250.....	829	France by New	796
Industries, Effect of the War Upon		Ships Hear Hun Wireless to U-Boats	973
Telegraph and	585	Using Wireless to Measure Sea Distances	622
Receiver, Measurement of the Audi-		Uttmark, Navigator and Educator, Cap-	
bility Current of a	114	tain Fritz E.	26
Lines, The Use of Telegraph and....	897	V	
Without Diaphragms for Code Prac-		Vacuum Tube to the Crystal Detector,	
tice, A	966	Changing From the	960
Telephonic Time Service in Switzerland	488	Valve Bulb, A Socket for a Tubular	584
Telephony, Process of Wireless.....	799, 1014	Valve for Use With the Einthoven Gal-	
Telephony, Radio:		vanometer and Photographic De-	
Article X	12	vice, Adapting the	11
Article XI	103	Valve Measurements of the Intensity of	
Article XII	228	Wireless Telegraph Signals With	
Article XIII	316	the Oscillating	7
Article XIV	399	Valve Receiving Set, A Design for a Com-	
Article XV	491	bination	165
Thaw an "Ace," Major.....	824	Valve Rectifiers for Charging Storage Bat-	
Major William,	928	teries	417
Tikker for the Reception of Undamped		Valve Receiver for Wireless Signals, The	
Oscillations	772	Which Restricts the Flow of Elec-	
Torpedo's Story Self Told, The.....	159	trons, A	185
Training Operators for the Navy.....	6	Variable Condenser and Inductance for a	
Trans-Atlantic Flight of the War Aero-		Receiving Circuit, A.....	844
planes, The Proposed.....	181	Variometer, A Simple Way to Make a	
Transformer, A ½ kw. 500 Cycle Motor-		Good	595
Generator and a ½ kw. 500 Cycle		Vatican, The World-Girdling Communica-	
High Voltage	244	tion Plan Suggested for the.....	182
How to Make a ¼ kw. Step-Up....	167	Victor Makes Records	445
Instructions for Designing a Step-		Voltmeter, An Electrostatic	769
Down	76	W	
The Design of a 500-Cycle,	1031	War and Merchant Marine, The.....	102
The Elimination of End-Turns in Re-		Calls Off Patent Litigations.....	796
ceiving	247	The Engineer and the.....	156
The Design of a 150 Watt Step-		The Telephone and the World.....	589
Down	249	Time, Education in	487
Transil Oil, How to Remove Moisture		Warning, A Mysterious Appeal and	5
From	768	Washington to Hawaii by Government	
Transmission, The Problems of Iron		Wireless, From	94
Wire	682	Wave-Changing Devices, Progress in....	454
Transmitters, Faulty	525	Weagant's Method for Group Frequency	
Tuning and Wave-Length Changing		Tuning	627
of Wireless	411	Western Railroad Operation Largely Gov-	
Troop Ship, Our New.....	547	erned by Marine Radio.....	796
Tropics, Mr. Swanson's Work in the... 6		When the Alamance Went Under.....	762
Try This in Your Spare Hours.....	600	Wings, Cotton Approved for.....	672
Tungsten Lamps, Enormous Growth in		Wireless Aerial in the Submarine Zone,	
Sale of	1021	Protection for	904
Tuning and Wave-Length Changing of		and Buzzer Work, A Call for Instruc-	
Wireless Transmitters	411	tors in	95
Coil, A Multi-layered	961	and Early Systems of Telegraph	
Coils, A Method of Making Card-		Communication	71
board Tubes for	878	and the New York Police.....	365
Weagant's Method for Group Fre-		Apparatus and Advertising.....	242
quency	627	Bungalow, A	1041
Which Has Proven Successful, Novel		as an Aid to Commerce Destroyers	92
Capacity	78	Calculations, Convenient Chart in	
U		Making	958
U-Boats in Face of Odds, Seaplanes De-		Chain, The Pan-American	891
stroy	751	Class for Women, The.....	339
Undamped Oscillations, A Receiver for	451	Defiance, Hun Humor in.....	444
The Detection of	186	Enemy in Our Own Country, The..	180
Under-Sea Telegraph Equipment, An... 10		Fire Alarm, A Cantonment With... 270	
Union of Power Companies.....	587	Instruction, Wartime:	
Uni-Polar Generator, The.....	767	Article VI	57
United States, The Advance of Wire		Article VII	137
Telephony in the.....	157	Article VIII	209

	PAGE		PAGE
Wireless Instruction, Wartime:		Telegraph Signals With the Oscillating Vacuum Valve, Measurements of the Intensity of	7
Article IX	308	Telegraphy, Detecting Breaks in Transmission Lines by.....	488
Article X	385	Telephony, A Recent Development in	281
Article XI	464	Telephony, Modulation of Antenna Current in	526
Article XII	551	The Dependence of German Aviators on	183
Article XIII	674	Time Signals, Lag on	490
Article XIV	752	to Bluejackets in the Northwest, Teaching	152
Article XV	849	to Measure Sea Distances, Using...	622
Article XVI	905	to Solve Air Mail Pilot's Problems..	971
Article XVII	986	Warnings of Submarine Raids Sent in Advance	797
Instrument, A Novel.....	697	Wire Telephony in the United States, The Advance of	157
In the Halifax Disaster, The Employment of	181	Women Break Down the Barriers, The..	355
Link With U. S. Established, Italy's	446	Telegraphists, Great Britain's Use of	710
Music for Wounded Soldiers.....	590	The Wireless Class for	339
News Agency Reorganizes	531	Work, All in a Day's.....	31
Opens, Salvador-Mexico	531	X-Ray Tubes, An Improved Target for	538
Plants in Mexico, Six German.....	624	Tubes, Advance in the Design of....	982
Possibility, International Strafing a..	447	"Zep" Apparatus Given by Crew, Description of	269
President's Master Message Speeded by	268		
Progress in Australia, Substantial..	885		
Project, Enormous Benefits Seen in Pan-American	620		
Project, Pan-American	358		
Signaling From Military Airplanes..	2		
Signals, The Valve Receiver for....	360		
Stations and Spies	4		

AUTHORS

	PAGE		PAGE
Alter, W. Wayne	167	Lee, Maurice	872
Armstrong, Capt. Edwin H.....	119	Lenoir, Lieut.-Col. B. O.	395, 929
Austin, F. E.	162	Ligmond, Joseph	1029
Benson, Thos. W.	861	Lovis, D. B.	959
Bradshaw, Wesley	1041	McCartney, S. F.	960
Buclier, Elmer E.	57	MacGregor, J. E.	76
137, 209, 308, 385, 464, 551, 674		McMurtray, H. D.	247
752, 799, 849, 905, 986, 1014		Marple, Albert	590
Butt, Harvey R.	762	Miranda, Maurice Stephen	510, 689
Carter, Cecil S.	886	Moore, John B.	866
Cisin, Clarence	31	Moorhead, Ross	334
Clark, R. U.	686	Morris, Jr., Joseph	166
Cohen, Samuel	78	Moss, Frank R.	342
Coleman, John B.	690	Perkins, Frank C.	964, 1038
Collison, P. B.	271	Pray, Francis R.....	424
Connely, Willard	152	Rose, Sergeant Frank A.	811
Crocker, Francis B.	23	Schmidt, Norman F.	164
Dio, R. A.	242	Smith, B. L.	772
Doty, Charles R.	863	Smith, D. C.	763
Duskis, E.	962, 966	Stelzer, J. G.	702
Estey, F. Clifford	953	Stevens, A. Leo	482
Foster, R. H.	509	Taylor, C. H.	711, 831, 931
Foulois, Brig. Gen. Benjamin D.....	136	Thompson, Allan	249
Geiger, Charles W.	242	Tingley, E. M.	958
Goldsmith, Dr. Alfred N.....	12	Uttmark, Capt. Fritz E.....	26
103, 228, 316, 399, 491		27, 97, 221, 283, 483, 566, 640, 724	
Gravelly, W. T.	773	837, 937	
Gray, Erwin F.	881	Vance, Harold C.	421
Greenman, Lieut. R. D.....	1033	Vian, Albert J. C.	774
Halligan, J. W.	582	Watson, Paul G.	418
Hansen, Peter M.	241, 598	West, M. B.	595
Hassell, Donald	596	Wildonger, Charles	961
Hilson, Edward	542	White, Howard	422
Holahan, John J.....	244, 1031	White, Major J. Andrew	38
Hull, Dr. Albert W.	634, 717, 941	120, 190, 289, 370, 455, 559, 651,	
Jameson, Fred W.	505, 778	732, 825, 913, 919, 999	
Jensen, G. A.	761	Wiseman, Jr., J.....	1032
Jones, E. T.	426, 428, 1035, 1037	Wolfe, Lloyd	583
Kingley, E. M.	336	Woodhouse, Henry	45
Klaus, Henry	878	129, 200, 301, 377, 474, 573, 661, 741	
Lathrop, Gordon	974	814, 919, 999	

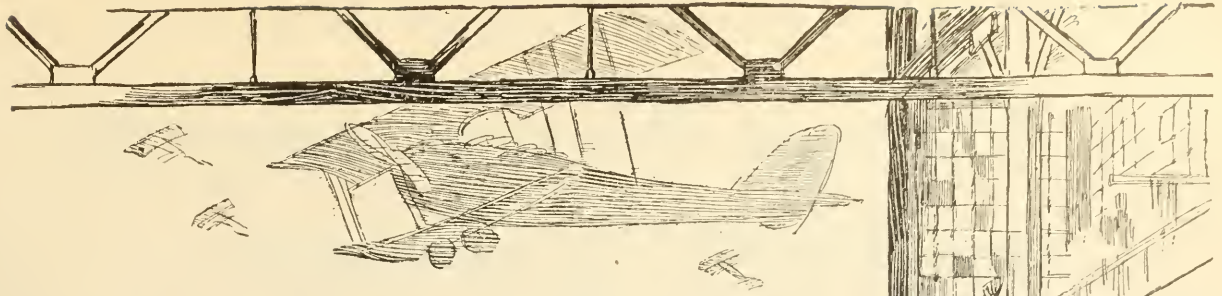

The Right Men in the Right Jobs Will Win The War

THE true American wants to work where he will help win the war. He wants to fit in. America needs the Right Men in the Right Jobs. Only when this comes about can maximum production be obtained to support our armies at the front.

The needs of all war industries can be anticipated and met by the Government if employers and laborers will avail themselves solely of the nation-wide machinery which is at hand. The length of the War depends directly on our Country's ability to supply all War Industry with the best workers the country can produce the moment they are needed.

The U. S. Employment Service is the official bureau of the Federal Government in charge of the distribution of labor. The President has declared that it is the official agency for recruiting and distributing unskilled labor for war work.

It has over 500 branches throughout the nation, and 20,000 U. S. Public Service Reserve enrollment agents. Ask the local post office or newspaper for name and address of the nearest representative, or write to the U. S. Employment Service, Washington, D. C.

Those employers in war work who seek to get labor through their own or private recruiting agencies are interfering with the Government's machinery and preferring their interests to those of the nation. Only through strict compliance with the Government's program can the constant restless shifting of labor from one war job to another with the consequent diminution in production and efficiency, be prevented.

Above all, the Government urges every man engaged in war work to stick to his job until the Government recommends that he change. Any man not engaged in war work should put himself at the disposal of the nation by registering with the Public Service Reserve. This is a tremendously important duty! The war worker ranks with the fighter in the trenches. He will help beat the Hun.

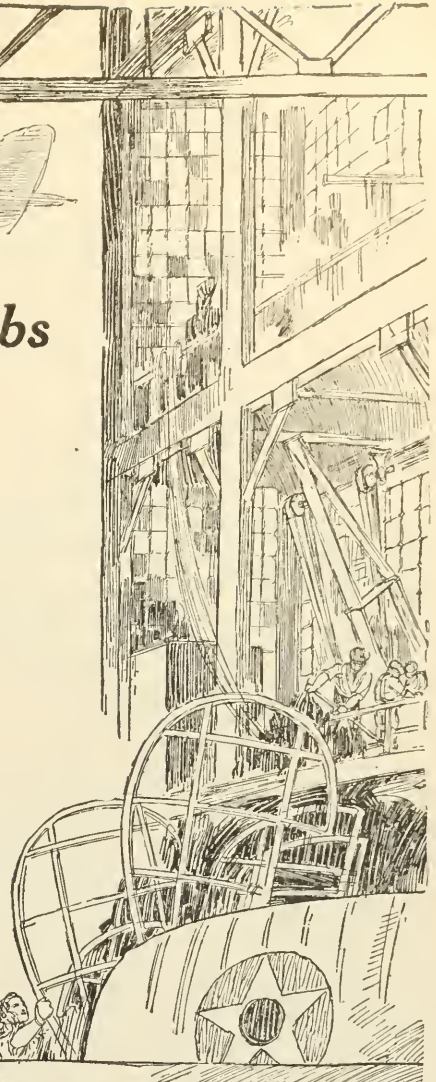

United States
Employment Service
U.S. Dept. of Labor W.B. Wilson Secy.



Contributed through Division of Advertising.



United States Gov't Comm. Public Information.

This space contributed for the Winning of the War by

THE WIRELESS PRESS, Inc.

25 Elm Street

New York, N. Y.

When writing to Advertisers please mention THE WIRELESS AGE

Pan-American Wireless Telegraph and Telephone Company

EDWARD J. NALLY, President

233 Broadway

New York City

**WIRELESS STATION
TO BE WORLD'S BIGGEST**
Marconi Project in Argentina In-
cludes Three Towers of
Eiffel Size.

BUENOS AIRES, July 8.—The Marconi Company is to erect the largest wireless station in the world near Buenos Aires. Edward J. Nally, Vice President and General Manager of the company, has just closed a contract for the installation. The power of the new station, it is announced, will be 11,000 kilowatts, and three towers will be erected, each the size of the Eiffel Tower.

Germany, before the departure from Buenos Aires of Count Luxburg, the deposed German Minister, made every effort to gain the consent of the Argentine Government to the maintenance of a wireless station powerful enough to insure direct communication with the big German station at Nauhen.

From
New York
Times,
July 9,
1918

Such a station has been established, but when Luxburg received his passports this station was dismantled. It had been operating under a temporary concession to enable a German syndicate to conduct experiments, on the promise that the station would merely attempt to receive Nauhen dispatches and would not be used for the transmission of messages. It later became known that the station was sending, as well as receiving. This German station was situated about forty-five miles from Buenos Aires. The Argentine Government sealed, and later dismantled, it.

THE main purpose of the PAN - AMERICAN WIRELESS TELEGRAPH AND TELEPHONE CO. is the closer linking of the Americas by means of the modern and economical method of communication—Radio Telegraphy and Telephony.

☞ A connection with the Marconi Wireless Telegraph Company of America extends its wireless telegraph facilities to Europe and the Orient.

☞ High speed duplex working and reduced rates will be features of the new competitive service of the Pan-American Wireless Telegraph and Telephone Company.

Pan-American Wireless Telegraph and Telephone Company

233 Broadway

New York City

Thousands of

Edison Army-Navy Special Storage Batteries

are in extensive use by the *Radio Divisions* of the United States and all Allied Governments, because the

Edison

is the most rugged, most practical

Storage Battery

in the world.

Our New Type W2-T, Army-Navy Special Edison Battery, of $2\frac{1}{2}$ ampere hour capacity, very small and of light weight, is adopted by at least one great Nation as its standard for operating the wing circuit of electron relays.

The types B-2 and B-4 batteries have long been universally conceded as being the best obtainable batteries for operating the filament circuit of electron relays and for reserve source of power for the entire radio apparatus.

ADDRESS

MILLER - REESE - HUTCHISON, INC.

Storage Battery Specialists

Orange, N. J.

CROCKER-WHEELER

LIKE THE PYRAMIDS, BUILT TO LAST

ELECTRIC MOTORS

Motor Generator Sets

for

Wireless Telegraphy

and

Wireless Telephony

Crocker-Wheeler Radio Generators embody the Crocker-Wheeler Standards of quality and engineering precision. Designed for land stations, ships, portable stations and for a wide variety of special purposes.



BALTIMORE
BIRMINGHAM
BOSTON
CHICAGO

CLEVELAND
DENVER
DETROIT

NEWARK
NEW HAVEN
NEW YORK
PHILADELPHIA

PITTSBURGH
ST. PAUL
SAN FRANCISCO
SYRACUSE