

FEBRUARY, 1925

25 CENTS

# Wireless Age

## The Radio Magazine



REVERE & WISSEHUFF

# Magic Notes from Golden Throats

Both the magic and the golden tone quality are retained if your receiving set is equipped with Cunningham Tubes. To detect accurately, to amplify clearly, to give the utmost in radio reception—that is their job. Cunningham Tubes serve long and well. They combine the rarest scientific accuracy with rugged durability.

Since 1915 standard  
for all sets.

Types C-301A, C-299,  
C-300, C-11 and C-12—  
In the Orange and Blue  
Carton.

# Cunningham RADIO TUBES

Home Office:  
182 Second Street,  
SAN FRANCISCO

*E. J. Cunningham Inc.*

CHICAGO  
NEW YORK

PATENT NOTICE: Cunningham tubes are covered  
by patents dated 2-18-08, 2-18-12, 12-30-13, 10-23-17,  
10-23-17, and others issued and pending.





**APPROVED /  
THE WORLD /  
OVER !**

Approved by magazines and newspapers the world over, including Radio News, Radio Broadcast, Popular Radio, Radio, New York Sun-Globe, and everywhere else wherever subjected to tests.

— and recognized as the  
**World's Greatest Headset Value**

**TOWER'S  
Scientific**  
*Perfect  
Tone  
Mates*  
**\$1  
NOW  
2.95**

Only because we are the **LARGEST EXCLUSIVE MANUFACTURERS** of Headsets in the country are we able to produce the **TOWER'S SCIENTIFIC** at the low price of **\$2.95.**

Every Set of Tower's Scientifics are tested and approved by licensed radio operators.

**TOWER'S Scientific**, lightest of all in weight, offers higher resistance, with elimination of distortion.

Longer cord (full 5 feet). Every set covered with our money-back guarantee.

Production over one million double headsets for this season. Fourteen days' production, if placed in cartons, one on top of the other, would reach a mile into the sky.

*Plus a few Cents Postage*

If your dealer cannot supply you, order direct by postcard, and we will ship immediately, parcel post, C. O. D.

**THE TOWER MFG. CORP.**  
**98-0 Brookline Ave., Boston, Mass.**



# Wireless Age

The Radio Magazine

Vol. XII

No. 5

## February, 1925—Contents

Cover Design, By Revere F. Wistehuff	
Editorial Chat - - - - -	14
Radio-Paris, By Miss Anne C. Granbeck - - - - -	17
The Photo-Radiogram, By K. M. MacIlvain - - - - -	20
Classified Advertisement, By F. R. Buckley - - - - -	24
Around and About the Golden Gate, By Dr. Ralph L. Power - - - - -	28
John Stone Stone, By Oscar C. Roos - - - - -	31
The Children's Hour, By Golda M. Goldman - - - - -	32
A Very Low-Loss Receiver, By R. A. Bradley - - - - -	34
Radio Schools of Housewifery, By Mrs. Christine Frederick - - - - -	36
Among the Broadcasters, By Ed. Randall - - - - -	39
Modifying the Reinartz, By W. P. Lukens - - - - -	40
Loud Speakers and Radio Reception, By John P. Minton, Ph.D - - - - -	42
World Wide Wireless, By C. S. Anderson - - - - -	44
What's the Trouble? By Robert Alan - - - - -	46
Radio Apartments, By Elizabeth Ives - - - - -	47
Production of Electric Current, By Samuel C. Miller - - - - -	48
Los Angeles Exposition - - - - -	50
Broadcasting Station Directory - - - - -	51
Afloat and Ashore With the Operator, By W. S. Fitzpatrick - - - - -	53
One Tube Transmitting Circuits, By John R. Meagher - - - - -	54
Appliances and Devices - - - - -	56
Crossword Contest, By Miss Helen F. Dittus - - - - -	57
A Home-Made Storage Battery, By J. W. Conzelman, M.E. - - - - -	58
Book Reviews - - - - -	93
Amateur Radio Stations - - - - -	96

## Your Authors

DR. R. L. POWER (Around and About the Golden Gate) is well qualified to tell us about the principal feature programs that are broadcast regularly from the several broadcast stations bordering the Pacific Coast. He is actively engaged at station KFI in arranging programs to suit the popular taste in which he has been highly successful.

MISS ANNE C. GRANBECK (Radio-Paris) is an experienced journalist, having written for quite a few weeklies and dailies including the "New York World", "Travel Magazine" and "Hardware Age". She has operated a Tourist's Advice Agency and has an extensive knowledge of matters pertaining to travel both here and abroad. During the War she served with the American Expeditionary Forces and rendered valuable service.

DR. J. P. MINTON (Loud Speakers and Radio Reception) graduated as an Electrical Engineer at the Bradley Polytechnic Institute. He also graduated in Mathematical Physics at the Massachusetts Institute of Technology with the degree of B. Sc. As post graduate student in Physics and Mathematics, University of Chicago, Dr. Minton was awarded the degree of Doctor of Philosophy, the highest honors given by the University. Working three years in the General Electric Co. Research Laboratories he developed the cathode ray tube to a high state of perfection, and invented the cathode ray tube watt-meter and oscillograph.

### PUBLISHED MONTHLY AT WIRELESS PRESS, INC., 326 BROADWAY, NEW YORK

Los Angeles, Calif., 1116 Chapman St., Coast Publishers Co. Chicago, Ill., Wrigley Bldg., Wheeler & Northrup. Boston, 18 Stewart St., Charles M. White.  
 San Francisco, 821 Market St., Coast Publishers Co. Great Britain, 12-13 Henrietta St., London. Australia, 97 Clarence St., Sydney. N. S. W.  
 Yearly subscription in U. S. A., \$2.50—Outside U. S. A., \$3.00; Single Copies, 25 cents. Entered as second class matter Oct. 9, 1913, Post Office, New York, N. Y. under the Act of March 3, 1879. Copyright, 1925, Wireless Press, Inc. When subscription expires you will find a renewal blank enclosed. Return with remittance promptly.

James G. Harbord, Pres. Pierre Boucheron, Vice-Pres. and Gen'l Mgr. L. MacConnach, Secy. George S. DeSousa, Treas. H. H. Reber, Bus. Mgr. C. F. Boag, Adv. Mgr.  
 C. S. Anderson, Managing Editor R. A. Bradley, Technical Editor

Because certain statements and expressions of opinion from correspondents and others, appearing in these columns from time to time may be found to be the subject of controversy in scientific circles and in the courts either now or in the future and to sometimes involve questions of priority of invention and the comparative merits of apparatus employed in wireless signaling, the owners and publishers of this magazine positively and emphatically disclaim any privity or responsibility for any statements of opinion or partisan expression if such should at any time appear herein.

Printed in U. S. A.

THE WIRELESS AGE is a member of the Audit Bureau of Circulations

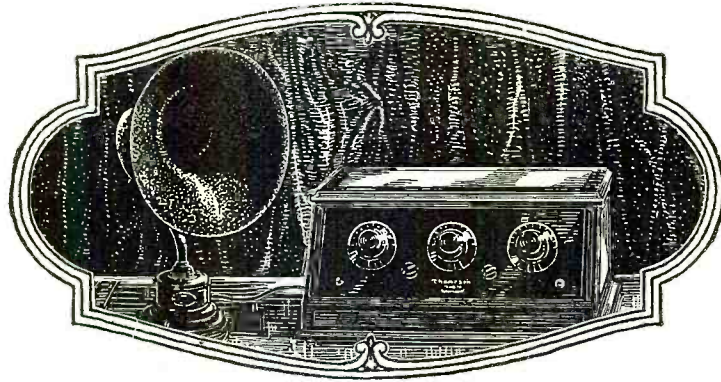

*"Experience is the Vital Factor in Excellence"*

# THOMPSON RADIO

THE Thompson Organization is unique among radiomanufacturers in having a background of 15 years experience in designing, developing and manufacturing intricate and delicate radio apparatus for the armies, navies and commercial institutions of the world.

During this time its research laboratories have perfected developments which have contributed largely to the advancement of the radio industry.



This wide experience, now available in the Thompson apparatus, means Receivers and Speakers that embody the latest and best practice in Radio Engineering. A critical investigation of each model will disclose outstanding features of genuine excellence — in artistic appearance, naturalness of tone, simplicity of operation.

Thompson Receiving sets range in price from \$125 to \$180. The Thompson Speaker is now \$28.

*Write for attractive literature and name of Thompson dealer near you.*

R. E. THOMPSON MANUFACTURING CO.  
30 CHURCH STREET NEW YORK, N. Y.

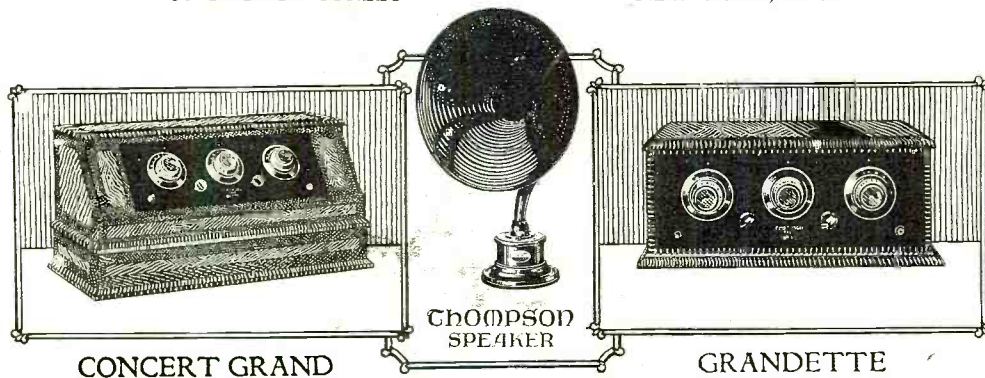

CONCERT GRAND

THOMPSON  
SPEAKER

GRANDETTE

# Somerset Quality

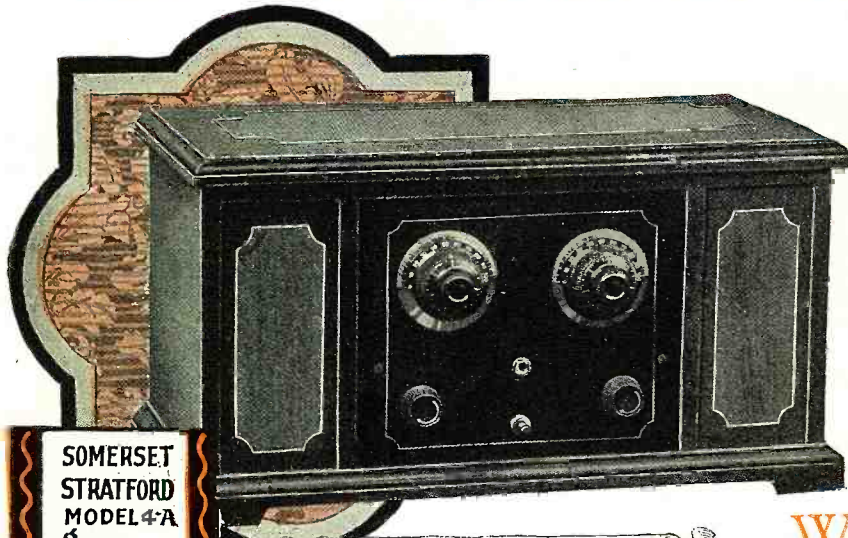

SOMERSET  
STRATFORD  
MODEL 4-A  
\$65

STRATFORD MODEL 4-A

### 4 Tubes—Dual Control

A superior four tube, tuned radio frequency receiver—two dial control—operates on storage battery or dry cells. Automatic filament control insures long life of tubes. The finest "low loss" condensers and the famous SOMERSET Calibrated Transformers are features. "B" battery space is provided in the handsome two-tone mahogany finish cabinet. Size 21" x 15" x 11".

List \$65

Prices subject to change without notice

SHELBOURNE MODEL 4-B

SOMERSET  
SHELBOURNE  
MODEL 4-B  
\$85

### 4 Tubes—Single Dial Control

Our perfected tuned radio frequency circuit with single dial synchronized control. Storage battery or dry cell operation, automatic filament control, the finest "low loss" condensers, and the famous SOMERSET Calibrated Transformers. Compartments for large sized storage "A" and dry cell "B" batteries. Mahogany finished cabinet hand-rubbed two-tone effect. Size 27" x 15" x 12".

List \$85

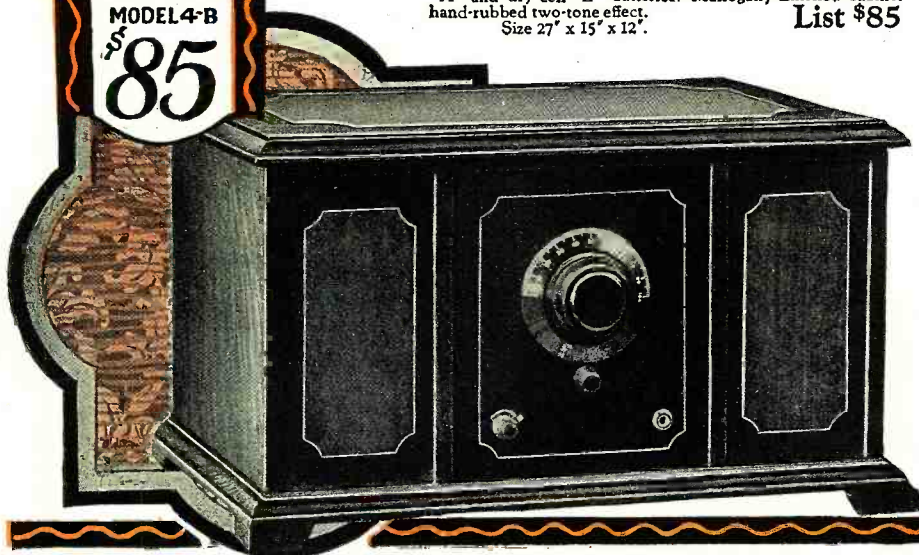

EVERY once in a while somebody brings forth an idea so big, so valuable, and so obvious, that everybody recognizes its merit immediately and wonders why it wasn't done long before. That is the reception which the public has accorded the Somerset Radio Receiver—the perfect tuned radio frequency line. Almost overnight it has leaped into leadership through its unmistakable superiority in design, quality and value. The Somerset line consists of four models—Stratford Model 4-A, 4 tube set, 2 dials—\$65. Mars Model 5-A, 5 tube set, 3 dials—\$75. Shelbourne, Model 4-B, 4 tube set, 1 dial, synchronized control—\$85. Standish, Model 4-C, 4 tube set, 1 dial, synchronized control, with built-in loud speaker—\$150.

WHEN you buy a Somerset Radio Receiver our obligation just begins. For we sell not merely radio receivers but radio reception. You must be satisfied, and you should not be satisfied with anything less than the best reception possible in your location. Somerset Service is organized to see that you get it. Every Somerset dealer is trained in Somerset Service and is anxious that you shall get the best possible results. He will take a real interest in seeing that you do get them. That is why he is a Somerset dealer. But if, by any chance, he should disappoint you, we pledge the entire resources of the Somerset organization to your complete satisfaction.

EVERY STATION IS E-A-S-Y with the single dial synchronized control—featured on our Shelbourne and Standish Models. A simple twist of the big comfortable dial and your favorite station comes in—always at the same point. No need to fuss and adjust—you turn to it as confidently as you turn into your own street going home. The Somerset single dial synchronized control has been perfected after most exhaustive tests, and is made possible only by the most painstaking selection and matching of coils, condensers and transformers. Leading radio engineers have pronounced it a triumph of radio engineering.

### Low Prices!

Each Somerset Radio Receiver represents the best that can be produced for the money—the utmost in results and permanent satisfaction to the owner. Compare them feature for feature with any others at or near their price range—bar none. Fill out and mail the coupon for full information about these splendid instruments. Don't put it off—send today.

Real Values!

## Somerset Radio Receivers

# Radio at a Price!

**S**OMERSET cabinets are unique — each a piece of fine furniture to grace milady's drawing room. Substantial construction, with artistic two-toned, hand-rubbed mahogany finish. Somerset technical features are equally remarkable—secured not only by superior wiring and workmanship but by painstaking care and test in selecting parts and materials. Somerset Radio Receivers are easily the greatest value in radio to-day. And Somerset technical features—too many to describe in detail here—are equally notable. In simplicity of operation, reliability, range, selectivity and tone, Somerset Radio Receivers are without peers in their price range—easily the greatest values in radio to-day!

*The Famous Somerset Guarantee — Satisfaction—or Money Back*

**Y**OU must be satisfied with this receiver or we do not want you to keep it. If for any reason you feel that it is not exactly as represented or that it is not the quality and value which you have a right to expect, we want you to return it for exchange or for refund, whichever you prefer. We will cheerfully and promptly make good any Somerset product which does not fully measure up to your expectations.

**E**VERY completed Somerset Radio Receiver must pass the rigid tests of the Somerset Engineering Laboratories before it is certified "O.K. for shipment". It must function perfectly or it cannot leave the Somerset laboratory. And that is why Somerset Receivers are so remarkably sensitive and selective, reaching out to get broadcast programs from incredible distances, and reproducing them with precise fidelity and rich mellow tone. It is this infinite care with the "tremendous trifles" that places Somerset Radio Receivers in a class by themselves.

## Fill Out

National Airphone Corp.  
16 Hudson St., N. Y. City

Without any obligation to me send full details and information on the Somerset line

Name .....

City .....

State .....

**Mail Today**



SOMERSET MARS Model 5-A

SOMERSET MARS MODEL 5-A \$75

### 5 Tubes—Three Dial Control

Two stages tuned radio frequency, detector, and two stages audio frequency. Storage battery or dry cell operation, automatic filament control, highest quality "low loss" condensers and the famous SOMERSET Calibrated Transformers. Artistic cabinet hand-rubbed mahogany finish providing space for dry cell "B" batteries. Size 29" x 14" x 12" . . . .

List \$75

Prices subject to change without notice

### 4 Tubes—Single Dial Control with built-in loud speaker

Combining a built-in loud speaker of the highest type and the four tube tuned radio frequency circuit with single dial synchronized control—all the latest and best in radio. Storage battery or dry cell operation, automatic filament control, highest quality "low loss" condensers, and the famous SOMERSET Calibrated Transformers. Ample space is reserved in this cabinet for standard size high ampere hour storage "A" batteries and dry "B" batteries. Exquisite cabinet, antique mahogany finish. Size 29" x 13" x 14".

List \$150

STANDISH MODEL 4-C

SOMERSET STANDISH MODEL 4-C \$150

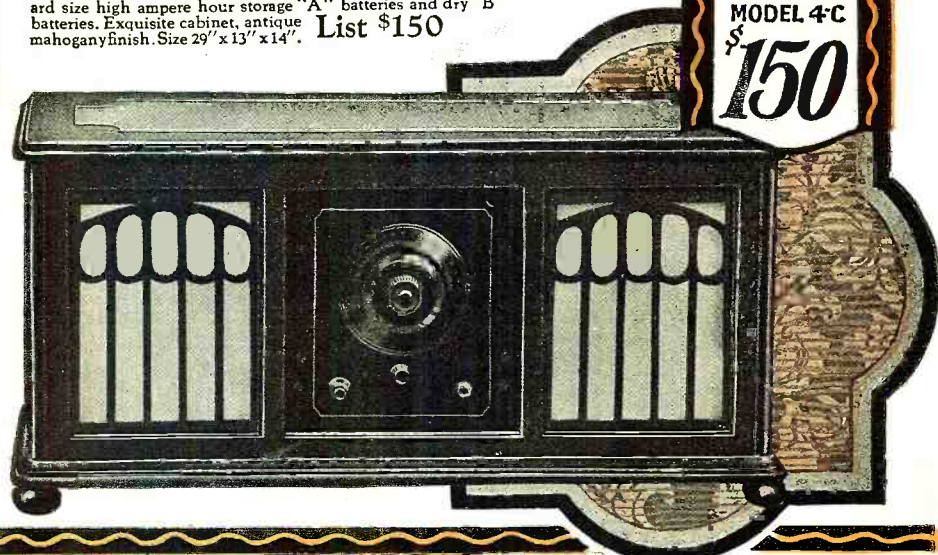

MFD. by

**NATIONAL AIRPHONE CORP.**

16-22 Hudson St.  
New York City

Prices west of the Mississippi, add 10%.

"Quality Goods for Quality Readers"

LET the others have their card games—Grandpa settles down to real amusement—at the radio.

His dependable Brandes Headset shuts out the babble. Its *Matched Tone* gives him each word clearly—with identical tone and equal volume for both ears.

Grandpa's in a world of his own—and the game continues undisturbed. Everybody's happy!

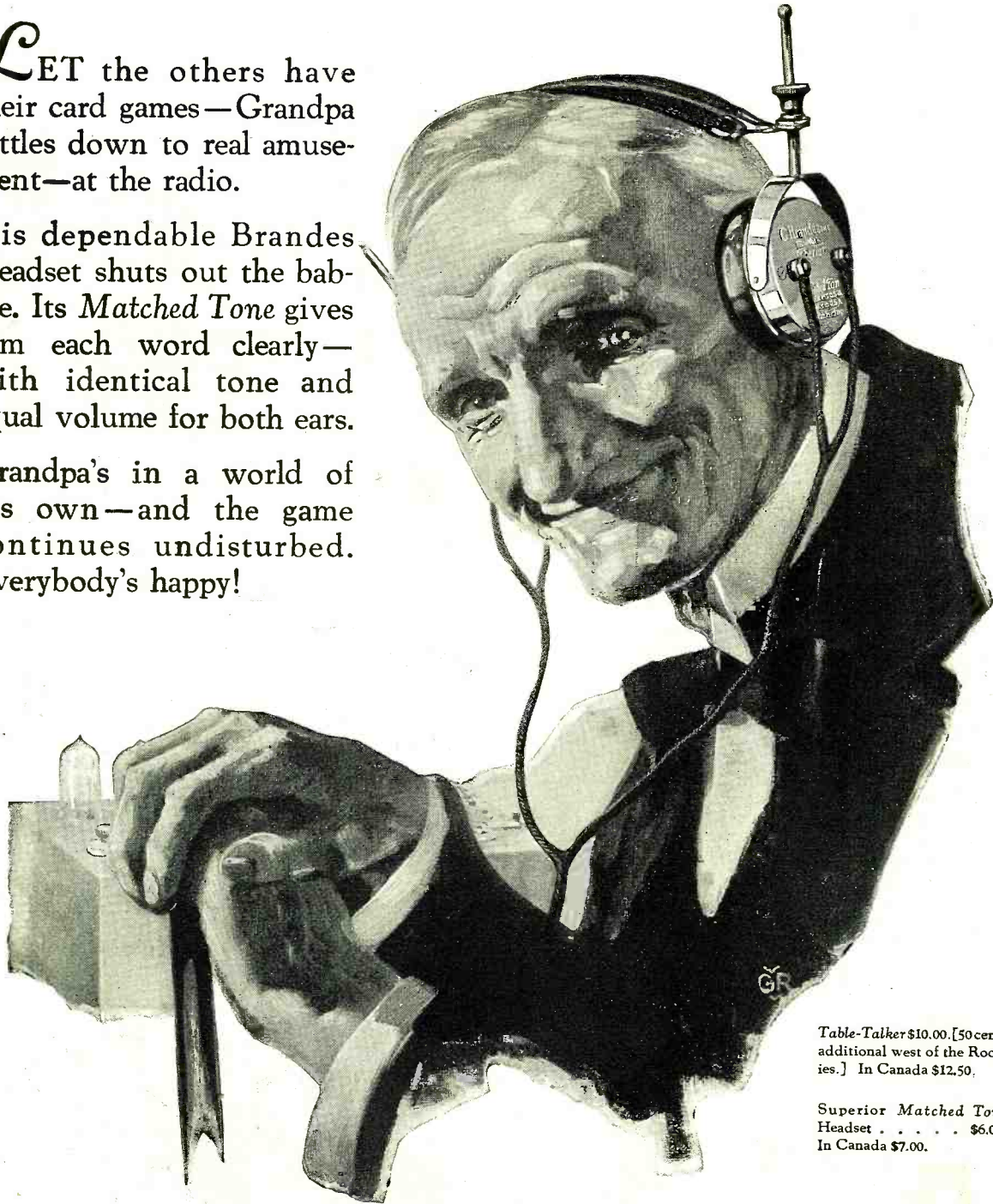

Table-Talker \$10.00. [50 cents additional west of the Rockies.] In Canada \$12.50.

Superior Matched Tone Headset . . . . . \$6.00. In Canada \$7.00.

# Brandes

*The name to know in Radio*

© Copyrighted by C. Brandes, Inc., 1925



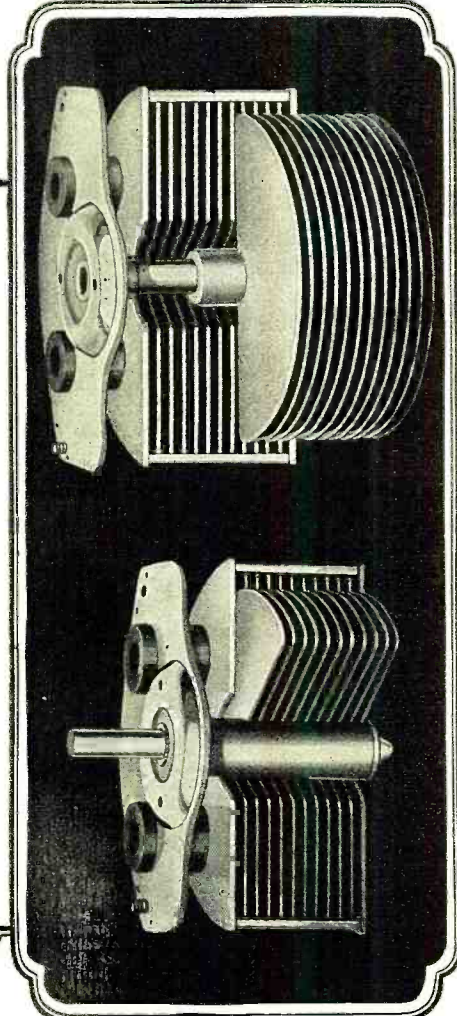
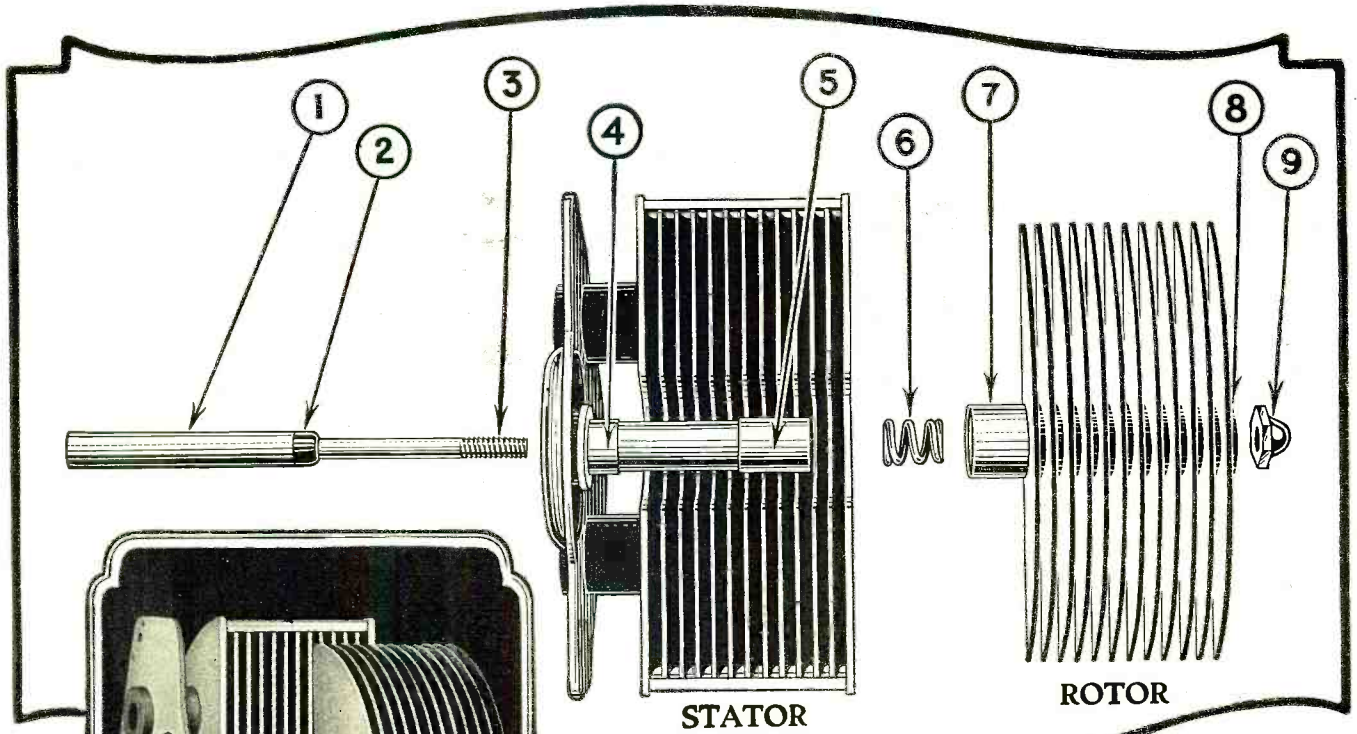

# The Condenser with the "full floating axle"

The striking feature of the Bradleydenser is the rigid double bearing, based on the principle of the "full-floating" automobile axle, that eliminates the usual outer pivot-bearing for the rotor shaft, and still provides a non-sagging support that insures perfect alignment of the rotor plates.

The rotor plates, soldered on a long, hollow tube extending from [7] to [8], revolve on a hollow steel stem provided with two bearings [4] and [5]. The alignment and support of the rotor is independent of the condenser shaft [1], as shown by the first photograph at the left. The shaft [1] merely turns the rotor. It slips through the hollow steel stem and its threaded end [3] is secured to the rotor at [8] with the nut [9] as shown in the second photograph. The spring [6] prevents end-play.

This design, combined with the use of soldered brass plates, results in a rugged, long-life condenser of extremely high efficiency. For superior service use the Bradleydenser.

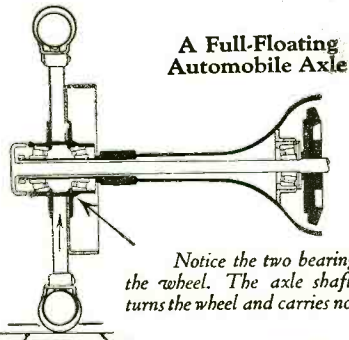

A Full-Floating Automobile Axle

Notice the two bearings for the wheel. The axle shaft only turns the wheel and carries no load.

Allen-Bradley Co.  
Electric Controlling Apparatus

General Office and Factory: 283 Greenfield Ave., Milwaukee, Wisconsin

# Bradleydenser

PERFECT VARIABLE CONDENSER

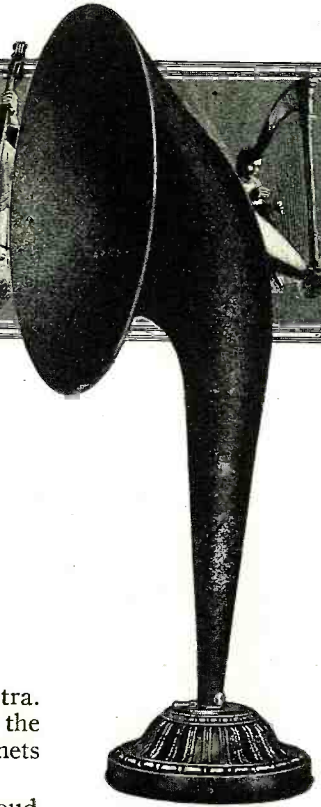

## Each Instrument in PERFECT TUNE



HERE is the test of a loud speaker. Tune in a great orchestra. Do you hear a grand ensemble in perfect harmony? Or,—do the upper tones of the violins, the flutes, the oboes and the clarinets come in a trifle "flat"?

Music—not mere noise—is what you should demand in a loud speaker these days. And music is not music unless it is harmony.

The Bristol Audiophone brings in voice or instrument in perfect tune just as it sounds in the studio. This is because it is itself a true musical instrument; not merely a phone unit in a horn. You will love your Audiophone as you would love a fine violin.

There are five Bristol Audiophones, priced from \$12.50 to \$30.00. If not at your dealer's, write for Bulletins Nos. 3011, 3017 and 3022-V.

**THE BRISTOL COMPANY, Waterbury, Conn.**

Model S  
Audiophone  
\$25.00

Rubber horn 14 1/4" in diameter. Cast metal throat. Velvet mat finish of mottled bronze and gold.



Cabinet  
Model  
\$30.00

Beautifully finished mahogany. Full floating wooden horn and cast metal throat. Musically, a companion to the finest set ever built; size 17x10x10 1/4".

**BRISTOL** TRADE MARK **AUDIOPHONE** REG. U.S. PAT. OFFICE **Loud Speaker**



**D**AVEN is the real word for dependability when connected with Resistance Coupled Amplification. Daven engineers designed and built the first Resistance Coupled Amplifier offered the Broadcast fan—they were the pioneers and their devices have blazed the way for others to follow.



The Daven Resistance Coupled Amplifier Kits are highly perfected—their assembly is very simple—their output perfect. By adding this amplifier to your favorite tuner, you will have a worthy combination, hard to beat, and amplification that is perfect.



With Resistance Coupling the volume is adequate for all purposes, while the tone quality is overwhelmingly superior to any other form of amplification. The name Daven is the "Sine of Merit" and your safeguard when you go out to buy.



The Daven Super Amplifier Unit is laboratory tested and comes ready to install. The base is of molded Bakelite and small enough to fit within any cabinet. All wiring is hidden beneath the base.



The Daven Kits are supplied for either three or four stages—sockets and mica fixed condensers are not included, but instructions are furnished giving complete information and diagrams.

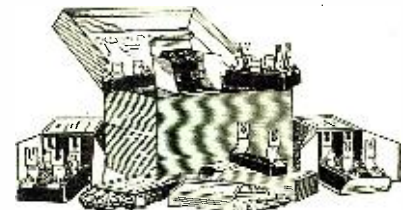

You can buy the Daven Products at any good Radio Store.

TRADE MARK  
**DAVEN RADIO**  
*"The Sine of Merit"*  
**CORPORATION**  
*Resistor Specialists*

Newark,

New Jersey

Ask your Dealer for a copy of our 25c handbook—"RESISTOR MANUAL" telling about the many possibilities of Resistance Coupled Amplification and how to use it with any of the standard forms of receivers.

# SWEET THE AIR S With Air-Way



The Leader of the five-tube, tuned radio-frequency receivers, in which is embodied all of the latest developments in low-loss construction, clarity of tone, simplicity in tuning, and mechanical excellence.

Range to reach any point in North America, and European stations under reasonably favorable conditions.

Selectivity to cut through the worst of local interference.

The only receiving set of this type now on the market equipped to operate with either loop or antenna, with switch for making instant change.

Tone unexcelled in musical quality.

Volume to operate an efficient loud speaker on any station with sending power capable of reaching the set.

Appearance, dignified design; material of cabinet, five-ply black walnut; and finish to match the surroundings of the best appointed homes.

A set that meets the requirements of the most discriminating buyer, yet sold at a price to meet popular demand.

We invite investigation on the part of live and responsible dealers who are able to appreciate the value to them of a radio set that sells easily and stays sold, with profit to them and satisfaction to the customer.

**Air-way Model 51, Five point, Five tube receiver. Price in cabinet as illustrated, \$125.00.**

Model 52, practically the same in detail as Model 51, but built into the handsomest console cabinet in the market; in which is ample room for all batteries and equipment, and a built-in loud speaker with Thorola unit, making a set complete in itself. **Price, \$375.00.**

Our Model 41 is a four-tube, tuned radio frequency receiving set unexcelled in quality and efficiency, and we believe beyond question the most satisfactory four-tube set on the market. **Price, \$65.00.**

*Live dealers write for further details, and our Special introductory proposition*

**AIR-WAY ELECTRIC APPLIANCE CORPORATION**  
TOLEDO OHIO



THE

NEW

# PARAGON

REG. U. S. PAT. OFF.

## FOUR \$65

### Gets Everything

**P**LUG the loudspeaker in—press the switch button—turn the one tuning dial—and the whole country's broadcasting is at your command. Strong, clear, natural, the far-distant stations separate themselves from nearby ones. The announcers' voices ring out undistorted, and the broadcasting, whether music or speech, satisfies you as you've never expected to be satisfied.

This new four-tube set is the latest Paragon triumph—Paragon, whose distinguished past records entitle it to a premier place in the radio world. And whose manufacturing experience enables the production now of this real Paragon set at such a surprisingly low price.

**WRITE FOR "STATION PLEASE"**

Interesting free booklet describing the Paragon Four and other Paragon Receivers.

**NEW PARAGON FOUR \$65.00**

Four tubes. Single dial control. Range almost unlimited for clear loudspeaker reception. New Paradyne non-radiating circuit. Mahogany case, 21 inches long.

**NEW PARAGON THREE \$48.50**

Three tubes. Single dial control. Loudspeaker volume over surprising range. Mahogany case, 17 inches long.

**NEW PARAGON TWO \$27.50**

Two tubes. Single dial control. Loudspeaker volume over moderate range. Mahogany case, 11 inches long.

**ADAMS MORGAN CO., Inc.** 8 Alvin Ave., Upper Montclair, N. J.  
*Makers since 1915 of Record-holding Radio Receivers*

"Quality Goods for Quality Readers"

# The Latest Achievement

of  
the



## GENERAL RADIO LABORATORY



### The NEW Type 285 Audio Transformer

The current radio season has seen the advent of many new audio transformers—some of them worthy contributions to better amplification.

Now comes the announcement of the new General Radio transformer which sets an even higher standard of amplification. One stage of amplification using a type 285 transformer operates a loudspeaker with good

volume and a quality of tone that is unequalled.

It amplifies high and low notes evenly over the whole audio range so that instrumental or vocal tones are reproduced individually or in combination with a naturalness which delights the most critical radio listener.

If you want the best there is in transformer design, the type 285 should be your choice.

**Price \$7.00**

*See one at your Dealer's*

**GENERAL RADIO Co.**  
Cambridge, Mass.

GENERAL RADIO Co.



Cambridge, Mass.  
U.S.A.

Write for Descriptive Bulletin 920 - W

# The Question of B Battery Current Has Been Solved with the Trans "B" former

The *Kellogg* Trans-B-former furnishes the necessary plate voltages for your radio set, from your 110AC, 60 cycle, electric light socket without any interferences.

This unvarying current is furnished at less than one-fifth cent per hour. Throw away your "B" batteries and install a Trans-B-former and your set will operate at maximum efficiency constantly.

The *Kellogg* Trans-B-former will:

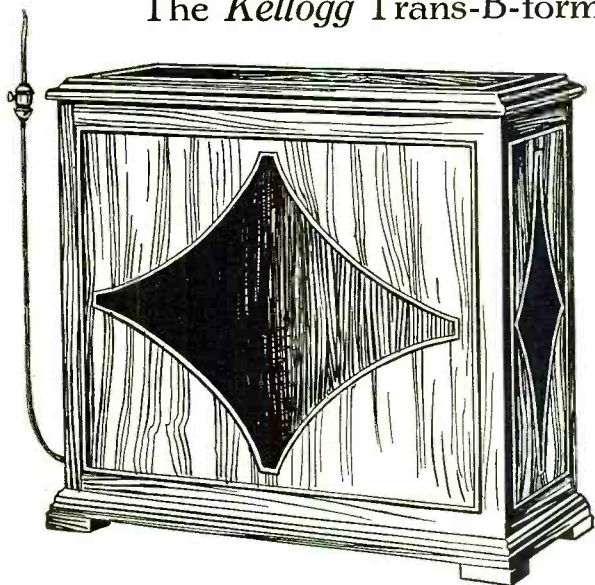

- Improve reception.
- Reduce operating cost to a minimum.
- Add to the appearance of your set.
- Increase DX possibilities.
- Developed,perfected and guaranteed by the Kellogg Switchboard and Supply Company.

*At Your Dealers*

Each.....\$50.00

**KELLOGG SWITCHBOARD & SUPPLY CO.**

1066 WEST ADAMS STREET, CHICAGO

# Editorial Chat

**W**HAT the radio art advanced during last year is evidenced by short wave transmission, Marconi's beam system or directional transmission and the Radio Corporation of America's development of the Photoradiogram, the story of which appears in this issue, written by one of the engineers who helped in the development of the system. "The Photoradiogram" opens up a vista of potential uses in modern life that only yesterday were considered dreams. In the same vein—with the latest information on the subject—you will undoubtedly enjoy reading "Loud Speakers and Radio Reception." It will appeal to radio fans particularly—since it concerns each and all what quality of sound waves radio receivers generate.

## *Radio-Paris*

Miss Anne C. Granbeck, a well versed travel writer, in this issue of WIRELESS AGE conducts us to France to view radio broadcasting conditions there. Capt. Moore, just returned from abroad, is interviewed by Miss Granbeck for WIRELESS AGE readers, to inform, suggest and entertain.

## *Fiction—Personality*

"Classified Advertisement" is Buckley's latest—a zippy radio yarn. It is novel in style, quaint in humor and breezy in atmosphere. Listening to some dreamy melodies o'er the radio would be an excellent way to read it.

And the story of John Stone Stone pictures an outstanding personality who twenty-five years ago unraveled some of Heaviside's involved mathematics and helped develop the mathematics of tuned radio circuits to such an extent that radio could go to work for mankind.

## *Women's Appeal*

Go to school again via radio—that's what a great many women are doing throughout the country. "Radio Schools of Housewifery" tells you all about it—study courses, registration, examinations, graduations and certificates. Two million women are already attending radio schools—mayhap you'll want to join after reading this article.

## *Technical and General*

Reduction of losses in receiving apparatus is a recent development. "How to Build a Very Low-Loss Tuner" will help you understand the theory of low losses and note the practice in construction of such receivers—Mr. Meagher's "One-Tube Transmitters" is as good as his "One-Tube Circuits" which our readers liked so well—"Modifying the Reinartz" reviews and stresses important phases of this circuit and includes an improved Reinartz receiver—More useful technical material will be found as you thumb through the pages—it is all up to WIRELESS AGE standard.

In addition you will find in this issue of WIRELESS AGE—THE RADIO MAGAZINE—articles of broadcast interest, news items, amateur and broadcast station lists and much more that is informative and entertaining—

But, by all means, don't overlook page 57—that is the departure this month, and if sufficient response is evidenced it will be continued. —THE EDITOR.





## Controlled Volume

With a Radio set of only moderate ability, Superspeaker reproduction of nearby stations might often be stronger than you could possibly need.

But there is always the Superspeaker Volume Control. With it you can modify the heaviest message almost to a whisper. Yet it also puts at your command the greater power you need behind your set, as you reach out and sweep the ether for messages from far away.

This same Volume Control makes you independent of varying battery strength, and enables you to balance delicately every change in temperature or humidity.

Just hear The Superspeaker! Compare it, before you buy, with any other reproducing device, and learn the difference for yourself!

A high quality musical instrument handsomely finished in ebony gloss, standing 26 inches high and weighing more than five pounds. No extra batteries or coils. Nothing to wear out. Built complete by a manufacturer whose reputation, resources and ability are common knowledge throughout the industry.

JEWETT RADIO & PHONOGRAPH COMPANY  
5678 TWELFTH STREET  
DETROIT, MICHIGAN

"THERE IS NO SUBSTITUTE FOR THE BEST"

# The Superspeaker

Trademark  
Registered

"Quality Goods for Quality Readers"



# FADA Radio

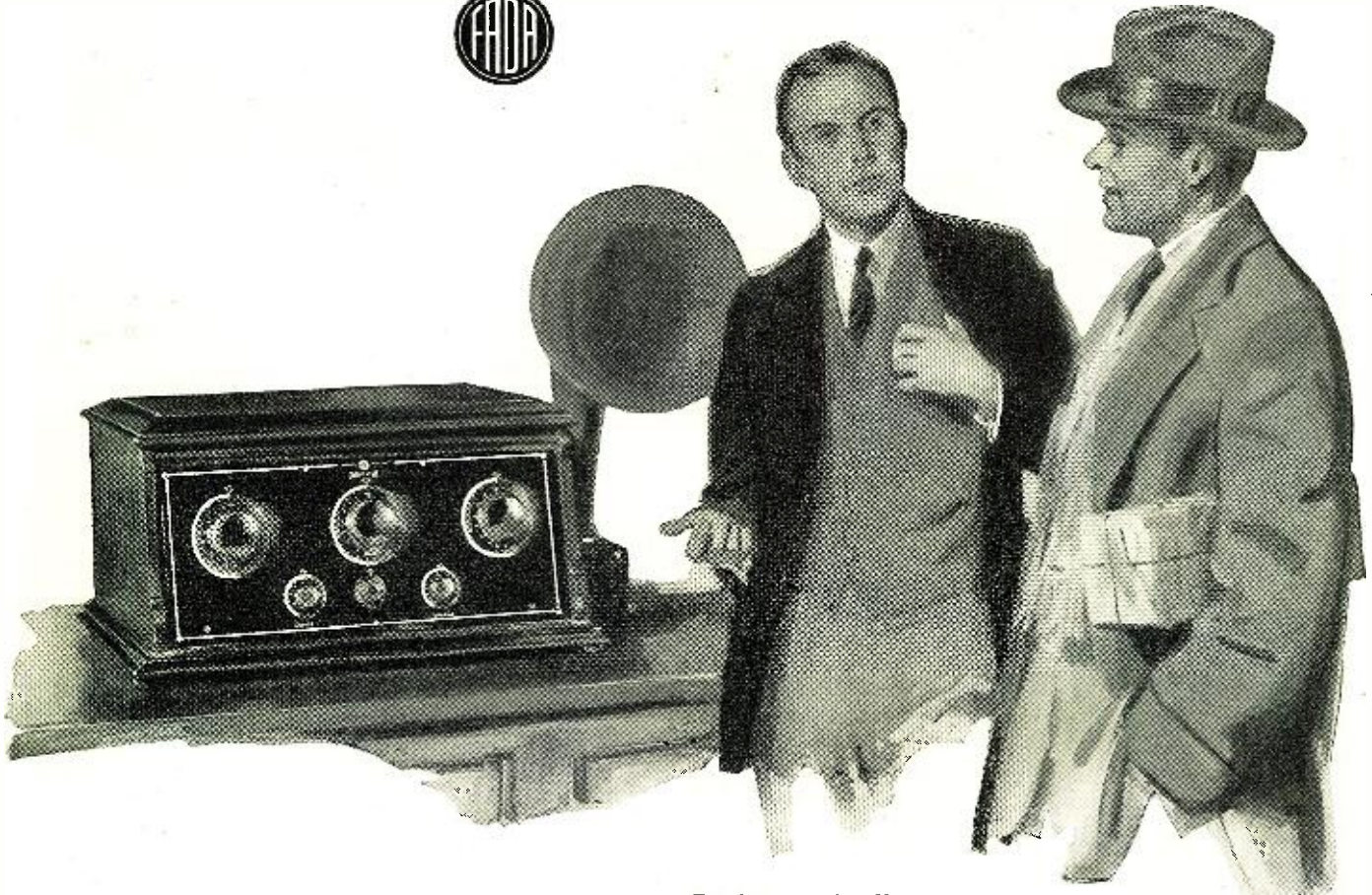

FADA Neutroceiver No. 175-A  
Mahogany cabinet. Inclined panel  
and roomy battery shelf. 5 tubes.  
Price (less tubes, batteries, etc.)  
\$160.

## Indecision vanishes when you hear the FADA

RADIO shopping ends triumphantly when you find the FADA. People who know radio and have conducted comparative tests say that the Neutroceiver is the best they have ever tried. Have the FADA Neutroceiver demonstrated in your home. Listen to its marvelously faithful reproduction. Tune in a distant station yourself loud and clear and see how easy it is. Observe the beautiful cabinet design. You will exclaim: "At last! This is just the

set I have always wanted!" If you prefer a set with self-contained loud speaker, the FADA Neutrola Grand meets your desire in this respect, as in all others. Whether FADA Neutrodyne receivers are the first or the fifteenth make you investigate, they will be your final choice. You need look no further. Through the FADA Neutrodyne your radio wishes become realities. See your dealer.

**F. A. D. ANDREA, INC.**  
1581 JEROME AVENUE NEW YORK  
"Quality Goods for Quality Readers"

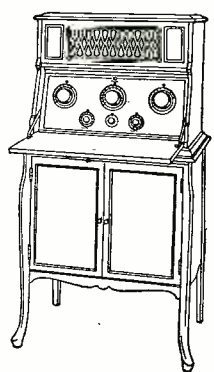

**FADA Neutrola Grand**  
**No. 185/90-A**  
The five-tube Neutrola 185-A, mounted on FADA Cabinet Table No. 190-A. Price (less tubes, batteries, etc.) \$270.





The studio of Radio-Paris

## Radio-Paris

Plans to install 10-kilowatt equipment so you'll hear French programs when you wish—Broadcast conditions in France

By Miss Anne C. Granbeck

“AND how crazy did you find the French about radio?” I asked Capt. G. C. Moore, editor of the *Cavalry Journal*, Washington, D. C., who has just come from a visit to Paris.

“Would you believe it,” he exclaimed in surprise, “the French have not yet really caught the radio fever!”

“But,” I exclaimed in astonishment, “I have been hearing about the Eiffel Tower and other programs and I thought France was just as keen about it as the English and the Americans.”

“Not at all,” said my friend. “You can imagine how I—an American radio fan living in an apartment house in which eleven out of fifteen tenants have a radio set—felt when I heard not a comment during all my Parisian stay about radio. I positively had to use a pair of pliers to get any information on the subject.”

“What’s the matter?” I asked curiously. “Is it the broadcasting situation or the French character and point of view?”

“A little of both,” replied Capt. Moore. “I learn that there are 400,000 sets in France now; but that, according to American standards at present, is not much; and when you analyze it still more closely, it is even less than it seems. The post-office department controls the broadcasting stations and fixes the wave lengths. There are, at present, only four broadcasting stations in all France—every one of them in Paris. You speak of Eiffel Tower, but ‘Radio-Paris’ is the principal one.

“You see,” continued my friend, “it may not seem so strange when you consider that France is composed of two halves, figuratively speaking; one being Paris and its ultra-modern population, and the other rural France,

which is rather below the standard and alertness of our own rural sections and is rather indifferent to the ideas, foibles, and pastimes of sophisticated Paris. The French peasant stolidly plows his furrow and follows his traditional habits. It will, no doubt, be a long time before he is as alert to radio as our own farm country in the United States.

"That leaves us Paris, and you find in Paris a set of conditions making for the present at least, somewhat against radio. Their amusements for instance. We Americans have no idea of the enthusiasm with which Parisians follow horse racing. It is their favorite recreation. There are half a dozen courses about Paris, and races are going on every day. There is just positively too little about a horse race that you can broadcast, despite the ingenuity of our modern broadcasting. The French want to see the horses and expend their enthusiasm rooting for their favorite. That's that! Then you have, of course, a tremendous theater-going and music hall review or vaudeville audience. The congestion is so bad in the theater districts that theater prices, taxi-fares, etc., are distorted and the congestion very trying. Few Parisians dream of getting much entertainment via radio. He wants to be present at the theaters so nearby."

"But what about jazz, which I am told is

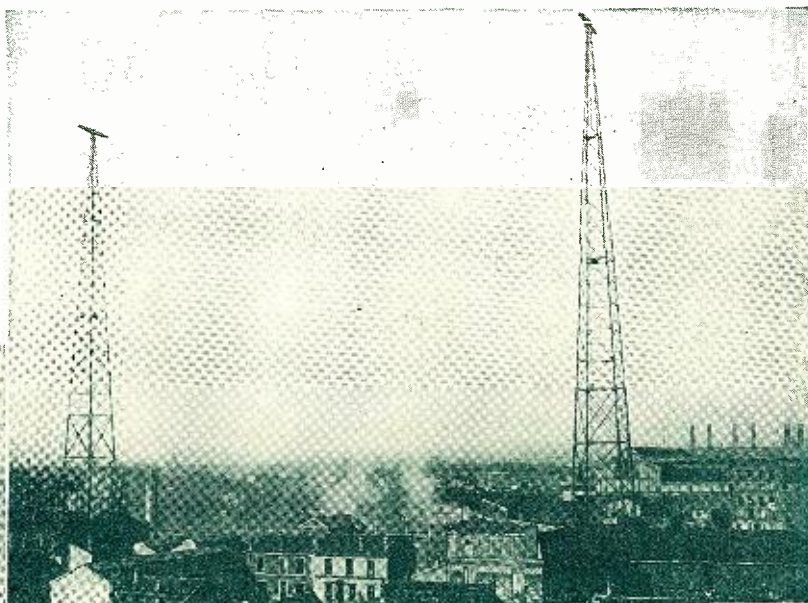
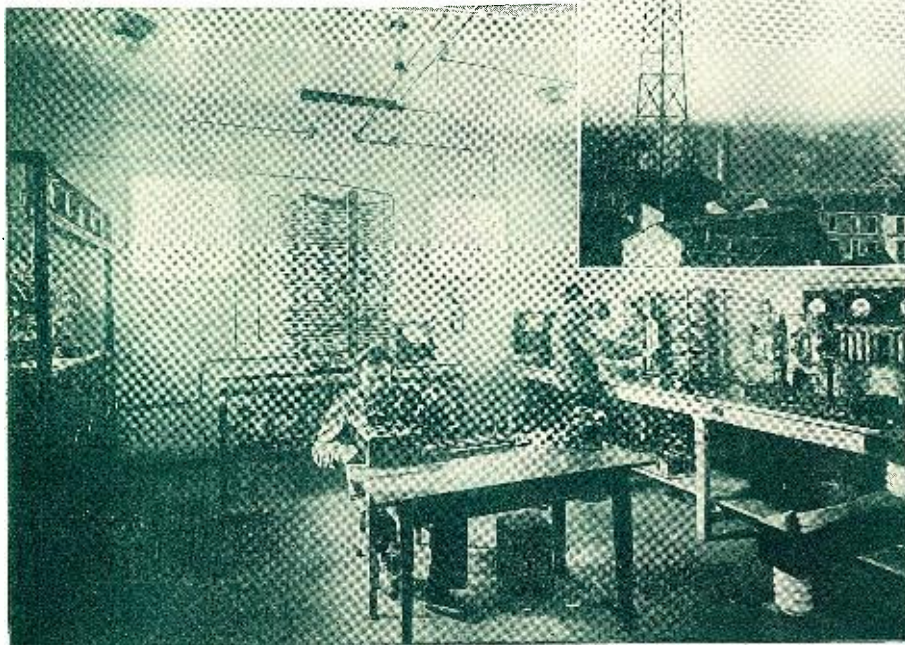

Transmitting apparatus and antenna system of Radio-Paris station

taking all Europe by storm?" I asked rather curiously.

"Yes, it is true that radio stations are now broadcasting jazz—but notice how! The great new Chelmsford station in England gives a jazz concert twice a week, and the French broadcasting station 'Radio-Paris' catches it and re-transmits it! There is, of course, a fair vogue for this type of music and other music as well. But you never, by any chance, meet a real 'radio bug' among the French; they do not seem to have worked up any great enthusiasm at all. As a matter of fact, radio is having something of an uphill fight there. You see, France is amazingly political-minded—so much so that the primary usefulness of any radio station is believed by the French to be military and political, and thus they keep a strangle hold on it and minimize the importance of it for entertainment.

"I rather suspect," my friend went on, "that the intensely economical nature of the French has also something to do with it. I was walking in Paris one day and saw a little sign saying that radio programs could be heard inside. I went into the café, ordered a drink, and pre-

pared to listen to some French broadcasting. But when nothing happened and I asked the proprietor, he told me nonchalantly, that he had taken out the apparatus because it was too expensive. He told me his hard luck story, and it illustrates what the French listener-in has to put up with. (And who shall say that we Americans wouldn't fret, too, if we had to indulge our radio appetites under the same handicaps?) He said the set cost him 1800 francs, the batteries 300 francs, a Government tax 200, and then 300 more francs as royalty to the Society of Authors and Composers, and then again a Parisian tax on radio sets costing 96 francs a year, which, incidentally, goes to the poor. Here we have about 2700 francs which it cost the proprietor to put in a receiving set for public use. He

complained that it had not made any impression on his public, and, therefore, he had disposed of it. It discloses at once the official system in operation whereby the broadcasting or a fair part of it is supported by taxes on receiving sets. As a matter of fact, broadcasting does not profit by the taxation very much, since the tax for private receiving sets is low. The only thing that is keeping broadcasting alive is the fact that the banks are paying for broadcasting quotations to all their branches. The makers of radio equipment pay 'Radio-Paris'—the principal broadcasting station—according to the number of working people they employ, while the makers of tubes pay for each valve sold. 'Radio-Paris' receives only one franc on each receiving set used and gets a small subsidy through the Post Office Department. On the other hand, the artists are paid by the broadcasters and also receive royalties from the radio use of their plays and musical compositions."

"What kind of stuff do they broadcast?" I inquired.

"Operas, musical comedies, classical music, dance music and jazz. The opera situation there is not much different from here, as an organization of opera singers is preventing the broadcasting of high class grand opera; but still opera is the first preference on the programs of the broadcasting stations. But the service isn't good. The technical standards are not quite up to the quality of our best American stations. I don't know whether they have powerful enough stations or the most modern equipment, but at any rate, there's no comparison between the service of

some of our good American stations and that of even the best in Paris.

"This is militating against radio development in France. It seems that a considerable number of Frenchmen tried radio earlier in the development period and didn't like it much, and are now rather prejudiced. The broadcasting at first was pretty poor; the technical side was distinctly bad. So you have many Frenchmen saying radio is '*pas bon*.'

"Now, as in the United States, a livelier interest is being developed through publications. There are half a dozen or

more weekly or monthly papers giving much space to radio, and there is a gradual increase in interest.

"The system of taxation of receiving sets is, peculiarly enough, divided into receiving sets installed for public entertainment and those used privately. The public receiving sets pay 50 francs in towns of less than 25,000; 100 francs up to 100,000; 200 francs for over 100,000. The little café proprietor, to whom I referred, living in Paris, although in an out-of-the-way quarter, nevertheless had to pay a big tax. The private receiving set is taxed a franc, and it is also illegal to radiate any wave that can inter-

fere with neighboring stations or nearby receiving sets.

"The French now recognize that further development of broadcasting is desirable; and the Government's Committee is interested in the profits which radio is capable of producing, and thus providing revenue. It has now reached the conclusion that the commercial development of broadcasting stations is much to be desired, and is encouraging the three new stations which are going to be built next year at Lyons, Marseilles and one other place. The Government will pay something toward the expenses for the transmission of re-



Gabriel Germinet—prominent radio playwright of France

ports and communications and has even promised to endow hospitals, schools and country communities with receiving stations. The licensing of broadcasting stations is to be governed by a technical and administrative and financial committee and each case is to be judged separately. Amateur transmitting stations are limited to 100 watts, with a wave length of from 100 to 200 meters. Only the holder of a radio operator's license may operate a transmitting station. An examination is given at the applicant's home by a Government agent, and

(Turn to page 87)



Photoradiogram of President Coolidge transmitted from London

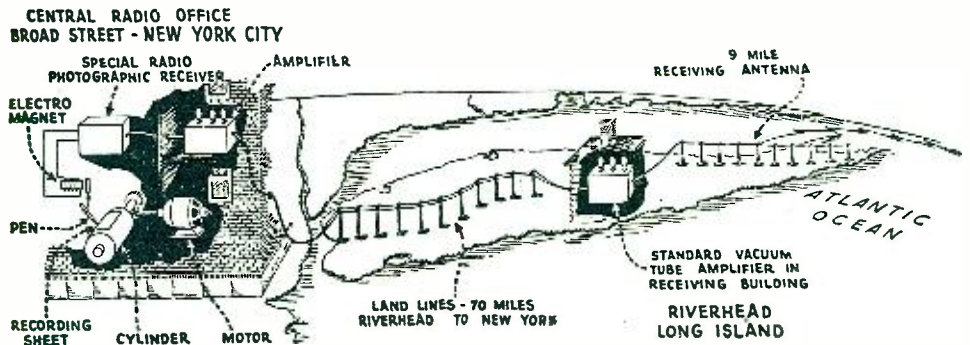

# THE PHOTO-

It is now possible to trans-  
on one side of the world to people

*By K. M. MacIlvain,*

**P**RECEDING radio achievements must fade into the background and give way to the epoch making event which took place Sunday, November 30th, 1924, when Captain R. H. Ranger of the Radio Corporation of America demonstrated the feasibility of transmitting pictures across the Atlantic Ocean.

It is now possible to transmit pictures of happenings on one side of the world to people on the other side, without the aid of any metallic connecting medium. A picture can be taken in London of an event of universal interest and transmitted to New York so that within a few minutes from the time the picture is taken in London, it is available for our perusal here in New York.

An analysis of the many attempts of others to solve the same problem, indicated that one of the chief difficulties was more a question of economics than engineering. Thus the nature of the problem made it necessary, for anyone attempting its solution, to not only have an inventive slant, but to be a mechanical engineer, an electrical engineer, an economist and an expert photographer imbued with an artistic temperament, as well.

In view of the quite generally prevalent fact that the most economical method of transmit-

ting intelligence from a point on one side of the world to another point on the opposite side, is by means of the radio telegraph systems, the logical method of procedure was to devise some scheme whereby pictures could be interpreted in terms of dots and dashes. This is exactly what was done and the pictures that are being sent by radio across the Atlantic at the present time are composed of dots and dashes, the tonal value being brought out by the length of these dots and dashes.

It might be of interest at this point to suggest a theory as to why previous systems, which had been capable of showing very good results over land line circuits, had failed over radio circuits. Some of the best schemes for

transmitting pictures between two points which were connected by wires were based on "intensity." That is, the variations in the intensity of the operating current brought out the tonal values in the received picture.

It is one thing to control the signal intensity down to the  $n$ th degree over a short stretch of land lines and another to execute the same degree of control on the intensity of signals to be transmitted by radio and received at a point over 3,000 miles away.

Today you see proof of the feasibility of transmitting pictures by radio over thousands of miles of land and water and most of you probably realize the untiring effort that must have been maintained by those interested in the success of the undertaking, the obstacles met and overcome, the disappointments finally culminating in success.

Captain Ranger has been working on the perfection of this system for only a number of months, however, which is a surprisingly short length of time considering the magnitude of the accomplishment. Last summer the system was perfected to a degree warranting its application to a local radio circuit. Consequently, the output of the photographic transmitting apparatus in Captain Ranger's office was plugged in on the land line running out to

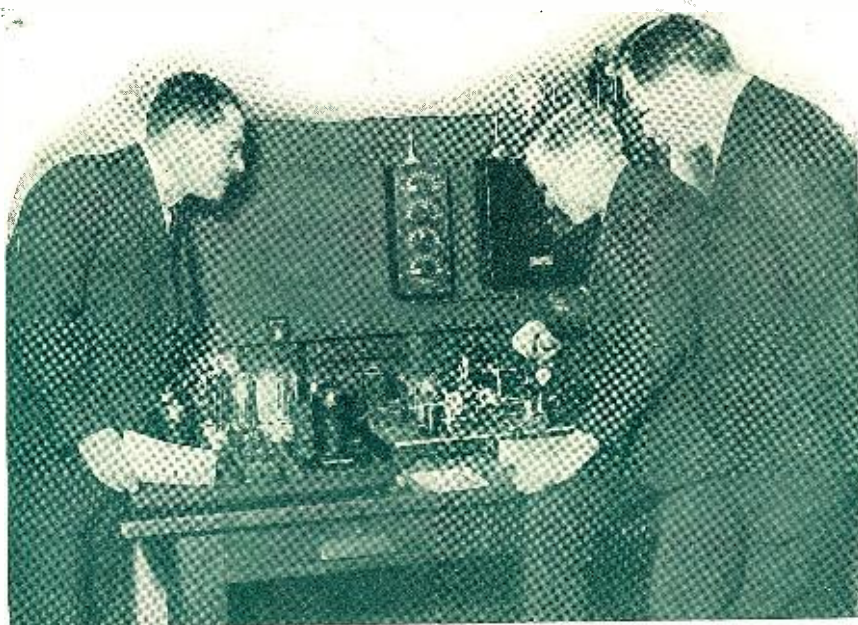

At the receiving end in New York were E. F. W. Alexanderson, R. H. Ranger and Charles H. Taylor, all R.C.A. Engineers

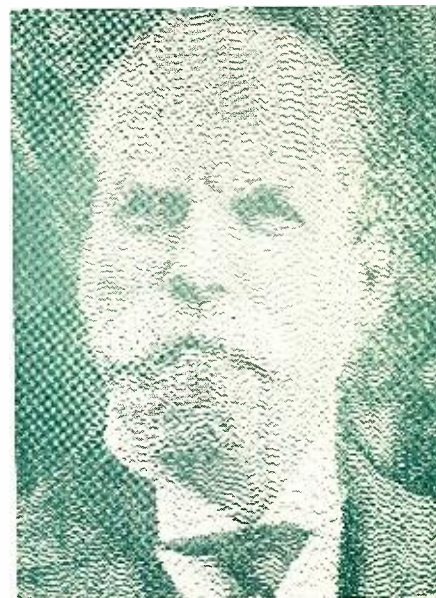
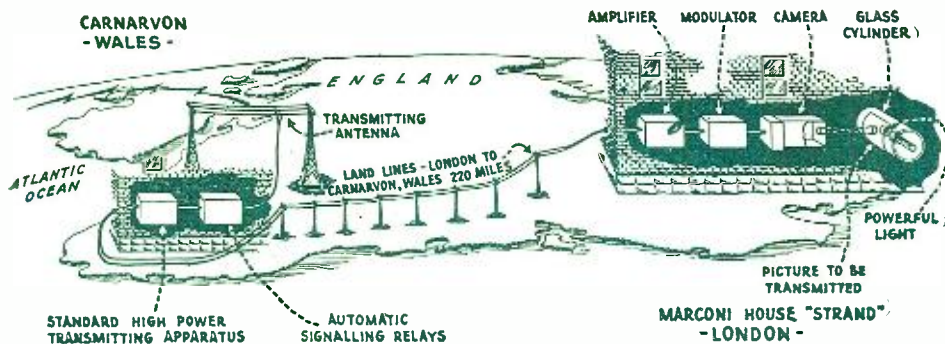

Photoradiogram of Secretary Hughes sent to New York from London

# RADIOGRAM

mit pictures of happenings on the other side by radio

R. C. A. Research Engineer

one of the Radio Corporation's transmitting stations. The dots and dashes sent out over the control line from the photo-transmitter operated the control relays at the transmitting station which controlled the output of the transmitter. These dots and dashes were picked up at the company's receiving station at Riverhead, Long Island and piped in to Captain Ranger's office at 66 Broad Street, New York City. A summary of the local circuit, then, was from the New York office to the high power transmitting station by land line, to Riverhead, Long Island, by radio, and then back to the New York office by land line.

Later, the development reached a stage which warranted its application to a transatlantic radio circuit. An immediate test was desirable but there was only one photographic receiver and it was located in the New York office. This prohibited the transmission of pictures from the United States to Europe, immediately, but Captain Ranger said, "What is to prevent our transmitting a picture to England and retransmitting it so that we may receive it here in New York?"

This was a novel way of utilizing the facilities available at the time and the plan was immediately put into operation. The photographic transmitter was plugged

in on the control line to the Radio Corporation's high power station at New Brunswick, New Jersey, and the picture modulated radio-frequency waves were sent on their way to England. These signals were received in England, amplified, rectified and made to operate a relay which in turn operated the control relays at the Marconi Company's transatlantic radio transmitter at Carnarvon. The dots and dashes transmitted from Carnarvon were picked up at Riverhead, Long Island, and piped over the land line to New York where they were translated back into the picture from which they emanated.

The results at this time were very satisfying and seemed to indicate that the development had reached a point

where it was possible to give a public demonstration.

Finally, in November 1924, Captain Ranger was satisfied that the time for the demonstration had arrived. Consequently, early in November, Mr. Donald Gordon Ward, one of the engineers of The Radio Corporation of America, left New York on the *Majestic*, bound for London, England, with the photographic transmitting apparatus, to install it in the London office of the Marconi Company. When this had been accomplished the first pictures of the initial transatlantic test started coming in during the wee small hours of Thanksgiving morning.

The first one was a photograph of a radiogram and all the details were reproduced faithfully. The first portrait to come through was that of the inventor himself, Captain Ranger. The moment his likeness was registered on the recorder paper, the success of the undertaking was assured. It was remarkably clear and distinct. A picture of President Coolidge came through next, and one of Secretary Hughes followed immediately after. An old Chinese proverb, "one picture is worth 10,000 words" was quite appropriately sent through next. These pictures all came through in rapid succession. There were no intermediate tests or adjust-



Donald Gordon Ward, R.C.A. Engineer, who traveled to Europe to handle the transmission, and G. S. Whitmore, Director of Communications, observing the test

ments necessary. Once transmission was started Thanksgiving morning, the pictures came through with the utmost regularity.

The public demonstration was set for the following Sunday, November 30th and the photographic receiver was in operation at all intervals between Thursday and Sunday when the English transmitter could be relieved from regular traffic to transmit pictures.

By special arrangement the photographic receiver was kept in constant operation from early Sunday morning until late that night. The many notable engineers and business men who had been invited to witness the demonstration began arriving at the New

The above gives only a slight idea of the speed of the photoradiogram service. For instance, it would be possible at this early stage in the development of this new type of service, to have a copy of the front page of a London newspaper or a part of it, here in New York within an hour after it appeared on the streets in London. There is no doubt that the time is not so very far away when they will be selling the London papers on the streets of New York within an hour or two after they appear on the streets of London.

Another very interesting picture that came through was that of the group of people around the transmitter at the London end. The picture was trans-

may be described briefly. The accompanying diagrams show the layout of the transmitting and receiving end schematically. Whatever is to be sent is first photographed on an ordinary camera film. This film is developed and then placed on a glass cylinder, being held firmly in place by metal clips.

There is an ordinary incandescent lamp inside of this glass cylinder which is focused in a minute beam on the film. To effect transmission, the cylinder is set in motion and as the light and dark portions of the picture are traversed by the light beam, the intensity of the ray which penetrates the film is changed. This ever changing beam after having passed through the

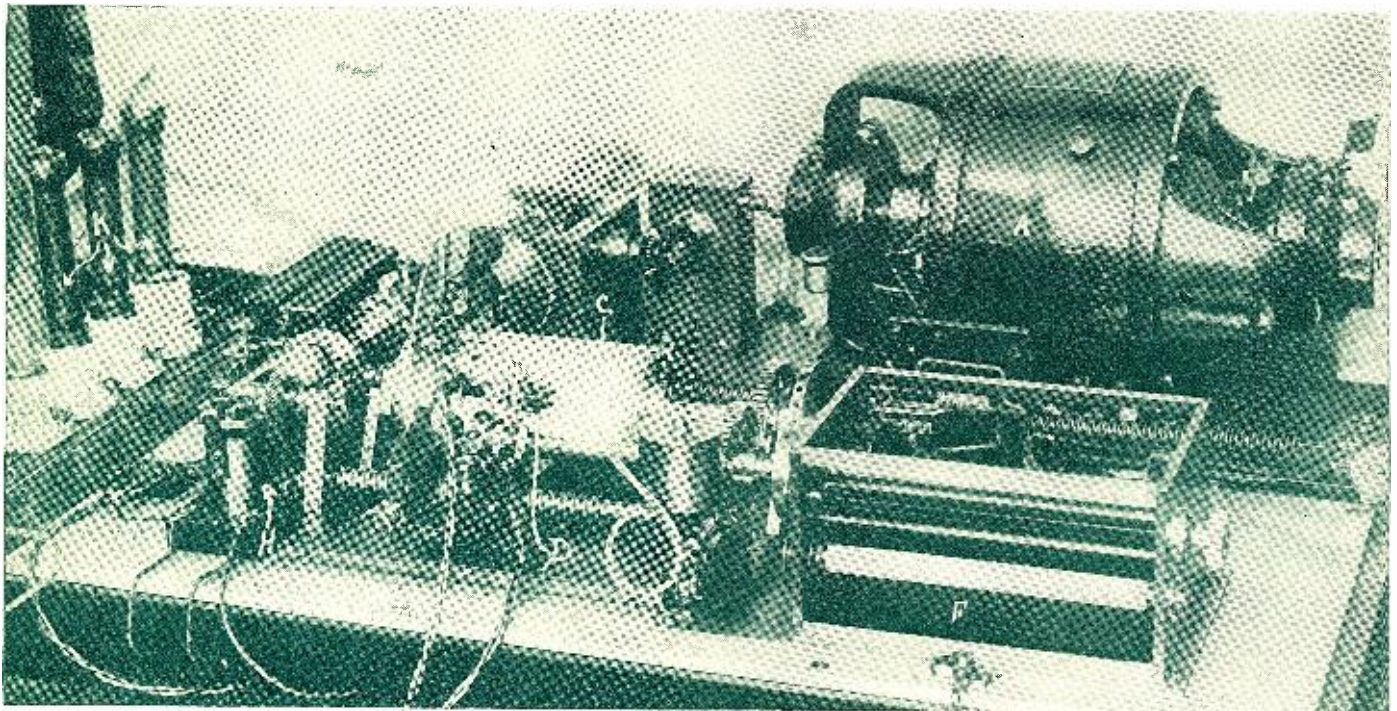

The receiving apparatus—the cylinder C oscillates to receive the ink record as well as to produce the film record. At the right (A) is the motor which drives the cylinder

York office about 10 o'clock in the morning. Another notable gathering in the London office of the Marconi Company was watching the photographic transmitter function.

An editorial which appeared in one of the New York newspapers after the demonstration quite aptly termed it "a real miracle." There were no special conditions required and absolute proof was available as to the reality of the miracle.

One of the pictures which came through during the demonstration was that of the finish of a race between Oxford and Cambridge which took place in England the day before the demonstration. This picture was transmitted during the demonstration on Sunday and was reproduced in the New York morning papers on Monday. Thus a picture of an event that took place on Saturday in England was printed in the New York papers within 30 hours.

mitted to New York and arrived here within an hour after it had been taken in the London office. Most of the persons in the picture were strangers to the engineers here on this side but there was not the least doubt in the world as to which of them was Mr. Ward.

There are many things which have been made possible by the photoradiogram service. A document in London which needs the signature of a man in New York could be sent to New York, signed and returned with the signature attached, all within a few hours time. A photograph could be made of the document in London and this photograph transmitted to New York. The print available in New York after transmission could be signed by the desired person, the document with signature attached photographed and this last photo retransmitted to London.

The technical side of the subject

film is again focused on the sensitive element of the photo-cell, which transforms the light rays into electrical impulses.

The resistance of the photo-cell varies in accordance with the amount of light which strikes it and in this way the light rays which penetrate the film are changed into electrical impulses. There is practically no lost motion in the functioning of the photo-cell; that is, the current in the output circuit of the photo-cell changes the instant there is the slightest change in the amount of light striking its sensitive surface. In order to cover all of the film which is undergoing transmission, the glass cylinder is rotated back and forth, and in this manner the entire surface of the film is eventually exposed to the piercing light beam. The film rotates through an angle equal to the width of the picture and the photo-cell carriage itself advances down the length of the



picture, one notch at a time. Thus, line upon line, the whole picture is covered.

The variations in the photo-cell output circuit pass through a suitable amplifying system and are then fed into a modulating device for transmission. The electrical interpretation of the picture is then transmitted over land wires to the radio transmitting station. In the case shown in the diagram there was a land line stretch of 220 miles from the London office of the Marconi Company to the transmitting station at Carnarvon, Wales. Here, the dots and dashes coming in on the control line from the photographic transmitter in London, were made to operate the re-

ord is made at the receiving end is wrapped about a rotating cylinder which greatly resembles the early type of phonograph record. A specially constructed pen marks on this paper as the cylinder rotates back and forth. The markings of the pen are controlled by the incoming signals and the fineness of the dots and dashes recorded on the paper—due to the high rate of speed at which they are sent—gives an artistic effect to the picture, greatly resembling stippling.

Besides the visible ink record there is a duplicate record being made on a sensitive film inside of a dark box. This double record eliminates the uncertainty of the photographic record

Officials of the Marconi Company in London were quick to declare their belief that the system will become capable of commercial application in the near future.

They outlined the immense possibilities to the group of English and American correspondents who stood by with G. S. Whitmore, Marconi communications engineer, while D. G. Ward for the engineering department of the Radio Corporation, operated the intricate and semi-secret device.

Other English and American papers were permitted to send one picture each and for general distribution pictures of Ambassador Kellogg, Queen Mary, Owen D. Young, Westminster

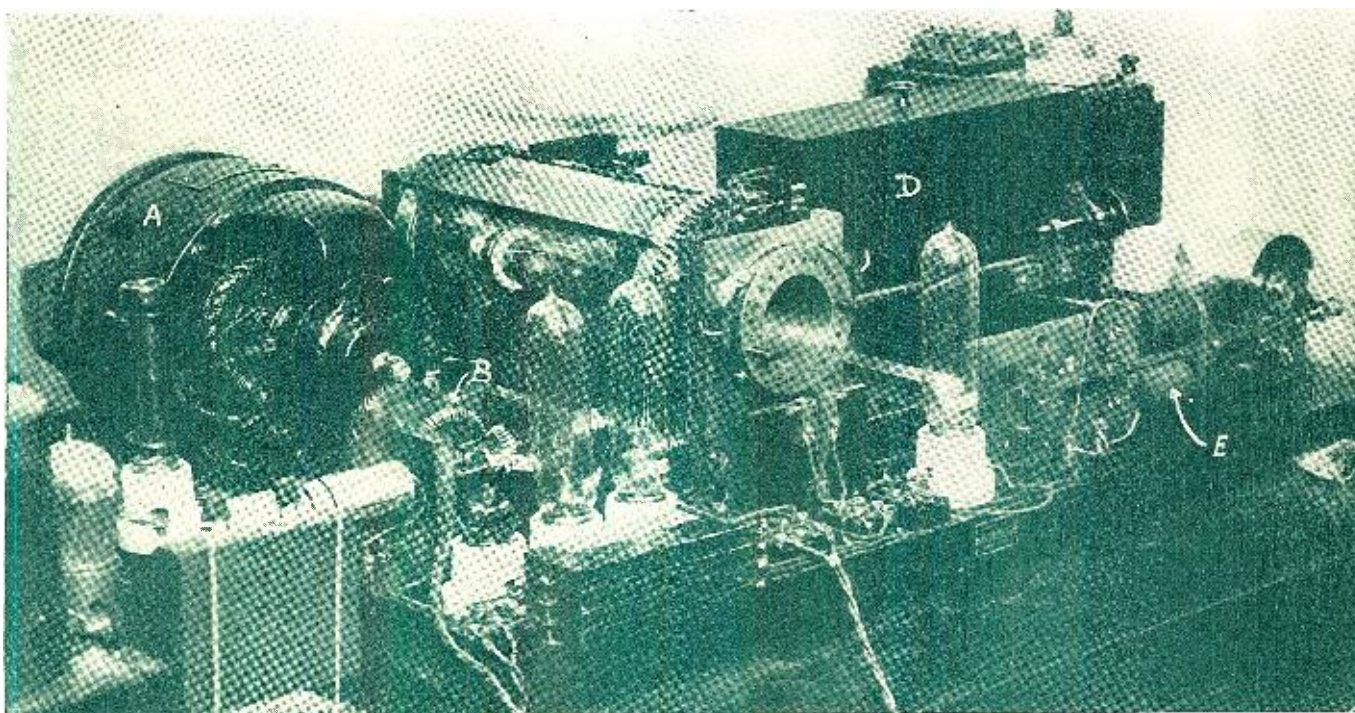

The transmitter—a special constant speed motor (A) actuates the gearing (B) which drives the glass cylinder (C) back and forth in front of the photo cell camera box (D). Magnets (E) advance the camera box (D) down the length of the glass cylinder to cover the complete picture rotating on the cylinder line upon line

lays which controlled the transmitter output.

We have heard of "voice" modulation and "telegraph" modulation, and now we have "picture" modulation, because that is the type of CW wave which is sent out from a high power transmitting station which is controlled by a photographic transmitter. The dots and dashes sent out from England were picked up on one of the nine-mile receiving antennas of the Radio Corporation of America at Riverhead, Long Island. They were amplified, heterodyned and detected and put on the land line to the New York office in the form of audio-frequency dots and dashes.

The photographic receiving apparatus in the New York office decoded the complex photo messages which were transmitted from England and each dot and dash performed its function.

The paper on which the picture rec-

alone. If the picture were being received on the film alone, it would be impossible to tell how the picture was coming through until the transmission had been completed and the film developed. The ink record which is being built up progressively and visibly, tells the story as to how the picture is coming through, long before it is completed. If it is too dark it can be noticed immediately and the operator at the transmitting end informed so that he may make the necessary adjustments without stopping or repeating the picture. This has been found to be a great help in saving time and expense.

At the completion of the transmission of a picture, the film is developed and any number of prints can be made from it. The original ink-record can be photographed if desired and any number of prints made from the film thus obtained.

Abbey, St. Paul's, the Nelson Column in Trafalgar Square and a group photograph of the correspondents watching Ward were flashed through space.

The demonstration closed with an expression of regret by Whitmore that the limited time available for installation of the apparatus did not permit using the special device by which the photographs sent from London could be immediately flashed back from New York. He said such a device has already been perfected.

This wonderful invention has created world-wide interest. There is no doubt that it holds the center of the stage of radio science at the present time and that the system will be developed to perfection in the months to come. With the practical development will come a commercial value that can barely be estimated at the present time and a new use of radio will have become established.

# Classified



“Gramp” journeys to Red Dog, advertising rates, to set at tiring their tongues won-granddaughter (a) married sheriff, Mr. Mac Gregor, suddenly, (c) returned to and (d) left him again a half hour, in spite of his just having done Gramp and her a great service

*By F. R. Buckley*

Illustrated by Revere F. Wistehuff

---

“He'll have me,  
and I'll have him;  
and we'll both  
have the radio for  
outside company”

---

**I**T may be considered good manners here in Red Dog, but in the township where I own five thousand acres any newspaper editor who received a stranger with a shotgun across his knees and two compositors in the background all ready to hurl type-metal, would be socially ostriched, and serve him right. As anybody who saw me in town the other day can bear witness, I am at least sixty-seven years of age, and look more; and if I did happen to be carrying two revolvers and a rifle, I can give an excellent reason for it; viz., I had driven all the way down in a flivver at fifty miles an hour, and it had seemed to me I might maybe run over a jackrabbit or something and have to put the poor animal out of its misery.

---

DRINK “TROMBONE.” It slides down.—Advt.

---

My mission in Red Dog was not only peaceful, but in the nature of a public charity; I having heard that various persons with nothing else to do, were tiring their tongues wondering why my granddaughter (a) married your sheriff, Mr. McGregor (b) left him suddenly (c) returned to him again a week later and (d) left him again suddenly within half an hour, in spite of his just having done her and me a great service.

Admitting that these proceedings might look a bit

strange to persons unused to minding their own business and keeping their faces closed, I aimed to drop in on those who had been talking, and explain matters. Finding that all these gents had either left for parts unknown, or were just leaving for them in clouds of dust, I naturally dropped into the office of this newspaper to see if I couldn't do my explaining in print, so that he who ran might read: and here I am doing it—at advertising rates.

I don't mind the money; I don't even mind having this here literary production classed with and stuck down among the classified advertisements; but the editor's suspicious attitude certainly does stick in my craw.

Way he talked and handled that shotgun, honest, you'd think it was yesterday I killed the four Watson brothers, instead of thirty years ago.

Well, that's enough about my own personal griefs. Now for the explanation about my little girl and her husband.

---

IF BRITO will clean dirty nickel-ware, won't it do the same for your teeth? Six bits. Wilson's Drug Store.—Advt.

---

I don't know to this day why Mary chose to teach school; or, anyhow, why she should have picked on a scandal-mongering dust-heap like this town to do it in.

# Advertisement

Dog and breaks into print, at address various persons who were dering why his ried Red Dog's (b) left him him a week later suddenly, within

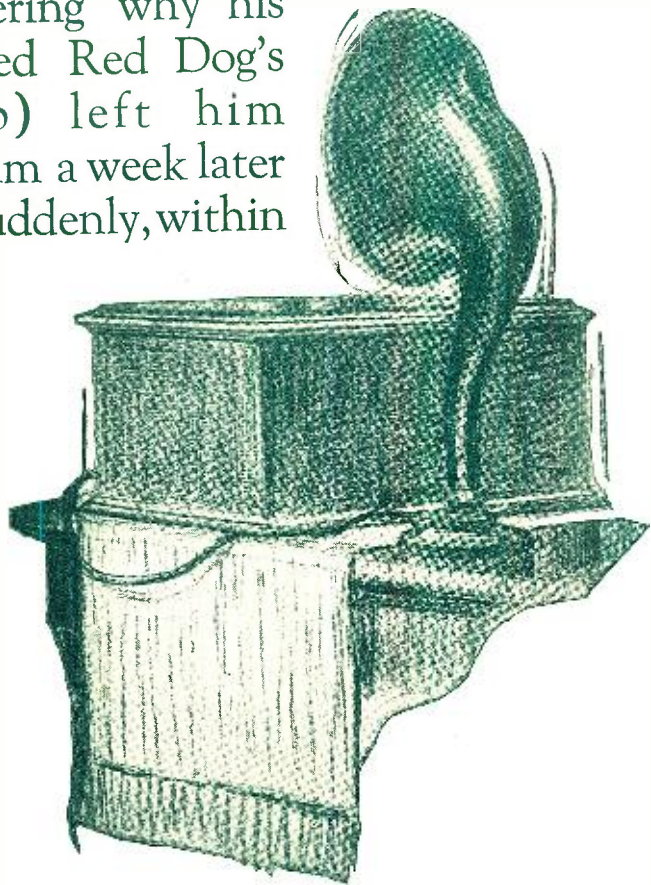

She is kind of independent in her mind, and not fond of explanations, which is why I'm having to do all this writing. She just looked up from a book one evening back there at the ranch, and remarked that she'd got the job; and similarly, after she'd pumped knowledge into the Red Puppies for a couple of months, she strolled in one afternoon when I figured she was seventy miles away, and said:

"Well, Gramp, I'm going to marry a man."

---

ARE YOU DEAD? Let me bury you. Woburn's Parlors, 14 Marginal Street. Phone Connection.—Advt.

---

Just for the minute, waking up from my after-lunch doze with my spectacles way out of place, I figured she must be joking.

"Oh, a man, eh?" says I lightsomely, trying to adjust them, untangle my newspaper, and feel for the makings simultaneously. "Now, that's funny. I've always made a point of marrying women, myself."

Saying which, I got my glasses on, and perceived she was in sober earnest.

"You don't mean to tell me," says I, "that he's a *real* man?"

"He's the sheriff of Red Dog County," says Mary casually. "An imitation wouldn't last there very long."

"Has he got a name?" I inquired, after a pause of reflection.

"Angus McGregor," says Mary. "He's of Scotch descent."

"That's a big load off my mind," says I. "For the moment, I feared he might be a Chinaman."

"No," says Mary gravely. That's a funny thing I've noticed about people in love, by the way. You can guy the stuffings out of the person uppermost in their minds, and they'll never crack a smile. To use a radio expression—I'm coming to radio in a minute, so I may as well get the good of it now—the aforesaid is in fact quite a sensitive test.

---

GRAPE JUICE for sale, first class, beautiful stuff, fit for angels, \$1 per gallon. Ditto, spoiled by being kept too long, \$5 per gallon. H. Jones, Respectable Farmer, RFD 6.—Advt.

---

I perceived Mary to be, in short, considerably stuck on this "Hoot Mon!"

Yet obviously there was something on her mind.

"The only thing that has been worrying me," she remarked, "is how I should keep my sanity, living in that perfectly awful town. Gramp, you've no idea. You never did, in all your life, see such a horrible, dull, dismal, brutal, vicious, ugly hole as Red Dog."

I am sorry to be putting these words in the *Red Dog Weekly Howl*; naturally, I'd have suppressed them, if I'd been given the courtesy of its columns. As it is—truth is mighty, and will prevail.

"Except Angus, there isn't a man in the town who hasn't got legs like the frame on an oval mirror," Mary went on, "and as for the women—the nearest thing to sociability they ever pull off is a weekly reputation-murdering, called a sewing-circle."

"The best thing you can do," says I, wagging my head joyfully, "is to stay at home with your old Gramp. There's a pair of socks in the bureau drawer, now, Mary—"

"I thought so myself," says the girl reflectively, "until Angus figured out a solution. He's slow, Angus is, and he doesn't say much; but he has awfully good ideas. He's going to buy a radio; and then we'll just cut local society out. He'll have me, and I'll have him; and we'll both have the radio for outside company."

There was kind of a lyrical lilt to her voice which warned me that it was all settled, and that I'd better save my breath to get into my boiled shirt with.

"Have you ever heard a radio?" I inquired.

"No," says Mary. "Have you?"

"No," says I, thus failing to break the deadlock.

She came over and kissed me on the top of the head.

"Wedding's tomorrow at four o'clock," she said rather breathlessly. "You're going to give me away. Oh, Gramp, I *do* love him a lot; and I *am* so happy."

---

FOR SALE, Model 1911 Detroit Four touring car. Good rubber 1/4 way around. Original engine. Good practice for buckjumper. Offers under five dollars save stamps. N. Brewer, M.D., Three Pines.—Advt.

---

So far, so good; in fact, we went a whole lot farther than that without running into any very considerable disadvantages. I made inquiries of various persons concerning this Angus McGregor; found he was generally considered a remarkably level-headed, regular living, reliable young man and a first class revolver shot, which indicated that he wouldn't be throwing any widows back on my hands; and accordingly, I graced the wedding with my presence—in fact, the ceremony was pulled off in my house.

Mr. McGregor, judging by what I could see of him over my starched collar, had a good, earnest face, and he wasn't one of those brash kids that talk all the time, either. Far from it. Almost too far for my taste. To tell the truth, the remark of "Yes" at one point of the marriage service was about all the chatter he hazarded until 'way along about the end of the afternoon, when he chanced to meet up with a fellow named Wilkinson, from Longhorn City. I was passing by with two cups of coffee in each hand when they started to talk—Wilkinson was just mentioning a mutual friend they appeared to have named Mike O'Farad; and from then on, their conversation was fast and furious. They had been talking, not to mention drawing diagrams, for all of two hours and a half, when I went out on to the verandah to cool off, and found Mary

menced a kind of oration. The Longhorn City *Clarion* was lying on the table, open at a full page advertisement of somebody's Super-Resistodyne, and as far as I could judge by the way Mary was tearing the page to pieces, it must have been this that set her off.

"WJZ! KDKA! 2 LO! WEAFF! WGY!" she was saying, more or less hysterically, if you know what I mean. "This is Uncle Bunny, darlings! Uncle Bunny, of the Texas State Agricultural Experiment Station. It's hot weather in Miami, Florida, and the prune crop is expected to total six hundred thousand cases."

Having said this, she picked up a small, but solid chair and heaved it through a window; after which she tore off her hat, threw it into the fireplace, looked at me helplessly for several seconds, and finally burst into tears.

**If you have read F. R. Buckley's "Per Land Line," "Alias Slimmy O'Dyne" and "DX—A Yuletide Story of Radio," already published in *Wireless Age*, you'll surely enjoy the quaint humor in "Classified Advertisement." Describing some of the complications in urban life caused by radio finds Buckley at his best**

standing all dressed in her traveling clothes, tapping her foot on the boards and looking impatient, to say the least of it.

"Why," I inquired, "what's the matter?"

After saying "Nothing—nothing!" the way women always seem to feel bound to do, it developed that she and her new husband had had it all fixed up to skip out of the proceedings while the guests were occupied with the eats; thus escaping the shower of rice, confetti, old boots, and horseshoes usual under the circumstances. It further developed that the bridegroom, in the stress of his conversation with Wilkinson, had forgotten all about this arrangement.

"I know that we are married now, and that therefore I can't expect the same politeness as formerly; but I should be obliged," says Mary, "if you would drop in, Gramp, and remind Mr. McGregor of my continued existence."

I did just that; but unfortunately, he and Wilkinson were so absorbed in drawing pictures of a new aerial or something—it was radio they were discussing—that I had to speak rather loudly; and that kind of gave the alarm to the assembled guests; and naturally, to make up for nearly having been cheated of their sport, the aforesaid guests threw more rice and assorted bric-a-brac than they had originally intended to. Two Toes Trotter, who must have brought his own with him, actually got so enthusiastic as to throw half a roast chicken.

Well, this was on a Thursday; and those who have had their only female relatives married away from them will sympathize with me when I say that by the Thursday following, I was just about ready to drop over to Red Dog and see Mary again; incidentally diagnosing as far as possible whether this marriage looked like turning out to be a success. It was a nuisance getting my black clothes out of the mothballs again so soon; I got nearly frantic looking for my collar-buttons; and you may imagine it didn't make me feel any better, just as I was straining my heart over the crank-handle of my flivver, to look up and see the station jitney arriving with Mary herself—and all her trunks.

All the boys had come out of the bunk-house to hear me talking to the car, so I couldn't say anything to her then and there. And by the time I reached the ranch-house living-room, my granddaughter had already com-

Tact is the thing at a crisis like that. I went right over and started patting her gently on the shoulder.

"The radio," I said soothingly, "has been getting on your nerves, for some reason or other."

"Some reason or other!" she bursts forth, jumping up with her hands clenched and her eyes blazing. "He spends the entire first week of our marriage listening in on the infernal thing; wakes me up at 4 a. m. to tell me he's got Honolulu, and then you say 'for some reason or other!'"

She did a couple of gulps.

"I went out for a walk this morning to think it over," says the poor child tremulously, "and I came back, and I said 'Angus; you can choose between that thing and me!'"

She sat down on the sofa and buried her face in her hands.

"Well?" says I, after a decent interval.

"He held up one finger," says Mary, "and s-said 'B-be quiet a minute! I'm getting P-P-Paris, Fuffuffrance!'"

Well, sirs, it made my blood boil, I started for the door.

"He'll get Gehenna, Hell, soon's this Ford'll start," I remarked through my teeth; and went out onto the piazza only to come face to face with the culprit himself.

Judging by the looks of himself and horse, he had raced the train from Red Dog to my place—carrying weight, too; a long black box across the cantle of his saddle. For a couple of moments we looked at each other.

"Well?" says I.

"Mary here?" says Angus McGregor.

"Have you come," says I, "to do your duty, and swear off that home-breakin' machine I see you are packin' along?"

"With an ax," says Angus.

"Inside," says I, jerking my thumb over my shoulder, and starting off for a nice walk so's to leave a clear field for the reconciliation.

A word in your ear. St. James' Oil.—Advt.

Well, he smashed the radio all over my hearth-rug, so that I got splinters of glass in my soles the very next time I took my shoes off; but Mary didn't go back to Red Dog with him that evening.

"He gave me a week of unhappiness," says Mary, when

I expressed some surprise at finding her alone in the ranch-house on my return. "A week for a week, Gramp. I'll go back next Thursday. Not before."

NOTICE. The man who put the cockleburr under my saddle last week is known, I advise him to laugh all he can while he still has a face; signed, W. Besnan.—Adv.

Well, now we come to the part of this story which is hardest for me to write, however easy it may be for a lot of impudent young persons to read.

On the following Monday, a cified looking fellow with a kind of terrified look in his eyes and mud all over him from top to toe, came staggering into the ranch-house about 7 p. m., and said that the motorcar of his employer, Mr. Henry J. Davidson, of New York City, N. Y., was stuck in a stretch of gumbo five miles down the trail.

"You'll have to get a dozen horses at least," stammers this secretary-person, or valet, or whatever he was. "We were hurrying to—we were hurrying, and we're in over all four wheels. You'll have to hurry."

I didn't care for his manner much.

"Who says so?" I inquired.

"A hundred dollars says so!"

And, since the money was right there to speak for itself, of course there was no further argument. I roused out the boys, took fifteen horses and a stump-puller; and, to cut a long and muddy story short, it was barely three hours before we had Mr. Henry J. Davidson drying himself externally with fire, and warming himself internally with whiskey, in my ranch-house living room. He was a very different sort of hair-pin from his secretary; a great big bluff, handsome guy in a fur coat, regularly exuding health, wealth and happiness—especially wealth. The car was one of those four-thousand-dollar racers with two seats and twelve cylinders; its owner was wearing a four or five-carat diamond stickpin; and there was also a morocco leather handbag thing large enough to hold a million dollars in paper money, which Mr. Davidson politely, but firmly refused to let out of his own hands.

"I can't thank you enough for pulling me out of that hole," he said, shaking my hand heartily. "Business is a hard master, you know; I was driving pretty fast—due in Mexico to close a big deal tomorrow afternoon at latest; and that stretch of gumbo didn't look half as sticky as it was."

"And it wasn't half as sticky as a dozen or so you've got ahead of you," I told him.

His jaw dropped.

"Are there any more of those—those man-traps on the road?" he asked.

"About twelve or fourteen," I told him. "And the only way you can avoid 'em is to keep a sharp eye out, and turn off the road on to the prairie when you see one."

"But," says Mr. Davidson reflectively, "you can't tell them from solid road at night."

"Which was just why I was figuring to ask you," says I, "to stop here the night, if you cared to."

He glanced at me sharply, and hesitated.

"We haven't ever murdered a guest for his money here yet, that I remember," says I reassuringly, "but if you feel that a gun would be of any comfort to you during the long night hours, I can supply you with a couple, and there are bolts on all the bedroom doors. The fact of the matter is, my granddaughter and I are more or less cut off from the world down here, and we occasionally crave a little conversation."

"Haven't you got a radio?" says Davidson, smiling at Mary, who had just come in, as if he approved of her highly. I have since learned that it was this smile that decided her to go to bed. At the time, I thought it was the mention of the toy that had wrecked her home.

Anyhow, she went; and Mr. Davidson and I proceeded to spend a congenial evening. He was kind of cagy and high-financierish at first; but as time and the bottle passed, he loosened up and became very human, not to say confidential.

"To tell you the truth, old man," says he, about 2 a. m., speaking in a thick and affectionate voice which was peculiar, he having poured all his drinks into a potted palm, as I found when the plant died, "to tell you the honest truth, I'm going into Mexico for nothing but bribery and corruption. But what's a man going to do? When there's fifty million dollars' worth of petroleum a hundred yards the other side of the border, and I can get control of it by paying an official a mere five hundred thousand—I'd be a fool not to do it, wouldn't I? I'll say I would. Imagine it—right near the surface. A well fifty feet deep'd strike a gusher, I really believe; twenty-five miles of pipe-line'd hook us up with the Trans-continental—and there we are!"

"Gosh!" says I, trying to remember the copy-book maxims about easy money being something to run away from with all four feet.

"The only thing that's worrying me," says Davidson, appearing to put another drink where the rest hadn't gone, "is this—you'll think it's kind of silly; superstitious; but I've followed superstitions all my life, and if you were to ask the First National Bank of Chicago or the Central National Trust Company of New York, I guess they'd say I haven't lost by it. Well—this is it—there's thirteen

(Turn to page 78)



— he having poured all his drinks into a potted plant, as I found when the plant died"

# Around and About the Golden Gate

Meet some of the regular feature artists broadcasting from the Pacific coast stations

By Dr. Ralph L. Power

FROM the simple life in the backwoods country to the rigorous and strenuous daily existence in a big city without losing her youthful charm and vigor has brought to Olive Ann Alcorn the title of "the most perfectly molded girl in America."

Miss Alcorn delivered a series of fifteen ten-minute talks through KFI in Los Angeles last year and told radioland how to reduce, or grow fat, and gave exercises. The talks provoked considerable favorable comment from fans everywhere and she was called to speak before more than a score of women's clubs and similar organizations up and down the Pacific Coast. And several vaudeville engagements resulted from her radio talks so thousands have also seen her dancing interpretations on the legitimate stage.

But Olive Ann thought she owed a big debt to radio and realized that she couldn't entertain radioland forever by talks and they couldn't see her dance. So she studied voice culture for months and now she has leaped into radio's limelight as a singer having made her debut as a soloist at the Los Angeles radio show in December when *The Examiner* broadcast its programs from the exposition.

All of which brought her to the attention of influential movie directors and now she has signed to appear in a series of two-reel films in which America's "most perfectly molded girl" will appear in important rôles.

Certainly radio has held its thrills for Olive Ann Alcorn and it has brought to her the fulfillment of her life's dreams.

EVER on the lookout for the new and novel stunt, KHJ in Los Angeles, recently presented something decidedly unique. With the assistance of the Hollywood Record Company a complete machine for the making of records was taken to the studio and used during the children's hour.

Little Queen Titania, "The Fairy of the Microphone," has appeared for 67 consecutive Tuesdays at 7 o'clock in *The Times* studio, and has established an enviable record. So Titania was seated before the microphone where



Dean H. V. Carpenter, "the man behind" KFAE

she read some selections as she always does on the Tuesday evening program. While this was taking place the recording machinery started and the story was on the recording disk in a jiffy.

When little Titania stopped speaking the needle was reversed and radioland heard the words repeated—coming the second time from the machine record. The recording was so perfect that the listener-in was unable to distinguish the actual voice of the little Queen and the record.

During the Los Angeles Radio Exposition Titania met many of the radio friends she has made in the past fifteen months and autographed hundreds of photographs. Her trip to the studio each week with the "Radio Fairies" and the selections from the "Fairy Library" delight thousands of kiddies far and near. Her little book is just off the press and it puts in permanent form much material that has been given during the children's hour.

WITH the constant endeavor to give the best in drama via radio, stage props have undergone radical

changes. Radio drama, to be successfully transmitted, depends to a large extent upon sound property. Probably nowhere else in radio broadcast programs is the ingenuity of the staff taxed so much as in this important feature of the work.

Wind has, of course, been simulated with dried peas being rolled through a paper tube and the same realistic effect may be brought out by dropping peas on a drum head. A wind sheet for a gale, a vacuum cleaner or electric fan to bring out the flight of an airplane or automobile have also been used with almost immediate success.

Edward Murphy, director of the Community Broadcasters in Pasadena, California, recently put across a remarkably successful playlet depicting life in an orange grove—a program broadcast for one of the fruit growers' organizations of Southern California. This began with planting, irrigating and cultivating the orange grove, spading, pruning and picking the ripened fruit. A couple of buckets of water poured back and forth supplied the irrigating effect, a flat of dirt with a hoe gave the sound of cultivating the ground, breaking tree branches did for the picking of the fruit, and so forth.

Radio studio props include every conceivable thing—sirens from police motorcycles and fire engines, gongs and cash registers from the street car companies, wind mills for Dutch scenes, and the water scenes to simulate dripping caves or coal mines. In short, the average studio rapidly accumulates a fine assortment of props without much difficulty.

An excellent forest fire is made by means of a blow torch. The breaking of matches and the crushing of paper give the effect of rushing wind and flames.

It is practically certain that the children's hour of the future will depend more largely upon props than it does now. Color will be lent to the setting by means of properties such as the cuckoo or singing of birds to go with bird stories, the time honored "grunt" made with a lard pail and used in side shows to give wild animal calls, and other devices.

# Golden Gate Entertainers



*Queen Tania of KHJ, who has appeared in the Los Angeles Times studio for 67 consecutive Tuesday nights during the children's hour program*



*Olive Ann Alcorn, in her new role of soloist, sings to the audiences of station KFI*

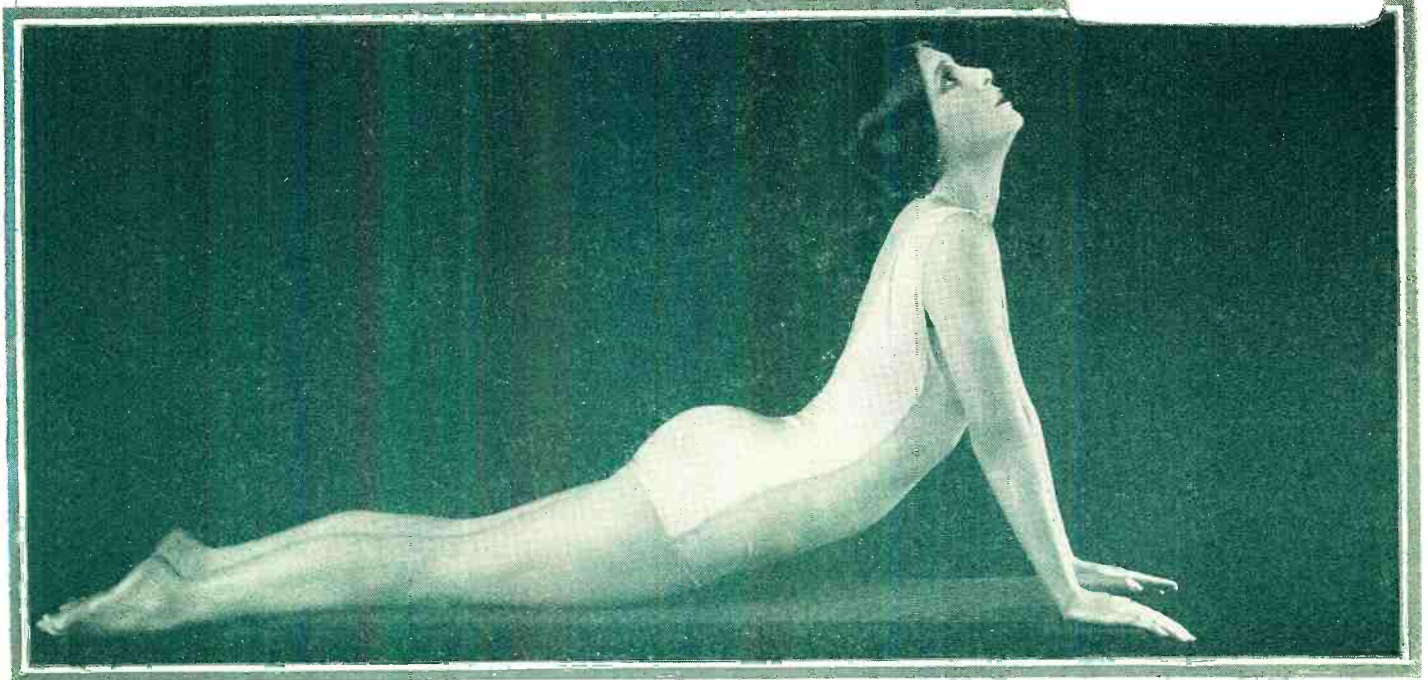

*"America's most perfectly molded woman," Olive Ann Alcorn, originally perfected reducing exercises and gave them to radioland from Los Angeles, but more recently her charming songs have entertained broadcast audiences*

Action is created and simulated by sound—the device varying with the needs of each production. While screen acting made immense and radical changes in stage presentations, radio plays and playlets are making even more sweeping changes in props. As you close your eyes and listen to radio dramatic productions, little do you dream that an entire staff has been planning and working for days to make the props complete even to the minutest detail. An error or miscalculation in it would be more easily detected than on the stage and might mar the entire performance.

WHEN KFAE went on the air for the first time two years ago last December, from the electrical engineering laboratories of the State College of Washington at Pullman, it was through the vigorous work of President E. O. Holland who was instrumental in securing financial appropriations. But it was through Hubert Vinton Carpenter, dean of the College of Mechanical Arts and Engineering that college sentiment was roused to the pitch where the students and alumni demanded a station.

Most of the people in the outlying districts in Washington and Idaho couldn't get long distance reception for most of their sets were crystal sets, and so they thought some of their tax money ought to come back in the form of a broadcast station. And it did.

Dean Carpenter graduated from the University of Illinois with specializing in electrical engineering for his undergraduate work and in mathematics and physics for the post graduate studies. He has been a member of the state college faculty since 1901 and Dean for the past eight years. He has contributed articles to various technical periodicals along his particular field and, at last, his ideas have become crystallized in the establishment of the state college station which is a pioneer in the field of state colleges.

KFAE uses a 330-meter wave length, but the new assignment will change this to 535. During the college year this 500-watt station broadcasts Monday, Wednesday and Friday nights from 7:30 to 9. Some lectures are, of course, given by faculty members, but a good deal of the entertainment is furnished by the music faculty of the state college.

THE first 1,000 watt-er in the Pacific Northwest is now on the air in Seattle with the call letters of KFQX

owned by the American Radio Telephone Company with studio located in the mammoth L. C. Smith office building on the twenty-first floor.

A remote control line operates to the Hotel Butler orchestra which broadcasts twice each night. The new station observes Sunday and Thursday as silent nights and the daily programs are practically continuous from 6:45 until 11:00 o'clock.

From the studio, high above the busy mart of trade and commerce, commanding views of the surrounding country greet the eye of the artist amidst the artistic furnishings of a



The famous Zoellner Quartette broadcasts frequently from KNX

commodious studio that has been pronounced by radio technicians as practically acoustically perfect.

One of the popular features of the programs is the bedtime story by Aunt Vivien. Instead of a motherly old soul of mature years, Aunt Vivien is a pretty, vivacious Miss in the early twenties. Miss Vivien Potter, program arranger and announcer, doubles also as Aunt Vivien and her quaint animal stories for the youngsters have met with popular favor.

Earl Gray and his orchestra, playing in the Rose Bowl of the Hotel Butler, have received telegrams from every state in the union since they began to broadcast early in December.

Alfred M. Hubbard, Seattle electrical wizard, who operates the station and who owns fifty per cent. of the American Radio Telephone Company stock, is authority for the statement that application is to be made for a 1,500 watt license early this year.

KNX made its initial bow to the radio public late last year in Los Angeles and brought the total number of 500-watt stations in that city to four as well as the 1,000 KFI station.

Known as "the voice of Hollywood" the new station of the *Los Angeles Express* has been selected for a series of tests extending through a period of six months by the city school board and, Tuesday mornings, children in all primary schools have a lecture via radio from KNX.

The opening night program was put on the air by Milton Sills, veteran stage and screen actor, and Charlie Wellman, a prince of jazz, acted as announcer.

The station comes on the air daily at eight o'clock with the morning prayer and the "Town Crier" brings forth news items every hour until six in the evening when a musical program is broadcast until midnight.

One control line is now in operation to the Ambassador Hotel with the famous Cocomanut Grove and the Concert Orchestras. Afternoon musicales were broadcast by this station during the December radio show via remote control.

The mechanical equipment and studio is in the Paul G. Hoffman-Studebaker Building in the heart of Hollywood, with its vast wealth of screen talent, and already a number of fine community programs have been sent out from KNX.

Mrs. Carrie Preston Rittmeister, former hostess of KHJ, is the program arranger at Southern California's newest station, which operates most of its programs on a toll basis and presents its entertainment through the courtesy of commercial and industrial firms of the Southland.

THE Naval Radio Station NPX, in Inglewood, just outside of Los Angeles, has been sold by the Federal Government to the National Electric School. This station, long considered one of the most powerful sending stations on the Pacific Coast, has not been in operation for a number of months.

The new equipment is being moved to the School headquarters at Figueroa and Santa Barbara Streets, Los Angeles, where classes are held to coach for government license examinations and for training in every phase of technical, commercial and broadcast radio.





# JOHN STONE STONE

A mathematical physicist whose work on the mathematics of tuned radio circuits made possible the practical radio results of today

*By Oscar C. Roos, B.S., M.E., Fellow I.R.E.*

**M**ANY names are blazoned on the radio honor roll today and yet very few of those interested in this rapidly spreading art know of the epoch making work which this remarkable mathematical physicist did nearly a generation ago in a field too difficult for any but the most highly gifted to explore. His work on the mathematics of tuned radio circuits, especially with regard to the different kinds of couplings, condenser

coupling, resistance coupling and inductance coupling, was the means of leading engineers along a path which permitted the remarkable results we are now getting today in tuning—years after the laws governing these effects were laid down.

It is therefore somewhat of a late hour for laymen and recent radio experts to talk about radio being in its infancy. As a matter of fact, it is no more in its infancy than the

automobile industry and it is only within the last three years that a great deal of the early research work done by Stone has been put to practical use by others. If a general estimate were to be made of what this pioneer has done, it might be said that he has shown the way in which to apply the principles governing carrier wave telephony and most of our modern filter-circuits so as to permit multiplex

*(Turn to page 82)*

# The Children's Hour

A Sunday morning program that is an inspiration to young and old, presented regularly from WJZ by prodigies

By Golda M. Goldman

*"Between the dark and the daylight*

*When the night is beginning to lower,*

*Comes a pause in the day's occupation*

*That is known as the children's hour."*



Constance Campbell, who has appeared with Broadway stars in benefit performances

THAT enterprising studio WJZ has transferred this sacred period from the evening to nine o'clock of a Sunday morning when daddy and mother may turn over for the best sleep of the week while the kiddies tune in for their own special entertainment.

If Longfellow with his love for children could stray into the midst of this very modern children's hour what joy he would find. Whole bevvies of bright-faced, happy youngsters throng the rooms on the sixth floor of the Aeolian Building in New York City. There are little black velvet frocks with parti-colored ribbons, little pink crêpe de chine frocks with blue ribbons, little yellow frocks with ruffles, little boys in white silk blouses or trimly clad in belted suits, this one a musician, that one a poet, another a dancer. What a feast of youth and beauty it would be for the beloved New England poet and how the children would indeed storm "The Round Tower" of his heart.

The presiding genius of the morning is Mr. J. V. Smith of "The New York American." Perhaps it is because Mr. Smith is a bachelor that he is so well able to appreciate and manage the children with whom he comes in contact. Certainly he loves them, as his work with "The Christmas Fund

of the New York American" shows, and surely the children love him, from Baby Betty Sargent who wants to be fondling him constantly, to Omar La Gant, the boy poet.

There are so many talented children from whom the studio can choose that it is an impossibility for them to put

on a program which is not remarkable in its variety and value. Of course, the most popular is Sylvia Froos, who likes to be called "Baby Sylvia," although she is growing so tall that she will soon be able to talk into the microphone without standing on a chair. The fact that she has a most remarkable voice is attested to by the fact that she draws five hundred a week on the Keith Circuit and is known all over the country for her syncopation. She appeared at the Eddie Cantor dinner where she followed the great comedian and caused almost an equal sensation. Sylvia never took a singing lesson in her life. When she and her mother are traveling about the coun-



Boy and girl entertainers in the WLS Woodshed Theater Play

try a private teacher goes with them and when she returns to New York she goes back to school where at present she is attending P. S. 64 in the Bronx and is in Class 5B. Sylvia is a born mimic and can put more pep into a five-minute performance than most entertainers can put into an hour. In a black velvet frock embroidered in colors and black patent-leather Cossack boots with gray tops and socks she is a perfect little star as she faces the microphone which presents no terror for her.

Another favorite is Omar La Gant who is the typical artist with long, blond, wavy hair, white silk blouse and black knee-breeches. Omar, who will probably be an actor one day, is at present an elocutionist who has won many contests. For instance, he has a gold medal presented by "The Southland Singers," a body of professional entertainers which meets at the Plaza Hotel. The medal was a token of his work on their monthly programs. Another gold medal comes from the "Metropolitan Theater League," and was won in open contest at the Waldorf-Astoria in the drive to form a Junior Auxiliary. Last October he won a silver loving cup offered by the Detenu Social Club in Lenox Assembly Hall in a best entertainer's contest. Omar has been taught by Mr. J. G. Geiger and Miss Isabell Mersin, of the School of the Theater. He has appeared in the excellent fairy tale performances which were given last year on Saturday afternoons by the School of the Theater, such as "Pinkie and the Fairy." His excellent diction and unusual interpretations have won him notices in many

of the dramatic journals of the day.

Little Anna Diamond, the nine-year-old pianist, is to make her debut at Aeolian Hall this winter. She studies under Boris Feibish of New York and is his youngest pupil to have ever made a solo debut. Anna, however, does not possess all the musical talent in her family as her brother who is seven years old, plays the violin so well that they will appear together at a concert at the Academy of Music in Brooklyn in February. Anna's unusual talent may be judged by the fact that her concert program includes the "Hungarian Phantasy" by Liszt, the "Four Impromptus" by Schubert, "Lasches" by Paganini-Liszt, and the "Concert Stuck" by Weber.

It is unfortunate that dancing cannot be transmitted via radio for then Gertrude Chevallier, the ward of Madame Chevallier, the dancing mistress, would be able to do her Russian and Acrobatic Dancing for her young audience. As it is, however, she recites comics for them instead. She may be seen frequently at Hunts Point Palace and will soon appear in vaudeville on the Keith Circuit.

You would love to see little Henrietta Luhrs, a seven-year-old vision in fluffy pink, as she stands on a chair to sing "Barefoot Days" into the microphone. Henrietta is probably an old friend of yours from the movies for

she has appeared with Tommy Meighan and many other stars. For instance, she was in "West of the Water Tower" with Glenn Hunter and May McAvoy, in "The Snow Bride" with Alice Brady, and in "Zaza" with Gloria Swanson. Henrietta is also a student of Madame Chevallier and her forte is Oriental dancing and high acrobatic kicks which she can do with a perfection seldom found in a young child.

Perhaps the most unusual entertain-  
(Turn to page 75)

These little tots are worth tuning in on

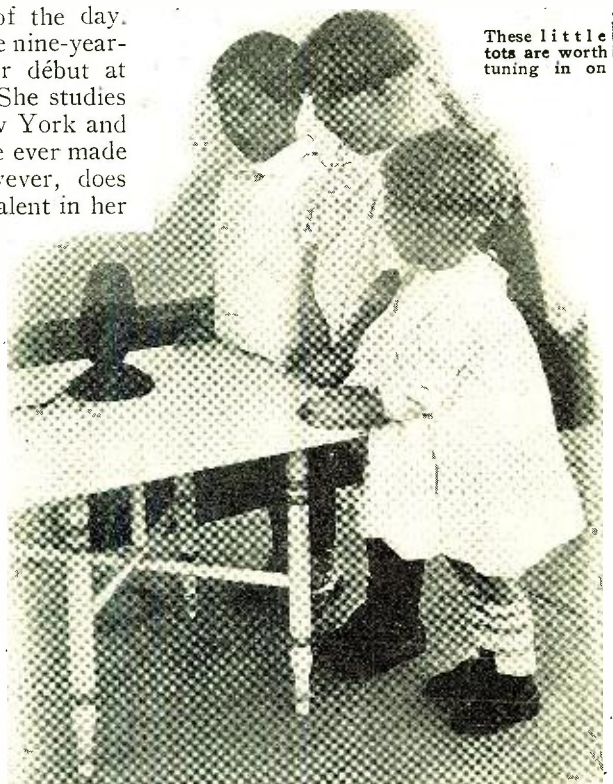

Little Sylvia Froos and her sister Mildred entertaining some notables—Jas. Swinnerton, Winsor McCay and Uncle WIP of Philadelphia—while broadcasting their program from WJZ

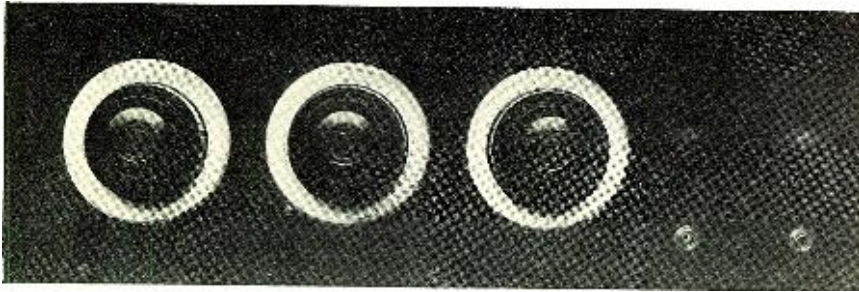

*REDUCTION of losses in receiving apparatus marks the most recent development in radio—learn what it's all about by building this set*

# A HOW TO BUILD Very Low-Loss Receiver

*By R. A. Bradley*

WHEREVER you go or wherever you are, at the present time, you hear "low loss" this and "low loss" that. What does it mean anyway when you get down to hard facts? Is this another fad sweeping the fans like a new circuit or is it a real development?

It most certainly is a development—a marked and notable one. And one needs only to make comparisons between a real low loss receiver and standard "hiloss" sets of a year ago, to be convinced. When you look back over the receiver you used a few years ago you cannot help but wonder how the poor little micro-volt of signal energy ever reached your headphones.

The reduction of losses in receiving apparatus marks one of the outstanding developments in radio in the past ten years.

What does the reduction of losses accomplish? It sharpens tuning; it increases signal strength; reduces set and tube noises; and in these ways the

- | LIST OF MATERIALS  |
|--|
| One Low Loss tuner (Radio Engineering Laboratories)        |
| One .0005 mfd. variable condenser (General Instrument Co.) |
| Three Standard sockets (Howard)                            |
| Two Audio transformers (Pacent)                            |
| Two Single closed circuit filament lighting jacks (Pacent) |
| Two Bradleystats   |
| Three Micro-Dials (Jewett)                                 |
| One 7x21 Panel (Pyradiolin)                                |
| Six Eby Binding Posts                                      |
| One .002 mfd. fixed condenser (Dubilier)                   |
| One Bradleyleak and .00025 mfd. Condenser                  |

reduction of losses means a more efficient receiver.

The receiver about to be described has been used for only a month, yet in that time it has certainly proved what low loss design, construction, and assembly will accomplish in a receiver.

The main tuning unit is manufactured complete and includes a basket weave fixed secondary, a tickler coil and a primary coil. The latter two are

wound solenoid fashion on bakelite tubes. Perhaps you wonder why low loss design is not carried into effect in these instances. Why?—because there is absolutely no advantage to be had from the reduction of resistance in the plate circuit of a regenerative detector tube. Did you know that the average fan's antenna has comparatively very high resistance and that the removal of one ohm from the primary coil will have no effect on the operation of the set? Such is the actual truth of the matter.

The variable condenser tuning the secondary further carries out the low loss practice. It is a grounded rotor condenser of superior construction insulated with Isolantite which needs no introduction.

The sockets are those which have excellent side-wiping contacts with real honest-to-goodness springs in them. When you put the tube in the socket—you know it's hitting "on all four" contacts.

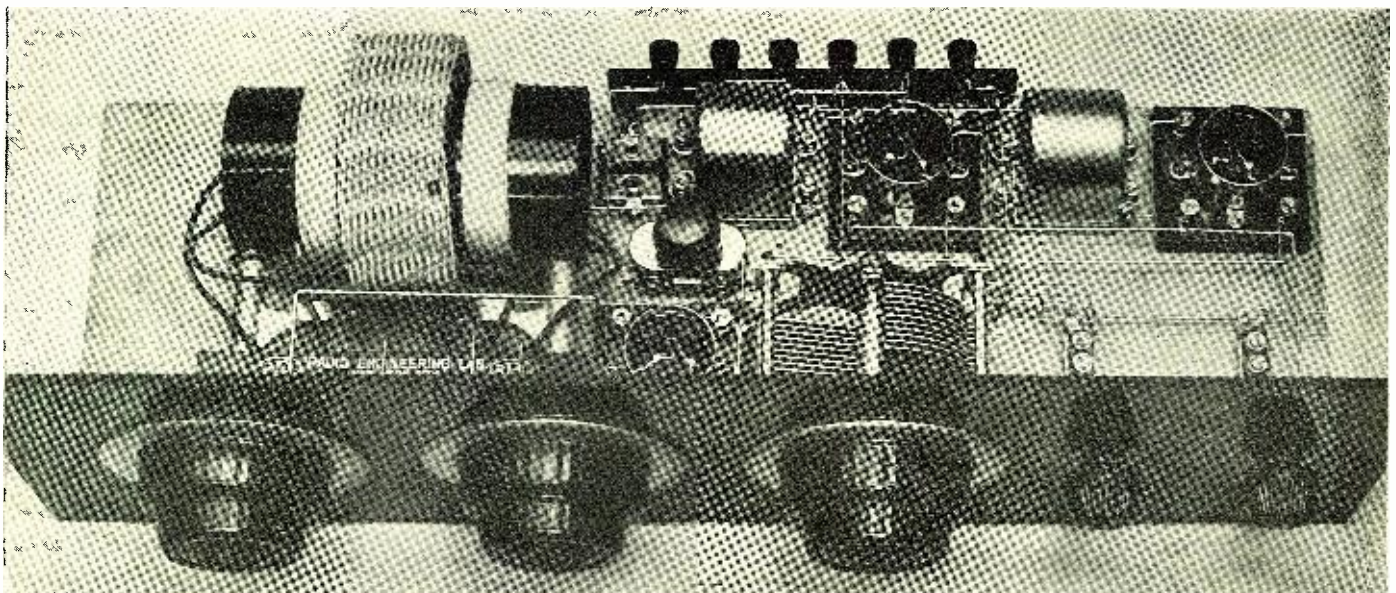

By placing the detector tube socket as shown between the tuner and the variable condenser, the shortest possible leads are secured. The Bradleyleak together with the grid condenser connected directly across its terminals is placed directly behind the detector tube socket

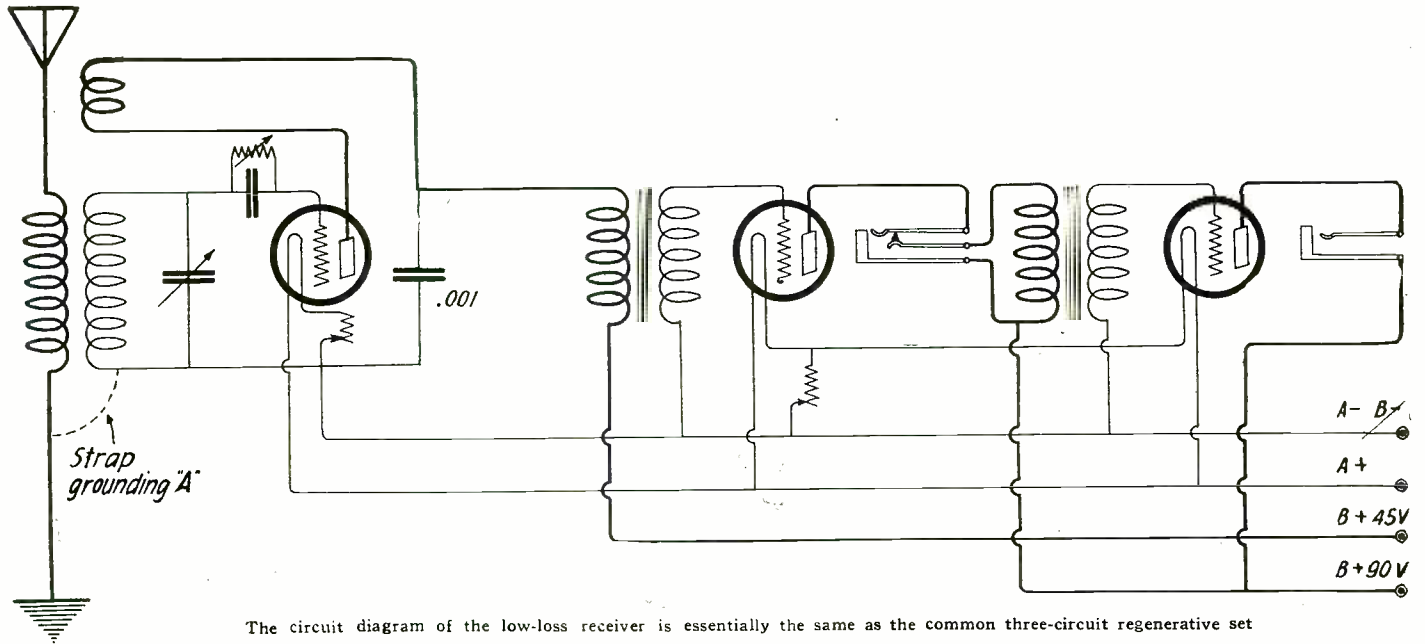

The circuit diagram of the low-loss receiver is essentially the same as the common three-circuit regenerative set

You see now what we meant by low loss in construction and assembly when it is carried even to contact springs on sockets, and the results speak volumes and these results are more convincing than ever printed words could be.

**How to BUILD IT**

The main consideration in the first stages of the receiver's construction is the panel layout. You must have a 7" x 21" panel and on this panel must go three tuning dials, two rheostats and two jacks. The best arrangement is as follows: The hole for the shaft of the primary coil is drilled 3½" from the left end of the panel and centered, up and down. The template furnished with the tuner will indicate the proper drillings for the tickler

shaft and supporting screws. The distance between shaft centers is given on the template. Measure off an equal distance to the right of the tickler shaft and center punch this for the shaft of the tuning condenser.

When this is accomplished the position of the rheostats will be simple to locate. The two jacks are placed in a line 1¾" from the base of the panel. This completes the panel layout. Attention is next directed to the baseboard and to the instruments mounted thereon. Particular attention was paid to the layout of the transformers and sockets for most efficient operation, shortest leads and simplest connections. By placing the detector tube socket between the low loss coil and the variable

condenser it is possible to secure very short leads. The audio frequency unit is then laid out along the rear edge of the baseboard in as compact a manner as possible. We wish to call your attention particularly to the method of making connections to these excellent audio frequency transformers. The leads are brought out in such a way that it permits mounting the transformers slightly to the rear of the sockets, and the plate and grid connections come out directly to the tube socket binding posts. The B plus and A minus are to the rear of the transformer and go directly to their respective binding posts. This is the ideal method of making transformer con-

(Turn to page 73)

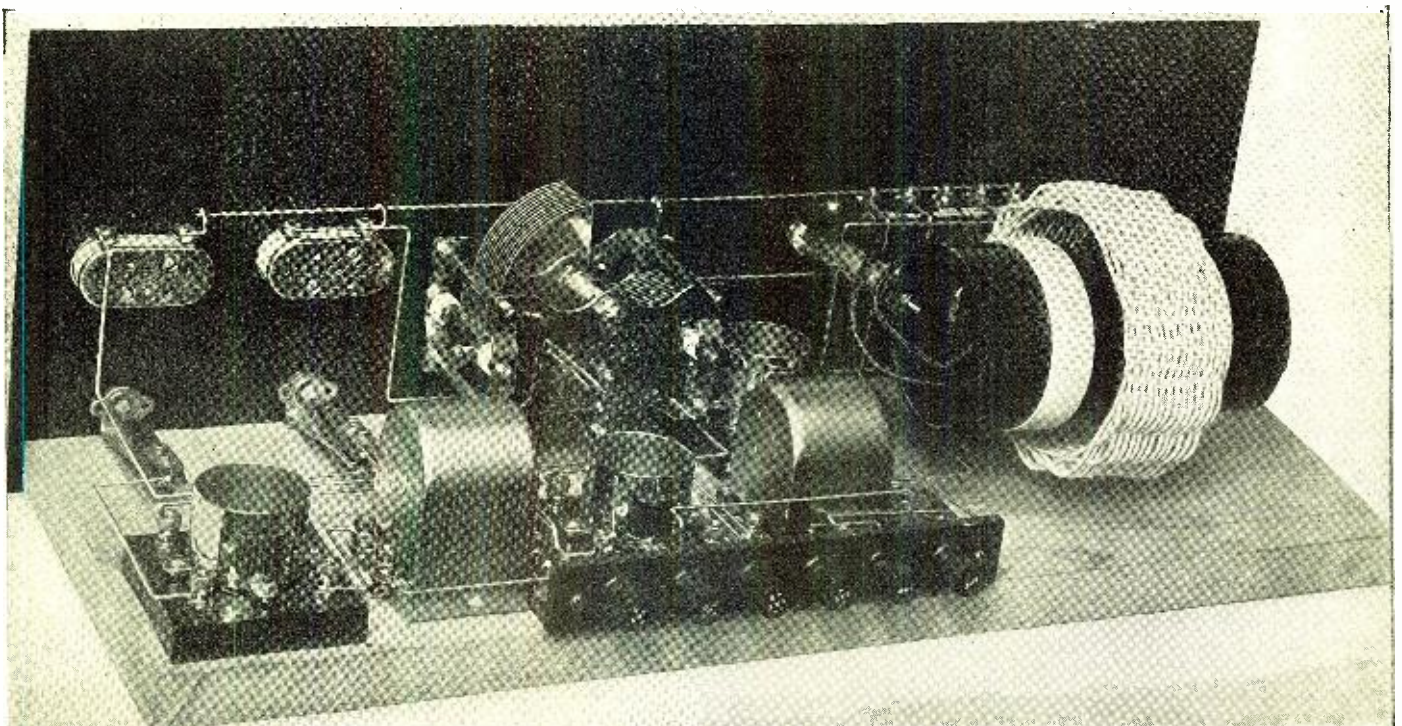

The relative positions of all instruments is clearly shown in this illustration. The long piece of bus-bar running along the panel is the common negative return lead

Miss Eleanor  
Ahearn,  
director of the  
Home Service  
Department  
of W L W



A test kitchen  
is utilized to  
develop all  
recipes broad-  
cast from WLW

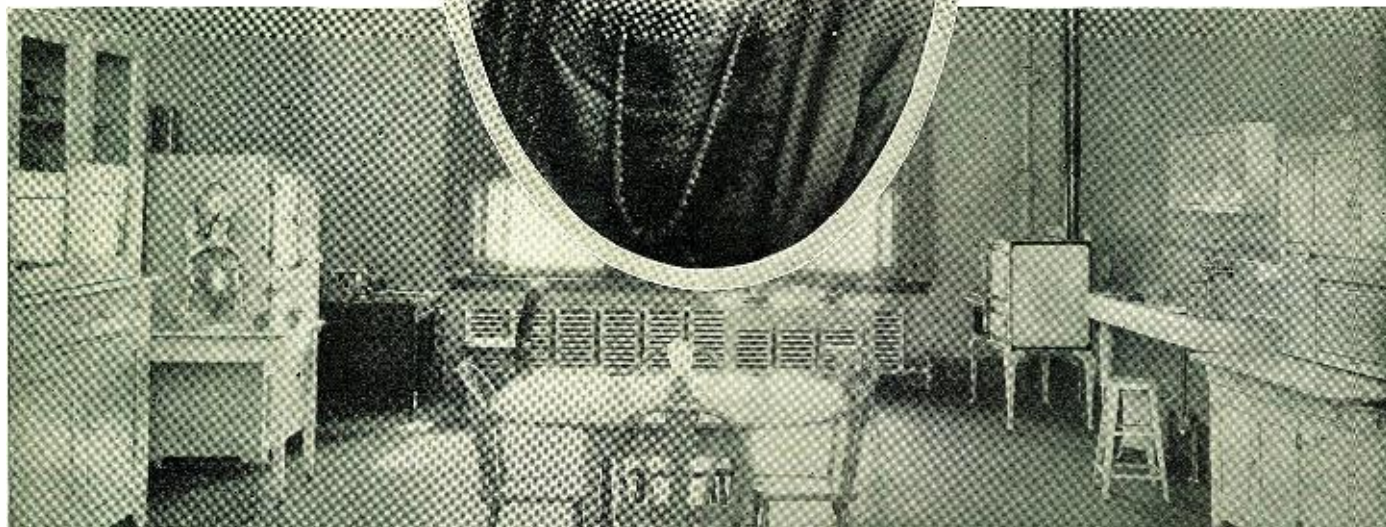

# Radio Schools of Housewifery

Well defined study courses in home subjects, with all the paraphernalia of registration, examination and graduation—all by radio!

*By Mrs. Christine Frederick*

SO much attention is focused on music, political talks, etc., by radio that perhaps the biggest and most significant single development of radio broadcasting is being overlooked. I refer to the broadcasting of cooking and household information, and home education via radio throughout the country. This development has, in the past year, reached quite surprising proportions. Three years ago, when I wrote an article in "Good Housekeeping" advocating greater attention to this subject—then almost neglected—I felt I was voicing a hope rather than an expectation. I believed very strongly that radio could do a great deal to lift American housewifery to new levels of enlightenment, but it seemed rather optimistic to hope for big results very soon. But in radio all things seem to move rapidly; in tune perhaps with the 186,000 miles per second of the radio waves!

At any rate, 1924 has been a remarkable year for variety of education and

service, on cooking and household and other topics rendered to women by radio broadcasting stations. It is all the more remarkable for the reason that such service has been established permanently, which indicates certainty of future growth to splendid proportions.

A few years ago there was very little service to women. One or two stations had little ten-minute talks to housewives; and the stations which sold advertising time had occasional paid talks on miscellaneous food and household subjects. Today, there are at least 50 large sized broadcasting stations in the country which have a more or less regular service of more than usual competence and scope. This number is increasing almost every week. In fact there are large sized broadcasting stations owned by great companies having a definite interest in better cookery who devote a considerable part of the station to the task of home education. Even this is not all. There are now

universities and other institutions offering well defined study courses in home subjects, with all the paraphernalia of registration certificates, examination papers and certificates of graduation—all by radio!

I have thus sketched in brief what has been going on, and while estimates of listeners-in in the radio field are likely to suffer from "Wallingfordian" exaggeration, I feel it safe to say that at least 1,000,000 women, if not 2,000,000 women are listeners-in on home economics information and help.

I can do no better in picturing the situation than to describe some of the actual work of stations along these lines, and leave you to judge of its value as well as to infer the equally valuable work done by other stations not mentioned.

It will be impossible to describe the work of all stations; and I select from a survey I have made on the subject some of the more unique and interesting examples.

The stations I name, not only include stations operated by private companies, but by universities, newspapers, etc. I have tried to give some idea of the varied nature of the service to women and also to select examples from sections all over the country.

Perhaps we may well start with examples of university facilities offered to women over the radio, since this is, no doubt, a more important development than others. I have known, for years, that a great number of women who have children and even those whose children are grown up, have yearned to go to school again, and wished for educational advantages denied them in earlier years. But the great response which cooking and home making courses via radio have met with has surprised everybody.

Let us start with the always unique state of Kansas, whose State Agricultural College at Manhattan, Kansas, Station WTG, 273 meters, has a well planned course in home economics, requiring the applicant to sign an enrollment card which definitely makes her a part of the student body. Dr. Margaret Justin lectures every Thursday evening, and if you suppose that only Kansas women are enrolled, you will have a pleasant surprise, for a dozen or more states are represented in the enrollment. Women as far away as Canada are interested, and the teachers have a heavy mail. A certificate is granted those who pass the course satisfactorily and you may be assured that no fancy sheepskin from a great university is more highly prized than this certificate.

It may be supposed from the foregoing that only women in Western University states are interested — but you are wrong again! Possibly the most zestful and active of the courses of home education, the one which has been operating longest, is that operated by the Peoples Light & Gas Company of Chicago. When I organized this company's "Home Economics Department" several years ago, thousands of women came personally to the daily lecture rooms, and being a radio fan, I realized that radio would certainly be a means of further extending such

service, especially to women who could not leave their homes. Mrs. Anna Peterson's talks and lessons on cooking over the radio in Chicago are now classics and are listened to by many thousands of women. This course requires an enrollment and offers a cer-

"compiled out of the air" to you.

Possibly the most thoroughgoing of all such radio courses is the one operated by station WCCO at Minneapolis, Minn. This station is owned by the Washburn-Crosby Company, makers of Gold Medal Flour, and it is easy to see why such great emphasis is placed on service to housewives. It is one of the facts of modern advertising that whatever increases the intelligence and alertness of the housewife is sure to be of benefit to the companies supplying her; and the broad-minded educational attitude assumed by the Gold Medal people is naturally a most valuable public service. Miss Betty Crocker lectures to women over the radio each morning at 10:45. On Mondays and Tuesdays it's a cooking lesson; on Wednesday, Home Management; on Thursday, meal planning; on Friday, practical nutrition, and on Saturday, talks to girls. In this way the full range of home knowledge is gone over. A direct connection making the service practical from a business point of view is operated by sending to those who inquire and ask for them, printed recipe cards to be used in the card recipe file. A cooking course running eight weeks is broadcast each Tuesday night, constituting a complete line of study for which certificates are issued. This station aims to achieve the reputation of being most definitely for women's practical benefit, and operates a service probably unequaled



Gilson V. Willets, operator and technician at WOC

throughout the country for scope and variety of women's material. There is a further women's hour every afternoon at 2, used for a great variety of home topics—beauty talks—dance lessons, music, cultural topics, women's club work, business and politics.

Another station which is a l r e a d y widely known nationally—the Radiophone station WOC, 484 meters—the Palmer School of Chiropractic, of Davenport, operates also a rather unique service. A regular fea-

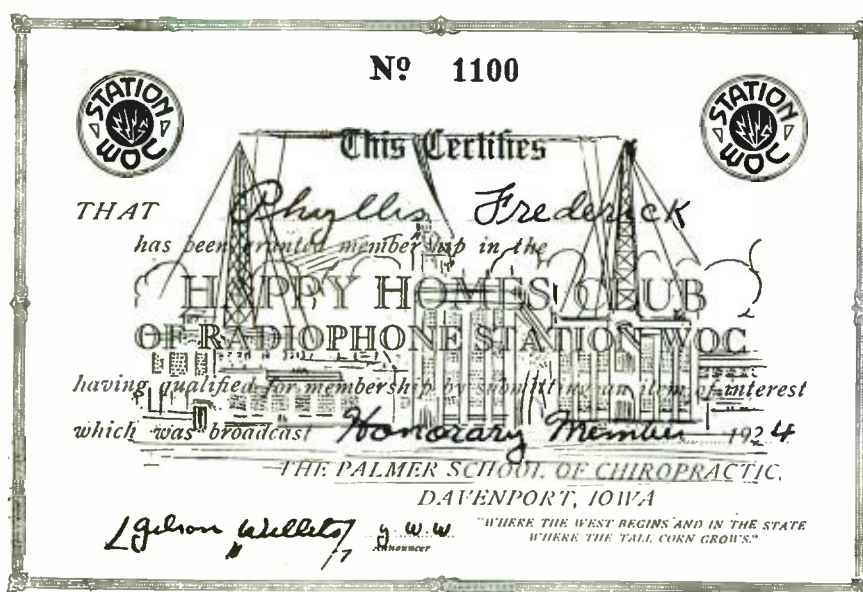

Membership certificate of the Happy Homes Club awarded by station WOC

certificate on completion of the course. The Gas Company furnishes nicely printed blank books for recording the recipes broadcast as they come over the radio, and thus brings into existence a totally new kind of cook book

ture which is increasing in popularity is the Happy Homes Club which specializes on a daily morning talk of home helps. Instead of dully broadcasting a lecture, the schedule calls for a *meeting of the Club*, and thus gives it something

of a social aspect. The service to the home is made concrete and vivid by the publication of an elaborate booklet of "helpful hints for happy homes" which contains 64 pages of recipes, together with a description of the service of the station and blank pages for the insertion of broadcast recipes. WOC when first starting the home service work secured the co-operation of the home economics department of the United States Department of Agriculture, which especially prepared a daily bulletin for broadcasting. The most popular plan operated by this station, however, was to ask housewives to submit their recipes and household hints so that they might be broadcast. Particular interest was developed by setting aside each week for definite types of dishes. This brought a great mass of recipes. An additional success was developed during the Spring and Summer season by a daily garden talk. The WOC Club is in the hands of Mr. Wilson Willets, who nearly two years ago organized the first women's service from this station and understands the need for and the response to material of this sort. There are talks on Interior Decoration, Cooking, House-cleaning, Travelogues, Dress-making, Fashion, Children's Games, Poetry and many other items. The unique feature of this Happy Homes Club is that it is run by its members. Membership is granted as soon as they send in a recipe, or give other indication of definite interest. A certificate of such membership is shown on page 37.

During the Christmas holidays, prizes were given for the first and second best complete menus submitted by listeners-in, thus giving the stimulus of competition to the station.

Sears, Roebuck & Company, operate station WLS, 345 meters, in Chicago, and with its usual advertising genius has made a great deal of this service. It has in charge of its Home Maker's Hours, Margaret Reese Filkins, and instructive talks are broadcast by executives of the Illinois League of

Women Voters, the Federation of Women's Organizations, as well as others who are utilized. Each day household material is broadcast, the subjects covering a broad range of material including, for instance, a talk by Elizabeth Weirich on clothing and textiles for the home woman. At Christmas time a big hit was made by broadcasting a special Christmas menu by a

famous Chicago chef, M. Henri, Chef of College Inn at the Hotel Sherman. This menu is reproduced herewith for its special interest.

Another station which is utilizing the special interest of a large well-known concern is the Crosley Radio Station WLW, 423 meters, at Cincinnati, which broadcasts a home service department in charge of Miss Eleanor Ahearn, who is Director of Household Research with the Procter & Gamble Company. A cooking school is broadcast from this station, and is another example of happy combination of private and public interest.

New York has been rather slow to develop broadcasting of such material, but WJZ, 455 meters, The Radio Corporation of America's New York station, has a women's hour of real value and interest each morning. WEA, 492 meters, the A. T. & T. New York station, has started a very extensive home study course backed by the kindergarten of Teacher's College, Columbia University. The subject upon which they will concentrate this winter is *child training*. The lectures are delivered actually at Columbia University and operated through

"remote control" system, relaying to the WEA studio. The lectures will even include part of the University Chapel service, to give mothers taking these courses the further sensation of going to college. The subjects listed for this quite important course cover a wide range—"How Mothers May Keep in Touch with Children's Interests;" "How Mothers Can Help Children to read;" "Games Children Love to Play;" "Children's Nature Interests;" "Children's Religious Problems;" "Songs for Children;" "How to Tell Biological Facts to Children;" "Choosing Books for Children;" "How Children Can Make Christmas Gifts and Playthings;" and "Worth While Toys and Playthings for Children."

The lectures of the series are to be 20 minutes long, which is less than

(Turn to page 69)



Rosemary Cramb, announcer at WGY, in charge of programs for women

#### CHRISTMAS MENU

M. Henri, Chef; College Inn  
Hotel Sherman, Chicago

Fruit Cocktail

Celery—Olives—Salted Almonds

Chicken Broth in Cup  
Saltine Wafers

Roast Turkey Stuffed with Oysters  
Green Peas in Cream  
Candied Sweet Potatoes  
Cranberry Sauce

Head Lettuce French Dressing

English Plum Pudding  
Hard and Brandy Sauce

Assorted Nuts

Coffee



# Among the Broadcasters

By Ed Randall



"Hook" Kennedy, Scotch comedian and singer, who has toured the country several times and has won the unqualified approval of WRC fans

## In Defense!

By Carl Dreher

AMONG the cruel and unusual hardships to which broadcast operators are subject, is the fact that they can never get married. Working at night, they are unable to take their best girls to the movies, which embitters these charming maidens and alienates their affections in a short time. When a technical broadcaster does marry, it is by dumb luck or misrepresentation. Furthermore, owing to the excessive wisdom of the broadcast operator, it is impossible for a woman to live with him once such an ill-starred marriage has taken place. Remember, my friends, that a broadcast operator has listened to thousands of informing talks on cheese brokerage, the boll weevil, why girls should stay at home, what to feed the children when they bawl into the airshaft at 3 A. M., how to get to Flatbush, and countless other significant topics. His head whirls and swells with all this intelligence, and consequently he becomes unbearable. Whenever his wife speaks to him, he catches up her first phrase



Arthur Murray, well known dance instructor, broadcasting one of his latest—the "Radio Glide"

and releases a torrent of exposition on the single tax or mumps. She has no chance to get a word in edgewise, and, as we all know, nothing could be more galling to a woman. The result is, in this case, that she resorts to force, but the broadcaster-husband, having absorbed numerous talks on boxing and ju-jitsu, knocks her through a window. A few such incidents are enough to end any marriage.

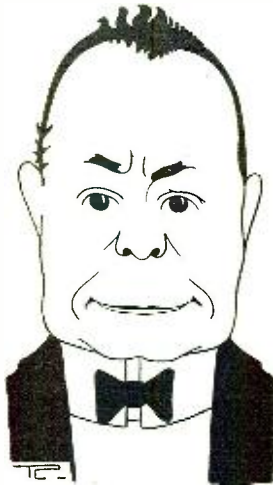

Joseph Knecht, the modest but brilliant director of the Waldorf-Astoria Concert Orchestra, "just loves" to speak to "Mike"

But here we contemplate a striking instance of poetic justice in real life. The affliction suffered by the broadcast operator's wife whose case we have just analyzed, is a daily occurrence in the life of the unfortunate operator himself. For eight hours each day he suffers under the impact of



Graham McNamee, reading—not "speaking" this time—a rare occasion for this busy and well liked announcer

songs, sermons, bedtime stories, political arguments, ukulele solos, and all manner of sounds of man and beast, without the slightest chance to pour out his own soul—and he has one—in any of these ways. The listener may tune to what he pleases or shut off everything with a flip of the switch, but the operator must stay at his post—or go back to the soda fountain. His own urge for self-expression is constantly smothered under the multiplied similar urges of other people. Some day, it is to be feared, the technical staff of a broadcasting station will rise in armed rebellion, seize the



"The Radio Franks"—Wright and Bessinger—just tickle themselves, the piano and everybody

equipment, and run amuck on the air until shock troops can be dispatched to put down the revolution and return the station to the forces of sanity and order. While the operators hold the fortress, what a caterwauling and bedlam will din into the ears of the amazed listeners! All the technical experts will try to talk and entertain at once, and none will stay behind to monitor the apparatus, which, sizzling and on the point of melting, will add its own quota of discord to the horrible medley. Then indeed, the broadcast critics will have something to write about!

And now we must consider the special injury the broadcast operator suffers when he transmits from a theater. Picture a susceptible young man, seated at his amplifier in the wings, in the act of broadcasting a musical comedy. He is surrounded by ravishing chorus girls in costume, who flutter around him, when they are not on the stage, and simply throttle him with their admiration and attentions. They all want to listen to the output of the amplifier, and I have seen such a crush of dazzling females around the operator at a theatrical event that he thought

(Turn to page 70)



Chas. Wold, perhaps, has perverted the proper use of drinking glasses, but his broadcast audiences become intoxicated just the same whenever it is his treat

One of the simplest and best of the regenerative receivers

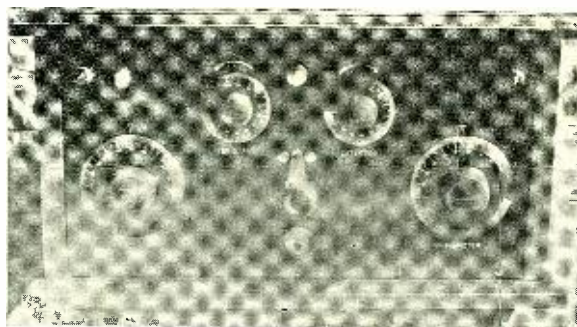

A set that affords a most consistent type of performance

# Modifying the Reinartz

By W. P. Lukens

THESE are some circuits known to practically everyone who has combined wire, metal plates and insulation to form a receiving set. These circuits are based on the "Old Reliable," known variously as the "Armstrong," the "Short Wave Regenerative," "Two Variometer and Variocoupler," etc., and the "Reinartz." These circuits are comparatively simple and all of them will work when everything else seems intent on failing. The Armstrong has probably been the most modified and experimented with because it is the most easily understood. In the Reinartz form it is usually associated with the mysterious-looking spider-web coil, and while many different forms and types of this winding have been produced, it remains essentially the same as regards ratio and number of turns. I have seen the "Reinartz Coil" wound with everything from No. 18 enameled wire to No. 28 d.s.c., on everything from an air core to bakelite discs and wooden spokes.

The main difficulty with modifying the Reinartz is that as soon as it is perceptibly modified it no longer stays a Reinartz. However, for a short period there appeared a form of the Reinartz which used a specially wound variocoupler instead of the special coil. This modification was as good in action as the regular circuit and offered no advantages in the way of either construction or operation. More recently there has appeared another modification of the circuit which is at least as good in operation as the original and is very much easier to construct. Its tuning is as simple as that of the "Ultra-audion" and in addition it will do a few things in the way of reception which are strongly reminiscent of radio-frequency amplification rather than of regeneration. However, I am not so sure that this modified circuit is still

a Reinartz, which may account for some of its peculiarities.

To show the development of this circuit, it may be well to examine the regular Reinartz, in the form in which it is usually drawn, as shown in figure 1. The complication of the three sets of taps is clearly indicated; but if the diagram is re-drawn, as shown in figure 2, it is much easier to understand what it is all about. Here it is clear that

also that in many cases poorly constructed switches decrease the effectiveness of the set, through setting up losses of poor contact.

The first step toward modification of the circuit consists in changing the method of controlling regeneration. Instead of a tuned feed-back, a tuned plate circuit is used, accomplished by eliminating the regenerative coil and condenser and inserting a variometer, exactly as the plate circuit is tuned in the Armstrong. This change naturally very largely changes the type of tuning inductance, and while the spider-web coil may still be used, there is no reason why a simpler tube-wound coil may not be used. Keeping this fact in mind the next transition is to do away with all the remaining taps through the simple process of designing the tuned and untuned coils so as to cover the existing broadcast range. Figure 3 shows the use of tap-tuned coils as compared with the use of fixed coils shown in figure 4.

The circuit of figure 4 is the one which has been used in making up a considerable number of sets, but if one is inclined to build a set which is even a bit simpler and appears slightly better mechanically, the circuit shown in figure 5 is the next step. This presents, of course, merely another method of tuning the plate circuit, using a coil and condenser instead of the variometer. I believe that two of the usual "neutrodyne" transformers and condensers could be used quite satisfactorily, though this has not been tested, and it is possible that some modification of the coils might be required before the best arrangement is determined.

The circuit shown in figure 5 naturally suggests the addition of another tube to result in a tuned-impedance radio frequency set, but there is no real reason for following out this sug-

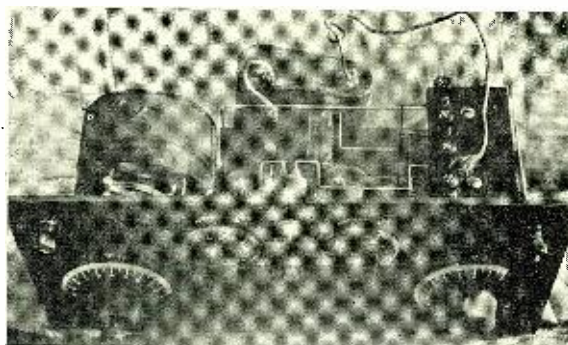

A most compact panel and base board arrangement is afforded by following Mr. Lukens' design

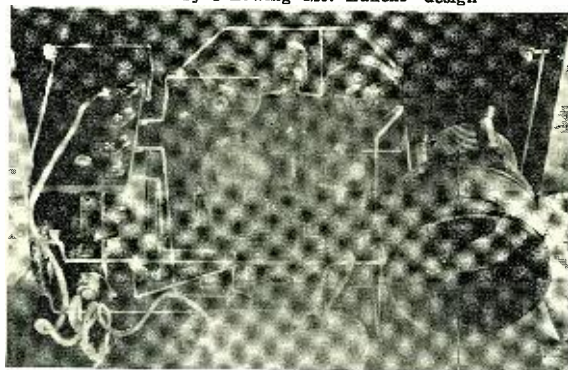

The author's two-tube variometer-tuned plate Reinartz receiver showing a rear view

an aerial circuit is tuned by means of taps, and that a secondary circuit is tuned both by means of taps and a condenser. The regenerative action is apparently a species of tuned conductive feedback, controlled by both taps and condenser. Many people never get to understand the function of the different condensers and taps and for that reason never realize the full effectiveness of their sets. It is probably

### Station at Zurich

A NEW broadcasting station at Zurich, Switzerland, was put into service recently. The Bell Telephone Manufacturing Company of Antwerp, which is associated with the International Western Electric Company, supplied the equipment.

### Government Buys 80 K. W. Tube

THE Bureau of Engineering of the United States Navy Department has awarded a contract to the General Electric Company for the manufacture of an 80 kilowatt or 80,000 watt electron tube transmitter. This powerful radio-telegraph transmitting device will, when completed, be installed either at the naval high power station at San Diego or Mare Island.

It is understood that the General Electric Company is constructing three of these 80,000 watt transmitting tubes. This really means "superpower."

### German Patents in Demand

THE Navy Department is being flooded with requests from American radio manufacturers for the use of the German radio patents recently offered on reciprocal licenses. A standard non-exclusive, non-transferable but revocable license has been drawn up and will soon be submitted to applicants with a request for a list of their patents which would become available to the government. The process of going over the many applications and accompanying lists of patents will require considerable time. All applications will not be granted; probably only those firms having pat-

ents believed of value to the government will be cross licensed.

Fifty-three applications already listed indicate that considerable interest is manifested in the Schloemilch-von Bronk reflex hookup, which is the best known of the German patents.

### Wave Lengths Shifted

REALLOCATION of wave lengths for broadcasting stations throughout the United States is being made in an effort to eliminate "squeals."

WNYC, municipal broadcasting station, has been ordered to take a wave length of 528.8 metres and approximately 567 kilocycles to avoid interference with Station WOAW, Omaha, Neb. KDKA is broadcasting experimentally on 316 metres, shared by Stations WGBS and WAHG, and at 309 metres WSAI is trying 326 metres. WWJ, Detroit, is expected to receive a new wave length.

### Radio and the Public

By HERBERT HOOVER

THE greatest development in broadcasting up to the present has not been in the application of new methods of transmission or reception, important as improvements in these lines have been. It is rather in the change in public attitude. Listeners are becom-

ing more and more appreciative of the real service of radio and increasingly critical both as to the character of the matter furnished them and as to the efficiency with which it reaches them. The whole broadcasting structure is built up on service to the listeners. They are beginning to realize their importance, to assert their interest and to voice their wishes. Broadcasting must be conducted to meet their demands and this necessarily means higher character in what is transmitted and better quality in its reproduction to the ears of the listener. The broadcasters as a whole are alive to the situation. There is a growing realization on their part of the public responsibilities they assume in conducting an agency so greatly affecting the cultural progress of our people. The innovations of which we hear so much—national programs, wire interconnection, short wave re-broadcasting, increased power, and wired radio, which are already playing so important a part and are destined to have still greater influence for good—are based entirely upon the necessity for meeting the growing popular requirement of better service. The demand will continue to increase, and new methods of efficiency will continue to be found to meet it. But beyond all radio has begun to enrich American life by a real contribution to the home. It yet has far greater service to perform in this way and I believe this year will see great and more definite advance in this direction.

### Bureau of Standards Scientific Paper No. 469

PART of the information contained in the article entitled "The Beam System," by K. M. MacIlvain, appearing in the December WIRELESS AGE was obtained from the Bureau of Standards Scientific Paper No. 469 entitled "Directive Radio Transmission on a Wave Length of Ten Meters," by F. W. Dunmore and F. H. Engel. Mention of this fact was omitted in the article mentioned and Mr. MacIlvain desires to have that omission corrected.

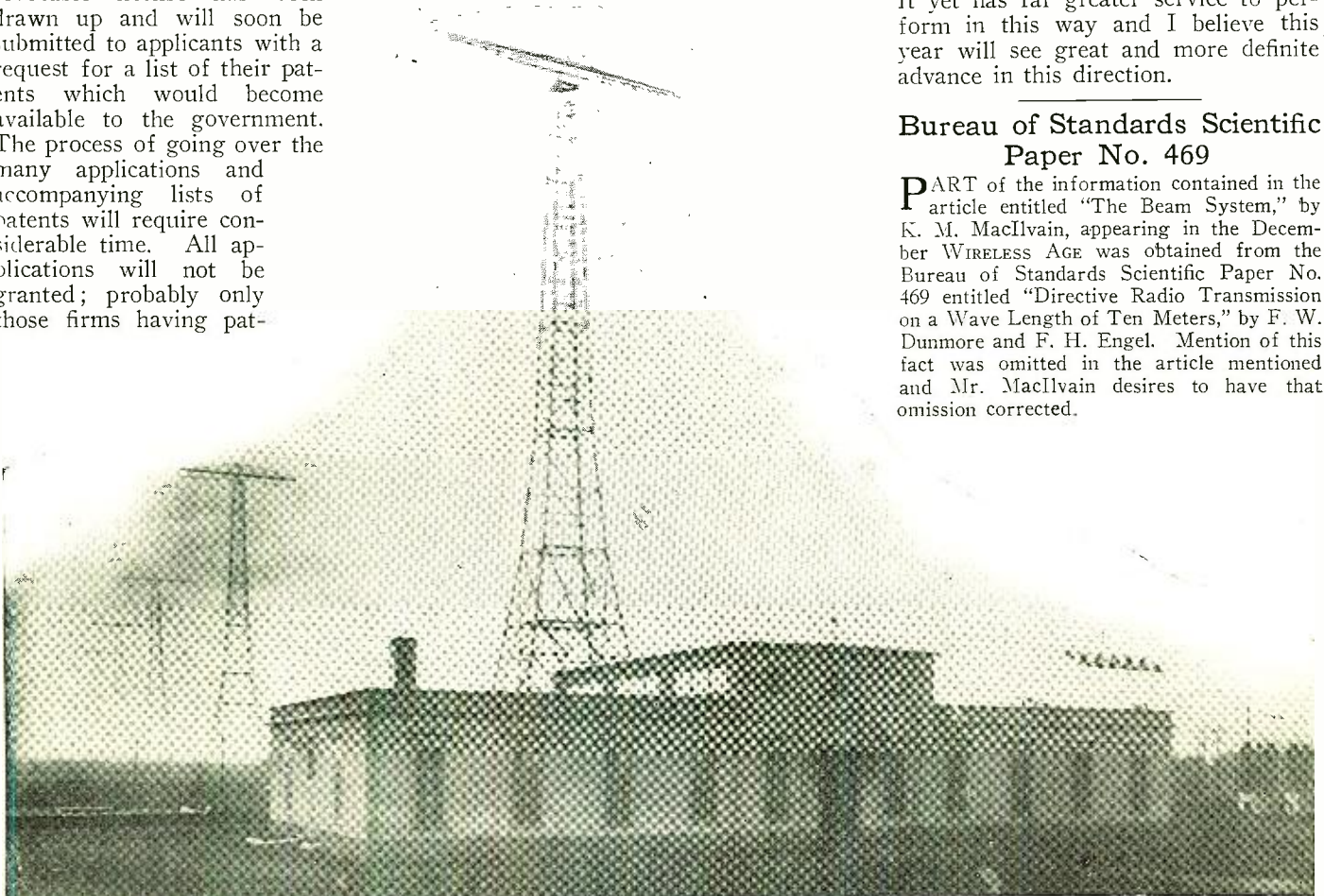

The Swedish high power station at Grimeton, near Göteborg

# What's the Trouble?

Here are a few pointers that may save you time and worry

By Robert Alan

WHEN you are just about convinced that your receiving set is the best little static collector in the world and that you have collected all the static that there is to be collected it is about time to look over your set. Static of course is responsible for most of the noises that come through your set which is not defined as music or clear speech. But you can't blame static for everything any more than you can honestly blame "those blasted amateurs" when some ship operator decides that it is necessary for him to use two kilowatts of a broad spark to work WNY upon entering the harbor. A shorted condenser or one in which the plates touch in their rotary motion will produce very annoying clicks and explosions and frying noises and you may be laying the blame on static when it is nothing more nor less than a condenser which has served its purpose in this world and is ready to be junked. Good variable condensers don't suffer from misalignment of the plates nor shorting. But we all haven't got the best condensers. One way, and probably the best way, for determining whether your condenser is shorted or whether the plates touch in their circular movement is shown in the accompanying illustration. Take a spare B battery, a voltmeter, and the variable condenser in question and connect them in series as shown. If any reading is obtained on the voltmeter whatsoever the condenser is shorted. In performing this operation rotate slowly the rotary plates throughout the entire 360 degrees several times and make sure that there is no short circuit. This is not harmful to your B battery so you need not be skeptical as to its advisability. The same test can be tried with your audio frequency transformers. Many sets go dead because of a blown primary winding. This is not entirely avoidable except that care should be exercised in connecting or disconnecting the B battery lead on the trans-



By means of a screw driver, bend up the socket contacts to make good contact with the tube

former when the filaments are turned on. This sometimes causes voltage surges requiring the very fine wire to carry greater current for an instant than it is designed to carry resulting in a punctured winding. In order to

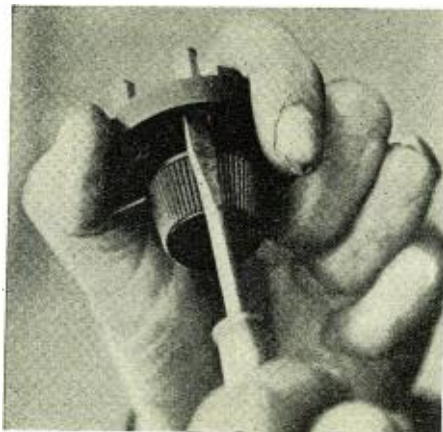

Tighten up the back screws on binding posts before putting the instrument into the set

definitely tell whether the transformer is blown or not, disconnect it and remove it from the set and put it through the same test as your variable condenser. The result of the test in this case will be exactly the opposite as it

was in the case of the condenser. You should get a reading on the voltmeter if the winding is intact. Of course it will not be the full 22 volts of the B battery or whatever your supply happens to be, because of the resistance of the winding. The use of a pair of phones instead of a voltmeter is not so accurate because unless the ear is trained to an open circuited click in the phones, there will be a click heard whether the winding is O. K. or open-circuited.

If your tubes have a peculiar way of going out and coming back again as you turn up the filament rheostat you can be very sure that the contact arm of your rheostat is not on speaking terms with the resistive winding. In most rheostats this can be remedied by removing the knob and contact arm and bending the latter so that it brings more pressure to bear on the winding. While you are doing this get the screw driver into action and tighten up the binding post screws on the terminals of the rheostat. This will mean that you won't have to do it the next time. Please note the illustration in which the socket prongs are being bent up by a screwdriver. This is great stuff providing you take the socket out of your set before you do it, but don't under any circumstances get a screwdriver near the socket with batteries and tubes connected as you can cause considerable damage if you do.

Before the sockets are installed in the set see that the prongs are making proper contact, put the tube in the socket, try the tension of the springs. This should make good stiff contact. After your set has been in operation for six months or so it will be well to remove the tubes from the sockets, disconnect the batteries and go after them with a screwdriver. A side wiping contact such as in the Howard Socket, General Radio, Radio Corporation, The Caldwell and others need no such treat-

(Turn to page 93)

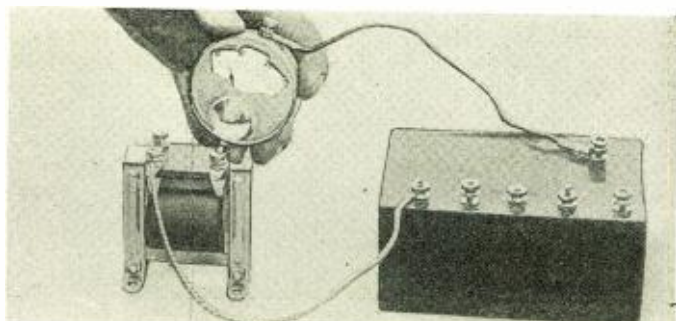
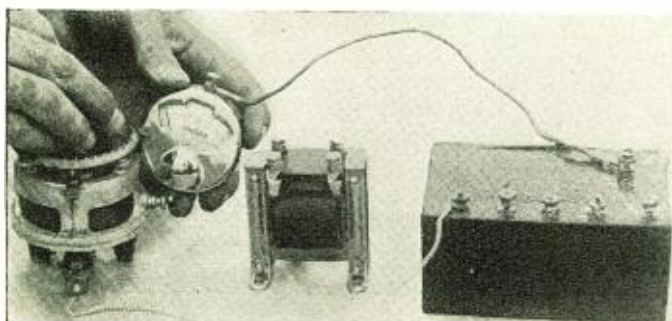

Testing variable condensers and transformers before mounting them in the finished set will often eliminate the task of removing faulty apparatus

# Radio Apartments

Plug into any one of several programs without tuning or trouble of operation

By Elizabeth Ives

**T**O hear famous speeches, music, songs, stories, it is merely necessary for the 354 apartment owners of "Hudson View Gardens" to push a plug into the wall. It's as easy as turning on the electric light switch! There is no dialing, no tuning in. With this one motion the program of any broadcasting station is theirs.

I could hardly believe it. In fact all my Missouri ancestors rose up in me and asked "to be shown" as Mr. Smith told me of this new wizardry—the just invented multiple radio system that offers a choice of programs, the only one in existence. He led me into one of the 354 apartments. There in the sitting room on a table was a small loud-speaker with a cord attached. And near the floor was a small square face-plate having four holes in it. It looked very much like an electric light wall outlet. "Make yourself comfortable and try it," said Mr. Smith. I sank into an easy upholstered chair near the table, stretched out my hand

for the plug at the end of the cord. I pushed it into one of the four holes, and instantly we were listening to Walter Damrosch's Symphony Concert.

And any broadcasting station was at my command. King Canute commanding the waves to retire never felt half as powerful as I at that moment. Nevertheless I was merely one of 354 pluggers. The power behind the plugger is Harold L. Kerr.

We found him sitting up in a little box-like room on the roof among his gigantic apparatus, worth about \$35,000. The walls of the little room are covered with it; a big shelf and table

filled with it and only room enough is left for one wooden chair on which Kerr sits and tunes, and dials, and listens far into every night.

Kerr is the radio engineer and the control operator. Up in this room he can receive and transmit four programs simultaneously to one or to 354 apartments! Here on one shelf stands, within two feet of each other, four up-to-date receivers with loop antennas—a sight to astound even the most expert of radio fans!

Kerr keeps himself continuously connected with three local broadcast-

(Turn to page 77)

This is all there's to it—plug in and enjoy the program

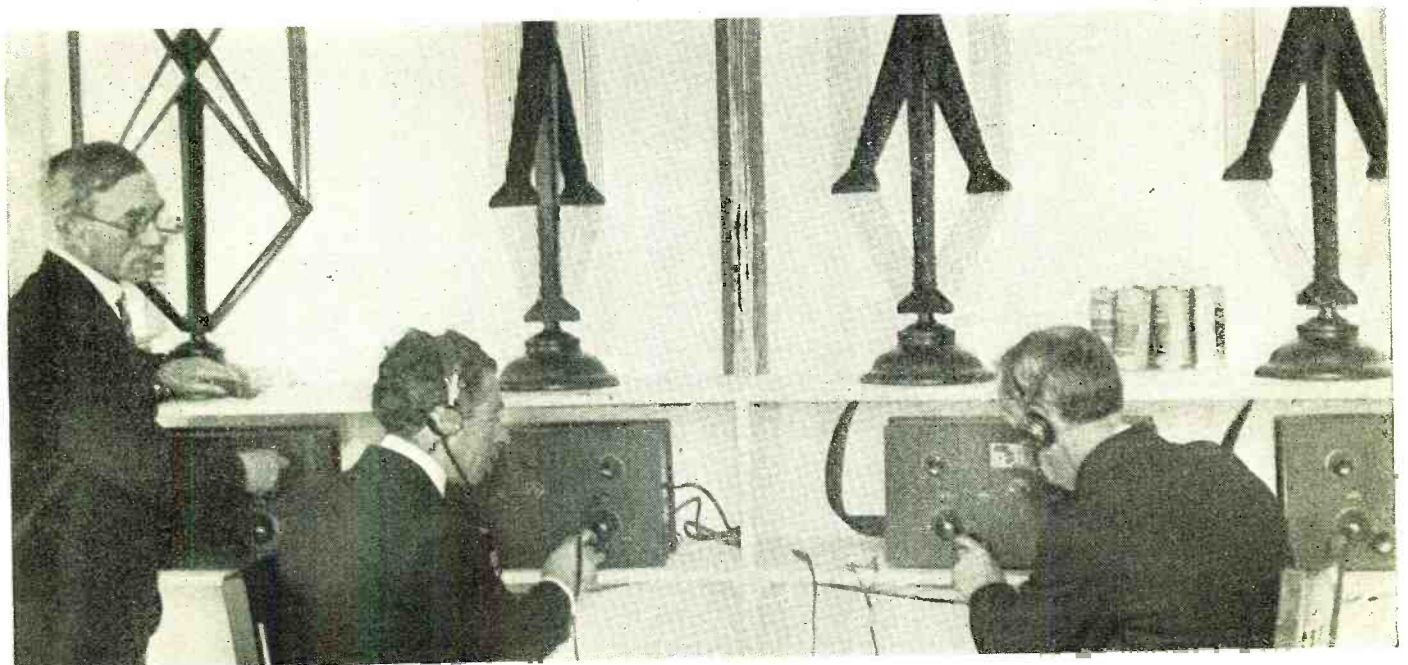
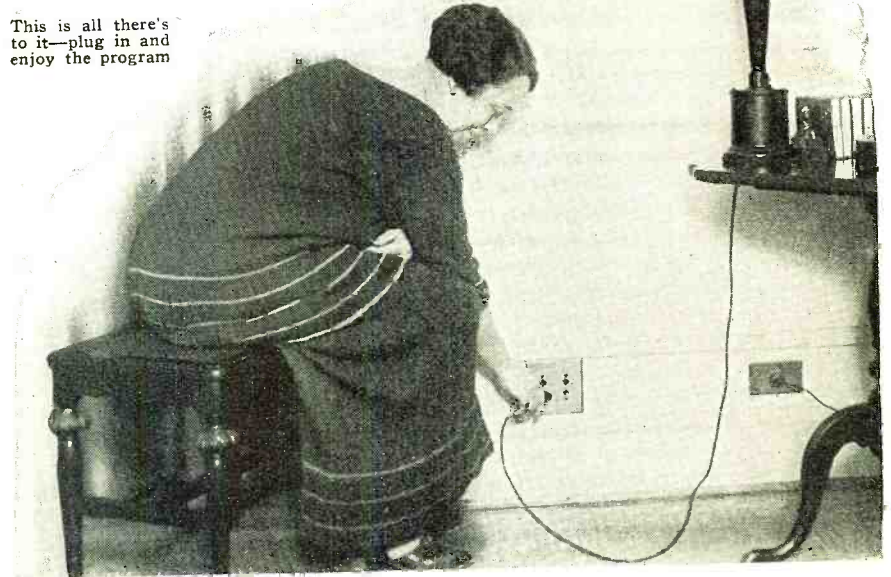

Four loop receivers are used to tune in the broadcast programs selected for the families in the radio apartment house

# PRODUCTION of ELECTRIC CURRENT

How the Dry-cell and Storage Battery Operates—Construction and Care—High Voltage Radio Batteries

By Samuel C. Miller

Member Institute of Radio Engineers

THE batteries play an important part in radio today because practically every receiving set employs them in one form or another. Without the batteries the receiver is like an automobile without gasoline, the prime factor in making the machine run. If the broadcast listener is interested in the principles of radio, it is very essential for him to know how a current is generated within a dry cell or utilized in a storage battery. This is one of the fundamentals in electricity and should be mastered not only because of the knowledge obtained, but also because a better understanding is gained in the care of these units. A knowledge of the operation and care required of storage batteries would be especially helpful to those who use them, as they are often given a great deal of abuse.

This article discusses thoroughly the various types of batteries in use and also partly covers the generation of an electric current by a mechanical device.

## ANALOGY OF AN ELECTRIC CURRENT

The production of a steady electric current is more easily seen if the method of obtaining a steady flow of water in a building is taken as an analogy. To produce a steady flow of

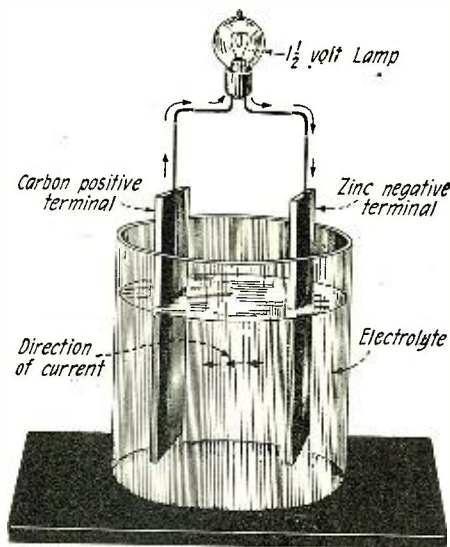

An electrolytic cell or set battery similar to the type used in land line telegraphy

water in a pipe, there must be available a hydraulic pressure, or, as it is technically called, a "head" of water. To obtain this head, the water is first pumped into the tank provided on the roof of the building from the water main in the street until a height is reached in the tank which will give the steady pressure of water required for use throughout the building.

A similar condition is required for the production of a steady electric current. There must be available a steadily maintained electric pressure known under different aspects as "electromotive force," "potential difference" or "voltage" which has the force to cause a current to flow. This produces energy of an electrical form that has the facility of performing work of various natures. Electrical energy is used to give us light and heat and to drive machinery; it allows us to communicate by means of the telephone, telegraph or radio. It is one of the most powerful agencies the human race has at its disposal today, and without a doubt the progress of civilization can be attributed in part to the day that Volta gave the world the simple cell which provided a source of voltage for producing an electric current.

The necessary electromotive force or voltage required to cause the electric current to flow may be obtained in either one of two ways: chemically or mechanically.

## SOURCE OF VOLTAGE FROM A CHEMICAL DEVICE

Very early in the investigations leading to our present day knowledge of electrical phenomena, Volta dis-

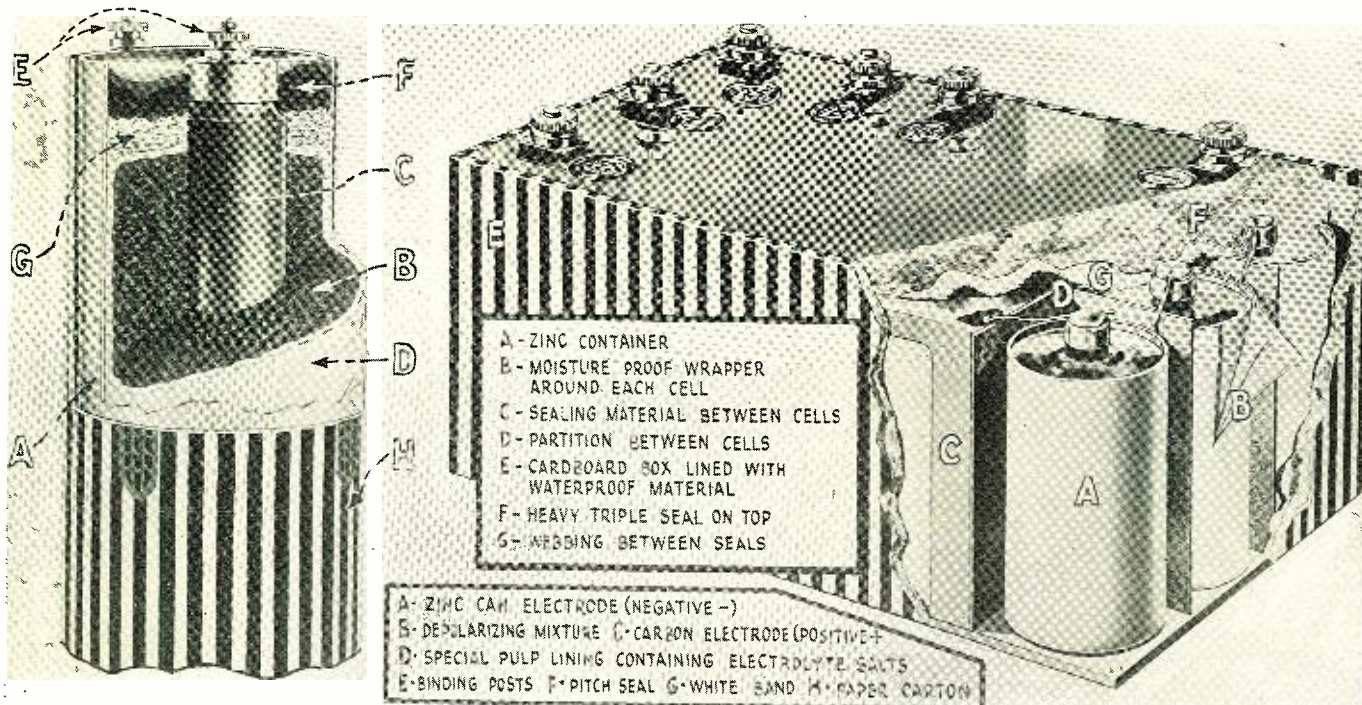

The inner workings of the two most important batteries of a radio receiver. The dry-cell and the dry B battery. The cut away portions of the illustration show how these much used sources of energy are assembled and the elements incorporated

covered that all metals have a relationship to each other, and if one metal such as zinc is brought into contact with another metal such as iron, an electric current will flow. This phenomenon can be readily demonstrated by any one. One of the simplest experiments is to take a copper penny and a silver dime and lay between the two a moistened piece of paper. If the two terminals of a pair of phones are placed one on the dime and the other on the penny, a click will be produced in the phones. This indicates that, in the circuit consisting of the penny, the moisture, the phones and the dime, a current has flowed which was caused by a voltage or electromotive force being produced by the contact of the two dissimilar metals.

A scale for the different metals has been worked out, showing which metals are most positive and which are least positive. The following list is so arranged that the metal first on the list becomes positively electrified when touched by any taking rank after it:

- +zinc
- lead
- tin
- iron
- copper
- silver
- gold
- graphite.

For example zinc is more positive than iron, but iron when used with graphite becomes the positive element. In the experiment given above the copper penny is more positive than the silver dime.

Going still further, Volta found that certain liquids acted in a similar manner when brought into contact with metals. He found that by virtue of the chemical action between the liquid and the metals, a source of voltage could be produced that will cause a current to flow when the unit is connected to an outside source. He therefore had a device that converted the chemical action between the liquid and metals into electrical energy.

THE VOLTAIC CELL

When two dissimilar metals as carbon and zinc are immersed in an electrolyte of sal-ammoniac dissolved in water, the chemical action on the zinc

will cause an electrical current to flow in the closed path formed externally between the carbon and the zinc. This is shown in figure 1 where a simple voltaic cell is connected to a lamp. The chemical action in the electrolyte causes the current to flow from the zinc to the carbon within the solution and from the carbon to the zinc, through the lamp in the outside circuit. Because the current leaves the carbon, it is called the *positive* terminal and

classes, primary and secondary. Cells are said to be primary if they generate a current within themselves and secondary if they first require a charge from an external source of energy before they become operative.

The primary type is illustrated by the dry cell in common use, where a relatively large current is supplied momentarily or a very small current is required for a long period of time. Every one is acquainted with the dry cell as used for ringing a bell or lighting a bulb in a flashlight and those who have radio sets with WD-11 or UV-199 vacuum tubes require dry cells for lighting the filaments. When the dry cell has lost its electrical energy then a new one must be bought for replacement as the old one becomes useless and is discarded.

However, when a battery is desired that will give a relatively high current or high power for a length of time, then the secondary type of battery is available. The secondary type or storage battery is suited for automobile starting and lighting, the driving of small motor apparatus and in radio, principally for supplying a steady flow of current to the filaments of six-volt vacuum tubes of the UV-201A type. It is very important that the current supplied to the filament of a vacuum tube be very constant as any change in the source of voltage will interfere in the proper operation of the receiving set. A storage battery fulfils this condition admirably as it will deliver a steady

current of considerable power for a relatively long length of time; the length of time depending on the capacity and condition of the battery.

DRY CELL

The dry cell in common use today consists of a zinc plate made to act as a container and also as the negative pole, and a carbon positive plate in the form of a rod in the center of the container. The container is first lined with a bibulous paper moistened with electrolyte and then filled with a depolarizing mixture made up of pul-

(Turn to page 64)

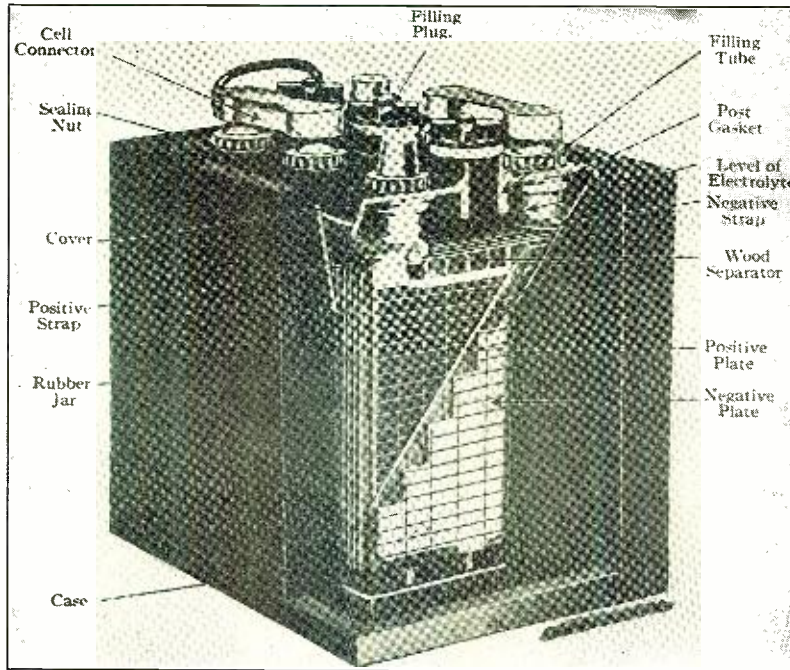

A radio storage cell showing a cross-section view exposing the internal elements of an individual cell and its surrounding casing

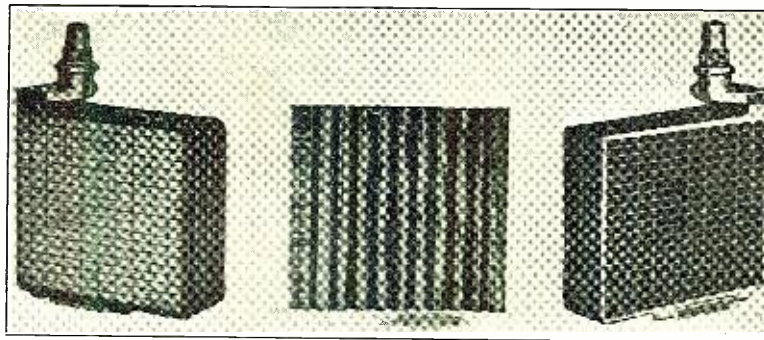

The positive and negative plates and the separator used to keep the individual cells from short-circuiting. To each set of positive and negative plates a connector post is burned or soldered

the zinc becomes the *negative* terminal because the current enters it on passing through the lamp.

The metals are termed elements and the liquid is the electrolyte. The combination of the elements, electrolyte and the containing vessel constitutes a voltaic cell.

When two or more cells are placed in a container so as to form a single unit, this unit is termed a battery. The word battery is frequently used incorrectly to designate a single cell.

CLASSES OF BATTERIES

Batteries are divided into two

# Los Angeles Exposition

A radio show that beat Horse-shows,  
Dog-shows and all other shows

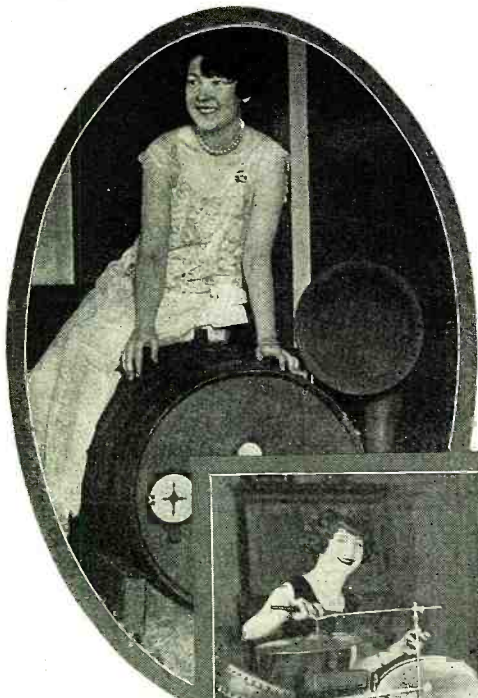

Miss Louise Klos, talented harp soloist, tapping — no, tuning in one of the best sets at the show



(Left)—Vi Dodd's Syn-copators furnished the music for all the happy dancers

(Below)—Louise Glaum, scenarist, who presented a one-act skit



THE second annual radio exposition held in Los Angeles by the American Radio Exposition Company of New York was the center of attraction for six days commencing December sixth in the auditorium of the Ambassador Hotel.

The Public Address System brought the exposition programs to the audience, while both KNX and KFI broadcast programs from the stage by the *Los Angeles Express* and *Los Angeles Examiner*. The programs brought considerable interest because of the fact that famous actors of the stage and screen acted as master of ceremonies including Monte Blue, Larry Semon, Lew Cody and others.

The radio industry banquet was held in the Fiesta Room of the hotel during the exposition with an immense representation of well known people in radio activities including representatives of the broadcast stations, Colonel J. F. Dillon, Federal supervisor for the sixth district, and members of the following organizations: Radio Jobbers' Association, Radio Manufacturers' Association, Radio Retail Division of the Music Trades Association of Southern California and the Credit Bureau of the Radio Jobbers' Association.

The exposition was operated on a co-operative basis with the radio organizations of Southern California and most of the features of the first show that did not meet with popular favor were eliminated. No demonstrations

of loud speakers, amplifiers or other sound producing apparatus by exhibitors were allowed and this eliminated one of the objections of a year ago. Likewise the floor space for exhibits and visitors was practically doubled and there was not the crowding as at the original exposition.

Many well known radio characters were present in various booths—those of broadcast stations and also of commercial concerns. Some of those included Uncle Remus, otherwise known as E. M. Bonnell; The Sandman and Queen Titania, of KHJ; Madelyn Hardy, the radio girl, and Louise Sullivan, singing violinist, of KFI; as well as the announcers and studio directors of Los Angeles who met throngs of radio friends afternoons and evenings at the auditorium.

While the Los Angeles exhibit held its full quota of the unusual in radio—of miniature sets, and the like—it was particularly noticeable that there was far greater interest than usual on the part of the public in the more expensive sets. The sets which are well known for distance getting and the sets with cabinets in period designs drew large crowds.

Interest did not lag in the display and demonstration of parts and the cheaper sets, but Los Angeles is rapidly becoming the Mecca for de luxe receiving sets. In Hollywood, for instance, movie stars are ordering quaint designed cabinets and sets for their palatial homes—designed to match the

period furniture or perhaps so wired that each guest room will have a concealed loud speaker for entertainment.

In the 108 booths arranged around the sides of the Ambassador Auditorium every conceivable kind of firm was represented. Many radio publications had representatives as well as all the large radio manufacturers in addition to the local concerns and branch offices.

With the end of the second show there can be little doubt but that the experimental stage is past and this is now to be a permanent annual event in the Pacific Southwest. This year's event attracted in proportion a greater number of the general public than any other event of similar character. Horse shows, dog shows, and all kinds and varieties of exhibits, attract a certain percentage of people, but a radio show brings together about everyone in the community.



# BROADCASTING STATION DIRECTORY

The Most Authentic, Up-to-the-Minute List of Stations Broadcasting in the United States, Canada, Cuba and other countries.

KDKA	Westinghouse Electric & Mfg. Co., East Pittsburgh, Pa.	326	KFNG	Women's Radio Shop	Coldwater, Miss.	254	KWH	Los Angeles Examiner	Los Angeles, Cal.	360
KDPT	Westinghouse Electric & Mfg. Co., Cleveland, O.	270	KFNJ	Central Mo. State Teachers College			KYW	Electric Shop	Honolulu, Hawaii	270
KDPM	Southern Electrical Co., San Diego, Cal.	244	KFNL	Radio Broadcast Association	Paso Robles, Cal.	234	KYW	Westinghouse Elec. & Mfg. Co.	Chicago, Ill.	536
KDYM	Savoy Hotel	Salt Lake City, Utah	KFNV	E. A. Drake, 505 Third St.	Santa Rosa, Cal.	234	KZM	Preston D. Allen, 13th & Franklin Sts.	Oakland, Cal.	360
KDYQ	Oregon Institute of Technology	Portland, Ore.	KFNY	Montana Phonograph Co.	Helena, Mont.	261	WAAB	Valdemar Jensen, 137 S. St. Patrick St.	New Orleans, La.	268
KDZB	Frank E. Siefert	Bakersfield, Cal.	KFNZ	Royal Radio Co.	Burlingame, Cal.	231	WAAC	Tulane University	New Orleans, La.	360
KDZP	Rhodes Department Store	Seattle, Wash.	KFOA	Rhodes Dept. Store	Seattle, Wash.	456	WAAD	Ohio Mechanics Institute	Cincinnati, Ohio	360
KDZR	Bellingham Publishing Co.	Bellingham, Wash.	KFOC	First Christian Church	Whittier, Cal.	235	WAAF	Chicago Daily Worker's Journal	Chicago, Ill.	286
KFAA	McArthur Bros. Mercantile Co.	Phoenix, Ariz.	KFOE	The Radio Shop	Wallace, Idaho	240	WAAM	University of Missouri	Columbia, Mo.	254
KFAE	State College of Washington	Pullman, Wash.	KFOF	Rhodes Electric Co.	Marsfield, Ore.	244	WAAN	University of Missouri	Columbia, Mo.	254
KFAF	Western Radio Corporation	Denver, Colo.	KFOJ	Moberly High School Radio Club	Moberly, Mo.	246	WAAP	Omaha Grain Exchange	Omaha, Neb.	286
KFAJ	University of Colorado	Boulder, Colo.	KFOL	Leslie M. Scharbuch, 502 W. Marion St.	Marengo, Iowa	234	WABB	Harrisburg Sporting Goods Co.	Harrisburg, Pa.	266
KFAN	The Electric Shop	Moscow, Idaho	KFON	Echophone Radio Shop	Long Beach, Cal.	234	WABD	Parker High School	Dayton, Ohio	283
KFAR	Studio Lighting Service Co. (O. K. Olsen)	Hollywood, Cal.	KFOO	Letter Day Saints University			WABH	Lake Shore Tire Co.	Sandusky, Ohio	240
KFAU	Independent School District of Boise City	Boise High School, Boise, Idaho	KFOR	David City Tire & Electric Co.	David City, Neb.	226	WABJ	Bancor Railway & Electric Co.	Bancor, Me.	240
KFAY	The Radio Den	Santa Ana, Cal.	KFOT	College Hill Radio Club	Wichita, Kans.	231	WABL	Connecticut Agricultural College	Storrs, Conn.	283
KFBV	Virgin's Radio Service	Medford, Ore.	KFOU	Hommel Manufacturing Co.	Richmond, Cal.	254	WABM	F. E. Doherty Automotive & Radio Equipment Co.	Saginaw, Mich.	254
KFBW	F. A. Buttery & Co.	Haarve, Mont.	KFOX	Technical High School	Omaha, Neb.	248	WABN	Ott Radio, Inc., 1627 State St.	La Crosse, Wis.	244
KFBC	W. K. Azbill	San Diego, Cal.	KFOY	Beacon Radio Service	St. Paul, Mich.	226	WABO	Lake Ave. Baptist Church	Rochester, N. Y.	283
KFBE	Reuben H. Horn	San Luis Obispo, Cal.	KFOZ	Leon Hudson Real Estate Co.	Fort Smith, Ark.	253	WABP	Robert F. Weing, 522 Wooster Ave.	Dover, Ohio	266
KFBG	First Presbyterian Church	Tacoma, Wash.	KFPA	Garriston & Dennis	Los Angeles, Cal.	238	WABQ	Haverford College Radio Club	Haverford, Pa.	261
KFBH	Kimball-Upson Co.	Sacramento, Cal.	KFPH	Howard C. Mailander, 992 Lake St.	Salt Lake City, Utah	242	WABR	Scott High School	Toledo, Ohio	270
KFBL	Leese Bros.	Everett, Wash.	KFPL	C. C. Baxter, 205 Grafton St.	Dublin, Texas	242	WABU	Victor Talking Machine Co.	Camden, N. J.	226
KFBS	Trinidad Gas & Electric Supply Co. and Chronicle News, Trinidad, Colo.	280	KFPM	New Furniture Co.	Greenville, Texas	242	WABV	College of Wooster	Wooster, Ohio	234
KFBY	The Cathedral	Laramie, Wyo.	KFPN	Missouri National Guard, 70th Infantry Brigade			WABX	Henry B. Joy	Mount Clemens, Mich.	270
KFCB	Nielson Radio Supply Co.	Phoenix, Ariz.	KFPQ	Colorado National Guard, Forty-fifth Division			WABY	John Magaldi, Jr., 815 Kimball St.	Phila., Pa.	242
KFCF	Frank A. Moore	Walla Walla, Wash.	KFPR	G. & G. Radio & Electric Shop	Olympia, Wash.	236	WABZ	Coliseum Place Baptist Church	New Orleans, La.	263
KFCG	Leslie E. Rice, Los Angeles Union Stock Yards	Los Angeles, Cal.	KFPT	Cope & Johnson	Los Angeles, Cal.	231	WABH	A. H. Garbe Co.	Brooklyn, N. Y.	316
KFCP	Ralph W. Flygare	Ogden, Utah	KFPV	Heintz & Kohlmos	Salt Lake City, Utah	268	WBA	Purdue University	West Lafayette, Ind.	283
KFCV	Fred Mahaffey, Jr.	Houston, Texas	KFPW	St. John's Church	Cartersville, Mo.	268	WBA	Wireless Phone Corporation	Paterson, N. J.	244
KFCZ	Omaha Central High School	Omaha, Neb.	KFPX	First Presbyterian Church	Pine Bluff, Ark.	242	WBA	James Millikin University	Decatur, Ill.	275
KFDD	St. Michael's Cathedral	Boise, Idaho	KFPY	Simons Investment Co.	Spokane, Wash.	283	WBA	Erner & Hopkins Co.	Columbus, Ohio	423
KFDH	University of Arizona	Tucson, Ariz.	KFQA	The Principia, 5539 Page Ave.	St. Louis, Mo.	261	WBA	John H. Stenger, Jr., 66 Gildersleeve St.	Wilkesbarre, Pa.	360
KFDJ	Oregon Agricultural College	Corvallis, Ore.	KFQB	Searchlight Publishing Co.	Fort Worth, Texas	267	WBB	Barbey Battery Service	Reading, Pa.	234
KFDL	Knight-Campbell Music Co.	Denver, Colo.	KFQC	Kidd Brothers Radio Shop	Taft, Cal.	281	WBB	Georgia School of Technology	Atlanta, Georgia	270
KFDM	Magnolia Petroleum Co.	Beaumont, Texas	KFQD	Chorin Supply Co.	Anchorage, Alaska	280	WBB	Irving Vermilya	Mattapoisett, Mass.	248
KFDX	First Baptist Church	Shreveport, La.	KFQE	Dickenson, Henry, Radio Laboratories	Colorado Springs, Colo.	224	WBB	J. Irving Bell, 1511 Gordon St.	Port Huron, Mich.	246
KFDY	South Dakota State College	Brookings, S. D.	KFQF	Donald A. Boulton, 2544 Pleasant Ave.	Minneapolis, Minn.	224	WBB	Grace Covenant Church	Richmond, Va.	283
KFDZ	Harry O. Iverson	Minneapolis, Minn.	KFQG	Southern California Radio Association	Exposition Park, Los Angeles, Cal.	226	WBB	Petoskey High School	Petoskey, Mich.	246
KFEC	Meier & Frank Co.	Portland, Ore.	KFQH	Albert Sherman, Hillsborough Box 51	Burlingame, Cal.	231	WBB	Peoples Pulpit Association	Rossville, N. Y.	273
KFEL	Winner Radio Corp.	Denver, Colo.	KFQJ	Thomas H. Ince Corp.	Culver City, Cal.	234	WBB	First Baptist Church	New Orleans, La.	252
KFEM	Scroggin & Co.	Bank, Okla.	KFQK	Harbour-Lomgren Co.	Oklahoma City, Okla.	236	WBB	Lloyd Brothers	Philadelphia, Pa.	251
KFER	Auto Electric Service	Fort Dodge, Iowa	KFQL	Democrat Leader	Fayette, Mo.	256	WBB	Jenks Motor Sales Co.	Monmouth, Ill.	224
KFEF	Augsburg Seminary	Minneapolis, Minn.	KFQM	Oklahoma Free State Fair Association	Muskogee, Okla.	256	WBB	Johnstown Radio Co.	Johnstown, Pa.	248
KFEY	Bunker Hill & Sullivan Mining and Concentrating Co., Kellogg, Idaho	360	KFQN	Texas Highway Bulletin	Austin, Texas	268	WBB	Ruffner Junior High School	Norfolk, Va.	222
KFFB	Jenkins Furniture Co.	Boise, Idaho	KFQO	Third Baptist Church	Portland, Oregon	283	WBB	Washington Light Infantry	Charleston, S. C.	268
KFFE	Eastern Oregon Radio Co.	Pendleton, Ore.	KFQP	Meier Radio Shop	Russell, Kansas	261	WBB	Nobie B. Watson, 233 Iowa St.	Indianapolis, Ind.	227
KFFG	First Baptist Church	Des Moines, Mo.	KFQR	Walter L. Ellis, 625 East 6th St.	Oklahoma City, Okla.	250	WBB	T & H Radio Co.	Anthony, Kansas	254
KFFH	Nevada State Normal	Sparks, Nev.	KFQS	Alfred M. Hubbard, 310 Green Bldg.	Seattle, Wash.	233	WBB	D. W. May (Inc.)	Newark, N. J.	360
KFFI	Graceland College	Lamoni, Ia.	KFQT	Farmers State Bank	Belden, Neb.	273	WBB	Southern Radio Corp.	Charlottesville, N. C.	360
KFFJ	Louisiana College for Women	Baton Rouge, La.	KFQU	Taft Radio Co., 5653 De Longpre Ave.	Hollywood, Cal.	240	WBB	Westinghouse Elec. & Mfg. Co.	Springfield, Mass.	337
KFFK	Louisiana State University	Baton Rouge, La.	KFQV	Marvin S. Olson	Carver, Minn.	280	WBB	St. Lawrence University	Canton, N. Y.	280
KFFL	Oklahoma College for Women	Chickasha, Okla.	KFR	Radioart Studio	San Francisco, Cal.	280	WBB	Kaufman & Baer Co.	Pittsburgh, Pa.	462
KFFM	Leland Stanford University	Stanford, Calif.	KFR	W. R. Brown	Alexandria, La.	280	WBB	Clyde R. Randall, 2813 Calhoun St.	New Orleans, La.	268
KFFN	Snell and Irvy	Arlington, Va.	KFR	Cleveland High School	St. Louis, Mo.	236	WBB	Entreklin Electric Co.	Columbus, Ohio	286
KFFO	Craw Hardware Co.	Boone, Iowa	KFR	The Radio Shop	Grafton, N. D.	268	WBB	Nebraska Wesleyan University	Lincoln, Neb.	280
KFFP	First Presbyterian Church	Orange, Texas	KFR	Reynolds Radio Co., 1534 Glenarm St.	Denver, Colo.	224	WBB	University Place, Nebr.	280	
KFFZ	Emmanuel Missionary College	Berrien Springs, Mich.	KFR	Guy Simmons, Jr., 515 Clifton St.	Denver, Colo.	250	WBB	St. Olaf College	Northfield, Minn.	360
KFHA	Western State College of Colorado	Gunnison, Colo.	KFR	Men's Club of First Presbyterian Church	Grand Forks, N. Dak.	240	WBB	The Sanders and Stayman Co.	Baltimore, Md.	275
KFHB	Fallon & Co.	Santa Barbara, Cal.	KFR	Lieut. James P. Boland, U. S. A.	Fort Sill, Okla.	263	WBB	Chesapeake & Potomac Telephone Co.	Washington, D. C.	469
KFHC	Penn College	Oskaloosa, Iowa	KFR	M. Laurence Short	Hanford, Cal.	224	WBB	Southern Radio Corp. of Texas	San Antonio, Texas	360
KFHD	Star Electric & Radio Co.	Seattle, Wash.	KFR	Curtis Printing Co., 1109 8th Ave.	Fort Worth, Texas	246	WBB	Wm. Hook Dunwoody Industrial Institute	Minneapolis, Minn.	280
KFHE	Earle C. Anthony, Inc.	Los Angeles, Cal.	KFR	J. Gordon Klemgard	Pullman, Wash.	268	WBB	South Dakota State School of Mines	Rapid City, S. D.	240
KFHF	Benson Polytechnic Institute	Laramie, Wyo.	KFR	Bible Institute of Los Angeles	Los Angeles, Cal.	271	WBB	Durham & Co.	Philadelphia, Pa.	286
KFHG	North Central High School	Spokane, Wash.	KFR	Echo Park Evangelistic Association	Los Angeles, Cal.	268	WBB	J. C. Diez Electric Co.	Little Rock, Ark.	260
KFHI	First Methodist Church	Yakima, Wash.	KFR	Van Blaricom Co., 20 So. Main St.	Helena, Mont.	278	WBB	University of Vermont	Burlington, Vt.	360
KFHO	Alaska Elec. Light & Power Co.	Juneau, Alaska	KFR	Walter Hemrich	Kukuk Bay, Alaska	260	WBB	Milwaukee Civic Broadcasting Station		
KFHP	Reorganized Church of Jesus Christ of Latter Day Saints, Independence, Mo.	268	KFR	Tacoma Daily Locker	Tacoma, Wash.	252	WBB	Hotel Antlers, Milwaukee, Wis.	266	
KFHZ	Daily Commonwealth and Oscar A. Ruessman, Fond du Lac, Wis.	273	KFR	Hallock & Watson Radio Service	Portland, Ore.	360	WBB	Charles W. Heimbach, 101 Allen St.	Allentown, Pa.	280
KFJB	Marshall Electric Co.	Marshalltown, Iowa	KFR	General Electric Co.	Oakland, Cal.	312	WBB	University of Michigan	Ann Arbor, Mich.	280
KFJC	Seattle Post Intelligencer	Seattle, Wash.	KFR	Marion A. Muirson	Honolulu, Hawaii	360	WBB	Wilbur G. Voliva	Nashville, Tenn.	256
KFJD	National Radio Mfg. Co.	Oklahoma City, Okla.	KFR	Portland Morning Oregonian	Portland, Ore.	492	WBB	Uhart Radio Co.	New Orleans, La.	263
KFJE	Liberty Theatre	Astoria, Ore.	KFR	St. Martin's College	Lacey, Wash.	258	WBB	Howard S. Williams	Pascagoula, Miss.	268
KFJF	Delano Radio & Electric Co.	Bozeman, Mont.	KFR	Times Mirror Co.	Los Angeles, Cal.	395	WBB	University of Mississippi	Oxford, Miss.	242
KFJG	University of North Dakota	Grand Forks, N. D.	KFR	Louis Wasmer	Seattle, Wash.	360	WBB	Nicol, Duncan & Rush	Memphis, Tenn.	240
KFJH	Electric Construction Co., Valley Radio Division	Grand Forks, N. D.	KFR	C. O. Gould	Stockton, Cal.	273	WBB	J. C. Mans	Jennings, La.	244
KFJI	Ashley, C. Dixon & Son	Stevensville, Mont.	KFR	North West Radio Service	Seattle, Wash.	283	WBB	E. Richard Hall, 2801 Central Ave.	St. Petersburg, Fla.	266
KFJK	Iowa State Teachers College	Cedar Falls, Iowa	KFR	Warner Bros. Radio Supplies Co.	Oakland, Cal.	509	WBB	Northern Radio Mfg. Co.	Houston, Me.	280
KFJL	Tunwall Radio Co.	Fort Dodge, Iowa	KFR	Tribune Publishing Co.	Oakland, Cal.	360	WBB	Charles Schwarz, Charles and North Aves.	Baltimore, Md.	229
KFJM	Texas National Guard, 112th Cavalry	Fort Worth, Texas	KFR	Reynolds Radio Co.	Denver, Colo.	283	WBB	Radio Shop (Inc.)	Baltimore, Md.	250
KFJN	Colorado State Teachers College	Greeley, Colo.	KFR	San Joaquin Lt. & Power Corp.	Fresno, Cal.	248	WBB	First Baptist Church	Nashville, Tenn.	256
KFJO	Brinkley-Jones Hospital Association	Midford, Kan.	KFR	Love Electric Co.	Tacoma, Wash.	360	WBB	Charles H. Messter	Providence, R. I.	246
KFKQ	Conway Radio Laboratories	Conway, Ark.	KFR	Walter Hemrich	Kukuk Bay, Alaska	260	WBB	Clark University	Worcester, Mass.	238
KFKR	F. F. Gray, 3200 Richardson St.	Butte, Mont.	KFR	"Hollywood" Los Angeles Evening Express	Los Angeles, Cal.	327	WBB	Arnold Wireless Supply Co.	Arnold, Pa.	254
KFKS	Westinghouse Electric & Mfg. Co.	Hastings, Neb.	KFR	New Mexico College of Agriculture and Mechanic Arts, State College, N. M.	360	WBB	Pullahoma Radio Club	Pullahoma, Tenn.	252	
KFKT	Nassour Bros. Radio Co.	Colorado Springs, Colo.	KFR	Detroit Police Dept.	Detroit, Mich.	286	WBB	George P. Rankin, Jr., and Maitland Solomon	Chicago, Ill.	248
KFLA	Abner R. Wilson, 1321 W. Blatinum St.	Butte, Mont.	KFR	Hale Bros.	San Francisco, Cal.	423	WBB	Forks Electrical Shop	Buck Hill Falls, Pa.	268
KFLB	Signal Electric Mfg. Co.	Menominee, Mich.	KFR	Apple Electric Co.	Wood River, Ore.	360	WBB	Coppotelli Brothers Music House	Chicago Heights, Ill.	248
KFLC	National Educational Service	Denver, Colo.	KFR	Chas. D. Herold, 467 First St.	San Jose, Cal.	270	WBB	Washburn Crosby Co., 200 Chamber of Commerce	Minneapolis, Minn.	417
KFLD	Bizzell Radio Shop	Little Rock, Ark.	KFR	Berkeley Daily Gazette	Berkeley, Cal.	275	WBB	Stix Baer & Fuller Dry Goods Co.,	St. Louis, Mo.	360
KFLR	University of New Mexico	Albuquerque, N. M.	KFR	First Dispatch (Pulitzer Pub. Co.)	St. Louis, Mo.	246	WBB	The Detroit Free Press	Detroit, Mich.	517
KFLS	Rio Grande Radio Supply House	San Benito, Texas	KFR	First Presbyterian Church	Seattle, Wash.	360	WBB	Tampa Daily Times	Tampa, Fla.	360
KFLV	Swedish Evangelical Mission Church	Rockford, Ill.	KFR	Examining Printing Co.	San Francisco, Cal.	360	WBB	Kansas City Star	Kansas City, Mo.	411
KFLW	Missoula Electric Supply Co.	Missoula, Mont.	KFR	Portable Wireless Telephone Co.	Stockton, Cal.	360	WBB	J. Laurence Martin	Amarillo, Tex.	263
KFLX	George R. Clough, 1214 40th St.	Galveston, Tex.	KFR				WBB	Trinity Methodist Church (South)	El Paso, Tex.	268
KFLZ	Atlantic Automobile Co.	Atlantic, Iowa	KFR				WBB	Lit Bros.	Philadelphia, Pa.	395
KFMB	Christian Churches of Little Rock	Little Rock, Ark.	KFR				WBB	Sam Waite's Radio Shop	Worcester, Mass.	360
KFMQ	University of Arkansas	Fayetteville, Ark.	KFR				WBB	Slocum & Kilburn	New Bedford, Mass.	360
KFMR	Morningside College	Sioux City, Iowa	KFR				WBB	Radio Equipment Corp.	Fargo, N. D.	244
KFMT	George W. Young, 2219 W. Bryant Ave.	Minneapolis, Minn.	KFR				WBB	A. H. Waite & Co.	Dartmouth, Mass.	229
KFMW	M. G. Sateron, 127 Blanche St.	Houghton, Mich.	KFR				WBB	Kirk Johnson & Co.	Lancaster, Pa.	258
KFMX	Carleton College	Northfield, Minn.	KFR							
KFNF	Henry Field Seed Co.	Shenandoah, Iowa	KFR							

WDBD	Herman E. Burns.....	Martinsburg, W. Va.	268
WDBF	Robert G. Phillips.....	Youngstown, Ohio	246
WDBH	C. T. Sherer.....	Worcester, Mass.	268
WDBI	Radio Specialty Co.....	St. Petersburg, Fla.	226
WDBJ	Richardson-Wayland Electrical Corp.	Roanoke, Va.	229
WDBK	M. F. Broz, Furniture, Hardware & Radio Co.	Cleveland, Ohio	248
WDBN	Maine Electric Light and Power Co.	Bangor, Me.	252
WDBO	Rollins College.....	Winter Park, Fla.	240
WDBP	Superior State Normal School.....	Superior, Wis.	261
WDBQ	Morton Radio Supply Co.....	Salem, N. J.	236
WDBR	Tremont Temple Baptist Church.....	Buffalo, Mass.	256
WDBS	S. M. K. Radio Corp.....	Dayton, Ohio	283
WDBT	Taylor's Book Store.....	Hattiesburg, Miss.	236
WDBV	Strand Theatre.....	Fort Wayne, Ind.	258
WDBW	The Radio Den.....	Columbia, Tenn.	268
WDBX	Otto Baur, 138 Dyckman St., New York, N. Y.	233	
WDBY	North Shore Congregational Church.....	Chicago, Ill.	258
WDBZ	Boy Scouts of America, Ulster County Council,	Kingston, N. Y.	233
WDM	The Church of the Covenant.....	Washington, D. C.	234
WDL	J. L. Bush.....	Tuscola, Ill.	278
WEAA	Frank D. Fallain, Police Building.....	Flint, Mich.	280
WEAF	American Telephone & Telegraph Co.,	New York, N. Y.	492
WEAH	Wichita Board of Trade.....	Wichita, Kan.	280
WEAI	Cornell University.....	Ithaca, N. Y.	286
WEAJ	University of South Dakota.....	Vermillion, S. D.	283
WEAM	Broch of North Plainfield,	North Plainfield, N. J.	280
WEAN	Shepard Co.....	Providence, R. I.	273
WEAO	The Ohio State University.....	Columbus, Ohio	360
WEAP	Mobile Radio Co.....	Mobile, Ala.	360
WEAU	Davidson Bros. Company.....	Sioux City, Iowa	275
WEAY	Iris Theatre.....	Houston, Texas	360
WEB	Benwood Co.....	St. Louis, Mo.	273
WEBA	The Electric Shop.....	Highland Park, N. J.	233
WEBC	Walter C. Bridges.....	Superior, Wis.	242
WEBD	Electrical Equipment Service Co.....	Anderson, Ind.	246
WEBE	Roy W. Waller.....	Cambridge, Ohio	248
WEBH	Edgewater Beach Hotel Co.....	Chicago, Ill.	370
WEBI	Walter Gibbons.....	Salisbury, Md.	242
WEBJ	Third Ave. Ry. Co.....	New York City	273
WEBK	Grand Rapids Radio Co.....	Grand Rapids, Mich.	261
WEBL	R. C. A. United States (portable),	226	
WEBP	Spanish Fort Amusement Park.....	New Orleans, La.	280
WEBQ	Tate Radio Co.....	Harrisburg, Ill.	246
WEBR	H. H. Howell.....	Buffalo, N. Y.	240
WEBT	Dayton Cooperative Industrial High School,	Dayton, Ohio	270
WEBU	De Land Piano & Music Co.....	De Land, Fla.	258
WEBW	Beloit College.....	Beloit, Wis.	283
WEBX	Nashville, Tenn., R. R. No. 9, Franklin Pike,	John E. Cain Jr.	263
WEBY	Hobart Radio Co.....	Rollingdale, Mass.	263
WEZ	Savannah Radio Corp.....	Savannah, Ga.	280
WEV	Hurlburt-Still Electrical Co.....	Houston, Texas	263
WEW	St. Louis University.....	St. Louis, Mo.	280
WFAA	The Dallas News, The Dallas Journal,	Dallas, Texas	476
WFAM	Times Publishing Co.....	St. Cloud, Minn.	273
WFAN	Hutchinson Electric Service Co.,	Hutchinson, Minn.	286
WFAV	University of Nebraska.....	Lincoln, Neb.	273
WFB	Eureka College.....	Eureka, Ill.	240
WFBG	William F. Gable Co.....	Altona, Pa.	261
WFBH	Concourse Radio Corp.....	New York, N. Y.	273
WFBK	Galvin Radio Supply Co.....	Camden, N. J.	236
WFBM	Dartmouth College.....	Hanover, N. H.	256
WFBP	Onondaga Hotel.....	Syracuse, N. Y.	286
WFBQ	Merchants Heat & Light Co., 519 Guaranty	Building, Indianapolis, Ind.	268
WFBN	Radio Sales & Service Co., 1 Broad St.,	Bridgewater, Mass.	226
WFBQ	Wynne Radio Co., 226 Fayetteville St.,	Raleigh, N. C.	252
WFBR	Fifth Infantry, Maryland N. G.,	Fifth Regiment Armory, Baltimore, Md.	254
WFBT	Gloucester County Civic League.....	Pitman, N. J.	231
WFBV	Commonwealth Radio Association.....	Boston, Mass.	395
WFI	Strawbridge & Clothier.....	Philadelphia, Pa.	395
WGAL	Lancaster Elec. Supply & Const. Co.,	Lancaster, Pa.	248
WGAN	Cecil E. Lloyd, 216 W. Romana St.,	Pensacola, Fla.	360
WGAQ	Yourses Hotel.....	Shreveport, La.	252
WGAZ	The South Bend Tribune.....	South Bend, Ind.	360
WGBC	Jones Elec. & Radio Mfg. Co.....	Baltimore, Md.	254
WGBS	Gimbel Brothers.....	New York City	316
WGI	American Radio & Research Corp.,	Medford Hillside, Mass.	360
WGL	Thomas F. J. Howlette, 2303 N. Broad St.,	Philadelphia, Pa.	360
WGN	Drake Hotel.....	Chicago, Ill.	370
WGR	Federal Telephone Mfg. Co.....	Buffalo, N. Y.	319
WGS	General Electric Co.....	Schenectady, N. Y.	380
WHA	University of Wisconsin.....	Madison, Wis.	283
WHAA	State University of Iowa.....	Iowa City, Iowa	484
WHAD	Marquette University.....	Milwaukee, Wis.	280
WHAM	University of Cincinnati.....	Cincinnati, Ohio	222
WHAN	University of Rochester.....	Rochester, N. Y.	283
WHAR	Seaside Hotel.....	Atlantic City, N. J.	275
WHAS	Courier Journal and Louisville Times,	Louisville, Ky.	400
WHAU	Wilmington Electrical Specialty Co., Inc.,	Wilmington, Del.	360
WHB	Rensselaer Polytechnic Institute.....	Troy, N. Y.	380
WHC	Sweeney School Co.....	Kansas City, Mo.	411
WHK	Radiolor Co.....	Cleveland, Ohio	283
WHN	George Schubel, Loew's State Theatre Building,	New York City	360
WHO	Bankers Life Co.....	Des Moines, Iowa	526
WHAB	Art A. Johnson's Garage.....	Rockford, Ill.	252
WHAC	Galveston Tribune.....	Galveston, Texas	360
WHAD	Howard R. Miller, 6318 N. Park Ave.,	Philadelphia, Pa.	254
WHAK	Journal-Stockman Co.....	Omaha, Neb.	278
WHAS	Home Electric Co.....	Burlington, Iowa	283
WHB	K. & L. Electric Co.....	McKeesport, Pa.	234
WHC	Gimbel Brothers.....	Philadelphia, Pa.	503
WHD	American Electric Co.....	Lincoln, Neb.	229
WHJ	Jackson's Radio Engineering Laboratories,	Waco, Texas	360
WHK	The Norfolk Daily News.....	Norfolk, Neb.	283
WHL	Clifford L. White.....	Greentown, Ind.	254
WHM	D. M. Perham, 332 Third Ave.,	W. Cedar Rapids, Iowa	268
WHN	Peoria Star.....	Peoria, Ill.	280
WHO	The Outlet Co.....	Providence, R. I.	360
WHB	Pittsburgh Radio Supply Co.....	Pittsburgh, Pa.	286
WHC	Union Trust Co.....	Cleveland, Ohio	390
WHD	Chicago Electric Laboratory.....	Chicago, Ill.	268
WHJ	Denison University.....	Granville, Ohio	229
WHK	Moosheart.....	Moosheart, Ill.	278
WHL	R. C. A.....	New York City	405
WHM	R. C. A.....	New York City	455
WHN	H. F. Paar, 1444 Second Ave. E.,	Cedar Rapids, Iowa	278

WKAD	Charles Loeffl (Crescent Park),	East Providence, R. I.	240
WKAF	W. S. Radio Supply Co.....	Wichita Falls, Texas	326
WKAN	United Battery Service Co.....	Montgomery, Ala.	266
WKAP	Dutee W. Flint.....	Cranston, R. I.	286
WKAQ	Radio Corp. of Porto Rico.....	San Juan, P. R.	360
WKAR	Michigan Agricultural College, East Lansing, Mich.	280	
WKAV	Laconia Radio Club.....	Laconia, N. H.	286
WKBF	Dutee W. Flint.....	Cranston, R. I.	286
WKCY	W. K. Y. Radio Shop.....	Oklahoma City, Okla.	360
WLAL	Naylor Electrical Co.....	Tulsa, Okla.	360
WLAP	W. V. Jordan, 306 W. Breckenridge St.,	Louisville, Ky.	286
WLAX	Greencastle Community Broadcasting Station,	Greencastle, Ind.	231
WLB	University of Minnesota at Minneapolis, Minn.	231	
WLBL	Wisconsin Department of Markets,	Stevens Point, Wis.	278
WLS	Sears, Roebuck & Co.....	Chicago, Ill.	245
WLW	Cross Radio Corp.....	Cincinnati, Ohio	423
WLX	Clive B. Meredith.....	Cazenovia, N. Y.	261
WLZ	Round Hills Radio Corp.....	Dartmouth, Mass.	261
WMAH	General Supply Co.....	Lincoln, Neb.	254
WMAK	Northern Laboratories.....	Lockport, N. Y.	273
WMAN	First Baptist Church.....	Columbus, Ohio	286
WMAQ	Chicago Daily News.....	Chicago, Ill.	448
WMAV	Alabama Polytechnic Inst.....	Auburn, Ala.	250
WMAZ	Kingshighway Presbyterian Church,	St. Louis, Mo.	280
WMAZ	Mercer University.....	Macon, Ga.	261
WMC	Commercial Appeal.....	Memphis, Tenn.	300
WME	Intercity Radio Telegraph Co.,	McDougal Terminal Bldg., Duluth, Minn.	309
WMH	Ainsworth-Gates Radio Co.....	Cincinnati, Ohio	309
WMU	Doubleday-Hill Electric Co.....	Washington, D. C.	278
WMAC	Shepard Stores.....	Boston, Mass.	261
WMAD	University of Oklahoma.....	Norman, Okla.	254
WMAL	Omaha Central High School.....	Omaha, Neb.	258
WMAP	Whitening College.....	Springfield, Ohio	275
WMAR	First Christian Church.....	Tyler, Texas	360
WMAT	Lennig Bros. Co.....	Philadelphia, Pa.	250
WMAY	Henry Kunzmann, Box 167.....	Fort Monroe, Va.	264
WMBA	Dakota Radio Apparatus Co.....	Yankton, S. D.	340
WMBC	Radio Shop of Newark.....	Newark, N. J.	233
WMBY	City of New York.....	New York, N. Y.	256
WMCA	Page Organ Co.....	Lima, Ohio	266
WMCC	Midland College.....	Fremont, Neb.	280
WMCD	Tyler Commercial College.....	Tyler, Texas	360
WMCE	Southern Equipment Co.....	San Antonio, Texas	388
WMCF	Ervin Electrical Co.....	Parsons, Kan.	255
WMCG	Vaughn Conservatory of Music,	Lawrenceburg, Tenn.	360
WMCH	Henry P. Ludskow.....	Kenosha, Wis.	229
WMCI	2nd Battalion, 112th Inf., P. N. G.,	Erie, Pa.	242
WMCM	Woodmen of the World.....	Omaha, Neb.	246
WMCN	Franklyn J. Wolff, 600 Ingham Ave.,	Trenton, N. J.	520
WMCN	The Palmer School of Chiropractic,	Davenport, Iowa	484
WMCN	Iowa State College.....	Ames, Iowa	360
WMCN	John Wanamaker.....	Philadelphia, Pa.	509
WMCN	Western Radio Co.....	Kansas City, Mo.	360
WMCN	L. Bamberger & Co.....	Newark, N. J.	405
WMCN	Missouri State Marketing Bureau,	Jefferson City, Mo.	441
WMCN	Pennsylvania State College, State College, Pa.	283	
WMCN	Donaldson Radio Co.....	Okmulgee, Okla.	360
WMCN	Doolittle Radio Corp.....	New Haven, Conn.	268
WMCN	North Dakota Agricultural College,	Agricultural College, N. D.	283
WMCN	Ward Battery & Radio Co.....	Beloit, Kan.	236
WMCN	Concordia College.....	Moorhead, Minn.	286
WMCN	Dr. John R. Koch.....	Charleston, W. Va.	273
WMCN	Horace A. Beale, Jr.....	Parkeburg, Pa.	260
WMCN	Radio Service Co.....	Waco, Texas	360
WMCN	Moore Radio News Station.....	Springfield, Va.	275
WMCN	Sandusky Register.....	Sandusky, Ohio	240
WMCN	Electrical Equipment Co.....	Miami, Fla.	283
WMCN	Seranton Times.....	Seranton, Pa.	280
WMCN	Calvary Baptist Church.....	New York, N. Y.	360
WMCN	Prince-Walter Co.....	Lowell, Mass.	266
WMCN	Radio Equipment Co.....	Riverside, Ill.	244
WMCN	Concordia Radio Co.....	Chicago, Ill.	228
WMCN	The Radio Club.....	Laporte, Ind.	248
WMCN	Northern States Power Co.,	St. Croix Falls, Wis.	248
WMCN	Lombard College.....	Galesburg, Ill.	244
WMCN	Black Hawk Electrical Co.....	Waterloo, Iowa	236
WMCN	St. Louis Radio Service Co.....	St. Louis, Mo.	360
WMCN	Antioch College.....	Yellow Springs, Ohio	242
WMCN	Avenue Radio Shop.....	Reading, Pa.	268
WMCN	Plexons Garage.....	Gloucester City, N. J.	288
WMCN	Immanuel Lutheran Church.....	Valparaiso, Ind.	278
WMCN	Reo Motor Car Co.....	Lansing, Mich.	288
WMCN	Radio Corp. of America.....	Washington, D. C.	469
WMCN	Doron Bros. Elec. Co.....	Hamilton, Ohio	360
WMCN	Union College.....	Schenectady, N. Y.	360
WMCN	University of Illinois.....	Urbana, Ill.	273
WMCN	City of Dallas Police and Fire Signal Dept.,	Dallas, Texas	360
WMCN	Tarrytown Radio Research Laboratory,	Tarrytown, N. Y.	273
WMCN	South East Missouri State Teachers College,	Cape Girardeau, Mo.	360
WMCN	Clemson Agricultural College,	Clemson College, S. C.	361
WMCN	J. A. Foster Co.....	Providence, R. I.	260
WMCN	United Playing Card Co.....	Cincinnati, Ohio	360
WMCN	Grove City College.....	Grove City, Pa.	263
WMCN	Seventh Day Adventist Church, N. Y. C., N. Y.	283	
WMCN	Doughty & Welch Elec. Co.....	Fall River, Mass.	254
WMCN	Camp Marienfeld.....	Chesham, N. H.	229
WMCN	Clifford W. Vizek Radio Construction Co.,	Houston, Texas	360
WMCN	Chas Electric Shop.....	Pomero, Ohio	258
WMCN	Atlanta Journal.....	Atlanta, Ga.	429
WMCN	J. & M. Electric Co.....	Utica, N. Y.	273
WMCN	School of Engineering of Milwaukee.....	Milwaukee, Wis.	246
WMCN	Alabama Power Co.....	Birmingham, Ala.	360
WMCN	Fall River Daily Herald Pub. Co.,	Fall River, Mass.	260
WMCN	Penn. Traffic Co.....	Johnstown, Pa.	275
WMCN	Louis J. Gallo, 2222 Lapeyrouse St.,	New Orleans, La.	268
WMCN	Toledo Radio & Elec. Co.....	Toledo, Ohio	252
WMCN	Willard Storage Battery Co.....	Cleveland, Ohio	360
WMCN	Cambridge Radio & Elec. Co.....	Cambridge, Ill.	242
WMCN	S. H. Van Gorden & Son.....	Osseo, Wis.	284
WMCN	Reliance Elec. Co.....	Norfolk, Va.	250
WMCN	Charles E. Erbstein, R. F. D. 6, Box 75,	Elgin, Ill.	286
WMCN	Edison Electric Illuminating Co.....	Boston, Mass.	242
WMCN	Rugg Battery and Electric Co.....	Tecumseh, Neb.	244
WMCN	Agricultural & Mechanical College Station,	Streator, Texas	280
WMCN	Williams Hardware Co.....	Streator, Ill.	231
WMCN	Oak Leaves Broadcasting Station,	Oak Park, Ill.	283
WMCN	Thomas J. McGuire.....	Lambertville, N. J.	261

WTG	Kansas State Agricultural College,	Manhattan, Kan.	273
WTL	H. G. Saal Co.....	Chicago, Ill.	269
WWAD	Wright & Wright, Inc.....	Philadelphia, Pa.	360
WWAE	Lawrence J. Crowley (Alamo Ball Room),	St. Louis, Mo.	242
WWAO	Michigan College of Mines.....	Houghton, Mich.	244
WWI	Ford Motor Co.....	Dearborn, Mich.	273
WWJ	Detroit News.....	Detroit, Mich.	517
WWL	Loyola University.....	New Orleans, La.	280
<b>Alaska</b>			
KFIU	Alaska Electric Light & Power Co.....	Juneau	226
KFQD	Chovin Supply Co.....	Anchorage	280
KNT	Walter Heinrich.....	Kukak Bay	263
<b>Argentina</b>			
LOR	Cia Radio Argentina.....	Buenos Aires	350
LOX	Radio Cultura.....	Buenos Aires	325
LOZ	Radio Sud America.....	Buenos Aires	375
TCR	Francisco J. Brusca.....	Buenos Aires	300
<b>Australia</b>			
2CF	Farmer & Co., Ltd.....	Sydney	1,120
2BL	Broadcastings Sydney (Ltd.).....	Sydney	380
2AB	Associated Radio Co. (Ltd.).....	Melbourne	480
6WF	West Australian Farmers (Ltd.).....	Perth	1,250
<b>Austria</b>			
"Radio Wien"	Technologische Gewerbemuseum.....	Vienna	700
OHW	Radio Hekaphon.....	Vienna	600
<b>Belgium</b>			
SRB	No data.....	Brussels	405
BAV	No data.....	Brussels	900
<b>Canada</b>			
CFCS	Eastern Telephone & Telegraph Co.,	Halifax, Nova Scotia	410
CFCE	Marconi.....	Halifax, Nova Scotia	440
CHAC	Radio Engineers.....	Halifax, Nova Scotia	400
CICI	Maritime Radio Corp.....	St. John, New Brunswick	400
CFCE	Jones Electric Co.....	St. John, New Brunswick	400
CFCE	Marconi.....	Montreal, Quebec	440
CHYC	Northern Electric Co.....	Montreal, Quebec	410
CJBC	Denius Freres.....	Montreal, Quebec	420
CKAC	La Presse Publishing Co.....	Montreal, Quebec	430
CFUC	University of Montreal.....	Montreal, Quebec	400
CFJC	Northern Electric Co.....	Montreal, Quebec	410
CHCJ	La Cje de L'Evenement.....	Quebec, Quebec	410
CHCD	Canadian Wireless and Electric Co.,	Quebec, Quebec	410
CFQC	Semmelbaack-Dickson (Ltd.).....	Bellevue, Quebec	450
CFCC	International Radio Development Co.,	Fort Frances, Ont.	400
CKOC	Wentworth Radio Supply Co.,	Hamilton, Ontario	410
CJCF	The News-Record (Ltd.).....	Kitichener, Ont.	420
CHCX	J. R. Booth, Jr.....	Ottawa, Ont.	400
CFCH	Abitibi Power & Paper Co.,	Iroquois Falls, Ont.	400
CFCR	Laurentide Air Service.....	Sudbury, Ont.	410
CFRC	Queens University.....	Kingston, Ont.	450
CFCW	Radio Shop.....	London, Ont.	420
CJCG	Free Press Printing Co.....	London, Ont.	430
CKCC	Radio Supply Co. (Ltd.).....	London, Ont.	410
CHCO	London Radio Shop.....	London, Ont.	410
CKCE	Canadian Independent Telephone Co.,	Toronto, Ont.	450
CFCA	Star Publishing & Printing Co.,	Toronto, Ont.	400
CJCD	T. Eaton Co.....	Toronto, Ont.	410
CHCB	Marconi.....	Toronto, Ont.	440
CHCC	Metropolitan Motors.....	Toronto, Ont.	410
CJCN	Simon Grey & Co.....	Toronto, Ont.	400
CJCS	Evening Telegram.....	Toronto, Ont.	430
CJCG	Manitoba Free Press.....	Winnipeg, Manitoba	410
CHCF	G. Melrose Bell.....	Winnipeg, Manitoba	430
CJNC	Tribune Newspaper Co.....	Winnipeg, Manitoba	400
CKCZ	Salton Radio Engineering Co.,	Winnipeg, Manitoba	420
CKCA	Manitoba Telephone System,	Winnipeg, Manitoba	450
CKCK	G. Melrose Bell, Leader Publishing Co.,	Regina, Saskatchewan	420
CFQC			



Solving crosswords by radio

# Cross Word Contest

One-year subscriptions will be awarded to the first 100 solvers of this easy acrostic

## HORIZONTAL

- 2—What live batteries contain.
- 9—Type of battery.
- 15—Radio operators' signal for "Go ahead."
- 16—What "TRs" were originally called.
- 18—Neither masculine nor feminine.
- 19—An exclusive right.
- 20—A professional degree.
- 21—Unit of resistance.
- 23—Presently.
- 24—Musical pipe.
- 25—A helpful hint.
- 26—Hurt.
- 28—Send forth.
- 29—Connection across grid circuit.
- 30—Short term for college society.
- 31—Apparatus.
- 33—Necessary implement in building a set.
- 35—Da dit, dit dit, dit.
- 36—Front of radio set.
- 40—Dit, dit da dit, da.
- 42—Ourselves.
- 44—Place of the seal (legal abbrev.)
- 46—"The ambulance call of the sea."
- 48—Definite article (French).
- 49—Elder (abbrev.).
- 50—Reply prepaid radiograms.
- 52—Exclamation.
- 54—Dit da, da da da.
- 55—A detector.
- 56—A knock.
- 57—Number.
- 58—Nothing.
- 59—Personal pronoun.
- 60—Period of time.
- 61—Conjunction.
- 63—Radio code for "Right."
- 64—What we do to live.
- 65—Point on compass.
- 66—Note of musical scale.
- 67—Electrical term.
- 69—Exclamation.
- 71—Southern state (abbreviation).
- 72—Metallic element.
- 73—Elementary substance.
- 74—A favorite.
- 75—Radio signal for "OK."
- 76—Radiograms calling for repetition.
- 77—His Majesty (abbreviation).
- 79—An animal.
- 81—Straight.
- 86—A telegraph instrument.
- 90—Call for assistance.
- 92—Prepare for publication.
- 94—One thing.
- 95—One inside every Radiotron.
- 96—Used profusely in wireless.
- 97—Pleasing.
- 98—Da dit dit, da.
- 99—Pronoun.
- 100—Let it stand.
- 101—Remembrances.
- 102—Printer's measure.
- 103—Preposition.
- 104—Admittance.

## VERTICAL

- 1—Type of aerial.
- 3—Preposition.
- 4—Grassy field.
- 5—What you must do for "DX."
- 6—Smallest particle.
- 7—Da da dit, dit, da dit, dit dit.
- 8—A suffix.
- 9—Southern Pacific (abbreviation).
- 10—Allowance for waste.
- 11—Da da da, da, dit, dit da.
- 12—Emit vapor.
- 13—Conjunction.
- 14—"Get" (Radio code).
- 15—Southern California broadcast station.
- 17—Woolly hair.
- 20—At least one on face of your receiver.
- 22—Manner.
- 25—Gait of a horse.
- 27—Metal pin.
- 30—The golfer's call to those ahead.
- 32—That which retards flow of current in your set.
- 33—Art of communication.
- 34—Needed to light tubes.
- 36—Radio signal for paid radiogram.
- 37—Radio signal for "Wait."
- 38—Negative.
- 39—Used to form plural of some nouns.
- 41—Type of radio detector.
- 43—Extra Radiotron not in use.
- 45—Unit of transmitting set.
- 47—What the voltmeter registers.
- 49—A close watch or guard.
- 51—Watering place.
- 53—Personal pronoun.
- 54—A good Radiotron contains none.
- 55—Personal pronoun.
- 62—The letter "E" in radio.
- 61—Adapt.
- 67—That is.
- 68—Western continent.
- 70—To shut in.
- 73—Greatest wonder of the age.
- 78—Center of transformer (Pl.).
- 79—Suffix denoting result.
- 80—Notch.
- 82—"Are you?" (Radio code.)
- 83—Conclusion.
- 84—To quote.
- 85—Radio operator's code for "That".
- 86—Royal Guard (abbreviation).
- 87—The Land of Shamrocks.
- 88—What tube did when current was turned on.
- 89—Item in newspaper (abbrev.).
- 90—Location.
- 91—Radio equipment (Pl.).
- 93—Small mound of earth.
- 96—Famous marine coastal radio station.

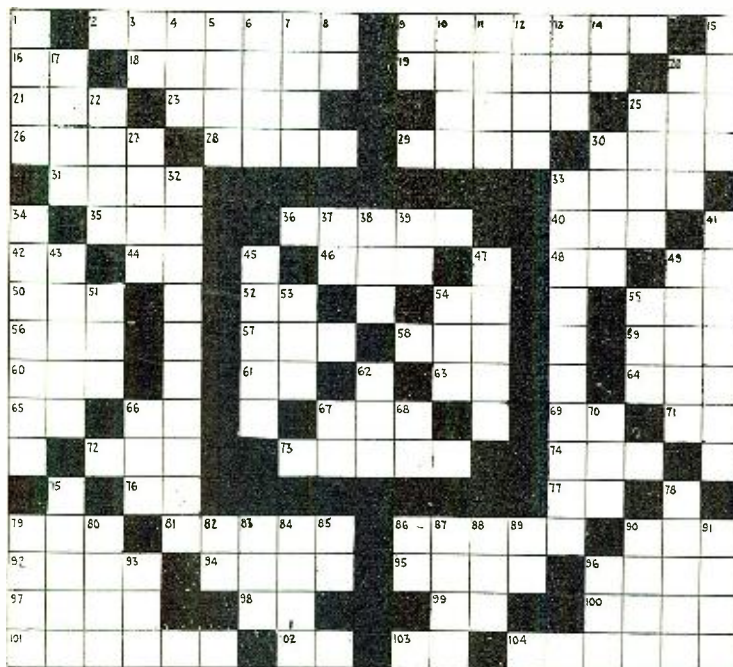

## RADIO CROSSING

Composed by *Helen F. Dittus*

### PRIZE CONDITIONS

A year's subscription to WIRELESS AGE—The Radio Magazine will be awarded to each of the first (post date to determine) 100 persons sending in the correct solution to this comparatively easy acrostic—Contest closes Feb. 25—The solution will appear in March WIRELESS AGE and the prize winners will be announced in the April issue. Address replies to Cross Word Contest, WIRELESS AGE—326 Broadway, New York City.

# A Home-Made Storage Battery

By J. W. Conzelman, M. E.

THESE comes a time in the experience of every radio fan with his set when the question of a better B-battery is paramount. If the average one of us were to trace our radio development we would find that tuning coils and condensers supplied our first worries, then suitable detectors followed in quick order and probably the A-battery was the next weak link in the set.

As the radio "bug" adds to the set, a storage A-battery must be used and thus the item is disposed of for a time, at least. You are just about to relax, thinking that all your problems are settled when the dry B-battery starts acting up and the question arises: "Shall I buy two more 45-volt dry batteries, or shall I invest in a storage B-battery?" The first solution offers temporary relief for six or eight months. The second represents an investment that is considerable and it sometimes seems questionable whether or not the extra trouble in-

involved in looking after the storage cells does not offset the advantages gained in the operation of the set.

Why not make a simple, high voltage, small capacity source of power? It sounds easy, and if one follows the scent through the various types of primary cells, the voltaic pile, thermocouple generators and all, he finds that each one offers disadvantages, either due to internal or local action. Friction machines have been tried out and small motor-generator sets, but have been discarded as unsuitable.

In the storage battery field the non-acid battery was eliminated because it offered no particular advantages over the lead-acid cell, and the unit cell voltage is considerably lower than that of the lead-acid cell. The lead-acid battery gives slightly better than two volts per cell and anyone familiar with regular storage batteries for automobile work, or for filament lighting, knows how to keep the cells in good operating condition.

To make the lead-acid cell there is required two lead plates and a dilute solution of sulphuric acid. If the lead peroxide plate and a plain lead plate are put into a dilute sulphuric acid solution a cell is formed with the peroxide plate at the higher potential. As the cell discharges, both plates are converted into lead sulphate ( $PbSO_4$ ) at the expense of the acid radical in the sulphuric acid solution ( $H_2SO_4$ ). The action reversible and lead peroxide is reformed on the positive plate with pure spongy lead on the negative upon charging. The reactions are very complicated in nature, but the results may be expressed thus:

Equation expressing action during discharging  $PbO_2 + H_2SO_4 \rightarrow PbSO_4 + H_2O + O$  at the + plate and  $Pb + H_2SO_4 \rightarrow PbSO_4 + 2H$  at the negative plate.

Since the reactions are reversible, reading the equations from right to left shows the reactions during charging conditions.

(Turn to page 62)

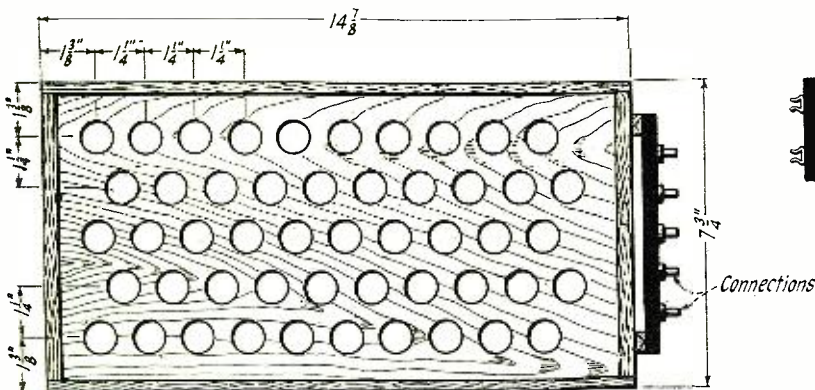

Plan showing arrangement of test tubes

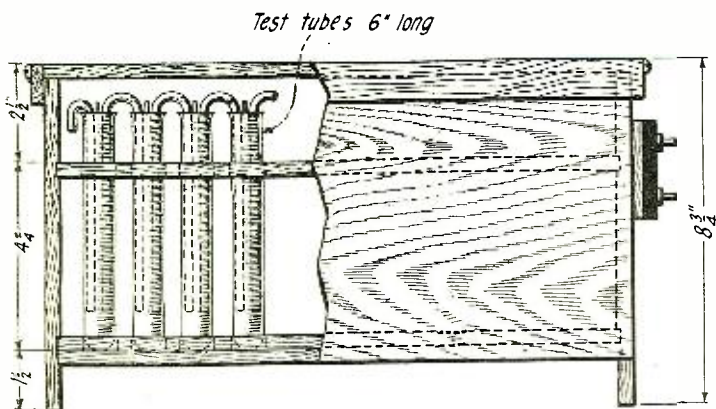

Side cut away to show cells

FIG. 1

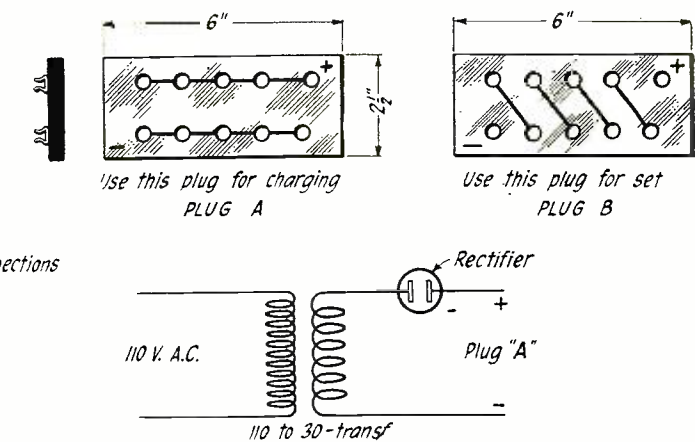
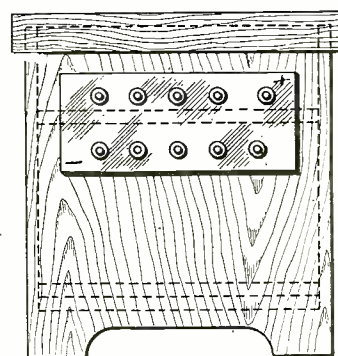
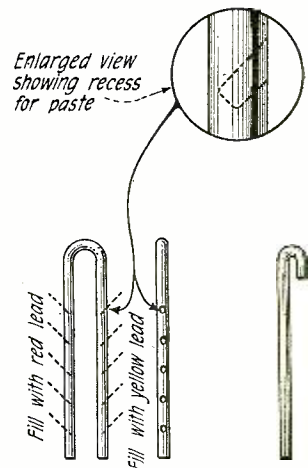

FIG. 3



End View



Electrodes made of 1/4" lead wire  
FIG. 2



# How I Earn \$100<sup>00</sup> a Week as a Radio Expert

A year ago I was mighty blue and discouraged. It seemed to me that I would never be more than a low-paid bank clerk. Of course I had a small increase in salary every now and then, but I knew that pretty soon I would reach my limit and there would be no further advancement for me. What future had I to look forward to? Where would I be in five years? I became restless and discouraged and began to look around for some other opportunity.

It was then that I discovered that the demand is for *trained men*, that the opportunities are all for men who can do some one thing better than anything else. There were wonderful opportunities for men who were experts or specialists—but I was—a clerk. How I regretted then that I hadn't prepared myself for some definite career!

## I Wanted to Marry

The thing that made me more restless at that time than anything else was the fact that Marian and I were—that is, we wanted to be married. But we both knew that we couldn't possibly get along on my small salary. If only there was something I could do that would bring me a larger salary!

It was just about the time that everyone became so interested in radio. Our whole town became radio-mad, and of course what was happening in our town was happening all over the country—all over the world. I managed to save up enough to buy a receiving set and I was never quite so happy as when I was trying to tune in on stations.

The thing fascinated me. Playing with air waves! Bringing melodies and messages out of the sky! I was never so interested in anything before.

Marian was the first to sense the great opportunity. "Why don't you become a radio expert?" she said. "You like it, and I am sure there must be a big demand for

men who understand it. It's a new field and there's plenty of room for wide-awake men."

"But—but I'm not trained!" The thought excited me. To be a radio expert! To find my future in this fascinating new field! "I don't know anything about it, Marian" I said. "I wish I did, though."

"Well, why don't you find out about it?" she retorted. "You can't learn about radio just by listening in to the concerts. Why don't you take a course?"

But we found out that most courses were expensive or that they would interfere with my other work. We were about discouraged when I discovered that through the National Radio Institute it is possible to become a radio expert by studying right at home in spare time. I told Marian about it and she was elated. "Send off for information, at once—today!" she exclaimed.

## Advances Quickly to \$100 a Week

I did, and the following day received an attractive booklet, "Rich Rewards in Radio" telling all about radio opportunities and how to become an expert in any particular phase of the work.

Here was my opportunity at last!

I began to study in all my spare time. It was the most interesting and absorbing study I had ever made. The secret of the radio revealed to me! Day by day I became more skilled and deft until I was able to take apart receiving sets and put them together again as though I were playing with a toy. It was fun! In a month I was able to take a position as lineman at a bigger salary than I was getting at the bank. This was wonderful experience for me, and I kept right on with my studies. It wasn't long before I qualified for a position as radio engineer at a salary of \$100.00 a week! That is what I am earning now, though I expect to make more soon. It seems to me almost too good to be true, after all those

years as a low-paid clerk in a bank. And Marian, who will soon be my bride, keeps saying, "I told you so!"

As a radio expert I can tell you that there is a tremendous demand for men who can build, sell and install radio sets, who can design, test, repair. Men are needed as operators, engineers and executives, all over the world. The opportunities are limitless, and if you like radio there is no reason why you cannot qualify for one of these positions by studying in your spare time at home as I did.

The National Radio Institute offers an absolutely complete course which prepares you for the Government First Class Commercial License and for the bigger-paying jobs in Radio. The Director, E. R. Haas, will be glad to send you all details of their marvelous new method of practical instruction, including information concerning the Free Employment Service which secures positions for National Radio Institute graduates. Everyone interested should have this information. *It's free*, and this coupon will bring it to you. I advise you to send it off today. Radio is a new and interesting field, and it offers you more money than you probably ever dreamed possible!

## Important

Those who mail the coupon *at once* will also receive details of Special Short Time Reduced Rate. Do it now.

National Radio Institute, Dept. 46DB.  
Washington, D. C.

I am interested in radio and would like to find out whether or not I am suited for a radio career. Please send me, without the slightest obligation your interesting free book called "Rich Rewards in Radio." Also full details concerning your special Short Time offer.

Name .....  
Address ..... Age.....  
City ..... State.....

multiple. if a 25 or 30 volt B-battery charger is available.

Eleven pounds of  $\frac{1}{4}$ " round lead wire will be needed for electrodes. Cut this, after straightening, into forty-five  $11\frac{1}{2}$ " lengths and ten pieces 7" long. Drill or punch with a sharp tool five small holes in each end of the  $11\frac{1}{2}$ " lengths, as indicated in figure 2. Punching is recommended, as it is faster and requires less care. Do not go clear through with the hole. These pockets are used to contain the paste used to assist in forming the plates.

At the drug store get about  $\frac{1}{4}$  lb. of red lead C.P. and an equal weight of yellow lead C.P. and make these powders into pastes by mixing with dilute sulphuric acid. Use C.P. acid

and mix one part acid with four parts of water to make the pastes.

When the wire is clean use an old knife and press the red lead paste into the holes on one end of each piece and the yellow lead paste into the other end. Lay the hair-pin shaped electrodes aside for at least 24 hours so they will dry slowly. The short pieces are to be treated as above, except that half are made into "+" plates with red lead paste and half into "-" plates with yellow lead paste.

When all have dried out place them in the test tubes, being careful to keep all "+" ends of the plates to one hand and all "-" ends to the opposite hand. Put the single plates in their proper places in the end cells.

To make the electrolyte, buy about a pint and a half of C.P. sulphuric acid, and in a fine stream slowly pour this into a glass or porcelain vessel, containing about three pints of distilled water. Danger! Never pour the water into the acid, because the heat generated will crack the glass vessel and may blow the acid into your eyes and face. The density should be between 1230 and 1240. If below 1230 add more acid slowly as before. If above 1240 add some distilled water very slowly. In either case let it cool again and take another reading.

To keep the electrolyte from creeping paint the tops of the test tubes and the V bend of the lead with molten paraffin or wax.

#### CONNECTING UP THE BATTERY AND FILLING

Put all the plates in the tubes and have the red lead plates to the right as shown in figure 1. Secure some lamp cord wire and untwist the two wires, using this to connect up the end cells to the connectors shown at the end of the battery. Solder a wire from each of the top connectors to each of the single "+" plates in the cells at the right end. Solder a wire from each of the bottom connectors to each of the single "-" plates in the cells at the left end and then brush over these soldered connections with molten paraffin.

We are now ready to fill the tubes with the acid solution. Use the hydrometer for this purpose and fill all tubes evenly to a point about one inch from the top.

The battery is now ready for charging. On account of the relatively small area of the plates, a very small charging rate is recommended, not over .2 ampere per cell, or when charging the five rows in parallel, the charging rate should not exceed one ampere.

Charge the battery at this rate for twenty-four hours and it will show one hundred volts, or a little more, across outside terminals. Discharge through a 40-watt 110-volt lamp until the lamp ceases to glow and again charge for twenty-four hours. After repeating this for three or four days, the battery may be used all evening in the radio without a material drop in voltage.

#### Production of Electric Current

(Continued from page 49)

verized manganese dioxide mixed with sal-ammoniac and carbon which is rammed around the carbon rod. The container is filled almost to the top with this compound and the top is sealed with asphalt.

The voltage obtained from a dry cell varies between 1 and 2 volts depending on the type of cell. The standard cell in common use is one

"In September you advertised a one mfd. By-Pass Condenser to be attached across the "B" battery. As I had three sets of "B" batteries (detector, amplifier, and power amplifier) I purchased and installed three of them. They 'did the work' magnificently."

**"They did the work!"**

This message came from one pleased radio fan—from just one radio fan—but the experience of many others is identical.

And you, too, will find that a Dubilier By-Pass Condenser in your set will eliminate noises—purify reception—and do the work magnificently!



# Dubilier

CONDENSER AND RADIO CORPORATION



*Resonant Wood  
insures  
Tone Quality*

## Music Master Gives Life to Radio Voices

WORLD fame comes to singers through a mysterious something in the voice—a personal quality that grips the hearers and holds them in a spell of delight.

When voices with delicate modulations and elusive sweetness of tone are broadcast, only a master instrument can reproduce them faithfully. Such an instrument is Music Master.

Two celebrated opera stars sing the Duet of the Flowers from Madame Butterfly. Hear the quality of greatness in their voices, as it can be heard only through Music Master.

Radio impulses entering the sensitive precision instrument in the base are translated into sound waves, undistorted and faithful to the original voice or instrument. In the tapered tone chamber of cast aluminum these sound waves grow clear and bell-like and, finally, the full, mature tones pour forth in rich resonance through the Music Master amplifying bell of natural wood.

Music Master is a musical instrument—the musical instrument of radio. Hear it at your dealer's; or, better still, have one sent to your home to prove with your own set.

*Dealers Everywhere*

**Music Master Corporation**

*Makers and Distributors of High-Grade Radio Apparatus*

10th and Cherry Streets

Chicago

PHILADELPHIA

Pittsburgh

**Music  
Master**  
RADIO REPRODUCER

Connect MUSIC MASTER  
in place of headphones.

No batteries required.

No adjustments.

MODEL VI \$30

14 inch bell

MODEL VII \$35

21 inch bell

MODEL VIII \$35

(Cabinet Type)  
with "Full Floating"  
Wood Horn

having the elements and electrolyte described in the preceding paragraph. The voltage of this cell is 1.5 volts.

This cell is made in a variety of sizes depending upon the service requirement. If it is to supply a relatively large current of  $\frac{1}{4}$  ampere as is required for lighting the filament of a WD-11 dry cell tube, a large type of cell such as the one shown in the photograph is necessary.

#### PLATE OR "B" BATTERIES

The introduction of the present vacuum tube system in radio, necessitating a battery of from 20 to 40 volts for obtaining a source of voltage for the plate of the vacuum tube, has led

to the adoption of a very neat and compact unit as a standard, consisting of 15 cells in an adding combination. This unit can be bought in a number of sizes, one of which weighs a little less than a pound. Its arrangement is indicated in the photograph which shows a partial section of one cell of the complete battery. Each cell consists of a zinc container which holds a carbon rod around which is molded the depolarizing mix wrapped in cheese cloth, in a cartridge form. The negative terminal is brought out in the form of a short wire soldered to the outside of the container and the positive wire is brought out from a brass cap pressed on to the top of the carbon

rod after the cartridge is placed in the container, the space between is filled with electrolyte in the form of a flour paste and the cell is then sealed with a small amount of asphalt. The 15 cells are assembled in a pasteboard box lined with waterproof material and connected in an adding combination (that is, in series). The space between the cells is filled with sealing material to make the cells moisture-proof and for insulating one cell from the other. The top of the entire unit is again sealed with asphalt making a battery which combines long service with great compactness and small weight. The intermediate size plate battery has a life of over 500 hours in continuous operation in a vacuum tube set using only one UV-201A tube: that is, when supplying a current of .002 ampere (two one-thousandths of an ampere) which is the average plate current required by a tube. Larger size of plate, or "B" batteries as they are commonly called, will give a corresponding increase of life. These batteries are also sold with taps brought out at 16, 18½, 19 and 21 volts as shown in the photograph to give the purchaser a means for a fine adjustment on the voltage applied to the plate. This is necessary when used on a soft detector tube.

The chief disadvantage of dry cells is their depreciation when not in use. This is due to impurities inherent in the zinc element which cause local electrolytic action on the zinc plate, resulting in the wasting away of the zinc. For this reason, cells should never be relied on for periods longer than 12 months after their manufacture even if they were not in use and the purchaser of a new cell should always look on the cover for the date when manufactured.

*"Production of Electric Current" will be continued in a future issue of "Wireless Age." The subjects treated will be storage batteries, mechanical devices, generators, motors and motor-generators.*

#### A Letter from a South American Humorist

SEÑOR EDITOR JEFE of WIRELESS AGE amigo mio, since coming to your pure and holy country as secretario to our venezulean pugilist i read much about white slavery and thought at first that this meant the prohibition that has been depended on your oculars, but the other evening i listened to one of your escaciones difusoras and heard your silver tongued annoncerio, j andrew white, describing the firpo dempsey controversy, and now i know what white slavery is, but yet i cannot understand why white is so willing to suffer it; please enlighten me. jorje clairek.



## Radio Panels In Individual Envelopes

### Your Assurance of Manufacture Under the Special Spaulding Process

Just the size panel you need—protected against marring and guaranteed by this envelope container to be Spaulding-Bakelite. You can safely put your faith in panels sold in these envelope containers. They are processed expressly for radio, with the same unlimited facilities which produce all Spaulding fibre products, famous the world over.

A laminated phenolic condensation product that possesses high dielectric properties and great strength; drills, saws, engraves without chipping; retains a beautiful, everlasting lustre.

Write nearest office for descriptive circular.

### SPAULDING FIBRE COMPANY, Inc.

Factory—Tonawanda, New York

Branch Offices—Warehouses

484 Broome St., N. Y. C.

15 Elkins St., Boston

659 W. Lake St., Chicago

310 E. 4th St., Los Angeles

141 N. 4th St., Phila.

171 Second St., San Francisco

509 First National Bank Bldg., Milwaukee

# Spaulding BAKELITE

#### Manufacturers

Spaulding - Bakelite panels are available in Black, Mahogany, and Walnut finishes. Prompt shipments assured from Spaulding warehouses conveniently located on the Atlantic and Pacific Coasts and Mid-Continent. Each branch is newly equipped with the machinery for producing Bakelite Panels, coils and specialties to manufacturer's order. Our nearest office employs skilled Bakelite Engineers to serve you.



for a minute, and the technical staff must run the gauntlet. Nor is that ail. The broadcasters are blamed, not only for their actual failures, but for mishaps over which they have no control and of which they are not even aware. A violet ray machine or a leaky high tension line, interfering with reception in some remote backwoods, brings down a shower of denunciation on the technical martyrs whose cause I have the honor to plead. If they were not such patient and public-spirited individuals they would, on some disastrous night, take the bias off the modulator grids, turn the grid control up to the explosion point, pour molasses into the microphones, beat up the announcers, and jump off the towers to their just reward.

It would be impossible, in the time allotted to this discourse, to give a complete list of all the privations to which the broadcast operator falls victim, and, if I continue, I fear that I shall burst into language so strong that my own colleagues will take me away. I have, however, a novel and original plan for remedying the evils of this situation, and averting the catastrophes at which I have hinted. This plan I now take great pleasure in presenting to my readers.

The fundamental trouble, I have become convinced after long and prayerful study, is with the listeners. If there were no listeners it would be easy to run a broadcasting station. Anything could be put out on the air without danger of libel suits, for there would be nobody to hear it. The impresario of the program division would not have to cudgel his brains and impair his health in pursuit of interesting program features, for one event would be just as interesting as another. The engineers would not have to worry about the modulation, for it could sound like ten dog fights for all the harm it would be doing. The engineers could, in fact, leave the sets and play mah jong or blackjack; and no doubt that is just what they would do.

Clearly, therefore, the listeners must be eliminated. But, ladies and gentlemen and good children, do not be alarmed. I am not preaching a crusade for the violent extermination of broadcast listeners. Such a consummation, in fact, would shock and distress me more than anyone else. The solution, on the contrary, is at the transmitting end. My years of engineering experience and sleepless nights devoted to intense thought have brought me the answer. The thing to do is to build a broadcasting station, complete in every detail, but without an aerial. A broadcasting station to be run in vacuum, so to speak, and purely for the pleasure of the operating staff. I now close with an urgent appeal for funds for the immediate erection of such a station. Five million dollars will do nicely. Good night, and thank you kindly.

### Modifying the Reinartz

(Continued from page 41)

speaking radius is approximately 1,000 miles, under average conditions. Loudspeaking with this hook-up is particularly satisfying, for with good transformers such as the Amertran or Acme there is practically no distortion in the second stage. The only difficulty is that local stations come in so strongly on the second stage that the volume is too great to be handled by a Baldwin



**Adapto**  
RADIO CABINET

**Converts Your Radio Receiver Into a Thing of Beauty!**

You can now dress up your radio set—convert it instantly to a beautiful console receiver.

The Adapto Cabinet is uniquely designed to enclose all batteries and accessories. Adjustable mounting frame—to fit any size of any make radio set. A beautiful art design made of finest woods by skilled cabinet craftsmen. Equipped with built horn, adaptable to any unit.

Furnished in red mahogany or walnut finishes.  
35" long, 45" high and 18" deep.

**L.R. DONEHUE CO. ~ PERTH AMBOY, N.J.**

## CARTER "HOLD-TITE" Jacks



70c.

Carter Jacks are known everywhere for their originality of design and preferred for their quality and fine workmanship.

Made in ten different spring combinations, a style for every circuit.

Any dealer can supply.

In Canada—Carter Radio Co., Limited—Toronto



"Quality Goods for Quality Readers"

# 9600 MILES WITH B-T LOW LOSS TUNER

## Read What They Say!

Radio 2WR, Arthur G. Wester, Asst. Division Mgr., American Radio Relay League, wrote us as follows: "Having obtained one of your new Short Wave Tuners I would like to mention results obtained. New Zealand 4AA was copied on Nov. 13th steadily from 6:16 to 6:39 A. M. E. S. T. The estimated distance is 9600 miles. Mexican BX was worked from this station on Nov. 15th and not one word was missed. Stations all over the U. S. have been copied."

R. A. Bradley, Technical Editor of Wireless Age, reports that—"The results that I obtained with your Broadcast tuner and transformer have never been equaled by myself nor any of my associates. The adjustable coupling on your Low Loss Tuner is one of the most valuable things that has been added to the regenerative type tuner. For people living in any of the congested broadcasting centers I know of no combination that would be more suitable." (See December Wireless Age, or write us.)

Radio 9ZA, Chicago, Illinois, has received English, French, Dutch and Mexican Stations with one of our Short Wave Tuners.

These letters are typical. Experts everywhere agree that B-T parts are in a class by themselves. Don't fail to see these parts at your dealers! Our 40 page book, Better Tuning, contains complete details, hook-ups, tuning, construction and general information. Sent postpaid for 10c.

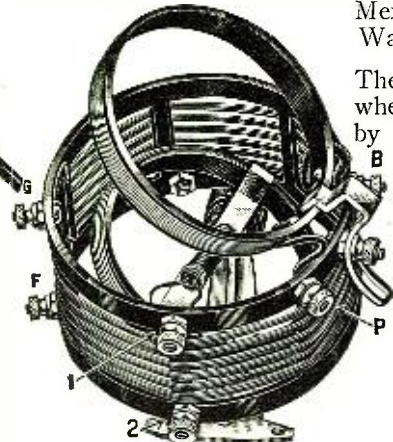

**B-T LOW LOSS TUNER**  
Made for Broadcast or Short Wave work. Ranges covered with L-11 Condenser:  
Type B.....200 to 565.....\$5.00  
Type SW.....50 to 150.....\$5.00

B-T LIFETIME CONDENSER	
Type	Price
L-7 125 M. M. F.	\$4.25
L-11 250 M. M. F.	4.50
L-23 500 M. M. F.	5.00
L-35 750 M. M. F.	6.50

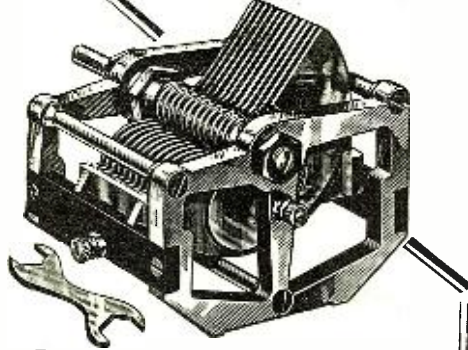

**BREMER-TULLY MFG. CO.**  
"Pioneers of Better Tuning"  
532 S. Canal Street  
Chicago Illinois

unit. In my opinion a well built three tube set using this circuit leaves nothing to be desired in the way of sensitivity, volume, clarity and ease of tuning, and its selectivity is surpassed only by such sets as the Superdyne and Neurodyne, and of course, the Super-heterodyne.

In experimenting with this circuit various combinations of apparatus have been used in the different sets, such as different forms of inductance, different types of condenser, different makes of variometer and different values of grid leak and grid condenser. The only general rules to be drawn are that the higher grade the apparatus and the more nearly it approaches the "low loss" condition, the better the set will perform. Very good results have been secured using a spider web coil for the tuning inductance. The type of variometer makes no real difference, although each different variometer gives slightly different control characteristics. The nicest control was obtained using a moulded (Manhattan) variometer, which has a very high inductance. With this variometer an interesting variation in set construction was also possible, in that the instrument was secured to the panel upside down and a binding-post panel made by fastening a small strip of bakelite to the projection intended for a base mounting of the instrument. The variable grid leak was found to possess no advantages over the fixed leak. However, a vernier control over the condenser is essential, either by means of a vernier plate or vernier dial—one method is as good as the other. In no case was shielding found to be necessary, since there is an absolute lack of body capacity when good apparatus is used.

Excellent results have been secured using the 201-A tubes, with which it was noted that 45 volts on the detector tube resulted in appreciably greater volume and selectivity. The UV-200 detector has also given splendid results. No undesirable coupling effects seem to exist between the tuning inductance and the plate variometer, so that the positioning of the apparatus is relatively unimportant.

Naturally this set must not be considered a "record breaker" for it is after all only a very good regenerative receiver. Thus, under favorable conditions it has brought the west coast stations into Chicago and it has shown a log of thirty-five distant stations in one night. In August, 1924, a three-tube set of this construction brought in twenty-five distant stations, fifteen on the loud speaker, and it has given loud speaker reception of Davenport at noon, in bright sunlight. The point is that it is one of the simplest and best of the regenerative circuits and may be relied on for the most consistent type of performance.

14-inch Bell  
Polished Pyralin



Aluminum sound column

## Burns A Speaker of Distinctive Lines

All the volume you want with no sacrifice of clearness or naturalness. The full true tones of voice or music are reproduced. Equal to hearing the original. Speaker Unit only supplied for use on phonographs—fits any make.

- No. 205B—Polished black flare.....\$22.50
- No. 205D—Shell pyralin flare..... 25.00
- No. 100—Unit for phonograph use..... 10.00

Makers of telephones for 30 years.

Manufactured by  
*American Electric Company*

State and 64th Streets  
CHICAGO

"Quality Goods for Quality Readers"

**Low Loss Receiver**

*(Continued from page 35)*

nections and greatly simplifies the wiring. The lead running along the top of the low loss tuner terminal strip to the Bradleystat as shown in the accompanying illustrations is the A minus lead and all returns are made to this lead, and it is finally grounded by a strap connection to the ground binding post wherever convenient. In making this connection, run one piece of bus wire from the farthest Bradleystat to the ground terminal on the low loss tuner. Then take all connections which should go to this minus A line, off from this one main lead.

We prefer to use in an audio frequency amplifier single closed circuit jacks for cutting in the phones at various stations. If wired according to the diagram, they work just as well as double circuit jacks and are much easier to connect up. When the phones are plugged in the jack, the transformer of the following stage is automatically disconnected. We always make a practise of connecting the framework of the jack to the positive of the B battery in every instance and likewise the top contact of the jack to the plate of the preceding tube. This provides a standard and it is just as well to make as many things as possible standard in your set. By connecting the jack in this manner you have a ready means of testing your B battery voltage by placing one contact of the voltmeter on the jack and the other on the filament switch. This is a more correct method of testing batteries than by taking a reading directly across the batteries themselves as it indicates exactly what the working voltage of your battery is at the set itself. You may have 45 volts in the B battery under the table, but after passing through some high resistance leads connections and contacts it may be anything from 38 to 40 volts by the time it reaches your tubes. If you stop to realize how many connections the battery current must go through in order to reach your tube, you will exercise more care in making clean-cut connections, soldering where possible, and eliminating all useless resistance. Notice the location of the Bradleyleak fastened to the baseboard of the set near the grid terminal of the detector tube socket. This excellent gridleak is now being supplied with a .00025 mfd. Dubilier Micadon condenser which fits directly across its terminals. This makes the unit complete, for one needs only to use this variable gridleak with a stubborn detector tube in order to appreciate the value of a good variable gridleak. This leak should be turned all the way out, and the tickler rotated until the set goes into oscillation. Now turn the gridleak "in" which decreases its resistance until the set goes into

**Direct Tuning**



Designed by R. E. Lacault, E.E., A.M.I.R.E., inventor of the famous Ultradyne circuit. This monogram seal (R. E. L.) is your assurance of Lacault design.

Stop fishing for your favorite station. *Select* the program you want get it lightning quick. Replace your old dials with ULTRA-VERNIER Tuning Controls. Then, when you have tuned in a delightful station, pencil-record it on the dial. Never again need you guess or fumble for that station, or bother with wave-lengths. Simply turn the finder to your pencilmark, and you hear it!

**\$2.50**

At your dealers

Should you move—or a station discontinue or wave-lengths change—erase the marks, leaving the dial beautifully clean and new. Thus, you may now have all the joy of radio, with none of the discouragements. Moreover, the ULTRA-VERNIER is a single vernier tuning control.

Made by the Hammarlund Mfg. Co., your assurance of quality and dependability—produced solely for the Phenix Radio Corporation.

*At your dealer; otherwise send purchase price and you will be supplied postpaid.*

**ULTRA-VERNIER TUNING CONTROL**

PHENIX RADIO CORPORATION

3-5 BEEKMAN STREET

NEW YORK CITY

**Learn the Code at Home with the Omnigraph**

*"Just Listen—The Omnigraph will do the teaching"*

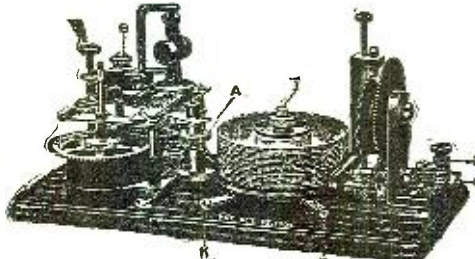

THE OMNIGRAPH Automatic Transmitter will teach you both the Wireless and Morse Codes—right in your own home—quickly, easily and inexpensively. Connected with Buzzer, Buzzer and Phone or Sounder, it will send you unlimited messages, at any speed from 5 to 50 words a minute. THE OMNIGRAPH is not an experiment. For more than 15 years it has been sold all over the world with a money back guarantee. THE OMNIGRAPH is used by several Depts. of the U. S. Govt.—in fact the Dept. of Commerce uses THE OMNIGRAPH to test all applicants applying for a radio license. THE OMNIGRAPH has been successfully adopted by the leading Universities, Colleges and Radio Schools.

Send for FREE Catalog describing three models. DO IT TODAY.

THE OMNIGRAPH MFG. CO.  
16B Hudson St. New York City

**If you own a Radio Phone set and don't know the Code—you are missing most of the fun**

"Quality Goods for Quality Readers"

# They say~ (continued from last month)

**5** THEY SAY OF THE ULTRADYNE L-2:  
 "Selectivity is so high and amplification so strong that distant stations can be tuned in through local stations and put on the loud speaker."  
*Ultradyn e amplifies with Thordarsons!*

**6** THEY SAY OF THE PFANSTIEHL MODEL 7:  
 "People now want trouble-proof service and purity of tone. The new Pfanstiehl . . . gives a clear, natural tone at any distance. . . . There is no distortion, however great the amplification. . . . It comes in like velvet. . . . Two stages of audio amplification—low ratio, of course, to give perfect quality, with all the volume desired."  
*Pfanstiehl amplifies with Thordarsons!*

**7** THEY SAY OF THE HOWARD NEUTRODYNE:  
 "It brings in distant stations distinctly. It has natural tone qualities. It has remarkable volume."  
*Howard amplifies with Thordarsons!*

**8** THEY SAY OF THE RADIODYNE:  
 "When you own a Radiodyne you can hear singers' voices and orchestral harmonics faithfully reproduced thru the loud speaker . . . so clear and distinct that you lose nothing."  
*Radiodyne amplifies with Thordarsons!*

**ZENITH**  
**KENNEDY**  
 Radiodyne  
 THERMIODYNE  
 ULTRADYNE  
 MURDOCK  
 AZARKA  
 Pfanstiehl  
 MICHIGAN  
 Deresnadyne  
 MALONE LEMON  
 MASTER RADIO  
**ROYAL**  
 Pathe  
 HARMONY  
 AUDIOLA  
 GLOBE  
 SAAL AND  
 MANY OTHERS



**SUPER HET BUILDERS!**  
 For the Remler Super-Heterodyne Radio  
 Magazine and other leading authorities recommend in highest terms the Thordarson 2:1 ratio transformers. Take no others!

## When Better Transformers Can Be Bought—They Will Be Thordarsons!

*Tone quality! Clear, natural reception! Even volume, over the entire musical range! That is what the public demands today. And is getting in the finer sets—equipped with Thordarsons for musical amplification. Leading set makers continually test and compare transformers. They use more Thordarsons than all competitive makes combined—which answers the transformer question. If you want the best amplification, simply follow their lead: build or replace with Thordarsons! All stores can now supply you. Accept no substitutes. If your dealer is sold out, you may order from us by mentioning his name. Interesting bulletins on amplification mailed free. Write.*

**THORDARSON ELECTRIC MANUFACTURING CO.**  
*Transformer specialists since 1895*  
**WORLD'S OLDEST AND LARGEST EXCLUSIVE TRANSFORMER MAKERS**  
 Chicago, U.S.A.

## Unconditionally Guaranteed THORDARSON Super AMPLIFYING TRANSFORMERS

*Standard on the majority of quality sets*

**TYPES AND PRICES:** Thordarson "Super" Audio Frequency Transformers are now to be had in three ratios: 2-1, \$5; 3½-1, \$4; 6-1, \$4.50. Thordarson Power Amplifying Transformers are \$13 the pair. Thordarson Interstage Power Amplifying Transformer, \$8. Write for latest hook-up bulletins—free!

oscillation smoothly without a click and with no hangover. When this is obtained it should be left in the position.

### OPERATION

Many of the fans seem to be scared of a three control regenerative receiver and seem to shun them as something fearful. The addition of one more tuning control—the variable primary should be looked upon as a convenience and a distinct aid in tuning rather than "just one more knob."

If you set this dial at 100, that is with the windings of the primary parallel to the windings of the secondary coil and rotate the variable condenser slowly over the entire scale it will be found that with the average antenna there is a spot somewhere between 200 and 300 meters where the set will not oscillate readily and regeneration is almost impossible. Nine times out of ten this is the fundamental wavelength for your antenna and at this point your antenna system is absorbing too much energy from your tube circuit to permit its action as generator of continuous oscillations. Keep the condenser at this spot and the tickler setting the same and rotate the primary coupling dial slightly and it will be found that the set will now oscillate at the point where it did not, a moment before. Now this is not the only use which the variable coupling has. If it should happen that your receiver tunes broadly which is possible (but hardly probable) with this combination then the rotation of the primary coil 15 or 20 degrees off the parallel will greatly increase the selectivity of your receiver. On a well-designed tuner such as the one used in this receiver, loosening of your antenna coupling will not materially affect the wavelength of the secondary circuit. However, it does to a very slight extent. If you reduce the coupling or rotate the coil away from the parallel it will be found that it is necessary to slightly increase the dial reading on the tuning condenser to compensate. For this reason all three dials should be calibrated for a given station so that you may return to the exact setting.

In conclusion we would like to again bring up the subject of choice of parts. We make a practice of specifying a given part for your guidance in building the featured receiver each month. Many have a wrong idea of what this list is for. It is perfectly possible to build up this receiver using apparatus (other than that specified), in every single instance from the tuner to the panel itself and have it work well providing good material is used, but for the benefit of the many fans who cannot readily recognize efficient apparatus from apparatus which is otherwise, we print a list of materials to be used in building the set.

**ZENITH Super-Portable**  
 A six-tube radio set, completely self-contained. Does not need to be opened to operate. Write today for full particulars and name of nearest dealer.  
**ZENITH RADIO CORPORATION**  
 McCormick Building, Chicago



**EMPIRE**  
 Oiled Tubing  
 Real Radio Sets of today—the kind that last long and work best—are insulated with genuine Empire Oiled Tubing.  
**MICA INSULATOR CO.**  
 68 Church St. New York  
 542 So. Dearborn St. Chicago  
 Works: Schenectady, N. Y. 2030-F



**The Children's Hour**

*(Continued from page 33)*

er of the "Children's Hour" programs is Billy Osborne, a ten-year-old from New Brunswick, New Jersey. His mother calls him "The Boy Outlaw of the New Jersey Woods" for by prowling about in the woods he has learned the bird-calls and songs of "Bob-White," "Whip-poor-will," the "White-throated Sparrow," the "Bob-o-link," and a dozen other birds whose notes he can reproduce with such accuracy that the birds themselves answer him. It is practically impossible to distinguish his voice from the voice of the bird whom he is imitating.

Florence Hines' voice is so beautiful that when she is singing people frequently phone the studio protesting that a grown woman is being introduced as a child. Her voice is the rich, strong soprano of a woman who has been studying for years and as she is only ten years old now one can imagine the future which lies before her. Florence has had the honor of singing before President Coolidge in Washington and when her voice has received the training which is promised her she will probably be singing before the crowned heads of Europe as well.

One might go on almost indefinitely talking about these children. Constance Campbell, a nine-year-old prima donna of Great Neck, Long Island has achieved success on the stage in benefits in which Broadway stars have also appeared. She is a great little character actress and her comics are always received with enthusiasm.

Nathalia Crane has a nation-wide reputation as a poet, for at the age of eleven she already has to her credit a volume entitled, "The Janitor's Boy" which is now in its fourth edition, as well as another volume called, "So and So Verses." She is a favorite at WJZ for she recites her own unique verses for her listeners-in.

But no children's hour could be complete without a real baby and the infant of the Sunday morning entertainment is little Betty Sargent a four-year-old wonder who both sings and recites with the most perfect self-possession. For her the transmitter has none of the terrors which confront her elders who realize its possibilities. She adores Mr. Smith and he adores her.

One might go on almost indefinitely for each Sunday brings new prodigies to the studios. All these that I have mentioned were discovered in the first three months. Besides the entertainment which they give, the "Children's Hour" also includes a reading of part of an editorial and the interpretation of the comics in that day's paper so that the parents may sleep undisturbed and not have little folks clamoring to have the funny pages read to them.

# MAGNAVOX Radio

Receiving Set TRF-5 with  
Reproducer M4 • \$125.00



EXPERIENCED radio users have stated that this Magnavox equipment (illustrated below) represents the highest standard of real value and usefulness ever offered in the radio field.

The Magnavox 5-tube circuit is a special development of tuned radio frequency in which a splendid balance of selectivity, range and volume have been attained. The one dial Station Selector eliminates all tuning adjustments; while the Magnavox Reproducer insures sonorous, pleasing tone for all programs.

*Magnavox Radio Receiving Sets, Tubes and Reproducers are carried by reliable dealers. Illustrated booklet on request.*

**THE MAGNAVOX COMPANY**  
OAKLAND, CALIFORNIA

New York: 350 West 31st Street Chicago: 162 N. State Street San Francisco: 274 Brannan Street  
Canadian Distributors: Perkins Electric Limited  
Toronto, Montreal, Winnipeg

2R



Get on the  
Subscription List of  
*The*  
**WIRELESS AGE**  
and be sure of getting  
your copy

**RADIO**  
Big, complete stock. Standard prices. And you're sure it's reliable if its comes from Andrae. *Send for our catalog*  
JULIUS ANDRAE & SONS CO.  
124 Michigan St. Milwaukee, Wis.  
**ANDRAE** *In Business Since 1860*

**MARLE ENGINEERING CO.**  
*"Radio's Best Transformer"*  
Write for Literature  
**MARLE ENGINEERING CO.**  
ORANGE NEW JERSEY

# The Modern "Arabian Nights Entertainment"



Connect the Mu-Rad MA 20 to Any Electric Light Socket and be Entertained without Further Effort.

"This rug, my master," said the merchant to the prince. "will carry you where you will. Simply express the wish and instantly you are transported."

—Arabian Nights Entertainment

## The New MU-RAD RECEIVER

*The Last Word in Radio*

**T**HE "magic carpet" expressed the medieval idea of the ultimate in swift transportation. The modern conception of the ultimate in radio reception is the new **Mu-Rad Receiver MA-20**. Entertainment from the cities of a continent at your command, simply by turning the dials to certain numbers — always the same. No batteries to wear out or recharge.

**Cabinet Model MA-20**

*The MA-20 can also be purchased in a handsome Adam Brown hand-rubbed finish mahogany cabinet with engraved Formica panel.*

*Write for Literature and the Name of the Nearest Store Where You Can See the Nu-Rad MA-20*

**NO** Antenna or Loop  
A or B Batteries  
Battery Charger



**MU-RAD LABORATORIES, INC.**  
808 FIFTH AVE ASBURY PARK, NEW JERSEY

When the "Children's Hour" first started it was given in the evening as a bed-time story with such people as Thornton Burgess, himself at the microphone but Mr. Smith's conviction was that this did not meet the needs nor the desires of the children and in fact, when it was discontinued practically no protests were entered. Now the Sunday morning program frequently includes such people as James Swinerton, the creator of "Little Jimmy" cartoons, and other famous cartoonists, and story-tellers who do their little bit on the same program with the little children.

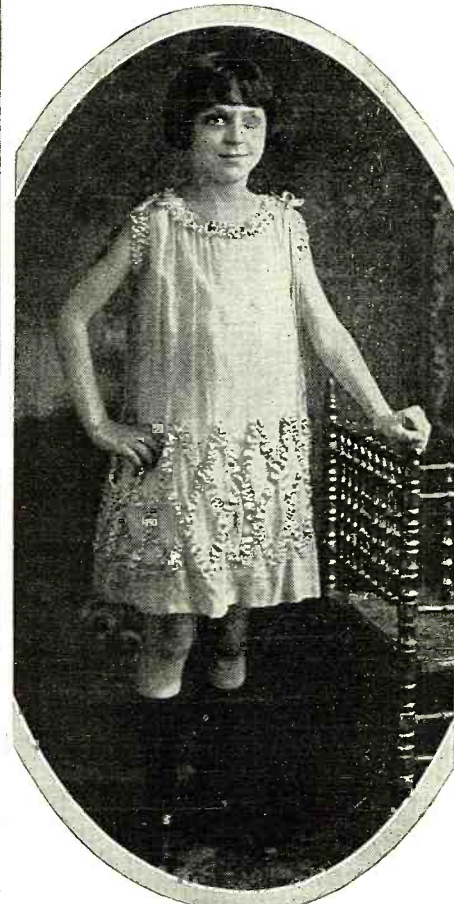

Anna Diamond, pianist, who, at nine years of age, will give her first recital at Aeolian Hall in February

For the program as a whole Mr. Smith says, "The fact that the program is presented by children is an inspiration in itself to the youngsters who listen-in. For instance: The children hear a young girl of ten years old who possesses a very attractive soprano voice. Any child with a promising voice also wants to improve her voice, to sing just as well as the singer she heard over the radio. One of the greatest difficulties of having a child broadcast is that most of them desire to sing popular songs. They all seem to think that is the best way to test their merits, but it is not the popular song that appeals on Sunday mornings, and the most effective songs are those of the lullaby and other old-fashioned types."

**I**F you could make a comparison *capacity test* of our noiseless mica condensers, — as many leading set manufacturers have done, — you likewise would ever after insist on **NEW YORK COIL CO'S.**  
338 Pearl Street, New York City

Pacific Coast Representatives  
**MARSHANK SALES COMPANY**  
926 Insurance Bldg. Los Angeles, Calif.



## HERCULES Aerial Mast

*All Steel Construction*

Painted black complete with galvanized steel guy wires and masthead pulley. 20' mast \$10, 30' mast \$25, 60' mast \$45. We pay freight. Ideal for receiving or transmitting. Greater range. More satisfactory results. Write for literature and large

**FREE BLUEPRINT**

S. W. HULL & CO., Dept. D3  
2048 E. 79th St. Cleveland, Ohio

Mr. Smith is putting so much thought on the work of this very unusual broadcasting feature that it will undoubtedly become one of the most valuable hours of any studio. In fact, WJZ has already asked him to double the length of his entertainment.

Child Thespians are presenting plays in the Woodshed Theater over WLS, Chicago, The Woodshed Theater is a mythical playhouse which Ford Rush and Glenn Rowell built in their imagination during the Lullaby Hour Period, doing the job piece by piece until it was announced to the boy and girl radio fans that the Woodshed Theater was ready for the opening performance and that the actors and actresses would be members of the WLS Lullaby Tots club. There soon was a rush to the WLS studio in the Hotel Sherman, and after rehearsals under the direction of Harry Sadler, the first playlet, "Robinson Crusoe's Princess," was produced over the radio. On the evening of November 13th, "Going to School in Mother Gooseland" was the attraction. Since then "Mr. and Mrs. Robin Find a Winter Home," "The Sleeping Beauty," and other playlets have been broadcast from WLS.

**Radio Apartments**

*(Continued from page 47)*

ing stations, and at any time the tenant may push in a plug and be connected with any one of these three. A fourth apparatus Kerr keeps free for special requests and can "get" any station.

Meanwhile the tenant down in his sitting rooms sits, as I sat, with the best the world has to offer at his elbow. If he wants one of the three local broadcasting stations he puts the plug into that one of the three holes that corresponds and gets his desired program. But he is not limited to these three. Suppose he wants any other station, local or far away, he has only to telephone up to the control operator and tell him, for instance that he wants XYZ—Los Angeles; then push his plug into the fourth hole and in a moment Los Angeles' best orchestra is playing for him.

Possibly you think that to live in such an apartment house, where the radio is considered as much a part of the necessary furniture as the telephone, would be as peaceful as living in the midst of an anti-prohibition meeting, or on the peak of the Tower of Babel. But the renting agent assured me that every apartment is sound-proof.

Or perhaps you would like to dial and fuss with your own radio? You don't like "canned" stuff. Everything is arranged. The family can plug in and listen to the apartment radio and yet not a sound will disturb you as you

**This WINDING**  
*minimizes distortion*



It is patented and known nationally as the famous

**HELICAL WINDING**

which is different than any other winding used in Transformer construction. This Helical Winding is the reason why

**Samson Helical Wound Transformers**

on recent trans-Atlantic tests gave conclusive proof of Samson Helical Wound Transformer efficiency by bringing in English stations on loud speaker with only one stage of audio.

Get distance; get volume; get quality of tone; tune out your strongest local station and tune in for any point with a "Super" built with Samson Transformers. Send for information on our new Super-Kit. If your Dealer can't supply, write:

**Samson Electric Co.**  
*Mfrs. for over 40 years*  
 Canton Mass.

AT RIGHT—Showing two types of transformers.

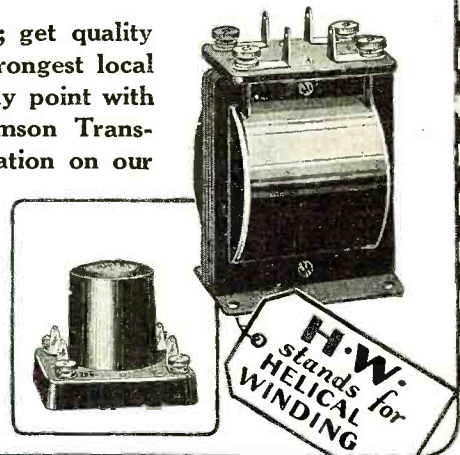

**E B Y**  
 BINDING POSTS

Twenty-five Different Engraved Tops They Don't Lose Their Heads



**H. H. EBY MFG. CO.**  
 Philadelphia

ANT LOOP

**Use RESISTANCE!**

**DURHAM**  
 Grid Leaks



Variable:—  
 No. 101—1 to 5 megs.—soft tubes.  
 No. 201A—2 to 10 megs.—hard tubes.  
 No. 100—1000 to 100,000 ohms by-pass.  
 Metalized Fixed:—  
 Over 1/2 meg., 50c.; under, 75c.

**75¢**  
 at dealers or postpaid

DURHAM & CO., INC. 1936 Market Street, Philadelphia

"Quality Goods for Quality Readers"

Write today for your **FREE** copy of—

# Ward's New Radio Catalogue

**T**HIS advertisement is published to tell you three things that everyone interested in Radio *should know*.

That we believe Ward's is today the greatest Radio store in the world—that it is the real Headquarters for Radio.

Second, that at Ward's you can buy everything in Radio without paying the usual "Radio Profits."

Third, that this big 68-page book—a genuine reference book on Radio—is yours free for the asking.

### Our Radio Experts

This Catalogue is a book gotten up by experts. It shows all the best hook-ups, everything in parts and complete

sets—so simple that you yourself can easily install them.

And it shows only tested and approved Radio equipment—selected and tested thoroughly by our Experts who are up-to-the-minute in Radio.

Write for Ward's free 68-page Radio Catalogue and see the low prices.

### Our 53 Year Old Policy

Every Radio set we sell is guaranteed to give complete satisfaction. In buying Radio from Ward's you are buying from a house whose reliability is above question. For 53 years we have sold quality goods only. Address our house nearest you. Dept. No. 24-R

## Headquarters for Radio

Satisfaction Guaranteed or Your Money Back

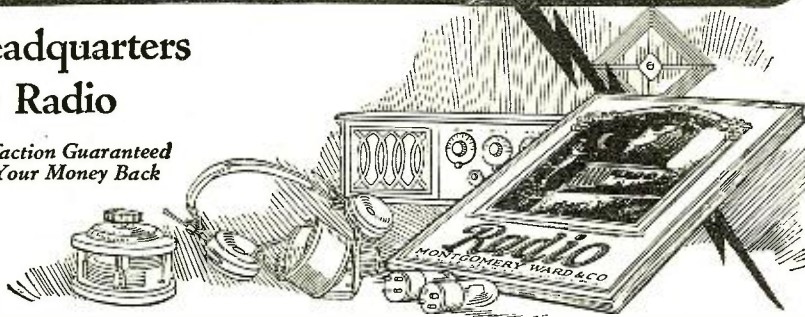

# Montgomery Ward & Co.

The Oldest Mail Order House is Today the Most Progressive

Chicago Kansas City St. Paul Portland, Ore. Oakland, Calif. Fort Worth

## You will be satisfied with a "Pacentized" set

**T**HE man who uses Pacent Radio Essentials in building his set has the assurance that he is using the finest parts that engineering skill and trained hands can build. That this confidence is not misplaced is shown by the fact that over 40 of the leading radio set manufacturers use one or more Pacent Radio Essentials for standard equipment. This shows the leadership that Pacent has attained in the radio parts industry.

Select the parts for the new set you contemplate building from the list given opposite. Get them from your favorite dealer—he carries them or can get them for you.

PACENT ELECTRIC COMPANY, Inc.  
91 Seventh Avenue, New York City

Washington Minneapolis Boston San Francisco  
Chicago Birmingham Philadelphia St. Louis  
Buffalo Jacksonville Detroit

# Pacent

RADIO ESSENTIALS

- PACENT**  
Radio Essentials  
Adapters  
Improved Audioformer  
Autoplug  
Coil Plug  
Coil Plug Receptacle  
Condensers, Low Loss  
Detector Stand  
Duojack  
Duo-plug  
Duo-Lateral Coils  
Headsets, Everyone  
Jacks  
Jack Set  
Radioloop  
Loop Plug  
Loop Jack  
Multijack  
Plugs  
Potentiometers  
Rheostats  
Resistors, Laboratory  
Sockets  
Twinadapter, etc., etc.



**"DON'T IMPROVISE — PACENTIZE"**

"Quality Goods for Quality Readers"

tune in and dial away in your corner. They are all provided with head sets. For instance, little Mary and John both like to hear the bedtime stories. They have a twin headset attached to one cord with one plug and they plug into their special hole. Your wife with her head set plugs into another hole and listens to her favorite concert. And two more holes and plugs and head sets are ready for guests. At last how to spend a quiet evening at home is discovered!

### Classified Ads

(Continued from page 27)

of us in on the company. I didn't let anybody in that I absolutely didn't have to, naturally—and I was looking over the list this afternoon, where we stopped for lunch and I find there's just thirteen. Rockefeller, Morgan, Armour, the Goulds—well, never mind who they are; but I swear that number's why I landed in that mudhole today."

"Take another in, and make it fourteen," says I.

He laughed.

"Ah—very likely," he says, wagging his head. "No thanks." We don't want to split a plum like this any more ways than we have to. The only way I'd do it would be to take on a dummy—just a nominal shareholder—twenty thousand dollars, or so; and, of course, nobody I know'd bother with chicken feed like that."

"I would," says I, not having poured my liquor into any palm trees.

He didn't seem to hear me.

"I would!"

"Eh?" demands Mr. Davidson, coming out of a brown study. "You would what?"

In order to save as many of these ten-cents-per-agate lines as possible, I will sum up what subsequently happened by stating that when Mr. Davidson left my place the next morning, he also left a beautiful certificate for five shares in the Sunset Oil Corporation, and carried with him my check for twenty thousand dollars, which he cashed at the Acacia National Bank as he passed through that city on his way to Red Dog and the border.

Bait! Bait! BAIT! For suckers, a specialty—Jim's Sporting Goods Emporium, Hazel Street.—Advt.

I am sorry not to be regaling my readers with jokes and descriptions of the local scenery, like F. R. Buckley and all them Western authors do, but you have got to remember that whereas they get paid more, the more they write, I am paying out the price of a good healthy heifer to get even a plain bald statement before the public.



Excuse me, accordingly if I kind of skip over my going to bed after Mr. Davidson's departure; waking up with a bad headache at four o'clock in the afternoon; finding a perfect stranger in a red shirt waiting for me; and riding with the said perfect stranger—who claimed to be Angus McGregor's deputy—to the city of Red Dog.









Owing to one circumstance and another my recent sociability being the principal cause—we were easily half way there before I even summoned enough ambition to ask what Angus wanted with me; and then either the deputy didn't tell me much, or I didn't understand what he did tell me, probably the latter.

Anyhow, nobody could possibly have been more surprised than I was when we suddenly came across Mr. Davidson's yellow racing car standing idle by the side of the trail; and when, arriving at Angus McGregor's house, we found Mr. Davidson himself, not to mention his valet, sitting in two chairs with Angus between them and the door. Apparently, no violence had taken place theretofore; but my entrance seemed to apply what you might call a spark to the dynamite. Just as I pushed open the door, Mr. Davidson jumped to his feet with a kind of snarl, simultaneously reaching for his hip-pocket; and at that same instant, Angus McGregor did a Brodie over the table and hit the financier and his henchman simultaneously under the jaw. He fell. So did the valet, or secretary, or whoever he was—tipped over backward out of his chair and lay with his head in the ashes of the fireplace, howling like a motherless calf.

"Sold you some oil stock, didn't he?" asked Angus McGregor, recovering his balance and licking his knuckles. "Wasn't that your check for twenty thousand he was cashing at the Acacia National this morning?"

I suppose my dropped jaw gave consent. Anyhow, Angus picked up the leather grip that reposed under the chair recently vacated by Mr. Davidson, jerked a bunch of keys out of Mr. Davidson's pocket, unlocked it, and handed me a package of twenty thousand-dollar bills.

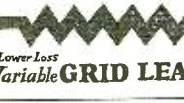
"This bird's wanted in four states, for usin' the mails to defraud," says Angus. "Alarm for him went out last night. He was makin' his getaway when he ran into you. Illegal for me to be givin' you your money back like this. Say nothin' about it. You're responsible for the capture in a way. I was over at the bank this mornin', gettin' one of my own checks cashed, an' heard him mention your name. Looked at him. Recognized him from the description. Remembered twenty thousand was just the amount you were goin' to leave Mary in your will."

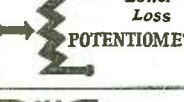
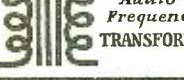
	Anti-capacity <b>JACKS</b>
	Anti-capacity <b>SWITCHES</b>
	Lower-Loss <b>VARIABLE Vernier CONDENSERS</b>
	Lower-Loss <b>PHONE PLUGS</b>
	Lower-Loss <b>RHEOSTATS</b>
	Lower-Loss <b>SOCKETS</b>
	Lower-Loss <b>VARIO-COUPPLERS</b>
	Lower-Loss <b>Variable GRID LEAKS</b>
	Lower-Loss <b>INDUCTANCE SWITCHES</b>
	Lower-Loss <b>POTENTIOMETERS</b>
	Audio-Frequency <b>TRANSFORMERS</b>

# Ready!

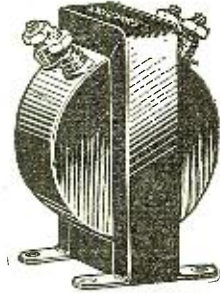

## The Jones Transformer

Volume without distortion is assured by the use of the J. W. JONES Transformer. A low ratio audio frequency transformer which always gives maximum value of signal intensity. May be used in both stages and with all tubes.

Throw away your soldering iron and build with J. W. JONES parts: Audio Frequency Transformers; Variable Vernier Condensers; Low Loss Variable Grid Leaks, Vario-couplers, Potentiometers, Rheostats, Inductance Switches, Phone Plugs, Sockets; and Anti-capacity Jacks and Switches. Simple binding posts make all connections. And less drilling is required.

**JOS. W. JONES**  
TRADE MARK

**"Improved" radio parts**

**JOS. W. JONES RADIO MFG. CO., Inc.**

Home Office: 40-42-44-46 West 25th Street New York

Branch Offices:

Philadelphia:  
1011 Chestnut St.

Chicago:  
Monadnock Bldg.

Boston:  
99 Bedford St.

## FREE RADIO CATALOG Sent You Every Month

ALL the latest improved apparatus is listed in our monthly bulletin: "The American Radio Transmitter." If it's new we have it.

**Lowest Prices in U. S.**

Our prices to dealers are the lowest in the United States. All nationally advertised goods at discounts that make you real money. Dealers, get your name on our mailing list. Simply send name today for latest, big monthly bulletin, showing 75 nationally advertised factory lines and 4,800 items.



AMERICAN RADIO MFG. CO. 5 W. 14th St. Dept. U, Kansas City, Mo.

### CRESCENT LAVITE RESISTANCES

ABSOLUTELY NON-INDUCTIVE

12,000, 48,000, 50,000, 100,000 Ohms

List \$1.50 Each



Special Sizes to Order

USED IN ALL CIRCUITS AND RESISTANCE COUPLED AMPLIFIERS

When better resistances are made they will bear the Crescent label.

Dealers write for discount

**CRESCENT RADIO SUPPLY CO.**  
3 LIBERTY ST. JAMAICA, N. Y.

"Quality Goods for Quality Readers"

# BAKELITE

TRADE MARK REG. U. S. PAT. OFF.

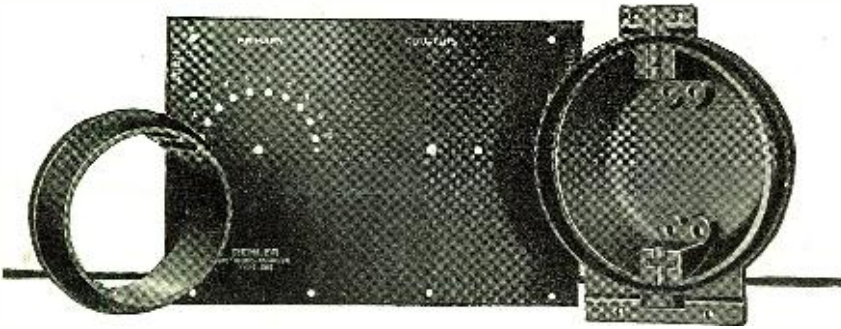

## Endorsed by Remler, Too—

Manufacturers know from experience that radio parts must be constructed with the best materials, if satisfactory service is to be obtained. That is why the Remler Radio Mfg. Co. of San Francisco uses Bakelite for tube sockets, variometers and many other parts.

As an insulation, Bakelite is in a class by itself. It possesses high dielectric strength, is unaffected by atmospheric changes, and its properties are not impaired with age.

Insist on genuine Bakelite radio parts, and you can rest assured that your equipment is of the highest quality.

Send for our Booklet A

### BAKELITE CORPORATION

247 Park Avenue, New York, N. Y.  
Chicago Office: 636 West 22d Street



THE MATERIAL OF A THOUSAND USES

"I—was tryin' to quadruple it for her," says I. "Why—why didn't you arrest the guy then and there?"

"I'm under bond. No false arrests. Wanted you to identify him."

"But if his car hadn't broken down, he'd be in Mexico by this time!"

"I put sugar in his gasoline while he was in the bank. Kills the engine after five miles or so. Then happened to come by with a led horse."

Well, I didn't say anything; some gratitude is too deep for words. But first I took a violent grip of my grandson-in-law's hands; and then I telephoned Mary a full and complete account of the affair. She seemed kind of tremulous when I'd finished; and remarked, with a desperate endeavor to be casual, that she would be down on the next train. When I told this to Mr. McGregor, he in his turn took a violent grip of my hands.

For the next ten minutes after that, we both were busy taking violent grips of the hands and the throats of Mr. Davidson and his valet, who seemed to be laboring under the delusion that, having been duly and legally knocked out, all they had to do was get up and shoot us with pocket-revolvers. The deputy had to come and help us to convince them that such wasn't the case.

I suppose this fracas, and the subsequent excitement of getting the two prisoners to the town lockup, was the reason why I didn't ask Angus any questions. However, Mary, who claims to be so smart, had been in the house a full ten minutes before she said anything either except "My Darling!" and such beside-the-point remarks. Gosh, what a reconciliation that was! Wonderful what young folks' ribs will stand.

"You'd never have thought of putting sugar in his gasoline if your mind had been full of that horrid radio business," says Mary triumphantly. "By the way—how did you get the alarm and the description of the man, if it was only sent out from Chicago last night?"

There was a terrible silence.

There was some more terrible silence, during which second instalment, Mr. McGregor started to go red from the neck up.

As he abandoned this pastime and began to go green instead, Mary gave him one blazing look, threw open the door of the inner room, and disclosed—a much bigger radio set than the one he'd smashed, all set up and shining on a table! There was a mirror on the inside of the bedroom door, too; and as she turned around to take a look at the shrinking Angus, she perceived that right bang across the back of her new vermilion silk waist, which she'd put on in honor of the heroic husband, there was a great big greenish stain in the shape of a human hand.

**FARAWAY RADIO**

**\$29.50**

Gets stations Far and near Loud and Clear

FARAWAY Radio Sets are amazing values at bargain prices. Users get stations from New York to Frisco—loud and clear. Operate with either dry cells or storage batteries. Beautiful cabinet finished in mahogany with new platinum-finished panel. SATISFACTION GUARANTEED—Don't pay \$100 to \$150. Write for our money-saving plan and literature.

2-Tube Set - \$29.50  
4-Tube Set - 59.50

Dealers - Agents: Biggest possibilities you ever heard of. Write for plan and territory quickly.

THE FARAWAY RADIO CO., 658 W. THIRD ST., CINCINNATI, O.

**OVERSTOCK BARGAINS**

IN

**Neutrodynes and Regeneratives**

**BELOW COST**

Write for List W

**J. H. BUNNELL & CO.**

32 Park Place New York

"Quality Goods for Quality Readers"

Davidson, when he fell for the fourth or fifth time, had knocked over a bunch of little boxes which I since learned were storage batteries. When Mary arrived, Angus had been busy wiping up a lot of water that'd run out of them. I have since learned that this water was sulphuric acid.

"You—" hissed Mary.

But at that moment, as I have since learned, she felt the sulphuric acid of that handprint quit work on her blouse, and start in on her back.

She therefore ceased to talk, and started to walk. She walked out of that house, and she walked down to the railroad station, and she took Number 17 home.

Having followed her thither, and being mindful of the return of my twenty thousand dollars, I took the risk of interrupting a two-hour crying-spell to plead with her on Mr. McGregor's behalf, pointing out as a grand peroration, the dangers of his trade or profession.

"I don't care!" storms Mary in reply to this. "I don't care if he's stabbed, strangled, stunned, or run over by wild horses. I don't care if he's drowned in molten lead. I don't care if he's shot till he looks like one of his own honeycomb coils. I don't care—"

She went on for some time like that; but the upshot of it was that she wouldn't return.

And I hope this \$27.50 I've spent will keep you Red Dogs from any further wondering why not.

**EDITOR'S NOTE:** While out buying groceries with the proceeds of the above classified advertisement, ye Editor figured to drop in on our genial townsman and sheriff, Angus McGregor; who, as is well known, scalded both of his hands while endeavoring to make coffee for himself in a percolator yesterday.

Ye Editor was pleased and surprised to find that the news of this accident had reached Prairie Dog, and that Mrs. Angus McGregor had arrived to nurse her injured husband, wearing a handsome vermilion silk blouse with a large sailor collar of black silk hanging down the back. According to our genial medico, Dr. Brewer—whose advertisement of a car for sale appears in these columns—anxiety had made Mrs. McGregor slightly hysterical, but on being reassured that Mr. McGregor would live, she recovered, and spent last evening manipulating the dials of our competent, but bandaged sheriff's radio set.

"It really is remarkable," said Mrs. McGregor to ye Editor. "We got Pittsburgh as clear as a bell, and after Angus had gone to bed, about four o'clock this morning, I'm just certain I heard New Zealand. I'm going to try it again tonight."

# When Winter Winds Blow Cold

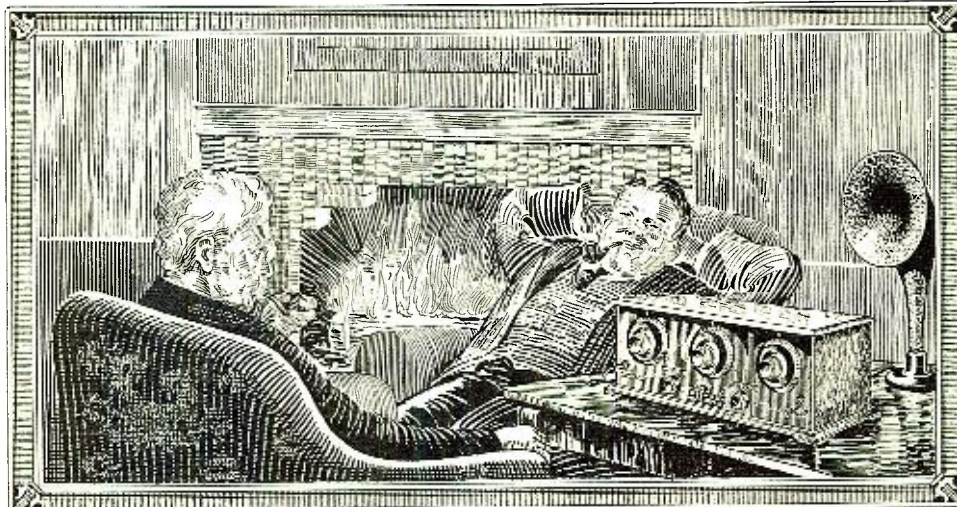

## FRESHMAN MASTERPIECE

*The Greatest Value Ever Offered .  
In A Radio Receiving Set!*

### A 5-tube tuned Radio Frequency Set

made of the finest low loss materials and in a beautiful genuine solid mahogany cabinet, that is attractive enough for the most pretentious room, and at sixty dollars, economical enough for the most modest.

Combines all points essential to the perfect receiver. Real distance reception without that squealing and howling. So selective that once a station is picked up—it can be brought in again at the same points on the dials whenever you want it. And, what's more,

*It is Mighty Easy to Operate*



**Have Your Dealer Install One in Your Home!**

All genuine Freshman Masterpiece Sets have a serial number and trade-mark riveted on the sub-panel. The Receiver is not guaranteed if number has been removed or tampered with.

**Chas. Freshman Co. Inc.**  
*Radio Receivers and Parts*  
**FRESHMAN BUILDING**  
**240-248 WEST 40TH ST.—NEW YORK, N.Y.**

### Tuned Radio Frequency Kit

**\$17.50**



### It's Easy to Build

a five-tube radio frequency receiver when you use the Freshman Masterpiece Kit. The result will be a receiver that will bring in even the most distant stations with the volume and clarity of locals. The equal of any 5 tube set in selectivity, simplicity of operation and all around efficiency.

**No Neutralizing  
or Balancing  
Condensers Required**

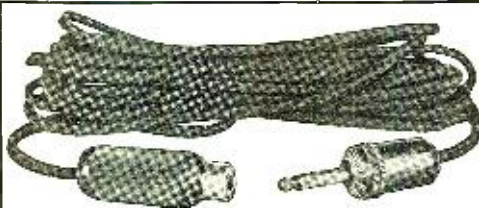

**HIS COMPLETE UNIT** enables those who want to use the loud speaker in other parts of the house to do so without removing set. Insert plug from loud speaker into jack; place plug on end of cord, into set. This can be done readily and saves the trouble of using tools or soldering iron.

### Something NEW!— Loud Speaker Extension Unit **COMPLETE**

Prices, including Jack, Plug and Cord:  
10 ft. cord \$2.25    40 ft. cord \$3.00  
20 ft. cord 2.50    50 ft. cord 3.50  
30 ft. cord 2.75    100 ft. cord 5.75

*Manufactured by  
Four Way Co., Springfield, Mass.*

**— at good dealers' everywhere**

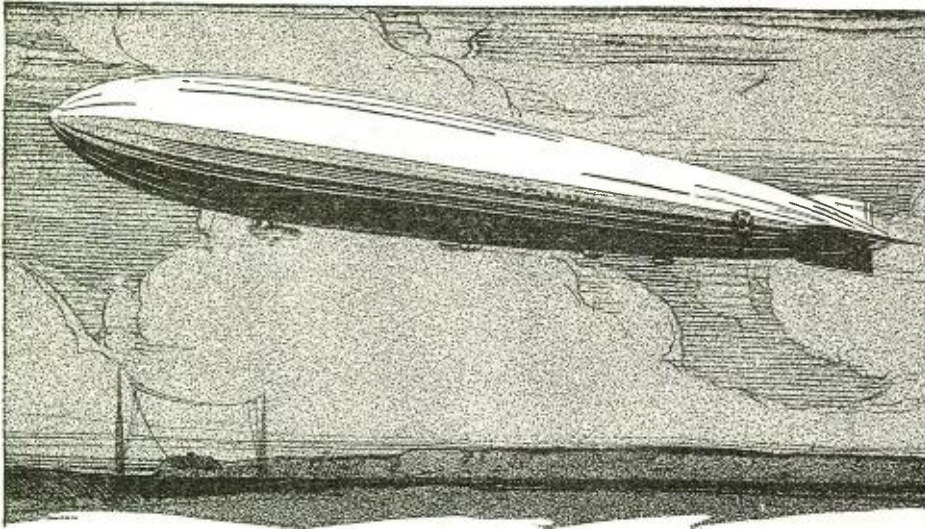

## DUBILIER CONDENSERS

### *Important Links between the Shenandoah and Land:*

Communication with land—under all conditions—at all times—this was the imperative need of the Shenandoah on its experimental flight across the continent. Impressed with this need, army and navy engineers equipped both transmitting and receiving sets with Dubilier mica condensers—not specially designed condensers but the regular standard product. Only complete confidence in the supreme reliability and efficiency of Dubilier condensers can explain their use in this important and daring adventure.

# Dubilier

CONDENSER AND RADIO CORPORATION

### Makers of Dots and Dashes

By PIERRE BOUCHERON

I RECENTLY learned that General Harbord, although a soldier most of his life, actually started his career as a telegraph operator back in 1884. It was at the railroad station of St. George, Kansas, on the Kansas division of the Union Pacific. He was substitute night operator; the call of the station was "RG," and the salary \$40 a month. Later, the future General taught telegraphy at Kansas State Agricultural College. He was also a lineman on occasion.

It may or may not be significant that a great many distinguished Americans began as telegraph operators. A few in this galaxy of stars are Andrew Carnegie, Thos. A. Edison, Frank A. Munsey, Edwin M. Herr, David Sarnoff, Colonel Robert Ewing, James M. Crea, R. C. Clowry, William Gillette. One meets "ex-brass pounders" in every walk of life; there are thousands of them.

This great brotherhood of Morsemen holds closer ties perhaps than any other profession. Whether still operator or not, one has an immediate feeling of warmth toward the stranger who knows the meaning of "73," of "om," of "os." I have seen at least two of the above stars stand close to the sounder of a chance telegraph office and, almost surreptitiously, read the stuff going on over the wire—this, years after they had ticked off their last official "ok" to a message.

I saw a strange light come to the eyes of these big men. And when I dropped my gaze down to their right hands, I thought I detected the unconscious movement of the first three fingers to the "Catlin grip" position. I have even seen one, great man though he was, almost beg the humble telegrapher in charge to let him send a regular message again—"just to see if I can still use the fist."

John Stone-Stone

(Continued from page 31)

working for telephony and telegraphy, and after that in radio broadcasting.

Dr. Stone was born Sept. 24, 1869, of American parents within the shadow of the Khedive's palace in Egypt—his father holding an official position in connection with the educational projects of the Egyptian ruler. In after years it was rather startling to hear from the office of this profound investigator a sudden series of exclamations in guttural language, percolate through the door whenever results were not coming as they should! Dr. Stone's earlier education led him finally to Johns Hopkins University, Baltimore, where he met and knew intimately Major-General George O. Squier who since has developed line radio for "narrow casting" purposes.



**The 100%  
Self Shielded  
Transformer**

has made a big hit with both set makers and set manufacturers because of its small size, its amazing volume, and most of all, because of its pure, undistorted tone. It is half the size of other transformers, but its results are unsurpassed. Absolutely new and scientific design and construction. Ratios 1 to 3, 1 to 4, 1 to 5, \$3.50; Ratio 1 to 10, \$4.50.  
SEND FOR BULLETIN No. 94. Read all the exclusive features of this and other Premier parts. Tells how to get free hook-up diagrams beautifully printed in two colors.

Premier Electric Co., 3806 Ravenswood Ave., Chicago

**PREMIER Quality  
Radio Parts**

### THE FAMOUS BEL-CANTO LOUD SPEAKERS

NOW at your DEALER

10" Bell, 22" High.....\$10.00  
15" Bell, 29" High.....\$15.00  
(Goose neck)

If your dealer cannot supply you write us  
and we will advise where to purchase one.

BEL-CANTO RADIO AND TEL. EQUIP. CO., Inc.  
872 B'way, N. Y. C. Tel.: Stuy. 1921

"Quality Goods for Quality Readers"



Both these investigators were pupils of the famous professor, Henry A. Rowland, who experimentally proved that a moving electric charge is equivalent to an electric current in all respects, thus crowning the edifice which Maxwell had built years before and which is at the basis of all radio engineering.

Dr. Stone, about 1890 was employed as research engineer by the A. T. and T. Company where his marvelous grasp of the mathematical processes of the differential calculus led him to master the almost impossible methods used by Oliver Heaviside in England. The chief difficulty of Heaviside's methods was that he took an impish delight in solving some profoundly obscure problem in electric transmission of impulses by means of a new method which he called "the operational method." He meant by this that instead of treating symbols to represent quantities that he treated them to represent mathematical operations. He discovered the laws of these operations, but gave no general justification for his system in the form of a detailed and exhaustive proof. It was very exasperating to those who tried to follow him.

Stone, however, in spite of these difficulties filled out the missing proof for his own brilliant researches and got into communication with Heaviside. This rather "porcupinish" English genius came out of his retreat and actually sent a letter of almost tearful appreciation to Stone hailing him as the first one to really appreciate his work.

In blazing this trail for all subsequent mathematical physicists, Stone found that the method was so concise that the chief difficulty after the problem was solved in the form of "operational equations" was to interpret the results and narrow them down to a particular case. All those who followed the method had a great advantage over their contemporaries using the older methods, and it is only recently that engineers like Fry in the Western Electric Company, Carson in the A. T. & T. Company, Nicholson and a few others have used the methods employed by Stone and his assistants twenty years ago.

The result of Stone's work was that he became very much interested in the question of simultaneous telegraphy and telephony by means of what we now call "carrier waves." One of the earliest patents on this problem caused an interference between the French engineers Hutin and LeBlanc, Michael Pupin and Stone. After an incomplete prosecution short of the highest court the case was dropped for financial reasons. It is interesting to note that at this early date—about 1893—there was a difference of opinion

## GENERAL INSTRUMENT MULTIPLE VARIABLE CONDENSERS

LICENSED UNDER HOGAN PATENT 1014002 FOR  
**SINGLE CONTROL WORK**

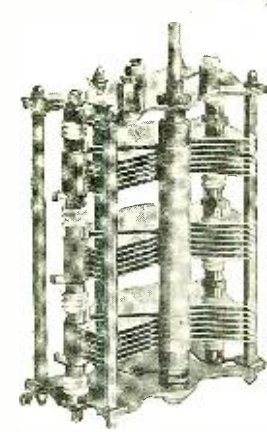

### NOLOSS



(TRADE MARK)

**INSULATED WITH PYREX**  
**INSULATED WITH ISOLANTITE**

**TYPE 75 DUO CONDENSER \$10**  
**TYPE 76 TRIO CONDENSER \$15**

### GENERAL INSTRUMENT CORPORATION

MANUFACTURERS OF LABORATORY EQUIPMENT  
**423 BROOME STREET**  
NEW YORK CITY

fits Grid Leak  
any mounting

FRESHMAN PLUNGER  
TYPE VARIABLE GRID LEAK

was designed especially for the non-technical set owner who can replace in an instant the fixed grid leak with this new, efficient cartridge type Variable Grid Leak without requiring the change of a single wire.

At your dealer or by mail post-paid. Write for free catalogue.



65c

240-248 W.  
40th St., New York

## AMBASSADOR Low Loss Products





Master Tuning Coils  
Twin Tone Head Phones  
Low Loss Condensers

High grade, standard radio products that will increase the efficiency of any set and add to the satisfaction of the user. Ambassador Low Loss Products have long been the choice of particular fans. See them—compare them, and you will choose them too.

At all good dealers.

Write for free diagrams of circuits in which Ambassador products can be used.

**AMBASSADOR SALES CO., INC.**  
108 Greenwich St., New York  
326 W. Madison St., Chicago



The limitless field of radio — growing by leaps and bounds — daily opens up new opportunities for success. And here is your opportunity to qualify for a good position — with substantial pay and a chance to grow with radio.

**STUDY RADIO AT HOME**

You do not have to give up your present employment. The Radio Institute of America—the world's oldest radio school—with 7,000 graduates—now offers a *new and completely revised* HOME STUDY COURSE in radio that will prepare you to successfully pass the U. S. Government examination for a Commercial Radio License.

**RADIOLA III — FREE with course**

An omnigraph, a buzzer set, up-to-date text-books, and Radiola III with two tubes and Brandes Headset are free with the course. These are the best text-books and apparatus obtainable.

The Radio Corporation of America conducts the school. The largest radio companies give employment preference to our graduates because of their superior training. Mail the coupon today for more information.

**Radio Institute of America**

(formerly Marconi Institute)  
Established in 1909

326 Broadway New York City

Radio Institute of America  
326 Broadway, New York City

Please send me full information about your Home Study Course of radio instruction.

I am interested in the complete course including code instruction.

I am interested in the technical course without code instruction.

Name .....

Address .....

among experts as to what was meant precisely by "resonance." On the one side was Dr. Kennelly of Harvard and on the other side was Stone. The latter maintained that from a physical standpoint, the frequency of resonance was that at which the maximum current occurred in a tuned circuit. The former maintained that the resonant frequency was that at which the condenser reactance equaled the inductor reactance. These questions are not of serious engineering importance today, but a great deal hinged on them in this classical suit.

We thus see that Stone is one of the precursors of "wired-wireless" now so successfully used for telephony between two important cities in the United States where five simultaneous telephone messages are sent through wire and cable circuits by the use of five separate carrier waves of inaudible frequencies.

Again, we find that Stone as a pioneer had the talent to solve the most difficult mathematical problem then before the world of radio investigators; that is, the problem of the performance of two coupled circuits including resistance of radiation from the antenna, and even the skin-effect in the circuit. This work unfortunately was never published, but was checked up afterwards to the work of Max Wien who had also become interested in the question of coupled circuits. The result of this work was that Stone in 1906 was tuning out frequencies using spark transmission when the difference between these frequencies was as small as 3 per cent.!

Another early investigation of Stone's which showed his vision, is that which he undertook in collaboration with Dr. Ladd of Boston about 1900 in direction finding by means of experiments made with extremely short waves of about the same length as those used by Hertz in his famous experiments. The power used by Stone was far too small to give the results which have recently been obtained by Franklin and Marconi using C.W., but the methods used were the same and the results over short distances were practically what we have today over longer distances.

These experiments using damped waves led Stone to develop his transmission system whereby the energy from the "Whip-crack" circuit was stored in a second circuit having very small damping. This circuit together with the famous "intermediate" or "weeding-out" circuit gave Stone just as small a damping in his transmitter (down to .02) as he desired and for receivers he reduced his damping to a fraction of the above amount at even these early dates in laboratory experiments.

The patents granted him could have been used to apply to the entire art



**THE JEWELL RADIO TEST SET**

This portable radio test set is the only complete set of its kind on the market and was designed to meet the demands coming to us from serious experimenters, manufacturers and radio dealers for a complete testing outfit.

While the various ranges of readings permit making practically every test necessary in connection with radio receiving sets, it is especially valuable for the taking of characteristic curves on vacuum tubes.

The several instruments may be used independently, and include an 0-1.2 filament ammeter, an 0-6 filament voltmeter, an 0-120 plate voltmeter, an 0-10 plate milliammeter and a 10-0-10 grid voltmeter.

Ask your dealer or send for Special 14-C circular. Also 15-A complete radio catalog.

**Jewell Electrical Instrument Co.**  
1650 Walnut Street — Chicago  
U. S. A.

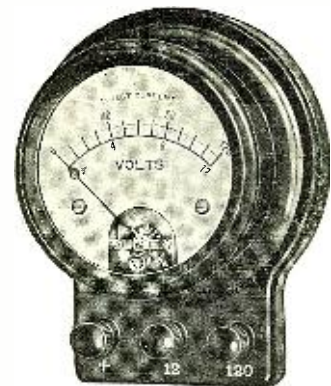

No. 57 "A" and "B" Battery  
Double Range Voltmeter  
(7½ and 150 Volts) \$10.00

of transmission and reception if he had so chosen, but he was too engrossed in the science to bother with the commercial aspect of radio. His accomplishments were made possible to some extent from the fact that he was the only worker at the head of an organized company who seemed to have a clear idea of all the factors which determined "selectivity" in the circuit. What is even more important in regard to early receiver design is the fact that he was able to show the connection between selectivity and great persistency in the wave-train of a circuit in regard to the sharpness of tuning obtainable with it. A great many modern so-called wave traps are nothing but Stone's weeding-out circuit under different forms.

Stone did some of the earliest work in the country on stationary waves on wires and, together with the writer of this article, got out the first direction finder by means of radio waves without "swinging" the ship. This was done by stationary waves on a kind of dephasing device by which electrical angles were measured instead of turning the ship.

In 1904 Stone at St. Louis delivered some papers before the International Electric Congress and the Canadian Society of Civil Engineers in 1905 at Montreal. He also read papers before the Society of Wireless Telegraph Engineers and Institute of Radio Engineers. He was awarded the Edward Longstreth Medal by the Franklin Institute in 1913 and the Medal of Honor of the Institute of Radio Engineers in 1923.

Among the useful inventions which were used by operators and developed under Stone, there are found a practical "break" system, so that operators may interrupt each other even when using as high as fifteen K.W. input. Closely related to this was a patent by which the usual lowering of voltage in a transmitting room from 110 to about 40 with the key down was done away with. By obtaining what is known as "unity power-factor," Stone found that his apparatus acted as a pure resistance load and did not either magnetize nor demagnetize the field of his A.C. generator. The net result was that in 1907 at the Brooklyn Navy Yard with George Davis as chief operator at the station called "PT" it was possible to throw on a full load of 15 K.W. and see the voltage change only from 112 to 110½.

Another interesting apparatus which was successfully tried out before (then) Commander S. S. Robison of the U. S. Navy, was a secrecy-sender by which a message could be delivered without much possibility of an enemy "listening in." This device had a transmitter which sent out a continuous

*No. 3 of a series of 10  
"FILTER FACTS"  
Follow them thru monthly*

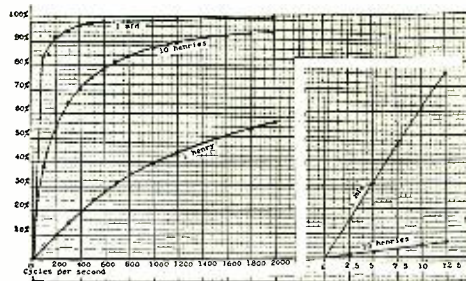

**INDUCTANCE.** Inductance in series with the plate supply suppresses a certain per cent of the a.c. component, dependent upon the frequency of the ripple and the value of the inductance. The curves show the per cent of suppression for a 1 henry and a 10 henry choke at common ripple frequencies for a small transmitting tube. For comparison the percentage of ripple by-passed by a 1 mfd. condenser as outlined in "No. 2," is plotted to the same scale. The insert curves are the 1 mfd. and 10 henry curves replotted to show their effects at the very low frequencies common to moving contact disturbances. Note the change in the shape of the curves as the inductance is increased, that the increase in suppression is not directly proportional to the value of "L" and that a small choke will be of little use especially at the lower frequencies.

The condenser curve should not be mistaken for a percentage reduction in ripple. It does not represent suppression, but by-pass. Reduction of the ripple thru the plate circuit takes place only when the current thru the condenser has become so large that it "breaks down" the ripple voltage. This action is dependent upon the design of the generator, and the load that it is operating under.

ESCO generators are so designed that their minute ripple is of as low amplitude and as high frequency as is practical.

**ELECTRIC SPECIALTY COMPANY**

TRADE "ESCO" MARK

STAMFORD, CONN., U.S.A.

231 SOUTH STREET

IF INTERESTED IN MAXIMUM MILES PER WATT YOU WILL BE INTERESTED IN BULLETIN 237E



★  
**\$10**  
Complete  
with  
cord

**Pipe Organ Music**

When the deep thundering notes of a pipe organ come in over your Needlephone and phonograph, then you will really appreciate how much better reproduction the Needlephone gives.

**Rhamstine ★  
NEEDLEPHONE**

The Needlephone uses the entire reproducer of the phonograph—needle and mica diaphragm as well as the tone arm. As a result it gives sweeter, clearer, more melodious music than can possibly be reproduced any other way. It is easily attached—requires no extra equipment and can be used on any phonograph including the Edison with Victor adapter.

**Send No Money. Take No Risk**

Send the coupon today, pay on delivery, and try the Needlephone on your own set with your own phonograph. Try it with a soft needle on local broadcasting and see what delightful music you get. Try it with a loud needle and enjoy greater volume without metallic noises. Then if you are not entirely satisfied—if you cannot say you get better reproduction—return it and Rhamstine\* will refund your money.

Send the coupon today! Now!

**J. Thos. RHAMSTINE★**

J. THOS. RHAMSTINE\* (2)  
504 E. Woodbridge, Detroit, Mich.

Send me the Needlephone. I'll pay the postman \$10 upon its arrival. It is distinctly understood I may return it if I desire, within 5 days and receive a refund in full.

Name .....  
Address .....

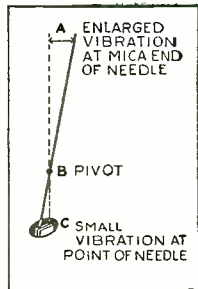

This illustrates the "magnified reproduction" principle of Rhamstine\* Needlephone. The delicate vibrations of the reed at "C" are transmitted through the pivoted needle and magnified at "A."

Mail  
**This Coupon  
To-day**



**Just use ordinary tools on this panel**

**—built to order for radio**

**YOU** don't need special tools to do a good job on a Radion Panel. Just the usual tools found around any house will give you clean-cut, workmanlike results. You need have not the slightest fear of chipping.

Radion is the easiest of all to cut, drill and saw. It was developed **TO ORDER** by our engineers to meet the demands of radio set builders. There is nothing quite like it for real results.

**Highest rating as radio-frequency insulation**

Authoritative laboratory tests give Radion the highest rating as radio-frequency insulation. That means that losses from surface leakage and dielectric absorption are exceptionally low. And low losses mean clearer reception, more volume and more distance.

You can see that Radion is different by looking at the finish. But that high-polished, satin-like surface is not for beauty alone. It's useful, too. Moisture and dirt cannot gather to cause leakage and leakage noises.

Radion resists warping. It's strong. It's moisture proof. It comes in eighteen stock sizes and two kinds, Black and Mahogany. Radio dealers have the exact size you want for your set.

**Send for booklet "Building your own set"**

Our new booklet, "Building Your Own Set," giving wiring diagrams, front and rear views, showing a new set with slanting panel, sets with the new Radion built-in horn, lists of parts and directions for building the most popular circuits—mailed for ten cents. Mail coupon today.

**AMERICAN HARD RUBBER COMPANY**  
Dept. G2 11 Mercer St., New York City

Chicago Office: Conway Building  
Pacific Coast Agent: Goodyear Rubber Co.,  
San Francisco—Portland

# RADION

*The Supreme Insulation*

## PANELS

*Dials, Sockets, Binding Post Panels, etc.*

American Hard Rubber Company,  
Dept. G2, 11 Mercer St.,  
New York City.

Please send me your new booklet, "Building Your Own Set" for which I enclose 10 cents (stamps or coin).

Name .....  
Address .....  
City ..... State .....

"nonsense message" on about 600 meters and alternate signals as dots and dashes at 570 and 630 meters respectively. The receiver was tuned to both these latter frequencies and excluded the "nonsense frequency." But alas, it had fourteen adjustments. These all had to be set by calculation so as to be simultaneously correct. Cut-and-try methods simply worked in a circle and produced chaos!

In quoting the above instances of very early work demanding a knowledge of how to obtain high selectivity and pure waves twenty years ago, it is merely desired to emphasize the fact that the natural genius and sincerity of this investigator led him to avoid the temptations of a very active stock market, based upon radio, which was then at high tide.

Perhaps the one outstanding short and sharp achievement which Stone has left to the radio art is the fact that he pointed out that close coupling is the inveterate enemy of sharp tuning and pure radiation and he not only showed why this was so, but he showed exhaustively how all the various factors which entered into this condition are related. He not only answered the question "in what way?" but he also answered the question "to what degree?" No engineer can do more.

It is impossible in a brief article to describe the more than one hundred patents granted to Dr. Stone. Many of them were transferred to the A. T. and T. Company some years ago, and today have run out. Stone was the first to point out to those interested what an ideal telephone repeater the vacuum tube would be; as he had been working on the original problem of the repeater with Dr. White back in the early 90's.

To the men who worked with Stone, namely Sewall Cabot, Fred Holster, Ernest R. Cram, George H. Clark, and the writer, his personality as a cosmopolite, his polish as a man of the world, his personal magnetism and his remarkable powers of analysis have been sources of inspiration in all their subsequent professional work.

Dr. Stone was one of the first to examine the question of an auxiliary language for engineers and other professional men in 1905 when the great physical chemist, Ostwald came to the United States as the champion of Esperanto. Unfortunately both Ostwald and Stone decided that it was too unscientific and uncouth in appearance and pronunciation to be of service. They both have gone over to the younger and more carefully developed system called Ilo (Ido) and Dr. Stone is now, together with Mr. E. F. W. Alexanderson, an honorary president of the Radio Auxiliary International Language Society with headquarters

"Quality Goods for Quality Readers"

# New Adventures of BURGESS RADIO BATTERIES



(Above)—They Roamed the World In the Speejack's Radio Room—U&U Photo

(Below)—Dog Sleds Carry Them to the Arctic Outposts of Civilization

You're fortunate — you average buyer of radio equipment. For when you are in need of new batteries you can phone or walk a few blocks for fresh ones to replace those in your receiver. Not so fortunate are those who wander across the world or spend their lives in the lonely outposts on the frontiers of civilization.

To them the correct selection of dependable receiving equipment is vital. For to be deprived of the use of their radio set is a dire catastrophe, and results in complete isolation from the world outside.

Those who must receive absolute, unflinching service over longer periods always buy Burgess "A," "B" and "C" Radio Batteries.

*"Ask Any Radio Engineer"*

**BURGESS BATTERY COMPANY**  
Engineers DRY BATTERIES Manufacturers  
Flashlight - Radio - Ignition - Telephone  
General

Laboratories and Works:  
Madison, Wisc.  
In Canada:  
Niagara Falls and Winnipeg







## RADIO EXPERTS EARN BIG MONEY

Thousands of big pay opportunities open to the radio trained man. Success easily won in the fastest growing industry of all time. From land and sea comes the urgent call for men who can construct, install, operate, repair, maintain and sell radio equipment.

### CASH for Your Spare Time!

Take orders from your neighbors for radio sets. Get big fees for your services and advice. Home study qualifies you—short course, low cost, easy terms, money back guarantee.

**FREE** Wonderful tube receiving set of latest design. Range over 1000 miles. Write today for FREE copy of "Radio Facts".

A. G. MOHAUPT, Radio Engineer  
**RADIO ASSOCIATION OF AMERICA**  
 4513 Ravenswood Ave., Dept. G1 Chicago



## The NEW UNCLE SAM MASTER COIL TUNING

THE COIL WITHOUT LOSSES

- 1—Wound on moulded hard rubber.
- 2—Increases volume 50% to 250%, also selectivity, over old type.
- 3—Eliminates all adhesives.
- 4—One hole mount and thin gold plated compensating spring contacts.

**FREE!** Ask your dealer or send us four cents in stamps for wiring diagrams of circuits in which this remarkable coil can be used.

UNCLE SAM ELECTRIC CO.  
 208 E. Sixth St. Plainfield, N. J.



## The Works of the DeJUR one hole RHEOSTAT

### Genuine Bakelite Throughout

Note below how contact slider and shaft are made in one piece. Permanently set at the factory, this insures perfect contact throughout the entire resistance range. The one hole makes DeJur the easiest rheostat to mount and when mounted, it sets fixed and rigid. No screws to get loose and no back panel fussing. Compare the DeJur. You will readily recognize its difference and superiority over all other rheostats.

At dealers everywhere  
 Jobbers—Write for discounts.  
 Patents Applied for

**DE JUR PRODUCTS Co.,**  
 Lafayette & Broome Sts.  
 New York

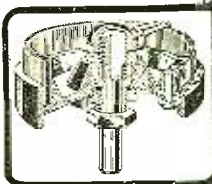

at Beacon Chambers, Boston, Massachusetts which is spreading a knowledge of radio in foreign countries by correspondence.

### Radio-Paris

(Continued from page 19)

the application fee costs 16 francs. He must be able to send and receive 8 words per minute. For an experimenter's license, the speed requirement is 15 words per minute. He must be able to adjust his apparatus for use on three different wave lengths.

"There are also restrictions of a political nature, such as the permission of French only as a language of transmission. Special methods of transmission are forbidden. Some of the radio papers have objected to this as a discouraging factor in experiments. All transmitting stations in France are required to pay 100 francs per year per kilowatt. This is the total sum which the amateur or the experimenter has to pay in taxes. There is complaint that only 60 conversations can be maintained between 150 and 200 meters and that private radio communications are already cramped in this narrow band. There is also considerable complaint of interference from outside the boundary of France. One of Holland's big stations is causing considerable interference in France. You must remember that France is about the size of an American state and that obviously stations from other nearby territory break in upon her. However, this is a sword that cuts two ways—the Eiffel Tower and other stations no doubt interfere with other countries. It seems to the American like the same old petty politics of nationalism to sit on the lid of radio for political and nationalistic reasons. Yet this is what is occurring in Europe.

"England herself only recently cleared her skirts of this political hamper to radio and has developed enormously in radio broadcasting since that time. Because of considerable interference only the Parisian listeners-in hear at all well; and the listeners-in over the rest of France haven't very much success. This is extremely prejudicial to the best interests of radio, and it is probably just as well that the country districts are not yet thinking of radio very much, since the service is pretty poor.

"Next year an international conference is going to meet to agree upon wave lengths, and undoubtedly much of the same broad-minded clearing up of interference will take place in Europe that has taken place in the United States.

"One of the evidences of radio's lesser stature in France is how the Parisian newspapers treat it. Every American is familiar with the special weekly radio magazines issued by many newspapers or the many columns of material given in regular pages. Parisian papers—even the Paris New York Herald—which is printed in English—have only a couple of inches, single

"Quality Goods for Quality Readers"

## For quality results RESISTANCE COUPLING!

You can build your own amplifier with resistances instead of transformers.

### THIS BOOK TELLS HOW



514 PAGES  
 254  
 Illustrations

Compiled by  
 HARRY F. DART  
 E.E.

Formerly with the  
 Western Electric  
 Co., and U. S.  
 Army Instructor  
 of Radio. Techni-  
 cally edited by  
 F. H. Doane.

100,000 ALREADY SOLD

**E**XPERTS all say that resistance-coupled amplifiers give most perfect reproduction. They are quite simple to make, and inexpensive too. Try them. See pages 327 and 328, I. C. S. Radio Handbook, for details of a resistance-coupled radio frequency amplifier. Pages 331 and 332 give details of a resistance-coupled audio frequency amplifier. Complete information on transformer and choke coil coupled radio and audio frequency amplification given on other pages in the same section of this practical book. This is just one example of the inclusiveness of the I. C. S. Radio Handbook.

**IT EXPLAINS:** Electricity and electrical terms and formulas, antennas, batteries, motors and generators, vacuum tubes, transmitting and receiving principles and practices, radio and audio frequency amplification, battery chargers, rectifiers, filters, condensers, super-regeneration, codes, license rules. Many other features.

This is the greatest amount of workable radio information ever assembled in a handbook. Contains the practical wisdom of radio engineers, written in plain language so all can understand without previous technical training.

**Send \$1 today and get this 514-page I. C. S. Radio Handbook—it will save its small cost many times over. Money back if not satisfied.**

INTERNATIONAL CORRESPONDENCE SCHOOLS  
 Box 6036, Scranton, Penna.

I enclose One Dollar. Please send me—post-paid—the 514-page I. C. S. Radio Handbook. It is understood that if I am not entirely satisfied I may return this book within five days and you will refund my money.

Name.....

Address.....

Check here  and enclose \$1.50 if you wish the deluxe edition, bound in Leatheroid.



## N.A.A. Get 'Em 60c

The only scientifically selected detector minerals on the market today are the genuine N.A.A.

# METER TESTED RADIO CRYSTALS

Full, clear rectification insured by newly developed visible laboratory meter-testing. Perfect for reflex. Price 60c at your dealer or direct. Recommended by Radio News, Popular Radio, Acme Apparatus Company, etc.

The Newman-Stearns  
 1740 East Twelfth Street  
 Cleveland, Ohio  
 Pioneers in Tested Crystals

Nuggets of Sensitiveness

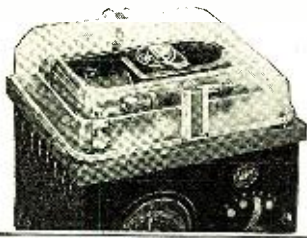

**For All Batteries**

**Valley Battery Charger**

For 2-volt peanut tube cells, for 6-volt A batteries and for 24-volt B batteries in from one to four units, the Valley Battery Charger is the only charger which you need.

Plugs into the ordinary light socket like a fan or other household necessity. Just as easy to operate. Takes about a dime's worth of current to bring your battery up to full charge.

- Quiet in operation
- Full 6-ampere charging rate
- No liquids. No bulbs

It has a grained and engraved Bakelite panel which harmonizes with any radio set. Clear glass top shows the simple, patented working parts at all times. Scientifically planned and substantially made by experienced manufacturers of storage battery charging equipment.

At radio dealers everywhere. Further information gladly furnished on request.

**VALLEY ELECTRIC CO.**  
3157 S. Kingshighway, St. Louis, Mo.

*The Complete Efficient and Economical Aerial*

**ANTENELLA**

No Aerial or Antenna Needed



**\$1.25**

Why pay \$10.00 or more to have an aerial spoil the appearance of your home? Antenna eliminates all unsightly wiring, lightning arresters, etc., and precludes the possibility of dangerous grounding on a power line. It also stops "canary bird" re-radiation from nearby oscillating sets from interfering.

**ANTENELLA**

is not only a real distance getter, but also overcomes troublesome static.

At your Dealer, otherwise send purchase price and you will be supplied postpaid.

**Chas. Freshman Co. Inc.**  
*Radio Condenser Products*  
FRESHMAN BUILDING  
240-248 W. 40th Street, New York

column, with an ambiguous heading giving space to radio, 'For Radio Amateurs.' As a rule only three stations are mentioned—'Radio-Paris,' which has a wave length of 1780 meters; Eiffel Tower with a wave length of 2600, and Ecoles des Postes with a wave length of 450 meters. These programs are set in the smallest type used in the newspaper, located in an inconspicuous corner, and certainly do little to stimulate radio interest."

"What are the programs they broadcast?"

"Well, for instance, at 12:45 Radio-Paris has some orchestra music; at 1:45 a news bulletin; at 4:45 some concert of the music of Wagner, Saint-Saëns, Massenet; at 5:45 news bulletins; at 8:30 some more news bulletins; and at 9:30 P. M. dance music. The Ecoles des Postes broadcast the Jaures' memorial ceremony outdoors at the Pantheon and various other places. At 2 P. M. a speech by M. Herriot. All three stations give news bulletins more frequently than anything else, which again illustrates the Parisian and French character—the constant overshadowing interest in politics.

"In America news material is definitely stale and undesired as radio material, except for selected special events. We Americans prefer our newspapers for the news, and look to radio for entertainment, music and instruction. The Frenchman, on the other hand, is so primarily political-minded that when the program says 'News Bulletin' it means, to a large extent, political news, for the Frenchman has not a great deal of interest in the news of other countries, excepting where it rather definitely impinges upon French interests or concerns French international diplomatic controversies.

"Another thing that seems entirely absent in French broadcasting is the famous American bedtime story. French children apparently still have this thrill coming to them.

"It certainly will not do, however, to cast any slight upon French genius and character in respect to radio, for already something is developing which may give to the world some of France's best genius in relation to radio. A number of men, one of them a chief of a modern broadcasting station, is working up technique and interest in 'A Wireless Theater.' This is Gabriel Germinet, who is collaborating with Pierre Cusy, a writer who has several novels to his credit, written while wounded, and who is Chevalier of the Legion of Honor. Germinet hopes to develop a theatrical technique which will enable the listener-in to thoroughly enjoy a theatrical performance via radio. The French genius for the theater is thus tackling a problem that is within its sphere, and we may hear

"Quality Goods for Quality Readers"

**POLYPLUG**

POSITIVE CONTACT ALWAYS MAINTAINED

Assuring uninterrupted and clearer reception of programs. All unsatisfactory features of screw type plugs are eliminated. Slip the Polyplug into the socket and you have instant and positive contact. The tension slot, an exclusive feature, makes the Polyplug the most convenient and efficient plug made.

*It's Genuine Bakelite Too*

Sold by all Dealers

**POLYMET MFG. CORP.**  
70 LAFAYETTE ST. N.Y. CITY

75¢ WORTH IT

**100 to 1**

**AMERICAN BRAND CONDENSER**

with the **Worm Drive VERNIER**

**23 PLATE \$5.00 only**

**For Sale Everywhere**

**AMERICAN BRAND CORPORATION**  
8 WEST PARK ST. NEWARK, N. J.

**HEATH**

**Radiant NON-DIELECTRIC Condensers**

**Permanently Flat Plates**  
Stamped under huge presses to absolute flatness and tempered to prevent warping.

**Micrometer Geared Vernier**  
Ordinary adjustments reduced to hairbreadth distinction. Guaranteed to be more highly selective than any condenser employing a vernier, actuating ALL of the plates.

**Write for Literature**

**HEATH RADIO & ELECTRIC MFG. CO**  
203 First St. Newark, N. J.

Exclusive Canadian Distributors:  
Marconi Wireless Telegraph Company, Ltd.  
Montreal, Canada

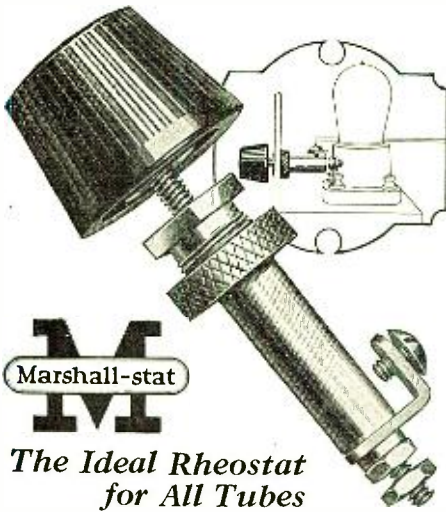

**M**  
Marshall-stat

**The Ideal Rheostat for All Tubes**

The Marshall-stat provides a means of obtaining any desired tube adjustment with absolute precision. The Marshall-stat varies the resistance, not step by step, but smoothly, continuously, and uninterruptedly from zero to maximum.

The Marshall-stat provides vernier precision throughout its entire range. Yet there is only one knob to manipulate—no double adjustment to make.

Besides its precision and ease of operation, the Marshall-stat requires only one hole in the panel, has only two terminals, can be used with any tube or combination of tubes, and is so scientifically constructed that breakage of the specially-treated Marshall discs is impossible. Compact—note full-size cut above. Can be fitted anywhere. Price \$1.75.



MARSHALL ELECTRIC COMPANY  
3239 Locust Blvd., St. Louis, Mo.

Send for Old Man Ohm's descriptive folder on the Marshall-stat.

something about this later on.

"The new technique was given a splendid and successful tryout some months ago, when the *Uncle Grande Première* of 'Maremoto,' the radio play, occurred. This play was carefully planned, with every resource of both radio and theatrical art, to attain a new era in dramatic representation. 'Maremoto,' as its name implies is a play about the sea, about a ship 'Le Ville de Saint Martin.' There is of course no such ship registered, but thousands of radio fans believed so, especially when its skipper gave her latitude and longitude—but severed the time-honored sea practice by giving longitude first: 23° 15' 25" longitude north; 14° 35' 40" latitude east. The radio fan who was no seaman didn't know that this position is not on the briny deep, but in the Sahara desert!

"Special mechanical devices and ingenious methods were used for the onomatopoeic sounds (the imitations of noises), peculiar to the play's location and action. In fact, in this new theatrical art of radio plays, there is, of course, no scenery — all is sound. Therefore, the various means of making sound are important, and a radio playwright has naturally to learn and devise many new things. A sea play, with the action laid on shipboard, offers many unique sound possibilities. A saxophone was used for the roaring of the sea in a storm; and a piece of silk stretched taut, and played upon violin fashion made a perfect imitation of the wind swishing through the rigging. No wonder that not only the radio listeners, but even some of the newspapers were taken in for a while—they really believed that the broadcasting was done on shipboard. The Parisian newspapers wrote ecstatic blurbs about the play, and a great many letters were received from fans enthusiastic over the new art.

"You see, the French are great theater-goers, and love the spectacularly dramatic. If this new radio theater art can be put across, and playwrights developed who will be able to make artistic use of radio technique, we may see a new dramatic development as important as the movie. The movie, after all, appeals to but one of the senses, sight; which misses all the inflections and drama that lie in sound—in spoken words. Radio can have words and also sounds of other kinds.

"A book is being prepared on the subject, and not only the wireless field, but also the theatrical field is much interested. In 'Comoedia' a well known French theatrical paper. Max Frantel said after the première of 'Maremoto': 'In a few years we shall be proud to say that we were at the first presentation of this first radio play. The radio papers likewise had lively reviews and comment.

"Quality Goods for Quality Readers"

Reg. U.S. Pat. Office  
**Lincoln**  
RADIO PRODUCTS

**Collapsible Loop Aerials**

4-Point Tapped Loop \$8.00  
Center-tapped Loop \$6.50

If your dealer cannot supply you, order direct giving your dealer's name.



**Now . . . the Standard Loop of the Radio Industry**

Efficiency has won leadership for Lincoln Collapsible Loop Aerials. Simplicity, superior performance, beauty of finish . . . all that the radio enthusiast demands is found in Lincoln Loops. Thousands of Radio Fans have given them preference. Here is great selectivity and quality reception . . . convenience and super-efficiency . . . beauty and grace. Follow the lead of those who know . . . buy a Lincoln Loop . . . built by radio engineers and fully guaranteed. Built for every radio frequency receiver. Can be used on Neutrodyne sets where an outdoor aerial is impractical. Lincoln Loops are sold by leading dealers everywhere.

**Write for Catalog**



Fully describes all Lincoln Laboratory Tested and Guaranteed products—Lincoln Low-Loss Condenser, Lincoln Collapsible Loops, Lincoln "Long 45" Tuner, Lincoln Kits, Lincoln Oscilloscope—and shows 6 interesting hook-ups. Send your name and your dealer's name for a copy.

**Lincoln Radio Corporation**  
224 North Wells Street, Chicago

**NOW**  
-its the  
**"SELF ADJUSTING" RHEOSTAT**

No more guessing and uncertainty as to your tube filament voltage. AMPERITE inside your set, one for each tube, automatically gives just the right current to bring the most out of every tube. Simplifies wiring and operation. Increases set compactness. Lengthens tube life. Tested, proved and adopted by more than 50 set manufacturers. The set you buy or build will not be up-to-the-minute in effectiveness without it.

\$1.10 Everywhere

RADIALL COMPANY  
Dept. W.A.-6 50 Franklin Street, New York

Write for  
**FREE**  
Hook-ups



**AMPERITE**  
REG. U.S. PAT. OFF.  
"means right amperes"

**The Standard of the World**



The base-type  
**Freshman Variable Grid Leak**

is the standard for those who build their own sets. It is the most compact and being entirely sealed it always remains unaffected by any climatic conditions.

Complete with either .00025 or .0005 Freshman Condenser—**\$1.00**  
without condenser . . . 75

At your dealer's, otherwise, send purchase price and you will be supplied postpaid

Chas. Freshman Company, Inc.  
240-248 W. 40th St., New York

**WHOLESALE DISTRIBUTORS**  
FOR



# Radiolas and Radiotrons

Radio Corporation of America

*Sales Dept., Suite 2066: 233 Broadway, New York*  
*District Sales Offices:*

10 South LaSalle St., Chicago, Ill.      433 California St., San Francisco, Cal.



**ILLINOIS**

**TUSCOLA RADIO SUPPLY STATION**  
*Dependable Radio Apparatus*  
TUSCOLA ILLINOIS

**OHIO**

**THE MILNOR ELECTRIC COMPANY**  
*Large Stocks—Quick Service*  
129 GOVERNMENT SQUARE  
CINCINNATI, OHIO

**MAINE**

**ATLANTIC RADIO CO., Inc.**  
*Complete*  *Service*  
21 TEMPLE ST. PORTLAND, ME.

**PENNSYLVANIA**

WHOLESALE **LUDWIG HOMMEL & CO** EXCLUSIVELY  
929 PENN AVENUE PITTSBURGH, PA.  
**WHOLESALES 100% THROUGH DEALERS ONLY**  
WRITE FOR HOMMEL'S ENCYCLOPEDIA OF RADIO APPARATUS 256-E

**MASSACHUSETTS**

**F. D. PITTS CO., Inc.**  
*Exclusively Radio*  *Exclusively Wholesale*  
219 Columbus Ave. Boston, Mass.

**PENN ELECTRICAL ENGINEERING CO.**  
*Westinghouse Agent Jobbers*  
SCRANTON, PA.

**ATLANTIC RADIO CO., Inc.**

*Complete*  *Service*  
727 Boylston St. Boston, Mass.

**THE PHILADELPHIA ELECTRIC COMPANY SUPPLY DEPT.**  
130-32 So. Eleventh St.  
Philadelphia

**MISSOURI**

**WESTERN RADIO CO.**  
*Dependable Merchandise from America's Greatest Manufacturers*  
BALTIMORE AT FOURTEENTH  
KANSAS CITY, MO.

**WEST VIRGINIA**

**CHARLESTON ELECTRICAL SUPPLY CO.**  
*Electrical Jobbers*  
CHARLESTON, WEST VIRGINIA

**NEW YORK**

**CONTINENTAL RADIO AND ELECTRIC CORP'N**  
*New York's Leading Radio House*  
15 WARREN STREET  
NEW YORK

**DEALERS**  
*Here*  
you will find the  
**R. C. A. DISTRIBUTOR**  
who can serve you  
best  
*Tie up to him*

**TIMES APPLIANCE CO., Inc.**  
*Approved Radio Merchandise Wholesale Only*  
145 WEST 45th ST. NEW YORK

"The play 'Maremoto' was written incidentally, in a competition by 'Impartial François' a newspaper, for a 5,000-franc prize.

"I think one of the most significant situations in French radio is the royalty situation, in view of conditions in this country. Certainly French artists exhibited nothing like the broad liberality over a number of years, which the American artists have shown, and if anyone is inclined to judge harshly the demand of American artists for pay from radio stations, one has only to consider the French situation to realize that they are certainly not unfair in their demand for pay. The French law basically provides for royalty for artists, for the artist has in France always been a person whose interests were well guarded and taken care of. That is the special glory of France, for by means of it she has fostered art until she is the most artistic nation in the world. Public and private support for the artistic accomplishments of her race have always been abundant.

"Precisely the same royalty rates which exist in the theater are operated in broadcasting. It is arranged in this way: Radio-Paris buys the annual right to use the material and music of members of the Society of Authors and Composers. Complete programs are sent to the Society every month, and these form the basis for proportioning the payment of royalties. It is true that Eiffel Tower and P. T. T. stations do not, at present, pay their artists. Subscriptions are offered by listening fans for this purpose. Radio-Paris, however, being a commercial broadcasting station, needs a great part of its income for giving the Composers

**A National Radio Product**

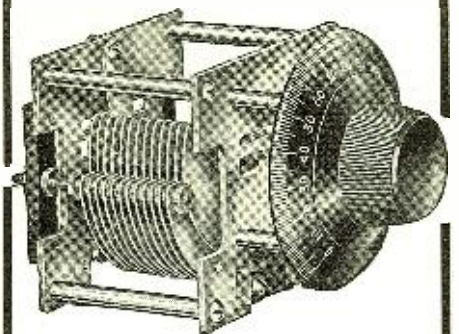

**Performance**

—not argument—  
accounts for the leadership of  
National

**VELVET VERNIER  
Condensers and Dials**

**Buy the Best!**

Tell your dealer you want a National. Nothing else will do.

Manufactured by  
**NATIONAL COMPANY, INC.**  
110 Brookline Street Cambridge, Mass.

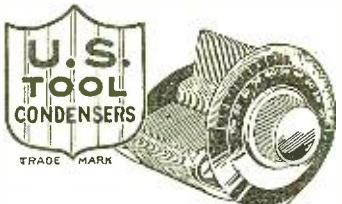

**U. S. TOOL CONDENSERS**  
TRADE MARK

**A Unique U. S. Tool Feature ONE PIECE STATOR**  
(Pat. Applied for)

Found in no other make, the one piece stator makes the U. S. Tool Condenser 100% efficient. Eliminates leakage, resistance, broken contacts and soldered joints. In types 3 (plain) and 4 (all-vermieri), **CELORON END PLATES**; types 5 (plain) and 6 (all - vermieri), **METAL END PLATES**; types featuring the Hexagon Shaft.

CS and CV low price types always in stock. 100% GUARANTEED Write for Literature

**U. S. TOOL COMPANY, Inc.**  
113 Mechanic Street Newark, N. J.  
Mfrs. of special tools, dies, jigs, automatic machinery and sub presses.



**HONEYCOMB COILS**

The Universal all-wave inductance. Back and front panel mountings. Send 25c for Super Het., R. F. and Honeycomb Coil Circuits and Complete Catalog.

Chas. A. Branston, Inc.  
Dept. 14, 815 Main Street Buffalo, N. Y.

**YOUR CRYSTAL SET**

will work 400 to 1000 miles if made by my plans. No tubes or batteries. Copyrighted plans \$1.00; or furnished FREE with complete parts for building set, including special coil and panel correctly drilled for only \$5.00. Satisfaction guaranteed or money refunded. Satisfied customers everywhere. Particulars free.

**LEON LAMBERT**  
674 Kaufman Bldg., Wichita, Kansas



**12 Cells 24 Volts Solid Rubber Case**

**\$3.50 SPECIAL INTRODUCTORY PRICE**

For a limited time only, and to introduce this new and superior Storage "B" Radio Battery to the Public, we are selling it for \$3.50. Regular Retail Price is \$5.50. You save \$2.00 by ordering NOW. A finer battery cannot be built than the

**World Storage "B" Battery**  
(12 CELLS—24 VOLTS)

To ten million homes with Radio Sets—and to countless millions of prospective buyers—the World Storage "B" Battery brings a new conception of battery economy and performance. Here is a battery that pays for itself in a few weeks—will last for years and can be recharged at a negligible cost. And you save \$2.00 by ordering now.

**A Superior Battery Equipped With**  
Has heavy duty 2 1/8 in. x 1 in. x 1 1/4 in. plates and plenty of acid circulation. Extra heavy glass jars allow ready observation of charge and prevent leakage and seepage of current. It holds its charge, while idling, at constant voltage. You will find this battery a boon to long distance reception. It does away with a great many noises so often blamed on "static." Mail your order today.

**SEND NO MONEY**

Just state number of batteries wanted and we will ship day order is received. EXTRA OFFER: 4 batteries in series (36 volts), \$13.00. Pay Expressman after examining batteries, 5 per cent discount for cash in full with order. Send your order NOW and save \$2.00.

**WORLD BATTERY COMPANY**  
Makers of the famous World Radio "A" Storage Battery  
1219 S. Wabash Ave., Dept. 79 Chicago, Ill.

**SAVE \$2.00 BY ORDERING NOW!**

and Artists what they are entitled to by law, since it is a private broadcasting company. Radio-Paris has now arranged to broadcast from *Salle Gaveau*, where piano recitals and stringed instruments are to be heard in concert, and these are now part of its program. Radio-Paris also hopes to acquire a large hall in order to operate a double plan of concerts to large audiences, while at the same time the performance is broadcasted. Radio-Paris has spent 2,000,000 francs on the new station at Clichy not far from Paris and is hoping to get permission for a 10-kilowatt equipment. If such permission is granted, we will certainly be able to hear this best of all Paris stations without difficulty in America. It will be on 1780 meters. Radio-Paris now has a studio located at 79 Boulevard Haussmann in a basement which is not at all satisfactory. Even the River Seine overflowed into the studio not long ago and artists had to walk about on planks. Such a condition is almost inconceivable in America."

"What about the French radio receiving sets—what are they like?" I inquired.

"Well, they are certainly not like our own. As in England the French do not even call a tube a tube, they call it a 'valve.' An outstanding characteristic of French sets is the mounting of the tubes outside the cabinets. Oddly enough this has been copied by some in American radio, whereas the tendency in France is now away from this and toward enclosed tubes. Sets with a loop antenna are sold in very handsome finishings, in black morocco, leather, walnut, and mahogany, and the loop antenna sets are decidedly popular. French ingenuity has evidenced itself in disguising the loops in screens, tapestries, etc., while French textile genius has produced a triumph—embroidery and silk, harmonizing with your furnishings, with a loop made up inside of it!

"Another one of the unique types of receivers is in a cabinet closing like a roll top desk. The Winter Radio Show at the *Grande Palais* indicated considerable use in France of pancake or other interchangeable inductances. Their general technical detail is otherwise not essentially different. It would appear that a constant stream of new circuits and hook-ups does not intrigue the French very much, for they seem to be doing very well with the ordinary single and three-circuit regenerative hook-ups. As for experimenting with super-regeneration and super-heterodynes, they were at the Exposition, but the buzzing crowds of fans displayed only ordinary interest in them. Radio-frequency amplification is used by some manufacturers."

"What do they do for loud speakers?" I asked.

"Quality Goods for Quality Readers"

**on the dot**

It's as easy as placing your pencil point on a town on the map—this tuning in with Apex Vernier Dials.

They make logging a simple matter and "getting a station" positive. The ratio is 12 to 1. Sells in Royal Brass Finish for \$2.00—Satin Silver Finish \$2.50 DeLuxe Gold Plated (24k) \$3.50. Applied to any shaft—quickly.

Apex 7-Tube Microdyne—Super-Heterodyne knock-down sets sell for \$97.50. The Apex Super Five in a Walnut Cabinet is \$95.00. See your better Radio Dealers.

**Apex Electric Mfg. Co.**  
1414 W. 59th St. CHICAGO Dept. 219



**Laboratory Figures Convince Engineers Results Convince Users**

A prominent engineer reports that "laboratory tests consistently show that, if it were possible to make a tuner with lower losses than

**THE LOPEZ LOW LOSS TUNER**

the quality of reproduction in broadcast reception would suffer."

One enthusiast writes:

"After using one of your low-loss tuners, in an amateur receiver, I decided to try out one in a Broadcast receiver, employing two stages of audio frequency. The first night that I had the set operating I logged sixty-two stations, finishing off with station KGO, of the Gen'l Elect. Co. at Oakland, California. I held this station two hours, and many of the numbers were audible over the entire house, on a loud speaker. This reception has been confirmed by the station in question. You may refer any prospective customer to me for a good recommendation, for I sure am a booster for the Lopez Low Loss Tuner. — Robert E. Kearney, The Electric Storage Battery Co.

Broadcast Type 200 to 600 meters Regular Amateur 40 to 285 meters

Circuit diagrams, panel drilling templates and instructions with each tuner.

**Price \$10.00 Each**

At your dealer's or sent direct postpaid

**A. C. LOPEZ & CO.**  
344 Fifth Ave., Dept. W. New York City



**FREE**

To Each Purchaser of a **World Battery**



A 24-Volt "B" Storage Battery positively given FREE with each purchase of a WORLD "A" Storage Battery. The WORLD Battery is famous for its guaranteed quality and service. Backed by years of Successful Manufacture and Thousands of Satisfied Users. You save 50%.

**Prices That Save and Satisfy**

Auto Batteries	Radio Batteries
6-Volt, 11 Plate \$12.25	6-Volt, 100 Amps. 12.50
6-Volt, 13 Plate 14.25	6-Volt, 120 Amps. 14.50
12-Volt, 7 Plate 17.00	6-Volt, 140 Amps. 16.00

Shipment Express C. O. D. subject to examination. 5 per cent discount for cash in full with order.

**2-Yr. Guarantee Bond in Writing With Each World Storage Battery**

Proves satisfactory World performance. Mail this ad with your name and address — we will ship battery day order (received), and give you your choice of "B" Storage Battery or a handsome nickel finish Auto Spotlite, FREE. Write TODAY.

**WORLD BATTERY COMPANY**  
1219 So. Wabash Ave. Dept. 27 CHICAGO, ILL.

This FREE "B" Storage Battery takes the place of dry cell "B" batteries. Can be recharged and will last indefinitely. To be sold retail for \$8.00. It is the only battery of its kind equipped with solid rubber case—and insurance against acid and leakage. Take advantage of this remarkable introductory offer NOW. (To those who prefer it, we will send FREE a handsome nickel finish Auto Spotlite, instead of the "B" Battery. Be sure to specify which is wanted.)

**GIVEN FREE**

To introduce this new and superior World "B" Storage Battery to the Public



**LATEST WHOLESALE RADIO CATALOG**

**FREE** Simply send name TODAY for big 48-page catalog of latest radio goods at Wholesale. Live dealers and agents wanted.

STANDARD RADIO CO., 110 East 13th, Kansas City, Mo.

**Make BIG MONEY! — IN RADIO**

**We Need Men—Can You Qualify?**

Ozarka representatives make real money because they give real values and deliver a real service. For instance, there is a 4-tube Ozarka Instrument for loud speaker operation, giving wide range of reception at \$39.50. Our men demonstrate Ozarka Instruments and Install. The Instrument makes the sale easy by its performance. We train you to know radio and our methods, make you worthy to wear the Ozarka button as our accredited representative. Previous experience is not necessary. In fact we prefer to do our own educating. If you have a clean record, are industrious, and have saved up a little cash, here's a real opportunity, if you can qualify for an exclusive territory. We already have 2247 representatives. Territory going fast.

**FREE, LARGE Illustrated BOOK**

WRITE Today for illustrated book No. 101 that gives the entire Ozarka Plan. Don't fail to give the name of your county.

**OZARKA, Inc.**  
857 Washington Blvd.  
CHICAGO

**4 Tube Sets As Low as \$39.50**

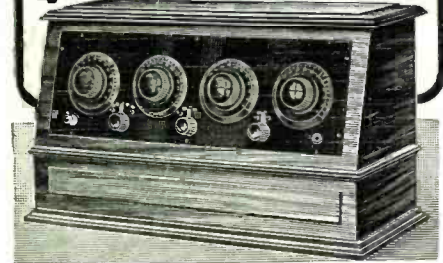

"Funny, that seems to be the problem all over the world. The French are particularly in need of it. As I have said, transmission is not highly satisfactory and the French, no more than anyone else, do not like to be muzzled in ear-pieces for any length of time. There is, therefore, a large variety of loud speakers on sale in France, possibly a greater and more motley variety than even our own, for in America a fairly standard type seems to have been developed. There are crinkly paper cones, old fashioned gramophone horns and other bizarre shapes. An engineer named Lakhovsky has produced something new in this direction consisting of two horns fitted one within the other, the space between being occupied with an oil which is solid at normal temperature. Tap the edge of the horn and it will not ring. The diaphragm is made of two plates instead of one with a thin layer of the oil paste between them. M. Lakhovsky, the inventor, was one of the committee to award a gold medal to M. Leon Deloy at Nice, the first French amateur to communicate with American amateurs."

"Are there many radio stores in Paris?"

"Yes, there are quite a number of them, but hardly to the extent with which we are familiar in America. Nor are there many radio publications. Some that are worth looking at are: *Radioelectricite*, *T. S. F. Moderne*, *L'Onde Electrique*, (of more strictly technical appeal); the *Radio Review* (official monthly of the Radio Club de France), and *Radio Amateurs* (official monthly of the Association of Radio-Amateur Français)."

"How about DX nuts? Have the Frenchmen developed them yet?"

"Oh, yes, indeed. A French 'fan,' of whom there are, after all, a few, has all of Europe to prey upon. What with the English stations working between 353 and 495 meters, with the new Chelmsford station at 1500; Belgium between 1100 and 1300; Germany on 2700 and 400; and Holland on 1050, a DX fan needs only some good interchangeable coils and he has the makings of a League of Nations Convention in all languages. Of course, a French DX fan, unlike an American, has to be something of a polyglot in language qualifications, for he will hear one minute a señorita sing, and the next moment he can tune in a Dutch maiden or a German gretchen or an English lassie, all doing their national songs in their own languages, all by the turn of a wrist. To make this interesting he really ought to know what they are singing so cutely! Jazz is the new international musical language which apparently has a more ready popular acceptance than any other single type of music."

"Quality Goods for Quality Readers"

**ONE DOLLAR BUYS**

**THE ANTENNAPHONE**

Replaces the Aerial

**INCREASES SELECTIVITY AND QUALITY OF RECEPTION**

Safer than a troublesome outdoor aerial  
Better than an unsightly indoor aerial  
**EASY TO INSTALL**

The telephone is not attached, but merely placed upon the Antennaphone. Then connect the wire of the Antennaphone to the antenna-post of your set (tube or crystal) and tune in.

The Antennaphone gives you Sharper Tuning and Reduces Interference

Our Money-Back Guarantee  
The Antennaphone will not interfere with the use of your telephone and is guaranteed to work with any receiver or your dollar will be refunded.

The Antenna-\$1.00 phone, complete with insulated wire, price.....

**AT YOUR DEALER**  
Or sent by Mail Upon Receipt of One Dollar.  
**ANTENNAPHONE CO.,**  
90 West St., N. Y. City.



**Small Ads of Big Interest**

80 cents a line. Payable in advance.  
Minimum space 7 lines

**IMPORTANT** wholesale and retail Firm in Paris willing to accept representation for France for detached parts of T.S.F. Highest commercial and banking references. Write to S. S. Sep., 10, rue de la Victorie, Paris, France.

**JOIN** the Radio Parts Exchange Club. Your parts inspected (Fee 25c.) and exchanged for the parts you need. What have you; what parts do you require? Write us for details.  
The Radio Parts Exchange Club,  
112 So. Homan Ave., Chicago.

**RADIO GENERATORS—500V 100 watt \$28.50.** Battery Charging Generators \$8.50. High Speed Motors, Motor Generator Sets, all sizes. **MOTOR SPECIALTIES CO.,** Crafton, Penna.

**158 GENUINE Foreign Stamps.** Mexico War Issues. Venezuela, Salvador and India Service, Guatemala, China, etc., only 5c. Finest approval Sheets 50 to 60%. Agents Wanted. Big 72-p. Lists Free. We Buy Stamps. Established 20 years. Hussman Stamp Co., Dept. 157, St. Louis, Mo.

**IMPERIAL** Four Tube Radio Frequency Receiver—\$45.00. Guaranteed one year. To see or hear the IMPERIAL means to buy it—and buying it means satisfaction. Write for literature on this and other types of receivers. Agents wanted—full or spare time. Write for our proposition. **IMPERIAL RADIO COMPANY, BINGHAMTON, N. Y.**

**MAKE YOUR NEUT REACH OUT—**Same panel, same layout, fewer parts. Our \$5.00 Kit includes the one different part, 22 feet real gold sheathed wire, lithographed print of Kladag Coast to Coast Circuit, and Complete, simple instructions. Nothing else to buy. Gives selectivity with deep, resonant volume. Not obtainable elsewhere. We originated this and can name scores of buyers it has delighted. Satisfaction guaranteed. Details, 10c. Kit prepaid anywhere, \$5.00. New 48-page catalog, thousands of items, many exclusive, for stamp. We accept postage stamps same as cash. **KLADAG RADIO LABORATORIES, KENT, OHIO.**



**the Panel of  
sure quality**

Dilecto is the quality standard by which all paneling material is judged. It has gained in popularity because of its merits for—strength!—beauty!—finish!—service!—machinability!—dielectrical resistance. The U. S. Navy and Signal Corps have subjected Dilecto to more than ordinary requirements, and it has met every test.

Dilecto never changes—it is never affected by heat (up to 220° F.) cold, water, oil, gasoline, fumes, ozone, solvents, and most chemicals. It will not crack, chip, check or warp.

Look for the Red Stripe that runs along the edge of the panel you buy and you'll be sure of the best panel that can be made.

# Dilecto

(distinguished by its red stripe)

THE CONTINENTAL FIBRE CO.  
FACTORY: NEWARK, DEL.

Service on Dilecto (also Conite, Conter and Vulcanized Fibre) from:

NEW YORK, Woolworth Bldg.  
CHICAGO, Wrigley Bldg.  
PITTSBURGH, Farmer's Bank Bldg.  
LOS ANGELES, 307 S. Hill St.  
SAN FRANCISCO, 75 Fremont St.  
SEATTLE, 1041 Sixth Ave., So.  
(Offices and Agents throught the world)



**FROST-RADIO ADAPTER**

THE adapter shown here may be used in economically converting standard base sockets to those suitable for dry cell tube use, either C-299 or CV-199. The price is low—the quality is unequalled. Polished Bakelite. Nickel plated bronze contact springs and prongs. Secure as many as you will need for your multi-tube set from your dealer. Ask him for Frost-Radio No. 611 Adapter.

**HERBERT H. FROST Inc.**  
154 West Lake Street  
CHICAGO



**50c**  
List Price

**FROST-RADIO**

## Advertisers' Index

Adams-Morgan Co., Inc.	11
Air-Way Electric Appliance Corp.	19
Allen-Bradley Co.	7
Ambassador Sales Co.	83
American Brand Corp.	88
American Elec. Co.	72
American Hard Rubber Co.	86
American Radio Mfg. Co.	79
Andrae & Sons Co., J.	75
Andrea, F. A. D.	16
Antennaphone Co., The	92
Apex Electric Mfg. Co.	91
Bakelite Corporation	80
Bel-Canto Mfg. Co.	82
Brandes, C., Inc.	6
Branston, Inc., Chas. A.	91
Bremer-Tully Mfg. Co.	72
Bristol Co., The	8
Bunnell & Co., J. H.	80
Burgess Battery Company	86
Carter Radio Co.	71
Continental Fibre Co., The	95
Continental Radio & Elec. Corp.	67
Crescent Radio Supply Co.	79
Crosley Radio Corp., The	Third Cover
Cummingham, E. T.	Second Cover
Daven Radio Co.	9
De Jur Products Co.	87
Donelue, L. R. Co.	71
Dubilier Condense and Radio Corp.	61
Durham & Co.	77
Eastern Coil Corp.	93
Eby Mfg. Co., H. H.	77
Electric Specialty Co.	85
Faraway Radio Co.	80
Federal Telephone & Telegraph Co.	67
Four Way Co.	81
Freshman Co., Inc., Chas.	81, 88, 88, 89
Frost, Herbert H.	95
General Electric Co.	68
General Instrument Co.	83
General Radio Co.	12
Hammarslund Mfg. Co.	93
Heath Radio & Electric Mfg. Co.	88
Hull & Co., S. W.	76
International Correspondence Schools	87
Jewell Elec. Instrument Co.	84
Jewett Radio & Phonograph Co.	15
Jones, Joseph W.	79
Kellogg Switchboard & Supply Co.	13
Lambert, Leon	91
Lincoln Radio Corp.	89
Lopez, A. C., & Co.	91
Magnavox Co., The	75
Marle Engineering Co.	75
Marshall Electric Co.	89
Metro Electric Co.	95
Mica Insulator Co.	74
Montgomery, Ward & Co.	78
Mozart Grand Co.	70
Mu-Rad Laboratories	76
Music Master Corp.	65
Mylar Radio Co.	62
National Airphone Corp.	4, 5
National Carbon Co.	59
National Company, Inc.	90
National Radio Institute	63
Newman-Stern Co., The	87
New York Coil Co.	76
Omnigraph Mfg. Co., The	73
Ozarka, Inc.	92
Pacnet Electric Co., Inc.	78
Phenix Radio Corp.	69, 73
Polymet	88
Premier Electric Co.	82
Radiall Co.	89
Radio Assoc. of America	87
Radio Corporation of America	Fourth Cover
Radio Corporation of America Distributors	90
Radio Institute of America	84
Rautand Mfg. Co.	60, 61
Rhamstine, Thos. J.	85
Samson Electric Co.	77
Small Ads of Big Interest	92
Spaulding Fibre Co.	66
Standard Radio Co.	92
Thompson Mfg. Co., R. E.	3
Thorndarson Electric Mfg. Co.	74
Tower Mfg. Corp., The	1
U. S. Tool Company, Inc.	91
Uncle Sam Elec. Co.	87
Valley Elec. Co.	88
Walbert Mfg. Co., The	95
Ware Radio Corp.	95
Wireless Press, Inc.	75
World Battery Company	91, 92
Zenith Radio Corp.	74

The best switch made  
and  
it **LOCKS**  
your set, too!

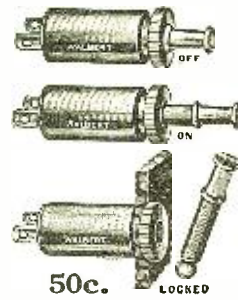

DON'T worry any more about someone meddling with your radio set while you are away. Simply remove key from Walbert Filament Lock Switch and take it with you just as you'd take the ignition key from an auto. Sturdy, compact, efficient. Shell and key handle insulated from circuit. No finer switch made, and none with unique lock feature. Extra key with special key ring attachment, 25c.

At your dealer or sent postpaid on receipt of purchase price.  
(Please mention dealer's name.)

Jobbers and Dealers: Write for Discounts  
**THE WALBERT MANUFACTURING CO.**  
925 Wrightwood Avenue Chicago, Ill.

**WALBERT**  
FILAMENT  
**LOCK SWITCH**  
Safeguards Tubes and Batteries

*Ware*

**NEUTRODYNE**  
Receivers

Type T  
\$65.00  
without accessories

**WARE RADIO CORPORATION, N.Y. C.**

**5 TUBE RADIO SET \$38.50**  
COMPLETELY ASSEMBLED



**10 DAYS FREE TRIAL**  
*Coast to Coast*

**Direct from Factory to you at Less Than Dealer's Cost** Marvelous 5 tube radio set. Latest and most efficient **TUNED RADIO FREQUENCY** circuit. Approved by America's Leading Radio Engineers and the Institute of Standards. Easy to operate. Dials can be logged. Tune in your favorite stations instantly, on the same dial numbers every time. No guessing. Mr. Howard, of Chicago, said, "While 5 Chicago Broadcasting Stations were on the air, I tuned in 17 out-of-town stations from 40 to 1,000 miles away, on my loud speaker, very loud and clear, as though they were all in Chicago."

**Description:** 5 tube set. Comes completely assembled in beautiful mahogany cabinet, size 25x7½x7½. Has 2 stages Tuned Radio Frequency, Detector and 2 stages Audio Frequency. Equipped with the highest quality, approved standard low-loss parts. Genuine Bakelite Panel, Bakelite dials. Use any standard tubes and batteries.

### 10 DAYS' FREE TRIAL

Don't miss this chance to buy this high grade 5 tube set direct from factory. Regular value \$100.00. Our factory price only **\$38.50**. Send no money. Sign and mail coupon. Pay only \$38.50 when delivered, (plus small transportation charges). Try it 10 days. If you are not delighted with results—if you do not consider it equal or better than any \$100.00 set, send it back and we will cheerfully refund your money.

**METRO ELECTRIC CO.**  
400 N. Michigan Ave., Dept. 16 Chicago, Ill.

Gentlemen: Ship me on approval your 5 tube long distance radio set. I will pay \$38.50 on arrival (plus transportation charges) with the understanding that if I am not fully satisfied after 10 days' free trial, I may return it and you will refund my money.

Name.....

Address.....

City.....

# Amateur Radio Stations of the United States

## Supplementary list brought up-to-date

### First District

- 1 AAD Robert C. Saunders, Bourne Street, Clinton, Mass.
- 1 AAE Charles M. Campbell, 31 Boylston St., Pittsfield, Mass.
- 1 AAK George E. Hall, Jr., Washington St., Newburyport, Mass.
- 1 AAL Raymond S. Brown, 398 Lake Ave., Worcester, Mass.
- 1 AAS Philip M. Houton, 58 Elm Street, Bradford, Mass.
- 1 AEF Marcus & Rose Electric Co., 311 Bennington Street, E. Boston, Mass.
- 1 AHN Richard E. Osgood, South Main Street, Windsor, Vt.
- 1 AHE John H. Kinnear, 84 Water Street, Clinton, Mass.
- 1 AHY William M. Derby, 164 Fairfield Ave., Stamford, Conn.
- 1 AKA Harold M. Claffin, 19 1/2 Western Ave., Waterville, Me.
- 1 ALY Robert G. Ballard, 59 Washington St., Penacook, N. H.
- 1 ANG Clayton W. Howard, Waterford, Conn.
- 1 APY Casimir Jarolski, 37 Sweetser St., Wakefield, Mass.
- 1 AQE Edward D. Blodgett, Webster Lake, Franklin, N. H.
- 1 AHD Herbert J. O'Brien, 899 Broadway, S. Boston, Mass.
- 1 ARI Wachusett Radio Assn., 19 Mechanic St., Leominster, Mass.
- 1 ARQ Anthony J. Cherry, 134 Monroe St., Bridgeport, Conn.
- 1 ARS Arthur L. Budlong, 503 S. Main St., E. Hartford, Conn.
- 1 AUE Arthur F. G. Bruder, Box 67, Grove St., Upton, Mass.
- 1 IL Joseph Kozakas, 64 W. Newton St., Lynn, Mass.
- 1 NW Harry W. Marchbank, Noroton Ave., Noroton Heights, Conn.
- 1 OB Alfred R. Gray, 16 Union St., Windsor, Vt.
- 1 PK Roger A. Sykes, 45 Ascotney St., Windsor, Vt.
- 1 PS Edwin B. Dallin, 76 Oakland Ave., Arlington Heights, Mass.
- 1 QB Ernest E. McAviney, 180 Lawrence St., New Haven, Conn.
- 1 QC Sidney A. Brookes, 943 Boylston St., Newton Hids., Mass.
- 1 QH Elden U. Benner, 57 Linden St., Bangor, Maine
- 1 QI Walter J. Munzer, Lone Trout Farm, Ridgfield, Conn.
- 1 QK Govan J. Wright, 14 Elm St., Southbridge, Mass.
- 1 QL George T. Adams, 107 Linwood Ave., Pawtucket, R. I.
- 1 QV Robert Y. Chapman, 4 1/2 Hillside Ave., Westerly, R. I.
- 1 SG Edwin B. Dallin, 76 Oakland Ave., Arlington Heights, Mass.
- 1 TE John E. Wilkinson, 55 Malvey St., Fall River, Mass.
- 1 TC Charles R. Santos, 27 East St., Providence, R. I.
- 1 US Maurice R. Francis, 15 Pleasant St., Fair Haven, Conn.
- 1 LY Leslie S. Wilkins, 37 Magnolia Ave., Magnolia, Mass.
- 1 WN Clarence H. Warme, 19 Temple St., Brockton, Mass.
- 1 ABQ Kendall W. Guilford, 468 Watertown St., Newtonville, Mass.
- 1 ABR Carroll T. Downes, 221 Highland Ave., Arlington, Mass.
- 1 ACP George C. Starkey, 101 Abbott Ave., Fitchburg, Mass.
- 1 APF Charles Favreau, 57 Montgomery St., North Adams, Mass.
- 1 AMW Henry P. Thomas, 12 Main St., Hamilton, Mass.
- 1 ASY Malcolm H. Smith, 12 Chapel St., Gloucester, Mass.
- 1 BDR E.H. Lurie, 39 Flagg St., Boston, Mass.
- 1 BGE Robert W. Lynch, 522 Hampshire St., Lawrence, Mass.
- 1 CPE Frank R. Leave, 286 Columbia Rd., Dorchester, Mass.
- 1 WI Kermit F. Hanson, 124 Brown St., Portland, Maine
- 1 ABW Herbert O. Fairfield, 63 Eleanor St., Chelsea, Mass.
- 1 ACD Perry Huntington, 245 Whiting Lane, W. Hartford, Conn.
- 1 ADD Felix S. Waltersdorf, 21 Merritt St., Bridgeport, Conn.
- 1 ADG Harold M. Towne, 45 Livingston Ave., Pittsfield, Mass.
- 1 APA Gilbert F. Williams, 71 Wade St., Bridgeport, Conn.
- 1 APS George D. Cowie, Mill St., Norfolk, Conn.
- 1 ARA James L. Spates, 69 Saunders Rd., Lynn, Mass.
- 1 AVT Jean M. Pariseau, 4 Spring St., Providence, R. I.
- 1 AVB Alphonse J. St. Cyr, 107 5th St., Leominster, Mass.
- 1 AVZ Lewis P. Birnie, 21 Highland Ave., Barre, Vt.
- 1 BWW Raymond E. Hall, 94 Westford Ave., Springfield, Mass.
- 1 ID Charles A. Service, Jr., Main St., Glastonbury, Conn.
- 1 LF William A. Gordon, Jr., 82 Myrtle St., Shelton, Conn.
- 1 OK Roger L. Goodwin, 33 Reading Hill Ave., Merline, Mass.
- 1 QB William J. M. Dermott, 31 Pleasant St., Bristol, Conn.
- 1 RP Franklin M. Doolittle, 167 Willard St., New Haven, Conn.
- 1 ANA Roland B. Bourne, 27 Argyle Ave., W. Hartford, Conn.
- 1 AQJ Malcolm J. MacDonald, 14 Park Ave., Medford, Mass.
- 1 ARD Leo Charette, 17 Wamess St., Lowell, Mass.
- 1 ACS Ales Martin, 115 Thomas St., Fall River, Mass.
- 1 AGE Donald Eddy, 28 Summer St., Lancaster, N. H.
- 1 AJM Albert Cloutier, 27 Mt. Pleasant Ave., Leominster, Mass.
- 1 AJW William Hoisington, 105 Gardner Rd., Brookline, Mass.
- 1 AKV John Daugherty, 161 Oak St., Providence, R. I.
- 1 ALF Philip Robinson (Portable), 119 Hollis Ave., Braintree, Mass.
- 1 ALN Aram Paronassian, 3 Milford St., Boston, Mass.
- 1 AMO William C. Doonan, 90 Columbia Ave., Malden, Mass.
- 1 AMU Franklin B. Rowell, 105 Cedar St., Pawtucket, R. I.
- 1 ANZ John Medeiros, Jr., 58 Jenny Lind St., New Bedford, Mass.
- 1 AOB James N. Oswald, South Paris, Me.
- 1 ARX Glen Aikman, 52 N. Prospect St., Burlington, Vt.
- 1 AUB Jack P. Ooley, Union St., Mills, Mass.
- 1 AWX Acholphe Plante, Jr., 511 Hillman St., New Bedford, Mass.
- 1 AXG John F. Desmond, 508 Hillman St., New Bedford, Mass.
- 1 BG Roger M. Spicer, 7 Milled Ave., Holyoke, Mass.
- 1 GO Carleton F. Wright, "Bayswater," Plymouth, Mass.
- 1 LI Raymond J. Mallory, State Sanitarium, Walling Lake, R. I.
- 1 QE Chester A. Baker, Main St., Gorham, Mass.
- 1 TQ Raymond A. Balkcom, 59 Progress St., Pawtucket, R. I.
- 1 UV Stephen A. Hammond, South St., Shrewsbury, Mass.
- 1 UW Clarence B. Goodwin, 8 Elizabeth St., Attleboro, Mass.
- 1 UX Carroll T. Downes, 221 Highland Ave., Arlington, Mass.
- 1 VB Laurence D. Yont, Chesham, N. H.
- 1 ABC Arthur Z. Smith, 12 Russell Ave., E. Providence, R. I.
- 1 ABQ Kendall W. Guilford, 48 1/2 Watertown St., Newtonville, Mass.
- 1 ADJ Thomas H. Kearney, 708 Howard Ave., Bridgeport, Conn.

- 1 AEA Joseph A. Sjogren, 22 Wood St., Whitneyville, Conn.
- 1 ANX Earl C. Burdick, 30 Palmer St., Pawcatuck, Conn.
- 1 BAB Everett E. Zissell, 183 Berkshire Ave., Bridgeport, Conn.
- 1 BAN C. C. Butler & K. V. R. Lansingh, Wellesey, Mass.
- 1 BBR Charles E. Kachele, 149 Lamartine St., Jamaica Plain, Mass.
- 1 BDT Sheldon S. Heap, 132 Atlantic St., Quincy, Mass.
- 1 BHG Edmund Howard, 88 Cedar St., New Haven, Conn.
- 1 BJA Edmund W. Schwarzenberg, 27 Boylston St., Lawrence, Mass.
- 1 BKK Leon E. Felker, 34 Glenview, Augusta, Me.
- 1 BSG Ransom H. Willard, 30 Revere St., Malden, Mass.
- 1 BTU Harold W. Birk, 339 Main St., Hockanum, Conn.
- 1 BWV Everard W. Dalton, 129 Main St., Brattleboro, Vt.
- 1 GA George A. Hinckley, 16 Montvale St., Roslindale, Mass.
- 1 OA Schiller Kruse, 503 S. Main St., Silver Lane, Conn.

### Second District

- 2 KA Charles H. F. Hennig, 214 Van Buren St., Newark, N. J.
- 2 ABA Isidore Lazarowitz, 433 E. 68th St., N. Y. C.
- 2 AAN Stanley E. Hart, 19 Marshall Rd., Yonkers, N. Y.
- 2 AAX Nathan Rubinstein, 645 E. 9th St., N. Y. C.
- 2 AK John B. Koen, Randall's Island, South End, N. Y. C.
- 2 AV John L. Heins, Jr., Box 457, Bay Promenade, Saltare, Fla., Id. Beach, N. Y.
- 2 ALE Frank J. Ostman, Kampster Ave., Islip, N. Y.
- 2 AN Will J. Madoe, 129 Furman St., Brooklyn, N. Y.
- 2 JA David Carruthers, 135 Waverly Place, N. Y. C.
- 2 LM Arthur Davidson, 529 W. 147th St., N. Y. C.
- 2 ABJ Edgar Messing, New Ambassador Hotel, Long Branch, N. J.
- 2 ABC Joseph N. Morrison, 944 W. 6th St., Plainfield, N. J.
- 2 AQC Raymond H. Gore, 13 Cleveland St., Caldwell, N. J.
- 2 ABU William R. Giannattasio, Martense & Moore Place, South Elmhurst, N. Y.
- 2 AZ George Y. Allen, 23 Waldo Ave., Bloomfield, N. J.
- 2 ACQ Newburgh Radio Shop, Inc., 125 Broadway, Newburgh, N. Y.
- 2 BC Raymond Robertori, 31 Hudson Place, Weehawken, N. J.
- 2 CRC Fred B. Woodworth, 82 Broad St., Bloomfield, N. J.
- 2 AAQ Robert E. Johnson, Villa & Livingston St., Yonon, N. Y.
- 2 FB Robert E. Kearney, 19 St. Paul's Rd., Hempstead, N. Y.
- 2 ACT Howard T. Cervantes, 4541 Heiser St., Woodside, N. Y.
- 2 BS Theodore Heinenmeyer, 4 Fernwood Terrace, Elizabeth, N. J.
- 2 ACH Edward W. Taylor, 724 Hobert Ave., Plainfield, N. J.
- 2 ACP Frederick Boardman, 553 Chrysler Ave., Schenectady, N. Y.
- 2 CU Oscar Oehmen, Dock Rd., Springfield, N. Y.
- 2 ACR Walter Baron, 27 2nd St., Maspeth, N. Y.
- 2 DS Jesse W. Holland, 570 9th St., Brooklyn, N. Y.
- 2 CL James R. Heeney, 336 W. 29th St., N. Y. C.
- 2 CS Gustav Lux, 1396 Avenue A, N. Y. C.
- 2 AFR Fordham Radio Laboratory, 584 E. 191st St., N. Y. C.
- 2 CH Kenneth R. Cooke, 86 Van Houten Place, Belleville, N. J.
- 2 DK Alfred R. Marcy, 2687 Heath Ave., N. Y. C.
- 2 CD Percy Ridout, 225 McClellan St., N. Y. C.
- 2 ACW Abraham Elterman, 115 E. 29th St., Brooklyn, N. Y.
- 2 CJS George M. Smith, Jr., Waterford Rd., Island Park, Long Beach, N. Y.
- 2 ATN Harold J. Walters, 1430 Commonwealth Ave., N. Y. C.
- 2 LO Nelson Dunham, 181 Neilson St., New Brunswick, N. J.
- 2 CQD Winfield G. Beck, 116 Warren Ave., Roselle Park, N. J.
- 2 ANS Alfred B. Cartier, 1026 Grant Ave., N. Y. C.
- 2 ACX George Hastings, 9 Central Ave., Troy, N. Y.
- 2 DD William F. Kavanah, Seymour Place, Yonkers, N. Y.
- 2 ADN George B. Engelhardt, 373 Ocean Ave., Brooklyn, N. Y.
- 2 FA William E. Devereux, 1371 Greene Ave., Brooklyn, N. Y.
- 2 EF Herman W. Bryan, 402 Ocean Ave., Brooklyn, N. Y.
- 2 ADP George Phelps, Shorehead, Oyster Bay, N. Y.
- 2 AIN Charles I. Hodgson, 187 15 Plymouth St., Hollis, N. Y.
- 2 AZZ Robert M. Averill, 360 Lenox Ave., So. Orange, N. J.
- 2 CXR Robert M. Lacey, 17 W. 54th St., N. Y. C.
- 2 XNB College of City of New York, Townsend-Harris Hall Radio Club, 140th St., N. Y. C.
- 2 XN Radio Corp. of America, Van Cortlandt Pk., South & Saxon Ave., N. Y. C.
- 2 XBI People's Pulpit Assn., 105th St., Rossville, N. Y.
- 2 XNA College City of New York City College Radio Club, 140th St. & Convent Ave., N. Y. C.
- 2 BAQ Charles Bruns, 143 5th Ave., North Pelham, N. Y.
- 2 GC Albert E. Sonn, 68 Yantecap Ave., Bloomfield, N. J.
- 2 AEK Buzalski, Thomas J., 50 Fairbank St., Hillside, N. J.
- 2 AEP Edward Stroetz, 1233 Greene Ave., Brooklyn, N. Y.
- 2 AEO Peter Testan, 2123 Troy Ave., Brooklyn, N. Y.
- 2 AFE Morton Singer, 1273 Eastern Parkway, Brooklyn, N. Y.
- 2 APN Herman Lehner, 1327 Wilkins Ave., Bronx, N. Y.
- 2 EN Edwin Alexander, 305 Huguenot St., New Rochelle, N. Y.
- 2 EZ Thomas J. O'Dea, 351 Sussex St., Paterson, N. J.
- 2 FM Edward Williams, 136 New St., Newark, N. J.
- 2 FP Vernon C. Macnabb, 26 Whittelsey Ave., East Orange, N. J.
- 2 GG Elias Shapiro, The Observatory, U. S. Military Academy, West Point, N. Y.
- 2 KL Arthur V. Gregory, 67 Broad St., Red Bank, N. J.
- 2 CQP Harold W. Davis, 457 E. 35th St., Paterson, N. J.
- 2 KR Morton B. Kahn, 617 W. 141st St., New York, N. Y.
- 2 EQ Charles F. DuBois, 75 Prospect Park West, Brooklyn, N. Y.
- 2 ADC John Rogers, 154 Senator St., Brooklyn, N. Y.
- 2 BQ Frederick T. Hausie, Junction & Kingsland Ave., Corona, N. Y.
- 2 CDR Milton E. Walker, Jr., 296 Whitford Ave., Nutley, N. J.
- 2 BYV Hugh V. D. Roberts, 173-55 105th Ave., Jamaica, N. Y.
- 2 AV John L. Heins, Jr., Merrick Rd., Babylon, N. Y.
- 2 GH Myles Hardy, 618 St. Nicholas Ave., New York, N. Y.

- 2 AIZ Richard Weir, Jr., Box 145, Locust Valley, N. Y.
- 2 AJM John N. Brahy, 283 Crescent St., Long Island City, N. Y.
- 2 AJO Erieh Potts, 4544 Hudson Blvd., Union, N. J.
- 2 ABK Robert Kuhn, 95 Pilling St., Brooklyn, N. Y.
- 2 AIP Leroy F. Spangenberg, 15 Cottage Pl., East Orange, N. J.
- 2 AGI Karl Rossbach, 620 Wyoming Ave., Elizabeth, N. J.
- 2 AGH Isidore Fiseinberg, 497 Riverdale Ave., Brooklyn, N. Y.
- 2 GN Arthur D. Hopper, Central Ave., Pearl River, N. Y.
- 2 GX Russel Deloye Valentine, 40 Broad St., Newark, N. J.
- 2 AJS Max Coroff, 1227 Boston Rd., New York, N. Y.
- 2 GS Albert C. Schuster, 750 Franklin Ave., Brooklyn, N. Y.
- 2 AJI Ferdinand Henry Bischoff, 222-16 Cherry Ave., Springfield, N. Y.
- 2 AVJ Jean Meyer, 503 Savoye St., West Hoboken, N. J.
- 2 AJK William Franck, 299 Pacific St., Paterson, N. J.
- 2 AJJ Harry Flyer, 361 Macy Place, New York, N. Y.
- 2 HA Peter Testan, 2123 Troy Ave., Brooklyn, N. Y.
- 2 GP Jesse W. Baldwin, 485 Central Park West, New York, N. Y.
- 2 AJQ Norman G. Schutt, 420 Park Hill Ave., Brooklyn, N. Y.
- 2 CHU Harold Davidson, 6 Morningside Ave., New York, N. Y.
- 2 BUM Edward Heuerhusen, 47 Garfield Pl., Lynbrook, N. Y.
- 2 AFG Robert T. DeCamp, Jr., 120 Central Ave., Newark, N. J.
- 2 LM Arthur Davidson, 527 W. 150th St., New York, N. Y.
- 2 ER Charles W. Brown, 84 Somers St., Brooklyn, N. Y.
- 2 ARB John J. Kulik, 124 Clifton Ave., Clifton, N. J.
- 2 CZJ Frank Evans, 5920 4th Ave., Brooklyn, N. Y.
- 2 CXP Edna Radio & Elec. Co., 548 Howard Ave., Brooklyn, N. Y.
- 2 AES John Hartnett, 359 E. 135th St., New York, N. Y.
- 2 AHA J. Clarence Keenan, 865 St. Nicholas Ave., New York, N. Y.
- 2 AKB Charles Butt, 310 Paige St., Schenectady, N. Y.
- 2 ANQ Charles Struble, 601 Page Ave., Asbury Park, N. J.
- 2 HE Maurice Sufirin, 167 Cornelia St., Brooklyn, N. Y.
- 2 ALD Peter Speth, 137 Astoria Ave., Astoria, N. Y.
- 2 AKV Charles E. Warren, Jr., Hawlett, N. Y.
- 2 GU Lettets A. McClelland, Jr., 78 McDonough St., Brooklyn, N. Y.
- 2 AJL Samuel Gottenker, 388 E. 10th St., New York, N. Y.
- 2 BBN John T. Wilcox, 518 9th St., Carlstadt, N. J.
- 2 BBH Bernard Zweig, 101 W. 52nd St., Bayonne, N. J.

### Eighth District

- 8 BY Wm. J. Massey, 102 Water St., Buffalo, N. Y.
- 8 CL Alexander Darragh, 255 College Ave., Beaver, Pa.
- 8 JZ Paul D. Tennant, Shinnston, W. Va.
- 8 LO Toledo Radio Club, Nasby Bldg., Toledo, Ohio
- 8 NT Stuart W. Farmer, 233 West Perry St., Buffalo, N. Y.
- 8 RA Dwight P. Hill, R. F. D. No. 1, 43M2 Clover St., Cleveland, Ohio
- 8 UP Merrell Kent, 517 Teuth St., Monessen, Pa.
- 8 AAM Walter Shultz, 327 Oxford St., Alliance, Ohio
- 8 AEZ Dean R. Baker, 207 E. DeFrance, DeFrance, Ohio
- 8 ANG Charles F. Gilbert, 428 Third St., Toledo, Ohio
- 8 AQR John J. O'Connor, Kiskiminetas School, Salsburg, Pa.
- 8 ASH Emory E. Bowen, R. F. D. No. 5, Ionia, Mich.
- 8 AUM Robt. Gilliland, 1036 Brownell St., Lorain, Ohio
- 8 AVY L. Donald Koons, R. D. No. 2, Waverly, N. Y.
- 8 AWB Raymond D. Reichel, 2457 Bailey St., Buffalo, N. Y.
- 8 AWZ John H. Fuhrman, 4303 Beech Hill Ave., N. S., Cincinnati, Ohio
- 8 ANO Alfred K. Harvey, 1621 Capuchin Ave., Serrano, Pa.
- 8 AYH Emil Gasteb, Washington Pike, Bridgeville, Kirwan Hts., Pa.
- 8 AYY McCabe Murden, 1016 N. Pine St., Lansink, Mich.
- 8 BAB Guy Lempink, 308 Barnes St., Wilkinsburg, Pa.
- 8 BAC Robt. T. Schlaneder, 3471 East 149th St., Cleveland, Ohio
- 8 BBA Harold Brundage, 302 Connecticut St., Buffalo, N. Y.
- 8 BBL Coleman Murphy, 55 Dinsmore Ave., Crafon, Pa.
- 8 BER Richard Palmer, 207 John St., Owosso, Mich.
- 8 BOK Wm. H. Roberts, 3 Park St., Amsterdam, N. Y.
- 8 BOL Robt. Squibb, Clark St., Cambridge, Ohio
- 8 BQM John H. Fufsdiller, Fargo St. No. 44, Buffalo, N. Y.
- 8 BGN Lawrence Cook, 731 Delaware Ave., Buffalo, N. Y.
- 8 BSA Martin L. Mroch, 925 Tecumseh St., Toledo, Ohio
- 8 BTG Ralph Walters, 3891 West 38th St., Cleveland, Ohio
- 8 BTZ Alfred G. Nickley, R. F. D. No. 3, Vermilion, Ohio
- 8 BUE Frank Harris, 1307 Russell St., Detroit, Mich.
- 8 BUR Thomas B. Pinxton, 3340 Mayfield St., Cleveland Heights, Ohio
- 8 BUS Stanley R. Pearce, Fifth St., Lewiston, N. Y.
- 8 BVE Donald Mahaffey, 712 Dearborn St., Cleveland, Ohio
- 8 BWA Anthony Carnevale, 523 West Ave., Buffalo, N. Y.
- 8 BWE Geo. Minsel, Brown St., Toledo, Ohio
- 8 BWW Robert T. Ferguson, Moxahala, Ohio
- 8 BXM Mortimer J. McConnell, Main St., Arsenal Station, Pittsburgh, Pa.
- 8 BSR Norman L. Moyer, 132 Riverside St., Buffalo, N. Y.
- 8 BYR John C. Coven, 321 Philadelphia Ave., Detroit, Mich.
- 8 BYV Harry Kraus, 3601 Trent Ave., S. W., Cleveland, Ohio
- 8 BZB Wm. Schoener, Cherry St., Gnadenhuthen, Ohio
- 8 BZE Clarence W. Boltz, 626 Goodyear St., Buffalo, N. Y.
- 8 BZI Frank Herzig, 6060 Edgewater St., Toledo, Ohio
- 8 BZO Clifford C. May, 418 Clinton St., Owosso, Mich.
- 8 BZW Wm. D. Settle, Main St., West Lafayette, Ohio
- 8 BZY Henry Eckhardt, 712 Dearborn St., Cleveland, Ohio
- 8 CAO Norman Senf, 447 Catalina Ave., Youngstown, Ohio
- 8 CAQ Violet Miller, 27 King St., Elred, Pa.
- 8 CAR Anthony A. Abraham, 30 Windsor St., Rochester, N. Y.
- 8 CEG Gordon E. Hann, 1519 Wood Rd., Cleveland Heights, Ohio
- 8 COB John A. Yurginos, 5000 McBride Ave., Cleveland, Ohio
- 8 COC Clyde H. Peet, Coral Ave., Trilby, Ohio
- 8 CBQ Charles K. Deming, 213 Prospect St., Cadillac, Mich.
- 8 DLJ Carl A. Pilkington, Portland, Mich.
- 8 DOP Lawrence Hennigan, 27 King St., Elred, Pa.
- 8 DSR John Bruning, Jr., 2344 Clifton Ave., Cincinnati, Ohio
- 8 LR Roy R. Palmer, 325 N. Penn Ave. (Rear), Lansing, Mich.
- 8 ON Gordon W. Jewett, 510 Clay St., Watertown, N. Y.
- 8 TX Earl H. Schwenger, 1924 E. 93rd St., Cleveland, Ohio
- 8 UX Donald A. Hoffman, 1551 Suite 8, E. 93rd St., Cleveland, Ohio
- 8 AZC Levon McDonald, 214 Lansing St., Owosso, Mich.
- 8 ARV Joseph J. Elias, 6371 Army St., Detroit, Mich.



# 3 Tubes DO THE WORK OF 6

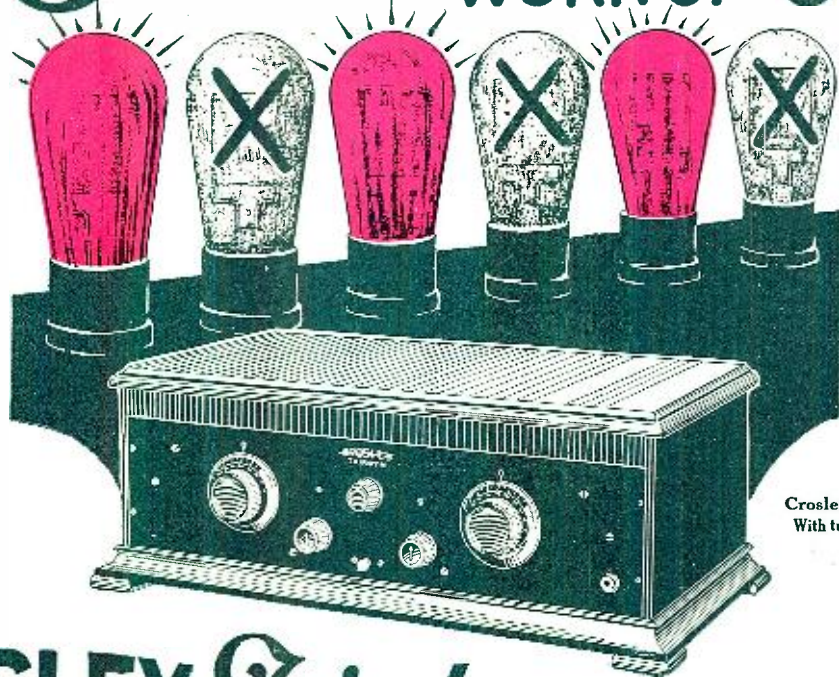

Crosley Trirdyn Special, \$60.00  
With tubes and Crosley Phones, \$75.75

## In the CROSLEY Trirdyn

SINCE the inception of radio, the results obtained with Armstrong Regenerative Receivers have been the goal of comparison for all others. Trick circuits have been designed to get around the Armstrong Patent hoping to obtain results "just as good." This has resulted in the use of more tubes, necessary without, but unnecessary with regeneration.

This is one reason why Crosley Radios, licensed under Armstrong U. S. Patent No. 1,113,149 have performed everywhere so remarkably on so few tubes.

The Crosley Trirdyn, employing Armstrong Regeneration combined with tuned non-oscillating radio frequency amplification and reflexed audio frequency amplification and using only three tubes, consistently gives greater selectivity, more volume and wider range than can be obtained where five or six tubes are employed without regeneration. With no regeneration, two stages of radio frequency amplification, requiring at least two additional tubes, must be employed in front of the detector tube to get the same results as furnished by one tube where regeneration is used.

Every additional tube means additional expense; an added dial to tune, greater difficulty in operation, more distortion and more tube noises. The three tube Crosley Trirdyn has only two dials. These operate but two circuits, making tuning and logging very easy.

You can't beat the results obtained from an Armstrong Regenerative Crosley Radio. A trial will convince you.

**BEFORE YOU BUY—COMPARE  
YOUR CHOICE WILL BE A CROSLEY  
For Sale By Good Dealers Everywhere**

*Crosley Regenerative Receivers are licensed under Armstrong  
U. S. Patent 1,113,149. Prices West of Rockies—Add 10%*

*Write for Complete Catalog*

### THE CROSLEY RADIO CORPORATION

Powel Crosley, Jr., President

228 Sassafras St.

Cincinnati, Ohio

*Crosley Owns and Operates Broadcasting Station WLW*

### CROSLEY Better—Costs Less Radio

*Crosley  
Head Phones  
Better—Cost Less  
\$3.75*



Crosley One Tube  
Model 50, \$14.50  
With tube and Crosley Phones \$22.25



Crosley Two Tube  
Model 51, \$18.50  
With tubes and Crosley Phones, \$30.25



Crosley Three Tube  
Model 52, \$30.00  
With tubes and Crosley Phones \$45.75



Crosley Trirdyn Regular, \$50.00  
With tubes and Crosley Phones, \$65.75



Crosley Trirdyn Newport, \$85.00  
With tubes and Crosley Phones, \$100.75



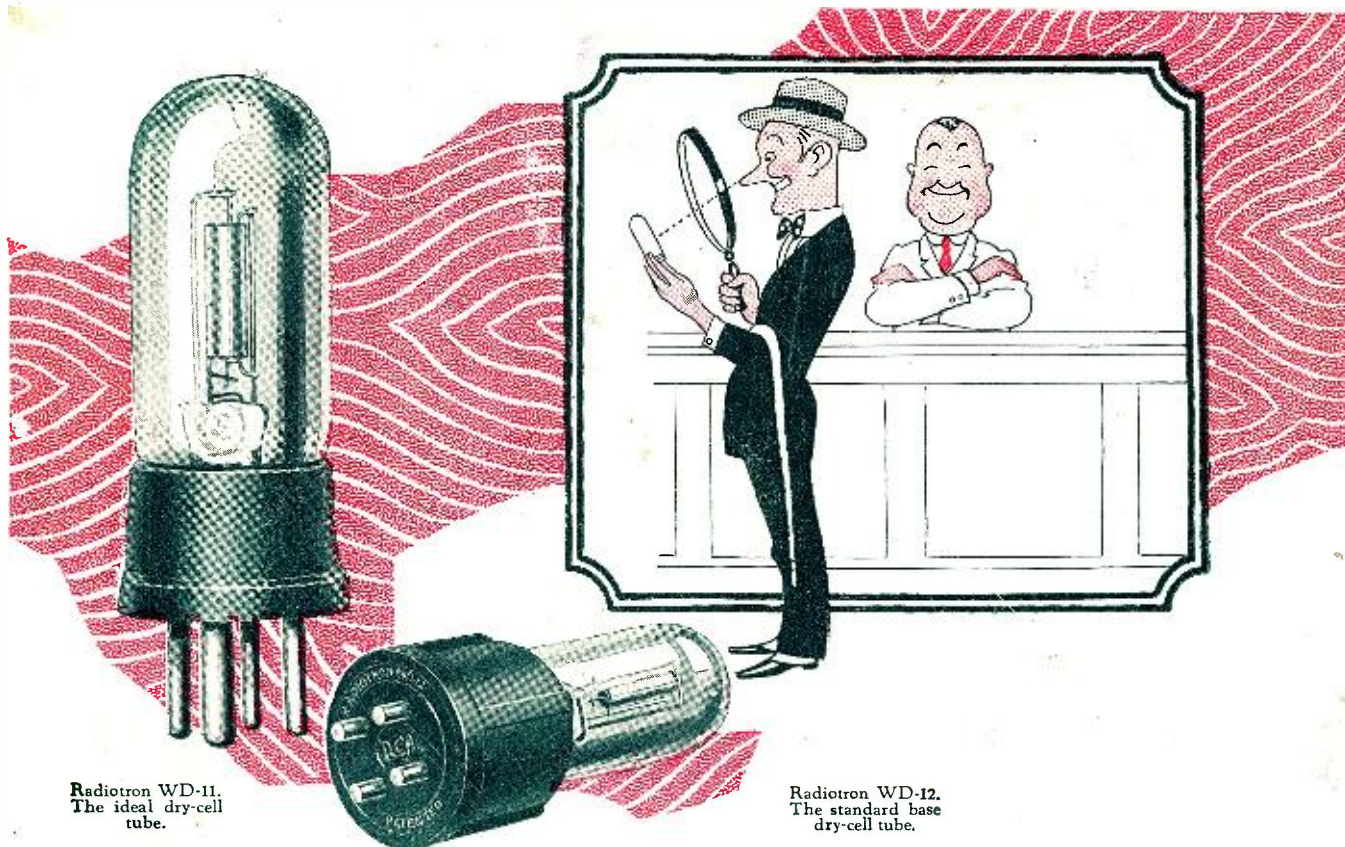

Radiotron WD-11.  
The ideal dry-cell  
tube.

Radiotron WD-12.  
The standard base  
dry-cell tube.

# For *Distance* ~ the *tube* is important

Radiotrons WD-11 and WD-12 are the same except for the base.

Radiotron WD-12 has a standard navy type base. Use it to change your set to dry battery operation. Ask your dealer today.



This symbol of  
quality is your  
protection

Radio reception is not only a question of power, but of sensitivity to weak signals—and *clear* amplification. Radiotrons WD-11 and WD-12 are sensitive to the extremely feeble signals from distant stations — are silent in operation—and economical. They are famous for radio frequency amplification as for audio frequency—and detection. Get *genuine* WD-11's or WD-12's. Look for the name Radiotron and the RCA mark.

Radio Corporation of America

Sales Offices:

233 Broadway, New York

10 So. La Salle St., Chicago, Ill.

28 Geary St., San Francisco, Cal.

# Radiotron

REG. U. S. PAT. OFF.