

February 1922
PRINCETON UNIVERSITY

25 CENTS

RECEIVED
FEB 27 1922
LIBRARY

The

WIRELESS AGE

Volume 9

Number 5



Entertainment by radiophone even out at sea has become as popular as the movies and movie stars are becoming interested

Radiophone Broadcasting Station WDY

And Many Exclusive Features in This Issue
Original from PRINCETON UNIVERSITY

WORLD'S ONLY MAKER

Moulded High Frequency High Tension Insulators

POTENTIALS 1,000 — TO — 1,000,000 VOLTS



Medal and Diploma
received at
World's
Columbian
Exposition
Chicago, 1893



ELECTROSE
REG. U.S. PAT. OFF. & FOREIGN COUNTRIES.

INSULATION
"MADE IN AMERICA"

Louis Steinberger's Patents



Medal and Diploma
received at
World's
Fair,
St. Louis,
1904



- ARRIVED -

TRADE
ELECTROSE
MARK
REG. U.S. PAT. OFF. & FOREIGN COUNTRIES.

AIR-GAP

Louis Steinberger's Patents

Radio Frequencies
Radio Telegraph
Radio Telephony
X-Ray Apparatus
Damped or Sustained
Voltages

Air Gap
1-4" and Upward

Maximum Dielectric
Strength

Minimum Dielectric Loss
Minimum Weight

Materials so proportioned that:

MAXIMUM ELECTRIC STRESSES FORMED IN AIR

EXTENSIVE TESTS under sustained radio frequency operation show:

**NO HEATING
ARC-OVER ESTABLISHED IN AIR**

"ELECTROSE" Insulators are standard with United States Navy and Army and Wireless Telegraph and Telephone Companies.

"ELECTROSE" is made in a number of grades for various requirements, each grade possessing special characteristics.

"ELECTROSE" Insulators—Best in the World for High Frequency Currents, Power and Transmission Circuits.

SOLE MANUFACTURERS

ELECTROSE MFG. CO.

60-82 Washington Street
66-76 Front Street

27-37 York Street
1-23 Flint Street

Brooklyn, N. Y., America

- ARRIVED -

TRADE
ELECTROSE
MARK
REG. U.S. PAT. OFF. & FOREIGN COUNTRIES.

AIR-GAP

Louis Steinberger's Patents

Audio Frequencies
Transmission Lines
Sub Station Insulators
Transformer Insulators
Oil Switch Insulators
Circuit Breakers, Bus-bars,
Supports, Etc., Etc.

Air Gap
1-4" and Upward

Maximum Mechanical
Strength

Minimum Cost
Minimum Physical Dimensions

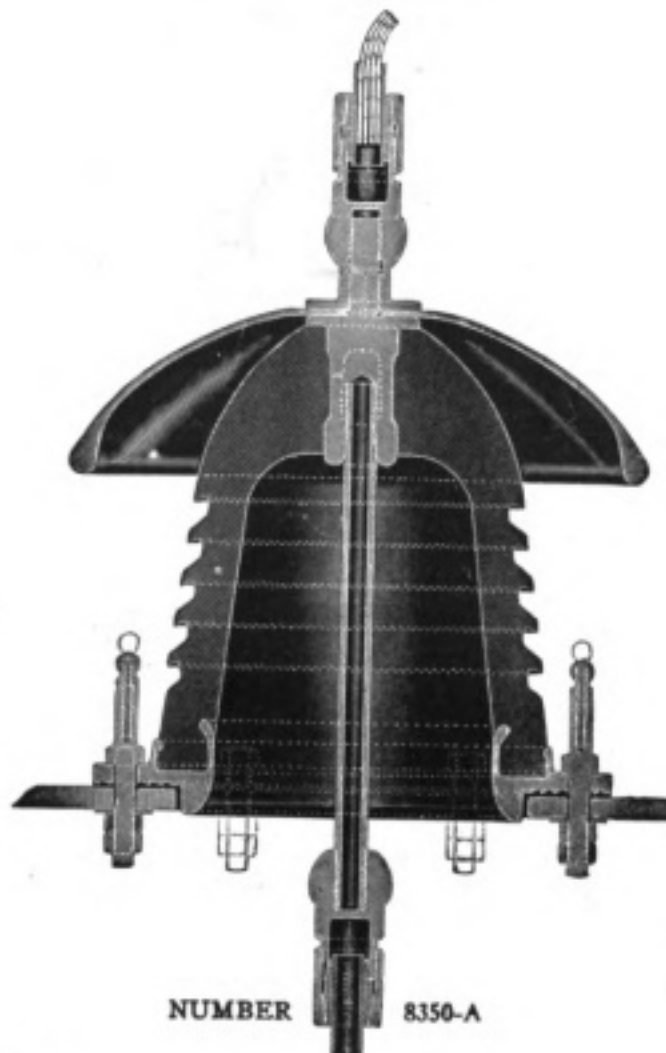



Ask For These Folders

They tell all about Westinghouse Radio Receiving Sets, and about the Broadcasting Stations that provide a carefully balanced and judiciously chosen series of nightly entertainments, including news, weather, crop and stock reports, all kinds of sporting events and, on Sundays, complete church services.

Broadcasting stations are located as follows:

East Pittsburgh, Pa., Station "KDKA"	- -	360 Meters
Newark, N. J., Station "WJZ"	- - - -	360 Meters
Springfield, Mass., Station "WBZ"	- - - -	360 Meters
Chicago, Ill., Station "KYW"	- - - -	360 Meters

WESTINGHOUSE ELECTRIC & MANUFACTURING CO.
EAST PITTSBURGH, PA.

Westinghouse

Digitized by Google

Original from
UNIVERSITY OF MICHIGAN

When writing to advertisers please mention THE WIRELESS AGE

Contents of THE WIRELESS AGE for Feb., 1922

VOLUME 9

Edited by J. ANDREW WHITE

No. 5

WORLD WIDE WIRELESS	15	An Efficient Five-Watt Tube Transmitter. By L. R. Felder	30	A Short, Medium and Long Wave Receiver. By E. T. Jones	38
Radiophone Broadcasting Station WDY. 18		Batteries Reverse Polarity at Low Temperature	31	A New Type of Coupler for Short Waves 39	
The UV-217 Kenotron—Its Operation and Application	20	The Dimensions of Inductances. By C. M. Grabson	34	A Hook-Up That Simplifies Tuning. By F. C. Greenwald	40
Radiophone Broadcasting	26	1QP an Active Station	36	N. A. W. A.	41
EXPERIMENTERS' WORLD		A Very Simple Radiophone	36	STATIONS WORKED AND HEARD	43
A Five-Watt Vacuum Tube Transmitter. By Geo. Louis Gates (first prize)	28	Portable Radio Set	37	QUERIES ANSWERED	48
A Five-Watt Tube Transmitter. By Floyd Rittman (second prize)	29				
ADVERTISEMENTS					
Acme Apparatus Co.	54	Firth & Co., John	52	Pinkerton Electric Equipment Co.	61
Adams-Morgan Co.	51	France Mfg. Co., The	62	Pioneer Electric Co.	58
American Electro Technical Appliance	58	General Radio Co.	47	Pitts Co., F. D.	6. 54
American Eveready Works	3	Grebe & Co., A. H.	61	Precision Equipment Co.	55
Andrea, Frank A. D.	62	Hommel & Co., Ludwig	45	Q.S.T. American Radio Relay League	60
Andrews & Hollingwood	45	Johnston, Chas. H.	57	Radio Corporation of America	4. 5. 12
Atlantic Radio Co., The	57	Jones Radio Co., The	59	Radio Distributing Co.	32. 33
Atlantic-Pacific Radio Supplies Co.	51	Kalb Electric Co.	55	Radio Institute of America	8. 11
Automatic Electrical Devices Co.	48	Karlowa Radio Co.	58	Radiotelec Shop	61
Benson, Albert G.	58	Kennedy Co., The Colin B.	63	Rice Mfg. Co.	63
Brandes, C.	62	Keystone Radio Co.	54	Ship Owners Radio Service, Inc.	61
Bunnell & Co., J. H.	56	Klosner Apparatus Co.	53	Simplex Radio Co.	57
Chambers Inst. of Wireless Telegraphy	60	Linze Electrical Supply Co.	59	Somerville Radio Lab.	54
Chicago Radio Apparatus Co.	59	Magnavox	7	Stanton & Co., Frank T.	57
Clapp-Eastham Co.	60	Manhattan Electrical Supply Co.	58	Stockwell, P. J.	63
Continental Fibre Co., The	Third Cover	Marshall-Gerken Co.	2	Tresco	57
Continental Radio & Elec. Co.	64	Mass. Radio & Telegraph School	63	Tuska Co., The C. D.	55
Corwin & Co., A. H.	57. 60	Million Point Mineral Co.	58	Tufts, W. & G.	58
Crosley Manufacturing Co.	Fourth Cover	Murdoch Co., Wm. J.	14	Vibroplex Co., The	50
Davis Co., C. A.	55	Mu Radio Laboratory	44	Western Radio Electric Co.	46
Diamond State Fibre Co.	56	Mutual Purchasers Association	59	Westinghouse Electric & Mfg. Co.	1
Doubleday-Hill Electric Co.	60	Newman-Stern Co., The	57	Weston Electrical Instrument Co.	10
Dreyfuss Sales Corp.	60	Nola Radio Co.	11	Whitall Electric Co.	63
Duck Co., The William B.	54	New York Wireless Institute	11	Wireless Equipment Co.	45
Eastern Radio Institute	54	Omnigraph Mfg. Co.	53	Wireless Press, Inc.	9. 13
Electrose Mfg. Co.	Second Cover	Parent Electric Co., Inc.	48	Y. M. C. A. Radio School	56
Executive Radio Council	49	Phila. School of Wireless Telegraphy	59	SMALL ADS OF BIG INTEREST	62
Federal Telephone & Telegraph Co.	55				

RENEWALS—When subscription expires you will find a renewal blank enclosed. Return with remittance promptly.
CHANGE OF ADDRESS—Notify us of any change in your address, giving both the old and new location.

PUBLISHED MONTHLY AT WIRELESS PRESS, INC., 326 BROADWAY, NEW YORK

GREAT BRITAIN, 12-13 Henrietta St., London. AUSTRALIA, 97 Clarence St., Sydney, N. S. W.

Yearly subscription in U. S. A., \$2.50—Outside U. S. A., \$3.00; Single Copies, 25 cents.

Entered as second class matter Oct. 9, 1913. Post Office, New York, N. Y., under the Act of March 3, 1879. Copyright, 1922, Wireless Press, Inc.
Edward J. Nally, Pres. J. Andrew White, Vice-Pres. L. MacConnach, Sec'y. George DeSousa, Treas. J. D. Conmee, Business Mgr.

Owing to the fact that certain statements and expressions of opinion from correspondents and others appearing in these columns from time to time may be found to be the subject of controversy in scientific circles and in the courts, either now or in the future, and to sometimes involve questions of priority of invention and the comparative merits of apparatus employed in wireless signalling, the owners and publishers of this magazine positively and emphatically disclaim any privity or responsibility for any statements of opinion or partisan expressions if such should at any time appear herein.
Printed in U. S. A.

The Demand

For Marshall-Gerken Products

has been so great that a congestion of orders for our most popular parts can only be avoided by concentrating our future efforts on the manufacture of the following:

New Moulded Variometer

with bronze spring connections.
Their correct weight renders screws unnecessary for table operation—four screws supplied for panel mounting. Type M.V.G. for Grid and Type M.V.P. for plate. \$6.50

Detectors and Amplifiers

New style detectors and amplifiers, used alone or inter-paneled. Their neat appearance and operating efficiency have gained instant and general popularity.

DETECTORS	AMPLIFIERS
Detector-Only	One-Stage Amplifier
Detector-One Step	Two-Stage Amplifier
Detector-Two Step	Three-Stage Amplifier
Detector-Only and One-Stage Amplifier Only	

Furnished With or Without Cabinets.

Small Parts and Switch Arms

Switch Levers, Grid Condensers, Graphite Potentiometers, Binding Posts, Knobs, Contacts, Switch Arms, Metal Scales, Brass Slides, Rheostat Sectors, Name Plates, Detector Cups, Helix Clips, Stop Pins.

Standard Vario-Coupler

Designed to accompany our Moulded Variometer. Primary adjustments are varied in units of 1 and 6 turns respectively. They are standard equipment with discriminating users everywhere. \$5.00

New 'Read'Em' Binding Posts

Do away entirely with engraving panels, thus saving expense and confusion; give specific directions and add to appearance of set; insure correct Hook-up.

We are Distributors for:

Radio Corp.	Relly-Klotz	Weston meters
Westinghouse	"Arkay" Radio	Facnet Electric
Baldwin Phone	horn	Signal Electric

Dealers will enjoy our new service—our stock is complete and an even, steady flow of production of parts keeps us in a position to make shipments on time.

The Marshall-Gerken Company

Manufacturers and Jobbers

U.S.A.

UNIVERSITY OF MICHIGAN

THE WIRELESS AGE

WORLD WIDE WIRELESS

International Radio Station in Brazil

ANNOUNCEMENT that plans have been completed for an international radio central at Rio de Janeiro, Brazil, which will be modelled upon the plans of the big American radio station on Long Island, was made by E. F. W. Alexanderson, wireless expert for the General Electric Company and Chief Engineer of the Radio Corporation of America.

Mr. Alexanderson, who has just returned from a conference with radio engineers from the United States, Britain, France and Germany, said the monster station would be constructed by the International Radio Company and that a sub-station would be built at Para.

+ + +

Goldsmith Comments on Amateur Transatlantic Achievement

PROFESSOR Alfred N. Goldsmith, head of the radio and electrical departments of the College of the City of New York, commented on the success of the six wireless amateurs at Greenwich, Conn., who succeeded in transmitting a message to Ardrossan, Scotland, spanning the Atlantic with the feeble power and short wave length to which amateurs are restricted by law.

"This feat has aroused the keenest interest among the 100,000 or more wireless enthusiasts in this country," said Professor Goldsmith.

"If the British radio regulations for amateurs were no stricter than those of the United States, the boys in England might accomplish similar feats.

"Due to the strict British laws, however, the British amateurs are confined at present to reception only, and the sending must be done from this side."

Prof. Goldsmith compared the picking up of the feeble signals in Scotland to the perception by eyesight of the rays of an ordinary electric bulb at a distance of 3,000 miles. This, he asserted, would give an intimation of the extraordinary sensitiveness of the

receiving instruments which picked up the amateur signals abroad.

"The power used by the wireless amateurs in transmission is not much more than that used by a large electric bulb," he said. "The only difference is that the light rays are visible to the human eye, while the radio energy is not and must be recorded by electrical instruments which convert them into sounds that may be converted by the human ear."

Radio Warns of Volcanic Eruption in Mexico

WIRELESS warnings relayed from the City of Mexico to Point Isabel picked up at a local National Guard radio station, stated that Popocatepetl was in violent eruption, and all towns in the vicinity of the volcano were warned that the eruptions were the most serious of any since the volcano suddenly started.



Surgeon-General Hugh S. Cumming of the United States Health Service inaugurating the radiophone health bulletin service which is broadcasted twice a week from Washington

Radio Call Brings Doctor by Airplane

A PHYSICIAN at the Naval Air Station went by airplane from Norfolk to Hatteras, N. C., 130 miles, to take medical aid to the wife of a naval radio operator at the North Carolina station.

Hatteras is two hours from Norfolk by air, but it is three days from here by overland route. The naval radio station there has no physician, but a hospital man gives such medical attention as he can.

He sent a wireless message for a doctor, reporting that the wife of one of the operators was seriously ill. Lieutenant L. B. Stump left the Norfolk air station, carrying Dr. Angel as a passenger. The doctor found the patient suffering from pneumonia, for which he prescribed and gave instruction as to treatment.

Radio Station North of the Arctic Circle

A WIRELESS station has been established on an Arctic island, according to "The Daily News." The intrepid party of scientists who set out to establish a wireless observatory on the lonely island of Jan Meyen, in the North Atlantic, 300 miles north of the Arctic Circle, have now erected their wireless station and are sending out daily reports of the weather.

The party consists of a group of Cambridge naturalists, a representative of the Norwegian Weather Service, the secretary of the International Glacier Commission and a German wireless operator. They left Bergen, Norway, in two boats laden with wood for huts, a complete wireless installation, and oil fuel to work it, and a set of meteorological instruments.

No one has before stayed long on this cold island, the average temperature of which throughout the year is below the freezing point, but during the last century a rough map of the island, showing a glacier-covered mountain at one end, a fresh-water lake and several tiny harbors, was drawn by an Austrian explorer.

The object of the reports is to give warning of storms sweeping toward Europe from the polar regions to fishermen and shipping generally.

Radiophones on Paris Trains

WIRELESS telephone conversations between trains moving at the rate of forty miles an hour and the Paris central station, which have been achieved in the last few days, hold out a promise of greater safety for passengers, as well as a considerable diminution of intermediate signaling stations.

Antenna constructed on top of an ordinary coach were in constant communication with other antenna between two telegraph poles midway of the experimental area and enabled the use of telegraph wires to carry the messages to the receiving point. The voice of a train conductor could be heard clearly over a distance of fifty miles by the receiving station in Paris as the train passed each station or railroad siding.

The Nord companies are extending the experiments as far as Calais. Wireless signaling from Paris as far as Rouen has been in use for several months and with complete satisfaction. Meanwhile the State lines are considering the elimination of obsolete telephonic dispatching.

Radiophone Studio Destroyed

THE Broadcasting Studio of the Westinghouse Radio station in Newark, N. J., was destroyed by fire on the night of January 17. It was caused by a flashlight discharge. The fire occurred at the close of a special performance and for a time endangered the lives of several hundred people who had attended the concert.

At the close of the performance, which featured Ida Geer Wheeler, soloist, and Edna Rockwell, accompanist, a photographer sought to take a flashlight photograph of the principals. They consented and took positions near the screen. When the flashlight was discharged burning specks of powder flew in all directions and set the screen on fire. The performers narrowly escaped.

In less than a minute the entire screen was aflame and the crowd, which was leaving the studio, began to fight for exits. A general alarm was

sounded and the company's fire department reported. In a short time they succeeded in getting the fire under control before it spread beyond the studio. Valuable Vocalion records and two pianos were destroyed.

The damage was estimated at \$7,000.

International Radio Congress Planned

A PROPOSAL for a congress of French, Belgian, English and American radiologists which would be held next year in Paris, was put before

personnel has orders to speed up the lightning service.

The first message was filed in the main telegraph office at Berlin at 9 o'clock in the morning, transmitted at 9.03, receipt acknowledged at 9.05, and telephoned to addressee at 9.10.

Army Gives Up Wire for Radio

AS a means of economy the United States Army is communicating most of its messages between stations by radio instead of telegraph, it has been announced at Second



An interesting exhibit at the Radio Convention held in San Francisco. In the case at the right a Marconi coherer and a modern radiophone were exhibited showing the old and the new methods of radio reception. On a table behind the show case was shown a Marconi magnetic detector and an old-time tuner equipped with a crystal detector in striking contrast to the present day highly efficient vacuum tube receiver units

Radiological Society of North America, at its meeting in Chicago, Ill. Dr. A. E. Barclay of Manchester, England, suggested the international meeting.

The proposal has met with favor from the members and plans for formal action toward its realization are being launched.

Berlin "Lightning Wireless" Service

"LIGHTNING wireless service" was inaugurated recently between Berlin and Hamburg. Technically termed "Blitzfunk," or "lightning spark," the dispatches are to take precedence at a tenfold rate over all other wireless traffic, and the

Corps Headquarters, Governor's Island, New York.

The radio messages are sent and received by soldier operators of the Signal Corps, and as this organization is plentifully equipped with radio sets, the hundreds of messages necessary to the administration of the army now cost the government nothing except the time of the soldiers involved and the slight costs of operation.

Radiograms are sent daily from every army headquarters to posts and stations in the vicinity which are equipped to receive the messages. Second Corps area, for example, is in daily communication by radio with Puerto Rico and with the forts and stations adjacent to New York. The latest post to be equipped

with radio has been the U. S. Military Academy at West Point.

In order to keep a supply of trained operators on hand for the administration of the radio stations the U. S. Army General Recruiting Service is now recruiting young men who will be trained as radio operators and put to work handling the new system.

♦ ♦ ♦

Private Radio Stations in France

EVERY French manufacturer can now have a private wireless telephone system connecting his factories with the central office in Paris, thanks to the decision of the French Ministry to commercialize the recent wireless successes.

Whether this will be followed by general permission to install wireless telegraph apparatus on tops of Paris buildings on the payment of a substantial fee remains doubtful. It is evident, however, that the Government will not let anything stand in the way of obtaining new revenues, and as there is no longer any need for French censorship of either incoming or outgoing messages it is suggested that the time is not far distant when Paris correspondents will have direct communication with their newspapers across the Atlantic, each with a special calling signal and wave length assigned to him by the French Government.

The cost of maintaining land wires here is understood to have delayed the general use of the telephone, and, indeed, it is rarely that one finds a telephone in a private residence outside of Paris. But the extension of the wireless system promises to change all this. The Government is willing to rent the wireless apparatus at a rate of only \$25 a year a mile of communication involved and an additional \$2 a year a mile to cover all expenses of repair and the maintenance of communication free from the interference of other wireless users. This is ridiculously cheap when the cost of installation of an ordinary telephone in a private home or office today is almost \$100, with a yearly subscription, as the French call it, of \$70.

Of course the Government's offer does not apply except in connecting up two stations, but business men are confident that once the ground is broken it will develop into an auxiliary system that will grow so rapidly as to oust the present inefficient organization.

♦ ♦ ♦

German Radio Plant in Argentina

A NEW powerful German wireless station has been constructed at Monte Grande, in the Province of

Buenos Ayres, and successfully tested. Messages were received from stations 15,000 kilometres distant in the course of the tests. A code message being transmitted from San Francisco to Tokyo was picked up.

The station has been installed over an area of 569 hectares (approximately 1,400 acres). When completed, it will consist of six big towers, each of which is to be 210 metres high (approximately 630 feet). It is asserted that the station will be able to communicate with points all over the world. Service is to be started about the middle of next year for receiving, and in February, 1923, for sending.

♦ ♦ ♦

Isle of Yap Radio Regulations

UNDER the treaty, or convention, between the United States and Japan relating to the Island of Yap



Modern fire fighting service requires the use of radio apparatus as evidenced by the installation at headquarters of the Cambridge, Mass., Fire Department

and the mandated islands of the Pacific, over which Japan has the mandate, the United States secures the rights of cable and wireless privileges, for which it has contended since the treaty of Versailles was drawn up. Japan retains the administrative control over the island.

The Yap cable and wireless rights are given by the new treaty to the American and Japanese governments and their nationals alike, on terms of equality. These rights are regarded as particularly important because of the position of Yap, in the center of the Pacific group to the south of Japan.

♦ ♦ ♦

Radio Relieves Distress at Sea

A WIRELESS dispatch received at Queenstown, Ireland, reported that a fire on board the Dutch freight steamship *Sommelsdyk*, which during the day had caused the vessel to send out calls for aid, had been extinguished and the vessel was proceeding on her voyage to Rotterdam.

The *Sommelsdyk*, which is a freighter, left Baltimore December 20, and after touching at Newport News, proceeded for Rotterdam.

Wireless messages received at Boston reported the United States Shipping Board steamer *Mount Evans* in distress 600 miles east of Boston. The vessel was without fuel oil the radios said.

Charlestown Navy Yard officials expressed the belief that the vessel had been taken in tow, but had as yet received no word to that effect.

The *Mount Evans* was bound from Antwerp to New York with a valuable cargo. She carries a crew of fifty officers and men.

A radio message sent to the United States Line offices, New York City, by Captain A. B. Randall of the steamship *Hudson* reported the rescue of

six members of the crew of the French schooner *Reine des Mers* in a heavy storm after the captain had been washed overboard. The schooner was laden with salt cod and ling fish from St. Pierre and Miquelon, whence she sailed on December 27 for Bordeaux. The rescued seamen landed in New York aboard the *Hudson*.

♦ ♦ ♦

MacMillan in the Arctic Greeted by Radio

DONALD B. MacMILLAN, the arctic explorer, supposed to be frozen in at his winter base 1500 miles north of Boston, off the West Coast of Baffin Land, has been given a life membership in the Theta Delta Chi Founders' Corporation. Through the co-operation of the Carnegie Institution of Washington and the courtesy of the director of Naval Communications of the United States Navy Department, a wireless message was sent to Dr. MacMillan, apprizing him of the gift.

Radiophone Broadcasting Station W D Y

General Description of Station, Transmitting Set, Antenna Installation and Artists' Studio

THE radiophone broadcasting station of the Radio Corporation of America at Roselle Park, New Jersey, call letters WDY, has been in operation every week day night since December 15th. During the time the station has been in operation several thousand letters have been received requesting information as to the details of the station, the type of set used, the size of the antenna and everything else that can be imagined to be of interest

Aldene section of Roselle Park, New Jersey. It is about sixteen miles due west from New York City, in the central part of the state of New Jersey.

Two steel lattice towers each 175 feet high and 20 feet square at the base support a six wire cage type antenna 10 inches in diameter. These towers are 200 feet apart. The antenna is of the multiple-tuned type and has two cage leads, one of which is connected to the center, of the horizontal

nished by the Public Service Corporation of New Jersey and goes into the power room at 2200 volts, 2 phase. This alternating current is used to drive the A. C.-D. C. motor-generator from which current for the D. C. motor-generator of the set itself is secured. An auxiliary A. C.-D. C. set is also installed and this draws power direct from the A. C. supply.

The radio set is of General Electric Company manufacture. The filaments



Studio of WDY Station. On the operating table at the left are located the receiving equipment of the station and all controls of the transmitting set

to the thousands of listeners who have enjoyed the informal programs broadcasted by this station.

While nothing would give more pleasure than the writing of a personal reply to all of these letters, this of course, has been impossible and this article is therefore written with the idea of covering the inquiries contained in the large number of letters received.

WDY station is located in the General Electric Company's plant, formerly the old Marconi plant in the

part of the antenna, being connected through a tuning coil to ground. The other lead which is connected to one end of the horizontal portion of the antenna leads down to the set in the station. Both of these leads are of cage type, 4 inches in diameter. This multiple tuning of the antenna gives much greater efficiency on the short wave of 360 meters than would be true of any other type of antenna arrangement. The antenna current of the station is between 8 and 10 amperes,

The power for the station is fur-

of all tubes are lighted with A. C. which is supplied from a special winding on the radio motor-generator set.

The voltage of the generator which supplies the plate potential for the large tubes used in the set is 2,000 D. C. Four 250 watt radio-tubes UV-204 are used in the set itself, two as power tubes, or oscillators, and two as modulators. A 50 watt tube is used as a speech amplifier in connection with a system of 5 watt tubes used as modulation amplifiers, the latter in turn receiving their energy

from several microphones of special type placed about the room at desirable points. By means of a set of resistances in the modulation amplifier circuit it is possible to regulate voice and music modulation to any degree desired.

WDY is really not a radio station—it is a studio. It is of hexagonal shape furnished in blue and gold draperies; the carpets and rugs carry out the same color scheme. This color scheme is also carried further in the lighting arrangements, a large chandelier in the center of the studio giving a soft, mellow light to the whole place.

By referring to the illustration it will be seen that on one side of the studio is a Knabe-Ampico piano which is used for piano selections and accompaniments. On the other side will be seen an Edison re-creation phonograph.

The radio set used at WDY shows up clearly in the illustration.

An interesting feature of the station is a large map of the United States which hangs in the foyer of the studio. Tacks have been placed on this map on points from which reports of the reception of the music and speech from the station have been reported and examination of this map shows that the extreme range of the station extends from points in Eastern Canada to Porto Rico, Cuba and Florida Peninsula and as far west as Omaha, Nebraska.

The staff of the station consists of J. Andrew White, editor of THE WIRELESS AGE, who is in charge of all programs. On opera nights Mr. White takes entire charge and handles the descriptive part of the programs which are regularly broadcasted from this station. J. O. Smith is in charge of the operation of the station and does all of the regular announcing. R. H. Ranger and E. V. Amy are the radio engineers of the station.

The character of the programs broadcasted from WDY have been different from any others heretofore broadcasted and have created an untold amount of interest and enthusiasm on the part of listeners throughout the territory covered by the station. These programs will continue, as in the past, and it is planned to broadcast a high grade form of entertainment from the station in the future.

Until further notice WDY will be operated on Monday, Wednesday and Friday nights, WJZ station of the Westinghouse Company working the other four nights of the week.

Occasionally there will be talks by well-known people on popular subjects, beginning at approximately 7 p. m. Regular hour of operation will be from 8 to 10 p. m. WDY will hereafter broadcast time signals at 10 p. m. and official weather reports im-

mediately afterward on the nights on which it is operated.

As a general rule, the Monday night programs will consist of vocal and instrumental selections by well known artists of the operatic, concert and vaudeville stage.

Wednesday night will be opera night, when interpretative performances of the popular operas will be given.

Friday nights will be the regular "party" nights, when those informal

they realize it, the writers of these letters have really been the means of determining future policies of broadcasting, insofar as type of entertainment is concerned.

For many of the singers and players who have entertained great radio audiences from WDY, by radio, for the first time, the event was not only an unusual undertaking but really an ordeal. They could visualize the great audience, all right, but could not,



Towers and multiple tuned antenna at WDY Station, Roselle Park, New Jersey

parties so well known and liked by the general public will be held.

The number of letters received by the Radio Corporation with reference to the programs of WDY has been so great that it has been physically impossible to reply to them individually. The fact that it was not possible to reply to all such letters individually might appear to some of those who so kindly responded to the request for criticism of the programs that their letters had not been appreciated. As a matter of fact, however, all such letters have been greatly appreciated and they have all been given proper consideration in planning programs for the future. In fact, whether or not

of course, know whether or not they were pleasing that audience. These artists are making it possible to send the best in entertainment into the homes in the city, the suburbs, towns, villages, hamlets, and, even on isolated farms, and the great unseen audience whom they entertain can expect to have this music, speech and entertainment sent into the home, if it continues to show its appreciation in the future as it has in the past, by letters. If there is no appreciation, there will be very little incentive to artists to entertain. Talented artists will be interested in entertaining the public via radio in the proportion that the great radio public responds in appreciation of their efforts.

The UV-217 Kenotron—Its Operation and Application

By W. R. G. Baker

Radio Engineer, General Electric Company

IN a preceding article we considered the operation and application of the Kenotron UV-216. This device was considered in particular as a means of supplying high voltage direct current to radiotrons UV-202. It is now proposed to continue our consideration of Kenotrons, and particularly the application of model UV-217, as a source of high voltage direct current supply for Radiotron UV-203.

Kenotron UV-217 has an overall height of approximately 7½ inches and a maximum diameter of 2 inches. The plate (anode) is of sheet molybdenum about 5 mils thick, which is formed into an oval box 1¼ inches high and 1¼ inches wide. The distance between the parallel sides of the box is about ¾ inches. The "W" shaped filament (cathode) is of ductile tungsten wire about 10 mils in diameter and 3¾ inches long. The glass container is of special heat resisting glass. These elements are clearly shown in figure 1. The complete Kenotron is illustrated in figure 2 and the UV-203 Radiotron in figure 3.

As with Kenotron UV-216 the first characteristic to be considered is the relation between the filament current (or volts) and the plate current. This characteristic is obtained by using the circuit connections shown in figure 4 under the condition that the plate potential is maintained at a value sufficiently great to withdraw to the plate all the electrons emitted by the filament. The saturation current characteristic is shown in figure 5. This characteristic, as we have found, depends upon the emission of electrons

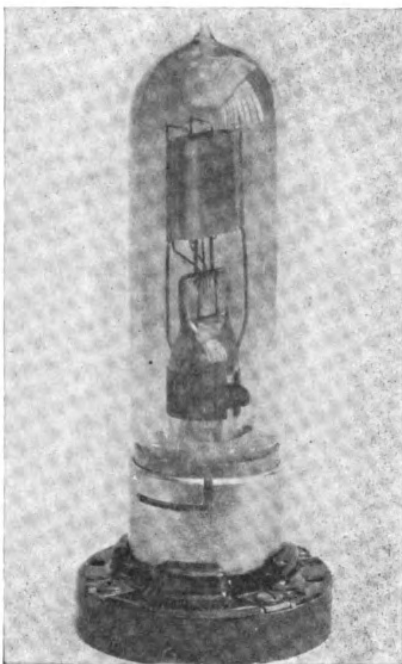

Figure 2—UV-217 Kenotron mounted in socket

from the heated filament. In general the factors regulating the rate of emission from the filament are:

1. Area of filament.
2. Filament temperature.
3. Filament material.
4. Nature of gas if any is present.
5. Pressure of gas.

The relation between the saturation current can be expressed by the equation:

$$i = A \sqrt{T \epsilon - \frac{b}{T}}$$

where "A" and "b" depend upon the filament material. "T" is the absolute temperature (degrees centigrade — 273) and "i" the saturation current per unit of filament area. When the filament is of tungsten and a perfect vacuum is assumed the value of "A" is 23.6×10^9 and "b" is 52,500, in which case "i" is expressed in milliamperes per square centimeter. As a comparison, the value of "A" for molybdenum has been found to be about 21.0×10^9 and "b" about 50,000. One ampere represents a passage of 6.28×10^{18} electrons per second. In the type of Kenotron illustrated by the UV-217 factors, Nos. 4 and 5 do not have any appreciable effect due to the high degree of evacuation.

The $I_p - E_p$ and $I_p - E_r$ or the volt ampere characteristics are obtained as with the UV-216 and are shown in figures 6 and 7. Figure 6 illustrates the limitation of current due to the temperature, that is, with a given filament voltage the current between the filament and plate increases with increased values of E_p until I_p equals the saturation current at that filament temperature. Theoretically any further increase in plate potential should result in no further increases in I_p . It will be noted that the plate current does continue to increase slightly and this apparent discrepancy will be considered later.

Figure 7 shows the effect of the space charge in limiting the electron current. An inspection of these curves shows that as the temperature (E_r) of the filament is increased I_p at first

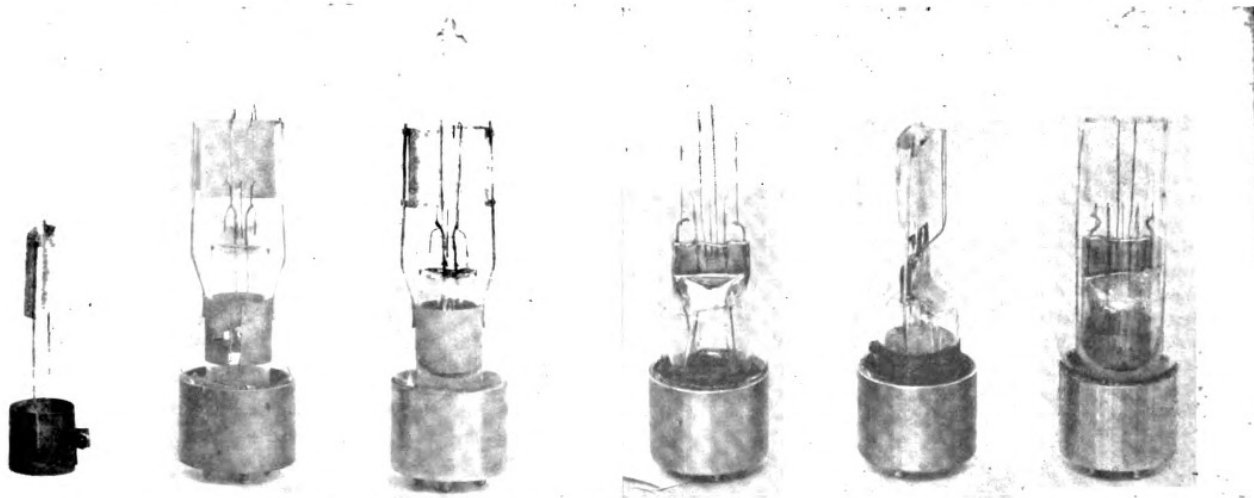

Figure 1—UV-217 Kenotron having a rated D. C. output of 150 watts at 1000 volts. Center view has one-half of plate cut away to show the filament

Figure 3—Model UV-203 Radiotron

increases and then tends to become constant. Also that the temperature (filament voltage) at which the plate current becomes limited is increased as the plate voltage is increased. This limiting effect is due to the electrostatic field produced by the electrons emitted from the filament. The effect of this field is to repel the movement of electrons from the filament to the plate. When the plate voltage (E_p) is increased, the strength of this field is reduced, since some of the electrons that established the repelling effect, are drawn to the plate. We

the characteristic curve, let us consider the distribution of potential between the filament and plate of a Kenotron. We shall assume that the filament and plate are equi-potential surfaces of infinite area and that the electrons emerge from the filament with zero velocity.

Considering the circuit conditions shown in figure 4, if we reduce the temperature of the filament until no electrons are emitted and plot a curve showing the drop of potential through the tube, we have the straight line as shown in curve 1, figure 8. If now we

ment temperature would be to depress a portion of the curve below the line of zero potential.

Based on these considerations of the space charge effect the characteristic curve of the Kenotron should be as shown by curve 1 in figure 9. From 0 to A the current between the filament and plate varies as the $\frac{3}{2}$ power of the plate voltage and is dependent upon the space charge effect. The horizontal portion of the curve represents the saturation current, that is,

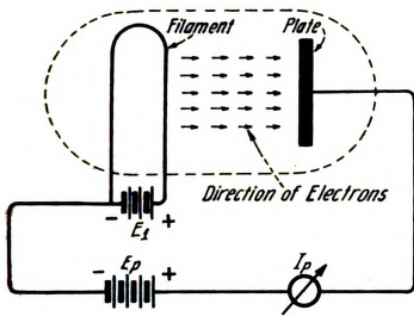

Figure 4—Circuit to determine relation between filament and plate currents

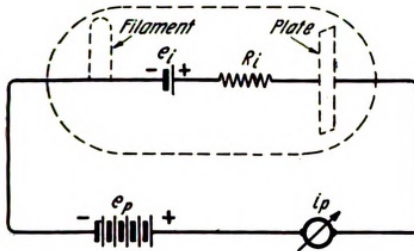

Figure 10—Circuit arranged with space charge effect equal to a counter-electromotive force

find, therefore, that the electron current is limited not only by the temperature of the filament, but also by the space charge effect.

In comparing the characteristic curves of the UV-216 and UV-217 Kenotrons we see that the curves, while quite similar, differ to some extent. It is, therefore, desirable to consider the cause and effect of the shape of the characteristic curves. It is assumed that the reader of this article has read the previous article on Kenotron UV-216.

The principal factors effecting the shape of the characteristic curve of the Kenotron are—

1. Space charge.
2. Velocity of the electrons.
3. Voltage drop through the filament.
4. Electron emission.

In order to obtain a physical conception of the space charge effect on

increase the temperature of the filament by increasing the filament voltage the potential distribution between the filament and plate is modified. The electrons emitted may be considered to produce a negative potential throughout a portion of the space between the filament and plate, and especially in the neighborhood of the filament. Now if in the section 0 to 1 the negative potential due to the electrons was just sufficient to balance the positive potential due to the applied voltage, it is evident that the resultant of these two opposing potentials must be zero, so that the curve coincides with the horizontal line, as shown in curve 2. This same effect occurs in section 1 to 2 but to a lesser degree, with the result that curve 2 while slightly depressed begins to rise. The effect of any further increase in fila-

all the electrons emitted by the filament are drawn to the plate. The saturation current is shown in figure 5 for various filament temperatures (filament voltage).

We assumed in considering the effect of the space charge on the characteristic curve that the electrons were emitted at zero velocity. Actually the electrons are emitted throughout a considerable range of velocities, which results in a modification of curve 1, figure 9. The effect of the initial velocity of the electrons is to accentuate the depression of the curves shown in figure 8. We may consider that the initial velocity permits the emitted electrons to move further away from the filament against the opposing force of the field set up by electrons already in the space between the filament and plate. Under some conditions the po-

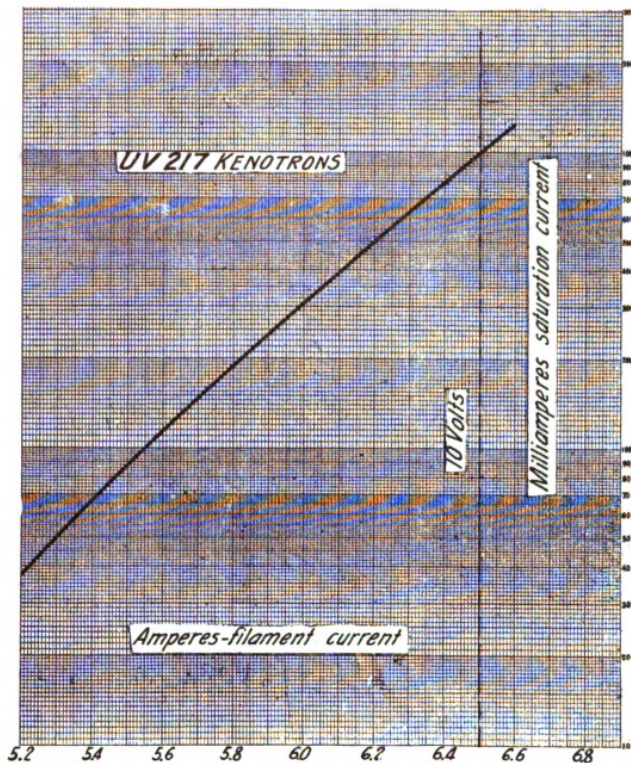

Figure 5—Saturation current graph

tential distribution between filament and plate might approach that represented by curve 3, figure 8.

Curve 2, figure 9, represents the effect of the initial velocity of the electrons, which causes the curve to assume a position to the left of curve 1, throughout the lower portion of the curve. This indicates that the effect of the initial velocity is to increase the current between the filament and plate, especially at low plate voltages. This is, of course, what might be expected, since the effect of the initial velocity is to assist the plate voltage in drawing the electrons to the plate.

curve is the limitation of emission from the filament as the plate voltage assumes values corresponding to the upper section of the curve. This limitation of emission results in the gradual bending over of curve 3 as shown by the dotted curve 4, figure 9.

Considering now the curve shown in figure 6 for $E_f = 10$ volts. We have found that the lower portion of this curve varies from the theoretical curve due to initial velocities and the potential drop through the filament. Also that the upper section is materially affected by the limitation of electron

plate current beyond the knee of the curve.

Inspection of figure 6 indicates that curves for the higher filament voltage show a greater tendency to increase, after the saturated condition has been reached, than those for low filament voltages. This is due to the fact that the greater emission, when the higher filament voltages are used, results in a more severe bombardment of the plate, hence a higher plate temperature and more heat radiation to the filament.

The action and application of a Kenotron under various conditions

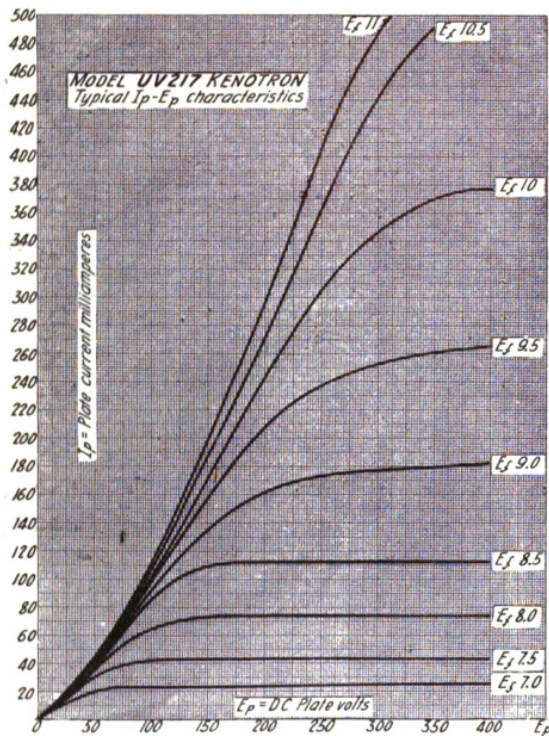

Figure 6—Volt ampere characteristics showing limitation of current due to temperature

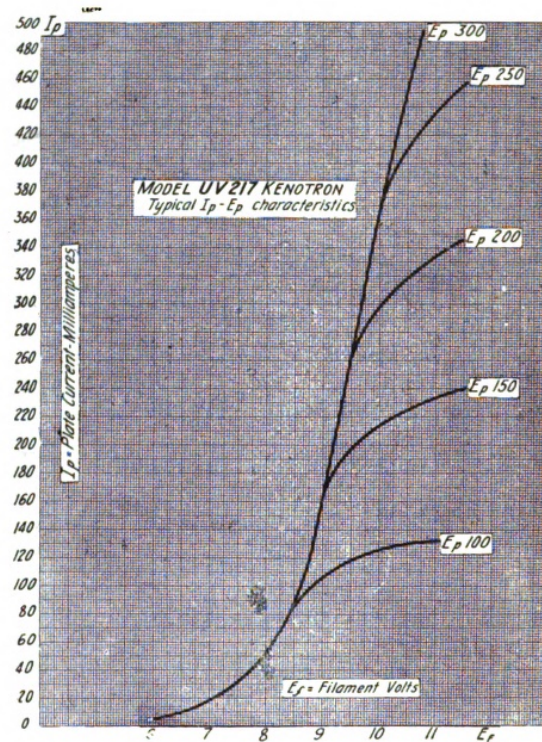

Figure 7—Volt ampere characteristics showing effect of space charge in limiting the electron current

Since the filament is not an equipotential surface as we previously assumed, the characteristic curve may in some cases be considerably modified, especially if the voltage drop through the filament is an appreciable percentage of the saturation voltage. When the plate circuit is returned to the negative side of the filament the effect of the potential drop through the filament is to reduce the electron current, due to the fact that the average potential between the filament and plate is less than the potential between the negative end of the filament and the plate. This limitation in space current tends to neutralize the effect of the initial velocity of the electrons. The resulting characteristic curve is shown by curve 3, figure 9.

An additional factor tending to still further modify the characteristic

emission from the filament. An additional point to be noted is that the curves in figure 6 do not actually become parallel to the E_p axis as would be expected from wholly theoretical considerations. Instead of becoming level they continue to rise gradually as the plate voltage is increased. One reason for this effect is the increase in filament temperature due to heat radiated from the plate. We know that as the plate voltage is increased the electrons are drawn to the plate with a greater velocity. This electronic bombardment of the plate causes it to heat up. As the temperature of the plate increases the heat radiated to the filament becomes sufficient to increase the temperature of this element. This increase in temperature results in somewhat greater emission, hence a gradual increase in

may be illustrated by assuming the space charge effect equivalent to a counter electromotive force located within the Kenotron. The circuit arrangement based on this assumption is shown in figure 10. The circuit constants within the dotted circle represent the internal impedance and internal e.m.f. of the Kenotron. e_s represents the space charge effect which has been found to limit the flow of electrons from the filament to the plate, hence we may represent this effect by a potential in opposition to that of the plate potential.

We have found that the volt-ampere or $I_p - E_p$ characteristic of the Kenotron is, in general, made up of three sections. We will consider only the approximately straight line portion of the characteristic. The portion of the characteristic in which we are interested is indicated by A.B.

figure 11, where the line has been extended to cut the e_p axis at the point A, resulting in the intercept OA. This intercept represents the value of e_1 . We require the equation of this straight line. The equation of the straight line may be expressed in terms of the co-ordinates of any two points on the line and the slope. Hence if X, Y and X_1, Y_1 are the co-ordinates of any two points and m the slope of the line, we have the equation:

$$Y - Y_1 = M (X - X_1)$$

If now the point B has co-ordinates (e_p, i_p) corresponding to X, Y, and the point A co-ordinates ($e_1, 0$) corresponding to (X_1, Y_1) we have:

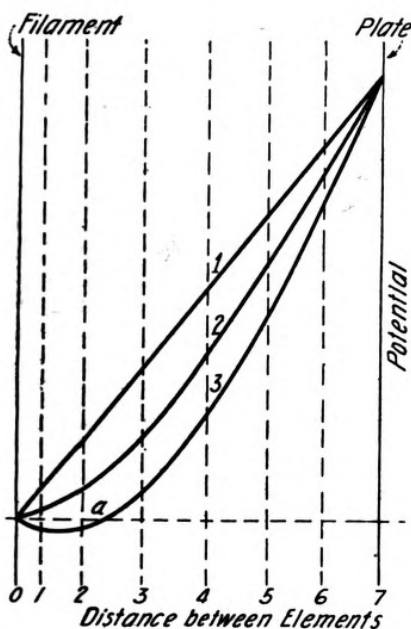

Figure 8—Potential distribution in the Kenotron under various filament temperatures

$$i_p - 0 = M (e_p - e_1) \text{ or } i_p = M (e_p - e_1)$$

Since we are considering the entire line AB the slope M is simply the tangent of the angle between the line AB and the e_p axis, or—

$$\tan \angle BAC = \frac{BC}{AC} = \frac{i_p}{e_p}$$

This ratio represents a conductance and is sometimes called the conductance of the Kenotron.

If we consider the actual characteristic and take the ratio $\frac{i_p}{e_p}$ over a considerable portion of the curve we find that the apparent conductance of the Kenotron varies with e_p . Hence, in order to permit calculation we must determine the ratio $\frac{i_p}{e_p}$ for a very small

section on the straight line portion of the curve. The conductance — and counter e.f.m. (e_1) obtained in this manner may then be considered instantaneous values.

Let us consider the $I_p - E_p$ curve (figure 6) obtained when the filament voltage was maintained at 10 and determine how the apparent conductance or its reciprocal, the apparent resistance, varies.

The following tabulation indicates how r_1 varies with E_p .

E_p	E_p	$E_p - E^p$	I_{p1}	I_p	$I_{p1} - I_p$	$\frac{E_p - E^p}{I_{p1} - I_p}$
125	100	25	136	101	35	710
150	125	25	171	136	35	710
175	150	25	206	171	35	710
200	175	25	241	206	35	710

Suppose we wish to know the increase in current through the Kenotron when E_p is increased 20 volts, we may proceed as follows:

$$i_p = \frac{E_p}{r_1} = \frac{20}{710} = .028 \text{ amperes}$$

From the characteristic curve (fig-

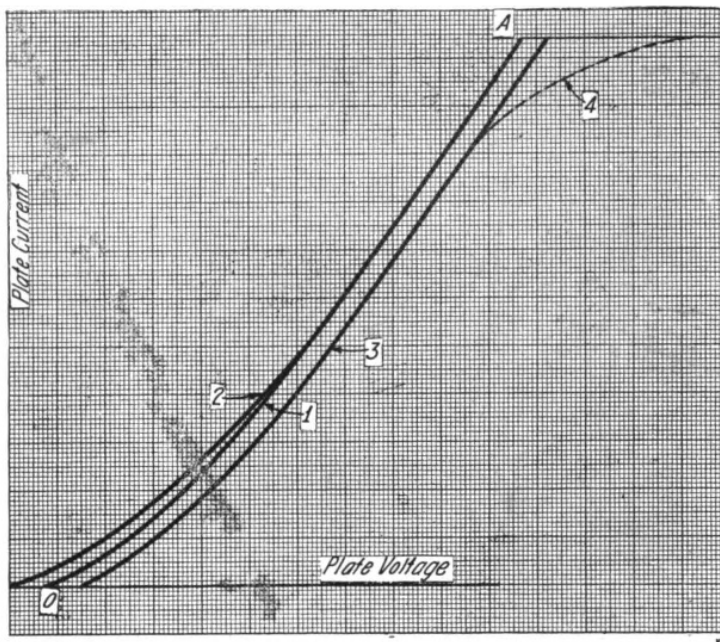

Figure 9—Modifying factors of the characteristic curve

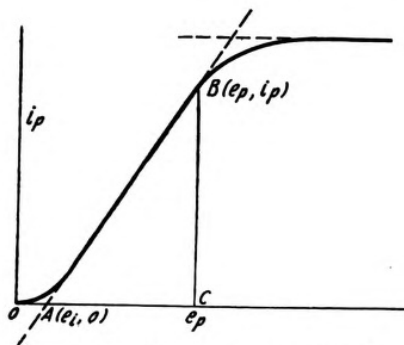

Figure 11—Section AB characteristics

E_p volts	I_p amperes	$\frac{E_p}{I_p}$ ohms
100	.101	990
125	.136	920
150	.171	878
175	.206	850
200	.241	830

If now we determine the instantaneous value of r_1 at several different points on the characteristic, we find that the instantaneous resistance is constant.

ure 6, $E_r = 10$) we find that I_p equals .171 amperes when E_p equals 150, hence if E_p is increased to 170, I_p should increase to .199 amperes.

When a resistance r_p is inserted in the plate circuit, we have a series circuit containing two resistances and two sources of potential. The resultant potential in the circuit is $e_p - e_1$. The total resistance is $r_p + r_1$. Hence the current through the circuit is

$$i_p = \frac{e_p - e_1}{r_p + r_1}$$

This equation shows that the potential between the filament and plate of the Kenotron may be expressed as $(e_p - e_1)$ or $i_p (r_p + r_1)$. If we consider only the straight portion of the characteristic and required the change in i_p corresponding to a variation in e_p we may write the equation

$$\Delta i_p = \frac{\Delta e_p}{r_p + r_1}$$

where Δi_p and Δe_p represent the in-

crease or decrease in i_p and e_p , respectively.

If we insert a resistance of 1000 ohms in the plate circuit and provide a source E of 321 volts in the plate circuit, the current through the Kenotron will be .171 amperes. Since 1000

peres. If now we find the value of A C we can then determine O A, since $O C = 170$ volts. We know the slope to be $\frac{I}{r_1}$, hence

The transformer indicated in the circuits shown in figures 16 and 17 was designed for use with Kenotron UV-217 and Radiotron UV-203. This unit which is known as Type UP-1016 (figures 18 and 19) has three secondary windings, one for the Kenotron fila-

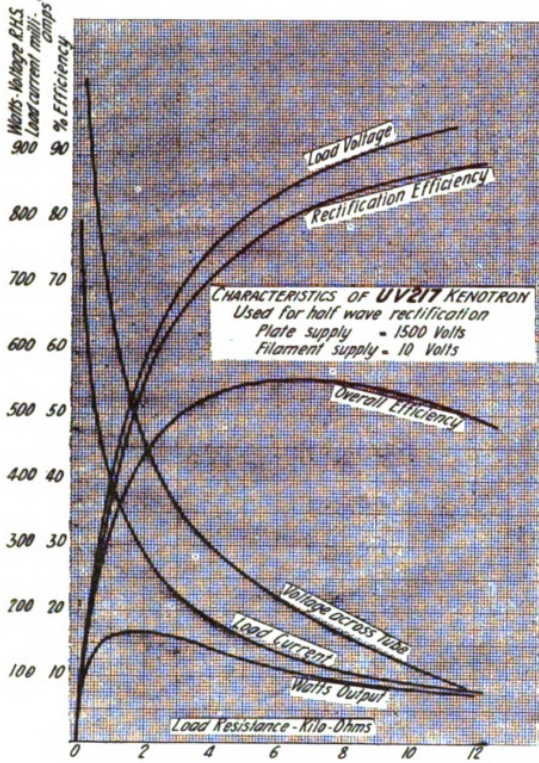

Figure 12—Load characteristics

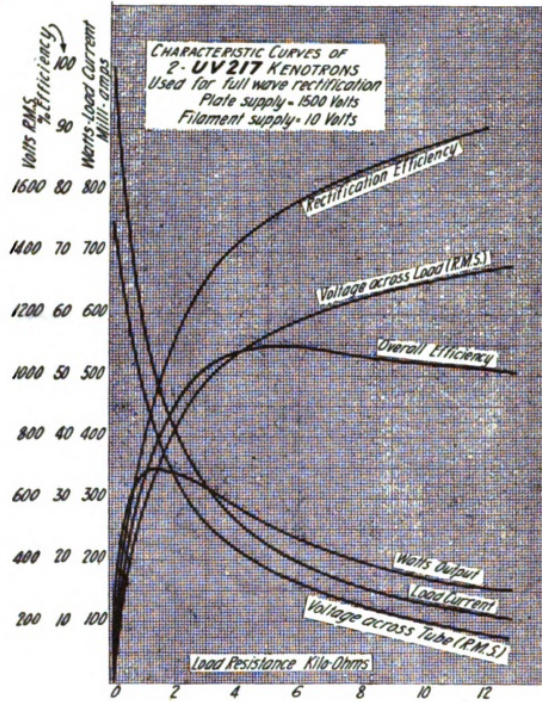

Figure 13—Load characteristics

$\times .171 = 171$ volts represents the drop across the load resistance, we have $321 - 171$ volts applied to the plate. From the characteristic we find that $I_p = .171$ amperes when $E_p = 150$ volts. Or we may proceed on the following basis:

$$A C = \frac{.199}{I} = 141.3 \text{ volts}$$

$$\text{so that } e_1 = 170 - 141.3 = 28.7 \text{ volts}$$

Substituting $e_1 = 28.7$ in the above we have

$$i_p = \frac{321 - 28.7}{\frac{1710}{292.3}} = \frac{292.3}{1710} = .171 \text{ amperes}$$

The application of Kenotron UV-217 is essentially the same as that of UV-216. Load characteristics of UV-217 are shown in figures 12, 13, 14 and 15. These characteristics were obtained with the circuits for full and half wave rectification illustrated in figures 16 and 17. A comparison of the load characteristics with the rating of the UV-217 shows that this device is conservatively rated.

Filament volts, 10.0.
 Filament amperes, 6.5.
 A.C. Input Voltage, 1250.00.
 D.C. Output, 150 watts at 1000 volts

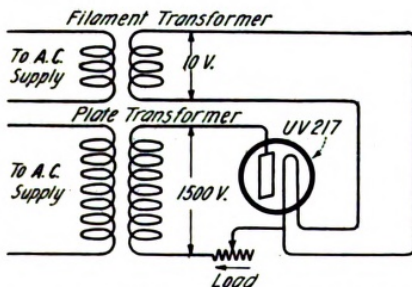

Figure 16—Circuit for half-wave rectification

$E = 321$ volts
 $r_p = 1000$ ohms
 $r_1 = 710$ ohms
 e_1 is unknown

hence $i_p = \frac{321 - e_1}{1000 + 710}$

The value of e_1 may be determined by the use of figure 11. Assume that point B represents the condition where $e_p = 170$ volts so that $i_p = .199$ am-

ments, one for the Radiotron filaments and the third for supplying the high voltage alternating current to the Kenotron plates. The Kenotron filament winding has sufficient capacity for two UV-217 Kenotrons. This winding is very carefully insulated since the Ken-

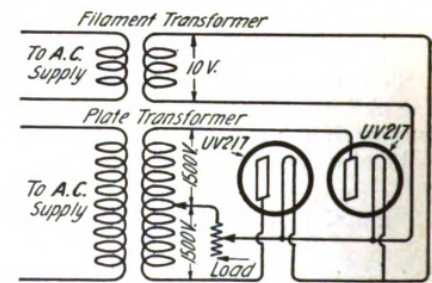

Figure 17—Circuit for full wave rectification

otron filaments assume a value equal to the plate voltage during the part of the cycle the tube is non-conductive. The Radiotron filament winding has a capacity sufficient to supply filament energy to two UV-203 Radiotrons. Both Kenotron and Radiotron filament windings are provided with mid-taps. This is not actually required for the Kenotron winding but provides a more flexible unit. The plate winding is designed for use with two UV-217

Kenotrons. Special attention has been given to the insulation and distributed capacitance of all windings to prevent break-down and losses due to radio frequencies by passing to ground.

The primary of this transformer is provided with taps and a selector switch.

ment winding due to the fact that this winding is at plate potential during a portion of the cycle.

The operating precautions that should be observed with the UV-217 are in general the same as for the UV-216. It has been shown that from theoretical conditions alone the cur-

then the total voltage is applied directly to the Kenotron so that all the energy is liberated at the plate. The effect of a short circuit on the Kenotron is, therefore, quite likely to ruin the tube either by evolving gas or melting the plate.

In order to obtain long life, it is of

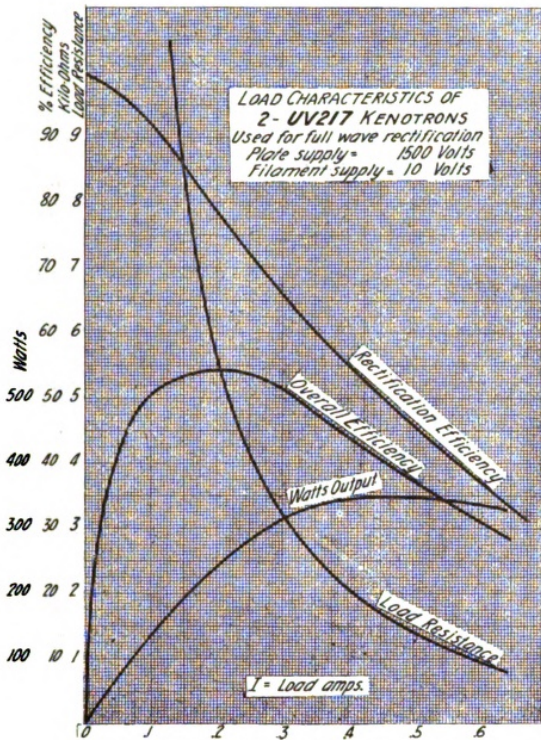

Figure 14—Load characteristics

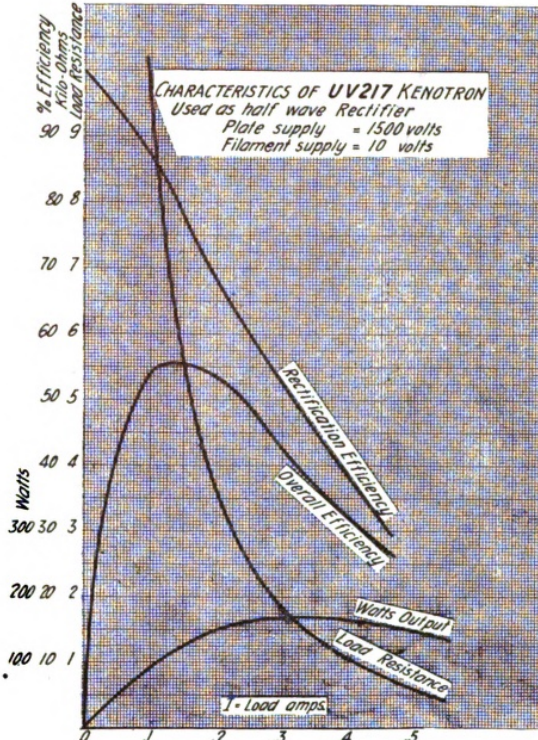

Figure 15—Load characteristics

This arrangement eliminates, except in special cases, the use of filament rheostats since the taps correspond to values of line voltage usually available at the amateur station.

The windings are so designed that

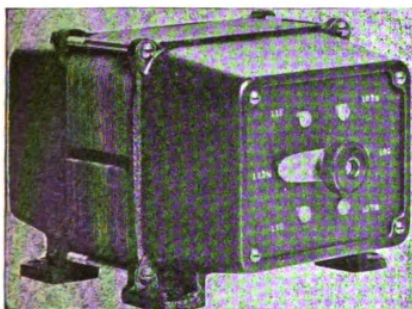

Figure 18—Amateur radio plate and filament transformer. Front view showing the switchboard

when the selector switch is set on a tap which results in the proper voltage on any one secondary winding, then the other two secondary voltages are correct. A voltmeter should not be connected across the Kenotron fila-

rent through the Kenotron should increase with the three-halves power of the voltage until the saturation current is obtained—

$$i_p = KV \frac{3}{2}$$

where V equals the potential between the plate and filament and K is a constant depending upon the shape of the electrodes. When a resistance is connected in series with the plate and a voltage E impressed across the circuit, we have

$$i_p = K (E - i_p R) \frac{3}{2}$$

If E is maintained constant the rectified current continues to increase as R is decreased until the saturation current is reached. A further decrease in R produces no increase in the current passing through the Kenotron with the result that the voltage across the tube increases. That is, the drop across the tube always equals the difference between the potential across the entire circuit less the drop ($i_p R$) through the load. If the load resistance is reduced to zero

course necessary to never exceed the maximum rated filament voltage which, with the UV-217, is 10 volts. The operator should always bear in

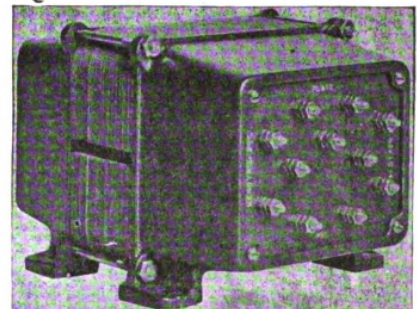

Figure 19—UP-1016 Amateur radio plate and filament transformer. Rear view showing the terminal board

mind that, if the filaments are maintained at a voltage approximately 5 per cent. above normal, the life of the tube is halved. Also that operation at a filament voltage 5 per cent. below normal results in doubling the life of the Kenotron.

RADIOPHONE BROADCASTING

At the WDY and WJZ Radio Studios

EACH day the popular interest in radiophone broadcasting becomes more intense and widespread. Not a little credit for the recent rapid development of this popular interest may be given to the Radio Corporation of America and the Westinghouse Electric and Manufacturing Company, which have provided the means for broadcasting over large areas the radiophone news bulletins, concerts by famous singers and musicians, addresses by noted speakers, weather and market reports, stories for children and interpretative opera recitals.

The daily programs are of a high order and provide a great variety of entertainment. The following are some of the artists and speakers that have recently appeared at WDY and WJZ radio studios:

Artists—Mlle. Fanny Rezzia of the Paris Grand Opera; Premier Male Quartet composed of Messrs. Bradley, Cole, Bier and Brasch; Miss May Peterson, Metropolitan Opera Co.; Marie Sundelius, Metropolitan Opera Co.; Joseph Meyer, Musical Director at Pasadena Hotel, California; Sophie Tucker, vaudeville star; Jack Neal of George White's "Scandals"; Bennie Davis, composer of "Margarie"; Joe Collins, saxophone artist; Miss Berta Reviere, contralto; Billy Hettrick, baritone; Miss Vivienne Segal, star of "The Blue Paradise"; Franco Pizzo, Italian Violinist; Ignatz Friedman, pianist; John Stell, star of "Monsieur Beaucaire"; Mme. Lydia Lipkovska, Imperial Opera at Petrograd; Reginald Pasch, tenor from Holland; Vernon Dalhart, Edison Recreation tenor; Constance Rowland, violiniste and Miss Elizabeth Spencer, soprano for Edison Recreations.

Speakers—Gov. Edward I. Edwards of New Jersey; Joseph P. Tumulty, Ex-Gov. Runyon of New Jersey; Herschel Jones, Food Commissioner of New York; Eddie Rickenbacker, premier American Ace; Roger W. Babson, business economist and statistician; Edna Ferber, short story writer; Sanford Hunt, adventurer, writer and sportsman.

Operatic Recitals—Madame Butterfly, Faust, Cavalleria Rusticana, Il Pagliacci, Carmen, La Boheme.

Sermons—Rev. Charles Lee Reynolds, D.D., Park Presbyterian Church, Newark, N. J.; Rev. M. Joseph

Broadcasting Stations

WDY—360 meters. Mondays, Wednesdays, and Fridays 11 A. M. to 10 P. M. Radio Corporation of America, at Roselle Park, N. J.
WJZ—360 meters. Sundays, Tuesdays, Thursdays and Saturdays, 11 A. M. to 10 P. M. Westinghouse Station located at Newark, N. J.
WDY and WJZ are in the New York District.
KDKA—360 meters. Daily, 8 to 10 P. M. Westinghouse Station located at East Pittsburgh.
WBZ—360 meters. Sundays, Mondays, Wednesdays and Fridays, 8 P. M. Westinghouse Station located at Springfield, Mass.
KYW—360 meters. Daily, 8 P. M. Central time, 9 P. M. eastern time. Westinghouse Station located at Chicago, Ill.

Twomey, D.D., Peddie Memorial Baptist Church, Newark, N. J.

To the average person who desires to listen to concerts of an evening, dance to popular music, hear a sermon on Sunday or an address during the week, or to have his little ones hear a bed-time story before they say their evening prayers, the radiophone—as it exists today—with its nominal first cost and simple installation and operation, surpasses everything as an instrument of entertainment and education in the home.

Regarding Visits to WDY

IN reply to many requests from correspondents for invitations to visit the Radiophone Broadcasting Studio WDY, we desire to state that at this time it is practically impossible to extend such invitations due to limited space in the studio. Artists and operators at the station require all the accommodations now available and it is hoped that our radio friends will understand that we would gladly welcome visitors generally if proper accommodations were possible. It is hoped that in the near future necessary arrangements can be made to enlarge the present size of the studio so that a number of our many friends can be invited to visit us.

Faust Popular With Radio "Fans"

IT is interesting to note that the opera "Faust" was selected for broadcasting by WDY because of the majority request of a large number of radio "fans" who wrote in to the company. "Faust" is not alone popular among wireless enthusiasts, but is probably the most popular of all music dramas among opera-goers.

Banquet Music by Radiophone

THE latest convert to the fascination of the wireless 'phone is the New York State Association of Electrical Contractors and Dealers, which held its annual banquet at the Hotel Astor. The after-dinner speeches consisted of a half hour of musical entertainment by the radiophone.

Baseball "Fans" Hear Frisch by Radio

FRANK FRISCH flashed a snappy baseball talk into the transmitter at WDY recently in describing his activities on the diamond.

It was the first time Frisch had ever "toured" with a concert troupe. For he went to Roselle Park, from New York with the Premier Quartet, which followed Frankie on the bill, while the Flash made his "appearance" immediately after the news reel. He flashed a beautiful San Antonio sunburn shade when he was "introduced" to his invisible audience. His hearers in the 200 mile radius were many times the number of a world's series game crowd and he seemed to fear at first that some voice from the "stands" might give him the razz. But no one talked back to Frankie; it was a great opportunity to practise telling an umpire what you thought of him. But Frank warmed to his part and gave a neat little talk on baseball, answering questions that were put to him by a few onlookers in the "sending studio" of the broadcasting station and pepping up his chatter with a little persiflage.

With a little more practice he ought to be ready for a monologue act on the variety stage. His one regret was that he did not bring his violin along with him. Frank would have been less "fussed" fiddling than talking. He prophesied over the radio that the Giants would win the pennant again and hoped they might meet the Yanks again for the world's series. He denied that he had been given a mortgage on the Polo Grounds as part of his salary increase. "I don't mind being moved from third back to second to make room for Heinie Groh," he told radiophone fans who were listening in on the "WDY" call, "for I have confidence in Manager McGraw and know that whatever way he arranges his players it is always the wise way and the way that works out best for every man under his command."

"Gee! I'm glad that's over," breathed Frank when finally J. Andrew White, editor of THE WIRELESS AGE, lifted the earpiece from his head. "My knees were actually shaking when I started to chin into that fool thing. I'd rather bat against Wilbur Cooper all season than do that again. If I'd only thought to bring my violin! If any fans out in St. Louis, where they 'love' the Giants so, heard that stuff of mine they'll probably want to sue Mr. Radio for breach of contract. Tough luck for people who thought they were going to hear a concert to have a ball player palmed off on 'em. And I needed a shave, too.

"Say, that radio jigger is a pretty nifty thing when you come to think of it," said Frank on the train coming back to New York that night. "I s'pose these electrical sharps will be building a baseball radio machine soon for use in coaching. Mac ought to hear of it. He would be ordering one to use from the bench. Every base runner could be equipped with a receiving apparatus like I read the Chicago taxicabs are fixed up with, and with a private code of trick letters the guys could be moved around as directed without the aid of the men on the coaching lines."

Radio Cheers the Aged

ALTHOUGH more than 80 years old, Mrs. Lavinia Campbell has had installed in her room at the home of her daughter in Flushing, L. I., a complete wireless outfit from which she receives messages daily.

Clocks in the Campbell household are set by reports from Arlington, weather reports are received from Washington and messages are received from ships at sea.

Mrs. Campbell is planning a wonderful treat for her little friends among the children in the neighborhood and she has set aside the hour from 2 to 3 o'clock each day for the youngsters' radio party.

DEAR MAN WITH THE END ON
ILL STEM TO THE WIRELESS
SAY HELLO TO MESSOME MIGHT
I AM A LITTLE STAR

BUDDY SHAW
ROSELLE PARK & FEARS
W. J.

From one of our little listeners

Radio Sermon by Rev. Dr. Reynolds

WITH only the collection and congregational singing omitted, Rev. Dr. Charles Lee Reynolds, pastor of the Park Presbyterian Church, Newark, preached a sermon, offered prayer, read the Scriptures and made an-

Artist and Audience

The artists and speakers at the various radio phone studios and their unseen audiences can meet in the columns of THE WIRELESS AGE if readers will send in short descriptions and photos of their radio parties, consisting of group pictures including the radio apparatus. The Radio-Phone Broadcasting department will serve audience and artist alike by presenting whatever is of interest to either, so send in your stories and let's get acquainted.

nouncements on a Sunday afternoon recently at WJZ to an unseen audience estimated to have numbered half a million.

Clarence E. Watters, church organist, played a prelude and a postlude, and accompanied Mrs. Persons, soloist of Park Church, in a hymn.

The service lasted half an hour, Dr. Reynolds preaching twenty minutes. Referring to an offering, Dr. Reynolds said over the instrument:

"At this point in any service we would take up the collection, but I don't see how I can ask my radio audience to give an offering and I can't ask you to 'join' in singing a hymn."

Dr. Reynolds remarked after the service that he thought those edified by "listening in" on these radio sermons might be encouraged to send in offerings in order to install instruments in hospitals where invalids could hear sermons.

Dr. Reynolds had received a letter from his mother, Mrs. James E. Reynolds, at South Bend, Ind., saying she would be one of the "listeners in." He also was informed by telegram that many of his former parishioners at the Second Presbyterian Church, Lexington, Ky., would gather in the engineering department of the university of that city to hear the sermon.

In W D Y Mail Box

That's the "stuff." We want "Radio Vaudeville."

Mother and Dad like old-fashioned songs, while I like concerts. Mr. Cook was very good, but so were all the rest.

I have listened in on your concerts and will tell you that I appreciate them immensely as that is my sole recreation. I am nearly blind and therefore not able to see good shows or other recreation known to other young men.

All hail to the Radio Rajah of Roselle!

We enjoyed a good waltz to "Peggy O'Neil."

I really think it is a most wonderful thing to be able to sit home by a fire place and listen to the wonderful concerts.

Enjoyed your dance program very much last night, though we didn't have a very good floor.

The music was enjoyed very much here and we all shook a "lean foot" as you called it.

Wish to commend you upon the qualities of the transmission, and what

is equally desirable, the inimitableness of your officiating disseminator.

We danced downstairs to the music coming in upstairs. We are more than 1000 miles from your station. Your operator is a genius—a very accommodating fellow and very pleasant gentleman. I feel almost personally acquainted with him and should be glad of the opportunity sometime to meet him.

Your modulation is the best of any radiophone that I hear and I get a lot of them.

Those Saxophone solos have got the world cheated for anything in the solo

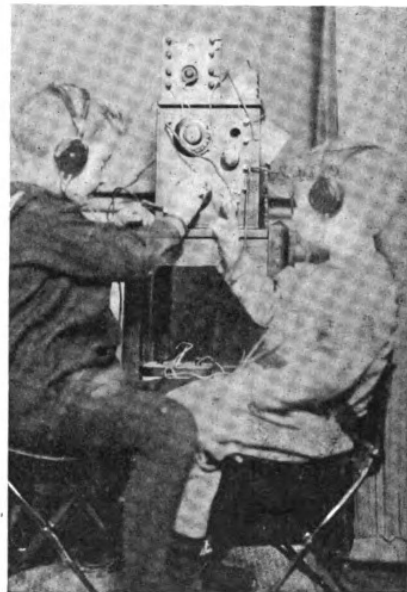

Members of the radio broadcasting audience

line, so we are living in hopes that you can arrange to give us some more Saxophone music. The whole town is going wild about your music and talks, as it is by far the plainest and strongest we have heard.

I want particularly to express my appreciation of the gentleman who, I take for granted, is in charge. I am as expectant of his announcements as I am appreciative of his selections.

We especially enjoyed the rendering of the opera "La Boheme" and certainly would appreciate more of the same kind of music.

It was fine, and we had "just as good a time as you had"—dancing.

Wonderful!
Delightful!
Yours truly.

We enjoy your parties very much. What my wife likes most is the announcements. I'm glad we live so far away or she'd be on your trail, I'm afraid. But then we are both over fifty, so your girl needn't fear. From your voice you seem to be twenty-nine, medium dark, medium tall, gray suit and a striped tie. So if my wife really saw you there would be nothing doing. More power to you.

(Continued on page 50)

tions are more stable and give more output than other tubes. Any type of socket may be used but care should be taken that the high voltage does not leak from the plate point to the filament or grid, as this will spoil the efficiency of the set. A rheostat may be used for the filament, but I found that the filament voltage from the transformer was just right for the Radiotron tube, which must be lighted to full brilliancy if the maximum output is to

26 turns and is tapped at the thirteenth turn for the filament lead. The secondary has 8 turns of the same size wire without taps. The windings should be separated about a half inch.

Any standard radiation ammeter with low reading scale may be used. If the constructor wishes he may substitute a 3-volt flashlight bulb for the ammeter with fair results. Of course, the flashlight bulb will not tell when maximum radiation is obtained, but

the plate of the power tube unless the filament is lighted as the high voltage will tend to break down the construction and insulation inside the tube.

In order to make the set operate the key in the grid circuit must be closed when voice modulation is desired. The set is tuned by turning the variable condenser until the flashlight or ammeter shows the greatest reading. The beauty of this circuit is that it requires no skill to tune the

former. The size of windings may be obtained by noting your core size on the left and reading over.

each containing one thousand turns of wire.

An electrolytic rectifier of twenty

bulb begins to oscillate. The second is an ammeter, scale 0-5 amperes, and is used in the filament circuit. The filament of a five-watt tube should not draw more than two and four-tenths amperes.

In sending with C.W. the key may be placed in two places. The first is in the filament connection to the inductance, as shown in the diagram. The second place is in the primary circuit of the high tension transformer. The second position is the better because it permits the use of a shorter connection from the filament to the coil. If the set refuses to work try reversing the high voltage connections, and make sure that the condensers across the line are not blown. An open secondary in the spark coil will also keep the set from working.

The variable condenser which is shunted across the spark coil has a great deal to do with the modulation. It will be noticed that as the capacity of the condenser decreases the radiation decreases. The drop in radiation is slow at first, and then abrupt. At a point just preceding this drop, the modulation is best. This may be seen by listening in on the receiving set while the phone is being adjusted.

Under favorable conditions this set will radiate six-tenths of an ampere C.W., and four-tenths of an ampere on voice. With six-tenths of ampere radiation and a favorable location, distances up to one hundred miles can be covered easily.

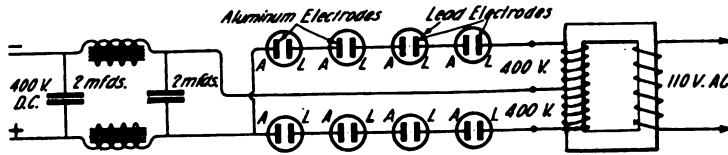

Figure 3—Hook-up of the electrolytic rectifier

Cross section of core in square inches	Turns per volt.	Number of turns on primary	Number of turns in each 400-volt secondary pile
1 "x1 1/4"	5.5	605	2200
1 1/4 "x1 1/4"	5	550	2000
1 "x1 1/2"	4.5	495	1800
1 1/4 "x1 1/2"	4	440	1600
1 1/2 "x1 1/2"	3.5	385	1400
1 1/4 "x2 "	3	330	1200
1 1/2 "x2 "	2.5	275	1000

The primary is wound with size twenty, double cotton covered copper wire, and should be well insulated from the core. The two secondary pies are wound with size thirty, double cotton covered copper wire. It is not advisable to use anything finer than this because the transformer will heat up considerably when first used. Referring to the table, if the cross section of your transformer is three square inches, we find that the last line in the table applies to your case, and your primary will have two hundred and seventy-five turns; the secondary will be made up of two pies,

cells is used to rectify the alternating current delivered by the transformer. Test tubes can be used for the cells of the rectifier and a concentrated solution of "Twenty Mule Team Borax" forms the electrolyte. The electrodes are pieces of lead wire and aluminum aerial wire. The diagram of the hook-up is given in figure 3.

The rectified current is pulsating, and to smooth it out two microfarad fixed condensers are needed. If enough condensers are used there will be no choke coils required. A Ford spark coil is used as a modulation transformer. The secondary is connected in the grid circuit, and shunted by a .001 microfarad variable condenser. The vibrator is removed from the coil, and an ordinary telephone transmitter and a six-volt battery connected in series with the primary. There are two meters required: first a milliammeter, scale 0-600 mils. This is used first in the plate circuit, and shifted to the aerial circuit, when the

An Efficient 5-Watt Tube Transformer

By L. R. Felder

THIRD PRIZE \$3.00

IN the April issue of THE WIRELESS AGE, a vacuum tube transmitter was described which was found to be very useful and efficient. Not much design data was given at the time and it is the writer's purpose now to consider the design of this circuit to secure maximum efficiency and to adapt this circuit for use on 110 V. D. C. power lines.

The efficient design of a circuit for use with vacuum tubes consists essentially in the choice of proper circuit constants. Thus a circuit which is well designed in all other respects may be made very inefficient by the choice of wrong constants for grid condenser and leak. Furthermore it is important to note that circuit constants which are suitable for one particular type of vacuum tube may be altogether inefficient when used with another type of tube.

The complete oscillating circuit excluding the filter, in this transmitting set is seen in figure 1. The constants of this particular circuit are intended

for use with two UV-202 Radiotrons. The filament current may be obtained from a 12-volt storage bat-

tery. It is recommended that a voltmeter across the filament terminals be used instead of a series ammeter, and that the voltage across terminals be kept at 7.5 volts. This will result in a

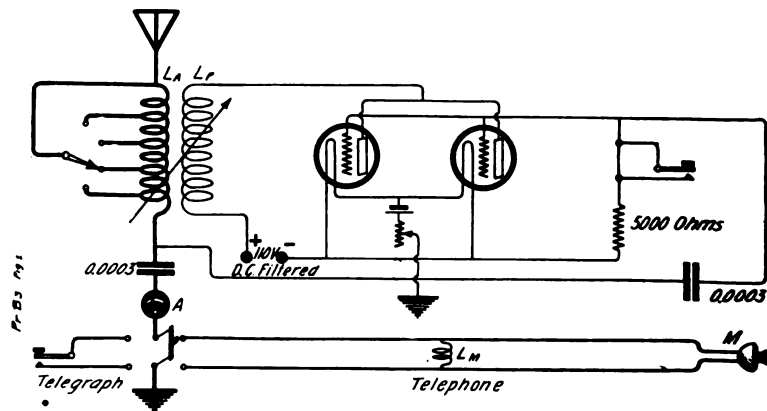

Figure 1—The complete transmitting circuit excluding the filter

tery in series with a filament rheostat. The operating current in the filament should be 2.4 to 2.5 amperes.

longer life for the tube. The circuit requires a plate-antenna transformer, antenna series condenser, grid con-

denser and leak, and for telephony, a microphone and microphone inductance.

The grid condenser and leak have specific values found to be suitable for the UV-202 tubes. The grid condenser capacity is .0003 microfarad and the grid resistance is 5000 ohms. These should be fixed and not variable, as no advantage is gained by making them variable. The antenna condenser should be .0003 microfarad and fixed.

The design of the plate-antenna transformer is one of the most im-

D.C.C. wire. The antenna coil should be 5 inches in diameter and have 25 turns of No. 18 D.C.C. The entire winding in the plate coil can be efficiently utilized. The antenna coil, however, both for tuning purposes and for adjustment to the plate coil, should be tapped at every three turns. The mechanical design of the coil and the means for coupling variation are numerous and well known to most amateurs. However, two suggestions are here offered. Figure 2 shows one design utilizing two coaxial cylindrical coils, the inner plate

suitable filter to permit using the 110-volt D.C. mains. Unless a filter is used there will be a strong commutator hum which will be applied to the plate of the vacuum tubes and will thus produce an undesirable modulation which interferes with reception. The filter absorbs this commutator ripple. Figure 4 shows the complete filter circuit which, when designed as shown, will eliminate the hum completely. Across the mains a 1-microfarad condenser is used, such as a paraffined paper telephone condenser. On the positive side of the line an iron core choke having a minimum induction of two henries is connected and then another 1-microfarad condenser. Any large iron core inductance, such as the secondary of a spark coil (primary open) will be satisfactory. The negative side of the line should be grounded, for then practically absolute silence is obtained.

This set will be found extremely simple to construct and operate. It requires but few parts and has only two simple adjustments, namely, plate-antenna coupling and antenna tap. It is quite inexpensive, and therefore suitable for any amateur's pocket

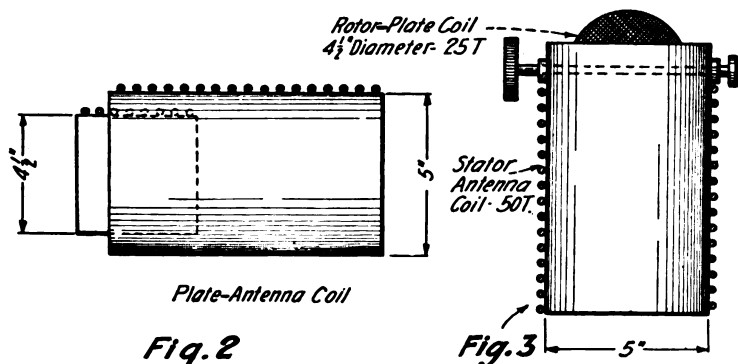

Constructional dimensions of two types of plate antenna coil

portant elements of vacuum tube transmitter design, and it will be found that in most instances it is here that sets fail. In order to design this unit properly it is necessary to understand its function. It is, of course, known that the antenna coil serves to tune the antenna to the transmitting wave, but the antenna inductance is one coil of the plate-antenna oscillation transformer. This transformer has the extremely important function of "adapting" the transmitter tube to the antenna. It has been demonstrated in numerous articles that maximum output and efficiency in a vacuum tube transmitter will be obtained when the internal impedance of the tube equals the impedance of the output circuit. Now the internal impedance of our two UV 202 tubes (parallel) is 2000 ohms. Our antenna circuit has a resistance of 8 to 15 ohms. How can these be equalized to secure maximum output and efficiency? By properly designing the plate-antenna transformer, so that by varying the coupling, the transformation ratio of the antenna is "adapted" to the tube, and the transferred impedance of the antenna in the plate circuit will equal the plate resistance of the tube.

This means then that the plate-antenna transformer should have its transformation ratio variable and also its coupling. The plate-antenna transformer design here described is intended for use with the UV transmitting tubes. The plate coil should be about 4 1/2 inches in diameter and should have 50 turns of No. 18

coil being movable relative to the outer antenna coil, in this way permitting coupling variation. Figure 3 shows a sketch for a variometer transformer, the coils having the same number of turns as above. The variometer transformer is recommended for those making a panel type of set.

The telegraph key may be placed in series with the antenna as shown, or in series with the grid leak, as shown in the dotted lines figure 1. Both positions give excellent results. For telephony the best place to put the microphone is in series with the antenna. It is also the simplest place requiring a minimum of apparatus. It simply requires a small shunt inductance (LM) which serves the purpose of deflecting a portion of the antenna current, since the entire current need not pass through the microphone, and thus avoids packing. The complete constructional details of this inductance are simply 4 turns of the No. 12 bare copper wire, spaced one-half inch between turns, on a wooden form one inch in diameter and two inches long. The microphone should be a Western Electric 284-W.

Finally we consider the design of a

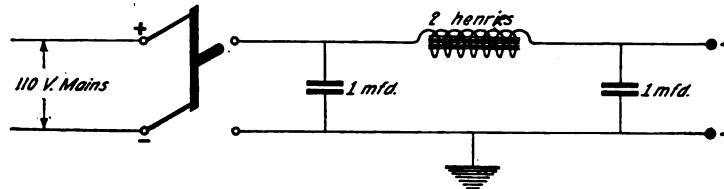

Figure 4—The filter circuit

book, while at the same time a maximum degree of efficiency is secured by proper design of the various circuit elements.

Batteries Reverse Polarity at Low Temperature

WHEN storage batteries or dry cells are cooled down to 170 degrees below zero Centigrade, the temperature of liquid air, these producers of electricity may reverse their voltage. This is the scientifically startling phenomenon that has been discovered at the Bureau of Standards, Department of Commerce, by two physicists, G. W. Vinal and F. W. Altrup, who were making tests to determine the reliability of batteries at arctic temperatures. So far as is known, this is the first time this phenomenon has been observed.

A storage cell of the same material as used on thousands of automobiles every day was gradually cooled down and the open circuit voltages at the various temperatures were determined. Down to 80 degrees below, the voltage remained at the normal value just as it

(Continued on page 47)

RADIS

"Your Assurance of Satisfact

DURING the past few months the acute shortage of radio apparatus has prevented *any* radio dealer from adequately meeting his customers' needs. However, thru all the confusion, one fact becomes more clearly established daily: RADISCO is making better deliveries to its agencies than are obtainable from any other source.

The tremendous buying power of the Radisco organization insures immediate recognition and shipment, by the manufacturers, of its immense orders. Its close co-operation with the leading manufacturers results in immediate notice of the latest developments, which information is promptly passed on to you.

"RADISCO RECOMMENDED" Apparatus, carried by all the Radisco Agencies, includes the *complete line* of Westinghouse, Radio Corp., Radisco, Firco, Murdock, Acme and other recognized leaders. More and more amateurs are realizing that it is well to rely on the nearest RADISCO Agency for *all* their radio supplies.

RADIO DISTRIBUTING COMPANY - NEWARK, N. J.

RAD

These

ALBANY, N. Y.
Shotton Radio Mfg. Co.
8 Market St.

ASHVILLE, N. C.
Hi-Grade Wireless Instrument Co.

ATLANTIC CITY, N. J.
Paramount Radio Supply
Arkansas & Pacific Av.

BOSTON, MASS.
Atlantic Radio Co.
727 Boylston St.

BROOKLYN, N. Y.
Kelly & Phillips
312 Flatbush Ave.

EUREKA, ILL.
Klaus Radio Co.

KANSAS CITY, MO.
McCreary Radio Supply
4th and Delaware Sts.

McKEESPORT, PA.
K. & L. Electric Co.
727 Olive St.

CO

Performance"

Below is an illustration reproduced from an actual photograph showing a fully assembled, well equipped, efficient receiving station, and at the same time moderately priced. This set is made up of "RADISCO RECOMMENDED" Apparatus, including Radisco variometers and coupler, grid condensers, Better "B" Batteries and all small parts. Also Corwin dials and switches, Murdoch No. 56 phones and rheostats, A. R. Co. transformers and Station Type Vocaloud. This set may be assembled with parts sold by the Radisco dealers listed here.

CO AGENCIES

Agents are GOOD Dealers

NEWARK, N. J.
H. H. Corwin & Co.
West Park St.

NEW ORLEANS, LA.
Radio Supply
84 Gravier St.

NEW BRUNSWICK, N. J.
Geo. N. DeLaplaine
87 George Street and
14th and Magnolia Sts.

PHILADELPHIA, PENN.
Philadelphia School of
Wireless Telegraphy
33 Pine St.

PHILADELPHIA, PENN.
Radio Electric Co.
97 Fifth Avenue

PITTSFIELD, N. J.
Wm. R. Collier
4 E. Front St.

PORTLAND, ME.
Atlantic Radio Co.
Temple St.

PROVIDENCE, R. I.
Rhode Island Electrical
Equipment Co.
45 Washington St.

SCRANTON, PENN.
Shotton Radio Mfg. Co.
P. O. Box 3
Branch 8, Kingbury St.
Jamestown, N. Y.

SEATTLE, WASH.
Northwest Radio Service
609 Fourth Ave.

WASHINGTON, D. C.
Eastern Radio and Elec.
Co., 1405 Florida Ave.
N. W.

Canadian

MONTREAL, QUEBEC
J. B. Miller
136 Vendome Ave.
N. D. G.

TORONTO, ONTARIO
The Vinyl Supply Co.
567 College Street

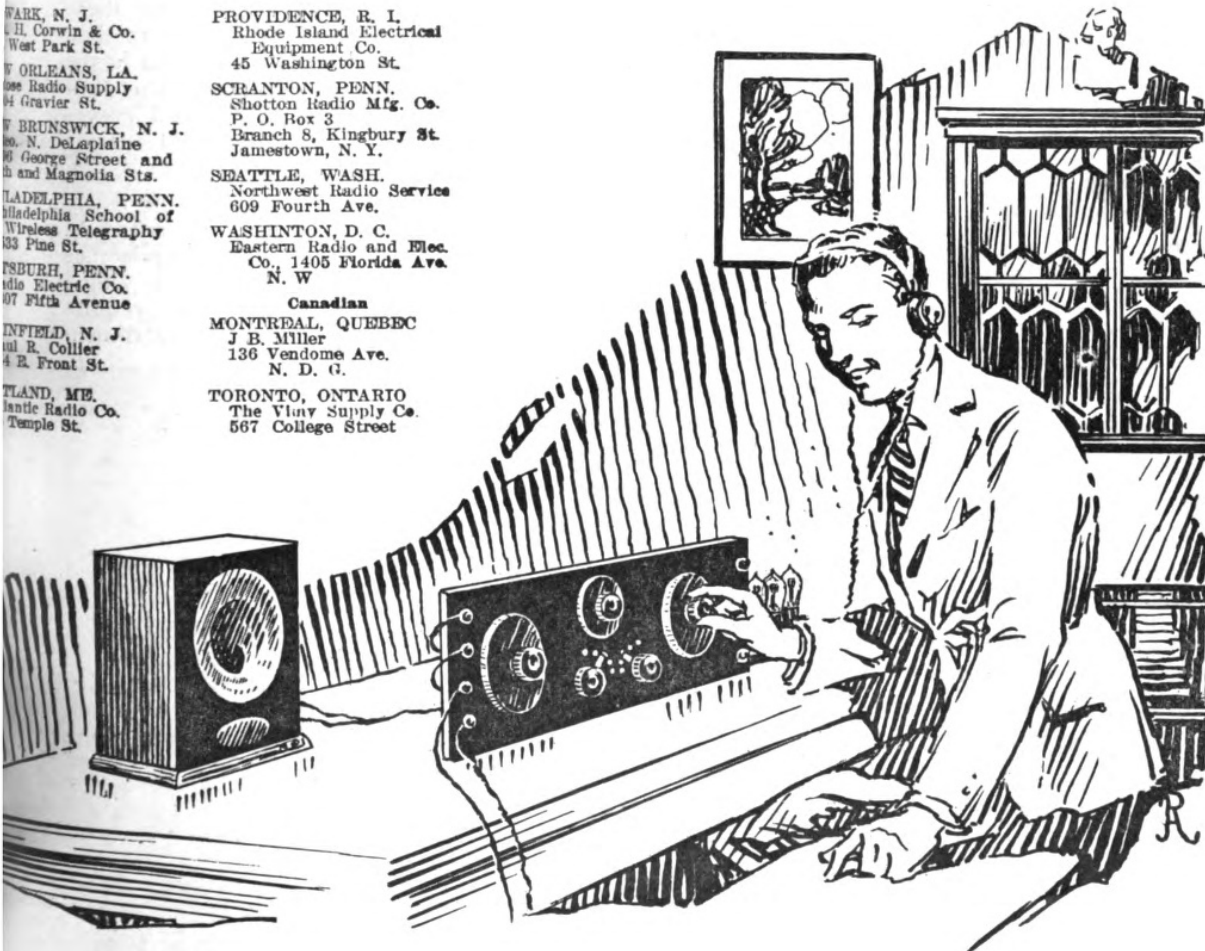

The Dimensions of Inductances

By C. M. Grabson

THERE appeared in the issue of THE WIRELESS AGE, June, 1921, an article on the above subject by Philip R. Coursey. Having occasion to design some inductances recently I used the method outlined in the mentioned article. It can safely be said that the method facilitates calculations considerably and is therefore a great time saver. It is also quite accurate for designing purposes.

However, as Mr. Coursey points out himself, it does not work out in practice that exact values will be obtained of the constants k_1 and k_2 as given in the table. It frequently happens that intermediate values are obtained. The tables for these constants, as given in the mentioned article, do not help much in such cases, and it is wasteful of time to interpolate from the tables. The suggestion of Mr. Coursey was therefore followed and curves were drawn showing the relationship between the constants k_1 and k_2 and the ratio of length of coil to diameter. These curves are here submitted for the benefit of other amateurs and experimenters in designing their coils.

In using these curves it must not be forgotten that the value of k_1 and k_2 —as calculated by Mr. Coursey's method—must be multiplied by 10,000 before using the curves. To illustrate the use of the curves, where the table would be wasteful

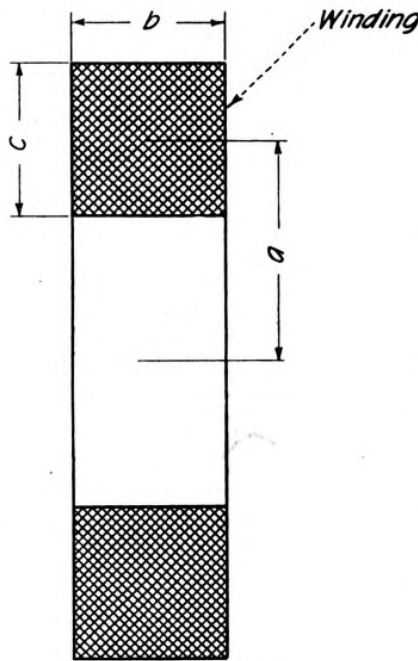

Figure 5—Coil design

missible coil diameter is 4 inches, and conditions require the use of No. 22 D.C.C. wire. This size wire gives a winding of 30 turns per inch. From Mr. Coursey's formula

$$k^1 = \frac{L}{D^2 n^2} = \frac{2000}{64 \times 900} = .0347 \times 10^4 = 347$$

corresponding value of 1.77 for the ratio $\frac{l}{D}$.

Therefore $l = 4 \times 1.77 = 7.08''$ which is the length of the coil.
make $l = 7''$

In a similar manner the curve giving the relationship between k_2 and $\frac{l}{D}$ is employed. It is obvious that

this method is useful only for single layer solenoids. However other types of coils are frequently required and similar simple devices for designing would prove useful. One of the types of coil which is much in use is the so-called circular coil with square cross-section, the winding being a multiple layer one, as seen from the accompanying drawing. A simple method similar to the above for single layer coils has been described for the design of these square sectioned coils. This method is described by C. O. Gibbon in the July, 1920, Proceedings of the A. I. E. E., and the method and curves are here briefly reproduced for the benefit of the readers of THE WIRELESS AGE.

The problem here presented is, given the inductance and resistance of the coil, to design a coil having a minimum weight. We require therefore to determine the dimen-

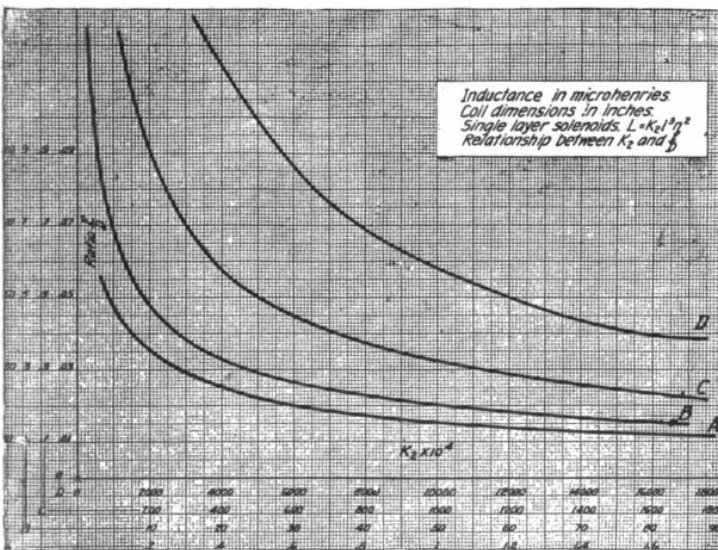

Figure 2

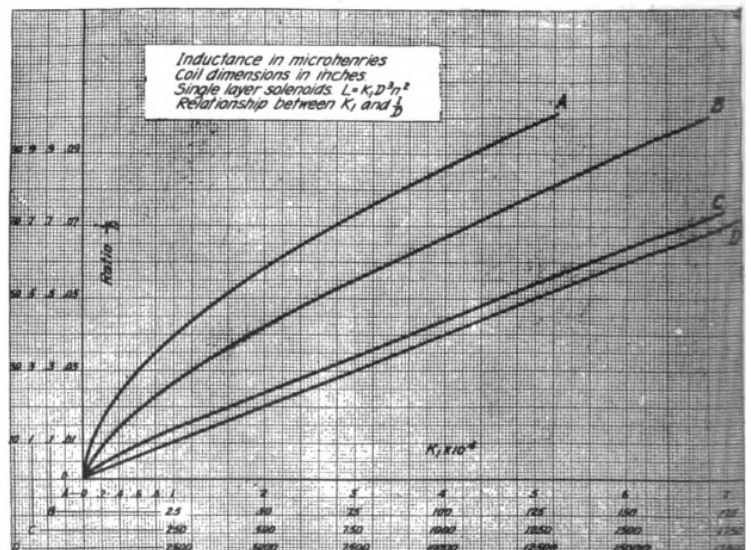

Figure 1

Graphs showing constructional dimensions of coils

of time, consider the following design problem.

An inductance of 2000 microhenries is required, for which a single layer solenoid is suitable. The per-

This value of k_1 is not in the table. However, from figure 1, we see that curve C covers this value. Looking up the value of k_1 equal to 347, we find that the curve C gives the

sions of the coil, a , b , and c , and the number of turns in the winding. It is shown in the above-mentioned article that the most efficient coil for a given inductance and resist-

ance will have a square winding—that is dimension b will equal dimension c , in figure 1. It is also shown that the inductance of such a coil in millihenries is given by the following formula

$$L = 18.85 \times 10^{-6} N^2 a \text{ mh.}$$

where, N = number of turns

required inductance being given and also the permissible resistance. The procedure for designing this coil would be as follows:

1. Knowing L and R , the value of $\frac{L}{R}$ is calculated and from figure 3

allowable resistance being 7 ohms. The coil is to be light, compact and occupy a minimum of space. The multi-layer, square-section, circular coil is suitable for this.

1. $L = 15$ mh, and $R = 7$ ohms. Therefore $\frac{L}{R} = 2.14$.

2. From figure 3 we find that corresponding to $\frac{L}{R} = 2.14$, $a = 2.2$ cms.

$b = c = 0.541 \times a = 1.19$ cms. The winding dimensions are therefore 1.19 cms. square.

3. The number of turns in the coil are found from equation 3 as

$$N = 230.3 \sqrt{\frac{L}{a}} = 230.3 \sqrt{\frac{15}{2.2}} = 608 \text{ turns.}$$

4. The turns per layer are $\sqrt{608} = 24.6$ turns. Take the nearest whole number, making the turns per layer 25 turns.

5. The diameter of wire is given by $\frac{b}{v}$ and is $\frac{1.19}{25} = 0.0475$ cms. This gives a winding of 53 turns per

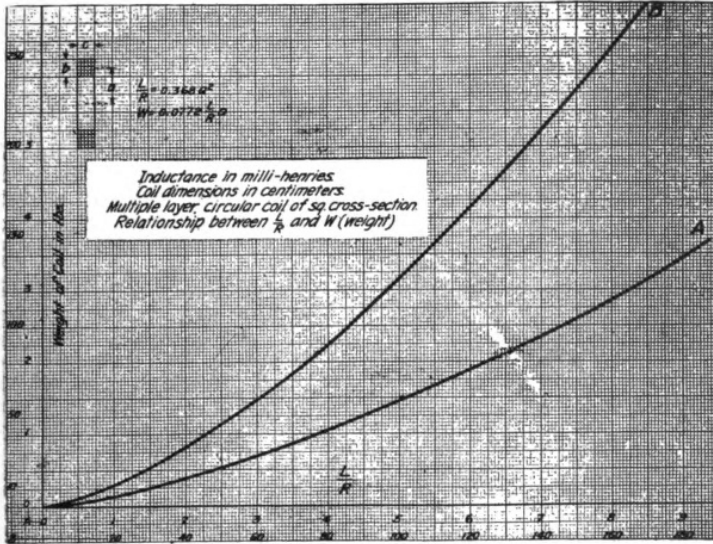

Figure 4—Graph for weight of coil in lbs.

$$b = c = 0.541a$$

a is the mean radius of coil

The two following equations are then derived, showing the relationship between L , R , W (weight) and dimensions of coil.

$$\frac{L}{R} = K = 0.368a^2 \quad (1)$$

$$W = (\text{weight}) = 0.0772 \frac{L}{R} a \text{ lbs.} \quad (2)$$

Equations 1 and 2 enable curves to be plotted, from which the coil may be designed for any given inductance and resistance. These curves are here shown in figures 3 and 4. With the aid of these curves, and the following additional equations the complete coil may be designed. These additional equations are:

$$N = 230.3 \sqrt{\frac{L \text{ (mh)}}{a \text{ (cms)}}} \quad (3)$$

Since the coil is of square cross-section

$$v = \sqrt{N} \quad (4)$$

$$d = \frac{b}{v} \quad (5)$$

where,

N is the number of turns in the coil
 v is the number of turns per layer
 d is the diameter of the wire to be used.

Suppose it is desired to design a multiple layer, square section, circular coil either for choking purposes, or for loading purposes, the

the coil dimension a is found corresponding to this value of $\frac{L}{R}$.

2. The winding dimensions b and c are then calculated from $b = c = 0.541a$.
3. The number of turns can now be found from equation (3) above.
4. The turns per layer is now calculated from equation (4).
5. The diameter of the wire to be used is obtained from equation (5).
6. The weight of the coil can be predetermined from figure 4.

Problem: It is required to design a loading coil of 15 millihenries, the

inch, for which No. 29 D.C.C. wire is found suitable from tables.

6. The value of $\frac{L}{R}$ being 2.14, by

using figure 4, curve A, we see that the weight of the coil corresponding to this value is 0.4 lb.

It will be evident that when other conditions and values are given, by the same use of these formulas and curves the other design data may be worked out. These curves are sufficiently accurate for design and engineering purposes and it is recommended that they be used in coil design as time and labor-saving devices.

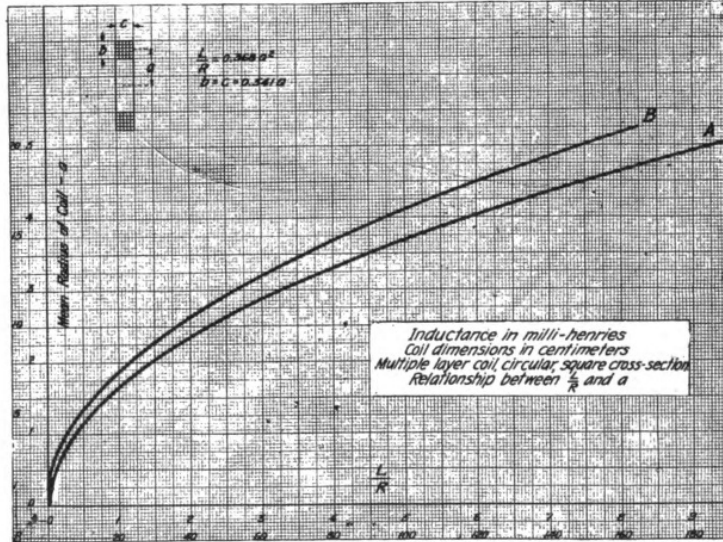
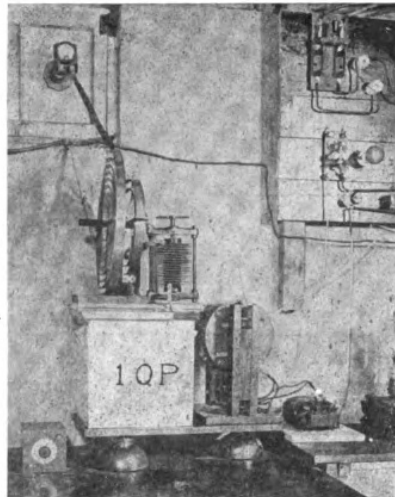

Figure 3—Graph for mean radius of coil

1QP An Active Station

THE amateur radio station of John Reinartz, 371 Hartford Road, South Manchester, Conn., Call 1QP (formerly 1XT), is one which is well known to the amateurs of the Eastern part of the country.

The design of station 1QP necessitated noiseless operation, hence the reason for the quenched gap. During the nearly two years of operation the quenched gap has been tried on both very low, i. e., 30-cycle note and very high 1,000-cycle note, the first giving 2 amperes and the latter giving 9 amperes radiation. Either tone, however, is very pretty and the DX quality of both is about the same, being reported by fourth district stations as very good, the low note being mistaken for 60-cycle C.



Quenched gap transmitter

tricts but the 6th and 7th having been copied with it, numbering 450 for the past winter.

For the benefit of those desiring to try this hook-up it is shown below:

The aerial at 1QP is of six wires, No. 6 B. & S. gauge aluminum, separation two feet, 75 feet long and flat top, 65 feet high at far end and 35 feet high at near end. The wires are continuous, without joints, to change-over switch.

The ground system is composed of several wires radiating from the secondary of the oscillation trans-



Receiving set at 1QP

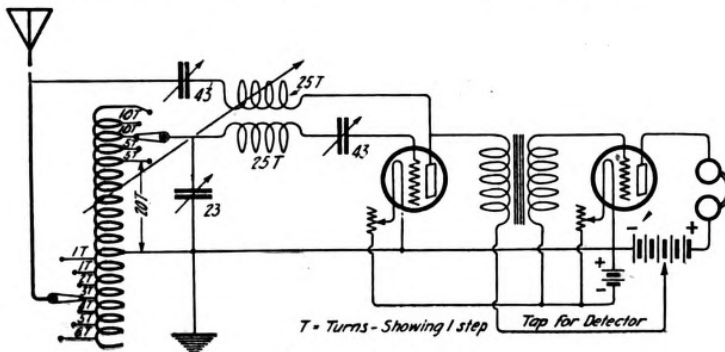

Hook-up of receiver

W. at times. Both tones will be used at times this winter and reports on the signals of 1QP will be appreciated.

The receiver of 1QP is of new design, primarily for C. W. reception, but is as good for spark as most three-circuit receivers, all dis-

former over the ground under the entire aerial and also of buried wires and pipes, and the water and gas piping in the house.

A Very Simple Radiophone

MANY amateurs would like to construct small radiophones, but the numerous instruments that are used confuse them and they are afraid to build one for fear it will not work. I have built a set that is the last word in simplicity. It is very efficient and with 60 volts on the plate, will cover 5 miles very easily. I have been heard at a distance of 20 miles. A circuit diagram of the set is given in figure 1.

The inductance consists of a cardboard tube 2 inches in diameter wound with 36 turns of number 16 D.C.C. wire. The wire should be wound from one end (A) and at the 19th turn a tap off (B). Seventeen more turns should be wound to make 36 turns in all. The variable condenser in shunt to the inductance has a capacity of .0005 mfd. The plate potential can be composed of three ordinary "B" batteries connected in series, but if a few more are used, so much the bet-

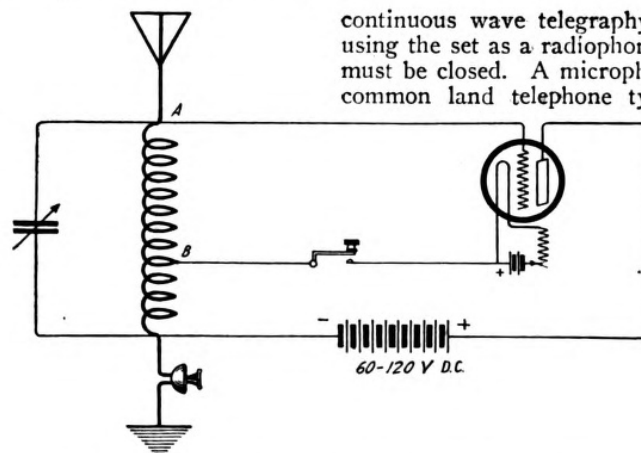

Figure 1—Circuit diagram of a simple CW transmitter

ter. When using the set as a radiophone, this key must be closed. A microphone of the common land telephone type, which

can be purchased very cheaply, is connected in the ground lead. Altogether this set is very simple to construct and is reliable and stable in operation.

Portable Radio Set

THE type of apparatus to be employed in any portable radio receiving set is determined by facilities for transportation and the range to be covered. The usual practise is to use crystal detectors, principally because of their simplicity and light weight, but their use necessitates a large aerial which is not only heavy but adds to the difficulty of erecting the station. In view of the fact that a portable aerial is at best a makeshift it becomes necessary to use the most sensitive detector obtainable to work over an appreciable range.

It will be apparent that the vacuum tube is the solution of the problem and in spite of the batteries necessary to operate it the complete set will be but slightly heavier than a crystal set on account of the small aerial necessary.

The set described employs a vacuum tube detector, and is extremely simple as regards tuning apparatus, but it gives a range of wave-lengths up to 3,000 meters with sharp tuning. It is complete in itself with the exception of the filament battery which may consist of dry cells or a small storage battery.

The illustrations show the assembly of the set. The containing case is a small fibre suitcase, measuring 14 by 12 by 5 inches outside. The body of the case is four inches deep and encloses a tuning and B battery box. The lid, being one inch deep, forms a handy place to carry the aerial wire. The tuning apparatus and detector bulb are mounted in a small box that fits into the case, its width being about two-thirds the length of the case. By so mounting the instruments they can be readily removed from the case and used in the home station, permitting the case to be used for other purposes.

The circuit used is the single slide tuner, series condenser feed back. The inductance consists of 550 turns of No. 22 S.S.C. wire wound on a tube 8 inches long and 3 inches in diameter. The winding is banked in two layers and tapped to an eight point switch at the following turns—40, 70, 120, 180, 250, 350, 450, 550. The condenser has a maximum capacity of .001 mfd. The location of capacity and inductance are shown in the illustration.

A socket is mounted flush in the panel to take the vacuum tube. A rheostat controls the filament cur-

rent as shown. The usual grid condenser provided with an adjustable grid leak is mounted as shown by the dotted lines, the leak should be carefully adjusted when the set is assembled to get maximum signal strength. This completes the apparatus proper, six binding posts be-

side. The remaining space in the case is occupied by the phones. The tube is to be removed and placed in a small box with cotton and packed with the phones when the set is not in use. The wiring diagram is well known for its ease of adjustment, selectivity and regen-

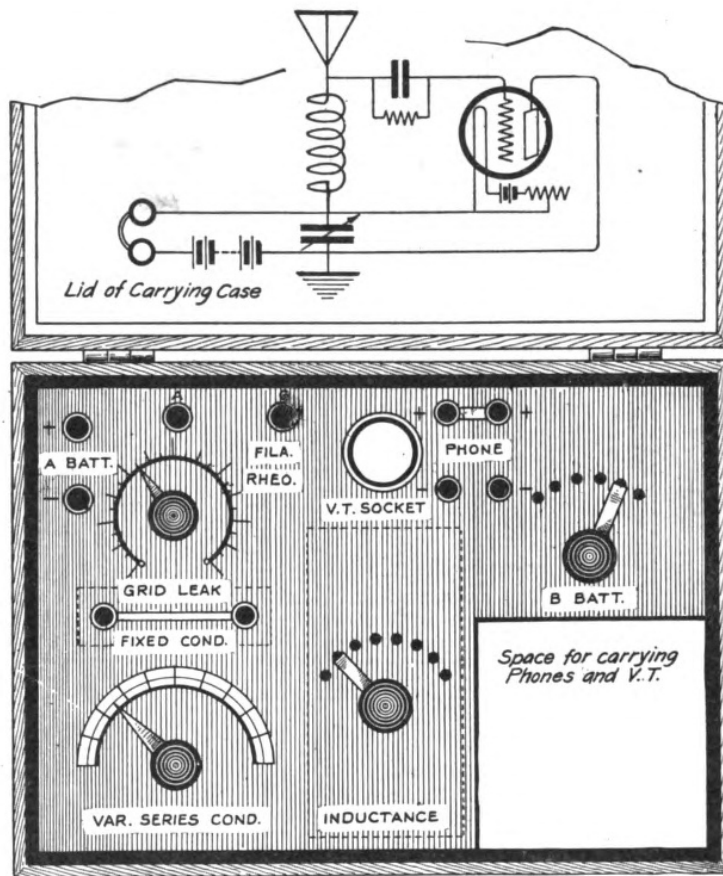

The portable radio set assembled

ing provided to connect aerial, ground, A and B batteries.

The B battery is mounted in another small box and consists of two 22½ V. units connected to a multipoint switch on the box to permit of voltage control when a soft tube is used. Two binding posts on this box permit it being connected to the tuner and detector. It will be noted that a short jumper connects one terminal of the B battery to the tuning box, the phones being connected across the other two to complete the circuit. Disconnecting the phones while the set is not in use reduces the likelihood of a short on the cells during transportation.

The tuning and battery boxes are held in place in the case by short wood screws driven in from the out-

erative effect. The feed back is due to the series condenser and can be readily controlled.

The aerial should be about 200 feet of No. 18 D. C. wire which can be rolled into a coil and tied with cord and fitted into the lid. For the filament three dry cells or a small storage battery are necessary and must be carried separate. Dry cells are entirely practical if the set is in use for short periods only.

This outfit will meet the requirements of any camp or outing and after the trip is over the instruments can be removed from the case and set up in the permanent station. The tuner will be found sufficiently selective to deserve constant use and will often be preferred to the more complicated sets.

A Short, Medium and Long Wave Receiver

By E. T. Jones

NO doubt, many experimenters have arrived at the conclusion that the receiver described by me in the December, 1920, issue of THE WIRELESS AGE has lived up to its name under all conditions. For the benefit of readers who did not see the article referred to a brief summary will be given. The tuning coil is nothing more than a double slide tuner. The antenna connection goes directly to one slider and to the grid through the grid condenser. The remaining slider connects to the negative side of the vacuum tube filament. The bottom portion of the winding has its end connected to one side of the telephone receivers and then to the ground. The remainder of the plate circuit is the same as the standard practice.



Inductance load coil

Furthermore, that it was best to connect the ground to the filament in preference to the plate-inductance connection. The variable condenser is now shunted across the aerial and ground with the ground to the filament. See figure 1 for the latest connection with all the improvements. Particular attention should be given the series-shunt switch. This switch is much more simple in construction and operation than most types.

SHORT WAVE RECEIVER

A vario-coupler was constructed along the usual lines and in addition an ordinary variometer was connected in the circuit with the medium wave receiver so that the tuning inductance acts as the plate variometer. Note that the same tube, A and B batteries and

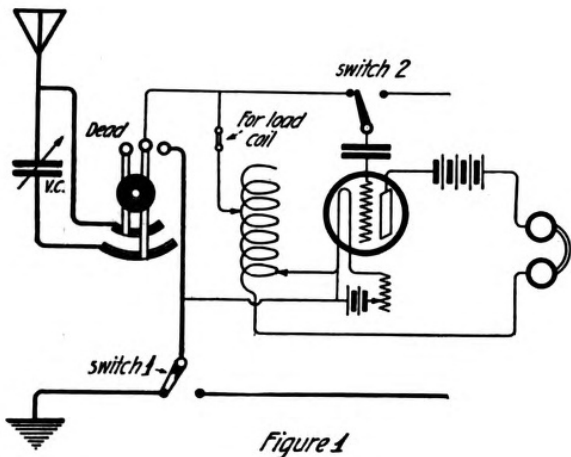

Figure 1

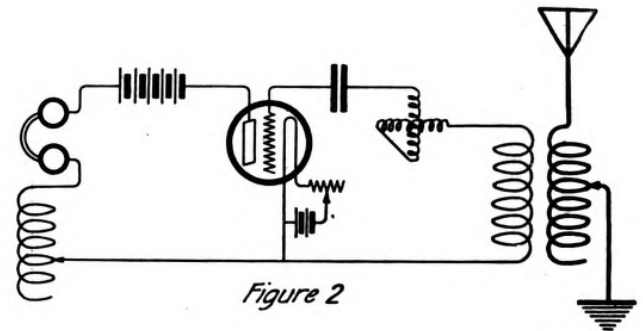

Figure 2

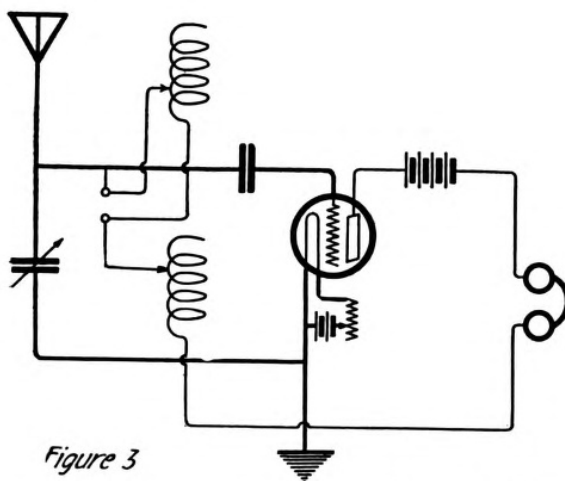

Figure 3

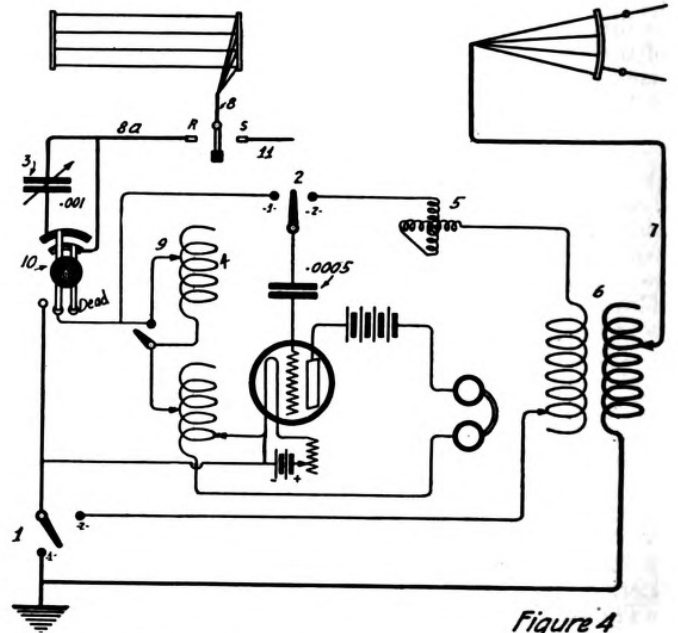

Figure 4

Various circuits for short, medium and long wave reception

For short wave reception, i.e., any wavelength below 1000 meters, a variable condenser is placed in series with the antenna, and for reception of signals on wavelengths in excess of 1000 meters, the condenser is shunted across the secondary tuning side.

Several changes have been made in the circuit over the one described in the December, 1920, issue. It was found that the signal audibility was increased 20 per cent. with the variable condenser in series with the antenna instead of in series with the ground.

phones are employed in both circuits for the same purpose.

The switch No. 2 throws the grid and its condenser in either the short or medium wave circuit. See figure 2 for short wave receiver, which is connected to a small antenna. Switch No.

I throws the ground connection off the filament and places the filament to the tuning side of the short wave receiver.

Tuning of the plate circuit is accomplished by increasing or decreasing the inductance in that circuit which is the same inductance employed in the medium and long wave circuit. Maximum strength of signal is brought about by adjusting the variometer in the tuning circuit.

With the switches in their right po-

sition the medium wave receiver is the same as that shown in figure 1.

LONG WAVE RECEIVER

The large inductance load coil is so arranged to act as though it were on the same tube as the medium wave coil. Since it is in the plane of the coil in the box (both are vertically aligned), maximum results are obtained. The long wave circuit is shown in figure 3.

It can be seen that this is a very

favorable arrangement in that it permits the use of one tube and its ordinary accessories to function in three different circuits without the need of several vacuum tubes and their control units.

Those of you who constructed the medium wave tuner described in the December issue of THE WIRELESS AGE should not hesitate to install these very necessary and useful additions. Figure 4 gives the entire circuit.

A New Type of Coupler for Short Waves

By Geo. A. Grogan

AFTER considerable experimenting with various inductances for short wave reception I have designed a coupler similar in looks to the vario-coupler so familiar in regenerative sets. Variometers are not necessary for sharp tuning with this coupler, but may be used if desired.

The primary consists of a tube (cardboard or fibre may be used) four and one-half inches in diameter and five inches high, wound with sixty-four turns of No. 26 B.&S. gauge D.C.C. magnet wire. The winding is begun one-half inch from the top of the tube and 36 turns are wound. Then a space of one inch is left between the two groups of winding. In the center of this space a hole is drilled for the rod, which varies the rotor, see figure 1.

Any size rod may be used, but a one-fourth inch rod is best as it fits most dials on the market. Six taps are taken off the primary, three from each section of the winding. They may be taken off at every twelve turns. When the second section of winding is finished there is a space of one inch remaining. This will serve to bring the hole for the rotor shaft near the top of the panel and leave room for the primary switch. After winding, the primary is given a coat of orange shellac. The primary is now complete

from any of the large radio supply houses for about one dollar. A hole is drilled in the center of the rotor for the shaft. The rotor may be boiled in paraffine or shellac before winding. One half on the rotor is

going to the binding posts on the panel and should be about five inches long. The secondary leads should be about the same length. The secondary is wound on the other half of the rotor with forty strands of No. 28 B.&S.

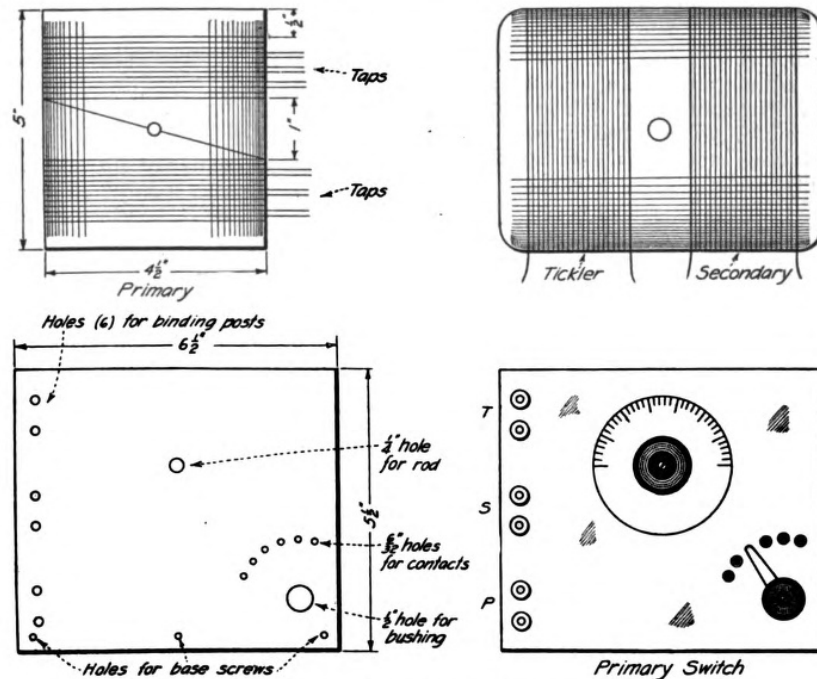

Figure 1—Constructional details of the vario-coupler

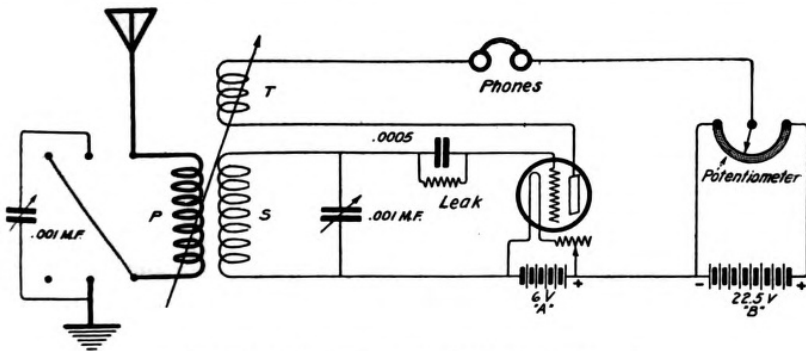

Figure 2—Hook-up for best results of vario-coupler

and the leads at the taps are scraped to get rid of the insulation.

The rotor form may be purchased

wound with twenty-four turns of No. 20 B.&S. D.C.C. magnet wire. This is the tickler which has two leads

S.C.C. magnet wire. After winding the rotor should be given a coat of shellac and allowed to dry after which the rod is inserted to fit the rotor tightly. The winding is now finished and the instrument ready for mounting.

An oak base 5 1/2 x 6 1/2 x 1/2 inches is then secured. This may be stained or shellacked as the constructor desires.

A panel, preferably bakelite, 5 1/2 x 6 1/2 x 1/8 inches is purchased. It may be grained with oil and sandpaper to make a good appearance. A 1/4 inch hole for the shaft is drilled two inches from the top and three and one quarter inches from the sides. In the low-

(Continued on page 47)

A Hook-Up That Simplifies Tuning

By F. C. Greenwald

I HAVE noticed beginners hereabouts using home-made or purchased apparatus embodying the usual aerial short wave condenser, a loose coupling arrangement between primary and secondary, a secondary condenser, a grid condenser, usually adjustable, and a bridging adjustable condenser. All these with the standard adjustable filament rheostat make a total of five adjustments necessary where tuning or attempting to tune in when receiving. Some few are using the Armstrong arrangement with variometers, which appears to be a very efficient circuit, but also entails a multiplicity of adjustments during use. An operator's time is in immediate demand, copying messages, and the less time necessary to spend on adjustment, the better, all round. Also it is very much easier to explore with one or two adjustments, than with five, when on the lookout for C. W. in the form of music, voice, straight or buzzer modulated telegraph. Few adjustments are even an advantage when tuning in the broad waves emitted by the spark sets.

I have tried out a great number of receiving circuits, capacity coupled, inductively coupled, and conductively coupled, combined primary and secondary, separate primary and secondary with and without secondary condenser, tuned and untuned grid circuit, adjustable bridging condenser in plate circuit, and variometer in the plate circuit, and variometers in grid and plate circuits as connected to the vacuum tube.

I was led to believe that from a standpoint of both simplicity and efficiency a vacuum tube should be connected to only a grid circuit and a plate circuit, each arranged to tune to the other and the aerial should be connected directly to the grid or plate circuit through a condenser, if necessary, whether into the grid or plate circuit depending entirely upon its use as a receiving circuit or as a transmitting arrangement. The diagram figure 1 will make this clear. I use only one inductance coil tapped at or near the center. I found it convenient to use a pasteboard tube 3 inches in diameter $1\frac{1}{2}$ inches long on which was wound 22 turns of No. 26 B. & S. double covered cotton insulated wire, a tap taken off by twisting a loop in the wire after renewing the insulating and then continuing to wind in the same direction for 22 more turns, making a total of 44 turns. The middle tap of this coil was connected to ground, one end connected to one side of a .001

mfd. variable condenser, the other side of the condenser being connected to an indoor aerial. This aerial is a single wire, extending from basement to loft, about twenty-five feet high and perhaps twenty feet long in the loft of the building. One side of a fixed small capacity condenser, .0003 to

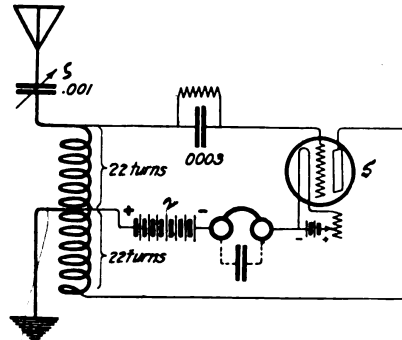

Figure 1—Receiving circuit that simplifies tuning

.0007 mfd. is connected to the end of the coil, which is connected to the variable short wave condenser. The remaining side is connected to the grid of the tube, the grid leak being connected across the grid condenser. I use a variable grid leak, as I find each tube requires a somewhat different grid leak. The

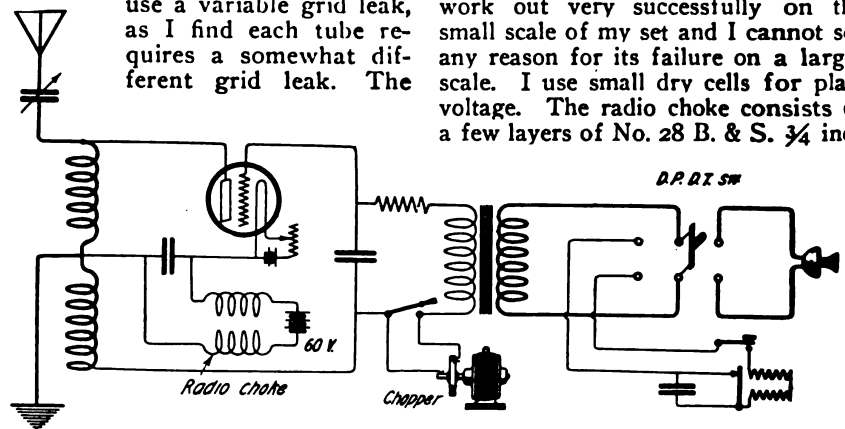

Figure 2—Hook-up for the transmitting set

other end of the coil is attached to the plate. The telephone and "B" battery are in series and extend from the negative side of the "A" battery to the ground tap at approximately the middle point of the coil. Perhaps it may be necessary when setting up this circuit and tuning the aerial to remove or add a few turns to the grid end of the coil. For the average amateur aerial twenty-two turns will be about the correct value, as the adjustable condensers allow considerable range in tuning. The condenser indicated in broken lines merely indicates the theoretical condenser caused by the proximity of the wires

leading to the head set and which have a very practical value. It is not necessary to place an actual condenser at this point, as the usual receiver cord provides this.

In operation it is found advisable to bring the filament brightness to a point where the tube oscillates with a squeal or howl or at least exhibits a state of liveliness, with the short wave condenser setting at zero. When this condition is established exploring is in order by moving the condenser pointer over the scale until the best point of audibility of signals is reached. When this position is found, bring up the filament brightness until the tube oscillates at this point and then back off a trifle. Only two adjustments are needed, the short wave condenser and the filament rheostat, against four or five in other arrangements. It is quite possible with a loose coupled set to get a nearby spark transmitter much louder than with this simple outfit, but we should realize the weak distant signal must be catered to rather than the nearby stone crusher.

Figure 2 embodies the same idea used in the single receiving set applied to the transmission set. It appears to work out very successfully on the small scale of my set and I cannot see any reason for its failure on a larger scale. I use small dry cells for plate voltage. The radio choke consists of a few layers of No. 28 B. & S. $\frac{3}{4}$ inch

diameter $1\frac{1}{2}$ inches long and is used to prevent the battery from short circuiting the condenser by radio frequency current. The telephone, buzzer and chopper arrangement in the grid arrangement in the grid modulation scheme are conventional and need not be described, being illustrated freely on standard phone circuits.

Amateurs of limited means will find these two circuits to their liking, the coils can be made easily in the ordinary workshop. An old type Ford coil makes a good modulation transformer for the transmission hook-up. A simple arrangement for phone work

(Continued on page 48)

The Monthly Service Bulletin of the NATIONAL AMATEUR WIRELESS ASSOCIATION

Guglielmo Marconi
President

J. Andrew White
Acting President

H. L. Welker
Secretary

Founded to promote the best interest of radio communication among wireless amateurs in America

NATIONAL ADVISORY BOARD OF VICE-PRESIDENTS

Prof. A. E. Kennelly
Harvard University.
Maj. Gen. George O. Squire
Chief Signal Officer, U. S. Army

Rear Admiral M. Johnston
Director of Naval Communications
Prof. Alfred N. Goldsmith
College of the City of New York

E. E. Bucher
Instructing Engineer
Prof. Charles R. Cross
Massachusetts Institute of Technology

HEADQUARTERS: 326 BROADWAY, NEW YORK

THE Department of Commerce has received so many complaints from owners of receiving sets regarding the great amount of broadcasting of music, speech, unofficial news items, and other matter being done by amateur stations which interfere with the reception of the programs of the regular commercial broadcasting stations.

As a result of these complaints the Department of Commerce made an extensive investigation and the result is that it has been decided to amend the radio laws and regulations of the United States governing amateur radio station operation by the addition of the following which will hereafter be incorporated in all amateur station licenses:

"This station is not licensed to broadcast weather reports, market reports, music, concerts, speeches, news, or similar information or entertainments."

As above stated, this ruling applies to all general and restricted amateur radio stations.

The order prohibiting the broadcasting of general and restricted amateur radio stations in the United States, was signed by C. H. Huston assistant secretary of Commerce and becomes effective at once.

△ △

THE Cedar Rapids Radio Club of Iowa was organized December 6 at Coe College, for the purpose of regulating traffic and promote fellowship among the amateurs in this locality. An invitation is extended to those interested in radio to attend the meetings of the club which are held on the first and third Tuesdays of every month at the Chamber of Commerce building. The officers are president, M. Jennings; vice-president, Charles Boegel; secretary, Lester MacMellon; treasurer, George Keppel.

△ △

THE call letters of Burton P. Williams' station, 3220 Orlean street, Pittsburgh, Pa., have been changed from 8ZD to 8ZAE.

△ △

THE second annual amateur radio convention-exhibition of the Executive Radio Council, Second District, will be held at the Pennsylvania Hotel, New York on March 7-11, 1922.

The glass-enclosed roof garden of the hotel will be the exhibit hall, and the adjoining Butterfly Room the lecture hall, with adequate seating capacity. Only papers of vital interest to amateurs will be presented.

The convention and exhibition will open at 7 p. m., March 7, and will be open from 2 p. m. to 11 p. m. on the following days. A season badge will be sold at the door 50 cents, covering the five days. One time admissions 25 cents.

A banquet for everybody, male and female, will be held on the night of the 11th (Saturday).

That dusky-hued girl who was the sensa-

tion of last year's dinner will be there again to demonstrate the last gasp in Hawaiian grass costumes. All male guests will be searched at the door for concealed lawnmowers.

The banquet charge will be \$4.00. The number which can be accommodated is limited to 600. Tickets will be allotted up to this number only, in the order in which applications are received. Applications by mail should be made to John Di Blasi, 6 Warren Street, New York.

△ △

THE inaugural meeting of the "Cape Breton Amateur Radio Association took place on December 21 at the home of G. A. Edwards, North Sydney, Nova Scotia, and was well attended by representative amateurs from Sydney, Sydney Mines and North Sydney.

It was decided that the association should include the whole of Cape Breton Island, with local branches in each town. The constitution was drawn up and officers were elected for the first period of six months dating from January 1 to June 30, 1922.

The objects of the association are the organization and advancement of radio amateurs within the island of Cape Breton. Particular stress is being laid upon the question of interference both with commercial and amateur stations; and with this object in view the members have decided to install and use C.W. transmission as far as possible. Traffic rules are to be drawn up and routine hours for working and experimenting will be arranged.

The officers elected to serve for the first six months are: President, G. A. Edwards, North Sydney (1AW); Sydney Vice-President, G. D. Crowell (1BM); North Sydney Vice-President, M. J. Cleary; Sydney Mines Vice-President, S. Jones (1AJ). For the present the vice-presidents will act as secretary-treasurers and traffic supervisors for their respective districts and the president will undertake the duties of general secretary.

Correspondence is invited from other amateur organizations. Information will gladly be given regarding membership and regulations to those interested.

△ △

THE first meeting of radio enthusiasts in Porto Rico was held at the Carnegie Library at San Juan, P. R., on December 25, which resulted in the organization of a radio club to be known as the Porto Rico Radio Club. The following Board of Directors was elected for the term of one year: Joaquin Augusty, President; Jesus T. Pintero, Vice-President; Jose T. Madero, Secretary-Treasurer; Enrique Camunas and Alberto P. Graham. The above members hold first class amateur licenses and Mr. Camunas holds a commercial license.

A LONG, unpainted and hence unsightly pole raised recently in Midwood Manor, Brooklyn, N. Y., stirred up a clamor of protest and the cry of "nuisance," has unexpectedly been turned into a community blessing, according to Gaston Koch, president of the Midwood Manor Association, who was the official buffer of the protests. Mr. Koch, directed by a number of indignant fingers, went to 967 E. 10th street, where he found the offensive pole planted in the back yard. Charles C. Cahn, a new resident of the community, proved to be the owner of the pole. He confided to Mr. Koch that his one big hobby was radio, and that he had a pleasant surprise for his neighbors. The pole, he said, was to hold up aerials for a private plant which would not only afford him pleasure but, that of all Midwood. It would be painted, too, and made to blend harmoniously with its environs.

He said he had made arrangements with people in charge to hear a series of concerts to be given by Metropolitan Opera stars beginning in January. If everybody was agreed he would place his receiving apparatus with an amplifier and Magnavox in the auditorium of Public School No. 99, where all Midwood can assemble and enjoy the best music that can be heard. Mr. Koch, at a meeting of the Midwood Manor Association, announced these tidings. Also that Mr. Cahn had offered his service as radio instructor to the Boy and Girl Scouts of Midwood.

△ △

THE Scott High School Radio Club of Toledo, Ohio, held an "open meeting" at the school recently and entertained the parents and friends of the members. A special antenna and sensitive receiving apparatus were used to receive radiophone music and speeches from Pittsburgh, Detroit and other points where radiophone broadcasting stations are located.

The meeting was in charge of Robert Tiedeman, the club's president. Among the speakers were J. W. B. Foley, radio instructor of Scott High, and Edward Featherstone, another member of the school's faculty.

△ △

AT a recent meeting of the Hudson City Radio Club, Inc., held at the headquarters, 37-41 Sherman avenue, New Jersey, Robert Lange, August Heins and Frank Eichinger were admitted into membership. Nineteen members are on the roster of the club at present and it is expected that ten more will be added at the next meeting. The club has installed a one-half K.W. spark set, a rectifier for charging the members' batteries, a two-step amplifier and a radiophone set station, call 2CBK. A code practicing table has also been a recent addition. The public is invited to inspect and listen through the wireless phone at the office of Mr. Bremer, 89-91 Franklin street, between 8 and 10 p. m. Application for membership may also be had from Mr. Bremer.

EITHER the attempts of certain commercial interests to advance the science of radio by broadcasting concerts, lectures and other matters through the ether must suffer interminably or else amateur operators may face cancellation of their licenses to have sending stations unless interference in wireless telephone traffic is soon stopped, according to Walter Butterworth, Government radio inspector for the First District, who addressed the Radio Council of Southern New England at its meeting and dinner in the Providence Plantations Club.

Mr. Butterworth outlined the problem which now seems to present an obstacle to the conducting of further experiments tending to increase the value of radio. He explained that the United States and Canadian Governments are the only ones in the world which allow other than professional operators to send messages, and in view of this fact had specified that wavelengths of no more than 200 meters should be used by amateurs.

Commercial enterprises are now sending abroad between the hours of 8 and 10 every evening weather reports, musicales, addresses and other things calculated to excite a greater interest in the possibilities and the actualities of the wireless telephone. The project has been handicapped, however, by amateur telegraphers, who have not tuned their instruments within the limit set by the Government, and interfere with the telephone waves.

Receiving stations, whether telegraph or telephone, do not require licenses, but permits must be obtained by sending stations.

Mr. Butterworth urged his hearers not only to tune their instruments properly, but when possible to refrain from sending messages during the telephone broadcasting period, between 8 and 10 o'clock at night, in order to reduce the danger of cancellation of licenses. The speaker revealed that there are now 3,000 licensed radio transmitting stations in New England, which is three times as many as existed before the war.

For the benefit of the science as a whole, Mr. Butterworth besought his hearers to

co-operate to the best of their ability with the Government in its efforts to regulate wireless activities, that all branches may be allowed a maximum opportunity for beneficial development.

The Radio Council of Southern New England was formed last spring and so far has held three meetings, all of which have been well attended by amateurs and students of radio from Rhode Island and Massachusetts. The purpose of the group is to stimulate interest in the topic in this section of the country and to work to the advantage of the art from a non-commercial standpoint. Another aim is to bring together at regular intervals persons who otherwise would know each other only through aerial messages. The organization is open to members of both sexes.

Included in the plan of organization is a vigilance committee, by which the council will keep watch over its own members and will receive and adjust complaints as to willful interference, illegal use of transmitters and the use of illegal wavelengths, and will also report such cases to the district radio inspector when necessary.

△ △

A MEETING of the Hudson County Radio Club, New Jersey, held at the Standfast Club, entertained Mr. Ranger, Engineer of Radio Corporation, who delivered a lecture to the members. The talk was highly interesting.

The Hudson County Radio Club holds semi-annual meetings in the Standfast Club, and all interested in radio work are invited to join. The officers are: Gaylord Smith, 2746 Boulevard, president; T. W. Cooper, vice-president; H. Silbersdorff, treasurer; J. A. Erhard, secretary; P. H. Rank, assistant secretary; F. V. Bremer, traffic manager. Executive committee—William Michel, Paul Wandelt and Paul Zeyn.

△ △

A RADIO Club has been formed at South High School, Broadway and Fullerton avenue, Cleveland, Ohio. Five girls are included among the seventeen members.

Every member of the club will be able to receive 12 and send 10 words a minute by the end of the term, says Grover Muthersbaugh, instructor.

△ △

THE Stevens "Tech" Radio Club of Hoboken, N. J., has outlined an ambitious program for the year. The first item is a trip to Port Jefferson, L. I., to inspect the largest radio station in the world. The trip was arranged by a Stevens man connected with the gigantic project and is limited to a few members of the club.

To give the beginners instruction in wireless, the club has installed a small receiving set in the radio room, the new installation saving the larger and more expensive set from possible damage by inexperienced hands. Another improvement made by the club is that the aerial, instead of being stretched diagonally across the court of the Navy building is now directly across it, enabling them to obtain greater height.

A loud-speaker was recently installed and a radiophone sending apparatus is to be purchased as an adjunct to the powerful telegraphic radio transmitter now possessed by the club. Messages are sent for students within a radius of 250 miles.

△ △

ARRANGEMENTS have been made for the St. Clair County Radio Association, with headquarters in the Sexton Building, Main street and Division avenue, East St. Louis, to use the wireless equipment of the Boy Scouts in East St. Louis. Classes in advanced instruction will be held. Jerome Hartmann and Arthur Beckwith, senior operators, will be in charge.

△ △

WIRELESS telegraph operators and those having telephone equipment are planning to form a club in Martinsburg, W. Va., and those who are known to have such equipment as to make them eligible have been advised of the project.

Operators who are interested are asked to communicate with Mr. Burns, West John street.

△ △

JOHN F. O'NEILL, director of Knights of Columbus Free Evening School for ex-service men, announces a new class in wireless telegraphy and telephony will be formed at the Hut, 601 Newark avenue, Jersey City. Any ex-service man who desires to secure a thorough training in radio subjects is privileged to enroll.

In addition to the class now forming sessions of an advanced class will be continued. Both classes will meet Tuesday and Thursday evenings at 7.30.

△ △

A WIRELESS telephone has been installed in the electrical shop of Victor Werner, at Catalpa avenue and Fresh Pond road, Ridgewood, L. I.

The device has excited the wonder of the residents of the section, who gather at the shop daily to hear concerts transmitted from all over the country, particularly from the Westinghouse Manufacturing Company of Newark, N. J., from which point prominent artists are heard clearly, without the aid of an amplifier.

On one occasion, a customer who saw the horn and heard the sound of music issuing, thought it to be a phonograph. After hearing several selections played without the machine being attended to, she asked, "How many songs does that record hold?"

(Continued on page 46)

Prize Contest Announcement

The subject for the new prize contest of our year-round series is:

MODULATION SYSTEM

CLOSING DATE :: :: MARCH 1, 1922

Contestants are requested to submit articles at the earliest practical date.

Prize winning articles will appear in the May, 1922, issue.

All manuscripts should be addressed to the CONTEST EDITOR OF THE WIRELESS AGE.

The best type of modulation system to use with a moderate power tube transmitter either with or without modulation tubes. Data to include details necessary to construct complete transmitter.

PRIZE CONTEST CONDITIONS—Manuscripts on the subject announced above are judged by the Editors of THE WIRELESS AGE from the viewpoint of the ingeniousness of the idea presented, its practicability and general utility, originality and clearness in description. Literary ability is not needed, but neatness in manuscript and drawing is taken into account. Finished drawings are not required, sketches will do. Contest is open to everybody. The closing date is given in the above announcement. THE WIRELESS AGE will award the following prizes: First Prize, \$10.00; Second Prize, \$5.00; Third Prize, \$3.00, in addition to the regular space rate paid for technical articles.

STATIONS WORKED AND HEARD

Stations worked should be enclosed in brackets. All monthly lists of distant stations worked and heard which are received by the 10th of each month will be published in the next month's issue. For example, lists received by November 10th will be published in the December issue. Spark and C. W. stations should be arranged in separate groups.

304, F. B. OSTMAN, 180 Broad St., Ridge-wood, N. J. (November and December).

Spark—1ACK, (1ADC), (1ADL), (1AEV), (1AHF), (1AIT), (1AKG), (1AMD), (1APO), (1ARY), (1ASF), (1ASW), (1ASZ), (1AW), (1AWM), (1AWO), (1AZK), (1BDC), (1BDI), (1BDT), (1BDV), (1BIR), (1BIS), (1BJN), (1BLE), (1BMR), (1BQ), (1BQA), (1BQL), (1BRQ), (1BVB), (1BWZ), (1BYG), (1CAK), (1CEO), (1CHJ), (1CK), (1CM), (1CO), (1COK), (1DY), (1DZ), (1FU), (1GM), (1HK), (1IA), (1MA), (1OE), (1OJ), (1RV), (1SN), (1UA), (1XB), (1YB), (1YD), (1ZE), (2PV), (2XQ), (2AWF), (Canadians), (3BP), (3EJ), (3FQ), (3GE), (3JL), (3LI), (3QJ), (3AC), (3ACE), (3AFB), (3AHF), (3AHK), (3AIC), (3AIS), (3AJD), (3ALI), (3ALN), (3AOZ), (3ARM), (3ARN), (3ATZ), (3AUN), (3AUW), (3BFU), (3RGT), (3BJ), (3CG), (3CK), (3CN), (3DM), (3FB), (3GX), (3HG), (3HJ), (3IW), (3KM), (3LP), (3LY), (3NB), (3NH), (3OU), (3QF), (3RW), (3TH), (3TJ), (3TT), (3UC), (3US), (3VW), (3XF), (3XM), (3YO), (3ZA), (3ZF), (3ZO), (4AL), (4AS), (4BQ), (4BX), (4CX), (4DH), (4DQ), (4EA), (4EY), (4FD), (4GN), (4XC), (5DA), (5EA), (5ER), (5FJ), (5FV), (5HK), (5JD), (5XF), (5XU), (5ZL), (7XD), (7ZU), (8AAE), (8AAG), (8AAV), (8ACF), (8ADE), (8AFB), (8AFD), (8AFG), (8AFS), (8AGB), (8AGF), (8AGK), (8AGT), (8AHE), (8AHF), (8AHH), (8AHS), (8AIB), (8AIG), (8AIZ), (8AJO), (8AJT), (8AJV), (8AJW), (8AKQ), (8ALT), (8AMB), (8AMK), (8AMZ), (8ANO), (8AOI), (8AOT), (8AOU), (8APB), (8AQV), (8AQZ), (8ARD), (8ARG), (8ARS), (8ATU), (8AUE), (8AUR), (8AVI), (8AVO), (8AVT), (8AWR), (8AXN), (8AYN), (8AYS), (8BAH), (8BAI), (8BBY), (8BCO), (8BDB), (8BDL), (8BDY), (8BFN), (8BEP), (8BFH), (8BFV), (8BHA), (8BHV), (8BPP), (8BRL), (8BSY), (8BUA), (8BUN), (8BVA), (8BXC), (8CAY), (8CF), (8CG), (8CI), (8CP), (8CX), (8DE), (8DY), (8DZ), (8EA), (8EB), (8EF), (8EV), (8EW), (8FI), (8FT), (8GW), (8HG), (8HY), (8HU), (8IN), (8JJ), (8JP), (8JQ), (8JU), (8KE), (8KK), (8LH), (8LQ), (8MJ), (8MZ), (8NO), (8OI), (8OL), (8OPM), (8PQ), (8PT), (8QC), (8RB), (8RQ), (8RU), (8SP), (8STJ), (8TK), (8TT), (8TY), (8UC), (8UD), (8UP), (8VL), (8VO), (8UR), (8VW), (8WA), (8WE), (8WO), (8WZ), (8XE), (8XU), (8YAA), (8YM), (8YN), (8YU), (8ZAC), (8ZG), (8ZO), (8ZN), (8ZR), (8ZY), (9AAW), (9ACB), (9ACY), (9ACZ), (9AFK), (9AEY), (9AF), (9AFF), (9AFK), (9AGH), (9AGR), (9AIP), (9AIR), (9AIV), (9AKR), (9AMA), (9AMK), (9AOE), (9AOJ), (9APK), (9AOE), (9AOM), (9AOV), (9ARG), (9ARZ), (9AS), (9AST), (9ASK), (9ASU), (9AU), (9AWX), (9AWZ), (9AXU), (9AZA), (9AZE), (9RDE), (9CP), (9DRW), (9DEH), (9DLX), (9DMJ), (9DOI), (9DPH), (9DQY), (9DWP), (9DXM), (9DYU), (9DZT), (9ET), (9GO), (9GX), (9HM), (9HR), (9II), (9JN), (9ME), (9MC), (9OX), (9PD), (9PS), (9RC), (9TL), (9UH), (9UU), (9VG), (9VL), (9VZ), (9WT), (9WU), (9YH), (9ZJ), (9ZN), (9ZY).

C.W.—1AEV, (1AFV), 1AJP, (1ALY), 1ARY, (1AVI), 1AVR, 1AWB, (1AZW), (1BCG), (1BDI), 1BEA, (1BKQ), 1BMY, 1BSD, (1BWJ), 1CDR, (1ES), (1PE), (1PT), (1QP), 1UN, (1XM), 1ZE, (2XQ), (Canadian 3BP), 3AAN, 3ABI, 3AHK, (3BEC), (3BHL), 3CA, (3CG), (3DH), (3EM), 3GR, 3HG, (3HJ), (3IW), (3MO), (3RF), 3ZO, (4BY), (4CX), 4FF, 4GL,

Distance Records

WHEN signals from a radio station are heard at unusual distances it is proof that the station is an efficient radiator of energy. The location, apparatus, construction and operation of an efficient station is therefore, of great interest to all amateurs, and THE WIRELESS AGE wants this information.

You are therefore requested to send us a monthly list of distant amateur stations heard, which will be published regularly. Report only stations located 200 miles or more distant from your station. Arrange the calls by districts in numerical order.

State whether the stations heard use a spark or C. W. transmitter. THE WIRELESS AGE will follow the records closely and whenever possible will secure and print illustrated articles on the stations consistently heard over long distances, for your benefit and the benefit of amateurs.

If a station is an efficient radiator of energy, it should be given proper credit in the history of amateur progress, and at the same time you will be given credit for efficiency in receiving in having heard it, as your name, address and call letters will be published with all lists submitted by you.—THE EDITOR.

4GX, 4ID, 5XK cw voice, 6WV, (8ADR), (8AGZ), 8AIO, 8ALB, 8AML, (8AMM), 8AQV, 8AWP, (8AXC), 8BCI, 8BEF, (8BFX), 8BK, 8BNJ, 8BNI, 8BO, 8BOX, (8BPL), (8BRL), (8BUM), 8BVR, (8BWK), 8DE, 8DR, (8HJ), (8IB), 8IQ, 8IV, 8JL, (8JQ), 8LJ, (8LX), (8PT), 8SE, 8UJ, 8UO, 8UU, 8VJ, 8VO, 8WY, 8XK, 8XM, 8ZAE, 8ZD, 9AAV, 9AMB, (XFI), (NZO).

2AQP, E. LAUFER, 699 E. 137 Street, New York (December)

C. W.—1AEH, 1AFV, 1AGI, 1AIP, 1AJI, 1AJP, 1AJS, 1AKB, 1ALG, 1ANQ, 1AOE, 1ARY, 1AVR, 1AWB, 1AYL, 1AZJ, 1AZW, 1BAK, 1BCF, 1BCG, 1BDI, 1BEA, 1BES, 1BIS, 1BJH, 1BKA, 1BMY, 1BQE, 1BUA, 1BWJ, 1CAE, 1CAK, 1CCP, 1CF, 1CG, 1CGO, 1CJH, 1DE, 1EBJ, 1FB, 1FF, 1IV, 1NN, 1PT, 1QG, 1QN, 1QR, 1RU, 1RV, 1RZ, 1TS, 1UN, 1VG, 1XE, 1XK, 1XM, 1YK, 1ZE, 3AAB, 3AAE, 3ADT, 3AFY, 3AGN, 3AHK, 3AJN, 3BC, 3BEC, 3BH, 3BIY, 3BUW, 3BZ, 3CA, 3CC, 3CG, 3DH, 3FS, 3HG, 3IQ, 3IW, 3LO, 3LR, 3MO, 3NH, 3OR, 3RF, 3SM, 3ZO, 3ZY, 4AWL, 4BT, 4BQ, 4BY, 4CD, 4CO, 4EK, 4EL, 4EN, 4FF, 4FS, 4GK, 4GL, 4GX, 4HO, 4HW, 4ID, 4II, 4IL, 4XC, 4XD, 4XF, 4XQ, 4XR, 4Z, 5HA, 5IL, 5LO, 7Y, 8ACF, 8ADG, 8AEF, 8AGZ, 8AIL, 8AIV, 8AMB, 8AMM, 8AMQ, 8ANP, 8AOA, 8AOE, 8AOG, 8APT, 8AQF, 8AQH, 8AOG, 8AWP, 8AWX, 8AWY, 8AXC, 8AXU, 8AXN, 8BFX, 8BMA, 8BMW, 8BM, 8BNJ, 8BNO, 8BO, 8BOX, 8BPL, 8BRL, 8BUM,

8BXA, 8CI, 8CJ, 8CUD, 8DR, 8DX, 8GV, 8GX, 8IL, 8IQ, 8IV, 8JL, 8JQ, 8KM, 8KP, 8LJ, 8LP, 8LU, 8LX, 8OV, 8OW, 8RQ, 8SF, 8TB, 8UJ, 8UK, 8UN, 8VG, 8VJ, 8VY, 8WJ, 8WY, 8XH, 8XK, 8XM, 8XU, 8XV, 8ZAE, 8ZG, 8ZU, 8ZV, 9ACT, 9AHV, 9AIK, 9AJH, 9AYX, 9BBH, 9DMJ, 9DV, 9DWJ, 9GY, 9II, 9LQ, 9UJ, 9XM, 9ZD, 9ZV, 9ZY, Canadian 3BP, 9AW, 9EF, XFI, NMW, NZO, WLZ, WRZ.

Spark.—1AA, 1ABB, 1ACO, 1AEV, 1AHF, 1AHL, 1AIT, 1APO, 1ARY, 1ASF, 1AW, 1AWB, 1AYQ, 1AZK, 1BDI, 1BDT, 1BEA, 1BGF, 1BIR, 1BIS, 1BJN, 1BJS, 1BJW, 1BMA, 1BQA, 1BSR, 1BVB, 1BWV, 1BWX, 1CAAA, 1CHJ, 1CJA, 1CK, 1CM, 1CWB, 1DY, 1GM, 1HK, 1HO, 1IA, 1MA, 1OE, 1OJ, 1RV, 1SQ, 1UL, 1YD, 3AFB, 3AFD, 3AFK, 3AGT, 3AHF, 3AHK, 3AIA, 3AIC, 3AIH, 3AII, 3AJD, 3ALN, 3ANI, 3ARM, 3AQR, 3ARY, 3AUE, 3AUW, 3BG, 3BM, 3CG, 3CK, 3CN, 3FP, 3CM, 3GX, 3GY, 3HJ, 3HX, 3IW, 3LI, 3NB, 3OU, 3PB, 3RW, 3TP, 3VG, 3VW, 3XF, 3XM, 3ZO, 3ZV, 4AAK, 4AU, 4AXK, 4BF, 4BG, 4BX, 4CK, 4CX, 4DH, 4EA, 4FW, 4FD, 4GD, 4GN, 4LX, 4XD, 4XQ, 4YA, 5DA, 5FV, 5HY, 5JD, 5KM, 5XA, 5XB, 6EN, 8ACF, 8AFA, 8AFB, 8AFD, 8AFG, 8AFI, 8AGB, 8AHH, 8AHS, 8AHU, 8AIH, 8AJ, 8AJD, 8AJT, 8AJW, 8ALD, 8ALO, 8ALT, 8AMZ, 8ANK, 8ANO, 8ANV, 8AOT, 8APB, 8ARB, 8ARD, 8ARG, 8AUE, 8AVT, 8AXN, 8AXO, 8AYN, 8BAX, 8BCO, 8BEP, 8BFH, 8BGJ, 8BHV, 8BKS, 8BPT, 8BRL, 8BUK, 8BVA, 8CAH, 8CAY, 8CM, 8DO, 8DP, 8DY, 8DZ, 8EF, 8EV, 8FW, 8HG, 8HY, 8IFA, 8ID, 8JO, 8IO, 8IT, 8KK, 8LH, 8MJ, 8MZ, 8NI, 8NO, 8OE, 8OB, 8RO, 8SP, 8TK, 8UC, 8UP, 8VF, 8VW, 8WE, 8WK, 8WO, 8XE, 8YAA, 8YN, 8ZAC, 8ZN, 9ACX, 9AFU, 9AGH, 9AGR, 9AST, 9AWI, 9AWU, 9AWX, 9AXN, 9AYH, 9AZE, 9CPT, 9CP, 9DLX, 9DMJ, 9DMO, 9DV, 9DWP, 9DX, 9GP, 9GV, 9HM, 9MC, 9MD, 9OX, 9PD, 9TK, 9TL, 9UH, 9WU, 9YC, 9ZJ, 9ZN, Canadian 3BP, 5MA, BG4.

2BAK, JOSEPH B. SLAVIN, Old Post Road Garage, Tarrytown, N. Y.

C. W.—1NE, 1ZE, 1BDI, (2BAS-phone), 3BP-Can., 3BZ, 3ZY, 3AAE, 3ADT, 3AHK, 3ALN, 4EI, (5FV), 5UU, 5ZA, 8BK, 8IV, (8IQ), (8VY), 8XK, 8XV, 8ZN, (8ZV), 8ZZ, (8ABO), 8AGF, 8AGL, (8AGZ), 8AIO, 8ALB, 8ALY, 8AOF, (8AOV), 8AOZ, 8AWP, (8BFX), 8BRC, 8BRL, 8BXA, 9DV, 9II, 9RT, 9XM, 9AKR, 9ARK, 9BLO, 9XAB, MNW, FI.

5YAA and 8AXC, EDWARD MANLEY, 328 Fourth Street, Marletta, Ohio

Spark.—1AW, 1CK, 1GM, 1YD, 1AEV, 1AMD, 1ARY, 1AZK, 1BGF, 2BR, 2BV, 2CY, 2DK, 2DN, 2FL, (2OM), 2TJ, 2TS, 2WB, 2WP, 2WZ, 2XK, 2XO, 2ZC, 2AIM, 2AOI, 2BIS, (2BIO), 3AC, 3BG, 3CC, 3CG, 3CN, 3DH, 3FB, 3FJ, 3HB, 3HJ, 3IW, 3LP, (3NB), 3OU, 3PU, 3QJ, 3UC, 3XM, 3YV, 3ZA, 3ZC, 3ZN, 3ZO, 3ZV, 3ZY, 3AM, 3AAN, (3AHK), 3AJD, 3ALN, 3AMB, 3AOV, 3AQR, 3ARM, (3AUW), 3BFU, 4AS, 4RS, (4CD), 4CG, 4CX, 4DH, 4DT, 4EA, 4EK, 4EY, 4FB, 4FD, 4GH, (4GN), 4HS, 4HW, 4LX, 4XA, 4YB, 5DA, 5EK,

5ER, 5FJ, 5FV, 5HK, 5JD, 5KC, 5XA, 5XB, 5XK, 5XU, 5YL, (5ZL), 5ZE, 5ZW, 5ZZ, 5ZAB, 5ZAD, 8CG, 8CH, 8DP, 8DY, 8EB, 8EF, 8EW, 8FI, (8FT), 8HY, 8JJ, 8KK, 8LH, 8MJ, 8MZ, 8NG, 8NO, 8OI, 8SP, 8TJ, 8TT, 8VL, 8VQ, 8WE, 8WK, 8WO, 8WZ, 8XA, 8XE, 8YN, 8ZA, 8ZN, 8ZY, (8ZAC), 8AAV, 8ACF, 8ACH, 8AFB, (8AFD), 8AHH, 8AHU, 8AIZ, 8AJT, (8AJV), 8AKS, 8ALU, 8AMZ, 8AOG, 8AOT, 8APB, 8ARD, (8AUE), 8AUY, (8AXN), 8AXO, 8AXQ, 8AXS, 8AYN, 8BAH, 8BCO, 8BDY, 8BEP, 8BFH, 8BIB, 8BRL, 8BUN, 8BVA, 8CAY, 8AU, 9CP, 9DF, 9DR, 9FU, 9GS, 9HI, 9HM, 9HR, 9IQ, 9KF, 9LF, 9LW, 9MC, 9ME, 9NR, 9OX, 9PD, 9PS, 9TL, 9UH, 9UU, 9VL, 9WU, 9WT, 9XI, 9YA, 9YB, 9YC, 9YM, 9YQ, 9YAC, 9YAE, 9YAK, 9ZC, 9ZJ, 9AAP, 9AAW, 9ACB, 9ACN, 9AEG, 9AEY, 9AFF, 9AGG, 9AGH, 9AGR, 9AIF, 9AIG, (9AIR), 9ALU, 9AMK, 9AMO, 9AMQ, (9AMS), 9AOJ, 9AOU, 9AOX.

9AQE, 9AQM, 9ARR, 9ASJ, 9AWX, 9AXU, 9AYH, (9AYW), 9AZA, 9AZE, (9BDS), 9BEE, 9DAJ, (9DHz), 9DLX, 9DMJ, (9DOI), 9DQO, 9DQY, 9DRT, 9DRV, 9DVE, (9DWP), 9DXE, 9DXM, 9DZI, Canadians 3BP, 3GE.
 C. W.—(1QP), 1RU icw, 1TS, 1UN, 1XM icw, 1ABU, 1AJP, 1ANQ, 1ARY, 1AVR, 1BCF, 1BCG, 1BDI, 1BKQ, 1BUI, 2BB fone, 2CS, (2EH), 2FD, (2FP icw) cw, 2KP, 2MW, 2NN, (2OM), 2RU, 2XD fone, 2XQ cw icw, 2ZD, 2ZL fone cw, 2ZV, 2AAB, 2AAX, 2AFP, 2AGB, 2AJE, 2AST, 2AUV, 2AWA, 2AWF, 2AWL, 2BAK, 2BAY, 2BBF, 2BEA, 2BEB, 2BFZ, 2BML, 2BRB, 3BB fone, 3BC, 3BZ, 3CA, 3FS, 3HG icw, 3HJ, (3MO), 3RF, 3XT, 3ZO fone cw, 3ZY, 3ZAB, 3AAE, 3AHK, 3AIS, 3AJB, 3BIY, 4BQ, 4BY, 4CE, 4CO, 4EH, 4EL, 4EN, 4GL, 4HO, 4HW, 4II, 5AA, 5UU, 5ZL, 8AR, 8BK, 8BO, 8BU, 8CI icw, 8DR, 8II, 8IV, 8JQ, 8KH, 8LX, 8SP cw icw, 8UJ, 8VJ, 8XK, 8XM, 8XV, 8ZG,

8ZU, 8ZV, 8ABO, 8AGZ, 8AIL, 8AIX, 8ALB, 8ALV, 8AMK, 8AMM, 8AMQ, 8AOA, 8AQI, 8AQV, 8AOZ, 8ARW, 8AUO, 8AWP, 8AWX, (8BEF), 8BFX, 8BLT, 8BNY, 8BOX, (8BUM), 8BXA, 8BXF, 9FM, 9II, 9NX, 9PG, 9VG, 9WC, 9ZY, 9ZAF, 9AJA, 9AJH, 9AKR, 9BBF, 9BED, 9BIK, 9BMD, 9DVA, 9DWJ, 9DYU, 9DZQ, Canadians 3BP, 9AW, KDKA, NMW, NOF cw icw, NSF cw icw, NZO cw icw, WDJ, WJZ, XF-1, KY.
 SBDB, JOE J. HILL, 1572 Virginia Street, Charleston, W. Va. (December)
 Spark.—1AW, 1BVB, 1MA, 2AR, 2AFK, 2A1M, 2AHU, 2BAS, 2DK, 2DR, 2OM, 2TC, 2WB, 3AC, 3AHK, 3AJD, 3AOV, 3AQR, 3ARM, 3AUW, 3BG, 3CG, 3CN, 3DM, 3HJ, 3OU, 3RW, 3UC, 3VW, 3YV, 4BQ, 4CX, 4DH, 4EA, 4FD, 4GN, 4YB, 5BY, 5EK, 5FV, 5HK, 5PY, 5XA, 5ZAB, 5ZL, 5ZZ, 8ACF, 8AFB, 8AFG, 8AHS, 8AIZ, 8AJT, 8AJV, 8AKQ, 8ALT, 8AMB, 8AND, 8ANO, 8ANV, 8AOT, 8APB, 8ARD, 8ARS, 8AUE, 8AVT, 8AXN, 8BQ, 8BCO, 8BDY, 8BEP, 8BEN, 8BFH, 8BHV, 8BIB, 8BQT, 8BSY, 8BUN, 8CAY, 8DP, 8DY, 8DZ, 8EB, 8EF, 8EV, 8HR, 8IA, 8KP, 8LF, 8LH, 8MJ, 8ML, 8MZ, 8OI, (8OJ) 8TK, 8TT, 8UC, 8UP, 8UW, 8VL, 8WE, 8WL, 8WO, 8XE, 8YAA, 9AAK, 9ACL, 9ACN, 9AEK, 9AEY, 9FC, 9AGH, 9AGR, 9AIF, 9AIR, 9ALP, 9AMK, 9AMS, 9APS, 9AQE, 9AQM, 9ARG, 9ASJ, 9AUH, 9AWU, 9AWX, 9ABL, Canadian 3BP, 3LI.
 C. W.—1AFV, 1AJP, 1ARY, 1BCG, 1CAE, 1CLI, 1QN, 1UN, 1XM, 1YK, 1ZE, 2AAB, 2AAX, 2AJW, 2AWF, 2AWL, 2BAK, 2BB, 2BGH, 2BFG, 2BSC, 2FD, 2FP, 2KL, 2NN, 2NZ, 2OE, 2UD, 2VA, 2XQ, 2XR, 2ZV, 3AAE, 3AAV, 3AIS, 3BA, 3BEC, 3BHL, 3FS, 3LR, 3MO, 3VS, 3XL, 3ZY, 3ZO, 4BK, 4CY, 4DH, 4EL, 4GL, 4TD, 4ZF, 8ABQ, 8ADR, 8AGZ, 8ALB, 8ALY, 8ARW, 8AWP, 8AWY, 8BO, 8BU, 8BEX, 8BFX, 8BNJ, 8BNI, 8BNY, 8BOX, 8BUM, 8BXA, 8BZJ, 8DR, 8DV, 8FQ, 8HJ, 8IK, 8JQ, 8NN, 8OW, 8UJ, 8XK, 8XM, 8XAE, 9AAV, 9AJH, 9AKR, 9ARK, 9BAP, 9BIZ, 9II, 9XI.
 SGP.A. HARP, 4838 Lincoln Avenue, Detroit, Mich. (December)
 Spark.—4EA, 5FO, 5HK, 5XA, 5ZZ, 8CP, 8LF, 8SP, 8UC, 8UR, 9AAP, 9AAW, 9ACN, 9AGH, 9AKU, 9AQE, 9AWX, 9DKV, 9DQO, 9DWP, 9DXM, 9DYU, 9HM, 9LF, 9LW, 9TL, 9WT, 9ZN.
 C. W.—1ARY, 1BCG, 2AWL, 2FP, 3AAB, 3AAE, 3AAX, 3AHK, 3HG, 3LR, 4EN, 4BY, 4GL, 5LA, 8AGZ, 8AOV, 8BEF, 8BFX, 8BMA, 8JL, 8LX, 8XV, 9AUL, 9AJA, 9AYS, 9BBF, 9HW, 9LE, 9NX, 9RV, 9XI.
 SZAC, CLIFFORD H. GALLOWAY, Barnesville, Ohio (December)
 Spark.—1ABB, (1AEV), 1AKG, (1ALK), 1AMD, (1APO), 1ARY, 1AW, 1AWN, 1AZK, 1BDC, 1BGF, (1BVB), 1BWK, 1CHJ, 1CM, 1DY, (1DZ), 1GM, 1HK, 1RV, 1SN, 1TS, 1WR, 1YD, 2AAF (2AER), 2AFP, (2AIM), 2AJE, 2ALY, 2AQI, 2AWF, 2AWU, 2AYR, (2BJO) (2BK), 2BM, 2CC, 2CM, (2CY), 2DA, 2DN, (2EL), 2DR, 2FD, 2FJ, (2FP) 2GK, 2JU, 2MK, 2MO, (2OM), 2PI, 2PL 2PV, (2QR), 2RM, 2TF, 2TJ, 2TL, 2TS 2VK, 2VM, 2VU, 2WB, 2WC, 2YV, 2XK 2ZZ, (3AC), 3ACM, 3AHF, (3AHK) 3AJM, (3ALN), 3ANQ, 3AOU, (3AQR) (3ARM), (3AUW), 3BG, 3BGT, (3BFU) 3BHL, (3CG), 3CN, 3DM, 3FB, 3GG 3GM, (3HG), (3HJ), 3HZ, (3IW), 3KM (3LP), 3NB, 3OB, 3OU, 3PB, 3QV 3RW, (3TA), 3UC, 3UK, (3UQ), 3XC (3XF), 3XM, 3YV, 3ZA, 3ZJ, 3ZO (4AG), (4AS), 4AU, 4BI, 4BQ, 4BX 4CG, (4CX), (4DH), 4EA, 4EL, 4FD 4GH, 4GN, 4GU, 4HS, 4WC, 4YA, (4XC)



R.F. Amplifier
Type MA-11

Wavelength
150-500 m.

Mu-Rad Radio Frequency Amplifiers Use A. C. for Filament and Plate Supply.

Saves charging of storage batteries
Saves plate battery cost
Increases tube life 60%

Uses four tubes, three for amplification, one as rectifier. To be connected between tuner and detector and operated direct from alternating current house lighting circuit. NO A. C. HUM.
GUARANTEE. Sold with a guarantee of greater amplification than that of any similar amplifier thus far produced.

R. F. Amplifier Type MA-11 - Price \$125.00
(without tubes)



MU-RAD R. F. Amplifier Transformers bring in signals which are absolutely inaudible with detector and audio-frequency amplification (however great). Supplant and far surpass regenerative tuners in sensitivity. No tuning adjustments or ticklers.
GUARANTEE: Sold with a guarantee of greater amplification than that of any other similar transformer available.

R. F. Amplifier Transformer Type T-11 Wavelength 150-500 m. **Price \$9.00**

Superlative Performance - - - Superlative Workmanship
Dealers: Write

MU-RAD LABORATORIES

ASBURY PARK, N. J.

ST. LOUIS, MO.

5AA, 5AF, 5DA, 5EK, 5EW, 5FI, 5FJ, 5FV, 5HK, 5IS, (5JD), 5KC, 5LV, 5PY, 5RL, (5SM), 5UG, (5XA), 5XB, 5XJ, 5XK, 5XU, 5YE, 5YL, (5ZAB), 5ZL, 5ZW, 5ZZ, 7ZU, 9AAJ, 9AAP, (9AAW), 9AC, 9ACB, 9ACL, (9ACM), 9ACN, (9ACY), 9AEK, 9AEY, 9AF, 9AFC, 9AFV, 9AFW, 9AGN, (9AGR), (9AHZ), (9AIE), (9AIG), 9AIP, (9AIR), 9AJA, 9AKA, 9AKV, (9ALH), 9ALP, 9ALS, 9ALU, 9AMA, 9AMK, 9AMS, 9AMT, 9ANS, 9AOE, (9AOH), 9AOJ, 9AOU, 9APS, 9APX, (9AQE), 9AQL, (9AQM), (9ARG), 9ARI, 9ARX, 9ARZ, 9ASE, 9ASJ, 9ASK, (9ASU), (9ATN), (9AU), 9AVC, (9AVP), (9AWX), 9AZA, 9AZE, 9BD, 9BP, (9CP), (9CS), 9DAL, 9DBI, 9DF, (9DHz), (9DLX), (9DMJ), 9DOI, 9DPB, 9DPH, 9DQ, (9DRJ), 9DV, 9DVK, 9DVM, 9DWJ, 9DWP, 9DXM, 9DYU, (9DZE), (9DZI), 9EE, 9EG, 9ET, 9FS, 9FU, 9GN, 9GP, 9GX, 9HI, 9HM, 9HR, 9HT, 9JN, (9JQ), 9KF, 9KO, 9LF, (9LW), (9LZ), 9MC, 9ME, 9MP, 9MS, 9NH, 9NR, (9OX), 9PI, 9PN, 9PS, 9QH, 9RI, 9RP, 9RY, 9TL, 9UC, (9UH), 9UM, (9UU), 9UY, (9VK), 9VL, 9VZ, 9WK, (9WT), (9WU), 9XJ, 9YAC, 9YAE, 9YAK, 9YC, 9YM, (9ZB), (9ZJ), 9ZN, Canadian 3BP, 3EI, 3FO, (3GE), 3SP.

C. W.—(1AFV icw), 1AJP, 1ARY, 1AYL icw, 1BCG, 1BDG, 1BEA, 1BEP fone, 1BKE fone, 1ID, 1QN, 1QR fone, 1TS, 1UN, 1XD fone, 1XM icw, 2AAX, 2AJR, 2AJW, (2ARB), 2ARY, 2AWL, 2BB fone, (2BML), 2BRB, 2BRC, 2BFZ, (2CAP icw), (2EH), 2EL, 2FD, (2FP icw), 2FS, 2KL, 2OM, (2RB), 2RU, 2TK, 2UD, 2WX, 2XB fone, 2XD fone, 2XI fone, 2XJ fone, (2XQ icw), 2XR fone, 2ZD fone, 2ZL, 2ZV fone, 3AAE, 3AEV, 3AFU, 3BA, 3BQ, 3BZ, 3DH icw, 3GR, 3HJ, 3SQ, 3ZO fone, 4BQ, 4BY, 4EB, 4EL fone, 4GL, 4GX, 4XC, 5FV icw, 5UU icw, 5ZA, 6XAD, 9AAV, 9ANE, 9ARK, 9EK, 9FM, 9NX, 9RT, 9ZV, 9XM fone. Canadian 3BP fone. Also C.W. AN5, NSF, WAI, WL2, XFI.

SBYZ, HARRY SCHOENFELDER, 513 Boone Street, Pottsville, Pa. (December)

1AG, 1AW, 1HO, 1TS, 1VO, 1XE, 1XD, 1ZE 1AFV, 1AEV, 1ARY, 1BEG, 1BEO, 1BYG, 1XAB, 2EH, 2EL, 2ER, 2CK, 2XB, 2XQ, 2BKA, 2BWK, 3AF, 3AG, 3AH, 3BD, 3BF, 3BK, 3BM, 3BX, 3CK, 3DH, 3DF, 3DM, 3FB, 3FR, 3GG, 3GX, 3HJ, 3IW, 3PL, 3LP, 3RB, 3RG, 3TA, 3TS, 3UZ, 3XF, 3ZO, 3ZV, 3ZY, 3AAV, 3ABK, 3AJD, 3AJS, 3ACV, 3AIC, 3ARY, 3ASQ, 4EA, 8AP, 8OP, 8OX, 8BF, 8BU, 8CG, 8EF, 8HR, 8HY, 8IN, 8ME, 8OA, 8OF, 8OP, 8OX, 8PQ, 8SP, 8ZY, 8AEF, 8AFD, 8AIK, 8AIO, 8ALM, 8APB, 8ASY, 8AVV, 8AYN, 8AZO, 8BEP, 8BPO, 9CP, 9VL, 9XM, 9ZF, 9TL, 9AIR, 9DWP.

SZG, A. J. MANNING, Salem, O. (December)

C. W.—1QN, (1TS), (1ZE), 1AFV, 1ARY, 1BCG, 1BDI, 1BWJ, 1XAD voice, 2BB, 2BG, 2CS, 2OM, 2OZ, 2UD, 2WP, 2ZV, 2ZD, 2XQ, 2AAB, 2AAC, 2AAX, 2AUU, 2AWL, 2BIS, (2BAK), 2BED, 2BEB, 2BUA, 3BZ, 3CA, 3EQ, 3FM, 3FP, 3FR, 3FS, 3LR, 3MO, 3VA, 3XY, 3ZM, (3AAE), 3AAN, 3AFB, 3AFU, 3BEC, Can. 3BP, 4BT, 4BQ, 4BY, 4CD, (4EL), 4ID, 4XC, 4YA, 4ZF, 6XAC, 6XAD, 8AI, 8VY, 8XY, 8ZU, 8ZZ, 8BRC, 8BXA, 8BZJ, 9EA, 9EM, 9II, 9PG, 9RT, 9VG, 9ZB, (9ZT), 9ZY, 9XM, 9XI, 9AAS, 9AAV, (9AJH), 9ACO, 9AKB, (9AKR), 9AJP, 9AVN, 9BBF, (9BIC), 9BLO, 9BED, 9DWI, 9XAB.

WUBC, FIELD ARTILLERY SCHOOL, Camp Knox, Ky. (Dec. and Jan.)

Spark—2MO, 2FD, 3HD, 3ZZ, 3GO, 4AG, 4BQ, 4GN, 5ZAB, 5ZZ, 5ZA, 5XA, 5XB, 5ZL, 5JN, 5ZJ, eights and nines too numerous.

C.W.—1AN, 1XE, 1UN, (1ARY), 1AMQ, 1BCG, 1BUA, 1ZE, 1BKG, 1XM, 1BZY, 1AYL, 1CAK, 1WX, 1AJZ, 1ARN, 1BCX, 2WP, 2XQ, 2FP, 2FD, 2JM, 2BQ, 2BK, 2AKO, 2BRZ, 2BIS, 2BSY, 2BGH, 2BFZ, 2BZG, 2AWL, 2AAB, 2AAE, 2AHK, 2FS, 2MO, 2AHA, 2FF, 2ZL, 2KL, 2BGU, 3BZ, 3DH, 3EG, 3EN, 3EZ, 3FM, (3FS), 3HJ, 3XC, 3ZO, 3ZY, 3HG, 3TJ, (3BP-Can.), 4AS, 4BK, 4BY, 4BZ, (4BQ), 4CO, 4CX, 4DH, 4HW, 4XB, 4GL, 4GN, 4GE, 4GU, 4EL, (4FT), 4AI, 4ID, 4II, 4LE, 4EN, 5DA, 5KU, (5KP), 5UU, 5FV, 5JD, 5DU, 5ZAK, 5KA, 5ZC, 5ZZ, (5ZU), 5FV, 5XJ, 5FX, 5XB, 5ZA, 5LO, 5ZL, 6WV, 7ZU, 8AF, 8BA, 8CP, (8BK), 8BO, 8DR, 8DV, 8EA, 8FI, 8GE, 8GV, 8IH, 8II, 8IV, 8JL, 8JP, 8JS, (8KH), 8NM, (8BK), (8BUM), 8ARZ, 8ZV, 8ZZ, 8ZAE, 8GX, 8ANO, 8BFZ, 8AWP, 8AMZ, 8AWY, 8AOV, (8BXA), 8AGZ, 8BPL, 8NO, 8ILV, 8ARX, 8AKJ, 8BRC, 8AQF, 8QAE, 8ZG, 8ZAC, 8UJ, 8AWF, 8VY, 8ADV, 8MQU, 8AYP, 8AIO, 8ARZ, 8YAF, (8UK), 8BEQ, 8AJU, (8LX), (8LV), (8LU), 8BFX, 8AFD, 8AGL, 8AHR, 8ACR, 8AHR, 8BEP, 8AKJ, 8ZN, 8XV, 8WY, 8ABW, 8AOG, 8AGZ, 8PF, 8AY, 8WP, 8ML, 8ALY, 8BEF, 8BEP, 8BS, 8BBW, 8UJ, (8VJ), 8WR, 8ZP, 8NQ, (8BOX), 8ADR, 8BRZ, 9AU, 9BL, (9ARK), (9HK), 9DY, 9FM, 9HI, 9HM, 9HW, 9II, 9IO, 9JD, 9LF, 9KF, (9LQ), 9NQ, 9NR, (9NX), 9AON, 9PS, (9PG), (9OU), 9UC, 9ZB, 9ZY, 9ZQ, 9WD, (9YC), (9LK), (9ZJ), (9VG), (9BDE), (9BIK), 9BOP, 9BBF, 9YQ, 9AUA, (9PG), 9AQR, 9AJA, 9HW, (9AYS), 9FG, 9DKP, 9AKR, 9ALG, 9ARY, 9AKB, 9KR, (9AAV), 9ARJ, 9BBF, 9BHE, 9ARJ, 9XI, 9IX, 9DVA, 9DKV, 9II, WL2, WJZ, WDY, KDKA, NX1, (AN5), (XF1), XBI, NZO, NMW, NSF.

SCP, ORLO PALMER, 233 E. 11th Street, Holland, Michigan. (December)

(Can. 2EL), Can. 3BK, Can. 3BP, Can. 3GE, Can. 3IE, (2AWF), 2FP, (2OM), 2PU, 3AIC, 4BQ, 4DH, 4GN, 5FV, 5HD, 5HK, 5XA, 8CI, (8DZ), (8EB), (8EW), (8FI), (8FT), 8MJ, 8MO, (8NO), 8OU, 8PM, 8RU, 8TJ, (8TK), (8UP), (8VY), (8WE), (8WD), 8XE, 8TO, 8ZA, (8ZF), (8AFB), (8AIB), 8AIO, (8AIX), 8AKQ, (8AMZ), 8APB, 8AQV, 8ARS, (8ASZ), 8ATU, (8AUM), (8AVT), (8AWU), 8AXN, 8AYS, (8AZG), 8BAP, 8BCO, (8BCY), (8BEN), (8BEP), (8BLW), (8BOG), (8BPG), (8BTL), (8BUC), 9CA,



Brand new—16 page—two color ABC Catalogue just off the press, profusely illustrated from cover to cover. It describes in detail the unusual features of ABC UNITS, built on the sectional system so that you can add to your station like a sectional bookcase. Also describes fully ABC Coils; ABC Saccod Clad Transformers; ABC Variable Condensers and a complete line of small parts. Valuable information about Wireless Telephone broadcasting is also included. Prices quoted represent a new low level for apparatus of recognized quality.

Send ten cents today for Catalog W2.
WIRELESS EQUIPMENT CO. Inc.
32 Austin Street, Newark, N.J.

TELLS TIME BY THE SUN



The Ansonia **SUNWATCH**

A Vest Pocket Sun-dial and Compass in one

THE ONLY COMPASS THAT GIVES THE TRUE DIRECTION

DAN BEARD says: "I would like to see every scout have one"

ANDREWS & HOLLINWOOD
500 Fifth Avenue, N. Y. Dept. 4.
Sent postpaid for \$1.00

THE WIRELESS AGE Classified Ads Bring Results!

Dealers and Radio Citizens

Order Your Needs From Our

LARGE AND COMPLETE ASSORTED STOCK PARTS OF ALL KINDS COMPLETE SETS

Largest Stock Radiotrons and Kenotrons in U. S. A.

Write for our new price list No. 100-E



Ludwig Hommel & Co.
530-534 Fernando St.,
PITTSBURGH, PA.

Original from
UNIVERSITY OF MICHIGAN

9CP, 9DZ, 9ET, (9FU), 9GN, 9HT, 9HM, (9JN), 9KO, 9MC, (9OA), (9OX), 9PS, (9PD), 9RC, 9RY, 9TL, (9UG), (9UH), (9UI), 9UU, (9VL), 9WU, (9XI), 9ZN, 9ACB, 9AFC, 9AGR, 9AIF, 9AIK, 9AIR, (9ALH), 9AMA, 9AMQ, (9ANO), 9ANP, 9AON, 9APA, 9ARG, (9ARZ), (9ASE), (9AS), (9ASK), 9ATN, 9AWX, 9AXU, (9AZE), (9AZF), 9BDS, 9BIJ, 9DRU, (9DKQ), 9DQQ, 9DNJ, 9DNC, 9DYU, 9DYY, 9DZE, (9DZI), 9DWP.

8ZAE (ex-8ZD), Pittsburgh, Pennsylvania, (December and January).

C.W.—(1AFV), (1AJP), 1ANQ, (1ARY), 1BCG, 1BDC, 1BKQ, 1BMY, 1BDI, (1BWJ), 1AZW, 1BSD, 1BEA, 1CAK, 1DY, 1FF, 1UN, 1RQ, (1RS), 1TS, (1RZ), 2AAB, 2AID, (2AWF), 2AJW, 2AYQ, 2BIS, (2BFZ), 2BC, 2BRB, 2BEB, 2BR, 2CBG, 2AYI, 2AVX, 2DN, 2EL, 2FP, 2NZ, 2OM, (2MW), 2PF, 2KP, 2WP, 2XB, 2XQ, 3AFB, 3ARM, 3AFU, 3AHK, 3ANJ,

3AEV, 3BZ, 3BFU, 3CC, (3CG), 3GE, 3HG, 3HJ, (3MO), (3SM), 3ZY, 3ZO, 3ZZ, 4BQ, 4BY, 4BK, (4EL), 4EN, 4CY, 4DC, (4EH), 4FF, 4HO, 4GL, 4GH, 4HW, 4II, 4ID, 4ZE, 4ZF, 5FV, 5LA, (5UU), 5ZA, 8ADR, 8AIL, 8AIZ, (8AQV), 8AMQ, (8ARW), (8AWY), 8AWF, 8AKI, 8AGI, 8AGL, 8BFH, (8BFX), (8BRC), (8BXA), (8BNY), 8BVT, 8BLT, 8AWP, 8BEF, 8BZO, 8BOX, 8BBK, 8BRT, 8IQ, (8IV), 8II, 8IH, 8JS, 8JL, 8KH, 8LV, 8NI, 8SP, 8UJ, (8UK), 8VK, 8VL, 8SE, 8UQ, (8YAC), (8ZG), 9AAS, 9AJA, 9AAV, (9AJH), 9AKB, (9AKR), 9AXK, 9AYS, 9AJP, 9BNO, 9BBF, 9DV, 9DWJ, 9GL, 9HW, 9II, 9XM, 9ZB, NSF, NZO, NOF, NMW, (DF-1), CF-2, CL-2, KDPM, WJZ, WDY, KYW.

Spark—1AW, 1AYL, 1BRW, 1HO, 1BOQ, 1SC, 2AAC, 2AAX, 2AJW, 2AR, 2EL, 2OM, 2FP, 2QR, 2NZ, 3ALN, 3BP, 3GO, 3HJ, 3KG, 3LI, 3EI, 3GN, 3QW, 3PU,

3OU, 3XC, 3XL, 3XM, 3YK, 4BQ, 4BX, 4CX, 4EA, 4GN, 4II, 5DA, 5FJ, 5FV, 5HK, 5PY, 5XA, 5XF, 5ZL, 5ZZ, 8AFG, 8AYN, 8AXK, 8BEP, 8BXX, 8CEB, 8CH, 8AXO, 8AJB, 8DY, 8FI, 8BXC, 8GH, 8HG, 8JO, 8JJ, 8KK, 8MM, 8NB, 8NZ, 8MJ, (8PT), 8TT, 8TJ, 8OL, 8WA, 8WE, 8WO, (8XE), 8YN, 8YM, 8ZA, 8ZAC, 8ZP, 8ZAA, 9ACB, 9ACY, 9AU, 9AAX, 9AWX, 9AMB, 9AQE, 9ARG, 9AGR, 9ARY, 9DLX, 9DXM, 9DYM, 9DSO, 9FS, 9HR, 9CA, 9MC, 9ME, 9OX, 9UU, 9UH, 9VL, 9YM, 9YC, 9YA, 9YB, 9YAE.

Longest distance covered by 8ZAE to date 6BF on January 1st with 10 watts CW.

National Amateur Wireless Association

(Continued from page 42)

LOCAL amateur wireless operators have become so numerous that the St. Catharines Radio Association, Ontario, has decided to rule the waves overhead. Hereafter low power transmission only will be permitted during certain night hours, while others are set apart for long distance work exclusively and for testing.

"Free ether for all" is the rule during the daytime.

The following schedule for operation of amateur stations has been adopted:

From 7 a. m. to 5.30 p. m. free ether for all.

From 5.50 p. m. to 6 p. m. testing only.

From 6 p. m. to 7.30 p. m., low power transmission only.

From 7.30 p. m. to 10 p. m. silence, listening-in period for concerts and so forth.

From 10 p. m. to 11 p. m., free ether for all.

From 11 p. m. to 7 a. m., long distance work only; all local work ceases.

△ △

THE Arlington Radio Club, Arlington, Mass., has recently acquired a station license, 1COD, and is now operating a telephone transmitter using 5-watt tubes. This station is noted for its fine modulation. Plans are under way to install in the near future a C.W. transmitter using 3 50-watt tubes for C.W., ICW and phone.

△ △

WIRELESS enthusiasts of all ages and both sexes compose the membership of the Seattle Radio Association.

The purpose of the organization is two-fold. It serves to control the traffic of the air to both radiophone and telegraph communication, supervision being placed in the hands of Traffic Manager Howard S. Mason, who is also president of the club. Rules governing the hours at which local and long distance conversations may take place have been worked out by the club, and as a result, the confusion which reigned prior to its inception is being replaced by carefully regulated traffic.

The other object of the club is to encourage experiments.

Regular weekly meetings of the club at the assembly hall of the Chamber of Commerce will be addressed by authorities on radio developments.

△ △

B. P. WILLIAMS, station call 8ZAE (formerly 8ZD) of Pittsburgh, Pa. using two 5-watt UV-202 tubes has been reported heard in Santa Paula, Cal., by Paul

Hello Everybody!

(This is Radio KZC Speaking)

THE LATEST SELECTION IS

"MAIL ORDER BLUES"

Have you ever heard it? No! Well, then you must be one of the many satisfied customers who have tried

Wesrad Service

Send For Our

LATEST PRICE DICTIONARY

It is indispensable to the careful purchaser

The Fifth Edition has 3,000 Circulation

Are you one of the wide-awake men who use this Bulletin and service exclusively.

WESTERN RADIO ELECTRIC CO.

550 South Flower
Los Angeles, Cal.

274 Twelfth Street
Oakland, Cal.

K. Churchill, 6BF. Mr. Churchill writing under date of January 2, states he heard 8ZAE on night of January 1, calling CQ, and then 5FA at about 9.50 P. M., Pacific time. The C.W. signals were QRZ on one stage. Mr. Williams has checked this DX record with his log and found it correct.

△ △

IN listing the stations heard by P. F. Godley in Scotland, during the recent trans-Atlantic tests, the station of J. Edward Brown, 1BKA, Glenbrook, Conn., was omitted through error. Signals from 1BKA station were heard by Mr. Godley on the same night that signals from 1RZ, 2ARY, 2AJW and 3FB stations were heard.

△ △

IN addition to 2ZL, the following stations have been reported as having been heard by English amateurs, during the recent trans-Atlantic tests.

- IZE, Irving Vermilya, Marion, Mass.
- IDA, Frank Wigglesworth, 2 West Hill Place, Boston, Mass.
- IUN, Joseph B. Dodge, 26 School Street, Manchester, Mass.
- IAFV, F. Clifford Estey, 11 Mt. Vernon Street, Salem, Mass.

△ △

SIGNALS from the station of A. C. Mertz, 9AKR, Mt. Carroll, Ill., have been heard recently at 6AOW, Riverside, Calif., and also at other points on the Coast. The transmitter at 9AKR is a 100-watt Kenotron set, employing two kenotrons and two UV-203 Radiotrons.

△ △

AT its regular monthly meeting, January 27, a paper was presented on Radio Central, world's largest and most powerful radio station, by Pierre Boucheron. Slides of the various views of the big plant and its apparatus were shown and described and the subject was concluded by the showing of moving pictures featuring construction scenes as well as most interesting sideights and personalities during the recent formal opening. The event took place at Columbia University School of Journalism, New York City. This pictorial exhibit may be borrowed by responsible local radio clubs. Inquiries should be directed to the secretary of the Radio Club of America, 380 Riverside Drive, New York.

Batteries Reverse Polarity At Low Temperature

(Continued from page 31)

does in ordinary operation at normal air temperatures. But between 80 and 100 degrees below, after the electrolyte had "under-cooled," it increased in temperature slightly as freezing began. The voltage dropped down nothing at about minus-100 degrees Centigrade and then, at a slightly lower temperature, strangely registered a minus reading. Still more unexpected was the fact that there was registered as high as 10 volts in the direction opposite to the normal voltage. Then the voltage violently fluctuated ranging from positive ten volts to negative ten volts. These reversals hap-

pened whenever the frozen electrolyte of the cell "ticked."

A dry cell of an electric flashlight of commercial grade was given the same cooling treatment, and after giving slightly higher voltages than normal at 115 degrees below, it gradually reduced voltage until at 170 degrees below it reversed its voltage also.

But while the voltages shown under the sub-arctic temperatures are reversed and remarkably large, no hope is held out that storage batteries can be recharged by the simple method of cooling them to the low temperatures used in the Bureau of Standards' tests. The currents at these low temperatures are very small.

Coupler for Short Waves

(Continued from page 39)

er right hand corner is the primary switch, which may be any standard lever and seven contact points. On the right hand side are drilled six $\frac{1}{8}$ inch holes for the binding posts. The binding posts, knob and dial, switch lever, contacts, etc., are put on the panel and the panel screwed to the base. The primary, secondary and tickler are connected to the six posts and the taps fastened to the contacts. Only one variable condenser across the secondary is necessary. The coupler gives best results when used in the hook-up shown in figure 2.

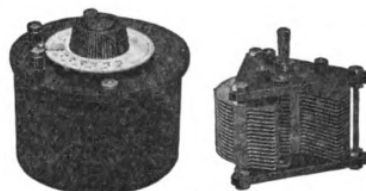

TYPE 247 CONDENSER

ANOTHER GENERAL RADIO ACCOMPLISHMENT

FOR MANY YEARS the GENERAL RADIO COMPANY has been supplying the research and educational institution laboratories throughout the country with high-grade radio apparatus suitable for research work. Only instruments of the finest quality are accepted in this class of work. The experience obtained in this line has enabled us to design instruments for the citizen radio field that represent the latest developments in engineering and mechanical skill.

The newest instrument in this line is the variable air condenser illustrated above. Here is an instrument of laboratory quality, yet selling at a price within reach of the experimenter.

EXAMINE SOME OF ITS FEATURES:

CAPACITY SCALE: In addition to regular scale divided into 100 equal divisions, the dial is also graduated in micromicrofarads, thus showing capacity at any setting.

LOW DIELECTRIC LOSS: Hard rubber is the only solid dielectric used. Quantity used is small and is so placed with respect to the electrostatic field that the dielectric hysteresis losses are kept a minimum. This is a very important feature in obtaining sharpness of tuning, and one which is commonly overlooked in condenser construction.

PLATES SOLDERED TOGETHER: Resistance is reduced and kept constant. Capacity, also, kept constant.

HEAVY ZINC PLATES, ADEQUATELY SPACED: Danger of short circuiting minimized.

SPECIAL SPRING BEARINGS: Tension always remains the same. Good contact insured.

THRUST ALL ON ONE BEARING: No short circuiting if distance between bearings is changed.

LOW ZERO CAPACITY: Makes wide range possible.

METAL CASE GROUNDED TO ROTARY PLATES: Shields condenser, reducing capacity effects of hand while tuning.

You cannot afford to deny your set the advantages of this condenser. Give the long distance messages a chance.

Inspect this condenser at your local dealer's.

TYPE 247 CONDENSER, COMPLETELY MOUNTED,
CAPACITY .001 MICROFARAD

PRICE \$5.50

MAY ALSO BE SUPPLIED UNMOUNTED FOR PANEL MOUNTING

Send for Free Radio Bulletin 910-W

GENERAL RADIO CO.
Massachusetts Avenue and Windsor Street
Cambridge 39 Massachusetts

Standardize on General Radio Equipment Throughout



FIRST!
BEST!
100%

PACENT UNIVERSAL PLUG

This is a radio plug. It fits all standard jacks—and pocketbooks. Of course, no solder is used to make a connection with the Pacent plug. The cord tips are held in such a way that pulling—up to and beyond the breaking of the cord—only tightens the grip. Yet the tips may be released instantly by proper manipulation of the springy strips. A soft, velvety black finish with polished metal parts makes the Pacent plug easy to look at; it is truly beautiful. Rugged construction makes the device good for a lifetime. There is only one Pacent Plug and that is approved by the United States Government and used by the foremost amateurs. Don't forget to insist on the original, 100% plug.

FROM YOUR DEALER OR DIRECT - \$2.00

You should have a copy of our booklet PW entitled "Pacent Radio Essentials" which will be sent you on receipt of five cents in stamps.

Pacent Electric Company, Inc.

LOUIS G. PACENT, Pres.

Manufacturers and Distributors

150 NASSAU STREET - - - - NEW YORK, N. Y.

Member Radio Section Associated Manufacturers of Electrical Supplies

A perfect rectifier at last, fully automatic and fool-proof in every respect. It can be operated by anyone.

The HOMCHARGER

connects to any alternating current socket, gives a taper charge—will fully charge any "A" battery over night. It is self-polarizing. Connect your battery either way and it will always charge.

Automatically disconnects battery when power is interrupted. Restarts charging when connections are restored. Adjustable for wave form, frequency and voltage. Contains only one moving and two wearing parts, lasting thousands of hours, replaceable as a unit for \$1.00.

The highest charging rate, greatest efficiency, and simplest of any rectifier selling for less than \$100.00. Bulletin 628 proves it. Ask for your copy.

Manufactured in sizes for charging three or six-cell batteries from both alternating and direct current circuits. Cannot injure battery—will last a lifetime—approved by underwriters—satisfaction guaranteed. For sale by all Radio, electrical and accessory dealers or shipped express prepaid for purchase

PRICE \$18.50

ATTENTION MOTORISTS!

Send for special Bulletin 58, showing how easy it is to "HOMCHARGE" your battery.

THE AUTOMATIC ELECTRICAL DEVICES CO.
119 West Third Street, Cincinnati, Ohio

Canadian Distributors—Rowley & Moody, Ltd., Toronto.

Hook-up That Simplifies Tuning

(Continued from page 40)

would be to place a telephone transmitter between the middle tap and the ground, eliminating the transformer in series with the grid leak, but ground modulating appears to be not so efficient as the grid leak variety.

The aerial need not be pretentious to obtain surprising results, merely a single strand inside of house to garret will suffice. Later, when your enthusiasm grows, an outdoor multi-strand aerial for real long distance work connection with amplifier circuits, may be erected.

Using a dry battery instead of the usual storage battery for filament lighting, a pair of 3000 Murdocks and a set of standard type B battery, twenty-five dollars ought to cover the expense of a crackerjack outfit, using this simple circuit.

Queries Answered

ANSWERS will be given in this department to questions of subscribers, covering the full range of wireless subjects, but only those which relate to the technical phases of the art and which are of general interest to readers will be published here. The subscriber's name and address must be given in all letters and only one side of the paper written on; where diagrams are necessary they must be on a separate sheet and drawn with India ink. Not more than five questions of one reader can be answered in the same issue. To receive attention these rules must be rigidly observed.

Positively no questions answered by mail.

C. H. C., Chicago, Ill.

Q. 1. Have never seen a plan for a step-up transformer printed, and would like you to supply me some working data.

Ans. 1. A step-up transformer for vacuum tubes is described in our Prize Article in this issue. Additional information on transformers will be found in "The Wireless Experimenter's manual" by Elmer E. Bucher, price \$2.25.

* * *

G. C. H., Fort Stockton, Texas.

Q. 1. Kindly give an explanation of how it comes that I have no difficulty whatever in copying WGG on galena, just an ordinary galena hook-up, any hour of day or night when he is sending. I get other C. W. stations also, at times, but he is always readable, and comes in nearly as strong as on one V. T.

Ans. 1. This is probably due to the presence of some form of high frequency induction which acts as a beat to produce the signals which you receive. Just what is the cause of it however, we are unable to state not being familiar with the exact situation of your antenna with respect to power lines.

MUTUAL PURCHASERS ASS'N

Send stamp for particulars regarding the saving you can make on anything radio you require.

2-4 Stone Street, NEW YORK

SECOND ANNUAL AMATEUR RADIO Convention - Exhibition

A Real Radio Convention and a
Real Exhibition of Radio Equipment

Pennsylvania Hotel - New York

MARCH 7-8-9-10-11, 1922.

Another year has rolled around and the time for the Second District Convention and Radio Show, the big event of radio, is almost here. Everybody remembers, (for everybody was there), the smashing big success of last year. Well this year is going to add another big success to the history of radio. There isn't any doubt about it, for everybody who was there last year will be on hand again to meet everybody else, and will bring with them all the new converts to the cause created by radiophone broadcasting.

This Simon-pure radio show will be the most interesting and instructive affair of the kind ever held. The general arrangements are practically the same as last year.

The glass-enclosed roof garden of the hotel will be the exhibit hall, and the adjoining Butterfly Room affords an excellent lecture hall, with adequate seating capacity. Only papers of vital interest to amateurs will be presented.

Developments in the new and rapidly broadening field of radio have come thick and fast since last year. Some of them are so amazing in character and so far beyond anything yet generally known to the average radio operator, that any attempt to describe them on this printed page would result only in a very poor and inadequate effort. Come yourself and hear about them and see these new epoch-making devices in actual operation, and you will immediately wonder at the almost unlimited applications of radio to useful purposes.

A banquet for everybody, male and female, will be held on the night of the 11th (Saturday). And it's going to be SOME banquet. This refers both to the dinner and what will be done and who will do it. All the big men of radio will be there.

This convention-exhibition is held under the auspices of the Second District Executive Radio Council. It is non-partisan, non-sectarian, non-everything—just a straight out and out Second District Amateur Radio Affair, sponsored by all the radio clubs of the Second District.

This is an unparalleled opportunity for material gain, for acquiring knowledge, the making of personal acquaintances, and for general good. It will be the biggest thing ever done in the history of amateur radio.

That dusky-hued girl who was the sensation of last year's dinner will be there again, to demonstrate the last gasp in Hawaiian grass costumes. All male guests will be searched at the door for concealed lawn-mowers.

The Convention and Exhibition will open at 7 p. m., March 7, and will be open from 2 p. m. to 11 p. m. on the following days. A season badge will be sold at the door for 50 cents, covering the five days. One time admissions 25 cents.

The banquet charge will be \$4.00. The number which can be accommodated is limited to 600. Tickets will be allotted up to this number only, in the order in which applications are received. Applications by mail should be made to John Di Blasi, 6 Warren Street, New York.

Tickets are also on sale at

Continental Radio & Electric Corporation,
6 Warren Street, New York.

Manhattan Electrical Supply Company,
17 Park Place, New York.

J. H. Bunnell Company,
32 Park Place, New York.

American Electro Technical Appliance Company,
235 Fulton Street, New York.

Wireless Press,
326 Broadway, New York.

EXECUTIVE RADIO COUNCIL--Second District

COMMITTEE

J. O. Smith, *Chairman*
326 Broadway, New York.

R. H. McMann, *Ass't. Chairman*

John Di Blasi
A. F. Clough
J. B. Ferguson
C. Hobson

A. C. Mills
F. B. Ostman
C. J. Goette
C. E. Trube

B. B. Jackson
W. A. Remy
W. J. Howell
R. Hertzberg

L. M. Cockaday
C. E. Huffman
J. J. Kulick

Radiophone Broadcasting

(Continued from page 27)

W J Z Notes

THE Radio Chapel Service seems to be very popular with radio fans and their immediate friends. Innumerable letters have come to our attention in which the owner of the receiving set has had as many as twenty friends listening to this extremely novel method of observing the Sabbath. One commendable instance of appreciation for this home delivered service was a contribution sent by E. D. Every of Roselle Park, N. J., who, after hearing the sermon delivered, forwarded to the preacher a collection taken up by him at the conclusion of the services on Sunday night, feeling, as he stated, that this was the only lacking element in the otherwise complete service.

To unfortunate people who through some affliction are unable to go about the radiophone means immeasurable pleasure. One man, acknowledging the Sunday service sent out by WJZ, states that he suffers from paralysis and is unable to leave his bed, but by the aid of the phone by his side enjoyed to the fullest extent the first sermon he has heard in years.

At the 23d Regiment Armory, Bedford and Atlantic avenues, Brooklyn, where the Brooklyn Manufacturers' Industrial Exposition was held, large audiences were entertained with the WDY and WJZ radio programs. A new amplifier was tried out in one of the squad rooms and afforded entertainment for every one within ear-shot of the place.

Paul F. Godley at WDY

PAUL F. GODLEY greeted his fellow amateurs by informing them that he was particularly pleased to be able to speak to his many friends from the very room where he spent many

happy moments a few years ago while employed at the then Marconi Plant, now being used by WDY.

A list of stations heard was then given, it being pointed out that, while 27 stations in all were heard, only 7 were spark stations while 20 of the stations used continuous wave, the latest and most efficient method of transmission. Some of these stations using such small power inputs as 30 watts. A plea was made by Mr. Godley for the abandonment of spark methods by amateur relay men, and in particular the abandonment of the spark coil which is, as generally used, obnoxious to all interests and a great cause of present day interference.

It is an interesting fact that Mr. J. O. Smith, Chairman of the 2nd District Executive Radio Council, who introduced Mr. Godley to his Radio Audience, was also heard in England, through his station 2ZL during the trans-Atlantic tests, but by British Amateurs. Mr. Smith, who is an amateur of many years experience, first met Mr. Godley as the direct result of secret service work done with Mr. Smith as the subject under investigation and the happy results of which developed considerable humor.

The Radio Installation at WDY is located in an artistically appointed studio which occupies a room at the old factory of the Marconi Wireless Telegraph Co. at Roselle Park, once filled with a maze of precision machine tools used for the construction of model radio equipment.

During the World War, Godley spent much of his time both day and night in this room in an effort to hasten the supply of equipment for use by the Army and Navy. A list of stations heard by Mr. Godley at Ardrossan, Scotland, follows:

SPARK

- 1ARY Burlington, Vt.
- 1BDT Atlantic, Mass.
- 2BK Yonkers, N. Y.
- 2EL Freeport, L. I.
- 1AAW Illegal station not located.
- 2DN Yonkers, N. Y.
- 3BP Newmarket, Ontario.

CONTINUOUS WAVE

- 1RU Hartford, Conn.
- 1ARY Burlington, Vt.
- 1BDT Atlantic, Mass.
- 1BKA Glenbrook, Conn.
- 1YK Worcester, Mass.
- 2FD New York, N. Y.
- 2ARY Brooklyn, N. Y.
- 2BML Riverhead, N. Y.
- 8BU Cleveland, Ohio.
- 8XV Pittsburgh, Pa.
- 1RZ Ridgefield, Conn.
- 1BCG Greenwich, Conn.
- 1BGF Hartford, Conn.
- 1XM Cambridge, Mass.
- 2EH Riverhead, N. Y.
- 2FP Brooklyn, N. Y.
- 2AJW Babylon, L. I.
- 3DH Princeton University.
- 3FB Atlantic City, N. J.
- 8ACF Washington, Pa.

About a half dozen stations were also heard by British Amateurs during these tests, one of which was that of Mr. Smith as mentioned above. Complete reports from British stations have not yet been compiled, but will probably be published at an early date.

Mr. Godley concluded his talk by calling for close co-operation on the part of the great amateur body with the government radio officials so as to prevent unnecessary interference and illegal transmissions.

IN GREAT DEMAND BY WIRELESS OPERATORS

NEW AND IMPROVED Genuine (Old Style) Single Lever VIBROPLEX

THE NEW AND IMPROVED VIBROPLEX is in great demand by experienced wireless operators because it transmits clearer, faster signals than is possible on the ordinary key, and because it reduces muscular effort to the minimum. This world-famed sending machine holds all long distance sending records in land, cable and radio service. In addition to the features which made these records possible, the NEW AND IMPROVED VIBROPLEX embodies a number of improvements designed to make it even more valuable to wireless operators.

NEW AND IMPROVED FEATURES

- Improved Trunnion Lever
- Extra Heavy Contact Points Throughout
- Convenient Size
- Improved Design

Whether actively engaged in Radio service or an experimenter, you'll need the IMPROVED VIBROPLEX to complete your equipment. BUY NOW!

Japanese Base - - \$17.00. Nickel-Plated Base - - \$19.00
Remit by Money Order or Registered Mail.

THE VIBROPLEX COMPANY, INC., Dept. WA, 825 Broadway, New York

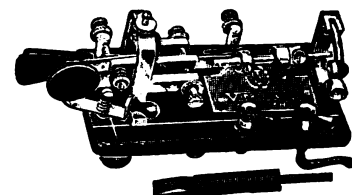

The Vibroplex is used by Code Instructors of Radio Institute of America, (formerly Marconi Institute), America's Foremost School for Instruction in Radio Telegraphy, in Teaching Code Reception.

ASK ANY EXPERIENCED
WIRELESS OPERATOR

J. E. ALBRIGHT, President.