

# THE WIRELESS AGE

Engineering Library  
SEP 11 1917  
UNIV. OF MICH. LIBRARY

Devoted to the Highest Form of Electrical Experimenting

## HOW TO BECOME AN AVIATOR

*Second Article of a Series*  
BY HENRY WOODHOUSE

## SIGNAL OFFICERS' TRAINING COURSE

*A Chapter on Reconnaissance and Map Reading*  
BY MAJOR J. ANDREW WHITE

## WIRELESS INSTRUCTION FOR MILITARY SERVICE

*A Practical Home-Study Course*  
BY ELMER E. BUCHER

## "SEND THE WIRELESS MEN ABROAD IMMEDIATELY"

*An Exclusive Review of Conditions in France*  
BY GUGLIELMO MARCONI

## RADIO TELEPHONY

*Alternator Generation of Currents*  
BY PROF. ALFRED N. GOLDSMITH

## A VISIT FROM KING NEPTUNE IN MID-PACIFIC

*The Arrival of the Burlesque Sea Sovereign*  
TOLD BY DAVID MANN TAYLOR

## WHEN MY SHIP WAS SUNK BY A TORPEDO

*The Thrilling Experiences of an Operator*  
BY WATSON SIDNEY

---

### OTHER FEATURES

---

- WIRELESS IN TROPICAL EXPLORATION
- WARNINGS FOR ELUDING SUBMARINES
- TRAIN DISPATCHING BY RADIO 'PHONE
- IRON WIRES FOR POWER TRANSMISSION
- A COMPACT UNDAMPED WAVE TUNER
- AUTOMATIC ANTENNA SWITCH

- WIRELESS CLASS FOR WOMEN
- BULLETIN OF THE N. A. W. A.
- USES OF ELECTRICITY ABOARD SHIP
- A PANEL TYPE TRANSMITTER
- GOVERNMENT NITRATE PLANTS
- SERVICE GARAGE FOR ELECTRICS

THE FUTURE APPLICATIONS OF ELECTRICAL POWER

## Through **THE WIRELESS AGE** you can keep in touch with everybody and everything worth while in wireless work

In this illustrated monthly magazine of radio communication every new achievement is reported, and all the latest improvements and developments in the progress of wireless throughout the world are detailed interestingly.

You need this information. No radio engineer or wireless amateur can afford to be without it.

Government officials, heads of Universities and eminent scientists acknowledge **The Wireless Age** as the authority on wireless matters. There is no guess work; all its information is secured from the investigators themselves, whether the subject be governmental work, commercial development or individual experimentation.

The magazine encourages young inventors to write and ask questions. Properly qualified authorities answer them.

Thus **The Wireless Age** helps you to avoid costly mistakes. Its main purpose is to advance radio communication and to assist wireless experimenters. The unsolved problems in radio communication are many. There is no doubt that among the amateurs today are many who will work these out and earn the world's recognition and gratitude. By telling them what has been done and is being done, they are equipped for the task.

One of the strongest features of the magazine is the contest designed to bring out new ideas among amateurs. Valuable prizes are awarded each month for the four best suggestions or informative reports on experiments conducted by readers. This contest is open to all.

Instructive articles by experts appear each month. The beginner as well as the advanced student is provided for.

Training Courses in **WIRELESS TELEGRAPHY** by E. E. Bucher, Instructing Engineer of the Marconi School, and in **SIGNAL CORPS WORK** and **TACTICS** by Maj. J. A. White, are provided in the current and forthcoming issues.

# THE WIRELESS AGE

## America's National Magazine of RADIO COMMUNICATION

MONTHLY, SUBSCRIPTION PRICE \$2.00 A YEAR  
*Foreign Postage, 48c additional*

**FREE** with each subscription sent in direct, at \$2.00 a year, in U. S. A., a cloth bound copy of the only complete reference work on wireless,  
**The Year Book of Wireless Telegraphy  
and Telephony**

### The Annual Encyclopedia of Wireless

Contains a yearly record of the progress of wireless telegraphy and telephony; the regulations of the International Convention; the radio laws of all countries; complete lists of ship and shore stations throughout the world, their call letters, wave-lengths, range and hours of service; articles by the greatest authorities on vital questions, the Articles of the International Convention on Safety of Life at Sea; application of wireless to the mercantile marine; the technical situation of radiotelephony—in fact, everything YOU haven't been able to find out elsewhere. Also full glossary of the most useful wireless data ever compiled and

### THE WIRELESS MAP OF THE WORLD

A Thousand Pages

Well Illustrated

Send 15c Extra for Postage

THE WIRELESS PRESS, Inc.

42 BROAD STREET

NEW YORK

# THE WIRELESS AGE

## An Illustrated Monthly Magazine of RADIO COMMUNICATION

Owing to the fact that certain statements and expressions of opinion from correspondents and others appearing in these columns from time to time may be found to be the subject of controversy in scientific circles and in the courts, either now or in the future, and to sometimes involve questions of priority of invention and the comparative merits of apparatus employed in wireless signaling, the owners and publishers of this magazine positively and emphatically disclaim any privity or responsibility for any statements of opinion or partisan expressions if such should at any time appear herein.

Published by WIRELESS PRESS, INC., 42 Broad St., N. Y. City.  
 Edward J. Nally, Pres. Charles J. Ross, Vice-Pres. David Sarnoff, Secy. John Bottomley, Treas.  
 J. ANDREW WHITE, Editor. WHEELER N. SOPER, Asst. Editor.

Volume 4 (New Series)

September, 1917

No. 12

### CONTENTS

	PAGE		PAGE
<b>WORLD-WIDE WIRELESS</b>		<b>UNIVERSITY WIRELESS EXTENSION</b>	
Marconi's Message to the Amateurs. . . . .	870	Radio Telephony. Article IX. By	
Wireless in Tropical Exploration. . . . .	871	Alfred N. Goldsmith, Ph. D. . . . .	910
The War Activities of Wireless Men. . . . .	872	<b>DIGEST OF ELECTRICAL PROGRESS</b>	
New Employments for the Art. . . . .	873	Iron and Steel Wires for Power	
Eluding Submarines . . . . .	873	Transmission . . . . .	918
Annual Statement of Marconi's Wire-		The Future Application of Electrical	
less Telegraph Co. . . . .	874	Power . . . . .	919
The Report of the Marconi Interna-		An Electric Truck Service (Garage	
tional Marine Communication Co. . . . .	874	by a Public Lighting Corporation. . . . .	921
Fined for Breaking Into Station. . . . .	874	Wireless Telephone for Train Dis-	
<b>PROFESSIONAL OPERATORS</b>		patching . . . . .	922
A Visit from King Neptune in Mid-		Nitrate Plants to Be Built by the	
Pacific. By David Mann Taylor. . . . .	875	U. S. Government. . . . .	922
When My Ship Was Sunk by a Tor-		The Uses of Electricity Aboard Ship. . . . .	923
pedo. By Watson Sidney. . . . .	877	<b>AMATEUR DEPARTMENT</b>	
<b>MILITARY PREPAREDNESS</b>		Wireless Class for Women. . . . .	926
Signal Officers' Training Course.		From and for Those Who Help	
Fourth Article. By Major J. An-		Themselves . . . . .	928
drew White . . . . .	878	The Monthly Service Bulletin of the	
"Send the Wireless Men Abroad Im-		National Amateur Wireless Asso-	
mediately." By Guglielmo Marconi. . . . .	888	ciation . . . . .	936
Wireless Instruction for Military		Queries Answered . . . . .	944
Service. Article V. By Elmer E.			
Bucher. . . . .	892		
How to Become an Aviator. Second			
Article. By Henry Woodhouse. . . . .	905	Index to Volume IV. . . . .	938

**RENEWALS** When your subscription expires you will find a renewal blank enclosed. You should fill out and return same with remittance at once to avoid missing a number. Positively no copies will be mailed on any subscription after same expires unless renewed, and we cannot agree to begin subscriptions with back numbers.

**CHANGE OF ADDRESS** Notify us promptly of any change in your address, giving both the old and new location. Since our mailing list for each issue closes the 5th of the month, changes received after that date must necessarily take effect with issue for the second month following. Postmaster as well as Publisher should always be notified of changes in order to forward mail sent to old address.

**ISSUED MONTHLY BY WIRELESS PRESS, INC.**

42 BROAD ST., NEW YORK.

Yearly Subscription in U. S. \$2.00; Outside U. S. \$2.48; Single Copies, 20 cents

Entered as second class matter at the Post Office, New York.



## MARCONI'S MESSAGE TO THE AMATEURS

**W**ITH an entirely new light on the usage of wireless in the war, Mr. Marconi's utterances in this issue carry a tremendous inspiration to all wireless men. Their sphere of usefulness is not only made distinct, but tremendously important. And that there is room for all—nay, that all are *needed*—is made plain to the hundred thousand or more experimenters of this country. To illustrate the opportunities in the service, one need only refer to House Bill No. 5326, which provides for 75,000 officers and men for the air service. It is noted also that the recommendation of General Squier, Chief Signal Officer, U. S. A., and Vice-President, National Amateur Wireless Association, calls for 22,625 airplanes the first year! General Squier, upon whose shoulders rests the burden of supplying an air service for our soldiers, is a wireless man of note and close to the experimental field. No better man could have been chosen, from the amateur's point of view. Therefore, as it is his problem to fill up the Signal Corps ranks with competent and skilled men—a large proportion of whom are to be radio operators—so it is the duty of amateurs of ability to support him by coming forward for enlistment, irrespective of draft exemption and other considerations. THE WIRELESS AGE and the National Amateur Wireless Association will assist the experimental field in every way possible. More than ever, it rests with patriotic amateurs to prepare themselves for war service.

Marconi's message to the field clearly defines the duty of spotting artillery fire which devolves on the operator-aviator. How preparation for this reconnaissance work is being pursued in the United States is interesting. At the present writing there are some 1,200 student fliers hard at work in various educational institutions. They are studying to avoid many of the most serious mistakes made by foreign fliers in the early stages of the war.

One of the forms of laxity was in the adoption of a "popular" radio code instead of adhering rigidly to the technique of carefully devised symbols. A favorite signal, it is reported, for the concentration of artillery fire was F L H, literally an abbreviation of "Fire like hell." The home-made code of which this symbol is typical, was soon found to be more picturesque than practical and a code properly designed for effectiveness in attack and defense was quickly created to insure against error.

Fire control by wireless from aircraft is now considered an exact science. It is a matter of official record that in the battle of Messines Ridge so accurate was the information sent from an English air squadron that seventy-two German batteries were put out of action in the hours between dawn and six in the morning, when the attack began. It was due to this effectiveness in fire control that the English infantry stormed the slope and captured the key position with comparatively slight losses.

The young men of America who are being trained to transmit the radio messages while flying are now studying observation principles in an interesting manner. A birdseye view of a section of a typical battleground is represented in a picture spread on the ground, covering an area of about sixteen square feet and drawn from aviation photographs. The roads, rivers and houses, trenches and redoubts, appear as they would from a height of 7,000 feet above ground, at which altitude modern warfare aerial observation is secured. The student views this "landscape" from the top of a ladder, radio key in hand. The instructor manipulates a switch board and flashes numerous little electric lights distributed over the surface. Whereupon the embryo operator-aviator takes note of these imaginary explosions and ticks off appropriate fire control messages to supposed artillery.

### WIRELESS IN TROPICAL EXPLORATION

**A**CCUSTOMED as the readers of THE WIRELESS AGE are to the strange experiences of wireless men, that of the radio operator who accompanied the scientific expedition of Dr. Alexander Hamilton Rice and his wife into the wilds of Rio Negro, South America, will command their deepest interest. Not content with making their way 2,100 miles up the Amazon River, a distance penetrated by few explorers, members of the party proceeded up the Rio Negro River to Santa Isabel and San Gabriel and would have pushed on still farther but for a freak of the inky stream the waters of which dropped steadily. This freak was directly contrary to the laws of nature for it took place during the month of February when, according to past observations, the river should have risen.

Although the journey of the adventurers through the jungle was marked by unusual incidents, the objects of the exploration were carried out. These included the testing of the practicability of wireless telegraphy in the wilds; study of the causes of certain tropical diseases; the fixing of certain latitudes and longitudes; the mapping of a large part of the Northwest Amazon basin, and the study of the constantly fluctuating channels of the Amazon and Rio Negro.

A noteworthy feature of the trip was the accomplishment of wireless communication with the outside world while the explorers were in remote parts of the jungle. Other adventurers had taken a day's journey into the wilds and found themselves entirely out of touch with civilization. But the members of Dr. Rice's party kept in communication with persons thousands of miles distant from the heart of the jungle.

Members of the Rice party steamed away from New York on November 15th, 1916, on the yacht Alberta, which was chartered by Dr. Rice from Frederick G. Bourne. A launch which was employed to explore the Rio Negro had been previously sent by steamship to Brazil. In addition to Dr. and Mrs. Rice, the party included Dr. W. C. Councilman of the Harvard Medical School; Dr. R. A. Lambert of the Columbia Medical School; W. H. Boyle, wireless operator; Dr. Ernest Howe, at one time attached to the United States Geological Survey; E. F. Church of the Coast and Geodetic Survey, and J. C. Couzon.

Accounts of the trip say that the Alberta steamed up the Amazon to Iquitos, a thousand miles farther than the point reached by Commodore Benedict on a previous exploring trip. Commander Todd is credited with having taken the gunboat Wilmington to Iquitos on one occasion and the British gunboat Pelorous also made the same journey.

The value of wireless was demonstrated at an early stage of the journey.

While the yacht was off Iquitos the radio operator picked up without difficulty signals sent from Arlington. They were sharp and clear, it is related, and doubtless afforded no small degree of comfort to the little band in the far away tropics.

Returning to Manaus in December, the explorers prepared for the topographical, hydrographical and geological work they had planned to accomplish in the Rio Negro. They also planned further testing of the portable wireless apparatus which was made especially for the journey.

The Rio Negro is quite true to its name, a black-water stream, and is unusually free from logs, drift wood and debris. In parts, however, there are rapids and cataracts which make navigation extremely dangerous. The explorers reached Santa Isabel, where they remained a week, and then proceeded on to Camamaos and later to San Gabriel. However, the falling of the waters in the Rio Negro made a change of plans necessary and the party started down stream, intending to reach the mouth of the Paduiri River and ascend it. But the low water again interfered and it was impossible to enter the mouth of the Paduiri. A large sand bank had formed at the mouth of the river and here the adventurers camped and took observations for longitude and latitude.

Then Dr. Rice and his companions descended the river along the north bank in an attempt to obtain an accurate map of this side of the river. After many mishaps they arrived late in March at Manaus.

At many points, wireless was successful in picking up the Arlington signals and Dr. Rice was struck by the fact that, save in one instance, all of the success in receiving was while the members of the party were on the south bank of the river. He was enthusiastic regarding the employment of radio, he declared on his return to the United States, and believes that the experiments made will be of great value to explorers in the future.

In this glimpse of the use of wireless and the wireless man in tropical exploration is found one of the impressive contrasts which from time to time meet the attention of those who follow the events connected with the art. It is interesting to note that while the nations of the world are devising means to further increase the effectiveness of wireless in warfare, its importance in other fields has not been lost sight of.

## THE WAR ACTIVITIES OF WIRELESS MEN

ONE of the results of the world-war thus far has been to show the active part which wireless and wireless men have taken in the struggle. Hardly a week passes in which is not chronicled some deed of heroism on the part of a radio man, some achievement in which wireless did not largely figure. An instance in point was the attack by three Austrian cruisers on a line of British drifters employed in guarding anti-submarine nets in the Straits of Otranto.

On the Leonidas, one of the drifters, was a wireless operator who did not fail to live up to the standard of duty and courage set by his brothers among the Allies. The Leonidas was considerably damaged by the Austrian cruisers, but her radio man stuck to his post despite the efforts of the enemy to destroy the wireless apparatus. At the conclusion of the engagement he was found dead in his chair, having collapsed over the log in which he was writing at the moment of his death.

And even when the wireless man is not an active figure in world-stirring events he is a witness of them. An operator on a British vessel which recently arrived at an American port from Portugal, had an experience typical of those

met with by men of the radio cabins. Standing in the rigging of his ship for nearly four hours, he saw the shelling of a defenceless town by a submarine, the rout of the U-boat by an American collier and eventually the submerging of the undersea craft.

The engagement took place in the harbor of St. Michaels, the Azores, early in the morning of July 4th. The submarine, which had two long-range guns, fired the first shot at the town at half-past three o'clock. This awakened the operator and others on his ship and even as they sought places of vantage to view the engagement a second shell exploded. Then followed a third explosion and the crew of the American collier, lying alongside, manned their guns and began firing.

From his place in the rigging the wireless man noted that the members of the collier's crew were free from excitement and worked their guns with remarkable speed. He saw the shells hurtling through the air and bursting, like sky rockets. He saw, as the dawn approached, the submarine retire out of range, driven to cover by the collier's fire. Then, when there was a lull in the shelling, the U-boat stole back to her former position, fired several shots and retired again. It was like a game of hide and seek.

This witness of the making of history had photographed on his mind an indelible picture, it is not every day that one has an opportunity to see a sea fight at close range, the privilege of being among the audience while an act of an international drama is staged. The seeker after adventure could not ask more.

### NEW EMPLOYMENTS FOR THE ART

**P**EDESTRIANS in Broadway, in the heart of the New York theater district, have had their attention attracted for several weeks by a wireless station which flashed forth appeals for enlistment in the United States Signal Corps. "If you are a good enough wireless man to read this," ran the message, "why don't you enlist in the Signal Corps and help to can the Kaiser?"

The strength of this appeal is attested by the fact that in one day fifteen men heeded this summons and joined the Signal Corps. Thus was established another use to which wireless may be put. As the war progresses doubtless other new means of employment for the art will be found.

### ELUDING SUBMARINES

**I**N the account of the chase of three speedy trans-Atlantic liners by submarines is found an illustration of how wireless enables vessels to elude the German undersea craft.

The liners were steaming abreast off the Irish coast, with a freighter in their wake, when the latter wirelessly a warning. The message said that she was being attacked by U-boats, one shot having already passed her bow. Those on the liners prepared to put on lifebelts, lifeboats were made ready for launching and orders were given for full steam ahead. The largest of the liners soon outdistanced the other two, but they learned by wireless afterward that the latter had eluded the submarines.

All of which leads to the conclusion that the Allies have reason to congratulate themselves on the fact that the far-reaching wireless is at hand as an effective means of protection against the enemy.

## ANNUAL STATEMENT OF MARCONI'S WIRELESS TELEGRAPH COMPANY

THE annual statement of the Marconi's Wireless Telegraph Company, Limited, of London, shows that the net profit for 1916 amounted to £318,000. It was announced that at a general meeting of the Company to be held August 9th, the directors will recommend a final dividend of ten per cent. on the ordinary shares and five per cent. on the preference shares. This makes a payment for the year of fifteen per cent. on the ordinary shares and twelve per cent. on the preference shares.

The directors also recommend that the sum of £32,000 be placed in the general reserve and £380,000 carried forward in the profit and loss account.

The statement, which does not include the claim of the English Company against the British Government, is considered highly satisfactory under existing conditions.

## THE REPORT OF THE MARCONI INTERNATIONAL MARINE COMMUNICATION COMPANY

AT the seventeenth ordinary general meeting of the Marconi International Marine Communication Company, Limited, held in London on July 4th, Godfrey C. Isaacs, the managing director, referring to the balance sheet, said that in the appropriation account, to the credit of profit and loss account, would be found the sum of £123,744, being the profit for the year plus the amount carried forward from last account after deduction of excess profits duty. The Company has already paid an interim dividend of five per cent., which amounted to £16,622 and it is now proposing to pay a final dividend of ten per cent., which will absorb a sum of £34,996. After placing £3,500 to reserve for payment of debentures, as is the yearly custom, and crediting the general reserve with £17,346, a sum of £51,279 is carried forward, which, of course, is subject to excess profits duty. The general reserve account has been increased from £17,639, at which it stood last year, to £47,653 10s., and to this figure was added £17,346 10s., bringing the reserve account up to £65,000.

The subsidies alone on June 30th, had increased to £431,713 per annum. Regarding this statement Mr. Isaacs remarked that ". . . you will appreciate the necessity of our summoning an extraordinary general meeting to ask you to approve of the Company's capital being increased by the creation of 250,000 new shares."

Before concluding his remarks, Mr. Isaacs related several examples of the bravery of Marconi operators. "Notwithstanding the great increase of risk and danger in the services which they perform," he said, "in no single instance has any one of them murmured, and in no case has any one failed in the critical moment to do a full and heroic duty."

## FINED FOR BREAKING INTO STATION

Ellman B. Myers, who was indicted by the grand jury of Monmouth County, New Jersey, for breaking into the station of the Marconi Wireless Telegraph Company of America at Belmar and pleaded non vult, has been fined \$500 and costs, amounting to about \$40, and placed on probation for one year. The details of the case were printed in the June, 1917, issue of THE WIRELESS AGE.





## A Visit From King Neptune in Mid-Pacific

What Happened  
When the Mythical  
Ruler of the Sea  
and His Retinue  
Came Aboard the  
Ecuador



Duckings in a Swim-  
ming Tank and  
Unwelcome Attentions  
From the  
Royal Barber—How  
the Monarch Was  
Received

By **DAVID MANN TAYLOR**  
*Marconi Operator*

**I**N the days before steam, when sailing ships were prowling about the farthest corners of the Seven Seas, there was romance galore, as we have been assured by Captain Marryat, W. Clark Russell and other authors of their school. Richard Henry Dana and a few of his ultra-practical type, among whom are to be found several old-time whaling skippers of New England, stripped some of the romance from the voyages of wind-dependent ships by telling the truth about them. Nevertheless, we whose boyhood ambitions were fired by the stirring narratives of the first-mentioned writers, prefer to remember their romantic descriptions of life on the sea rather than the hardships and privations that fell to the lot of their heroes and heroines.

Sea-going nowadays is a business, for with the advent of steam the mariner is no longer compelled to rely entirely upon the vagaries of the ocean winds. In fact, voyages are now planned so minutely that the date and even the hour of the ship's arrival at her destination can be accurately determined before the vessel leaves port.

Fifty years of steam navigation have greatly altered sea travel and the old types of deep-water sailors and ships are rarely seen. There are some incidental features of ocean life, however, that have survived: Here and there, on overseas journeys to the antipodes and from America to Japan, many events crop out that make the voyager hark back to the days of the old square-riggers and their clouds of billowing canvas.

King Neptune's visit to a ship in the days of old was a noteworthy occurrence. The treatment of the victims was far from dignified, but a grotesque dignity marked the event notwithstanding.



*King Neptune and his court taking leave with all the grotesque dignity which marks his equatorial visit*

This article has principally to do with the visit which King Neptune made to the steamship *Ecudor* on May 19th, 1917, at half-past three o'clock in the afternoon. The vessel was crossing the 180th Meridian—the International date line in mid-Pacific—when the King and his consort, Queen Prosperine, with their retinues, boarded the ship, coming ceremoniously over the bows. Upon reaching the promenade deck, the King and Queen proceeded aft, meeting our commantler, Captain R. Lobez, amidships, where greetings were exchanged. Escorted by the captain, the royal couple made their way to the throne room which had been erected upon one end of the large swimming tank on the after-deck. An address from the King to the passengers concerning his visit followed. It was interspersed with quaint nautical sayings by the Queen—in reality a sea-dog of the old school—one Captain C. E. Stewart.

At the conclusion of the address the culprits (those who had never crossed the line before) were arraigned before the King. With impressive manner the Court Herald announced that his royal master had learned that these malefactors had invaded Neptune's domains without permission. Now, he declared, they stood before his majesty to receive just punishment and later to be accepted as his loyal subjects.

The trial was brief, each culprit being found guilty with remarkable dispatch. He was then placed in charge of the Royal Doctor who, having taken his pulse, temperature and heart action, pronounced him prepared to go through the initiation. The Royal Barber was then called upon to take part in the ceremony. With a large paste brush in hand and a bucket of lather by his side, he thoroughly daubed the face of the victim, not neglecting to cover up his eyes, fill his ears and, if possible, his mouth. A large wooden razor was used for shaving and then the object of these attentions was thrown into the tank to be ducked.

There were seven culprits, five men and two women, but the King gallantly pardoned the latter. The remainder of the prospective victims, with the exception of one, pleaded guilty and accepted their sentences philosophically. The obdurate culprit demanded a sea lawyer. Considerable palavering followed, all of which was to no purpose—he was tipped backward into the tank.

This marked the conclusion of the ceremonies. The King was satisfied that in the future his laws would be respected and the new subjects were convinced that an entrance to Neptune's domains was not an event to be considered lightly. So, after the amateur photographers had been given an opportunity to snapshot the royal party, the visitors marched to the bows, where a farewell exchange of courtesies took place.

Then, with the same abruptness with which they had made their appearance, they nimbly vaulted the ship's rail and leaped into the sea, their leave-taking being marked by the splash of the waters in which the mythical ruler and his subjects dwelt.

---

## WHEN MY SHIP WAS SUNK BY A TORPEDO

*By Watson Sidney*

ON March 18th the Aztec of the Oriental Navigation Company left New York for Havre, being the first armed American ship to leave an American port—after a sharp contest for this honor with the Manchuria and St. Louis.

At six o'clock in the morning of April 1st, one of the gunners on lookout sighted a submarine following the ship; she immediately submerged on sighting our guns, and we did not see anything more of her.

About 9:30 p. m. the Chief Engineer warned me that my port hole was showing light and I left the wireless cabin to take a look at it. As I stepped out on deck the wind was howling and rain and hail was falling. I kept close to the steel deck house for protection.

The chief gunner was standing at the rail, leaning over and searching the seas for signs of a possible submarine. I hailed him, asking if he had seen anything; he had not replied when a torpedo struck directly below where we were standing. The gunner immediately disappeared, and nothing more was seen or heard of him. Another man standing near had his head blown clean off. At the same instant I was struck by a piece of flying wreckage, which tore away the leg of my trousers and inflicted a gash fourteen inches in length in my left leg. The force of the explosion hurled me twenty-five feet along the deck.

I picked myself up and ran to the wireless cabin; there I found the apparatus completely wrecked and the water up to my knees. I then returned to the deck, and observed four sailors and three chinamen lowering a life boat. The rope fouled in the block and the ship's carpenter slashed at it. One end of the small boat dived down and was smashed to bits against the ship's side, spilling its seven occupants into the sea.

I went in search of the captain, to report the destruction of my apparatus, but failed to locate him in either the chart room or on the bridge. I returned to the deck and saw another boat lowered; it immediately rowed away from the ship. Nearby, I observed the captain talking with the naval lieutenant; he ordered me into the gunners' life boat, which was being lowered. As I jumped from the deck of the ship into the boat, followed by the captain and naval lieutenant, and left, the ship was settling fast. When we were about a hundred yards away we saw her slide beneath the surface of the sea, seven minutes after she was struck.

We had floundered around in the stormy sea for five hours when a French patrol boat, the Joan d'Arc, came in sight. We fired off our pistols, but they were not heard; and the lieutenant lighted a Coston distress signal which was observed.

The French officers took us aboard and gave us dry clothing and warm quarters.

The Aztec carried a crew of thirty-six men, of whom only six were rescued.

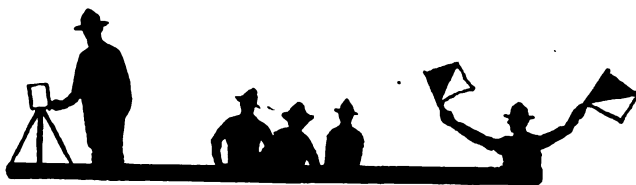

## Military Preparedness

# Signal Officers' Training Course

A Wartime Instruction Series for Advanced  
Amateurs Preparing for U. S. Army Service

FOURTH ARTICLE

By MAJOR J. ANDREW WHITE

*Chief Signal Officer, Junior American Guard*

*(Copyright, 1917, Wireless Press, Inc.)*

**I**N Marconi's message to American amateurs, which appears elsewhere in this issue, the distinguished inventor and, now, war veteran, advises: "Begin at once some form of military training. Begin with essentials, and later take up the study of map reading and observation."

This message determines a slight deviation from the original schedule for this instructional series, designed to train aspirants for promotion in the U. S. Army Signal Corps. In the preceding articles what Mr. Marconi terms "essentials" have been covered; the student has been made familiar with the elementary instruction to make a citizen recruit a soldier, and the principles of drill which have been designed for uniformity, unity and agility of action. Since the purpose of this course is mainly for self-training and home study, it will not be amiss to devote this article to the recommended "study of map reading and observation."

It is not too early to introduce the subject here. I have tried the experiment within the past few weeks and found it practicable. Student soldiers-to-be of the Junior American Guard, encamped at Stony Point, N. Y., and familiar only with drill regulations and semaphore signaling, were given outpost work in a night attack and made a very successful reconnaissance. Then, applying their newly gained knowledge, they completed a military map of the terrain wherein the camp was located.

The type of map which is made for military needs is slightly different from those found in the ordinary atlas. At first glance it seems many times more complicated and appears to be very difficult of interpretation. Many candidates for officers' commissions become discouraged at this point and feel the

subject so difficult of mastery that they mentally handicap themselves out of all proportion to the task. Map making and map reading is as simple as A-B-C if approached in the right spirit; every symbol and sketching method is based upon common sense visualization of the object it represents, and this minimizes the "memory trick" which many consider irksome.

It may be well to note here, before proceeding to the subject itself, that a knowledge of map reading is absolutely essential for a prospective officer in Signal Corps. It is obvious that communication lines cannot be laid without clear knowledge of the country, or terrain, in which the troops are operating. The shortest cut to mastery of the subject is *actual field work* and the student is urged to use the country about his home for practice, once the essentials have been grasped, as hereafter outlined.

Primarily, the function of the Signal Corps is the *speedy dissemination of military information*. Not only communication, but collection, of information is its function. Eyes and ears must be kept wide open at all times, if the signalman is to properly discharge his duty.

Signal Corps men must know *what* and *how* to observe. The book, "Military Signal Corps Manual," upon which this course is based, contains an abundance of material on this subject, a few extracts from which are given here.

Personal experience in the instruction of signal troops has demonstrated that mastery of map reading is best obtained by the student doing reconnaissance work—securing, himself, information of the country and sending back messages which can be easily understood.

In obtaining facts the following should be kept in mind:

**Roads.** Their direction, their nature (macadamized, corduroy, plank direct, etc.), their condition of repair, their grade, the nature of crossroads, and the points where they leave the main roads; their borders (woods, hedges, fences or ditches), the places at which they pass through defiles, cross heights or rivers, and where they intersect railroads, their breadth (whether suitable for column of fours or platoons, etc.)

**Railroads.** Their direction, gauge, the number of tracks, stations and junctions, their grade, the length and height of the cuts, embankments and tunnels.

**Bridges.** Their position, their width and length, their construction (trestle, girder, etc.), material (wood, brick, stone or iron), the roads and approaches on each bank.

**Rivers and Other Streams.** Their direction, width and depth, the rapidity of the current, liability to sudden rises and the highest and lowest points reached by the water, as indicated by drift wood, etc., fords, the nature of the banks, kinds, position and number of islands at suitable points of passage, heights in the vicinity and their command over the banks.

**Woods.** Their situation, extent and shape; whether clear or containing underbrush; the number and extent of "clearings" (open spaces); whether cut up by ravines or containing marshes, etc.; nature of roads passing through them.

**Canals.** Their direction, width and depth; condition of towpaths; locks and means of protecting or destroying them.

**Telegraphs.** Whether they follow railroads or common roads; stations, number of wires.

**Villages.** Their situation (on a height, in a valley or on a plain); nature of the surrounding country; construction of the houses, nature (straight or crooked) and width of streets; means of defense.

**Defiles.** Their direction; whether straight or crooked; whether heights on either side are accessible or inaccessible; nature of ground at each extremity; width (frontage of column that can pass through.)

**Ponds and Marshes.** Means of crossing; defensive use that might be made of them as obstacles against enemy; whether the marshy grounds are practicable for any or all arms.

**Springs and Rivulets.** Nature of approaches; whether water is drinkable and abundant.

**Valleys.** Extent and nature; towns, villages, hamlets, streams, roads and paths therein; obstacles offered by or in the valley, to the movement of troops.

**Heights.** Whether slopes are easy or steep; whether good defensive positions are offered; whether plateau is wide or narrow; whether passages are easy or difficult; whether the ground is broken or smooth, wooded or clear.

The powers of observation are quickly trained by observing the facts of the landscape in view, in accordance with the foregoing, and making notes of

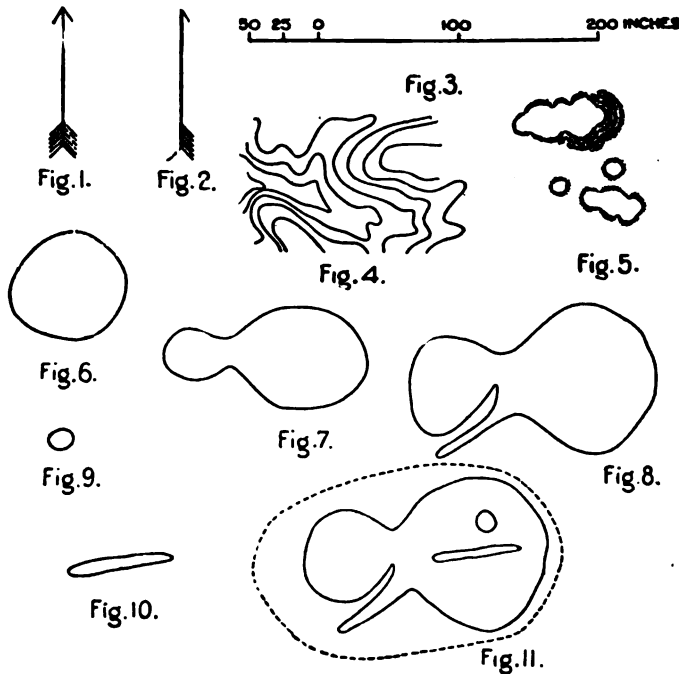

*Elementary guides for the study of military map contours*

the observation. Study of surroundings should be made by the watch, starting with a 10-minute observation from cover, and successively noting the facts obtained in 5 minutes, 3 minutes and 1 minute studies of terrain. Quick sketches, supplemented by marginal notes, are efficient aids in training for quick recording of observations.

When the student feels that he has mastered the art of *seeing* a landscape, rather than merely *looking* at it, the study of map reading may be begun.

Reproduced herewith is a portion of the military map which appears in "Military Signal Corps Manual," showing the vicinity of Fort Leavenworth, where the Army Signal Corps school is located. This may be used as a basis for elementary study.

The first question is: Where is north? On any map this can usually be told by an arrow (see Fig. 1) which will be found in one of the corners of the map, and which points to the true north—the north of the north star.

On some maps no arrow is to be found. The chances are a hundred to one that the north is at the top of the map, as it is on almost all printed maps. But you can only assure yourself of that fact by checking the map with the ground it represents. For instance, if you ascertain that the city of Philadelphia is due east of the city of Columbus, then the Philadelphia-Columbus line on the map is a due east-and-west line, and establishes at once all the other map directions.

Let it be understood that the map represents the ground as nearly as it can be represented on a flat piece of paper. If you are standing up facing the north, your right hand will be in the east, your left in the west, and your back to the south. It is the same with a map; if you look across it in the direction of the arrow—that is, towards its north—your right hand will be toward what is east on the map; your left hand to the west; the south will be at the bottom of the map.

There is another kind of an arrow that sometimes appears on a map. It is like the one in Figure 2, and points not to the true north, but to the magnetic north, which is the north of the compass. Though the compass needle, and therefore the arrow that represents it on the map, does not point exactly north, the deviation is, from a military point of view, slight, and appreciable error will rarely result through the use of the true north in the solution of any military problems.

Should you be curious to know the exact deviation, consult your local surveyor or any civil engineer.

Both arrows may appear on your map. In that case disregard the magnetic arrow unless you are using the map in connection with a compass.

If a map is being used on the ground, the first thing to be done is to put the lines of the map parallel to the real outlines of the ground forms, and roads, fences, railroads, etc., that the map shows; for the making of a map is no more than the drawing on paper of lines parallel to and proportional in length to real directions and distances on the ground.

For instance, the road between two places runs due north and south. Then on the map a line representing the road will be parallel to the arrow showing the north and will be proportional in length to the real road. In this way a map is a picture, or, better, a bare outline sketch; and, as we can make out a picture, though it be upside down, or crooked on the wall, so we can use a map that is upside down or not parallel to the real ground forms. But it is easier to make out both the picture and the map if their lines are parallel to what they represent. So in using a map on the ground the lines are always placed parallel to the actual features they show. This is easy if the map has an arrow.

If the map has no arrow, you must locate some objects or features on the ground, and on the map, their representations. Draw on the map a line connecting any two of the features; place this line parallel to an imaginary line through the two actual features located, and your map will be correctly placed. Look to it that you do not reverse on the map the positions of the two objects or features, or your map will be exactly upside down.

When the map has been turned into the proper position—that is to say, “oriented”—the next thing is to locate on the map your position. If you are in the village of Easton and there is a place on the map labeled Easton, the answer is apparent. But if you are out in the country, at an unlabeled point that looks like any one of a dozen other similar points, the task is more complicated. In this latter case you must locate and identify, both on the map and on the ground, other points—hills, villages, peculiar bends in rivers, forests—any ground features that have some easily recognizable peculiarity and that you can see from your position.

Soil and Cultivation.

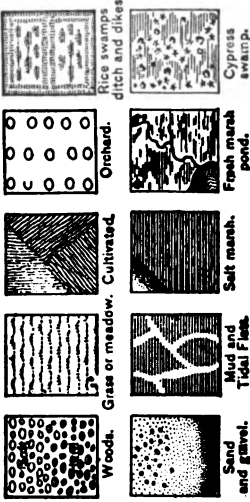

Telegraph Line

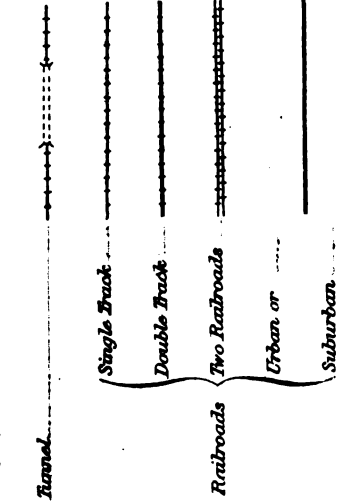

Military Signs.

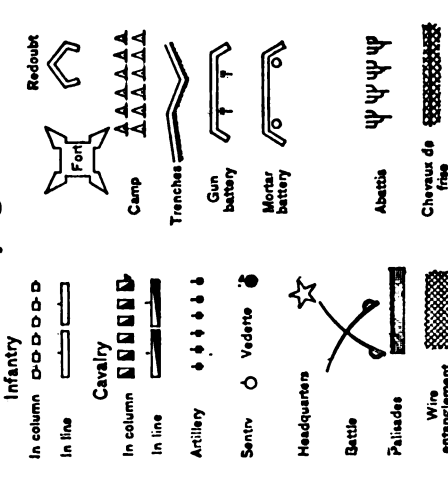

Enclosures

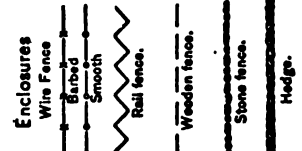

Communications

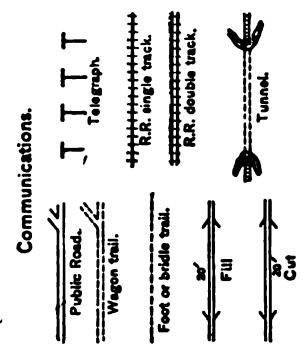

Bridges

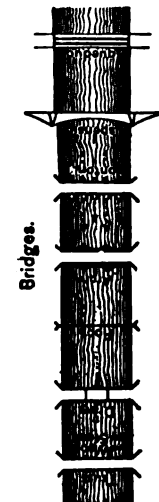

River Crossings



Miscellaneous

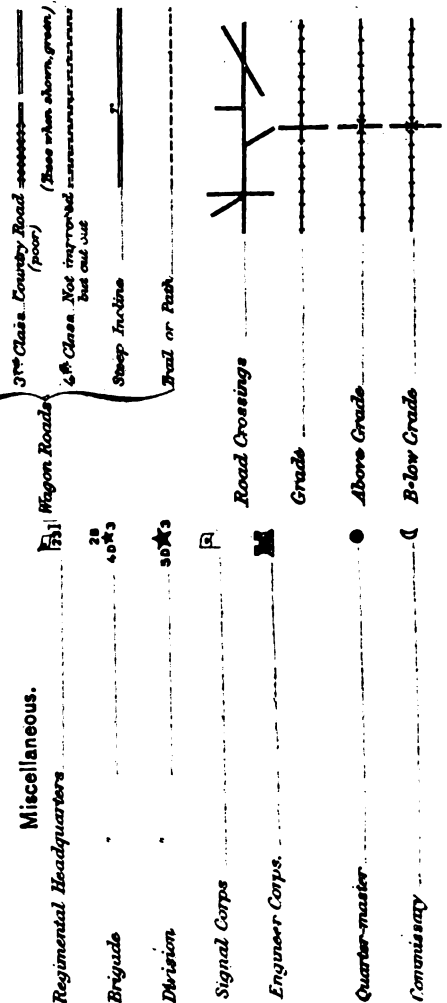



Suppose, for instance, you were near Leavenworth and wanted to locate your exact position, of which you are uncertain. You refer to the map, and, looking about, you see southwest from where you stand the United States Penitentiary; also, halfway between the south and the southeast—south-southeast a sailor would say—the reservoir (rectangle west of "O" in "Missouri"). Having oriented your map, draw on it a line from the map position of the reservoir toward its actual position on the ground. Similarly draw a line from the map position of penitentiary toward its actual position. Prolong the two lines until they intersect; the intersection of the lines will mark the place where you stand—south Merritt Hill.

After "What direction?" comes "How far?" To answer this, one must understand that the map distance between any two points shown bears a fixed and definite relation or proportion to the real distance between the two points.

For instance: We measure on a map and find the distance between two points to be 1 inch. Then we measure the real distance on the ground and find it to be 10,000 inches; hence the relation between the map distance and the real distance is 1 to 10,000 or 1-10,000. Now, if the map is properly drawn the same relation will hold good for all distances, and we can obtain any ground distance by multiplying by 10,000 the corresponding map distance.

This relation need not be 1-10,000, but may be anything from 1-100 that an architect might use in making a map or plan of a house up to one over a billion and a half, which is about the proportion between map and real distances in a pocket-atlas representation of the whole world on a 6-inch page. Map makers call this relation the "scale" of the map and put it down in a corner in one of three ways.

For the sake of an illustration, say the relation between map and ground distances is 1 to 100; that is, 1 inch on the map is equal to 100 on the ground. The scale may be written:

First. 1 inch equals 100.

Second. 1-100.

Third. As shown by figure 3.

These expressions mean one and the same thing. A variation of the first method on a map of different scale might be: 1 inch equals 1 mile. Since a mile contains 63,360 inches, then the real distance between any two points shown on the map is 63,360 times the map distance.

To find the ground distance by the third kind of scale, copy it on the edge of a slip of paper, apply the slip directly to the map, and read off the distance; and so we answer the question, "How far?"

After direction and distance comes the interpretation of the signs, symbols, and abbreviations on the map. Those authorized are given, but there are a good many other conventional signs in common use. A key to them is published by the War Department and is called "Conventional Signs, United States Army." From these you read at once the natural and artificial features of the country shown on your map. It should be borne in mind that these conventional signs are not necessarily drawn to scale, as are the distances. They show the position and outline of the features, rather than the size. This, for the reason that many of the features shown, if drawn to scale, would be so small that one could not make them out except with a magnifying glass. If the exact dimensions are of any importance they will be written in figures on the map. For instance, bridges.

In addition to the conventional signs, we have CONTOURS to show the elevations, depressions, slope and shape of the ground. Abroad, HACHURES are much used, but they serve only to indicate elevation, and as compared to contours are of little value. Contours resemble the lines shown in Figure 4.

Hachures are shown in Figure 5, and may be found on any European map.

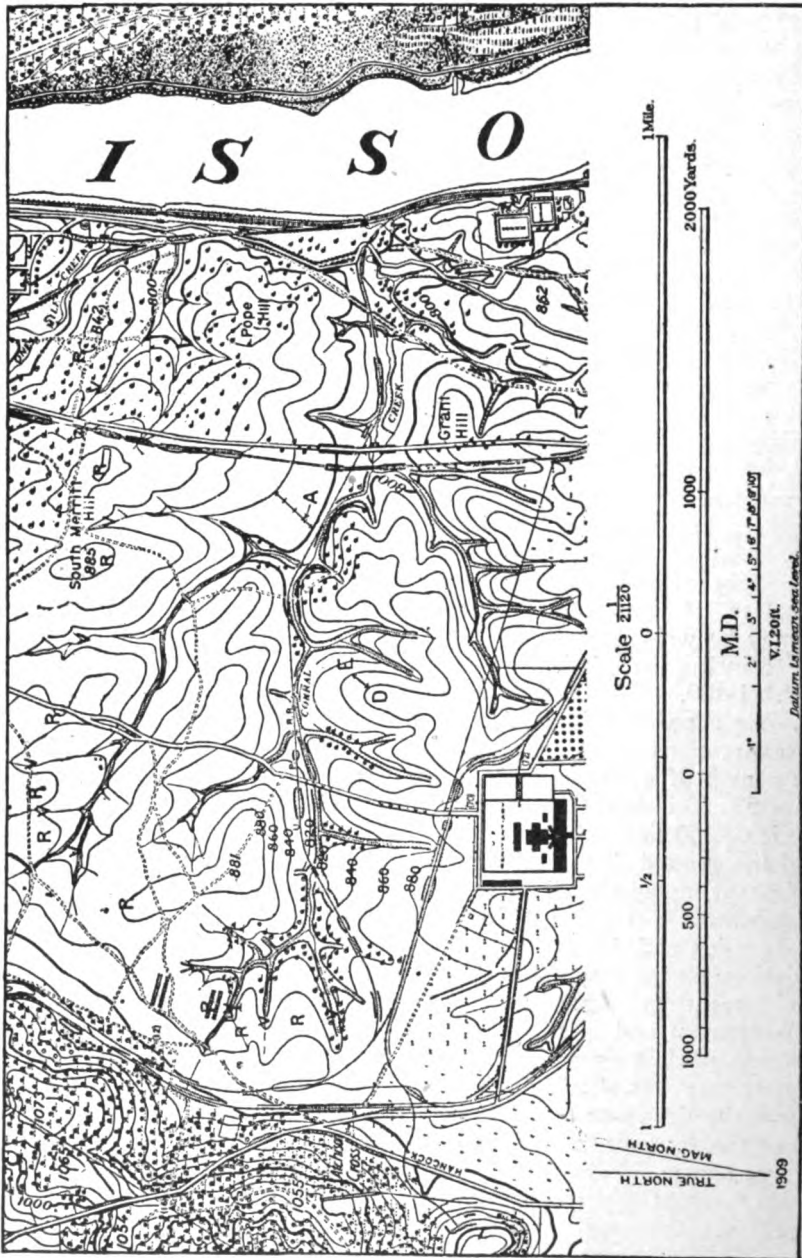

*Military map of the vicinity of Fort Leavenworth, where the Signal Corps school is located*

They simply show slopes and, when carefully drawn, show steeper slopes by heavier shading and gentler slopes by the fainter hachures. The crest of the mountain is within the hachures. (See Fig. 5.)

For examples of contours turn to the map and, starting at the United States Penitentiary, note the smooth, flowing, irregular curved lines marked 880, 860, 840, 860, etc.

The only other lines on the map that at all resemble contours are stream lines, like "Corral Creek," but the stream lines are readily distinguished from contours by the fact that they cross the contours squarely, while the contours run approximately parallel with each other. Note the stream line just to the west of South Merritt Hill.

The contours represent lines on the ground that are horizontal and whose meanderings follow the surface, just as the edge of a flood would follow the irregularities of the hills about it. Those lines that contours stand for are just as level as the water's edge of a lake but horizontally they wander back and forth to just as great a degree.

The line marked 880 at the penitentiary passes through on that particular piece of ground, every point that is 880 feet above sea level. Should the Missouri River rise in flood to 880 feet, the penitentiary would be on an island, the edge of which is marked by the 880 contour.

Contours show several things; among them the height of the ground they cross. Usually the contour has labeled on it in figures the height above some



*Signalman preparing an elementary military map of the terrain of a new camp location*

starting point, called the DATUM PLANE—generally sea level. If, with a surveying instrument, you put in on a piece of ground a lot of stakes, each one of which is exactly the same height above sea level—that is, run a line of levels—then make a map showing the location of the stakes, a line drawn on the map through all the stake positions is a contour and shows the position of all points of that particular height.

On any given map all contours are equally spaced in a vertical direction, and the map shows the location of a great number of points at certain fixed levels. If you know the vertical interval between any two adjacent contours, you know the vertical interval for all the contours on that map, for these intervals on a given map are all the same.

With reference to a point through which no contour passes, we can only say the point in question is not higher than the next contour up the hill nor lower than the next one down the hill. For the purposes of any problem, it is usual to assume that the ground slopes evenly between the two adjacent contours, and that the vertical height of the point above the lower contour is proportional to its horizontal distance from the contour, as compared to the whole distance between the two contours. For instance, on the map, find the height of point A. The horizontal measurements are as shown on the map. The vertical distance between the contours is 20 feet, A is about one-quarter of the distance between the 800 and the 820 contours, and we assume its height to be one-quarter of 20 feet (5 feet) higher than 800 feet. So the height of A is 805 feet.

The vertical interval is usually indicated in the corner of the map by the letters "V. I." For instance, V. I.=20 feet.

On maps of very small pieces of ground, the V. I. is usually small—perhaps as small as 1 foot; on maps of large areas on a small scale it may be very great—even 1,000 feet.

Contours also show SLOPES. It has already been explained that from any contour to the next one above it the ground rises a fixed number of feet, according to the vertical interval of that map. From the scale of distances on the map the horizontal distance between any two contours can be found. For example:



On the map, the horizontal distance between D and E is 90 yards, or 270 feet. The vertical distance is 20 feet the V. I. of the map. The slope then is  $20/270 = 1/13.5 = 7\frac{1}{2}\% = 4\frac{1}{2}^\circ$  in all of which different ways the slope can be expressed.

On a good many contoured maps a figure like this will be found in one of the corners:



On that particular map contours separated by the distance



on the vertical scale show a slope of  $1^\circ$ . A slope of  $1^\circ$  is a rise of 1 foot in 57. To use this scale of slopes copy it on the edge of a piece of paper just as you did the scale of distances and apply it directly to the map.

You will notice that where the contours lie closest the slope is steepest; where they are farthest apart the ground is most nearly flat.

It has already been set forth how contours show height and slope; in addition to this they show the shape of the ground, or GROUND FORMS. Each single contour shows the shape at its particular level of the hill or valley it outlines; for instance, the 880 contour about the penitentiary shows that the hill at that level has a shape somewhat like a horse's head. Similarly every contour on the map gives us the form of the ground at its particular level, and knowing these ground forms for many levels we can form a fair conception of what the whole surface is like.

A round contour like the letter O outlines a round ground feature; a long narrow one indicates a long narrow ground feature.

Different hills and depressions have different shapes. A good many of them have one shape at one level and another shape at another level, all of which information will be given you by the contours on the map.

One of the ways to see how contours show the shape of the ground is to pour half a bucket of water into a small depression in the ground. The water's edge will be exactly level and if the depression is approximately round, the water's edge will also be approximately round. The outline will look something like Figure 6.

Draw roughly on a piece of paper a figure of the same shape and you will have a contour showing the shape of the bit of ground where you poured your water.

Next with your heel gouge out on one edge of your little pond a small round bay. The water will rush in and the watermark on the soil will now be shaped something like Figure 7.

Alter your drawing accordingly, and the new contour will show the new ground shape.

Again do violence to the face of nature by digging with a stick a narrow inlet opening out of your miniature ocean, and the watermark will now look something like Figure 8.

Alter your drawing once more and your contour shows again the new ground form. Drop into your main pond a round clod and you will have a new watermark, like Figure 9, to add to your drawing. This new contour, of the same level with the one showing the limit of the depression, shows on the drawing the round island.

Drop in a second clod, this time long and narrow; the watermark will be like Figure 10, and the drawing of it, properly placed, will show another island of another shape. Your drawing now will look like Figure 11.

It shows a depression approximately round, off which open a round bay and a long narrow bay. There is also a round elevation and a long narrow one; a long, narrow ridge, jutting out between the two bays, and a short, broad one across the neck of the round bay.

Now flood your lake deeply enough to cover up the features you have introduced. The new water line, about as shown by the dotted line in Figure 11, shows the oblong shape of the depression at a higher level; the solid lines show the shape farther down; the horizontal distance between the two contours at different points shows where the bank is steep and where the slope is gentler.

Put together the information that each of these contours gives you, and you will see how contours show the shape of the ground. On the little map you have drawn you have introduced all the varieties of ground forms there are; therefore all the contour forms.

The contours on an ordinary map seem much more complicated, but this is due only to the number of them, their length, and many turns before they finally close on themselves. Or they may close off the paper. But trace each one out, and it will resolve itself into one of the forms shown in Figure 11.

# “Send the Wireless Men Abroad Immediately”



---

---

“My Word to the  
Amateur of America is:  
Begin at Once Some Form  
of Military Training”

---

---

By GUGLIELMO MARCONI

**Editorial Note:** It is a well-known fact that Mr. Marconi has never written a line for publication. The article which follows is based on an exclusive interview which was given to the editor of this magazine in connection with his work as Acting President of the National Amateur Wireless Association, and is published as Mr. Marconi's official statement to the loyal wireless experimenters of the United States.

**T**HE most striking feature of my observations since I have been on this official visit to the United States is the surprising ignorance of your wireless men concerning the conditions in the fighting zone abroad. It has required a readjustment of viewpoint for me to appreciate the fact that so much of the scientific development of the wireless art has been kept secret for military reasons; naturally the United States cannot know of things which to us have seemingly become elementary.

For example, it appears that American wireless men still look upon a portable set as a novelty; whereas, on the Western front, and particularly in the trenches, portable sets of all types have become indispensable. They vary in appearance from carefully designed equipments in neat containers to a key, coil and crudely manufactured accessories, strapped to a board. There has been no attempt at standardization—we have not had time.

A second impression, very general among Americans, is that wireless has not been a great factor in the war. In various quarters I have heard it

said that you understood wireless was tried in the early months of the fighting and, being found impractical, was virtually abandoned so far as the army is concerned. Nothing could be further from the truth. To illustrate its great importance in modern warfare, I have only to say that with the exception of the first two or three months of the war, wireless has furnished the sole means of communication in the first line of trenches.

### THE WIRELESS MAN HOLDS THE FIRST-LINE TRENCH

No longer are wire telephones and telegraphs used in the trenches bordering no man's land. We found it impossible to maintain these lines with the constant shelling by high explosives. When you go into a first-line trench today, you will find very little else occupying it but the wireless men. These trenches are not filled up with infantry at all times, as the popular conception has it. Unless an engagement is in progress, there will be found only a handful of fighting men with machine guns, distributed in small detachments about every 400 yards, and supported by the ever-present wireless man with his portable set. Through the continued and heavy shelling it is not possible to maintain many troops in these trenches, so until an advance of enemy infantry is observed, the wireless man and a few infantrymen to protect him are in sole possession. With the first observation of an infantry attack, the wireless man gets in action and sends back his call for troops from the supporting trenches. They pour in then through a traverse and the hand-to-hand engagement begins.

It can be readily seen from this that the Allies faced some serious problems in supplying the right sort of men for this duty, and, in fact, in supplying the armies with sufficient wireless men for their needs. We were far better equipped, however, than the Americans, because of the fact that the European nations had large standing armies with men well trained for their soldierly duties. It was better for us to take soldiers and train them as operators, and this we did. We had very little choice in the matter, however, because we had no great body of amateurs to call upon, as you have in this country. Your war problem, so far as wireless is concerned, is obviously directly opposite to ours—by our, I mean all the allied European nations. It appears to me the most logical, and the only practical thing to do here, since you have no great standing army, is to train your wireless operators as soldiers, which is a relatively short process when compared with the necessity which we faced of training soldiers technically. I do not know but that you are better off than we were, for this reason. It is certain, anyhow, that the United States can be a material factor in the war by sending us at the earliest possible date all its available wireless men.

What I have said may convey the impression that there is no such person as a wire operator at the front. On the contrary, there are a great many, as many I should say as there are wireless operators, but certainly not more. Their duties are a little different. They maintain the very important telephone and telegraph communications between the supporting trenches and the field bases, and keep in operation a network of connecting lines directly back of the fighting zone. There is a constant need for signalmen, and the American development of amateur experimenting having been so extensive, I look to the wireless men to make a great record in this war.

### HOW AERIAL WIRES ARE STRUNG ALONG TRENCH TOPS

The trained signalmen of the United States Army are a fine, efficient lot, and they will do very effective service for us in France; but their numbers are

so few they will have to be considerably augmented to occupy the space we provide in our tactical organizations. Furthermore, as with us before the war, the United States Army has done its field work on a manœuvre basis. They will have much to learn, and something to unlearn, just as we did. But used as a leaven for the host of civilian signalmen which can be quickly gathered together, they will be very valuable.

So pressing has been the need for operators, we have taught some of our men transmitting only, and assigned them to duties where a knowledge of receiving is not essential. It is, of course, obvious though, that a man who can both send and receive is far better equipped for duties where the lives of thousands of human beings are involved.

There seems to be a general misunderstanding in this country as to the use of aërials. I have heard it said that most American wireless men believe aerial wires are laid along the bottom of the trenches, and that masts have been dispensed with. This is not literally so. In the first line of trenches, the aerial wires are strung along a parapet just behind the barricade. Some of the aerial lines in the supporting trenches are raised a few feet above the ground. Still further back, where greater distances must be spanned, masts are used, but these are bamboo poles with a maximum height of twenty feet. We are not using the familiar sixty and eighty-foot sectional masts, which were part of all tractor wireless equipments before the outbreak of hostilities. And we use horizontal aërials, not so much to eliminate the size of the mark which draws artillery fire, as for convenience.

## THE AIRCRAFT WIRELESS GOVERNS ALL ARTILLERY FIRE SPOTTING

Now in the consideration of wireless as applied to air service, I have a subject which caused me greater surprise than anything I have learned here as to American misconceptions of what has been done. The general supposition seems to have been that spotting of artillery fire has been accomplished through the use of various forms of visual signaling, such as flags and smoke bombs dropped from a 'plane. The truth of the matter is that our entire heavy artillery fire control is conducted by wireless from aircraft. At the very outset of the war, we had neither equipment, experience or personnel to accomplish this, so it was our custom to send up an observer with the airplane pilot who carefully drew a picture of the enemy battery emplacements, flew back to his own lines and dropped these drawings. This is no longer done. The observer now notes the results of his artillery fire and sends back by wireless such messages as "Too short." "Three to right." "Two to left," and so on.

The reconnaissance machines are protected by fighting 'planes which fly in squadrons over enemy lines, attacking every enemy machine they encounter, and thus allowing the observers to complete their work undisturbed. It is such an ordinary sight to see these airplanes at all hours of the day that their presence means nothing special to us. They are merely part of the great fighting machine which we have builded up. Their observations continue all day long and are of incalculable value. Many of the airplanes now in use show amazing development in power, speed and carrying capacity; we have quite a number of 'planes which carry as many as six or eight men armed with machine guns.

The wireless operator who makes the observations for fire control is provided with a map of the terrain blocked off into small squares. As he spots the fall of the shells, he sends back by wireless the number of the square and records a hit or gives directions for greater accuracy. While he is spotting



he is continually subjected to tremendous shelling; white puffs of smoke break around the reconnaissance 'planes all day long, but it is surprisingly seldom that they are hit.

## JUST WHY THE AMERICAN AMATEUR IS VALUABLE IN WAR

I do not know that I can say anything further than the generalities with which I have just dealt, because our technical development is a very carefully guarded secret. Quite amazing things have been done in the navy, as well as in the army, but I am not at liberty to disclose any of the details. I do wish to say this, however:

American wireless men are exceptionally well qualified to take an active part in important signaling work. Much valuable material will be found in the amateur ranks, as these young men are accustomed to transmission on short wave-lengths. A great deal of our communication is carried on with low power and wave-lengths in the neighborhood of 200 meters—the exact type of communication to which they are most accustomed.

We have not had the reserve of amateurs which the United States has to call upon. So the training of our soldiers for communication has been both rapid and continuous. For example, in Chelmsford, England, we have a school where seldom less than 400 men are studying at a time.

The demand for wireless operators is best illustrated by saying that at least half of the signalmen are wireless operators. The communication service is about equally divided between wire and wireless.

America is fortunate in having perfected its organization of the amateur field. The National Amateur Wireless Association, which has had my hearty support since its inception, has done valuable work in co-ordination and standardization of instructional methods. The younger men in the experimental field have a very definite place in the war scheme. The military laws of the allied nations did not permit using boys under eighteen, but I can see no reason why a boy of sixteen who has the necessary qualifications cannot be used; in fact, I think this will be done, if it is not already being done. Ability to communicate at a speed of twenty words per minute is adequate, for it is seldom that we have to use a greater speed than this, but while operation of this kind can be taught in a comparatively short time to any intelligent person, the amateur has a tremendous advantage in possessing the fundamental knowledge of wireless, which requires extended study. Extremely valuable also is his knowledge of all kinds, sizes, and types of low-power equipment.

## MARCONI'S HOPE TO SEE YOU "OVER THERE"

My word to the amateurs of America is: Begin at once some form of military training. Begin with essentials, and later take up the study of map reading and observation; it will help wonderfully in increasing wartime efficiency and will be invaluable to those subject to draft.

I am not given to inspirational utterances as a rule, but I have been impressed and pleased with what I have learned of the work the amateurs are doing in the Junior American Guard. I had hoped to see them in an exhibition, but my engagements prevented this.

Perhaps it will not be long, however, before I will see many of them—over there.

Editor's Note.—This message to wireless men was given just before Mr. Marconi left America. His safe arrival in Paris on August 6th has since been announced.

# Wireless Instruction for Military Service

## A Practical Course for Radio Operators

ARTICLE V.

---

By **Elmer E. Bucher**

*Instructing Engineer, Marconi School of Instruction*

*(Copyright, 1917, by Wireless Press, Inc.)*

---

EDITOR'S NOTE.—This is the fifth installment of a condensed course in wireless telegraphy, especially prepared for training young men and women in the technical phases of radio in the shortest possible time. It is written particularly with the view of instructing prospective radio operators whose spirit of patriotism has inspired a desire to join signal branches of the United States reserve forces or the staff of a commercial wireless telegraph company, but who live at points far from wireless telegraph schools. The lessons to be published serially in this magazine are in fact a condensed version of the textbook, "Practical Wireless Telegraphy," and those students who have the opportunity and desire to go more fully into the subject will find the author's textbook a complete exposition of the wireless art in its most up-to-date phases. Where time will permit, its use in conjunction with this course is recommended.

The outstanding feature of the lessons will be the absence of cumbersome detail. Being intended to assist men to qualify for commercial positions in the shortest possible time consistent with a perfect understanding of the duties of operators, the course will contain only the essentials required to obtain a Government commercial first grade license certificate and knowledge of the practical operation of wireless telegraph apparatus.

To aid in an easy grasp of the lessons as they appear, numerous diagrams and drawings will illustrate the text, and, in so far as possible, the material pertaining to a particular diagram or illustration will be placed on the same page.

Because they will only contain the essential instructions for working modern wireless telegraph equipment, the lessons will be presented in such a way that the field telegraphist can use them in action as well as the student at home.

Beginning with the elements of electricity and magnetism, the course will continue through the construction and functioning of dynamos and motors, high voltage transformers into wireless telegraph equipment proper. Complete instruction will be given in the tuning of radio sets, adjustment of transmitting and receiving apparatus and elementary practical measurements.

This series began in the May, 1917, issue of THE WIRELESS AGE. Beginners should secure back copies, as the subject matter presented therein will aid them to grasp the explanations more readily. If possible, the series should be followed consecutively. The next issue will take up the fundamental principles of the dynamo and the motor.

## THE MAGNETIC EFFECTS OF THE ELECTRICAL CURRENT

### Electromagnetic Induction

#### ELECTROMAGNETIC PHENOMENA

Since the study of the magnetic effects of the electrical current constitutes an important phase of a student's elementary education, we shall review the more important phenomena of electromagnetism.

(1) As stated in a previous article, a compass needle, if suspended freely, will set itself in a certain definite direction; it will lie parallel with the earth's magnetic field, which is to say, the earth's magnetism exerts a force upon the needle and will hold it in this position.

(2) When the needle is in the position above mentioned, and a current-carrying conductor is placed either underneath or above, the needle will be deflected to the right or to the left, depending upon the direction of the flow of current or whether the wire is above or below the compass needle.

(3) If, for example, the needle is deflected to the right and the current in the conductor is afterward reversed, the needle will change its position and turn to the left.

(4) Or, if the wire is placed above the needle and the latter is deflected to the right and the wire is then placed below the needle, it will turn or be deflected to the left.

(5) The foregoing experiment demonstrates conclusively that the flow of electricity is always accompanied by a magnetic field, because, as previously shown, only magnetism will affect or turn a compass needle. The direction of the magnetic field is evidently at right angles to the wire for, if a strong current is passed through the wire, the needle will take up a position practically at a right angle to the conductor.

(6) The stronger the current the greater will be the deflection of the needle; also the further away from the wire the compass needle is placed the less will be the deflection. (Note Figure 19 following:)

(7) From the foregoing experiments we deduce that the magnetic field accompanying a current-carrying conductor has a distinct direction, which depends upon the direction of the flow of current (explained in detail further on). (Note Figures 20 and 21.)

(8) The strength of the magnetic field may be increased by coiling the wire into the form of a **helix**.

(9) It may be further increased from 200 to 2,000 times by inserting an **iron core** in the coil.

(10) Such a coil is termed a **solenoid** and its polarity will depend upon the direction of the flow of current. This coil is also known as an **electromagnet**.

(11) The magnetic force of the coil **depends upon the strength of the current and the number of turns in the coil**. A coil of 5 turns through which a current of 20 amperes flows will have the same magnetic effect as a coil of 20 turns with 5 amperes flowing.

(12) The product of the number of turns times the amperes is called the **ampere-turns**. The density of the magnetic field increases with the ampere-turns, but there is a limit to the number (of lines of force) which may be stored up in a solenoid with an iron core. This limit is called the **point of saturation**. An increase of current in the coil up to a certain point will increase the strength of the magnetism, but beyond this point an increase of current will have less and less effect until finally the core is completely saturated with flux.

(13) If a direct current of unvarying strength flows through a solenoid, the lines of force will stand still when the flow of current is fully established.

(14) If the rate of flow of current is increased or decreased, the lines of force will increase or diminish accordingly, or stated in another way, when the current rises, the lines of force move away from the wire, but when the current falls, the lines of force collapse back upon the wire.

## **ELECTROMAGNETIC INDUCTION**

(1) If a bar magnet be suddenly plunged into a coil of wire which is connected in series with a current-measuring or indicating instrument, such as the **galvanometer**, the needle of this meter will give a momentary or brief deflection. This experiment indicates the flow of an electrical current through the coil because it requires a current to turn the pointer of a galvanometer. Evidently this current has been set into motion by the magnetic field thrust into the coil by the bar.

(2) If the magnet be suddenly withdrawn, the needle of the galvanometer will be deflected to the opposite direction. This experiment indicates that the current, during the withdrawal of the magnet, flows in the direction opposite to that mentioned in 1) because as previously mentioned, the direction in which the needle of a compass or a galvanometer will turn depends upon the direction of the current.

(3) To put it more plainly, when the bar magnet is plunged into the coil of wire and then withdrawn, an alternating current flows through the coil, i. e., a current first in one direction followed by a second current in the opposite direction. This current is said to be induced by **magnetic induction**. It is the cutting of the lines of force through the coil which causes the current to be induced therein.

(4) This experiment can be repeated by substituting a **current-carrying coil** for the bar magnet. The effects upon the galvanometer will now be much greater because a stronger magnetic field can be created by the **electromagnet**, than by the permanent or bar magnet.

(5) The same principle may be extended further. For instance, if a wire is moved across a line of force, an **electromotive force** will be created in the wire. The greater the density of the lines of force or the faster the movement of the wire, the greater will be the **electromotive force** induced in the wire; and if the wire forms a closed circuit, a current of electricity will flow. If, instead of a single wire, a number of wires properly connected in series, or in parallel, are employed, the inductive effects will be greatly increased and a much higher voltage or a much larger current will be induced in the coil.

(6) Scientists have determined that the cutting of 100,000,000 lines of force per second by a wire will create an **electromotive force of one volt**. The cutting of two hundred million lines of force per second will generate an electromotive force of two volts and so on.

(7) Machines for generating electricity by rotating a wire through a magnetic field are called **dynamos or generators**.

(8) Dynamos may generate **direct or alternating current**, but whatever the nature of the current the basic principle previously explained is employed, i. e., copper conductors are revolved through a magnetic field and the cutting through this field generates an **E. M. F.**

(9) Dynamos are driven by some source of mechanical power such as a steam engine, gas engine or water wheel. Dynamos driven by electric motors are called **motor generators**.

(10) If an external source of electricity is connected to a direct current dynamo, it will revolve as an electrical motor, the electrical current being converted into mechanical energy. All direct current dynamos will act as motors and all direct current motors if driven by mechanical power will generate a current of electricity.

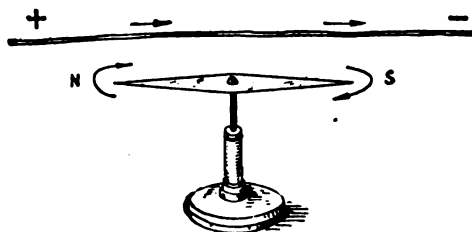

Figure 19

### OBJECT OF THE DIAGRAM

- (1) To show how a compass needle is deflected by the magnetic field of an electric current.
- (2) To prove that a magnetic field accompanies the flow of an electric current.

### PRINCIPLE

The flow of electric current through a conductor is accompanied by a magnetic field at right angles.

### DESCRIPTION OF THE APPARATUS

An ordinary compass needle is placed on a pivot and allowed to come to rest. A current-carrying conductor is placed parallel to the needle and above it.

### OPERATION

If a direct current of electricity flows through the wire, the needle will turn at right angles in the direction shown by the arrows.

If the current is turned off, the needle will return to its original position.

If the current in a horizontal conductor flows towards the north and the compass needle is placed under the wire, the north pole of the needle will be deflected towards the west.

If the current in a conductor is reversed, the needle will be deflected in the opposite way.

### SPECIAL REMARKS

(1) From this experiment we deduce that magnetic lines of force exist in concentric circles around a conductor carrying electrical current.

(2) By enlargement of the principle shown in Figure 19, using a coil of wire of several turns, an increased effect upon the needle is produced. (See Figure 28.) The apparatus can then be employed to measure the intensity of currents. Such a device would be called a **galvanometer**.

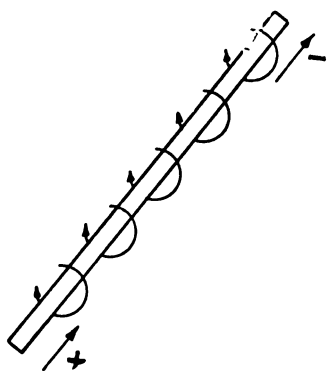
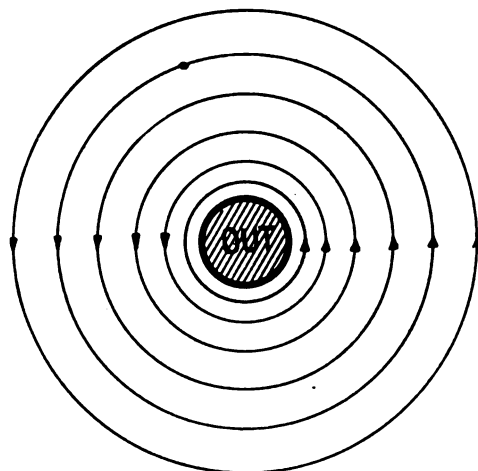
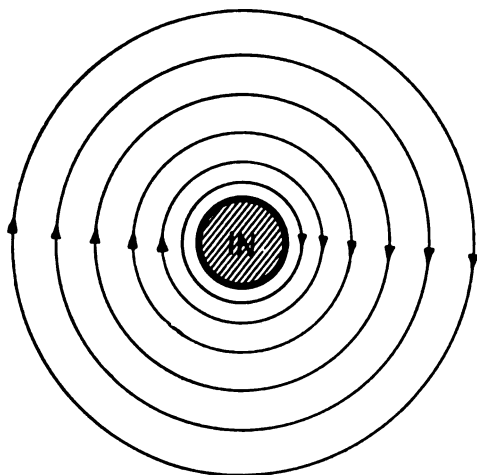

Figure 20

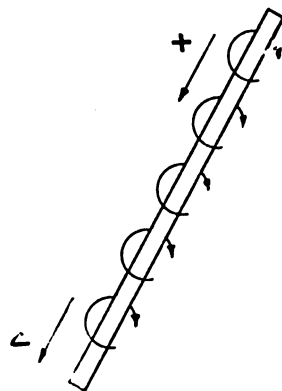

Figure 21

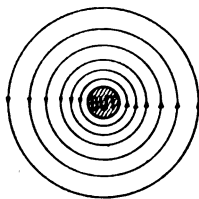
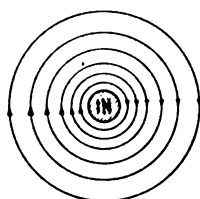

Figure 22

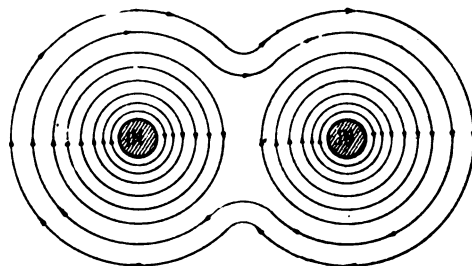

Figure 23

**OBJECT OF THE DIAGRAMS**

(1) Figure 20. To show the direction of the magnetic lines of force around a current-carrying conductor, with the current flowing in a definite direction.

(2) Figure 21. To show the direction of the magnetic lines of force when the current flows in the direction opposite to that indicated in Figure 20.

(3) **Figure 22.** To show the lines of force about two parallel conductors carrying current in opposite directions.

(4) **Figure 23.** To show the direction of the lines of force about two conductors carrying current in the same direction.

## PRINCIPLE

The direction of the magnetic field encircling a wire during the flow of electric current will depend upon the direction of the current, and if the current flows away from the reader as shown in Figure 20, then the lines of force will encircle the wire in a clockwise direction.

If the current is reversed, as in Figure 21, the lines of force will reverse, that is, their general direction will be counter clockwise.

The magnetic fields of two wires carrying current in opposite directions will repel each other, but the fields of two wires carrying current in the same direction will attract each other (as shown in Figures 22 and 23 respectively).

## SPECIAL REMARKS

(1) The magnetic fields of mutually related coils will have the same effect upon each other as the fields issuing from two parallel wires or the fields issuing from two bar magnets, i. e., for instance, if two coils of wire are suspended end on and current circulates in the same direction in both, then there will be attraction between the coils, but if the current circulates in the opposite direction in each there will be repulsion between the coils. The effects, of course, will be considerably magnified by placing an iron core within the coil.

*QUES.—What are some of the applications of electromagnetism?*

*Ans.—*The magnetic field resulting from an electromagnet or number of electromagnets is employed to operate the armature of the telegraph sounder, the diaphragm of the telephone receiver and will cause the armature of an electric motor to revolve. It is also employed to transform electric currents from low voltage to high voltage. It is used in numerous other ways as will become apparent further on.



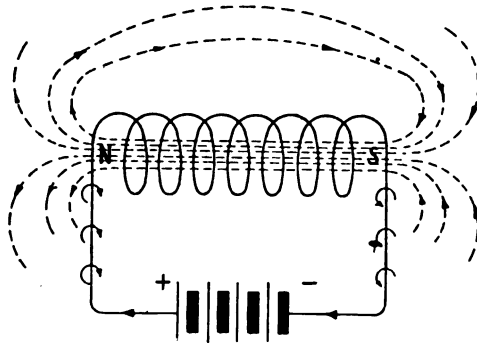

Figure 24.

### OBJECT OF THE DIAGRAM

To show the direction of the magnetic field around a coil of wire or solenoid.

### PRINCIPLE

If a number of turns of wire are wound in the form of a spiral as in Figure 24, the magnetic effect is greatly increased, the lines of force generated by each turn of wire uniting with those set up by adjacent turns.

Such a coil will have poles just as a bar magnet, and if current flows in the direction shown (from the positive to the negative pole of the battery), the lines of force around the connecting leads will have the general direction of the encircling arrows. Inside the spiral there will be a general movement of flux from the south to the north pole and on the outside from the north to the south pole.

If the left hand terminal of the coil were connected to the negative pole of the battery and the right hand end to the positive pole of the battery, i. e., the connections reversed, the polarity of the coil would be reversed, being just opposite to that shown.

### DESCRIPTION OF THE APPARATUS

A simple coil of wire is connected to four primary cells connected in series.

### SPECIAL REMARKS

(1) If direct current of unvarying strength flows through the solenoid, the lines of force remain stationary when the flow of current is fully established.

(2) If the rate of flow of current is increased or decreased, the lines of force increase or decrease accordingly.

(3) The strength of the magnet field is proportional to the strength of the electric current passing through it and the number of turns of wire.

(4) The magnetic flux of a solenoid may be increased many times by inserting an iron core or bar of soft iron within the coils.

(5) The polarity of a magnet coil is determined by the following general rule: If in looking at the end of the coil the current flows around its turn clockwise, the end nearest to the observer will be a south pole, and by the same argument if the current flows in the opposite direction, the same end will be a north pole.

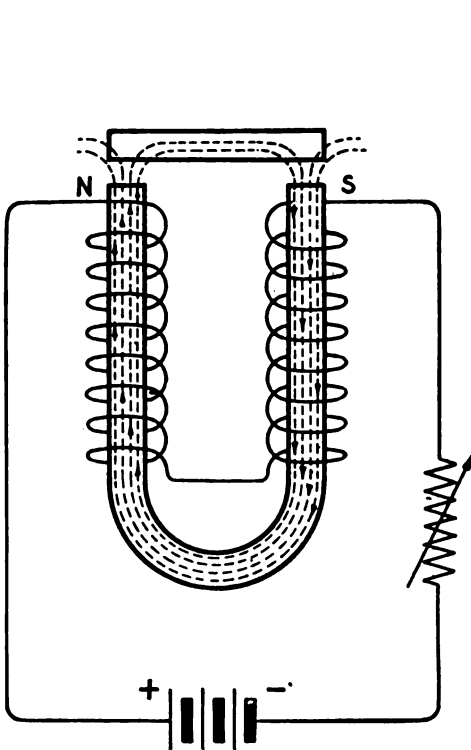

Figure 25

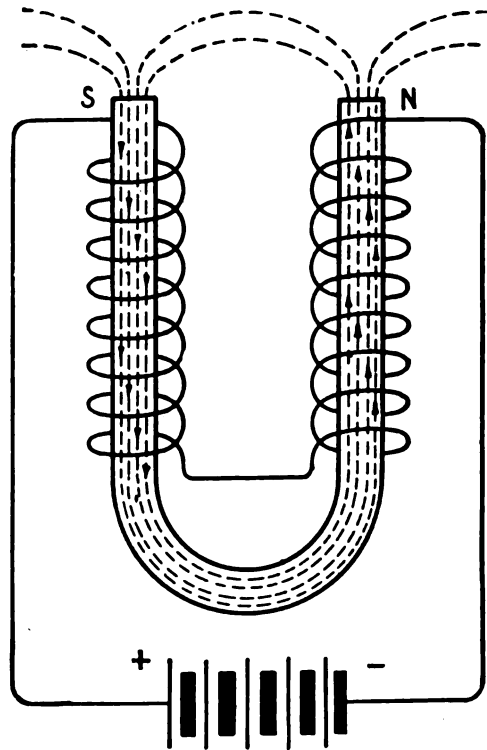

Figure 26

### OBJECT OF THE SKETCHES

- (1) To show the direction of the magnetic field about a horseshoe electromagnet.
- (2) To indicate how the magnetic field reverses with reversal of the current.

### PRINCIPLE

Very powerful magnetic fields can be created by an electrical current circulating through a coil of wire wound upon an iron bar, and if the bar is bent in the form of a horseshoe, the north and south poles both can be made to concentrate on a given object and an increased effect thus obtained.

### DESCRIPTION OF THE APPARATUS

In Figure 25 a battery of primary cells is connected to the terminals of a horseshoe magnet with a small resistance coil connected in series. In Figure 26 the current flows in the reverse direction.

### SPECIAL REMARKS

- (1) If the variable resistance in Figure 25 is carefully regulated, the strength of the magnetic field issuing from poles N and S will increase or decrease with the amount of current flowing.
- (2) If the current is reversed as in Figure 26, the polarity of the magnetic field will reverse accordingly.
- (3) If very high values of resistance are added at Figure 25, the current may be reduced to a degree that the magnet will barely attract the armature.
- (4) If a horseshoe of hard tempered steel be inserted in the windings of Figure 25 or Figure 26 in place of the soft iron core and allowed to remain for a few seconds, upon removal it will be found to be permanently magnetized.
- (5) An electromagnet may be employed for mechanical work such as lifting masses of iron or for exciting the magnets of a dynamo or motor, and owing to the fact that the strength of the magnetic field can be carefully regulated and moreover a much more powerful field obtained in this manner, the electromagnet is seen to have a distinct advantage over the bar magnet, the strength of the field of which is limited.

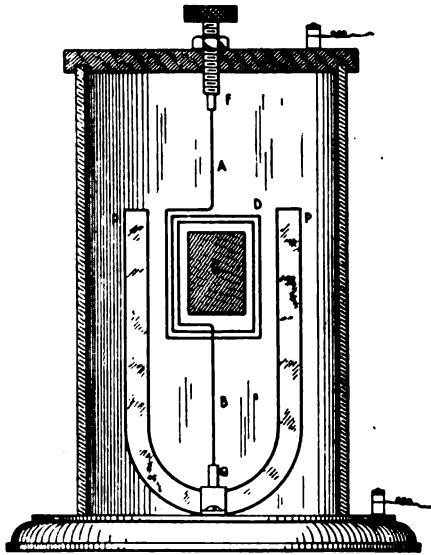

Figure 27

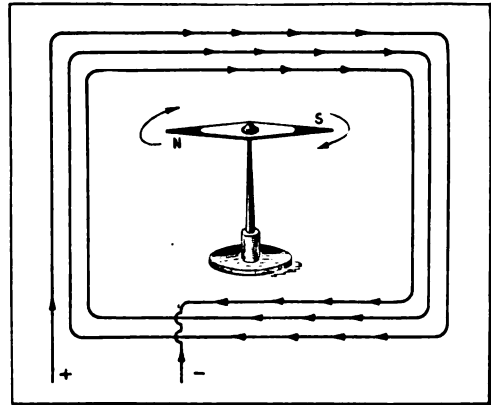

Figure 28

**OBJECT OF THE DIAGRAM**

- (1) Figure 27. To outline the construction of a magnetic galvanometer, i. e., an instrument to indicate the passage of an electric current.
- (2) Figure 28. To show the construction of the simplest type of galvanometer.

**PRINCIPLE**

If a current-carrying coil is placed in a magnetic field, it will tend to turn until it encloses the maximum number of lines of force.

**DESCRIPTION OF THE APPARATUS**

A rectangular coil of several turns of copper wire, D (Figure 27) is suspended between the poles of a horseshoe magnet P, P. Between the poles is the stationary iron core C which reduces the reluctance of the air gap and thereby intensifies the strength of the magnetic field from pole to pole. The coil is suspended from the screw F and the current to be measured enters at the wire A and leaves by the wire B.

In Figure 28 a simple compass needle is placed inside a rectangular coil of wire.

**OPERATION**

If the binding posts connected to the wires A and B are in turn connected to a feeble source of E. M. F., the coil D will turn at right angles to the poles of the magnet, but will be resisted by the torsion of the suspended wires. If a pointer and suitable scale are attached to this coil, comparative readings of the strength of the current may be made.

**SPECIAL REMARKS**

- (1) Galvanometers are found to be very delicate and will readily measure a current of .000001 of an ampere.
- (2) If the coil, D, had very high resistance, the scale attached to the instrument might be calibrated in volts, but if it is of low resistance, it may be connected in series with the circuit and employed to measure the current strength or amperes. Used in the first way it would be called a **voltmeter** and in the second way an **ammeter**.

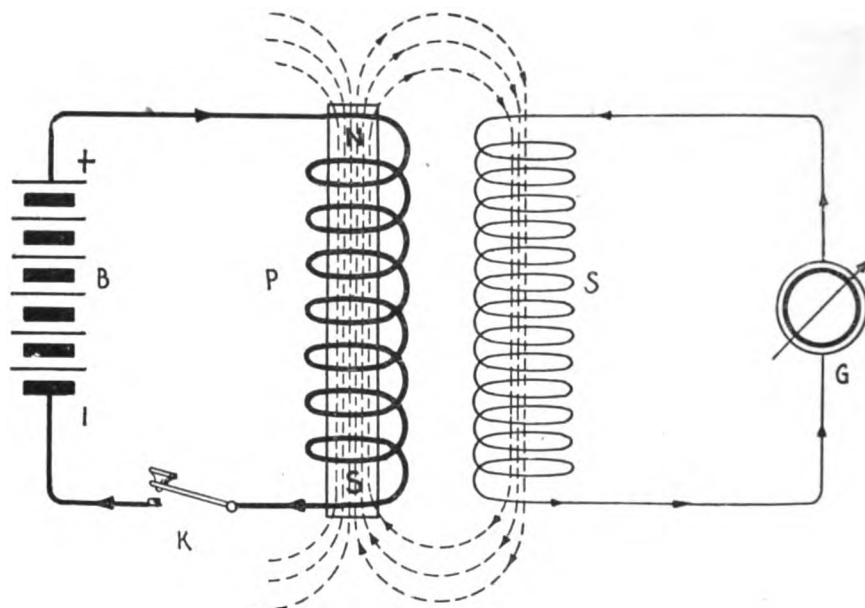

Figure 29

### OBJECT OF THE DIAGRAM

- (1) To show the principle of electromagnetic induction.
- (2) How direct current may be raised to high voltage alternating current.
- (3) To indicate the fundamental principle of the transformer.

### PRINCIPLE

If a coil of wire is placed in a magnetic field of varying strength and in a defined position, a current will be induced in the coil, the intensity of which will depend upon the rate of change of flux.

If two coils of wire, one of which is connected to a source of direct current, E. M. F., and the other wound directly about it and the current is turned off and on in the first coil, a current of electricity will be induced in the second coil provided it forms a closed circuit.

### DESCRIPTION OF THE APPARATUS

In Figure 29 a coil of wire is wound over an iron core, and its terminals connected to the battery B. A key for opening and closing the circuit is denoted at K. Another winding, S, wound directly over P (but for clearness of illustration placed to the side of P) has its terminals connected to a galvanometer, G.

### OPERATION

If the key, K, is opened and closed, the needle of the galvanometer will give a deflection in one direction when the key is closed, and in the opposite direction when the key is opened.

### SPECIAL REMARKS

- (1) This experiment indicates that the magnetic field generated by winding P threading in and out of coil S induces a current in the winding, S.
- (2) It is important to note that current is induced in S only when the circuit of P is made or broken.
- (3) When current of constant strength flows through P, the magnetic lines of force are stationary, and consequently no current flows in winding S.

(4) When the lines of force about S rise and fall, there will be a movement of current through S.

(5) If winding S were placed at right angles to winding P there would be no induction in S.

(6) When the lines of force increase through S, the induced pressure is counter to that which originally flowed in winding P, but when the lines of force decrease through S, the induced current has the same direction as the original current in winding P.

(7) The lines of force in S are therefore in the opposite direction to those which set up the current in S.

(8) The field of force created around S re-acts upon winding P, tending to build up a current in opposition to that already flowing in P, that is to say, a change in the strength of the primary current, P, induces a secondary current in S which in turn, induces a back pressure in P. The induction due to the two circuits upon each other in this way is called their **mutual induction** which is a measurable quantity.

(9) The field produced by each turn in winding P not only creates an E. M. F. in winding S, but also cuts neighboring turns in its own coil, thereby inducing in them E. M. F.'s that tend to oppose the E. M. F. of the original current. On the other hand when the current in winding P diminishes, the lines of force contract and thereby induce E. M. F. in adjacent turns that tend to set up the current in the same direction as the original current.

(10) This inductive action of the coil upon a conductor is called **self induction**.

(11) **Self induction** may be defined as the property of a circuit that tends to prevent any change in the strength of the current passing through it.

(12) The effects of self-induction are only noticeable in circuits carrying direct current when the current is turned on and off, but in circuits carrying alternating current they are ever present.

(13) All conductors have self-induction, the amount depending upon their size and shape. Coiled wires have greater self-induction than long straight wires. The self-induction of a coil is increased by inserting in it an iron core.

(14) The **coefficient of self-induction** or **inductance** is defined as the property of a conductor by which energy may be stored up in magnetic form.

(15) If a coil has such dimensions that when one ampere flows through it per second, it is surrounded by one hundred million lines of force, and furthermore if this current is turned off, the back E. M. F. generated by the collapsing field is one volt, and the coil is said to have **self-inductance of one henry**.

(16) The unit, the henry, is too large for practical purposes, hence, the **microhenry**, the **millihenry** and the centimeter are in practical use.

$$1,000 \text{ centimeters} = 1 \text{ microhenry}$$

$$1 \text{ microhenry} = \frac{1}{1,000,000} \text{ henry}$$

$$1 \text{ millihenry} = \frac{1}{1,000} \text{ henry.}$$

(17) If winding P has a few turns of comparatively coarse wire, such as No. 14 or No. 16 B. & S., wound over an iron core, and S has several thousand turns of fine wire, such as No. 36 B. & S., an electromotive force of several hundred thousand volts may be induced in S.

(18) If winding S has less turns than winding P the E. M. F. induced in S will be lower than that of winding P.

(19) To properly distinguish the various circuits, the winding, P, is called the **primary coil**; and the winding S the **secondary coil**. The current in P is termed the **primary current** and in S the **secondary current**.

(20) One type of apparatus which is constructed in accordance with this principle is known as the **induction coil**, which has a primary and secondary winding, a source of direct current E. M. F. and a magnetic interruptor which makes and breaks the current flowing in the primary circuit. This causes a magnetic field to rise and fall about the winding S and induces therein a current of considerable pressure. An E. M. F. of 100,000 volts is thus readily obtained.

*(To Be Continued.)*

# How to Become an Aviator

The Second Article of a Series for Wireless Men in the Service of the United States Government Giving the Elements of Airplane Design, Power, Equipment and Military Tactics

By HENRY WOODHOUSE

Author of "Text Book of Naval Aeronautics"

*Photos. Underwood & Underwood*

## THE AWAKENING OF THE UNITED STATES

**T**HE people of the United States are now beginning to realize the importance of aeronautics, and the steps recently taken to develop our air service are so far-reaching in their scope and importance that we cannot for the moment realize the magnitude of the undertaking or the stimulus to commercial use of the airplane which is bound to follow.

The entire country is co-operating with the Aircraft Production Board and the Army and Navy in developing the air service. Corporations employing hundreds of skilled mechanics for the construction of low and high speed scouting airplanes, scouting seaplanes and special types for special service have been formed. About 30,000 applications have been received from young men wishing to join the air service. Most of these are college men, several hundred of whom are now learning to fly at their own expense in order to be ready to meet an emergency. Six units of the aerial coast patrol are under organization. The members of these organizations are training at their own expense and have purchased seaplanes, the use of which they have offered to the Government. The same is true in the naval militia. Patriotic persons who became interested in aerial preparedness through the efforts of the Aero Club of America have contributed airplanes and funds with which to start aviation sections in the naval militia of a number of states. It is now expected that this country, which has produced such men as Langley, the Wrights, Curtiss and other pioneers, will take giant steps in the development of our much needed air service.

## BRIEF OUTLINE OF AVIATION INSTRUCTION FOR SERVICE ON THE WAR FRONTS

The training of aviators is fast becoming an exact science. When, early in the war, aviators were needed in large numbers and were employed mainly for scouting, aerial coast patrol and spotting of shots, even the European navies were willing to suspend practically all the qualifications apart from flying. Later, as the duties of aviators increased rapidly, and the shortage of trained men made it necessary to "break in" civilians, their training had to be carried out on scientific lines.

Whenever the personnel available is untrained in naval matters, it is necessary to teach the students the rudiments of naval discipline and naval regulations as well as aeronautics. Great Britain has been obliged to do so to obtain military aviators, and the British system, which has been adopted by her Allies and Canada, is undoubtedly the best system to follow to-day.

In connection with the training of a naval aviator, the experience of the British Air Organization of which General W. S. Brancker, R. A., is director, will be of interest, particularly to such civilians who heretofore have had no idea of the detailed work required to train a modern aviator. He says in part:

"The civilian who wishes to join the Army or Navy Air Service in Great Britain or Canada at present has first to join the service as a cadet and go through a course in the cadets' school, at which military subjects as well as aeronautic subjects are taught. He gets a grounding drill and discipline, care of arms, interior economy, military law, and the use of the machine gun; this course lasts about two months. From this the cadet is sent to a Flying Corps Training School, School of Military Aeronautics, where he begins his technical training on the ground. In Canada, and in some cases in England, he gets the first mentioned military training at the same time as he gets the rudimentary training in flying or operation of dirigibles and observation balloons. He goes through a course in the care of engines and rigging, is given some ideas of the theory of flight, and is taught wireless signalling and receiving.

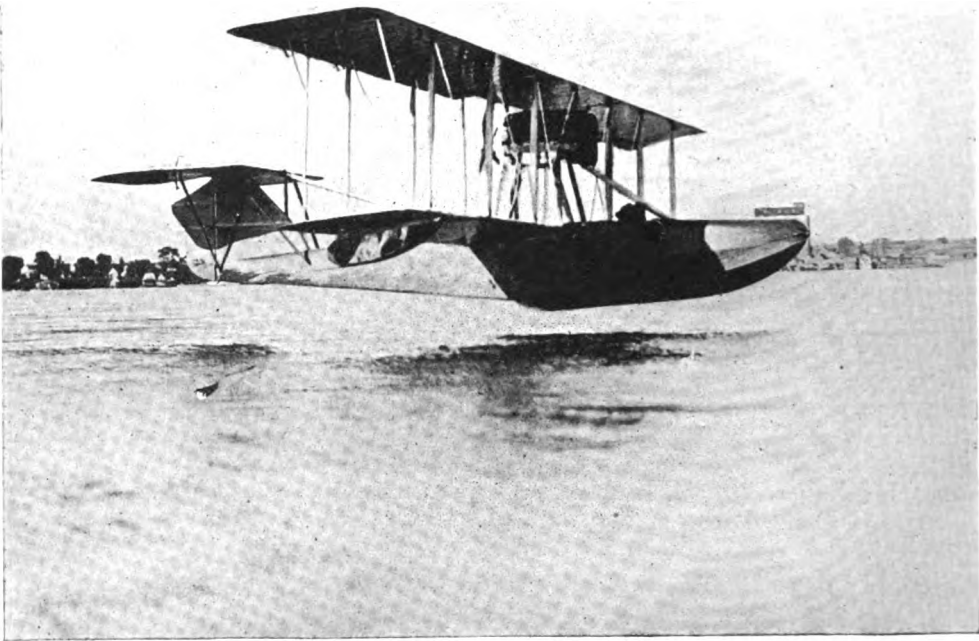

*The naval type of airplane of recent design starting on a long test flight*

"He gets instruction in the care of machine guns, in the use of the camera, in map reading, in the observation of artillery fire with models, and in his spare moments he gets a certain amount of drill. This course lasts another two months, and if he gets through this successfully, he is given a commission on the General List. He then joins a preliminary training squadron as a pupil and starts his instruction usually on the slow Maurice Farman airplane, his training both in military and technical subjects going on concurrently. After reaching a certain standard of efficiency and having completed a certain number of hours in the air, he is sent on to an advanced training squadron or service squadron, where he learns to fly Service types of machines for military purposes, and eventually qualifies for his wings. He is then gazetted as a flying officer of the Royal Flying Corps and posted to a service squadron. If he shows exceptional promise as a pilot after his qualification, he is sent to the Central



Flying School, where he is given extra higher instruction on flying scouts. During the period of advanced training, he goes through a course of aerial gunnery away from his squadron. The total time in the air usually required to reach the qualification stage is about thirty hours' solo in present circumstances, but, of course, the length of time that it takes to reach this standard depends entirely on the weather and the number of airplanes available. During the winter it works out to about four months, but in the summer it is considerably shorter."

All this may seem a long process, but it is doubtless the best and will prove the shortest in the end in producing well-trained aviators.

### THE NAVAL AIR SERVICE

The naval air service of any Government should be divided into three distinct, separate branches, whose functions are quite different and which may be designated as:

- (1) The Offensive Air Service, which consists of squadrons of seaplanes stationed on seaplane carriers and aeronautic bases, which are used for air raids, independent of the fleet; also dirigibles which operate from bases;
- (2) The Auxiliary Air Service of the fleet, including seaplanes and kite balloons which operate with the fleet, using ships as bases;
- (3) The Aerial Coast Patrol, which operates from naval stations and naval bases. This patrol is accompanied by aircraft mother ships which contain airplane repair machinery, repair parts, extra seaplanes, and which are also employed to furnish fuel and supplies to airplanes operating on coasts far from naval bases or large cities.

There are numerous services which aircraft render as auxiliaries to the Navy, some of which are here enumerated. These apply particularly to dirigibles, airplanes and kite balloons. Some of the services rendered in the present European conflict follow:

- (1) Attacked ships and submarines at sea with bombs, torpedoes and guns. (Seaplanes and dirigibles used.)
- (2) Bombed the enemy's bases and stations. (Land airplanes, seaplanes and dirigibles used.)
- (3) Attacked the enemy's aircraft in the air. (Airplanes and seaplanes used.)
- (4) Served as the eyes and scouts of fleets at sea. (Dirigibles, seaplanes and kite balloons used.)
- (5) Protected ships at sea and in ports against attacks from hostile submarines and battleships. (Seaplanes and dirigibles used.)
- (6) Defended and protected naval bases and stations from naval and aerial attacks. (Land airplanes, seaplanes and dirigibles used.)
- (7) Convoyed troop ships and merchant ships on coastwise trips. (Dirigibles and seaplanes used.)
- (8) Patrolled the coasts, holding up and inspecting doubtful ships, and convoying them to examining stations and searching coasts for submarine bases. (Dirigibles used.)
- (9) Prevented hostile aircraft from locating the position and finding the composition and disposition of the fleet, getting the range of ships, naval bases, stations, magazines, etc. (Land airplanes and seaplanes used.)

- (10) Located and assisted trawlers, destroyers and gunners in capturing or destroying hostile submarines. (Seaplanes, dirigibles and kite balloons used.)
- (11) Co-operated with submarines, guiding them in attacks on ships. (Dirigibles and seaplanes used.)
- (12) Located mine fields and assisted trawlers in destroying mines. (Dirigibles, seaplanes and kite balloons used.)
- (13) Served as the "eyes in planting mines," minimizing the time required for mine planting. (Dirigibles, seaplanes and kite balloons used.)
- (14) Served as "spotters" in locating the position of the hostile ships and directing gunfire. (Dirigibles, seaplanes and kite balloons used.)
- (15) Served as carriers of important messages between ships which could not be entrusted to wireless owing to the possibility of the enemy wireless picking up the messages, such as communicating to incoming ships information regarding the location of mines, submarines and courses, to avoid mistakes and confusion. (Seaplanes and dirigibles used.)
- (16) Carried out operations over land and sea intended to divert the attention of and mislead the enemy while strategical operations were being carried out by the fleet of squadrons. (Land airplanes, seaplanes and dirigibles used.)
- (17) Have made it possible for commanders to get films of theaters of operation, photographs of the location, composition and disposition of hostile naval forces, and photographic records of condition and of the movements and operations of their own as well as of the hostile naval forces.

The civilian will now realize the immense importance of a properly equipped fleet of seaplanes to assist the operations of naval vessels. It should be self-evident that seaplanes can reconnoitre any distance into bays, rivers and behind protected fortresses over which coast patrols or naval vessels have positively no control.

One of the most important uses to which aircraft have been put since the beginning of the European war has been the locating of submerged submarines and mines. In any discussion of what can be done against the submarine, it must be first stated whether we mean the protection of ships at sea or on coast-wise trips. Nothing could protect the sea lanes so well as large dirigibles, as capable as the Zeppelins are, of cruising for 3,000 miles without stopping.

Unfortunately, no country outside of Germany has large dirigibles for use for this purpose. If we had such airships to patrol the ship lanes daily, no submarine would be safe, no matter where, on sea, if large dirigibles were thus patrolling because large dirigibles carry guns of sufficient caliber to sink a submarine with a single shot. Likewise, observers from a dirigible, as in the case of an observer from an airplane, can see a submarine miles away when a man from a ship cannot detect it. The airship travels many times faster than undersea craft, and the submarine could not easily detect the approach of an airship.

The submarine menace could be checked by present-day aircraft—seaplanes, small dirigibles and kite balloons. We are now building large seaplanes which are capable of carrying fuel for continuous flights over a period of fifteen hours and capable of gaining a speed of more than seventy-five miles an hour. A number of such other seaplanes have already been supplied to England and have done very effective work.

The first aerial submarine hunt in American history took place in March.

1917. Following the report of the keeper of the lighthouse at Quogue, Long Island, that there was evidence that two U-boats were "lying in toward the Sound," a fleet of civilian aviators, who later became a part of the Aerial Reserve Squad at Governor's Island, rose from the Mineola, Long Island, Aviation Field in a forty-mile an hour gale and rain and a bad fog. They were detailed to patrol the Long Island coast from Oyster Bay to Montauk Point, while Governor's Island aviators watched over the shore from the island to Oyster Bay. Two of the aviators, Acosta and Briggs, were out for three days. They did not return to their headquarters, merely landing when they were forced to do so.

Considering that there was a gale blowing, the weather was foggy, and it

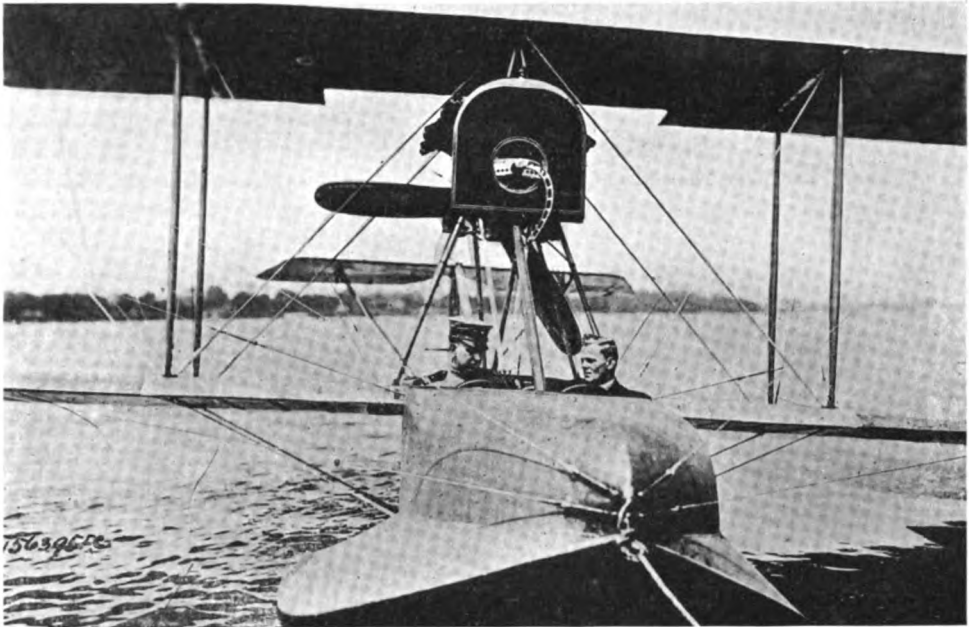

*Lieut. C. C. Witmer, U. S. N. R. F., and David McCullough examining one of the latest model flying boats made for the navy*

was their first experience of the kind, it was quite a difficult task, but it was well done by all. Captain Briggs and Lieutenant Wehrle flew a distance of 124 miles in a driving rain-storm. The machines went out between five and eleven miles at sea, the inlets and bays were searched, vessels plotted, compass directions and time when located were given, but the submarines were not found. None of the machines were equipped with wireless telegraphy, neither was there a receiving station in operation. But there was a cruiser within range that could have been summoned if the submarine had been found.

It was later found out by the Navy Department that the vessels sighted were new coast patrol boats which were returning from a trial trip and which passed Montauk Point at six o'clock on the evening of March 26th, heading into Long Island Sound. However, the Navy Department was gratified in positively determining that there were no U-boats in the vicinity of these shores.

The flight of the seaplanes was fully justified in view of the recent exploits of the German submarine, U-53, which suddenly appeared one day at Newport Harbor and which during the return trip sank a half dozen ships in succession.

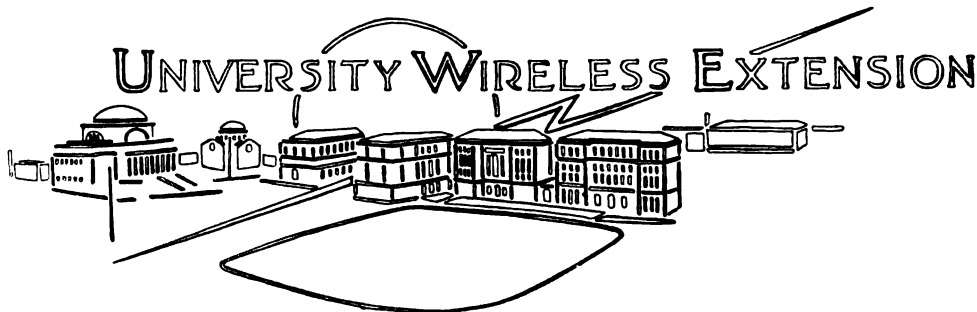

# Radio Telephony

By ALFRED N. GOLDSMITH, PH.D.

*Director of the Radio Telegraphic and Telephonic Laboratory of the College of the City of New York*

## ARTICLE IX

*(Copyright, 1917, by Wireless Press, Inc.)*

CONTINUING our consideration of the generation of radio frequency currents by alternators, we pass to an interesting and important form of alternator largely developed by E. F. W. Alexanderson of the General Electric Company. This machine has generally been distinguished by the direct generation of the very high frequency desired, and its construction has given rise to numerous difficult problems. The experimental work in connection with these alternators was originally undertaken by the General Electric Company at the suggestion of Mr. R. A. Fessenden, then associated with the National Electric

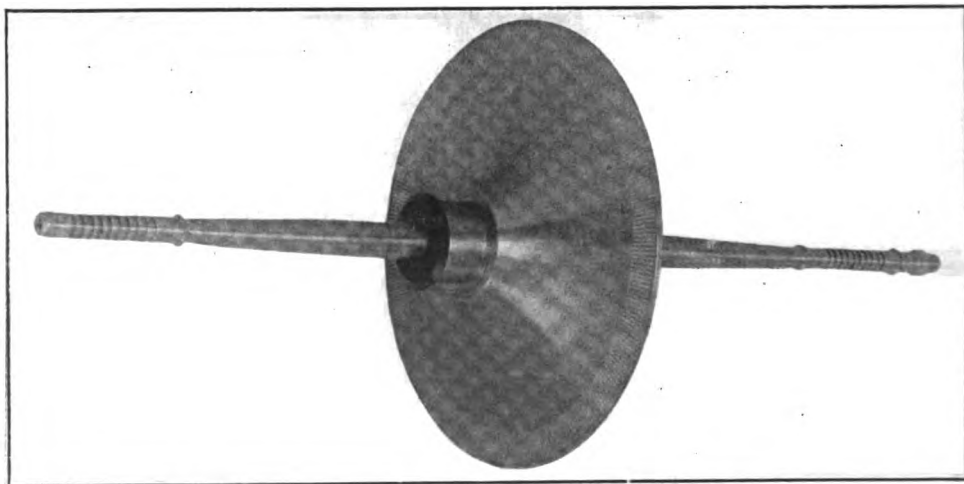

Figure 104—Rotor and shaft of 100,000 cycle Alexanderson alternator

Signaling Company; and much of the earlier development was done in conjunction with that company.

In 1908, Mr. Alexanderson described a 100,000 cycle alternator of this type, built to deliver approximately 2 kilowatts. A later description given by him follows (with brief additions by the author):

“The alternator is of the inductor type (that is, with stationary armature and field, but with a rotating element which causes a pulsating field to cut the armature conductors), and is provided with a novel arrangement of the magnetic circuit, allowing the construction of a rotor which can be operated at exceedingly high speeds. In the final form of the alternator, shown in Figure 103, the rotor, *C*, consists of a steel disc with a thin rim and much thicker hub, shaped for maximum strength (that is, with a width that progressively diminishes from the shaft out, so that the strain on the material outward because of centrifugal force is the same from the shaft to outer rim). The field excitation is provided by two coils, *A*, located concentric with the disc and creating a magnetic field the lines of force, *F*, of which pass through the cast iron frame, *D*, the laminated armature support, *B* and *E*, with its teeth, and the disc, *C*. This flux also passes through the narrow air gaps on each side of the disc rotor, and is indicated in the figure by the dashed line with arrows. *B* represents the two armatures which are secured in the frame by means of a thread, in order to allow an adjustment of the air-gap, the laminations carrying the armature conductors being located at *E*. Instead of poles or teeth, the disc, *C*, is provided with slots which are milled through the thin rim so as to leave spokes of steel between the slots. The slots are filled with a non-magnetic material (phosphor bronze) which is riveted in place solidly, in order to stand the centrifugal force and to provide a smooth surface on the disc so as to reduce air friction. The centrifugal force on each slot filler is no less than eighty pounds at the high speed at which the machine is run.

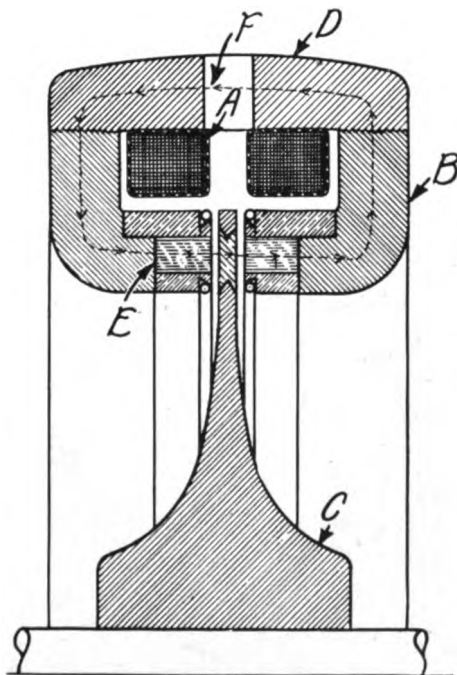

Figure 103 —General Electric Company—  
Alexanderson alternator

“The standard 100,000 cycle rotor of chrome nickel steel with 300 slots is shown in Figure 104.” The shaft bearings are clearly visible at the ends, and it will be seen that they are arranged so as to make forced oiling practicable. The shaft in this type of alternator is long and flexible, thus permitting the rotor to center itself and rotate about its center of mass somewhat as is done in the case of centrifugal dryers for laundries. In this way, excessive shaft strains are avoided. There are certain speeds (1,700 and 9,000 R. P. M.) for which the shaft and rotor pass through their own resonant periods of mechanical vibration, and at these speeds marked shaft vibration tends to occur.

A closer view of a portion of the

rotor, showing the slot fillers of non-magnetic material is given in Figure 105. Some idea of the care required in the construction of such a machine can be gained from the details of the rotor construction. Since the speed of rotation of the rotor is 20,000 revolutions per minute, or over 330 revolutions per second, the actual speed at the rim is nearly twelve miles per minute! (A whimsical calculation has been made which shows that the rotor, if released while spinning at full speed, would, if it maintained its speed thereafter, roll from America to Europe in a few hours!) Such a machine must, accordingly, be considered a masterpiece of engineering design.

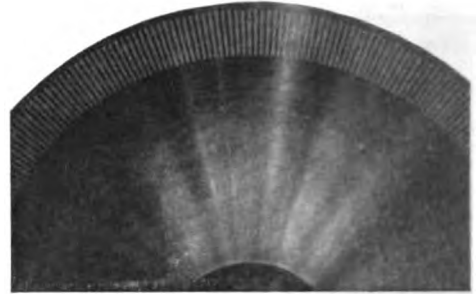

Figure 105—Portion of rotor of Alexanderson 100,000 cycle alternator, showing slots in disc

There are two methods of armature winding employed in the simpler forms of these machines. The first form, which is a simple to-and-fro winding (one turn per slot) is shown in Figure 106. In this form of armature there are 600 slots for a 100,000 cycle machine. A second form of winding for the armature has only 400 slots for the 100,000 cycle machine. It is shown in Figure 107, and really consists of two windings in parallel in each of which, by a sort of vernier action, a 300-slot rotor field produces 100,000 cycle current in the same phase in each of the armature windings.

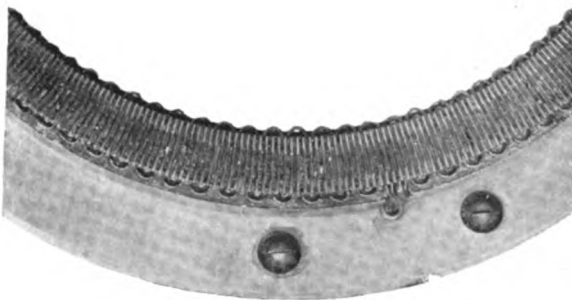

Figure 106—Portion of armature winding of 100,000 cycle Alexanderson alternator; 600 slot type

used at the Brant Rock station of the National Electric Signaling Company in 1906. This machine had a double inductor with inward projecting teeth on each half, and the stator lay between the two "saucer" shaped inductors. It will be seen that this machine was belt driven to get the proper ratio of motor to alternator speeds, and that

*It is possible, using an 800-slot armature winding of the last-mentioned type, to produce a 200,000 cycle current by direct generation. This is by far the highest frequency which has as yet been produced directly by an alternator.*

Through the courtesy of John L. Hogan, Jr., of the National Electric Signaling Company, we are enabled to show in Figure 108 a test of an early form of 80,000 cycle alternator built by the General Electric Company and

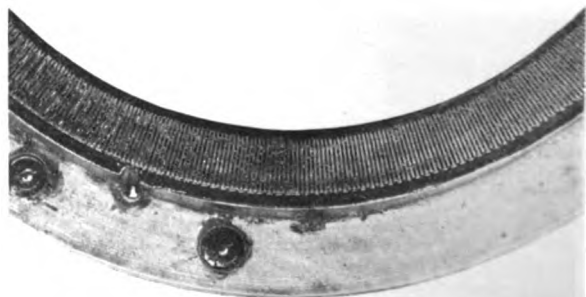

Figure 107—Portion of armature winding of 100,000 cycle Alexanderson alternator; 400 slot type

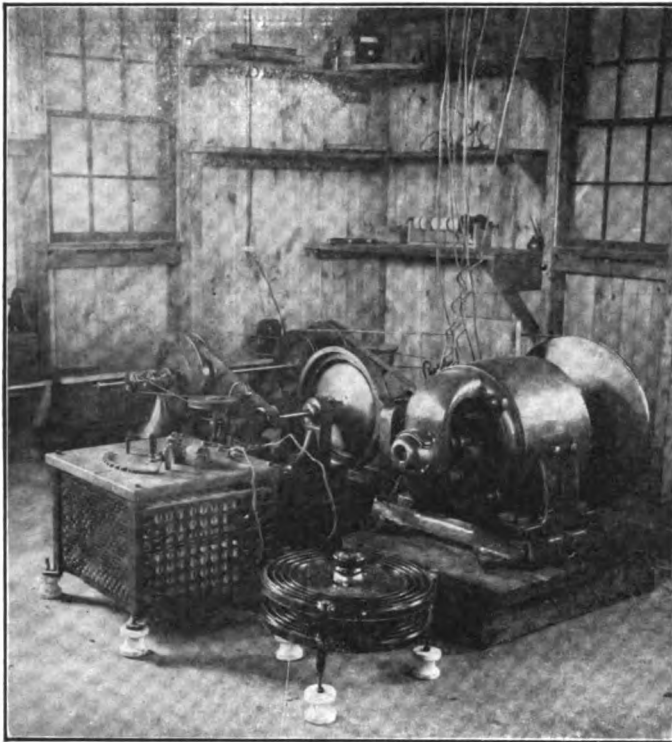

Figure 108—Early form of Alexanderson alternator under test at Brant Rock station of National Electric Signaling Company

the motor is much larger than the alternator. This is quite explicable when it is remembered that the windage loss in these machines at 20,000 R. P. M. is high, it having been claimed that the rotor is actually polished either by air friction or by the friction of floating dust particles. In any case, the air streaming out from the machine is appreciably warmed. This windage loss becomes unimportant in any but the smallest alternators of this type.

A somewhat similar machine built by the National Electric Signaling Company in 1907 and equipped with de Laval steam turbine

drive is shown in Figure 109. This has the advantage that, since the turbine is itself an extremely high speed machine, the gearing losses are eliminated by the direct drive. Sufficiently accurate speed regulation of a steam driven machine is secured in practice by maintaining the steam pressure and radio frequency load at constant values. The gearing shown in the figure is used to reduce the main shaft speed in the ratio of 1-to-10 for the operation of the turbine governor. It will be noted that the alternator in this figure has an adjustment to rotate each armature slightly relative to the frame so as to bring the generated currents into phase and also has an adjustment whereby, as stated previously, the armatures may be brought nearer to or further from the rotor for precise adjustment of the air

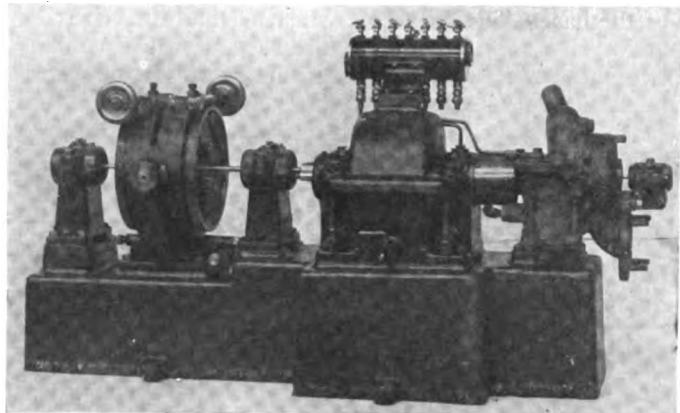

Figure 109—Early form of Alexanderson alternator coupled to de Laval turbine; under test by National Electric Signaling Company

gap. Such an adjustment is of importance since the output of the machine is largely dependent on the air gap, and a very small air gap (of 5 or 10 thousandths of an inch, or a tenth to a fifth of a millimeter) is of advantage. The usual gap is 0.015 inch (0.38 mm.) with a generated voltage of 150, although voltages as high as 300 can be obtained with a 0.004 inch gap.

This machine was in almost daily use at Brant Rock for several years, and ran for hours at a time without attention. The maximum output was something over 1 K. W. at 100,000 cycles.

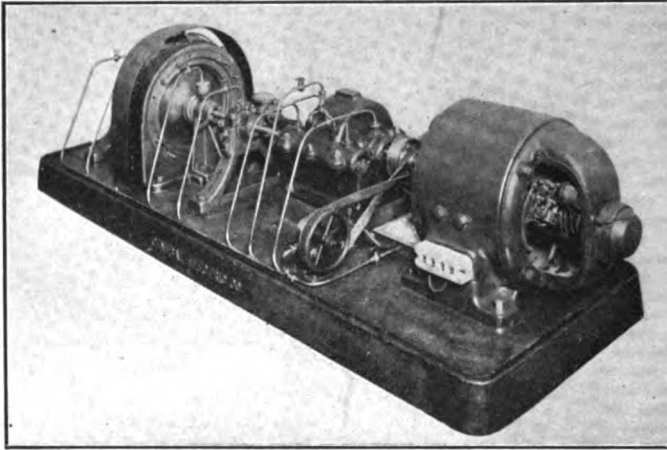

Figure 110—Intermediate type of Alexanderson alternator

A later form of a 2 K. W. Alexanderson alternator is shown in Figure 110. This set shows the elaborate forced-feed oiling system which has been adopted for the later machines. The auxiliary and main bearings to the right of the rotor are clearly visible.

The most recent form of 2 K. W. machine of this type is shown in Figure 111. The oiling system in this machine is provided with an interesting protective device. The oil which is returned to the reservoir at the right of the base plate (the tank having a sheet metal cover with handle) strikes a small pivoted shovel. Its weight depresses this shovel against a controlling spring tension. Should the flow of oil cease for any reason, the shovel flies up and automatically opens the driving motor circuits. In this way, any danger of unoiled bearings "freezing" is obviated. In this set, the alternator is driven by a 110 or 220-volt, direct current, shunt motor with commutating poles. The motor speed is 2,000 revolutions per minute and this is raised to the requisite 20,000 revolutions per minute by the 1-to-10 helical-cut gearing enclosed in the housing at the center of the base. The oil pump, which is chain driven from the motor shaft, is shown at the right hand corner of the base. To prevent any possibility of binding between the two thrust bearings, due to expansion of the shaft because of heating, the machine is provided with a system of equalizing levers to compensate for such shaft heating. These levers are shown in the left front of Figure 111 with the elastic controlling leaf between them. Any tendency which would cause a change in air gap is counteracted by the automatic action of the levers. If the air gap should tend to change at either side, the magnetic attraction at that side would cause an additional pressure and consequent heating on the thrust bearings at that end; and a consequent expansion of the shaft there would bring the rotating disc back to a central position.

The expansion of the shaft by temperature is thus taken advantage of to insure a correct alignment. The usual output of these alternators is from 10 amperes at 200 volts to 20 amperes and 100 volts, depending on the nature of the load and the mode of internal connection of the armature sections of the machine. The effective resistance of the armature is 1.2 ohms, the inductance being 8.6 microhenrys corresponding to 5.4 ohms at a frequency of 100,000 cycles, or wave length of 3,000 meters. The resonance condenser load would, therefore, be 0.29



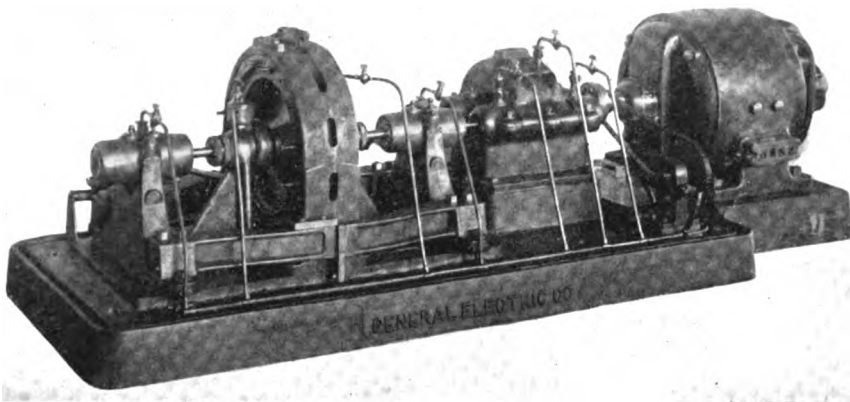

Figure 111—Recent type of 2 K. V. A., 100,000 cycle Alexanderson alternator

microfarad at the frequency mentioned, if no loading coil were used external to the machine.

Another recent type of Alexanderson radio frequency alternator is the so-called "gyro alternator." The designation is based on the similarity of bearings in the machine in question and those in a high speed gyroscopic compass. A heavy shaft is used, so that vibration at the "critical speeds" does not occur, these speeds being much higher than those at which the machine is actually run. The use of ball bearings in this machine has simplified the construction. No auxiliary bearings are needed in this machine.

Figure 112 shows one of these machines with belted driving motor and all auxiliaries needed for a complete radiophone equipment mounted on a base. The particular equipment shown has been used for the transmission of speech 160

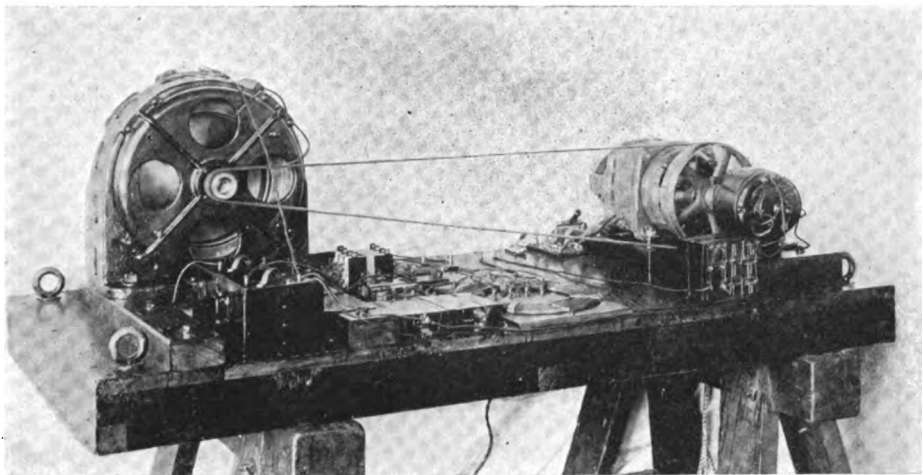
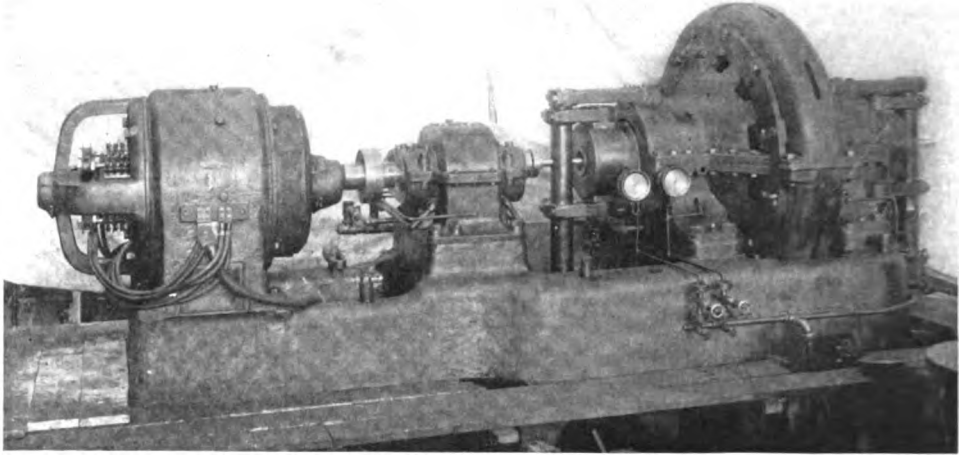

Figure 112—Recent General Electric Company-Alexanderson alternator of "gyro" type

miles (250 km.). The alternator generates 33,000 cycles per second, which is transformed into 100,000 cycles (corresponding to a wave length of 3,000 m.). The 100,000 cycle energy is modulated by a magnetic amplifier which is controlled directly by a standard microphone. A description of the magnetic amplifier system of modulation follows under "Modulation Control Systems."

Passing from the smaller machines, Mr. Alexanderson has had built a 50 kilowatt, 50,000 cycle alternator (and very considerably larger machines are under test and construction). This machine is shown in Figure 113. The open circuit voltage of this machine and the transformer described below is about 550 volts, but the machine is normally operated at about 125 amperes and 400 volts. The rotor is similar to, although naturally larger than that of the smaller machines previously described, but an extremely heavy and rigid shaft is used. The machine has proven capable of furnishing 85 kilowatts for brief periods. Operating at 3,500 revolutions per minute, its bearings and shaft construction are similar to those of normal high speed turbines. The machine speed never attains the "critical speed" value, thus avoiding the necessity for auxiliary bearings. Because



*Figure 113—50 kilowatt, 50,000 cycle, General Electric Company-Alexanderson alternator*

of the very rigid shaft, the rotor is not measurably deflected by the magnetic field. "The thrust bearings for the collars shown at each end of the rotor shaft are held in position with a system of equalizers, which have for their object the avoidance of any possibility of binding in the bearings due to expansion of the shaft from change in temperature, and at the same time automatically draw up all slack in the bearings as they become worn. The equalizers are the heavy vertical columns and links shown in the photograph of the assembled machine.

"The direct generation of radio frequencies by a machine working on the principle of a simple alternator is possible only by the use of a very low voltage winding. On the other hand, if the alternator windings were designed to be connected directly in series with an antenna, the terminal voltage would be about 2,000 to 3,000 volts. Thus it is apparent that with this type of machine it is necessary to use a transformer between the machine and its output circuit. The alternator windings consist of thirty-two independent circuits connected to the same number of independent primaries of the transformer. The transformer has a number of secondary circuits which can be connected for various ratios of transformation between 4-to-1 and 24-to-1. Thus the alternator can be adapted to antennas of greatly different characteristics. The primary windings of the transformer are grounded in the middle, so that the greatest potential difference to ground on the alternator winding is one-half the voltage generated by one alternator circuit.

"The transformer is a closely coupled one, the coupling coefficient being 0.95. In the phraseology of the alternating current designers, the transformer may be described as having about 30 per cent. magnetizing current and 30 per cent. total

leakage. Although the transformer has no iron core, it has a measurable core loss due to the eddy currents in the conductors caused by the magnetic flux. If it were not for these eddy currents, the efficiency of the transformer would be close to 99 per cent. ; as it is, the efficiency is about 95 per cent. This efficiency is approximately constant between frequencies of 25,000 and 50,000 cycles, because what the transformer in one sense gains by the higher frequency, it loses on account of the higher eddy current accompanying that frequency. The numerous multiple circuits in the primary, as well as those in the secondary, are carefully transposed so as to make cross currents impossible between the different circuits.

"While it appears that the most practical arrangement from all points of view is the one described, *i. e.*, a low voltage winding and transformer, experiments have been made with windings distributed in such a way that larger slots can be used with room for more insulation. A sample machine of this type of 3 K. W. output at 45,000 cycles was built, and a diagrammatic representation of the armature cross section and rotor is given in Figure 114. This generates a frequency three times as high as the one for which the slots on the winding are apparently designed. This method may be characterized as generating triple harmonics without the fundamental.

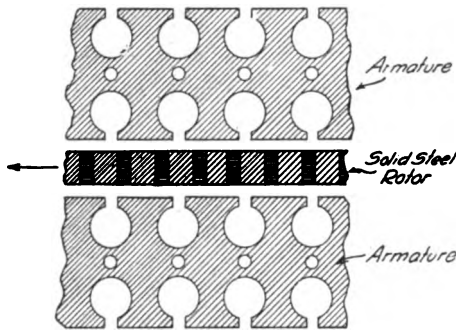

Figure 114—Diagrammatic representation of Alexanderson alternator for direct generator of triple frequency

The action is somewhat like that of a vernier, the flux through the stator projections changing from that due to two teeth on the rotor to that due to one tooth at three times the apparent frequency of the machine. While the characteristics of this machine have proven entirely satisfactory, in accordance with expectations, it is probable that the original simple form of winding will be adhered to, because the concentration of large conductors with more current in one slot causes not only higher

losses, but also a lower rate of heat dissipation and therefore less output can be expected from the same amount of material."

It may here be mentioned that the machines shown in Figures 110, 111, 112, and 113 have all been used for radio telephony in connection with further devices which will be described under "Control Systems." The first was used principally by the National Electric Signaling Company in Mr. Fessenden's tests between Boston and New York (Jamaica), a distance of some 150 miles (240 km.). This was, however, not a matter of regular communication, but rather of test work. The machine shown in Figure 111 has enabled quite regular communication between Schenectady and New York, the distance being 150 miles (250 km.). Even the smallest machine (of Figure 112) running on much reduced power, has enabled the same stretch to be bridged when suitable receiving apparatus was employed.

With the large machine shown in Figure 113, employing the magnetic amplifier controlling device to be described hereafter, the output was successfully modulated between 5.8 kilowatts minimum and 42.7 kilowatts maximum. This is, to date, the maximum amount of radio frequency energy controlled telephonically by any means.

This is the ninth article of a series on "Radio Telephony" by Dr. Goldsmith. In Article X, which will appear in the October issue, the author discusses the modulation of power by the human voice and the degree and stability of its control. The rating of radiophone transmitters is considered and the classification of control systems. In microphone transmitters the work of Seibt, Poulsen, Goldschmidt, Fessenden, Colin and Jeance is described.

# A Digest of Electrical Progress

Experiments with Iron and Steel Wires for Power Transmission—The Future Application of Electrical Power—An Electric Truck Garage—Wireless' Phone for Train Dispatching—Government Nitrate Plants

## IRON AND STEEL WIRES FOR POWER TRANSMISSION

**I**N view of the enormous demands of the war upon the aluminum and copper industries we may yet witness the use of steel wires for the transmission of power. Not that such transmission can be carried on equally well by steel wires, but that the lack of material may cause engineers to adopt such systems for transferring power from point to point.

In a recent issue of the *Electrical World*, the results of certain experiments conducted by L. W. W. Morrow of the University of Oklahoma are recorded, and it is shown that if necessary, it would be possible to use such metals at least over short distribution territory.

The *World* remarks editorially:

“War is a condition which necessarily interferes with normal conditions of supply in commodities. It is useless to cavil or repine at war prices. There would be no credit in being optimistic if the turning of a nation to warfare left all the industry and prices in the ordinary status quo ante bellum. The demands for the electrically-conducting metals tend to raise their prices to economically unattainable values. If copper and aluminum are not at present available for conductors, the question arises of what can be found during the interim to meet immediate needs in electric transmission.”

In the experiments of Professor Morrow, three kinds of wire were tested, namely:  $\frac{1}{4}$ -inch E. B. B.,  $\frac{1}{4}$ -inch Siemens-Martin steel, and  $\frac{5}{16}$ -inch standard Bessemer messenger copper cable. These were arranged in pairs on the pole line in such a way that the measurements could be made on the generator and the load-end of the line with the same instruments.

The electrical test consisted of measuring the power input to the line, the impressed and terminal voltages, the line current, the efficiency of transmission and the regulation. Other measurements included that of the impedance, the effective resistance, the ohmic resistance and reactance.

It is a well known fact that losses in copper or in aluminum wires depend only on the cross section at a given temperature, and such losses can be pre-calculated with the greatest accuracy, but in the case of a magnetic wire, such as iron or steel, the skin effect is very appreciable even at 60 cycles, and this depends to some extent upon the strength of the alternating current carried by the conductor. This is due to the fact that the skin effect depends upon the

permeability of the wire at a particular frequency. Some of the results noted were as follows:

"The effective resistance for a mile of wire or the resistance to 60-cycle alternating current is not constant owing to skin effect and magnetic properties of iron. It increases rapidly until saturation is approached when it becomes almost constant. The Siemens-Martin cable did not show saturation effects. Its resistance increases less rapidly with current than that of the other wires tested and is higher than that of E. B. B. cable for currents less than 15 amperes, but less for currents greater than 15 amperes. The permeability also has a marked effect on the reactance, that of Siemens-Martin cable being much less than that of E. B. B. cable of the same size."

From the mechanical test, it is concluded that the greater strength of iron wire compared with the copper enables the use of longer spans and hence reduces the number of poles and power required. Therefore, the interest on investment saved may partly or wholly offset the inefficiency of transmission of iron wire.

In the mechanical test of three types of cables, it was determined that Siemens-Martin wire has the lowest co-efficient of expansion and the greatest strength, and its resistance and reactance increase less rapidly with the current than for any of the other wires, and with heavy current, the resistance, reactance and impedance are individually less than the same values for other types of iron wire of the same size. At low current values, Siemens-Martin wire has higher impedance than resistance.

The writer concludes:

"On account of the effect of iron or steel on the electrical characteristics of alloys, it is doubtful whether better transmission can be obtained from the latter than with plain iron or steel wire. Conditions as to cost of copper, power to be transmitted, voltage, etc., will determine the advisability of using iron instead of copper wire, and also will determine the type of iron wire which should be used."

### THE FUTURE APPLICATION OF ELECTRICAL POWER

**D**ECRYING the indiscriminate erection of power plants throughout the United States without regard to future developments or cheaper means now available, C. W. Stone, in a current issue of the *General Electric Review*, calls attention to certain phases of the situation which should have the approval of electrical engineers at large. He mentions that there probably has never been a time where there has been more rapid development in the adaptation of electricity to given power purposes than in the last few years, which can be directly accounted for by the fact that manufacturers of this country have been called upon to increase their facilities, and they have found the quickest and best way to secure this increased capacity was to make use of electrical power available from a central station. The word "power" as originally used in electrical industry referred to motors of different characters, but to-day the available energy of the central station is put to other useful purposes such as electrical enameling, ovens, core baking ovens, electrical sherardizing, the heating of glue pots, electrical steel furnaces, electrical brass furnaces, hardening

furnaces, electrical welding and many other applications which cannot be enumerated here.

It would seem that this step-by-step adoption of electrical power would finally lead up to its universal application, and although there has been remarkable expansion in this direction, and although there has been remarkable expansion in this direction, there is probably more work done to-day by hand power or by other mechanical means than by electrical power.

The writer goes on to mention that one of the severest handicaps to further progress in this direction is the fact that two and even three frequencies of alternating current have been adopted as standard for electrical work. He mentions a few isolated developments which unfortunately have adopted the frequency of forty cycles and calls attention to the fact that any engineer who is recommending the installation of any new plant at this frequency is making a mistake which will some day cost the user a large amount of money to rectify.

The standardization of frequencies is not the only standardizing work which should be undertaken, but is that which should have attention first.

He urges that a definite program should be laid out to standardize the speeds of power motors and voltages for different grades of service. Too little attempt has been made in this direction. It has been the common method to develop a mechanical machine first and then fit a motor to it, but better results would be obtained by co-operative work, developing the machine and the motor as a complete unit and thereby eliminating a very large number of special motors which have proven expensive.

Some of the handicaps which Mr. Stone tells us must be removed to make way for the universal application of electrical power are set forth as follows:

"One of the essential features is that we should have universal frequency on our alternating current systems. Sixty cycles is more commonly used than any other frequency. Twenty-five cycles is probably the next most commonly used frequency, but this frequency is largely confined to systems requiring other than alternating currents; in other words, twenty-five cycles is seldom used for any direct application, as it is usually converted into either low-voltage direct current or high voltage direct current. Consequently 60 cycle could be used just as well for this purpose. There are a few systems using 33 cycles and still fewer using 50 cycles. There is no reason for the existence of either one and the sooner they are eliminated the better.

"It would appear that the future development in this country should be to stop in some way indiscriminate building of small power houses, such as isolated plants, etc., and to start to develop a complete and continuous network of wires all over the country, not necessarily all owned and operated by one company; on the contrary, a probably better arrangement would be to have individual distributing companies in each community large enough to support it, and then have large power generating companies scattered all over the country in places where fuel can be most readily obtained, as well as water, labor, etc., all these power generating stations being interconnected and exchanging power as the demand for power in the adjacent neighborhoods develops. Operating in such a manner would mean that power could be produced for far less than it can be at present, both on account of the great reduction in fuel costs and also in capital investments. Also, there would be additional saving in labor."

## AN ELECTRIC TRUCK SERVICE GARAGE BY A PUBLIC LIGHTING CORPORATION

**H**OW the Commonwealth Edison Company of Chicago, Ill., proposes to enlarge its electrical service department to include a garage for the supervision and maintenance of electric trucks, is the subject of an article by E. W. Lloyd, general contract agent, in a recent issue of the *Electrical Review and Western Electrician*. The decision to supply this service was the outcome of observation of the problems involved, especially those of cost and maintenance.

A large service station is being erected at Jackson Boulevard and Morgan Street, practically in the heart of the trucking center. This building will be complete by the end of the summer and will accommodate one hundred trucks. If the service proves successful, additional space will be provided in the same neighborhood. Additional service stations are contemplated as the project develops.

A comprehensive system has been laid down whereby the customer will be enabled to determine in advance the operating cost of any particular type of electric truck or fleet of trucks. Only new trucks will be accepted in the service. The rate for each size, equipped with a standard battery, will be a flat figure per annum payable monthly in twelve equal parts. Trucks equipped with batteries of larger size than the standard, will be charged for at proportionally higher rates. The service proposed will provide for renewal of battery, tires, and mechanical parts when they wear out. In fact, the customer's vehicle will be practically as good as new at the end of the contract period, except for such depreciation as may have taken place in the non-wearing parts. If this project is successful, it will undoubtedly be taken up by other cities throughout the country. It should result in a great stimulus to the electrical vehicle industry.

The service contemplated is outlined as follows:

"The proposed service will naturally first cover the ordinary garaging or storage, including the cleaning and care of vehicles. Secondly, it will include the supply of energy for charging the battery and in the third place it will provide for the maintenance or upkeep of the wearing parts of the vehicle, including tires, battery and mechanical parts.

"The maintenance will cover minor repairs of all kinds as well as the renewal of tires and battery when worn out. It will also include painting of the body at specified intervals, and provide for retouching and varnishing at intermediate times.

"Such service will obviously relieve the customer of administrative expense and the cost of supervision, both direct and indirect, which he would have to bear if he operated the vehicles in his own garage. It must be understood that the owner pays the drivers' wages, insurance, and the cost of damage by accidents."

A specially qualified staff for the development and conduct of this service will be employed. Commenting on this, the writer says:

"Salesmen, supplemented by transportation engineering service, will be able to present to prospective customers having large horse-truck equipments, facts and figures which will satisfy them as to their present expense, and will subsequently present statements which will prove the reduced expense to be effected by substituting electric trucks for these horse equipments."

It is remarked that this undertaking is not only the broadest of its kind, but it is intended to eliminate the difficulties experienced in other partial service systems.

### WIRELESS TELEPHONE FOR TRAIN DISPATCHING

**I**F the series of tests about to be carried out by the Public Service Company of Northern Illinois in respect to the use of wireless telephones for load dispatching prove satisfactory, it is quite likely that one set will be installed in the system operator's office at the Joliet, Ill., generating station, and another will be placed in the company's generating station at Blue Island, Ill. It is hoped to use the instruments to facilitate load dispatching in event of any emergency that may be occasioned by failure of the company's private metallic-circuit line. As reported in a recent issue of the *Electrical World*, two wireless telephone sets suitable for communicating between stations 150 miles apart have been purchased and are being tested with the co-operation of the United States Navy Department. While it is thoroughly understood that the Government will not permit the use of wireless telegraph and telephone equipments except under its own supervision, these tests are being made to determine its practicability when conditions will permit its use. The probable extensions of the service are commented upon in the *Electrical World* as follows:

"If the unit proves practicable in these locations, their use will probably be extended to other important switching centers. The use of the radio telephone rather than the wireless telegraph was favored by the Engineering Department of the Public Service of Northern Illinois because the instruments can be used without a knowledge of the Continental Morse Code and because it is possible to transmit messages with greater speed by telephone than by telegraph."

### NITRATE PLANTS TO BE BUILT BY THE UNITED STATES GOVERNMENT

**T**HE following statement has been authorized by the Secretary of War:

"By direction of the President certain plants will be immediately constructed for the production of nitrates from atmospheric nitrogen. The plants to be constructed do not involve the use of water power, but use a process which is a modification of processes previously known, and the total expenditure involved in these projects is about \$4,000,000. Nothing further can be said at this time about the process or the location of the works which are about to be constructed. Of the total amount appropriated by Congress—namely, \$20,000,000—substantially \$16,000,000 remains undesignated as to its expenditure by the President.

"The committee, consisting of the Secretaries of War, Interior and Agriculture, to which the President referred the question of the selection of a site or sites for the development of water power, has made no report to the President on that subject, but is engaged in the making of further engineering studies, and the subject is temporarily closed to further discussion by localities and communities desiring to be considered as possible sites for the plants."



## THE USES OF ELECTRICITY ABOARD SHIP

The broadening use of electricity on all types of vessels, sailing, freight and passengers, irrespective of tonnage, is treated at length in a recent issue of the *Electrical Review*. At first, the use of electrical current was confined to the higher class of passenger steamers and naval vessels, but gradually it has been extended to include all vessels except those of small tonnage used strictly for sailing purposes, and even many of this class have found it convenient to install an electric lighting plant for operation of hoists, for ventilation and other purposes.

Chief among the uses of the electric current beyond that of lighting, are the operation of the searchlight, the operation of radio telegraphic apparatus, and the running of miscellaneous power apparatus. It is remarked:

“In order of development, the searchlight is the oldest application of electricity on shipboard, naval vessels being among the first to employ it soon after the arclight generator came into being nearly fifty years ago. Electric incandescent lighting followed some fifteen years later and now is utilized almost exclusively for general lighting on all kinds of watercraft from small pleasure launches to ocean greyhounds and superdreadnoughts. Electric motors came into use for various power purposes gradually, at first on naval ships and later on merchant steamers; now they are employed for a great variety of machinery driving, from electric fans to the main propellers, especially on navy boats. Wireless telegraphy received its first application on shipboard barely twenty years ago. Its progress has been so rapid that now it is in practically universal use on all ships except those making short coastwise runs or sailing on interior waterways. Electric cooking and baking have in recent years been introduced extensively on navy ships where their safety and reliability have won such recognition as to bring about their use on other vessels also.”

The problems encountered in the illumination of vessels vary widely, depending chiefly upon the service in which the vessel is engaged. Launches, ferry-boats and bulk-cargo carriers are the present special problems which require new means of solution.

The problem is especially complicated by the low-head room nearly always available, except in the large rooms which sometimes extend through two or more decks. In these cases, it is possible to employ large lighting units scientifically designed and yet attractive fixtures which will secure a very economical but pleasing installation.

Many parts of a vessel not generally open to passengers require artificial lighting at all times, especially in the engine and boiler rooms, purser's office, etc. Electric lighting of these quarters is the only safe, reliable and economical method available, and so far the tungsten lamps have proven especially suitable on account of their economy as compared with the carbon lamps which are still considerably used aboard ship. Fire rooms are now being equipped with large gas lamps of the tungsten type up to 250 watts, with very good results. On open decks or other places where lamps are exposed to the wash or spray of the sea or to considerable dampness or vapor, it is customary to

employ weatherproof or vaporproof fixtures. Safety in navigation also demands certain so-called running lights which include red and green lights on the port and starboard sides of the vessel and white lights on the mainmast which must be kept burning under a heavy penalty. If such lamps are equipped with some such safeguard as tell-tale lamps, the officers are assured of full compliance with the law.

Searchlights have been provided most liberally on navy vessels, which not only have been of considerable aid in naval routine, but also for navigation, signalling and for use in docking, coaling and provisioning the ship at night. Before the event of radio communication, powerful searchlights of the carbon type were employed for signalling over distances of fifty miles. It is mentioned that the most important development in powerful searchlights have been made in recent years, such developments being due principally to Henrick Beck of Germany and E. A. Sperry of New York City.

Commenting upon the expansion of the use of radio aboard ships in the past ten years, the *Electrical Review* says:

"It is only twenty years ago that the first experiments in wireless communication between a ship and shore were conducted. It took several years before the system was perfected enough to bring about its commercial use on shipboard. Since 1901 the developments have been fast and far-reaching, the range and reliability of radio signals being steadily improved. It was recognized quite early that probably the chief field of usefulness for wireless telegraphy would be as a means of communication between ship and shore stations and between ships at sea. The value of such service was gradually being demonstrated, but it was not until January, 1909, that a most spectacular proof was made of its value in saving life. The steamer Republic, after a collision in the Atlantic, succeeded in calling assistance by wireless, with the result that all her passengers and crew were saved before the vessel sank. This event aroused the whole world and soon afterwards legislation was enacted by the leading countries requiring important ships to be equipped with radio apparatus."

Mention is made of the fact that since July 1, 1911, all vessels leaving American ports were required to be equipped with radio apparatus, capable of transmitting and receiving over a distance of 100 miles by day or night. Later this act was amended to apply to all vessels navigating the ocean or the Great Lakes, carrying fifty or more persons (passengers, crew or both) except vessels plying between ports less than 200 miles apart. An auxiliary source of power was also required, which is usually a storage battery capable of operating the motor generator for obtaining alternating current. An auxiliary engine may be used as an alternative. Efficient and direct communication, however, between the operator in the radio room and the bridge must be maintained at all times. It is shown that safety is the first advantage resulting from radio equipment. Not only is the vessel enabled to call for assistance in case of disaster, but it is enabled to assist other vessels within range.

It is pointed out that an electric fan was one of the first applications of electricity aboard ship, the appealing feature being that it required but small current. It was found very useful on passenger vessels. The naval authorities.

however, were the first to observe that an electric motor could be employed to advantage where a small steam engine, due to the immense length of piping required, was out of the question.

Countless needs for power aboard naval vessels arose, such as for turning of turrets, gun pointing, ammunition hoisting, operation of water-tight doors and hatches, driving of workshop machinery, refrigerating machines, etc. For such work it became very desirable to employ electric motors which have now reached such a stage of perfection that they can withstand extremely severe and exposed conditions without harm. In fact, such motors as are to be exposed to the weather are tested for water-tightness by a hose stream at a pressure head of thirty-five feet which is held ten feet from the motor. They will only pass official inspection if they will withstand this powerful stream without leakage.

Another recent application of electricity aboard ship is that of electric propulsion. Ship propellers operate at highest efficiency at speeds of eighty to 125 revolutions per minute, but the steam turbine proves most economical at speeds varying from 2,000 to 3,600 revolutions per minute. It became necessary to reduce the speed of this propeller by gear reductions. That the advantages of electric current excel the geared drive is emphasized by the writer as follows:

“Gear reductions have been used, but in comparison with them electric propulsion has advantages under certain conditions, especially on large battleships or cruisers that must be capable of running economically under wide ranges of speed. With electric propulsion, the main turbine drives a direct connected three-phase generator which supplies energy to special induction motors that drive the propellers. On a large vessel there results marked economy of room and weight, greater efficiency, and much simpler and more responsive control that is of special value in maneuvering. The vessels equipped for electric propulsion have given excellent accounts of themselves so that this method of driving is likely to be extended.”

It is also shown that electric cooking eliminates the fire hazard because many fires have broken out aboard ship on account of the spilling of grease over an open fire causing an instant blaze which is extremely difficult to extinguish. Some of the more important advantages of electric cooking aboard ship which have been recognized by our Navy where it is employed extensively are as follows:

“Saving of floor space, cleanliness; elimination of the handling of wood, charcoal, coal and ashes; confining of the heat to the electric range and oven and avoidance of excessive heating of the kitchen; comfortable working conditions for the chef and his assistants; avoidance of smoke and gas; more rapid cooking operations in the case of broiling, frying, roasting and baking, which can be done more speedily on an electric range than on a coal or wood range; more palatable and savory food, because the cooking is under perfect control and not subject to an unreliable fire in the stoves; less waste of food, due to spoilage and shrinkage.”

Reviewing the matter in its entirety, it would seem that the Navy man of the future will have to be highly trained in electrical matters, and that his technical training will by no means be sub-ordinated to his nautical training.

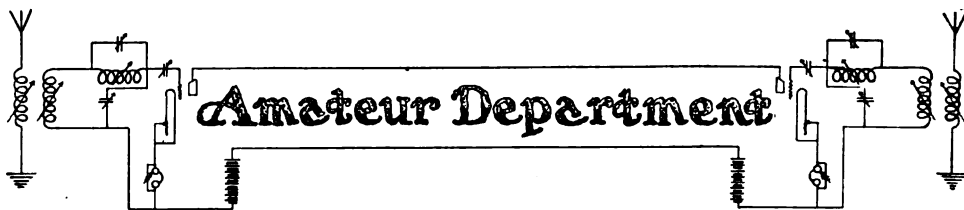

# Wireless Class for Women

Under the Auspices of the

NATIONAL AMATEUR WIRELESS ASSOCIATION

**I**N order to facilitate the study of wireless among women, the Wireless Class for Women, which was formed at Hunter College, New York City, under the direction of the National League for Woman's Service, will in the future be conducted under the auspices of the National Amateur Wireless Association. Following requests for instruction in wireless from persons throughout the United States, arrangements have been made to establish a preparatory course in the art. The salient features of the plan follow:

THE WIRELESS AGE will publish in monthly instalments a preparatory wireless training course.

The course will be conducted by Elmer E. Bucher, instructing engineer of the Marconi School of Instruction, New York City.

The monthly instalments will be in a form similar to the lectures Mr. Bucher delivers to the students in the Marconi School.

These lessons will give the essentials of the art in condensed form. However, they will be sufficiently complete to enable students to acquire the necessary practical knowledge and ability to operate sets in the shortest possible time. They will include every detail that the prospective operator will need.

The course will be complete, beginning with exact elementary instruction and leading, step by step, to the more difficult phases of wireless.

Diagrams and illustrations will accompany each instalment of the course. Wiring diagrams, beginning with the most elementary circuits, and gradually leading up to the more complicated ones, together

with illustrations of apparatus and the various parts, will be published. The lessons will be in logical order, in order that students may easily grasp the instructions.

The text relating to each diagram will be brief. Minute instructions will be given in regard to apparatus and equipment and the care, maintenance and operation of stations, together with the operation of sets under ordinary and extraordinary conditions.

This course was designed to prepare efficient woman wireless operators for service at stations conducting Government or commercial radio traffic.

Any student who applies herself conscientiously and consistently to the study of wireless as outlined in this course will be able to equip herself for a profitable vocation. She will also be in a position to render valuable service to the nation.

After mastering the fundamentals and receiving the preparatory training, students who desire to do so may take a supplementary intensive finishing course, without additional charge for tuition, at Hunter College.

The cost to the student of the preparatory course is as follows:

Registration fee, \$1.00.

THE WIRELESS AGE for one year, containing Mr. Bucher's lecture course, \$2 postpaid.

Head telephones, buzzers, keys, two dry cells, required by students for practice, \$7.50.

Additional text books as they may be required. Practical Wireless Telegraphy, cloth bound, 330 pages, fully illustrated, 6½ by 9½, \$1.50, postage extra.

"How to Pass U. S. Government License

Examinations," paper bound, fully illustrated, 7 by 10, 50 cents, postage extra.

All communications should be addressed to Mrs. Herbert Sumner Owen, Director of the Women's Division of the National Amateur Wireless Association, Hunter College, Lexington Avenue and 67th Street, New York City.

All checks and post-office money orders for registration fees, equipment and apparatus should be made out to the registrar of Hunter College.

The Wireless Class for Women now numbers five divisions, averaging twenty-five members each. A number of experienced operators have applied for admission. Radio Aid Van Dyke, stationed at the New York Navy Yard, lectured to the class recently. He called attention to the fact that while a satisfactory speed in code and a knowledge of the technical side of wireless are



*At the Marconi School of Instruction man and woman wireless students work side by side*

Mrs. Herbert Sumner Owen, who was formerly national chairman of wireless of the National League for Woman's Service, has resigned from the League to become the director of the Women's Division of the National Amateur Wireless Association. This new affiliation will make possible the nationalizing of an opportunity in wireless for women. Mrs. Owen expects to develop the plans of the Division so that help and advice can be offered those who are ambitious to take up the art, either as a patriotic service or as a means of earning a liveli-

essential, there are other qualifications in a student which are quite as necessary, and in some ways more valuable. He emphasized the fact that to be a successful operator the student should have steady nerves, good judgment, an alert mind and a capacity for handling unusual situations.

Students ambitious to take up wireless with the aim of utilizing their knowledge in the national service will find the intensive course of great aid. Preliminary details regarding this course were pub-

# From and For those who help themselves



## FIRST PRIZE, TEN DOLLARS A Panel Type Transmitter With Interesting Features

Now is the time for amateurs to prepare for the grand opening which is to come sooner or later. Attention for the present should be given to the transmitting apparatus which, as is well known, requires more thorough construction than any other part of an amateur's equipment. I have designed a panel type transmitter which, although it is not much different from the average, has a few points that might be of interest to the owner of a first class set.

In my station the transmitter is located on the ground floor, which permits the use of a very short earth lead, a most important factor in an efficient transmitter. My panel is constructed after the dimensions shown in the accompanying drawing, but it can be made smaller to suit the wish of the builder, if desired.

The panel board is made of  $\frac{3}{4}$ -inch white-wood glued together in strips. After it is completed, it is sandpapered and given a coat of shellac or varnish, the operation being repeated after each coating, using a finer grain of sandpaper. The last coat usually gives a very high finish. The panel is 2 feet from the floor and is supported by two two-by-four's turned edgewise; that is, the 2-inch side faces the panel. Upon the lower end of the panel is mounted a small shelf supported by iron brackets to hold the sending transformer and condensers. It is intended that the panel be located near the receiving operator. I have numbered the working parts, 1, 2, 3, 4, 5, 6, 7, etc.,

and the function of each part of the apparatus will be explained.

No. 1 is the hot wire ammeter and No. 2 is a small single pole single throw switch that cuts the ammeter in or out of the circuit while testing. No. 3 is a rubber knob on which is fastened a rod to adjust the coupling between the closed and open oscillatory circuits. The primary of the oscillation transformer is stationary and is fastened to the back of the panel with good insulators, while the secondary can be adjusted by sliding No. 3 in or out.

No. 4 is a simple rotary changeover switch to change from receiving "R" (marked on the panel) to sending "S." This is a large brass or copper switch arm fastened to the center rod and must be short enough so it will swing clear of No. 3. The receivers for this switch arm are made of heavy spring brass or copper clips, like those used on the big knife switches, and should be well insulated from the panel board. Nos. 5 and 6 are the large size snap switches. No. 5 opens and closes the circuit to the sending transformer and should be left in the "on" position all the time while transmitting, while No. 6 starts the rotary gap.

These switches can be of the knife type, but the snap type takes up less room and is quicker to operate. The rotary gap is shown in No. 7. The disc extends through the panel so that it can be adjusted and watched. At No. 8 are shown single pole single throw switches for adjusting the capacity of condensers No. 9. These condensers are of the Murdock moulded type, each having capacity of .0017 microfarad. Four to six are generally used, but extra ones can

be cut in by the switches in case one burns out. No. 10 is the sending transformer with a variable input which can be regulated by the small switch located on the front of the box. Referring to the side plan, P is the primary of the oscillation transformer and S is the secondary. R shows the side view of the rotary switch and how the arm fits into the clip. The two-by-four is shown at

leads, which should be made of wide brass or copper strips. At points where the leads go through the board, very thick porcelain tubes are employed which should be cut a little longer than the thickness of the panel boards. Great care should be taken not to run the 110-volt wires parallel to the high potential wires as this is apt to cause "blowouts" and "kickbacks." In my case the panel

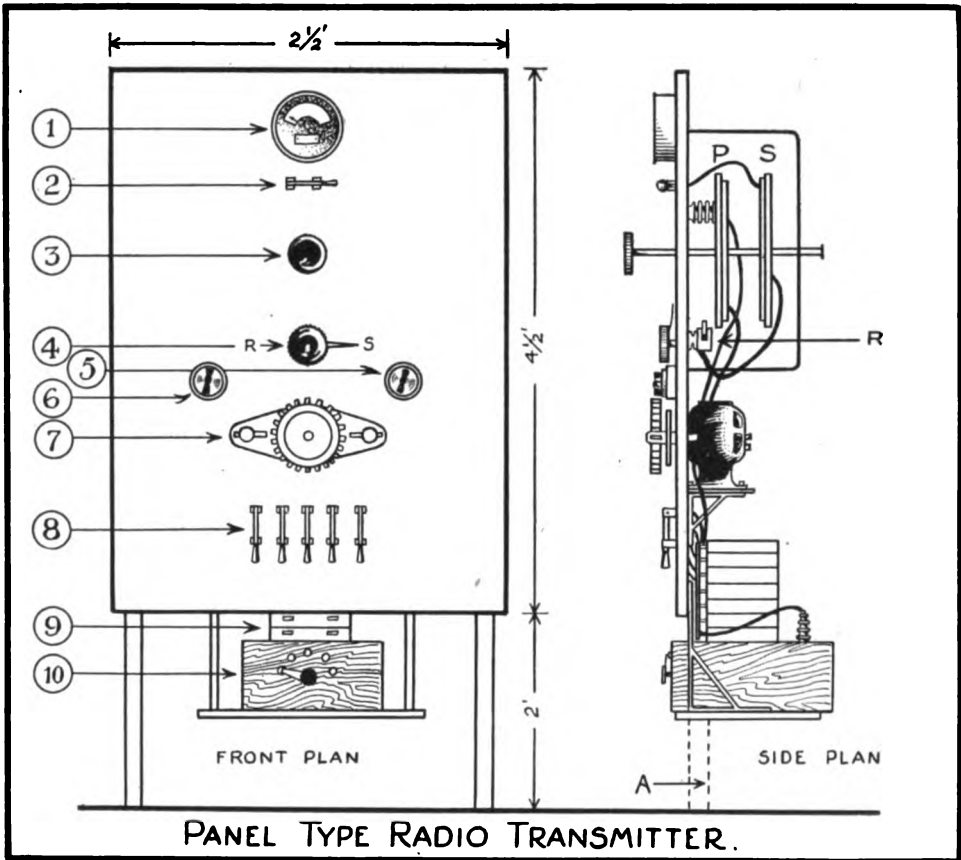

PANEL TYPE RADIO TRANSMITTER.

Drawing—First prize article

A, which runs to the top of the panel board, but is not shown in the drawing as it would obstruct the other apparatus. The rest of the drawing is self-explanatory.

As will be noted, the set in this panel type is very compact and will come in handy for "short leads" so important to maximum efficiency. All wiring on the rear of this panel should be carefully insulated, especially the high potential

board is set up very close to the wall, but I found that I could not get back of it very well to oil the motor, etc. Therefore I put the entire panel on heavy hinges so it could be swung around for adjustment.

If other amateurs decide to build a set like this one, I should like to hear from them.

HARRY R. HICK, Rocky Hill, Conn.

## SECOND PRIZE, FIVE DOLLARS

### The Construction of a Compact Undamped Wave Receiving Tuner

A receiving tuner which will respond to waves of 12,000 meters when connected to an aerial 200 feet in length is

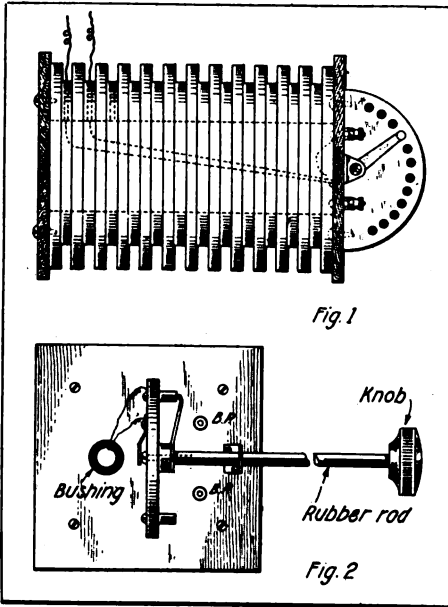

Drawings—Second prize article

shown in detail in Figures 1, 2 and 3. The receiving transformer is not only very small, but it requires no loading inductances and employs but three variable condensers.

It is to be especially noted that multi-layered windings are employed in both the primary and secondary windings, such windings being made in grooves and wound irregularly to reduce the effects of electrostatic capacity between turns.

Figure 1 shows the general construction of the primary winding which is identical with the secondary winding except the size of the wire. These windings are not arranged to be telescoped, one within the other, but in fact, the tightest coupling is obtained when the windings are "end on."

The primary and secondary forms are made of wood. They are  $6\frac{1}{4}$  inches in length,  $4\frac{1}{2}$  inches in diameter, with 12

grooves  $\frac{3}{8}$ ths of an inch in depth,  $\frac{1}{4}$ th of an inch in width and  $\frac{1}{4}$ th of an inch apart. These are, of course, cut in on a wood turning lathe. A 2-inch hole is cut through the entire length of the core to permit the running of taps from the windings to the switch.

The end supporting blocks are  $\frac{1}{4}$ th-inch stock, 5 inches square, which are fastened to the cylinders with  $\frac{1}{2}$ -inch oval headed brass screws. The constructor should drill a small hole through each tube at the bottom of every groove to admit a tap connection, as shown by dotted lines in Figure 1.

The primary tube should be wound with seventy-five turns of No. 28 S. C. C. in each groove and a wire extended from the hole of each groove to the taps of a multi-point switch as shown.

The secondary winding has 1,200 turns of No. 32 S. C. C. wire which is wound on the second cylinder, 100 turns being placed in each groove. Taps are taken from this winding as from the primary winding.

The construction of the multi-point switch should be noted. A semi-circular piece of  $1\frac{1}{2}$  inches radius and  $\frac{1}{4}$ th of an inch in thickness is screwed to one end block of each coil to support the switch and contacts. Twelve  $\frac{1}{4}$ th-inch contact studs are mounted on a radius of  $1\frac{1}{4}$  inches. These are connected with the taps from the winding which are

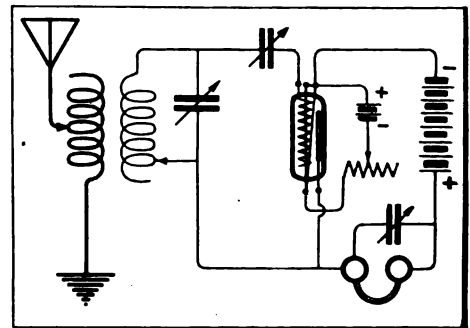

Figure 3—Second prize article

brought through an insulating bushing behind the semi-circle, as in Figure 2.

The construction of the switch will be clear from Figure 2 wherein it will be noted that the lever is held between a



threaded washer and a rubber rod which is also threaded. Enough play is allowed between the washer and the screw head so that the mechanism will revolve freely.

The hard rubber rod is  $\frac{1}{4}$ th of an inch in diameter and 9 inches in length with a control knob mounted on it for the contact lever. There is an advantage in the use of a long switch handle as shown, because the circuits of the transformer are not thrown out of resonance by the capacity of the body of the manipulator. Both primary and secondary coils are

### THIRD PRIZE, THREE DOLLARS How to Make an Automatic Antenna Change-Over Switch

The accompanying drawings, Nos. 1 to 7, show in detail the construction of an aerial change-over switch operated by magnetic solenoids which are energized by 110-volt direct current. A switch of this construction may be mounted on a switchboard on the operating table or at any point convenient to the associated apparatus. It is manipulated by two push buttons, preferably

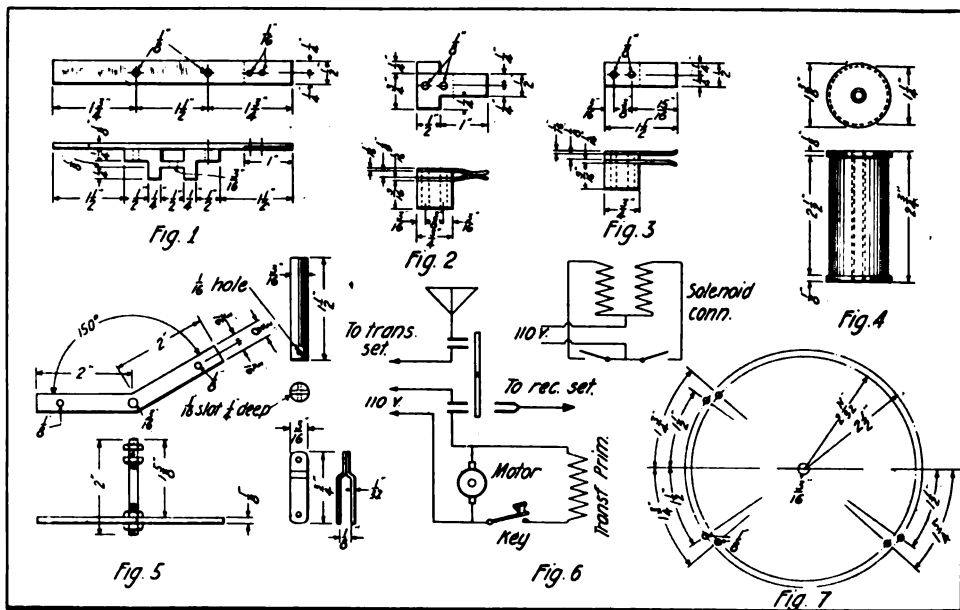

Drawings—Third prize article

covered with a sheet of hard rubber  $\frac{1}{64}$ th of an inch in thickness. They are placed end to end when in use, the coupling being varied by moving one away from the other. Very loose coupling may be employed when atmospheric electricity is especially severe.

With an apparatus of this kind I have heard Darien, Isthmus of Panama, with the primary and secondary separated by as much as eight feet, and also various arc stations in the United States. I have also obtained good signals from "O U I" and "P O Z."

JAMES B. ARMSTRONG, *New York.*

placed near the transmitting key. By pressing one of these buttons, the switch is drawn to the sending position and by pressing the opposite button the switch is changed to a receiving position. It can also be fitted with auxiliary contacts, as shown, for closing the power circuit through the rotary gap motor and the primary winding of the transformer.

As shown in Figure 1, the switch is made of copper with a piece of hard rubber riveted to the under side on one end. Care should be taken to have the rivets well towards the center so that they do not come in contact with the clips.

The standard on which the blade is fastened is made of hard rubber and is bolted to the blade with two brass bolts, as shown in Figure 1. As can be seen from the diagram, the shaft is fastened to this standard in a way that it will not touch the blade.

The construction of the high tension clip is shown in Figure 2. The two sections of the clip are of copper, insulated from each other and the base on which they are mounted is made of hard rubber. A bushing  $\frac{3}{16}$ ths of an inch in diameter,  $\frac{13}{16}$ ths of an inch in length, with a  $\frac{1}{8}$ th-inch bore, is inserted to insulate the two sections from the bolts which hold the clip to the switchboard. These two sections should only make contact when the switch blade is not between them. Two fibre washers insulate the heads of the bolts from the clips. In order to fasten on lugs for the leads, the side of each section projects on the opposite side of the clips, as the diagram clearly shows. It is preferable to solder the leads to these extension clips.

The clip for the receiving side of the switch is shown in Figure 3. It is built exactly like the high tension clip with the exception that no insulation is required between the two sides. The standard on which the clip is mounted is of hard rubber and instead of a section of hard rubber being placed in between the two clips, a piece of copper is used. They are held through the switchboard by means of  $\frac{1}{8}$ th-inch bolts.

The construction of the power clip is nearly like that of the high tension clip with the difference that the two sections never come in contact, except when the blade is between them. The power clip closes the circuit of the rotary gap motor through the transformer when the switch is in the sending position and opens these circuits in the receiving position.

The two solenoids which operate the blade are identical in construction. The dimensions are shown in detail in Figure 4. A spool is made out of hard rubber or fibre tube with two circular ends of hard rubber or fibre. Both spools are wound to about  $\frac{1}{16}$ th of an inch from

the edge of the end pieces, with No. 22 double cotton-covered magnet wire.

The mechanism of the shaft and armature is shown in Figure 5. The shaft is made of  $\frac{3}{16}$ th of an inch round brass threaded on one end for about  $\frac{1}{2}$  inch and on the other end for about  $\frac{3}{4}$ ths of an inch. It is 2 inches in length. The switch blade is held against the switchboard by a spring slipped over the shaft and placed between the switchboard and the arm. The arm to which the two armatures are fastened is made of brass and is  $\frac{3}{8}$ ths of an inch in width and  $\frac{1}{8}$ th of an inch in thickness. It is cut so that the two halves are at an angle of  $150^\circ$ . Each half is 2 inches long. In the center a  $\frac{3}{16}$ th-inch hole is drilled to fit the shaft. One-half inch from each end is bored a  $\frac{1}{8}$ th-inch hole to which the armatures are fastened.

The two armatures which slide in and out of the solenoids are  $\frac{3}{16}$ ths of an inch in diameter and are made of soft iron. At one end of each a  $\frac{1}{16}$ th-inch slot is cut to a depth of  $\frac{1}{4}$ th of an inch. A hole  $\frac{1}{16}$ th of an inch in diameter is bored  $\frac{1}{8}$ th of an inch from the end at right angles to the slot. Two small connecting rods connect the armatures to the shaft arm so that they move in and out of the solenoids easily and without jamming or sticking. The construction of these pieces is shown in detail in Figure 5.

To mount the switch on a switchboard or table, a line is drawn horizontally to the bottom edge. With a center anywhere on this line, circumscribe a circle having a diameter of 5 inches; inside of this circle and with the same center, draw another circle having a radius of  $2\frac{11}{32}$  inches. Taking the point where the outer circle intersects the line on the left as a center, and with a radius of  $1\frac{3}{4}$ ths inches, make a mark on the outer circle in the three places as shown in Figure 7. At the point where the inner circle intersects the horizontal line as a center and with a radius of  $1\frac{1}{2}$  inches, mark off the points as shown in Figure 7.

At the point just located, holes  $\frac{1}{8}$ th of an inch in diameter are drilled, and the contact clips are bolted in place. The high tension clip is placed in the upper



several positions in the tuning circuits by means of the change-over switch, C-2.

When the switch, C-2, is in the position, 1, the condenser, K-1, is in series with the primary circuit which makes the whole circuit responsive to short waves; when it is in the position, 2, it is in shunt across the tuning coil to increase the possible wave-length adjustments of this circuit. The inductance of the primary portion of the tuning coil, B, is adjustable by means of a two 3-point switch, C-3.

The inductance of the secondary circuit of the coil, B, is adjustable by two three-point switches, C-4 and C-5; the circuit further includes three good crystal detectors, D-1, D-2 and D-3, which are

Holes are drilled in the panel to receive the contact points, as shown in Figure 2. One way of constructing the multi-point switch is shown in Figure 4. A hard rubber knob, R, is attached to the shaft of the switch as indicated. Switches of this type can be purchased direct from the manufacturer, but in the event that they cannot be purchased, it will be necessary to drill the panel accordingly.

A tuning coil, B, is made of a cardboard tube 11 1/5th inches in length by 3 3/5th inches in diameter wound with 345 turns of No. 22 S. S. C. wire. Taps are taken off all the turns and connected to the switches, C-3, C-4 and C-5, in the following order. The first tap is connected at the first point of the switch,

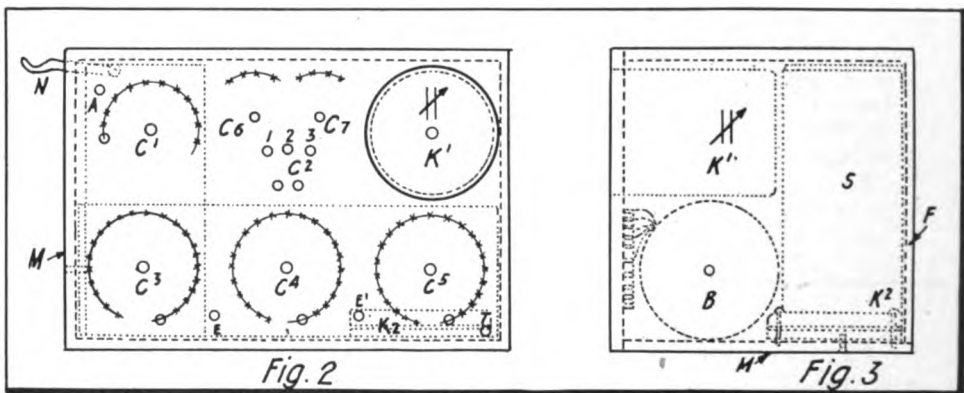

Drawings—Fourth prize article

cut into the circuit by the switch, C-6. A pair of good telephone receivers, E and E<sup>1</sup>, are connected in shunt across the detector and a fixed condenser, K-2, which is adjustable in large steps by means of the four-point switch is connected in series.

The case shown in Figures 2 and 3 has overall dimensions of 12 inches by 8 inches by 8 inches and it is preferably constructed of hard wood approximately 1/3rd of an inch in thickness. The vertical rectangular back, F, is made in the form of a slider so that it can be readily removed to give the manipulator access to the connections. The panel, P, on which these switches are fastened is a piece of mahogany 12 inches by 18 inches, but if the apparatus is used in damp climates, it is preferable to have it of Ebonite or Bakelite.

C-3; the second five turns thereafter at the beginning of C-4; the third at the beginning of C-5; the fourth at the beginning of C-3; the fifth at the second point of C-4, and so on to the sixty-ninth connection. To explain at greater length, the sixty-nine taps will cover the entire 345 turns. Each switch controls fifteen turns and very precise adjustment can be obtained if the loading coil is properly employed, likewise the variable condensers.

Two wooden discs, as shown at D in Figure 4, are glued in the end of the tube which is fastened horizontally in the box by two screws at the center (Figures 2 and 3).

The loading coil, S, is constructed in the same manner. The tube is 1/4th of an inch in length by 3 and 1/5th inches in diameter, wound for 7 inches with

No. 24 S. S. C. wire. It will have approximately 264 turns. Taps are taken off at each twenty turns and connected to the eleven points of the switch, C-1.

It is attached in the fashion as shown in Figure 3. The connections from the various plates of the condenser are clearly shown in Figure 1.

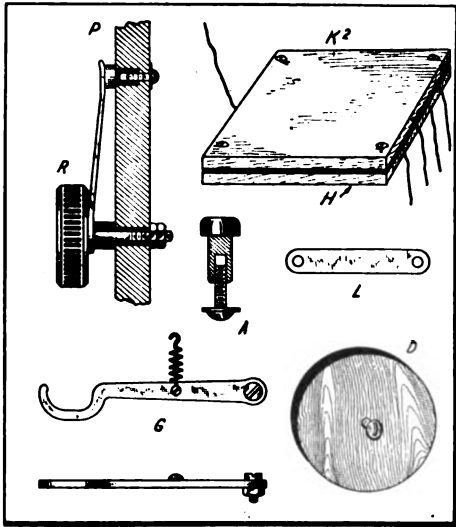

Figure 4—Fourth prize article

This coil is placed vertically in the box (Figures 2 and 3).

It is found of great value to construct the condenser, K-1, so that it can be adjusted progressively. The type of rotary variable condenser which is sold by the average manufacturer will fulfil the requirements. It generally has a maximum capacity of .001 microfarad. To mount it on the panel, a large hole of the diameter of the condenser container is drilled in order that it may be fastened to the front of the panel.

The switch, 2, is one of the ordinary type; in fact, it is the type of reversing switch used in telegraph work. The details are shown clearly in Figure 4. Two holes are drilled at either end of the brass strip, L, to slip over the shaft.

The condenser, K-2, may be of fixed capacity, but to obtain the very finest adjustment of the circuit, it is preferable to have it adjustable in steps as by the switch, C-6. This condenser is constructed of five sheets of tinfoil,  $3\frac{5}{8}$ ths inches by 4 inches, between which are placed sheets of paraffin paper, about 4 by  $4\frac{1}{2}$  inches. The entire condenser, after being properly assembled, is placed between two small blocks of wood and secured together, as shown in Figure 4.

Three good crystal rectifiers should now be selected and mounted on the top of the panel set. They can be connected in the circuit successively by throwing the switch from one point to the other. The most sensitive detector is thus quickly found during the reception of signals. Two binding posts provided for the aerial and earth connections are fixed in the upper left hand and lower right hand corners of the panel. Two additional posts are placed at E and E' to connect a double set of sensitive wireless telephone receivers such as the Murdock telephone, varying in resistance from 500 to 2,000 ohms.

I have also shown in Figure 4 a small hook switch which, when the telephones are hung on it, will automatically connect the antenna direct to the earth and

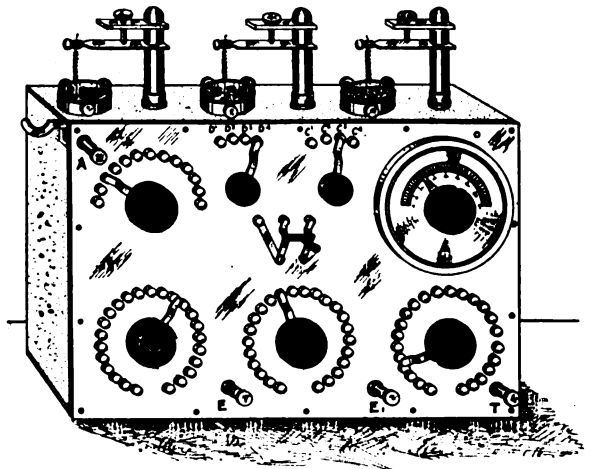

Figure 5—Fourth prize article

protect the apparatus from lightning discharges. The details of this are shown in Figures 1, 4 (G) and 5. The indexes for the switches can be made on white celluloid.

A receiving set of this type makes a handsome appearance and takes up a small amount of space. Connected to a good aerial, well insulated, the reception of spark signals at normal wave-lengths over distances of 1,000 to 1,500 miles is possible; in certain cases this has been exceeded.

# The Monthly Service Bulletin

of the

## NATIONAL AMATEUR WIRELESS ASSOCIATION

Founded to promote the best interests of radio communication among wireless amateurs in America

J. ANDREW WHITE, Acting President GUGLIELMO MARCONI, President ALONZO FOGAL, JR., Secretary

### NATIONAL ADVISORY BOARD OF VICE-PRESIDENTS

Prof. A. E. KENNELLY  
Harvard University  
Brig. Gen. GEORGE O. SQUIER  
Chief Signal Officer, U. S.  
Army  
Commander D. W. TODD, U.S.N.  
Director Naval Communica-  
tions  
Major WILLIAM H. ELLIOTT  
Junior American Guard

Prof. ALFRED N. GOLDSMITH  
College of the City of New  
York  
Capt. W. H. G. BULLARD,  
U. S. N.  
E. E. BUCHER  
Instructing Engineer  
Prof. SAMUEL SHELDON  
Brooklyn Polytechnic Insti-  
tute

Prof. CHARLES R. CROSS  
Massachusetts Institute of  
Technology  
Colonel SAMUEL REBER  
Signal Corps, U. S. Army  
WILLIAM H. KIRWIN  
Chief of Relay Communica-  
tions

Headquarters, 42 Broad St., New York

THERE is evidence on every hand that experimenters who have not been called into the Government Service are taking full advantage of the present opportunity to rebuild their apparatus or to educate themselves technically to a higher degree of proficiency. We have, in fact, received a number of inquiries on very important phases of radio telegraphic design, which bespeak the growing desire for scientific knowledge on the part of experimenters. These communications indicate that the amateur is more alert than ever and is only too glad to have a quiet period in which to reflect upon the radio situation as a whole. He has observed, perhaps, in his experience during the last few years that by re-arranging the design of his apparatus he obtained better results, and now he is taking advantage of the opportunity afforded by war conditions to take up this task. So he spends many evenings in his workshop.

Sooner or later every experimenter realizes that the operation and the construction of electrical apparatus are based upon scientific principles; moreover, unless this apparatus is designed in accordance with certain fundamental laws, the maximum efficiency cannot be obtained.

The experimenter building apparatus

from designs furnished by others is often in doubt whether his money is being put into material which will give him the best results. There is only one way in which he can assure himself on this point, and that is by gaining such knowledge as will permit him to design apparatus according to a definite principle.

The foregoing assuredly applies to the amateur radio telegraphist because he deals with scientific principles which a few years ago were not well understood, but are now aptly described as representing "the highest form of engineering expression." The genuine satisfaction in constructing a piece of electrical apparatus such as a high voltage transformer, for instance, does not come in merely following the dimensions and working instructions given by another. The real delight is experienced by the experimenter when he calculates for himself the constants for a given instrument. He, at least, experiences the satisfaction of knowing that he will have a transformer that will give the highest degree of efficiency within the present knowledge of the art.

The little use which the average experimenter of to-day makes of his local library is astonishing. Any number of

good books on electrical design and construction containing a number of formulae for magnetic and electrical calculations can be found in the electrical division. The man with only average intelligence can easily comprehend these formulae and their practical application will eliminate hours of needless experimenting.

---

Did you know that the word "amateur" as used in the French language possesses an entirely different meaning than that given it by the American press and public?

Here an amateur who follows any particular hobby is generally considered as one who does not possess the attainments of a professional, i. e., his status has not been passed upon by some board of inquiry, or governorship; but in the French language an amateur is one who is deeply interested with his work or hobby and considers all else secondary to the particular subject in which he is engrossed. It does not imply that he is particularly ignorant of the hobby he has adopted. On the contrary, he may be highly informed upon the subject and yet be an amateur on account of his attitude toward his work.

The word "amateur" well fits the American experimenter for as soon as he becomes absorbed in wireless, he is an amateur, according to the French definition of the word.

---

We have received several communications at headquarters in reference to the design of 500-cycle generators.

Inquirers should take into consideration the vast amount of calculations and the innumerable machine shop drawings required to answer such a question. A professional engineer has estimated the cost of providing such information at several hundred dollars.

---

One member of the Association writes as follows concerning regenerative receivers about which so much argument prevails at present:

"I have read with considerable interest the second prize article by F. J. Scup-

holm in the April, 1917, issue of THE WIRELESS AGE and would like to say that I have built a set somewhat similar to that described by Mr. Scupholm and have obtained even better results than he has. I make the following suggestions:

"First—Do away with the condenser across the secondary as even the slightest capacity at this point will reduce the strength of signals on short waves about 50 per cent.

"Second—To tune the secondary connect a variometer in series with one side of the secondary leads, preferably to the terminal connected to the grid of the vacuum valve.

"Third—To do away with the slightest dead-end effect, take no taps whatsoever from the secondary coil. My secondary winding is  $3\frac{1}{8}$  inches in diameter and has fifty turns, No. 28 S. C. C. wire. With a variometer, in which the windings are made from No. 30 S. C. C., on tubes 4 inches in length by 3 inches in diameter, with fifty turns on each tube, wave-lengths up to 500 meters can be read.

"These suggestions may seem small, but the one referring to taking out the secondary condenser is alone worth the price of admission.

"Using a single vacuum valve, an aerial only 80 feet long and 40 feet high, I copied 2AGJ at Albany almost every night during the latter part of the season. 2PM was copied about a month. 2LK and 7ZL were heard about three times, and last but not least, 6EA at Los Angeles was copied on six nights. Of course, numerous 8 and 9 stations have been copied and a total of about 190 8's and 9's. Also, I would like to call your attention to the fact that it was 5 BV not 5 BC that Scupholm has down for Little Rock in the April number."

JOHN M. CLAYTON, *Arkansas.*

---

Wireless communication between the United States and Japan was inaugurated July 27th, 1915, the messages being relayed by the Marconi high-power station at Honolulu. The transmitting station in Japan is located at Funabashi.

# Index—Volume IV.

## October, 1916 to September, 1917

	PAGE	PAGE
<b>A</b>		
Advice for the Amateur, General		
312, 396,	506	
Aerial Insulator, An	678	
Mast of Unique Construction, Description of An	774	
Receiving Without An	509	
Aeroplane Receiving Set, New	435	
Sets on View	395	
Transmission, New Record	95	
Afire in Mid-Pacific	359	
Aircraft and Wireless Economic Factors	577	
Airplane, The Wireless Equipped	702	
Alaska's Freak Conditions	566	
Alaskan Rates, Reduction in	115	
Stations Closed	240	
Ally's Stations, Our Northern	752	
Amateurs are Responding to the Call to Arms, How	687	
Faults and Suggestions for Improvements	432	
Amateur Stations, Possibility of Using Wireless Stations Being Dismantled, All	549	
The Wireless	316	
Amateurs, With the	64	
131, 205, 352, 429, 510,	590	
In West, Work of	350	
American Marconi Equipment Best in the World	362	
Ammeter Easily Calibrated, A Precision Hot-Wire	579	
Quick-Acting Hot wire	412	
Antennae Construction, Advice Regarding	134	
For Testing, Dummy	663	
Antimony Silicon Detectors and Their Advantages	775	
Arc Generator of High Frequency Current, An	583	
Arcs, High Frequencies from Direct Current Arcs	805	
Armstrong Receives Honor Medal	617	
Army Radio Company Planned for Canal Zone	462	
Artillery Fire Directed from Aeroplanes by Wireless	66	
Atlantic Communication Co. Sued by National Electric Signaling Co.	155	
Audion Loses to Fleming Valve	650	
Of de Forest an Infringement	82	
Aviator, How to Become An:		
Article I	833	
Article II	905	
<b>B</b>		
Base for Rotary Gap, A Shock Absorbing	55	
Battle of the Wireless, The	168	
Bay State, The Stranding of the	97	
Binns, ("Jack") Enlists	755	
Parting Message	792	
Boat, Hammond's New Radio	154	
Book Review:		
Practical Wireless Telegraphy—Bucher	840	
The Wireless Telegraphists' Pocket-book—Fleming	649	
Border, My Trip to the	26	
On the Texas	454	
Boston Women Want Commercial Licenses	362	
British Law to Compel Ship Installations	241	
Buenos Aires Receives S O S	329	
Building Stations on Shipboard	459	
<b>C</b>		
Cabinet, Instructions for Making a Transmitting	501	
Receiving Set	414	
Calibrated Receiver Shunt Box, Construction and Use of A	267	
Call to the Colors, Making Ready for the	614	
Camp Equipment, Military Men Praise	26	
Canadian Stations, Description of	752	
Signal Corps, Photos of	770	
Canal Zone, Army Radio Company Planned for	462	
Cape May's New Station	638	
Card Index of Amateur Stations, A	855	
Carranza's Operator, License for	399	
Censors, Change in Naval	216	
Chick, Reward for Owen	37	
Civil Service Examinations	803	
Close 800 Stations in New York	589	
Clutch, Auto Magnetic	58	
Coast Guards' Wireless Achievements	360	
Coils, A Convenient Method of Calculating Inductance of	514	
A Winding Machine for Transformer	675	
College of City of New York Station Open	769	
Collision, Races to Port After	686	
Columbia Defense Preparations	593	
Condenser, A High Potential Transmitting	504	
1 K. W. Oil-Immersed High Voltage Sections, How to Use Burned-Out Moulded	587	
Suitable for Amateurs, A High Potential	141	
Congo, With the Naval Expedition in the Congress' People Escaped the Flames, How the	11	
	96	



	PAGE		PAGE
Control of Wireless:		Wireless Agents, The Round-Up of.	703
Government Monopoly or Private		Girl Operators in Commercial Field . . . . .	359
Enterprise? . . . . .	651	Operator, License for Mexican . . . . .	399
Copper Wire, Manufacturers of Insulated	57	Operator, Tacoma's . . . . .	387
D			
Damped Waves, Receiving Set for . . . . .	933	Girls Organize, Pa. State College . . . . .	769
De Forest Audion an Infringement . . . . .	82	Government Ownership of Wireless . . . . .	300
De Groot's Paper, A Summary of . . . . .	327	Gulf Storm, Wireless In . . . . .	15
Paper, Dr. . . . .	240	H	
Detector, A Dust Proof . . . . .	503, 852	Half-Kilowatt 200-Meter Amateur	
Dewey's Death Broadcasted by Wireless	339	Transmitting Set . . . . .	175
Direction Finder of Simple Construction,		Hammond's New Radio Boat Completed	154
A . . . . .	841	Hammond Torpedo Ready to Test . . . . .	431
Distance Determining Apparatus . . . . .	411	Harvard in Preparedness Movement . . . . .	462
Record, New . . . . .	216	Naval Wireless Students at . . . . .	764
Dividend Declared . . . . .	361	Hebden's Loyalty, In Recognition of	
Drifting . . . . .	291	Operator . . . . .	293
Dummy Antennae for Testing . . . . .	663	Herald Station, The Re-Equipment of	
Dyer, (General) Head of New York		the . . . . .	460
State Home Defense . . . . .	546	High Potential Transmitting Condenser,	
Brig. Gen. in Command of Junior		A . . . . .	504
American Guard . . . . .	341	Hostile Communication on Short Wave-	
E			
Earth Connection, An Efficient . . . . .	421	Lengths . . . . .	616
Efficiency Cup, 9 ZF Winner of . . . . .	668	I	
Election Returns First In, Radio . . . . .	266	Ideas by the Thousands, Wireless . . . . .	164
Electrolytic Interrupter, Advice Regarding		Index of Amateur Stations, A Card . . . . .	855
Construction of . . . . .	348	Indoor Aerial, Experiments With . . . . .	116
Electromagnet Can Be Put To Practical		Inductance of Coils, A Convenient	
Use, How the . . . . .	853	Method of Calculating . . . . .	514
Electrometer, Reading Radio Signals		Induction Troubles, Removing . . . . .	498
With the Capillary . . . . .	847	Interstellar Communication, Speculation	
Enemies, The Activities of Alien . . . . .	790	Regarding . . . . .	179
Engineering Study, Military . . . . .	661	Institute of Radio Engineers:	
Equator, Crossing the . . . . .	317	Award of Honor Medal . . . . .	617
Estrada, Licenses for Maria Dolores . . . . .	399	Changes Meeting Place . . . . .	61
Examinations for Radio Operators . . . . .	438	De Groot's Paper . . . . .	240
Taking U. S. Government License . . . . .	838	Paper on Energy Losses . . . . .	179
Exploration, Wireless in Tropical . . . . .	871	Paper by E. H. Armstrong . . . . .	130
F			
Famous Wireless Sets . . . . .	266	Medal of Honor . . . . .	592
Fascination of the Wireless, The . . . . .	309	Washington Section Dinner to Gen-	
Father of Wireless Speaks . . . . .	616	eral Squier . . . . .	541
Fiction:		Insulator, An Aerial . . . . .	678
Flight of the War Birds . . . . .	16	Interference, The Problems of . . . . .	27
The Phantom Call . . . . .	88	Interrupter, Advice Regarding Construc-	
The Mutiny on the Santana . . . . .	169	tion of an Electrolytic . . . . .	348
A Fable . . . . .	513	Inventor, Suggestions and Ideas for the	856
Five-Cent Crystal Holder . . . . .	74	J	
Flashes from Five Vessels in Distress . . . . .	328	Japan, Wireless Linking U. S. to . . . . .	256
Fleming Valve Sustained Over "Audion"		Japanese Ad. of Service . . . . .	640
Valve Controversy Settled by Court	82	Jungle, Bridging Distance in 3,000,000	
Flight of the War Birds . . . . .	16	Square Miles of . . . . .	103
Fort Vaux Received Election News, How		Junior Naval Reserve Camp . . . . .	337
Freak Conditions Prevail, Where . . . . .	566	K	
G			
Gap, An Improvement on the Average		Kennelly, (Prof.) on Legislation . . . . .	568
Spark . . . . .	282	Key, High Speed Vibrating . . . . .	186
Garage, An Electric Truck . . . . .	921	Home-Made Transmitting . . . . .	184
Generator of High Frequency Current,		Knight of the Key, The Boy of Promise	
An Arc . . . . .	583	Who Became A . . . . .	513
German Attack on Sepnavolak Station . . . . .	266	Korea's Last Trans-Pacific Voyage, The	38
Portable Sets in the War . . . . .	283	K P H, An Idyl of . . . . .	427
Stations Jamming . . . . .	66	L	
H			
Law to Compel Ship Installations,		British . . . . .	241
Lawn Fête, Club Gives . . . . .	87		

	PAGE		PAGE
Legislation:		Mexico City, Another Viewpoint on the Station in .....	543
Dangers of the Proposed New Radio Bill .....	374	Reported in Wireless Touch With Berlin .....	462
Government Monopoly or Private Enterprise? .....	651	Military Engineering Study .....	661
Interference Between Stations .....	707	Military Preparedness, Wireless Instruction for:	
Prof. Kennelly Champions Cause of Amateurs .....	568	Article I .....	550
Opposition to Proposed Bill by Prof. Pupin .....	463	Article II .....	624
Some Recommendations for Improved Amateur .....	434	Article III .....	728
The New Radio .....	226	Article IV .....	821
License Examinations, Taking U. S. Government .....	838	Article V .....	892
Lightning Switch for Amateurs.....	416	Monkey Arrives via Wireless .....	10
Lights, Device for Preventing Flickering of .....	504	Motorcycle Equipment, A.....	7
Long Distance Communication and the Work of 5 BV.....	56	Mt. Monadnock, Receiving on.....	8
Distance Transmission on Low Power and Short Wave-Lengths:		Multiplying Wireless by Magic.....	794
Part II .....	33	Myers, Arrest of Ellman B.....	617
Part III .....	106	(Ellman B.) Fined .....	874
Distance Work .....	192, 497	National Amateur Wireless Assn.:	
		Views of Military Camp.....	22
M		Nation-Wide Relay for Members..	80
Making Wireless Sets.....	156	Signal Corps Set of Military Committee .....	200
Manga Reva in Distress.....	329	Commander Todd, a Vice President	284
Marconi Co.—Annual Report of the American .....	597	Coast-to-Coast Relay Plans .....	423
Marconi Co. Asks Million Dollars' Damages from U. S.....	21	Cross-Continent Relay Successful..	471
Marconi Awarded Decision in Audion Case .....	82	Wm. H. Kirwan, Relay Chief (biog.)	422
Marconi Factory, A Visit to.....	156	Trophy Donated by Relay Chief... 491	
Expansion .....	794	The Washington's Birthday Relay..	532
Marconi, Guglielmo:		General Squier Accepts Office....	544
In the Navy .....	65	Monthly Bulletin for July.....	762
On Artillery Fire Direction.....	66	Monthly Bulletin for August.....	841
On More Useful Communication....	265	Monthly Bulletin for September... 936	
On Wilson's Peace Note.....	361	Wireless Class for Women.....	926
An Inventor's Letter to.....	428	National Electric Signaling Co. Sues Atlantic Communication Co. ....	155
His Letter to Ambassador Page....	616	Naval Sensors, Change In.....	216
Credited With U-Boat Destroyer... 667		Expedition in the Congo, With the	11
Man of Action.....	717	Nick-Name, Earning A .....	777
His Message to New York School-boys .....	793	Reserve Enrollment .....	837
Message to Amateurs.....	870	Service Announcement .....	61
"Send the Wireless Men Abroad"...	888	Navy, Amateurs in the .....	596
Marconi Co., Many Sets Ordered from American .....	85	Department Calls for Equipment... 130	
Meets Emergency .....	598	Type Receiving Set, Directions for Making .....	182
Marconi International Marine Communication Co., Report of.....	874	Neptune, A Visit from King.....	875
Marconi's Wireless Telegraph Co., Ltd., Annual Statement of.....	874	News Distributed by Wireless.....	356
Marlboro Club's Anniversary .....	671	Nitrate Plants to be Built by U. S. Government .....	922
Mast, An Amateur's .....	420		
Erection, Overcoming Difficulties of Unique Construction, Description of an Aerial .....	774	O	
Masts Made of Metal, Construction of Light Supporting .....	672	Odds and Ends for Amateur Station... 98	
Medal of Honor, I. R. E.....	592	Old Timer, Random Thoughts of An.. 210	
		Operator and the Tramp, The..... 242	
		Organ, Simple Method for Constructing a Wireless .....	50
		P	
		Pack Set, On the Texas Border With a Panel, How to Make a Highly Polished Black .....	774
		Receiving Set, A New Type of....	53
		Transmitter, A .....	928
		Transmitter, A Small .....	274
		Patents, Thousands of Wireless .....	164
		Paul Reveres of Our Own Time....	196

	PAGE		PAGE
Pearl Shell Stood Up Under the Test, How the .....	756	Wireless Age Index—Aug. 21—rc—Gal Four	Four
Pennsylvania State College Girls Or- ganize .....	769	Rip Van Winkle of Wireless, A Word From A .....	332
Photo Electric Phenomena .....	122	Rotary Gap and Circuit Interrupter, How to Make a Synchronous.....	138
Poem:		Quenched Gap, Design for a Non- Synchronous .....	135
A Song of Wireless .....	426	Russian Revolution, Wireless Gives First Announcement of .....	705
Police Preparedness in New York.....	213	S	
Test of Wireless .....	358	San Diego Station Completed.....	115
Wireless a Demonstrated Success..	684	Wilson Flashes Message to.....	425
Portable Receiving Cabinet.....	417	San Melito, Reward for Operator of...	37
Sets in the War, German.....	283	Sarnoff, (David) Weds.....	803
Tubular Vacuum Valve Receiving Set .....	277	Scandinavian Sends S O S.....	329
Porto Rico, High-Power Station Asked for .....	431	Scriven Retired, Chief Signal Officer..	338
Power, The Future Application of Elec- trical .....	919	Secret Station Discovered .....	660
Powhatan Rescue .....	328	Sepnavolak Station, German Attack On..	266
Priest Who Made a Name in Wireless	118	Sets, Famous Wireless .....	266
Pupin's Attack on Legislation.....	463	Making Wireless .....	156
Pupin, Medal for Prof. ....	432	Share Market, The 61, 115, 216, 265, 387, 471, .....	362 598
Michael I. (biog.).....	664	Shopping by Wireless .....	115
Q		Shunt Box, Construction and Use of a Calibrated Receiver .....	267
Quenched Gap, Design for a Non-Syn- chronous Rotary .....	135	Siasconset Station, Latest Installation at.	2
Queries Answered.....67, 145, 217, 294, 439, 517, 599, 688, 776, 860,	363	Siberia, The Last Voyage of the.....	636
R		Signal Corps in the Field, New York..	436
Radio Cub, How to Conduct A:		On the Border With a Pack Set in the .....	454
Article XXVIII .....	12	Photos of Toronto.....	770
Radium and Wireless in An Experi- ment .....	215	Recruiting for the.....	873
Random Thoughts of an Old Timer...	210	Reserve, Amateurs in the.....	687
Range of Sets, Increasing the.....	846	Set, The Ideal .....	200
Theoretical Determination of Sig- naling .....	483	The War Spirit of the.....	547
Receiver, An Inexpensive Telephone...	854	Work of Ohio .....	196
Receiving Apparatus, Suggestions for Improving the Design of.....	771	Signal Enlisted Reserve Corps.....	719
Cabinet, Portable .....	417	Signal Officers' Training Course:	
Set, A Long Distance.....	676	Army Requirements .....	618
Set, Cabinet .....	414	School of the Soldier.....	720
Set for Damped Waves, A Compact Set for Damped and Undamped Waves .....	933 344	School of the Squad.....	817
Receivers, Novel Design in Bucher's...	715	Reconnaissance and Map Reading..	878
Record Broken in Trans-Atlantic Test..	461	Silver Shell, Under Fire With an Ama- teur on the .....	799
Time, Ship Installations Made in..	459	Speed Records, Some Wireless.....	265
Refugees Aided, Little .....	489	Squier, I. R. E. Dinner to Gen'l.....	541
Regenerative Amplifying Circuit, Results Obtained With A.....	588	(General) Scientist, Inventor and Soldier .....	544
Receiving Set of Compact Design..	849	Static Elimination With Undamped Waves .....	804
Vacuum Valve Panel Set.....	499	Storm Detector, The Wireless .....	388
Regulator, A Vacuum Valve.....	586	Wireless in Gulf.....	15
Relay, A Coast-to-Coast .....	423	Strada's Wireless .....	716
A Record Breaker .....	670	Stratagem, Using S O S in War.....	338
Lines in the Middle West.....	204	Submarine, On the Ship That Sunk a German .....	799
For N. A. W. A. Members, Nation- Wide .....	80	Eluding .....	873
Results of the Presidential.....	285	Suggestions and Ideas for the Wireless Inventor .....	856
Successful Cross-Continent .....	471	Sumner Aground, U. S. A. Transport..	329
The Washington's Birthday .....	532	Switch, A Multi-Contact .....	850
Relays, Plan to Facilitate Amateur.....	491	An Automatic Antenna Change- Over .....	931
Repairs at Sea, Emergency .....	59	Lightning .....	416
Reward for Operator of San Melito....	37	Making an Aerial Change-Over....	498
		Of Simple Construction.....	140

T		PAGE		PAGE
Telephone Conversations, Supposed and Actual .....	775		Typhoons in Oriental Waters, Besting..	330
Telephony, Radio:			U	
Article I .....	248		U-Boat Attacks and Wireless Calls....	62
Article II .....	320		Destroyer, Marconi's .....	667
Article III .....	400		U-53, In the Wake of the .....	193
Article IV .....	472		The Raid of the .....	86
Article V .....	555		Undamped Wave Receiving Tuner, A Compact .....	930
Article VI .....	641		V	
Article VII .....	742		Vacuum Valve Decision to Marconi, Court Awards .....	82
Article VIII .....	808		Regulator, A .....	586
Article IX .....	910		Supplying Current for .....	45
Tennyson, The Seventy-Seventh Voyage of the .....	119		Valve Panel Set, Regenerative .....	499
Timed Spark Tests, Results of Marconi	461		W	
Todd, Commander D. U.....	281		War Activities of Wireless Men, The..	872
Torpedo, Radio Controlled.....	714		Incidents .....	594
Ready to Test Hammond .....	431		The Declaration of.....	614
When My Ship Was Sunk By A....	877		The New Factor in.....	702
Train Dispatching, Wireless Telephone for .....	922		Unusual Employment of Radio in the Will Not Interfere .....	706
Tramp, The Operator and the.....	242		War's Wireless Record, The.....	433
Transformer Coils, A Winding Machine for .....	675		Warfare, The New Factor in.....	792
Transmit Efficiently, How to.....	279		Wave-Length Committee, Work of the..	61
Transmitter, A Panel .....	928		Wilson, Wireless Conveys Re-Election News to .....	265
Of Compactness at Reasonable Cost.	343		Winding Machine for Transformer Coils, A .....	675
Transmitting Cabinet, Instructions for Making a .....	501		Wires for Power Transmission, Iron and Steel .....	918
Key, Home-Made .....	184		Women, Wireless Class for.....	926
Set, An Amateur.....	188		Can Do and Are Doing. What.....	765
Trophy Donated by 9 XE.....	490		Report for Duty, Boston Young.....	769
9 ZF Wins Kirwan.....	668		Students Thank the Marconi Co....	683
Tropical Exploration, Wireless in.....	871		Want Licenses .....	362
Tuner, A Compact Undamped Wave Receiving .....	930		Woman's Work in Wireless .....	690
Inductively Coupled Receiving .....	346		Z	
Of Variable Range, How to Make a Receiving .....	578		Zabriskie, Death of General .....	87
Reconstructed, A Type D.....	180		Zenneck, Arrest of Prof.....	790
			200-Meter Amateur Transmitting Set, A Half-Kilowatt .....	175

# Authors

	PAGE		PAGE
Alexander, Hodge .....	192	Blatterman, A. S.....	33, 106
Alexander, Lot .....	192	Bradshaw, W. ....	773
Applegate, Clyde James.....	332	Brady, J. B.....	55, 164
Armstrong, James B.....	930	Brown, Hugh A.....	514
Ashley, Carlisle M.....	55	Bucher, E. E. 12, 98, 175, 312, 396, 506 550, 624, 728, 821,	892
Ballantine, Charles C.....	274	Cady, W. G.....	116
Ballantine, Charles S.....	483	Clayton, John M.....	56
Barrett, Louis G.....	8	Cobb, Merle A.....	503
Barttro, J. L.....	103	Coleman, John B.....	849
Battin, Clyde R.....	854	Corman, Albert .....	933
Benson, T. W.....	771	Cote, O. E.....	184, 416, 850
Betts, Philander H.....	412	Daly, T. M.....	500
Bison, Carl H.....	343		

	PAGE		PAGE
Dean, Joseph M.....	141	Mapes, Harold T.....	799
Dickow, H. W.....	180	Maxwell, Edward Gwaltney.....	309
Droste, George T.....	454	Maynes, Walter N.....	45
Dye, M. M.....	678	McIlvaine, V. C.....	774
Elenschneider, J. B.....	2	McLean, Blaine.....	266
Eriksen, E. C.....	186	Merry Reginald.....	119
Falconi, Louis.....	583	Miller, J. F.....	775
Farwell, Irving.....	134	Minnium, Byron B.....	282
Fetter, L. E.....	777	Miranda, Maurice Stephens.....	678
Fleming, J. A.....	122	Moore, F. W.....	586
Fowler, F. E.....	586	Murray, A. F.....	348
Fox, Florian J.....	846	Nicholson, K. W.....	279
Gannon, George H. P.....	774	Packman, W. E.....	491
Goldblatt, Leo.....	756	Parks, W. A.....	432
Goldsmith, Alfred N. 248, 320, 400, 472, 742, 808,	910	Perkins, Frank C.....	752
Gould, C. S.....	26	Potts, H. Lawton.....	636
Gray, Erwin F.....	854	Pyle, Howard S.....	350
Hall, Robert.....	504	Reeder, Lattimer W.....	675
Hanson, Oscar B.....	193	Reynolds, E. C.....	504
Harrington, John Walker.....	794	Sandreuter, Stuart.....	344
Harris, Percy W.....	27	Scallon, Francis.....	337
Hartnell, E. H.....	497	Schneider, Alexander.....	291
Hassler, F. A.....	716	Scupholm, F. J.....	499, 588
Hibbs, E. D.....	138	Sidney, Watson.....	877
Hick, Harry R.....	928	Sly, E. E.....	498
Hoagland, Ralph.....	135	Smith, William Lincoln.....	57, 267
Hoffman, Roy.....	852	Sommer, James M.....	501
Hutchinson, Cary T.....	664	Stansfield, A. C.....	775
Jewel, V. C.....	426	Sturley, George.....	277
Jones, J. Edward.....	242	Taylor, David Mann.....	38, 330, 875
Kennedy, Robert.....	182, 513	Tompkins, F. N.....	676
Kirwan, William H. (9 XE) 285, 423, 434,	532	Upton, Albert.....	578
Kluge, Arno A.....	855	Valandi, James W.....	156
Koch, Felix J.....	196	Vaux, Patrick.....	16
Krone, Julian E.....	587	Walden, Edward.....	427
Kruse, S.....	672	Warner, K. B.....	50
Lawrence, W. H.....	388	Werner, Herman Edward.....	847, 931
Le Fevre, Eugene.....	417	West, M. B.....	188, 596
Leigh, Magda.....	88, 169	Werer, J. A.....	140
Lowe, M. B.....	414	White, F. Schuyler.....	346
Lowe, Meredith B.....	421	White, Major J. Andrew.....	618, 720, 817, 878
Maloney, Capt. Robert W.....	436	Whitney, Aubrey.....	420
Manuel, Lloyd.....	210	Wilkins, R. A.....	58
		Woodhouse, Henry.....	833, 905
		Zinn, M. K.....	579

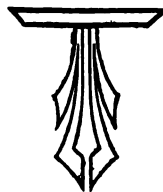

# Queries Answered

Answers will be given in this department to questions of subscribers, covering the full range of wireless subjects, but only those which relate to the technical phases of the art and which are of general interest to readers will be published here. The subscriber's name and address must be given in all letters and only one side of the paper written on; where diagrams are necessary they must be on a separate sheet and drawn with India ink. Not more than five questions of one reader can be answered in the same issue. To receive attention these rules must be rigidly observed.

## Positively no Questions Answered by Mail.

D. R. Z., Savannah, Ga., inquires:

Ques.—(1) What are the fundamental points of the Galletti system of radio telegraphy?

Ans.—(1) To our knowledge, this system is now employed commercially, but some important experimental work has been carried out at stations in France and Switzerland. The Galletti transmitter is energized by high voltage direct current, from 30,000 to 100,000 volts being employed. A number of oscillating circuits are coupled to a common condenser, which are excited alternately in such a way as to afford practically an even or continuous flow of alternating current in the antenna system. In each discharge circuit there are a number of gaps in series which are enclosed in an airtight drum. The gaps are widened out so that no sparking can take place until an additional E. M. F. from an auxiliary apparatus is supplied. By properly timing the auxiliary discharge voltages the sparks discharge successively and a practically continuous flow of oscillations is obtained in the antenna circuit. This method of obtaining sustained oscillations was first employed by Marconi and his assistants.

\* \* \*

R. W., Portsmouth, Ohio, inquires:

Ques.—(1) What is the cause of the peculiar "gurgle" in the tone of the wireless station at Buffalo? I have heard several other sets with practically the same spark tone, but I cannot recollect their call letters at this writing.

Ans.—(1) The note you hear is due to the use of a non-synchronous spark discharger which gives a peculiar musical tone. Usually these dischargers are adjusted to give about 400 sparks a second when the frequency of the alternating current charging the condenser is sixty cycles per second.

Ques.—(2) What station in Canada signs the call letters B Z Q? I first heard this station about six months ago.

Ans.—(2) We have been informed that B Z Q is the British Government station on the Bermuda Islands, but we are not prepared to make any definite statement on this point.

Ques.—(3) Why do commercial wireless telegraph companies use open core transformers in preference to the closed core

type? Furthermore, why is the amateur trade supplied with the closed core type almost exclusively?

Ans.—(3) You will find both the open and closed core transformers used in commercial wireless telegraph apparatus. One reason why the open core transformer was originally adopted lies in the fact that it possessed certain operating characteristics highly desirable for a radio transmitter. You will readily understand this by considering certain phases of the action of a radio transmitter. When the condenser discharges across the spark gap, the secondary winding of the transformer is placed practically on short circuit, and unless there is a certain amount of magnetic leakage in the transformer system there will be an abnormal rise in current which may burn it out. The open core naturally possesses the requisite magnetic leakage and the closed core transformer can be made to have the same operating characteristic, provided the magnetic circuit is fitted with a magnetic leakage gap such as is used on the Clapp-Eastham transformer.

In the Marconi apparatus, the requisite magnetic leakage does not take place at the transformer, but is obtained by a peculiar design of the generator of the motor-generator.

You will find about an equal number of both types of transformers in the Marconi service.

Ques.—(4) Is there any physical examination connected with the Marconi service?

Ans.—(4) The general statement of the applicant for admission is accepted, but if there are any prominent physical deformities, such as loss of arm or limb, or other disfigurement, the applicant will be rejected.

Ques.—(5) What is your idea as to what the status of the wireless amateur will be at the close of the war; that is, the really serious amateur?

Ans.—(5) It is too early to answer this question precisely. We see no reason whatsoever why the original rights of the amateur should not be restored. The amateur station will, of course, always be subject to Government restriction, but we see no reason why amateur stations cannot be allowed to reopen under the same restrictions in force previous to the war.

# BAKELITE-DILECTO

*the Standard Insulating Material for all Radio work.*

Water-proof, permanent, strong, used by all important Manufacturers of Wireless Apparatus, and others requiring the *utmost* in Insulation.

Furnished in Sheets, Rods and Tube.

## The Continental Fibre Co.,

Newark, Delaware

233 Broadway  
New York City

525 Market St.  
San Francisco, Cal.

3325 Michigan Ave.  
Chicago, Ill.

411 S. Main St.  
Los Angeles, Cal.

316 Fourth Ave., Pittsburgh, Pa.

# The Book Everybody Endorses

## Learn to Figure Faster

**THE  
BOOK  
YOU  
WANT**

**THE DEMANDS OF THE DAY REQUIRE IT OF EVERYONE.  
THIS IS AN AGE OF SHORT CUTS.**

The greatest short-cut of any age, the Panama Canal, could not have been completed on time if other short-cuts had not been used in working it out. Labor-saving devices are found on every hand to-day. The successful manufacturer does not hesitate to discard a machine be it ever so new for one that will do the work quicker, cheaper, better. **EVERYBODY USES ARITHMETIC.** Learn the latest and best. It saves time, labor, worry. Don't depend upon a piece of paper or machine to do your figuring when it can be done easier, cheaper, quicker, better by the new simple, short-cut methods of the Prewett system explained in **"HOW TO FIGURE FAST."** Every one likes it and most people need it every day in business regardless of age or vocation. Get out of the rut. Cut out the brain-fagging, nerve-trying, old way of figuring and free yourself forever from the drudgery of cumbersome calculations by learning **"How to Figure Fast."** You will agree with F. M. Marshall, Expert Accountant, who says: "It is the best thing I ever saw." Professor McCallum, Teacher of Mathematics: "It is a

**THE  
BOOK  
YOU  
NEED**

grand work and I want every teacher under me to have one." Thousands of others endorse this little book like G. J. Felix, of Connecticut, who says: "Best book I ever had. Am thoroughly satisfied." The Gulf Coast Lumberman says: "It is the marvel of the age." There are 60 pages of boiled down printed matter with embossed leatherette cover in convenient form for pocket, office or home, sent anywhere upon receipt of \$1— or by parcel post c. o. d., for \$1.10. That Dollar will do you more real good personally than \$100 spent in many other ways. Get your order in the mail to-day and make us both glad thereafter. Circular full of strong testimonials free. Money back if not as represented.

Address  
E. C. ROBERTSON, General Salesman 1408 Prairie Ave., Houston, Texas

# The Book That Counts

F. J., Baltimore, Md., inquires:

Ques.—(1) Will you kindly furnish me with complete information and detailed instruction concerning a  $\frac{1}{2}$  K. W. 500-cycle generator suitable for the operation of a wireless transmitting set? I wish to construct such a generator in order that I may have it ready by the time that amateurs are allowed again to operate their sets.

Ans.—(1) The data you require could only be obtained at a great expense from a designing engineer connected with some reputable concern. We are of the opinion that any electrical supply house or any electrical engineering corporation would supply you with this information provided you were willing to pay for it. You, of course, appreciate that for us to discuss this matter in detail in these columns is impossible because of lack of space. Furthermore, manufacturing concerns are somewhat reluctant to disclose details of construction of these high frequency generators. We believe, however, that if you are willing to pay a fair price for such design, you will be able to obtain it. All in all, you would probably find it just as cheap to purchase a generator of this type as to attempt to construct it, for a special set of jigs and templates would be necessary to carry out the work.

\* \* \*

The "C" Brothers, Newark, N. J., inquire:

Ques.—(1) We note that Mr. Tompkins' article, which won third prize in the June issue of THE WIRELESS AGE, was not accompanied by a wiring diagram. As we desire to construct a receiving set of this type, we should like to see the diagram published.

Ans.—(1) We regret that this manuscript was not accompanied by a diagram of connections, but the designer's idea is clear. The extreme lefthand coil is the primary winding of the receiving transformer and the middle coil the secondary winding. The extreme righthand coil is inductively coupled to the secondary in order to have the wing circuit re-act upon the grid circuit of the three electrode vacuum valve.

\* \* \*

D. M. D., Newark, N. J., inquires:

Ques.—(1) Explain how the logarithmic decrement of damping is measured?

Ans.—(1) A detailed explanation of this measurement would require too much space in these columns, but the subject is taken up in detail in the book, "Practical Wireless Telegraphy." To measure the logarithmic decrement of damping, a wave-meter fitted with some sort of a current indicating device, such as a hot wire ammeter, or a hot wire wattmeter is required. The wave-meter is then placed in resonance with the antenna circuit of a given transmitting set and the condenser is shifted to a capacity above resonance and to a capacity below resonance where the deflection of the indicating instrument is one-half that obtained

at resonance. By noting the three condenser capacities, their values may be inserted in a simple formula, as follows:

$$\delta_1 + \delta_2 = \frac{C_a - C_b}{C_r} \times 1.57$$

Where  $\delta_1$  = the decrement of the circuit under measurement.

$\delta_2$  = the decrement of the wave-meter.

$C_a$  = the capacity of the variable condenser at a point above resonance (as above noted).

$C_b$  = the condenser capacity at a point below resonance (as above noted).

$C_r$  = the capacity of this condenser at resonance.

Generally a table of decrements for the wave-meter at various adjustments of wavelength is furnished, but if not, the decrement of the instrument can be determined by the method shown in "Practical Wireless Telegraphy."

Ques.—(2) What is the value of plotting a resonance curve, and how would you go about it?

Ans.—(2) You should use precisely the same apparatus employed for measurement of the logarithmic decrement. The data for the resonance curve can be obtained by adjusting the wave-meter to various wavelengths on and off resonance, noting at the same time the corresponding deflections of the hot wire wattmeter. To plot a resonance curve, the experimenter should have some knowledge of co-ordinate geometry. The value of such curves lie in the fact that they permit an estimation of the apparent "sharpness" or "broadness" of the radiated wave.

The logarithmic decrement, of course, can be calculated directly from the resonance curve.

Ques.—(3) Where can I obtain a diagram of a modern 2 K. W. 500-cycle transmitting set of the Marconi panel type, and also the Marconi type 103 receiving tuner? Give the function of each part of the transmitter.

Ans.—(3) A complete answer to this query would require all the available space of this Department, and since this information appears in full in the publication, "How to Pass U. S. Government Examinations," also in the text-book, "Practical Wireless Telegraphy," you are referred to either book for further information.

\* \* \*

A. C. A., Evanstown, Wyo., inquires:

Ques.—(1) Please explain how the Marconi magnetic detector works. Is it being displaced in commercial work by the modern crystal rectifiers?

Ans.—(1) The Marconi magnetic detector possesses extreme stability of adjustment, and it is very sensitive at wavelengths of about 2,000 to 3,000 meters. It is





**Super-Sensitive Microphone Only \$7.50**

This instrument is offered at an extremely low price. It is excellent for building your own radio amplifier. Can also be used in many experiments where a sensitive microphone is required.

Send for One To-day and Convince Yourself  
**MICROPHO-DETECTOR COMPANY,**

**Makers of Super-Sensitive Microphone Apparatus**

**Detectagraph \$15**

This detecting instrument of marvelous sensitivity can be used for detecting secret conversations. Outfit consists of Sensitive Transmitter, 25-ft. Black Cord, Receiver, Headband, Case and Battery.

Send for One To-day and Convince Yourself  
**26-28 Corlandt St., New York**



**BIGLOW QUALITY STANDS FOR**

***Tasteful* Printing**

**L. H. BIGLOW & COMPANY 62 BROAD STREET NEW YORK**

**WIRELESS**

**BOOKS, RAW MATERIALS**

While your station is dismantled you can study and build apparatus. Buy from our stocks which we still maintain complete.

The Electro-set Co. now known as  
**THE NEWMAN-STERN CO., Dept. WA-16, Cleveland, O.**

**CORNELL & UNDERHILL**

**NEW YORK**

**Pipe, Boiler Tubes  
 Fittings and Valves**

**Pipe Bending and Fabricating**

**HABIRSHAW**

*"Proven by the test of time"*

**Insulated Wire**

Its world-wide use in every branch of industry recommends it for wireless work wherever insulated conductors are used.

14 B & S Duplex—10 B & S Lead Covered. Aerial—Underground—Submarine.

*For particulars, write*

**THE HABIRSHAW ELECTRIC CABLE CO., Inc.**  
 10 E. 43d St. New York

**DO YOU READ THE  
 WIRELESS WORLD?**

In it you will find articles relating to the PRACTICE of Radioteleg-raphy as well as to the THEORY.

The QUESTIONS and AN-SWERS SECTION is open to YOU for the SOLUTION OF YOUR DIFFICULTIES.

INSTRUCTIONAL ARTICLES for Home Study WRITTEN BY EXPERTS.

REVIEWS OF BOOKS useful to Wireless Students. The interests of Operators are well catered for.

WRITE for a Specimen Copy, post free to

**THE WIRELESS PRESS, Ltd.**

Marconi House, Strand, London, England

"WIRELESS WORLD," \$2.00 per annum for America. Single Copies, 20c Post Paid

Telephone Bryant 5477

**Electrical Industries Mfg. Co.**

328 West 41st St. New York

**MILITARY  
 SIGNAL CORPS MANUAL**

By MAJOR J. ANDREW WHITE

*Chief Signal Officer of the Junior American Guard*

IN PRESS

This manual, the first of its kind, has been prepared for those who will respond to the call to the colors. It contains all the essential information on the broad subject of army signaling, including instruction, field work and tactical employment of visual and electrical signaling methods. Compiled to enable amateur wireless men to qualify for Signal Corps service, in which they may serve most efficiently. It supplies the basis of organization and training for those who will later be eligible for service with expeditionary forces or home defence bodies.

Prepared with the full co-operation and approval of the Chief Signal Officer, U. S. Army.

PRICE NOT FIXED

used on practically all the vessels of the English Marconi Company, being employed largely for obtaining long distance press dispatches. In fact, by the use of the magnetic detector, operators frequently report the reception of signals from South Wellsfleet, Mass., or Poldhu, England, at distances up to 2,200 miles. This proves conclusively that it is a detector which can be relied upon for long distance work. It is found, however, that it is not so sensitive on the shorter range of wave-lengths. However, it is a very satisfactory device for communication up to several hundred miles. There is some argument concerning the principle upon which it works, but it is believed that the incoming oscillations which circulate through the fine wire winding (which is wound over the glass tube through which the iron band circulates) temporarily demagnetize the iron band which causes a change of flux in the small bobbin of wire connected to the receiving telephone. A single sound is therefore produced for each group of incoming oscillations.

Ques.—(2) Is the magnetic detector practical for amateur use?

Ans.—(2) There is no reason why it cannot be employed for amateur use as well as for commercial use. It will be found an extremely interesting detector and possesses the great advantage that it is not affected by the local transmitter. Of course, it is not as sensitive on the lower waves as the better class of crystal rectifiers.

Ques.—(3) Please give the formula for calculating the current in a receiving antenna during normal conditions?

Ans.—(3) We herewith give you the AustinCohen formula which is now generally accepted by radio engineers as correct in the present knowledge of the art:

$$I_r = \frac{635 I_s h_1 h_2}{D \lambda \sqrt{\lambda}} e^{-0.0762 D}$$

Where  $I_r$  = the current in the receiving antenna in microamperes.

$I_s$  = the current in the sending aerial in amperes.

$h_1$  = the height of sending aerial in feet.

$h_2$  = the height of receiving aerial in feet.

$\lambda$  = the wave-length in meters.

$D$  = the distance in miles.

The factor, 635, in the equation is correct for a receiving antenna of 25 ohms equivalent resistance, which is probably a little lower than that obtained in the average amateur land stations. The factor, 0.0762, is the absorption co-efficient; that is, it is the measure of the rapidity with which the waves are absorbed in their travel. This formula is strictly applicable to transmission over sea-water, and has been de-

termined by Professor Taylor and A. S. Elattermann. It is believed to be applicable for transmission overland during the early hours of the evening in the United States.

Ques.—(4) Discarding all guess work, what is the method used in obtaining the difference of intensity of incoming signals?

Ans.—(4) No strictly satisfactory method has been devised so far, but the shunted phone method is employed for most experimental determinations. This method is completely explained in the "Naval Manual" and "Practical Wireless Telegraphy," also in other text-books on the art. A calibrated resistance is connected in shunt to the head telephone and the value of the resistance is gradually decreased until the signals just disappear. If the resistance of the telephone is known, then

$$\text{The current in the receiver} = \frac{R+T}{R} \times C_a$$

Where  $C_a$  = the least audible current required to make a sound in the head telephone;

$R$  = the resistance of the shunt;

$T$  = the resistance of the telephone.

This formula does not take into account the impedance of the telephone receiver windings which, of course, changes with each change of spark frequency at the transmitting apparatus. The use of this method, while not extremely accurate, is, of course, much superior to mere guesswork.

\* \* \*

A. C., Paris, France, inquires:

Ques.—(1) What is the best system for selective tuning consistent with the strength of signals and long distance range? Which gives the best tuning, a two or three-slide direct coupled set, or an inductively-coupled receiving tuner? Why?

Ans.—(1) Equal degrees of selectivity will be obtained with the three-slide tuner or the inductively-coupled transformer, but the inductively-coupled transformer gives the advantage that it is much less difficult to alter the coupling between the primary and secondary windings. With the straight single coil tuner fitted with three sliders, it is necessary to work all three of them to lower the mutual inductance to any degree desired. You will readily understand that the inductively-coupled transformer will be more convenient in this respect.

Ques.—(2) What is the best length and diameter for the primary and secondary windings of a receiving tuner for tuning on all wave-lengths up to 15,000 meters? Please give the length of the coils, the diameter and insulation of the wire and tell me whether or not it should be adjustable by taps or by sliders; how should the current be divided?

Ans.—(2) The dimensions of this tuner will depend very largely upon the type of

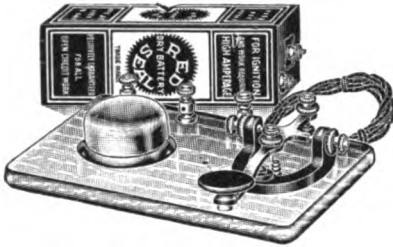

**TELEGRAPH PRACTICE SET  
FOR LEARNING THE TELEGRAPH CODES**

The Practice Set comprises a regular telegraph key, without circuit breaker, a special high pitch buzzer, one cell Red Seal Dry Battery, and four feet of green silk covered flexible cord. The main object of the set is to enable the beginner to master the various codes. The buzzer reproduces the sound of the air signals of the most modern telegraph stations perfectly.

- List No. Price  
 342. Practice Set, with Battery and Cord . . . \$2.70  
 344. Practice Set only, no Battery or Cord . . . 2.55

Send for Copy of Our New Catalog N 28, 248 Pages, Ready About Sept. 1st.

**MANHATTAN ELECTRICAL SUPPLY CO., Inc.**

17 Park Place, NEW YORK 114 S. 5th Ave., CHICAGO 1106 Pine St., ST. LOUIS 604 Mission St., SAN FRANCISCO

*"THERE'S MONEY IN IT"*

**AT HOME LEARN TELEGRAPHY AT HOME**

**MORSE AND WIRELESS**

**TEACH YOURSELF**



In half usual time, at trifling cost, with the wonderful Automatic Transmitter, **THE OMNIGRAPH**. Sends unlimited Morse or Continental messages, at any speed, just as an expert operator would. *Adopted by U. S. Government. 4 styles. Catalogue free.*

**OMNIGRAPH MFG. CO., 39-C. Cortlandt St., New York**



*Brandes  
"Superior"  
Head Set  
Price, \$5.50*

**Try for Better Wireless Results;  
We'll Take All Risk**

**GET** yourself a Brandes Wireless Head Set. Then go after those weak, far-away signals that have been eluding you. Go after the long-distance records.

If our wireless receivers don't show up better than any receivers you compare them with, send them back within ten days and we'll return your money without a question.

**MATCHED TONE** is the scientific reason for Brandes supremacy. Send 4c today for Catalog W, which tells about Brandes Receivers.

C. BRANDES, Inc., Wireless Receiver Specialists, Room 818, 32 Union Square, New York.

**BRANDES**  
**WIRELESS HEAD SETS**

*The Receivers with Matched Tone*

**SILVER**

FOR

**Spark Gaps or  
Contacts**

*We can furnish immediately:*

Pure silver for sparking purposes on quenched spark gaps.

Sterling silver for contacts on sending or relay keys.

Pure granulated silver for coatings on Leyden Jars.

*Ask for our prices*

**CHAS. S. PLATT CO.**

29 GOLD STREET NEW YORK CITY

receiving aerial with which it is to be employed. If you should include all the primary and secondary inductances in the coupler, the tuner would be rather inconvenient to manipulate. Therefore we recommend that the primary winding be about 14 inches in length and  $6\frac{1}{2}$  inches in diameter. The secondary winding should be 14 inches in length by 6 inches in diameter.

The primary coil should be wound with No. 24 S. S. C. wire and the secondary coil with No. 32 S. S. C. A loading coil, about 18 inches in length and 6 inches in diameter, wound with No. 32 wire, should be included in series with the secondary winding. The dimensions of the primary winding will vary according to the size of the antenna, and consequently the exact values of inductance will have to be determined by experiment. It makes practically no difference whether the inductance of these two windings is varied by a multi-point switch or by a sliding contact, but the multi-point switch is preferred because it does not wear off the wires.

It is customary in the United States to insert a variometer inductance in series with the receiving antenna and then fit the primary winding with a simple multi-point switch, each of the taps for which are attached about one-half inch apart on the primary winding.

It is not necessary to tap the secondary winding more often than by spaces of 1 inch.

The necessary fineness of adjustment in the secondary circuit is obtained by a variable condenser connected in shunt.

Ques.—(3.) Which method of connection in the receiving apparatus do you prefer: to connect a crystal detector in series with the head telephone, or to place the head telephone in shunt to the crystal detector?

Ans.—(3) In the majority of cases, a louder signal will be obtained with the telephone in series with the crystal and shunted by a telephone condenser. This has been explained by one writer as being due to the fact that the flow of radio-frequency currents in the secondary winding of a receiving tuner is invariably accompanied by harmonic currents, and when the condenser is thus connected in shunt to the head telephone, all these harmonic currents are collected as well as the fundamental current; therefore an increase in the strength of signals is obtained. We are not prepared to say that these are the actual facts of operation but they represent one theory which has been set forth.

Ques.—(4) What do you consider the best resistance for each receiver of a head telephone?

Ans.—(4) General practice seems to indicate that 1,500 ohms for each headpiece are sufficient.

Ques.—(5) For the adjustment of receiving apparatus, do you prefer a receiving

tubular adjustable condenser, or a rotary variable condenser?

Ans.—(5) Generally the rotary variable condenser is more convenient to operate, but equal strength of signals will be obtained with either type provided identical values of capacity are used.

A. T. R., Wisconsin:

The diagram you forwarded concerning the dimensions of the radio-frequency amplifying circuit shown in the January, 1916, issue of THE WIRELESS AGE has just come under our observation. Referring to the notations on your drawing: The coils, L-7 and L-8, are in variable inductive relation, also the coils, L-5 and L-6. Their dimensions should be such that the circuit, L-7, C-3, L-6, is in resonance with the circuit, L-2, C-6, L-3.

The coils, L-3 and L-4, can approximate the dimensions used in the average amateur coupler for tuning up to 3,000 meters. Similar dimensions would apply to the coils, L-5 and L-6. The dimensions of L-1 and L-2 will, of course, vary with the dimensions of the antenna and for response of signals up to 10,000 or 12,000 meters, the primary winding should be 14 inches in length and  $6\frac{1}{2}$  inches in diameter, wound with No. 24 S. S. C. wire. The secondary winding should be 14 inches in length, 6 inches in diameter, wound with No. 32 S. S. C. wire. Small loading coils would then be required in both the primary and secondary circuits. The secondary loading coil should be from 12 to 18 inches in length and about 6 inches in diameter, wound with No. 32 S. S. C. wire.

If this apparatus is to be used on the shorter range of wave-lengths up to 3,000 meters, you will be able to obtain the dimensions of such a coupler from the book, "How to Conduct a Radio Club" and also from previous issues of THE WIRELESS AGE.

\* \* \*

H. S. A., Operator, Spokane:

We cannot agree with you that the placing of soap on the spark gap electrodes is good practice, and we urge that it be discontinued in commercial work. The effect of placing soap on the spark electrodes is about the same as using a very fine pointed electrode, namely, the spark note is increased thereby because the discharger points are not blunt. Under the heat of the spark discharge, the soap volatilizes and therefore offers less resistance to the condenser discharge, but this does not necessarily imply that the effectiveness of a transmitting set is thereby increased. As a matter of fact, the amplitude of the antenna current may be decreased. Of course, increased response is obtained in the receiving telephone by the use of a musical spark note, and operators should do everything possible to maintain clear notes. In fact, a greater volume of sound will be obtained in the average receiving telephone when

**B**ATTERIES manufactured by the Electric Storage Battery Company have been used in Wireless Service since its first successful introduction.

The dependability of the "Exide" battery for this very important class of service is illustrated in its use by the U. S. Navy and many large steamship companies.

## THE ELECTRIC STORAGE BATTERY CO.

1888—PHILADELPHIA, PA.—1917

New York  
Chicago  
Boston

Cleveland  
St. Louis  
Kansas City

Denver  
Detroit  
San Francisco

Rochester  
Atlanta  
Washington

Minneapolis  
Pittsburgh  
Toronto

Tel. Madison Sq. 726

## Charles F. Campbell

**ELECTRICAL  
SUPPLIES**

WHOLESALE AND RETAIL

14 West 31st St. New York  
Bet. Broadway and Fifth Ave.

Established 1905

## THE LUZERNE RUBBER CO.

Manufacturers of Fine Quality

## HARD RUBBER GOODS

STANDARD AND SPECIAL

Main Office and Factory:

TRENTON      :-      :-      NEW JERSEY

**A. J. Cox & Company**

WESTERN REPRESENTATIVES

28 South Jefferson Street      CHICAGO, ILL.

## New Undamped Wave Coupler No. 749 Special Introductory Price \$18.00

32 in. long, 10 in. high and 9 in. wide over all. On average sized Aerial, tunes to 15,000 meters. Used with the new CHAMBERS CIRCUIT, will bring in signals from all local and long-distance Undamped Arc Stations without the use of Loading Coils, or Oscillating Coils; as they are sometimes called. Lose no time placing your order, or you will miss a great offer.

CHAMBERS' CIRCUIT is entirely new, and think of it! No extra Coils to pay for, and price of Coupler only \$18.00.

Write for descriptive matter.

**F. B. CHAMBERS & CO.**

2046 Arch St.      Phila., Pa.

## VALEAU FILES

*For the Exacting File Users*

Those whose file requirements are unusually severe always specify VALEAU after using them once. They are made of the best steel.

We have a large stock of all shapes and sizes ready for prompt shipment.

If you want a better file than you are now using—try the

VALEAU

**T. P. WALLS T. & S. CO.**

75 Walker St.      New York City

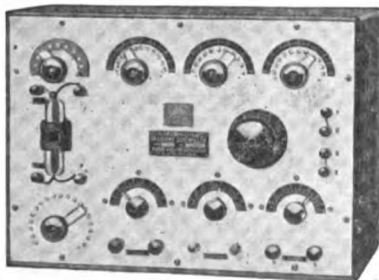

## MIGNON UNDAMPED WAVE WIRELESS APPARATUS

AMATEUR and COMMERCIAL USE

This latest Mignon invention is entering a new field in Radio Engineering, eliminating the so familiar LOOSE COUPLERS and LOADING COILS, and introduces adjustable DISC-CORES, heretofore considered impossible. DISTANCE RANGE UNLIMITED.



WRITE FOR CATALOGUE

**Mignon Wireless Corporation**

ELMIRA, N. Y., U. S. A.

AND MENTION WIRELESS AGE

the spark discharge is uniform rather than rough or irregular, but there is nothing in the instructions issued by the Marconi Company permitting an operator to use soap or any other volatile substance on the electrodes of the spark gap.

\* \* \*

A. B. J., Warren, Pa.:

Your questions concerning the diagrams and the mode of operation of certain receiving apparatus evidently refer to various forms of regenerative circuits in use, although you did not make this clear. We therefore advise you to purchase a copy of the third revised edition of the book, "How to Conduct a Radio Club" and note therein a complete set of diagrams for the various types of such circuits. These are also shown in "Practical Wireless Telegraphy." Further diagrams will be found in the September, 1915, issue of the Proceedings of the Institute of Radio Engineers.

\* \* \*

A. B. Q., Boston, Mass.:

The results of Dr. Austin's experiments with receiving detectors follow: At the wave-length of 900 meters, it was found that it required 2.1 times as much energy to make an audible sound in the receiver with the magnetic detector as with the zincite-bornite detector. It was also shown that the magnetic with the telephone circuit tuned to the spark frequency of the transmitter gave signals one and one-half times as strong as the zincite-bornite detector at the wave-length of 3,000 meters. At the wave-length of 350 meters the zincite-bornite combination was nearly five times as sensitive as the magnetic detector. Whether the results of this investigation would apply to all types of receiving circuits now in use we are unable to say. This merely represents a single set of measurements taken under a given set of operating conditions which may not always be duplicated in actual practice.

\* \* \*

T. B. R., Omaha, Neb.:

There is a distinct difference between a starting box and a speed-controlling rheostat. The resistances of a starting box are only intended for temporary use and if they are allowed to remain in the circuit for several minutes, the coils will doubtless burn out. The speed controlling rheostat, however, is of such resistance and has such an amount of heat radiating surface that it will withstand a continuous flow of current without burning out. The handle of the speed controlling rheostat may be placed at any desired contact point and left there indefinitely.

The motor-generators of commercial wireless telegraphy employ differential and plain shunt wound motors. In cases where very careful speed regulation is required, the differentially wound motor is used.

The Robbins and Meyers motor-generators have an accumulative compound generator field which is intended to give a regulation of the A. C. voltage under load.

You are quite right in believing that 500-cycle generators are of special design. In fact, those used in connection with quenched spark transmitters have special operating characteristics which are not found in the ordinary type of generator. Generally the method of designing these machines is withheld by the manufacturer, and complete details are not available for publication.

The permeability of a good grade of soft wrought iron is sometimes three thousand times that of air, but, of course, it varies with the quality.

\* \* \*

B. D. H., St. Louis, Mo.:

The apparent current of an alternating current circuit having self-induction is sometimes considerably greater than the actual current depending upon the value of the inductance. The apparent current, however, determines the heating effect, and the conductors must be made large enough to take care of its value even though it represents partly a "wattless component" or "idle" current.

\* \* \*

N. R. A., Montreal, Canada:

The safe current carrying capacity of .000 B. & S. wire with rubber insulation is 210 amperes and with other insulation 312 amperes. A cable of 1,000,000 circular mils will carry a current of 1,000 amperes. No. 18 B. & S. wire will carry 3 amperes with rubber insulation and 5 amperes with other insulation. Tables showing the safe current carrying capacity of various wires can be obtained from the fire underwriters in your city.

Slow burning wire generally consists of a copper conductor covered with several layers of cotton or thread, which is saturated with a fireproof compound. Wires of this type are generally employed for work behind switchboards or in places where several copper conductors are grouped together in a small space.

In designing a wireless telegraph transmitter to radiate a definite wave, it is, of course, best to begin with the antenna, giving it such dimensions that a small amount of inductance can be inserted in series to act as the secondary winding of the oscillation transformer. Generally it is not feasible to boost the natural wave-length of an aerial to twice its value because beyond this point the insertion of inductance is apt to reduce the flow of current. The dimensions of the aerial having been decided on, the power of the set must next be taken into consideration. With 500-cycle generators, 2 K. W. can be easily handled at the wave-length of 600 meters. As a matter of fact, it would be possible to take care of 3 or 4 K. W. at this wave-length, but it would be rather difficult to handle



We have now in stock and ready for immediate delivery

## PRACTICAL WIRELESS TELEGRAPHY

By **ELMER E. BUCHER**

*Instructing Engineer of the Marconi Company*

This book is the last word in wireless text books. It furnishes much information of utmost value in regard to the very latest styles of wireless sets now in use, and which has not appeared in print before.

PRACTICAL WIRELESS TELEGRAPHY is the first wireless text book to treat each topic separately and completely, furnishing a progressive study from first principles to expert practice. Starting with elementary data, it progresses, chapter by chapter, over the entire field of wireless—fundamentals, construction and practical operation.

Three chapters are devoted entirely to basic electrical principles. The motor-generator, the dynamotor and rotary converter are treated in detail. The nickel-iron and lead plate storage batteries, now supplied for emergency purposes with all commercial radio equipments are the subject of an entire chapter, a description of the apparatus associated with the charging of batteries and complete instructions for their care being furnished.

The radio transmitter is treated both in theory and in practice. The book contains complete diagrams, photographs and descriptions of modern commercial marine transmitters and instructions for the adjustment and operation of the apparatus. Receiving apparatus is treated in like manner, descriptions and working instructions being given for all types of up-to-date receiving sets, including the two and three-electrode valves.

A full chapter is devoted to practical radio

The 340 illustrations alone, specially drawn, form a complete diagrammatic study and impress upon the reader's mind a pictorial outline of the entire subject. Many of these illustrations reveal details of construction of the newest types of sets and apparatus never before published.

PRACTICAL WIRELESS TELEGRAPHY is a practical man's book from cover to cover and *up to the minute*. Size 330 pp. 6 x 9 inches, handsomely bound in full cloth with cover stamping in gold and black.

Price \$1.50 net. Mailing weight 2 lbs.

Postage as per schedule on second page.

*This volume has been a very expensive one to prepare. Ordinarily it would be priced at \$2.50, but to meet the requirements of students and amateurs for a moderate priced, up-to-date text the lower price has been fixed.*

Specialists in  
Wireless Literature

Wireless Press, Inc.

42 BROAD ST.  
NEW YORK, N. Y.



We supply all books, in print, at publisher's prices, whether issued in the U. S. A. or imported. Please add charges for postage or expressage to remittances.

**RATE TABLE FOR PARCEL POST SHIPMENTS**

All books sent by mail take parcel post rates. Packages up to 4 ounces in weight are carried at the rate of 1 cent an ounce, regardless of distance. Packages over 4 ounces are charged for by the pound. The rate per pound varies according to the distance, which is measured by the Government zone system, each zone covering a certain number of miles from point of shipment. Distances and rates are shown in the table below. Books carried by parcel post are handled just like any other mail matter. They are delivered to your box by your rural mail carrier if you live on a rural route, or delivered to your door if you live in a city where there is carrier service, or delivered to your local postoffice if you live where there is no carrier service.

Weight of Package	LOCAL ZONE	ZONES 1 AND 2	ZONE 3	ZONE 4	ZONE 5	ZONE 6	ZONE 7	ZONES
	For Shipments From Our Store in New York to Customers within New York.	Not Over 150 Miles From New York.	151 to 300 Miles From New York.	301 to 600 Miles From New York.	601 to 1,000 Miles From New York.	1,001 to 1,400 Miles From New York.	1,401 to 1,800 Miles From New York.	Over 1,800 Miles From
	Charges Required	Charges Required	Charges Required	Charges Required	Charges Required	Charges Required	Charges Required	Charges Required
Over 4 oz. up to 1 lb...	5c	5c	6c	7c	\$0.08	\$0.09	\$0.11	\$0.12
Over 1 lb. up to 2 lbs..	6c	6c	8c	11c	.14	.17	.21	.24
Over 2 lbs. up to 3 lbs..	6c	7c	10c	15c	.20	.25	.31	.36
Over 3 lbs. up to 4 lbs..	7c	8c	12c	19c	.26	.33	.41	.48
Over 4 lbs. up to 5 lbs..	7c	9c	14c	23c	.32	.41	.51	.65
Over 5 lbs. up to 6 lbs..	8c	10c	16c	27c	.38	.49	.61	.73
Over 6 lbs. up to 7 lbs..	8c	11c	18c	31c	.44	.57	.71	.84
Over 7 lbs. up to 8 lbs..	9c	12c	20c	35c	.50	.65	.81	.96
Over 8 lbs. up to 9 lbs..	9c	13c	22c	39c	.56	.73	.91	1.08
Over 9 lbs. up to 10 lbs..	10c	14c	24c	43c	.62	.81	1.01	1.20

To points where parcels post charges exceed 8c per lb. books will be forwarded by BOOK EXPRESS, at the rate of 8c per lb.

Include the amount for postage charges in the money order, check or currency you send us. This charge for mailing must be paid in advance as the Government has not provided for the collection of mailing charge on delivery. If in doubt as to what amount is required for any order you are perfectly safe in adding even more than you think necessary, for we will ship by the most economical method and will return you any amount that is left over.

Within Local Zone and Zones 1 and 2 packages up to 50 pounds in weight are carried. The limit of weight for all other zones is 20 pounds.

**STANLEY, RUPERT, B. A., M. I. E. E.,** Professor of Physics and Electrical Engineering, Municipal Technical Institute, Belfast.

**TEXT-BOOK ON WIRELESS TELEGRAPHY**

A Text Book for students with no previous knowledge of electrical matter; covers the technics and construction of all apparatus used in the principal Systems of Wireless Telegraphy. It deals with simple scientific facts concerning matter, air and ether, leading up to electrical and magnetic phenomena, explained on the modern electron theory in such a way that it can be easily understood.

Each chapter is followed by questions and examples; these enable the reader to test and revise his knowledge of the subject matter of the chapter. These questions will prove useful to teachers and students. The book is illustrated by over 200 diagrams and views; it also contains a very complete chapter on Tests and Measurements.

**CONTENTS**—The Earth, the Atmosphere and the Ether—Matter and Electrons—Magnetism and Magnetic Strains in the Ether—Electricity and Electric Strain in the Ether—Electrical Measurements and Calculations—Capacity and Induction Effects—Induction Coils, Alternators and Transformers—Oscillatory Discharges—Historical Development of Radio-Telegraphy—How Ether Waves are Propagated and Received—Coupling of Circuits—Transmitter Circuits for Spark Systems—Transmitting Apparatus—

Aerials, Insulators and Earth Connections—Receiver Circuits—Detectors—Receiving Circuit Apparatus—Undamped Wave Systems—Miscellaneous Apparatus, Measurements in Radio-Telegraphy.

**APPENDICES**—International Morse Code—Call Letters of British Stations—Extracts from the International Radio-Telegraphic Regulations—Eiffel Tower Time Signals and Weather Reports—Index.

Cloth Svo. 340 pages. Illustrated. PRICE \$2.25 net. Mailing weight 3 lbs. Add book postage as per schedule on second page.

Specialists in  
Wireless Literature

**Wireless Press, Inc.**

42 BROAD ST.  
NEW YORK, N. Y.





**FLEMING, J. A., M. A., D. Sc., F. R. S.,** Professor of Electrical Engineering in the University of London, Member of the Royal Institution of Great Britain.

**Elementary Manual of  
RADIOTELEGRAPHY AND RADIOTELEPHONY  
For Students and Operators.**

This book contains complete information to enable students and operators and amateurs familiar with the elementary facts of electricity and magnetism to master RADIOTELEGRAPHY and RADIOTELEPHONY. It explains the scientific principles underlying the Radio art in a manner suitable for students, operators and amateurs and general readers. "WIRELESS" has gained such importance in Naval and Military signalling and in marine and land communication that adequate means of teaching the subject to electro-technical students and practical operators and amateurs are required. Dr. Fleming's book meets that demand.

**CONTENTS**—Electric Oscillations and Electric Resonance—Damped Electric Oscillations—Undamped Electric Oscillations—Electromagnetic Waves—Radiating and Receiving Circuits—Oscillation Detectors—Radiotelegraphic Stations—Radiotelegraphic Measurements—Radiotelephony.

**THIRD EDITION, REVISED AND ENLARGED.**

Cloth 8vo. 360 pages. Many illustrations and diagrams. PRICE \$2.00 net. Mailing weight 2 lbs. With one year's subscription to THE WIRELESS AGE, \$3.50.

Add book postage as per schedule on second page.

**FRANKLIN, WM. S., AND MacNUTT, BARRY  
ADVANCED THEORY OF ELECTRICITY AND MAGNETISM**

*A Text Book for Colleges and Technical Schools.*

To make the study of theoretical physics something besides a purely formal mathematical exercise, it is necessary to keep physical things always clearly and vividly in mind. It is comparatively easy to do this in the study of applied science, but it is extremely difficult to do it in the study of many of the unfamiliar topics which are here discussed. The character of the treatment in this book has been determined throughout by the desire to keep the student's mind concentrated upon physical things.

Cloth 8vo. 300 pp. illus. PRICE \$2.50 net. Mailing weight 2 lbs.

Add book postage as per schedule on second page.

**HAUSMANN, ERICH**

*Assistant Professor of Physics and Electrical Engineering, Polytechnic Institute of Brooklyn.*

**TELEGRAPH ENGINEERING**

**A Manual for Practicing Telegraph Engineers and Engineering Students.**

**CONTENTS**—Simplex Telegraphy—Duplex Telegraphy—Quadruplex Telegraphy—Automatic and Printing Telegraph—Telegraph Office Equipment and Telegraph Traffic—Miscellaneous Telegraphs—Municipal Telegraphs—Railway Signal Systems—Telegraph Lines and Cables—Theory of Current Propagation in Line Conductors—Submarine Telegraphy—Tables.

Presents in a logical manner the subject of modern overland and submarine telegraphy from an engineering viewpoint, its theoretical and practical aspects being correlated.

Cloth 8vo. 416 pp. PRICE \$3.00 net. Mailing weight 2 lbs.

Add book postage as per schedule on second page.

**HAWKHEAD, J. C., AND DOWSETT, H. M.  
HANDBOOK OF TECHNICAL  
INSTRUCTION FOR WIRELESS  
TELEGRAPHISTS**

Arranged to meet the requirements of candidates for appointment as sea or land operators and other students of wireless telegraphy. It enables the sea operator particularly to fully master all details of the construction, efficient operation and maintenance of his station.

Completely revised and up-to-date, with full description of both new and old types of apparatus.

**CONTENTS**—Preliminary Considerations—Primary Cells—Accumulators—Current Electricity: Its Laws and Units—Magnetism—Electro Magnets—Dynamo, Motor, Rotary Converter—Inductance—Direct and Alternating Current Measurements—Condensers—Electromagnetic Waves—The Receiving Circuit— $1\frac{1}{2}$  K.W. Sets—Emergency Transmitting Apparatus—The  $1\frac{1}{2}$  K.W. Aerial— $\frac{1}{2}$  K.W. Sets—5 K.W. Sets—Portable Sets—Faults.—INDEX.

Cloth. 309 pp. illus. PRICE \$1.50 net. Mailing weight 2 lbs.

With one year's subscription to THE WIRELESS AGE, \$3.00.

Add book postage as per schedule on second page.

**PROCEEDINGS OF THE INSTITUTE  
OF RADIO ENGINEERS**

**Giving Every Modern Improvement and Advance. Always up-to-date.**

The most recent inventions in radio telegraphy and telephony are accurately and fully described by the engineers who discovered them.

There is no better way of following the trend of radio work than thru its pages.

Svo. 600 pp. Buckram Binding. Price \$7.00 net.

With One Year's Subscription to THE WIRELESS AGE, \$8.50.



**BANGAY, R. D.**

## ELEMENTARY PRINCIPLES OF WIRELESS TELEGRAPHY

NEW EDITION, THOROUGHLY REVISED AND ENLARGED.

This book explains in the simplest manner the theory and practice of wireless telegraphy. It makes the subject intelligible to those who possess limited technical knowledge and is adapted particularly to the needs of students, amateurs and Boy Scouts.

**CONTENTS**—Morse Code—Symbols Used in Diagrams—Electricity and Magnetism—Magnetism—The Principles of Wave Motion—Pressure Waves—Production of Electric Waves—Production of Oscillating Currents in an Aerial—Coupled Oscillatory Circuits—The Wavemeter—Wireless Telegraph Receivers—The Tuning Busser—The Magnetic Detector "Atmospherics"—Aerials—Index.

Cloth. 212 pp. Many illustrations. PRICE 75c net. Mailing weight 1 lb.  
With one year's subscription to THE WIRELESS AGE, \$2.00.

*Add book postage as per schedule on second page.*

**GOLDSMITH, ALFRED N., Ph. D.,** of the Institute of Radio Engineers and College of the City of New York.

## RADIO TELEPHONY

Dr. Goldsmith has been engaged for years in exhaustive research in this field, and gives complete descriptions of all existing operative systems of wireless telephony. He has secured large numbers of new photographs and wiring diagrams, previously unpublished. All this valuable material is available FIRST to the readers of THE WIRELESS AGE, in which the entire series, profusely illustrated, is now being published. All professionals and amateurs who hope to be able to carry on wireless telephony and stay at the front of the "radio procession" need this book.

### A Partial Summary of Topics

#### WORLD ASPECTS

#### PERSONAL ASPECTS

#### USES OF RADIO TELEPHONY

- a) Ship-to-ship and ship-to-shore
- b) Trans-oceanic and trans-continental
- c) Exceptional regions
- d) Train-to-train or train-to-station
- e) Underground, aeroplane, submarine, etc.

#### RADIO VERSUS WIRE TELEPHONY

- a) For land telephony
- b) For oversea telephony

#### BROAD PROBLEMS INVOLVED IN RADIO TELEPHONY

- a) Radiation of modulated energy
- b) Causes of speech distortion
- c) Distortion of "non-linear" type
- d) Secrecy in radio telephony
- e) Strays

#### SUSTAINED WAVE GENERATORS

- a) Arcs
- b) Radio-frequent sparks
- c) Vacuum tube oscillators
- d) Alternators of radio frequency

#### MODULATION CONTROL IN RADIO TELEPHONY

- a) Microphone transmitter
- b) High current microphones
- c) Vacuum tube types
- d) Magnetic amplifiers and other controls
- e) Combination systems
- f) Comparison of control systems

#### ANTENNAE AND GROUNDS

- a) For transmission
- b) For reception

#### RECEIVING SETS

- a) Proportional response
- b) Selectivity vs. aperiodicity
- c) Sustained wave beat interference
- d) Heterodyne radiophonic reception
- e) Stray interference
- f) Telephone receivers
- g) Range in radio telephony

#### RADIOPHONE TRAFFIC AND ITS REGULATION

- a) Long distance
- b) Ship-to-ship and ship-to-shore
- c) Two-way radio telephony

#### FUTURE DEVELOPMENT OF RADIO TELEPHONY

Cloth 8vo. Fully illustrated. PRICE—In advance of publication only—\$1.25. Mailing weight 2 lbs.  
With one year's subscription to THE WIRELESS AGE, \$2.50.

*Add book postage as per schedule on second page.*

Specialists in  
Wireless Literature

Wireless Press, Inc.

42 BROAD ST.  
NEW YORK, N. Y.



# The Wireless Man's BOOKSHELF



**FLEMING, J. A., M. A., D. Sc., F. R. S.,** *Professor of Electrical Engineering in the University of London, Member of the Royal Institution of Great Britain.*

## THE PRINCIPLES OF ELECTRIC WAVE TELEGRAPHY AND TELEPHONY

The author deals with principles rather than details of apparatus. He gives a comprehensive view of the subject particularly on its scientific side, and that part of it which is concerned with quantitative measurements and the underlying theory. The immense attention which has been given to this attractive subject is a consequence of the interesting physical and important practical aspects of it, and no one at present can add to it who has not a firm grasp of the electrical principles and facts which lie at its root, as well as broad acquaintance with inventions and discoveries.

This third edition has been in great part, re-written and rearranged. A new chapter has been added on the Transmission of Radio-telegraphic Waves over the earth. Much of the merely historical portions and of the descriptions of apparatus which had become antiquated, has been removed. Sufficient, however, has been kept to enable the student to appreciate the development of the subject.

**CONTENTS**—The Production of High Frequency Currents and Electric Oscillations—High Frequency Electrical Measurements—Damping and Resonance—Stationary Electric Waves on Wires—Electric Radiation—Detection and

Measurement of Electric Waves—The Apparatus of Electric Wave Telegraphy—Radiotelegraphic Stations—Radio-telegraphic Transmission—Radio-telephony.

**Cloth Svo. 912 pages. Many illustrations. PRICE \$10.00 net. Mailing weight 5 lbs.**

*Add book postage as per schedule on second page*

**KENNELLY, A. E. A. M., Sc. D.,**

*Professor of Electrical Engineering in Harvard University.*

## WIRELESS TELEGRAPHY AND TELEPHONY

Gives in simple language an explanation of electro-magnetic waves and their propagation through space; also the fundamental and essential principles of both wireless telegraphy and wireless telephony. A complete, authoritative and popular presentation of these latest of modern scientific wonders, down to their latest developments.

**CONTENTS**—Introductory—Waves and Wave-Motion—Magnetism and Electricity—Electromagnetic Waves Guided Over Conductors—Electromagnetic Waves Guided by Single Wires—Radiated Electromagnetic Waves Guided by the Ground—Unguided or Spherically Radiated Electromagnetic Waves—Plane Electromagnetic Waves—The Simple Antenna or Vertical Rod Oscillator—Electromagnetic Wave-Detectors or Wireless Telegraph Receivers—Wireless Telegraph Working—Tuned or Selective Signaling—Measurements of Electromagnetic Waves—Industrial Wireless Telegraphy—Considerations Preliminary to Wireless Telephony—The Principles of Wire Telephony—Principles of Wireless Telephony.

**Revised and Enlarged Edition.**

**Cloth. 279 pp. Illus. PRICE \$1.25. Mailing weight 2 lbs.**

**With one year's subscription to THE WIRELESS AGE, \$2.50.**

*Add book postage as per schedule on second page.*

**MORGAN, ALFRED P.**

## WIRELESS TELEGRAPH CONSTRUCTION FOR AMATEURS

**Build Your Own Wireless Outfit**

Shows you how to construct various outfits capable of receiving from 100 to 1500 miles and transmitting from 3 to 100 miles, giving in minute detail complete directions for the construction of each part. Also clearly explains the purpose and action of each instrument with directions for operating and testing, etc.

Its thoroughness is a feature not often shown in such books; this together with its splendid treatise of wireless along constructive lines makes it the ideal book for an amateur. It embodies all improvements and changes which have taken place. Photographs and working drawings of a great many new instruments accompanied by full descriptive matter explaining the construction of new types of apparatus, and a full copy of the Wireless Law is included.

**CONTENTS**—Introductory—The Apparatus—Aerial and Earth Connections—Induction Coils—Interrupters—Transformer—Oscillation Condensers and Leyden Jars—Spark Gaps or Oscillators—Transmitting Helices—Keys—Aerial Switches and Anchor Gaps—Hot Wire Ammeter—Oscillation Detectors—Tuning Coils and Transformers—Receiving Condensers—Telephone Receivers and Headbands—Operation—The Amateur and Wireless Law—What it is—How to Comply—How to Secure a License—Appendix—Index.

Every wireless amateur or experimenter should have a copy of this splendid book. Send for a copy to-day.

**Revised and Enlarged Edition.**

**Cloth. 225 pp. 167 Illus. PRICE \$1.50. Mailing weight 2 lbs.**

**With one year's subscription to THE WIRELESS AGE, \$2.50.**

*Add book postage as per schedule on second page.*

Specialists in  
Wireless Literature

Wireless Press, Inc.

42 BROAD ST.  
NEW YORK, N. Y.



**PIERCE, GEORGE W., A.M., Ph.D.,**

*Assistant Professor of Physics in Harvard University.*

## PRINCIPLES OF WIRELESS TELEGRAPHY

**Theory - Application - Construction**

It Covers:—I. The fundamental reasoning and experiments leading to the conception of electric waves.

II. The properties of electric waves and oscillations.

III. The applications of electric waves to wireless telegraphy.

IV. The principles and methods of wireless telegraphy for the use of students, and amateur and professional operators.

Professor Pierce has played an important part, both in the scientific and practical development of wireless telegraphy. His book is practical, for use as a text or reference work. It is based on his lectures at Harvard University. It begins with simple theory, covers methods and principles, and goes thoroughly into construction, operation, data, etc. It is a complete and logical analysis of the field of electric-wave telegraphy from the viewpoint of the most modern practice.

**CONTENTS**—Introduction—Theories as to the Nature of Electricity—Relation Between Electricity and Magnetism—Resemblance of Self-Induction to Mechanical Inertia—Electrostatic Capacity—Discharge of a Condenser Through an Inductance and Resistance—Maxwell's Theory. Electric Waves—Electromagnetic Theory of Light—Experiments of Hertz—Experiments on the Identity of Electric Waves and Light—Propagation of Electric Waves on Wires—Wireless Telegraphy Before Hertz—Wireless Telegraphy by Hertzian Waves—Marconi, 1896-1898—Electric Wave Telegraphy by Resonant Circuits—Nature of the Oscillation—The Grounding of Circuits—Propagation Over the Earth—Detectors—Crystal Rectifiers Electrolytic Detector and Vacuum Detectors—Electrical Resonance—Wave Meters—Resonance in Simple Condenser Circuits—Electrical Oscillations of Connected Systems of Condenser Circuits—Tuning the Sending Station—Some Recent Methods of Exciting Electric Waves—The Singing Arc, the Singing Spark, and the Quenched Spark—Resonance of Receiving Circuits—The Possibility of Preventing Interference—Directed Wireless Telegraphy—Wireless Telephony—Some Details of Construction of Wireless Telegraphic Apparatus—Conclusion.

**APPENDIX I.** Elementary Facts About Electricity, and Definitions of Units.

**APPENDIX II.** Concerning the Calculation of Resistance, Self-Inductance and Capacity.

**Cloth. 350 pp. 6 x 9. 235 illus. PRICE \$3.00. Mailing weight 2 lbs.**

With one year's subscription to  
**THE WIRELESS AGE, \$4.25.**

*Add book postage as per schedule on second page.*

**ROWLAND, ARTHUR J.,**

*Professor of Electrical Engineering at the Drexel Institute, Philadelphia.*

## APPLIED ELECTRICITY FOR PRACTICAL MEN

A clear treatment of the application of electrical engineering, written from the standpoint of the worker who installs or operates commercial circuits and machinery.

It assumes a knowledge only of how to handle simple arithmetic calculations, how to make ordinary mensuration computations, and simple equations and formulae in algebra.

Prepared for use as a textbook for men who have not studied science, in trade schools, technical high schools, or in a freshman course in college.

It contains a large collection of problems and questions.

**CONTENTS**—I. Fundamental Principles.—II. Electromotive Force and Ohm's Law.—III. Magnets and Magnetic Flux.—IV. Direct-Current Dynamo. E. M. F.—V. Drum Armatures and Multipole Machines.—VI. Electric Heating; Electric Power.—VII. Direct-Current Systems of Distribution.—VIII. Direct-Current Motors.—IX. More Principles.—X. Alternating-Current Principles.—XI. Alternating-Current Transformers.—XII. Polyphase-Current Principles.—XIII. Alternators.—XIV. Alternating-Current Motors.—XV. Other Alternating-Current Machinery.—XVI. Storage Batteries.—XVII. Electric Lights.—XVIII. Wire and Wiring.

**Cloth. 375 pp. 323 illus. PRICE \$2.00 net. Mailing weight 2 lbs.**

*Add book postage as per schedule on second page.*

**EDELMAN, PHILIP E.**

## EXPERIMENTAL WIRELESS STATIONS

A book for amateurs, detailing the theory, design, construction and operation of Standard Wireless Stations. It was prepared for experimenters who regard "wireless" as more than a plaything. It is intended to serve as a stepping stone to serious preparation for high positions in the practical field of the "Wireless" profession.

It enables you to master the important principles and working methods of modern wireless systems, to build the apparatus, study the principles of transmission, perform all calculations using simple arithmetic only, to design and use efficient stations and instruments and to have no end of real instruction and pleasure in getting the greatest possible benefits from the art.

**Cloth. 272 pp. Illus. PRICE \$1.50. Mailing weight 1 lb.**

With one year's subscription to  
**THE WIRELESS AGE, \$2.50.**

*Add book postage as per schedule on second page.*

Specialists in  
Wireless Literature

Wireless Press, Inc.

42 BROAD ST.  
NEW YORK, N. Y.



**BUCHER, E. E.,** *Instructing Engineer of The Marconi School of Instruction.*

## HOW TO PASS U. S. GOVERNMENT WIRELESS LICENSE EXAMINATIONS

Third Edition Largely Revised and Extended

142 Questions and Answers.

**CONTENTS**—Explanation of Electrical Symbols—Definitions of Electrical Terms—Part I. Transmitting Apparatus—Part II. Motor Generators—Part III. Storage Batteries and the Auxiliary Set—Part IV. Antenna or Aerials—Part V. Receiving Apparatus—Part VI. Radio

Laws and Regulations—Part VII. General Information Concerning Operator's License Examinations—Practical Equations for Radio Telegraphy—Equations for Ordinary Power Work.

**PRICE 50c net. Mailing weight 1 lb.**

With one year's subscription to **THE WIRELESS AGE, \$2.00.**

Add book postage as per schedule on second page.

**THOMPSON, SILVANUS P.**

## ELEMENTARY LESSONS IN ELECTRICITY AND MAGNETISM

NEW EDITION REVISED AND ENLARGED.

The complete revision of this standard text brings it abreast of the latest developments in both the theory and practice of the science. Topics treated in the older volume have been rewritten and expanded to include the recent advances in the subject. Additional chapters have been devoted to such newer phases as Wireless Telegraphy, the Electron Theory, the application of electric power to railroads and automobiles, and high power transmission. A thorough rearrangement of material has been made in the interest of greater clearness and continuity of treatment, while the increased use of illustrations and the introduction of up-to-date terminology increase the practical teaching value of the text.

Cloth. 706 pp. **PRICE \$1.50 net. Mailing weight 2 lbs.**

Add book postage as per schedule on second page.

**SWOOPE, C. WALTON,**

*Member American Institute of Electrical Engineers.*

## PRACTICAL ELECTRICITY

An Elementary Textbook.

**Principles—Experiments—Arithmetical Problems**  
This book combines the principles of electricity upon which the practical applications of to-day depend, with the experimental demonstration of these principles and the elements of the arithmetics of electricity used in making practical electrical measurements and calculations.

**CONTENTS**—Magnetism—Magnetisation—Magnetic Fields—Theory of Magnetism—Magnetic Induction—Magnetic Circuits—Earth's Magnetism— Voltaic Electricity—Batteries—Electrolysis—Measurement of Current Strength—Resistance—Ohm's Law and Battery Connection—Circuits and Their Resistance—Electromagnetism—Galvanometers—Electromagnets—Ammeters—Electrical work and Power—Measurement of Pressure—Measurement of Resistance—Electrical Development of Heat—Electrodynamics—Electromagnetic Induction—The Induction Coil—Dynamo Electric Machines—Armatures—Direct Current Dynamos—Direct-Current Motors—Electric Lighting—Alternating Currents—Tables—Formulas.

FIFTEENTH EDITION.

Cloth. 517 pp. 404 illus. **PRICE \$2.00 net. Mailing weight 2 lbs.**

With one year's subscription to **THE WIRELESS AGE, \$3.50.**

Add book postage as per schedule on second page.

JUST ISSUED

## TRAFFIC RULES AND REGULATIONS FOR MARCONI OPERATORS

We have just issued this compact volume for the **MARCONI WIRELESS TELEGRAPH COMPANY OF AMERICA.**

At the request of several radio schools, who believe it will be of the utmost value to their students now preparing for professional wireless service, we have secured permission from the **MARCONI COMPANY** to offer a limited number of copies for sale to persons who are deeply interested and who wish to master the details of practical wireless service.

It contains complete instructions covering every feature connected with the routing and handling of wireless traffic; an interpretation of the International Convention rules as applied to commercial practice; conduct of wireless operators at sea and the method of accounting for traffic with affiliated companies.

**CONTENTS**—General Instructions—Traffic—Apparatus—Clerical Duties—International Radiotelegraphic Convention—International Telegraph Convention—U. S. Radio Law—Rates Through All Stations of the United States and

Canada—Abstracting of Messages and Accounting of Ship and Shore Tolls—Map of Principal Trans-Oceanic Wireless Stations and Coast Stations of the World.

Cloth 12mo. **PRICE \$1.00 net. Mailing weight 1 lb.**

With one year's subscription to **THE WIRELESS AGE, \$2.00.**

Add book postage as per schedule on second page.

Specialists in  
Wireless Literature

Wireless Press, Inc.

42 BROAD ST.  
NEW YORK, N. Y.



**BUCHER, ELMER E.**

## **HOW TO CONDUCT A RADIO CLUB**

**New Edition—Revised and Enlarged**

Completely revised and enlarged, this useful volume is once more presented to the great and growing field of radio students. It is a complete guide for the formation of a radio club or class, and an excellent manual for experimenter's shop work. It also contains a wealth of information that is indispensable to the radio student in commercial, navy, or army work.

Tutors in army and navy schools and commercial radiotelegraphic schools will find in this volume instruction of an advanced character in the design of certain parts of radiotelegraphic equipment.

The opening chapters review the amateur situation, showing what is expected of the amateur operator, and the requirements of a first-class amateur station. Another chapter is devoted to instruction in the telegraphic code, showing how to wire up a code practice table for the production of artificial radio telegraphic signals for one or more students at a time. Various modifications of buzzer practice systems are described.

The text matter rapidly leads into more advanced experiments, complete data being given, for instance, for the construction of a wavemeter, and instructions for its use under all conditions. This includes tuning, the measurement of inductance capacity of a wireless telegraph aerial, and general methods of calibration. The measurement of the logarithmic decrement is treated in a way easily understood by the beginner. The design and working drawings for several types of low power transmitters are included, covering the construction of a quenched spark gap and apparatus associated therewith.

The receiving apparatus and detectors of

wireless telegraphy are treated at length, practically every type of detector in use being described, together with the circuits best suited for the operation of each.

The two-electrode and three-electrode vacuum valves are described and every known circuit for their use is shown. This includes complete cascade amplification circuits, regenerative and beat receivers, heterodyne receivers, etc.

Long distance receiving apparatus for the reception of long waves which will permit the recording of signals over 6,000 miles are shown by diagram and by a complete set of dimensions.

The experimenter is shown how to construct a receiving tuner for any range of wave lengths; how to design a receiving tuner specifically for the reception of Arlington time signals; how to make use of the balancing-out aerial for the elimination of interference; one chapter is devoted to the construction of variometers in various forms.

The amateur is told how to construct a simple wireless telephone by use of a battery of vacuum valve oscillators. Numerous experiments are described, showing how to get the best out of a given transmitter and receiver.

This book will be found to be a first-rate reference work for students and amateurs. It presents the latest developments in the wireless art up to and including the latter half of the year 1917.

**8vo. 6½ x 9½. 134 Illustrations. Price 50c net.**

**With One Year's Subscription to the Wireless Age \$2.00**

Mailing weight one pound.

Add book postage as per schedule on second page.

Specialists in  
Wireless Literature

Wireless Press, Inc.

42 BROAD ST.  
NEW YORK, N. Y.

**If you ever use  
an M-A-F you will  
always use one.**

Multi-Audi-Fone . . . . \$ 18.00  
Two Step M. A. F. . . . 75.00  
Un-Damped Waver . . . 100.00  
M. A. F. Detector Stand 4.25  
Detectorfone . . . . . 35.00

*Send for Circular*

**MULTI-AUDI-FONE**

271 Morris Avenue  
ELIZABETH, N. J.

**MURDOCK RECEIVERS**

2000 OHM SET \$4.00		3000 OHM SET \$5.00
------------------------------	--	------------------------------

**GUARANTEED**

to equal or surpass in SENSITIVENESS, any 'phones obtainable anywhere at DOUBLE the prices. FOURTEEN DAYS' TRIAL allowed and money back if unsatisfactory in any way.

*Our Catalog of wireless apparatus is FREE. Send for it today.*

**WM. J. MURDOCK CO.**  
60 Carter St. CHELSEA, MASS.  
221 Second St., San Francisco

**THE HIGH COST OF  
LISTENING OVERCOME  
BY**

**The Lenzite Detector**

Supersensitive and won't jar out. If your dealer hasn't it send us his name. Your money refunded if not satisfactory.

**The Lenzite Crystal Corporation**  
PASADENA, CALIF.

Send money order, express order or check for \$5.00 and we will send you, postage prepaid, one of our Lenzite wireless detectors.

The Marconi Trans-Atlantic Wireless Telegraph Stations of America, Canada, England and Italy are equipped with

**American Transformers**

made by specialists in the design and construction of transformers for extremely high potentials for testing, ozone generation, wireless work, etc.

**American Transformer Co.**  
NEWARK, N. J.

this power at the wave-length of, say, 300 meters. At the wave-length of 200 meters,  $\frac{1}{2}$  K. W. as about the limit of power consumption of the apparatus. You can readily understand that the wave-length limits the size of a condenser in a closed oscillation circuit because a certain amount of inductance must be inserted in the primary winding to transfer energy to the secondary circuit.

In designing wireless telegraph sets, experimenters often do not take into consideration the fact that the efficiency of the set is greatly governed by the design of a spark gap. A spark gap that has quenching properties is the one most desirable. Quenching effects will be obtained from almost any type of gap, provided it is designed so the transformer arc will not follow the discharge of the condenser across the gap.

\* \* \*

H. B. Q., Vancouver, British Columbia: Marconi's famous patent No. 7777 was issued in 1900. The claims of this patent have been sustained in practically every court in which they were contested.

The report of the British Association for the Advancement of Science on the subject of static or atmospheric electricity shows conclusively that atmospheric electricity is much severer during the night hours than during the day hours, and these observations evidently hold good throughout the world. There are a number of other interesting observations reported in the "Year Book of Wireless Telegraphy and Telephony" for 1916.

The special diagram of connections for the measurement of signal intensity to which you make reference appears on page 670 of the "Year Book of Wireless Telegraphy and Telephony" for 1916.

## WIRELESS CLASS FOR WOMEN

(Concluded from page 927)

lished in the July issue of THE WIRELESS AGE. The cost of the intensive course will be \$35.

Mrs. Owen has received the following letter from C. McK. Saltzman, acting chief signal officer of the United States Army:

"My dear Mrs. Owen:

"Permit me to congratulate you, and through you the twenty-eight young women who have begun their training in telegraphy at Hunter College, for the spirit of self-sacrifice and patriotism. As the present war goes on more and more men must be released from civil employment to take their places in the active field forces of the Nation and

their present position filled by women. Particularly is this true in the cases of radio and land line telegraphs.

"The womanhood of America must be depended upon to assist in bringing this war to a successful termination, and while there is no fear as to what their response will be, still it is most reassuring to see such concrete evidence of the fact as your League offers.

"Very truly yours,

"C. McK. SALTZMAN,

"Colonel, Signal Corps,

"Acting Chief Signal Officer  
of the Army.

"By: (Signed) GEO. G. GIBBS,

"Lieutenant Colonel, Signal Corps."

The United States Government has need of land line telegraphers as well as wireless operators, according to word received from Washington by Mrs. Owen. She has approved a plan to establish a class in land line telegraphy in connection with the wireless class.

The wireless class recently adopted resolutions thanking George F. Davis, president of Hunter College, and Professor Louis D. Hill of the college, for their efforts in behalf of the class. President Davis acknowledged the resolutions.

## WANTED: RADIO ELECTRICIANS

RADIO ELECTRICIANS, six, required by October 1st, for duty at the Washington Navy Yard, and for training as expert radio aids and assistants to radio expert aids, as well as for installation and design work at other yards in the United States. The qualifications are—graduates of technical schools of recognized standing; having either a course in theoretical radio engineering, or two years' experience in commercial or technical institutions of standing. Oral examinations will be held at the Washington Navy Yard. The base pay, to start, ranges from \$4.40 to \$5.28 per diem. Applications should be made to the Labor Board, Navy Yard, Washington, D. C. Men working for the following companies will not be employed without consent of the company under which employed: Marconi Wireless Telegraph Co., Western Electric Co. Wireless Specialty Apparatus Co., (Boston). National Electrical Supply Co., National Electric Signalling Co., F. Lowenstein, E. J. Simon, DeForest Radio Telephone & Telegraph Co., Kilbourne & Klark Mfg. Co., Federal Telegraph Co.





**SUBMARINE CHASERS**

Large numbers of submarine chasers are being built and equipped with Wireless. Many of our students are preparing to enter the Naval Reserve as Radio Operators, others are becoming efficient for the Enlisted Signal Reserve Corps, while others are preparing for the Merchant Service, so vital to our Cause.

Afternoon and Evening Classes limited in size, provide ample opportunity for you to progress as rapidly as you are able and to study just what you need.

To those who must earn while they learn, our Employment Department furnishes excellent service.

High-class instruction, ample equipment, large, cool classrooms and a central location have made our Radio School popular.

**EASTERN DISTRICT Y. M. C. A.**

**Marcy Ave., Near Broadway Brooklyn**  
Twelve minutes from New York City Hall.

**War Conditions Demand ELECTRICAL**

men with training. Prepare for service in military or industrial life. Of 193 students in class of 1917, about one-third are already in the Engineer Corps and two-thirds are speeding production in electrical industries. Having trained over 2000 young men in the past 24 years in the fundamentals of Applied Electricity, The Bliss Electrical School with its well-equipped shops and laboratories, is peculiarly qualified to give a condensed course in Electrical

**ENGINEERING**

Including Mathematics, Steam and Gas Engines, Mechanical Drawing, Shop Work, and Theoretical and Practical Electricity, in all branches. Students actually construct dynamos, install wiring and test efficiency of electrical machinery. Course, with diploma, complete

**IN ONE YEAR**

For practical young men with limited time. 25th year opens Sept. 26th. Catalogue on request. 135 Takoma Ave., Washington, D. C.



**PATENTS**

**WRITE FOR HOW TO OBTAIN A PATENT!** list of Patent Buyers, and inventions Wanted. \$1,000,000 in prizes offered for inventions. Send Sketch for free opinion as to patentability. Our Four Books sent **FREE**

free. Patents advertised Free. We assist inventors to sell their inventions. **VICTOR J. EVANS & CO., 708 Ninth, Washington, D. C.**

**ENORMOUS DEMAND For WIRELESS OPERATORS**

in the various branches of the **GOVERNMENT SERVICE**

and the ever-growing **MERCHANT MARINE**

LIVE-WIRE students may now complete our course in exceptionally short time. Opportunities to specialize in any branch of the profession are given. New classes constantly forming.

Expert Instructors—Complete Installation  
Dormitories Employment—Catalogue

**Y. M. C. A. RADIO SCHOOL**

157 East 86th Street

New York, N. Y.



**WIRELESS**

**THE MAN BEHIND THE KEY**

is equally as important today as the man behind the gun, as well as the man in the trench. The Gov't and Merchant Marine need thousands of trained operators **right now**, the demand far exceeding the supply. **Pick your rating before being drafted.**

Special short code courses day or evening for those desiring to join any branch of Radio for Gov't Service. Fall classes, both day and evening, start Oct. 1st. Send in your enrollment today. Students from all over the country.

Send for literature

**Eastern Radio Institute**

899C Boylston St., Boston, Mass.



**"You Get The Job"**

"We've been watching you, young man, and we know you're made of the stuff that wins. The man that cares enough about his future to study an I. C. S. course in his spare time is the kind we want for responsible positions. You're getting your promotion on what you *know*, and I wish we had more like you."

The boss can't take chances. When he has a responsible job to fill, he picks a man *trained to hold it*. He's watching YOU right now, hoping you'll be ready when your opportunity comes.

Start today and train yourself to do some one thing better than others. You can do it in spare time through the International Correspondence Schools. Over 5,000 men reported advancement last year as a result of their I. C. S. training.

The first step those men took was to mark and mail this coupon. Make your start the same way—right now.

**INTERNATIONAL CORRESPONDENCE SCHOOLS**  
Box 8017, Scranton, Pa.

- |  |   |   |
|--|---|---|
| <input type="checkbox"/> Explain fully about your Course in the subject marked X | <input type="checkbox"/> <b>ADVERTISING</b> | <input type="checkbox"/> <b>CHEMISTRY</b> |
| <input type="checkbox"/> Electrical Engineering                                  | <input type="checkbox"/> Salesmanship       | <input type="checkbox"/> Illustrating     |
| <input type="checkbox"/> Mechanical Engineering                                  | <input type="checkbox"/> Commercial Law     | <input type="checkbox"/> Farming          |
| <input type="checkbox"/> Mechanical Drafting                                     | <input type="checkbox"/> Civil Engineering  | <input type="checkbox"/> Poultry          |
| <input type="checkbox"/> Civil Engineering                                       | <input type="checkbox"/> <b>BOOKKEEPING</b> | <input type="checkbox"/> French           |
| <input type="checkbox"/> Stationary Engineering                                  | <input type="checkbox"/> Stenography        | <input type="checkbox"/> German           |
| <input type="checkbox"/> Mining Engineering                                      | <input type="checkbox"/> Civil Service      | <input type="checkbox"/> Italian          |
| <input type="checkbox"/> <b>ARCHITECTURE</b>                                     | <input type="checkbox"/> Ry. Mail Service   | <input type="checkbox"/> <b>SPANISH</b>   |
| <input type="checkbox"/> Architectural Drafting                                  | <input type="checkbox"/> <b>AUTOMOBILES</b> |   |

Name \_\_\_\_\_

Address \_\_\_\_\_



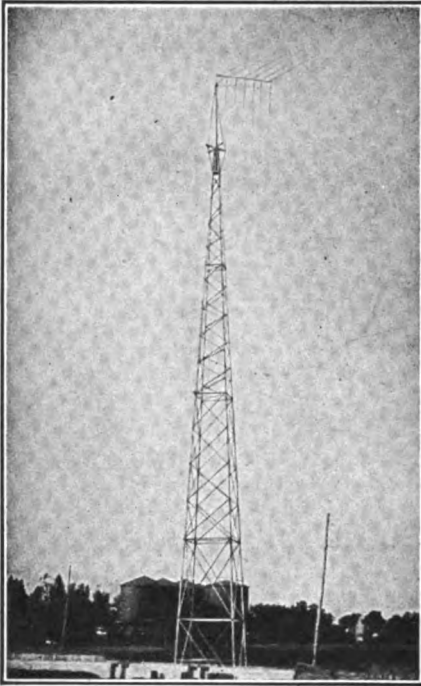

Station at Fort Monroe, Virginia

## STEEL TOWERS GALVANIZED *or* PAINTED

*of any desired height, of first class construction and at extremely low prices.*

*The self-supporting type does away with guys entirely and those of moderate height do not require expensive concrete footings.*

### MILLIKEN BROTHERS INCORPORATED

NEW YORK, 111 BROADWAY

London - San Francisco - Buenos Aires

Hydro-Electric Transmission Engineers  
Manufacturers of all Classes of  
Structural Steel Work.

## Public Utilities Bought and Sold

### Investigation and Engineering Reports Furnished

*We are interested in and can furnish information concerning the following Companies:—*

Long Island Lighting Company  
Suffolk Gas & Electric Light Co.  
Suffolk Light, Heat & Power Co.  
Huntington Light & Power Co.  
North Shore Electric Light & Power Co.  
Perry Electric Light Co.  
Sag Harbor Electric Light & Power Co.  
Long Island Gas Corporation  
South Shore Gas Co.  
Consumers Gas Co. of Long Island  
Warsaw Gas & Electric Co.  
Northport Water Works Co.

*Consult us before installing Wireless Stations.*

## E. L. PHILLIPS & CO.

ENGINEERS

50 Church St., N. Y. C.



High Frequency

## MOTOR - GENERATORS

for

Wireless Telegraphy

and

Wireless Telephony  
**CROCKER - WHEELER  
COMPANY**

Ampere, New Jersey

**“For  
Active  
Service”**



From a purely scientific standpoint, this Company is proud of its contributions to the theory of Electrical Measurement. It is still more proud of

**Weston**

**Indicating Instruments**

In design, in material, in their structural perfection, they are thoroughly worthy to represent Weston ideas and ideals in the field of active service.

**Weston Electrical Instrument Co.**  
27 Weston Ave., Newark, N. J.

23 Branch Offices in the Larger Cities.

Weston Round Pattern Switchboard Instruments of 7-inch diameter are the standard for use on Wireless Telegraph Panels. As they are of the highest grade and designed for commercial installation, they are not adapted to experiments in wireless work. Write for more specific information.

# WANTED! LICENSED RADIO OPERATORS

**FOR THE MARCONI SERVICE**

ADVANCED AMATEURS, COMMERCIAL WIRE OPERATORS, and others possessing FIRST OR SECOND GRADE COMMERCIAL LICENSE CERTIFICATES are invited to send in their applications at once.

**Immediate Positions Assured**

**NEW WAGE SCHEDULE IN EFFECT**

Prepare to serve your country by joining the operating staff of the Marconi Company.

**FREE INSTRUCTION** GIVEN IN BOTH THE DAY AND EVENING CLASSES

Applicants having some knowledge of Continental Telegraph Code preferred.

Call, 'Phone or Write,

**INSTRUCTING ENGINEER**

**NEW YORK CITY**

**EDISON BUILDING, 25 ELM STREET**

**SAN FRANCISCO, CALIFORNIA, NEW CALL BUILDING, NEW MONTGOMERY STREET**

Send for illustrated prospectus.



# Progress Ceases Where Profit Ends

Several ship owners on the Pacific Coast, who purchased unsatisfactory competitive apparatus, have removed it from their vessels, adopting the MARCONI SYSTEM.

## MARCONI SERVICE

Does Not End—Like Some Others—When the Apparatus Is Sold

*Complete Service can only be rendered by a Complete Organization.  
Marconi signifies World Wide Wireless—Continent to Continent—  
Shore to Ship—Ship to Ship*

The following important steamship lines on the Atlantic and Pacific Coasts carry MARCONI Equipment on their vessels:

Ward Line, Clyde Line, Mallory Line, Savannah Line, Southern Pacific S. S. Co., Merchants & Miners Line, International Mercantile Marine, N. Y. & Porto Rico Line, Old Dominion Line, Red D Line, Standard Oil Co., Texas Oil Co., Gulf Refining Co., Bull Insular Line, Luckenbach S. S. Co., Petroleum Transport Line, Vacuum Oil Co., Sun Oil Co., W. R. Grace & Co., Matson Navigation Co., North Pacific S. S. Co., Chas. R. McCormick & Co., Pacific Coast S. S. Co., Pacific Mail S. S. Co., and many others.

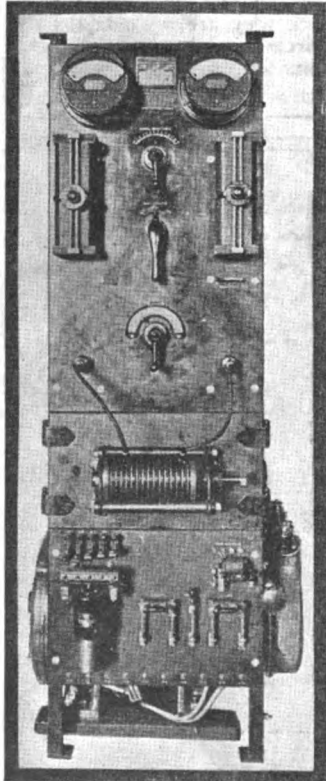

Standard MARCONI Panel Type Transmitting Apparatus

### RELIABILITY      EFFICIENCY      SERVICE

Marconi Service and Marconi Men Have Never Failed  
Wireless Service on 75% of the vessels carrying  
MARCONI is voluntary—that is, it is not required by law.

*A Marconi Contract Protects the Ship Owner Against All Possible Patent Litigation*

*A Proven Economical Rental Policy. Fair and Equitable Charges*

Write to have our representative call  
COMMERCIAL DEPARTMENT

## Marconi Wireless Telegraph Co. of America

WOOLWORTH BUILDING, NEW YORK

MARCONI Panel Sets installed on all important American passenger and freight steamers have a world-wide reputation.



Standard MARCONI Receiving Apparatus