

The **TELSEN** **RADIOMAG**

VOLI
NUMBER 6

3^D

RADIO'S GREATEST HOME CONSTRUCTORS JOURNAL



THE WORLD REVEALED!

The New

TELSEN

SUPERHET, BANDPASS & H.F. TRANSFORMER IRON-CORED COILS

with Built-in Switching

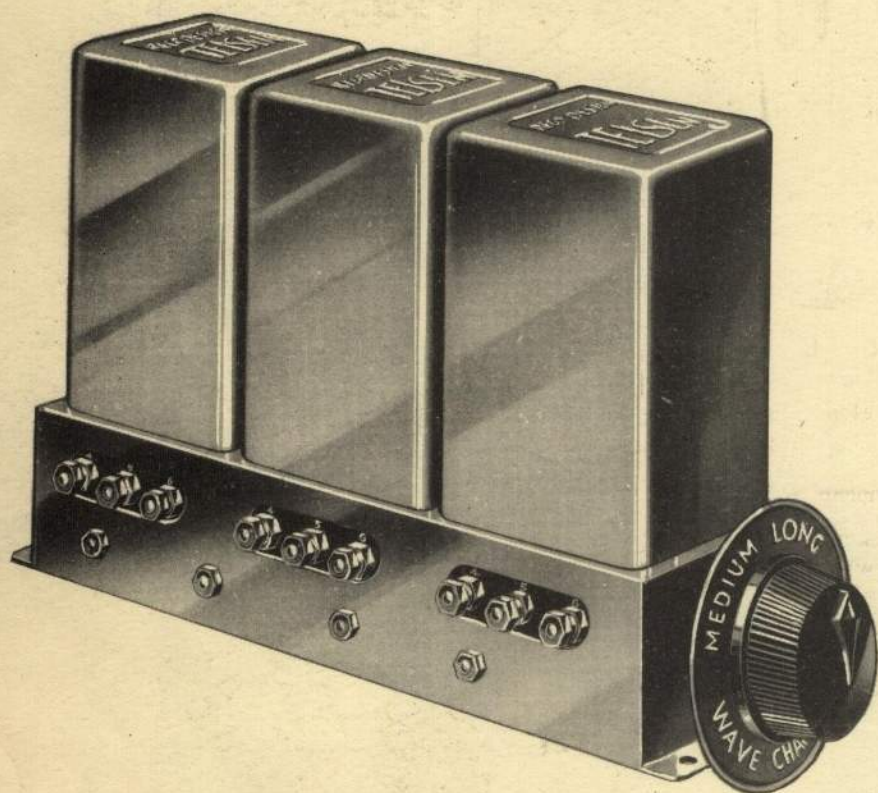

TELSEN IRON-CORED TRIPLE COIL UNIT

Suitable for band-pass filter followed by one tuned stage or for three tuned stages.

W.477

Price **30/-**

TELSEN IRON-CORED TWIN COIL UNIT

This twin coil unit consists of two iron-cored coils suitable for a band-pass filter or two tuned H.F. stages.

W.478

Price **19/6**

TELSEN IRON-CORED SUPERHET. PRESELECTOR AND OSCILLATOR COIL UNIT

This triple coil unit consists of two iron-cored coils and one oscillator coil. Designed to work in conjunction with a triple ganged condenser, having special shaped vanes for maintaining a constant frequency difference of 110 K.C. between the oscillator and signal frequency circuits. The preselector coils can be alternatively used as a band-pass unit where the receiver does not employ an H.F. stage.

W.476

Price **30/-**

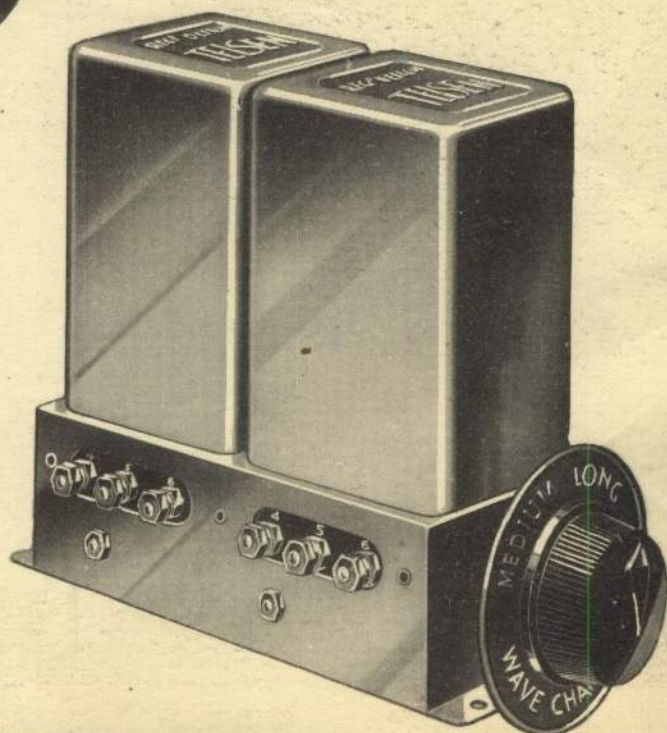



Technical Editor :
R. G. D. Holmes, A.M.I.W.T., A.I.Rad.E.

Editor :
RUPERT COLLINS

Editorial Offices :
THOMAS STREET, ASTON
BIRMINGHAM

EDITORIAL COMMENT

JUDGING by the amount of correspondence received during the last few months it is evident that the new issue of *The Telsen Radiomag* is anticipated with even greater enthusiasm than ever before.

In this issue you will find a further new range of components and many of the old established ones entirely re-designed and considerably improved. In this range we would particularly draw your attention to the new series of Iron Cored Coils with built-in switching and the new metal cased L.F. Transformers, in particular, the D.R.3 and G.S.4 types, the N.P.L. response curves of these models reproduced elsewhere, are comparable to anything on the market irrespective of price. Space does not permit of reference here to all our new components but they are referred to in detail in the coloured supplement and the article entitled "A Review of New Telsen Components."

In the range of home constructor sets we feel we have catered for the requirements of all readers. The range includes the

Telsen Short Wave Three which has been specially developed to meet the requirements of our Short Wave enthusiasts; secondly we have the Telsen Battery Economy S.G.3: this has the popular and well-tried favourite valve combination of Screened Grid, Detector and Pentode Output, and for those who favour the Superheterodyne Receiver we have developed a highly efficient 4-valve Battery Super. This Set has many outstanding features and will commend itself to the more ambitious home constructor.

Finally, we are including for the first time in the *Radiomag*, details of a high quality amplifier unit for those who wish to obtain the finest quality of reproduction from their receiver.

Full sized Blueprints of these circuits are given away free with this issue. Readers who require back numbers of the *Radiomag* can obtain them either from their radio dealer, news-agent, or direct from us, price 6d., post free.

CONTENTS

Television and Short Waves	2, 3, 4, 19	Distortion in Receivers and Amplifiers	49, 50, 51, 52
The Telsen "Short Wave Battery Three"	5, 6, 7, 8	Practical Hints and Tips	53, 54
Automatic Volume Control	9, 10	How to Build a High-Quality 3-Valve Amplifier	55, 56, 57, 58
How to Gang-up a Multi-Valve Receiver	11, 12, 13	What do you expect from your Radio Receiver?	59, 60, 61
The Telsen "Battery Economy 3"	14, 15, 16, 17, 18, 19	Medium and Long Wave Stations of Europe	62, 63
Review of New Telsen Components	20, 21, 22, 23, 24	Short Wave Stations of the World	63
Choice and Care of H.T. Batteries 41	List of Components 64
The Telsen "4-Valve Battery Super"	42, 43, 44, 45, 46, 47, 48		

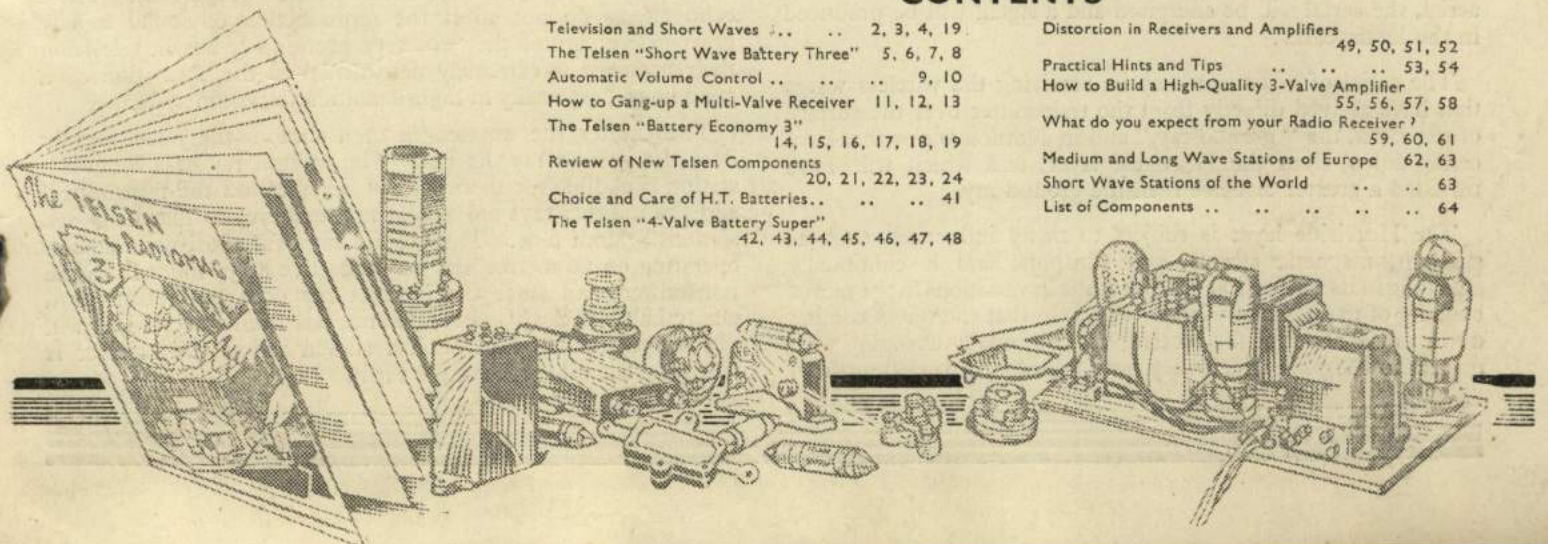

Notes on

TELEVISION and SHORT WAVES



THE owner of a wireless receiver which operates on the medium and long-wave broadcasting bands is familiar with the phenomenon of the variations in strength, or "fading," of the signal received from a distant transmitting station. He is also aware that this fading is practically non-existent on the long-wave stations, but becomes increasingly evident as the receiver approaches the lower end of the medium-wave band. This "fading" becomes very marked when a receiver operating on short waves of the order of 20-60 metres is in use, and has been one of the principal obstacles to the use of short waves.

The explanation advanced to account for this phenomenon is as follows. The waves radiated from the aerial of a transmitter spread out in all directions, in a manner similar to that in which waves spread out on the surface of the water when a stone is thrown into a pond, except that the wireless waves travel out in all directions, and are not confined to a single surface as are the water waves. Some of the waves travel over the surface of the earth, and on arrival at the aerial of a receiver manifest themselves as a signal in the loudspeaker. At the same time other waves travel in an upward direction from the transmitter aerial, and enter the upper, outer, atmosphere of the earth. In these regions they enter a layer of highly ionised air known as the Heaviside layer.

The Heaviside layer has the peculiar property of refracting, or bending the path, of the wireless waves, so that they return again to the earth. On arrival at the surface of the earth, they become reflected upwards again, in the same manner as a mirror reflects light waves, and once more enter the Heaviside layer, where their path is again bent so that they return to the earth. This process continues until the waves become so weak as to be incapable of actuating a receiver. The waves thus proceed over the earth in a series of hops, as it were.

It will be appreciated that if during their travel these refracted waves arrive at the surface of the earth in close proximity to an aerial, the aerial will be energised and a signal will be produced in the loudspeaker.

The aerial of a receiver may be receiving the wireless waves that have arrived directly from the transmitter over the surface of the earth, the "ground ray," and in addition waves that have come down from the Heaviside layer, and which will have travelled a greater distance than the ground ray.

The Heaviside layer is subject to many influences, such as sunlight, magnetic storms, and sunspots, and is continually changing in its properties. This results in variations in the rate of bending of the paths of wireless waves, so that the waves coming down to the aerial of the receiver are continually changing with respect to the path which they have followed in travelling from

the transmitter to the receiver. In addition, waves from several angles may arrive at the receiving aerial. The differences in the lengths of the paths followed by the waves in their journeys from the transmitter to the receiver result in some of the waves being a little late in arriving at the receiving aerial. The differences in time will not be very great, owing to the great speed at which wireless waves travel, but they will have the effect that some of the waves will assist each other and some will oppose each other. The net result, which determines the signal in the loudspeaker, is thus continually varying, due to the changes in the Heaviside layer, giving rise to the phenomenon of fading.

The shorter the wavelength, that is the higher the frequency of the transmitter, the less rapidly are the waves bent so as to return to the earth. On medium waves some of them return at about 20 miles from the transmitter, whilst waves of the order of 20 metres do not return until they have covered nearly half the circumference of the earth.

Transmissions on wavelengths of the order of 12 metres and under have the paths of their waves bent so slowly by the Heaviside layer that they do not return at all to the earth's surface, but proceed through the Heaviside layer into the atmosphere above it.

On wavelengths from 20 metres up to about 80 metres, some of the waves penetrate into the Heaviside layer and travel for great distances before returning to the surface of the earth, and during this time they may have travelled once or twice round the earth. One journey round the earth occupies about one-seventh second. If any of these waves arrive at an aerial which is tuned to their transmitter, "echoes" will be produced: similar "echo" effects are produced by waves which go right through the Heaviside layer, but which eventually return again to the earth for reasons not yet fully determined (a second layer of ionised air is assumed to be above the Heaviside layer, at some distance from it, with somewhat similar properties). These echo effects do not affect the reproduction of sound to any great extent, unless they are very prominent, but in television their presence is extremely detrimental to the formation of a good image, especially in high-definition television systems.

The shorter the wavelength of a station, the more rapidly does the ground ray die out. The ground ray of a longwave station is audible for thousands of miles round the transmitter, and the indirect rays are almost non-existent, so that longwave stations seldom fade. The ground ray of a short-wave station operating on 20 metres may be ineffective at 50 miles from the transmitter, and since the indirect ray does not return until nearly half the earth's circumference has been traversed, it will not be possible to hear such a station unless the receiver is located at the other side of the earth.

TELEVISION AND SHORT WAVES—continued

The minimum distance at which it is possible to receive signals from a short-wave transmitter by means of indirect rays is known as the "skip distance," since the indirect rays do not return within that distance. The shorter the wavelength of the transmitter, the greater is the skip distance.

Short waves, however, have many advantages. The waves in their passage through the Heaviside layer lose very little energy, as compared with the relatively much more rapid attenuation of the ground ray (including even the ground ray of a long-wave station). World-wide communication is thus possible using very little power, as has been shown by the amateur transmitters of all countries. Atmospheric are almost non-existent, and many more stations can be accommodated on short-waves than can be accommodated on the medium and long-wave bands. A consideration of the frequencies concerned will enable this to be seen clearly. The medium wave band extends from 200 metres to 600 metres, that is from 1500 K.C. a second to 500 K.C. a second, a difference of 1,000 K.C. per second. A frequency separation of 10 K.C. a second between each station would enable 100 stations to be accommodated on this band. The waveband of 20 metres to 60 metres extends from 15,000 K.C. a second to 5,000 K.C. a second, a range of 10,000 K.C. per second. 1,000 stations separated by 10 K.C. a second could be accommodated on this waveband.

The large number of stations that can be operated on the short waves is of considerable importance to the development of television: a television transmitter has to transmit a very wide range of frequencies, as will be shown, and it would be quite impossible to operate several such stations on the medium wave-band, even assuming that all the other broadcasting stations were prepared to close down for the television stations to function. But on short waves, and especially on ultra-short waves, many such stations may be operated, and for this reason television developments will probably rely on the use of these short wavelengths for transmission and reception.

A description of the salient features involved in the transmission and reception of television images will enable the reader to appreciate the special advantages of short waves in connection with television. As is well known, in the cinema the illusion of movement is obtained by projecting on to the screen a rapid succession of still pictures, in each of which the moving person being represented is in a very slightly different position. The human eye continues to see an object for a fraction of a second after the object has been removed. This persistence of vision enables the picture on the screen to be removed and replaced by the succeeding picture, the screen being dark whilst the change is made, without the apparent continuity of vision being disturbed. As in each succeeding picture the person or object being represented is in a slightly different position, the whole series of pictures blends into one apparently continuous representation of movement. The time between the removal of one picture and its replacement by the succeeding picture must be so short that the eye does not apprehend the dark interval during which the pictures are changed. The maximum permissible time which this dark interval can occupy is of the order of one-sixteenth of a second. If the picture were shown on the screen for an equal length of time, that is for one-sixteenth of a second, then there would be eight pictures a second (in practice the pictures are shown for a greater length of time than the time occupied by the dark interval, in order to obtain greater brightness on the screen). If the mechanism were subject to a slight inaccuracy, one of the dark intervals might be of slightly greater duration than one-sixteenth of a second, and would be apprehended by the eye. "Flicker" would thus occur.

In high class cinemas it is now standard practice to project twenty-four pictures (or "frames") a second, and flicker is absent.

Similar considerations apply in the projection of television images, with this difference, however: in the cinema, the whole of each picture is projected on to the screen for a fraction of a second, whilst in television it is necessary to delineate each picture a small portion at a time, several pictures a second of course, so that the difficulties are considerably increased.

The pictures are built up as follows. A device is used which converts light falling on it into electric current; a photo-electric cell is generally used, as this has the advantage of being almost instantaneous in its action. Changes in the amount of light falling on the cell produce changes in the current through it, and in television these changes of current are amplified and transmitted. In order to transmit in detail the portions of light and shade which make up the appearance of the object, it is necessary to examine it piece by piece.

This is achieved by examining it in strips, one strip at a time, so that every portion of the object is examined in succession. The photo-electric cell examines the beginning of the first strip, continues examining it until the end is reached and then commences at the beginning of the second strip, and so on until all the object has been examined, or "scanned." The varying amounts of light reflected from each portion of the object produce varying currents in the photo-electric cell, and these variations, corresponding to the variations in brightness of the object are amplified and transmitted. They are received and amplified and fed to the television apparatus, in which they produce variations in the intensity of a spot of light on the television viewing screen. The spot of light is caused to move over the screen so that it traces out strips of light corresponding to the strips in which the photo-electric cell examined the object. Since the spot varies in intensity in accordance with the light and shade of the object (due to the transmission and reception of the variations of current in the photo-electric cell, a reproduction of the object is seen on the screen. If now a person being televised moves, say, an arm, the photo-electric cell in examining the object will find in its next examination that the bright portion corresponding to the arm has moved down a little, and so the spot of light traversing the screen will become bright a little lower down the screen. In this manner any movement of the object is reproduced on the screen.

The maximum time that can elapse between the moment that the spot of light is at a certain portion of the screen and the moment when it is again at the same portion is about one-sixteenth of a second. This implies that there must be an equal number of pictures a second, that is, sixteen pictures for flicker to be non-existent. The spot of light must be of very great brilliance, for it is at each portion of the picture only once per picture, and it has to cover all the picture many times a second, so that it is at each portion for only a very short period of time.

It is necessary that the spot of light at the receiver should trace out on the viewing screen the same number of strips in a given time as the photo-electric cell examines in the same length of time. In the system in use by the B.B.C. the scanning of the object was originally performed by means of apertures in rotating discs, and a similar method was employed at the viewing end. To ensure the same time of traversing the picture by the light-spot as by the photo-electric cell, it was necessary for the two discs to run at the same speed: in engineering terms they had to run in synchronism. The process of ensuring that the speed of the light-spot and the speed of scanning are the same, is still known as synchronising.

To keep the light-spot in synchronism it is necessary for it to be controlled by the transmitter, as even a first-class clock does not maintain sufficiently constant a speed for it to be used to keep a television receiver in synchronism.

TELEVISION AND SHORT WAVES—continued

Synchronising signals are therefore added to the transmitter output. This can be done by arranging a dark band at the top or side of the picture, and in this dark band the synchronising signal is transmitted. This band is not reproduced at the viewing end and so does not form a portion of the image. Appropriate arrangements are made in the scanning device at the transmitter to correspond with the unreproduced dark band of the receiver, and the synchronising signal is inserted into the transmission in the dark band.

A signal controlling the speed of the light spot is thus received by the apparatus which flashes the spot over the screen, just before the commencement of each strip, so that the speed of the light spot is corrected many times in each picture. The method of controlling the speed of the spot, or in other words the method of synchronising the receiver and the transmitter, varies in the different systems of television which have been developed, as also does the method of flashing the spot over the screen.

In the latest systems of television a cathode-ray tube is used: in this, a stream of electrons moving at a high speed impinges on a screen at the end of the tube. The screen is composed of a material which glows or "fluoresces" where the electrons strike it, and by suitable arrangements the electron stream is focussed into a spot, which is flashed over the screen, the intensity of the spot being controlled by the television transmitter.

On viewing the screen a reproduction is seen of the object being examined by the transmitter. The cathode-ray tube has the advantage that the movements of the spot and also its rate of variation of intensity, can be very rapid, without the difficulties that attend the use of mechanical devices at high speeds.

That the spot of light traces out the same number of strips in a second as the transmitter examines in a second, and that it commences a strip at the same moment as the transmitter commences examining a strip, is insufficient. The light-spot must in addition be tracing out the same strip as that which the transmitter is examining. If at any moment for example, the transmitter was examining the third strip from the left, then the light-spot should similarly be tracing out the third strip from the left. This is done by advancing or retarding the light-spot by a whole number of strips until the required condition is obtained, and this operation is known as "framing" the image: during the operation of framing, the picture cannot be recognised. If the picture is incorrectly framed the left half will be reproduced on the right hand side of the picture and vice versa, with a line of demarcation where the two halves join, and the framing adjustment is operated until one or the other half of the picture diminishes to zero, when the picture will be correctly framed. This framing does not necessitate the transmission of a special signal from the transmitter, since if the light-spot is running in synchronism with the transmitter the images will remain correctly framed when once this adjustment has been effected.

If the size of the spot of light is say one sixth of an inch across, and there are thirty strips in the image, then the image will be 30 multiplied by $1/6$, that is five inches across. The width of the strips also determines the smallest portion of detail which can be televised in each strip: in examining the strip from end to end, if the photo-electric cell encounters a detail which is smaller along the direction of the strip than the width of a strip, it will not be reproduced at the receiving end since the size of the light-spot is equal to the width of a strip, and therefore a smaller detail cannot be reproduced. This is not strictly accurate, since the light-spot is continually varying in intensity along the line of the strip, but the amount of detail which can be transmitted along the direction of the scanning strips is found in practice to be approximately equal to the detail across the strips, that is,

detail smaller in size than the width of a strip cannot be transmitted and reproduced. For this reason, the object can be regarded as being broken up into a number of small squares, equal in size to the width of the strips used in scanning: similarly, the received picture can be regarded as being composed of a like number of small squares, equal in size to the size of the spot of light used in tracing out each strip.

In the system at present in use by the B.B.C. the pictures have a ratio of 7 to 3: thirty lines are used in the scanning process, so that ten lines are equivalent to a unit of length; the other dimension is then equivalent to 70 strips, and as shown in the foregoing paragraph, this is equivalent to $70 \times 30 = 2,100$ small squares into which the object is divided by the scanning process. These squares are usually termed "elements" The image at the receiver is thus formed of 2,100 elements, and if the light spot is say one sixth of an inch across, then the picture will be $70 \times 1/6 = 11 \frac{2}{3}$ " in one direction and $30 \times 1/6 = 5$ " in the other direction; that is it will be $11 \frac{2}{3} \times 5$ ".

2,100 elements are required to produce each of these pictures, and there have to be several such pictures in each second: the present B.B.C. television transmissions transmit $12\frac{1}{2}$ pictures a second, and as a result it is necessary to transmit $2,100 \times 12\frac{1}{2} = 26,250$ elements a second. If each alternate element was assumed to be black and white, that is, one portion was black and the next portion was white, and so on, the current in the photo-electric cell would vary from maximum to minimum and back again to maximum, and there would be 13,125 maxima a second: such a current variation can be shown to be equal to an alternating current of 13,125 cycles a second, with the addition of alternating currents of higher frequencies up to very high values.

The transmitter and receiver must therefore be designed to handle frequencies up to at least 13,000 cycles a second, in the case of the regular B.B.C. transmissions of television, and should if possible, handle considerably higher frequencies. If these elements change only slowly from black through various shades of grey to white, then the range of upper frequencies required is greatly reduced, for it is the rate of change of light values, and therefore rate of change of photo-cell current, that determines the upper frequencies that require to be transmitted. If, therefore, the television transmitter and receiver attenuate some of the upper frequencies, the change between light and shade will not be as clearly defined as it was originally in the object, and portions of the image will be blurred, or "run into" each other.

As in photography the colours of the object are not transmitted, but their values are reproduced by corresponding shades of grey.

In the new high-definition television systems which have given such promising results the picture is divided into 180 horizontal strips. The picture is of the proportions of 5 in height to 6 in length; each scanning strip is $5/180$ units in width, and the length is therefore equivalent to 6 divided by $5/180 = 180 \times 6/5$ strips. The number of picture elements is therefore $180 \times (180 \times 6/5) = 39,000$ elements approximately. Twenty-five pictures per second are transmitted, and this involves $39,000 \times 25$ pictures elements per second, that is approximately 970,000 elements per second. As we have seen, this involves the transmission of frequencies up to half this amount, that is up to 435,000 cycles a second, and to prevent blurring of the image in sharply contrasted areas of light and shade, frequencies up to at least 1,000,000 cycles a second are necessary. It will now be seen why it is quite impracticable to operate a medium-wave transmitter to deal with such methods of television, as a consideration of the frequencies involved will indicate. A transmitter operating on 200 metres, and transmitting frequencies up to 1,000 K.C. a second (one million cycles a second) will have a carrier frequency

(Continued on page 19)

The **TELSEN** **SHORT WAVE** **3** *Battery*



This is a Set of outstanding performance for the Short Wave enthusiast

THE charm of short wave listening is the charm of the unexpected. Even the most experienced listeners are unable to forecast with any degree of certainty whether conditions will be good, bad or indifferent. When conditions are good the ether seems to be packed to bursting-point with broadcast programmes, amateur transmissions and other services from the corners of the globe—from North and South America, Spain, the Vatican City at Rome, South Africa, Australia, the U.S.S.R. and many others. The novelty of receiving such varied and distant stations will, for most people, lend added interest to that of the programmes themselves, for distant listening possesses a fascination peculiarly its own.

Large numbers of people are already able to read the morse code, and in any case it is not difficult to learn. To these fortunate listeners the short waves have an even greater appeal. All messages preceded by the letters "C.Q." are intended to be read by all who are able to receive them, and in this category are distress messages, including S.O.S. signals, and also short wave amateur transmissions (other than British Amateurs who use the prefix "TEST"). Amateur transmissions may also be heard "on phone," particularly from America, while such widely distributed regions as the Philippine Islands, Canada, South America and Russia all contribute their share.

Very many different designs for short-wave receivers have, from time to time, made their appearance. Simple two and three valve combinations often give results approaching those of the highly complex multi-valve receivers, and it is the considered opinion of many designers that simplicity counts for much in short wave work. Simplicity of operation is particularly important when the receiver is to be handled by the non-technical public; in any case, tuning on the short waves is an operation requiring considerable care and any simplification of this process is greatly to be desired.

It was this consideration which led Telsen Engineers to reject first the S.G.—Det.—L.F. arrangement employing two tuned

circuits, and secondly the simple Det.2 L.F. combination, in favour of a circuit employing an aperiodic H.F. stage, detector and output valve. By this means the main difficulty of short-wave tuning—that of "dead spots" has been eliminated, and duplication of controls has been avoided.

In a simple Det. 2 L.F. receiver the aerial is directly coupled to the oscillatory circuit preceding the detector. Under these circumstances when the oscillatory circuit is tuned to a frequency corresponding to one of the natural modes of vibration of the aerial a large amount of power will be absorbed by the aerial and it will be found impossible to obtain reaction. Consequently at these points on the tuning dial the receiver is unable to receive any but the strongest stations and such positions are known as "dead spots."

The screened grid valve, by isolating the aerial from the tuned circuit, reduces the absorbed power to an entirely negligible amount and so completely cures this most annoying trouble.

Another point in favour of the use of a screened grid stage in short wave receivers is that it entirely prevents re-radiation. In order that a short-wave receiver may receive unmodulated continuous wave (C.W.) signals it must be used in an oscillating condition. When the aerial is directly coupled to the oscillatory circuit re-radiation occurs, and may interfere with short wave reception over a radius of 20 miles.

When the aerial is isolated from the oscillatory circuit by means of the S.G. valve, however, re-radiation cannot occur. It is to be noted that receivers which are capable of re-radiation are strongly disapproved by official bodies in all civilised countries, in fact in most of the Colonies re-radiating receivers are entirely prohibited.

From the circuit diagram of Fig. 1 it will be seen that the aerial is coupled aperiodically to the S.G. valve (i.e. in such a manner that it has no natural period of vibration). This valve is choke-coupled to the grid circuit of the detector, a .0001 mfd. blocking condenser being employed. The short wave chokes

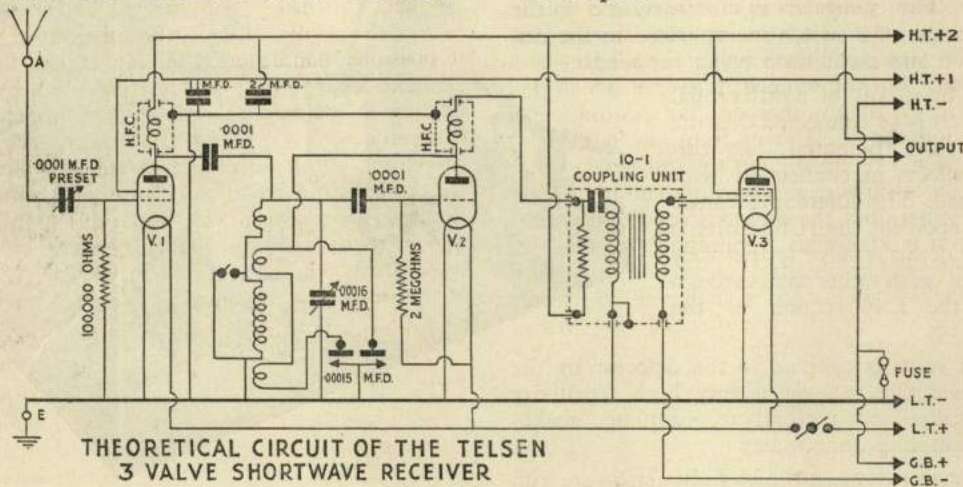

THEORETICAL CIRCUIT OF THE TELSEN 3 VALVE SHORTWAVE RECEIVER

Fig. 1

THE TELSEN "SHORT WAVE BATTERY 3" BRINGS

used in this circuit are carefully designed to avoid subsidiary resonances which would produce either "dead spots" or points of uncontrollable self oscillation. In addition they are carefully screened and earthed so as to prevent unwanted magnetic coupling.

The new short wave coil, of course, is the heart of the set, and it has been very carefully designed to give even reaction over the whole waveband. The tuning condenser is from the well-known "Eddystone" range of short-wave components and in conjunction with the Telsen coil gives a tuning range of 18 to 31, and 30 to 56 metres. This range has been chosen

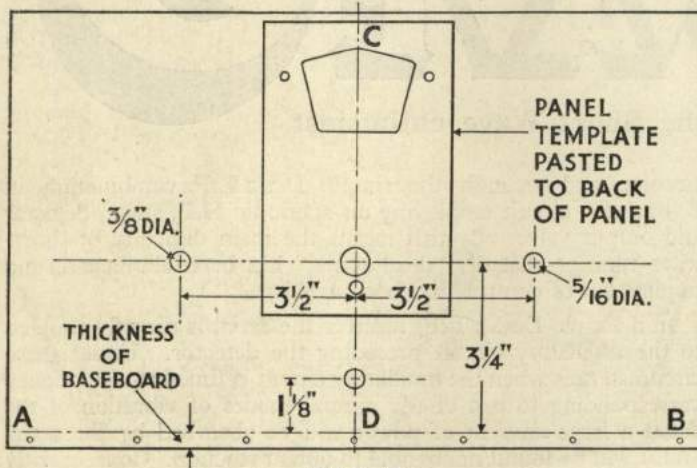

FIG. 2

because it includes those wavebands found by experience to be the most entertaining. The change from one waveband to the other is obtained by means of a switch incorporated in the coil base, a switch-rod, knob and escutcheon being supplied.

Reaction is obtained by means of a differential reaction condenser which is so connected that the reaction control is at earth potential. By this means hand-capacity effects in connection with this control are eliminated. The differential feature helps to keep a path open for the H.F. currents circulating through the detector valve so that they flow through this path to earth rather than through the H.F. Choke to the L.F. section of the receiver.

The pentode output valve is coupled to the detector by the 10:1 Unit which gives the receiver a very high sensitivity and, due to the parallel-feed method of coupling, makes additional detector decoupling unnecessary.

To ensure complete stability when the H.T. batteries are run down the two H.T. leads are earthed through large condensers, and because of this and the care taken in the layout and general design of the set there is an entire absence of "threshold howl."

A full size 1/- blue print is presented free with this issue of the Radiomag and with its help the following instructions will be found simple and easy to follow.

BUILDING THE TELSEN SHORT WAVE THREE.

ASSEMBLY

The first thing is to obtain the baseboard and panel. The baseboard should be made from 7 or 5 ply wood as this is not so likely to warp as ordinary board. This is important in short wave work as a slight displacement of the components or wiring will alter the calibration of the set. For this reason the panel is supported by two angle brackets in order to keep it quite rigid.

The baseboard is 14 inches long and 10 inches wide, and when a piece of plywood has been cut to this size it may be stained if desired.

Now place the lower portion of the blueprint over the baseboard so that the corners exactly register, and secure the print with drawing pins or tacks. Pierce through the fixing holes on the print with a sharp-pointed instrument, such as a bradawl, making the holes in the wood sufficiently deep to provide a start for the screws. This prevents the screws from lifting up the top layers of wood. By this means the components will be located in exactly the same positions as in the original model.

The panel should now be obtained. This is made from 16 or 18 S.W.G. sheet aluminium, a metal panel being essential in order to eliminate hand-capacity effects. The dimensions of the panel on the blueprint are $8\frac{3}{4} \times 13\frac{3}{8}$ but these sizes are not critical and $8\frac{3}{4} \times 14$ may be found more convenient. Fig. 2 shows how the panel is marked out for drilling. The line AB is first drawn on the back of the panel at a height above the lower edge of the panel equal to the thickness of the baseboard. The centre-line CD is then drawn and the hole for the switch rod marked on it $1\frac{1}{8}$ above the line AB. This hole is $\frac{3}{8}$ in diameter. The template supplied with the Disc Drive No. W.184 should now

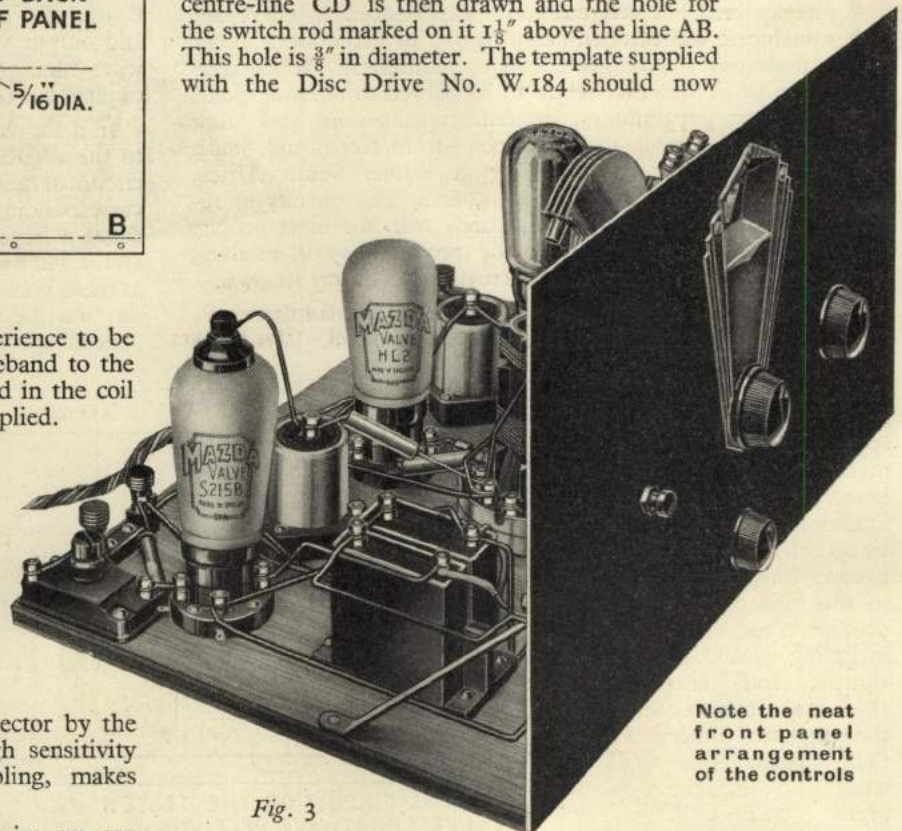

Fig. 3

be pasted to the back of the panel with its centre line coincident with CD and with the $\frac{5}{16}$ diameter hole $3\frac{1}{4}$ above AB as shown. In line with this hole, and $3\frac{1}{2}$ on either side are the holes for the switch and reaction condenser. These are $\frac{5}{16}$ diameter and $\frac{3}{8}$ diameter respectively as shown.

These holes, and those on the template should now be drilled, and the aperture for the dial cut, as described on the leaflet supplied with the Disc Drive; this leaflet also describes how to mount the drive on the panel, and this should now be done.

Now fix the remainder of the components. Take great care that the valveholders are mounted with their sockets the right way round as indicated in the print. The positions of the H.F. chokes must also be checked to ensure that the terminals marked "H.T.+" are the nearest to the panel; the earthing terminal of the 10:1 Unit should also be nearest to the panel. The numbers moulded on the base of the short wave coil bear no

IN STATIONS YOU HAVE NEVER HEARD BEFORE!

relation to those in the print, and should be ignored. The position of the coil is important, and is such that the switch-rod earthing tag is **away** from the panel as shown. The metal angle brackets should also be mounted.

WIRING.

Soldered connections are best, of course, but they are not essential, and excellent results are obtained with looped wires if the instructions given under "Practical Hints and Tips" are carried out.

The wiring is best carried out in the order detailed below, reference being made to the numbers in the print. In the print the valveholders have been marked V1, V2 and V3, and the terminal blocks T1 and T2 to distinguish them from one another, although no such lettering will actually be found on the components.

The wires should follow as far as possible the route shown in the blueprint, as in short wave sets the wiring layout is of first importance. It should be noted, however, that in the print the panel is shown as if it had been folded down flat. This necessarily makes some of the wires appear much longer than they really are, but reference to the photographs which have been included will obviate this difficulty.

ORDER OF WIRING.

- Terminal 1 on T2 to 2 on V1.
- " 2 on V1 to 3 on V2.
- " 3 on V2 to 4 on H.F. Choke "A".
- " 4 on H.F. Choke "A" to 5 on V3.
- " 1 on T2 to 6 on Fuseholder.
- " 6 on Fuseholder to 7 on H.F. Choke "B".
- " 7 on H.F. Choke "B" to 8 on 2 mfd. condenser.
- " 8 on 2 mfd. condenser to 9 on 1 mfd. condenser.
- " 9 on 1 mfd. condenser to 10 on panel. (the bracket fixing screw).
- " 7 on H.F. Choke "B" to 11 on coil.
- " 12 on coil to 13 on Tuning condenser.
- " 13 on Tuning condenser to 14 on reaction condenser.
- " 14 on Reaction condenser to 15 on 10 : 1 Unit.

- Terminal 16 on T2 to 17 on .0001 mfd. preset condenser.
- " 18 on .0001 mfd. preset condenser to 19 on V1.
- " 20 on V1 to 21 on switch.
- " 20 on V1 to 22 on grid leak holder.
- " 22 on grid leak holder to 23 on V2.

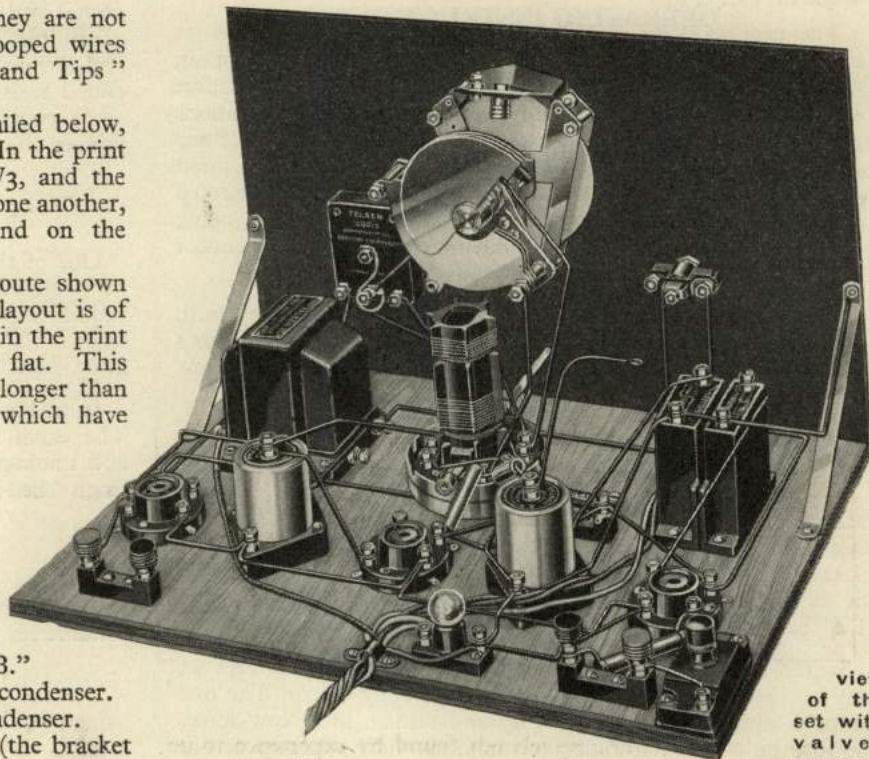

A view of the set with valves removed showing the connections

Fig. 5

- Terminal 23 on V2 to 24 on V3.
- " 25 on V1 to 26 on 1 mfd. condenser.
- " 27 on H.F. Choke "B" to terminal on top on valve 1.
- " 28 on H.F. Choke "B" to 29 on 2 mfd. condenser.
- " 29 on 2 mfd. condenser to 30 on 10 : 1 Unit.
- Terminal 30 on 10 : 1 Unit to 31 on V3.
- " 31 on V3 to 32 on T1.
- " 33 on Grid leak holder to 34 on V2.
- " 35 on V2 to 36 on H.F. Choke "A".
- " 36 on H.F. Choke "A" to 37 on coil.
- " 37 on coil to 38 on reaction condenser.
- " 39 on H.F. Choke "A" to 40 on 10 : 1 Unit.
- " 41 on 10 : 1 Unit to 42 on V3.
- " 43 on V3 to 44 on T1.
- " 45 on reaction condenser to 46 on coil.
- " 47 on coil to 48 on tuning condenser.
- " 11 on coil to 49 (the fixing screw passing through the earthing tag) on coil.

Connect a 100,000 ohm resistor between 19 on V1 and 1 on T2.

Connect a .0001 mfd. tubular condenser between 47 on coil and 34 on V2.

Connect a .0001 mfd. tubular condenser between 27 on H.F. Choke "B" and 47 on V2.

Now connect up the battery cord as follows :—

- L.T. — to 6 on fuseholder.
- L.T. + to 50 on switch.
- H.T. — to 51 on fuseholder.
- G.B. + to 51 on fuseholder.
- G.B. — to 52 on 10 : 1 Unit.
- H.T. + 1 to 26 on 1 mfd. condenser.
- H.T. + 2 to 29 on 2 mfd. condenser.

The Telsen "Short Wave 3" completely assembled

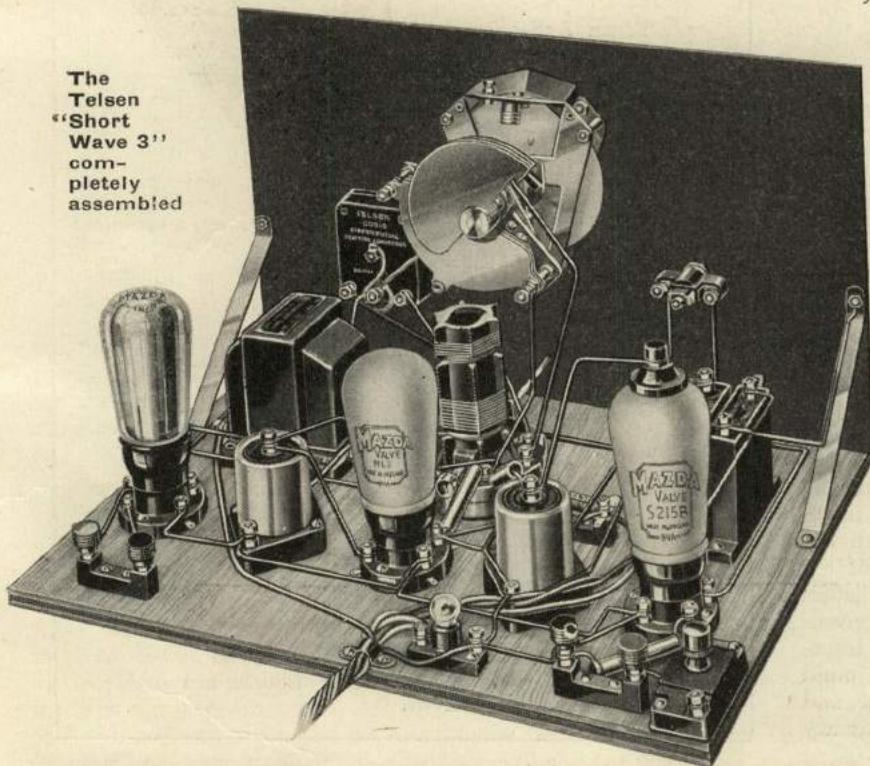

THE TELSEN 'SHORT WAVE BATTERY 3'—continued

If a dial lamp is desired, the wires shown dotted, viz. 10 on panel to 53 on pilot lamp holder and 54 on pilot lamp holder to 24 on V₃ should be added.

This completes the wiring.

OPERATING INSTRUCTIONS.

This receiver is intended primarily for headphone reception, as the additional sensitivity so obtained is of great value in short wave work. However it usually happens that certain stations are received at greater strength than can be comfortably received on headphones, and in such cases a loud speaker may be used with advantage. The loud speaker or phones should be connected to the terminals marked "Speaker" on the print, care being taken in the case of phones or a moving iron speaker to connect the + and - leads the right way round.

If the dial is to be illuminated, screw a 2 volt flashlamp bulb into the pilot lamp holder. It is to be noted that a pilot lamp consumes as much L.T. current as two valves, and many people therefore omit it.

Do not yet fit the valves. Connect the aerial and earth wires to the terminals so marked on the blueprint. Now connect the L.T. + and L.T. - leads respectively to the + (red) and - (black) terminals of the L.T. accumulator. Insert the G.B. + plug into the + socket, and G.B. - plug into the - 9 volt socket of the Grid Bias Battery. Place the H.T. + 1 plug in the 72 tapping and the H.T. + 2 plug in the 120 tapping of the H.T. battery.

Switch on by pulling out the switch on the panel. (The set may be switched off when required by pushing it in.) The dial lamp, if any, should now light up and remain lit. Now screw the fuse bulb into its holder and note carefully whether or not it "blows" (i.e. lights up brilliantly and then goes out). If it does "blow" it means that you have made a wiring error and everything must be checked once again.

Assuming that neither the fuse nor the dial lamp have blown it should be safe to insert the valves as follows:—

VALVES.

Valve Holder	Maker	Valve Type
V ₁	Mazda	S2I5B
V ₂	Mazda	H.L.2
V ₃	Mazda	Pen. 220A

Now connect the wire from terminal 27 to the terminal on the top of Valve 1. The receiver is now ready to receive signals.

OPERATION.

The newcomer to the short waves is always apt to tune too rapidly over the band, and by so doing he is bound to miss a large number of stations. It cannot be too strongly emphasised that when searching for stations the tuning knob must be turned **very** slowly. The tuning control is operated with the left hand, and the reaction control is simultaneously adjusted with the right. The receiver is maintained just on the verge of oscillation if speech or music is required, or just over the oscillation point if unmodulated C.W. morse signals are to be received. Because of the H.F. stage this is not likely to cause any interference with other listeners. When the station has been found it may be sufficiently loud to require a reduction in volume, and the reaction control may then be turned down. No tendency

to instability was found with the receiver on test, but it may happen that the layout of the aerial and phone wiring in some installations may be such as to introduce artificial feedback, with the result that threshold howl (i.e. a howl when the receiver is approaching reaction point) may be experienced. If this is the case, take care to keep the phone or L.S. wires well away from the aerial, and if the trouble persists try connecting a .006 mfd. mica condenser W.247 between terminal 44 on T₁ and terminal 5 on V₃. In very bad cases a 100,000 ohm wire-ended resistor W.381 should be connected between 41 on the 10 : 1 coupling unit and 42 on V₃ instead of the wire normally joining these points.

AERIAL AND EARTH.

One of the advantages of this receiver is the fact that it may be operated from the ordinary household aerial and does not require a special short wave aerial to remove the effects of "dead-spots." The aerial should be high and the lead-in spaced well away from the house.

In all short wave work it is essential to use an efficient earth. The earth wire should be as short and direct as practicable, and the connection to the water pipe or earth plate should be bright and clean to avoid intermittent contact.

BATTERIES.

The following batteries are recommended as being entirely suitable for this receiver.

H.T. Ediswan Cat. No. 69719.

G.B. " " " 69807.

L.T. " " " 69086. (Type E.L.7)

TELSEN SHORT WAVE BATTERY THREE

List of Components

Quantity	Description	Cat. No.	Price
2	Telsen Anti-Microphonic 4-pin Valve-holders	W.222	1/4
1	" Solid type 5-pin Valve-holder	W.225	8d.
2	" Screened Short-wave Chokes	W.342	7/-
1	" 10 : 1 Coupling Unit	W.215	12/6
1	" Short-Wave Coil	W.479	7/-
1	" Illuminated Disc Drive	W.184	2/6
1	" 2 mfd. Condenser	W.226	3/-
1	" 1 mfd. "	W.227	2/3
1	" .00015 mfd. Differential Reaction Condenser	W.352	2/6
1	" 2 point Push-Pull Switch	W.107	1/-
1	" 2 megohm Grid Leak	W.251	1/-
1	" Grid Leak Holder	W.148	6d.
2	" .0001 mfd. Tubular Condensers	W.402	2/-
1	" .0001 mfd. Pre-set Condenser	W.152	1/6
1	" 100,000 ohm Resistor	W.381	1/-
1	" Battery-type Fuseholder	W.146	6d.
2	" Terminal Blocks	W.204	1/-
1	" 100 milliamp Fuse Bulb	W.318	6d.
Sufficient	Connecting Wire	W.441	
1	Eddystone .00016 mfd. Short-Wave Tuning Condenser		
1	2 volt. Flashlamp Bulb if required for Pilot Light		
2	Metal Angle Brackets		
1	Battery Cord (7 leads)		
5	Wander Plugs:— H.T. + 2; H.T. + 1; H.T. -; G.B. +; G.B. -		
2	Spade Terminals L.T. +; L.T. -		
	Also Panel and Baseboard as described and woodscrews.		

Notes on AUTOMATIC VOLUME CONTROL

ALTHOUGH Automatic Volume Control is a comparatively recent development, a similar principle has been used by line telegraphy and telephony engineers for many years. Their circuits, however, bear only a faint resemblance to the modern systems, which are based upon the use of the variable mu valve. The reason for this is obvious when we consider that this valve made possible a perfect method of controlling volume by the variation of its grid-bias voltage, and it only remained to devise a circuit in which this bias automatically decreased or increased according to whether the signal to be received was feeble or strong. With such an arrangement, all stations are received at approximately the same strength without the use of a manual volume control, and the value of such a device is readily appreciated when a sensitive receiver, such as the superheterodyne, is tuned over the waveband. With the receiver

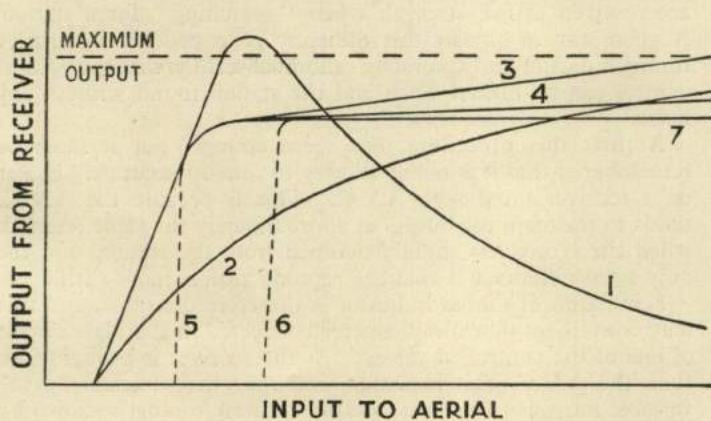

FIG. 1

in its most sensitive condition a very weak station may be received at good strength, but if the set is tuned to the local station the signal may easily be 5,000 times as strong, with the result that unless rapid use is made of the manual volume control the receiver will be heavily overloaded. Under these conditions the detector valve would probably cease to function, and the output would fall, as shown by the Curve 1 Figure 1. On the other hand, with the use of automatic volume control (AVC) the output of the set may only increase by two or three times, and no overloading will occur.

Let us now consider a simple A.V.C. circuit, such as that shown in Figure 2. L.C.1 is the tuned circuit across which signal voltages are built up. In consequence of the usual processes of rectification, into which it is not necessary to enter here, we have Radio frequency, Audio frequency and Direct voltages developed across the resistance R₁. The radio frequency currents are by-passed by the condenser C₂, and the audio frequency currents are led through the H.F. filter formed by the H.F. Choke and condenser C₃ to the L.F. amplifier. R₁, being a potentiometer, provides a manual volume control which will

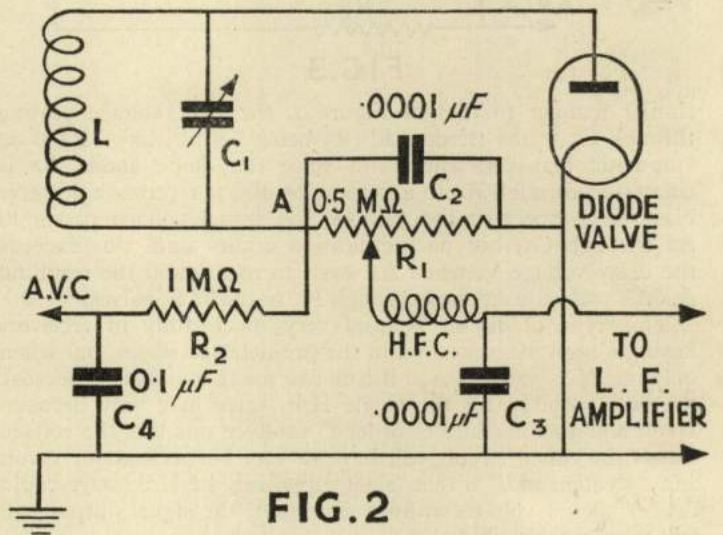

FIG. 2

be found useful. But we are particularly interested in the direct voltage, developed across R₁, which is such that the point "A" becomes negative with respect to earth by an amount nearly proportional to the strength of the signal. Here, then, we have the automatic bias which we have been seeking, and it is led through a filter composed of R₂ and C₄ to the grid circuits of the preceding H.F. variable mu valves.

This simple type of A.V.C. suffers from the rather serious drawback that it operates on all signals, even those which require maximum amplification. The Curve 2 of Figure 1 illustrates this point, for a station which would normally give full volume is reduced to about half this strength. Clearly we need some device which will delay the A.V.C. action until the receiver is giving its maximum undistorted output and then allow the A.V.C. to operate so that stronger stations are prevented from overloading the set. This is called "Delayed Automatic Volume Control" (D.A.V.C.) and would have a curve similar to 3 in Figure 1.

Now if we give the diode anode of Figure 2 a negative bias with respect to its cathode, no rectification will occur until the peak signal voltage exceeds this bias, and so the A.V.C. voltage will be delayed. This, however, is impracticable because the diode must rectify in order to act as a detector. The obvious way out of the difficulty, then, is to use two diodes, one to act as a detector, and the other, with a negative bias to supply the delayed A.V.C. voltage. Such a circuit is shown in Figure 3 in which the two diode anodes are put in the same glass envelope as the L.F. amplifying valve so as to use the same cathode. This valve is called a "double diode triode" but it is only used for convenience, and the same circuit could be employed with separate diodes or with metal rectifiers.

In this circuit the diode anode A1 rectifies the signal in a

AUTOMATIC VOLUME CONTROL—continued

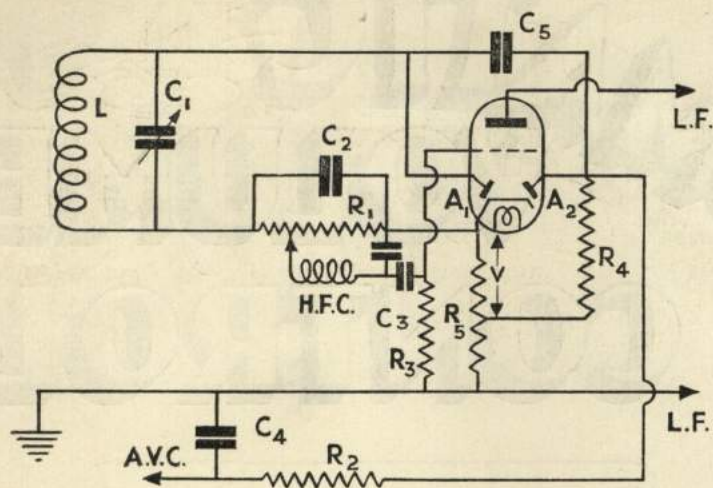

FIG. 3

similar manner to that of Figure 2, the L.F. voltage passing through C_3 to the triode grid (R_3 being a grid leak). R_5 is an automatic bias resistance, and since the diode anode A_2 is connected through R_4 to a tapping on R_5 , it receives a negative bias with respect to the cathode. A signal voltage passes to A_2 through C_5 , but no rectification occurs until this exceeds the delay voltage V , when A_2 starts to rectify and the resulting A.V.C. voltage is applied through R_2 to the H.F. valves.

This type of circuit is used very successfully in receivers having a high magnification in the pre-detector stages, but when only one H.F. valve is used it is not so suitable. This is because the bias required for the single H.F. valve may vary between 1 volt and 30 volts, and in order to produce this bias the voltage across the tuned circuit will have to vary between about 1 volt and 25 volts r.m.s. so that (even supposing the H.F. stage could deliver such a voltage without distortion) the signal output will still vary considerably.

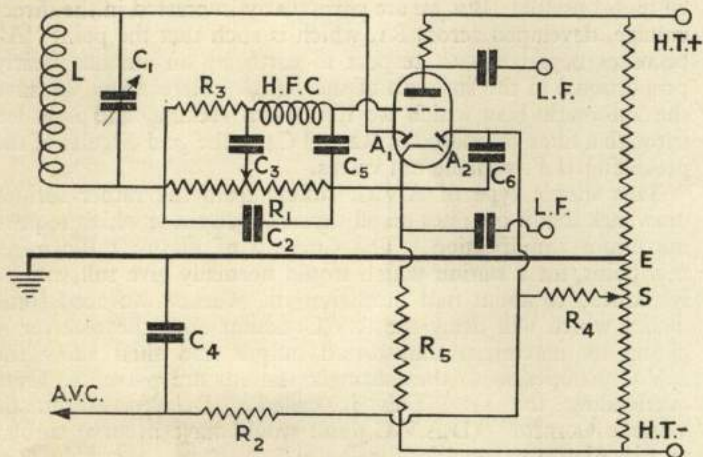

FIG. 4

To obviate this difficulty a circuit has been devised which gives the required range in A.V.C. voltage for a small change of signal input, the curve being more level as in 4 Figure 1. This is called "Amplified A.V.C.," and is shown in Figure 4. The circuit for the diode anode A_1 is similar to that in Figure 3, but the triode grid receives its bias through a high resistance R_3 connected to R_1 . Thus the A.V.C. voltage developed across R_1 (which we neglected in Figure 3), is now used to bias the triode. This does not affect the amplifying properties of the triode to any great extent, but it does vary the steady anode current, reducing it in proportion to the strength of the signal. Now the voltage drop across R_5 is proportional to the anode current and therefore decreases in proportion the signal strength,

and this variation may be ten times as great as the variation across R_1 . This explains the use of the word "amplified." Now we could take our A.V.C. bias direct from the cathode, but we wish to include the "delay" action which is so desirable, so the bias is taken from A_2 instead. Now as long as A_2 is at a lower potential than the cathode no current flows between it and the cathode, but as soon as the cathode is at a lower potential than A_2 current flows and A_2 is maintained at cathode potential. So A_2 is biased by means of the slider S so as to be negative to the cathode by a suitable amount and the earth wire of the set is connected, not to H.T.— as usual, but to a point E such that the voltage between E and S is the minimum bias required by the H.F. valves.

Now consider what happens as the signal strength is progressively increased. At first there is no D.C. voltage across R_1 , and the current in the triode and therefore the drop of voltage across R_5 is a maximum. The bias on the H.F. valves is a minimum. As the signal increases the bias developed across R increases, the current in the triode decreases, and the voltage across R_5 falls. When the signal has reached good loudspeaker strength the cathode should be at the same potential as A_2 so that any further increase in signal strength causes the cathode potential and also that of A_2 to fall, and the H.F. valves receive their A.V.C. bias.

Another way in which the output from a simple delayed diode system may be maintained more constant is to use a variable mu L.F. pentode instead of the triode of Figure 3 and take its bias from the A.V.C. line. In this way the L.F. amplification is made to compensate for the changes in detector output so that an approximately level curve, such as 7 in Figure 1, can be obtained.

With all these A.V.C. systems there is a great rise in sensitivity as the receiver is detuned from a station, so that any atmospheric are received at full strength when "searching" for a station. A good way to obviate this difficulty is to provide a sensitive tuning indicator and accurately calibrated scale so that the volume control can be turned down and the station found without any noise.

At first this procedure may seem strange, but it must be remembered that it is not at all easy to tune in accurately by ear on a receiver fitted with A.V.C. This is because the A.V.C. tends to maintain the output at approximately the same strength when the receiver is slightly detuned from the station, and the only aural difference is that the reproduction is more shrill.

Some kind of tuning indicator is therefore desirable, and this may conveniently be a millimeter connected in the plate circuit of one of the controlled valves. As the receiver is brought into tune the A.V.C. bias increases, and the current taken by the variable mu valve decreases, so that accurate tuning is shown by the point of minimum deflection of the meter.

The volume control is now turned up, and the programme comes in at correct strength.

Other methods can be used to cut out this inter-station noise, but they also cut out very weak stations, and usually require either a mechanical relay or an extra valve. Such systems are termed Quiet Automatic Volume Control (Q.A.V.C.) and would have curves corresponding to 5 and 6 in Figure 1.

A triple diode triode has recently been developed, however, which provides Quiet Amplified Delayed Automatic Volume Control without the use of an extra valve or relay, but the circuit is rather complicated, and is not given here, since unless the reader is well versed in circuit lore, he will be unable to follow its action.

In conclusion it is of interest to note that in every circuit the A.V.C. voltage has to pass through the resistance R_2 to a reservoir condenser C_4 . This introduces a time lag into the system so that the A.V.C. is unable to respond to the low frequency variations of the carrier amplitude. If this were not done the low notes would operate the A.V.C. system and so would suffer a reduction in strength.

How to Gang up @ MULTIVALVE RECEIVER



THE use of a gang condenser in a receiver enables all the circuits of a selective set to be tuned simultaneously by the rotation of a single knob: without this feature the receiver would be extremely difficult to operate. To obtain the best results, it is necessary that a little care be spent in making the preliminary adjustments. If the coils in the receiver are all of the same inductance, and if the capacity across them is the same at all settings of the tuning condenser, then the circuits will be in tune at all wavelengths. It is therefore essential that the coils in a ganged receiver be of matched inductance, to within ± 0.5 per cent.: an accuracy of this order can best be obtained by purchasing the coils ready matched.

The tuning condenser is carefully manufactured so that the capacity of each section is the same as that of the other sections at all positions of the dial: but this does not guarantee that the total capacity across each coil is the same, since the wires joining the condenser to the coil, and the coil to the valve, have a capacity, which though small, is of sufficient magnitude to affect the tuning. These capacities will not be the same in each circuit and to enable this difficulty to be overcome, small "trimmer" condensers are built into the main ganged condenser. These trimming condensers are adjustable from a very low value to a maximum of about .00005 mfd., and are in parallel with the main tuning condenser in each section. The circuit with the greatest capacity due to wiring, valveholder, etc., has its trimming condenser set to a low value, and the trimming condensers in the other circuits are adjusted until the capacities across the coils are the same in all the circuits: this is shown by the receiver being highly selective and tuning sharply. The receiver is now correctly adjusted and the circuits will remain in tune with each other over the whole waverange.

An aerial has a large capacity to earth, which has to be compensated by the trimmers: the disturbing effect of this capacity is reduced by the modern methods of coupling the aerial to the receiver circuits, but despite this it is well worth the effort to re-gang the receiver whenever a change of aerial is made, unless the change be of a very minor nature.

The position of the reaction condenser affects the tuning of the circuit to which it is connected. The detector throws a

capacity across the tuned circuit which varies with the bypass capacity in its anode circuit: a differential reaction condenser obviates this effect. If an ordinary reaction condenser is in use it is necessary to set it until the receiver is just short of oscillation, since the receiver will then be accurately ganged when the transferred capacity in the grid circuit of the detector corresponds to the most selective condition of the tuned circuits. A screen grid valve or a screened pentode valve functioning as a detector does not transfer a variable capacity to its grid circuit but it is still advisable to adjust the receiver to a point just short of oscillation, so as to perform the operation of ganging when the set is in its most selective condition.

The trimming condensers are built into the main tuning condenser, and are located at the side or top of the main assembly. They are controlled by star-wheels, or else have screwdriver slots. The Telsen condensers have star-wheels at the right-hand side of the condenser.

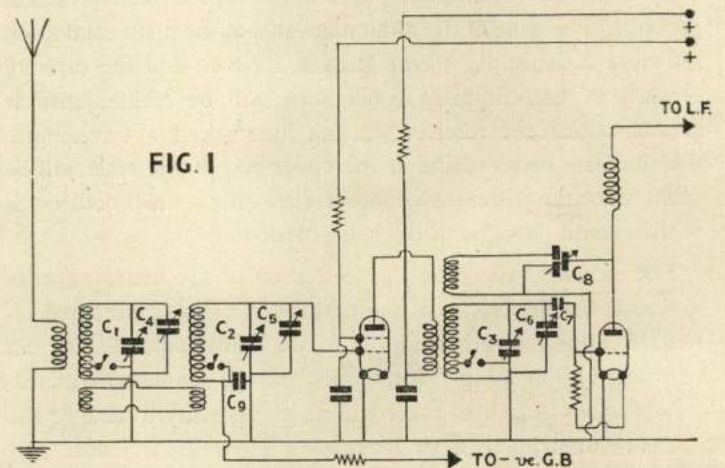

To gang a straight high frequency receiver, the procedure is as follows. The star-wheels are screwed fully in, then unscrewed as far as possible, and the number of turns counted. They are then screwed in for half this number of turns. The receiver is tuned by means of the main tuning condenser to a weak station at about 240 metres. The object is to obtain a weak signal, since the ear is very much more sensitive to small changes of volume when the total volume is small than it is when the total

HOW TO GANG UP A MULTI-VALVE RECEIVER—continued

volume is large. The trimmer on the detector tuning condenser is now adjusted for the maximum volume by moving it slightly in or out. The effect of very slightly readjusting the main tuning condenser and resetting the detector trimming condenser should be tried. In Figure 1, which shows the essential tuning circuits of a straight H.F. bandpass receiver, the detector trimming condenser is shown at C6. Attention is now transferred to the circuit feeding the H.F. valve, the trimming condenser of which is C5: this is varied both ways until the loudest signals are heard, the effect being tried of varying slightly the position of the main tuning condenser, as before. This condenser having been adjusted, C4, the trimming condenser of the aerial circuit, is adjusted in like manner. In receivers with a different number of tuned circuits, the correct procedure is to commence at the detector stage and work backwards to the aerial circuit.

If one of the trimming condensers has to be screwed fully in, the other two trimmers should be screwed out a little, and the receiver re-ganged. If this is not done, it is impossible to gang the receiver correctly. Similarly, if one trimmer is at its minimum value, the other two should be increased a little, and the receiver reganged.

When the receiver has been correctly ganged, the trimmers should be examined, and the trimmer which is screwed in the least should be unscrewed until it is almost fully out. The other trimmers should be reduced a little and the receiver re-ganged. The object of this procedure is to have the trimming condensers at the minimum value consistent with correct ganging in order to avoid restricting the tuning range of the receiver. If the trimming condensers are at a high value, then when the tuning condenser is at its minimum position, the capacity across each of the coils, consisting of the minimum value of the main condenser, the stray capacity due to the leads and valves, and the capacity of each of the trimming condensers, will be greater than is necessary, and the receiver will not tune to a low wavelength. The increase of waveband at the upper end of the scale will be small, since the trimming condensers are only a small percentage of the maximum value of the main condenser.

The receiver having been ganged at about 240 metres, a weak station at the upper end of the tuning-scale should be tuned in, and the trimmers varied slightly to see if any improvement can be effected by so doing. If the coils, and the condenser sections, are accurately matched, there will be no necessity to change the values of the trimmers.

The receivers should be finally and accurately ganged by tuning in a very weak station at almost the bottom end of the tuning scale, and performing carefully the adjustments of the trimmers described previously.

Careful layout of the wiring on symmetrical lines enables the receiver to be switched to the long-wave band without necessitating alteration of the trimming condensers, assuming that the coils are accurately matched on their long-wave sections in addition.

This feature has been carefully observed in the manufacture of the Telsen Coils.

The operation of ganging a superheterodyne is slightly different and depends on the method adopted to maintain the oscillator frequency at 110 K.C. difference from the tuning circuit frequency. In addition, the I.F. transformers have to be tuned.

With the system using a standard gang condenser, with padding condensers to keep the oscillator circuit at its correct frequency (which is the method formerly adopted in the Telsen kit superheterodynes), the trimmers on the I.F. transformers are rotated to a position midway between their maximum and minimum values, and if the I.F. Coils are adjustable these should be placed almost the maximum distance apart. The trimmer on the oscillator portion of the condenser is fully unscrewed, and the other trimmers set to midway positions. A weak station at about 240 metres is tuned in, and the I.F. trimmers C11, C12, C13,

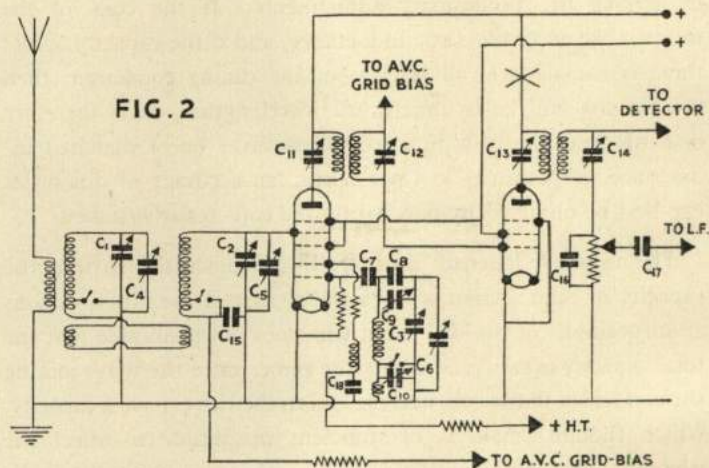

C14 in Figure 2, which shows the essential circuits of the Telsen Superheterodyne kit receivers, adjusted, in the sequence mentioned, until maximum volume is obtained. C11 should be at about the midway position. The trimming condenser on the band-pass coil, C5, is adjusted for maximum volume, the main tuning condenser being varied slightly if necessary whilst doing this.

A weak station at the top end of the medium waveband is then tuned in, and the padding condenser C9 varied a small amount at a time, retuning each time with the main gang condenser, until maximum volume is achieved. The receiver is then tuned to a weak station at the lower end of the waveband, and the trimming condenser C5 readjusted, after which the aerial trimming condenser C4 is adjusted. Should it be found that C4 has to be at its minimum value, a preset condenser of 0.0005 mfd. maximum should be inserted in the aerial lead, and varied until C5 is just off its minimum value, and then left unchanged.

The set is then switched to the long wavelength band, and a weak station at about 1,400 metres tuned in. All trimmers are

HOW TO GANG UP A MULTI-VALVE RECEIVER—continued

left untouched with the exception of the longwave padding condenser C_{10} , which is varied a little at a time, with variation of the main gang condenser position after each adjustment, until maximum signal strength is attained. The receiver is now correctly ganged over the whole of both wavebands. The I.F. transformer coils may now be more tightly coupled, if they are adjustable, by sliding them together on their formers, until the best compromise between selectivity and quality of reproduction is obtained.

The other method of maintaining the oscillator frequency at its correct distance from that of the high frequency circuits makes use of a gang condenser having specially shaped vanes, and the medium wave padding condenser is unnecessary. Figure 3 shows the connections of a superheterodyne receiver

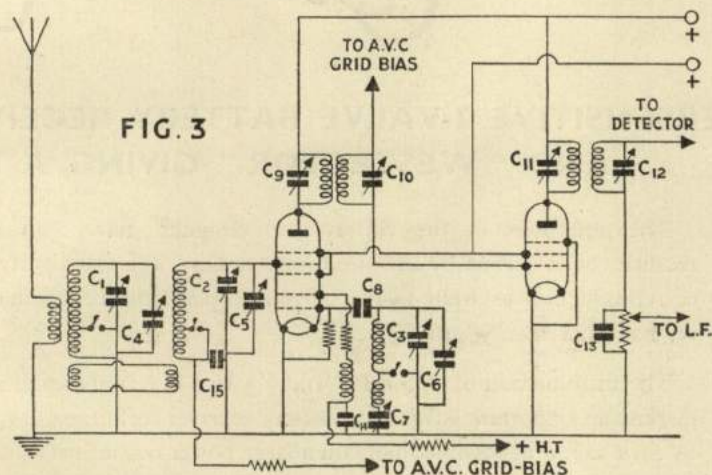

employing a shaped-vane gang condenser. As before, all trimmers are set to the midway position, including in this case the oscillator trimming condenser. A weak station at about 240 metres is tuned in, and the I.F. condensers C_9 , C_{10} , C_{11} , C_{12} adjusted, in that order, for maximum volume.

The bandpass trimming condenser C_5 and then the aerial trimming condenser C_4 are adjusted for maximum volume. A station on the upper portion of the waveband is tuned in, and the oscillator trimming condenser C_6 varied, with continual resetting of the gang condenser, until maximum volume is obtained. A return is made to the lower portion of the waveband, and the trimmers C_5 and C_4 readjusted. In the case of a shaped-vane condenser, the gang condenser is usually designed for an intermediate frequency of 110 K.C. a second, and the ganging will not be correct if the I.F. transformers are operating at some other frequency. Those resident near a high-power station may check the intermediate frequency of their receivers as follows. Ascertain the frequency of the local station from a list of stations giving their wavelength and frequency (e.g. London Regional is operating on a frequency of 877 K.C.) and find what station is approximately 220 K.C. below it in frequency (i.e. $877 \text{ K.C.} - 220 \text{ K.C.} = 657 \text{ K.C.}$). Langenberg is operating on 658 K.C.). If now the receiver is tuned to the other station (in our example, the receiver would be tuned to Langenberg) a whistle should be heard from the local station (London Regional). If the whistle is heard when the receiver is tuned to some other station, half the frequency difference of that station and the local station gives the frequency to which the intermediate stages are tuned. Should the frequency be other than 110 K.C. the

condensers C_9 , C_{10} , C_{11} , C_{12} must all be increased or decreased, and the receiver reganged as before until the correct intermediate frequency is obtained. Those not having a powerful local station will find that if it is not possible to obtain correct ganging over the whole of the waveband, a readjustment of the frequency of the I.F. transformers will enable this to be obtained. When the I.F. transformers are at their correct frequency and C_9 , C_{10} , C_{11} and C_{12} have been adjusted as before for maximum volume, C_5 and C_4 should be adjusted at the lower end of the waveband, and C_6 at the higher end, and this procedure repeated at least once, to obtain the best results.

The receiver is then switched to the longwave band, all the trimmers being left untouched, except the padding condenser C_7 which is varied a little at a time, retuning each time on the gang condenser, until maximum volume is obtained. The receiver is then correctly ganged over both wavebands.

In carrying out the operations of ganging a receiver, it will be appreciated that it is essential to tune in a station which is not subject to fading, since otherwise it will be impossible to decide whether or not the adjustments have effected an improvement. The performance of the operations in daylight, early evening for example (but not at dusk) will ensure that no fading is occurring. Longwave stations seldom fade. For a similar reason, a station transmitting speech is to be preferred, since music varies in volume over wide limits during a performance.

The use of a meter greatly facilitates the process of ganging, but is not an essential. A millimeter in the anode circuit of the I.F. valve, at the point X in Figure 2, will if this valve is controlled by A.V.C. read a minimum at the point of maximum signal strength. Adjustments are then made to obtain the minimum reading on the meter. In those receivers not incorporating A.V.C. a millimeter may be inserted in the H.T. positive lead of the detector, and will read a minimum at the strongest signal, on a leaky grid detector, and a maximum at the strongest signal on an anode bend detector.

In the performance of the operations of ganging the receiver, it has been assumed that the coils are of correct matched inductance. The coils of a receiver should be treated carefully, and the windings not bent or distorted in any manner, otherwise serious changes of inductance will occur. The coil screens should be securely in position, since the metal influences the inductances of the coils (the coils are matched in the factory with their screens in position). The wiring of the receiver should be rigid and not liable to sag or move: such movement will affect the capacity to earth of the wiring, necessitating reganging.

Changing the H.F., I.F., or detector valve, to another of the same make and type will not necessitate reganging, although trying the effect of this will occasion no harm. For the best results, reganging will be necessary if a change is made to a valve of a different make, or type. The correct operating voltages should be applied to the receiver, otherwise the capacities due to the valves will be incorrect.

The operation of ganging a receiver may perhaps appear a little formidable from the foregoing instructions, but it is in practice quite simple and interesting, if the work is carried out systematically. The reward is in the form of magnificent receiver performance.

VALVE RECEIVER

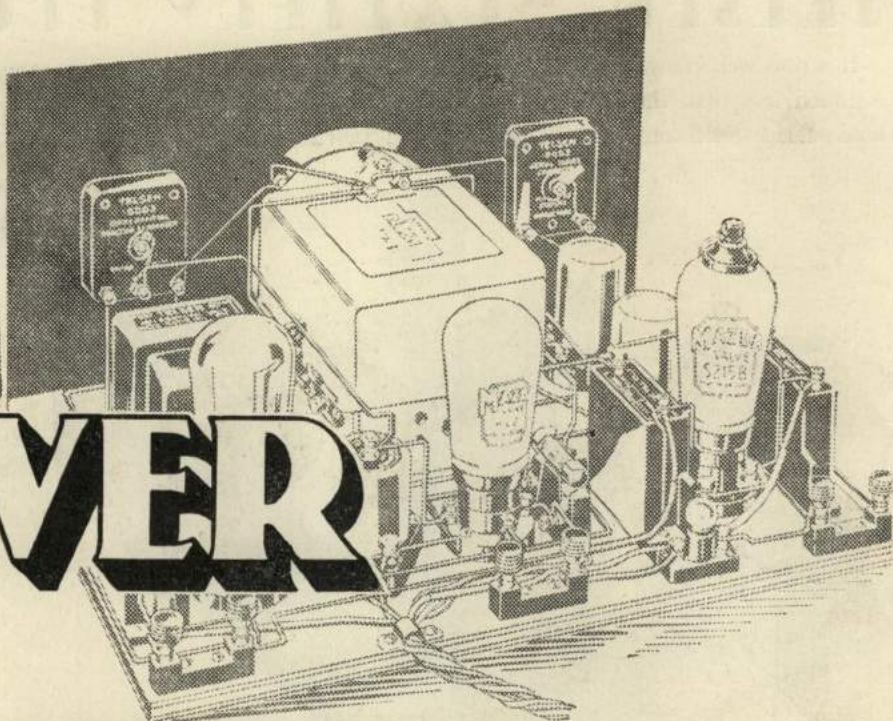

EMPLOYING "IRON CORED" COILS, GANGED CONDENSER FORMANCE OF OUTSTANDING MERIT

value sufficient to handle the signal without distortion.

On the other hand with an ordinary "Class A" output the same current is taken by the set whether a programme is being received or not. Research was, therefore, directed to the problem of reducing the H.T. current automatically during periods of no signal, as by this means a highly economical receiver would be obtained with normal pentode output. This is often more convenient than fitting a "Class B" output as so many home

constructors have pentode speakers and valves which they wish to utilise, and even though they may buy a new "Class B" valve they have still to purchase a "Class B" Output component in order to match the speaker to this valve.

The method by which the problem has been solved is shown in Fig. 1. which illustrates the circuit employed in the Telsen Economy 3. The bias applied to G.B.—2 is $-13\frac{1}{2}$ volts, and is sufficiently in excess of the normal value to reduce the anode current of the pentode output valve to the small value of 2.2 milliamps.

When a signal is received, the L.F. impulses are fed from the anode of the pentode through the 0.25 mfd. condenser and 100,000 ohm resistance to the "Westector" which is connected across the 50,000 ohm resistance. Now when a "Westector" is supplied with an alternating voltage (such as the signal voltage in this case) it builds up a direct voltage proportional to the strength of the alternating one. In this circuit the "Westector" is so connected that the junction of the 100,000 ohm resistance and the 50,000 ohm resistance tends to become positive when a signal is received and so part of the initial $13\frac{1}{2}$ volts negative bias is neutralised, the amount of neutralisation depending on the strength of the signal. The resultant voltage is communicated to the grid of the pentode through the 250,000 ohm resistance and the secondary winding of the transformer. Thus we see that when no signal is being received the pentode is biased almost to cut-off point, with a consequent saving in H.T. current, but on reception of a programme the bias falls to a value suited to the strength of the incoming signal.

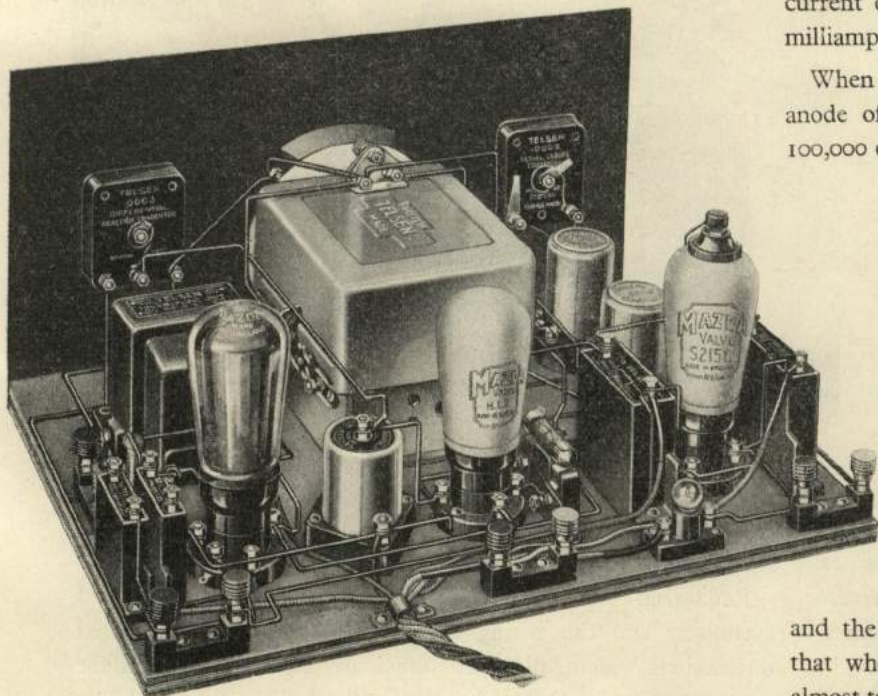

Fig. 3

The receiver completely built and ready for trial.

TELSEN "BATTERY ECONOMY 3" — continued

It is now well known that the average strength of a programme is much less than the maximum strength experienced during loud passages, and consequently, with a system such as the above,

receiver, and also tends to maintain the grid-filament capacity of the detector constant, so ensuring correct ganging.

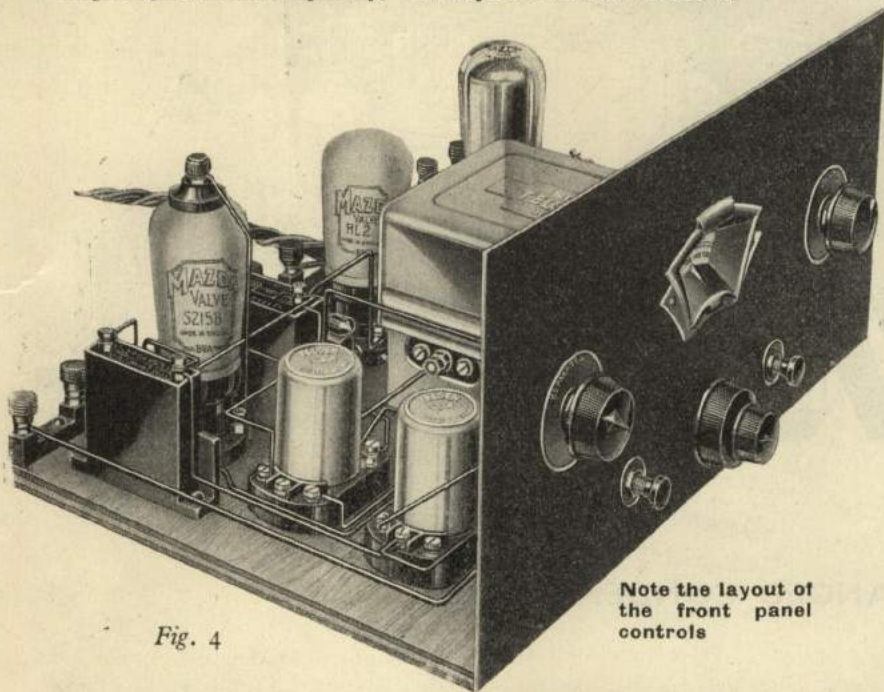

Fig. 4

Note the layout of the front panel controls

in which the current taken is proportional to the signal strength, the average current taken over a considerable period is remarkably low.

The 250,000 ohm resistance and 0.1 mfd condenser are included in order to filter out any L.F. impulses which would tend to cause self-oscillation of the output stage.

Let us now continue with the remainder of the circuit. The aerial is loosely coupled to the oscillatory circuit preceding the screened grid valve, a series condenser being included as a control of selectivity and volume. This condenser incorporates a switch which automatically short-circuits it in the position corresponding to maximum volume.

A high mutual-conductance screened-grid valve is used in the H.F. amplifier in order to obtain the utmost efficiency and it is coupled inductively to the iron cored coil preceding the detector. This coil and the one preceding the Screened Grid Valve are accurately matched together so that when tuned by the Telsen twin ganged condenser accurate ganging is ensured at all points along the scale. Incidentally the scale is illuminated by a pilot lamp so that accurate tuning is possible in a darkened room.

The use of highly efficient iron-cored coils has the effect of enhancing both the selectivity and sensitivity of the receiver. The reaction winding of the detector grid coil is fed from a differential reaction condenser, which, by keeping the capacitive component of the anode load sensibly constant helps to prevent leakage of H.F. signals into the L.F. section of the

Care is taken to ensure complete stability, the iron cored coils being screened, and earthed, as also are the H.F. Choke, 10:1 Unit, and ganged condenser, while adequate bypass condensers are provided across both H.T. tapings to prevent "motor boating" when the battery is old. For the same reason the leaky grid detector is followed by a H.F. Choke, which, in conjunction with the differential reaction condenser, effectively deflects all unwanted H.F. energy from the L.F. amplifier where it would set up instability.

Following the H.F. Choke is a 10:1 Coupling Unit which gives a remarkably large stage gain and helps to compensate for the tendency of the pentode to over-accentuate the high notes. The use of the parallel-feed method of coupling which is incorporated in the 10:1 Unit makes additional decoupling arrangements in the detector anode circuit unnecessary.

Provision is made for a gramophone pickup and the economy feature is operative during the reproduction of gramophone records.

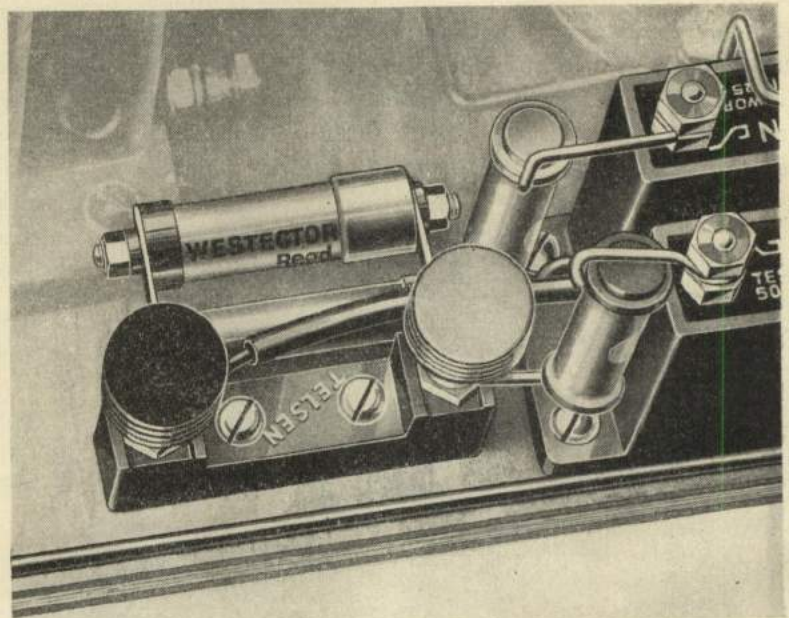

Fig. 5

A "close-up" showing the "Westector" and connection

A free full-size 1/- blueprint is included in this issue of the "Radiomag" in order that the components may be positioned accurately and the wiring carried out easily. The detailed instructions which follow are sufficiently clear and explicit for every stage to be followed easily, and no difficulty should be experienced in the construction and operation of the receiver.

"SINGLE KNOB" TUNING-PENTODE OUTPUT

ASSEMBLY

The first step in the assembly of any receiver is to obtain a suitable baseboard and panel. The baseboard is best made from 7 or 5 ply wood as this material is not likely to warp, while it is sufficiently thick to afford secure anchorage of the components.

A piece fourteen inches long and ten inches wide should be cut and may be stained if required. Now place the lower portion of the blue-print over the baseboard so that the corners exactly register and secure the print with the drawing pins or tacks.

Now with a sharp-pointed instrument pierce through the fixing holes in the print so as to locate exactly the positions of the components on the baseboard; these holes should be made sufficiently deep to provide a start for the screws as this prevents the screw from lifting up the top layers of wood. Remove the print and paste down over the fixing holes for the ganged condenser the template supplied in the same carton as this component. This should be done in such manner that the fixing holes on the template coincide with the holes pierced through from the blueprint.

Now obtain the panel. This should preferably be of ebonite but may be of wood provided that its thickness does not exceed $\frac{1}{4}$ " as otherwise the bushes of some of the panel components will be too short. The dimensions of the panel on the print are $6\frac{1}{8}" \times 13\frac{3}{8}"$. These sizes are not critical, however, and $7" \times 14"$ may be used if desired.

A metal panel may not be employed, unless means are used to insulate the spindle of the differential reaction condenser from the panel. Place the panel against the baseboard in the position it will finally occupy, and paste the panel template on the back of the panel in such a manner that the centre line of this template is in line with that of the baseboard template. The panel may now be cut as illustrated on the panel template. At the same time holes may be drilled for the Aerial Series Condenser, Differential Reaction Condensers and Switches. The positions of these holes can be ascertained from the print of the panel; no great accuracy is required other than for matters of appearance. The holes for the switches are $\frac{5}{16}"$ in diameter and those for the aerial series and reaction condensers are $\frac{3}{8}"$ diameter. When all the apertures have been made in the panel the components may be mounted upon it, and also upon the baseboard.

It is to be noted that in order to show the fixing holes of the 0.25 and 0.1 mfd. condensers the 100,000 and 250,000 ohm resistors have been moved aside in the print. Actually, as will be seen from the photographs, these resistors fit snugly in the corners of the condensers immediately above the fixing screws. Another point requiring explanation is that the numbers moulded on the bases of the iron cored coils bear no relation to the numbers in the print, and are only of use to assist in mounting the coils the right way round. With both coils the numbers 1, 2 and 3 should be on the side facing the ganged condenser.

Take great care when mounting the valve-holders, H.F. Choke,

and 10:1 Coupling Unit that the terminals are in the positions shown in the blue-print.



FIG. 2

The .0003 mfd. condenser and 2 Megohm Grid Leak are to be assembled as shown in Fig. 2, using the special clips supplied with the condenser, before mounting them on the baseboard. The "Wes-tector" must be mounted the right way round as shown on the blue-print.

WIRING.

Although soldered connections are always best, they are not essential, and excellent results are obtained with properly looped wires firmly screwed down under the terminal heads. Telsen connecting wire is recommended and before commencing wiring, the constructor should read the instructions given under "Practical Hints and Tips."

The wiring is best carried out in the order detailed below, reference being made to the numbers on the blue print. The valveholders in this print have been marked V1, V2 and V3, the coils A and B, and the terminal blocks T1, T2, T3 and T4 to distinguish them from one another, although no such lettering will actually be found on the components.

It is important also to recognise that the path taken by the wiring in the blueprint may deviate from the actual path by a slight amount because it is often impossible to show wires in their correct positions, without the print becoming confused. For example, the wires connected to components on the panel are actually quite short although on the print they appear very long. To obviate this difficulty we have included a number of actual photographs of the completed receiver so that in most cases the shape of the wires can be seen

ORDER OF WIRING.

- | | |
|----------|---|
| Terminal | 1 on V1 to 2 on .0003 mfd. Condenser. |
| " | 2 on .0003 mfd. Condenser to 3 on V2. |
| " | 2 on .0003 mfd. Condenser to 4 on pilot lamp holder. |
| " | 3 on V2 to 5 on V3. |
| " | 5 on V3 to 6 on S1. |
| " | 7 on terminal block T3 to 8 on fuse holder. |
| " | 7 on T3 to 9 on V1. |
| " | 9 on V1 to 10 on 1 mfd. Condenser. |
| " | 10 on 1 mfd. Condenser to 11 on coil A. |
| " | 11 on Coil A to 12 (the fixing screw) on coil A. |
| " | 12 on Coil A to 13 on coil A. |
| " | 13 on coil A to 14 on S2. |
| " | 13 on coil A to 15 on pilot lamp holder. |
| " | 15 on pilot lamp holder to 16 on Ganged Condenser. |
| " | 15 on pilot lamp holder to 17 (the escutcheon fixing screw) on panel. |

TELSEN "BATTERY ECONOMY 3"—continued

- Terminal 10 on 1 mfd. Condenser to 18 on 2 mfd. Condenser.
- ” 18 on 2 mfd. Condenser to 19 on Coil B.
- ” 19 on Coil B to 20 on Coil B.
- ” 18 on 2 mfd. Condenser to 21 on V2.
- ” 21 on V2 to 22 on H.F. Choke.
- ” 22 on H.F. Choke to 23 on V3.
- ” 23 on V3 to 24 on 0.1 mfd. Condenser.
- ” 25 on terminal block T3 to 26 on .0003 mfd. Aerial Series Condenser.
- ” 27 on Aerial Series Condenser to 28 on Coil A.
- ” 29 on coil A to 30 on S2.
- ” 31 on coil A to 32 on ganged condenser.
- ” 31 on coil A to 33 on V1.
- ” 34 on coil B to 35 on S2.
- ” 36 on coil B to 37 on ganged Condenser.
- ” 36 on coil B to 38 on .0003 mfd. Condenser.
- ” 39 on coil B to cap on top of valve V1.
- ” 40 on coil B to 41 on 2mfd. Condenser.
- ” 42 on coil B to 43 on Reaction Condenser.
- ” 44 on V1 to 45 on 1mfd. Condenser.
- ” 46 on .0003 mfd. Condenser to 47 on V2.
- ” 46 on .0003 mfd. Condenser to 48 on T2.
- ” 49 on V2 to 50 on H.F. Choke
- ” 50 on H.F. Choke to 51 on Reaction Condenser.
- ” 52 on H.F. Choke to 53 on 10-1 Unit.
- ” 54 on 10-1 Unit to 55 on T1.
- ” 56 on 10-1 Unit to 57 on Reaction Condenser.
- ” 57 on Reaction Condenser to 17 on panel. Connect a 50,000 ohm resistance between 58 and 59 on T4.
- ” Connect a Westector Type W.6 between 58 and 59 on T4.
- ” Connect a 100,000 ohm resistance between 59 on T4 and 60 on 0.25 mfd. Condenser.
- ” Connect a 250,000 ohm resistance between 59 on T4 and 61 on 0.1 mfd. Condenser.
- ” 61 on 0.1 mfd. Condenser to 62 on 10-1 Unit.
- ” 63 on 10-1 Unit to 64 on V3.
- ” 65 on V3 to 66 on T1.
- ” 66 on T1 to 67 on 0.25 mfd. Condenser.
- ” 68 on V3 to 55 on T1.
- ” 55 on T1 to 41 on 2 mfd. Condenser.

BATTERY CORD.

Now connect up the battery cord as follows. (See Practical Hints and Tips.)

- L.T.+ to 69 on S1.
- L.T.— to 22 on H.F. Choke.
- H.T.— to 70 on Fuse holder.
- G.B.+ to 70 on Fuse holder.
- G.B.— 1 to 71 on T2.
- G.B.— 2 to 58 on T4.
- H.T.+ 1 to 45 on 1 mfd. Condenser.
- H.T.+ 2 to 41 on 2mfd. Condenser.

OPERATING INSTRUCTIONS.

It is somewhat important to use the correct type of speaker as its impedance has a slight effect on the operation of the economy circuit and a considerable effect on the maximum

undistorted output. A speaker of 9,000 ohms impedance is optimum, although considerable latitude is allowed. The loud speaker should be connected to the terminals marked "speaker" on the print.

If the dial is to be illuminated, screw a 2 volt flashlamp bulb into the pilot lamp holder. It is to be noted that a dial lamp consumes as much L.T. current as two valves, and many people therefore omit it.

Do not yet fit the valves.

Connect the aerial and earth wires to the appropriate terminals as shown on the blueprint. Now connect the L.T.+ and L.T.— leads respectively to the + (red) and — (black) terminals of the L.T. accumulator. The G.B. + plug should be inserted into the + socket of the grid bias battery, the G.B. — 1 plug into the — 1½ volt socket and the G.B. — 2 plug into the — 13½ volt socket of the grid bias battery. The H.T. — plug should go to the — socket of the H.T. Battery, the H.T.

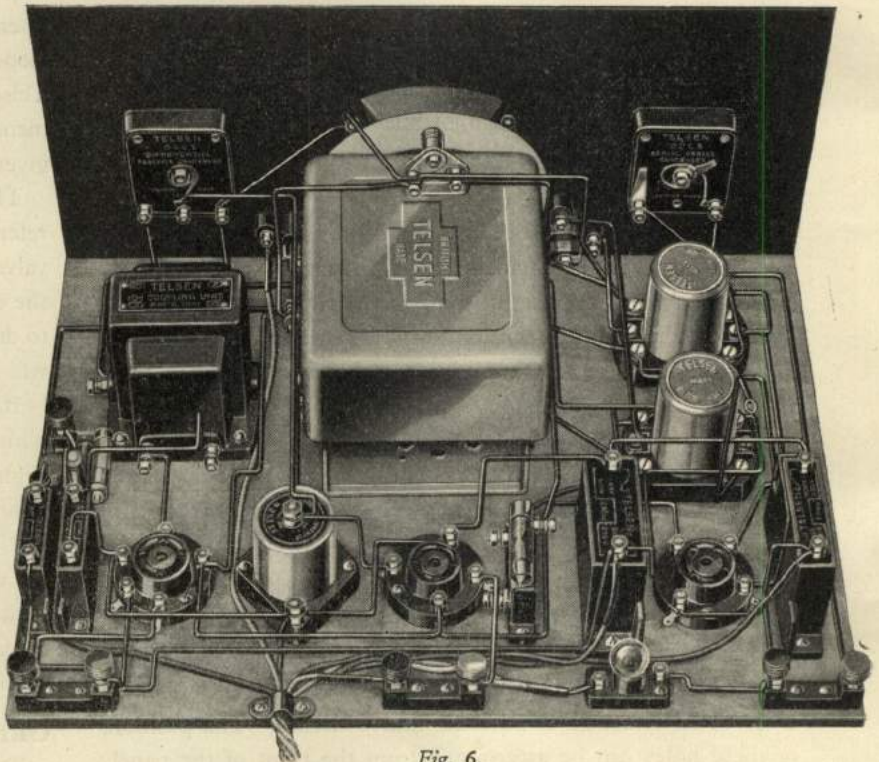

Fig. 6.

A Plan View of the Set, showing the various connections.

+ 1 going to the 72 socket, and the H.T. + 2 plug to the 120 socket of the H.T. Battery.

Switch on by pulling out the switch S1; the dial lamp should now light up and remain lit. Now screw the fuse bulb into its holder and note carefully whether or not it "blows" (i.e. lights up brilliantly and goes out). This is a check on your wiring, as if it "blows" it means there is a wrong connection.

Assuming that the fuse does not blow and the dial lamp has also not blown, it should be safe to insert the valves which should be as follows:—

VALVES.

Valve Holder	Maker	Valve Type
V1	Mazda	S.215.B.
V2	Mazda	H.L.2.
V3	Mazda	Pen.220.A.

Now connect the wire from terminal 39 to the terminal on the top of Valve V1. The set should now receive signals, but needs to be ganged.

"SINGLE KNOB" TUNING-PENTODE OUTPUT

GANGING OPERATIONS.

Set the wavechange switch S2 to the medium position (i.e. pulled out) and the aerial series condenser halfway over. Rotate the reaction (right hand) control until the set is almost (but not quite) oscillating and tune in a fairly weak station near the lower end of the wave band, keeping the trimmer (the knob concentric with the main tuning control) half-way between the limits of its travel. Now adjust the star-wheel on the right hand side of the ganged condenser to the position which gives maximum strength, keeping the station correctly tuned in by rocking the main tuning control.

Following adjustments of the aerial series condenser, which is used to reduce volume and improve selectivity when rotated anticlockwise, it may be necessary on weak stations to make slight ganging adjustments by means of the concentric trimmer, but the star-wheel trimmer will not require further adjustment.

TONE CORRECTOR.

The degree of tone correction required to compensate for the well known tendency of the pentode to overaccentuate high notes depends on the particular speaker used. Normally, sufficient correction is given by the 10:1 Unit and the bypass effect of the economy circuit, but if high notes are a little too shrill an improvement may be effected by connecting a .005 mfd. or .01 mfd. condenser across the L.S. terminals.

BATTERIES.

The use of a high capacity battery is recommended as such batteries have been shown to give better value in the long run, if purchased from a reliable maker. The Ediswan types, 69728 H.T. battery, and 69805 G.B. battery are ideal.

As the battery runs down it may be advisable to try a slightly lower G.B. tapping for G.B. —2 since this sometimes improves the reproduction.

THE TELSEN BATTERY ECONOMY 3.

List of Components.

Quantity	Description	Cat. No.	Price
1	Telsen 4-pin solid type Valve-holder ..	W.224	6d.
1	" 4-pin Anti-microphonic Valve-holder ..	W.222	8d.
1	" 5-pin solid type Valve-holder ..	W.225	8d.
1	" Set of two matched Iron Cored Coils ..	W.422	17/-
1	" Twin Ganged Condenser with cover ..	W.427	16/6
1	" 10:1 Coupling Unit ..	W.215	12/6
1	" 1 mfd. Self Sealing Condenser ..	W.227	2/3
1	" 2 mfd. Self Sealing Condenser ..	W.226	3/-
1	" 0.25 mfd. Self Sealing Condenser ..	W.229	2/-
1	" 0.1 mfd. Self Sealing Condenser ..	W.231	1/9
1	" .0003 mfd. Mica Condenser ..	W.242	1/-
1	" Aerial Series Condenser ..	W.350	2/6
1	" .0003 mfd. Differential Reaction Condenser ..	W.351	2/6
4	" Terminal blocks ..	W.204	2/-
1	" 2 Megohm Grid Leak ..	W.251	1/-
1	" Battery Type Fuse Holder ..	W.146	6d.
1	" 2-point Push-Pull Switch ..	W.107	1/-
1	" 3-point Push-Pull Switch ..	W.108	1/3
1	" 50,000 ohm Resistor ..	W.420	1/-
1	" 100,000 ohm Resistor ..	W.381	1/-
1	" 250,000 ohm Resistor ..	W.382	1/-
1	" 100 milliamp Fuse ..	W.318	6d.
1	" Standard Screened H.F. Choke ..	W.341	3/6
	Sufficient Connecting Wire ..	W.441	

- 1 "Westector" Type W.6
 - 1 2 volt flashlamp bulb as pilot-lamp if required.
 - 1 Battery Cord (8 wires)
 - 6 Wander plugs: H.T.+2; H.T.+1; H.T.—; G.B.+; G.B.—1; G.B.—2.
 - 2 Spade terminals, L.T.+; L.T.—.
- Also panel and baseboard as described.
Sufficient woodscrews.

TELEVISION AND SHORT WAVES—continued

of 1,500 K.C. and the sidebands will extend for 1,000 K.C. above and below the carrier frequency, that is, they will extend from 500 K.C. to 1,500 K.C. a second, and from 1,500 K.C. to 2,500 K.C. a second; in other words, from 600 metres to 200 metres and 200 metres to 120 metres, and the transmitter will occupy a total band from 600 metres to 120 metres; such a transmitter would entirely monopolise the medium-wave broadcast band.

A transmitter operating on 5 metres, however, is quite a practical proposition for television transmissions. The carrier frequency will be 60,000 K.C. a second, and the sidebands will extend from 59,000 K.C. to 60,000 K.C. and from 60,000 K.C. to 61,000 K.C. a second, that is from nearly 5.1 metres to 4.9 metres. Many such transmitters can be operated on these wavelengths, and the low ratio of maximum wavelength to minimum wavelength will simplify the design of the transmitter. Experimental transmissions have been conducted by the B.B.C. employing several systems of television, on a wavelength of 7 metres. Extremely promising results have been obtained, the images received being of a quality comparable to that obtained with cinematograph apparatus.

On a wavelength of 7 metres, the indirect rays from a transmitter do not return to the earth, so that a distant transmitter does not interfere with the reception from a nearby transmitter, and in addition echo effects will not spoil the images. As has been stated, the direct ground ray of a short-wave transmitter rapidly loses strength as it travels out from the transmitter, and at distances varying from 20 miles to 50 miles it is completely attenuated. Interference between transmitters situated fairly close together will thus not arise. Atmospherics (which would

produce markings on the images) are almost non-existent on such short waves. "Static" or noises due to tramway-cars and machinery are not usually troublesome, and will in time be completely eliminated. The chief offenders are the ignition systems of motor cars, the sparking-plugs of which produce a click at every spark. These can be prevented by inserting small suppressors in each lead from the coil or the magneto: these do not impair the performance of the car in any way, and should be regarded as being a standard fitment, especially in view of the present tendency to use radio receivers in motor cars. A 7 metre transmitter located in the centre of a populous area will provide an excellent television service of high entertainment value, not subject to fading or other variations. Steel-framed buildings cast a "shadow," but experiment will determine whether or not the effect is of great magnitude.

It will be apparent that television, using a short wavelength of the order of 5-7 metres, is a practical proposition, excellent results having been obtained with several systems of scanning and synchronising. The large number of controls that have in the past been necessary have been eliminated from the receiver, making the latter much simpler to operate. So excellent have been the results obtained with present-day high-definition television systems that the Government have formed a Commission of experts to investigate the whole matter, and make a report on the future policy of this country, and especially the B.B.C., in regard to broadcast television and the various systems now in use. The deliberations of the Committee will be watched with interest, and readers of the Telsen "Radiomag" may rest assured that the Telsen Electric Company will be well to the fore when regular high-definition television broadcasts are commenced.



THE NEW TELSEN IRON CORED COILS

THE Research Department of the Telsen Electric Company is never idle. Following closely on the design of the famous little midget iron cored coils W.349, last season, the Telsen Electric Company now announce the development of a wonderful series of iron cored H.F. coils which give a really remarkable performance.

As explained in the last edition of the *Radiomag*, the iron cored principle enables a coil to be made with greatly reduced physical size while still maintaining a high standard of performance. Considering the modern tendency to build complicated receivers on a small chassis with elaborate shielding, this was a step in the right direction. The only difficulty lay in the matter of switching. Contrary to popular opinion a switch is a most difficult component to design if it is to work efficiently at high frequencies and over long periods of time, and it is obviously better to use a well designed external switch than to build an inefficient switch in a confined space.

It was realised, however, that where sufficient space is available, these considerations do not apply, and the coils can be made larger, and consequently even more efficient, while a first-class switch can be incorporated. This is of great use in cases where two or three matched coils are used, as external switching then becomes rather complicated. Meanwhile, here was an opportunity to show what *could* be done in the way of efficiency.

Contrary to popular practice with iron-cored components a bank-wound short wave section was not employed. With a bank winding the "proximity effect" is high and consequently the efficiency is reduced, while the self-capacity of the coil is greatly increased, so that the tuning range is restricted.

A solenoid winding, on the other hand, has a low self-capacity and also a very low proximity effect, and has been employed in the Telsen Iron Cored Coils. Only one source of loss remained; this is known as "Skin Effect" and is due to the current tending to flow only on the surface of the wire. This was now greatly

reduced by the use of Litz wire in which a large number of strands of fine wire are so interwoven that they are all at approximately the same average distance from the centre of the bunch. The current flows equally through them and is not confined to the surface of one wire; the skin-effect is thus largely overcome and the efficiency of the coils vastly improved.

Attention was now focussed on the long-wave winding. This is usually bank-wound with a single strand of fine wire. Here again we have the same sources of loss—skin effect, proximity effect, and D.C. resistance, together with the disadvantages attendant on a high self-capacity. The long wave winding of the new Telsen Iron Cored Coils was therefore wave-wound with Litz wire. The wave-winding is done by an ingenious machine which builds up the wire in the form of a cylindrical coil, each turn being air-spaced from the next. By this means the self-capacity and proximity effect are greatly reduced. The wire is similar to that used for the solenoid short-wave winding and has a low D.C. resistance while skin effect is also very small due to the peculiar action of the Litz wire.

It will be seen from the above that no effort or expense was spared to ensure that the coil is the best available. The iron core, too, is a great improvement over those available last season. The permeability has been increased by nearly 40 per cent. with no appreciable increase in the losses. This means that less copper is required with a consequent further decrease in the total loss.

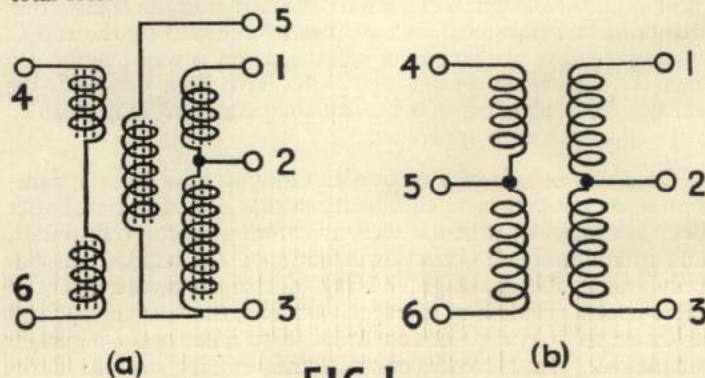

FIG. 1.

A REVIEW OF NEW TELSEN COMPONENTS—continued

The screening cans have also received great attention. Measurements were made with a large variety of shapes and materials and finally the square type of aluminium screen was decided upon. By making the can square instead of circular the average distance of the can from the coil was increased without increasing the overall dimensions. This meant that the screening loss was reduced and the efficiency of screening increased since the circulating currents in the can were reduced.

The coil switches were the result of an extensive investigation on contact materials, and finally a gold-silver alloy was used which reduces contact resistance to a negligible amount and which does not corrode in course of time. High quality phosphor-bronze strips are used to support these contacts and a snap-action cam actuated by the wave-change knob gives positive indication that the switch is open or closed.

The connections of the iron cored coil are shown in Fig. 1 (a), and those of the oscillator coil are shown in Fig. 1 (b). These coils are arranged in three different ways as follows:—

- 1.—Two matched iron cored coils with reaction windings and an oscillator. W.476.
- 2.—Three matched iron cored coils with reaction. W.477.
- 3.—Two matched iron cored coils with reaction. W.478.

The unit W.476 is ideal for building a superheterodyne receiver. The H.F. preselector stage in a superheterodyne is of great value in preventing "second channel" interference and other troubles arising from the presence of more than one signal (other than the oscillator signal) at the grid of the frequency changer. For example when receiving a weak station separated from the powerful local by twice the intermediate frequency both stations are likely to be heard at once, together with a continuous whistle. This, of course, completely spoils reception. The only solution is to obtain high selectivity in the preselector as this cuts down the signal from the local station to a very small amount. As has been shown, the new Telsen Iron Cored Coils are so highly efficient that greater selectivity is not possible in coils of their size. The constructor can, therefore, rest assured that his preselector is as efficient as it can possibly be, and that second channel interference is therefore reduced to an absolute minimum. Besides improving the second channel selectivity these coils also improve the adjacent channel selectivity. This means that if a weak station is being received a powerful station broadcasting on the next channel will not be heard at the same time.

The inductances of the coils are so arranged that correct tracking is obtained with the "British Radiophone Condenser," Type 693(r), that of the preselectors being 157 microhenries and that of the oscillator 126 microhenries.

Two variations of the circuit are possible with this unit. In the first case a band-pass input circuit employing the two preselector coils can feed the first detector, the oscillator coil either working with a separate oscillator valve, or with the combined detector oscillator. In the second case an H.F. valve may be

employed to give added range, the first and second preselector coils acting as aerial coil and H.F. transformer respectively.

The unit W.477 incorporates three H.F. Coils similar to those used in the preselector of unit W.476. These are intended for use when a band pass input is required for an H.F. valve, with a single H.F. transformer before the detector. Such an arrangement permits great selectivity to be obtained with excellent

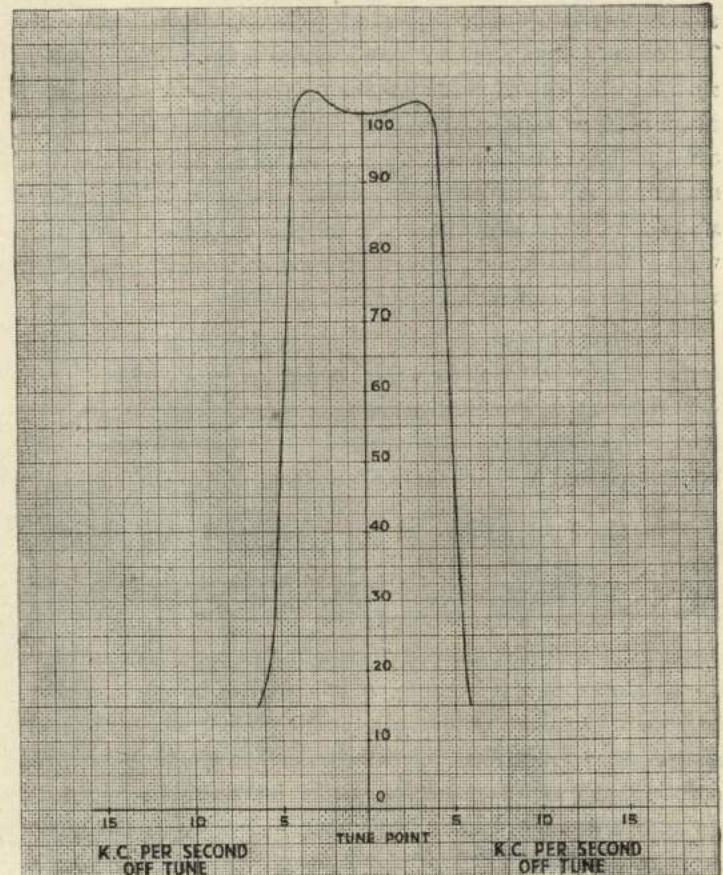

Fig. 2

high note response for since the detector grid coil can be made to compensate for the dip between the peaks of the band-pass response curve, these peaks may be widened without accentuating the high notes with respect to the low. On the other hand the skirts of the combined response curve are greatly attenuated by the three sharply tuned circuits and an extraordinary degree of selectivity is obtained. This selectivity will rarely need to be increased by the use of reaction, but in extreme circumstances reaction may be used to increase still further both the sensitivity and selectivity of the system.

The unit W.478 incorporates two H.F. coils similar to those in the preceding units. These may be used either as a band pass unit preceding the detector or else as an aerial coil preceding an H.F. valve followed by an H.F. transformer with reaction. In either case the coils are so efficient that the highest degree of selectivity and sensitivity is obtained.

A REVIEW OF NEW TELSEN COMPONENTS—continued

THE TELSEN SHORT WAVE COIL W.479

This new addition to the Telsen range of components merits special attention because it incorporates internal switching. Hitherto it has been usual to employ a panel-mounted switch with dual range short wave coils as the efficiency of the internal type was open to criticism. However, we feel that the difficulties inherent in switching at high frequencies have been overcome and in this component the switch is incorporated in the base. The coil is designed for use with a .00016 mfd. tuning condenser such as the .00016 mfd. condenser from the "Eddystone" range of short wave components. This combination is used in the "Telsen Short Wave Three" described elsewhere in this magazine, and gives excellent results. Reaction is particularly smooth and even, over the whole waveband, and, as every short wave enthusiast knows, this is the most important factor when searching for long-distance stations.

The wavelength ranges with the above condenser are 18 to 31 metres and 30 to 56 metres, these being the bands which are of most interest to the short-wave enthusiast. The readers who have never experienced the thrills of short-wave listening will be well advised to build the Telsen Short Wave Three.

THE TELSEN H.F. CHOKE W.454

It is not generally known that an H.F. Choke, which consists mainly of inductance, really functions as a small condenser. As a matter of fact, if it ceases to function as a condenser and acts as an inductance it is likely to set up severe instability. This is because at broadcast frequencies the high inductance offers such an impedance to the H.F. currents that they choose the alternative path through its stray capacity, just as they would if there were no inductance and just a small condenser. When the choke acts as a condenser the feed back to the grid of the valve through the small anode-grid capacity is negative, and the valve does not tend to oscillate. When the choke acts as an inductance, however, the feed back is positive and the valve goes into self-oscillation. The higher the inductance and the smaller the capacity, the better is the choke, provided that it remains as a condenser over the whole of the waveband. Unfortunately, due to the phenomenon known as "subsidiary resonance" the choke is apt to act as an inductance over small portions of the band, and at these positions there is apt to be instability.

The Telsen Electric Company realising these facts, have undertaken a great deal of investigation in order to design a highly efficient choke for the medium and long broadcast bands and the constructor who uses one of the new H.F. chokes can be satisfied that its performance is of a very high order.

H.F. Chokes find many applications, e.g., where H.F. energy has to be deflected from a supply circuit or where a mixture of H.F. and L.F. signals has to be filtered.

The anode feed to a screened grid valve preceding a tuned grid coupling is an example of the first type, while the anode

circuit of a detector exemplifies the second. In all these and similar circuits the Telsen H.F. Choke will be found to give unrivalled performance.

TELSEN I.F. TRANSFORMER W.482

In introducing the new type of I.F. Transformer W.482, the Telsen Electric Company have still further simplified the task of the home constructor. It has been found that in the hands of the inexperienced constructor the type of I.F. coil with adjustable coil spacing such as the Telsen W.294 is often used under conditions of coupling very far from the optimum, with consequently poor results. The spacing of the new coils is scientifically adjusted in the factory to give exactly 9 K.C. separation such as is demanded by the new Lucerne Plan, and no adjustment is required beyond that of tuning the coils for maximum response. Of course, the experienced constructor will still find the other type of coil extremely useful under certain conditions but there is no doubt that the new coil will find ready acceptance at the hands of the majority of constructors.

Very many factors have been considered in the design of the new coils, most of which, however, lie on the more technical side such as reliability and permanence, and are not of sufficient interest to discuss here. It is emphasised, however, that the new coil is a distinct advance in the design of this type of component. These coils have a wide range of adjustment extending from below 110 K.C. to above 125 K.C. in addition to ample tolerance for variations in circuit capacity.

TELSEN 500,000 ohm VOLUME CONTROL W.481

This new Telsen Volume control possesses several important features that are responsible for making it one of the most reliable yet introduced. The Resistance element consists of a straight strip $\frac{5}{16}$ " wide mounted inside a bakelite case. The material is a new development that is practically impervious to moisture, so that resistance change with changing humidity has been practically eliminated.

The control is noiseless in action and is not subject to wearing contacts, contact with the element being made by means of a rocking contactor. Friction only takes place between this flexible metal contactor and a permanently lubricated button.

The element is designed to follow a log law so that an equal variation in loudness occurs with an equal rotation of the knob.

The control is provided with a one hole fixing bush, two lock nuts and a special washer.

Among the many uses to which this control can be put is its use as a volume control connected across the secondary of an L.F. Transformer. Its high total resistance ensures a negligible effect on the characteristic of the transformer. Again in modern superhet. circuits diode detection is often employed and the volume control makes an ideal diode load resistance and manual volume control.

A REVIEW OF NEW TELSEN COMPONENTS—continued

TELSEN PAPER CONDENSERS

The new Telsen paper condensers are a distinct improvement on the old "Mansbridge" type. Instead of metallised paper, rolled foil is used with a dielectric of finest linen tissue. Impregnation takes place in an extremely high vacuum and a rapid cooling process ensures that the condensers are hermetically sealed. Factory tests show an insulation resistance of over 8,000 megohms per microfarad and an electrification of 30 per cent.

The test voltage is unusually stringent to ensure a very high standard of reliability. Every 250 v. condenser is tested at 1,500 volts, which is twice as severe as that specified by the Institution of Electrical Engineers. The condensers are designed for a working voltage of 250 A.C. rectified or unrectified, or 250 v.—375 v. D.C. To ensure that these voltages are not exceeded a test voltage of 500 is specified.

Used under the conditions given, Telsen paper condensers will maintain a higher level of efficiency than any other condenser of similar type. The range of values is as follows:—

Paper Condensers 500 v. Test			
Cat. No.	Capacity	Maximum Working Volts	Price
232	.01 mfd.	250 v. A.C. rectified and unrectified, or 250—375 D.C.	1/6
230	.04 mfd.	Ditto	1/9
231	.1 mfd.	Ditto	1/9
229	.25 mfd.	Ditto	2/-
228	.5 mfd.	Ditto	2/3
227	1 mfd.	Ditto	2/3
226	2 mfd.	Ditto	3/-

TELSEN TRANSFORMERS and CHOKES

Some important advances in the design and production of transformers have recently been achieved by the Telsen Electric Company. All Telsen transformers are now constructed with paper interleaved windings impregnated in vacuo.

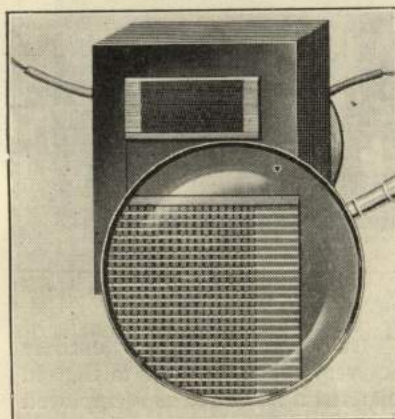

Fig. 3

By means of ingenious machines the wire is wound in layers at an even tension, accurately spaced, and interleaved with a prepared paper that forms a conducting medium used during the impregnating process. The interleaving provides a cushion for the support of each layer and absolutely precludes the possibility of shorted turns or mechanical breakdown arising from magnetic surges. The accurate spacing provides a larger effective winding area and a higher inductance while the resultant

honeycomb structure ensures a very low distributed capacity. Fig. 3 shows a sectional view of the winding.

The most frequent cause of breakdown of low frequency transformers is chemical and electrolytic action set up while the transformer is in use. Microscopic punctures in the insulation of the wire offer numerous points at which the copper can be attacked by impurities present in the atmosphere, or introduced at the time of winding. Attempts have been made in the past to overcome this difficulty by impregnating the windings with wax, but this has not been entirely successful as impurities already present on the surface of the wire have been impregnated at the same time. A new impregnating process has been developed to remedy this defect. For this purpose a special high vacuum impregnating plant has been installed. It is the most modern and the largest plant of its kind in Europe.

The windings, when complete, are introduced into a very high vacuum chamber, where they remain until all traces of moisture and other impurities which may be present are drawn off. During this process the temperature is gradually raised to that required for impregnation. While still in the vacuum, a special non-hygroscopic and chemically pure compound of very low specific inductive capacity is introduced, and under great pressure is forced into the windings. The interleaving material forms a conducting medium and the compound thus assisted penetrates the entire structure, permeating the windings and providing a coating on each individual turn of wire.

The pressure is then reversed to a value sufficient to draw off all the superfluous compound from the interstices of the windings.

A special rapid cooling process now takes place. Cold dry air from which all impurities have been removed by filtering, is passed across the coils causing the impregnating compound to solidify immediately. This prevents undue leakage of the protecting material and hermetically seals the outside of the windings, making it absolutely impossible for any moisture or impurities of any kind to enter the finished bobbin.

The bobbin and core are then assembled and enclosed in a metal case which provides complete screening, ensuring stability in operation and freedom from pickup in the presence of external magnetic fields.

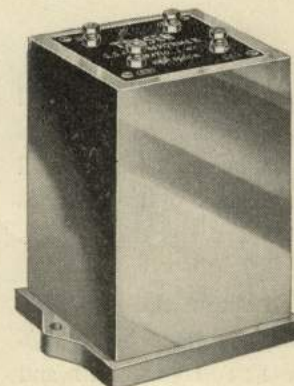

Fig. 4.

An analysis of the above processes will show that complete freedom from breakdown is assured.

The appearance of the completed transformer is indicated in Fig. 4. The case is satin finished and a particularly good appearance is achieved in addition to effective screening. All Telsen transformers are now assembled in these improved cases.

CLASS "B" TRANSFORMERS & CHOKES

TELSEN "CLASS B" TRANSFORMERS AND CHOKES

The Telsen "Class B" Components are all spaced layer wound and impregnated, and are now presented in the new attractive metal cases which provide complete magnetic screening.

DRIVER TRANSFORMERS

These are made in two ratios, and cover the requirements of all "Class B" valves available. Supplied with comprehensive instructions.

No. W.460. Ratio (overall) 1 : 1. (Prim. to half Secondary) 2 : 1. Price 10/6

No. W.461. Ratio (overall) 1.5 : 1. (Prim. to half Secondary) 3 : 1. Price 10/6

TELSEN "CLASS B" OUTPUT TRANSFORMER

The Telsen "Class B" Output Transformer, which gives ratios of 35 : 1, 50 : 1 and 65 : 1, will provide correct matching to moving coil speakers having low resistance speech coils, and, like the "Class B" Output Choke, has a low primary resistance (200 ohms per half winding) and a very large core section. Supplied with full instructions.

No. W.462
Price 10/6

TELSEN "CLASS B" OUTPUT CHOKE

This choke provides ratios of 1 : 1, 2 : 1, 2.6 : 1, whereby a "Class B" output stage can be matched to any moving coil speaker having either a high resistance speech coil or a low resistance coil and input transformer. The low D.C. resistance of 220 ohms per half winding and generous core section prevent the occurrence of distortion due to voltage drop or magnetic saturation on peak load. The total inductance is 18 henries. Supplied with full instructions.

No. W.463
Price 10/6

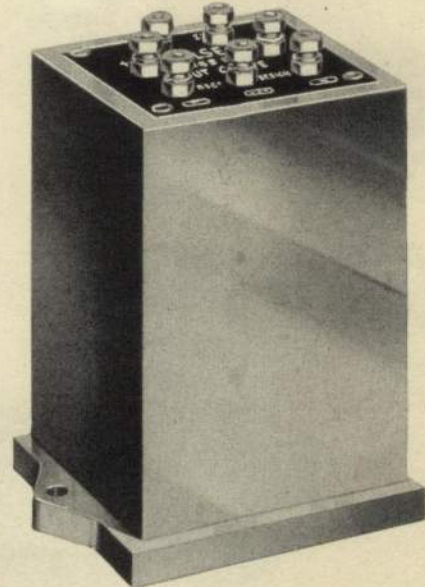
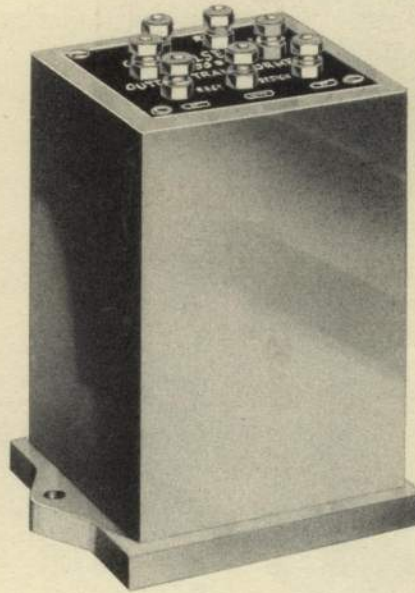
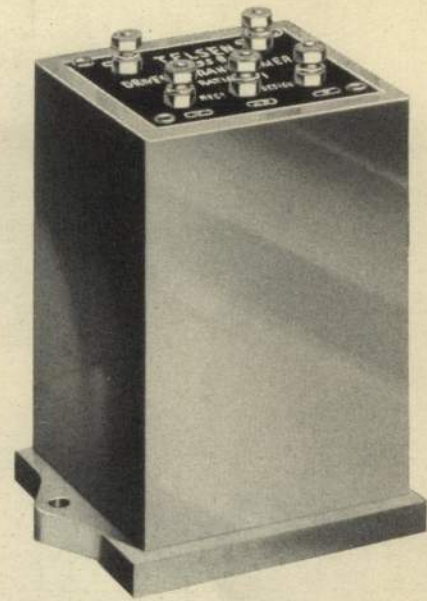

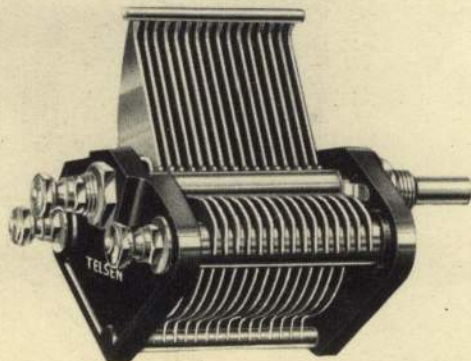
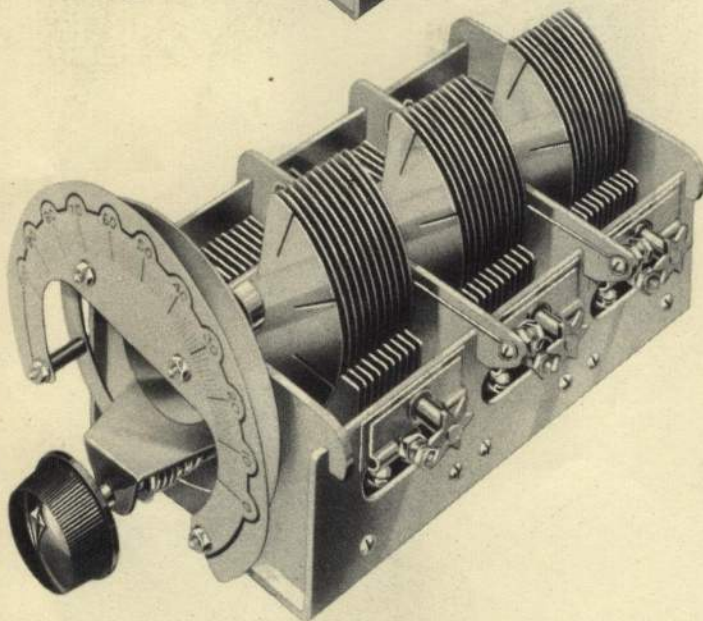
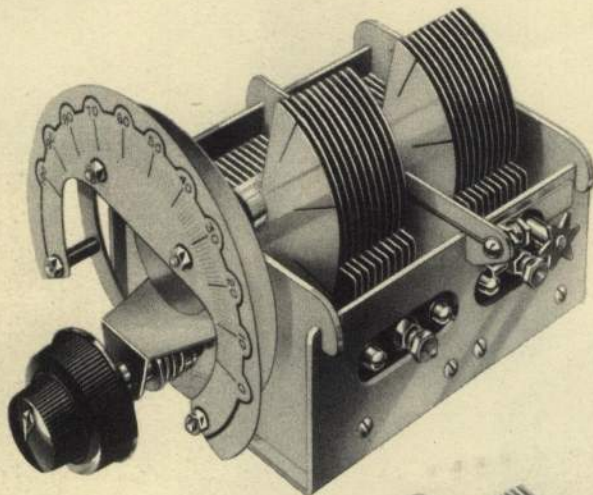
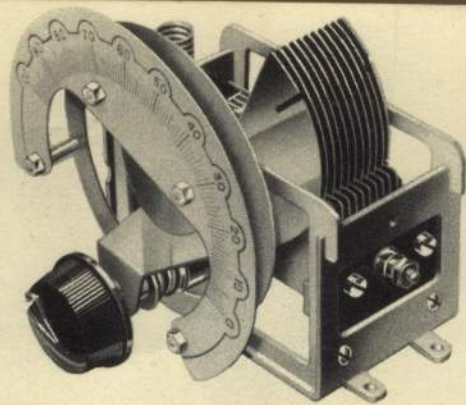

• VARIABLE • • CONDENSERS •

TELSEN SINGLE CONDENSER UNIT

This is a very high-class air-dielectric condenser with illuminated dial, and is intended for chassis or base-board mounting. A skeleton framework of nickel-plated steel supports the two sets of diecast vanes, great rigidity and low minimum capacity being achieved in the construction. A stator terminal is provided on each side of the condenser, and positive connection is made to the rotor by means of a flexible pigtail. The maximum capacity of this condenser is .00053 mfd. Two interchangeable dials are supplied, one of which is graduated in degrees, while the other is specially calibrated to give a direct indication of wavelength when the condenser is used with a Telsen Screened Coil No. W.216. Supplied with knob and escutcheon plate.

No. W.339

Price 8/6

TELSEN GANGED CONDENSERS

The Telsen Ganged Condenser Units have been designed for use in modern receiver circuits in which accurate and simultaneous tuning of two or three circuits is obtained by the rotation of one dial. A pressed steel frame of great rigidity completely obviates any tendency to distortion, while the rotor and stator vanes are let into one-piece high pressure die castings, ensuring accurate spacing. All sections are very carefully matched by means of split end vanes, and trimmers are provided across each section to compensate for differences in stray capacities. In the twin gang condenser the front section carries a variable trimmer operated by a knob concentric with the main tuning control. Both models have an attractive stove aluminium finish and are complete with disc drive, dust covers, escutcheon plate, pilot light holder, knob and two alternative tuning scales.

Twin Ganged Condenser

No. W.427 Price 16/6

Triple Ganged Condenser

No. W.428 Price 22/6

TELSEN LOGARITHMIC VARIABLE CONDENSERS

The Telsen Variable Condensers are built to withstand years of service. Rigidity in construction, the effective clamping of both rotor and stator vanes, and freedom from backlash and end play have been the primary features aimed at in their design, and thereby accurate and consistent spacing is assured as long as the condenser is in service.

Capacity .0005 mfd. No. W.132 3/6

.. .00025 .. No. W.130 2/6

.. .00035 .. No. W.131 3/6

TELSEN

RADIO COMPONENTS

TUNING, DIFFERENTIAL & REACTION CONDENSERS

TELSEN BAKELITE DIELECTRIC TUNING CONDENSERS

Designed on lines of great rigidity, compactness and high efficiency, these condensers are confidently recommended for use in cases where space is limited. A high grade dielectric is employed, ensuring accuracy of tuning with minimum losses. Complete with knob.

Capacity mfd.	No.	Price
.0005 ..	W.193 ..	2/6
.0003 ..	W.194 ..	2/6

TELSEN BAKELITE DIELECTRIC REACTION CONDENSERS

These condensers have been entirely re-designed, and now incorporate several valuable improvements. They are very rigidly made, and the spindle, to which positive contact is made by means of a flexible pigtail, is so constructed that all end-play, which may alter the capacity, is entirely prevented. The vanes are interleaved with finest quality solid dielectric, and the whole unit is enclosed in a strong dust-proof bakelite case, which, by excluding grit, prevents the occurrence of the annoying "rustling" noises so often found in other makes. Supplied complete with knob.

Capacity mfd.	No.	Price
.0003 ..	W.354	} 2/6
.00015 ..	W.355	
.0001 ..	W.356	
.00075 ..	W.357	
.0005 ..	W.358	

TELSEN DIFFERENTIAL CONDENSERS

These are similar in design and construction to the reaction condensers, and are supplied, complete with knob, in the following capacities :

Capacity mfd.	No.	Price
.0003 ..	W.351 ..	2/6
.00015 ..	W.352 ..	2/6
.0001 ..	W.353 ..	2/6

TELSEN AERIAL SERIES CONDENSER WITH SWITCH

Built on similar lines to the new reaction condensers, this condenser provides an ideal selectivity and volume control. The maximum capacity is .0003 mfd. with an extremely low minimum capacity. A switch arm is keyed to the spindle whereby the condenser is short-circuited at its maximum position, giving a "straight through" aerial connection when desired, which results in a wide range of control. Supplied complete with knob.

No. W.350
Price 2/6

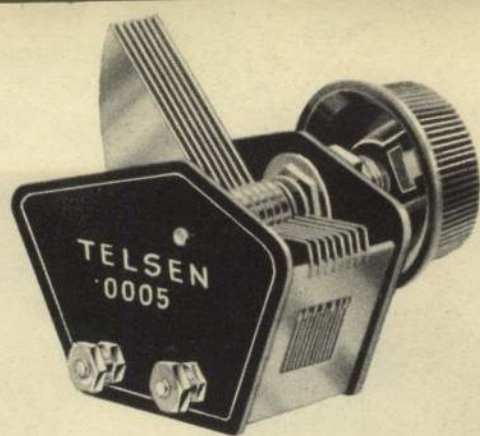

SLOW MOTION DIALS & DISC DRIVES

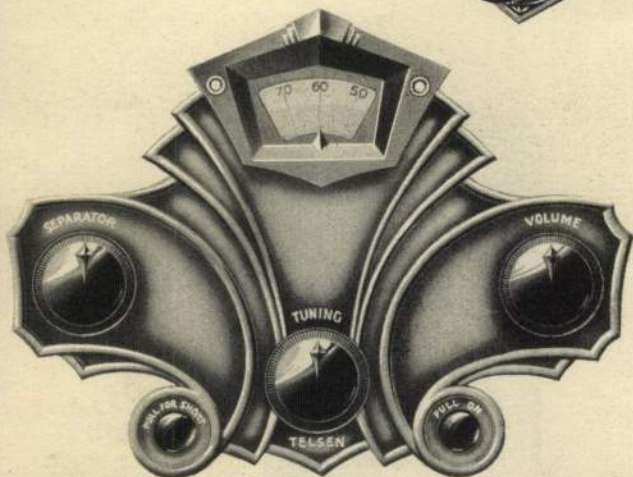
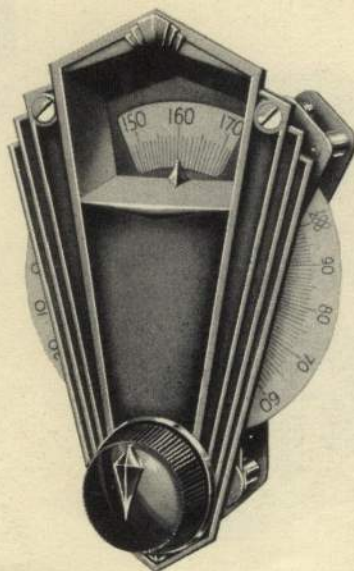
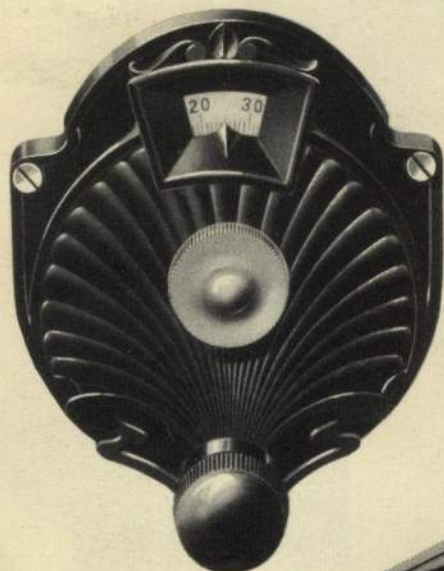

TELSEN SMALL FRICTION DISC DRIVE

A low-priced Disc Drive for auxiliary controls. It is extremely robust and may be usefully employed for main tuning condensers where limitations of space have to be considered.

No. W.257

Price 2/-

TELSEN BAKELITE SLOW MOTION DIAL

Made in black, this elegant little dial has a gear ratio of 8:1, the disc being graduated from 0 to 100 in both directions. It can be fitted to any of the Telsen Tuning and Reaction Condensers, or other standard makes having $\frac{1}{4}$ " spindle and is suitable for all panels up to $\frac{1}{8}$ " thickness. Mounting instructions are included with every dial.

No. W.141

Price 1/6

TELSEN ILLUMINATED DISC DRIVE

Fitted with a handsome oxydised silver escutcheon of modern design, this drive incorporates an improved movement. The gear ratio of approx. 5:1 and the bold and well-proportioned figures make for delightfully easy tuning. A double-ended spanner to fit all Telsen "one hole fixing" nuts is supplied free with every Disc Drive.

No. W.184

Price 2/6

TELSEN "313" DISC DRIVE

This is essentially an illuminated Disc Drive tuning control similar to W.184 and suitable for any standard tuning condenser with $\frac{1}{4}$ " spindle. This component with its exceptionally attractive escutcheon plate, is ideal for use in any receiver employing the usual panel controls indicated. These comprise "Separator" Volume Control, and Wavechange and "On-Off" Switches, thus grouping the main essentials of a complete control unit into a compact assembly. Escutcheon plate finished in Oxydised Silver.

No. W.313

Price 3/6

TELSEN

RADIO COMPONENTS

H. F. CHOKES

TELSEN STANDARD H.F. CHOKE

This popular Choke has now been re-designed and the efficiency considerably increased. It is particularly suitable for reaction circuits, has a very low self-capacity for its high inductance and occupies a minimum of space.

No. W.454
Price 2/6

TELSEN BINOCULAR H.F. CHOKE

In high class circuits calling for exceptionally efficient H.F. chokes, the Telsen Binocular Chokes can be relied upon in every respect. Its external field is negligible due to the binocular formation, it has a low self-capacity while its inductance is as high as 180,000 microhenries.

No. W.74
Price 4/6

TELSEN SCREENED H.F. CHOKES

These new chokes have been very carefully designed and constructed so that their efficiency is consistently high over the whole of the wave band for which they are intended. They are small and compact, and the metal screen, which is connected to an earthing terminal, entirely prevents interaction with other components.

Three types are available, W.341, which is designed for wavelengths between 100 and 2,000 metres, such as are met with in the ordinary broadcast receiver, W.342, which is a short wave choke for use between 10 and 100 metres, and W.340, a binocular choke suitable for "All-wave" sets working between 10 and 2,000 metres.

Standard Screened H.F. Choke. No. W.341
Price 3/6

All Wave Screened Binocular H.F. Choke.
No. W.340 Price 5/6

Short Wave Screened H.F. Choke No. W.342
Price 3/6

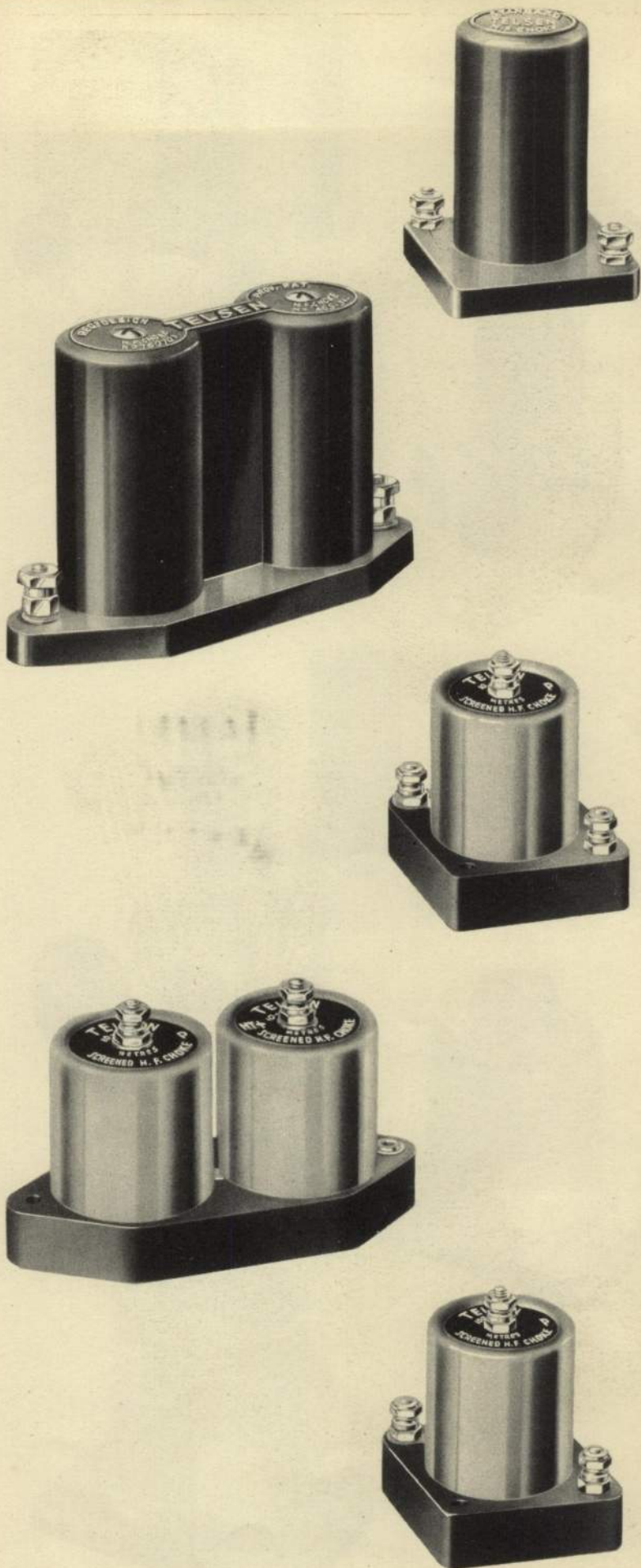

DUAL RANGE ARIAL, ANODE & SHORT WAVE COILS

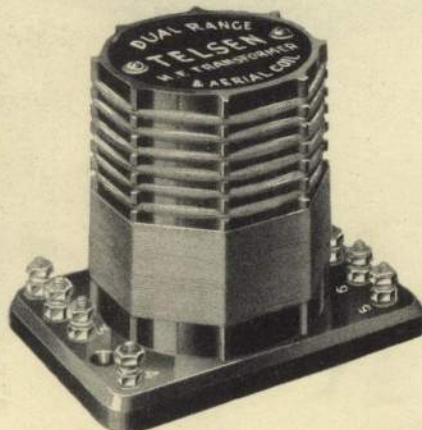
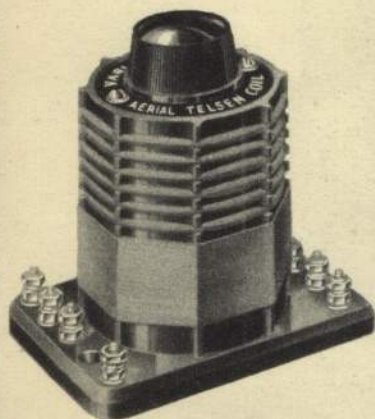
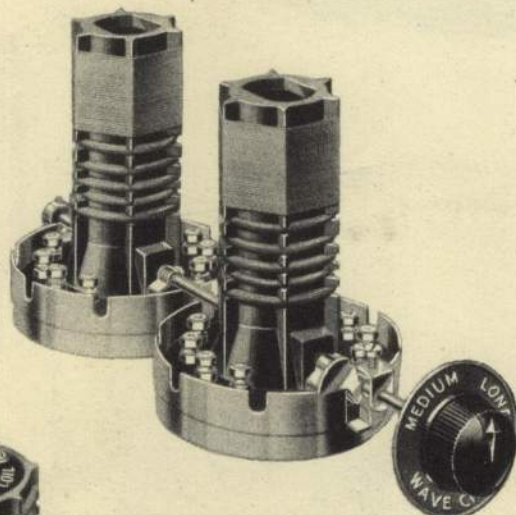
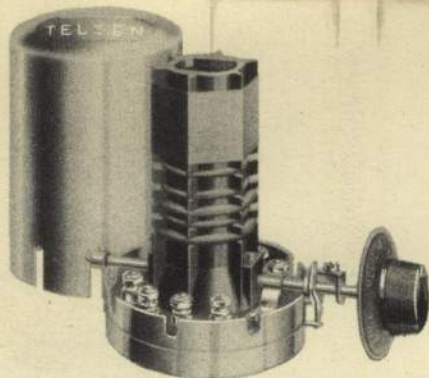
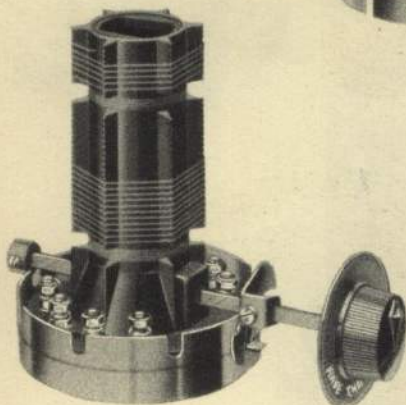

TELSEN SCREENED TUNING COILS

These coils embody the ultimate efficiency attainable in a perfectly shielded air-cored inductance of moderate dimensions. Provided with separate coupling coils for medium and long waves they are suitable for use as aerial coils or as anode coils following a screen grid valve, giving selectivity comparable only with a well designed band-pass filter. The coils are fitted with cam operated rotary switches with definite contacts and click mechanism, and are supplied complete with aluminium screening cans.

Single Screened Coil	W.216 ..	7/-
Twin Matched Screened Coils ..	W.287 ..	14/6
Triple Matched Screened Coils ..	W.288 ..	21/6

TELSEN COIL SWITCH COUPLING ASSEMBLY

When it is desired to mount two or more of the Telsen Shielded Coils in a line parallel to the panel, and to control the wave change switching by a single knob on the panel, this switch coupling assembly will be found indispensable.

No. W.217

Price 6d.

TELSEN COIL SWITCH KNOB ASSEMBLY

This knob is specially designed for use with the Telsen Shielded coupling coils. The extension on the knob spindle fits over the switch rod supplied with the coils, a firm coupling to the rod being ensured by tightening the small screw provided.

No. W.218

Price 1/-

TELSEN SHORT WAVE COIL

A highly efficient coil designed to cover the short wave broadcasting wavebands. Tuned with a .00016 Variable Condenser the coil covers 18—31 metres and 30—56 metres. Switching is incorporated in the coil. Supplied with full instructions.

No. W.479

Price 7/-

TELSEN DUAL RANGE AERIAL COILS

Incorporates a variable selectivity device, making the coil suitable for widely varying reception conditions. This adjustment also acts as an excellent volume control, and is equally effective on long and short waves. The wave-band change is effected by means of a three-point switch and a reaction winding is included.

No. W.76

Price 7/6

TELSEN H.F. COIL

May be used for H.F. amplification with screen grid valve, either as an H.F. transformer or alternatively as a tuned grid or tuned anode coil. It also makes a highly efficient aerial coil where the adjustable selectivity feature is not required.

No. W.154

Price 5/6

TELSEN
RADIO COMPONENTS

TELSEN "349" IRON-CORED SCREENED COILS

These coils employ an iron-dust core which has enabled their size to be greatly reduced without sacrifice of efficiency, which is considerably higher than that of the majority of air-cored coils. Magnification and selectivity are correspondingly improved, while the metal screening can prevent the occurrence of unwanted interaction. These coils can be used as aerial tuning coils or H.F. transformers, a reaction winding being included.

- Single Coil No. W.349 Price 8/6
- Twin Matched Coils . . No. W.422 Price 17/-
- Triple Matched Coils . . No. W.423 Price 25/6

TELSEN SCREENED IRON CORED COILS WITH SWITCHING

These are entirely new iron cored coils of very great efficiency. Designed in response to many requests for iron cored coils which incorporate switching. The dynamic resistance is extremely high and great magnification and selectivity is obtainable. The switching is of robust construction and can be depended upon to give reliable service.

Twin Coil Unit

Suitable for Band Pass Filter or two tuned stages.

No. W.478

• Price 19/6

Triple Coil Unit

Suitable for Band Pass Filter followed by one tuned stage or for three tuned stages.

No. W.477

Price 30/-

SUPERHET. PRESELECTOR AND OSCILLATOR COIL UNIT

This triple coil unit consists of two iron cored coils and one oscillator coil. Designed to work in conjunction with a triple ganged condenser having special shaped vanes for maintaining a constant frequency difference of 110 K.C. between the oscillator and signal frequency circuits. The Preselector coils can be alternatively used as a band pass unit where the receiver does not employ an H.F. stage.

No. W.476

Price 30/-

TELSEN INTERMEDIATE FREQUENCY TRANSFORMERS

Consist of two tuned circuits comprising a band pass intermediate frequency filter tuned to 110 K.C. by two pre-set balancing condensers fitted to the top of the coil. Two screws accessible from the top of the screen enable these condensers to be adjusted for different values of stray capacities. These coils have been entirely redesigned and special attention has been paid to the construction of the balancing condensers which will remain constant under all conditions.

No. W.482

Price 8/6

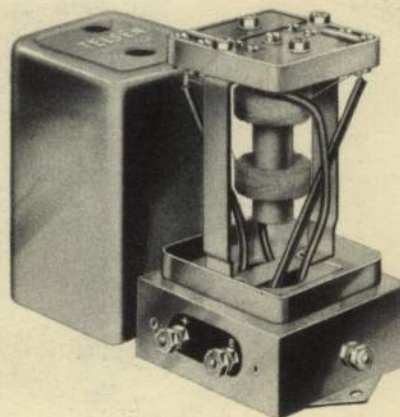
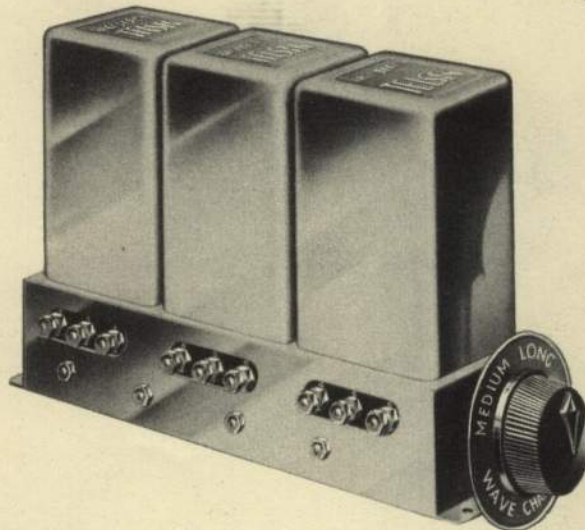
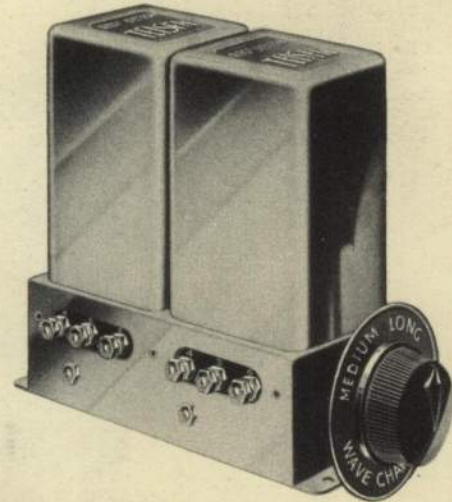
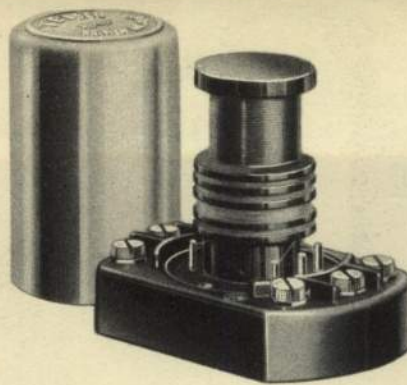

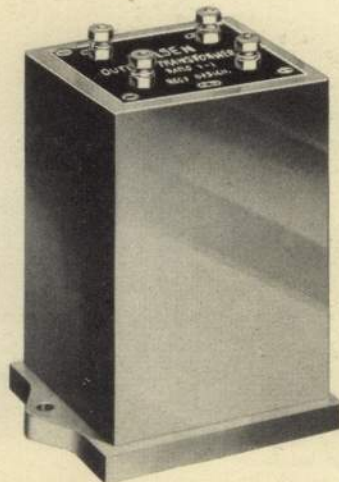
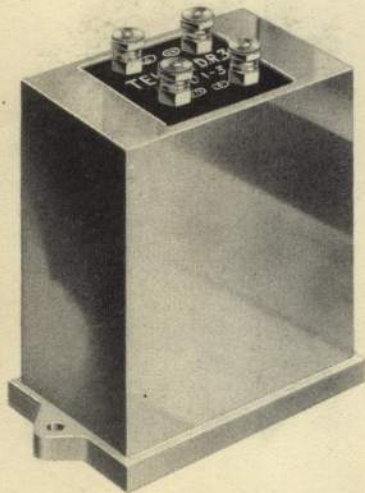
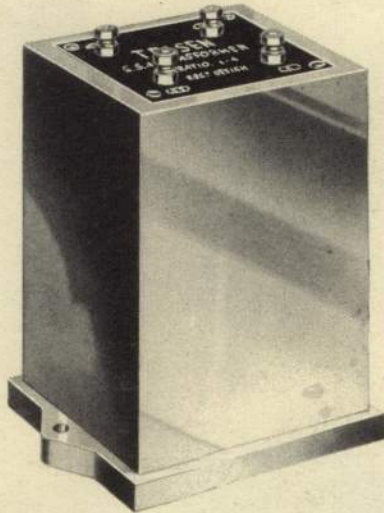
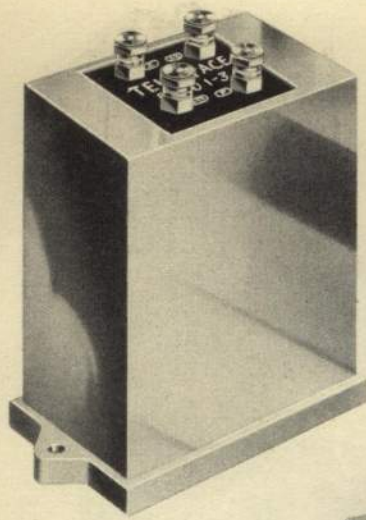

L.F. & OUTPUT TRANSFORMERS

TELSEN "ACE" L.F. TRANSFORMERS

These famous transformers have been entirely redesigned, and are now completely screened. Like all Telsens transformers, they are layer wound, and impregnated under pressure. In spite of their low cost their greatly improved characteristics will bear comparison with those of many expensive transformers.

No. W.455. Ratio 1 : 3. Prim. Ind. 50 H.

No. W.456. Ratio 1 : 5. Prim. Ind. 35 H.

Price 5/6 each

TELSEN GS.4 L.F. TRANSFORMER

A new addition to the Telsen range, this Transformer represents a definite advance in design of transformers for high quality Receivers and Amplifiers. Evolved from the results of extensive research, its performance is unsurpassed by any other directly fed transformer. Impregnated layer windings give complete freedom from breakdown. A copy of the amplification frequency characteristic as taken by the Nat. P. Lab. is available.

Ratio 1 : 4. Prim. Ind. 120 H at 0 D.C.

Price 12/6

TELSEN D.R. L.F. TRANSFORMERS

The Parallel Fed Transformer with a straight line characteristic. The amplification of all audible frequencies is absolutely uniform. A special nickel alloy core is used, and no D.C. current must therefore be passed through the primary. Full instructions for use are supplied with each Transformer.

No. W.448. Ratio 1 : 3. Prim. Ind. 150 H.

Price 8/6

No. W.449. Ratio 1 : 5. Prim. Ind. 60 H.

Price 8/6

TELSEN OUTPUT TRANSFORMERS 1 : 1 OUTPUT TRANSFORMER

Designed for use in the anode circuit of the valve enabling a high resistance speaker to be connected to a triode output valve without the necessity of passing direct current through the speaker windings.

No. W.458. Prim. Inductance 40 H at 40 mA. D.C.
Max. Permissible D.C.—40 mA.

Price 10/6

MULTI RATIO OUTPUT TRANSFORMER

For use with Moving Coil Loudspeakers having a low impedance speech coil.

No. W.459—Ratios 9 : 1, 15 : 1 and 22.5 : 1. Prim. Inductance 20—9 H, 0—40 mA. Max. Permissible D.C. 40 mA.

Price 10/6

Radio's

TEL
RADIO COM

PUSH PULL Q.P.P. COMPONENTS ' & SMOOTHING CHOKES '

PUSH PULL COMPONENTS

A range of High Quality Transformers and Chokes are now introduced to meet the needs of those employing this increasingly popular form of Low Frequency amplification.

Push Pull Input Transformer.

No. W.472. Ratio (overall), 1 : 4. Prim. Ind. 105 H
Price 12/6

Push Pull Output Transformer.

No. W.471. Ratios 35, 50 and 65 : 1. Prim. Ind. 16 H
Price 12/6

Push Pull Output Choke.

No. W.480. Ratios 1 : 1, 1.3 : 1, 2 : 1 and 2.6 : 1
Inductance 18H
Price 12/6

Q.P.P. COMPONENTS

The increase in power output and the reduction in H.T. consumption obtained with Quiescent Push Pull Amplification makes it particularly attractive to the builder of Battery Sets. Telsen Q.P.P. Components are specially designed for this type of coupling and careful matching of windings ensures freedom from distortion.

Q.P.P. Input Transformer.

No. W.473. Ratio 1 : 8 (overall). Prim. Ind. 40H.
Price 12/6

Q.P.P. Output Transformer.

No. W.474. Ratios 35, 50 and 65 : 1. Prim. Ind. 16H.
Price 12/6

Q.P.P. Output Choke.

No. W.475. Ratios 1 : 1, 1.3 : 1, 2 : 1 and 2.6 : 1.
Inductance 18 H.
Price 12/6

TELSEN SMOOTHING CHOKES

Like all Telsen Iron Cored L.F. components these chokes are now layer wound, impregnated and housed in metal screening cases. The 28 henry Choke has been designed to fulfil the requirements of efficient smoothing of the rectified mains supply of a receiver. The choke is gapped and has a sensibly constant inductance. At 0 mA. the inductance is 31 H., falling to 25 H. at 50 mA. D.C. Resistance 1,200 ohms.

No. W.467

Price 12/6

TELSEN HEAVY DUTY SMOOTHING CHOKES

This choke has the very low D.C. resistance of 600 ohms and so is particularly useful in smoothing circuits passing comparatively heavy currents where the maximum output voltage is needed. The inductance is 18 H at 50 mA. Max. permissible current, 75 mA.

No. W.468

Price 12/6

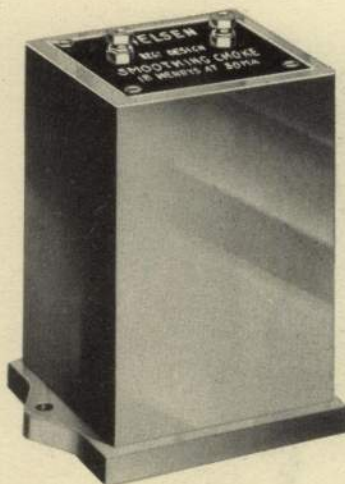
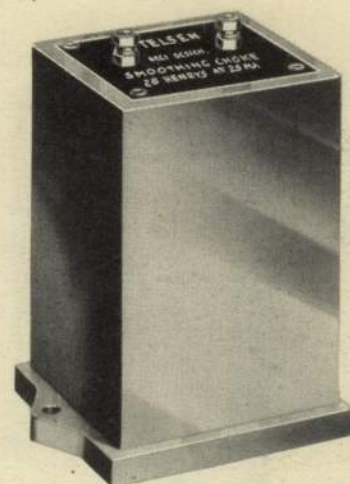
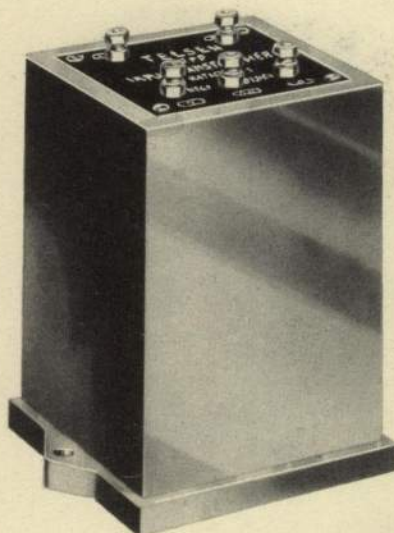

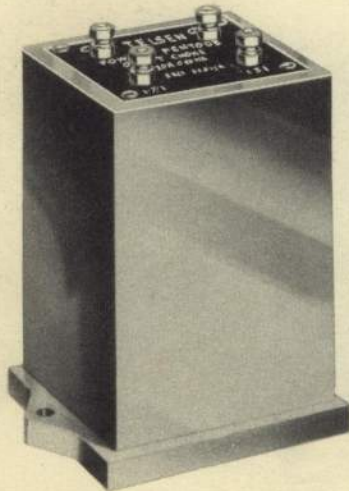
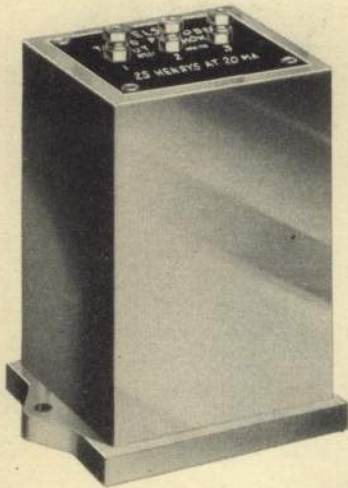
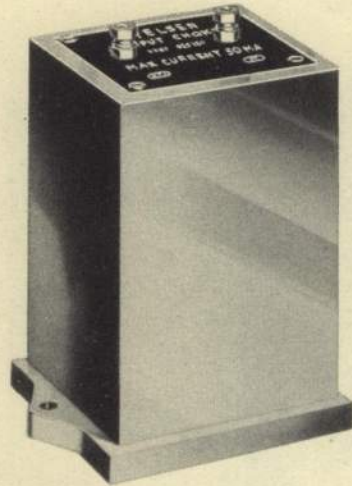
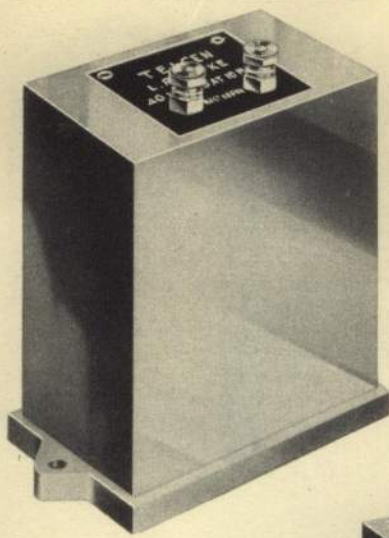

◀ L.F. CHOKES ETC. ▶

TELSEN INTERVALVE L.F. COUPLING CHOKES

Rating.	Normal Current.	Max. Current.
40 H.	3 mA.	10 mA.
100 H.	2 mA.	6 mA.

These popular L.F. Chokes are primarily intended for use as coupling chokes in the anode circuits of modern radio receivers, but may be used in any circuit not carrying more than the stipulated maximum current.

No. W.470. 100 H. Inductance 105—100 H. at 0—10 mA. Resistance 3,000 ohms.

Price 5/6

No. W.469. 40 H. Inductance 40—31 H. at 0—20 mA. Resistance 1,100 ohms.

Price 5/6

STANDARD OUTPUT CHOKE

Designed for use as an output filter in conjunction with a condenser of not less than 1 mfd. following any triode output valve taking up to 40 mA. Anode current. Supplied with full instructions.

No. W.464. Inductance 18 H

Price 7/6

TAPPED PENTODE OUTPUT CHOKE

This Choke is designed for pentodes taking an anode current of not more than 20 mA. Tappings provide ratios suitable for matching under widely varying conditions.

No. W.465. Ratios 1:1, 1:6, 1 and 2.5:1
Inductance 20 H at 30 mA. D.C.

Price 7/6

POWER PENTODE OUTPUT CHOKE

For use with Power Pentodes having anode currents up to 40 mA. A choice of 3 ratios provides for correct matching.

No. W.466. Ratios 1:1, 1.3:1 and 1.7:1 or by reversing 4:1 and 2.5:1.

Inductance 20 H. at 30 mA. D.C.

Price 10/6



TELSEN 7-PIN VALVE-HOLDERS

These valve-holders are accurately constructed to accommodate several new types of valve, such as the "Class B" valve. They are made in the solid and anti-microphonic types and in both types the contact sockets are extended in one piece to form the soldering tags, thus ensuring perfect connection. The terminals are numbered according to the system standardised by the R.M.A.

7-pin Solid Type Valve-holder No. W.337
Price 1/6

7-pin Anti-microphonic Type Valve-holder,
No. W.338
Price 1/9

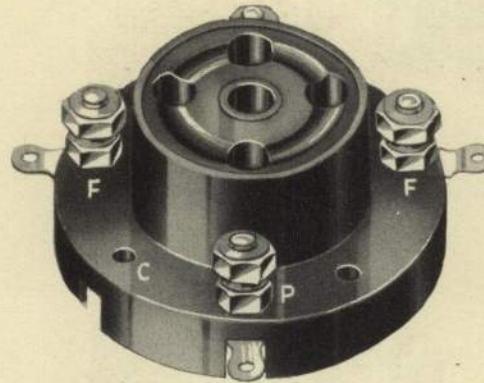
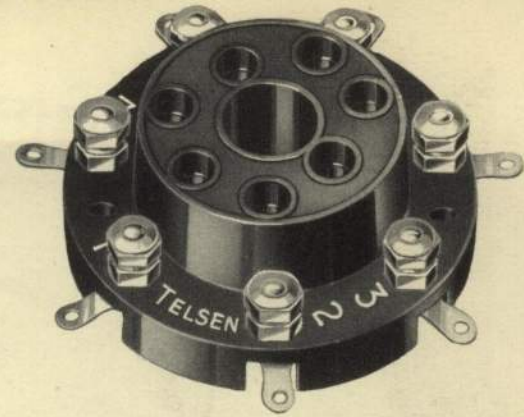

TELSEN VALVE-HOLDERS

The latest models of Telsens Valve-holders have an extremely low self-capacity and are made in both solid and anti-microphonic types. These embody special contact sockets of one-piece design with neat soldering tags and end terminals.

Solid Type	Anti-microphonic Type
4-pin No. W.224 6d.	4-pin No. W.222 8d.
5-pin No. W.225 8d.	5-pin No. W.223 10d.

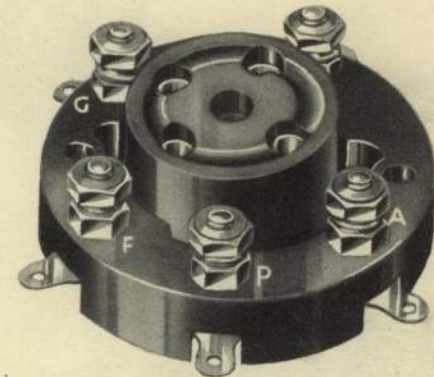

TELSEN UNIVERSAL VALVE-HOLDER

The Universal Valve-holder provides a method of supporting a screen grid valve in a horizontal position on a baseboard, and is ideal for use in conjunction with a vertical screen. Alternatively in confined spaces it enables any valve to be mounted parallel to the surface on which the holder is fixed.

No. W.198
Price 9d.

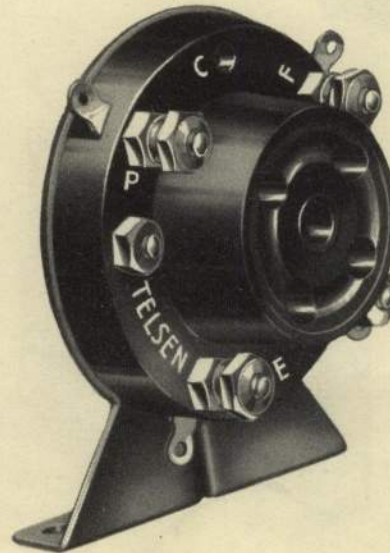

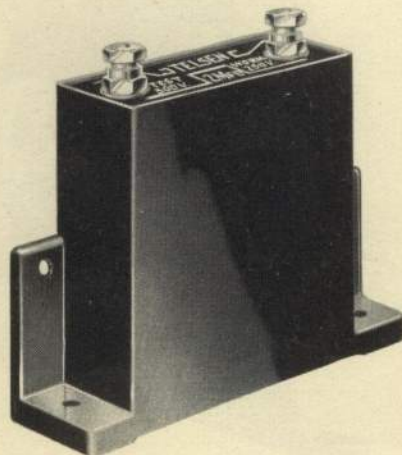
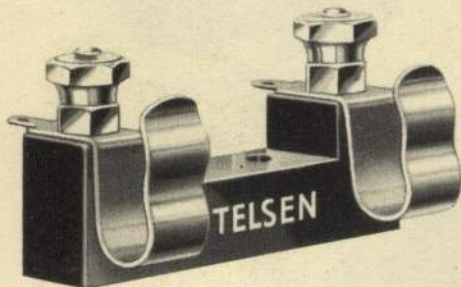

GRID LEAKS FIXED MICA & SELF SEALING CONDENSERS

TELSEN GRID LEAKS

These are absolutely silent and practically unbreakable and do not vary in resistance with application of different voltages. They are non-inductive and produce no capacity effects.

Capacities : 5, 4, 3, 2, 1, $\frac{1}{2}$, $\frac{1}{4}$ megohms.

Price 1/-

TELSEN GRID LEAK HOLDER

This will hold firmly any standard size or type of grid leak. The spring contacts are extended in one piece to form soldering tags, and the terminals and fixing holes are accessible without removing the grid leak.

No. W.148

Price 6d.

TELSEN MICA CONDENSERS

The new Telsens "Mica" Condensers represent an important advance in technique by which H.F. losses have been practically eliminated. The re-designed case is of more attractive appearance and can be mounted vertically or flat. Grid leaks, as before, may be mounted in series or shunt, clips being supplied free with capacities .0001, .0002 and .0003 mfd.

Capacity mfd.	No.	Price
.00005	W. 442	1/-
.0001	W. 240	1/-
.0002	W. 241	1/-
.0003	W. 242	1/-
.0004	W. 243	1/-
.0005	W. 244	1/-
.001	W. 245	1/3
.002	W. 246	1/6
.006	W. 247	1/6

The following mica condensers have also been added to the range for special purposes, e.g., band-pass filter circuits, etc.

Capacity mfd.	No.	Price
.01	W. 310	2/6
.02	W. 311	3/6
.05	W. 316	4/6

TELSEN PRE-SET CONDENSERS

The very low minimum capacity of the Telsens Pre-Set Condensers gives a wide range of selectivity adjustment when used in the aerial circuit. They are substantially made, easily adjusted and provided with a locking ring. Their high insulation and low loss adapts them for a number of uses.

Max. Cap. mfd.	Min. Cap. mfd.	No.	Price
.00005	.000005	W. 446	1/6
.002	.00025	W. 149	
.001	.000052	W. 150	
.0003	.000016	W. 151	
.0001	.000005	W. 152	

TELSEN SELF-SEALING CONDENSERS

The new Telsens paper condensers are a marked advance upon the old Mansbridge type. Factory tests show an insulation resistance of more than 8,000 ohms per microfarad and an electrification of 30 per cent.

Every 250 v. condenser is subjected to a test pressure of 1,500 volts, which is twice as severe as that set forth in the recommendations of the Institution of Electrical Engineers. The condensers are designed for a working voltage of 250 A.C., rectified or unrectified, or 250 v.—375 v. D.C. To ensure that these voltages are not exceeded a test voltage of 500 is specified.

Cat. No.	Capacity mfd.	Maximum Working Volts	Price
W.232	.01 mfd.	250 v. A.C. rectified and unrectified, or 250-375 D.C.	1/6
W.230	.04 mfd.	Ditto	1/9
W.231	.1 mfd.	Ditto	1/9
W.229	.25 mfd.	Ditto	2/-
W.228	.5 mfd.	Ditto	2/3
W.227	1 mfd.	Ditto	2/3
W.226	2 mfd.	Ditto	3/-



INTERVALVE COUPLING UNITS SPEAKER UNITS & CHASSIS

TELSEN 1 : 1 INTERVALVE COUPLING UNIT

This is a modern development of the one time deservedly popular R.C. units. It incorporates a low pass filter feed in its anode circuit, thus effectively preventing "motorboating," "threshold howl," and other forms of instability. With an H.L. type valve it will give an amplification of about 20, while consuming negligible H.T. current.

No. W.214
Price 7/6

TELSEN "R.C." COUPLING UNIT

No. W.285
Price 4/-

TELSEN 10 : 1 INTERVALVE COUPLING UNIT

A filter-fed Transformer using a high permeability nickel alloy core, and enabling a 10 : 1 voltage step-up to be attained while preserving an exceptionally good frequency characteristic which is compensated in the higher frequencies for use with a pentode valve.

No. W.215
Price 12/6

TELSEN LOUDSPEAKER UNIT

A reliable loudspeaker unit capable of giving a very pleasing performance at a low price. The magnets are of cobalt steel and the detachable rod which carries the cone is fitted with cone washers and clutch. The entire unit is enclosed in a beautifully moulded bakelite dust-cover.

No. W.54
Price 3/6

TELSEN LOUDSPEAKER CHASSIS

The fully floating cone of specially prepared damp resisting material is mounted on a flexible felt surround rigidly constructed, light pressed aluminium frame. The material and proportion of the cone give an exceptionally natural balanced tone, free from objectionable resonances. With the Telsen Unit W.54 it forms an ideal inexpensive combination, which, for natural reproduction and all-round performance, rivals the highest priced units.

Telsen "Popular" Loudspeaker Chassis, Diam. 11".
No. W.159 Price 5/6

Telsen "Major" Loudspeaker Chassis, Diam. 14½".
No. W.170 Price 7/6

TELSEN W.181 LOUDSPEAKER

An inexpensive combined loudspeaker cone chassis and unit.

Price 8/6

TELSEN W.182 & W.183 LOUDSPEAKERS

These complete Loudspeaker Chassis incorporate a powerful unit with a high degree of sensitivity and are capable of handling large power outputs. The tonal range is exceptionally fine.

No. W.182. Diam. 11" Price 11/6

No. W.183. Diam. 14½" Price 12/6

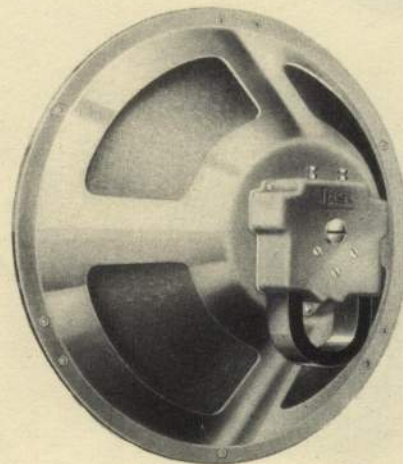
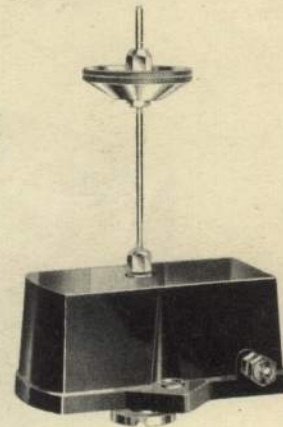
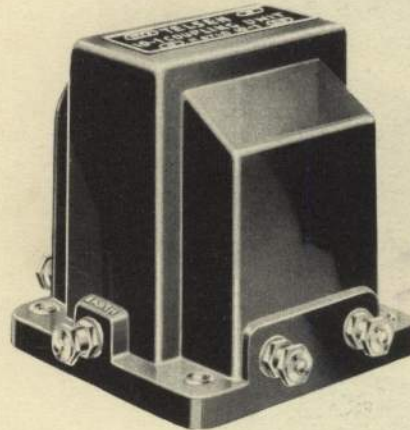
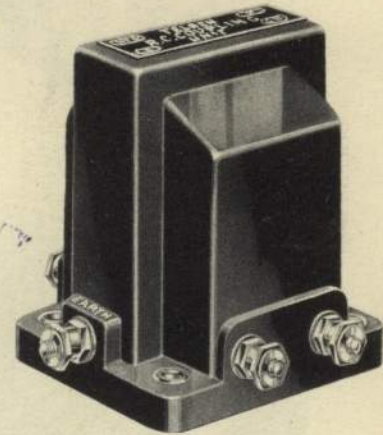
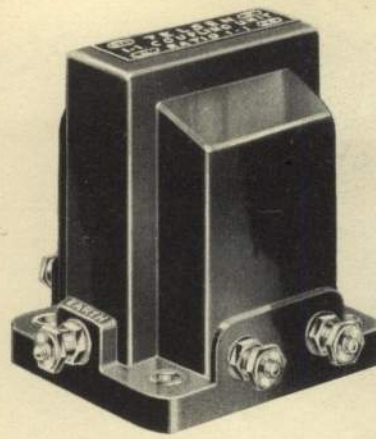

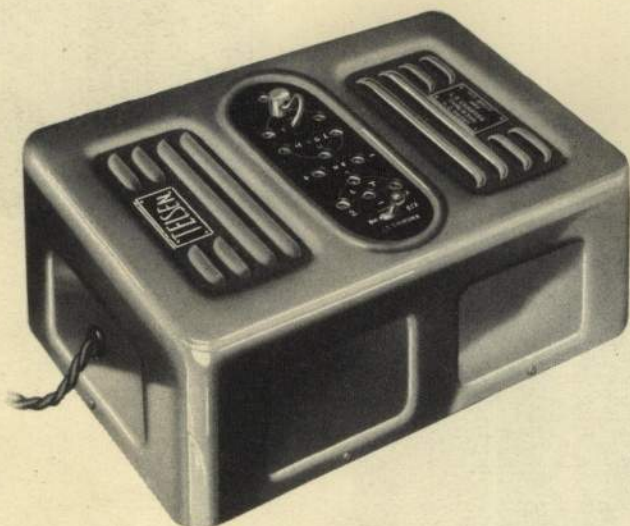
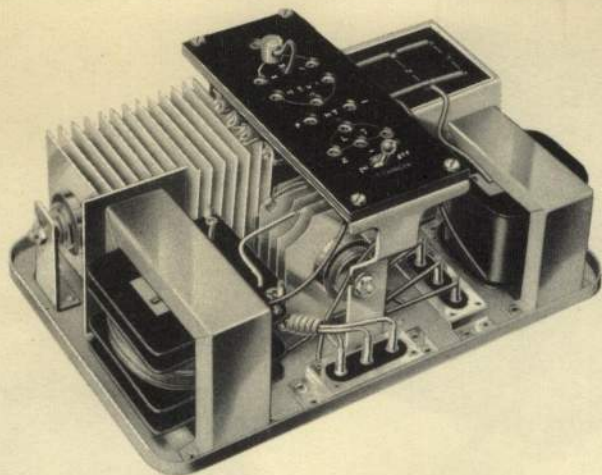

MAINS UNITS & SWITCHES

TELSEN H.T. UNIT AND L.T. CHARGER FOR A.C. MAINS

This Unit, which is suitable for input voltages between 200 and 250 at 40—100 cycles, will be specially welcomed by owners of battery receivers, who, while they desire to enjoy the economy of power supply from the mains, do not wish to discard their battery valves in favour of the A.C. variety. The unit is very solidly built and is completely screened by an artistically finished metal case. The H.T. output is 28 mA. at 150 volts with separate maximum, detector, and screened grid tapplings, on each of which a choice of high, medium or low voltages is available. Very generous smoothing equipment is provided to eliminate hum. Provision is made for charging 2, 4 or 6 volt accumulators at 0.5 amperes, and the use of these facilities leads to such a saving of charging costs that the unit soon pays for itself.

No. W.346

Price £3-12-6

TELSEN H.T. AND L.T. UNIT FOR A.C. MAINS

As regards input and H.T. output, this is similar to "H.T. Unit and L.T. Charger" No. W.346, but as it is intended to provide complete power supply for receivers employing A.C. valves, the L.T. charger is replaced by a centre tapped transformer winding capable of supplying 2.5 amps. at 4 volts. It is a very well made component and will be particularly appreciated by home constructors.

No. W.347

Price £2-10-0

TELSEN H.T. UNIT FOR D.C. MAINS

This unit is designed for D.C. inputs of from 200 to 250 volts. Adequate smoothing is provided to remove ripple, and the output is approximately 28 milliamps. at 150 volts. Three tapplings are provided, the maximum, screened grid, and detector tapplings, at each of which a choice of high, medium or low voltages is available. The unit is enclosed in a well finished metal case which provides complete screening.

No. W.348

Price 25/6

TELSEN MAINS SWITCH

A miniature switch of very robust construction. Its rapid make and break action makes it particularly suitable as a master switch in Mains and Battery Operated Receivers, for switching gramophone motors, and numerous other uses. Capable of handling up to 3 amperes at 250 volts with perfect safety. Enclosed in a neat moulded bakelite cover with one hole fixing.

No. W.297

Price 1/9

TELSEN

RADIO COMPONENTS

TELSEN .5 MEGOHM VOLUME CONTROL POTENTIOMETER

This new Telsen Volume Control possesses several important features that are responsible for making it one of the most reliable yet introduced. The Resistance element consists of a straight strip $\frac{1}{8}$ " wide mounted inside a Bakelite Case. The material is a new development that is practically impervious to moisture, so that Resistance change with changing humidity has been practically eliminated. The control is noiseless in action and is not subject to wear, contact with the element is made by means of a rocking contactor. Friction only takes place between the flexible metal contactor and a permanently lubricated button. The element is designed to follow a log law so that an equal variation in loudness occurs with an equal rotation of the knob. Supplied with full instructions.

No. W.481
Price 5/6

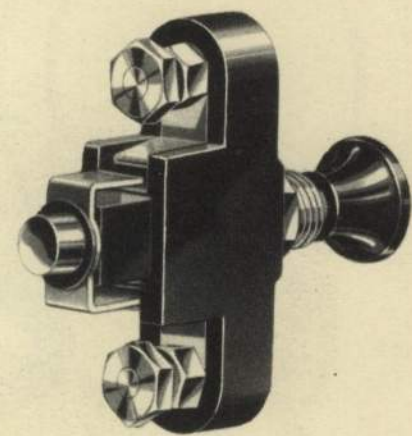
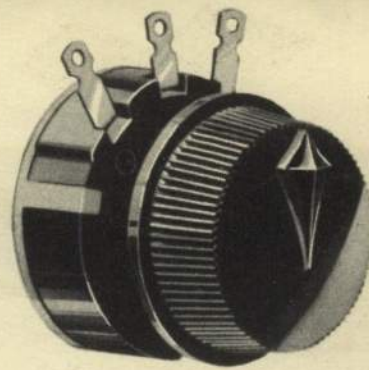

TELSEN PUSH-PULL SWITCHES

(Prov. Pat. No. 14125/31)

The Telsen Push-Pull Switches employ the "knife" type of self-cleaning contact, and a positive snap action. The nickel silver bridge piece is driven between the springy "fixed" contacts, and the wedge-shaped plunger squeezes the inner contacts outwards, closing the jaws in a firm grip. The series gap reduces self-capacity to a minimum and the spindle is insulated from all contacts. They can be usefully applied for several different purposes, e.g., for the switching on and off of the high and low tension and grid bias batteries, for wave change switching where two or three contacts are employed, etc. The shape of the spindle guide prevents any possibility of the contacts becoming out of alignment.

Two-point. No. W.107 Price 1/-
Three-point No. W.108 Price 1/3

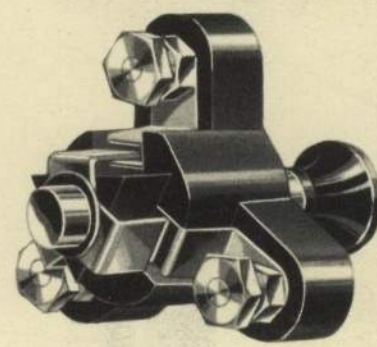

TELSEN FOUR-POINT "TWO-POLE" PUSH-PULL SWITCH

Designed on the same lines as the 2 and 3-point Switches this model is a two-pole switch highly suitable for use in wave changing on two coils or an H.F. transformer or for switching pick-up leads or an additional loud-speaker.

No. W.153
Price 1/3

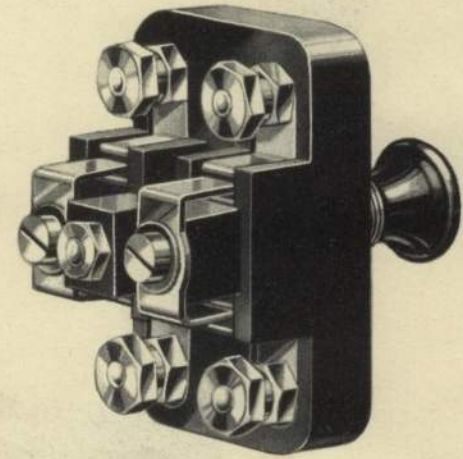

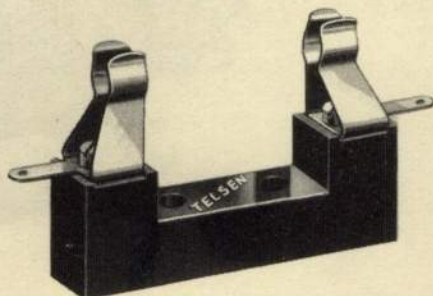
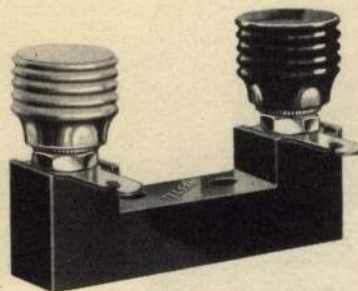
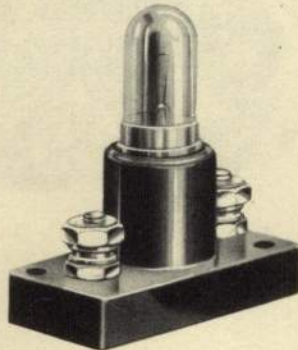
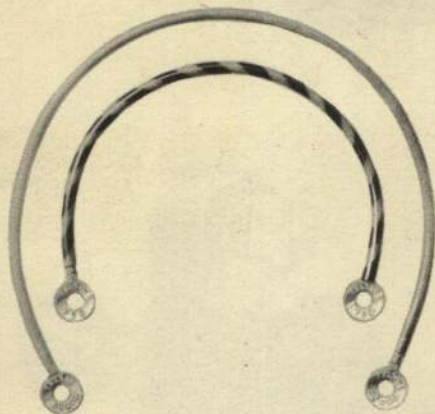
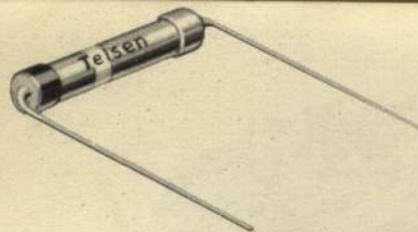

TERMINAL BLOCKS, FUSES & HOLDERS, RESISTANCES ETC.

TELSEN POWER FUSE

These efficient little power fuses utilise a special fuse wire having a very small "time-lag," when the fusing current has been attained. The wire is mounted in a glass tube hermetically sealed into caps of polished nickel. Made in four values.

Fusing current: $\frac{1}{2}$ amp. No. W.199
1 amp. No. W.200
2 amp. No. W.201
3 amp. No. W.202 } Price 6d.

TELSEN POWER FUSE HOLDER

Made for mounting the Telsen Power Fuse. The end clips are securely held and are in one piece with the soldering tag projections. Ordinary wire connections can also be made under the clips screws.

No. W.203 Price 6d.

TELSEN FUSE-HOLDER

A neat and inexpensive device which should be incorporated in every receiver as a precaution against burnt out valves. The terminals are easily accessible and the standard type fuse bulb is held firmly, giving a perfect contact which cannot become loose.

No. W.146 Price 6d.

TELSEN TERMINAL BLOCKS

Two insulated terminals are mounted upon a bakelite moulding as employed in the grid leak holder and power fuse holder. They may conveniently be used for aerial and earth, loudspeaker, pick-up, or extra battery connections, or for independent anchorage points.

No. W.204 Price 6d.

TELSEN SMALL TUBULAR CONDENSERS

This is a new range of very small tubular condensers, which despite their small size, are quite as efficient as the larger types. They are tested up to 1,500 volts, and as they have wired ends, are very suitable for suspension in the wiring.

Capacities .0001, .0002, .0003, .0005, .001, .002, .005, .006 mfd. Price 1/-
Capacity .01 mfd. Price 1/3
Capacity .1 mfd. Price 1/6

TELSEN RESISTORS WITH WIRED ENDS

The range of these components is very extensive both as regards resistance value and power rating. They are very small and light and are easily suspended in the wiring of a receiver, where their resistance is quickly identified by the standard colour code. For those unacquainted with the colour code, the resistance value is also printed on the carton. These resistors have negligible self-capacity and inductance, are noiseless in use, and their value remains unchanged under the most adverse circumstances. They are supplied in the following values:—Power rating of 1 watt: 250, 500, 1,000, 1,250, 5,000, 10,000, 20,000, 25,000, 50,000, 100,000, 250,000, 500,000 ohms resistance.

Price 1/-

TELSEN SPAGHETTI FLEXIBLE RESISTANCES

These resistances are made from the finest nickel-chrome wire, wound on a pure cotton core, stoved and impregnated so that moisture cannot attack the wire and cause corrosion. The bending of the resistance will not alter its value. Made in the following resistances:

300, 600, 750, 1,000 ohms—42 mA. Price 6d.
1,500, 2,000, 3,000, 4,000, 5,000 ohms—23 mA. Price 9d.
10,000, 15,000, 20,000, 25,000, 30,000 ohms—6 mA. Price 1/-
50,000, 60,000, 80,000, 100,000 ohms—3 mA. Price 1/6

TELSEN INSULATED CONNECTING WIRE

This special connecting wire has been evolved as the result of Telsen's long experience in supplying the wants of the home constructor. The core consists of high conductivity tinned copper wire, and this is provided with a special covering. The highly glazed finish of the covering gives the wiring of the receiver an extremely attractive appearance, and at the same time provides insulation of a very high order. The use of sleeving is eliminated as the snugly fitting covering provides all the insulation necessary. When making connections, the covering should be cut round with a knife, and the piece to be removed will then slide off the end of the wire. Supplied in 10 ft. lengths at the attractive price of 3d. per length.

No. W.441 Price 3d.

TELSEN 100 mA. FUSE BULB

Designed especially for the battery operated receiver where only a small anode current is passing, these fuse bulbs provide adequate protection for the delicate filaments of low consumption valves. That important factor "time-lag" has been given special attention, and these fuses can be relied upon to blow immediately the maximum rated current is passing. Fitted into an hermetically sealed bulb the fuse, in spite of its delicate filament, is extremely robust. This fuse is an essential accessory to every battery operated receiver, and an invaluable insurance against the possibility of burnt out valves.

No. W.318 Price 6d.

TELSEN

RADIO COMPONENTS

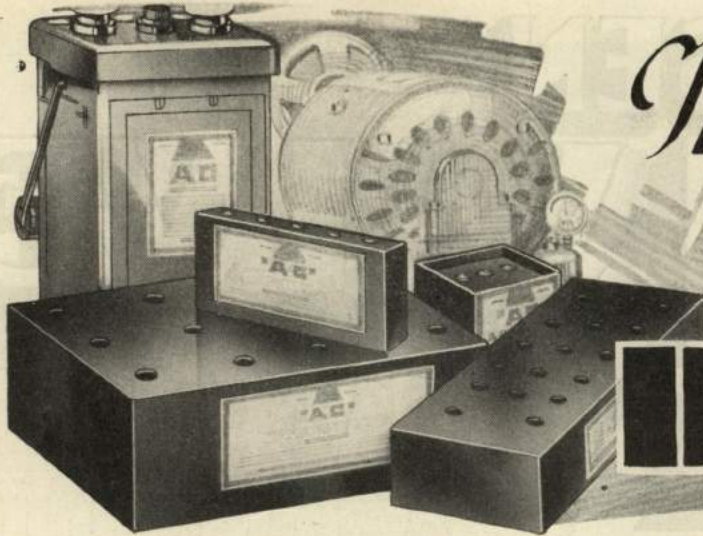

The choice and care of H.T. BATTERIES

IN many of the previous editions of the *Telsen Radiomag* we have emphasised the importance of one or two simple precautions which the reader should observe if he is to obtain the best service from his H.T. batteries. It is the purpose of the present article to recapitulate this advice and at the same time to explain the reasons upon which it is based.

Doubtless many of our readers have taken to pieces an old H.T. battery and wondered how the little metal cylinders or "cells" as they are called, could provide the power for months of wireless reception. Probably not so many have tackled the messy job of taking one of these cells to pieces, so to save them the task a cross-section of a typical cell is reproduced in Figure 1 which is almost self-explanatory.

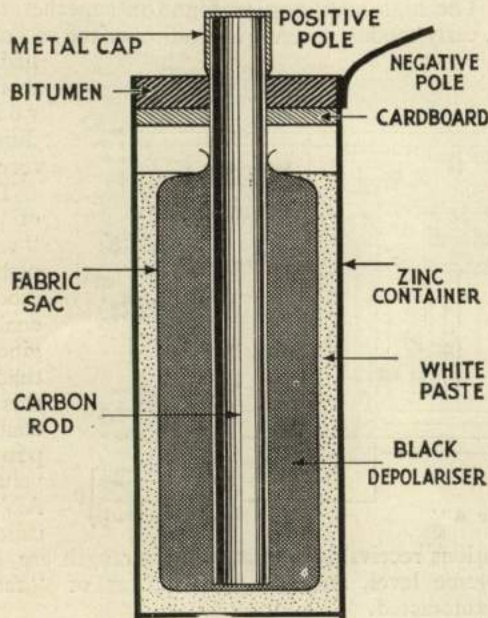

Fig. 1

The composition of the white paste varies with different manufacturers, but it always intrigues the layman, so a representative formula is given below.

- 10 parts ammonium chloride ("Sal Ammoniac").
- 5 " zinc chloride.
- 5 " glycerine.
- 5 " flour.
- 30 " plaster of Paris.
- 30 " water.

The black depolariser may consist of:—

- 45 parts manganese dioxide.
- 30 " powdered carbon.
- 14 " graphite (black-lead).

The zinc chloride absorbs moisture and so keeps the paste wet, while the glycerine and flour keep it sticky. The ammonium chloride reacts chemically with the zinc container and causes a gas to be given off which tends to collect on the carbon rod and so to impede the flow of current. This is called "polarisation." Consequently a "depolariser" is packed around the carbon rod, the object of which is to give the gas bubbles suitable points on which to collect and, in time, to remove them by chemical action.

The reaction between the ammonium chloride and the zinc also causes an electrical pressure or "voltage" of $1\frac{1}{2}$ volts to be set up between the poles of the cell. This voltage depends only on the chemicals used, and is independent of the size of the cell. A battery of 80 cells would thus give 120 volts or 100 cells 150 volts, whatever the size of the cells, but this size determines the "capacity" of the battery which in turn limits the maximum current which can be taken from it without damage.

The chemical reaction is vigorous when current is being taken from the cell and gradually results in the zinc being eaten away and the ammonium chloride being changed to other chemicals, the cell then being exhausted. This reaction continues in a small degree when the cell is not being used, due to impurities in the zinc giving rise to what is called "local action." For this reason the battery has a limited "shelf life" after which it is exhausted though unused, and therefore a battery should not be purchased if it has been a very long time in storage.

This brings us to an important point, the choice of a battery suited to the set. Suppose the receiver takes a current of 15 mA. The use of a battery designed for 8 mA. will lead to a shortened life due to continual over-discharge. On the other hand a battery designed for 30 mA. would not give a proportionally longer life because the termination of its shelf life would cut short the period of usefulness. Hence a size of battery suitable for the set should be obtained, and the manufacturers will be glad to specify the best capacity in any particular case.

Another factor tends to reduce the shelf-life, and this is poor inter-cell insulation. Unless the cells are carefully insulated from each other a slight leakage will occur which will impose a continual drain on the battery and the shelf life will be greatly reduced. The user can do much to prevent this by keeping the battery in a dry place, as most insulators leak when moist. On the other hand the battery should be kept cool, as heat tends to accelerate local action and to evaporate the moisture in the paste.

By keeping the grid bias plugs at the highest negative tapping consistent with good quality the current taken by the set is reduced to a minimum, and this adjustment should be made, as it avoids needless waste of H.T. current.

When all these precautions have been observed the most potent remaining factor is the design of the receiver itself. All Telsen battery sets are carefully designed to give good quality reproduction with a minimum consumption of H.T. current, and a notable achievement in this direction is the Battery Economy Receiver described elsewhere in this issue of the *Radiomag*.

Battery

SUPER

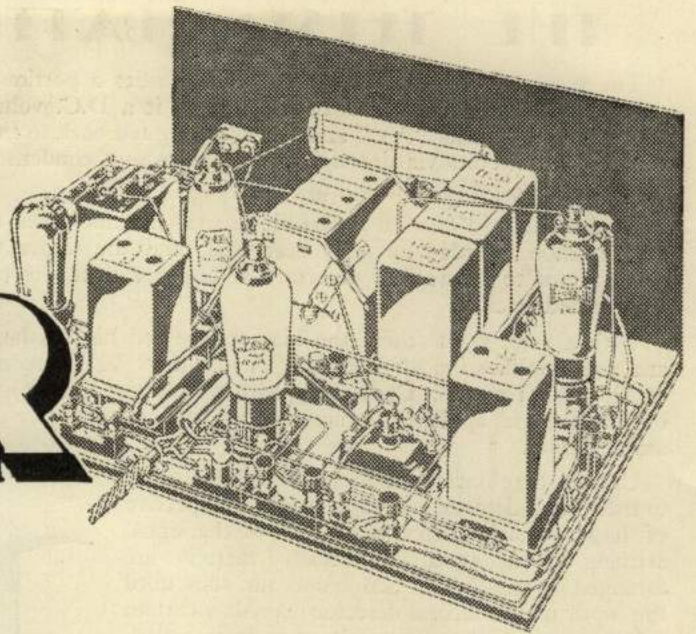

FOR THE DISTANT STATION ENTHUSIAST

For the benefit of the less technical reader, we may explain that the circuit employs four valves, arranged as 1st. detector, I.F. amplifier, 2nd. detector and output valve, that it is battery operated, and that it incorporates delayed automatic volume control. The operation of the receiver is as follows:—

The variable condensers "C₁" and "C₂" tune a band pass filter which "pre-selects" the desired signal and applies it to the control grid of the heptode valve "V₁." This valve then performs its function as first detector by mixing with the signals strong local oscillations generated in the circuit tuned by the condenser "C₃." This circuit is so adjusted that it oscillates at a frequency different from that of the signal being received, by an amount equal to the intermediate frequency, in this case 110 kilocycles. The ganging of the oscillator circuit to the pre-selector circuits is so arranged that this difference is maintained constant at any setting of the tuning control. "C₁," "C₂" and "C₃" are the three sections of a gang condenser in which "C₃" is a specially shaped section. The internal construction of the heptode "V₁," is such that the coupling between the local oscillator circuit and the pre-selector circuits is entirely *electronic*, so that there is no chance of locally generated oscillations finding their way into the aerial circuit and causing trouble by re-radiation. The heptode furthermore possesses the unique property that whilst one portion acts as an oscillator, another operates as a variable- μ amplifier. In other words, not only does the heptode change the frequency of the received signals, it also provides controllable amplification of them; to use the correct technical expression, it provides variable "conversion gain."

The fact that this conversion gain is variable contributes to better A.V.C. action as will be seen presently. Until recently, it was possible to obtain only a fixed value of amplification from a single valve frequency changer; the conversion gain afforded by it could not be controlled.

Reverting to the circuit diagram, it will be seen that "V₁" is coupled to an I.F. amplifying valve "V₂" by a selective band pass filter "I.F.T.1."

This provides selective amplification of the output from "V₁," which is at a frequency of 110 K.C. and is modulated by speech and music from the required station.

Due to the fact that "I.F.T.1," "V₂" and "I.F.T.2" form a fixed tune amplifier, only the wanted signals are amplified—any other signals in the output from "V₁" are rejected.

"V₂" is a variable μ valve and the amplification afforded by it can be varied within wide limits. After amplification, the signals are passed on to the second detector "V₃." This has two small diode rectifiers, one of which, marked "A" in the diagram, provides distortionless rectification of the signal voltages.

As a result of this process low frequency voltages corresponding to speech and music are developed across the manual volume control marked "M.V.C." The sliding contact of this can be set to adjust the volume to any desired level, by tapping off from the resistance a greater or smaller portion of these voltages, to be passed on to the L.F. amplifier. Further magnification of these voltages is carried out by the triode section of "V₃" which passes them on to the output valve via the low frequency transformer marked "G.S.4." The output valve, which is of the pentode type still further amplifies these voltages and provides sufficient power to operate the loud speaker.

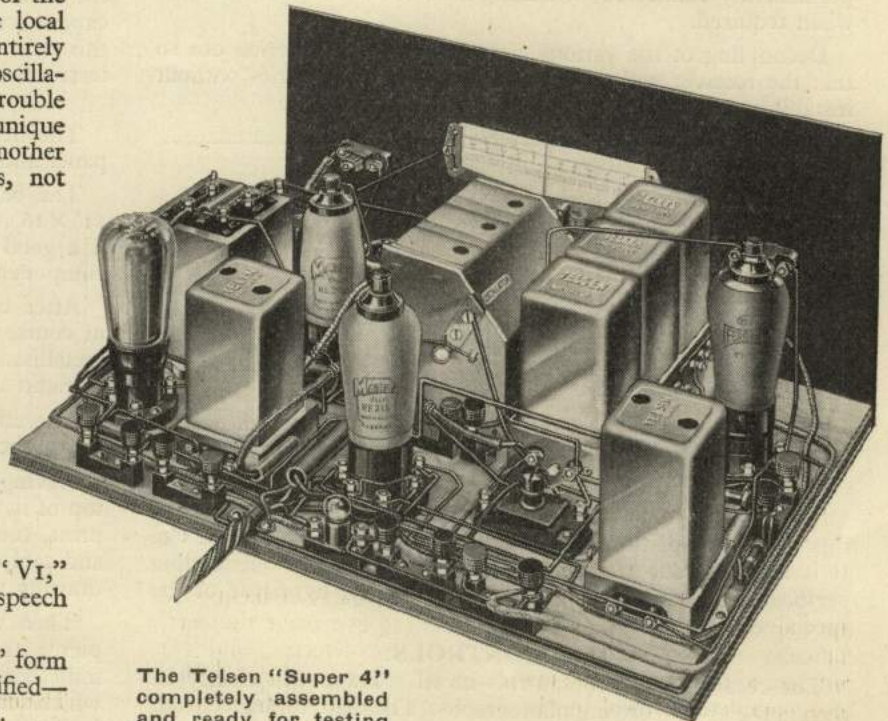

The Telsen "Super 4" completely assembled and ready for testing

THE TELSEN BATTERY "SUPER 4"—continued

The second diode anode marked "B" rectifies a portion of the output from "V₂" and develops from it a D.C. voltage which is used to bias "V₁" and "V₂," being fed back to their control grid circuits via decoupling resistances and condensers, which serve to prevent instability.

Now if the grid bias on a variable- μ valve is increased the amplification afforded by it is decreased, and the larger the signal input to the second detector the larger will be the bias voltage fed back.

With a large signal then, the bias voltage fed back is large, and the amplification afforded by "V₁" and "V₂" becomes considerably reduced. Conversely, with a weak signal, very little bias voltage is applied to these valves, which then give full amplification.

Under these circumstances, the voltage input to the second detector is held constant, irrespective of large variations in the strength of the signal arriving at the aerial. Actually, matters are arranged so that A.V.C. action does not start until the input to the second detector exceeds a certain value, equal to the delay voltage as it is called. For a more detailed explanation of the action of A.V.C. the reader is referred to the article on this subject elsewhere in this issue.

The fact that two valves are controlled instead of only one, means that a much greater change in total amplification results from a given change in bias voltage. Consequently, A.V.C. action is more sensitive and much better control is obtained.

As a result of all these processes, the receiver is enabled to select a large number of stations free of interference, and giving a distortionless output at a volume level which, once set by the user remains practically constant, irrespective of all but the most severe variations of input.

Having detailed the working principles of the receiver, one or two points deserve special mention.

Provision is made for the connection of a gramophone pickup, and a special switch is fitted, so that the user can leave the pickup permanently connected, switching it in or out of circuit as and when required.

Decoupling of the various circuits is carefully carried out so that the receiver will operate on ageing H.T. batteries without instability developing.

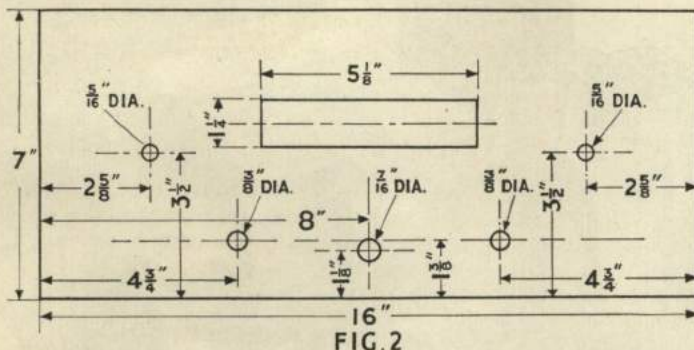

The "G.S.4" low frequency transformer incorporated in this set, is one of the latest products of the Telsen Electric Co. It is a high grade transformer giving not only an outstanding performance, but a high degree of reliability, by virtue of the special construction adopted.

THE CONTROLS.

The receiver has five controls in all. These will clearly be seen in the accompanying photographs. The main tuning control, operating the 3 gang condenser, is at the centre of the panel,

indications being given on the full vision rectangular scale above it. This scale is calibrated both in actual wavelengths and degrees.

Looking at the front of the panel, the wavechange switch is operated by the knob on the left of the panel, in line with the tuning control, whilst in a similar position on the right hand side is the manual volume control.

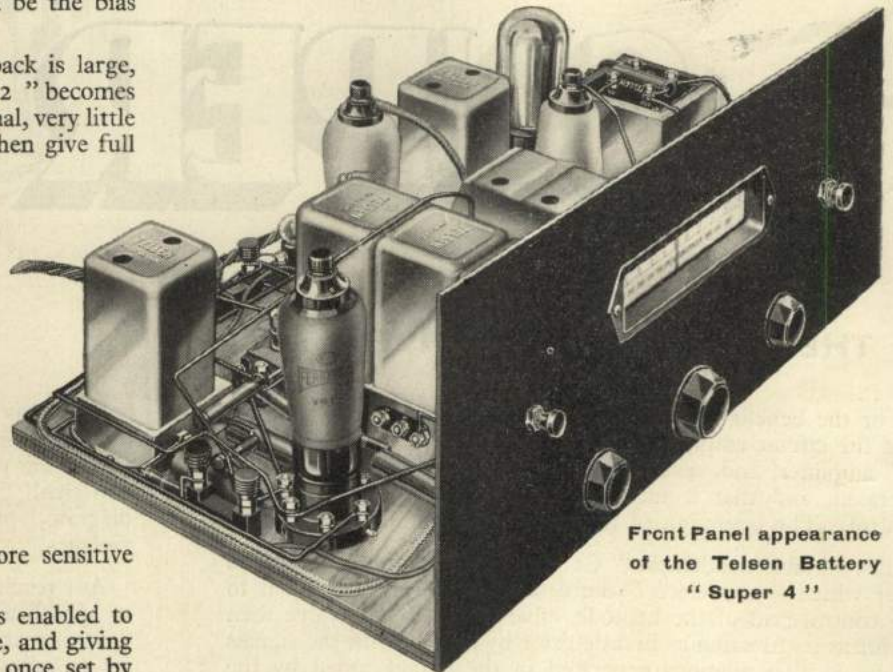

Front Panel appearance
of the Telsen Battery
"Super 4"

The small knobs disposed higher up at the left and right hand sides respectively, operate the on-off switch and the gramophone switch.

A full size 1/- blueprint illustrating the layout of the receiver is included free with this issue of the Radiomag. This will enable the components to be accurately positioned, and from it the details of the wiring may readily be observed. The least experienced constructor will have no difficulty in constructing this receiver, if this blueprint is studied in conjunction with the instructions contained in the following pages.

ASSEMBLY.

The first step in the assembly of the receiver is to obtain a panel and baseboard upon which to construct it.

The baseboard should be a piece of 5 or 7 ply wood, size 11" x 16". Nothing thinner than 5 ply wood should be used, if a good mechanical job is desired, with secure fixing of the components.

After being cut the wood may be stained, although this is of course not essential. There is no objection to the use of a metallised baseboard, such as is now obtainable from the majority of radio shops, if desired.

The effect of this is rather beneficial than otherwise and the appearance of the receiver will certainly be enhanced considerably.

Having prepared a suitable baseboard, place the blueprint on top of it, so that the edges of the baseboard as indicated on the print, coincide with the actual edges of the board underneath, and temporarily secure it in position by means of one or two drawing pins or tacks.

Then with a sharp pointed instrument, such as a bradawl, pierce through the fixing holes for the various components indicated on the print, so that the baseboard is marked by holes which serve to locate the components exactly, and which provide a start for the fixing screws, when the components are secured.

THE TELSEN BATTERY "SUPER 4"—continued

At this stage, it will probably be convenient for most constructors to prepare the panel, although this may be left until a little later if desired. The panel may be of wood or ebonite not exceeding $\frac{1}{4}$ " in thickness, or if preferred, a metal panel may be used. In the latter case, 18 gauge aluminium sheet is recommended.

Whichever material is chosen for a panel, it should be cut to a size 16" x 7" and it should be cut and drilled as indicated in Fig. 2.

For cutting out the rectangular aperture for the tuning scale, a fretsaw is probably the best instrument. In the case of a metal panel, special metal cutting saw blades are advised, although aluminium may be cut with ordinary blades, if a little patience is exercised. If the constructor does not care to tackle this part of the job, no doubt the dealer from whom the components are obtained will be willing to supply the panel ready cut and drilled.

Having prepared the panel and baseboard, the constructor should mount the components on to the baseboard, which has previously been marked out for fixing holes as described. It is advised that the mounting of components be proceeded with in the following order, using round headed wood screws for fixing them.

First mount the triple coil assembly, so that the end where the switch rod projects is near the front edge of the baseboard, then mount the I.F. transformers and the valveholders V1, V2, V3 and V4.

Next mount the "G.S.4" transformer so that the terminals marked "G" and "GB" are nearest the edge of the baseboard, and mount the 2 2mfd. condensers marked "A" and "B" in the print. Other components to be mounted are the H.F. Choke and the 8 terminal blocks numbered on the blueprint T1 to T8 inclusive. It should be noted that T8 is half of a terminal block which has been sawn in two. Finally, the .001 mfd. preset condenser and the fuseholder should be mounted. The saddle for securing the battery cord is not mounted until the cord is wired in. Take care to mount the H.F. Choke the correct way round, as in the print.

The 3 gang condenser is not finally mounted until a later stage in the construction of the set, for the reason that certain parts of the wiring are not easy to execute with this condenser in position. The final mounting of the condenser, therefore, is left until these particular portions of the wiring are completed.

At this stage the components should be mounted on the panel in the positions shown, taking care that the fixing nuts are locked up tightly. The panel should then be screwed to the front edge of the baseboard.

WIRING.

The way in which the wiring of the receiver is carried out will depend to a considerable extent on the capabilities of the individual constructor. The more advanced amateur may in some cases prefer to make soldered joints, and he will probably spend considerable time in making neat right angled bends, with nice parallel runs in the wiring. Like all Telsen designs for the home constructor, however, the "Super 4" is arranged so that it can be wired up without making a single soldered joint, and the constructor who has never made a radio set before will experience no difficulty whatever in carrying out this part of the work. If the wires in the attached list are crossed off as and when completed, it is impossible to omit a connection by accident, and the clarity of the blue print and accompanying photographs

render it extremely difficult for the constructor to make a mistake in any connections.

The wiring as carried out by the novice may not look quite so pretty as that executed by the more advanced constructor, but he is assured of obtaining results which are just as good.

It is recommended that Telsen connecting wire be used and before commencing the wiring the amateur is advised to refer to the notes on wiring under "Practical Hints and Tips," particular attention being paid to the method of making screened leads.

The constructor is asked to remember when looking at the blueprint, that several wires have had to be represented as being slightly out of their true positions. This has been necessary in some cases in order to show them on the print, as for instance, where one wire runs parallel to another, and directly over it. Another point is that although the wires running to the panel components appear long, they are actually quite short. This is due to the fact that the panel is represented as being folded forward flat, instead of being upright. When it is desired to show clearly the components mounted on it, this is a matter of necessity.

Where any doubt is felt on any of these points, reference to

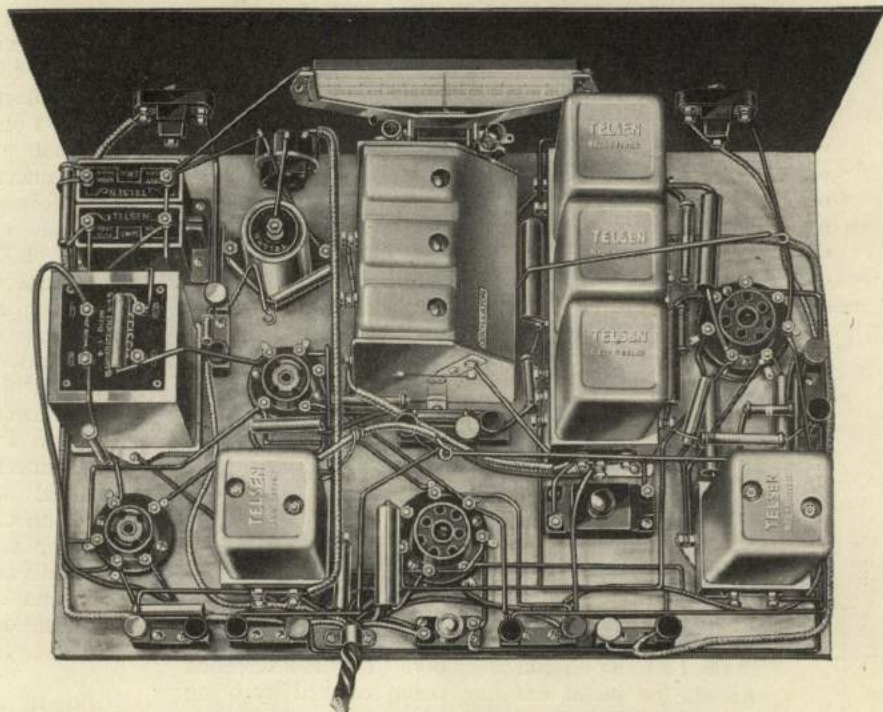

Plan View of the Telsen Battery "Super 4"

the accompanying photographs will make things clear, although it is pointed out that the exact position of a wire is not of great importance; as long as it is connected to the correct points, the constructor is safe in running it by the shortest possible route, between the points concerned.

The wiring should be carried out in the order detailed below, crossing off the connections as and when completed, for the reasons already mentioned. For convenience in making out this wiring list, numbers and letters have been given to the terminals, and certain of the components, which do not actually exist on them. They exist only on the blueprint and their purpose is to make the various points easy of reference. For instance "I.F. transformer A" calls the constructor's attention immediately to the I.F. transformer situated towards the rear of the baseboard, and at the right hand side of it, looking at the back of the set.

THE TELSEN BATTERY "SUPER 4"—continued

It will be obvious that this system saves a lot of confusion, and quite a lot of printer's ink.

At one or two stages in the wiring, it will be necessary to slip the gang condenser temporarily into place while connections to it are adjusted for length and shape. These connections are made permanently and firmly at the gang condenser end of them, when this component is fitted finally into place on completion of the wiring.

WIRING INSTRUCTIONS.

- Terminal 1 on T₃ to 2 on V₂.
 " 2 on V₂ to 3 on V₃.
 " 3 on V₃ to 4 on V₄.
 " 4 on V₄ to 5 on 2 mfd. condenser "B".
 " 5 on 2 mfd. condenser "B" to 6 on 2mfd. condenser "A."
 " 6 on 2 mfd. condenser "A" to 7 on volume control.
 " 7 on volume control to 8 on H.F. Choke.
 " 9 on volume control to 10 on H.F. Choke.
 " 11 on volume control to 12 on I.F. Coil "B." (This is a screened wire)
 " 1 on T₃ to 13 on T₂.
 " 13 on T₂ to 14 on coil assembly.
 " 14 on coil assembly to 15 on coil assembly.
 " 15 on coil assembly to 16 on coil assembly.
 " 16 on coil assembly to 17 on coil assembly.
 " 1 on T₃ to 18 on coil assembly.
 " 18 on coil assembly to 19 (the upper screw) on small metal plate at back of ganged condenser.
 " 18 on coil assembly to 20 on I.F. coil "A."
 " 20 on I.F. coil "A" to 21 on V₁.
 " 13 on T₂ to 22 on fuse holder.
 " 22 on fuse holder to 23 on V₂.
 " 23 on V₂ to 24 on V₂.
 " 24 on V₂ to 25 on I.F. coil "B."
 " 26 on panel (the escutcheon fixing screw) to 6 on 2 mfd. condenser "A."
 " 27 on G.S.4 transformer (the fixing screw) to 28 on I.F. coil "B" (also a fixing screw).
 " 29 on T₃ to 30 on V₂.
 " 30 on V₂ to 31 on V₃.
 " 31 on V₃ to 32 on V₄.
 " 29 on T₃ to 33 on V₁.
 " 33 on V₁ to 34 on S₂.
 " 35 on T₇ to 36 on V₄.
 " 36 on V₄ to 37 on 2 mfd. condenser "A."
 " 35 on T₇ to 38 on I.F. coil "B."
 " 38 on I.F. coil to 39 on T₁.
 " 40 on V₂ to 41 on V₁.
 " 42 on T₂ to 43 on coil assembly. (This is a screened lead, the metal braiding being earthed by being twisted and looped under the earth terminal 13).
 " 44 on coil assembly to 45 on ganged condenser.
 " 46 on ganged condenser to 47 on coil assembly.
 " 47 on coil assembly to cap on top of V₁.
 " 48 on ganged condenser to 49 on coil assembly. (this is a screened lead.)
 " 49 on coil assembly to 50 on preset condenser.
 " 51 on preset to 52 on coil assembly.
 " 52 on coil assembly to 53 on coil assembly.
 Connect a .0001 mfd. tubular condenser between 52 on coil assembly and 54 on V₁.
 Connect a 250,000 ohm resistor between 16 on coil assembly and 54 on V₁.
 Connect a .1 mfd. condenser between 16 on coil assembly and 41 on V₁.
 Connect a 1,000 ohm resistor between 55 on coil assembly and 56 on V₁.
 Connect a .1 mfd. condenser between 57 on coil assembly and 17 on coil assembly.
 Connect a 25,000 ohm resistor between 57 on coil assembly and 39 on T₁.
 Connect a .5 megohm resistor between 58 on T₁ and 59 on I.F. coil "A."
 Connect a .1 mfd. condenser between 59 on I.F. coil "A" and 21 on V₁.
 Connect a .1 mfd. condenser between 21 on V₁ and 60 on I.F. coil "A."
 Connect a 5,000 ohm resistor between 60 on I.F. coil "A" and 39 on T₁.
 Terminal 61 on V₁ to 62 on I.F. coil "A."
 " 63 on I.F. coil "A" to 64 on V₂.
 Connect a .1 mfd. condenser between 24 and 40 on V₂.
 Connect a .0001 mfd. condenser between 12 on I.F. coil "B" and 25 on I.F. coil "B."
 Terminal 65 on I.F. coil "B" to cap on top of Valve 2 (This is a screened lead).
 Connect a .001 mfd. condenser between 65 on I.F. coil "B" and 66 on V₃.
 Terminal 67 on I.F. coil "B" to 68 on V₃.
 Connect a 250,000 ohm resistor between 66 on V₃ and 69 on T₄.
 Connect a 250,000 ohm resistor between 69 and 70 on T₄.
 Terminal 69 on T₄ to 58 on T₁.
 " 71 on T₈ to 66 on V₃.
 Connect a .5 megohm resistor between 71 on T₈ and 72 on coil assembly.
 Connect a .1 mfd. condenser between 15 on coil assembly and 72 on Coil assembly.
 Terminal 73 on V₃ to 80 on G.S.4 transformer.
 Connect a .001 mfd. condenser between 80 on G.S.4 transformer and 81 on G.S.4 transformer.
 Terminal 81 on G.S.4 transformer to 82 on 2 mfd. condenser "B."
 Connect a 25,000 ohm resistor between 82 on 2 mfd. condenser "B" and 37 on 2 mfd. condenser "A."
 Connect a 250,000 ohm resistor between 83 on transformer and 84 on V₄.
 Terminal 85 on V₄ to 86 on T₇.
 Connect a .01 mfd. condenser between 4 on V₄ and 86 on T₇.
 Connect a .5 megohm resistor between 87 and 88 on T₆.
 Terminal 88 on T₆ to cap on top of valve 3.
 Connect a .001 mfd. condenser between 88 on T₆ to 89 on H.F. choke.
 Connect a .0002 mfd. condenser between 89 on H.F. choke and 8 on H.F. choke.
 Terminal 90 on S₁ to 88 on T₆.
 " 91 on S₁ to 92 on T₅. (This is a screened lead.)
 " 95 on T₅ to 70 on T₄.
 Connect together by means of fine bare copper wire the following points.
 5 on 2 mfd. condenser "B" to the braiding around the screened wire which connects 91 to 92.
 18 on Coil assembly to the braiding around the wire joining 48 to 49; on to the braiding round the wire joining 11 to 12 and also to the braiding around the wire joining 65 to the cap on V₂.

Before slipping the gang condenser finally into place mount the special 10 m.mfd. condenser on it, between terminals 45 and 46. This small coupling condenser, is made to give 10 m.mfd. capacity, as described in "Practical Hints and Tips." The looped ends of the other connections running to 45 and 46 on the gang condenser, should be partially untwisted so that they may be slipped under the terminal heads, without taking them off and detaching the special coupling condenser, when the gang condenser is in position.

When tightening up the grub screws in the boss of the gang condenser drive, arrange matters so that when the condenser is

THE TELSEN BATTERY "SUPER 4"—continued

"all in" i.e. spindle turned fully clockwise, looking at the panel, the pointer on the scale of the drive is fully over to the right.

After preparing the battery cord as described in "Practical Hints and Tips" connect it to the receiver as follows:—

- L.T. + to 93 on S2.
- L.T. — to 1 on T3.
- H.T. + 2 to 38 on I.F. coil "B."
- H.T. + 1 to 40 on V2.
- H.T. — to 94 on fuse holder.
- G.B. + to 94 on fuse holder.
- G.B. — 1 to 95 on T5.
- G.B. — 2 to 87 on T6.
- G.B. — 3 to 96 on G.S.4 transformer.

If it is desired to illuminate the tuning scale, wire up the two tags on each pilot lampholder to terminals 3 and 31 on "V3." Use 2 volt low consumption pilot lamp bulbs obtainable from your dealer.

ACCESSORIES FOR THE TELSEN SUPER 4.

The following accessories are required for use with the "Telsen Super 4."

- 1 Ferranti valve type "VHT2."
- 1 Mazda " " "VP215."
- 1 Mazda " " "HL21/DD."
- 1 Mazda " " "PEN 220A."
- 1 L.T. Accumulator.
- 1 120v. or 150v. H.T. battery.
- 1 9v. G.B. battery.
- 1 Loudspeaker.

A suitable L.T. battery is the Ediswan 2v. 60 ampere hour accumulator type E.L.7.

The G.B. battery may be an Ediswan type 69807 whilst the H.T. battery may be an Ediswan 120v. standard capacity battery type 69719. Although costing a little more, a 150 volt battery type 69707 will give much better results, in the way of increased power output and better quality.

The extra outlay is justified if a super capacity battery is bought, for although it costs more at the beginning, its life is so much longer that operating costs are brought down considerably. Suitable batteries are Ediswan 69728 (120 volts) or Ediswan 69729 (150 volts).

Regarding the loudspeaker for use with the "Super 4"; it may be of the moving iron or permanent magnet moving coil type, but the latter type is recommended.

Most small permanent magnet moving coil speakers are fitted with what is known as a universal transformer, which enables them to be matched either to triode or pentode valves, or, if desired, to be used with push-pull output stages. This type of speaker is quite alright for use with the "Super 4," but where it is not known that a speaker is fitted with this type of input transformer, it is well to specify when ordering it that it is to be used with a pentode valve. Do not attempt to economise too much when purchasing your speaker—a little extra money spent on it will make a lot of difference to the results obtained. A speaker with a 9" cone although it may cost a bit more, will give greatly superior volume and quality to those afforded by the midget types with 5" or 6" cones.

Where the constructor already has in his possession a moving coil speaker suited to triode output valves he may adapt it for use with the pentode valve used in the "Super 4," by using a Telsen Tapped Pentode Output Choke W. 465 as described in the leaflet enclosed with these components.

Where a moving iron speaker is available, it will in most cases match the output valve without trouble, but it may be necessary to increase the value of the condenser across the speaker (.01 mfd.)

to something a little larger, in order to prevent undue accentuation of the higher frequencies.

CONNECTING UP AND OPERATING THE TELSEN SUPER 4.

Before connecting up the "Super 4" for test, a suitable fuse bulb should be inserted in the fuseholder. A pilot lamp bulb consuming between .2 amp and .3 amp. is recommended; voltage is immaterial, but as usually available it will be between 2 and 6 volts.

Insert in valveholder "V1" the Ferranti heptode valve type "VHT2" and attach to its top cap the lead running from "47" on the coil assembly.

Insert in valveholder "V2" the Mazda "VP215" valve, attaching to the top cap of this valve the lead running from "65" on I.F. coil "B."

In valveholder "V3" insert the Mazda valve type

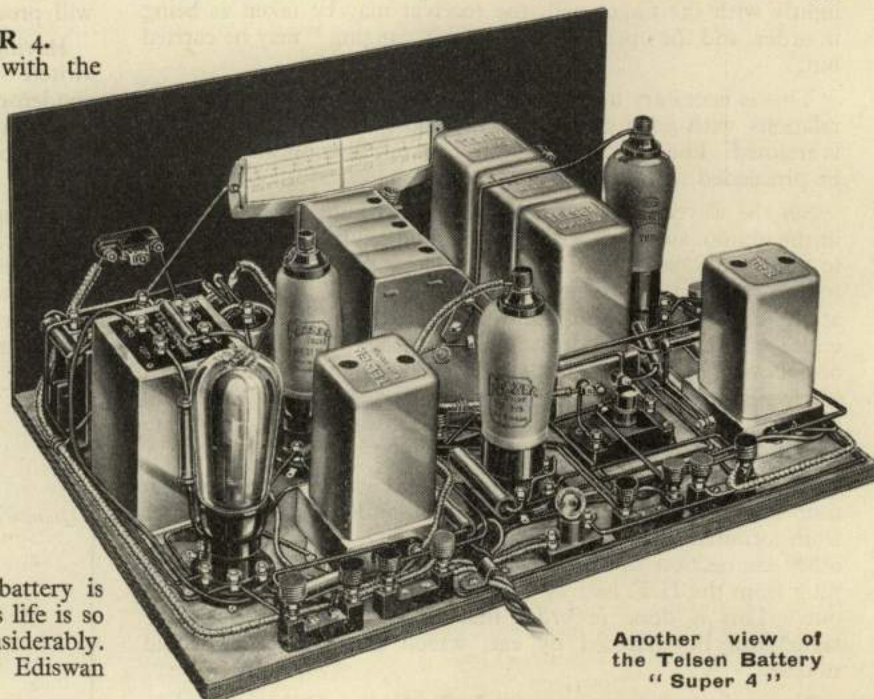

Another view of the Telsen Battery "Super 4"

"HL21/DD" attaching to its top cap the lead running from terminal 88 on the terminal block T6.

In valveholder "V4" the Mazda "PEN 220A" should be inserted; if this is not already in the constructor's possession, a 5 pin base type should be purchased, but if it is desired to use a 4 pin type having a side terminal, this may be done by connecting a short lead from terminal 36 on "V4" to the terminal on the side of the valve cap.

Having inserted 4 valves as detailed above, connecting an aerial and earth to terminals 42 and 13 respectively, on terminal block "T2," after which connect a suitable loudspeaker to terminals 35 and 86 on terminal block "T7."

On the subject of the loudspeaker, see the notes under "Accessories for the Super 4." Having connected a loudspeaker connect up the batteries as follows:—

Connect the "LT+" lead to the "+" (usually red) terminal of the LT. battery, and connect the L.T.— lead to the "—" (usually black or blue) terminal.

Then insert the "G.B.+" plug into the "+" socket of the grid battery, and plug "G.B.—1" into the —1½v. socket. "G.B.—2" goes into the —3v. socket, and if a 150 volt battery has been purchased "G.B.—3" should be plugged into a socket giving —9v. With a 120 volt H.T. battery, plug "G.B.—3" into the —7½v. socket of the grid battery.

THE TELSEN BATTERY "SUPER 4"—continued

As the H.T. battery runs down the value of bias applied to "G.B.—3" must be reduced slightly to produce the best results, but do not make any greater reduction than is necessary to produce an improvement in results, at various stages in the life of the H.T. battery.

Having connected up the grid battery, connect the H.T. battery as follows:—

Plug the "H.T.—" lead into the — socket of the battery; plug the "H.T.+1" lead into a socket giving 72v. and "H.T.+2" into the socket giving the highest voltage available — 120 or 150 volts as the case may be.

The receiver is now completely connected up, and should be switched on by pulling out the knob of the on-off switch (marked "S₂" on the blueprint.)

Assuming that the fuse bulb does not light up, and that a slight sound is heard from the speaker when "V₃" is tapped lightly with the finger nail, the receiver may be taken as being in order, and the operation known as "ganging" may be carried out.

This is necessary in order to adjust the tuning circuits to such relations with each other that the most efficient performance is attained. The operations involved are not difficult; they should be proceeded with as described.

Set the wavechange switch to the "medium" position, push in the gram. switch "S₁" and turn the manual volume control to the "full on" position—fully clockwise. Then rotate the tuning control until the local station is heard. If this is situated at the lower end of the scale, so much the better, but if not, endeavour to tune in a station of known identity and wavelength on about 261 metres—usually several English transmissions are available here. If the receiver in its present condition will not pick up a station on or about this wavelength, return to your local, however, and carry out ganging on that.

At this stage, the A.V.C. system is put out of action, for the time being, by disconnecting the .0001 mfd. tubular condenser from terminal 65 on I.F. transformer "B." Do not disturb the other connection to this terminal and remove the "H.T.—" plug from the H.T. battery whilst the operation is being carried out. This is done in order that changes in intensity of the signal can be detected by ear, which otherwise they would not be.

Now adjust the trimmers "A, B, C and D" on the I.F. transformers, for maximum volume. This done, observe that the pointer on the tuning scale is indicating the correct wavelength for the station being received; if not, rotate the tuning control until it is, and bring the station in again at maximum strength by rotating the trimmer "G" on the gang condenser.

After this, leave trimmer "G" alone, and rotate trimmers "F" and "E" in turn until the maximum signal strength is obtained. The receiver is now ganged for the short wave band, but if the local has had to be used for ganging, owing to the fact that the initial sensitivity of the set was low, it is now worth while to tune in a low wavelength station (which of course the receiver will now get easily) and check and possibly improve ganging by carrying out the foregoing operations again. Choose a fairly weak station, or turn the volume control down until it is not coming through very strongly.

Having done this, tune in a station at the top of the waveband, and note that the receiver is still perfectly ganged, i.e. that slight re-adjustment of trimmers "E" and "F" does not now produce an improvement in signal strength. If this re-adjustment is required, it means that although the I.F. transformers are lined up perfectly, they are not adjusted to the correct intermediate frequency.

To correct this, the trimmers "A, B, C, D" will all have to be screwed in or out slightly, depending on circumstances, and

afterwards adjusted for maximum signal strength again by slight individual adjustments which will "align" the I.F. transformers at their new frequency. If the trimmers "E" and "F" have had to be screwed in at the top end of the waveband, the I.F. transformer trimmers will all have to be screwed out, and vice versa. Trimmers "E" and "F" should then be adjusted for maximum strength again, and ganging checked at the top and bottom as before. Ganging will now probably be found perfect, but if not, repeat the operations using different I.F. trimmer settings until no re-adjustment of "E" and "F" is required when changing from the top to the bottom of the waveband.

To the reader who thinks this a lot of trouble, we would say that it is not absolutely necessary to have the intermediate frequency correct, he can if he likes be satisfied with his first I.F. trimmer settings, and he will obtain good results. There is always the chance, however, that re-adjustment on these lines will produce a further increase in efficiency.

Having ganged the receiver correctly for the short waves, switch over to the long waves, and adjust the .001 mfd. preset condenser until maximum signal strength is obtained on a long wave station. During this process the main tuning control will have to be moved slightly, one way or the other, to keep the station in tune.

Having ganged the receiver correctly on both long and short waves, reconnect the .0001 mfd. tubular condenser to terminal 65 on the I.F. transformer. This puts the A.V.C. system into action so that the receiver is in full working order, and capable of a performance which will more than repay the constructor for his trouble in building it.

THE BATTERY "SUPER FOUR," List of Components.

Quantity	Description.	Cat. No.	Price
2	Telsen Solid Type 7-pin Valve-holders ..	W.337	3/-
2	" Solid Type 5-pin Valve-holders ..	W.225	1/4
1	" Set of Triple Superheterodyne Coils	W.476	30/-
2	" I.F. Transformers (New Type) ..	W.482	17/-
1	" G.S.4 Transformer	W.457	12/6
1	" Screened H.F. Choke	W.341	3/6
2	" 2 mfd. Self-Sealing Condensers ..	W.226	6/-
1	" 500,000 ohm Volume Control ..	W.481	5/6
2	" 2-point Push-Pull Switches ..	W.107	2/-
1	" .001 mfd. Preset Condenser ..	W.150	1/6
8	" Terminal Blocks	W.204	4/-
1	" Battery Type Fuseholder	W.146	6d.
6	" 0.1 mfd. Tubular Condenser ..	W.411	9/-
1	" 0.01 mfd. Tubular Condenser ..	W.410	1/3
2	" .001 mfd. Tubular Condenser ..	W.406	2/-
1	" .0002 mfd. Tubular Condenser ..	W.403	1/-
3	" .0001 mfd. Tubular Condensers ..	W.402	3/-
3	" 500,000 ohm Resistors	W.383	3/-
4	" 250,000 ohm Resistors	W.382	4/-
2	" 25,000 ohm Resistors	W.380	2/-
1	" 5,000 ohm Resistor	W.377	1/-
1	" 1,000 ohm Resistor	W.375	1/-
Sufficient	" Connecting Wire	W.441	
1	" British Radiophone " Superhet Triple Gang Condenser with rear tracking section for 110 k.c. complete with tuning dial etc.	693 (r) and 802	22/6 6/6
1	Fuse Bulb—see remarks in text.		
1	Battery Cord (9 wires)		
Sufficient	Screened Wire		
7	Wander plugs— H.T.+2; H.T.+1; H.T.—; G.B.+; G.B.—1; G.B.—2; G.B.—3.		
2	Spade terminals— L.T.+ (red); L.T.— (black).		
	Panel and baseboard as described		
	Sufficient woodscrews		

DISTORTION IN AMPLIFIERS

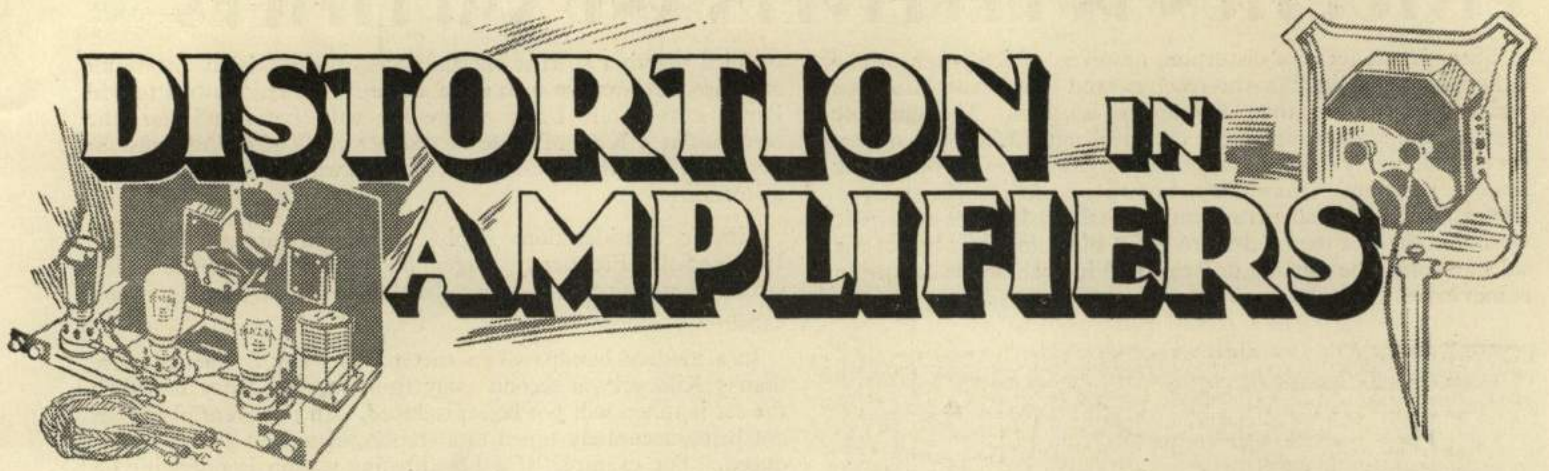

IN the broadcasting of speech and music, the transformations of energy are so numerous and so complex, in their passage from the studio to the microphone, the landlines, the transmitter, through the ether to the aerial of the receiver, and in the receiver itself until they are reproduced by the loudspeaker, that it is only by concentrated and long continued research that the magnificent performance of the modern receiver has been made possible.

distinguish between the various instruments of the orchestra. Figure 1 also shows the response curve of a correctly designed amplifier; it will be seen that the amplification is approximately the same over the whole of the frequency band from 50 to 6,000 cycles per second.

Secondly, the amplifier may add things to the reproduction which were not there originally: this phenomenon is due to the production of spurious notes, known as harmonics, the frequencies of which are whole multiples of the original notes. For example, the amplifier may be reproducing an organ pipe, which is playing a note corresponding to middle C on the piano, that is a frequency of 256 cycles a second: if the amplifier is introducing distortion by producing harmonics, then the output of the amplifier will contain notes of 256, 512, 1024, etc., cycles a second: the higher notes will be weaker than the fundamental note of 256 cycles, but their presence will render the reproduction harsh and displeasing.

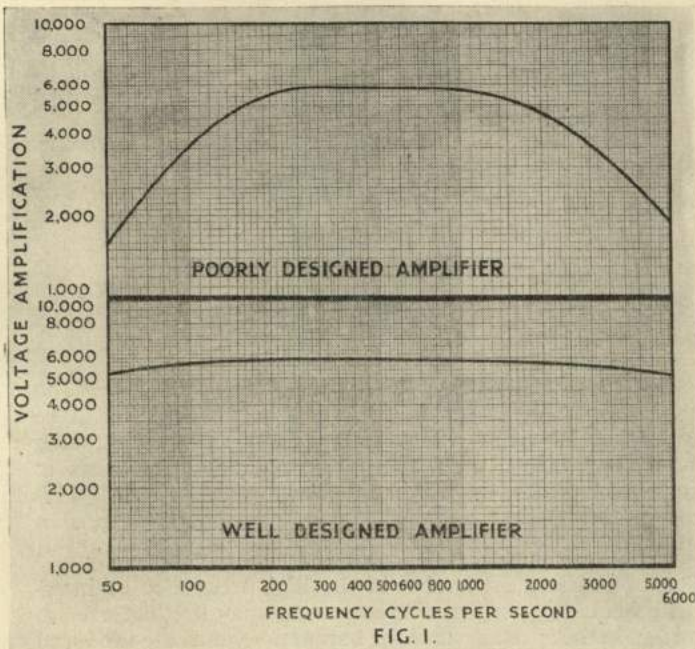

FIG. 1.

In this article some of the sources of distortion in receivers and amplifiers will be indicated, so that home constructors may receive guidance and obtain an idea of the principles involved in the construction and operation of distortionless receivers.

An amplifier may introduce distortion in two ways. Firstly, it may not reproduce the whole of the signal at the correct strength. Speech and musical sounds cover frequencies ranging from 50 cycles a second to 5,000 cycles a second, and the receiver must amplify the whole of this range to the same extent. In Figure 1 is shown a curve connecting frequency and amplification for a poor amplifier. It will be seen that the amplification of notes of 50 cycles a second is poor; the reproduction of such an amplifier would be lacking in bass. In addition the amplifier does not deal faithfully with notes of 5,000 cycles a second: the reproduction will thus be indistinct, and it will be difficult to

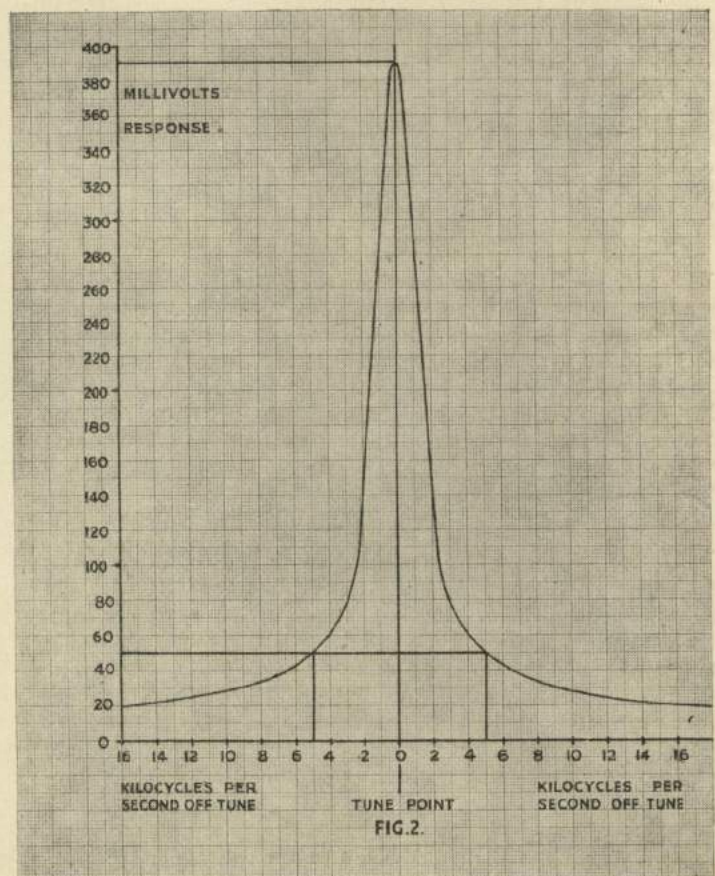
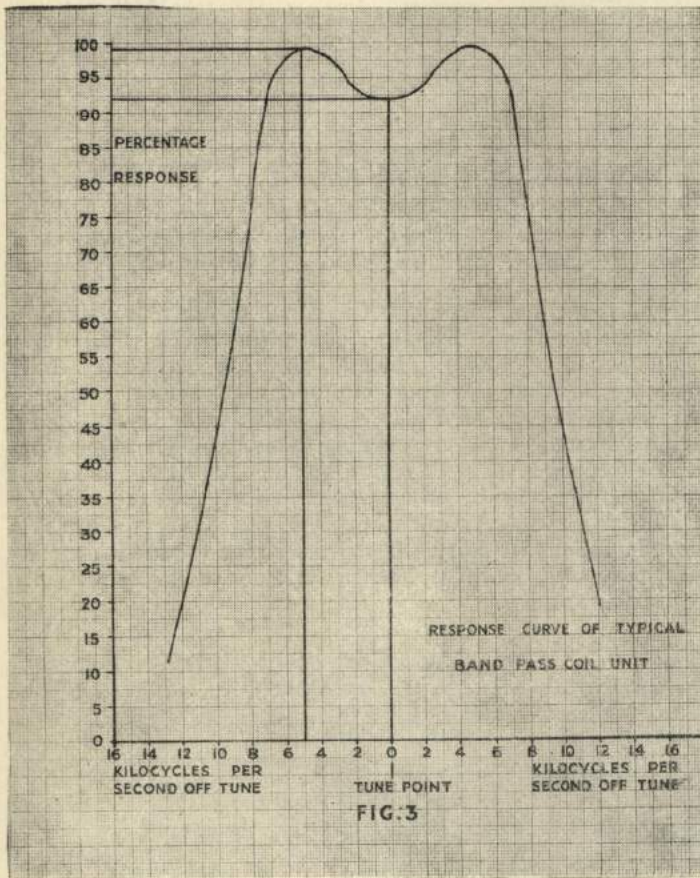

FIG. 2.

DISTORTION IN RECEIVERS AND AMPLIFIERS—cont.

There is one form of distortion, however, which is not due to either the transmitter or the receiver, and that is the distortion which occurs during the "fading" of a signal. At night time signals from stations operating on wavelengths below 600 metres vary considerably in strength, due to variations in the conducting layer in the upper atmosphere, known as the Heaviside layer. The variations in strength are counter-balanced by the automatic volume control of the modern receiver, but sometimes one of the sidebands may be missing or weak, and in such a case distortion is inevitable.



The tuning-circuits are the chief source of distortion in the high frequency amplifying portion of a receiver. The tuning circuits comprise an inductance and a condenser, the combination being resonant to one frequency, determined by the values of the coil and the condenser. The receiver is tuned by varying the value of the condenser, thus determining the frequency and therefore the station which the set will receive. A resonant circuit delivers a large voltage to the following valve when supplied with a signal at the frequency to which it is tuned, but only a small voltage if the signal is of a different frequency.

In Figure 2 is shown the resonance curve of a coil of 1.5 ohms resistance. It will be seen that at a frequency of 5 K.C. from that to which the coil is tuned the response is only 13 per cent. of the response at the tuning point. Four such stages would mean a response of 0.03 per cent. at 5 K.C. off tune. The sidebands corresponding to music at 5,000 cycles a second are thus much attenuated, with the result that musical notes of 5,000 cycles a second (just above the top note of the piano) are heard only weakly. The resultant reproduction would be low-pitched and indistinct.

This defect can be overcome by employing a bandpass filter. In this device, two circuits tuned to the same frequency are

coupled together so that one interacts on the other: the result is to produce a curve such as in Figure 3 which shows a typical Band Pass Coil Unit, where it will be seen that the response at 5 K.C. off tune is 109 per cent. of the response at tune, and even three or four such stages will produce no audible distortion.

Similar considerations apply to the circuits used in the Intermediate Frequency stages of a Superheterodyne: the circuits here tune even more sharply, and bandpass filters are essential to good quality.

In a modern bandpass superheterodyne, any frequency more than 5 Kilocycles a second away from the frequency to which the set is tuned will not be reproduced. In the event of the set not being accurately tuned to a station, distortion will be introduced. For example, if a broadcasting station is operating on 1,000 K.C. a second (300 metres) its carrier frequency will be 1,000 K.C., and the sidebands will be at frequencies 5 K.C. a second above and below this: if now the receiver is not quite accurately tuned to the station, but is tuned to say 1,001 K.C., it will receive frequencies from 996 K.C. to 1,001 K.C. and 1,001 K.C. to 1,006 K.C. But the sidebands of the transmitter corresponding to a musical note of 5,000 cycles a second will

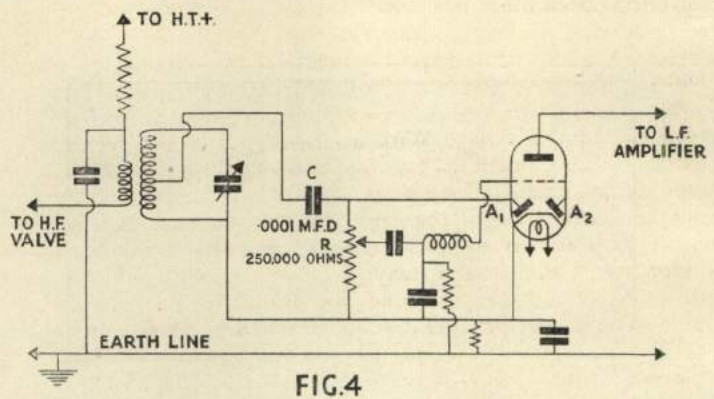

be as stated from 995 K.C. to 1,000 K.C. and 1,000 K.C. to 1,005 K.C. In other words, a portion of the signals will be missing, and distortion will result. To obviate this, a tuning indicator is fitted to the Telsen superheterodyne receivers to indicate when they are accurately tuned to a station. This feature greatly assists in reducing the distortion arising from mistuning.

The overloading of a valve in the high frequency or intermediate frequency portion of a receiver does not produce audible distortion in the speaker, since the harmonics which are produced are at high frequency and are filtered out by the tuned circuits, and so do not reach the detector. The overloading of a high frequency valve has the effect of reducing the selectivity however. "Cross-Modulation" occurs, so that an interfering station modulates the signal from the station it is desired to receive, and the succeeding tuned circuits can do nothing to eliminate this. It is essential therefore that high frequency valves be operated under the conditions specified by the manufacturers if the greatest selectivity is to be obtained: for the same reason, variable-mu pentodes are becoming popular, since they can handle a larger signal than the normal screen-grid valves.

The use of the modern diode detector enables distortionless detection to be obtained without great difficulty. The signal as received by the detector consists of a high frequency oscillation which varies in strength in accordance with the music or speech being received.

DISTORTION IN RECEIVERS AND AMPLIFIERS—cont.

Figure 4 shows the essential connections of a diode rectifier. Electrons from the cathode arrive at the diode anode A1 whenever it becomes positive, which occurs at every half-cycle of high frequency oscillation: these electrons charge up the condenser C, and return to the cathode via the resistance R. The voltage of the condenser C then varies in accordance with the signal being received and these variations are applied to the grid of the valve for amplification. For usual valves and circuits, the best value of R is 500,000 or 250,000 ohms, and the best value of C then becomes .0001 mfd. If C be made smaller, the efficiency of the rectifier is reduced, whilst if C be made much larger, it will bypass the higher audio frequencies, resulting in distortion. The same values and considerations apply in the choice of a grid condenser and leak for a leaky grid detector. In sets using a leaky grid detector where high sensitivity is essential, the more usual 0.0003 mfd. condenser and 2 Megohm leak may be employed in conjunction with an H or H.L. type valve: the intervalve transformer following such a valve will emphasise the higher audio-frequencies, thus tending to restore the balance of high and low notes.

A large input to the diode detector ensures negligible distortion. An extremely small input has the effect that the diode anode voltage is not a faithful copy of the variations in magnitude of the high frequency signals supplied to the valve: harmonics are produced, making the reproduction harsh and strident. The input to a detector should therefore be kept as large as possible. A leaky grid detector functions in addition as an amplifier. The low frequency signal which appears on the grid, exactly as though the valve was a diode, is amplified in the normal way by the valve. With a large input to the detector the anode voltage variations become correspondingly large, and if there is insufficient voltage on the valve, these variations cannot be exact copies of the grid voltage variations, and harmonics and distortion will be produced. For this reason there is a limit to the input that a leaky grid detector can handle, and care must be taken that it is possible fully to load the output valve without overloading the detector, i.e., use a high quality transformer of the G.S. type, or the D.R.3, and a sensitive output valve when using a leaky grid detector with 60 volts H.T.

Distortion in a low frequency amplifier or the low frequency portion of a receiver may be due to valve overloading or to incorrectly designed apparatus. The negative grid-bias on the valve must be greater than the peak value of the strongest signal to be handled, for should the signal swing the grid positive, current will flow in the grid circuit: this has the effect of reducing the grid voltage, resulting in the production of harmonics. Grid current occurs in all-mains valves when the grid is one volt negative, so that the grid bias of these types must be greater by one volt than the peak value of the strongest signal. (Class B valves operate with grid current flowing, but the driver valve and transformer are designed to deal with this and no distortion is produced.)

The minimum grid bias having been obtained, the anode voltage must be sufficiently high for the valve to function as an amplifier. Should the anode voltage be too low, anode bend rectification will occur, producing harmonics.

From the foregoing considerations it is evident that the valve must have sufficient grid bias to prevent grid current from flowing and sufficient anode voltage to function as an amplifier at this grid bias. The valve manufacturers publish tables showing the values of grid-bias necessary for the valve to amplify without distortion at various values of high tension supply, and if at any particular anode voltage the value of the grid bias they quote is larger than the peak value of the signal, then the valve will amplify without adding distortion to the output of the receiver.

This may be checked by examining the anode volts-anode current curves of the valve. A line corresponding in slope to the resistance in the anode circuit of the valve is drawn through the point of operation, corresponding to the values of high tension voltage and grid-bias in use. The maximum variations in grid-voltage must now cause equal anode voltage changes along the line of the resistance.

For instance, if it was decided in a high power amplifier to use a small power-valve resistance-coupled to the output valve, the line AOB would be drawn through the point O, which corresponds to the operating conditions of 150 volts H.T. and 9 volts grid bias (Figure 5) at a slope corresponding to a coupling resistance of 25,000 ohms.

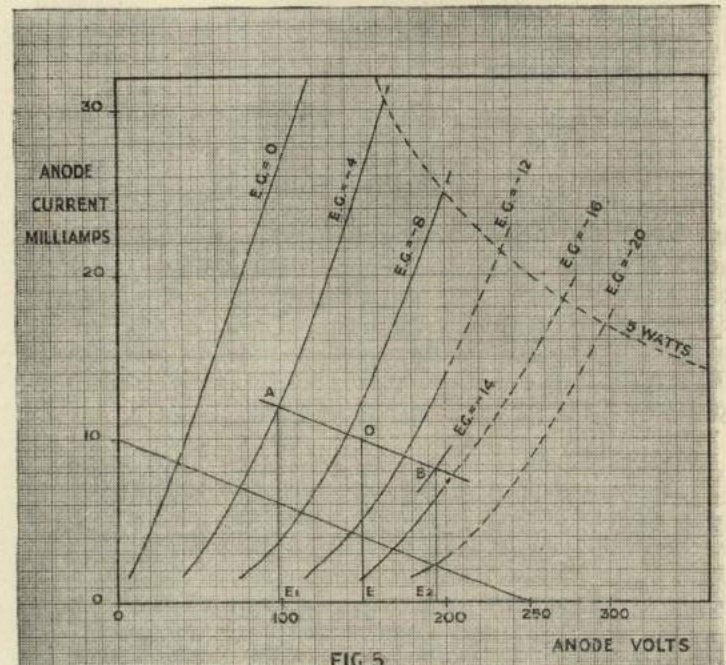

FIG 5

The slope of this line AOB may be found by drawing a line from 250 volts to 10 milliamperes, since 250 volts will pass 10 milliamperes through a 25,000 ohms resistance, and drawing AOB parallel to the line thus drawn. If now the signal on the grid of the valve has a peak value of 5 volts, the grid-voltage will vary from -4 to -14 volts, i.e., from A to B. The anode current will vary from E_1A to E_2B , and E_1A is nearly as much greater than EO as E_2B is less than EO . Little distortion will thus be introduced.

A badly designed low frequency transformer may produce distortion in many ways. If the inductance of the primary winding is low, then the amplification of bass notes will be poor, since the impedance of an inductance rises with frequency. In this connection, it is important that the magnetic circuit of the transformer be designed so that the primary winding can carry the anode current of the valve without the iron becoming magnetically saturated, otherwise the inductance of the transformer will be reduced: also there will be a production of third and higher harmonics. The iron losses should also be small.

The secondary winding of the transformer will of necessity have a great many turns and be relatively bulky, and it is therefore likely to have considerable self-capacity: this capacity will

DISTORTION IN RECEIVERS AND AMPLIFIERS *cont.*

seriously lower the amplification at the higher audio-frequencies, particularly if the transformer has a high ratio. The coupling between the primary and secondary should be as tight as possible: any leakage inductance between these two will resonate with the small capacities in the valve and the wiring, at a frequency of about four thousand cycles a second, giving greatly increased amplification at this frequency and producing the shrill piercing effect often encountered.

There is one class of transformer which is designed to operate without the passage of the direct anode current of the valve through the primary: indeed the transformer would be damaged if such a procedure were adopted. This class of transformer employs a special metal of high permeability for the core, resulting in high primary inductance and small physical dimensions, giving the advantages of low self-capacity and negligible leakage inductance. In addition the iron losses are extremely small. In this class of transformer are the Telsen D.R.3 and D.R.5 and the Telsen 10-1 Coupling Unit.

In a resistance coupled amplifier, the higher the resistance in the anode circuit of the valve, the greater is the amplification. There is a limit to the value that can be employed, however; firstly, the voltage on the anode of the valve is reduced owing to the voltage lost in the anode resistance; and secondly a high anode resistance necessitates a high value grid-leak. If high resistances are used, the small capacities to earth due to the wiring, valve legs, and valve input impedance, will cause a considerable reduction in the amplification of the higher audio frequencies, and in practice 100,000 ohms or 250,000 ohms is the greatest value employed in high quality apparatus.

In the operation of output valves, the preceding remarks on grid bias again apply. Since the object is to obtain power to operate the loudspeaker, the load in the anode circuit is adjusted to obtain the greatest output at the operating voltages in use. The optimum load is stated by the valve manufacturers, and an output transformer or tapped choke is employed to "match" the valve and the speaker: in other words, the transformer ratio is varied until the loudspeaker imposes the correct load on the output valve. The output valve produces distortion in the form of harmonics, and it has been agreed that the power output figures of a valve shall not include more than 5 per cent. of whichever harmonic is the stronger (second harmonic for triodes and third harmonic for pentodes and Class B valves). Should the output transformer have an incorrect ratio, then the output valve will be unable to deliver its rated power without causing considerable distortion. In the case of a triode valve, too high an output transformer ratio will also result in an increase of bass notes and a loss of high notes, and vice versa for too low a ratio.

The output transformer must possess sufficient inductance to present a high impedance at all frequencies down to 50 cycles a second, and must have very low leakage inductance. Since the transformer is a stepdown model, self-capacity of the secondary winding can be kept low. A most important requirement of output transformers is that the resistance of the windings must be as low as possible: in the primary, to avoid loss of high tension voltage to the output valve, and in the secondary to avoid serious loss of power in the speaker.

¹ Pentode and Class B valves require very careful matching of the speaker load, and it is found necessary to include an impedance limiting device in the loudspeaker circuit. The loudspeaker has a certain amount of inductance, and since the impedance of an inductance increases as the frequency rises, the load in the anode

circuit of the pentode is continually changing. To overcome this, the impedance limiting device consisting of a resistance of 20,000 ohms in series with a condenser of 0.005 mfd. is connected from the anode of the pentode to the filament. The impedance of the condenser decreases as the frequency rises, and the result is a constant load on the anode of the pentode. If this limiting device is omitted, the reproduction becomes very shrill. In Class B valves, a condenser of .01 mfd. may be connected to the two anodes.

It is not sufficient to avoid distortion in the component parts of an amplifier: the amplifier must be considered as a whole. In general, there is one impedance common to the whole amplifier, and that is the high tension supply. The low tension accumulator is also a common impedance in a battery receiver: it is of a very low value, however, and becomes troublesome only in commercial short wave receivers. The presence of the common impedance in the high tension supply (the internal resistance of the H.T. battery, or the common smoothing choke in all-mains receivers) results in a signal in the anode circuit of the last valve being communicated to the anode circuit of the preceding valve, and thence to the grid of the last valve; the result is self-oscillation of the last valve at a frequency decided by the coupling apparatus and smoothing choke: this is usually 20 cycles a second or less, and gives rise to the familiar popping noise known as "motor-boating." This can be prevented by "decoupling" the receiver, which consists essentially in connecting a resistance of the order of 20,000 ohms in the anode supply to each valve except the output stage, and connecting a condenser from the valve side of the resistance to the cathode of the valve, of a value of 2 mfd. or more. This effectively stops these oscillations. For H.F. stages, values of 600 ohms and 0.01 mfd. are sufficient, but it is important that the condenser be of the non-inductive type, such as the Telsen W232. Where grid bias for an all-mains valve is obtained by the insertion of a resistance in the cathode lead, the resistance must be shunted by a large condenser, of a minimum value of 4 mfd.: if this condenser be too small, the anti-reaction effect between the anode and grid circuits due to the grid bias resistance will greatly attenuate bass notes.

The moving-coil free-edged cone loudspeaker is to-day almost universal, and if suitably designed can be almost free from distortion. The cone must be suspended so that it moves freely and does not oscillate at a frequency higher than about 20 cycles a second, or bass notes will be over-accentuated, and speech will have the booming effect often encountered: at the same time the coil must not touch the polepieces of the magnet or buzzing will occur. Bass notes will be attenuated if the board to which the speaker is attached has an area less than 2' 6" by 2' 6", for sound waves from the back of the cone will have time to arrive at the front of the speaker around the edges of the baffleboard and cancel out the sound from the front of the speaker. These dimensions of 2' 6" square can be reduced if the speaker is placed in a box or cabinet as occurs in a receiver: the box must then be sufficiently rigid to avoid vibrating at a frequency of about 150 cycles a second, which it will do if it is not very carefully designed. This vibration has the effect of over-emphasising the reproduction of notes at that frequency, with consequent distortion. The cabinets of Telsen receivers are specially designed to avoid this. Should the cone of the speaker not be treated to render it impervious to atmospheric changes, the reproduction will vary from day to day. Any loose turns of wire in the coil will give rise to unpleasant buzzings. The speakers used in Telsen receivers are chosen to be free from these defects.

MORE Practical HINTS and TIPS



TELSEN connecting wire, sold under the list number W.441, is particularly recommended for wiring any type of radio receiver, where it is desired to make a really neat job. It is just sufficiently rigid to be self-supporting, without being difficult to bend and to form into loops, whilst its bright green insulating covering gives the wiring an extremely neat appearance. The usual type of radio constructor's pliers, having side cutters and a round nose, and obtainable for as little as 6d., will cut and bend the wire easily.

The covering is of such a nature that it does not pucker or crack when sharp bends are made, and although it may at first sight appear difficult to strip off, it is actually very easy, if the correct procedure is adopted.

The section of the wire from which it is desired to strip the insulation is simply squeezed tightly in a pair of pliers, exerting the maximum pressure by placing the wire well inside the jaws of the pliers.

Under these circumstances the covering will be found to be crushed and to have come away from the wire, just where the pliers have squeezed it. The insulation is then simply picked off with the fingers—it will come away cleanly and easily without leaving shreds or frayed ends, but no more and no less can be removed than has been squeezed in the pliers, and if it is desired to remove a further section, the operation should be repeated.

In other words, just as much of the insulation can be removed as desired, either at the ends of a section of wire, or at any point along its length, if it is desired to make a looped connection as described below.

MAKING LOOPED CONNECTIONS

Most radio components nowadays are made with screw terminals, so that a good connection can be made to them without the use of solder. With the needs of the home constructor always borne in mind, all Telsen components are fitted with adequate terminals for this purpose, in addition to being provided with solder tags, for those who prefer to solder.

Provided that a few simple precautions are observed, quite an efficient and reliable job can be made of wiring without solder.

Once it is decided to make looped connections, it is a good plan to take off the terminal heads at the outset, and to remove the solder tags which are gripped under them. When it is not desired to use them, these solder tags are best removed, as they have a habit of swinging round and producing unexpected short circuits if no connection is made to them.

The terminal heads may be left off, if the constructor so desires, and replaced as and when required. It is impossible to make a mistake in replacing them; there are only two sizes—and the wrong size definitely won't fit.

Now regarding the making of the loops for slipping over the terminal stems. First strip the wire for a distance of about

half an inch, in the manner described under the preceding heading, and using the round nosed pliers recommended, bend the bare portion into a complete circle which slips easily over the terminal stem, but is not so big that the "waist" of the terminal head or nut slips into it and spreads it outwards, when the head is screwed down. In other words, make the wire loop a close fit on the screwed stem of the terminal or otherwise a very unreliable connection may result.

In connection with this point, it is interesting to note that many constructors fall into the mistake of putting the loop on the terminal stem *the wrong way round*. The right and wrong way of doing this are shown in the accompanying figure. It will be seen that when the loop is fitted correctly, the tightening of the terminal head tends to wind up the loop so that it tightens up around the terminal stem, and grips it more closely.



Fig. 1

On the other hand, when fitted incorrectly, the tightening of the terminal head unwinds the wire loop so that it spreads outwards, and slips over the waist of the terminal head, and produces a connection which may fail at any moment.

This may seem quite a small detail, but attention to it may spare the constructor many unexpected breakdowns and mysterious crackling noises.

In cases where it is desired to make more than two connections to a terminal, it may be an advantage to make a loop in a wire as shown in Fig. 2.

This will avoid the necessity of putting more than two loops on one terminal, which in some cases will present difficulty owing to the fact that the terminal head cannot be started on the screwed stem.

With a loop made as in Fig. 2, however, one wire makes two connections, two wires four connections, and an undue number of loops on the terminal stem is saved.

HOW TO PREPARE BATTERY CORDS

When connecting the batteries to a receiver, undoubtedly the best result is achieved by the use of a multi-way cord where the wires, plaited or woven together, are distinctively coloured to identify the same wire at each end of the cord. This results in a very neat appearance.

PRACTICAL HINTS AND TIPS—continued

Where Telsen 8-way battery cord is used, it is convenient to adopt the following code, though this is of course by no means essential.

For H.T.—	use White.
„ H.T.+1	„ Maroon.
„ H.T.+2	„ Blue.
„ G.B.+	„ Red-White speckled.
„ G.B.—1	„ Yellow.
„ G.B.—2	„ Green.
„ L.T.+	„ Red.
„ L.T.—	„ Black.

Any wires not required are simply folded back at each end and bound up out of the way.

When fitting the wires to the various terminals on the receiver at one end, and when fitting to it the various plugs at the other, the following methods will preserve a neat appearance, and prevent any frayed ends from showing.

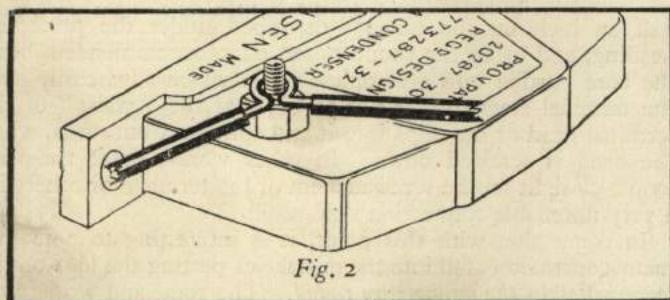

Fig. 2

First of all procure a small quantity of systoflex of a size which will just enable it to be slipped over the braided coverings of the various wires in the cord, and proceed as follows:—

Push back the braiding on the cord for about a quarter of an inch and cut off the wire to the same length, then slide the braiding forward again over the wire, moisten it and screw it to a point between finger and thumb, after which a short length of systoflex can be threaded easily over the braiding and pushed forward to the connecting loop or to the wander plug when fitted.

To fit a wander plug the braiding at the end of the wire is pushed back and the wire is bared and bent into a loop which is gripped between the screwed head and the insulating collar on the wander plug. After this, the short length of systoflex, previously fitted as described, is pushed forward up to the wander plug, so that it covers the end of the braiding.

The L.T.+ and L.T.— leads are fitted with spade tags. The type of tag recommended has a U shaped shank, fitted with teeth that can be bent right over. It is fitted as follows:—

Slip a short length of systoflex over the wire, as before, then bare the end of the wire for about $1\frac{1}{2}$ " and double it back on itself so as to form a thick wire giving a good grip for the shank of the spade tag. After the wire end is placed in the shank of the tag, close the teeth over, one by one, either with a pair of pliers or by hammering, so that the wire is gripped tightly. After that push the systoflex sleeve forward over the shank of the tag, so that the frayed end of the braiding is obscured.

It will be found necessary to untwist the component wires in the cord for about 18" or so at each end, in order to run them to the various points involved.

At the ends going to the batteries it is worth while to adopt a "grouping" scheme, whereby the three cords running to the H.T. battery are retwisted into a single cord, and those running to the G.B. and L.T. are treated similarly, so that the cords form three "groups". To prevent them untwisting bind the ends of the groups with cotton.

Where ordinary flex of one colour has to be used for battery connections, a somewhat different procedure will have to be adopted. The ends are finished off exactly as above, and the plugs and spades fitted as described. In this case, however, the various battery leads should be fitted separately and should be

fitted with their identifying plugs and spades, after they are fitted to the set, but before they are twisted or plaited together, otherwise it will be impossible to trace them through. Cut them a little longer than actually required—the twisting or plaiting process will shorten them somewhat.

If the wander plugs are not of the type having engraved heads, the leads should be identified by means of little tags (battery lead labels, as they are called) which are fastened on to the various leads near the plugs.

HOW TO MAKE SCREENED LEADS

The preparation of screened leads, such as are used in the Telsen "Super 4" in one or two positions, whilst not really difficult, calls for a certain amount of care, if a satisfactory job is to be made.

It is fairly easy, of course, to purchase screened wire from your dealer—this is readily available, but having cut from it the required lengths, the ends of the leads should be finished off carefully, if the braided metal covering is not to work forward and touch the wire which it shields. Screened wire should be purchased which has a single wire running through its centre; it is available with two conductors within its shielding—this is not required.

Having cut off a section to the required length, push back the metal braiding for about $1\frac{1}{2}$ " and strip the insulation off the wire for about 1". Then, holding the end of the braiding carefully in position, bind it tightly with cotton or thread, overlapping the braiding for about $\frac{1}{2}$ ", and continuing right over the $\frac{1}{2}$ " of insulation, to the bare portion of the wire. Put on several layers of wrapping and tie up the thread carefully. This will definitely prevent the braiding from slipping forward and contacting with the "live" wire at the end of the lead, which is bent into a loop for connection to the appropriate terminal.

The metal covering must, of course, be earthed, otherwise the screening is absolutely ineffective. Hence, a wire should be wrapped tightly around the metal braiding at some point or other along its length and connected to earth.

Those who can solder are recommended to solder this joint.

COUPLING CONDENSERS FOR BAND PASS FILTERS

A very efficient form of band pass filter, and one which can be constructed with ordinary matched screened coils i.e., without special windings, is that employing what is known as "top end" coupling.

A filter like this is employed in the "Super 4" described elsewhere in this issue.

Now this condenser is of extremely small capacity—of much smaller capacity than the smallest fixed condenser commercially available.

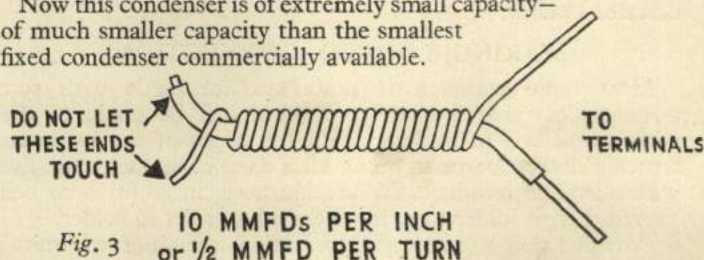

Fig. 3

A good average value, suitable in most cases is 10 micro-microfarads or .00001 mfd. As a condenser of this size cannot be bought, it has to be made. This, however, is not half so difficult as it sounds.

The easiest way to make it is to take a length of Telsen connecting wire, W.441, and to wrap round it with adjacent turns touching, some W.441 connecting wire which has been stripped, continuing the wrapping for about 1" along the insulated wire. Although the wire used for wrapping is bare, take care to preserve the insulation of the wire on which it is wrapped. The surplus length of the two wires is not cut off—it is used for connecting the "condenser" in circuit. The appearance of the finished article is illustrated in Fig. 3.

HOW TO BUILD A HIGH QUALITY AMPLIFIER

—continued

It was this requirement which led to the use of a "Class B" output stage. In a battery receiver economy of H.T. current is of the first importance. On the other hand it is impossible to obtain a large undistorted output with a triode valve unless a prohibitive amount of current is taken. The solution of this dilemma lay in the use of a Class B valve, since it is possible by this means to obtain a large undistorted power output while still maintaining strict economy of H.T. current. In this way three very desirable features were introduced. Firstly, the amount of harmonic distortion is below 5 per cent., this being less than can be detected by ear. Secondly, the power output is approximately three watts (provided the correct H.T. voltage is supplied). Thirdly, the total consumption of H.T. current is remarkably low, being of the order of 5 milliamps. under "quiescent" conditions.

Reference to the circuit diagram will show that a 500,000 ohms potentiometer is used as an input volume control. Due to its high total resistance this component throws only a negligible load across the input circuit, and consequently does not impair the flexibility of the amplifier. It is logarithmically wound and because of this the graduation in volume is more uniform than with a linear potentiometer.

Following the volume control is the Mazda H.L.2 valve. The theoretical magnification of this valve is 31 and since the signal at this stage is very small it is quite permissible to use such a high-slope valve, notwithstanding its comparatively small signal handling capacity.

The famous Telsen D.R.3 transformer follows the H.L.2

A view of the Telsen "Class B" Quality Amplifier completely built and ready for use.

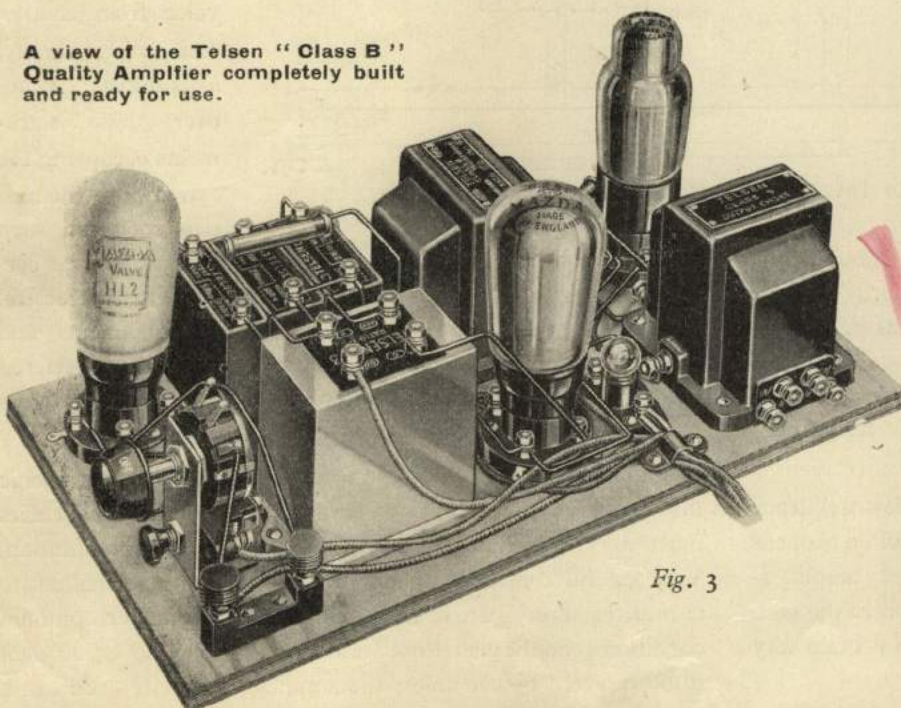
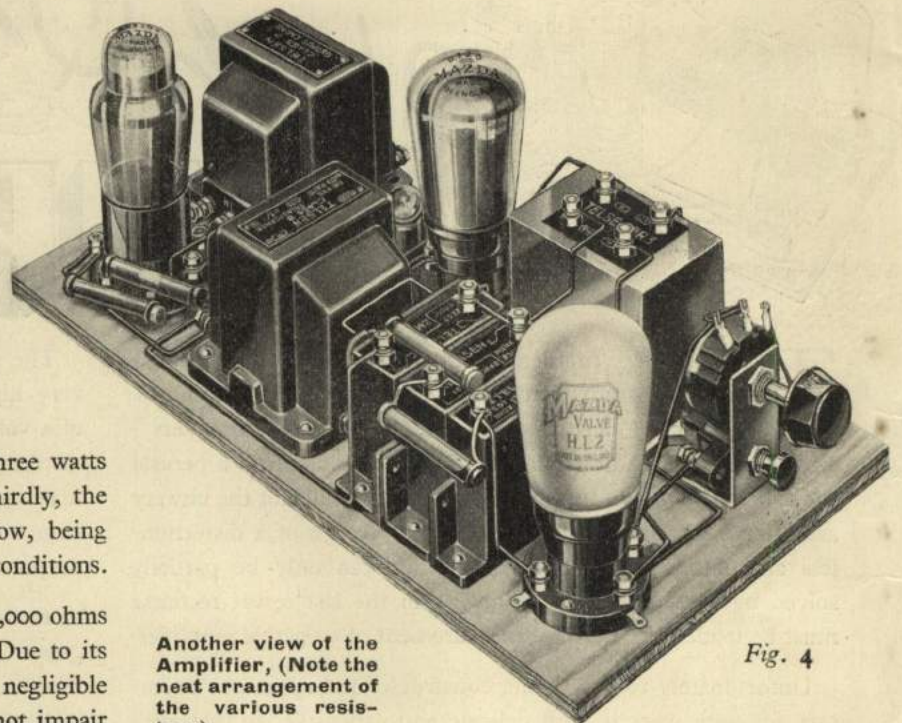

Fig. 3



Another view of the Amplifier, (Note the neat arrangement of the various resistors)

Fig. 4

valve, the reasons for this choice being as follows. A high magnification valve invariably has a high impedance. Now the amplification of the stage depends on this valve impedance and also on the impedance of the coupling component with which the valve operates. If the impedance of the coupling component is large compared with that of the valve, the actual magnification given by the stage will be nearly equal to the theoretical amplification of the valve. If, on the other hand, the impedance of the coupling component is low compared with the impedance of the valve, only a small fraction of the theoretical amplification will be realised. It follows, then, that the impedance of the coupling unit should be large compared with that of the valve. Now the impedance of a transformer depends upon two things, its primary inductance and the frequency of the signal. When the inductance is high the impedance is also high over a wide band of frequencies. On the other hand the impedance of a transformer having a small primary inductance falls to such a value at low frequencies that it is small compared with that of the valve, and the magnification of the stage suffers in consequence. In such a case it will be noted that the amplification is not the same at all frequencies and the balance of tone is completely upset. This is, of course, a far more serious matter than a slight loss of amplification over the whole frequency band, as in the latter case the balance of tone is not affected.

WIRING INSTRUCTIONS FOR THE TELSEN HIGH QUALITY AMPLIFIER—continued

Now the primary inductance of the Telsen D.R.3 transformer is 150 henries, and this is so high that the amplification of the stage is uniform from 25 to 6,000 cycles per second. At the same time, the transformer itself provides an additional magnification of 3 : 1.

The signal applied to the second valve is thus a very much magnified but wonderfully faithful replica of the original.

The second valve V2 is a Mazda P.220. This is chosen to supply the power required to operate the Class B output valve.

In discussing the remainder of the circuit it is best to consider it as a whole rather than as a chain of discrete components. In the design of the amplifier this has been done and the frequency response of the driver and output stage is remarkably level. It is in this portion of the amplifier, however, that amplitude distortion is most likely to be introduced and to avoid this several interesting problems have been solved. As is well known the Driver Valve of a Class B output stage must supply a certain amount of power to the grids of the Class B output valve. This is because these grids are allowed to become positive with respect to the filament so that grid-current flows and power is absorbed in the grid-filament circuit in just the same way as it would be absorbed in any other resistance. The P.220 is a small type of power valve and is admirably suited to this work. However, the driver transformer, through which the power flows, acts in a different manner from other intervalve transformers. With a Class A output stage of course the grid of the valve is never given a positive potential since grid current would flow and set up a voltage drop in the transformer, with the result that the voltage waveform would be flattened at the peaks and amplitude distortion would result. With the Class B system such distortion is reduced to a negligible value by special design of the Driver Transformer. The secondary winding is of very low resistance, and the two halves of the secondary are balanced both as regards resistance and inductance values. In addition the step-down ratio is of the correct value to match the load to the impedance of the Driver Valve and in consequence this valve is functioning under optimum conditions. Two resistances are connected across the two halves of the Driver Transformer secondary to prevent parasitic oscillation, as this would give rise to distortion and a high H.T. consumption.

The Class B valve is an improved type which operates with a negative bias and has a larger power output than the earlier Class B valves. A Class B choke is used in the anode circuit, and this provides correct matching to any type of high-resistance moving coil speaker. A moving iron speaker does not give such good results as a moving coil speaker, but may be used if a fairly large condenser (e.g., 0.02 mfd.) is connected across its input terminals to prevent too rapid a rise in its impedance.

A Free full size 1s. blueprint of the Telsen High Quality Amplifier is included in this issue of the *Radiomag*.

BUILDING THE TELSER HIGH QUALITY AMPLIFIER

The dimensions of the baseboard for building this amplifier are 12" x 6½". A piece of wood, preferably five or seven ply wood, should be cut to this size and stained if desired.

Now place the blueprint over the baseboard so that the corners exactly register and secure the print with drawing pins or tacks. Pierce through the fixing holes in the print with a sharp instrument, such as a bradawl, so as to locate the positions of these holes in the baseboard. The holes should be sufficiently deep to provide a start for the screws as this prevents the latter from lifting up the top layers of wood.

The volume control and switch may, if desired, be mounted apart from the baseboard, in which case they would be wired with flex. In the photographs these components have been shown mounted on a small bracket attached to the baseboard. Take great care when mounting the valveholders, transformers and choke that the terminals are the right way round as shown by the blueprint. It should be noted that in the print the volume control is viewed from the back, i.e., with the spindle pointing away from the observer. The size of the hole to be drilled for the switch is $\frac{5}{16}$ " and that for the volume control is $\frac{3}{8}$ ".

Wiring.

Although soldered connections are best they are not essential, and excellent results are obtained with properly looped wires firmly screwed down under the terminal heads. Telsen connecting wire is recommended, but before commencing wiring the constructor should read the instructions given under "Practical Hints and Tips."

The wiring is best carried out in the order detailed below, reference being made to the numbered terminals on the blueprint. The valveholders in the print have been numbered V1, V2 and V3, and the 2 mfd. condensers A and B to distinguish them from one another, although no such lettering will actually be found on the components.

A number of actual photographs of the amplifier are included to illustrate its construction.

Wiring Instructions

Connect :

- 1 on switch to 2 on V1.
- 2 on V1 to 3 on V2.
- 3 on V2 to 4 on V3.
- (Note that the numbers on the print are not the same as those stamped on the valve-holder, and wiring should follow the numbers on the print only.)
- 5 on V1 to 6 on V2.
- 6 on V2 to 7 on V3.
- 7 on V3 to 8 on driver transformer.
- 8 on driver transformer to 9 on 2 mfd. condenser "A."
- 9 on 2 mfd. condenser "A" to 10 on 2 mfd. condenser "B."
- 10 on 2 mfd. condenser "B" to 11 on D.R.3 transformer.
- 12 on terminal block to 13 on potentiometer.
- 14 on terminal block to 15 on potentiometer.
- 16 on potentiometer to 17 on V1.
- 18 on V1 to 19 on 0.5 mfd. condenser.
- 20 on 0.5 mfd. condenser to 21 on D.R.3 transformer.
- 22 on D.R.3 transformer to 23 on V2.
- 24 on V2 to 25 on driver transformer.
- 26 on driver transformer to 27 on 2 mfd. condenser "A."
- 27 on 2 mfd. condenser "A" to 28 on output choke.
- 29 on driver transformer to 30 on V3.
- 31 on driver transformer to 32 on V3.
- 33 on V3 to 34 on output choke.
- 35 on V3 to 36 on output choke.
- 37 on fuse holder to 38 on output choke
- 38 on output choke to 8 on driver transformer.
- Connect a 25,000 ohm resistor between 27 on 2 mfd. condenser "A" and 39 on 2 mfd. condenser "B."
- Connect a 25,000 ohm resistor between 39 on 2 mfd. condenser "B" and 19 on 0.5 mfd. condenser.
- Connect a 10,000 ohm resistor between 40 on driver transformer and 30 on V3.
- Connect a 10,000 ohm resistor between 40 on driver transformer and 32 on V3.

WIRING INSTRUCTIONS FOR THE TELSEN HIGH QUALITY AMPLIFIER—continued

Now connect the battery cord as follows :

- L.T.— to 6 on V2.
- L.T.+ to 41 on switch.
- H.T.— to 42 on fuse holder.
- G.B.+ to 42 on fuseholder.
- G.B.—1 to 12 on terminal block.
- G.B.—2 to 43 on D.R.3 transformer.
- G.B.—3 to 40 on driver transformer.
- H.T.+ to 27 on 2 mfd. condenser "A."

This completes the wiring.

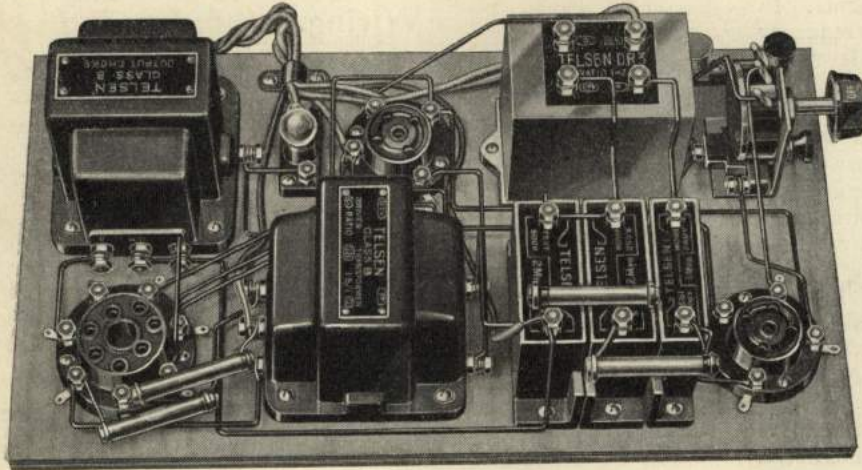

Plan View, showing the connections.

Operating Instructions

With the optimum speaker load the maximum undistorted power output of the Class B stage depends upon the H.T. voltage and "quiescent" current. With 150 volts H.T. the quiescent current should not be less than 1.2 mA.; with 120 volts H.T. it should not be less than 0.9 mA., while with only 80 volts H.T. it may be allowed to fall to 0.75 mA. The maximum undistorted output falls with a reduction of H.T. voltage, changing from about 3 watts at 150 volts with 2.3 mA. quiescent current to lower values as the H.T. voltage is reduced.

Those constructors who possess a voltmeter will be able to measure their H.T. voltage, and in that case the maximum value of grid bias for G.B.—3 is given below. It will be remembered that increased bias means decreased drain on the H.T. battery together with a reduction of fidelity, and conversely a reduction of bias usually means better reproduction but the H.T. battery is run down more rapidly.

H.T. voltage	"G.B.—3" voltage
150 to 130	—6
130 to 100	—4½
100 to 75	—3

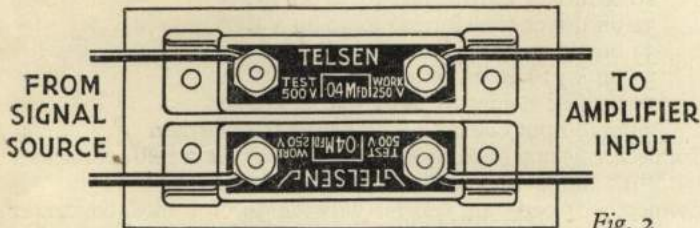

ISOLATING UNIT

It must be remembered that the input must never be earthed as otherwise the bias tapping G.B.—1 will be short-circuited. This means that the valve in V1 will be damaged and the bias on the other valves will be reduced to an incorrect value.

In most pickups the windings are completely isolated from the frame so that they may be connected to the amplifier input while the pickup frame is earthed. In other models, however, the windings are connected to the frame, and in such cases the pickup must be isolated from the amplifier by means of the isolating unit shown in Fig. 2. This is simply two Telsen 0.04 mfd. condensers W.230 mounted for convenience on a small wooden base. The arrangement and connections are clearly shown in the figure. When using a pickup a resistance should be connected across its leads of the value specified by the makers.

The wander plugs are connected up to the battery as follows :

- H.T.+ to the highest +ve H.T. tapping.
- H.T.— to the —ve tapping on the H.T. battery.
- L.T.+ to the + (red) terminal on the L.T. accumulator.
- L.T.— to the — (black) terminal on the L.T. accumulator.
- G.B.+ to the + tapping on the grid bias battery.
- G.B.—1 to the —1½ tapping on the grid bias battery.
- G.B.—2 to the —4½ tapping on the grid bias battery.
- G.B.—3 to the tapping suitable for the H.T. voltage, as previously described.

The loudspeaker impedance should be matched to the output valve by means of the Class B choke. The method of doing this is described in the leaflet supplied with this component.

BATTERIES

The use of a super capacity battery is recommended as such batteries have been shown to give best results on systems which take a fluctuating H.T. current. The standard capacity, however, may be used where first cost is a consideration.

The following "Ediswan" types are suitable :

Standard Capacity. 120 volt, No. 69719 or 150 volt No. 69707.

Super Capacity. 120 volt, No. 69728 or 150 volt, No. 69729.

Grid Bias Battery. 9 volt, No. 69807.

Low Tension Accumulator. E.L.7, No. 69086.

TELSEN HIGH QUALITY 3 VALVE AMPLIFIER.

List of Components.

Quantity	Description	Cat. No.	Price
2	Telsen 4-pin Solid Valve-holders ..	W.224	1/-
1	7-pin Solid Valve-holder ..	W.337	1/6
1	Class B Output Choke ..	W.345	10/6
1	Class B Driver Transformer 1.5 : 1 ..	W.359	10/6
1	D.R.3 Transformer ..	W.448	8/6
2	2 mfd. Condensers ..	W.226	6/-
1	0.5 mfd. Condenser ..	W.228	2/3
1	500,000 ohm Volume Control ..	W.481	5/6
1	2-point Push-Pull Switch ..	W.107	1/-
1	Terminal Block ..	W.204	6d.
1	Battery Type Fuseholder ..	W.146	6d.
2	10,000 ohm Resistors ..	W.378	2/-
2	25,000 ohm Resistors ..	W.380	2/-
1	100 milliamp Fuse Bulb ..	W.318	6d.
Sufficient	Connecting Wire ..	W.441	

- ✓ Battery Cord (8 wires)
 - ✓ 6 Wander Plugs : H.T. +; H.T. —; G.B. +; G.B.—1; G.B.—2; G.B.—3...
 - ✓ 2 Spade Terminals L.T. +; L.T.—
- Also Baseboard as described, and sufficient woodscrews.

Valves as follows :— 5-6 7-0
 V1—Mazda H.L.2 : V2—Mazda P220 : V3—Mazda PD220A.
 14-0



What do you expect from your

RADIO RECEIVER

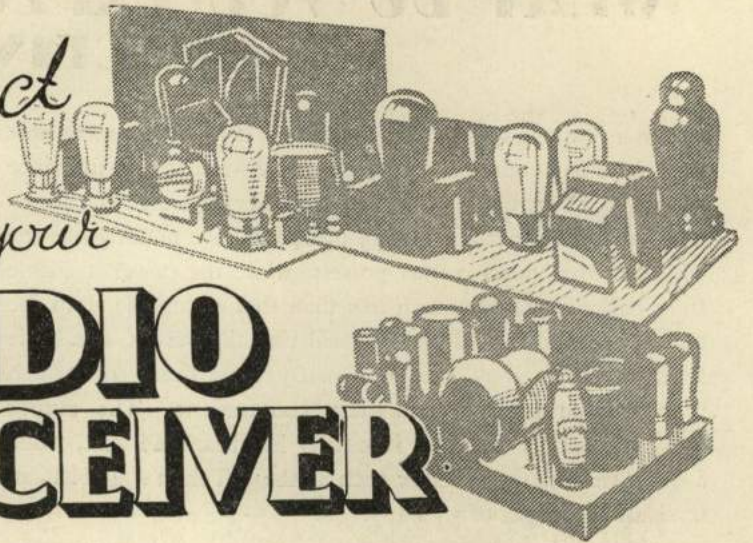

THE performance of a radio receiver varies with the conditions under which it is used. This fact, coupled with the multiplicity of circuit arrangements and valve types now available has created considerable confusion in the mind of non-technical listeners as to what may be expected from any particular type of receiver. An examination of the Theoretical circuit of a receiver will, if interpreted correctly, provide the information required. It is therefore the purpose of this article briefly to outline the various types of circuits employed in commercial receivers, indicating the kind of performance which can be expected.

A receiver can be considered as being divided into three sections, the H.F. Amplifier, the Detector and the L.F. Amplifier, and it is important to note the function of each of these sections. The H.F. Amplifier determines the range of the set, i.e., the number of distant stations that it will receive. Simple sets designed for purely local reception omit this section. The Detector is an essential part of every radio receiver as it converts the radio frequency signals into audible signals. The L.F. Amplifier brings the audible signals up to loudspeaker strength.

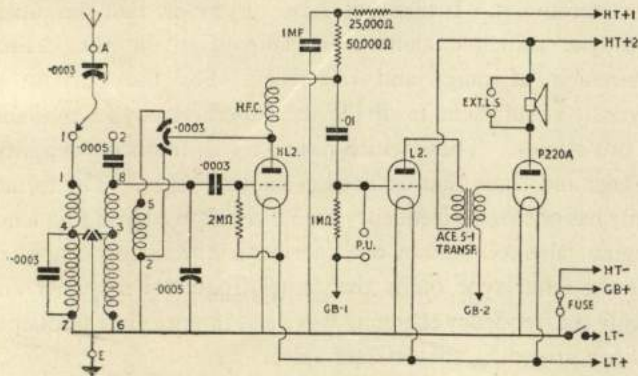

Fig. 1

3- AND 4-VALVE SETS

The simple type of receiver usually employs three valves which are coupled together either as a Detector followed by two Low Frequency stages or as one H.F. Amplifier, Detector and one L.F. Amplifier. The Detector and two L.F. Receiver (Fig. 1) is intended for the reception of local stations. It is, of course, possible to receive some high power Continental stations with such sets when they are used in a favourable district in conjunction with a high unscreened outdoor aerial.

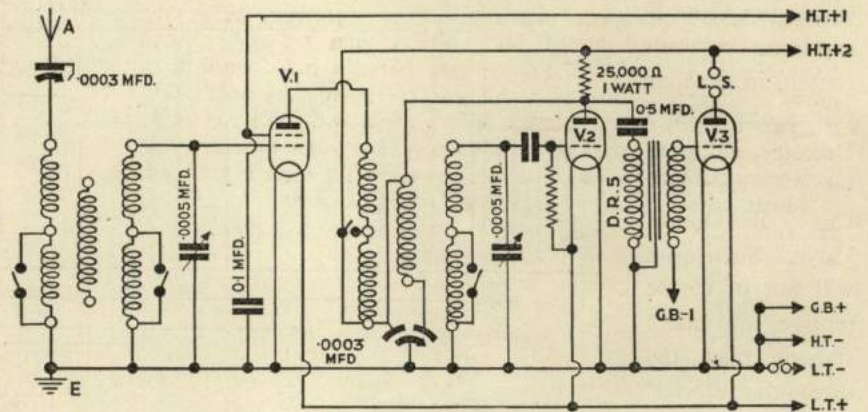

Fig. 2

Such reception is, however, unreliable and unselective and it cannot be said to possess more than a novelty value. The alternative combination of H.F. Detector and one L.F. is deservedly the most popular circuit arrangement, as it provides the best all-round performance of any low priced receiver (Fig. 2).

The H.F. Amplifier ensures some measure of selectivity and adds sufficiently to the range of the receiver to make the reception of some of the high power Continental stations reliable. Where it is impossible to use an outdoor aerial an H.F. Amplifying stage is essential for good reception unless the receiver is used

WHAT DO YOU EXPECT FROM YOUR RADIO RECEIVER—continued

within a few miles of the local station. It is important to note that there is a considerable difference between the performance of mains operated receivers and battery operated receivers. The valves designed for battery operation have nothing like the efficiency that mains valves possess, while the power available from batteries is very much less than that obtainable from the electric light mains. It can be said that the output obtainable from mains receivers is approximately three times that which is obtainable from their battery counterparts. The output of simple battery receivers is usually less than one watt, while a three valve mains receiver such as the "Telsen 474" has an undistorted output of $3\frac{1}{2}$ watts.

The quality of the reproduction depends to a considerable extent upon the power available, and it can be said that in general the quality of battery receivers is inferior to that obtainable with mains receivers. Recently a system of amplification known as Class "B" has been used with a view to providing greater output and better quality with the power available from batteries. This system necessitates the employment of two Low Frequency stages, i.e., the Driver Valve and the Class B Output Valve (see Fig. 3). This system provides an output of about 1,200 m.w. and gives very good quality reproduction without imposing a heavy drain on the batteries. It will therefore be seen that the battery counterpart of the "Telsen 474" receiver when employing Class B amplification will contain in all, four valves, one H.F., a Detector, followed by a Driver and Class B Output Valve. Such a set will not of course receive any more stations than the three valve receiver, employing one H.F. stage, as it is the H.F. Amplifier that determines the range or sensitivity of the set.

A radio receiver is first and foremost a musical instrument, and its primary requirement is high quality reproduction. This fact is often overlooked as is shown by the demand for low priced but highly selective receivers. Except in the case of expensive apparatus the quality is sacrificed to the attainment of range and selectivity, i.e., the ability to receive a large number of stations and to separate them adequately. The reception of a large number of distant stations is only possible if the receiver is highly selective as the stations are so closely crowded together. The degree of selectivity required is such that owing to sideband cutting poor quality results unless compara-

tively expensive apparatus and circuit arrangements are employed. It will therefore be seen that from the economical as well as the musical view point the less selective receiver such as the "Telsen 474" represents a very worth while investment.

The selectivity of such a set is sufficient to ensure the reception of a number of foreign stations without sacrificing quality.

MULTI-VALVE RECEIVERS

Receivers capable of the reception of many Continental programmes must have more than one H.F. stage. Most of the multi-valve receivers at present on the market come into this class, the added valve being used to increase the range of the receiver and to improve its selectivity.

There are a number, and it is to be hoped that it is an increasing number, of receivers employing several valves in the low frequency stages. These receivers are known as high fidelity receivers as their function is to give as near to perfect reproduction as it is possible to obtain in the present state of knowledge. The valves are used in what are known as push-pull circuits. It should also be noted that in many multi-valve receivers a different type of detector valve is employed to that used in the simple receivers. This is known as a diode. It is less sensitive than the detector used in the simple receiver, but as its characteristic is linear, it performs the function of detection without introducing any distortion.

Long range reception under present day conditions is only possible with a receiver employing some type of superheterodyne

circuit, consequently most long range commercial receivers are superheterodynes. It does not, however, follow that the superheterodyne principle alone is capable of giving the desired combination of range and selectivity. For the purpose of analysis it is sufficient to divide the superheterodynes available into two classes. Those which have a signal frequency amplifying stage and those that do not have such a stage. The former usually has one signal frequency amplifier followed by a frequency changing valve followed by one intermediate frequency amplifier, while the latter type omits the signal frequency amplifier and has only the frequency changing valve and intermediate frequency amplifier preceding the detector valve.

The superheterodyne type of receiver exhibits a much higher degree of selectivity than that possessed by the ordinary straight

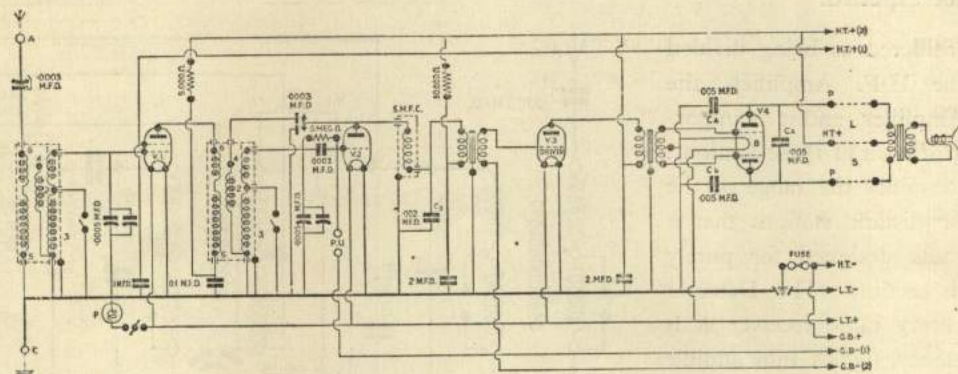

Fig. 3

WHAT DO YOU EXPECT FROM YOUR RADIO RECEIVER—continued

circuit, while the sensitivity is comparable with a receiver employing two or more high frequency stages. Unfortunately, however, as stated above, the frequency changing principle alone is inadequate for modern requirements. This is due to the peculiar effect produced by the proximity of the local stations, and to the fact that such a large number of powerful stations are crowded together in a comparatively small wave band.

Such conditions give rise to what is known as image frequency and second channel interference. This takes the form of whistles produced as the receiver is tuned. Many commercial superheterodynes, although apparently possessing great selectivity cannot receive more than fifty per cent. of the possible number of stations due to this form of interference. The solution lies in the securing of an extremely high degree of selectivity in the pre-selector circuits, that is in the circuits prior to the frequency changing valve. In some cases band pass pre-selector circuits with image suppressors are used, but at the best they are only a compromise. The most satisfactory form of superheterodyne is that which employs a signal frequency amplifying stage. In effect such a receiver will have the equivalent of three high frequency stages. This can be said to represent the irreducible minimum that will ensure the reception of all worth while foreign programmes free from interference. Such a circuit is incorporated in the "Telsen 3435" Superheterodyne.

It is well known that the reception of distant stations is often marred by the phenomenon of fading. At one moment the station will be coming in at full loudspeaker strength while at the next it will have faded to inaudibility. Compensation for this fading is obtained by the provision of what is known as automatic volume control. In most cases an extra valve is used for this purpose. In some cases two and even three valves are used. A further complication arises from the fact that these extra valves are often incorporated in the same bulb as those valves which perform the function of detection or low frequency amplification. Therefore when examining a circuit diagram of the more complicated receivers, such valves should be ignored, as they do not contribute anything to the range or power of the set.

The function of the valves provided for automatic volume control is to generate a voltage which is applied to the high frequency amplifying valve. When a powerful signal is received and applied to the A.V.C. valve it generates a high voltage which is sent back to the H.F. valve. This high voltage has the effect of cutting down the amplification of the H.F. valves. If only a weak signal is received the A.V.C. valve does not generate very much voltage, consequently very little pressure is sent back the H.F. valves, and their amplification is accordingly not cut down. It will therefore be seen that the sensitivity of the receiver is thereby made to adjust itself according to the strength of the received signal,

with the result that signals that may be fading badly are made to give a constant or level output.

In the case of "Telsen 3435" receiver only one valve is employed for the purpose of generating A.V.C. This is a diode valve and it is incorporated in the same bulb as the diode which is used as the detector. It will be evident that if a receiver has a number of H.F. valves less voltage will be required to control them, than would be in the case of a receiver containing a smaller number of H.F. amplifiers. As the Telsen receiver has the equivalent of three H.F. valves only one A.V.C. valve is necessary. As explained above some receivers employ more than one valve for the purposes of Automatic Volume Control. The system then employed is known as Amplified Automatic Volume Control. In such cases the voltage produced by the A.V.C. valve is first amplified before it is applied to the H.F. valve.

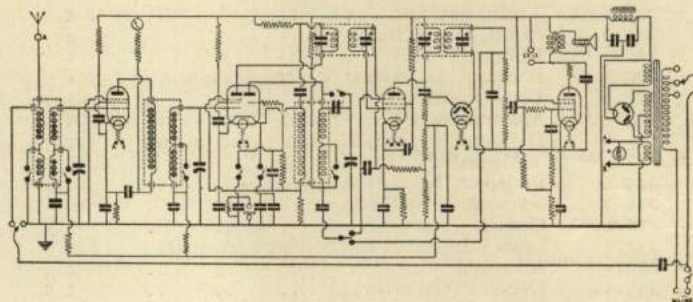

Fig. 4.

A typical circuit diagram of a receiver similar to the "Telsen 3435" Superheterodyne is given in Fig. 4. Such a receiver will give reliable reception of all worth while Continental programmes. The extra diode for A.V.C. will be noted.

The power output of a set is usually given by the manufacturers, and it will be noted that this depends quite as much upon the type of low frequency valve employed, as upon the number of low frequency valves used. This arises from the fact that many receivers use a pentode valve in the output stage. The type of pentode such as used in the Telsen receivers described gives an output of over three watts, which is as much as is obtainable with two ordinary triode valves.

To sum up, in order to estimate the performance of a receiver, it is essential that the circuit diagram be examined with a view to ascertaining the function of each valve, and the type of valve employed. The number of glass bulbs which may appear in the receiver is not necessarily an indication of the number of valves in the receiver, as more than one valve may be contained in the one glass envelope. For high quality reception use a receiver employing a straight circuit. For long range reception use a highly selective receiver of the superheterodyne type.

Medium and Long wave STATIONS of EUROPE

Metres.	Station.	kW.	Metres.	Station.	kW.
201.1	Nimes (France)	0.2	309.9	Grenoble (France)	20
203.5	Plymouth	0.3	312.8	Poste Parisien (France)	100
203.5	Bournemouth	1	315.8	Breslau (Germany)	60
204.7	Pecs (Hungary)	1.25	318.8	Göteborg (Sweden)	10
206	Fecamp (Radio Normandie)	10	318.8	Algiers (Algeria)	12
208.6	Minsk (U.S.S.R.)	100	321.9	Brussels, No. 2	15
209.9	Beziers (France)	2	325.4	Brno (Czechoslovakia)	32
209.9	Radio, LL (Paris)	0.8	328.6	Radio Toulouse (France)	60
209.6	Newcastle	1	331.9	Hamburg (Germany)	100
211.3	Tampere (Finland)	1.2	335.2	Helsinki (Finland)	10
215.4	Lyons (Radio Lyon) (France)	5	335.2	Limoges, PTT (France)	0.5
216.8	Warsaw, No. 2 (Poland)	2	338.6	Graz (Austria)	7
219.8	Turin, No. 2	1	342.1	London Regional	50
221.2	Milan, No. 2 (Italy)	4	345.6	Poznan (Poland)	16
222.6	Dublin	1	349.2	Strasbourg (France)	15
222.6	Bordeaux Sud-Ouest (France)	1	352.9	Valencia (Spain)	1.5
222.6	Lodz (Poland)	1.7	352.9	Bergen (Norway)	1
224	Montpellier, PTT (France)	5	356.7	Berlin Funkstunde	100
225.6	Hanover, Bremen, Flensburg, Stettin and Magdeburg.	1.5	360.6	Moscow, No. 4 (U.S.S.R.)	100
227.1	Budapest, No. 2 (Hungary)	0.8	364.5	Bucharest (Roumania)	12
228.7	Swedish Relay Stations	0.25	368.6	Milan (Italy)	50
230.2	Danzig	0.5	373.1	Scottish Regional	50
231.8	Linz, Klagenfurt and Salzburg (Austria)	0.5	377.4	Lwow (Poland)	16
233.5	Aberdeen	1	377.4	Barcelona, EAJI (Spain)	5
233.5	Dresden (Germany)	1.5	382.2	Leipzig (Germany)	120
235.1	Bodö, Stavanger and Kristiansand (Norway)	0.5	386.6	Toulouse, PTT (France)	2
236.8	Nürnberg and Augsburg (Germany)	2	391.1	Midland Regional	25
238.5	San Sebastian (Spain)	3	395.8	Katowice (Poland)	12
238.5	Rome, No. 3 (Italy)	1	400.5	Marseilles, PTT (France)	5
240.2	Juan-les-Pins (France)	2	405.4	Munich (Germany)	100
241.9	Cork (Irish Free State)	1	410.4	Seville (Spain)	1.5
243.7	Gleiwitz (Germany)	5	410.4	Tallinn (Estonia)	20
245.5	Trieste (Italy)	10	415.5	Kiev (U.S.S.R.)	100
247.3	Lille, PTT (France)	5	420.8	Rome, No. 1	50
249.2	Prague, No. 2 (Czechoslovakia)	5	426.1	Stockholm (Sweden)	55
251	Frankfurt (Germany)	17	431.7	Paris PTT (France)	7
255.1	Copenhagen (Denmark)	10	437.3	Belgrade (Yugoslavia)	2.5
257.1	Monte Ceneri (Switzerland)	15	443.1	Sottens (Switzerland)	25
259.1	Moravska-Ostrava (Czechoslovakia)	11.2	449.1	North Regional	50
261.1	West National	50	455.9	Cologne (Germany)	60
261.1	London National	50	463	Lyons, PTT (France)	15
263.2	Turin, No. 1 (Italy)	7	470.2	Prague, No. 1 (Czechoslovakia)	120
265.3	Hörby (Sweden)	10	476.9	Trondheim (Norway)	1.2
267.4	Nyiregyhaza (Hungary)	6.2	476.9	Lisbon (Portugal)	20
267.4	Belfast	1	483.9	Brussels, No. 1	15
269.5	Kosice (Czechoslovakia)	2.6	492.6	Florence (Italy)	20
271.7	Naples (Italy)	1.5	499.2	Sundsvall (Sweden)	10
274	Madrid, No. 2 (EAJ7)	1.3	499.2	Radio Maroc (Morocco)	6.5
276.2	Falun (Sweden)	2	506.8	Vienna (Bisamberg) (Austria)	120
276.2	Zagreb (Yugoslavia)	0.7	514.6	Agen (France)	0.6
278.6	Bordeaux-Lafayette	12	514.6	Riga (Latvia)	15
283.3	Bari (Italy)	20	522.6	Mühlacker (Stuttgart)	100
285.7	Scottish National	50	531	Palermo (Italy)	4
288.5	Leningrad (U.S.S.R.)	10	531	Athlone (Irish Free State)	60
291	Paredo (Portugal)	5	539.6	Beromunster (Switzerland)	60
291	Königsberg (Germany)	60	549.5	Budapest, No. 1 (Hungary)	120
293.5	Barcelona	3	559.7	Wilno (Poland)	16
296.2	North National	50	559.7	Bolzano (Italy)	1
298.8	Bratislava (Czechoslovakia)	13.5	569.3	Viipuri (Finland)	13
301.5	Hilversum (Holland)	20	569.3	Ljubljana (Yugoslavia)	5
304.3	Genoa (Italy)	10	578	Innsbruck (Austria)	0.5
304.3	Cracow (Poland)	2	578	Hamar (Norway)	0.7
307.1	West Regional	50	688	Oufa (U.S.S.R.)	10
			696	Oulu (Finland)	2
			726	Voroneje (Sweden)	10

SHORT WAVE

Broadcasting Stations
of the

WORLD



Metres	Call Sign.	Station
12.30	VE9GW	Bowmanville, Ont. (Canada)
13.92	W8XK	East Pittsburg
13.97	GSH	Daventry
16.86	GSG	Daventry
16.87	W9XF	Downers Grove, Ill. (U.S.A.)
16.87	W9XAA	Chicago, Ill. (U.S.A.)
16.87	W3XAL	Bound Brook, N.J.
16.88	PHI	Eindhoven (Holland)
16.89	DJE	Zeesen (Germany)
19.57	W2XAD	South Schenectady, N.Y. (U.S.A.)
19.64	W2XE	Wayne, N.J. (U.S.A.)
19.68	FYA	Pontoise (France)
19.72	W8XK	East Pittsburg, Pa. (U.S.A.)
19.73	DJB	Zeesen (Germany)
19.81	GSH	Daventry
19.84	HVJ	Vatican State, Rome
23.38	CNR	Rabat (Morocco)
25.0	RNE	Moscow
25.20	FYA	Pontoise (France)
25.27	W8XK	East Pittsburg, Pa. (U.S.A.)
25.28	GSE	Daventry
25.36	W9XAA	Chicago, Ill. (U.S.A.)
25.36	W2XE	Wayne, N.J. (U.S.A.)
25.4	2RO	Prato Smeraldo, Rome
25.45	W1XAL	Boston, Mass. (U.S.A.)
25.5	DJD	Zeesen (Germany)
25.53	GSD	Daventry
25.57	PHI	Eindhoven (Holland)
25.6	VE9JR	Winnipeg (Canada)
25.63	FYA	Pontoise (France)
26.83	CT3AQ	Funchal (Madeira)
28.98	LSX	Buenos Aires (Argentina)
30.0	EAQ	Aranjuez (Spain)
31.0	T14NRH	Heredia (Costa Rica)
31.25	CT1AA	Lisbon (Portugal)
31.27	HBL	Radio Nations Prangins (Switzerland)
31.28	VK2ME	Sydney (Australia)
31.28	W3XAU	Philadelphia, Pa. (U.S.A.)
31.29	GSC	Daventry
31.35	W1XAZ	East Springfield, Mass. (U.S.A.)
31.38	DJA	Zeesen (Germany)
31.48	W2XAF	Schenectady, N.Y. (U.S.A.)

Metres.	Call Sign.	Station
31.51	OXY	Skamlebaek (Denmark)
31.54	GSB	Daventry
31.55	VK3ME	Melbourne (Australia)
31.58	PRBA	Rio de Janeiro (Brazil)
33.50	TGX	Guatemala City (S. America)
37.04	HCJB	Quito (Ecuador)
37.33	CNR	Rabat (Morocco)
38.47	HBP	Radio Nations Prangins (Switzerland)
40.3	HBQ	Radio Nations Prangins (Switzerland)
41.7	VSIAB	Singapore (Malay States)
42.92	LCL	Jelby (Norway)
43.0	EAR110	Madrid
43.75	—	Radio Vitus, Paris
45.0	TGW	Guatemala City (Central America)
45.0	FM8KR	Constantine (Algeria)
45.38	RW72	Moscow
46.69	W3XL	Bound Brook, N.J. (U.S.A.)
47.0	HC1DR	Quito, Ecuador
47.97	HJ3ABF	Bogota (Colombia)
48.0	CN8MC	Casablanca (Morocco)
48.86	W8XK	East Pittsburg, Pa. (U.S.A.)
49.0	ZTJ	Johannesburg (S. Africa)
49.02	W2XE	Wayne, N.J. (U.S.A.)
49.1	VUC	Calcutta, India
49.18	W9XF	Downers Grove, Ill. (U.S.A.)
49.18	W3XAL	Bound Brook, N.Y.
49.22	VE9GW	Bowmanville, Ont. (Canada)
49.34	W9XAA	Chicago, Ill. (U.S.A.)
49.43	VE9CS	Vancouver, B.C. (Canada)
49.5	W8XAL	Mason, Ohio (U.S.A.)
49.5	VQ7LO	Nairobi (Kenya Colony)
49.5	W3XAU	Philadelphia, Pa. (U.S.A.)
49.58	GSA	Daventry
49.67	W4XB	Miami Beach, Florida (U.S.A.)
49.67	W1XAL	Boston, Mass. (U.S.A.)
49.83	DJC	Zeesen (Germany)
50.0	EAR25	Barcelona, Radio Club (Spain)
50.0	RW59	Moscow
50.26	HVJ	Vatican State, Rome
58.31	OK1MPT	Prague (Czechoslovakia)
62.56	VE9BY	London, Ont. (Canada)

MEDIUM AND LONG WAVE STATIONS—continued

Metres	Station	kW
726	Boden (Sweden)	0.6
748	Moscow, No. 3 (U.S.S.R.)	100
748	Geneva (Switzerland)	1.3
800	Sverdlovsk	50
824	Smolensk (U.S.S.R.)	10
845	Rostov-on-Don (U.S.S.R.)	20
1107	Moscow, No. 2 (U.S.S.R.)	100
1145	Madona (Latvia)	20
1154	Oslo (Norway)	60
1224	Leningrad (U.S.S.R.)	100
1261	Kalundborg (Denmark)	75
1304	Luxembourg	150
1339	Warsaw, No. 1 (Poland)	120
1389	Motala (Sweden)	30

Metres	Station	kW
1395	Eiffel Tower (Paris)	13
1442	Reykjavik (Iceland)	16
1442	Minsk (U.S.S.R.)	100
1500	Ankara (Turkey)	7
1500	Daventry National	30
1571	Königswusterhausen	60
1621	Istanbul (Turkey)	5
1648	Radio Paris (France)	75
1724	Moscow, No. 1 (U.S.S.R.)	500
1807	Lahti (Finland)	40
1875	Huizen (Holland)	50
1875	Brasov (Roumania)	20
1935	Kaunas (Lithuania)	7

TELSEN RADIO COMPONENTS

A Complete List, giving Catalogue Nos., Descriptions and Prices.

Cat. No.	Description	Price	Cat. No.	Description	Price	Cat. No.	Description	Price	Cat. No.	Description	Price
CHOKES											
W. 74	Binocular H.F. Choke ...	4/6	W. 340	All-Wave Screened Binocular H.F. Choke ...	5/6	W. 454	Standard H.F. Choke ...	2/6	W. 341	Standard Screened H.F. Choke ...	3/6
W. 342	Short Wave Screened H.F. Choke ...	3/6	W. 469	40 hy. L.F. Choke ...	5/6	W. 470	100 hy. L.F. Choke ...	5/6	W. 464	Output Choke ...	7/6
W. 478	Push-Pull Output Choke ...	12/6	W. 475	Q.P.P. Output Choke ...	12/6	W. 463	"Class B" Output Choke ...	10/6	W. 465	Tapped Pentode Output Choke ...	7/6
W. 466	Power Pentode Output Choke ...	10/6	W. 467	28 hy. Smoothing Choke ...	12/6	W. 468	18 hy. Smoothing Choke ...	12/6			
COILS											
W. 76	Dual Range Aerial Coil ...	7/6	W. 154	H.F. Transformer Coil ...	5/6	W. 216	Single Screened Coil ...	7/-	W. 287	Twin Matched Screened Coils ...	14/6
W. 288	Triple Matched Screened Coils ...	21/6	Screened Iron Cored Coils with Switching								
W. 478	Twin Coil Unit ...	19/6	W. 477	Triple Coil Unit ...	30/-	W. 476	Triple Iron Cored Superhet. Coils ...	30/-	W. 482	Intermediate Frequency Transformer Coil ...	8/6
W. 349	Single Iron Cored Screened Coil ...	8/6	W. 422	Twin Matched Iron Cored Screened Coils ...	19/6	W. 423	Triple Matched Iron Cored Screened Coils ...	30/-	W. 217	Coil Switch Coupling Assembly ...	6d.
W. 218	Coil Switch Knob Assembly ...	1/-	W. 479	Short Wave Coil ...	7/-						
TUNING CONDENSERS											
Air Dielectric											
W. 130	.00025 mfd. ...	2/6	W. 131	.00035 mfd. ...	3/6	W. 132	.0005 mfd. ...	3/6	W. 339	Single Condenser Unit ...	8/6
W. 427	Twin Ganged ...	16/6	W. 428	Triple Ganged ...	22/6						
TUNING CONDENSERS											
Bakelite Dielectric											
W. 194	.0003 mfd. ...	2/6	W. 193	.0005 mfd. ...	2/6						
AERIAL SERIES CONDENSER											
W. 350	Aerial Series .0003 with Switch ...	2/6									
REACTION CONDENSERS											
W. 356	.0001 mfd. ...	2/6	W. 355	.00015 mfd. ...	2/6	W. 354	.0003 mfd. ...	2/6	W. 358	.0005 mfd. ...	2/6
W. 357	.00075 mfd. ...	2/6									
DIFFERENTIAL CONDENSERS											
W. 353	.0001 mfd. ...	2/6	W. 352	.00015 mfd. ...	2/6	W. 351	.0003 mfd. ...	2/6			
PRE-SET CONDENSERS											
W. 446	.00005 mfd. ...	1/6	W. 152	.0001 mfd. ...	1/6	W. 151	.0003 mfd. ...	1/6	W. 150	.001 mfd. ...	1/6
W. 149	.002 mfd. ...	1/6									
FIXED MICA CONDENSERS											
W. 442	.00005 mfd. ...	1/-	W. 240	.0001 mfd. ...	1/-	W. 241	.0002 mfd. ...	1/-	W. 242	.0003 mfd. ...	1/-
W. 243	.0004 mfd. ...	1/-	W. 244	.0005 mfd. ...	1/-	W. 245	.001 mfd. ...	1/3	W. 246	.002 mfd. ...	1/6
W. 247	.006 mfd. ...	1/6	W. 310	.01 mfd. ...	2/6	W. 311	.02 mfd. ...	3/6	W. 316	.05 mfd. ...	4/6
PAPER CONDENSERS											
500 volt Test											
W. 232	.01 mfd. ...	1/6	W. 230	.04 mfd. ...	1/9	W. 231	.1 mfd. ...	1/9	W. 229	.25 mfd. ...	2/-
W. 228	.5 mfd. ...	2/3	W. 227	1 mfd. ...	2/3	W. 226	2 mfd. ...	3/-			
SMALL TUBULAR CONDENSERS											
W. 402	.0001 mfd. ...	1/-	W. 403	.0002 mfd. ...	1/-	W. 404	.0003 mfd. ...	1/-	W. 405	.0005 mfd. ...	1/-
W. 406	.001 mfd. ...	1/-	W. 407	.002 mfd. ...	1/-	W. 408	.005 mfd. ...	1/-	W. 409	.006 mfd. ...	1/-
W. 410	.01 mfd. ...	1/3	W. 411	.1 mfd. ...	1/6						
COUPLING UNITS											
W. 214	1:1 ...	7/6	W. 215	10:1 ...	12/6	W. 285	R.C. ...	4/-			
DIALS											
W. 141	Slow Motion, Black ...	1/6	W. 184	Illuminated Disc Drive ...	2/6	W. 257	Small Friction Disc Drive ...	2/-	W. 313	"313" Disc Drive ...	3/6
FUSES											
Mains Type											
W. 318	100 mA. Fuse Bulb ...	6d.	W. 199	.5 amp. ...	6d.	W. 200	1 amp. ...	6d.	W. 201	2 amp. ...	6d.
W. 202	3 amp. ...	6d.									
FUSE HOLDERS											
W. 146	Battery Type ...	6d.	W. 203	Power Type ...	6d.						
GRID LEAKS											
W. 248	.25 amp. ...	1/-	W. 249	.5 amp. ...	1/-	W. 250	1 amp. ...	1/-	W. 251	2 amp. ...	1/-
W. 252	3 amp. ...	1/-	W. 253	4 amp. ...	1/-	W. 254	5 amp. ...	1/-			
GRID LEAK HOLDER											
W. 148	6d.									
TERMINALS, Etc.											
W. 204	Terminal Block ...	6d.	W. 441	Connecting Wire ...	3d.						
RESISTANCES (FIXED)											
Spaghetti Type											
W. 109	300 ohms ...	6d.	W. 110	600 " ...	6d.	W. 111	750 " ...	6d.	W. 112	1,000 " ...	6d.
W. 113	1,500 " ...	9d.	W. 114	2,000 " ...	9d.	W. 115	3,000 " ...	9d.	W. 116	4,000 " ...	9d.
W. 117	5,000 " ...	9d.	W. 118	10,000 " ...	1/-	W. 119	15,000 " ...	1/-	W. 120	20,000 " ...	1/-
W. 121	25,000 " ...	1/-	W. 122	30,000 " ...	1/-	W. 123	50,000 " ...	1/6	W. 124	60,000 " ...	1/6
W. 125	80,000 " ...	1/6	W. 126	100,000 " ...	1/6						
RESISTORS											
1 watt Type											
W. 373	250 ohms ...	1/-	W. 374	500 " ...	1/-	W. 375	1,000 " ...	1/-	W. 376	1,250 " ...	1/-
W. 377	5,000 " ...	1/-	W. 378	10,000 " ...	1/-	W. 379	20,000 " ...	1/-	W. 380	25,000 " ...	1/-
W. 420	50,000 " ...	1/-	W. 381	100,000 " ...	1/-	W. 382	250,000 " ...	1/-	W. 383	500,000 " ...	1/-
SWITCHES											
W. 107	2-pt. Push Pull ...	1/-	W. 108	3-pt. Push Pull ...	1/3	W. 153	4-pt. Push Pull ...	1/3	W. 297	Mains Type ...	1/9
TRANSFORMERS (INTERVALVE)											
W. 455	1:3 "Ace" ...	5/6	W. 456	1:5 "Ace" ...	5/6						
G.S. TRANSFORMERS											
W. 457	G.S.4 L.F. Transformer ...	12/6									
D.R. TRANSFORMERS											
W. 448	D.R.3 (Ratio 1:3) ...	8/6	W. 449	D.R.5 (Ratio 1:5) ...	8/6						
"Class B"											
W. 460	Driver 1:1 ...	10/6	W. 461	Driver 1.5:1 ...	10/6						
OUTPUT TRANSFORMERS											
W. 462	"Class B" Output Transformer ...	10/6	W. 471	Push Pull Output Transformer ...	12/6	W. 474	Q.P.P. Output Transformer ...	12/6	W. 458	1:1 Output Transformer ...	10/6
W. 459	Multi Ratio Output Transformer ...	10/6									
INPUT TRANSFORMERS											
W. 472	Push-Pull Input Transformer ...	12/6	W. 473	Q.P.P. Input Transformer ...	12/6						
VALVE HOLDERS											
W. 224	4-pin Solid Type ...	6d.	W. 225	5-pin Solid Type ...	8d.	W. 337	7-pin Solid Type ...	1/6	W. 222	4-pin Anti-microphonic ...	8d.
W. 223	5-pin Anti-microphonic ...	10d.	W. 338	7-pin Anti-microphonic ...	1/9	W. 198	"Universal" ...	9d.			
VOLUME CONTROLS											
W. 481	500,000 ohms ...	5/6									
MAINS UNITS											
W. 346	H.T. Unit and L.T. Charger for A.C. Mains ...	72/6	W. 347	H.T. and L.T. Unit for A.C. Mains ...	50/-	W. 348	H.T. Unit for D.C. Mains ...	25/6			
LOUDSPEAKER UNITS AND CHASSIS											
W. 54	Loudspeaker Unit ...	3/6	W. 159	"Popular" Chassis ...	5/6	W. 170	"Major" Chassis ...	7/6	W. 181	Loudspeaker Unit and Chassis ...	8/6
W. 182	Loudspeaker Unit and Chassis ...	11/6	W. 183	Loudspeaker Unit and Chassis ...	12/6						
RECEIVERS											
Model 474. 4-valve A.C. Mains Band Pass Receiver ... £9-19-6											
Model 474. Universal 4-valve A.C./D.C. Band Pass Receiver ... £11-11-0											
Model 3435/MV. 6-valve A.C. Mains Superhet. Receiver (Vertical Model) £14-14-0											
Model 3435/MH. 6-valve A.C. Mains Superhet. Receiver (Horizontal Model) £14-14-0											
Model 3435/BV. 6-valve Battery Operated Superhet. Receiver (Vertical Model) ... £14-14-0											
Model 3435/BH. 6-valve Battery Operated Superhet. Receiver (Horizontal Model) ... £14-14-0											
Model 1240. 4-valve Mains Operated Radio-gramophone for A.C. Mains £18-18-0											
Model 3550/RG. 6-valve Mains Operated Superhet. Radiogramophone for A.C. Mains ... £25-4-0											
Model 3550/RGA. 6-valve Mains Operated Superhet. Automatic Radiogramophone for A.C. Mains £33-12-0											

The New

TELSEN

G.S.4 L.F. TRANSFORMER

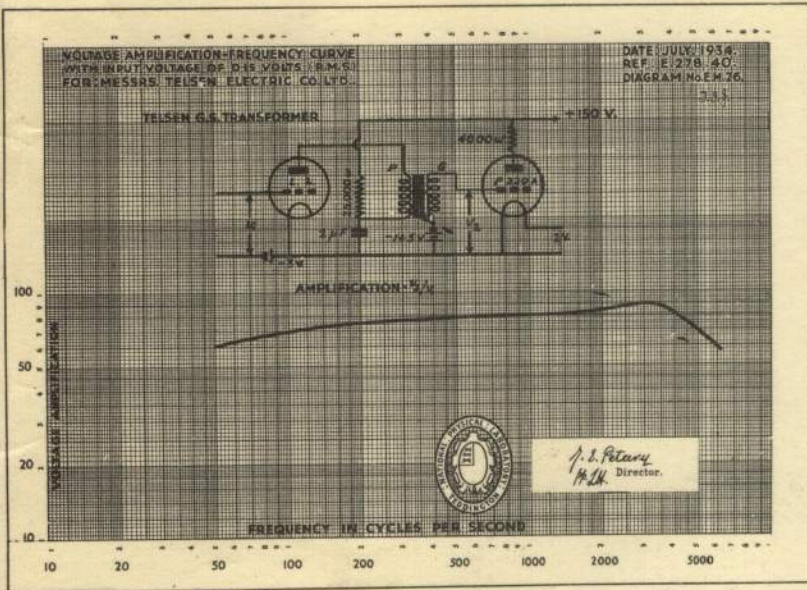

A NEW addition to the Telsen range, this Transformer represents a definite advance in design of transformers for high quality Receivers and Amplifiers. Evolved from the results of extensive research, its performance is unsurpassed by any other directly fed transformer. Impregnated layer windings give complete freedom from breakdown. A copy of the amplification frequency characteristic as taken by the National Physical Laboratory is shown on this page, and it will be noted that the response curve is comparable to anything on the market irrespective of price.

The outstanding performance of the G.S.4 is such that it is the ideal transformer to incorporate where the highest quality of reproduction is desired.

W.457 Ratio 1-4

Prim. Ind. 120H. at o.D.C.

12/6

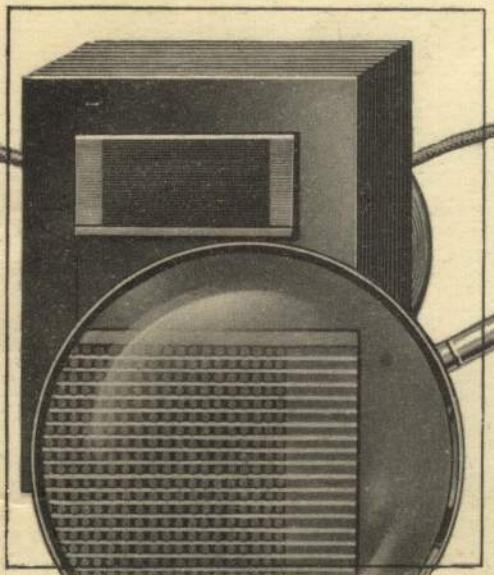

A sectional view of the Telsen G.S.4 Transformer showing the spaced layer windings and the paper interleaving process which is employed in the manufacture.

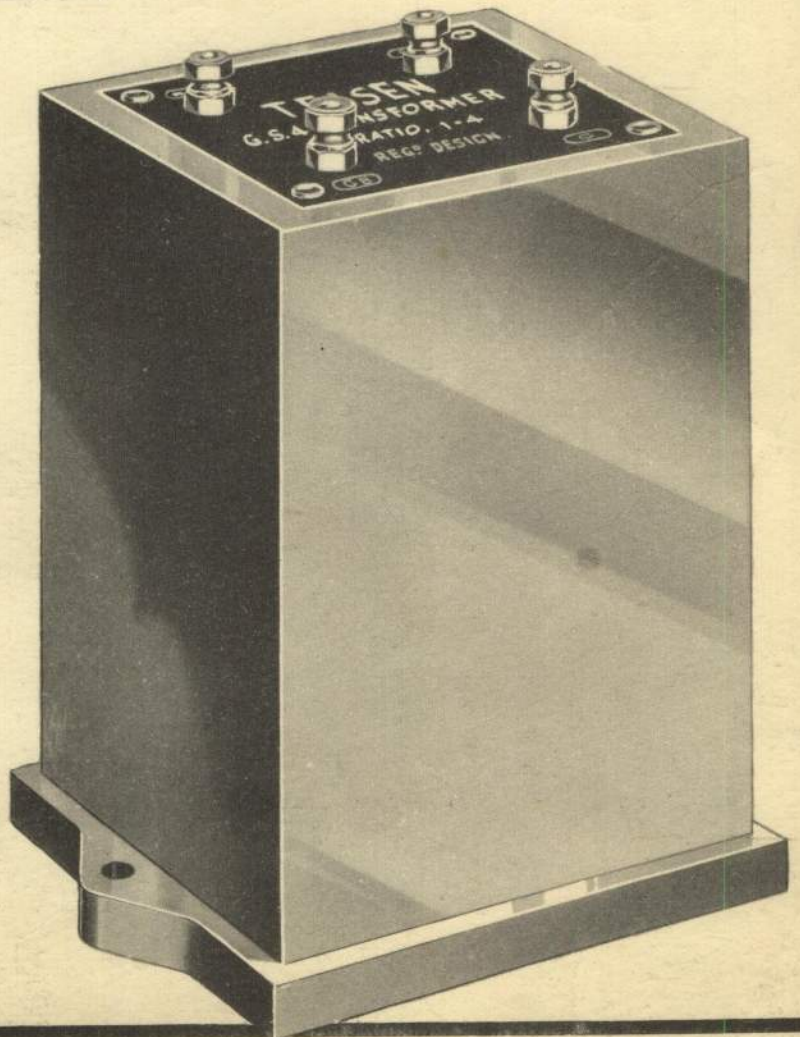

Where

TELSEN

PRODUCTS

are made

Every Telsen Triple Tested Component is specifically **GUARANTEED** for highest quality and efficiency. Behind every Component there stands the reputation for technical skill, sturdy mechanical construction and excellence of craftsmanship of the Telsen Factory at Aston, Birmingham.

**ALWAYS INSIST ON
TELSEN!**



THE TELSEN ELECTRIC COMPANY LIMITED, ASTON, BIRMINGHAM