

HINTS AND TIPS FOR NEW SET OWNERS

Television

and SHORT-WAVE WORLD

SEPTEMBER 1939

No. 139 Vol. XII.

**HOW YOUR
RECEIVER
WORKS**

**NEW BAIRD
COLOUR
TELEVISION**

**SQUARE
CATHODE-
RAY TUBE**

**SHORT
WAVES**

**LOW-NOISE PRE-SELECTOR
AMATEUR-BAND EXCITER UNIT
GUIDE TO NEW SHORT-WAVE COMPONENTS
AND ACCESSORIES**

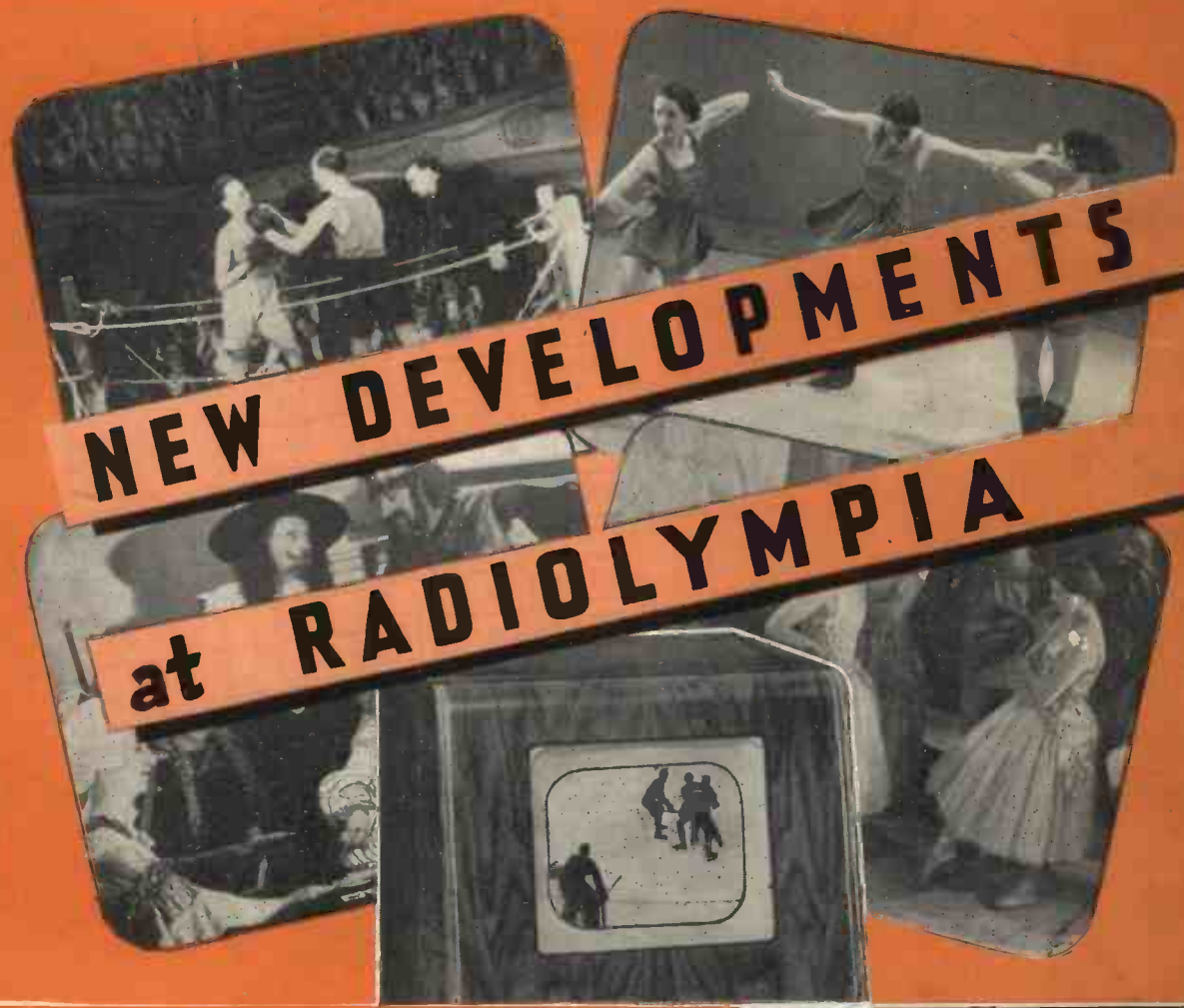

BERNARD JONES PUBLICATIONS LTD.
CHANSITOR HOUSE, CHANCERY LANE
LONDON W.C.2.

THE FIRST TELEVISION JOURNAL IN THE WORLD

BELLING-LEE

NEW SEASON'S PRICES

EFFECTIVE
FROM AUG 1st
1939



COAXIAL PLUG & SOCKET

To take and grip air-spaced or solid di-electric cables, for mounting on chassis or conduit box. Metal parts silver-plated. No. 373A (air-spaced) and 373S (solid), 3/6. In conduit box (suffix B), 6/6.



H.T. VALVE HOLDER

Bakelite moulding. Designed for rectifier valve in Television receivers, etc. Extra long creepage distances. No. 352 (6,000 v.), 1/3; No. 365 (12,000 v.), 2/-.



LOW LOSS STAND OFF INSULATORS

Carefully designed and suitable for use as a terminal or as support for low-loss coils, leads, etc. No. 1277, 1 inch, 1/6; No. 1292, 2 inch, 2/3.



FLAT PIN PLUG & SOCKET

Standardised for balanced television feeders, also for radio circuits up to 50 watts. Prevents loudspeaker, etc., being plugged into mains. Flush or surface mounting. Side flex entry and grip. In brown bakelite. Plug only, 303P, 1/-. Flush socket, 303F, 1/9. Surface socket, 303S, 1/9. Cream bakelite, plug, 3d., sockets, 6d., extra.



D.I. DIODE VALVE HOLDER

Specially made for Midget Diode Valves used for rectification and A.V.C. Spring contacts silver plated, with soldering tag connections. No. 357, 1/- High voltage, type No. 357H, 1/6.

H.T. PLUG & SOCKET



Both parts moulded bakelite. Suitable for Television, etc. Can be handled in perfect safety whilst carrying 6,000 volts. No. 353, 4/9.

TELEVISION AERIALS

The new Belling-Lee all-metal Television aerials feature a new type moulded insulator enclosing terminal connections and with extra long path to prevent picture variation with rain, snow and frost. The whole construction is more robust, and assembly a really easy matter. The steel tubes are insulated and rubber capped. Lightning arrestor built in. The table below shows the various assemblies available, feeder kits extra.

LIST NO.	Di-pole with built-in Lightning Arrestor.	Reflector.	12-ft. Mast.	Chimney Lashing.	Short Stand-off Arm.	Long Stand-off Arm.	Brickwork Mounting.	For Mounting on Customer's mast.	"Eliminate noise" and 75 ft. Cable.	PRICE (WITHOUT CABLE)
502 L	■	■	■	■						£4.7.6
502 W	■	■								£2.10.0
502 C	■	■				■	■			£2.2.0
501 L	■							■		£1.12.6
501 T	■			■		■				£1.5.0
501 W	■				■	■				£1.0.0
503 C*	■	■							■	£5.5.0
503 L*	■	■	■						■	£7.10.6

* Combined Television and Skyrod Aerial for use when separate aerial and earth terminals are correctly provided for medium and long wave reception.

CABLE KITS FOR ABOVE

FEEDER KITS (75 ft. with plug and socket in cartons) 366K Balanced Feeder with extra lightning arrestor (built-in arrestor operates only with coaxial cable); Suffix B, 17/6. 388K Solid coaxial; Suffix S, 25/- 389K Air-spaced coaxial; Suffix A, 50/-.

When ordering cable with aerial, merely add appropriate suffix to aerial list number.

Be Guided by the expert
use

AVO ELECTRICAL MEASURING INSTRUMENTS
REGD. TRADE MARK BRITISH MADE

The D.C. AVOMINOR

A high-grade 13-range combination meter, this instrument incorporates a fully-jewelled moving-coil movement which ensures accurate readings. Its 13 ranges are adequate for the majority of circuit, battery and resistance tests. The total resistance of the meter is 100,000 ohms; full scale deflection of 300 v. or 600 v. is obtained for a current consumption of only 3 m/A. and 6 m/A. respectively.

In case, complete with instruction booklet, leads, interchangeable crocodile clips and testing prods. **45/-**
Deferred Terms if desired.



13 Meters in One.

CURRENT.
0- 6 milliamps.
0- 30 "
0-120 "

VOLTAGE.
0- 6 volts.
0- 12 "
0-120 "
0-240 "
0-300 "
0-600 "

RESISTANCE.
0- 10,000 ohms
0- 60,000 "
0-1,200,000 "
0-3 megohms

THE instruments on which radio engineers rely—the meters that matter wherever precision testing is demanded—are "AVO" Instruments. If you invest in an Avominor you have at your command precision testing facilities similar to those afforded by the world-famous AvoMeter—which, because of its accuracy and exceptional utility, is regarded by radio and electrical engineers as being indispensable.

Write for descriptive leaflets

The UNIVERSAL AVOMINOR

This A.C./D.C. moving-coil precision meter covers all normal A.C. and D.C. testing. It has 22 ranges for the measurement of A.C. Voltage, D.C. Voltage, Current and Resistance. Direct readings are given with great accuracy on a 3-in. scale. The total resistance of the instrument is 200,000 ohms.

Complete with instruction booklet, leads, interchangeable testing prods and crocodile clips.

D.C. VOLTS. 0-75 millivolts. 0- 5 volts. 0- 25 " 0-100 " 0-250 " 0-500 "	D.C. MILLIAMPS. 0- 2.5 milliamps. 0- 5 " 0- 25 " 0-100 " 0-500 "
A.C. VOLTS. 0- 5 volts. 0- 25 " 0-100 " 0-250 " 0-500 "	RESISTANCE. 0- 20,000 ohms 0-100,000 " 0-500,000 " 0- 2 megohms 0- 5 " 0-10 "

£5:10s.

Leather Case, 10/-

Deferred Terms if desired

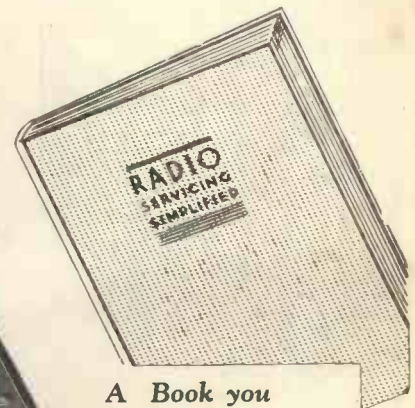

A Book you should have !

"Radio Servicing Simplified" is a valuable text book which gives practical information on the whole routine of testing present-day Receivers. It deals with prevalent sources of trouble and clearly describes every test. 150 pages. Numerous diagrams and graphs.

2/6 Post Free 2/10

Sole Proprietors & Manufacturers :

THE AUTOMATIC COIL WINDER & ELECTRICAL EQUIPMENT CO. LTD.

Winder House, Douglas Street, London, S.W.1. Telephone : Victoria 3404/7.

SEE THAT YOUR NEW SET IS FITTED WITH MAZDA



The
MOST FAMOUS
TELEVISION
SET MAKERS

Fit
MAZDA
CATHODE RAY
TUBES

AND MAZDA SPECIAL VALVES

Mazda Radio Valves & Cathode Ray Tubes are manufactured in Gl. Britain for the British Thomson-Houston Co. Ltd., London & Rugby and distributed by

THE EDISON SWAN ELECTRIC CO. LTD.



155 CHARING CROSS RD., LONDON, W.C.2

For full particulars write to Technical Service Department

The coming season should see the introduction of television receivers into a great many homes. This is the H.M.V. console model 1802.



TELEVISION

and

SHORT-WAVE WORLD

Proprietors :
 BERNARD JONES PUBLICATIONS, LTD.
Editor-in-Chief : BERNARD E. JONES.
Editor : H. CORBISHLEY, F.T.S.
Editorial, Advertising and Publishing Offices :
 Chansitor House, 38, Chancery Lane, London, W.C.2.

Telephones : Holborn 6158, 6159, 2857.
 Telegrams : Beejapee, Holb., London.
 Subscription Rates : Post paid to any part of the world—
 3 months, 3/6 ; 6 months, 7/- ; 12 months, 14/-. Pub-
 lished Monthly—1/- net., first day of the month.

Comment of the Month

The New Receivers

From a cursory survey of the new receivers it might be thought that little development has taken place during the last twelve months beyond cabinet design alterations, and a tendency towards direct viewing instead of the use of the inclined mirror. Owing to the large number of receivers now available it has not been possible to do more than briefly describe them in a special survey which is published in this issue, but later we hope to deal with many new features of comparatively recent introduction that are provided in a large number of them. These include such features as noise suppression on the sound channel, no-drift tuning, phase reversal on vision, booster amplifiers for long distance reception, attenuators, simplified control, and special safety devices.

The fact that there are no radical alterations is a matter for satisfaction, and it should do much to remove from the public mind the idea that some revolutionary development is in the offing which at any time might render obsolete all existing receivers. Twelve months' experience has resulted in a certain degree of standardisation, and a cleaning-up which is very apparent in the general im-

provement of results; this is convincing proof that the public need not refrain from buying. Prices, if anything, have tended to stiffen and there seems not the slightest hope of any reduction. Receivers in the past have undoubtedly been sold at uneconomic prices so there can be little expectation of reduction even with the introduction of mass production.

The Radiolympia Conventions

If you take more than a passing interest in general technical progress, quality reproduction, short waves or television, make a point of attending one or more of the popular conventions which have been organised to take place for the first time this year. These popular conventions are in addition to the dealers' conventions and admission is open to any visitor to Radiolympia, no special tickets being required. To the dealers' convention admission is by special ticket.

The arrangements for the Popular Conventions are as follows:—

Popular Technical Convention—1:

Monday, August 28th, 3.30 p.m.

Subject.—British technical progress and some comparisons with America.

Chairman.—Major L. H. Peter, M.C., A.F.C., A.M.I.E.E. (a Vice-Presi-

dent of the Radio Manufacturers' Association).

Speakers.—Mr. M. G. Scroggie, B.Sc., A.M.I.E.E.; Mr. T. E. Goldup, A.M.I.E.E.; Mr. G. Parr.

Popular Technical Convention—2

Tuesday, August 29th, 3.30 p.m.

Subject.—Quality Reproduction and what it means to-day.

Chairman.—Mr. Leslie McMichael, M.I.E.E., F. Inst. R.E. (a Vice-President of the R.M.A.).

Speakers.—Mr. P. G. A. H. Voigt, B.Sc., A.M.I.E.E.; Mr. C. T. Chapman; Mr. G. A. V. Sowter, B.Sc. (Eng.) Lond., A.M.I.E.E.

Popular Technical Convention—3

Wednesday, August 30th, 6.0 p.m.

Subject.—Short Waves.

Chairman.—Mr. E. M. Lee, B.Sc., Assoc. I.E.E. (Chairman of the R.M.A. Technical Advisory Committee.)

Speakers.—Dr. R. C. G. Williams, A.C.G.I., D.I.C., Ph.D. (Eng.); Mr. F. E. Henderson, A.M.I.E.E.

Popular Technical Convention—4

Thursday, August 31st, 6.0 p.m.

Subject.—Television.

Chairman.—Mr. H. J. Barton-Chapple, Wh. Sch., B.Sc. (Hons. Lond.) A.C.G.I., D.I.C., A.M.I.E.E., Hon. M.I.W.T. (Chairman of the R.M.A. Television Technical Sub-Committee).

Speakers.—Mr. R. G. Clark; Mr. J. H. Owen Harries, A.M.I.R.E.; Mr. T. C. Macnamara.

All the Conventions will be held in a special room in the Empire Hall reached from the Grand Hall Gallery. This room is on the Hammersmith Road side of Olympia and is reached by a staircase just where the Grand Hall opens into the Annexe. They will last for about two hours.

It will
have to be

SCOPHONY

AS AGAINST
'SMALL' SIZE
VIEWING ...

LARGE SCREEN TELEVISION

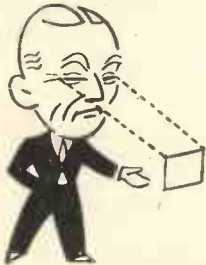

... THE SCOPHONY
LARGE SCREEN

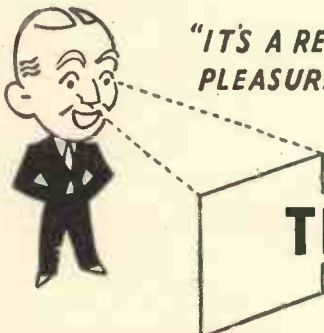

"IT'S A REAL
PLEASURE"

You would *not* use to-day a Crystal Set and ear-phones! Similarly, the future of Television is the LARGE home screen. Here Scophony are YEARS AHEAD! Only Scophony Home Television gives so high a standard of brightness on so large a screen with such simplicity. Write for details of Scophony Large-Screen Home Receivers—Screen sizes: 18 inch, TWO FOOT, and Palace de-Luxe FOUR FOOT—to Scophony Ltd., Thornwood Lodge, Campden Hill, London, W.8.

TELEVISION WITHOUT EYESTRAIN

TYPICAL LAYOUTS OF TELEVISION RECEIVERS

**YOUR
RECEIVER
WORKS
LIKE
THIS**

The stages which go to make up the typical television receiver shown in outline, with a brief explanation of the function of each. This information is based on designs available before the exhibition.

Although it is early to prophesy the developments which will be shown at Radiolympia, it is certain that there will be no radical departure from the lines given in this review, and visitors to the stands of the television manufacturers will find it instructive to try and pick out the various links in the chain from the aerial to the tube and identify them from these notes.

MANY readers who are introduced to television for the first time through their commercial television receiver may be puzzled by the apparent complexity of the "inside" as compared with the average radio receiver.

The reason for the complexity is mainly found in the extra circuits for the production of the line screen, and in the extra stages required for the amplification of the sound and vision signals.

It must be remembered that the amplification of very high frequencies, such as are used in the present system of transmission, presents a different problem from that of the ordinary broadcast signal, and the gain per valve stage is much lower. This necessitates the use of more stages, particularly on the vision side.

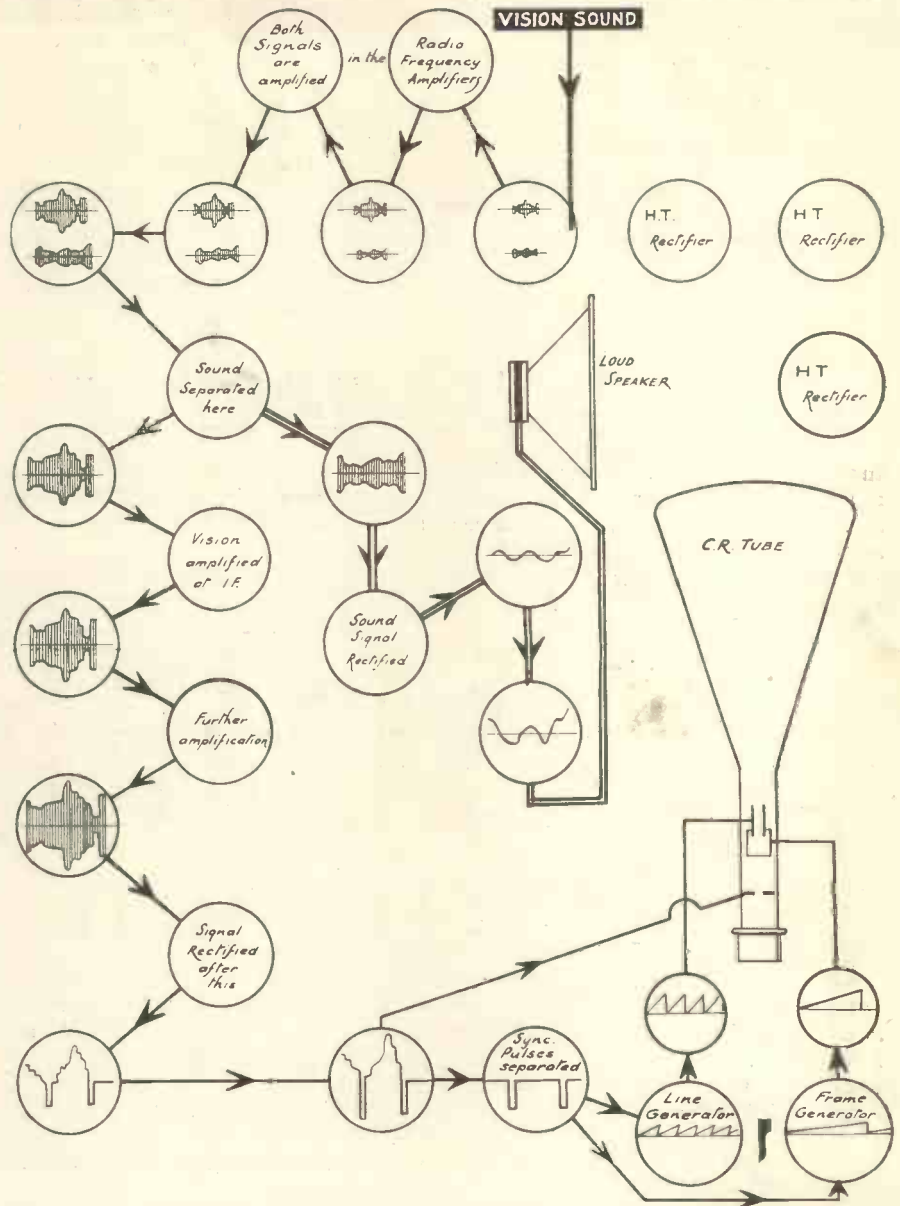

Valve line-up of G.E.C. model BT9121 receiver.

To obtain maximum gain, a superheterodyne receiver is nearly always used, although some manufacturers have a number of "straight" amplifying stages. Others precede the superheterodyne by one or two radio-frequency stages which amplify the signal as it comes from the aerial.

In nearly all cases both the sound and the vision signals are amplified by the first few valves, and the sound signal is then diverted by a separate tuned circuit and fed to the loudspeaker through its own detector and output valve.

The vision output is not only fed to the tube, but the synchronising

pulses are separated and fed to the valves of the scanning circuit.

This circuit has been simplified lately by the use of magnetic scanning, and usually consists of a gas-filled relay for generating the sawtooth waveform, followed by a pentode output valve for supplying the power to the scanning coils.

**G.E.C. RECEIVER MODEL
BT.9121**

As a typical example of the layout of a receiver we can take the G.E.C. model which is shown diagrammatically on this page. This has a 12 in. electrostatically con-

trolled tube, but the circuit is representative of that used for both magnetic and electrostatic tubes. The plan view of the chassis shows the layout of the valves and coils, and the lines show the path of the signal

frequency of "carrier" for further amplification.

At this point a separate tuned circuit is provided for the sound signal and it will be seen branching off to the right to go through another am-

plifier and then to the rectifier. The output from this is fed to a beam tetrode amplifier and thence to the speaker.

plifier and then to the rectifier. The output from this is fed to a beam tetrode amplifier and thence to the speaker.

hand corner. These in turn supply the scanning potential to the deflector plates of the tube. In magnetically scanned tubes the coils are connected to the amplifying valves of this circuit, but the layout is the same.

We can now see some more typical layouts and note the slight differences. The valves are labelled according to the work they perform:

R.F. is a radio frequency amplifier.

I.F. is the intermediate frequency amplifier which follows the frequency changer valve (F.C.).

V.F. is the video (vision) frequency amplifier.

S.S. is the sync. pulse separator. This valve has various functions, depending on the type of scanning circuit used.

H.M.V. TYPE 907

The arrangement of this receiver is very similar to that just described

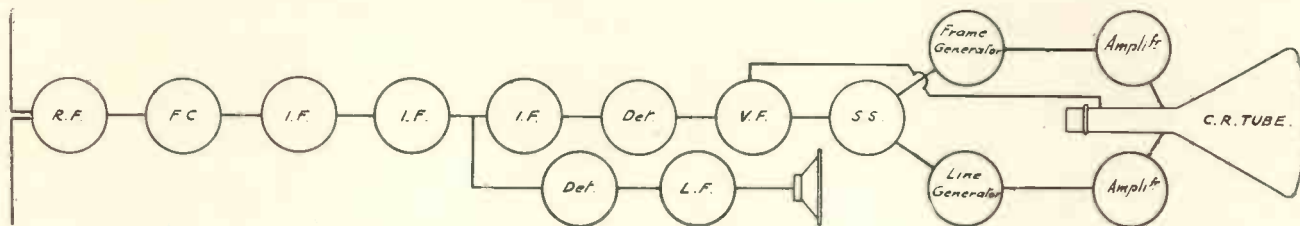

Valve line-up of H.M.V. model 907.

through the circuit. In each circle is shown the waveform of the signal as it passes through the valve stages and the gradual increase in size of the wave indicates how it is progressively amplified.

plifier and then to the rectifier. The output from this is fed to a beam tetrode amplifier and thence to the speaker.

Returning to the vision signal, after the frequency changer it is

hand corner. These in turn supply the scanning potential to the deflector plates of the tube. In magnetically scanned tubes the coils are connected to the amplifying valves of this circuit, but the layout is the same.

We can now see some more typical layouts and note the slight differences. The valves are labelled according to the work they perform:

R.F. is a radio frequency amplifier.

I.F. is the intermediate frequency amplifier which follows the frequency changer valve (F.C.).

V.F. is the video (vision) frequency amplifier.

S.S. is the sync. pulse separator. This valve has various functions, depending on the type of scanning circuit used.

H.M.V. TYPE 907

The arrangement of this receiver is very similar to that just described

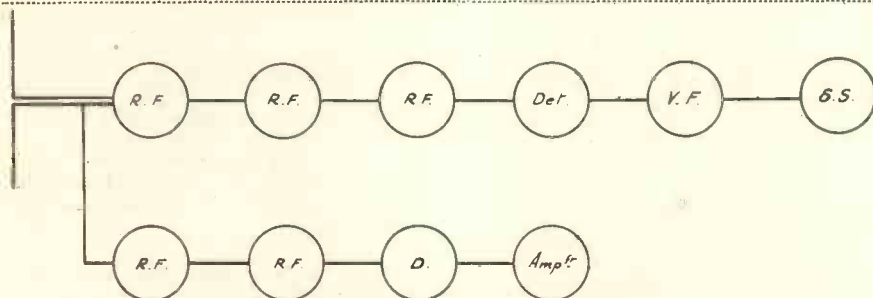

Valve arrangement of Ekco model TA207.

From the aerial, both the sound and vision signals pass through the first two radio frequency amplifiers with their tuned circuits. On the extreme left of the top row is the frequency changer valve which converts both signals to a lower fre-

quency of "carrier" for further amplification. At this point a separate tuned circuit is provided for the sound signal and it will be seen branching off to the right to go through another am-

plifier and then to the rectifier. The output from this is fed to a beam tetrode amplifier and thence to the speaker.

plifier and then to the rectifier. The output from this is fed to a beam tetrode amplifier and thence to the speaker.

hand corner. These in turn supply the scanning potential to the deflector plates of the tube. In magnetically scanned tubes the coils are connected to the amplifying valves of this circuit, but the layout is the same.

We can now see some more typical layouts and note the slight differences. The valves are labelled according to the work they perform:

R.F. is a radio frequency amplifier.

I.F. is the intermediate frequency amplifier which follows the frequency changer valve (F.C.).

V.F. is the video (vision) frequency amplifier.

S.S. is the sync. pulse separator. This valve has various functions, depending on the type of scanning circuit used.

H.M.V. TYPE 907

The arrangement of this receiver is very similar to that just described

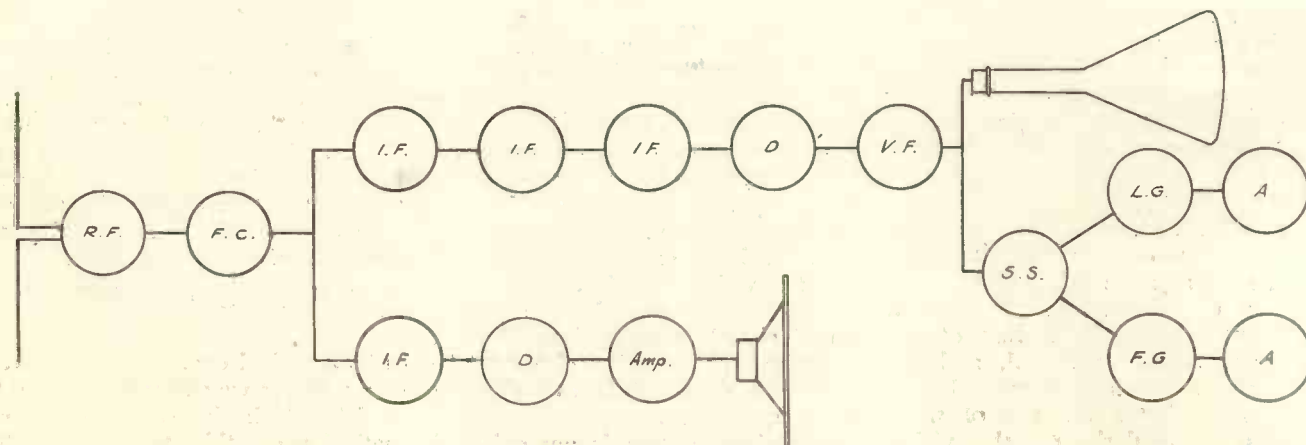

The Murphy model A56 valve line-up.

SEPTEMBER, 1939

in the G.E.C. model. There is one R.F. stage and three I.F. stages, the sound signal being diverted after the second of these.

EKCO MODEL TA.201

This unit is intended for use in conjunction with an existing radio receiver, and there is no loudspeaker. After the detector the sound signal

is amplified by a single stage and is then of sufficient amplitude to be applied to the pick-up sockets of an ordinary radio receiver.

On the vision side there are three R.F. stages instead of the super-heterodyne circuit.

MURPHY A.56

This well-known type is similar in

layout to the circuit which has been fully described. Note the separation of the sound signal after the frequency changer.

COSSOR MODEL 54

One common stage of intermediate frequency amplification is provided and the sound signal then has a separate stage before detection.

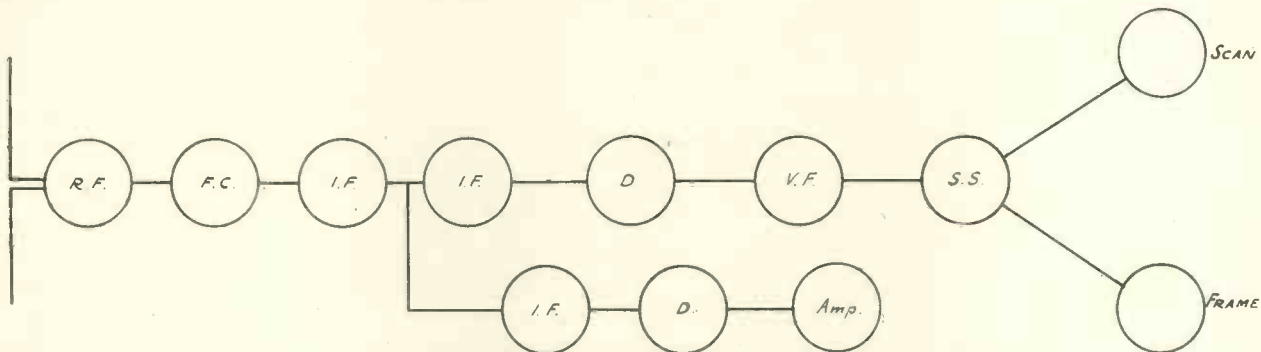

The valve arrangement of the Cossor Model 54 receiver.

HINTS AND TIPS FOR NEW SET OWNERS

The position of the receiver should be your first consideration. Although you may not intend to use it regularly during the day time there will be occasions when you will, and you should, therefore, try to place it in such a position that light does not come from the back of the receiver, as this is far more distracting than a small amount of light falling on the screen.

* * * *

Secondly, choose a position so that every time it is wished to view the programmes there is no need to disturb the existing arrangements of the room. Placing the receiver in some corner which necessitates sitting in unconventional places detracts from the enjoyment.

* * * *

Do not pay too much attention to a convenient position for the feeder cable; this can be run practically anywhere and any reasonable distance without detracting from results.

* * * *

If a long mains connection is necessary do not use flex and have it lying across the floor as this is a possible source of danger; it is worth while having a power point put in somewhere reasonably close to the receiver and where children cannot tamper with it.

* * * *

Aerial requirements will depend largely on the distance from the transmitting station. Within a few miles a length of wire 10 ft. 8 in. long will serve but it is always better to use a standard dipole. Dipole aerials are of two main types—with and without a reflector. Up to distances of approximately twelve miles a reflector is not necessary; above this distance it is usually essential for the best results.

* * * *

Whatever the distance from the station there is a certain advantage in using a dipole with reflector as it makes the aerial directional and is

therefore an asset in cutting out a certain amount of interference. At short distances the aerial and reflector should be oriented so that it is non-directional to the source of interference regardless of the position of the station. At long distances, however, it is usually necessary to set it so that it is directional to the station—that is so that aerial and reflector are in line with the station, the aerial being the needle.

* * * *

It is always advisable to experiment with aerial orientation until the best setting is found having regard to signal strength and interference. In many cases it is necessary to effect a compromise.

* * * *

Most interference is from car ignition systems and the best remedy is to erect the aerial as high and as far away from the source as possible. Length and position of the feeder cable is not of much consequence.

* * * *

Aerial height, position and correct setting when a reflector is employed are the main factors to which attention should be given if interference is troublesome. The normal range is approximately 35 miles but it is possible to receive pictures at far greater distances if you are prepared to erect a very high and efficient aerial and use a sensitive receiver. Many manufacturers are now marketing two types—one for local reception and the other for use outside the ordinarily accepted reception area.

* * * *

When the receiver is first installed you will most probably be told not to disturb the preset controls which as a rule are fitted at the back out of the way. This is sound advice but after a time you will most likely find that results can be improved by slight adjustment of these as various characteristics are liable to small changes. Do not, however, attempt to alter more than one of these at the same time and before making any adjustment note carefully

the position so that the original position can be reverted to. If more than one control is altered there is the possibility of considerable difficulty in finding the correct setting again owing to the number of combinations that are possible.

* * * *

Do not switch the receiver off and then on again suddenly. An interval of a couple of minutes should be allowed after switching off before switching on again as in some cases there is risk of injury to the receiver.

* * * *

Vision receivers are not expensive to run; they consume as much as four or even five times as much current as the average domestic radio set, but even so, 200 watts per hour is a good average consumption. With the electricity charged at about 1d. per unit, this means that the television receiver will cost a fifth of a penny per hour.

* * * *

If you already have a good radio set it is not necessary to dispense with this when buying a television receiver. Several manufacturers can supply add-on units which are merely a vision receiver and a short-wave convertor. This is connected in front of your existing wireless set the two working together.

* * * *

Most television receivers are now directly viewed, that is, the picture is seen actually on the face of the tube, however one or two manufacturers still feel that an indirectly viewed receiver has many advantages, particularly when space is of importance. With the indirectly viewed receiver the tube is mounted vertically, and the picture is seen from a mirror fitted at an angle of 45 degrees facing the tube. Choice is a matter of personal preference.

* * * *

The most popular size of picture is 10 ins. by 8 ins. Next comes the 7½ ins. by 6½ ins.; the small one are 5 ins. by 4 ins.

RADIOLYMPIA — 1939

TELEVISION

at Radiolympia

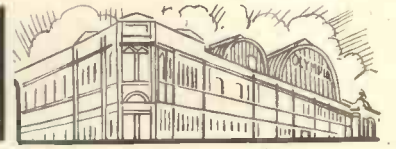

August 23
to September 2
inclusive

SPECIAL REPORT OF TELEVISION EXHIBITS

We present in the following pages a comprehensive survey of television receivers now available to the public. From the number of these it will be apparent that television occupies a very important place at the Radio Exhibition, and this year, for the first time, ownership of a receiver has become a personal matter with a large section of the public. This guide, therefore, will be helpful in enabling a choice of receiver to be made. No attempt has been made to provide technical specifications, but we hope to review many of the receivers in greater detail in future issues. It is of interest to note that compared with last year, there is no indication of any price reduction and there is no indication of such in the future, also, although detail improvements have been made, the basic principles remain exactly the same; the public, therefore, need have no hesitation in buying, either on the question of price reduction or some improbable new development.

BAIRD TELEVISION, LTD.
Crystal Palace, Anerley Hill,
S.E.19. Stand No. 27.

There are six receivers in the Baird range which is very comprehensive. Picture sizes from $7\frac{3}{4}$ in. to 12 in. wide are available.

30 gns. Model T.24.—A table

Simple in operation, it is possible, without any technical knowledge, to obtain consistently excellent results. Dimensions: $19\frac{1}{2}$ in. high by 15 in. wide by $14\frac{3}{4}$ in. deep.

33 gns. Model T28.—This is the console version of Model T24 and incorporates all its many attractive

find a special appeal to flat owners, etc., and where space is an essential consideration.

40 gns. Model T26 is the vision and sound receiver complementary to Model T25. The size of the picture is 10 in. wide by 8 in. high and viewed direct. Provision is made for

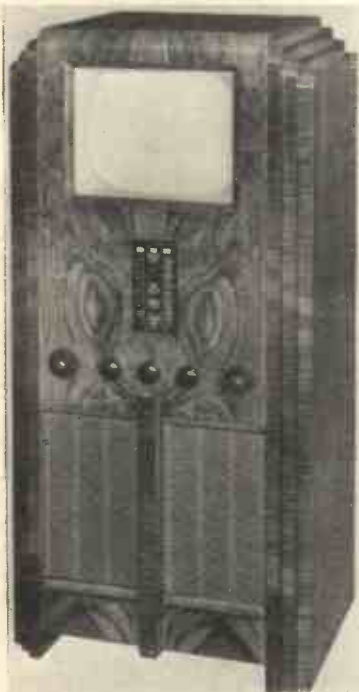

The Baird T25. A popular size and type at a moderate price.



The Baird T26 television receiver. 10x8 picture at 40 gns.



The Baird T28 at 33 gns. is remarkable value.

cabinet model of very compact design, handsomely finished in burr relieved with straight grained walnut, and incorporating a vision and sound receiver with 9 in. "Cathovisor" tube. The picture is $7\frac{3}{4}$ in. wide by $6\frac{1}{4}$ in. high and viewed direct.

features. The size of the picture is again $7\frac{3}{4}$ in. wide by $6\frac{1}{4}$ in. high and viewed direct. The cabinet is very distinctive in design and is constructed of walnut with a facing of Indian laurel. In view of the extreme compactness, this receiver should

receiving television sound only, so permitting the B.B.C. high-fidelity transmission on the television sound wavelength to be received independently of vision. The cabinet is available either in figured walnut or sapeli mahogany. If the latter is

BAIRD

::

BEETHOVEN

::

COSSOR

desired an additional charge is made of 30s.

47 gns. Model T25.—A combined television and all-wave radio receiver with an excellent performance. The picture is 10 in. wide by 8 in. high and viewed direct on the end of the "Cathovisor" tube. The sound receiver employs a high quality superheterodyne circuit which, in addition to the television sound, also covers three wavebands for radio programmes. (Short: 16-51 metres; medium: 198-560 metres; long: 850-2000 metres). The cabinet is constructed of richly figured walnut. Dimensions: 44½ in. high, 21 in. wide, 16½ in. deep.

48 gns. Model T27.—This attractive receiver, which incorporates a 15 in. Baird "Cathovisor" tube, has been designed for the reception of vision and its accompanying sound, so giving complete entertainment. A picture 12 in. wide by 9¾ in. high is produced and direct viewing is again featured. The handsome cabinet is veneered with choice straight-grained walnut, artistically relieved by selected burr. A special sliding panel is inbuilt, which acts as a screen when, on occasions, overhead room lights are in use. Dimensions: 44½ in. high, 20 in. wide, 22 in. deep.

50 gns. Model T27 (o).—This receiver, finished in oak, has exactly

the same specification and performance as the standard walnut Model T27. It is intended primarily to cater for the special conditions peculiar to schools, clubs, hotels, canteens, etc., and where oak as a finish is more in keeping with the furnishing scheme generally found in such places. Provided with a control lock which prevents unauthorised use. The additional charge for this instrument is £2 2s. Dimensions: 44½ in. high, 20 in. wide, 22½ in. deep.

**BEETHOVEN ELECTRIC
EQUIPMENT LTD.**

Chase Road, North Acton, London, N.W.10.

The Beethoven range of television receivers comprises two models, which are very similar in specification, the main difference being in the picture size. At the time of going to press the release date for these receivers has not been decided, and consequently, the prices quoted are open to revision.

33 gns. Model BT9.—This is a smaller version of the Beethoven model BT12 described above. The picture size is only 7½ in. by 6 in., but the actual specification is almost identical to the BT12.

43 gns. Model BT12.—A combined television sound and vision receiver in a console type cabinet of contrasting grain and figures French walnut. The picture is provided on a slight incline for ease of viewing, and the size of the screen in this particular model is 10 in. by 8 in. There are three controls—sound-volume and on-off switch, brightness and focus, and the latest type of Mullard short cathode-ray tube is used. Nineteen valves in all are employed, and the consumption is 250 watts. The model is suitable for A.C. mains, and the design of the sound section is such that the sound reproduction is practically indistinguishable from the actual performance.

A. C. COSSOR, LTD.

Cossor House, Highbury Grove, London, N.5. Stand No. 48.

23 gns. Model 54.—Among the Cossor range is the table model 54 at the surprisingly low price of 23 gns. This is a complete self-contained television sound and vision receiver which gives a direct vision picture and uses a 6¼ diameter cathode-ray

tube, giving a picture of approximately 20 square inches.

The cabinet, which is of walnut, is 17½ in. high, 13 in. wide and 20½ in. deep, and the receiver is intended for use within a radius of approximately 20 miles from Alexandra Palace. For use at greater distances, a similar model is available incorporating an extra amplifier (16 valves in all) the cost of which is 26 gns.

Only four controls are fitted and the receiver therefore is very simple to operate.

27 gns. Model 65.—This is a console type instrument giving a picture of approximately 6 in. by 5 in. It is for television sound and vision only and the picture is viewed directly on a 7-in. diameter tube.

There are four controls—two for vision and two for sound. Once the correct adjustment has been made these need only rarely be touched. Particular attention has been given to the quality of the sound receiver and the cabinet accommodates a massive 8-in. wide response moving coil loudspeaker, carefully matched with the output stages to ensure the best possible quality of reproduction. Only 13 valves are employed, and the effective range is approximately 20 miles from Alexandra Palace.

The cabinet is walnut, size 34½ in.



The Cossor 65 is a console model providing television sound and vision only. The picture measures 6 in. by 5 in.



A de luxe television and combined all-wave superhet radio receiver is the Cossor model 1210. The picture provided is 12 in. by 10 in.

COSSOR

::

DECCA

::

DYNATRON

high, 15 in. wide and 19½ in. deep. The voltage range is 200-250 volts. For use outside the ordinarily accepted range area a similar model, but employing 16 valves in all, is available at a cost of 3 gns. extra.

53 gns. Model 1210.—This is a de luxe television receiver combined with an all-wave superhet radio re-



Table model 54 made by A. C. Cossor Ltd. This televisor is marketed at the surprisingly low price of 23 gns.

ceiver. The picture provided is one of the largest available; it is 12 in. by 10 in. directly viewed and to give this picture size a 15-in. tube is fitted. Twenty-one valves are employed and a 10-in. energised speaker; covers three wavebands: viz., 16 to 52 metres, 195 to 560 metres, and 810 to 2,085 metres. The cabinet is a console type and measures 48½ in. high, 20½ in. and 24½ in. deep.

As with the other Cossor models, a modified type of this receiver employing 24 valves in order to give extra power for distances in excess of 20 miles from Alexandra Palace is available. The price of this is 56 gns.

It is understood that an additional console receiver is in the course of design, but particulars are not available at the present time.

DECCA RADIO & TELEVISION, LTD.

1-3 Brixton Road, London, S.W., Stand No. 44.

The Decca Company have concentrated on two models, both of the console type, one incorporating all-wave press-button radio and the other being for television sound and vision only.

39 gns. Model 39.—This is a



This photograph shows the Decca model 39, a console type televisor which provides a picture 10 in. by 8 in.

console model providing a picture 10 in. by 8 in. and employs 19 valves with a power consumption of 150 watts. The television section of this receiver is identical with the model 46 described below. The cabinet size is 35 in. high by 17 in. deep and 18 in. wide.

46 gns. Model 46.—This is a combined television receiver and all-wave press-button radio, covering three wavebands, viz: 16 to 50, 200 to 550, and 1,000 to 2,000 metres. The mechanical method of press button tuning is employed, and any



Another Decca receiver, but this model (the 46) includes an all-wave press-button radio in addition to television sound and vision.

button may be re-set to a new station in a few seconds.

In all, 22 valves are used for vision and radio, and for the complete instrument there are seven controls which include the press buttons giving a choice of any eight broadcast stations. The voltage range is 200 to 250 volts and the current consumption is 200 watts. The circuit comprises an R.F. stage for sound and vision with a common mixer stage for both. The sound output is 4½ watts. The cabinet is of walnut 41 in. high, 17 in. deep and 20 in. wide, and the picture is viewed direct.

DYNATRON RADIO LTD.

Perfect Works, Ray Lea Road, Maidenhead, Berks. Stands Nos. 1 and 39.

The Dynatron range of television receivers comprises three models. A 12-in. tube is employed, and the high quality of construction renders the Dynatron receiver suitable for satisfactory reception over long distances. The makers claim that successful installations have already been made in Gloucestershire, Norfolk and the South Coast



The Dynatron Falcon.

175 gns. Model 4518 (The Ether Emperor IV).—A large screen television receiver in which is incorporated, in addition to television sound and vision, a very sensitive all-wave radio receiver and an auto-changer radiogramophone. Forty-five valves are used and the output is 18 watts. This model is housed in a large walnut cabinet.

Visit

RADIOLYMPIA

Aug. 23rd—Sept. 2nd

1939

Special Attractions for the technically minded amateur

This year's Radiolympia will have considerably more interest for the techni-fan.

Model Factory

The model factory, working under actual practical conditions, will show almost every process of radio manufacture—such as coil winding, wire covering, wire joining, grid making, spring making, R.F. Coil adjusting, resonance test, impedance comparison, inductance comparison, ganged condenser testing, cutting and forming wires of tubular condensers, engraving, test and assembly and dry battery manufacture. Experts will be in attendance to explain these processes, and to deal with any difficulties, such as interference, "fading," etc., to the serious-minded amateur. In addition, there will be a revolving drum, showing the complete chassis of many of the leading manufacturers' sets.

Technical Conventions

Technical conventions will be held in the Convention Hall on the four days August 28th to August 31st, inclusive. The following subjects will be discussed by experts, and the meetings will be open for general discussion.

- (a) Short-wave technique.
- (b) High quality reproduction.
- (c) Television.
- (d) General technical topics.

Many distinguished visitors will attend and address these meetings.

Radio Theatre

The radio theatre at Olympia, specially built at a cost of over £5,000, is a replica of the famous "bowl" theatre at Hollywood, and is the *first theatre in the world* to be designed and constructed expressly for broadcasting AND TELEVISION.

Broadcasting and Televising Every Day

See the batteries of cameras and microphones at work in the hands of the full staff of B.B.C. experts.

TELEVISION

Television is the keynote of Radiolympia 1939. Apart from the 64 sets constantly working in "Television Avenue," literally HUNDREDS of sets will be receiving continuously throughout the exhibition . . . This is the greatest demonstration of television the world has ever seen.

Come and Be Televised Yourself

Special facilities for organised technical parties

Please apply to Secretary for particulars of reduced price tickets, Convention tickets, etc.

Radio Manufacturers' Association

59, Russell Square, London, W.C.1

Telegrams: OIARION, Westcent, London

Phone: MUSEum 4031

Osram Valves

MADE IN ENGLAND

British Made Valves

for Amateurs

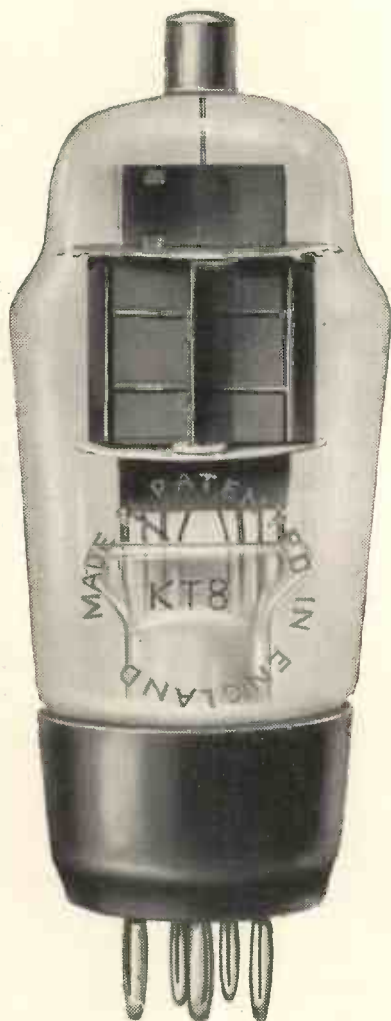

(TYPE KT8)

TYPE KT8

A beam tetrode for R.F. amplifier, oscillator or multiplier stage

Indirectly heated Cathode	6.3 v., 1.27 amps.
Max. output (telegraphy)	35 watts Class C
at 20 mc./sec. (telephony)	27 watts Class C
Anode voltage	.. 600 max. (475 max. for telephony)	
Anode dissipation	.. 25 watts max. (16.5 max. for telephony)	

British 5-pin base.

List Price **22/6**

TYPE KT66

A beam tetrode for A.F. amplifier (mod.) multiplier or R.F. drive

Indirectly heated cathode	6.3 v., 1.27 amps.
Max. output Class A	7.5 watts
Max. output Class AB1 push pull.	32 watts per pair
Max. output in push pull triode connected	15 watts per pair
Anode voltage	400 max.
Anode dissipation	21 watts max.

"International" Octal Base

List Price **15/-**

Write for leaflet giving full technical and operating data to the Osram Valve Dept. of THE GENERAL ELECTRIC CO. LTD., Magnet House, Kingsway, London, W.C.2.

EKCO

::

FERRANTI



A 19-valve table television receiver with a 6 1/4 in. by 5 in. picture is the Ekco model TS701. The four main controls are Focus Brightness, Contrast and Volume/On-off switch.

69 gns. Model TV23 (Falcon).—This is the newest Dynatron model. It is a console type receiver providing television sound and vision only. A 12-in. cathode-ray tube is employed, and there are 23 valves in all.

130 gns. Model M358 (Ether Monarch).—This is a modified version of the model 4518 described below. There are only 35 valves in all, and a less elaborate radio receiver is incorporated.

E. K. COLE, LTD., (EKCO)
Southend-on-Sea, Essex. Stand No. 47.

There are four models in the Ekco range, two of these being add-on units, that is the instruments provide vision only, but a convertor is incorporated so that they can be used in conjunction with any ordinary broadcast set with the provision of television sound.

22 gns. Model TA201 provides a picture of 6 1/4 in. by 5 in. and this low figure brings television practically within reach of all. Control is exceedingly simple and in these units there are only three, contrast, brightness and focus, that need be touched; tuning is fixed. The cabinet size is 19 1/2 in. by 17 in. by 16 in. and is of polished walnut. A stand is available at 2 gns. extra.

25 gns. Model TA901.—The general specification of this instrument is the same as model TA201, but it provides a larger picture, viz: 7 1/2 in. by 6 in. The sound output is 3 watts and the cabinet is slightly larger; this also, of course, is intended to be used in conjunction with

a broadcast receiver for the provision of sound.

26 gns. Model TS701.—This is a complete sound and vision table-type instrument giving a picture 6 1/4 in. by

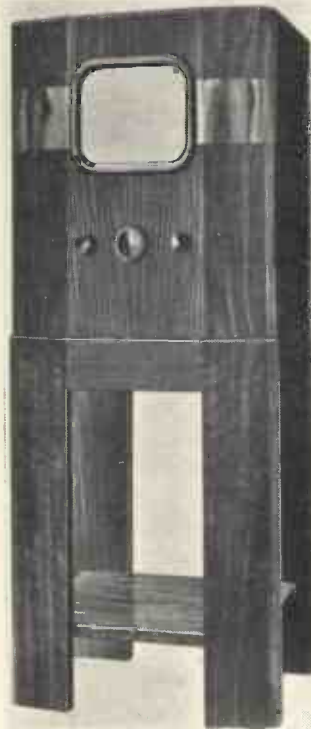

Another add-on unit by Ekco. The picture size is 6 1/4 in. by 5 in., and the stand is available at 2 gns. extra.



The model TSC902 by Ekco gives a picture 7 1/2 in. by 6 in. The specification of this receiver is similar to the TS701.



The Ekco model TA901. This is an add-on television unit providing a picture 7 1/2 in. by 6 in.

5 in. Nineteen valves are employed and the sound output is 3 watts. Four controls, focus, brightness, contrast and volume-on/off, are at the front of the cabinet. The cabinet is of walnut and measures 21 1/2 in. by 17 in. by 16 in.; a stand is available at 2 gns. extra.

30 gns. Model TSC902.—A console model giving a picture of 7 1/2 in. by 6 in., and the sound output is 3 watts. Four controls are provided as with the model TS701 and the general specification is the same but with increased picture size. The cabinet is of walnut, 38 in. high by 19 in. wide and 16 in. deep.

FERRANTI, LTD., RADIO WORKS

Moston, Manchester, 10. Stand No. 41.

Three receivers comprise the Ferranti range, these being a table television, a console television and an all-wave television.

30 gns. Model T10.—This is a table model giving a picture 7 in. by 5 3/4 in. and will receive both vision and the accompanying sound. The picture is viewed directly and the tube, which is of the magnetic type, is protected with a special glass, which can be moved quite easily for cleaning when necessary.

Three controls are provided, line hold, combined sound volume and on-off switch, combined brightness and television on-off switch. Provision is made for an extension speaker and gramophone pick-up connections are also provided. The cabinet is of walnut, 17 in. high, 20 3/4 in. wide, and 15 in. deep.

40 gns. Model T8.—A console

FERRANTI

::

G.E.C.

receiver for vision and sound only, giving a picture 10 in. by 8 in., which is viewed directly. Provision is made for an extension speaker, and the cabinet is of walnut, 45 in. high, 19 in. wide and 19 in. deep.

48 gns. Model T9.—The television section of this receiver is essentially the same as the model T8, but in addition there is incorporated an all-wave broadcast receiver, which comprises a 5-valve, three-waveband superhet covering 16.5 to 51 metres, in addition to the long and medium wavebands.

The cabinet dimensions are 45 in. high, 19 in. wide and 19 in. deep.

THE GENERAL ELECTRIC CO., LTD.

Magnet House, Kingsway, London, W.C.2. Stand No. 35.

Pre-set thermo-constant tuning, a vision interference limiter, electromagnetic scanning, electrostatic focusing, a built-in attenuator, and a safety mains lock are also included in the specification of this and the other receivers in the G.E.C. range.

22 gns. Model BT.0070. For those who already have a good radio set there is Model BT.0070, inexpensively priced at 22 gns. This receiver is compactly housed in a walnut cabinet finished in light and dark contrasting bands. The overall measurements are height 18½ in., width 14¼ in. and depth 14½ in. There are four external controls consisting of the mains switch, brightness control, contrast control, and focus



G.E.C. BT.0124. Television and all-wave radio-gramophone. 72 gns.

adjustment. To guard against current wastage and unwanted tube depreciation, a green pilot light is fitted. The picture given by a 7 in. Osram tube is 6 in. wide and 4¼ in. deep. The 15-valve superhet circuit consumes 180 watts and is therefore extremely economical in operation.

A Family Console

32 gns. Model BT.0091 is a console which at 32 gns. is excellent value. The dimensions are height 39 in., width 25¼ in., and depth 15½ in. In addition to the external controls for picture brightness and contrast, sound volume and tone quality, there are three push-buttons. The first switches on the sight and sound channels, and the second brings in sound reception only. The other button switches the set off. The picture, which is provided by an electromagnetic 9 in. Osram tube, measures 7½ in. by 6 in.

A 16-valve superhet circuit is employed, consuming 235 watts when used for sight and sound, and 115 watts when operating on the sound channel only. Provision is made for the connection of both extension speaker and gramophone pick-up.

A Luxury Receiver

40 gns. Model BT.0092. For only another 8 gns. G.E.C. model BT.0092 is available for those who wish to have all-wave radio and television in one instrument. This receiver is similar in appearance and general specification to model BT.0091. In addition to the controls

on the latter, however, there are fifteen push-buttons, including one for each of the wavebands, viz., 16.5-50 metres, 192-550 metres, 1,000-2,000 metres, another for the pick-up circuit, and eight for the selection of any eight stations. G.E.C. push-button control is a mechanical system giving great stability and simplicity of operation.

The circuit is a 17-valve superhet having a power consumption of 235 watts for sight and sound, 115 watts when used for television sound only, and 125 watts on radio.

72 gns. Model BT.0124. The last of the series of four G.E.C. sets was actually introduced in June, the others being shown for the first time at Radiolympia. This is a de-luxe receiver combining television, radio, and an eight-record autogram. The handsome walnut cabinet is 38½ in. high and covers a floor space 33½ in. by 23½ in. The picture which measures 10 in. by 8 in., is produced by a 12 in. Osram electrostatic tube. Both vision and radio manual controls and push-buttons are the same as for model BT.0092, as are the wave ranges covered, the loud-speaker, and other details of the specification.

In this receiver, instead of the components being mounted on one chassis, there are separate units for vision, sound, power, timebase and radio. Both scanning and focusing are electrostatic. The circuit incorporates 23 valves, 18 for television, and 5 for the all-wave radio.



G.E.C. BT.0091. Television console. 32 gns.



G.E.C. Television and all-wave radio console. BT.0092 40 gns.

H.M.V.

GRAMOPHONE CO., LTD.
(H.M.V.)

98/108 Clerkenwell Road, London.
Stands Nos. 46 and 53.

The H.M.V. range of television and combined television and radio receivers comprises seven models, four of which are entirely new superhets,



A console type model by H.M.V., the 1801 provides a picture size 6½ in. by 8½ in.

with which two different picture sizes are available. It will be of interest to consider some of the special features which are common to all the new H.M.V. models, and to this end a block diagram of the circuit is reproduced here.

A common superhet for both vision and sound is employed, the first H.F. valve being the new Z62; the frequency changer a triode-hexode X41C which is followed by two tuned grid I.F. amplifiers employing KTZ41 valves. The next stage of I.F. amplification, also a KTZ41, operates for vision only, and the "sound rejector" circuit ensures the freedom of this channel from any residual sound signal. The sound section of this signal is passed via a coupling coil to the separate I.F. stage which feeds a double diode triode, the various sections of which have the following uses. One diode is for demodulation. The triode is an I.F. amplifier feeding the output valve via the volume control. In the anode circuit of the output valve a

hiss limiter is connected. The other diode is connected so that it feeds an out-phase signal to the channel to cancel out sound interference.

The vision and synchronising signals up to the third I.F. stage are passed to a D43 for demodulation. The demodulated signal is then amplified by a KTZ41 in the anode circuit of which is connected the cathode of the cathode-ray tube from a limiting diode. This, in conjunction with a KTZ63, takes charge of the line synchronising signal and passes it to the line oscillator.

Similarly the other diode passes the frame pulses to the frame oscillator. An electro-magnetic tube is employed and a new technique enables a flatter end to be provided, and therefore use is made of the maximum area for the picture. A light stone coloured rubber mask is employed round the tube. The following are brief specifications of receivers in the H.M.V. range.

31 gns. Model 1800.—This is a particularly simple type of receiver in a table-type cabinet with only two front controls—picture brightness and sound-volume. It provides a picture 8½ in. wide by 6½ in. deep. Cabinet dimensions are: height 21½ in., width 15½ in. and depth 18 in., with a 2½ in. projection at the back.

35 gns. Model 905.—This is a combined radio and television receiver of the table type. The picture size is 6½ in. by 5 in. and the instrument comprises a three-waveband radio receiver and a vision receiver. It is a particularly compact instrument as the dimensions are only 19½ in. high, by 26 in. wide by 14½ in. deep, with a 3½ in. projection at the back. This is the model which was introduced last year and proved very popular.

36 gns. Model 1801.—This instrument is essentially the same as the model 1800, but is fitted into a

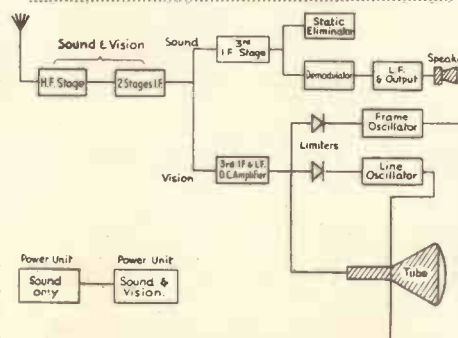

Schematic diagram of H.M.V. receivers.

console cabinet. The picture size is the same, viz: 6½ in. by 8½ in., the cabinet size is 38½ in. high, 18 in. wide and 19½ in. deep. Again there is a 2½ in. projection at the back.

44 gns. Model 1802.—A console model which provides a picture 11½ in. by 9½ in. Sound and vision are



A console type receiver is the H.M.V. 1850. The picture size is 11½ in. by 9½ in., and in addition, an all-wave push-button radio is provided.

pre-tuned and there is provision for an extra amplifier. The sound output is 5 watts and the mains current consumption for sound and vision is 215 watts. This is a very suitable instrument for viewing at a distance of 8 ft. or 10 ft., and it is, therefore, more accommodating in cases where a number of people wish to see the programmes.

45 gns. Model 907.—This is a combined television and radio receiver giving a picture 6 in. by 7½ in. It is a console model with a cabinet 39½ in. high, 17½ in. wide and 22½ in. deep, with a 3½ in. projection at the back.

57 gns. Model 1850 has the same television specification as the model 1802 (picture size 11½ in. by 9½ in.), but in addition all-wave push-button radio is provided. The radio receiver covers three wavebands 13.8 to 50 metres, 195 to 580 and 725 to 2,000 metres. It has an electronic tuning device and gramophone pick-up sockets are provided. The consump-

MARCONIPHONE

::

PHILIPS

tion is 285 watts for sound and vision and 70 watts for broadcasting.

80 gns. Model 900.—A de luxe instrument which follows an original design which in the past has been very popular. The picture, which is 10 in. by 8 in., is viewed indirectly in a mirror in the lid of the cabinet. The instrument combines television and a four-waveband radio receiver, and the performance of the latter, particularly on the short-waves, is of a very high order. The cabinet dimensions are 38½ in. high, 36 in. wide, and 19½ in. deep.

MARCONIPHONE CO., LTD.

210, Tottenham Court Road, W.1.
Stand No. 36.

31 gns. Model 710 is a table television sound and vision receiver, incorporating a 10-in. Emiscope tube giving a picture 6½ by 8½ in. Only two operating controls are provided for volume and brightness, and both sound and vision are pre-tuned, but pre-set controls are provided for initial adjustments.

Size is 21¾ in. high, 15¼ in. wide and 18 in. deep. The mains consumption is 215 watts.

35 gns. Model 707.—This is a table model television and three waveband radio receiver, employing a 7-in. all magnetic tube giving a picture 5 in. by 6½ in. A feature is the use of two independent mains transformers for purposes of current economy when it is desired to use the sound section of the instrument



The Marconiphone model 710 giving a picture 6½ in. by 8½ in. A noise suppressor circuit is incorporated in this receiver, and provision is made for an extra amplifier if it is desired to use the televisior outside the ordinary service area.



The new H.M.V. model 1800 table television receiver. It has a screen 8½ in. by 6½ in., and the two controls are picture brightness and sound-volume.

only. This model also can be had with an auxiliary amplifier at the cost of £1 5s.

There are provided external speaker and pick-up sockets. The dimensions are height 18¾ in., width 26 in. and depth 14½ in. The current consumption is 200 watts for television and 85 watts for broadcast radio.

36 gns. Model 711.—A console model for television sound and vision with practically the same specification as model 710 described above. The cabinet size, however, is height 38½ in., width 18 in. and depth 19½ in.

44 gns. Model 712. This is a console model television sound and vision receiver incorporating a 14-in. tube which provides a picture 9½ in. by 11½ in. The specification is similar to model 711 except that a larger picture is provided. The cabinet size is 39¾ in. high, 19½ in. wide and 23¾ in. deep.

45 gns. Model 709.—A console model television and three waveband radio receiver, employing a 9-in. tube, and giving a picture 6 in. by 7½ in. The height of the cabinet is 39 in., width 18 in. and depth 23 in.

57 gns. Model 713.—Television, sound and vision and 6-valve three waveband push-button console. The television section specification of this receiver is the same as the model 712 but the instrument in addition incorporates a three waveband push-button control radio receiver

Cabinet size is 48 in. high, 21½ in.

wide and 23¾ in. deep. The mains consumption for television and sound is 285 watts, broadcasting 70 watts.

80 gns. Model 705.—This is a de-luxe instrument combining television, (sound and vision) and four waveband radio receiver. A 12-in. tube is used, giving a picture size 10 in. by 8 in. An automatic waveband indicator, external speaker and pick-up sockets are provided.

MURPHY RADIO LTD.

Broadwater Road, Welwyn Garden City, Herts. Stand No. 33.

At the time of going to press details of the Murphy television exhibits were not available.

PHILIPS LAMPS, LIMITED

Century House, Shaftesbury Avenue, W.C.2. Stand No. 45.

Philips Lamps, Limited, have produced four new receivers—one table and three console models; they differ from each other only in the size of the picture and the fact that two of them incorporate an all-wave radio receiver with Philips' automatic tuning in addition to the television sound.

Fourteen valves are used in the television models, and 18 in the television and broadcast models.

32 gns. Model 2405 is a horizontal table model giving vision and sound accompaniment. The picture



A console type receiver by Marconiphone is the model 713. In addition to providing television sound and vision a 6-valve 3 waveband, push-button radio receiver is incorporated.



THREE WORDS...

that mean so much to you!

In the whole vast field of home entertainment, three words have always been outstanding "His Master's Voice."

To-day that name leads in a new field of achievement—Television, and here "His Master's Voice" engineers are in a unique position.

They are not only fully conversant with the developments in transmission technique, but over the past three years have amassed an unrivalled fund of detailed information, on the score of what best will reproduce the programmes sent out from Alexandra Palace under reception conditions of the widest possible variety.

This intensive field research manifests itself in the 1940 "H.M.V." receivers in many exclusive features.

Take an early opportunity of examining them at your "His Master's Voice" dealer's. He is specially qualified to advise you.

HIS MASTER'S VOICE *Television*

'CLEARLY' THE BEST!

★ COUPON

To "His Master's Voice," 98-108, Clerkenwell Road, London, E.C.1
I should be glad to receive a copy of your booklet illustrating the complete new range of "His Master's Voice" Television Receivers.

NAME

ADDRESS

Tel. Sept.:

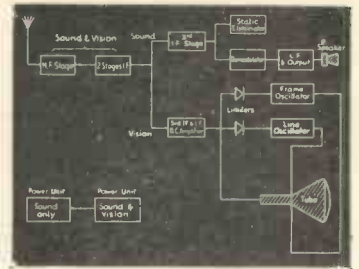

Block circuit diagram of the arrangement of the new "His Master's Voice" Television receivers. The high efficiency H.F. stage gives very high sensitivity and the arrangement of the line and frame oscillators ensures constant locking of the synchronising circuits.



The new Z62 H.F. valve as employed in the H.F. stages of the new "His Master's Voice" Television receivers owes its high efficiency in a large measure to the compactness of its design and the very stable electrode arrangement.

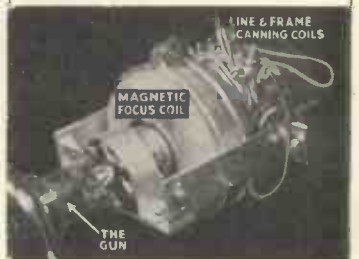

On the neck of the cathode ray tube in the new "His Master's Voice" Television receivers is supported this unit, which ensures the accuracy of focus and also provides the magnetic fields for line and frame scanning.

OTHER FEATURES INCLUDE

- ★ Phase reversal sound interference suppression.
- ★ Triode Cathode ray tube.
- ★ Accurate transient amplification and wide band I.F. circuits.

Before you buy an oscillograph

—or any other instrument....



THIS season manufacturers will require their dealers to have first-class servicing facilities. The public, too, will be guided to a large extent by the confidence they can place in their suppliers. For these reasons a well-equipped service department has become a vital necessity.

No matter how well your equipment has served you in the past, now is the time to consider seriously whether it is complete, and whether it is good enough for the future.

1. They are actual users of apparatus in their own factory and service department.
2. Their range of equipment covers all radio and television servicing requirements and is acknowledged to be the most efficient and reliable that can be obtained.
3. They have one of the finest Radio and Television training schools for service engineers in the industry.
4. They have a staff of service experts calling regularly on Radio

* Radio and Television Servicing with Cathode Ray Oscillographs
G.M.3152 and G.M.3155, Price 2/6 net.

You may already be thinking of a cathode ray oscillograph, a new oscillator or valve tester.

Before you decide, why not seek the advice of the organisation which has pioneered retail Service in this country and has the biggest reputation for efficient and dependable apparatus? Mullards offer all dealers the benefit of their vast experience in the design and application of modern service apparatus. They are the only organisation fully equipped to do this because:—

5. They have specially produced for service engineers a practical and comprehensive guide to the uses of the Cathode Ray Oscillograph *.
6. They have organised the biggest and most consistent service development campaign in this country.
7. They spend big sums annually in telling the public about service.
8. They have already equipped and advised well over 1,000 dealers.

Mullard

WIRELESS SERVICE COMPANY LTD.
CENTURY HOUSE, SHAFTESBURY AVENUE, LONDON, W.C.2
PHONE: GERRARD 7777

Cathode Ray Oscillograph Type G.M.3155.
(The G.M. 3152 is illustrated above.)

Service Signal Generator Type G.M.2880F.

Mullard Master Test Board Type 7629. Combined Valve Tester and Set Analyser.

Audio Frequency Oscillator Type G.M.2304.

Frequency modulated Oscillator Type G.M.2881.

Pye :: R.G.D.



The Philips projection receiver giving a picture 18 in. by 14½ in.

size is 7¼ in. by 5¾ in. The dimensions of the cabinet are 24½ in. wide, 16½ in. high and 14¼ in. deep with a projection of 2¼ in. for the end of the cathode ray tube.

35 gns. Model 2407. A console model giving a picture 7¼ in. by 5¾ in. with sound accompaniment of high quality. The cabinet measures 19¼ in. wide, by 32¾ in. high by 12¾ in. deep, plus a projection of 3¼ in. for the end of the cathode ray tube.

45 gns. Model 2412. A model similar in its main features to the 2407, but incorporating in addition the latest Philips 5-valve all-wave radio receiver with Philips' automatic tuning, giving television or ordinary broadcast programmes at will. The picture size is 7¼ in. by 5¾ in.

55 gns. Model 2415. This is the de luxe model of the new range, giving a picture 10 in. by 8 in. It incorporates a 5-valve all-wave radio receiver of advanced design, with Philips' automatic tuning and many other refinements.

120 gns. Model TEL 61. A large screen receiver incorporating Philips' picture projection system employing high-definition 4 in. cathode-ray tube. The picture size is 18 in. by 14½ in., and the model includes a 7-valve all-wave broadcast receiver chassis with motor driven press button tuning.

PYE, LTD.

Radio Works, Cambridge. Stand No. 32.

Pye Limited have introduced four new models, but the existing models are also being retained. The new models are as follows:—

32 gns. Model 9C.—A console receiver giving a picture approximately 7½ in. by 6 in.

39 gns. Model 12C.—A console receiver with a picture size 10 in. by 8 in.

47 gns. Model 12CR.—Similar to the model 12C but incorporating an all-wave radio receiver.

70 gns. Model 12RG providing a picture 10 in. by 8 in. and incorporating an auto-changer radiogram and all-wave radio.

The principal features in the Pye range of receivers are very similar. All of them include a synchronising stage of exclusive design which is entirely automatic, thus ensuring a perfectly steady picture without the need of adjustments. Another feature incorporated in the sound section is a noise suppression circuit which reduces to a considerable extent noise resulting from car ignition systems. The power consumption when both vision and sound sections are in operation is 200 watts, and that of the sound section alone is 60 watts.

Models 9C and 12C employ 17 valves, and models 12CR and 12RG 21 valves. All subsidiary controls are in front of the cabinet behind a panel between the two main controls.



Philips model 2412—television and all-wave radio.



Pye model 9C priced at 32 guineas.

RADIO GRAMOPHONE DEVELOPMENT CO., LTD.

Globe Works, Newtown Row, Birmingham, 6. Stand No. 29.

45 gns. Model 391. A 9-in. cathode-ray tube is employed, giving a directly-viewed picture 7½ in. by 6 in. The picture is on an inclined panel at a suitable angle for viewing.

The circuit is a 22-valve super-heterodyne vision and sound receiver with H.F. stage for vision and sound, separate oscillator and mixer valves, e.i.f. stages, diode second detector and video stage for vision, DDT valve and 5-watt tetrode for sound.

51 gns. (approx.). Model 393. The specification is the same as Model 391 except that a 12-in. cathode-ray tube is used giving a directly-viewed picture, 10 in. by 8 in.

75 gns. Model 391. R.G. The television specification is the same as model 391, but all-wave radio is included, consisting of a 6-valve 9-stage superheterodyne receiver operating on three wavebands; with fully automatic permeability push-button tuning on six stations, and also an automatic record-changer with magnetic pick-up.

130 gns. Model 392 R.G. employs a 12-in. cathode-ray tube giving a picture 10 in. by 8 in.

SCOPHONY

::

INVICTA

viewed through mirror in the lid. Independent television and radio is provided permitting ordinary radio programmes in one room, television in another. An automatic record-changer is included to play, or reject at will, eight 10-in. or 12-in. records mixed in any order. The cabinet is walnut, and all controls are mounted under the lid. The television receiver employs a 23-valve superheterodyne vision and sound receiver, and the radio circuit consists of an 11-valve 15-stage superheterodyne receiver operating on four wavebands.

controls being provided for vision and one control for sound.

An 18 in. receiver having built-in 10 valve all-wave push-button radio is also available.

Two Foot Receiver.—The 2 ft. receiver, an earlier model of which was shown at last year's Radiolympia, has since been considerably improved. This receiver has the high standards of brightness and definition achieved of the 18 in. receiver. As in the case of the 18 in. receiver the screen is built into the cabinet. This receiver is intended for the more spacious type of room available

ture can be operated by remote control.

As in the case of the other Scophony home receivers a super high-pressure mercury lamp, a product of the Scophony laboratories, is for the light source. The picture is projected from the rear on to a portable screen, and the sound is adequate for any size of room in which this receiver might be used.

Film Transmitters.—Scophony are also showing their latest type of film transmitter. The particular model is designed to work on 441 lines 60 frames a second, which is the



Of very special interest are the Scophony receivers as they are the only mechanical-optical type available. Above is the 4 ft. projection receiver and on the right a homes receiver giving a 2 ft. picture.



This is the Invicta model TL8.

SCOPHONY LIMITED

Thornwood Lodge, Campden Hill, W.8. Stand No. 49.

Scophony receivers are notable for the comparatively large pictures they produce, the smallest picture size being 18 in. by 14 in., while the largest is 4 ft. by 3 ft.; all utilise the Scophony optical-mechanical projection principles.

18-inch Receiver.—An entirely new development is this home receiver which gives a picture 18 in. by 14½ in. on a perfectly flat screen. The brightness is very high and the picture can be viewed with little less than ordinary room lighting. The picture is black and white and of excellent definition. The picture screen is built into the cabinet making a very attractive ensemble. This receiver is suitable for any size of living room, particular consideration having been given in connection with the design of this receiver to the average size of living room in modern London flats. Operation is very simple, only four

in the majority of larger houses. There are only four controls for vision and one control for sound. This receiver can also be obtained with all-wave push-button radio built in.

Large-screen Receiver

Palace de Luxe Receiver.—The development of this receiver is a striking contribution by the Scophony laboratories to modern requirements in entertainment. The receiver gives a picture approximately 4 ft. by 3 ft. 3 in. It has been designed for that type of town or country mansion which has a large size ballroom or a private cinema theatre so that any number of persons from a few dozen to three hundred can view the picture in comfort. Of course this receiver is also eminently suitable for clubs, schools, churches and any other type of small viewing hall.

The receiver is built into an all-metal cabinet with the electrical gear on a small rack from which the pic-

standard so far adopted by the United States of America. The fundamental principles of the Scophony optical system are employed in this transmitter and result in perfect geometrical definition. This model operates entirely the "tilt and bend" which occurs in the type of film transmitter at present in use.

INVICTA RADIO, LIMITED

St. Andrew's Road, Cambridge. Stand No. 16.

32 gns. Model TL7. Console receiver for vision and accompanying sound; picture on a screen measuring 7½ in. by 6 in.

39 gns. Model TL8 gives a picture measuring 10 in. by 8 in. Two main controls ensure that operation of the instrument is absolutely simple

70 gns. Model TL9 combines an all-wave press-button radio-gramophone with a vision receiver providing a large picture measuring 10 in. by 8 in.

IMPROVING THE TELEVISION CAMERA

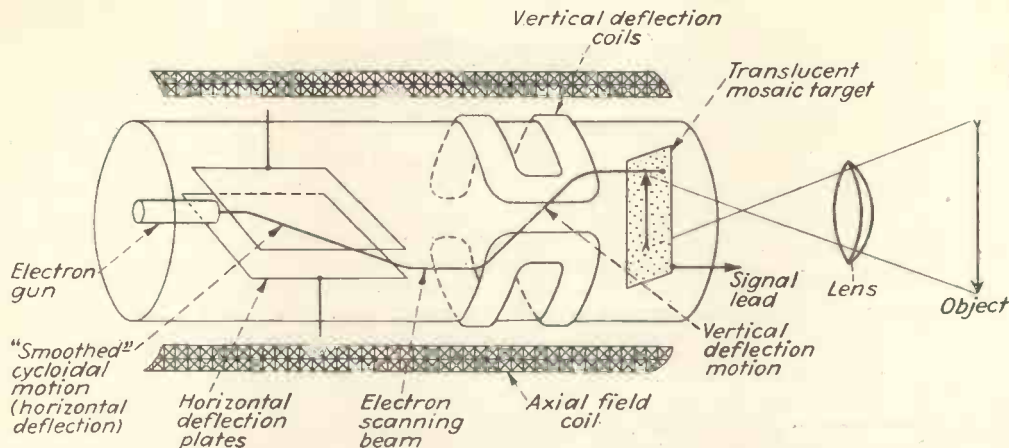

Fig. 3. Schematic diagram of the complete Orthicon. The deflection systems employed are shown in Figs. 4 and 5. It will be observed that the scanning beam impinges on the mosaic at right angles.

THE ORTHICON—A NEW PICK-UP TUBE

THE possibility of increasing the efficiency of the television camera is a matter which is continuously under investigation and, as is well known, notable improvements have been made in the Iconoscope within the past couple of years. Some original developments have recently been made by two engineers of the R.C.A. Manufacturing Co., Research Laboratories, Albert Rose and Harley Iams, which appear to have considerable promise and mark an advance upon the present type of Iconoscope.

In photographic parlance the new tube is a "gamma-unity" device, whereas the gamma of the conventional Iconoscope is in the neighbourhood of 0.7. The new tube it is claimed provides a more contrasty picture from a given subject than can the conventional pick-up tube.

Another advantage is the use of low velocity electrons for scanning the mosaic image plate by which effects of secondary emission from the surface of the plate are made negligibly small. No spurious "dark-spot" signal is generated, and the uneven shading so troublesome in Iconoscope pick-ups is thereby completely eliminated. Finally, the storage efficiency of the new tube is substantially 100 per cent., compared with 5 to 10 per cent. in the Iconoscope. The new tube therefore may be made to have an overall sensitivity 10 to 20 times that of the Iconoscope.

Low-velocity Scanning

The radical difference, between the Orthicon and all preceding forms of

Details of a new pick-up tube were recently revealed at the Convention of The Institute of Radio Engineers, New York. The advantages claimed are that spurious signals are obviated and the storage efficiency is consequently greater than in the case of the Iconoscope. We are indebted to "Electronics," New York, for the details of the paper which was read by the inventors—Albert Rose and Harley Iams of the R.C.A. Research Laboratories.

the Iconoscope, is the use of low-velocity electrons for scanning. This has made necessary the development of a new technique of scanning,

which combines the effects of a magnetic field and an electric field. This new deflection technique is a striking example of the practical application of low-velocity electron optics.

The tube is a cylindrical structure about 20 in. long and 4 in. in diameter. The image plate on which the optical image is focused is located at one end of the tube and measures about 2 in. by 2½ in. The picture resolution obtainable within this area can exceed 400 lines, and up to 700 lines has been achieved.

The relationship between light input and current output is linear from zero light to the value of light which exhausts the beam current (about one microampere). The maximum signal-to-noise ratio is from 300 to 500 times. The sensitivity of the present models is somewhat greater than that of the Iconoscope.

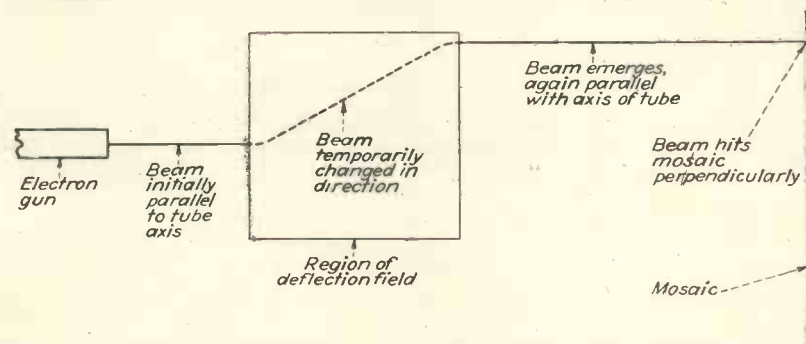

Fig. 1. In order to maintain perpendicular scanning a combination of electronic and magnetic forces is employed, the field deflecting the beam temporarily.

Defects of the Iconoscope

Inconoscope Principles

To appreciate the advantages of the newly-developed tube, it is necessary to recall the operation of the conventional Iconoscope and to realise how the use of a high-velocity scanning beam imposes limitations on the operation of the tube. These limitations were reviewed by Mr. Iams as follows: in the conventional

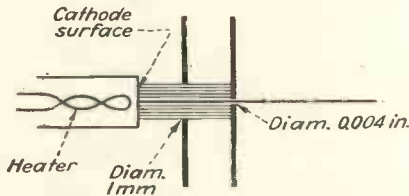

Fig. 2. The simple electric gun employed in the experimental Orthicon.

Iconoscope a mosaic composed of many tiny photosensitive globules is exposed to the optical image. The globules emit electrons under the influence of the light and thereby assume a positive charge in proportion to the amount of light falling on them.

Since the globules are insulated from one another, the charge distribution so acquired cannot redistribute itself, but remains stored on the surface of the mosaic until the

ventional Iconoscope is accelerated to a velocity equivalent to about 1,000 volts. The necessity of employing an electron velocity as high as this is the need for maintaining a sharply focused beam which will retain uniform focus over the entire area of the mosaic, and which will excite a high level of signal current.

When the electron beam hits the globules of the mosaic its immediate effect is to liberate secondary electrons from them. The number of secondary electrons liberated depends, among other things, on the positive charge which the mosaic has assumed due to the photoelectric emission. In consequence the secondary electron current from the mosaic varies with the charge distribution induced by the optical image on the mosaic. The variations of this secondary electron current, when collected by the collector electrode of the tube, constitute the signal current from the tube. Hence the secondary emission effect is of primary importance in the operation of the tube.

But, according to Mr. Iams, the secondary emission has other effects which are not desirable, and which in fact limit the operation of the tube. In the first place, there are more secondary electrons liberated than there are electrons received from the scanning beam, since the secondary

mosaic plate in a shower of electrons.

If the shower were perfectly uniform over the whole plate area, the only effect would be a loss of the distribution of stored charge. But the shower is not uniform, due in part to local irregularities in the secondary emission ratio on the plate, and due also to the effect of differences in the field existing at the plate surface. The shower of secondary electrons thus produces a random charge distribution which is superimposed on the regular charge distribution due to the optical image. The random distribution gives rise to a spurious signal, known as "dark-spot," which has no direct connection with the desired picture, and which has the effect of causing an unevenness in the background shading of the reproduced picture.

The presence of the high secondary electron emission has still another undesirable effect. It produces a retarding field at the surface of the mosaic which inhibits the emission of the photoelectric electrons under the influence of the optical image. Therefore the photoelectric current is not saturated, but has a value roughly one-third of saturation. This reduces the possible output of the camera tube by the same factor. The stored charge on the mosaic is, in addition, partially neutralised by the shower of returning secondary electrons, and this effect reduces the net photo-electric effect by another factor of three. The total output of current is thus reduced by two factors of roughly three, and the output signal current is accordingly one-ninth what it would be if the photo-electric emission were saturated and there were no loss of stored charge.

Avoiding Secondary Emission

To improve on the conventional Iconoscope, in the opinion of the authors, the indicated course of action is to get rid of the secondary emission (and thus obtain saturated photo-electric emission, no loss of stored charge and no spurious signal) and at the same time to substitute another agency for the secondary electrons in forming the picture signal.

In the new tube this result is effected by using a scanning beam com-

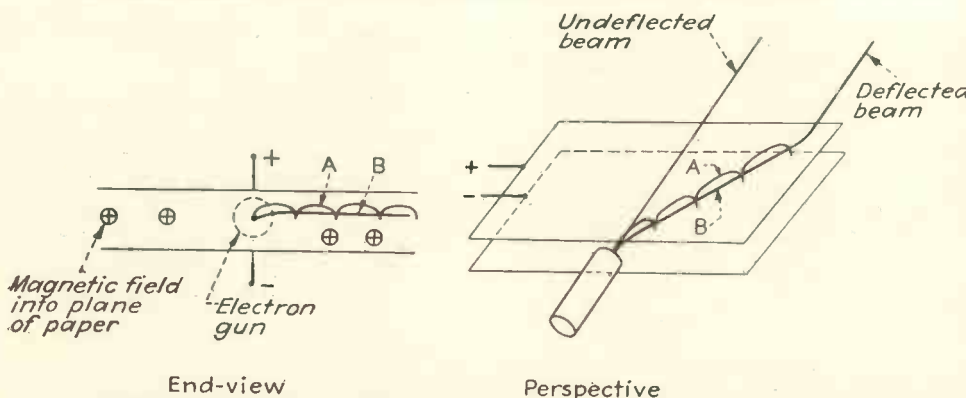

Fig. 4. Method of obtaining "temporary" deflection (horizontal direction). The cycloidal motion (A) is obtained with electric and magnetic fields. The smoother motion (B) is obtained by employing a "fringing field" in the electric component.

charge equilibrium is restored by the scanning beam. This beam, formed in an electron gun in a side-arm of the tube, is directed toward the plate and is deflected by electromagnetic deflecting fields to cover the plate in a pattern of interlaced scanning lines. The beam employed in the conven-

emission ratio is greater than unity. But the mosaic plate is insulated, therefore on the average the number of electrons leaving it must equal the number gained. Accordingly only part of the secondary electron current can be collected; the remainder must fall back on the

A Low-Velocity Beam

posed of low-velocity electrons. The mosaic target is maintained at the potential of the cathode of the electron gun. Consequently the electron beam travels between two electrodes (the cathode and the mosaic) which have no difference of potential between them. Since the electrons start off at a very small velocity at the cathode, they must meet the mosaic with an equally small velocity. The low-velocity beam electrons, when they impinge on the mosaic, are in no position to excite secondary emission, and, in fact, no secondary emission effects have been observed. Furthermore, the low-velocity beam electrons act as the agency for withdrawing the picture signal from the mosaic and conducting it to the collector electrode whence it travels to the external circuit.

The maximum value of the signal current is accordingly equal to the maximum value of beam current, which in the present experimental tubes is about one microampere. Passed through a 100,000-ohm load resistor, this output current is equivalent to a 0.1 volt output signal.

The use of a low-velocity scanning beam is not without its difficulties. In the first place such low-velocity beams are very subject to deflection by stray magnetic or electric fields. In the second place, low-velocity beams are in general subject to severe defocusing if the beam does not hit the scanned surface directly at right angles. Thus, if the scanned beam hits the surface perpendicularly and if the mosaic potential is the same as the cathode potential, the electron comes to rest at the surface, turns around and travels back toward the cathode directly away from the surface. The defocusing which occurs is due only to the emission velocity of electrons from the cathode. On the other hand, if the beam hits the surface at an angle the electrons "skid" along the surface tangentially and are reflected back toward the cathode at an angle equal to their angle of arrival. The point of contact of the electron with the surface is correspondingly ill-defined, that is, defocusing occurs.

To avoid this effect, it is preferable that the scanning beam impinge on the mosaic perpendicularly, no

matter at what point in the scanning pattern. This precludes the use of conventional deflecting technique, in which the scanning beam is caused to scan the surface by the application of deflection forces which change the direction of the beam. In this latter case, the electron beam hits the outer edges of the mosaic at an angle.

To produce a method of scanning in which the beam maintains a perpendicular relation to the mosaic at all points, it is possible to employ a deflecting system which changes the

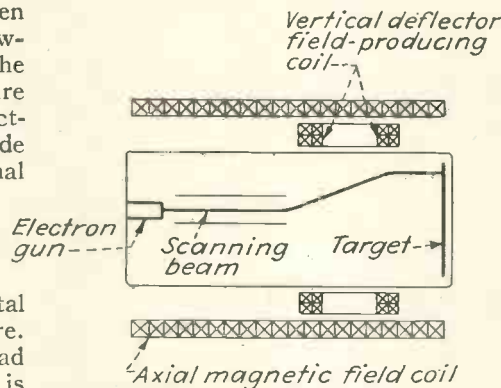

Fig. 5. Vertical deflection is obtained with a transverse magnetic field supplied by coils at right angles to tube axis.

angle of the beam temporarily, as shown in Fig. 1.

The beam enters the deflecting system as a stream of electrons from the gun. The deflecting system imposes a change in direction which persists only so long as the beam is within the deflecting field. Immediately after the beam emerges from the plates, it resumes its forward course and travels from the deflecting plates to the mosaic in a line parallel to the axis of the tube, and finally hits the mosaic perpendicularly. To produce a deflecting system of this type in practice is not simple.

Orthicon Construction

In developing a thermionic cathode type of tube, described by Dr. Rose, the first question was that of the electron gun. A very simple form was used, illustrated in Fig. 2. The cathode is a flat surface, directly in front of which is an aperture approximately 1 mm. in diameter. This aperture defines a bundle of electrons, which is further reduced in

cross-section by a pin-hole aperture (4/100th in. diameter). The positive potentials applied to the apertures are of low magnitude, so the beam is composed of low-velocity electrons and the cross-section of the beam is narrow and well defined.

Thereafter the beam travels into the tube proper, shown in Fig. 3. A coil surrounding the tube produces a uniform magnetic field whose lines of force are parallel to the axis of the tube. The low-velocity electrons in the beam, when left to their own devices travel along these lines of force. Deflection is accomplished by superimposing on the magnetic field an electrostatic field between two large deflecting plates. The actions of these deflecting plates is shown in Fig. 4. The deflecting plates impart a transverse motion to the electrons, in the direction of the positive plate. This transverse motion, through the axial magnetic field, causes the electron to describe a path which projected on the end-view resembles a half circle, returning the electron to its original distance from the positive plate. The half-circle motions are repeated and the result, as projected, is a cycloidal motion which displaces the beam to the right as shown.

During this motion, the beam is proceeding forward. Consequently when it emerges from the deflecting plates, the beam has been moved sidewise by the width of the cycloidal motion. However, on emerging from the plate, the beam no longer executes the cycloidal motion but takes a path depending on its components of velocity at the instant of leaving the field between the plates. If the electron happens, at this point, to be at the lowest point of one of cycloids, the path after emerging is a straight line parallel to the axis of the tube.

The cycloidal motion is a means of deflecting a beam without introducing any angular deviation between the beginning and end of the electron motion. While the cycloidal motion is a possible mode of operation it is difficult to control. The cycloidal motion may be modified, as shown by the line (B) in Fig. 4, to a motion which moves directly across the tube. This modification of the cycloidal motion is obtained by using deflection plates with appreciable

(Continued on page 573)

Scannings and Reflections



TELEVISION AT OLYMPIA

TELEVISION will be well to the fore at the Radiolympia Exhibition, where more than fifty sets will be continuously in action in the Television Avenue throughout the day, taking either the B.B.C. studio programmes from Alexandra Palace, relays from the Radiolympia theatre, or closed circuit relays which will not be radiated to home viewers.

The Radiolympia theatre is a reproduction of the famous "Hollywood Bowl." It is unique in that it is the first theatre ever to be built solely for sound and television broadcasting.

As in 1938, "Come and be Televised" will be a daily morning feature of the Exhibition. Jasmine Bligh and Elizabeth Cowell, the two television announcers, will be "at home" at Radiolympia during the mornings from 11 a.m. to 12 noon to welcome in front of the television cameras members of the public who would like to meet them personally. Visitors will be encouraged to chat informally on any subject which may appeal to them.

During the run of the Exhibition, Harold Cox, the producer, will be available from 2.30 to 5.30 p.m. each afternoon in the B.B.C. reception room.

TELEVISED ENTERTAINMENT

Home viewers and visitors to the Exhibition will be entertained by a whole galaxy of stars. Bobby Howell and his band will play throughout the Exhibition. The Kentucky Minstrels, with Harry S. Pepper and Doris Arnold, will be an almost daily feature, with a banjo accompaniment by Troise and his Mandoliers. Other popular radio and television stars taking part will be the Gordon Radiolympia Girls, C. Denier Warren, Adelaide Hall, Murray and Mooney, Ike Hatch, Scott and Whaley, Nosmo King and Hubert, and C. H. Middleton just to mention a few.

Visitors to the Exhibition will be

able to watch interesting personalities interviewed before the television cameras.

RADIOLYMPIA PROGRAMMES

From the revolving stage of the theatre at this year's big Radiolympia show—the first theatre ever to be built for both radio and television—five programmes, several of them packed with well-known artists, are to be broadcast by the B.B.C.

Arrangements have already been made for the following broadcasts to take place:—

August 23, National: Opening Night—All-Star Variety, with Jessie Matthews and Sonnie Hale; Scott and Whaley; Ike Hatch; Stanford and McNaughton; Adelaide Hall; Nosmo King and Hubert; Charles Austin; the Radiolympia Male Voice Choir; Bobby Howell and his Band; and Troise and his Mandoliers.

August 26, National: Stage version of Harry S. Pepper's "Kentucky Minstrels," with a cast that includes Scott and Whaley; C. Denier Warren; Ike Hatch; Nosmo King; Kentucky Minstrels' Chorus; and Bobby Howell's Orchestra. The guest artist will be Adelaide Hall and the conductor, David Evans.

August 28, Regional: Bobby Howell and his Band.

August 29, Regional: Troise and his Mandoliers, with Emilio, the boy accordionist, Percy Manchester, and Murray and Mooney.

September 1, Regional: Variety Half-Hour, with Nosmo King and Hubert; Adelaide Hall; Murray and Mooney; and the Gordon Radiolympia Girls.

"BITS AND PIECES"

Under this unpretentious title has been worked up what promises to be a most amusing half-hour of light entertainment with a programme which will include Bobbie Kimber in his own ventriloquial act; Robin Hood and Shelagh Furley will contribute songs and dances; Edward

Cooper will entertain with songs at the piano; and Jackie Billings and Diana Chase will be seen in dances.

"Bit and Pieces" will be produced in the evening of August 28 and repeated in the afternoon programme on September 2.

FILMS FOR TELEVISION

A film entitled "Galloping Dynamite" was televised from Alexandra Palace on August 21. Although this was quite a small film and comparatively old, the film trade feel that even this type of film should be withheld from the B.B.C., for television to them is still an important competitor.

TELEVISION AT OLYMPIA

Most of the manufacturers at Olympia this year will be using their own television theatres, some of which will actually be on the stands themselves. One manufacturer claims that 60 viewers at a time will be able to see their new models actually on the radio stand.

CHEAP TICKETS FOR OLYMPIA

The Radio Manufacturers' Association have inaugurated for the first time a special department to obtain low rail and coach fares and generally help dealers. Special party admission tickets are being supplied at 9d. (half their normal price) where a dealer is bringing 20 or more, and in many cases seats are being obtained in Radiolympia's broadcast and television theatre for only 1s. 3d.

GAUMONT-BRITISH AND TELEVISION

It was announced by Mr. Isidore Osterer that television of the big-screen type would be installed in all suitable Odeon cinemas just as fast as the equipment could be obtained. At the annual general meeting Mr. Osterer made the following statement:—

"From the theatre angle we are

MORE SCANNINGS

concerned in what is termed large-screen television and we have taken the necessary steps to secure the installation of these sets in our theatres as fast as they can be produced. Those theatres already equipped have shown many items of great interest during the year, culminating in the wonderful picture of the homecoming of the King and Queen."

GERMAN TELEVISION DELAYED

Owing to the lack of raw material having become so acute it is reported that the Standard television receiver which was exhibited at the Berlin Exhibition will not be available to the public until the end of the year.

TELEVISION FOR THE PROVINCES

On October 9, Mr. Graham White will ask the Postmaster-General for a statement regarding the possibility of a television in provincial centres. It is hoped that the P.M.G. will be able to provide a definite finding.

U.S.A. BAN ON FILMS

Distributors in America are baring the use of films for broadcasting over television channels. This bar comes into operation on August 26, and comes more or less into line with the point of view of the British exhibitors. American television companies are obtaining films at the present time mainly through independent companies, but this scheme has not proved satisfactory.

PUBLIC TELEVISION IN ITALY

Television has at last started in Italy and the first public television performance under the control of the E.R.A.R. was given before an audience of specially invited guests including Italian and foreign journalists.

Public are to be admitted free to the television shows which are to be given each evening at the Circus Maximus. The station situated at Monte Mario has a range of 30 miles and uses 7.40 metres for sound and 6.8 metres for vision.

FIFTY CINEMAS TO HAVE VISION

Captain West of Baird Television, Ltd., mentions that fifty Gaumont-British theatres would be equipped

for vision by the end of next year. He also stated that G.B. have five halls in the London area already equipped and this number will be increased to twelve before the end of 1939.

POLYTECHNIC LECTURES

A course of lectures have been organised by the Regent Street Polytechnic, details of which are as follows. On Monday, September 25, a course in Radio Gramophone Service Work will begin and this is in co-operation with the Gramophone Company, Limited. The second course, starting on September 25, is on Radio and Television Engineering; the enrolment dates are between September 18 and September 22. Full information on these and other radio courses can be obtained from W. H. Date, B.Sc., Polytechnic, 307-11 Regent Street, W.1.

WIRELESS LICENCES

The Post Office issued 363,114 wireless receiving licences during July, 1939. This figure represents a nett increase of 20,640 in the number of licence holders during the month after making allowance for expired licences and renewals.

The approximate total number of licences in force at the end of July, 1939, was 9,030,950 as compared with 8,657,100 at the end of July, 1938, an increase during the year of 373,850.

EDISON EXHIBITS AT RADIOLYMPIA

Mazda cathode-ray tubes, television valves and radio valves are shown on this stand, and a special feature is made of the new Mazda battery valves for dry cell operation. All these valves are fitted with the Mazda octal base.

A novel feature of this year's stand is the "Electroencephalograph," which may be described popularly as a receiving set for tapping in to the brain activity. The apparatus has been designed by Mr. Grey Walter, a physiologist who has spent many years in the special study of the brain. The final form of this instrument is manufactured by The Edison Swan Electric Co., Ltd. A reproduction of a room in a clinic has been set up on the stand and the working of the apparatus is

explained by models, diagrams and labels.

Ediswan are again making a feature of television; the viewing corridor situated at one corner of the stand allowing maximum ease for viewers in passing through. There will be three television screens, and fluorescent displays activated by ultra-violet radiation will form the scheme of decoration. B.T.H. R.K. speakers, headphones, and pick-ups will also be on show.

Modern Test Gear

As the advance in service engineering has been most marked in the past year the Mullard Wireless Service Company, Limited, are specialising in equipment for the advanced service specialist.

Amongst the gear available are the following: A cathode-ray oscilloscope incorporating a three hard-valve time base, a three valve two-stage amplifier, linear up to 1 Mc., and a hard tube. A special oscillograph with a 3 in. high vacuum tube for televising receiver servicing includes a vertical amplifier, with a linear frequency response up to 100 Kc., and again of more than 150 times.

A signal service generator with an R.F. range of 14 to 3,000 metres which uses only four valves and can be modulated or unmodulated as required. Included is a 6-position attenuator and a continuously variable potentiometer. Designed for use with the Signal Service Generator and cathode-ray oscillograph is a frequency modulated oscillator. It incorporates its own supply unit and three valves. The scale for the main frequency control is calibrated in kilocycles (minus 25 Kc. to plus 25 Kc.) so enabling band width to be directly read.

A beat-frequency audio oscillator with a range of 15 to 15,000 cycles is also available and is fitted with two directly calibrated frequency controls. A wide selection of output impedances is available and the maximum output with less than 2 per cent. harmonic content is more than 400 milliwatts.

In addition, radio and television receivers, cathode-ray tubes, receiving and transmitting valves of all kinds are being featured by Mullard this year.

TELEVISION IN GERMANY

BY OUR BERLIN CORRESPONDENT— 1939
A. A. GULLILAND

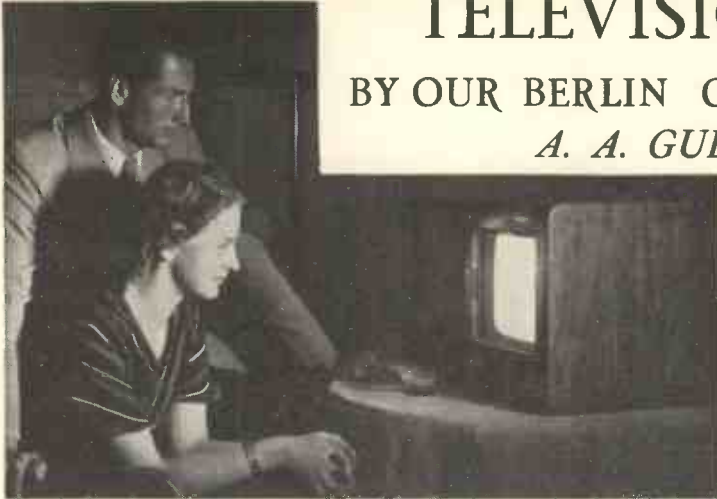

Germany's Standard television receiver is priced at 650 marks and the picture size is 19.5 cm. by 22.5 cm. The screen is flat ended and square short tube.

This article is a complete review of the immediate proposals for a television service in Germany. One receiver only will at first be available to the public.

AFTER more than ten years of public experimental services on various numbers of lines for definition, German television has at last become standardised on 441 lines, 50 half-frames per second, interlaced.

The official opening of the first entirely public service was scheduled for October 1st, 1938, but owing to the political situation at the time this was postponed until July 18th, 1939, the opening day of Berlin's sixteenth and incidentally last Radio Exhibition in consecutive series. (Next year there will only be a small show at Cologne in connection with an international exhibition there).

The German Service

Now that Germany, or rather Berlin has a full-fledged television service with regular daily programmes from 5 p.m. to 10 p.m. (from August 6th onwards) and with the possibility of purchasing sets in the shops in the near future, it is interesting to review, very briefly, the present position of German television.

There is one station operating in Berlin in the extreme West-End. The aerial of this station is not sufficiently high and therefore does not give good service in the extreme East End. It has been decided to erect a small 20 watt auxiliary transmitter on a high building in the East End to serve this area.

The two mountain-top transmitters, one in Central Germany on the summit of the Brocken and one near Frankfurt am Main on the summit of the Feldberg, have been completed. They are shortly to start tests. Further television transmitters are already being prepared for Hamburg,

Nuremberg, Munich, Vienna and Cologne.

These transmitters will not be ready until some two to three years' time. Meanwhile there are further plans for Berlin which are already under way and these include the building of a huge "Television Palace" on Spandauer Berg in the extreme West End of the town with a 330 ft. aerial tower. The new building will also contain the most modern television studios. Building is to commence immediately as the present studios are in a house which is to be demolished for the re-modelling of the Adolf Hitler Square into the Mussolini Place in the West End.

People's Receiver

To enable the largest possible number of people in Berlin to take advantage of the television programmes and on the other hand to give the manufacturers some profit without great capital investment, the authorities have prescribed a "standard" television set, which will, at first, be the only one on the

market. This receiver was designed jointly, by pooling experiences and patents, by the five German television firms: Fernseh A.G., Telefunken, Lorenz, Loewe, and TekaDe. The result is a small-sized table model with a picture 19.5 cm. by 22.5 cm. Five thousand of these are to be made by December as a first "service."

The most important improvement compared to former receivers is the introduction of a square tube with a flat face giving a square, flat picture, instead of the usual rounded type with a convex end.

A large number of economies have been effected by various means. Thus the vision receiver has 15 valves of which only four are rectifiers. This has been made possible by the development of two special valves. Then a method has been devised of using the "flash-over" on the transformer for the time-base circuits as anode current, this obviating the necessity for a special H.T. power supply.

These and other economies have made it possible to produce five thousand receivers at the price of £32 10s. od. each at par.

The production of these receivers by December is contingent upon sufficient raw materials being available for their production.

Apart from this standard receiver

The Standard television receiver will be the first to be sold to the public. Its design is the result of a combined effort on the part of the leading German manufacturers.

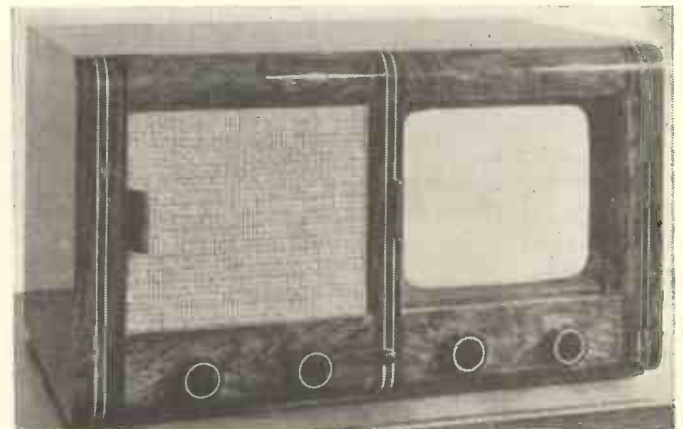

Square Cathode-ray Tubes

some of the television firms are to continue work on their more expensive receivers which may, at some future time, become available to the public.

Thus Telefunken is to continue its last year's cabinet receiver, Lorenz its compact table model, and Fernseh A.G. has gone a step forward and has produced three new types of receivers. These were not on general

Fernseh A.G., is 3 m. by 3.6 m. Illumination seemed good and even a little brighter than in some of the smaller 300-seat cinemas. But the television picture lacked the brilliance of the modern cinema screen. This hall will be open regularly to the public from September 1 onwards.

At the Radio Exhibition where the standard television set was shown as the only working instrument in the

screen, but this only worked on two days at the end of the show.

And now a word about the new organisation of the German Public Television Service. The programmes are supplied by the Broadcasting Company Studio equipment, operation, cameras, lighting are by a subsidiary Post Office organisation called The German Post Office Television Co., Ltd., cables and transmitters re-

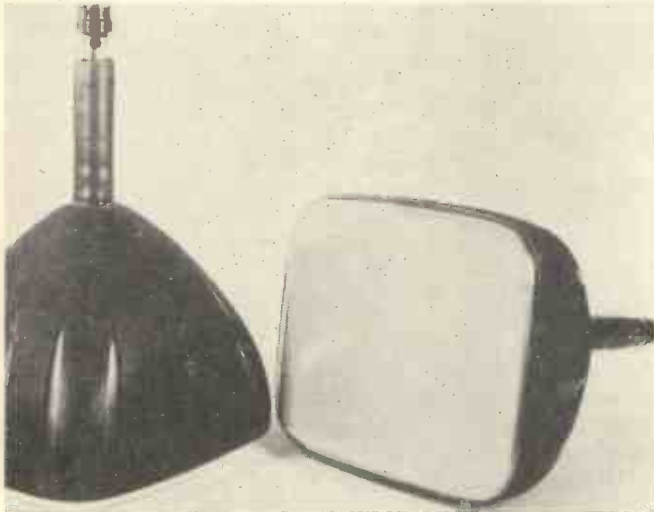

This is the new square flat-faced tube for Germany's Standard television receiver.



Interior of the Berlin studio with two cameras in operation.

view at the exhibition but were demonstrated only to private visitors in groups. One receiver is a table model with a screen 27.5 cm. by 31.5 cm. This employs one of the new German "short" tubes with a square and flat screen.

Then there is a small table model projection receiver for home use which produces a picture 42 cm. by 50 cm. on a special lens-screen in the lid of the set.

Television service in Germany will be by wireless and also by wire. For the wireless service a standard carrier frequency is used of 8.4 Mc. The wired television service, however, will use a carrier of only 4.2 Mc. Many of the new Fernseh A.-G. have been equipped with this frequency so as to permit of wired television reception.

As far as large-screen projection reception in Germany is concerned there was a very successful demonstration during the show in a Post Office in the North End of Berlin. This was in a hall three floors up and which has no lift. It will hold some 500-600 people. The screen, which is the new lens-type developed by

television section, a tent had been installed for a large-screen projector by Professor Karolus. Some trouble was experienced with this, however, and it was never demonstrated. On the other hand Telefunken installed a projection tube receiver for a small

main in the hands of the Post Office, as in the case of the broadcasting transmitters.

The formation of a Post Office company for the technical studio was due to the fact that this is the usual custom with the German Post Office

Full lines show television cables already in existence and dotted lines those proposed

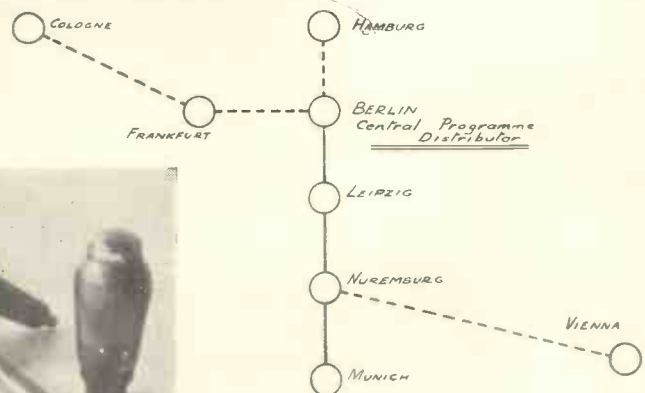

These are two of the small projector tubes used for the Fernseh home projector. An ordinary valve gives an idea of the size.

when it is wished to run an undertaking on semi-commercial lines.

The system of public televiewing rooms is to continue; there are ten of them in Berlin and one in Potsdam and all are equipped with 441-line receivers.

THE "AUGETRON"



MULTI-STAGE ELECTRON MULTIPLIER

IN certain respects the ordinary valve is far from being an ideal electrical device, particularly where either very small currents or very high frequencies are involved.

For example unwanted noise effects are inevitably produced in coupling resistances which set a limit to the smallness of the currents that it is possible to amplify.

The liberation of secondary electrons when surfaces are bombarded by electron streams has in the past been considered a troublesome effect, and in valve design special precautions are taken to reduce such secondary emission to a minimum. Now, however, it has been found possible to utilise secondary emission in such a way as to obtain very considerable amplification of currents over a very wide frequency range.

What the Secondary-Emission Tube is

The secondary emission multiplier tube, which is of comparatively recent development, consists essentially in a primary electron source, a suitable means of modulating the primary electron stream, one or more successive cathodes so treated as to produce copious secondary electrons when bombarded by that primary stream, and finally a collector electrode in the circuit of which may be placed the load in which the desired amplified output voltage will be developed. The primary cathode may be either photo-electric (in which case the incident light may be modulated) or it may be thermionic, in which case grid-modulation is employed, and voltage amplification becomes possible.

If the simplest case of electron source, secondary cathode and collector be first examined, some of the problems attendant upon the design of multipliers are at once apparent. It is necessary to devise an electron arrangement which allows as many

of the primary electrons as possible to bombard the second cathode, while providing at the same time on the secondary cathode surface, a suitable collecting field due to the final anode. But that collecting field must not be such that primaries are drawn directly on to the collector, otherwise the apparent ratio of secondaries to primaries will thereby be diminished.

Several methods of constructing multi-stage secondary emission multipliers are possible and of particular interest is the principle used in the Augetron. The cathode is in the form of a suitably sensitised metal plate, in which have been punched a large number of holes in funnel shaped depressions. In effect it may be said that when primary bombardment

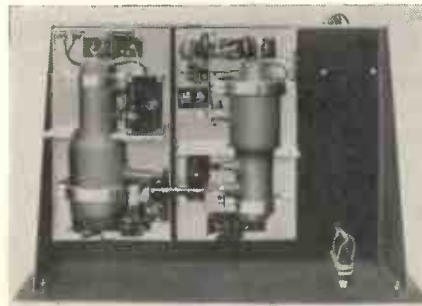

Underside of vision chassis employing Augetron.

occurs at any point on the surface, the secondaries so liberated already possess a component of velocity in the direction at right angles to the main surface of the cathode. The collecting field due to the succeeding positive electrode can then penetrate through the holes at the bottom of each depression, and so the secondaries are drawn through and accelerated in the desired direction.

There are, however, certain other requirements which are to be met before an effective thermionic multiplier valve for voltage amplification purposes become possible.

The secondary cathode arrangement must be robust, but there will

obviously be an upper limit of current and voltage above which wattage dissipation can cause undesirable heating effects. These effects will be more pronounced at the output end of the tube and hence a robust, flat perforated plate is employed as the final collector anode. The maximum current that may be handled by this anode is of the order of 20 milli-amperes at 250 volts. Hence, if the standing D.C. output current is limited, obviously the D.C. input current must be limited also (it must, of course, be appreciated that an electron multiplier amplifies the direct current equally as well as the desired A.C. signal component). Therefore, the input end must function with a very small standing current. The Augetron multiplier is designed for the gain of about a thousand, and has an output current of 10 milliamperes, so at the input end, the current must be 10 micro-amperes, and the problem arises of constructing a cathode-grid arrangement which possesses a good mutual conductance for such a small current.

By careful design it has been proved possible to construct an electron gun in which the mutual conductance is some four times the standing current. This will then give (for the desired input current of 10 micro-amperes) an output slope of 40 milliamperes per volt at 10 milliamperes current, a figure 3 or 4 times better than the best radio valves on the market. The electrode arrangement at the gun end consists of a specially shaped indirectly heated thermionic cathode assembly in which the control grid and accelerator electrode are so situated as to project the modulated beam to the centre of the first secondary cathode. The thermionic cathode has a large emitting area in the equi-potential metal surround provided by a partially closed cylinder at cathode potential.

In order to obtain the overall gain of a thousand, a 6 stage multiplier has been standardised, running at an overall voltage of about 2,000 volts, or some 300 volts per stage. Under these conditions, each normal secondary emitter gives a stage gain of about $2\frac{1}{2}$. The final stage consists of a flat plate secondary emitter preceded by a flat perforated plate collector. This arrangement is found to give a gain equivalent to a multiplication by approximately 7. It has been found that the flat plate is preferable to an open mesh grid on account of wattage dissipation and rigidity.

A NEW BAIRD COLOUR-TELEVISION SYSTEM

By F. W. Marchant

First technical details of an experimental colour television system employing a cathode-ray tube at the receiver

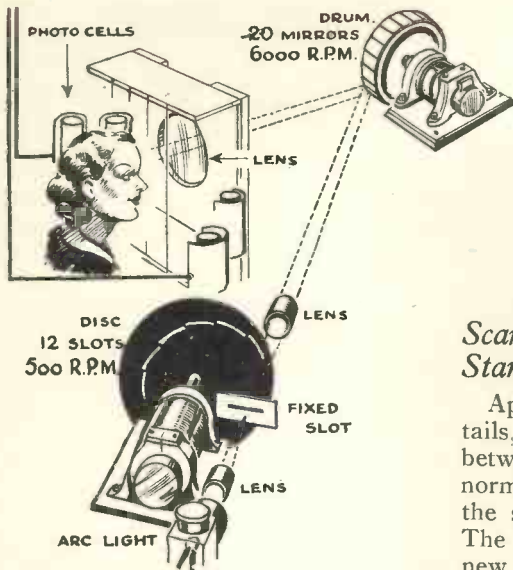

Fig. 1. The Baird colour television transmitter.

AS was briefly reported in last month's issue, towards the end of July, Mr. J. L. Baird demonstrated a very considerable advance in the technique of television in natural colours. Prior to this demonstration, Mr. Baird has employed apparatus which was wholly mechanical, both at the scanner and at the receiver, the last instance of this being when he gave a series of demonstrations at the Dominion Theatre, Tottenham Court Road. On that occasion rather cumbersome and expensive mechanical apparatus was employed, details of which appeared in this journal. The recent demonstration, although employing a transmitter similar in type and operation to the one used at the Dominion Theatre, made use of the cathode-ray tube as the receiver: a very great step forward.

It must be appreciated that it is permissible to use a mechanical scanner for the transmitter since at the transmitting end there are skilled technicians capable of operating the apparatus. At the receiver, however, it is a very different matter. While it is quite possible to have duplicate sets of an electronic apparatus, it is not an economical proposition, either with regard to finance or space, to duplicate a complicated mechanical scanner, from the point of view of the cinema, for which this apparatus is of very considerable interest. For this reason, and also since the system will perhaps eventually be suitable for normal television receivers, this demonstration of the use of the cathode-ray tube in colour television is of importance.

Scanning Standard

Apart from actual mechanical details, the fundamental difference between the colour system and the normal television system, is that of the standard of scanning employed. The scanning sequence is far from new, in fact Mr. Baird used it in some of his very early experiments in 1923. A description of the type of scanning now employed was given in this journal in January, 1937, but perhaps it would be as well to give here a brief description of the system, known as the "Baird Multi-mesh Scanning System."

Secondary Scans

The "raster" in this case is not covered by just two separate scans interlaced, but by a number of "secondary" scans, each composed of two interlaced scans, interpolated. This is achieved by producing the secondary scan in the manner mentioned, and then laterally displacing it a number of times. For instance, a final scan of 240 lines may be formed by a secondary scan composed of two 30-line scans interlaced, which is then displaced four times, so forming a final "raster" of (2 by 30) by 4 which equals 240 lines, multi-mesh scanning.

It is claimed for this system that it has a number of advantages over

the normal type of scanning. These are as follows: (1) a high frame frequency with an accompanying high-low-frequency cut off is obtained; (2) a reduction in flicker and a considerably increased light efficiency; (3) an exceedingly simple optical system of very high efficiency may be employed.

Will Receiver Sales be Influenced?

The manner in which the announcement of colour television would influence the sale of normal television receivers, was the cause of some misgiving in official sales services of the industry. It was felt that potential purchasers of receivers would consider waiting until it was possible to buy a set which would give coloured pictures. This is, of course, entirely the wrong attitude to take, but nevertheless there is little doubt that some people would think along these lines. The above description of the scanning system shows clearly that great alterations in the transmitting gear would be necessary before it would be possible to give the public a service of coloured television, and also it must not be forgotten that the B.B.C. has undertaken to make no changes which would make a change in receivers necessary, until after 1942 at the earliest.

The demonstration must be re-

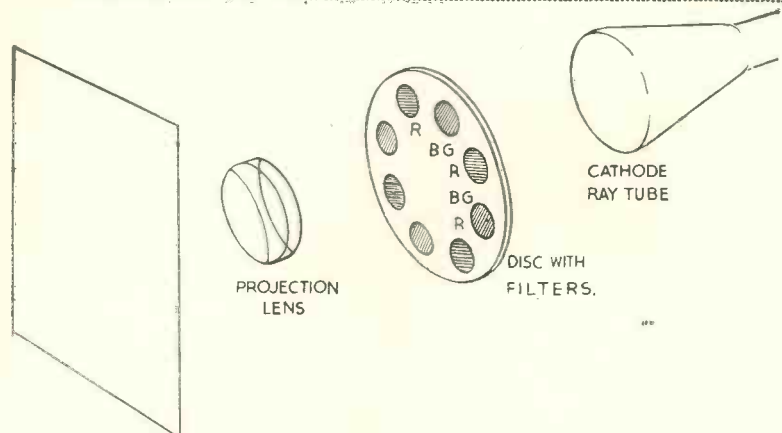

Fig. 2. Schematic outline of Baird colour television receiver.

garded as purely experimental and as showing how, in the near future, the system might be of great interest to the cinema, rather than to the ordinary television viewer. This does not necessarily mean that in the distant future colour television will not be available to the general public, but rather that the probabilities are that the cinema will be able to make use of it far earlier than the B.B.C., because cinemas could have their own transmitting station, and therefore not be dependent upon the normal transmissions.

Details of Apparatus

It is a well-known fact that all colours may be obtained by a mixture of the three primary colours, red, blue and green. J. L. Baird makes use of alternate red and blue-green filters in his apparatus, with which he obtains the suitable colour tones.

The method of scanning employed at the transmitter consists of the spot-light system. That is to say, the subject being televised, is scanned by a spot of light moving in the correct scanning sequence.

Fig. 1 shows clearly the manner in which the scanning apparatus operates. The light source is a high-intensity arc lamp, the rays of which are projected through a stationary slit, behind which revolves a scanning disc. This disc has arranged around its axis, a series of slots, in helical formation toward the centre of the disc. It will be clear that as the disc revolves, the slots passing in turn behind the slit, will in fact form a scanning spot which moves along the slit. The resulting spot of light is then projected upon a mirror drum, which in turn reflects it on to the subject being televised. The light reflected from the subject is then picked up by special colour sensitive photo-electric cells, the resulting electrical impulses being passed through the amplifiers to the radio transmitter.

Each slot in the scanning disc is covered with a colour filter, the first slot red, the next blue-green and so forth, so that in effect, the subject is being scanned with alternate spots of red and blue-green light, so that the special cells transmit a red and blue-green image depending upon which filter is in action. The mirror drum, which has 34 facets, revolves at 6,000 revolutions per minute, while the scanning disc revolves at 500 revolutions per minute. This combination

gives a final "raster" of 102 lines, at a monochrome frequency of $33\frac{1}{3}$ per second, being composed of a secondary scan, made up from three scans of 34 lines interlaced the secondary being displaced three times. This results in a 102 line red picture, superimposed on a 102 line blue-green

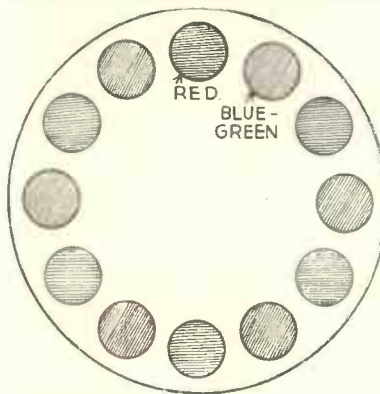

Fig. 3. Diagram of colour filter disc.

picture, the final result being a 102 line picture in natural colours at a colour picture frequency of $16\frac{2}{3}$.

It will be noted that the transmission end is similar to that used at the Dominion Theatre, but that instead of subjecting the televised person to

the rays of an exceedingly brilliant light, the spot-light system is used.

The Cathode-ray Tube as the Receiver

The application of the cathode-ray tube at the receiving end, although being the outstanding advance in this system, is quite simple. A glance at Fig. 2 will show quite clearly the manner in which the coloured pictures are obtained. The incoming picture signal is used to modulate a cathode-ray tube in the usual manner so giving a normal black and white picture on the tube. In front of the tube, there is rotated in synchronism with the scanning disc at the transmitter, another disc with colour filters arranged in the same order, Fig. 3. The picture on the tube is projected through these filters on to a screen, and since the transmitted signal represents alternately the red and the blue-green component of the subject, then in the same order a red and blue-green picture will be produced.

In the demonstration the picture shown was some 3 feet square, and was transmitted from the South Tower of the Crystal Palace to Mr. Baird's home in Sydenham.

150,000 R.P.M.

High-speed Motor-scanner Development

FOLLOWING experiments in television reception with the steel-ball scanner unit recently developed for the mechanical receiver described in this Journal, Mr. Jeffree is making slight modifications in the design to facilitate synchronising. These will have the effect of making this less dependent on the circuit used for driving the unit. The general appearance will not be much altered, but the efficiency in terms of torque developed for a given input will at the same time be improved.

At the same time a small motor of similar type, without the ball scanner, is being produced for experimental purposes, with a view particularly to its use in school laboratories. One characteristic of this type of motor is, that it can be synchronously run at a wide range of speeds, either under the control of an external frequency or at the speed determined by the uncontrolled oscillator setting. It can therefore be used for exact counting of oscillations and for driving light apparatus

at precisely controlled speeds, on the principle of the well-known electric clock, and also for experiments demanding very high speeds of rotation, such as the determination, even over path distance of a few yards, of the velocity of light. To facilitate its use for such purposes, a number of simple attachments will be made available, including a train of gears giving reductions of 10, 100, 1,000 and 10,000 to one, for recording the number of rotations in a given period; mirror attachment and auxiliary apparatus for measuring the speed of light.

A "really" high speed motor is also being worked on, designed to run at about 150,000 r.p.m. from a frequency of about 10,000 cps. This will be self-starting and synchronous only at the full running speed.

The two former types, for the mechanical receiver and for schools, will be obtainable, as hitherto, from H. E. Sanders and Co., of Grays Inn Road; the schools type, it is hoped, within a week or two.

A RECORD OF PATENTS AND PROGRESS

RECENT
TELEVISION
DEVELOPMENTS

PATENTEES

Radio Akt., D. S. Loewe
E. L. C. White and C. L. Faudell
Scophony Ltd., G. Wikkenhauser
and A. F. H. Thompson
J. D. McGee
Scophony Ltd., and F. Okolicsanyi
Fernseh Akt.

Interlaced Scanning
(Patent No. 504,460.)

IN interlaced scanning it is essential to ensure that the second series of lines fall exactly between the first set, because the eye is so sensitive that it will perceive the fault even if the displacement is only of the order of 1 per cent. The trouble usually

sible burn-out, should the scanning voltage fail for any reason and so allow the scanning spot either to come to rest on the screen, or to traverse the same scanning line several times in succession.

The line and frame scanning currents are fed to the deflecting coils of the C.R. tube from two separate amplifiers. Each amplifier is coupled

ply. Simultaneously a discharge path is provided to the comparatively-low voltage of the mains supply line. This renders the scanning beam harmless. —E. L. C. White and C. L. Faudell.

Scanning Systems
(Patent No. 504,668.)

The Figure shows in schematic form the arrangement of a two-sided mosaic-cell screen S, which is actually mounted inside a cathode-ray tube. The picture to be televised is projected through a lens L on to the front side of the screen, which is also subjected to the action of a scanning-stream of electrons from the gun G of the cathode-ray tube. The result of this scanning is to release electrons from the screen S on to a positively-charged anode A made in the form of a ring.

The other face of the screen is scanned by a strong ray of light projected from a rotating mirror-drum M and disc D. As a result electrons are liberated from the screen S on to a second ring-anode A₁, which is kept at a fixed positive potential.

The two scanning operations follow each other rapidly, but during the interval between their repetition (i.e. for practically the whole of one framing period) the mosaic cells are building-up a charge corresponding to each elementary "point" of the original picture. The sudden changes of potential produced during the

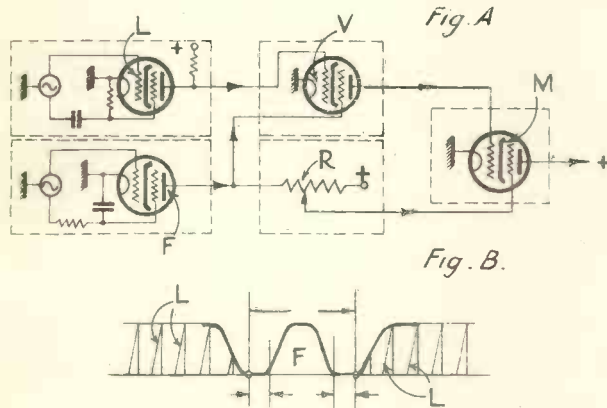

Method of ensuring accurate interlacing.
Patent No. 504,460.

arises when the framing impulses are not completely separated from the line impulses.

According to the invention, the problem is met by suppressing the line impulses for a short period immediately before the arrival of each framing impulse. In Fig. A the generator for the line impulses is shown at L, and that for the frame impulses at F. A valve V, which is connected between the line generator L and the mixer valve M feeding the transmitter is controlled by the frame-impulse voltages across the resistance R, so that it ceases to conduct just before and just after each framing signal. The result is shown in Fig. B, where the train L of line impulses is "cut out" on each side of the framing signal F.—Radio Akt., D. S. Loewe.

to a shunt rectifier, so as to develop a grid voltage for an auxiliary or control valve.

If the supply from either of the scanning circuits is interrupted for any reason, the voltage on the grid of the control valve cuts down the output current from that valve, and so automatically opens a relay in one of the leads to the high-tension sup-

Protecting the Fluorescent Screen
(Patent No. 505,490.)

The sensitive screen of a cathode-ray tube is safeguarded against pos-

Combined electronic and mechanical scanning system.
Patent No. 504,688.

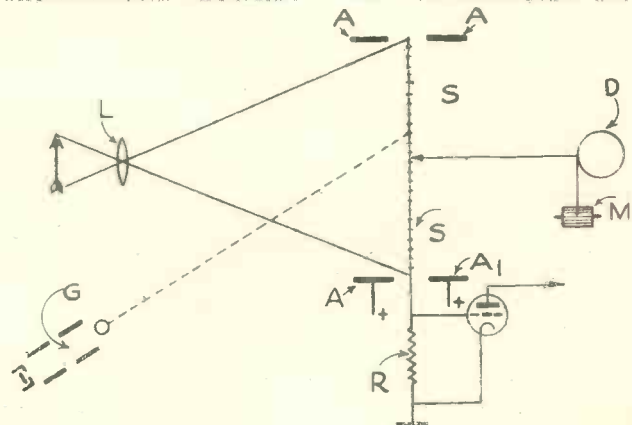

scanning operations develop picture signals across the resistance R.—*Scophony, Ltd.; G. Wikkenhauser; and A. F. H. Thompson.*

Electron-Multipliers

(Patent No. 504,927.)

A picture is projected on to a photo-sensitive cathode C, and the electrons emitted from the latter are focused by external windings W and passed in succession through a

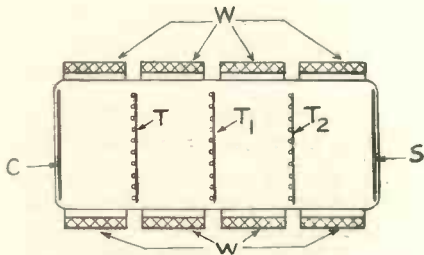

Electron-multiplier with permeable screen.
Patent No. 504,927.

series of secondary-emitting electrodes T, T₁, T₂. They finally reach a luminescent screen S, where the picture is reproduced at higher intensity owing to the successive amplification produced at each of the electrodes T.

The electrodes T are made of a very thin film of metal, a few millionths of a centimetre thick, laid over a fine-mesh wire grid. The metal is so thin that when electrons strike against one side of it, secondary electrons are projected from the other side. In effect each electrode is permeable to the stream, which can therefore pass from one end of the tube to the other.

The luminescent screen S is replaced by a "mosaic cell" screen when the arrangement is used for developing television signals for transmission.—*J. D. McGee.*

Television Systems

(Patent No. 505,653.)

The object of the invention is to make a more complete use of the variable factors present in the signals now used in television. In practice the amplitude of a given signal determines the brightness of a particular point on the picture, whilst the phase of the signal determines the position of that particular point in the picture as a whole.

Actually the eye is unable to follow very gradual changes of picture brightness, though the amplitude of the transmitted signal keeps pace

with every alteration, no matter how small it may be.

It is therefore proposed to use the amplitude-variation of a single signal impulse to transmit information of the changes in brightness of several picture-points, simultaneously. In this way better use is made of each signal wave, so that the frequency-band normally required to transmit pictures of a given quality can be reduced. Alternatively the same spread of frequency-band can be made to transmit more complete "information" such for instance as would enable the picture to be reproduced in colour.—*Scophony, Ltd., and F. Okolicsanyi.*

Optical Projectors

(Patent No. 505,850.)

The ordinary lens system used for projecting a picture from the fluorescent screen of a cathode-ray receiver on to an external viewing-screen is replaced by a "mosaic" lens, built up of a large number of small pieces of glass. The glass particles, which may be hemispherical in shape, are mounted on the back of the fluorescent screen by means of a transparent adhesive having a low refractive index.

Each individual lens should be of approximately the same size as the scanning-spot. It serves to collect the light from each elementary picture-point into a parallel beam, which is then easily projected on to the external viewing screen.

This avoids the loss of light which usually occurs, owing to the rays of light from the screen being dispersed in all directions. In such circumstances only a small proportion is collected even by a lens of large aperture.—*Fernseh Akt.*

Summary of Other Television Patents

(Patent No. 491,934.)

Producing saw-toothed scanning-impulses from a valve of the relaxation-oscillation type.—*C. L. Faudell and E. L. C. White.*

(Patent No. 504,109.)

Cathode-ray television receiver using secondary emission to increase the brilliancy of the received picture.—*O. Klemperer.*

(Patent No. 504,526.)

Cathode-ray transmitter in which an electron image is first analysed into elementary components which are then amplified before transmission.—*Farnsworth Television Inc.*

(Patent No. 504,725.)

Preventing distortion due to feedback "ripple" in a saw-toothed oscillation-generator.—*The British Thomson-Houston Co., Ltd., and D. J. Mynall.*

(Patent No. 504,898.)

Rotary scanning system for televising from cinema films combined with a lens unit for producing synchronising impulses.—*Electrical Research Products Inc.*

(Patent No. 505,022.)

"Blocking" oscillator for generating saw-toothed impulses for use in television.—*C. L. Faudell.*

(Patent No. 505,031.)

Preventing picture distortion produced by inaccurately tuning the sound circuits in a television receiver.—*Telefunken Ges fur drahtlose Telegraphie M.B.H.*

(Patent No. 505,197.)

Compensating for variations in the brightness of the scanning spot due to local variations in the thickness of the luminescent screen.—*Baird Television, Ltd.; G. Dovaston, and G. E. G. Graham.*

Better Reception

for

RADIO

and

TELEVISION

with

AUGETRON

Multi-Stage

Electron-Multiplier

The

Modern Amplifier

**VACUUM-SCIENCE
PRODUCTS, LTD.**

Bosch Electronics, 166, Weir Road,
S.W.12. Tel.: Tulse Hill 4606

WEBB'S LONDON AND BIRMINGHAM

FOUR-PAGE SUPPLEMENT

HALLICRAFTERS FREQUENCY METER

An accurate instrument for checking Frequencies ; for checking Receiver Calibration ; for callbrating Receivers and Crystals, etc. ; for Bandsetting Receivers ; for Locating Signals for Skeds ; for Setting ECO Frequency. This meter performs a very important function in amateur radio operations. For 110-250 volts A.C., £9.

'APEX' 3-BAND EXCITER

A very cleverly designed and economical three-Band Switched crystal and ECO Exciter unit, built on to a standard Eddystone 19-in. panel, with appropriate brackets and chassis. Price of the exciter, complete with all valves, coils and one crystal, £15 - 10 - 0. (Power Pack £6 - 10 - 0 extra.)

Special 10-15 watt crystal control transmitter, designed originally for use with the C.W.R. and R.N.W.A.R., it is capable of operation on all amateur frequencies, in addition to the special frequencies allotted to the above reserves. Price complete (but without crystal), £8. (Valpey Crystal 15/6 extra.)

C.W.R. TRANSMITTER

TRANSMITTERS

HALLICRAFTERS HT-6

Radiotelephone and telegraph 25-watt transmitter. Choice of any three bands by Selector Switch—changing all circuits from crystal to antennae. When changing bands it is only necessary to retune final amplifier plate. Oscillator tube works as straight oscillator on 20-40-80-160 metre bands, using fundamental crystal. For 5 and 10-metre bands, 10 and 20-metre crystals are used, respectively. Many other important features. Transmitter complete with valves for bandswitching any three amateur bands (but less coils and crystals), £30 - 0 - 0. SPECIAL MODEL FOR POLICE WORK U.H.F.

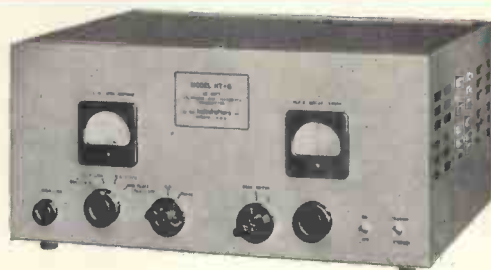

HALLICRAFTERS HT-1

The Model HT-1 transmitter is conservatively rated at 50 watts Phone Carrier output and 100 watts C.W., but in operation is equivalent to the performance of the 75 or 100 watts "input" kit constructed Phone Transmitter. Three Band Selector Switch for any three amateur ranges. No detail has been neglected to add to its dependability—generously oversized transformers and other components are used—the design was built round the latest, most advanced type Raytheon Tubes. Price complete, ready for operation on 3 Bands, less Microphone and Key, £73 - 0 - 0.

UHX-25 Model as illustrated. The new UHX-25 has everything you could ask for in performance, price and appearance. From the chrome-trimmed cabinet to the rugged chassis it looks and is an outstanding value in the transmitting field. Transmitter complete with valves and coils for 2 adjacent wave bands (no crystal, microphone, or key), £29 - 0 - 0. Coils for any wave band from 5 to 160 metres, 30/- per set. Crystals, 15/6 and 35/-. Power Pack for 230-volt input, £19 - 0 - 0.

UHX-10 The new UHX-10 all-purpose transmitter, having an unlimited number of possible applications in the general communications field. Due to the wide frequency coverage obtainable, it is especially useful in Commercial, Amateur and Experimental Services for both fixed and portable-mobile work. Complete with Valves, Crystal, Microphone and Key, for Two-Band operation, £19 - 0 - 0. Power Pack for 230 volt input, with valves, £6 - 10 - 0. Genemotor, with Remote Control and Filter, £9 - 16 - 0.



"APEX" MODULATOR

An economy type of modulator designed and built for the use of the transmitter operating with inputs up to 30 watts. An exceptionally efficient speech amplifier circuit using a high frequency pentode, type KTZ 63, with high impedance input for crystal microphone, followed by a double triode, type 6N7, is used to drive through paraphased couplings two KT66 beam power valves in push-pull. Price complete, £11.

SEE OVERLEAF FOR COMMUNICATION RECEIVERS

WEBB'S COMMUNICATIONS



SKYRIDER SUPER SPECIAL MODEL SX17

Though now 12-months old the **SKYRIDER SUPER SPECIAL** still stands supreme above all others. It is a custom-built job of outstanding merit. Leading features: TWO R.F. STAGES; COMPLETE COVERAGE—4.5 TO 550 METRES; BUILT-IN NOISE SILENCER; ELECTRICAL BAND SPREAD; R METER; DIE CAST ALUMINIUM CHASSIS; 13 VALVES; and VARIABLE B.F.O. INJECTION. Price for 110 to 250-volt A.C., including valves and crystal, £39 - 10 - 0. (Speaker, £4.)



SKYRIDER 5-10 The Finest U.H.F. Receiver

This receiver is designed for the amateur who needs and wants the exacting performance required for superior ultra high frequency reception. It covers the radio spectrum from 68 mc. to 27 mc. (4.4 to 11.1) in two bands with a degree of sensitivity and selectivity that offers unparalleled reception of the ultra high frequencies. Price complete with valves and speaker £20 (Carrier Level Meter £2 - 15 - 0).
Special model available for POLICE WORK. Full details to officials only.

RME DB20 PRESELECTOR



The DB20 Preselector is a great asset to ANY COMMUNICATION OR ORDINARY SHORT WAVE SUPERHETERODYNE RECEIVER, and will give a great gain in output, particularly from weak signals. A two-stage radio frequency amplifier, employing two 6K7 valves, with its own built-in power pack, and covering continuously from 9 to 550 metres. Price complete with valves, £12 - 10 - 0.

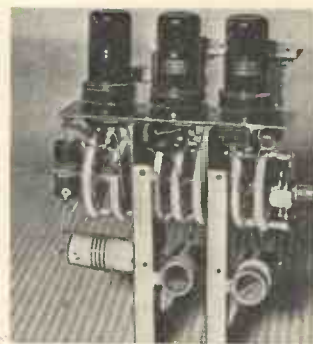

DM36 FREQUENCY EXPANDER

DM-36 by RME—Band expander for 5 and 10 metres, to be used with your present receiver as a double I.F. unit with the R.F. section set permanently at 10,000 kc. Radically improved in design and operation. Real band spread on 5 and 10 metres is readily obtained. Price, complete in cabinet, £12 - 0 - 0.

Sole Agents for H.A.

NEW SKYRIDER SX24

The Skyrider SX24 offers performance that can be avourably compared to any receiver regardless of price. It has new features, like BUILT-IN FREQUENCY METER TUNING, that are absolutely new. In addition, it has all the desirable features and qualities that are needed for outstanding amateur reception: GENERAL COVERAGE—43.5 to .54 mc. (6.8 to 555 m.); FREQUENCY METER TUNING; BUILT-IN NOISE LIMITER; VARIABLE SELECTIVITY; FREQUENCY STABILITY; BATTERY OPERATION; BREAK-IN RELAY OPERATION; CRYSTAL FILTER; FOUR BAND POSITIONS; 9 VALVES; ELECTRICAL BAND SPREAD. Price for 110 to 250-volt A.C., including valves and crystal, £21. (Speaker, £4.)

NEW SKYRIDER 23 Embodies all the features of the Ideal communications receiver. New in conception, new in design, new in performance—at the ideal price of £33 - 10 - 0. See Webb's Catalogue.



COMMUNICATION RECEIVERS

HALLICRAFTERS

NEW SKY CHAMPION

THE SKY CHAMPION is an 8-valve Receiver with Pre-Selection and Built-in Speaker, complete in every respect, offering the amateur a quality of performance never before available at this low price—Leading features: COMPLETE COVERAGE—6.8 to 550 METRES; FOUR BANDS; SEPARATE BAND SPREAD DIAL; INDIVIDUAL COILS FOR EACH BAND; INERTIA TUNING MECHANISM; BEAT FREQUENCY OSCILLATOR; AVC SWITCH; EXCELLENT SENSITIVITY AND SELECTIVITY; A.F. GAIN CONTROL; BAND-SWITCH; SENSITIVITY CONTROL. Price for 110 to 230-volt A.C., complete with Speaker, £15 - 15 - 0.

S.M. 'S' METER. This signal strength indicator has been designed as an accessory to the **SKY CHAMPION**. All that is necessary to connect the meter is to plug it into its socket on the back of the receiver chassis. Price complete, 55/-.

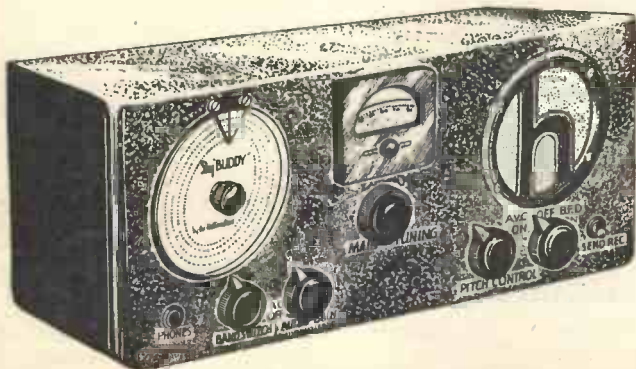

NEW SKY BUDDY

How can it be done? Here's a new **SKY BUDDY**, designed to include the 10-metre band and with the same Electrical Band Spread used in higher-priced Hallicrafter models, with better all-round performance than ever before—but still selling at an amazingly low price! This **NEW SKY BUDDY** has sensitivity, image ratio, signal-to-noise ratio and all-round performance that excels many receivers sold at twice its price. Leading features: 6 VALVES, WITH 8-VALVE PERFORMANCE; FOUR BANDS; COMPLETE COVERAGE—9.4 to 550 METRES; COVERS 10-METRE BAND; ELECTRICAL BAND SPREAD; SEPARATE BAND SPREAD DIAL; BUILT-IN SPEAKER; AVC SWITCH; BEAT FREQUENCY OSCILLATOR; PITCH CONTROL; SEND-RECEIVE SWITCH; PHONE JACK. Price for 110 to 250-volts A.C., £10.



NATIONAL HRO HIGH FREQUENCY

Two preselector stages give remarkable image frequency suppression, weak signal response and high Signal-to-Noise Ratio. The two high-gain I.F. stages employ Litz-wound coils and are tuned with air condensers. The usable sensitivity and selectivity are exceptional. Other circuit details are: automatic and manual volume control, a vacuum tube voltmeter calibrated in "S" units for carrier intensities, a phone jack, a Send-Receive switch and a Lamb Single-Signal crystal filter. This filter makes selectivity adjustable over a wide range and the circuits are so precisely balanced that heterodyning signals may be completely phased out. Standard model—2½-volt A.C. or 6-volt battery—complete with valves (but without speaker), £49 - 15 - 0. Additional coils from 160 to 6,000 metres available from stock.

NEW HAMMARLUND HQ120

This new amateur communications receiver includes many outstanding features. 12 valves, cover a range from 9 to 545 metres. New and revolutionary crystal filter circuit; special R.F. and detector circuits providing uniform gain throughout the amateur bands; entirely new design in tuning condensers providing extreme accuracy; CALIBRATED BAND-SPREAD DIAL as well as main tuning dial; new vacuum tube voltmeter circuit for accurate logging—meter is calibrated in "S" units up to "S-9" and also up to 40db. above "S-9." Antenna compensating control; noise limiter; phone reception. Possible by a flip of the switch to employ the crystal filter for the reception of voice or music. Price complete for 230 volts, £36 - 15 - 0.



MORE WEBB'S LINES



WEBB'S RADIO GLOBE

Of real importance to the radio amateur—and even to the ordinary listener to S.W. stations. Absolutely accurate in every detail; a very handsome production, and a fitting co-operator with the finest communication receiver. The diameter of the actual globe is exactly twelve inches, while the overall height is approximately 14 inches. Full colour printing is employed, all International Prefixes clearly marked, ENABLING ANY STATION HEARD TO BE INSTANTLY LOCATED. Price (post paid), 27/6.

RADIO MAP OF THE WORLD

One of the outstanding services which Webb's have rendered to the radio fraternity is the production of an azimuthal map centred on London. An enormous amount of time has been spent to assure that every detail of the map, both from the geographical and radio aspects, is correct. Every international prefix clearly marked and the map offers an enormous amount of data to the keen radio enthusiast. Size 40 x 30, post free, 4/6. (On heavy linen, 10/6.)

RADIO LOG BOOK

Contains 75 pages of log sheets to standard G.P.O. design, the reverse of each sheet is left blank for notes on operation, etc. "Q" and "RST" codes and valve connection data are included. Patent Spirax binding to ensure that open book remains perfectly flat and takes up minimum space. Size of pages, 8½ in. x 11 in. Price, post free, 2/6.

FINE 60-PAGE ILLUSTRATED CATALOGUE—Post Free 2d.

NEW U.H.F. COMPONENTS

To meet the demand for suitable components for use in Ultra High Frequency transmitters and receivers, **WEBB'S** are now stocking a full range of Cardwell & Hammarlund condensers in addition to the FULLEST POSSIBLE RANGE OF EDDYSTONE AND OTHER BRITISH INSTRUMENTS. See *Webb's Catalogue*.

'VALPEY' QUARTZ CRYSTALS

Type VM2 Mounted Crystal to your specified frequency in 7 mc. band (over 1,000 constantly stocked), 15/6; 3.5 mc. band within 5 kc. of your specified frequency, 15/6; 1.7 mc. special cut, 15/6; UNMOUNTED CRYSTALS, 7 mc. only, "X" cut, 10/6. CALIBRATION CERTIFICATE TO G.P.O. REQUIREMENTS, 1/6 extra.

★ Complete Range of **EDDYSTONE** Components and Receivers ★

WEBB'S LONDON

THE HOME OF THE SHORT-WAVE ENTHUSIAST
14, SOHO ST., OXFORD ST., W.1

Telephone: Gerrard 2089

Birmingham Depot:—41, CARRS LANE. Telephone: Mid 5669.

All Orders by Post to London address.

SEE OVERLEAF FOR COMMUNICATION RECEIVERS

T elegossip

MR. HAROLD COX, the producer of the feature "Come and Be Televised" at Radiolympia, tells me that he is faced this year with a problem precisely opposite to that which troubled him last August. At the last show members of the public were so shy of facing the cameras that for two or three days he was at his wits' end to find people who wanted to be televised.

After a harassing first day he was reduced to ringing up friends on the telephone and imploring them to help him out. Later on things improved.

This year the B.B.C. issued an early invitation to the public to send written applications to Alexandra Palace. The result was that at the time of writing Mr. Cox was wading through the best part of a thousand letters. One reason for the deluge appears to be that most of the writers were under the mistaken impression that the B.B.C. intended to pay them. Actually, the B.B.C. proposes to do nothing of the sort and in fact will not even pay expenses.

Amateur sopranos and raconteurs were in the majority among the applicants. Some had taken part in the Spanish civil war, but there were people with every sort of experience from big game hunting to service in the Foreign Legion. Six hairdressers wrote (all independently) offering to demonstrate how they had cut the hair of various famous people. Some fifty mothers told the B.B.C. they had offspring who were second Shirley Temples. One lady of seventy-five offered to give a display of physical culture. There were innumerable professionals, chiefly instrumentalists and acrobats, for whom the invitation was not strictly intended.

The setting for "Come and Be Televised" will be a drawing room, in which Jasmine Bligh will preside over the morning coffee-pot, and talk informally to her visitors. Each item will be a friendly chat more than an interview, and there will be no page-boy to introduce the arrivals, as last year.

Receiver Prices

Visitors to the exhibition will by now be aware that there are no reductions in receiver prices and in some cases there are actually small

By *L. Marsland-Gander*

increases. The manufacturers have made a big effort this year to put the market on a rational basis and have divided the sets into four classes with minimum price levels in each class. This is not a "ring" to force up prices but a sensible arrangement to turn losses into a small profit.

Low thunder clouds, some people are finding, are capable of causing ghost images.

I heard the other day that a set was installed on one of the training ships on the river, and the engineers were horrified to find that they had three distinct images instead of one. The trouble was only overcome when they erected a sharply directional aerial of the "tilted wire" type.

Incidentally the trade, while pressing hard for that Birmingham station, has not paid half enough attention to the problem of interference in general. If it were made compulsory to fit suppressors to the sparking plugs of motor cars, enormous handicap to television development in districts outside the service area would be removed. The potential audience would be doubled or trebled at a stroke.

Long-Distance Reception

I have recently watched programmes on sets in the neighbourhood of Littlehampton and Worthing, roughly sixty miles from Alexandra Palace. The snowstorm on the picture is bearable but car interference is particularly troublesome on the sound and does a lot to spoil enjoyment. Such interference is the more irritating when one reflects that it is really quite unnecessary. But the fact is that the car manufacturers have not had their consciences roused in the matter.

I took my car into the service depot of one of the leading manufacturers the other day and when I called to collect it was astonished to find that all the suppressors had been removed. When I asked the reason I was told "Oh, we always do that."

If the Television Committee of the R.M.A. would divert a tenth of the energy they have given to procuring provincial television to urging upon

A Causerie of Fact Comment and Criticism

the Postmaster-General the need for legislation on car interference, they would do viewers and the industry a great service. The last word of the Postmaster-General on the subject of the anti-interference clauses in the new Wireless Telegraphy Bill was that the long delay was being caused by the necessity for consulting so many different interests.

The picture as received at Littlehampton is excellent, apart from the superimposed noises and blemishes. There is no difficulty whatever in holding it, although the Downs just behind make a 500-foot barrier between the town and Alexandra Palace.

The News Reels

I hear that negotiations are going on between Mr. Gerald Cock, Sir Stephen Tallents and the cinema industry over the supply of news reels. The B.B.C. is desperately anxious to prevent the application of the threatened ban, and the prospects, at the moment, that they will succeed are quite hopeful.

This activity is, of course, purely defensive. I have not discovered any plans for an ambitious autumn programme "putsch." The disappointing fact is that for the past nine months there has been no development worthy the name at Alexandra Palace except staff increases to a total of 500. No progress whatever has been made with the scheme to convert the old theatre into a big new studio. The B.B.C. is still waiting for that Treasury grant. And we have been told *ad nauseam* that the B.B.C. cannot increase hours or launch out in other directions till cash is forthcoming to provide more studios.

Still, television troubles are not all financial. I understand that 80 per cent. of the potential variety artists in the country are now banned by their managements from appearing in television. The B.B.C. puts this forward as an excuse for the employment of so many foreign artists and it is certainly difficult to find the answer. However, the ban indicates that some of the people who are in the best position to judge entertainment value think that television is now so good as to be a very serious competitor.

Short Waves

Short-wave Editor,
Kenneth Jowers, G5ZJ

PRINCIPAL FEATURES

A Switched-coil Pre-amplifier	546
A Guide to Short-wave Equipment	550
Short-wave Radio Show	555
Frequency Stability in a C-O Stage	568
Building a Universal Exciter	570
On 56 Mc.	574
Long Skip	575

A QSL card can serve three purposes, or even four, if one regards it as a free substitute for wallpaper! Its chief use is to give written confirmation of a "first-time" QSO. A second object of the QSL is to convey details supplementing the brief description of the transmitter, receiver, antenna, etc., which may have been given "over the air." Third, the card can form an interesting souvenir of the station.

The first of these purposes is served by any QSL card printed to one of the standard designs produced by various firms of printers. It is the second and third functions of a QSL which may well be thought to justify any extra cost or trouble entailed in getting out an original design.

Incidentally, designing a card is an enjoyable hobby, affording plenty of scope for ingenuity, originality and artistic leanings—if any!

For ease of handling, the card should be standard postcard size, as anything larger than this may entail folding at the Bureau if you QSL via R.S.G.B. Printing or lettering on the card should be easily legible and with the call-sign should be large enough to show up boldly on the wall of a shack. The problem is how to print all the essential data on to the limited space of a postcard without spoiling the design, cramping the call-sign or making the smaller lettering almost illegible. This is where ingenuity is required!

If you can think out a novel, original way of arranging the design it will make the card more interesting and distinctive. A novel feature of my own QSL, for instance, is that it presents some of the data graphically. The time of the QSO is shown pictorially by simply making two strokes of the pen, on the clock-face in the top left-hand corner of the design. These pen-strokes represent the hour and minute hands in their correct positions to indicate when, by G.M.T. or B.S.T., the contact commenced.

Below this clock-face is a rectangular space large enough for the date to be stamped in with a rubber date-stamp, which saves time if one is doing a large batch of QSL's, and incidentally shows up very clearly and boldly, especially if one uses an inking-pad of a colour contrasting with the rest of the lettering.

Another item shown graphically on my card is the input in watts at the time of the QSO. As mine is a QRP station

Designing the QSL Card

By G3XT

the scale is graduated 0-10 watts, and I simply mark an arrow at the appropriate point on the scale to indicate the power used on any particular occasion.

In the case of a semi-pictorial card a line block is necessary for the diagrammatic portions, or the sketch of the QRA if one is included. If one can manage to do the lettering by hand well enough to pass muster, then the cheapest way is to do the entire design manually and have a post-card-sized line block made, so that any printer can run off as many copies as required without any typesetting being necessary.

The design should be drawn and lettered in proper black Indian ink or any other suitable black waterproof drawing ink, on a dead-white smooth-surfaced paper. Bristol-board paper, say "2-sheet thickness," is suitable. It is best to draw the design double the reproduction size; i.e., make it 10 in. by 6 in. The blockmakers can then reduce it photographically to 5 in. by 3 in., making the actual block this size. This leaves a margin of a quarter of an inch all round the design, when printed on to a standard 5½ in. by 3½ in. card. My printer said he could not conveniently print on to actual postcards with such a narrow margin, so he printed on larger sheets of card which

he afterwards trimmed down to the required size.

The maximum cost of a 5 in. by 3 in. line-block is about 7s. 6d. If, however, you want to include a photograph of the transmitter, QRA, or anything of this type, a half-tone block is necessary which is more costly.

A non-pictorial card, with lettering only, can be set up in type, which avoids the expense of blocks. It is not easy to make a card of this kind look quite so attractive as one which includes pictorial features in the design, but there are advantages, one being that you can get rather more data on to the card if you wish to do so.

Space can be saved, thus enabling you to include more data on the card legibly, or to arrange the lettering, etc., more artistically, if you are careful to avoid needless repetition. One often sees cards with the R.S.G.B. emblem, the words "Member of R.S.G.B." and "Pse QSL via R.S.G.B. or direct: Tnx." On my card I have minimised all this by working the emblem into the design and simply adding the words "Pse QSL via :—" alongside the emblem. The words "Or direct :—" I inserted above the name-space and address, as this seemed the logical place for them.

A possible objection to printing the whole QSL from a block is the difficulty of making any revisions before reprinting a further "edition" of the cards when the original batch is exhausted. This can be largely overcome, however, by anticipating possible future alterations to the transmitter, etc., and in the meantime simply crossing out any lettering which does not apply.



A simple but effective QSL card designed by the author.

A Switched-coil Pre-amplifier For 7-550 Metres

This pre-amplifier which gives a usable gain of 12 db covers all ham bands from 10 to 160 metres. It has been designed G8XI.

A PRE-AMPLIFIER is only of value if it provides a high R.F. gain without noise. It is quite a simple matter to build pre-selectors which bring up the noise level almost in ratio with the gain in signal level, and this type of pre-selector with the modern multi-valve set is more trouble than it is worth.

The average communication set used by amateurs generally provides more than sufficient output, but on weak signals noise level is inclined to be troublesome. This difficulty can be overcome to a very great extent by using a pre-selector which will provide an even greater signal, so that by reducing the I.F. gain the resultant output is still the same as before the preselector was connected into circuit. Provided the pre-selector is free from inherent noise, it enables unreadable signals to be brought up to a QSA₅ level.

I have heard many amateurs point out that they had no use for a pre-selector because the existing signal level was already more than they could handle. The same amateurs then go on to complain that they are unable to copy weak signals which really should be QSA₅. In such circumstances the noise is generally generated in the I.F. circuits, and although the noise can be decreased as the I.F. gain is reduced, the signal

unfortunately then vanishes altogether. However, a further two stages of radio-frequency amplification will generally bring back the signal to a good level, but minus noise.

It has been quite a problem designing efficient pre-amplifiers owing to the fact that a rise in gain was generally accom-

panied by a rise in noise level so that the overall gain was negligible. However, the new red "E" series of valves which include the low noise level EF8 heptodes has completely altered this state of affairs. It enabled me to produce a pre-selector, as a self-contained unit with built-in power supply and switched coils, that does provide an almost constant gain equal to between 12 and 14 db.

This gain is not the total gain, but the usable gain above the noise level. The frequency coverage is .55 Mc. right away down to 43 Mc., so that the unit will cover all ham bands and in cir-

20 Coils

The heart of the unit consists of a Peto-Scott tuner specially built for use in radio-frequency and aerial coupling circuits. No less than twenty coils are used, but as these are already wired and mounted around a Yaxley type of switch the number of wires that are left to be connected by the constructor are very few in number.

At first sight it may sound a little difficult lining up a two-stage pre-amplifier which embodies twenty coils. However, only two of these have to be trimmed and that is quite a simple matter. Actually the coil pack is sent out by the makers already lined, and the extra capacity caused by variations in wiring is so small that it is only a few moments' work to obtain the correct line-up and maximum gain.

Trimmers

It must also be appreciated that only two trimmers have to be adjusted for each band and this can be done by ear, merely using an insulated screwdriver and adjusting the trimmers until maximum volume is obtained. This trimming should always be carried out with

We have made arrangements for Messrs. Peto-Scott Limited of Pilot House, Stoke Newington, Church Street, London, N.16 to manufacture this pre-amplifier at a cost of £6 15s.

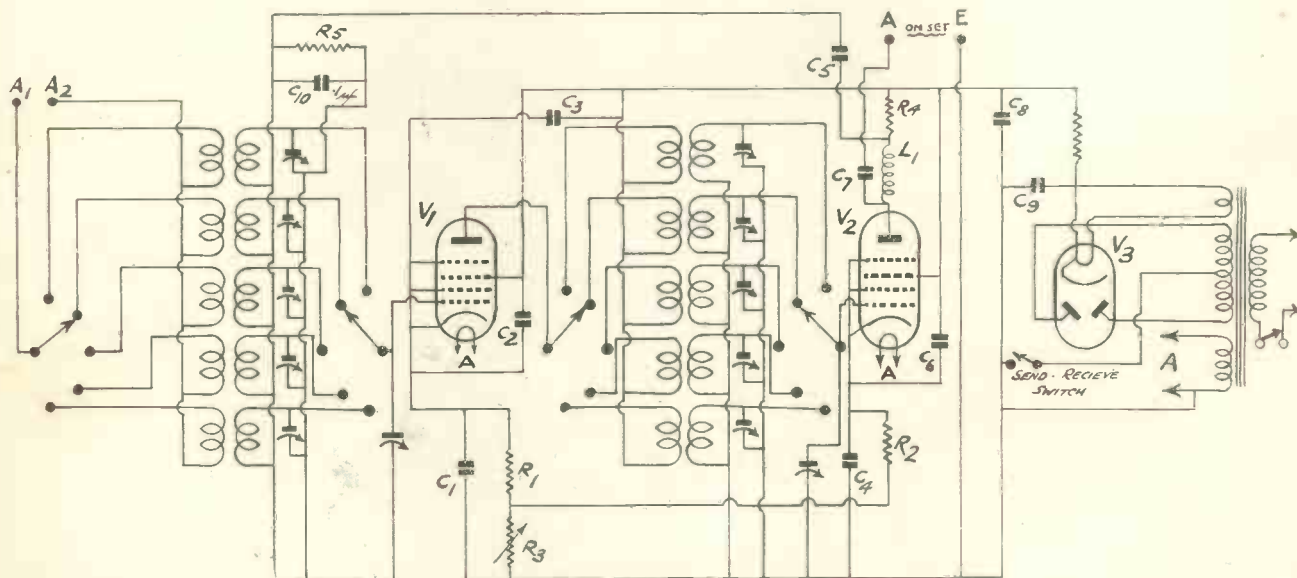

Although the circuit may look complicated all the coils are already wired together with the switches by the manufacturers of the tuning unit. They can also supply a complete kit of components if required.

Wave Ranges

an eye on the main tuning dial which should be set to a known frequency.

Two R.F. Amplifiers

The circuit of the pre-amplifier is shown on page 547, from which it can

which covers 19.7 megacycles, the 14 Mc. amateur band is covered with practically minimum tuning capacity. On this same band the 7 megacycle amateur band can also be received, but the efficiency is naturally lower than it should be owing to the fact that maxi-

megacycle ham band, so that this particular band can be covered on two separate coils.

The third channel also covers the 3.5-megacycle band and this actually is the only channel in which a fairly high tuning capacity is required, however, at this low frequency the exact L/C ratio is not necessary. On band four the frequency coverage is 2.9 to 1.2 megacycles with 1.3 megacycles to .55 megacycles on the final, or fifth band.

Band Spreading

Band spreading is arranged by means of a dial having a special pointer travelling round the outside edge of the dial where it is calibrated from zero to 100 degrees.

Transformer coupling is used between the first and second stages, for it was found that this provided the highest possible performance. Chokes were inclined to resonate unless very carefully designed, and in any case did not permit of high selectivity without a noticeable falling off in gain. With the transformer arrangement, the primary is adjusted for each band to give a compromise between maximum selectivity and gain, so that constructors will find the performance extremely level on all the ham bands covered.

As so much depends on the design of the coil pack, I do not consider it advisable for constructors to endeavour to build these coils for themselves so I have asked Messrs. Peto-Scott to supply the tuner as required, or better

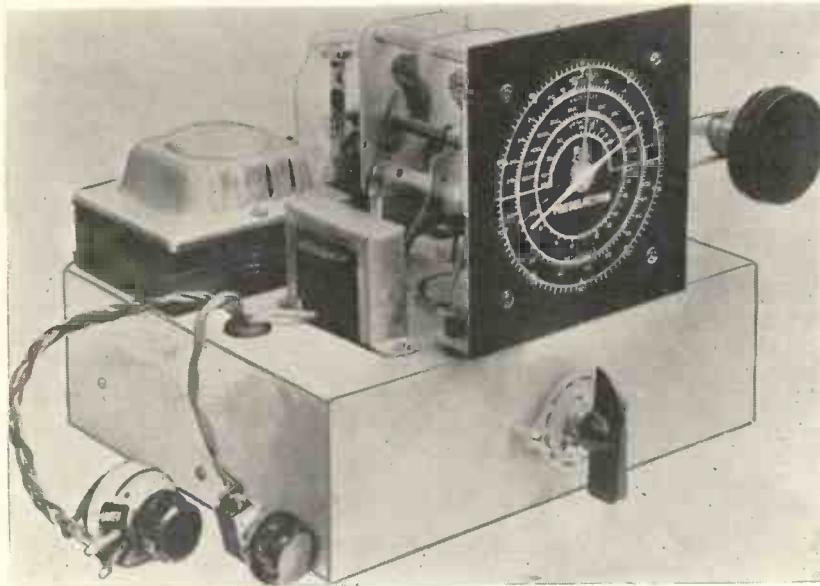

The variable resistance on the left-hand side is of the reversed log type and is actually a series resistor in the cathode circuit of both valves. The switch breaks the H.T. line while the multi-contact switch is for wave changing. The small choke is referred to in the text.

be seen that it is made up of two radio-frequency stages with provision for a di-pole input. Separate grid, primary and aerial coils are used for each band, so that the maximum efficiency is always obtained.

Gain Control

R.F. gain is controllable by a variable resistor in the cathode circuit of both valves, and, generally speaking, the total gain can never fully be utilised.

All condensers shown across the coils are of the mica postage stamp type which are actually mounted in the coil unit. Two main condensers, ganged together, are mounted above the chassis, as can be seen from the photographs, and in this way the leads from coil to condenser are kept extremely short.

Despite the fact that the unit is only an amplifier, extreme care has to be taken in the design of the coils if any sort of gain is to be obtained on the higher frequencies. It must be appreciated that the highest frequency band covers 18 to 43 megacycles with the 28 Mc. amateur band arranged for the best possible L/C ratio. The same remarks apply on the second band

num tuning capacity has to be employed. However, to remedy this defect on the third band, the first section of the condenser covers the 7-

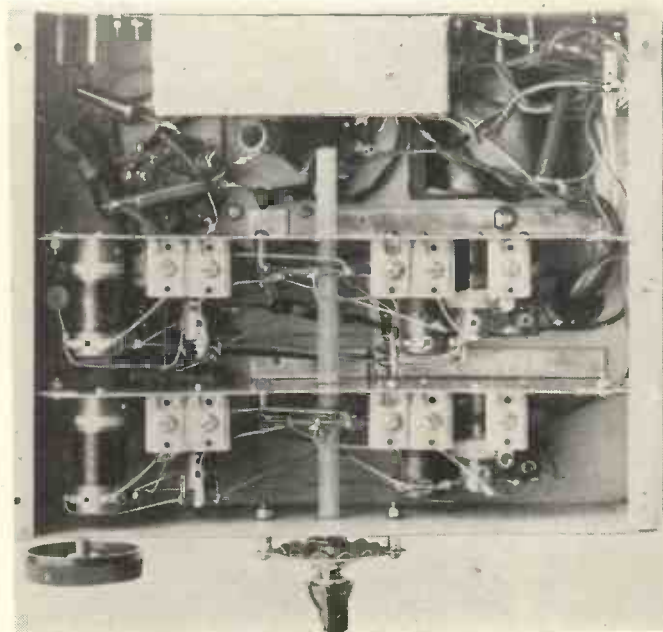

The whole of this first half of the amplifier is ready built and wired by the manufacturers so that the constructor really has very little to do in the way of wiring.

Making the Most of the Amplifier

still, a completely wired amplifier calibrated and checked for gain before delivery.

Component values are condensers C₁ to C₆ .1 non-inductive tubulars, C₇ .002 mica, C₈ and C₉ 8 minus 8 mfd. 500-volt electrolytic, C₁₀ .1 mfd. Resistor values R₁ and R₂ 200 ohms,

of the fact that Messrs. Peto-Scott can supply the wired chassis as required, it is really not worth while going to the trouble of building the pre-amplifier, but for those who find it more convenient the following details will probably be valuable.

The chassis is 18-gauge steel

condensers which should be mounted as close to their associated valve holder as possible.

A common earth point is recommended and the metal screens in the coil unit have to be anchored to this spot by means of a length of heavy braided cable.

Also notice from the illustrations how the three main supports of the two-gang condenser are also independently earthed by means of a heavy cable. Dial lights are wired in parallel and are of the 6.5 volt type. These have a long life and when connected across a 6.3 volt winding are not effected by possible voltage surge.

The whole of the tuning condenser and tuning drive are mounted together as one assembly, and it is essential to prevent microphony that they be mounted in such a way that thick rubber washers can be used as buffers in order to provide a certain amount of mechanical movement.

A send-receive switch is included and this is in series with the centre tap to the H.T. winding on the transformer. For those who wish to use the pre-amplifier in conjunction with the transmitter switch the connections to this can be extended and coupled up to the normal relay or keying system as required.

All wiring is carried out with 16 gauge tinned copper wire and arranged so that the connections are as short as possible, rather than square and symmetrical. This point is raised because of the difficulty in obtaining high gain on 28 megacycles with square wiring.

Bulgin valve holders are recommended for the EF8's, for as these valves are comparatively new to constructors some have difficulty in locating the correct pin numbers. However, on the Bulgin sockets each contact is actually numbered, so making construction very much more simple.

It is also suggested that high voltage leads be terminated at one point to a stand-off insulator or terminal block,

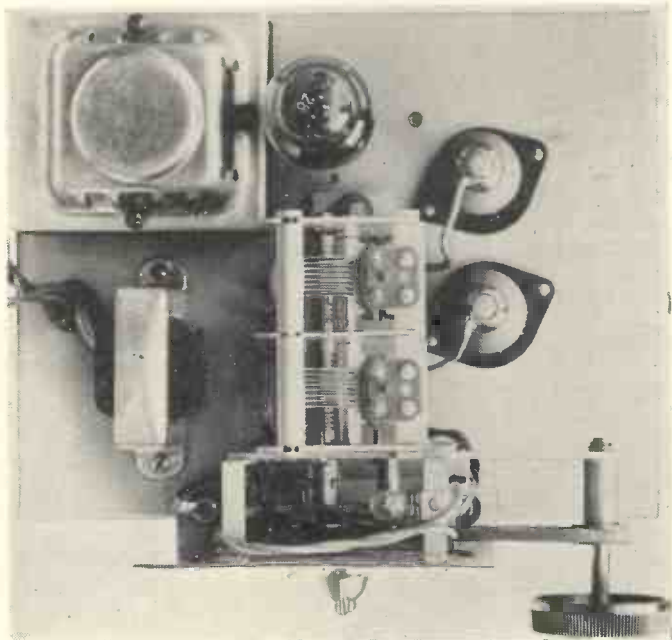

This plan view shows the power transformer in the left-hand corner and next to it the 5Z4G rectifying valve. The EF8's alongside the tuning condenser have quite short leads to their top caps.

R₃ 10,000 ohms variable reversed log type with switch, R₄ 10,000 ohms, R₅ 500,00 ohms, R₆ 5,000 ohms.

The power transformer provides 225 volts at approximately 30 mA. whilst smoothing can be carried out by either a resistance of 5,000 ohms or a small smoothing choke. There is very little to choose between these methods and it really is a matter of personal taste as to which system is employed. I have tried both without detecting any noticeable difference in hum level, while the gain is not increased despite the fact that the total H.T. voltage available is slightly decreased.

It is intended that a di-pole aerial be used, for this does provide maximum signal level with minimum noise if the aerial is cut to frequency, but for those who wish to use the Marconi aerial, then A₂ is merely connected to earth in the usual way.

In the output circuit the impedance is a small choke with a series condenser to the following receiver having a capacity of .0002 mfd. No provision is made for a low impedance line output circuit as this was not thought to be necessary.

Construction is simple, but in view

approximately 9½ in. wide by 7½ in. deep and an under-chassis depth of 3 in. The tuning unit takes up a good half of the under chassis, and is supplied complete with switch and selector panel. The mains transformer is mounted through the chassis so that a hole 3 in. by 2 in. has to be cut. I strongly recommend that all the valve holders and the power unit be mounted before the tuning unit is fixed into position, otherwise there will be considerable difficulty in soldering into circuit the small resistors and con-

Components for

THE SWITCHED COIL PRE-AMPLIFIER

CHASSIS.

1—Steel 9½ ins. by 7½ ins. by 3 ins.

CONDENSERS, FIXED.

C₁—1 non-inductive tubular.

C₂—1 non-inductive tubular.

C₃—1 non-inductive tubular.

C₄—1 non-inductive tubular.

C₅—1 non-inductive tubular.

C₆—1 non-inductive tubular.

C₇—0.002 mfd. mica.

C₈ and C₉—8 minus 8 mfd. 500 volt electrolytic.

C₁₀—1 mfd.

CONDENSERS, VARIABLE.

1—Two-section shortwave type (Jackson Bros).

DIAL.

1—Slow motion drive calibrated in frequencies (Peto-Scott).

HOLDERS, VALVE.

2—8-pin side contact (Bulgin).

1—8-pin octal (Clix).

SWITCH.

1—on/off toggle (Bulgin).

SUNDRIES.

1—Three-socket strip marked A₁, A₂ and E.

1—Two-socket strip marked A and E.

TRANSFORMERS.

1—Mains to give 220-0-220 at 30 mA.

5 volts at 2A.

6.3 volts at 1A.

VALVES.

2—EF8 (Tungsram).

1—5Z4G (Tungsram).

1939/40 SHORT-WAVE EQUIPMENT COMPONENTS - TEST GEAR - RECEIVERS

In this review of short-wave equipment, we also cover the exhibits at Radiolympia and the R.S.G.B. short-wave exhibition. A few all-wave receivers have been included when they provide a good short-wave performance.

READERS interested in short-wave equipment this year will have two exhibitions which they can visit. First, during the period August 23 to September 2 is the usual R.M.A. exhibition at Olympia where



The AVO 10-gn. all-wave oscillator.

radio in all its phases will be displayed. During the period September 21 to September 23, there is to be a short-wave exhibition organised by the Radio Society of Great Britain. This is open to members of the Society and special admission tickets have to be obtained. The R.M.A. exhibition is at Olympia, while the R.S.G.B. exhibition is to be at the Royal Hotel, Woburn Place, W.C.1, and is for three days only. During the description of equipment which follows manufacturers having a stand at Olympia will have the number prefixed with the letter "O" and those at the R.S.G.B. exhibition with the prefix "R."



A Test Bridge by AVO, price 8 gns.

A.C.S. Radio, 16 Grays Inn Road, W.C.1.—One of the new lines handled by this company is the McMurdo Silver 15/17 receiver advanced models of which are now available. This company has been appointed the London distributors for these receivers which are available in chassis form complete with giant loudspeaker for 43 gns. In view of the exceptionally fine performance on short waves of the McMurdo 15/17, it is being offered as a communication receiver to those who want a specialised

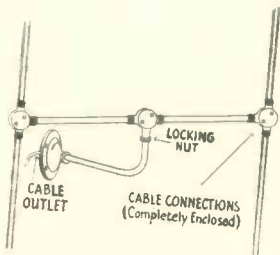

An example of the antiference television aerial.

instrument. Deliveries of the Guthman Diversity Coupler are also available and these should prove very popular. It can be added to any good short-wave receiver and the idea is to use two aerials to prevent fading and to allow for diversity reception. A.C.S. are also stocking every worth-while American communication receiver, and also components for the short-wave amateur.

Automatic Coil Winder & Electrical Equipment Co., Ltd., Winder House, Douglas Street, S.W.1.—Now that radio

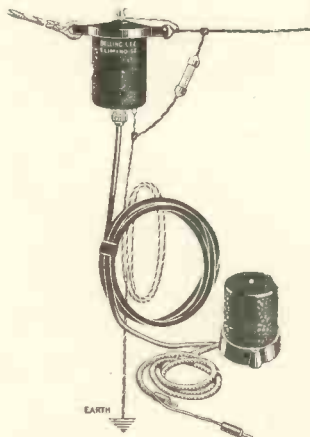

Belling-Lee have designed this Eliminoise aerial for use with all-wave receivers.

servicing has become almost a science, specialised test equipment is essential. The name of AVO stands out in this field and their range of instruments for the coming season is a very extensive one. Amongst the items listed are the following: Test Bridge, providing three ranges of capacity and three ranges of resistance. It has an accurately calibrated internal



The popular AVO capacity meter.

resistance and condenser standard which are automatically switched into circuit as required. The capacity ranges are from .000005 mfd. to 50 mfd. with resistance rangers from 5 ohms to 50 megohms. The accuracy is better than 5 per cent. This Test Bridge is priced at 8 gns. The AVO All-wave Oscillator is available as a battery model for 9 gns. complete or for 50 cycle mains at 10 gns. It covers



This is the 46 range Universal AVO meter.

Belling-Lee :: Brown :: Bulgin

a continuous fundamental frequency band from 95 Kc. to 40 Mc. by means of six separate coils mounted on a rotary selector. A harmonic calibration extends the range to 80 megacycles. The

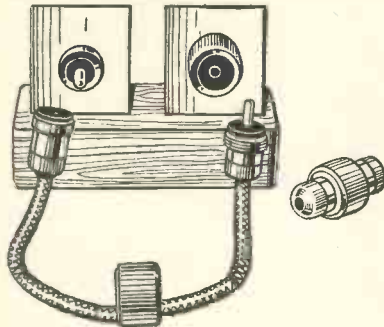

Belling-Lee screened plug and socket.

AVO range includes the ever popular 46-channel AVO meter at 16 gns., the D.C. AVO meter at 9 gns., the Universal AVO Minor at £5 10s., a new Valve Tester at 12 gns. and numerous multipliers, shunts and transformers.

Aerialite Limited, Castle Works, Stalybridge, Cheshire.—At Olympia this year Aerialite are showing four types of television aerial, from 15s. upwards, and a new type of television aerial which does not require any pole



S. G. Brown type "A" headphones are world-famous. They are extremely sensitive and are used by short-wave enthusiasts who require maximum sensitivity.

designed for direct lashing to the chimney. Co-axial cable retailing at 7d. per yard and air-spaced balanced feeder cable will also be shown. Stand No. 0.60.

Antiference, Limited, King's Yard, Bayham Place, N.W.1.—Twelve different types of television aerials are to be shown at Olympia, the cheapest for wall mounting being 16s. 6d. With reflector this type of aerial is priced at 35s. All television aerials are avail-

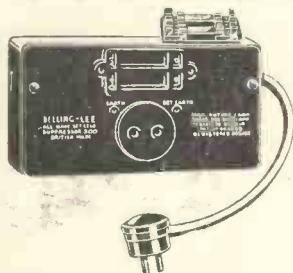

This Belling-Lee unit is for noise suppression and is connected in series with the mains leads.

able with either steel rods or aluminium rods as required, but naturally the latter type of aerial is rather more expensive. Stand No. 0.10.

Belling & Lee, Limited, Cambridge Arterial Road, Enfield, Middlesex.—A huge range of components and aerials of all kinds are being marketed by this company for the 1939/40 season. The new Sky Rod vertical aerial is now available in five types varying in price from £1 5s. to £5 15s. Each aerial carries a guarantee against lightning and an insurance for £1,000 against certain third party risks due to erection. Bell-



On the left is one of the new Bulgin double-spiral power resistors, while above is a new line in 4-watt resistors.

ing-Lee television aerials are available in eight types suitable for every possible location, while there is also a combined television and Sky Rod aerial for use when separate aerial and earth terminals are provided for medium, short and long wave reception. Stand Nos. 0.26 and 0.3.

British Insulated Cables, Limited, Prescott, Lancashire.—A wide selection of radio wires and cables, copper, aluminium sheets, earthing rods, solder-



Bulgin have always been famous for their resistances. Here is a new 60-watt type.

ing and jointing materials, condensers for radio and television and relay service fittings are being shown. The condensers exhibits cover paper dielectric and electrolytic condensers of all types. Stand No. 0.20.

British Pix Co., Ltd., Lillieshall Road, S.W.4.—Radio valves in battery and mains types are manufactured by this



A new Bulgin range of low-priced unit coils covering 6 to 2,600 metres T.R.F., and oscillator types available.

company and vary in price from 2s. 6d. to 10s. 6d. The Pix selectivity device priced at 2s. is still being marketed owing to its great popularity. They also produce a remote volume control, which can be fitted to almost any receiver, priced at 4s. Stand No. 0.64.

A. F. Bulgin & Co., Ltd., Abbey Road,



Bulgin's new tag strips for joining flexible cable.

Barking, Essex.—The latest Bulgin catalogue is now available and has a total of 128 pages and more than 300 new items. It covers every type of component the amateur is likely to require in addition to television aerials, which are complete with reflector, and suitable for orientation. Amongst some of the new 300 components are the following: Anti-break-through choke for 1s., to prevent medium wave interference on long waves, unit coils covering 7 to 2,600 metres from 1s. 9d. each, a new range of trimming tools for the constructor and service man comprising double ended fibre screw adjustors, hexicon nuts, trimmer wrenches, etc.,



A new range of wire-wound resistors, approximately 1 ohm to 10,000 ohms, in 15 ranges.

heavy current suppressor chokes, to carry 10 amperes, for use where interference is obtained through the mains, terminal blocks of all kinds, L.F. and microphone transformers, heavy mains transformers, vibrators of the synchronous and non-synchronous types, wire-wound volume controls up to 7½ watts rating, midget valve holders, all in addition to the thousand and one items already listed in their catalogue. Readers should make a point of visiting Stand No. 0.62.

Burndept, Limited, Light Gun Fac-

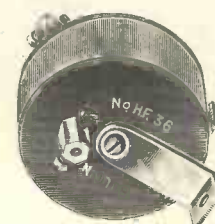

A vibrator or suppressor choke suitable for a current of 10 amperes. A new Bulgin line.

E.M.I. :: Dubilier :: Cossor :: Ferranti

tory, Erith, Kent.—All-wave radio is the keynote of this manufacturer, varying from the model 307, a three valve four band receiver for 7 gns., and the



The E.M.I. valve voltmeter, price £7 18s. 6d.

model 313, five valve A.C. receiver for 8 gns., up to an eight valve radio-gramophone with automatic record changer for 40 gns. Stand No. O.54.

Bush Radio, Limited, Power Road,



One of the new Dubilier condensers, which will be on show at Olympia.

Chiswick, W.4.—High-quality receivers are being produced by Bush this year and a typical example of their production is the model SUG-61, a five valve all-wave console priced at 11½ gns. There is also an interesting push-



The E.M.I. A.C. mains all-wave oscillator.

button console for 11½ gns., a D.C./A.C. push-button table receiver for 12½ gns., and finally a four valve seven stage battery operated superhet for 9½ gns. Stand No. O.34.

A. C. Cossor, Limited, Cossor House, Highbury Grove, N.5.—A new departure for this manufacturer is a car radio receiver with push buttons. It fits any make of car, can be easily installed, and is priced at 11 gns. There is also a new four valve all-wave battery superhet for 8 gns., a six valve all-wave superhet for 10½ gns. and a most interesting de-luxe six valver



The Cossor model 72 six-valve all-wave superhet.

type 73 for 12½ gns. Most readers will also be interested in a new Cossor radio-gramophone which is priced at 16 gns. Stand No. O.48.

The Dubilier Condenser Co. (1925), Limited, Ducon Works, Victoria Road, North Acton, W.3.—A comprehensive range of condenser and resistors will be shown by Dubilier at Olympia. Of special interest to short-wave enthusiasts are the short-wave condensers of the disc, cup and tubes types with



Cossor's five-valve model 81 all-wave superhet.

either positive or negative temperature co-efficients. Dry electrolytic condensers for high and low voltages and also the new surge proof condensers will also be available. Stand No. O.28.

E.M.I. Service, Limited, Sheraton Works, Hayes, Middlesex.—All service engineers should make a special point of visiting the E.M.I. stand on which will be shown test equipment of

all kinds including a frequency modulator, an A.C. mains all-wave oscillator, capacity tester, audio-frequency oscillator, valve voltmeter and many other items. Stand No. O.100.



This E.M.I. frequency modulator is priced at £8 2s. 6d.

Electro-Dynamic Construction Co., Ltd., St. Mary Cray, Kent.—A special D.C. to A.C. convertor for use with



Ericsson Telephones are extremely cheap and at their price are very good value for money.

television receivers has been manufactured by this company and varies in price from £23 3s. for 180-watt con-



A 1940 Ferranti receiver.

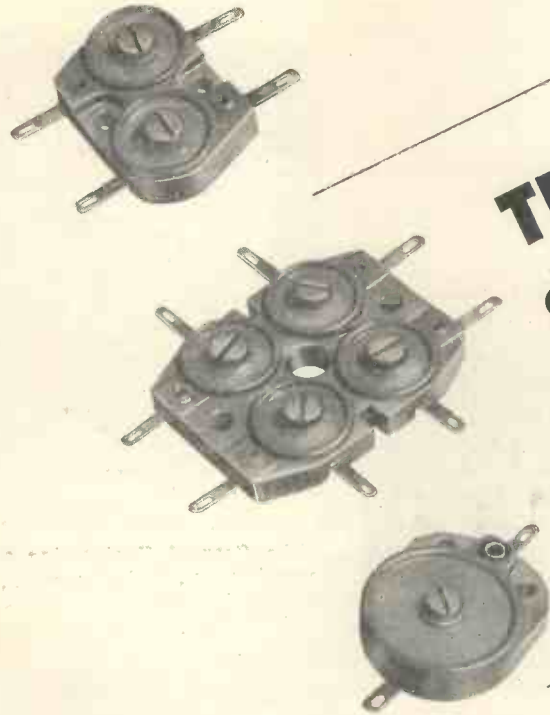

**THE BEST
SIMPLEST
AND MOST
STABLE...**

CERAMIC *Trimmer*

MADE IN OUR LONDON WORKS

Single, Double, Triple and Multiple Trimmers with or without added capacities. Power Trimmers.

Send for Booklet H 4 and Leaflets L 1 and L 2

CONDENSERS

Protected by British Patents Nos. 432793/1935, 430645/1935, 445495/1936, 453707/1936

FOR TELEVISION AND GENERAL RADIO WORK

UNITED INSULATOR C^o L^{TD}

12-16, LAYSTALL ST.,

Telephone
Terminus 4118-9

LONDON, E.C.1

Telegrams
Calanel Smith London



Hamrad :: G.E.C. :: Peto-Scott :: Masteradio

vertor up to £40 gs. for a 600-watt convertor. E.D.C. manufacture D.C./A.C. rotary convertors suitable for practically every radio and television set on the market.

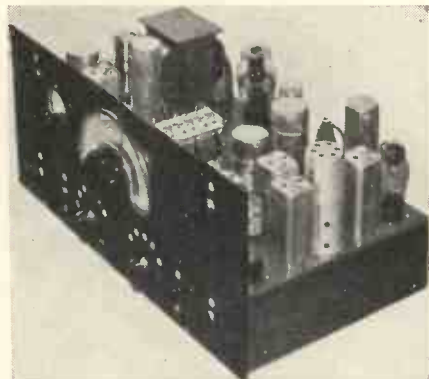

The star receiver model 140 in the Hamrad range, also available through John McClure, Ltd.

Ekco (E. K. Cole, Limited), South-end-on-Sea, Essex.—Motor driven condensers are being used with great success by Ekco. On their model PB515

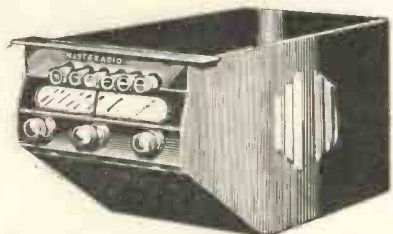

One of the new car radios built by Masteradio, which is an 8 stage all-wave superhet they have 11 stations press-button control, also motor wave changing, high-speed motor tuning and locked

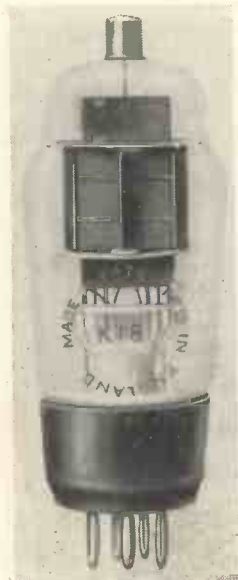

This is the G.E.C. KT8 transmitting tetrode, which is priced at 22s. 6d. It is similar to the 807. A second version with ceramic base is available for 24s.

frequency control. This receiver costs only 15 gns. The C509 console is a 6 stage receiver, and priced at 12½ gns. It is exceptional value for money. One of the largest Ekco sets is the autoradio-gramophone with press button control priced 50 gns. Stand No. O.47.

Ericsson Telephones, Limited, 22 Lincolns Inn Fields, W.C.2.—Ericsson headphones are used by all the services and by amateurs who require high efficiency at minimum cost. Their super-sensitive telephones with resistances of 120, 2,000 or 4,000 ohms are priced at 15s. each, while spare parts are now available if required.

Erie Resistor, Limited, Carlisle Road, The Hyde, Hendon, N.W.9.—On the



Peto-Scott's two-stage pre-selector providing a 12 dB gain.

Erie stand will be shown insulated resistors, ceramic low-loss condensers, silver mica condensers, standard carbon resistors, high-voltage resistors, and wire-wound resistors up to 100 watts rating. The transmitting amateur will find a considerable number of components of interest on Stand No. O.13.

Ferranti, Limited, Moston, Manchester 10.—All Ferranti receivers will be released on or before September 1, and includes several low-priced instruments of high efficiency. The cheapest receiver is a four-valve battery superhet using the new 1.4 volt valves and only one battery is required. No accumulator

or grid bias cell. It is priced at 7½ gns. There is also a five valve A.C. all-wave superhet for 9 gns., and a de-luxe five valve superhet for 12½ gns. Stand No. O.41.



A Hamrad high-voltage robust transmitting condenser. Notice the ceramic spindle.

The Garrard Engineering and Manufacturing Co., Ltd., Swindon, Wilts.—All good radio-gramophones now include automatic record changers for



The latest Peto-Scott set—the Trophy 6.

they are so fool-proof and necessary. Garrard, who are pioneers in record changers, have a comprehensive range this year, including the R.C.50 which will take ten or twelve inch records in any order. It includes automatic switch,

(Continued on page 556)

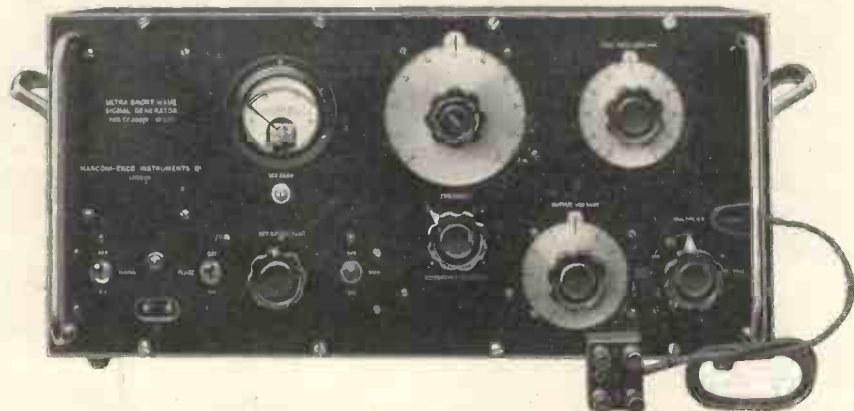

An ultra-shortwave signal generator built by Marconi-Ekco Instruments Limited.

SEPTEMBER, 1939

The R.S.G.B. Short-Wave Exhibition

As we briefly announced in our August issue, the Radio Society of Great Britain are organising a special exhibition for manufacturers of short-wave equipment to be held concurrently with their annual convention during the period Sept. 21 to Sept. 23.

This year the convention is being held at the Royal Hotel, Woburn Place, London, W.C.1, and is more comprehensive than usual. The programme for Thursday, September 21, is made up of three visits, the first to Broadcasting House, the second to the G.P.O.

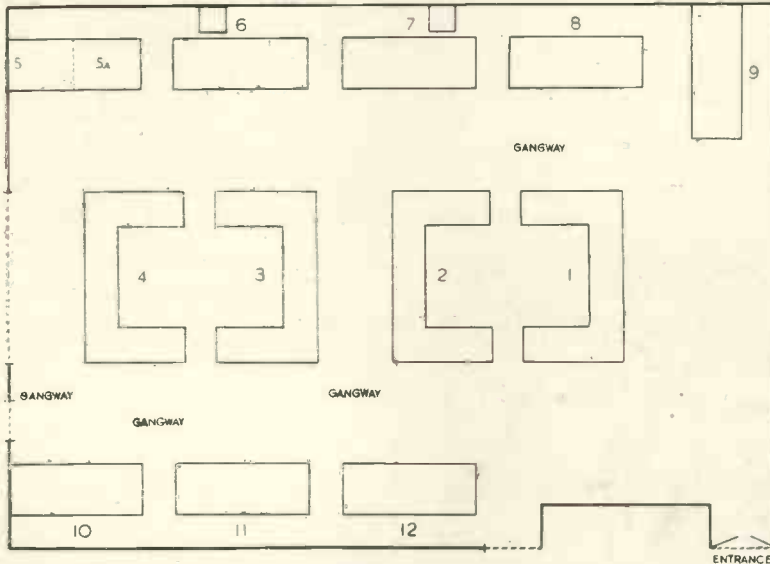

The layout of the R.S.G.B. exhibition. Stand holders are given in the text.

Research Station at Dollis Hill, the third to the Alexandra Palace Television Station.

During the evening there is to be a music hall performance followed by a unique feature in this country, a morse code contest. The idea of this contest is to find out who is our fastest code operator on the lines of competitions held annually in America.

On Friday, September 22, there is a visit to the Radio Research Station at Slough, also to the B.B.C. Listening Post at Tatsfield, and a return visit to the Alexandra Palace Station. A further code contest is scheduled for the evening of September 22, to be followed by a conversazione and technical discussions.

The final day, Saturday 23, is devoted to meetings in the morning, a technical lecture in the afternoon, and the 14th annual dinner in the evening.

A considerable number of well-known radio manufacturers have booked stands at this exhibition so that the cream of components and equipment generally available to amateurs will be there for all to see. Amongst the stand holders are:—

- Stand No. 1.—Webbs Radio.
- No. 2.—Stratton and Co., Ltd.
- No. 3.—Peto-Scott Co., Ltd.
- No. 4.—Radiomart (G5NI Birmingham), Ltd.

(Continued on page 573)

"The Complete Component Guide"

128 PAGE NEW EDITION, with revised, tabulated, and fully illustrated sections, covering

thousands of components for use in modern radio and television construction. Packed full with technical and dimensional data.

THE HANDBOOK OF THE INDUSTRY—YOU CANNOT AFFORD TO BE WITHOUT IT.

VISIT



A. F. Bulgin & Co. Ltd.
Abbey Road, Barking
Essex.

Telephone:
Rippleway 3474

...NOW

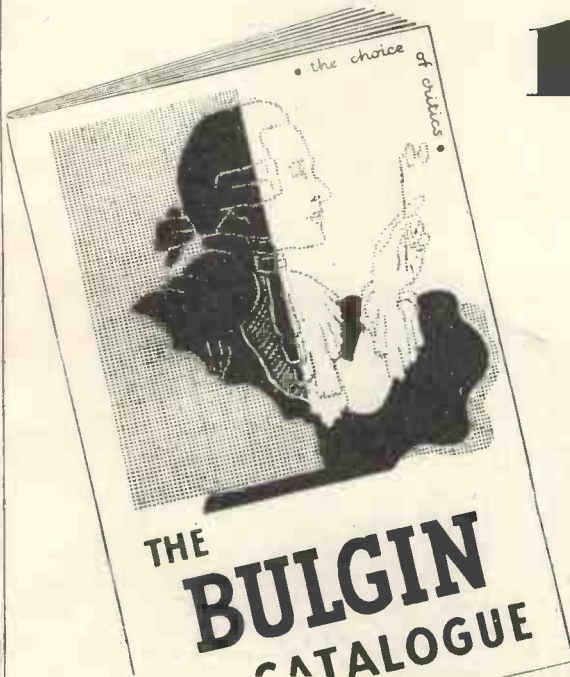

G.E.C. :: Premier :: Solon

(Continued from page 554)
arrangement for record rejection, does not interfere with radio and has a non-slip record spindle. Stand No. o.56.
The Gramophone Co., Ltd. (H.M.V.),



The Peto-Scott Trophy 8, communication receiver.

98/108 Clerkenwell Road, E.C.1.—The high spot of the H.M.V. range this year is the new model 1,200, an all-wave receiver with 12 press buttons. The condensers are motor tuned, both on short waves as well as on broadcast bands. The receiver uses seven valves including a KTW63 R.F. amplifier, and a KT66 output valve providing 10 watts of audio. Wavelength coverage is 16.5 to 50 metres, 192 to 560 metres and 750 to 2,000 metres. The performance on short-wave bands is exceptionally high with good frequency stability. Noise level is low so that American broadcasters can be received at entertainment value. This receiver is priced at 19½ gns. Stand Nos. o.46 and o.53.



Peto-Scott's Trophy 3.

The General Electric Co., Ltd., Magnet House, Kingsway, W.C.2.—Next season the General Electric Co., are producing a considerable number of valves for the short-wave amateur. The performance of these valves is good

will be available, the HA2 equal to a 955 at 45s., a ZA2, similar to the 954 price 50s. Designers of receivers will find that the G.E.C. will have a very good range of high-slope valves of the pentode type and the prices of these will be extremely low in view of their performance. Stand Nos. O35 and R9.
Hamrad Wholesale, Limited, 32 St. Lawrence Terrace, W.10.—Components of every kind likely to be needed by the amateur or short-wave experimenter will be handled by Hamrad this year. They are now stocking a complete range of the well-known Kenyon inter-valve, mains, modulation and output trans-



This Premier neutralising condenser is priced at 7s. 6d.

formers. Also, special air-spaced tank coils of a new design which are very competitive in price. The 10-metre coil mounted on Trolitule costs 5s. plus 2s. for the base. They are stocking all the well-known Denco components in addition to the Italian Ducati which are now becoming known in this country. All Taylor valves including TZ40 and TZ20 are now available in addition to the Gammatron valves type HK24 at 24s., HK54 at 52s. 6d., HK154 at 87s. 6d. and HK254 at 95s. Crystal holders, inexpensive resistors of all types, and many other interesting com-

ponents are all ready for the coming season. Stand No. R.6.

W. T. Henley's Telegraph Works Co., Ltd., Holborn Viaduct, E.C.1.—In all Solon electric irons the heating

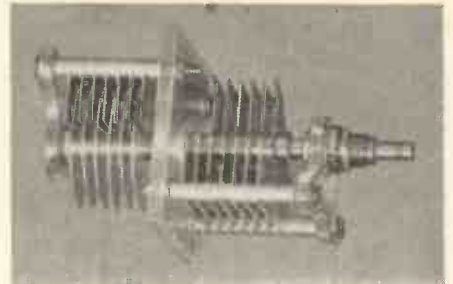

The new Premier split stator transmitting condenser priced at 10s. 6d.

element is actually contained in the bit so causing the iron to heat at the correct point and very speedily. The domestic model is loaded for 65 watts, although heavy duty Solons 125 watts or 240 watts are also available. Every Solon iron includes 6 ft. of flexible cord, and prices are from 8s. 6d. upwards.

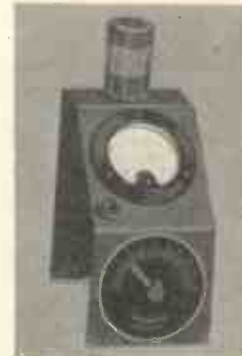

On the left is the Premier monitor and above, the cheap Premier crystal holder price, 2s. 6d.

Masteradio, Limited, Newton Street, High Holborn, W.C.2.—This company is concentrating on car radio receivers and vibrators and vibrapacks. The

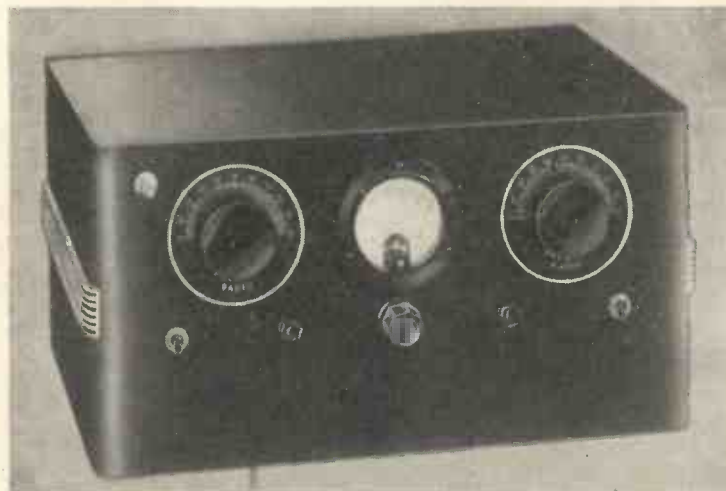

A 10.15 watt all-band transmitter for 10 gns., by Premier Radio.

McGRAW-HILL

BOOKS FOR RADIO MEN

Principles and Practice of Radio Servicing

By H. J. HICKS

305 pages, 9" x 6" 212 illustrations. 18/- net

Shows how to install, test, and repair radio receivers, giving not only instructions in all the servicing procedures, but also plain treatment of the theory of electricity and radio needed for most effective approach to servicing problems. Written in excellent self-study style for servicemen who want to improve their skill and readers who want to learn this practical field from the ground up.

Electron Optics in Television

With Theory and Application of Television Cathode-Ray Tube

By I. G. MALOFF and D.W. EPSTEIN

299 pages, 9" x 6" illustrated, 21/- net.

From the book the reader should get an understanding of electron optics and be able to use electron optics in various problems of pure and applied physics. He also should get the basic principles of the design of television cathode-ray tubes and associated circuits. Most of the material has never appeared in book form and some of it has not been published previously.

Radio Engineering

By FREDERICK EMMONS TERMAN

813 pages, 9" x 6", 475 illustrations. 30/- net

Second Edition Enlarged and Revised

This is what the Press says :

TELEVISION.—Cannot be too highly recommended. All radio students and experimenters should possess a copy.

ELECTRICAL REVIEW.—Should form an important addition to the library of the radio engineer.

T. & R. BULLETIN.—A book of outstanding merit in the field of radio-engineering and one which the keen engineer will value.

NATURE.—Should be at the right hand of every radio engineer.

POST OFFICE ELECTRICAL ENGINEERS' JOURNAL.—It certainly contains more general useful information on Radio Engineering than any other work.

WIRELESS WORLD.—Up to date and thorough, can be confidently recommended to all interested in the theory of wireless and the design of apparatus.

WIRELESS ENGINEER.—To students seeking a textbook and engineers a work of reference, Terman's revised edition can be recommended most heartily.

Theory and Applications of Electron Tubes

By HERBERT J. REICH

670 pages, 9" x 6", illustrated. 30/- net.

Gives the reader a sufficiently thorough grounding in the fundamental principles of electron tubes and associated circuits to enable him to apply electron tubes to the solution of new problems. At the same time, the book is exceptionally complete including, a wealth of material assembled and co-ordinated in a single volume.

New Catalogue Now Ready

To McGraw-Hill Publishing Co., Ltd., Aldwych House, London, W.C.2.

Please send me free and post free a copy of your new list of books on
ELECTRICAL AND RADIO ENGINEERING.

NAME

ADDRESS

Peto-Scott :: Murphy

cheapest car radio receiver with press button tuning is 10½ gns., while the large nine-valver with remote control



This 25-watt transmitter kit is priced at £4 19s. 6d., from Radiomart.

is priced at 22 gns. Both these prices include the aerial. Stand No. O.97.

Marconi-Ekco Instruments, Limited, Electra House, Victoria Embankment, W.C.2.—Experimenters and service engineers will find this company's exhibits at Olympia of particular interest.



The new Q.C.C. crystal holder, type U, priced at 6s. It has an American fitting.

We advise readers to inspect the ultra-shortwave signal generator, the valve voltmeter, and the Scopphony pattern generator. The U.S.W. signal generator is supplied in ranges of either 5-60, or 20-150 Mc., with an output voltage of .1 microvolts to 100 millivolts, except



A 4-watt A.C. or A.C./D.C. amplifier, wired and tested, for £2 15s., from Premier Radio.

above 60 Mc., where the maximum output is 50 millivolts. Stand No. O.109.

Murphy Radio, Limited, Broadwater Road, Welwyn Garden City, Herts.—At Olympia will be shown a new receiver type A76 which is one of the few all-wave sets to include band spreading. A seven-wave band switch controlled from the front panel brings into circuit any one of the seven short-wave bands, including the 21 and 42-metre amateur bands. Other features are variable selectivity and a tuning indicator. All coils not in use are



The new Pilot 5-valve all-wave superhet.

switched out of circuit so giving maximum efficiency. Stand No. O.33.

Peto-Scott Electrical Instruments (Holdings), Ltd., Pilot House, Stoke Newington Church Street, N.16.—Trophy receivers made by this company are now well known by British amateurs. The Trophy 8 at 12 gns. has been further improved and the sensitivity is now of a very high order. This applies particularly on the 10-metre band. A new receiver altogether is

the Trophy 6 at 9½ gns. which covers 6.5 to 545 metres. Also included is electrical band-spreading, calibrated frequency scale, A.V.C., B.F.O., and all



An inexpensive neutralising condenser costing 4s. 6d., from Premier Radio.



This oscilloscope by Premier Radio has a 3-in. tube and is priced at 10 gns.

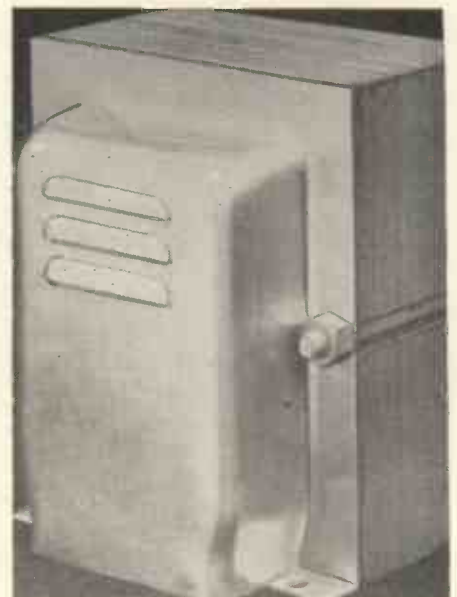

One of the new Radiomart power transformers, which are completely shrouded and have the connections coming through the base.

PREMIER 1939 RADIO



**Premier Matchmaker
Universal Modulation
Transformers**

Will match any modulator to any R.F. Secondary Load. Triodes, Tetrodes and Pentodes Class A, Single or Push-Pull Class "A", "B", "C" in Push-Pull or 500 ohms line Input, can easily be matched to any of the following Radio Frequency final stages requiring modulation. Triodes, Tetrodes, or Pentodes operating under Class "A", "B", "BC," and "C" conditions either Single or Push-Pull.

Totally enclosed in cast cases with engraved Panel, and full instructions. Ratings are based on R.F. Inputs.
50 Watt, 17/6. 150 Watt, 29/6. 300 Watt, 49/6.

A new range of "Matchmaker" Universal Output Transformers which are designed to match any output valves to any speaker impedance are now ready.
11 ratios, from 13 : 1 to 80 : 1.
5-7 Watt, 13/6. 10-15 Watt, 17/6. 20-30 Watt, 29/6.

PREMIER MOVING COIL METERS

Guaranteed Accuracy within \pm 2 per cent. Model No. 2—Bakelite Case, 3 in. by 3 in. square, with Zero Adjuster.

0-500 Microamps	31/-
0-1 m.a.	25/-
0-10 m.a.	22/6
0-50 m.a.	22/6
0-100 m.a.	22/6
0-250 m.a.	22/6
0-1 m.a. movements with calibrated scale	27/6
vols—ohms—m.a.	27/6
MODEL No. 21	MODEL No. 311.				
3-In. square case.	3½-In. diameter round case.				

0-1 m/A	...	18/6	0-1 m/A.	...	22/6
0-10 m/A.	...	17/6	0-10 m/A	...	20/-
0-50 m/A	...	17/6	0-50 m/A	...	20/-
0-100 m/A	...	17/6	0-100 m/A	...	20/-
0-250 m/A	...	17/6	0-250 m/A	...	20/-
MODEL 311.	0-1 m/A. movements, with calibrated scale, volts-ohms-m/A.,		...		
VOLTAGE MULTIPLIER RESISTANCES, guaranteed accuracy \pm 2 per cent. All standard ranges					
... 1/3 each.					
TAPPED SHUNT to provide readings of 5 m/A., 25 m/A., 250 m/A., and 1,000 m/A. ... 5/6.					

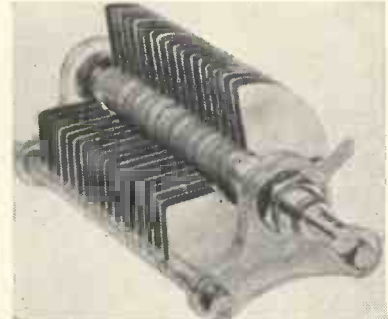

SHORT-WAVE CONDENSERS

Trolital insulation. Certified superior to ceramic. All-brass construction. Easily ganged.

15 m.mfd.	...	1/6	100 m.mfd.	...	2/-
25 m.mfd.	...	1/9	160 m.mfd.	...	2/3
40 m.mfd.	...	1/9	250 m.mfd.	...	2/6

All-brass slow-motion Condensers, 150 m.mfd., Tuning, 4/3 ; Reaction, 3/9
Double-Spaced Transmitting Types.
15 m.mfd. 2/9 40 m.mfd. 3/6
100 m.mfd. 4/- 160 m.mfd. 3/6
New Trolital Split-Stator Condensers
50 x 50 m.mfd. 10/6 each

PREMIER 3 - 60 WATT AMPLIFIERS

A NEW RANGE OF 7 HIGH FIDELITY PA AMPLIFIERS

Designed along the most modern lines and incorporating the very latest developments in radio technique, these amplifiers can be relied upon to give a continuous dependable performance.

All models up to 15 watts can be purchased in Kit form if desired, with the necessary straightforward diagrams and wiring instructions.

The 6-, 8-10 and 15-watt systems incorporate the new Premier Matchmaker Output Transformer, enabling any single or combination of speakers to be used. Two separate input channels are provided which can be mixed at any level. Built-in Pre-Amplifiers ensure that the gain is sufficient for any low-level crystal or velocity microphone.

The actual gain of the 6- and 15-watt units is over 100 decibels. A Tone Control is provided varying in all models, permitting compensation for varying acoustical conditions.

The 3-watt A.C. Amplifier has provision for energising a 2,500 ohm field speaker.

All amplifiers can be supplied with Matchmaker Modulation Output Transformers at the same price and are designed for 200-250 volt mains (A.C. Models 40-100 cycles).

	KIT with valves	Complete wired and tested
3-watt A.C.	... £2 0 0	£2 15 0
3-watt A.C./D.C.	... £2 0 0	£2 15 0
6-watt A.C.	... £5 5 0	£6] 0 0
8-10-watt A.C./D.C.	... £4 10 0	£5 5 0
15-watt A.C.	... £5 15 0	£7 0 0

Black Cracked Steel Cabinet (as illustrated) 15/- extra.

30-60-watt A.C. Amplifiers or Modulators, completely wired and tested, in Black Cracked steel case. Power Pack in separate case to match.
30-watt £12 : 12 : 0 complete. 60-watt £15 : 15 : 0 complete.

New Premier Self Powered Tuning Unit, incorporating a Var. Mu pentode amplifier followed by a power grid detector. Designed for high-fidelity reception. Wave range 200-560 and 800-2,000 metres.
£4 : 9 : 6 complete with valves



HUGE PRICE REDUCTIONS IN TRIAD FIRST QUALITY AMERICAN VALVES. NEW PRICES FROM 2/3. SEND FOR NEW LIST.

NOW READY! NEW PREMIER 1939/40 GIANT ILLUSTRATED CATALOGUE AND VALVE MANUAL. OVER 100 PAGES. SEND 6d. IN STAMPS FOR YOUR COPY!

ALL POST ORDERS to:—
Jubilee Works, 167, Lower Clapton
Road, London, E.5. Amherst 4723.

PREMIER RADIO

CALLERS to:—Jubilee Works, or 165
Fleet St., E.C.4. Central 2833 or 50 High
St., Clapham, S.W.4. Mazaalay 2381

Premier :: Q.C.C. :: Radiomart

the usual refinements necessary for a good communication receiver. Almost any short-wave set can be improved by the addition of a low-noise pre-selector. The P.S.E.I. three stage pre-selector

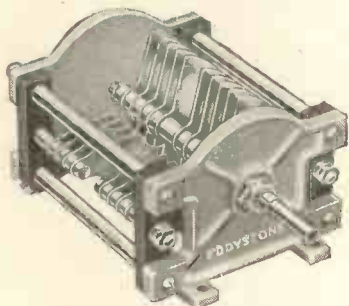

The Eddystone type 1081 condenser, price, 17s. 6d.

uses EF8 valves and has regeneration on the 10-metre band in order to keep the gain constant. Five wave bands with six coils are provided, while the slow motion tuning drive provides band spreading so that calibration can be made. It is priced at £6 15s. complete. Less expensive receivers in the Trophy range are the Trophy 3's, the A.C. model of which costs £6 6s. and the

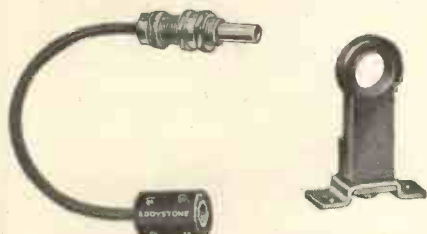

On the left is the Eddystone flexible drive shaft, and on the right one of the new insulated Eddystone brackets.

battery model £5 15s. Both sets are self-contained with moving coil loud-speaker, although provision for headphones is made. Both these receivers perform excellently on short waves and can be recommended for those who require an inexpensive set. Peto-Scott also manufacture specialised equipment such as complete amateur band trans-



The Taylor Universal meter, priced at 10 gns. for the model 80A.

mitters, direction finders, and test gear, which can be seen on their Stand No. R.3.

Premier Radio Company, Jubilee Works, 167 Lower Clapton Road, E.5.—Premier Radio components and accessories are being used by amateurs all over the world in addition to many Government departments. They have just issued a catalogue for 1940 which every reader should obtain. Amongst the new items listed are a 2-watt amplifier for 2 gns., a 4-watt mains amplifier at £2 15s., and a 30-watt amplifier for 12 gns. Also complete sound equipment for schools, hospitals, etc., from £24 upwards which includes a radio channel. The Premier velocity microphone at £4 10s., has a response level of 40 to 10,000 cycles with an output of 68dB. It is hum-free and can be used within 18 inches of a power supply. Microphone stands which are new this year vary in price from 7s. 6d. to 50s. Amateurs should be particularly interested in the new Premier 10-15 watt all-band transmitter which is complete for 10 gns. High level modulation is

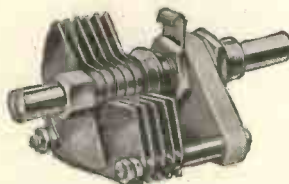

An example of the Apex short-wave condenser marketed by Webbs Radio.

used while a meter, power supply and all accessories are included. A 25-watt phone and C.W. transmitter in a three-tier rack is priced at £21, while to complete the amateur station there is the 5-V-5 communication receiver which complete with speaker is priced at 8 gns. This receiver includes iron-cored coils, coverage from 12 to 2,000 metres B.F.O., send-receive switch and, of course, band spreading. An innovation for Premier is a crystal holder for half-a-crown which we from experience can thoroughly recommend. They also have available a 3-in. cathode-ray oscilloscope for 10 gns., high resistance headphones for 3s. 9d. and a new range of shortwave variable condensers including a double spaced split-stator of 50-0-50 mmfd. capacity for 10s. 6d. Amateurs interested in portable equipment should make a special point of obtaining data on the new Premier vibrator battery eliminators. The model VP250 provides 250 volts at 50 mA. from a 6-volt accumulator and is priced at 59s. 6d. Premier moving coil meters in square or round cases range in price from 17s. 6d. and the 0-1 mA. makes a very good carrier level meter. Quartz Crystal Co., Ltd., 63 and 71

Kingston Road, New Malden, Surrey.—Amongst the new lines carried by this company is 100 Kc. bar which is cut and ground so that it will provide an-

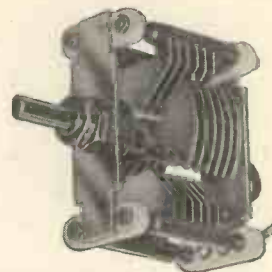

A good short-wave split stator condenser from Eddystone for 12s. 6d.

other frequency between 1,750 and 1,800 Kc. for frequency checking in the amateur bands. This unit is known as the B100/47 and is priced including holder at 35s. All National receivers and components are being stocked including the new tank coils which are complete with link winding. Quartz crystals from this company are being used by many Government departments



Triplett meters are world-famous—this is the model 1200A, priced at £8 10s.

with great success but we bring to our readers' attention the Q.C.C. crystal holder type U which has an American fitting of the conventional type. The new holder costs 6s., plus 1s. 3d. for a base board mounting sub-base. Stand No. R.12.

Radiomart (G5NI Birmingham), Limited, 44 Holloway Head, Birmingham, 1.—Amateurs wishing to purchase a complete transmitter or a complete kit of parts should obtain a copy of the latest Radiomart catalogue. The HX56 transmitter which will operate on 7 to

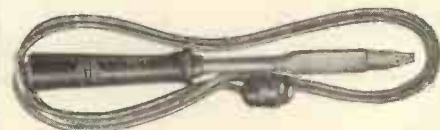

The Solon electric iron, which is now priced at 8s. 6d.



Silver Steel chassis and cabinets and panels.
Chassis 17 x 10 x 2 ... 4/6
" 17 x 12 x 2 ... 5/6
" 17 1/2 x 10 x 2 ... 4/9
Cabinets heavy folded and welded, with hinged lid and ventilating holes, black crackle finish.
19 x 9 x 10 1/2 deep ... 25/-
9 1/2 x 9 1/2 x 9 1/2 ... 16/-



VALVE HOLDERS

Ceramic valve holders for high-frequency work. Also trolitol and amenit all the same price. Yank types: 4, 5, 6, 7 and large 7, all 6d. British: 4 and 5 only, 6d. Octals in ceramic only, 8d. Pax types, Yank, 4-pin, 2 1/2 d.; 5-pin, 2 1/2 d.; 6-pin, 3d.; 7-pin, 3 1/2 d.; Octal, 4d. British, 4-pin, 2 1/2 d.; 5-pin, 3d.; 7-pin, 4d.; 9-pin, 4 1/2 d.; Octals' 4 1/2 d.

GAMMATRON TX TUBES.

HK24 " R.F. in a nutshell " ... 24/-
HK54 ... 52/6
HK154 ... 87/6
HK254 ... 95/-

The tubes for U.H.F. work. Immediate delivery. All Raytheon, Taylor, TX tubes, and all Raytheon receiving types stocked. Send us your enquiries.

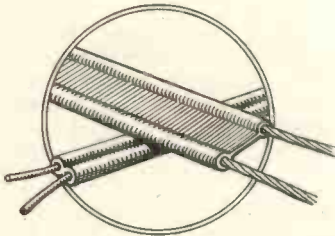

HAMRAD HIGH FREQUENCY FEEDER CABLES

Chlorinated vinyl, 72 ohm, 6d. per yard.
" " 350 ohm, 6d. per yard.
Belling-Lee 80-ohm feeder also stocked, price 6d. per yard.

Please send 1d. stamp for our latest list.

Some more of our agents.—

J. W. BEVAN EVANS (GW3GL), The Apiary, Conway, N. Wales. DEVON RADIO (G5IF), 165, Higher Union Street, Torquay, Devon. BRIGHOUSE RADIO SERVICE & EQUIPMENT CO., Royal Hotel Buildings, Brighouse, Yorks.

Allei unique resistors, all wire-wound on Ceramic 1 1/2 x 3/16 inch thick. These are space savers when you want to dissipate some watts.

5,000 ohms	6.5 watts	8d.
6,000 ohms	7.5 watts	8d.
7,000 ohms	9 watts	10d.
8,000 ohms	10 watts	1/-
9,000 ohms	12 watts	1/2
10,000 ohms	13 watts	1/4
12,000 ohms	15 watts	1/6
15,000 ohms	19 watts	1/8
17,000 ohms	22 watts	1/10
20,000 ohms	26 watts	1/11
25,000 ohms	32 watts	2/-
30,000 ohms	39 watts	2/2
40,000 ohms	50 watts	2/4



HELGO CONDENSERS

Electrolytics working at 550 volts, with surge of 750 volts. The can is not used as a ground. With the four-wire type you can series a 2 x 16 and get an 8 mfd. to use on 1,000 volts.

2-Wire Type		3-Wire Type	
8 mf.	2/-	2 x 8	2/6
12 mf.	2/3	2 x 12	2/3
16 mf.	2/6	2 x 16	4/-

4-Wire Type.	
2 x 8	3/-
2 x 12	3/7
2 x 16	4/3

New neutralising condenser all trolitol construction, tested at 3,000 volts A.C., to have a capacity of 12 mmf., twin disc type, horizontal, price, 7/6. U.H.F. chokes wound on trolitol, 2 1/2-12 metres, 1/-.

All Denco Components stocked. Insulated Sleeving 1/3d. per 12 yards.

Crackle Paint, 2/-, 3/6d. and 4/6d. Tins.

New type TX coil construction, a very firm job, spaced by trolitol rod, much stronger and rigid.
56 and 28 mc. ... 5/-
14 mc. ... 6/-
7 mc. ... 6/6 } All centre tapped.
Bases for above, 2/-.

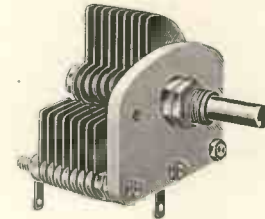

VARIABLE CONDENSERS

Single-ended type as illustrated.	Double-ended type.
Type 275	Type 370
50 mmf. ... 2/8	25 mmf. ... 4/9
100 mmf. ... 2/11	50 mmf. ... 5/-
150 mmf. ... 3/7	100 mmf. ... 5/11
	150 mmf. ... 6/10
	200 mmf. ... 10/-

Type 400
Transmitting type for high voltage working, 3,000 volts, very solid and F.B. jobs, with frequent end shafts and frequent spindle.
150 mmf. ... 28/- 250 mmf. ... 33/-

Panels 16 g. silver steel, black crackle finish.
19 x 3 1/2 ... 1/10 19 x 8 1/2 ... 3/6
19 x 7 ... 2/10 19 x 10 1/2 ... 3/10
Panels brackets, very strong, to take the heaviest power pack. Price, 2/6 per pair.

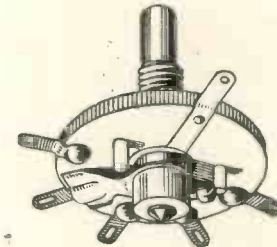

TROLITOL INSULATION

The ideal switch for low-loss switching.	
2-way ... 1/3	6-way ... 1/8
3-way ... 1/5	7-way ... 1/9
4-way ... 1/6	8-way ... 1/10
5-way ... 1/7	9-way ... 1/11

We have sheet trolitol, and rod and tube.
Sheet 15 x 9 x 1/4 ... 11/3
" 15 x 9 x 1/2 ... 16/10
Rod 1/2 diameter ... 9d. per foot
" " " ... 1/6 " "
Tube 1/2 " " ... 3/- " "
" 3/4 " " ... 2/6 " "
" 1 " " ... 4/- " "

Discounts given to all bona-fide Dealers.

HAMRAD WHOLESALE, LTD.
G8KZ, 2FYS.

LADBROKE 1166-1167
32, ST. LAWRENCE TERRACE, W.10

Radio Clearance :: Stratton

120 Mc., with an input 78 watts is priced at 51 gns. It is complete with all valves and coils for any band, crystal microphone, stand, morse key and blueprint. The R.F. chassis only

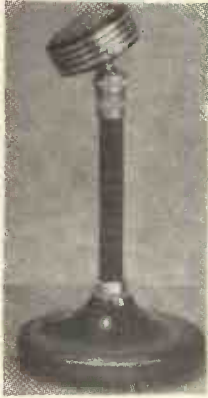

Turner microphones are becoming very popular. This is the model VT73, designed for amateur use, and available through Webbs Radio.

is priced at 10 gns. A larger instrument is the RF100 which is priced at 48 gns., but is not quite so comprehensive as the HX56. It uses two Taylor



Vibrator packs of this type are available from 60s. upwards through Webbs Radio.

T20's in the final stage. Beginners should notice the Junior transmitter kit, which is priced at £4 19s. 6d. complete. Radiomart are stocking all National

receivers, the Hammarland HQ-120X and all Howard receivers. Stocks of American components of all kinds are actually available while an inexpensive B.F.O. unit has just been produced for those who wish to modernise their receiver or to adapt a broadcast receiver for communication use. Stand No. R.4.

Radio Clearance, 63 High Holborn, W.C.1.—The new McMurdo-Silver communication receiver kit is being handled



The Vidor transportable receiver model 320.

by this company and we have just concluded our tests on one of the first production models. It is priced at 18 gns. includes ten valves, signal strength meter, noise suppressor regenerative I.F. amplifier and many other features. The wave range is nearly 600 metres down to 4.02 metres, while the sensitivity over the centre range is both level and high. The main feature of this receiver is the exceptionally low noise level.

Sound Sales, Limited, Marlborough Road, Holloway, N.—For the 1940 season this company are going to concentrate on high quality transformers and audio components in addition to their fine range of audio amplifiers for public address use. Sound Sales are fulfilling a large number of contracts of



One of the most popular receivers in this country at the present time, despite competition, is still the Halli Craft SX17, which has two stages of R.F. and is priced at £39 10s., complete with crystal.

P.A. equipment for hospitals and institutions and we can recommend any of our readers interested in this type of equipment to obtain the descriptive brochure which is available on request.

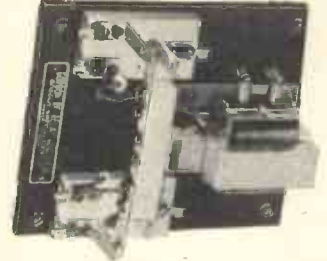

A Gordon heavy-duty R.F. relay. It is A.C. operated and is priced at 52s.

Stratton and Co., Ltd., Eddystone Works, Bromsgrove Street, Birmingham, 5.—The latest 20-page brochure issued by Stratton and Co., covering Eddystone short-wave components should be in the hands of every short-wave reader. Amongst the new lines are miniature condensers for transmitting use, 7,000-volt transmitting condensers of the single and split stator type and a small pattern split-stator condenser of low loss suitable for inputs up to 150 watts. Eddystone micro-condensers can be converted into two- or three-section ganged condensers by using the new condenser cradle type 1114 which is priced at 3s. 6d. The flexible driving shaft is also of interest for it enables components to be mounted in any convenient spot and driven through an angle of 90 degrees to the front panel. Glazed Frequentite formers for use up to 90 metres are available for 4s., while low-loss short-wave formers of 4-pin, 5-pin or 6-pin types are obtainable from 2s. upwards. Eddystone trans-



One of the new Webbs transmitting keys, priced at 25s.

mitting racks will prove very popular, particularly as they can be purchased in two sections. The first section consists of three tiers to which can be fitted a further three tiers if required. The complete relay rack is priced at 25s. and the extension outfit at 12s. 6d. Steel panels of the standard 19 in. width vary in price from 2s. 3d. upwards, while the standard steel chassis is priced at 4s. 6d. Constructors of communication receivers should obtain data on the Eddystone air-tuned I.F. transformers which are Litz wound and air trimmed. They can be used on any frequency between 400 and 500 Kc., and provide a band

Go to your Dealer & ask for EDDYSTONE SHORT WAVE COMPONENTS

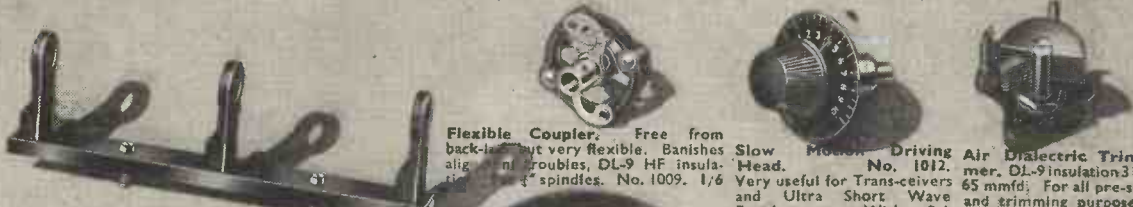

SEND
FOR
CATALOGUE

Condenser Cradle.
Enables three microcondensers to be mounted as three gang condenser unit. Rotors and stators completely isolated. Brass division plates available for screening condenser units. No. 1114, 3/6, Metal screens, No. 1125, 8d. pair.

Neutralising Condenser
No. 1088. For HF circuits using low-capacity triodes. Maximum voltage 2000 volts D.C. Capacity variation 1.8 mmfd. Frequency mounting, insulated adjusting knob. 6/6

Flexible Coupler. Free from back-lash but very flexible. Banishes alignment troubles, DL-9 HF insulation on spindles. No. 1009. 1/6

Slow Motion Driving Head. No. 1012. Very useful for Transceivers and Ultra Short Wave Receivers. With 9-1 reduction ratio; pointer moving through 180 degrees. 3/-

Air Dielectric Trimmer. DL-9 insulation 3 to 65 mmfd; For all pre-set and trimming purposes, particularly with IF transformers. No. 978. 3/6



All vision dual speed dial. No. 1070. A all vision dual speed dial with 20:1 and 100:1 speeds. Well graduated scale, reading increasing as frequency increases. For 1/2" panel and 1/2" spindles. Ideal for H.F. tuning. 10/6



Flexible Driving Shaft. For front panel control of awkwardly placed components. Drives through 90 degrees perfectly. Cable length 5 1/2". No. 1096. 3/6

WRITE FOR CATALOGUE

HIGH-VOLTAGE MICRO-DENSER. Soldered brass vanes. Constantly maintained capacity; very low minimum 3 mmfd. DL9 insulation. 1" spindle extended for ganging. Peak flashover voltage 3,500 volts. Easy to gang—capacity matched within 1 per cent. No. 1094. 3/9



MANUFACTURED BY STRATTON & CO. LTD., BROMSGROVE ST., BIRMINGHAM. (LONDON SERVICE, 14 SOHO ST., W.1)

Stand
30

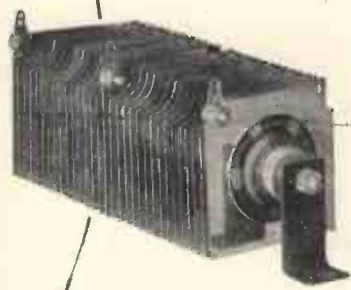

You must visit Stand 30 and inspect the latest range of Westinghouse Metal Rectifiers and Westectors, but, if you are unable to visit the Radio Show, make sure you send 3d. in stamps to Dept. T., for a copy of the latest edition of "The All Metal Way."

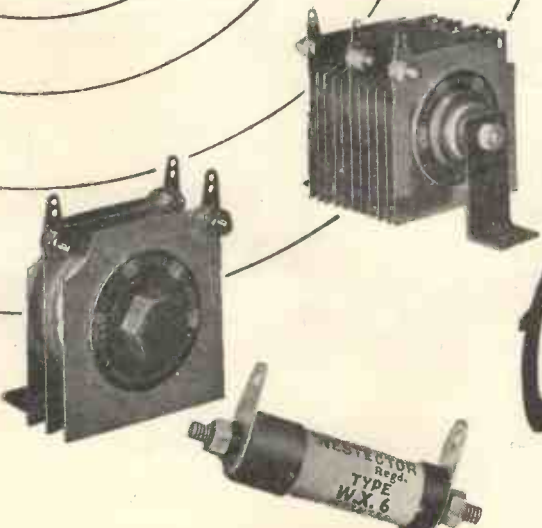

Westinghouse
METAL

RECTIFIERS

WESTINGHOUSE BRAKE & SIGNAL CO. LTD., 82, York Way, King's Cross, London, N.1.

T.C.C. :: United Insulators :: Webb's

width of 7 Kc. The price is 8s. 9d. Stand No. R.2.

Standard Telephones and Cables, Foots Cray, Sidcup, Kent.—Brimar valves are being handled by this company and in-



This McElroy key is priced at 6s. 6d.

clude the normal British types, International octals, American U.X. and the latest American loctal type. A complete brochure describing the large number of valves available can be obtained on request. Brimar valves are suitable for replacement in American built receivers.

Taylor Electrical Instruments, Limited, 45 Fouberts Place, Regent Street, W.1.—A complete range of test equipment is being marketed by this company which includes a new all-wave signal generator model 60 priced at 10 gns. It has a frequency range of 100 Kc. to



The Ekco PB510, priced at 12 gns.

46 Mc., in six bands, five of which are fundamental. Other features included are internal modulation at 400 cycles, external modulation in which the audio oscillating valve acts as a choke coupled amplifier, and operation is entirely from A.C. mains. The new model 90 Universal meter provides 32 ranges and will read up to 1,000 volts A.C. or D.C. It is priced at 7 gns. There is also a comprehensive and flexible valve tester

in which no less than 800 British and other valves can be tested for slope, emission, cathode reading, element shorts and filament continuity. The bench type costs 8½ gns. Stand No. O.101 and R5.

Telegraph Condenser Co., Ltd., Whales Farm Road, North Acton, W.3.—Fixed condensers of every description including paper, mica, wet electrolytics in aluminium cans, dry electrolytics in cartons, high frequency and high voltage filament condensers are being shown at Olympia. Also special con-



Another popular crystal microphone, type Shure WM15.

densers for transmitting use and for television service will be on view. Amateurs who are keen on ultra-short-wave work should make a point of seeing the silvered mica precision condensers and the other ceramic materials. Stand No. O.63.

Telegraph Construction and Maintenance Co., Ltd., 22 Old Broad Street, London, E.C.2.—Telcon cables are being displayed at Radiolympia and in addition most manufacturers are using Telcon feeder or co-axial cables either directly or indirectly. Special co-axial cables for amateur use in feeding aerials, etc., are now being manufactured by this company which we advise readers to see. Stand No. O.22.

United Insulator Co., Ltd., 12/16 Lay-stall Street, E.C.1.—A new type of ceramic trimmer of small physical

dimensions is being manufactured by this company primarily for use in television receivers. It has the highest insulation and a wide range of capacity. They are obtainable in single or double



The new Hallicrafter Defiant, which is complete with crystal and available from Webb's Radio.

types and can be used in any type of receiver or transmitter for balancing purposes. The components manufactured by this company are extremely interesting and we advise readers to obtain a copy of the brochure describing them.

Varley, Cambridge Row, Woolwich, S.E.18.—Varley components have for many years been well known amongst amateurs. They are now producing a wide range of superhet coils, I.F. transformers, and iron-cored coils. Also in their range this year is a B.F.O. oscillator, a 465 Kc. filter, power potentiometers, high-frequency chokes, and a

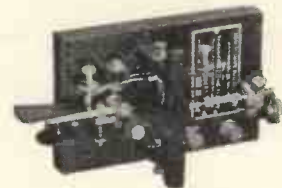

The new McElroy BUG key.

most interesting thermal delay switch. Amateurs should make a point of visiting the Varley exhibit at Radiolympia on Stand No. O.108.

Webb's Radio, 14 Soho Street, Oxford Stree, W.1. (41 Carr's Lane, Birmingham, 5).—This company whose offices and showrooms are the Mecca of all amateurs visiting London and Birmingham, now have the largest stocks of components, valves, receivers and short-wave equipment they have ever handled. Amongst the huge stock of specialised equipment available at the



The very popular Hammarlund HQ-120X receiver, priced at £38.10s. It uses 12 valves and has a special crystal gate circuit.

A good example of Ferranti design.



Discrimination!!

The rapid growth of the amateur movement, both in this country and the U.S., has unfortunately brought into the ranks both manufacturers and dealers of the usual crowd of "get-rich-quick" people to whom truth in advertising is entirely foreign. Unfortunately, as days go by we find more and more evidence of misleading advertisements which undoubtedly sell goods which are anything but satisfactory in service. The high and ultra high frequencies demand obviously the very best of material if performances of a high order are to be obtained, and much of the material sold is, in our estimation, totally unsuited for the job. We are outlining this month a number of the things that have come to our notice during the last few months. This list is by no means exhaustive and the purchaser should look for the snag in all the marvellous offers he reads before buying trouble of this description.

CRYSTAL HOLDERS: Here we have holders offered at extremely low prices by some companies. Points to note are that a good crystal holder has properly ground stainless steel electrodes, not a ferrous metal which oxidizes quickly and does not provide a clean surface for the crystal. The design also of the electrodes affects the frequency of the crystal anything up to 10 kc/s.

CRYSTALS: A crystal is invariably only as good as the company who manufacture it. A piece of quartz the size of a standard crystal is an exceptionally cheap article. What you pay for is accurate grinding, accuracy of calibration, activity and stability.

POWER TRANSFORMERS and CHOKES: Many power transformers are offered at the present time which have inadequate and inferior iron and copper components. Whilst some of these will work on the intermittent service of transmitting, it should be realized that if the component has had the material "skimped," even if it continues to function, the regulation is so bad that the rise in voltage between low loads and full load are such that condensers, rectifying tubes and other equipment in the power pack are seriously overloaded, and, in many cases, wrecked. To save, therefore, a few shillings on power transformers and to wreck high voltage condensers is, to say the least of it, very foolish.

CERAMICS: Unfortunately, almost any material can be labelled "Ceramic" or even "Steatite." In the case of this latter, if the amount of Steatite present is infinitesimal, it still can be called Ceramic. The difference between a high quality Ceramic, similar to our own RMX., Isolantite, Callit, and some of the pipe-clay types of materials offered is tremendous. Unfortunately, also, not only are components involved but complete radio receivers. We see claims by manufacturers such as "thousands of degrees of electrical band spread" . . . "dozens of degrees of variable selectivity," . . . "complete noise silencing" . . . and other claims of a similar nature, all of which should be investigated very carefully.

BAND-SPREAD: The electrical band-spread condenser very rarely rotates more than 180 degrees. It is easy, however, to fit it with a dial and count the number of revolutions of the knob, calling this band-spread. In the case of variable selectivity, with the exception of the infinite variable selectivity, where the IF. coils move, and also the new system fitted in the Hammarlund HQ.120X, such variable selectivity invariably boils down to two positions, broad and sharp, plus the standard crystal filter, no matter how many positions may appear on the variable selectivity knob, and also, it should be noted that this switched type of variable selectivity invariably demands that the receiver be aligned on the sharp position, and because of the switching out or in of a portion of the winding on the other positions, the IF. is very rarely accurately aligned, with the result that discrimination is impaired and you get a broad position (it is usually inefficient with it).

We could go on for a long time in the same strain but space does not permit us to point out all the catches.

THE MORAL !!

Buy your goods from a reputable company who have been trading for a considerable time (might we point out we are the oldest distributors of American Communication merchandise). Look carefully at all the exceptionally cheap offers and if they emanate from a new company, regard them with particular suspicion. On complete equipment, look back for a number of years and see what claims were made for their equipment which is now obsolete. You will find in many cases that the equipment then was the "last word," and yet probably four or five different models have appeared in the meantime. You can rest assured if you buy equipment where the manufacturer or distributor has handled the same equipment for a long period that this material could not sell without sheer merit making continuous sales possible. The National HRO. is a case in point; and, lastly, examine the second-hand values of the equipment you propose to purchase as this will give you a surer idea of the actual value than all the "ballyhoo" appearing in an advertisement.

THE SHORT-WAVE SPECIALISTS.

RADIOMART

GSNI (B'HAM) LTD.

DIRECTORS: W. H. D. NIGHTINGALE L. NIGHTINGALE

44 HOLLOWAY HEAD, BIRMINGHAM, I

Telephone: MIDLAND 3254

STABLE VOLTAGE

—the only solution to the problem of unstable supply voltage is the **STABILOVOLT**

CURRENTS UP TO 200 mA



Write for new pamphlet giving reduced prices and additional ranges. Full particulars from **MARCONI'S** WIRELESS TELEGRAPH CO. LTD. Electra House, Temple Place, London, W.C.2.



Said that veteran radio-man, Pace,
"That crystal set in its glass case
May make you amused,
But since FLUXITE I used,
It's the first of a very long race!"

See that FLUXITE is always by you—in the house—garage—workshop—wherever speedy soldering is needed. Used for 30 years in government works and by leading engineers and manufacturers. Of Ironmongers—in tins, 4d., 8d., 1/4 and 2/8. Ask to see the FLUXITE SMALL-SPACE SOLDERING SET—compact but substantial—complete with full instructions, 7/6 Write for Free Book on the art of "soft" soldering and ask for Leaflet on CASE-HARDENING STEEL and TEMPERING TOOLS with FLUXITE.

To CYCLISTS! Your wheels will NOT keep round and true unless the spokes are tied with fine wire at the crossings and SOLDERED. This makes a much stronger wheel. It's simple—with FLUXITE—but IMPORTANT.

THE FLUXITE GUN

is always ready to put Fluxite on the soldering job instantly. A little pressure places the right quantity on the right spot and one charging lasts for ages. Price 1/6, or filled 2/6.

ALL MECHANICS WILL HAVE

FLUXITE

IT SIMPLIFIES ALL SOLDERING

FLUXITE LTD. (DEPT. T.V.), DRAGON WORKS, BERMONDSEY ST., S.E.1

Westinghouse :: Wearite :: Polar

present time are the following which we have picked at random. Guardian relays for aerial change over, switching or keying purposes in all types from 5s. The A100, which has six contacts for

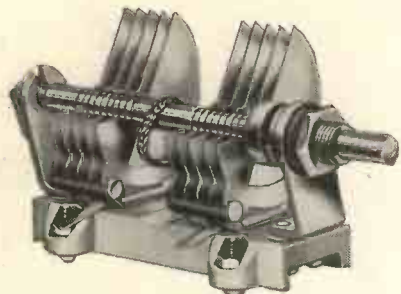

The Polar type "E" transmitting condenser.

aerial change over, and ceramic insulation is priced at 24s. Slideohm resistors of 25 watts rating are priced at 2s. 6d., including tapping clip. Valpey crystals both mounted and unmounted for spot frequencies on any amateur band are available complete with calibration certificate. In view of the rise in interest in morse code work, Webb's have now obtained a large stock of the McElroy practice sets which consist of a heavy duty morse key and mechanical 1,000 cycle oscillator. It is priced complete at 19s. 6d. One of the most popular sets handled by Webb's at the moment is the new Hammarlund HQ 120X, priced at £38 10s. It is a 12 valver covering 31 to .45 Mc. In order to help combat noise, with the average high-gain re-

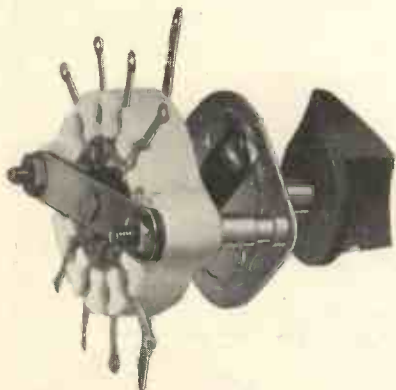

This Wearite ceramic switch is becoming very popular amongst discriminating users.

ceiver Webb's have imported a number of R.C.A. Spider Web aerials which are priced at 32s. 6d. We can recommend these aerials for use in noisy locations.

The special constructional department of Webb's Radio have produced the U.H.F. convertor described in the April issue of QST for 8 gns. complete. This convertor is being used by a number of British 5-metre workers with great success. RME, whose model 69 receiver proved so popular, have now produced a DM36 frequency expander

for 5 metres, which is a great improvement over the original model produced and which we can thoroughly recommend; it is priced at £12. There is also an RME L.F. expander for the reception of long-wave stations on the RME receiver. RME have also produced a 10-valve ultra-shortwave receiver. The type number is HF10 and the price 17½ gns.

The Hallicrafter HT7 is a frequency standard for use in checking transmitter frequency, checking receiver calibration, calibrating crystals, or for setting E.C.O. frequency with a high degree of accuracy. It is priced at £9 complete. A new Triplett meter has just been introduced; the model number is 666H, and the price £4 10s. It is 1,000 ohms per volt, reads A.C. or D.C. from 10 volts to 5,000 volts or resistances from 250,000 ohms to 10 ohms. A good investment is the Bassett handbook which deals very thoroughly with the feeding of aerial systems and in the design of rotary beams. At 1s. 3d. it is very good value for money and Webb's Radio have the book in stock. Turner microphones are becoming very popular, and they make a large number of different models, many of which Webb's have in stock. One of these is illustrated in these pages and the original can be seen in Webb's showroom. All American valves including the latest battery operated acorns, any good American communication set and most American technical publications are now available from Webb's Radio in either London or Birmingham. Stand No. R.1.

Westinghouse Brake and Signal Co., Ltd., York Way, N.1.—A full range of Westinghouse metal rectifier units for radio and television will be shown at Olympia this year. These include the high tension and low tension types for

mains units, battery charging, and loud speaker field supply; "Westectors"—the high-frequency rectifiers for detector, automatic volume control, battery economy, etc.; "H" and "J" types for television purposes—H.T. supply to cathode-ray tubes, time base, picture shift circuits, etc. Stand No. O.30.

Wright and Weaire, Limited, 740 High Road, Tottenham, N.17.—Amongst the components manufactured by Wearite this year are iron-cored coils, press-button tuners, mains transformers of every pattern—and some very interesting ceramic switches. These switches have a capacity of 1 mmfd. between



The Wearite Imp selector.

contacts and only 2 mmfd. between pole and contacts. They are ideal for use in ultra-shortwave receivers or similar circuits and vary in price from 5s. Stand No. O.102.

Wingrove and Rogers, Limited, 12 Dartmouth Street, S.W.1.—Polar short-wave condensers will be very popular this season. They have a number of new designs which we advise readers to see at Olympia, or at the R.S.G.B. exhibition. The type C801 is a short-wave trimmer priced 5s., the C1801 is a miniature U.H.F. condenser with steel frame and ceramic insulation. The prices vary from 7s. 6d. Stand No. O.110, R.5a.

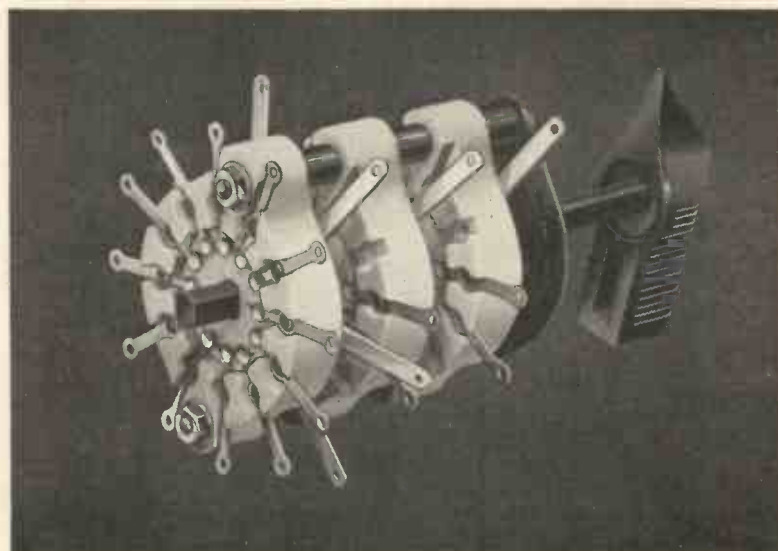

A three-bank model of the Wearite ceramic switch unit.

NOT AT THE SHOW but putting up a **GOOD SHOW** everywhere there is **S. W. Radio**



At all good radio dealers.
If you have any difficulty
in procuring, write direct.

Short-wave stations are tricky things . . . requiring very careful tuning before they are "resolved." Ericsson Supersensitive Telephones turn short-wave whispers into **SHOUTS**.

Wonderfully sensitive, comfortable in wear and very pure in tone. Ericsson Supersensitive Headphones have come to be regarded as standard for the keen short-wave enthusiast's equipment.

ERICSSON TELEPHONES LTD.

22, Lincolns Inn Fields, W.C.2

Tel: HOLborn 6936



**SUPERSENSITIVE
TELEPHONES**

WHATEVER CONDENSERS YOU NEED



If you need condensers, if you don't need them; if you want

to discuss them, or if your one desire is to forget them —

we'll still be very pleased to see you again at Stand No. 28.

STAND 28 GRAND HALL DUBILIER

Mica Condensers

Metallised Mica Condensers

Ceramic Condensers

Paper Condensers

Electrolytic Condensers

Surge Proof Condensers

Drilitic Condensers

Radio Interference Suppressors



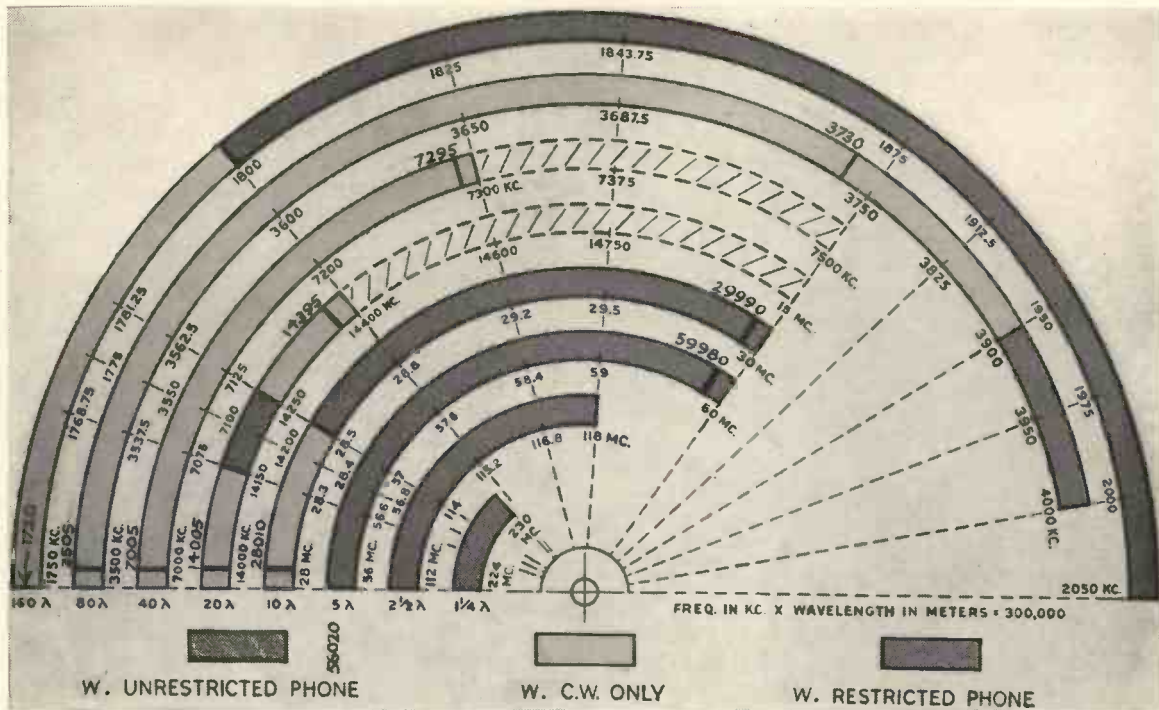

When purchasing crystals, this amateur frequency chart indicates very rapidly just where the harmonics of any crystal will fall. It also shows the limits of the British phone bands and the American phone and C.W. bands.

Frequency Stability in the C.O. Stage

IN these days of congested amateur bands it is difficult enough to find and maintain an operating frequency in just the desired spot.

There is a tendency to purchase crystals and immediately assume that the frequency of the signal emitted by the transmitter will always be that marked on the box by the crystal manufacturer, or the selected harmonic. There are, however, many important considerations, apart from the actual thickness of the crystal, which can affect the frequency at which it will oscillate and, if some of these are additive, a surprisingly wide divergence from the nominal frequency can result. It may be useful, therefore, to tabulate all the circumstances which govern the actual frequency of a crystal when used in a short-wave transmitter. These are:—

- The physical dimensions of the crystal.

- The nature of the mounting.

- The axis on which the crystal was cut.

- The crystal temperature.

- The electrical constants of the oscillator circuit.

Some of these are inter-dependent. For example, the design of the holder affects the working temperature, as we shall see from a more detailed consideration of these main controlling factors.

Dealing first with (a), the main factor is, of course, the thickness of

the quartz plate, but if there are any high-spots on its surface, or particles of dirt, the *effective* thickness may not be what it seems, and there are not uncommon causes of deviation from the supposed frequency of operation. Crystals can be cut so that they oscillate in two directions at right-angles to each other, and in such cases it is necessary to ensure that the desired frequency is being used. A familiar application of this property is the use of bars vibrating at 1,000 and 100 Kc/s for frequency standards.

The design of the crystal mounting has an important bearing on stability. A well-designed holder will help to dissipate heat, minimising drift and enabling a slightly higher anode voltage to be used, with a consequent increase in output. In some holders the air-gap between the crystal and one contact plate can be varied, so varying the frequency. Now that well-made enclosed holders are available at prices within the reach of every amateur's pocket the open type is very rarely seen, and it is not necessary to clean the crystal at frequent intervals.

The axis on which the crystal is cut from the original piece of quartz affects the activity and, more especially, the frequency temperature co-efficient of any piezo electric device. As the axis used is beyond the control of the user when once the crystal has been cut, it is not necessary to discuss this factor in detail here.

The operating temperature has a very important effect and can easily cause serious drift from the desired frequency. Apart from ensuring reasonable heat dissipation in the electrodes between which the crystal is mounted (as mentioned above), it is important to place the crystal well away from any components, such as valves and resistances, which are liable to large changes of temperature in use. It is also necessary to limit the anode voltage on the valve and the amount of regeneration used in the circuit, so that excessive heat is not generated in the crystal itself.

The circuit characteristics have a certain effect which must not be neglected in our calculations, but as these vary so widely it is impossible to generalise. The type of valve, the capacity of the crystal holder and the coils, condensers, etc., all produce some effect which would have to be considered by those requiring a high standard of accuracy.

The frequency chart at the top of the page should give amateurs a clear mental picture as to the width of each amateur band and the best spot in which to operate. There is always less QRM on frequencies which do not double into the next ham band, for despite the cheapness and accuracy of the modern crystal, such as the Valpey, amateurs are still inclined to make use of one crystal and to frequency multiply into numerous bands.

Why Solon Electric Soldering is easier



IRREGULAR HEAT IRON COOLS OFF CONSTANT HEAT

Cleanliness and constant heat are the secrets of successful soldering. The Solon is heated by the element clamped inside the bit. Ready in 4 minutes, maintaining constant heat at the point. 15 hours' use for 1 unit.

Supplied complete with resin-cored solder, flex and lamp adaptor, 8/6.

Solon resin-cored solder 6d. per reel.



W. T. HENLEY'S TELEGRAPH WORKS CO. LTD.
(DEPT 1/G), HOLBORN VIADUCT, LONDON, E.C.1

You hear more with "BROWN'S"



TYPE "A"
(Adjustable Reed)
Used throughout the World. **50/-**

TYPE "D"
Per Pair **35/-**

TYPE "F"
(Featherweight) Per Pair **20/-**

HEADPHONES BECAUSE OF THEIR EXCELLENCE OF DESIGN AND CONSTRUCTION. EACH TYPE GIVES EXCEPTIONAL VALUE FOR MONEY.

The following Stockists are ready to serve you:—

A.C.S. RADIO LTD., 16, Grays Inn Road, London, W.C.1.

CORDON-KNIGHT RADIO 39, Holland Park Mews, London, W.11.

DAY & ELLIOTT, 50, All Saints' Road, Peterborough.

HAMRAD WHOLESALE LTD., 32, St. Lawrence Terrace, London, W.10.

HOLLIDAY & HEMMERDINGER LTD., 74-78, Hardman Street, Deansgate, Manchester, 3.

QUARTZ CRYSTAL CO. LTD., Kingston Road, New Malden, Surrey.

RADIOMART (G5NI), 44, Holloway Head, Birmingham.

N. E. READ, 24, Church Street, Oswestry, Shropshire.

SHORT-WAVE RADIO LTD, 97, Park Lane, Leeds, 1.

WEBBS RADIO, 14, Soho Street, Oxford Street, London, W.1., and 41, Carrs Lane, Birmingham.

Any of the above suppliers will send you our illustrated leaflet, "T.S."

S.G. Brown Ltd.

VICTORIA ROAD, NORTH ACTON, W.3

Telephone: ACOrn 1174

RADIO CLEARANCE LTD.

63, HIGH HOLBORN, LONDON, W.C.1

HOLBORN
4631

LONDON'S LARGEST STOCKISTS OF GUARANTEED COMPONENTS.

GUTHMAN MCMURDO
SILVER COMMUNICATION
RECEIVER.

Wired and Aerial Tested,

£18 18s. 0d.

Unwired, £17.



TERMS.—Cash with order or C.O.D. Charges extra. Orders to the value of 5/-, post free. Under this amount, post extra.

Circuit, superhet, double regeneration obtained at signal frequency and also at intermediate frequency, as a result very high sensitivity and selectivity are obtained; controls include R. meter, silencer, tone, aerial trimmer, A.F. gain selectivity, beat oscillator, receive-send, A.V.C., B.F.O., on-off, B.F.O. pitch. Complete with valves.

CO-AXIAL CABLE. Finest quality for Television lead in. Heavy vulcanised tough rubber insulation closely meshed screen. Single, 6d. per yard; twin, 9d. per yard.
FILAMENT TRANSFORMERS.—Input 200-250 volts, output 4 volt 4 amps., 4 volt 6 amps., 4/11 each.
MAINS TRANSFORMERS.—American windings. Input 200-250 volts, tapped. Output 350-0-350 100 m/A., 5 volt 2 amp., 6.3 volt 5 amp., 7/11 each.
G.E.C. MAINS TRANSFORMERS.—American windings. 350-0-350 volt 65 m/A., 5 volt 2 amp., 6.3 volt 2.5 amps. Suitable for replacements in G.E.C. models, 5/6 each.
AUTO TRANSFORMERS.—100-230 volt, 5/11 each.
ELECTROLYTIC CONDENSERS.—Plessey 8 x 4 x 4 x 4 mfd., 570-volt working, 2/- each; 24 mfd., can-type electrolytics, 450-volt working, 10d. each; 8 x 8 mfd., 450-volt working, 1/- each. T.C.C., 8 mfd., can-type, wet electrolytics, 450-volt working, 1/3 each.
POLAR N.S.F. RESISTANCES.—1 gross parcels of 1/2 and 1/4 watt resistances, all good sizes, our selection, 4/6 each.
STANDARD PUSH BACK WIRE.—1d. per yard; 12 yards, 10d.
YAXLEY SWITCHES.—2-pole, 4-way, 3-bank, 1/6 each; 2-pole, 5-way, 4-bank, 2/- each.

CHASSIS MOUNTING VALVE HOLDERS.—American, 4, 5, 6 and 7-pin, 3d. each; Octal, 4d. each; Loctal, 8d. each; 7-pin English type, 2d. each.
ROTHERMEL PIEZO CRYSTAL SPEAKERS.—7 1/2-in. cone. List 55/-, our price, 9/6 each.
G.E.C. RELAYS, make and break type, 3,300 ohms, 4/- each.
CRYSTAL PICK-UP.—High-grade American, bronze finish, complete with arm, £1 5s. 0d. each.
POLAR N.S.F. 1-WATT RESISTANCES.—3/4d. each. 3/- doz., all sizes up to 2 meg.
WEARITE MAINS TRANSFORMERS.—Made to strict electrical standards, wire-end type, all windings centre tapped, screened primaries. Tapped inputs 200-250 volts, screw adjustment. Type R.C.2, 350-0-350 120 m/A., 4 volts 2.5 amp., 4 volts 5 amp., 11/- each; Type R.C.3, 350-0-350 150 m/A., 4 volts 2.5 amp., 4 volts 2 amp., 4 volts 5 amp., 12/6 each; Type R.C.4, 500-0-500 150 m/A., 4 volts 2 amp., 4 volts 2 amp., 4 volts 2.5 amp., 4 volt 5-6 amp., 19/6 each; R.C.2. Drop-through type, capped; R.C.3 and R.C.4, upright mounting type, fully shrouded.
AMERICAN C.T.S. VOLUME CONTROLS. Finest made. Divided spindles length 2 1/2 in. With Switch:

2,000, 5,000, 10,000, 25,000, 50,000, 100,000, 250,000, 500,000, 1 meg., 2/- each. Less Switch: 50,000, 100,000, 500,000, 1/9 each. Wire-wound 5-watt (less switch): 2,000, 10,000, 25,000, 50,000, 2/- each.
HEAVY-DUTY SPEECH TRANSFORMERS, 2/11 each.
T.C.C. CARDBOARD ELECTROLYTICS, wire-end type, sizes 2 1/2 in. x 1 1/2 in., 500-volt working, 600-volt surge, 8 mfd., type "Minor," 1/6 each; 8 plus 8, 4 lead, type "Minor," 2/6 each; 8 mfd. midget tubular, wire end, 500-volt working, 600-volt surge, 1/6 each; Bias wire-end type, 25 mfd., 50 volt, 1/3 each; 50 mfd., 12 volt, 1/- each; 50 mfd., 25 volt, 1/3 each; 25 mfd., 25 volt, 1/- each; 50 mfd., 50 volt, 1/6 each; Tubulars, wire end, non-inductive paper, all sizes up to 0.1, 4 1/2d. each, 4/- dozen; Metal case, 1-hole fixing, electrolytic condensers, 500-volt working, 600-volt surge, 8 mfd., 2/6 each.
STANDARD TELEPHONE HEADPHONES RESISTANCE, 2,000 and 4,000 ohms, 5/11 per pair.
RAYTHEON FIRST GRADE VALVES, Largest Stockists, all types in stock, including Glass Series, Glass Octal Series, Metal Series, Loctal Series, Bantam Series, Single-ended Metal Series, and Resistance Tubes. All at most competitive prices. Send for Lists.

Building a Universal Exciter Unit

This exciter, designed by the well-known radio engineer, G5NI, can be used as a low power multi-band transmitter, or to drive a high-power tetrode or pentode final amplifier.

THIS exciter has been designed and produced in such a way that it can be used to drive practically any kind of final amplifier or high-power sub-amplifier.

The components throughout are of a standard type with four Raytheon 6L6 valves. The power unit is quite separate and arranged so that it can be plugged into the exciter.

Upon examination of the recommended chassis it will be noticed that there is a large hole in the base, nine holes for valve sockets in the side, a small hole for fitting the meter grommit in the top, and an additional hole for the link strip at the right-hand end.

In the single hole at the bottom a four-pin bakelite socket of the American type is fitted, this is for power pack connections. The remaining nine holes are for valve holders, being valves and coils alternately. In the first or left-

hand hole—that is, farthest away from the exciter strip—a five-pin socket is fitted with the grid or odd pin towards the extreme left of the chassis. Next comes an octal valve holder, with the locating key pointing downwards towards the four-pin bakelite socket.

In the next hole is fitted a four-pin English type socket with the anode and one of the filament pins towards the left. In this order all the other sockets, octal and four-pin English, are fitted. The socket line-up, therefore, in the top of the chassis, working from left to right, is five-pin American, octal, four-pin English, octal, four-pin English, octal, four-pin English, octal, four-pin English, and finally the terminal strip for the link connections.

After all these sockets the meter grommit and a link connection strip have been fitted the various chassis connecting supports should be mounted. Wiring, with the exception of the con-

nections that go to the meter and link switch, can be completed, but the wires to the meter and switch should be left sufficiently long so that these components can be mounted when the construction is almost completed.

It should be noted that the 125-ohm, 2-watt resistor consists of a pair of 250-ohm 1-watt resistors connected in parallel. This is necessary owing to physical limitations and the space occupied by a suitable resistance of high rating.

Each stage with the exception of the crystal-oscillator is identical in design, so making construction extremely simple. However, as there is little space to spare in each stage, the components should be placed very carefully in order that they can be accommodated in such a way that the wiring is not complicated and there is little danger of short circuits through resistors touching the metal chassis.

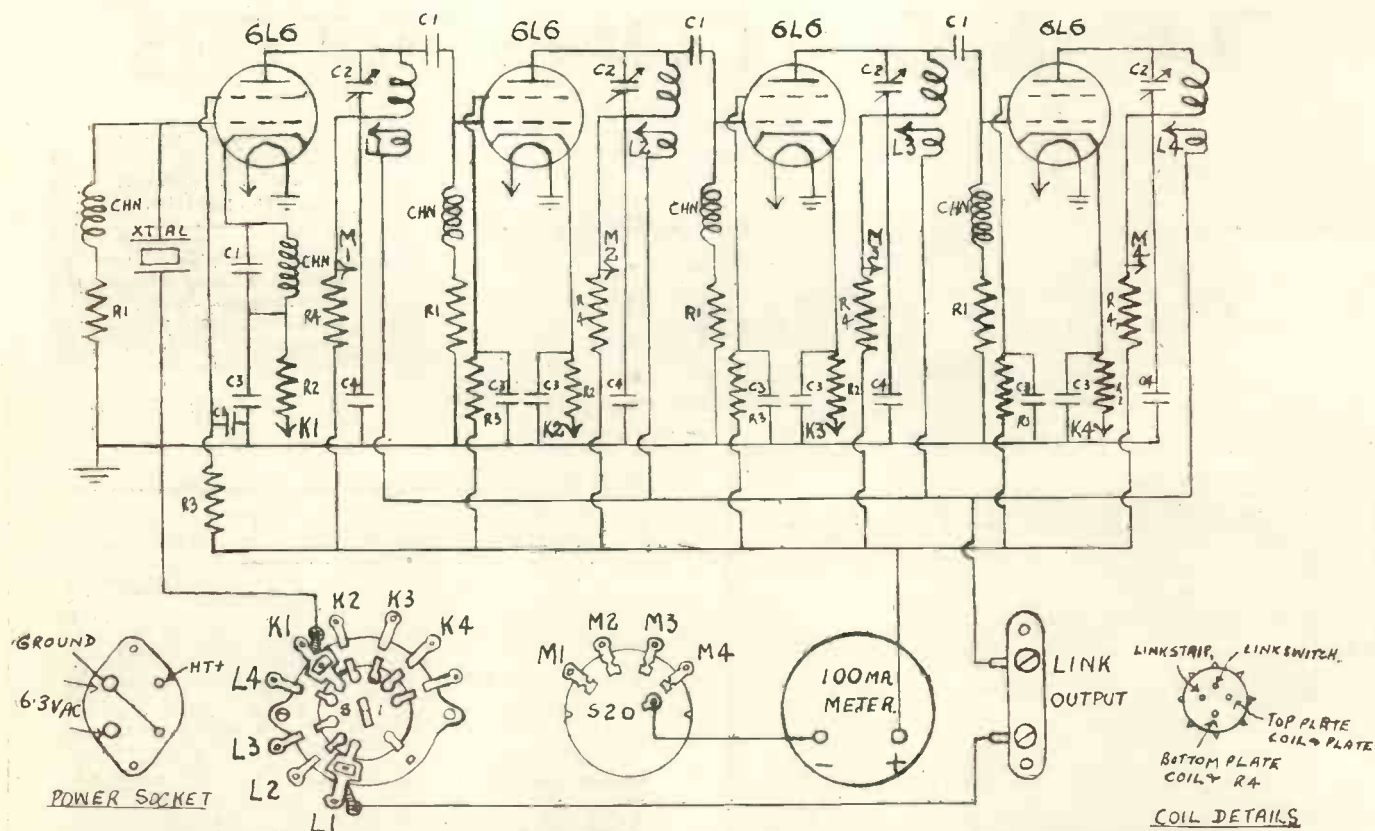

The complete circuit showing how the four 6L6's are used, following an 80-metre crystal-oscillator. Component values are : R1 10,000 ohms, R2 450 ohms, R3 20,000 ohms, R4 125 ohms, C1 .0001 mfd., C2 ATC 100, C3 .01 mfd., C4 .002 mfd.

IMPORTANT NOTICE!

Just to remind YOU that **SOUND SALES LIMITED** are Contractors to The Air Ministry, War Office, Admiralty, B.B.C., G.P.O. and L.C.C., etc., and specialise in the design and construction of Super Quality—

- (1) Amplifiers from 3 watts to 1 kW.
- (2) Transformers of all types—single and three phase, from miniature L.F. types up to high voltage models for Neon Bombarding.
- (3) Chokes iron cored and air cored.
- (4) Last but by no means least—Special Radio Equipment from £20 to £200, designed especially to appeal to the Music Lover and Engineer.

May we send you our latest catalogue and technical manual ... **PRICE 6d.**

Specified by **SOUND SALES LTD.** the Experts
MARLBOROUGH RD. UPPER HOLLOWAY,
LONDON, N.19. Telephone: Archway 1161/2/3

Hours of Business: Monday to Friday, 8.30 a.m. to 6 p.m.
SATURDAYS CLOSED

TELEVISION

We offer you choice from the new season's models by **BAIRD, BUSH, COSSOR, G.E.C., PHILIPS** and **INVICTA**. Easy terms to suit your convenience, and attractive part exchange allowances. Why not come and chat it over, without obligation.

SPECIAL SNIPS

BAIRD T20 Table Televisor, dem. soiled, full guarantee, £29-10.

BAIRD T23 Console, 13½ by 11 picture, unused 1939 model, listed 60 gns. £45.

DE LUXE ALL WAVE RADIO

We are agents for **Scott, McMurdo Silver** and **Keates Hacker** hand crafted Super receivers. It is generally recognised that these sets represent the cream of the market. Why not come and hear them? Deferred terms available of course, and fair and square part exchanges.

SPECIAL SNIPS

SCOTT IMPERIAL, 23 valves, 13-2,000 metres, chassis, amplifier and three speakers, overhauled, perfect, £32-10.

BRITISH McMURDO SILVER, 1939—15-17, new unused chassis, with Super Speaker, cost 43 gns., £22-10.

CELLOPHONE Radiogram, in polished cabinet, playing film ribbon records, cost 55 gns. Unused, £35.

COMMUNICATION EQUIPMENT

Our third, but not least, speciality is Amateur Radio apparatus. Our stock comprises the best in this field, including Hallicrafter, National, R.M.E., Howard and Hammarlund American receivers, and Eddystone, Hamrad, Philips and McMurdo Silver British receivers. If you cannot call, may we send you our illustrated folder, with specifications and prices? We not only offer easy terms and generous part exchanges, but a novel approval system.

Recommended Selection:

McMURDO SILVER Guthman anti-fading Diversity Coupler, complete, for any good set, £8-8.

SKYRIDER DEFIANT SX24, 9 tubes, crystal, 7-550 metres, built-in frequency meter, £21.

BRITISH McMURDO SILVER 1939/40 Model 15-17, 5-2,000 metres, chromium chassis, Super Speaker, £45.

NATIONAL NC100XA, 10-550 metres, 11 tubes, with crystal and 10 ins. speaker, £41-10.

Why not ring, write or call?



D.C.-A.C. CONVERTERS

Filtering, evolved through intensive research, enables Electro Dynamic converters to operate sets efficiently from 10 to 2,000 metres.

Particularly Suitable for Television.

ELECTRO DYNAMIC

ELECTRO DYNAMIC CONSTRUCTION CO. LTD., ST. MARY CRAY, KENT.

'PHONE: ORPINGTON 2560-1



LOUDSPEAKERS

P.M. and Mains Energised Speakers from 3" to 18". Power Packs, A.C. Rectifiers. Transformers to match any valve. SERVICE. Any make of speaker repaired in 24 hours.

SINCLAIR SPEAKERS,

PULTENEY TERRACE, COPENHAGEN STREET, LONDON, N.1.

Engineers' Guide

Shows how to qualify in Television, Sound Recording, Radio Engineering and Servicing, Wireless Communications, etc., by studying at home with The T.I.G.B. Write to-day for this Great Guide containing world's widest choice of engineering courses and which alone gives the Regulations for A.M.I.E.E., A.M.I.R.E., A.M.I.T.E., etc.

Free!

THE TECHNOLOGICAL INSTITUTE OF GREAT BRITAIN
160 Temple Bar House, London, E.C.4.
(Founded 1917 20,000 Successes)



To Success

200 Courses

Coil-winding Data

Prior to winding the coils, all the coil forms should be filed around the inside top edge with a half-round file, to allow for the tuning condenser to be let into the coil form. This condenser should be arranged so that the top of the ceramic end plate rests approximately 1/16th in. above the edge of the coil form.

the coil form, turned over, soldered and the surplus cut off.

Operation.—After the two leads coming through the grommit hole have been connected to the meter, and the necessary coils, valves, and 80-metre crystal have been inserted in the correct sockets, the unit is ready for testing. Fit knobs to the two switches and

Rotate switches in an anti-clockwise direction, and tune the 40-metre stage in a similar way. This operation is then followed for the 20- and 10-metre stages. It will be found that the oscillator will draw approximately 40 mA. in the unloaded condition with the remaining stages drawing approximately 30 mA. when unloaded.

A twisted pair of leads should be connected with one pair of ends to the link strip with the opposite ends to the grid stage of the final to be driven. For test purposes it is generally more convenient to connect the R.F. output into a three-turn loop so that with an absorption type wavemeter a check can be made on each stage.

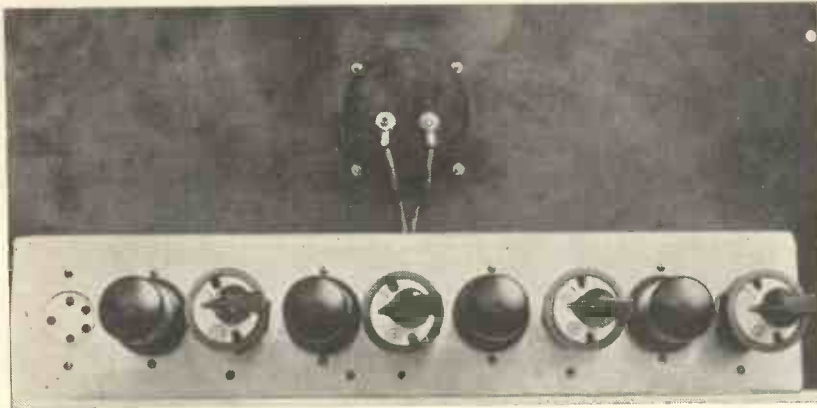

The coils and the R.F. portion of the exciter are all mounted on a small box type chassis in this fashion. Notice how the coils have their condensers mounted internally.

Connecting wires approximately 6 in. in length should be soldered to the rotor tag of each condenser, which is bent at right-angles and to the stator connections. These leads should not be thicker than 22-gauge wire and should be protected by systoflex or similar covering in order to prevent their touching the opposite member of the condenser.

Link windings in each case are wound directly following the anode windings with identical spacing. Connections are shown in the sketch.

80-Metre Coil.—This is wound on unthreaded former with turns close wound. Anode winding— $31\frac{3}{4}$ turns, grid winding—spaced $\frac{1}{8}$ in. from the bottom end of the anode winding, $4\frac{3}{4}$ turns with each turn touching its neighbour.

40-Metre Coil.—Wound on threaded former, with an anode winding of $20\frac{3}{4}$ turns and a link winding of $3\frac{3}{4}$ turns.

20-Metre Coil.—Again wound on a threaded former with an anode winding of $7\frac{1}{2}$ turns and a link coil of $3\frac{3}{4}$ turns.

10-Metre Coil.—Wound on threaded former with an anode winding of $4\frac{3}{4}$ turns, and a link coil of $3\frac{3}{4}$ turns.

Care should be taken in wiring switches and associated coils exactly. When the coils have been wound and the wires brought down to the correct pins, the tuning condenser should be drawn into the coil by the two leads which have already been soldered to the rotor and stator plates.

One lead goes to the top of the plate coil and the other to the bottom of the plate coil. All wires should be drawn through to the pins at the bottom of

turn these both to the extreme right, couple up to the recommended power pack, after which the crystal oscillator is ready for checking.

Tune the condenser in the top of the 80-metre or C.O. coil and test for R.F. output and resonance with the usual loop lamp or miniature neon. The point providing maximum R.F. will coincide with the approximate minimum anode current.

Components for: UNIVERSAL EXCITER UNIT

CHASSIS AND PANEL.

1—Foundation unit consisting of drilled cadmium plated chassis drilled rack panel, insulated mounting bracket and link bracket.

COIL FORMS.

3—Type CT4 (Raymart).

1—Type CF4 (Raymart).

CONDENSERS VARIABLE

4—Type ATC100 (Raymart).

CONDENSERS, FIXED.

4—.0001 mfd. 2,000 volt test.

4—.002 mfd. 2,000 volt test.

8—.or tubular.

CRYSTAL.

1—BC3 80-metre (Bliley).

METER.

1—0-100 m/A. moving coil type (Hoyt).

RESISTANCES.

14—1-watt resistors, to specification.

4—3-watt resistors, to specification.

SWITCHES.

1—Type SWE (Raymart).

1—Type SWM (Raymart).

VALVE HOLDERS.

1—VA5 (Raymart).

4—VA8 (Raymart).

4—VA4 (Raymart).

VALVES.

4—6L6 (Raytheon).

We have made arrangements with Messrs. Radiomart (G5NI B'ham), Ltd., to supply a complete kit of components less valves, meter and crystal, for 4 gns.

10-watts

Output

The exciter supplies ample drive for 10-watt final stage using a valve such as an RK20, RK47 or similar pentode or beam tetrode of equal rating. If used with triodes, in the driven stage, it should be remembered that the output although varying according to frequency is approximately 10 watts.

In such circumstances, where extra drive is required, an intermediate buffer amplifier using a valve such as the T20 or TZ20 should be used. Also, the transmitter as it stands with its output of 10 watts is ideal for the beginner for it will enable at least four wavebands to be covered with the minimum amount of cost and the greatest possible ease in coil switching.

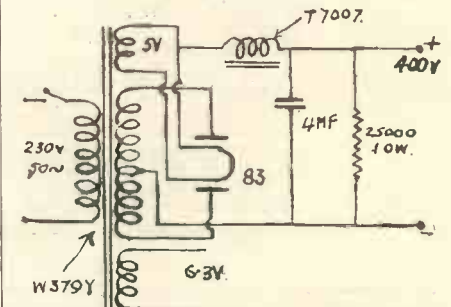

A suitable power unit with choke filter input.

Power Supply.—It is essential that the power supply be of a type that has extremely good regulation, so for this reason the choke input circuit is essential. The total load varies according to the band to which the exciter is tuned, but with the circuit shown the output does remain sensibly constant over wide variations in load.

The approximate drain on 80 metres is about 40 to 60 mA., whereas when the exciter is switched through to 10 metres, with all the valves drawing anode and screen current, the total current may rise to as much as 150 or even 200 mA.

SOCKETS

The eight sockets illustrated will give you some idea of the exceptional range of the thirty standard designs available to the Radio Industry, and consistently used by the designers of apparatus described in this Journal. There are CLIX Turned Resilient types—CLIX Rolled Resilient types—CLIX Embossed resilient types—CLIX Rigid Tube types and CLIX Insulated Panel Mounting Sockets.

Specifications and Illustrations of the complete range are given in CLIX Annual Catalogue, 1939 Edition. You are invited to apply for a copy.

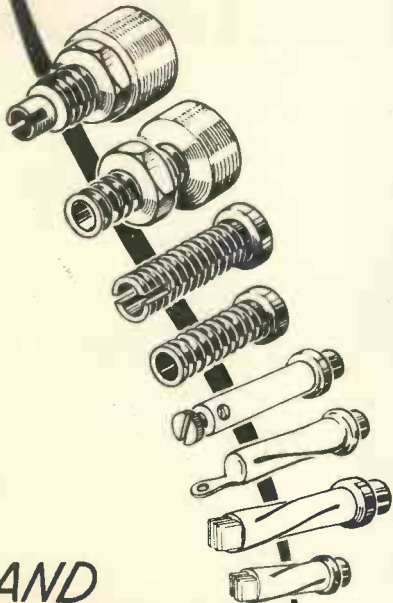

AND STRIPS

The standard stock types of CLIX Chassis Mounting Strips include those having from two to six sockets. These embody the CLIX patent Resilient turned Sockets with screw or soldering terminals and appropriate markings.

CLIX Voltage Selector Panels provide a speedy and safe means of selecting the required voltage from a series of mains supplies. For details of these and the full range of CLIX Valveholders, Trimmers, Plugs, Spades Terminals, Speaker Control Panels, etc., see CLIX Annual Catalogue, 1939 Edition. Free on request.

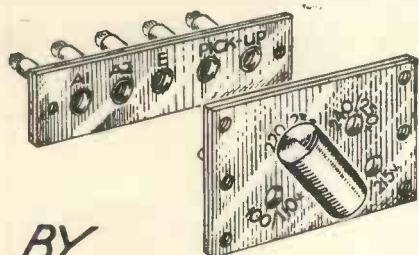

BY
CLIX

BRITISH MECHANICAL PRODUCTIONS LTD.,
79a, Rochester Row, London, S.W.1.

"THE ORTHICON"

(Continued from page 535.)

fringing field at their edges. The electron is thus introduced into the electric field gradually, and the cycloidal motion gives way to a straight-line motion across the tube. By means of curving the edges of the deflecting plates, the necessary fringing field is established, and the smooth deflection motion obtained.

A similar type of deflection could conceivably be used for both directions of scanning (vertical as well as horizontal), but it is more convenient to restrict this type of deflection to the high-speed horizontal motion. The low-speed vertical motion may then be introduced by the use of a transverse magnetic field imposed, as shown by Fig. 5, by a pair of magnetic coils whose axis is at right angles to the tube axis.

The complete tube is shown diagrammatically in Fig. 10. The internal coating of the tube is earthed and the cathode of the electron gun is operated at about 25 volts with respect to earth. The two-sided mosaic target at the other end of the tube assumes cathode potential automatically. The horizontal deflecting plates cause the beam to move along each line of the image, while the vertical deflecting coils cause the vertical frame-scanning motion. The electrons travel to the mosaic, and arrive there with substantially no velocity. If photo-electrons have been lost at that point, due to the influence of the optical image, the beam electron is collected by the mosaic, otherwise it turns around and travels back to a collector electrode near the cathode.

"The R.S.G.B. Exhibition"

(Continued from page 535.)

- No. 5.—Taylor Electrical Instruments, Ltd.
- No. 5a.—Wingrove and Rogers, Ltd.
- No. 6.—Hamrad Wholesale, Ltd.
- No. 7.—
- No. 8.—N. E. Read.
- No. 9.—General Electric Co., Ltd.
- No. 10.—Voigt Patents, Ltd.
- No. 11.—Dencu.
- No. 12.—Quartz Crystal Co., Ltd.

This exhibition is open to members of the Radio Society of Great Britain only and it is hoped that this year there will be a record attendance.

FOR INEXPENSIVE ACCURACY
The 70 Range, British Made, Universal

TAYLOR METER



[Illustration shows slip-hinge cover removed]

These meters are individually hand calibrated and carry a six months full service guarantee. See what they cover:—

Model 80 A.
2,000 ohms per volt A.C. & D.C.
£10. 10. 0

Model 80 B.
5,000 ohms p.volt D.C.
4,000 ohms p.volt A.C.
£12. 12. 0

Model 80 C.
20,000 ohms p.volt D.C.
16,700 ohms p.volt A.C.
£14. 14. 0

D.C. volts 0.002—2,000
A.C. Output/volts 0.2—2,000
D.C. Current 10μA—20 Amps.
A.C. Current 10μA—5 Amps.
Resistance 0.1 Ohms—5 meg-ohms.
Output—18 to + 60 DB.
4½" Moving Coil Movement.
Although unusually low in price it is extremely reliable, sensitive and accurate. Low deposit, easy terms available

USE THIS COUPON TO-DAY
To TAYLOR ELECTRICAL INSTRUMENTS LTD.
45 Foubert's Place, Regent St., London, W.
Please send full details of the TAYLOR METER
Name.....
Address.....75

A real job at the right price!

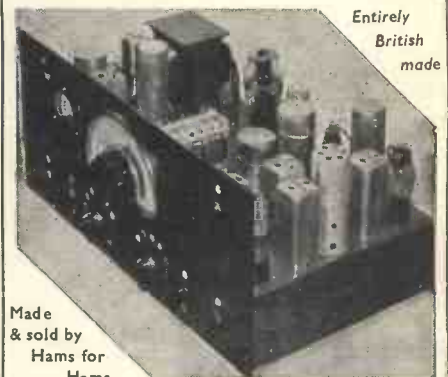

Entirely
British
made

Made
& sold by
Hams for
Hams.

Specification : RF, 1851 ; FC, 6J8 ; RF oscillator, 6F6 ; 2 LF stages, 6K7 ; 2nd det., 6H6 ; 1st L.F., 6F5 ; 2nd L.F., 6L6 ; rect., 5Z4 ; AVC Neg. rect., 6H6 ; AVC DC amp., 6C6 ; meter amp., 6C5 ; BFO, 6J7. Wave range ; 9-600 m., continuous in 5 bands ; electrical bandspread on all amateur bands ; R.F. stage on all bands ; separate FC and Osc ; variable delayed amplified AVC ; undelayed amplified 'R' meter ; differential crystal gate ; RF gain control ; BFO variable pitch ; 2 phone jacks ; switched AVC ; T/R switch ; dipole and Marconi inputs ; high and low impedance outputs ; for standard rack-mounting or in cabinet.

Price complete in cabinet £27-10s.

Designed and built entirely in our new works ; order direct from us. Large stocks available.

John Charles, Facilities Dept.

JOHN McCLURE LTD. (G6JM), Erskine Road, N.W.3. Primrose 5435-6. Agents for all Hamrad products.

On 56 Mc

This data on 5-metre working compiled by ACORN covers the period July 15 to August 15.

CONTRARY to expectations this summer, except for some sporadic periods, has not been very good for the higher frequencies; shall we have to wait for 1941 to see some real DX?

July 19 seems to have been a good day for short skip but it is to be regretted that our Italian friends were not active otherwise some QSO should have resulted. July 24 brought signals from CS3VA, of Lisbon, calling G6YL, heard by G5DJ at 17.45 RST 599.

July 29, during the GW tests, the following were worked by G6DH: G2ZVP 579, G6VX 589, G8JVP 569 (170 miles), G6CW 569 (130 miles), G2XC 549 (120 miles), whilst the following were worked on other dates: G5CM 549, G6QZ 579, G2VP 559, G2MV 569, and G6LL 569. Whilst writing these notes

I can hear F8AA and F8NW in QSO on 'phone.

Last month I gave you some particulars and the photograph of F8NW's station, and now have his consent to give you the description of his receiver.

The old "expander" used with an ordinary super having been scrapped, F8NW set himself to build a receiver which would compare favourably with the receiver built by his friend F8AA (as per ARRL Handbook 1938) and yet be more economical.

A 954 was found to be more efficient, not to say essential, in the position of first detector, whilst a 6C5 worked well as an oscillator. Standard 6K7's filled the gap in the I.F. stages. A 6F5 was used as second detector, a 6C5 as B.F.O. and a 6F6 as L.F. amplifier.

The first detector acorn 954 is

mounted on the special capacity built National Holder type XMA, this holder incorporates the cathode and screen decoupling condensers.

To those who would like to use an acorn as an H.F. oscillator, F8NW asserts that a 6C5 works very nicely up to 112 mc. so long as the connection between the screen grid of the 954 and the control grid of the 6C5 is *exceedingly* short. With a view to obtaining this the 6C5 is mounted with its connections above the chassis.

Coils L1 and L2, are both the same and mounted directly on the condensers and wound as follows:—

For 38.5 to 50 mc. 10 turns of 16 s.w.g. silver plated wire; diameter $\frac{1}{8}$ in.

For 50 to 65 mc. 7 turns of 16 s.w.g. silver plated wire; diameter $\frac{1}{8}$ in.

All I.F. transformers operate somewhere in the neighbourhood of 2,000 kc. These are close wound and close coupled, incorporating small trimmers for final adjustment.

(Continued on page 576.)

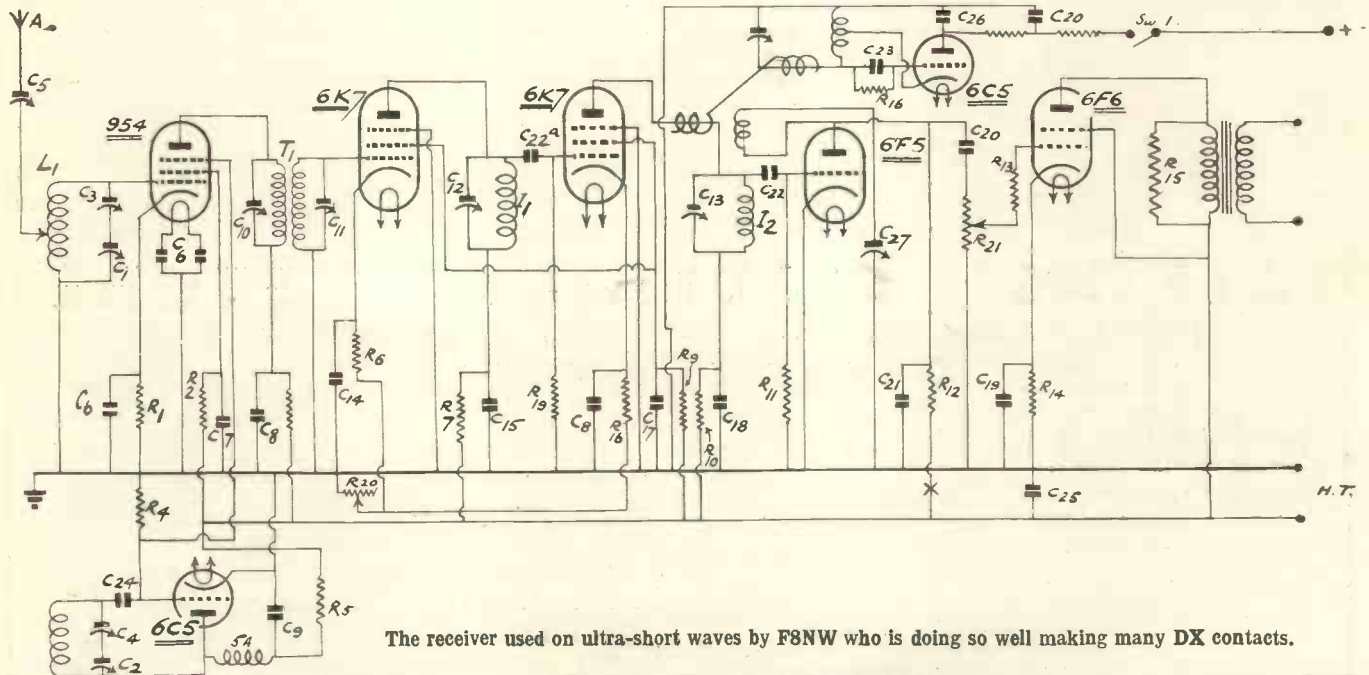

The receiver used on ultra-short waves by F8NW who is doing so well making many DX contacts.

Dits AND Dahs!!

THIS IS THE LANGUAGE OF THE AIR THAT EVERY RADIO AMATEUR MUST BE ABLE TO READ AND SEND.

CANDLER CODE COURSES

In the "Book of Facts," and "Telegraph World"—12-page Booklet, which will be sent free on request, you will see convincing evidence and full proof of the value of this scientific method of training. Full information is given concerning the subjects covered by the ADVANCED HIGH SPEED TELEGRAPHING COURSE for operators with speeds of 12 w.p.m. or over, and THE JUNIOR SCIENTIFIC CODE COURSE for beginners.

For a Free Copy of the "BOOK OF FACTS," write to
CANDLER SYSTEM CO., (Room 55B), 121 KINGSWAY, LONDON, W.C.1.
Candler System Co., Asheville, North Carolina, U.S.A.



Either course is supplied for Cash or on Monthly Payment terms.



FREQUENCY CONTROL UNITS

Ground to within 5 kc. of your specified frequency in the 7mc. amateur band, and supplied complete with official calibration certificate to an accuracy of 0.025%.

Q.C.C. Type S5. The Standard X Cut Crystal. Temp. Co-efficient 23 cycles per Mc. Max. R.F. crystal current 100 mA.

PRICES: Type S5 unit, 20/- Type S5 Crystal, unmounted 15/-

Type U Mount. A plug-in Mount ($\frac{1}{8}$ in. centres). Fitted with stainless steel electrodes and a smart nickel and black enamel cover plate 6/- Send 1½d. stamps for our full price list of all types of quartz crystals and radio transmission components.

THE QUARTZ CRYSTAL CO., LTD.
Kingston Road, NEW MALDEN, Surrey.
Telephone: MALDEN 0334



Specified for the 5-METRE CRYSTAL CONTROLLED TX described in August issue.

Long Skip

G5KA would like reports from any amateur logging new DX stations.

LONG distance conditions on the high-frequency bands the last few weeks have been as dismal as the weather. Over the last few days prior to the compilation of these notes a revival of conditions on 14Mc has been noticed. Whether this is a temporary revival only or an indication of a "set fair" period remains to be seen. The 56Mc enthusiasts are about the only ones who have had much to get excited about, the reason for this being the extraordinary conditions prevailing between this country and Italy and France.

Our remarks in last month's notes re G8XY and G8XZ (the stations of the Public Schools Exploring Society) have brought in a few queries as to whether we got hold of the right prefixes. These call signs are definitely the ones which will be used, but we are at a loss at the moment to account for the non-adoption of the VO prefix. G8XY is to be found on 7104 Kc and G8XZ on 2552 Kc. Reports of reception on these stations will be welcomed so keep a look out for them between 2,100 and 2,300 G.M.T.

G8PL has been lucky enough to grab most of the very few DX signals that

have been coming through on 14 Mc. On the HF end (all CW) he worked YV1AD, ZS6FU, XU8WS, and numerous W6 and W7's. Cards for XU8WS should be sent via XU8AA, Box 685, Shanghai. As XU8AA is the official QSL bureau for China it is advisable to send all XU cards to the bureau pending more settled conditions in that country. We understand from G8PL that W3EBC is after reliable skeds with "G" stations so CW men are asked to look for 3EBC around 14,360 Kc.

G3BS answered G6QX's request for data on a New Mexico station by sending along details of W5GGX, 14,390 Kcs, who has been appearing at around 0630 BST. This station is easy to identify as after every CQ call he signs "W5GGX, New Mex." G3BS is shortly moving from Chelmsford to a superb location at Hever, Kent, where he is anticipating the erection of a Signal Squirrel.

A tale of woe comes from G6QX to the effect that both his 48 ft. masts are down owing to the tabernacle of one of them breaking. Despite this, Bob has been working with a 66 ft. end fed Zepp only 9 ft. high! On this antenna

W4CEN gave Bob R8 and told him he was the loudest "G" signal into those parts! Plans are on foot at 6QX for the erection of a lattice mast 34 ft. high which is going to support a 4 element rotary beam. Bob is not far from our QRA so we hope he won't turn his beam in our direction! G6QX has now worked 94 countries with 87 confirmed. He regrets to inform us that his recent QSL to LZ1HL has just bounced back marked "inconnu." We shouldn't be at all surprised if that doesn't mean LZ1HL is a phoney!

G8PL, Romford, proudly informs us that he is one more country up thanks to KB4FCS, Virgin Islands, who seems to be a pretty consistent signal (CW) up the HF end. The recent allocation of new prefixes to some of the American possessions still seems to be causing quite a lot of confusion to a number of DX addicts, so we list them herewith for your benefit: K4, Porto Rico; KB4, Virgin Islands; KB6, Guam; KC6, Wake Island; KD6, Midway Island; KF6, Baker, Howland, Enderbury, Canton, and American Phoenix Islands; and KH6, U.S. Samoa. Canal Zone stations are still represented by the prefix K5, Alaska as K7, and Hawaii as K6.

Whatever the conditions, Dennis Tyler always manages to inspire us by his superb collection of DX 'phones.

(Continued on page 576.)

GALPINS ELECTRICAL STORES

TERMS : Cash with Order
or C.O.D. Charges extra

75, LEE HIGH ROAD, LEWISHAM, LONDON, S.E.13

Telephone :
LEE GREEN 5240

ALL GOODS SENT ON THREE DAYS APPROVAL AGAINST CASH

CROMPTON DYNAMO, 4-pole shunt wound, 1,750 r.p.m., 100 volts 10 amps., 70/-
Ditto, 50/75 volts 15 amps., 75/- C.F.
MACKIE MOTOR GENERATOR, 220 volts 3.35 amps. D.C. input, 10 volts 30 amps.
D.C. output, 37/6 C.F.
CROMPTON DYNAMOS, 4-pole shunt wound, 1,750 r.p.m., 220 volts 10 amps., 70/-
Ditto, 50/75 volts 25 amps., 90/- C.F.
NEWTON MOTOR GENERATOR, 220 volts D.C. to 16 volts 10 amps. D.C., 30/- C.F.
MACKIE MOTOR GENERATOR, 220 volts D.C. to 400 volts 170 m/A. and 15 volts
8 amps. D.C. Three pieces coupled together on bedplate, 55/- C.F.
CROMPTON MOTOR GENERATOR, 220 volts D.C. to 500/750 volts 200 m/A.
D.C., 40/- C.F.
DYNAMO BY ELECTROMOTORS, 400 revs., 100 volts 10 amps., shunt wound,
90/- C.F.
SMALL MOTORS. Beckenham Motor Generators, 220 volts D.C. to 500 volts 300
m/A. and 12 volts 12 amps. All three coupled together on slide rails. 35/- each. C.F.
E.C.C. SHUNT WOUND DYNAMO, 100 volts 50 amps., 1,500 r.p.m., £6/10/- C.F.
MACKIE ALTERNATOR, 120 volts D.C. input, 65 volts 1 ph. 150 cycles ½ kW.
output. Vertical type, 45/- C.F.
MACKIE DYNAMO, shunt wound, 75/90 volts 8/10 amps., 1,500 r.p.m., 55/- C.F.
C.A.V. SHUNT WOUND DYNAMOS, 25 volts 8 amps., 1,750 r.p.m., 32/6 C.F.
G.E.C. SHUNT WOUND DYNAMOS, 50 volts 6 amps., 1,500 r.p.m., 30/- C.F.
CROMPTON SHUNT WOUND DYNAMO, 100 volts 4 amps., 1,750 r.p.m., 35/- C.F.
MARCONI ½ kW. 500 CYCLE ALTERNATOR, 100 volts, 1 phase, 45/- C.F.
HIGH-VOLTAGE TRANSFORMERS for Television, Neon, etc. 200/240 volt 50 cy.
1 ph. primary, 5,000 and 7,000 volts secondary, enclosed in petroleum jelly. Size : 5 ½ in.
× 4 ½ in. × 4 ½ in. 7/6 each, post 1/-. Ditto, Skeleton type, 5/6, post 9d. All brand new.
EVERSHED EX-R.A.F. HAND-DRIVEN GENERATOR, in new condition, 800
volts 30 m/A. and 6 volts 2 ½ amps. D.C. Useful as megger genies and all test work.
20/- each, post 1/6.
MACKIE DOUBLE WOUND EX-R.A.F. GENERATORS, 1,200 volts 100 m/A. and
10 volts 4 amps., 3,000 r.p.m., 12/6 each. Carriage 1/6.
ELLIOTT MOVING COIL METER MOVEMENT, first grade, approx. 2 m/A., full
scale of 6 inches, 10/6 each, post 1/-.
500/750-WATT TRANSFORMER CORES FOR REWINDS. Size : 6 ½ in. × 5 ½ in.
× 1 ½ in. Ex Philips. 7/6 each, post 1/-.
EVERETT EDGUMBE ELECTROSTATIC VOLTMETER, 0 to 6,000 volts,
6-inch scale, 45/-, post 1/6. Ditto, 2,500 volts, 2 ½-inch scale, 25/-
EX-R.A.F. ONE-VALVE VISUAL WAVEMETERS, 350 to 2,500 metres. Less
valve, 4/6 each.
JOHNSON & PHILLIPS HOT-WIRE RADIO FREQUENCY METERS, 4 in. dial,
0 to 1.2 and 0 to 2 amps., 12/6 each, post 1/-.
SPARK COILS, 12-inch, with Condenser, 100/200 volts D.C. primary, in new condition,
£3. Ditto, 2-inch, work from 12 volts with trembler, 22/6, post 1/6.
EVERETT EDGUMBE PORTABLE THREE READING VOLTMETER, 0 to
5-25-250 volts, moving coil, first-grade movement, 4 in. dial, 20/- each.

MUIRHEAD 1 MF. CONDENSERS, 1,000-volt working, 1/- each, post 6d.; or three
for 2/6, post 1/-. Philips 1 mf., 3,000-volt working, 5/- T.C.C. 4 mf., 3,000-volt work-
ing, 9/6 each. Standard Telephone 1 mf., 400-volt working, 4d. each, or in lots of 100
for 12/6, post 1/6.
FERRANTI SPEAKER OUTPUT TRANSFORMERS, Type "A," ratio 7 ½ to 1, pri.
D.C. resist. 900 ohms impd. 12,500 to 30,000. Type "B," ratio 24.9 to 1, pri. D.C.
resist. 14,000 to 20,000 ohms, impd. over 111,000. Sec. D.C. resist. 13 ohms on both
types. In new condition, 2/6 each, post free.
PI STANDARD TELEPHONE PUSH-BACK CONNECTING WIRE (new), 220-
yard coils, 12/6 post 1/-.
SAVAGE MAINS TRANSFORMERS, 200/250 volts input, 50 volts 8 amps. output,
12/6 each.
STANDARD TELEPHONE MAINS TRANSFORMERS, input 200/250 volts,
output 250/0/250 volts 200 m/A., 3 × 4 volt windings and a 50-volt winding, 12/6 each.
SILVERTOWN GALVANOMETERS, jewelled movement, very sensitive, 5/- each.
SULLIVAN TRANSMITTING CONDENSERS, variable, in glass tank, .0005 mf. and
001 mf., 7/6 each post 1/-.
INSTRUMENT WIRE, 4-lb. reels of 20 G enamel, 6/-, P.F.; 15 lb. of 16 gauge enamel,
15/-, post 1/6; 7 lb. of 18 gauge D.C.C., 8/6, post 6d.; 7 lb. of 10 gauge D.C.C., 10/-,
P.F. All new wire.
ERNEST TURNER & WESTON 2-IN. DIAL MOVING COIL MILLIAMPE-
METERS, B.S. first grade, 0 to 5 and 0 to 150, 10/6 each.
WESTINGHOUSE RECTIFIERS, L.T. 6 volts 2 amps. D.C. output, input 11 volts, in
new condition, 10/- each.
MOVING COIL METER MOVEMENTS for recalibrating into multirange meters.
Low m/A. deflection. 2 ½-in. dial, 5/- each; 4-in. and 6-in. dial, 6/- each. Post 1/-.
(Note : All these meters are by good makers—Elliott, E. Edgcombe, etc.)
ELECTRIC LIGHT CHECK METERS, 200/250 volts, 50 cy. 1 phase, 5 and 10 amps.,
6/- each. P.F.
X-RAY TRANSFORMERS, by well-known makers, all fully guaranteed. 50 cycle
mains, 40,000 volts, 10 m/A., £5; 68,000 volts, 20 m/A., £7/10/-; 100,000 volts, 30 m/A.,
£10/10/-. All carriage forward.
ZENITH VITREOUS WIRE WOUND RESISTANCES, 2,500 ohms 170 m/A., 750
ohms 300 m/A., 4,500 ohms 100 m/A., 800 ohms 170 m/A., 5,000 ohms 71 m/A., 250
ohms 500 m/A. All at 1/- each, post 4d.
THE "RACON" MOVING COIL HORN SPEAKER UNITS, 15-ohm Speech Coil,
6-volt, fitted handle, 15 watts, 15/- each, post 1/6.
EX-G.P.O. GLASS TOP RELAYS, Type B. Useful as Keying Relays, 5/- each, post
6d. Also a few only that need points, which are easily fitted, 2/6 each. P.F.
T.C.C. 2,000 MF. ELECTROLYTIC CONDENSERS, 50-volt working (brand new),
5/- each, post 6d.
STANDARD TELEPHONE BELL WIRE, all brand new. 150-yd. coils, twin 22
gauge, 4/-, post 9d.; 250-yd. coils, single 16 gauge, 4/-, post 1/6; 300-yd. coil single
22 gauge, 3/-, post 6d.

"On 56 Mc"

(Continued from page 574.)

The second detector is of the regenerative type giving a higher sensitivity factor. One can also use its regeneration to receive C.W. signals, but for strong signals it is better to use the separate B.F.O. so avoiding saturation of the 6F5.

Aerial coupling is the most delicate part of the job, the coupling, of course, varies with the type of aerial used. F8NW now uses a 5-metre window with a feeder of 7 metres length connected to the coil at one turn from the earthy end.

Both H.T. and L.T. supply are entirely separate so as to avoid the dangers of induction. At the point marked X in the diagram, a milliamperemeter can be inserted with a reading 0 to 3 mA. It will show the intensity of signals received and is useful when trying directional aerials, etc.

The receiver as it has proved so efficient, is ideally suited for use by British amateurs, and the following components link up with the keying circuit diagram on this page.

C₁, C₂, 20 mmfd., C₃ and C₄ 50 mmfd. trimmers, C₅ 1 fixed and 1 moving vane, C₆, C₇, C₈ and C₉ 500 mmfd. mica, C₁₀, C₁₁, C₁₂, and C₁₃ 500 mmfd. air dielectric trimmers, C₁₄, C₁₅, C₁₆, C₁₇, and C₁₈ .5 mfd. paper, C₁₉, 20 mfd. electrolytic, C₂₀ .05mfd.

paper, C₂₁ .01 mfd. paper, C₂₂, C₂₃ and C₂₄ 150 mmfd. mica, C₂₅ 8 mfd. electrolytic, C₂₆ 2,000 mmfd. mica, C₂₇ 200 mmfd. R₁ 2,000 ohms, R₂ 100,000 ohms, R₃, R₇ and R₁₀, 10,000 ohms, R₄ and R₅ 50,000 ohms, R₆, R₈ and R₁₄ 300 ohms, R₉ 60,000 ohms, R₁₁ 1 megohm, R₁₂ and R₁₇ 100,000 ohms, R₁₃ 50,000 ohms, R₁₅, R₁₆ and R₁₈ 25,000 ohms, R₁₉ half megohm, R₂₀ 5,000 ohms variable, R₂₁ 500,000 ohms variable, T₁ I.F. transformer, see text, T₂ L.F. transformer.

All the above components are of normal manufacture and provided they are good quality can be either British or American products.

"Long Skip"

(Continued from page 575.)

His latest collection from the American 'phone band include such gems as W₉MAI, Nebraska; W₆MNN, Utah; W₅GGX, New Mexico; W₇EEB, Montana; and W₆ATN, Nevada. On the HF side he accounted for VQ₂CM, FN₁C, VS₇RA, KA₁CS, VP₁AA, OQ₅ZZ and XZ₂ST. The other end of the band provided Dennis with VE₅AHU, OA₆A, VP₁JR, FB₈AB, VP₁WB, VS₇JB, and PK₆XX, the Archbold Expedition at Hollandia, New Guinea. After perusing Dennis's DX lists we always wonder whether he is equipped with four pairs of ears! There is no doubt that if more DX men

followed his method of scanning every nook and cranny on the bands instead of grumbling about bad conditions they would hear something to their advantage.

G₁₆TK, Belfast, is now the proud possessor of his W.A.S. certificate, W₆QQL, Nevada, having at last yielded to Frank's patient calling. Frank has been doing might fine work in the early mornings playing about with W₆'s; his total number of stations worked in that district for this year now being well over 200. Some interesting information on TA₁AA is reported by G₁₆TK. After answering TA₁AA's CQ call several times without success, Frank amused himself by listening to TA₁AA's delightful T₁ note, while contacting other stations. Frank noticed that during one of TA₁AA's sign-offs he let slip with a "de SP" followed by a string of dots and a correction to TA₁AA. So it seems that TA₁AA can be written off as a dead loss so far as Turkey is concerned.

Ben Wallich, G₆BW, tells us of W₆FUO, Reno, Nevada, who has been putting through a terrific signal up the HF end of the American 'phone band. We got quite excited when we read in one of the national newspapers that Ben was after a QSO with Mars during that planet's somewhat nearer approach to this earth, but Ben assures us that this was nothing but a misrepresentation of facts on the part of the Press!

**The Amateur Radio
HANDBOOK
Reprinted**

To meet a widespread demand the first edition of the first and only British Amateur Radio Handbook has been reprinted.

**THREE HUNDRED PAGES PROFUSELY ILLUSTRATED.
EVERY PHASE OF AMATEUR RADIO FULLY COVERED.**

LIST OF CHAPTERS:—

- I. Amateur Radio. ii. Fundamentals. iii. Valves. iv. Receivers. v. Radio Transmitters. vi. Modulation and Keying. vii. Power Supply. viii. Audio Equipment. ix. Artificial Aerials. x. Aerials. xi. Prevention of Transmitter Interference. xii. Ultra High-Frequencies. xiii. Ultra High-Frequency Equipment. xiv. Television. xv. Frequency Measurements. xvi. Measuring Instruments. xvii. Station Planning. xviii. Operating a Station. xix. How to Become a Radio Amateur. xx. How to Obtain a Licence. xxi. Great Circle Routes. xxii. Selected References. xxiii. The R.S.G.B. and the Radio Amateur. xxiv. Useful Data, Charts and Abacs.

Price 2/6 (By post 3/-) Overseas 3/6 (Post Free)

Obtainable from:

R.S.G.B. SALES DEPT.
53, Victoria Street, London, S.W.1.

**TELEVISION
DEVELOPMENTS**

Are you keeping abreast of modern television developments? Whether amateur or professional you *must* be in touch with the latest trend of research.

The Television Society enables you to meet fellow workers in the field of television, both in this country and abroad.

Founded some 10 years ago The Television Society provides a scientific and non-partisan platform for discussion on all aspects of the subject. Meetings are held monthly during the session (October-June) and are reported in full in the Society's Journal which is sent free to all members.

The Society's activities have just been enlarged to meet the growing interest in the subject and members will have a unique opportunity of furthering their knowledge by contact with well-known television engineers.

Full particulars of membership qualifications may be had from the Hon. General Secretary:—J. J. Denton, 17, Anclerly Station Road, London, S.E.20.

THE TELEVISION SOCIETY
(Founded 1927)

President: Sir AMBROSE FLEMING, M.A., D.Sc., F.R.S.

OPPORTUNITIES SECTION

BUSINESS :: EQUIPMENT :: EMPLOYMENT :: MISCELLANEOUS

The charge for miscellaneous advertisements on this page is 12 words or less 2/-, and 2d. for every additional word. Single-column inch rate displayed, 12/6. All advertisements must be accompanied by remittance. Cheques and Postal Orders should be made payable to Bernard Jones Publications Ltd., and crossed, and should reach this office not later than the 15th of the month previous to date of issue.

Radio Society News

Dollis Hill Radio Society

This society are planning an amateur radio exhibition to be held about the end of November. They will be glad if societies willing to co-operate will communicate with the Hon. Sec., E. Aldridge, 79 Oxgate Gardens, Cricklewood, N.W.2. (Telephone Glad 3125). The fortnightly meetings will commence on the first Tuesday in October.

Slade Radio Society

The 500th meeting was recently held and Mr. A. E. Burr, of the Mullard Wireless Service Co., delivered an address on "E" type valves. This proved a most interesting lecture and a complete range of valves was discussed in detail. Potential members are requested to write to the Hon. Sec., L. A. Griffiths, at 47 Wellingdale Road, Erdington, Birmingham, 24.

Hoddesdon and District Radio Society

On Sunday, July 16, a Field Day was held at Tylers Causeway near Epping Green, when G5HOP was working on 1.7 Mc. On Sunday, July 29, the second Field Day was held at Goose Green, also on 1.7 Mc. Both events were well supported and the gear used provided was G5HF. The next Field Day is to be held in September and co-operation from other portable stations would be appreciated. Information can be obtained from the Hon. Sec., T. Knight, Jr., Caxton House, High Street, Hoddesdon, Herts.

PREMISES SUITABLE FOR RADIO AND TELEVISION DEALER NOW AVAILABLE IN A PROGRESSING AND POPULAR SUBURB

For all particulars apply: **HEALEY & BAKER**, Shop Specialists 29 St. George St., Hanover Sq., London, W.1. Phone: MAYFAIR 2965 (14 Lines)

FOYLES FOR RADIO BOOKS

Special Radio Department. New and secondhand books on radio and every other subject. Stock of nearly 3,000,000 volumes. Send for free catalogues.

★ FOYLES ★

113-125, CHARING CROSS RD., LONDON, W.C.2
Telephone: Gerrard 5660 (16 lines)

PHOENIX

Offers all Wireless and Radio Engineering books on new financial terms as low as 2/6 monthly. Write a card now for details and lists, or call personally at the **CHANDOS PLACE (W.C.2) SHOWROOMS** of the

PHOENIX

INDEX TO ADVERTISERS

	PAGE
A.G.S., Ltd.	571
Automatic Coil Winder & El. Equip. Co., Ltd.	513
Belling & Lee, Ltd.	Cover ii
British Institute of Eng. Technology	Cover iii
British Mechanical Productions, Ltd.	573
Brown, S. G., Ltd.	569
Bulgin, A. F., Co., Ltd.	555
Candler System Co.	574
Clix	573
Denton, J. J.	Cover iii
Dubilier Condenser Co., Ltd.	567
Edison Swan Electric Co., Ltd.	514
Electro Dynamic Construction Co., Ltd.	571
Ericsson Telephones, Ltd.	567
Fluxite, Ltd.	565
Galpins	575
General Electric Co., Ltd.	524
Hamrad Wholesale, Ltd.	561
Healey & Baker	Cover iii
Henley's, W. T., Telegraph Wks. Co., Ltd.	569
"His Master's Voice"	529
Marconi's Wireless Telegraph Co., Ltd.	565
Masters, C. E.	Cover iii
McClure, John, Ltd.	573
McGraw Hill Publishing Co., Ltd.	557
Mullard Wireless Service Co., Ltd.	530
Peto-Scott Co., Ltd.	Cover iv
Premier Supply Stores	559
Quartz Crystal Co., Ltd.	574
Radlomar	565
Radio Clearance, Ltd.	569
Radio Manufacturers' Association	523
Radio Society of Great Britain	576
Sanders, H. E., & Co.	Cover iii
Scophony, Ltd.	516
Sinclair Speakers	571
Sound Sales, Ltd.	571
Stratton & Co., Ltd.	563
Taylor Electrical Instruments, Ltd.	573
Technological Institute of Great Britain	571
Telegraph Construction & Maintenance	Cover ii
Television Society, The	576
United Insulator Co., Ltd.	553
Webb's Radio	1-iv
Westinghouse Brake & Signal Co., Ltd.	563

MISCELLANEOUS

ALL TYPES of Rotary Converters, electric motors, battery chargers, petrol electric generator sets, etc., in stock, new and second-hand.

A.C.-D.C. Conversion Units for Operating D.C. Receivers from A.C. Mains, 100 watts output, £3. 10 150 watts output, £3. 10.

WARD, 46, Farringdon St., London, E.C.4. Tel. Holborn 9703.

LOUDSPEAKER repairs, British, American, any make, 24-hour service; moderate prices.—Sinclair Speakers, Pulteney Terrace, Copenhagen Street, N.1.

I.F. AMPLIFIER. Heavy gauge copper chassis with sub screens, removable top plate carrying components. Three stages I.F. E.F.8's, DDT 2nd-det., pentode output. Iron core Meissner I.F.'s air trimmed. All unused, owner going abroad. Offers, Box No. 28.

WANTED, Multiplate Grid Cell, Drum, Neon, Box 27.

ELECTRICAL SERVICE

CONVERTERS wanted and for sale, E.D.C.C., approximately 200 watts. Easco, 18, Brixton Road S.W.9.

LOUDSPEAKERS

3,000 SPEAKERS P.M. and energised 4" to 14" including several Epoch 18". Sinclair Speakers Pulteney Terrace, Copenhagen Street, N.1.

PATENT AND TRADE MARK AGENTS

GEE & CO., patents and trade marks throughout the world (H. T. P. Gee, Mem. R.S.G.B., A.M.I.R.E., etc.), Estab. 1905. 51-52, Chancery Lane, London, W.C.2 (2 doors from Government Patent Office). Phone: Holborn 4547 and 4548. Handbook free.

KINGS PATENT AGENCY LTD. (B. T. King, A.I.Mech.E. (2BKT) Patent Agent) 146a, Queen Victoria Street, London, E.C.4. **ADVICE, Handbook and Consultations free.** Phone City 6161.

MECHANICAL - OPTICAL - TELEVISION

HIGH SPEED MOTORS SUPPLIED for SCANNING, VELOCITY of LIGHT EXPERIMENTS, GYRO, etc.

Send us Your Requirements

H. E. SANDERS & CO. Tele. 4 Grays Inn Rd., London, W.C.1 Chancery 8778

BOROUGH POLYTECHNIC, BOROUGH ROAD, S.E.I.

Enrolment begins 18th September, 1939.

A course of Lectures, Demonstrations and experiments on

TELEVISION

will be given on Thursdays, 8—9.30 p.m.

by **J. J. DENTON**

Beginning on 28th September

For further details apply to the Principal.

Read

"Television

and

Short-wave

World"

Regularly

TELEVISION.

A NEW COURSE OF INSTRUCTION.

We have pleasure in announcing that our new "Television" Course has met with remarkable success. The enormous demand for the Course has shown, beyond any shadow of doubt, that it fills that long-felt need which we anticipated when we went to such trouble and expense in its preparation.

We shall be happy to send full details of this special "Television" Course on request. Particulars are also available of other Courses in all branches of Wireless, Television, Talking Picture Engineering, etc., and of the easiest way in which to prepare for the A.M.I.E.E., A.M.I.W.T., A.M.I.R.E., etc., Examinations.

We teach by correspondence, and guarantee "NO PASS—NO FEE." Our Technical Consultant is Professor A. M. Low.

Send for full particulars to-day. Free and without obligation.

THE BRITISH INSTITUTE OF ENGINEERING TECHNOLOGY
337, SHAKESPEARE HOUSE, 17/19, STRATFORD PLACE
LONDON W.1.

TROPHY

*Performance-
Proved*

COMMUNICATION RECEIVERS



THERE is real enthusiasm about TROPHYS, the reason being that TROPHY performance—in all cases—can be relied upon, TROPHY gives more than that degree of satisfaction which the short-wave enthusiast looks for before purchase. TROPHY outlay is low for a preferred All-British instrument. TROPHY success is no mere slogan, it is a fact and taking the range covered by the TROPHY 3, 6 and 8-valvers and the useful PRESELECTOR, TROPHYS at a great saving ensure short-wave results that please—even for the most discriminating—exactly what is wanted—after all

TROPHY 8

8 valves. 5 Bands, 7-550 metres (43 mc. to 545 kc., continuous). Continuous bandspreading. Illuminated scale engraved in kilocycles, with divisions permitting of settings of 800 deg. in 1 deg. steps. R.F. on all bands. Separate oscillator. Beat frequency oscillator with separate pitch control. Send/Receive switch. A.V.C. and B.F.O. on/off switches. Self-contained smoothing circuit. High impedance output sockets are provided for use of separate P.M. speaker and jack incorporated for alternative headphone use. Pleasing black crackle-finish steel cabinet, size 16½ in. long by 9½ in. high by 10½ in. deep. For use on A.C. 200/250 v. 40/100 cycles supplies. Despatched accurately aligned and aerial tested. Terms, 15/6 down, 18 monthly payments of 15/6.

TROPHY 8 SPEAKER. Balanced permanent magnet moving-coil speaker, housed in celotex-lined steel cabinet, finish and design to match TROPHY 8. 2 gns. extra.

12 GNS.

TROPHY 6 All-Feature Receiver

Six international octal-type valves. Four frequency ranges, providing a continuous coverage from 6.5 to 545 metres. Directly calibrated frequency scale. Independent electrical bandspread with separate illuminated dial. Automatic volume control and beat frequency oscillator on/off switches. Send/Receive switch. Pitch control. Provision for using doublet input. Headphone jack. Built-in speaker. Cabinet in steel, pleasing black crystalline finish. Overall dimensions: 17½ in. wide, 10 in. high, 9 in. deep. Despatched accurately aligned and ready for operation on A.C. 200/250 v. 40/100 cycles supplies. Terms, 12/6 deposit and 18 monthly payments of 12/3.

9½ GNS.

TROPHY S/W3

"No doubt about its ability to pull them in"
Wireless World

Regenerative 3-valvers for A.C. and battery use (A.C. model, 2 plus rect.), with a really amazingly high degree of sensitivity. Wave-range, using self-locating coils for external insertion, 6.2 to 550 metres. Metre and band calibrated scale. Built-in speaker and phone jack. Left-hand lower illustration.

£5.15.0

A.C. MODEL £6 6s.

Terms, 7/6 down and 18 monthly payments of 7/9.
Supplied with coils for 12-52 metres or with coils for complete coverage, 16/9 extra.

BATTERY MODEL £5 15s.

Terms, 7/- down and 18 monthly payments of 7/-.

2-Stage Preselector

This is a recommended outlay where increased sensitivity, range, selectivity, signal strength or reduction to a minimum of 2nd channel interference are desirable. Employs two "E" series valves. Wave-range 7-550 metres continuous. Send/Receive Switch. Self-powered for A.C. 200/250V. TERMS: 11/9 deposit and 12 monthly payments of 11/7

£6 15s.

● See your Dealer now or may we meet you at a convenient Peto Scott branch? Send for free complete technical specifications. TROPHY 12 MONTHS' GUARANTEE includes valves.



PETO SCOTT CO., LTD., 77 (T.2), City Rd., London, E.C.1. Tel.: CLI 9875.
41, High Holborn, London, W.C.1. Tel.: HOL 3248.

Choose an ALL-BRITISH receiver—TROPHY for preference