

Television

and SHORT-WAVE WORLD

JULY 1939
No. 137 Vol. XII.

**LENSES
FOR
PROJECTION**

**HOME
MECHANICAL
RECEIVER**

**NEW
TELEVISION
SYSTEM**

**SHORT
WAVES**



**E.M.I.
CINEMA PROJECTOR**
DETAILS OF SYSTEM

LONG-DISTANCE BATTERY S.-W. RECEIVER
PUSH-PULL KTS TRANSMITTER
ONE-METRE OSCILLATOR

BERNARD JONES PUBLICATIONS LTD.
CHANSITOR HOUSE, CHANCERY LANE
LONDON W.C.2.



When a neighbour bemoaned to old White,
"My set crackles all day and all night,"
Whitey murmured, "Oh, yes,
That's your set's S.O.S.,
Just to tell you it's needing FLUXITE!"

See that FLUXITE is always by you—in the house—garage—workshop—wherever speedy soldering is needed. Used for 30 years in government works and by leading engineers and manufacturers. Of Ironmongers—in tins, 4d., 8d., 1/4 and 2/8. Ask to see the FLUXITE SMALL-SPACE SOLDERING SET—compact but substantial—complete with full instructions, 7/6. Write for Free Book on the art of "soft" soldering and ask for Leaflet on CASE-HARDENING STEEL and TEMPERING TOOLS with FLUXITE.

To CYCLISTS! Your wheels will NOT keep round and true unless the spokes are tied with fine wire at the crossings and SOLDERED. This makes a much stronger wheel. It's simple—with FLUXITE—but IMPORTANT.

THE FLUXITE GUN

is always ready to put Fluxite on the soldering job instantly. A little pressure places the right quantity on the right spot and one charging lasts for ages. Price 1/6, or filled 2/6.



ALL MECHANICS WILL HAVE

FLUXITE

IT SIMPLIFIES ALL SOLDERING

FLUXITE LTD. (DEPT. T.V.), DRAGON WORKS, BERMONDSEY ST., S.E.1

STABLE VOLTAGE

—the only solution to the problem of unstable supply voltage is the **STABILOVOLT**

CURRENTS UP TO 200 mA

Write for new pamphlet giving reduced prices and additional ranges. Full particulars from

MARCONI'S
WIRELESS TELEGRAPH CO. LTD.
Electra House, Temple Place,
London, W.C.2.

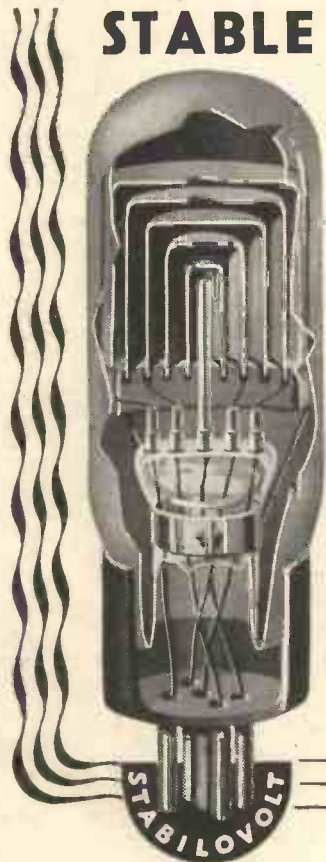

All over the country

Belling-Lee TELEVISION AERIALS



are giving outstanding results

A FEW RECENT INSTALLATIONS

- Middlesbrough
- Gloucester
- Shrewsbury
- Evesham
- Cheltenham
- Brighton
- Bexhill
- Battle
- Bognor Regis
- Southampton
- Portsmouth
- Bournemouth
- Shaftesbury
- Taunton
- Colchester

In places as far distant as Taunton and Cheltenham, Belling-Lee Television Aerial Installations are giving consistently good results. At Brighton—forty miles beyond the limits of the Service Area—reception is reported excellent. Some of these achievements may not do justice to television as an entertainment, but they show how experts and enthusiasts rely on Belling-Lee Television Aerials both for experimental purposes and for private amusement.

Four standard kits are available :

- No. 321K. Wall mounting di-pole without reflector but with stand-off arm and bracket, 65 ft. feeder cable, lightning arrestor and plug and socket for skirting ... 2½ gns.
- No. 321LK. As above but with chimney lashing (no mast) ... 3 gns.
- No. 323CK. Masthead di-pole and reflector, complete with 100 ft. balanced feeder cable, lightning arrestor and plug and socket for skirting ... 4 gns.
- No. 323LK. As above but with 16-ft. mast and necessary galvanised brackets and cables for lashing to chimney stack ... 6½ gns.

Prices do not apply to Eire

BELLING & LEE LTD
CAMBRIDGE ARTERIAL ROAD, ENFIELD, MIDDX

FOR BEST SHORT-WAVE RESULTS ALWAYS USE EDDYSTONE COMPONENTS

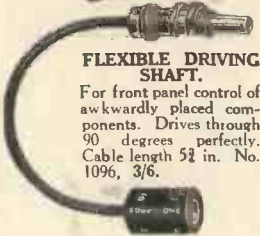

FLEXIBLE DRIVING SHAFT.

For front panel control of awkwardly placed components. Drives through 90 degrees perfectly. Cable length 5 1/2 in. No. 1096, 3/6.



FULL VISION DUAL SPEED DIAL. Cat. No. 1070.

A full vision dual speed dial with 20:1 & 100:1 speeds. Well graduated scale, reading increasing as frequency increases. For 1/2-in. panel and 1/4-in. spindles. Ideal for H.F. tuning. Price 10/6.

The superiority of Eddystone Short-Wave Components is sending the sales leaping up each month.

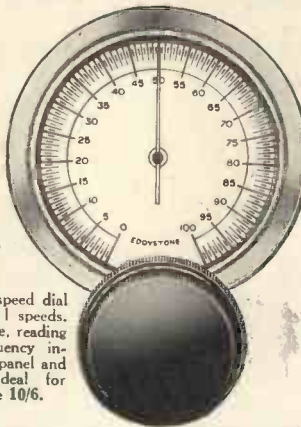

AIR DIELECTRIC TRIMMER.

DL-9 insulation, 3 to 65 mmfd. For all pre-set and trimming purposes and particularly for use with I.F. transformers. Cat. No. 978. Price 3/6.

Insist on Eddystone YOURSELF and you'll quickly know why. Eddystone is attracting so many adherents.



SLOW MOTION DRIVING HEAD. Cat. No. 1012.

Very useful for transceivers and ultra-shortwave Receivers. With 9:1 reduction ratio; pointer moving through 180 deg. Price 3/-.

NEUTRALISING CONDENSER. Cat. No. 1088.

For H.F. circuits using low-capacity triodes. Maximum voltage 2,000 volts D.C. Capacity variation 1-8 mmfd. Frequentite pillar insulator mounting, insulating adjusting knob. Price 6/6.

NEW TYPE MICRODENSER
Cat. No. 1094. 3 to 18 mmfd. D.C. flash-over voltage 3,500. Price 3/9

ASK YOUR DEALER—OR POST COUPON for CATALOGUE of

Manufacturers:
Stratton & Co. Ltd.,
Bromsgrove Street,
Birmingham.

EDDYSTONE

London Service:
14, Soho Street, W.1.

SHORT-WAVE COMPONENTS

COUPON

To **STRATTON & CO., LTD.**
Eddystone Works,
Bromsgrove Street,
Birmingham.

Please send me the Catalogue of
EDDYSTONE SHORT-WAVE COMPONENTS.

NAME

ADDRESS

T.S.W.



BRITISH
MADE

The word 'AVO' is our
Registered Trade Mark

CRITICAL TESTING

demands the

AvoMINOR

ELECTRICAL MEASURING INSTRUMENT

The D.C. AVOMINOR

ELECTRICAL MEASURING INSTRUMENT

13 Meters in ONE!		
CURRENT	VOLTAGE	RESISTANCE
0-6 milliamps.	0-6 volts.	0-10,000 ohms
0-30 "	0-12 "	0-60,000 "
0-120 "	0-120 "	0-1,200,000 "
	0-240 "	0-3 megohms
	0-300 "	
	0-600 "	

In case, complete with instruction booklet, leads, interchangeable crocodile clips and testing prods. 45/-

Deferred Terms if desired.

The UNIVERSAL AVOMINOR

ELECTRICAL MEASURING INSTRUMENT

22 Ranges of Direct Readings		
D.C. VOLTS	A.C. VOLTS	D.C. MILLIAMPS.
0-75 millivolts	0-5 volts	0-2.5 milliamps.
0-5 volt	0-25 "	0-5 "
0-25 "	0-100 "	0-25 "
0-100 "	0-250 "	0-100 "
0-250 "	0-500 "	0-500 "
0-500 "		
RESISTANCE		
0-20,000 ohms	0-2 megohms	
0-100,000 "	0-5 "	
0-500,000 "	0-10 "	

Complete with leads, interchangeable crocodile clips and testing prods; and instruction booklet. (Leather carrying case 10/-)

Deferred Terms if desired.

Radio engineers the world over rely upon "AVO" Instruments for rapid precision testing. In these AvoMinors the same critical testing facilities are available for the benefit of the keen amateur and serious experimenter. Combining high accuracy with unquestioned reliability, they are unrivalled in providing such comprehensive test facilities at so moderate a cost.

A VALUABLE BOOK!

RADIO SERVICING SIMPLIFIED. This book gives the whole routine of testing modern receivers, and explains causes of faults in receiving and amplifying apparatus. Also shows how to use effectively all radio instruments. Price 2/6 (Post free 2/10).

Sole Proprietors and Manufacturers:—

THE AUTOMATIC COIL WINDER & ELECTRICAL EQUIPMENT CO. LTD.

Winder House, Douglas Street, London, S.W.1.

Telephone: Victoria 3404/7

SEE THAT YOUR NEW SET IS FITTED WITH MAZDA



The
MOST FAMOUS
TELEVISION
SET MAKERS

Fit
MAZDA
CATHODE RAY
TUBES

AND MAZDA SPECIAL VALVES

Mazda Radio Valves & Cathode Ray Tubes are manufactured in Gt. Britain for the British Thomson-Houston Co. Ltd., London & Rugby and distributed by

THE EDISON SWAN ELECTRIC CO. LTD.  155 CHARING CROSS RD., LONDON, W.C.2

For full particulars write to Technical Service Department

TELEVISION

and SHORT-WAVE WORLD

Special Features

	PAGE
New G.E.C. Television Receiver ...	388
E.M.I. Cinema Projector ...	389
Lenses for Cathode-ray Projection ...	391
The Du Mont Television System ...	394
The Oscillograph for Television Receiver Servicing ...	397
Dipole Aerial with New Features ...	400
More Progress with Home Mechanical Receiver ...	404
Long-distance Battery S.W. Receiver ...	417
Beam Aerials and S.W. Programmes ...	420
Building a 1-metre Oscillator ...	421
Push-pull KT8 Transmitter ...	423
5-metre Crystal Exciter Unit ...	429
Frame Aerial Receiver ...	430

TELEVISION AND SHORT-WAVE WORLD

Proprietors:

BERNARD JONES PUBLICATIONS, LTD.

Editor-in-Chief:

BERNARD E. JONES.

Editor:

H. CORBISHLEY, F.T.S.

Short-Wave Editor: KENNETH JOWERS

Editorial, Advertising and Publishing Offices:

Chansitor House, 38, Chancery Lane, London, W.C.2.

Telephones: Holborn 6158, 6159.

Telegrams: Beejapee, Holb., London.

Subscription Rates: Post paid to any part of the world—3 months, 3/6; 6 months, 7/-; 12 months, 14/-.

Published Monthly—1/- net.
(On the first day of the month).

Contributions are invited and will be promptly considered. Correspondence should be addressed according to its nature, to the Editor, the Advertisement Manager, or the Publisher, "Television and Short-wave World," Chansitor House, Chancery Lane, London, W.C.2.

IMPORTANT

"Television and Short-wave World" is registered at the General Post Office, London, for transmission to Canada and Newfoundland by Magazine Post. Entered as Second-class mail matter, Boston, Mass.

COMMENT OF THE MONTH

Unreasonable Delay

QUITE a considerable number of interests are concerned about the development of television and several have sent deputations to the Postmaster-General in order to make representations regarding its effect upon their own particular sphere of activities. These have included the radio manufacturers, radio retailers, the cinema industry and theatrical professions.

The answer in each case has been that the subject is under consideration by the Television Advisory Committee and that their objections would receive sympathetic consideration when the time comes. In the meantime not the slightest indication of what is being done or when something will be done comes from the Committee. Manufacturers and trade and professional interests are wholly in the dark despite the fact that immediate decisions in view of developments that are taking place in other countries are becoming of vital importance if we are to retain the lead we now have.

Two of the matters of the most pressing importance are pronouncements on the erection of a transmitter in the Midlands and the position of the cinema with regard to television. The delay has been ascribed to various reasons, foremost of which are the international situation and finance. Nether of these, however, should be the concern of the Advisory Committee which is of a semi-technical character; its immediate problems are the technical possibilities of a station in the Midlands and the economic aspects of cinema television. The larger problems must ultimately be those of the Government.

The Popularity of Morse Code

DURING the past year or so there has been a gradual return to efficient morse code operating from the more simple and popular telephony operating.

The reasons for this change of heart by amateurs is not easy to discover for until last year speech was very rapidly taking the place of morse code. Amplifiers and all the equipment necessary for telephony operation are inexpensive.

Coincident with the crisis of last year, there was a sudden demand for morse keys, and, ever since that time this demand has remained quite steady. The change over might have been caused by very poor conditions on short waves making it more simple to communicate over long distances with morse code than with telephony. Alternatively, it may have been due to the demand of the Army, Navy and Air Force for proficient morse code operators.

At the present time the Three Services are training as many amateurs as they can induce to join their ranks, so that operating on amateur frequencies is now of a higher standard than ever before. As these Service-trained operators are being taught a definite system of procedure, they are taking a pride in operating, not only on Service frequencies, but also when inter-communicating on amateur frequencies.



The new G.E.C. BT.0124 combined television and all-wave auto-radiogram.

A NEW G.E.C. TELEVISION RECEIVER

COMBINED TELEVISION AND ALL-WAVE AUTO-RADIOGRAM

A NEW luxury addition has been made to the G.E.C. range of television receivers. This is a television and all-wave auto-radiogram for A.C. mains at 72 guineas. The instrument is operated almost entirely by automatic press button control, and gives the popular sized picture of 10 in. by 8 in.

Half of the cabinet face follows a straight vertical line behind which the screen of the cathode-ray tube is recessed at an angle sloped for comfortable viewing, thus providing a cabinet overhang that shelters the picture from unwanted light and reflections. The other side of the cabinet slopes evenly back, so that the gramophone deck takes up the smallest space necessary, and the radio tuning scale can be seen without stooping, with all the controls in the simplest position for operating.

In addition to eight buttons for station selection, there are seven additional buttons for purposes of control. The first button brings complete television entertainment; the second, television sound only for the special high fidelity sound broadcasts that are transmitted daily by the B.B.C.; the third brings the gramophone equipment into operation; and the fourth, fifth and sixth cover the short, medium and long sound broadcast wavebands. No matter which of these buttons is pressed first, it will automatically switch on the set, leaving the seventh and last button to switch it off.

The radio chassis incorporated

employs a very advanced 5-valve superheterodyne all-wave circuit, embodying A.V.C. and tone compensation. Its range is almost unlimited, and in addition to the choice of any eight favourite stations that the listener can make by push-button, any other programme can, of course, be tuned in by hand. Incidentally, the selection of push-button stations can be changed as often as the user wishes in a matter of a few seconds.

Simple Control

The manually operated controls in the front on the cabinet are few and extremely simple, combining a complete control of all the functions of the instrument. The first and second vary the picture brightness and the black-to-white contrast of the television picture. The third is a volume control, and the fourth a tone control, both being operative for television, radio and gramophone reproduction.

The gramophone equipment is entirely automatic in operation and will play batches of eight 10 in. or 12 in. records consecutively; at the conclusion of the last, the mechanism is switched off, and any record may be rejected during playing.

The sensitivity of the 18-valve television chassis is of a very high order, so that the instrument can be installed in any part of the service area.

This instrument is the first of a new series of G.E.C. television receivers to be released this season. It is actually the eighth successive G.E.C. television receiver since television transmissions began. The model is known as the BT.0124.

Landmarks in Television Development

ALTHOUGH it is generally assumed that television is a 20th century development, its basic principles were known and demonstrated in the 1880's! Silhouettes and crude outlines were televised, transmitted over wires for

short distances, and finally reproduced.

For several decades thereafter, television was rather dormant. It was regarded as an interesting laboratory subject of experiment but it appeared doubtful whether it could ever be perfected.

Progress was seriously hindered by the lack of a satisfactory medium for transmitting, but in the period 1914-1918, radio developed to such an extent that shortly after it entered the home, and the old crystal sets gave way to valve receivers.

It was discovered that crude pictures could be sent through the air on radio waves, and experimenters among whom was J. L. Baird, attacked the television problem anew. In America the Radio Corporation of America, was among the first to enter the field.

Of relevant importance are the following dates and the discoveries and progress made all have their significance in development as we know it to-day.

1676—Olaus Roemer discovered that light travels at finite velocity.

1817—Berzelius discovered selenium.

1830—Joseph N. Niepce and Louis Daguerre produced the first practical system of photography.

1845—Faraday found that a ray of light polarised in a certain plane can be diverted by action of a magnet.

1857—Geissler produced the first glass vacuum tube.

1873—Light-sensitive properties of selenium discovered by a telegraph operator named May, indicating that light values could be converted into equivalent electrical values.

1878—Sir William Crookes invented the Crookes' tube, and demonstrated cathode rays.

1883—Edison discovered the "Edison effect," occurring in an incandescent lamp. An electric current was made to pass through space from a burning filament to an adjacent metallic plate.

1884—Paul Nipkow patented the television scanning disc.

(Continued on page 390.)

THE E.M.I. CINEMA PROJECTOR

As mentioned in last month's issue, Electrical and Musical Industries Limited have now produced cinema television equipment which was first demonstrated privately on Derby Day.

THE E.M.I. television equipment for cinemas is the third of this class which is now available in this country, and though at the present time the field of use is extremely limited it is evident that manufacturers are preparing for the time when cinema television becomes general and equipment will become essential to every well-equipped cinema.

The E.M.I. television projection equipment consists essentially of two parts: (1) the actual projection apparatus used in the auditorium, and (2) the "driving" units which can be situated in a back-stage or other convenient equipment room.

The Projector

The actual projection apparatus of which photographs are shown on this page and the cover comprises scanning and modulation amplifiers, tube unit, lens system and control panels. The extreme compactness of the projector makes it eminently suitable for installation in any theatre with little

alteration to the existing seating arrangements, particular attention having been given in this respect to the design. The usual situation of this equipment would be at the front of the auditorium, but it is of such a nature that where the design of the theatre will permit, it could alternatively be mounted on a lift on the floor of the auditorium, in much the same way as an organ console, and could, therefore, be lowered out of the way when not required.

The angle of projection can be altered so that, by suitable inclination of the screen, the best viewing conditions can easily be obtained. In order to permit of this, the tube unit and lens system of the projector are mounted on a framework hinged at the back, and with a simple raising and lowering device at the front. Although, in general, the auditorium will probably be the most convenient location for the projector, the constructional arrangements of certain cinemas may permit of alternative positions. Where, for instance, the front line of the circle is about 50 ft. or so from the screen,



A rear view of the E.M.I. Projector showing the panels from which complete control of the equipment can be effected.

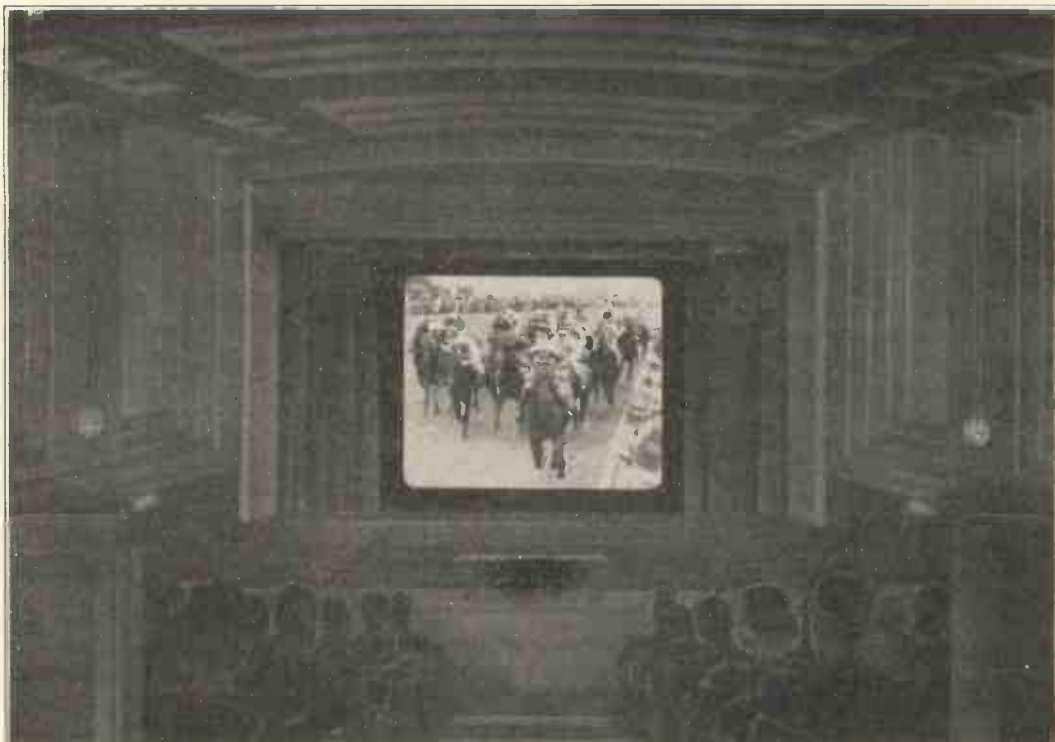

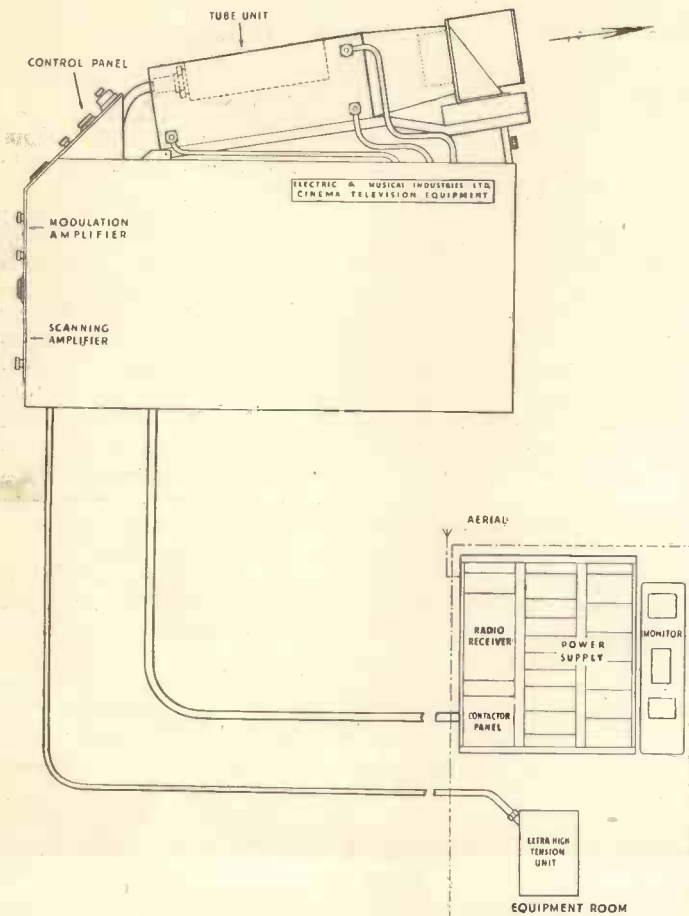

This is a schematic diagram of the arrangement of the E.M.I. cinema television equipment. The projector is in the auditorium and the drive unit in a separate room is provided with remote control.

1926—J. L. Baird, publicly demonstrated television transmission by wireless and wire by sending half-tone moving pictures from point to point.

1928—First television drama, "The Queen's Messenger," broadcast from WGY's studios, Schenectady.

1929—Vladimir Zworykin, of RCA, demonstrated a non-mechanical receiver using a special cathode-ray tube called the "Kinescope."

1930—First showing of television in a theatre. The programme was broadcast from the General Electric Laboratories to Proctor's Theatre, Schenectady.

1933—After 10 years of work Zworykin announced success of his "Iconoscope," the modern television camera tube.

1934—New television camera tube demonstrated by P. T. Farnsworth, in Philadelphia.

1935—New type of wire line, the coaxial cable, capable of transmitting television signals, announced by Bell Telephone Laboratories.

Back Issues Wanted

A correspondent, who wishes to complete his volumes of TELEVISION requires the following issues which are now out of print. If any reader has copies of these for disposal we shall be glad to receive a postcard stating which are available.

- 1931. September, October.
- 1932. April.
- 1933. March, October, November, December.
- 1934. January, April.
- 1935. March, June, October.
- 1936. January, February, March, April, May, July.
- 1937. April, December.
- 1938. January.

Television Interference

A new publication has recently been issued by the British Standard Institution devoted to radio interference suppression for automobiles and stationary internal combustion engines, which is the result of work carried out with the co-operation of the Society of Motor Manufacturers and Traders, the B.B.C., the Electrical Research Association and the G.P.O.

This will be of interest to all who suffer from interference not only with their television receivers, but also on short-waves generally. The specification (B.S. 833/1939) is priced 2s. 2d., post free.

the projector could, if preferred, be accommodated there instead of in the auditorium. Back-projection is also possible. With the projector situated approximately 50 ft. in front of the cinema screen a picture 15 ft. by 12 ft. 6 ins. is provided which is large enough for satisfactory viewing even in the largest cinemas.

Projection distance may be increased with a corresponding increase in size of pictures, still with sufficient illumination. The "drive" apparatus is operated by remote control from the projector and may, therefore, be some distance away. It comprises vertical racks, a monitor and a compact and safe high-tension unit. Included in this equipment are the vision and sound receiver and the contactor panel for remote operation of the equipment and power supply units. A special feature of the design of the contactor panel is that the circuits are interlocked in such a way as to ensure perfect safety of the equipment.

An independent monitor is provided for purposes of initial adjustment of the apparatus in the equipment room. High-tension supply for the complete equipment is obtained

from the extra high tension unit which is housed in the equipment room. This unit, which is of special design, is particularly compact and is absolutely safe in use.

The installation includes provision and erection of the aerial most suited to the particular locality in which the gear is to be used.

"Landmarks in Television Developments"

(Continued from page 388)

1888—Photoelectric cells were built.

1890—C. Francis Jenkins began experimenting with apparatus that could be used with the Nipkow scanning disc.

1906—Lee de Forest invented the three-element vacuum tube with a filament, plate and grid.

1925—C. F. Jenkins demonstrated apparatus which showed far-off, moving objects, or "shadow-graphs."

"Television and Short-wave World" circulates in all parts of the world.

LENSES FOR CATHODE-RAY PROJECTION

THE FACTORS GOVERNING THEIR CHOICE AND USE

By Arthur Cox (Aldis Bros. Ltd.)

TO understand what type of lens should be used in a given television layout involving the projection of a cathode-ray image, requires a knowledge of a few properties of lenses.

Suppose that we have a parallel beam of light incident on a lens, along its axis, as shown in Fig. 1. In a perfectly corrected lens, free from

principal planes $PP(1)$ and $PP(2)$ and focal points $FP(1)$ and $FP(2)$ as shown. The focal length is F . This lens forms an image I of an object O . If the distance of the object O from the first principal plane is U , and the distance of the image from the second principal plane is V , then there is a relation between U , V , and F . This relation is:

the separation of the principal planes, we get for the approximate overall length from object to image:

$$L = (M + 2)F \quad F = \frac{L}{M + 2} \dots\dots(4)$$

For example, if we have a lens of 6 in. focal length, and require a magnification sufficient to bring a 2 in. by 2 in. image on a cathode-ray tube to a 2 ft. by 2 ft. image on a screen—i.e., a magnification $M = 12$ —then the formula (4) gives an approximate overall length of 7 ft.

The next consideration is the amount of light received and transmitted by the lens.

The f /number of a lens is the diameter of the effective part of the front lens divided into the equivalent focus. By "effective" we mean that part which will transmit all the light incident, none being obstructed by stops and diaphragms inside the body of the lens. The smaller the f /number, the more light is transmitted through the lens.

It is sufficiently accurate to take the distance of the cathode-ray screen from the back of the lens as the back focus of the lens. This is true, as a rule, within a fraction of an inch for fairly large magnifications.

We can also take, as a reasonable

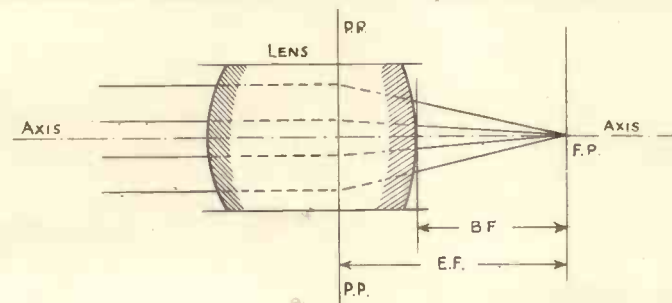

Fig. 1. Diagram showing the characteristics of a perfect lens.

all defects or aberrations, all the rays of light would be refracted so as to go through the point FP . This is the "focal point." The distance BF , from the vertex of the rearmost lens to the focal point, is the "back focus."

If the emergent rays are produced backwards, so that each meets the continuation of the incident ray from which it is derived, then the points of intersection are in a plane PP . This plane PP is a "principal plane." The distance PP to FP is the "equivalent focus," marked EF in the figure. When a lens maker gives the focal length, it is always understood that this refers to the equivalent focus. (The makers can supply, very readily as a rule, the back focus of a lens, if this is required to ensure the correct design of the layout.)

When the lens is turned round so that the light traverses it in the opposite direction, we get another focal point, another back focus, and another principle plane, but the focal length is the same as before. Thus, for any lens we have two focal points, two principal planes and back foci, but only one focal length.

Suppose that we have a lens with

$$\frac{1}{U} + \frac{1}{V} = \frac{1}{F} \dots\dots(1)$$

The image formed is upside down and as a rule is magnified. If the magnification is M we have:

$$M = \frac{V}{U} \dots\dots(2)$$

These two relations lead to the results, that if we have a lens of focal

Fig. 2. Diagram showing the formation of an image by a perfect lens.

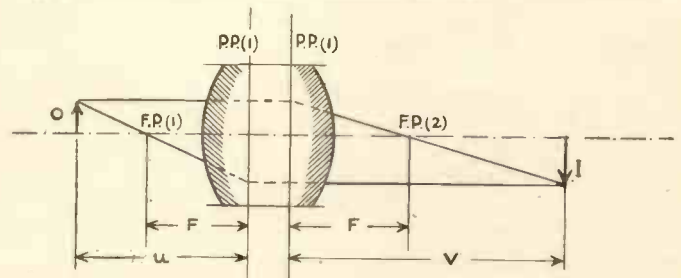

length F , and require a magnification M , then:

$$U = \left(1 + \frac{1}{M}\right)F \quad V = (M + 1)F \dots\dots(3)$$

and if we leave out of account $\frac{1}{M}$ and

assumption, that the intensity of the light emitted by an element of the tube screen is given by Lambert's Law. According to this the intensity $I(x)$ in a direction making an angle X° with the perpendicular to the surface is given by:

$$I(x) = I(0) \text{Cosine } x \dots\dots(5)$$

ABERRATIONS IN LENSES

The fraction of the light emitted by a small central spot E on the screen, that is collected by the lens, is:

$$\text{Fraction collected} = \frac{1}{1+4N^2} \dots (6)$$

where N is the f/number of the lens.

This result is rather interesting, as it shows that it is of no advantage to

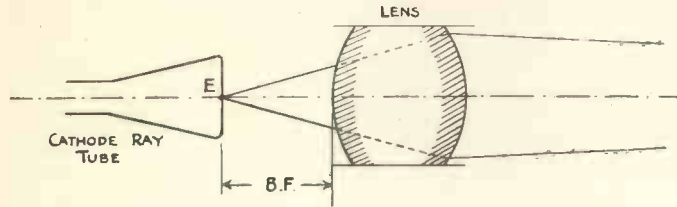

Fig. 3. Diagram showing the position of lens and cathode-ray screen.

design a lens to bring the back focus down; that is, as far as the central brightness of the image is concerned.

As the element of screen E moves away from the centre, the fraction of light collected becomes smaller. At first it is a slow decrease, and then it becomes more rapid. This may be left out of consideration here. As a rule a lens gives a sufficiently bright picture over the whole region in which it gives good definition.

The formula (6) shows quite clearly that to get the brightest image the f/number N has to be made as small as possible. The trouble now arises that it is difficult to get a lens with a small f/number and yet able to cover a relatively large field.

The above theory was worked out on the assumption that the lens was perfect. Actually there are six ways in which a lens may, and will, fall away from perfection. Six ways, that is, as a rough guide, but good enough for our purpose. These defects or aberrations are:—

- (1) Chromatic aberration.
- (2) Spherical aberration.
- (3) Coma.
- (4) Astigmatism.
- (5) Curvature of field.
- (6) Distortion.

(1) The amount by which light is bent when crossing a glass surface depends both on the glass and on the colour of the light. This may result in the blue rays of light coming to a shorter focus, say, than the red rays, and the image formed by the blue light may not only be in a different plane, but if this is corrected, of different size. The lens has so to be

constructed that the image formed by the blue rays is in the same position and of the same size as that formed by the red rays. That is, "chromatic aberration" is to be eliminated.

(2) Rays of light that pass through the edge of a lens are more strongly bent than rays passing through the centre. This may result in a point of light on the axis being

reproduced in the image as a blurred circular patch of light instead of a bright point. This is "spherical aberration."

(3) Some of the rays of light from a point off the axis, that should pass through the margins of the component lenses, may be shut off by stops and diaphragms. A possible result of this is that an extra-axial point is reproduced as a bright spot of light and a flair like the tail of a comet. This is "coma." When the tail of light stretches away from the axis we have "coma out"; when it stretches inwards we have "coma in."

(4) The rays of light, from a

is midway between the focal lines. In this position the image of the point of light is a small circular or elliptic patch, the "circle of least confusion."

(5) Even if all the rays from a point of light emerge after refraction to come to a focus at a point, there is no guarantee that all these image points corresponding to object points in a plane will themselves be in a plane. They may be on a curved surface, such as part of a sphere. In this case we have "curvature of field."

(6) Finally, even if a sharp focus, not spoiled by any of these five aberrations, is obtained on a flat surface, there remains still the possibility of a distorted image. Straight lines may be focused sharply on a screen as curved lines. A grille of straight lines may be reproduced pincushion- or barrel-shaped, as shown in Fig. 4.

The aberrations (2)-(6) are the "Seidel" or "first order" aberrations. With lenses of greater aperture and field there enter secondary and higher aberrations, which become of increasing and preponderant importance with the increase of aperture.

The aberrations are corrected by a skilful choice of radii for the lens curves, of lens thicknesses, and of lens separations. The more component glasses used in the lens, the better the correction that can be obtained.

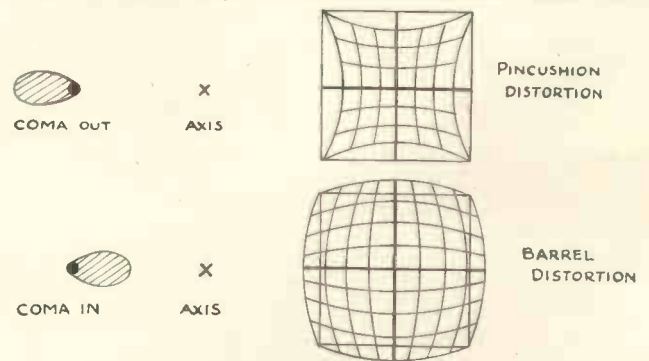

Fig. 4. Diagram showing the effects of two types of coma and distortion.

point away from the lens axis, may emerge after refraction in a bundle of rays of such a form that each ray goes through a fine slit or line l_1 and then through another line or slit l_2 . These are at right angles, and are the first and second "focal lines." In this case we have "astigmatism." The best focus we can get, when a lens suffers from astigmatism only,

The advantages of incorporating a number of component glasses are comparable to those derived from using a large number of stages in a radio circuit. Each stage or glass can work better because too much is not demanded of it. The disadvantage is the same—increased cost.

The attempts that have been made to eliminate the Seidel aberrations,

JULY, 1939

and the others that are important at wide apertures, have led to various more or less standardised types of lenses. Naturally the type depends on the use to which it is to be put.

Two types of lenses are available for use in projecting cathode-ray images. These are projection lenses and anastigmats.

The prototype of the projection lens is the Petzval lens. Designed

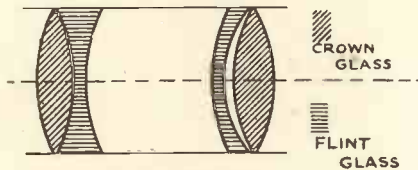

Fig. 5. Petzval-type lens.

about 1845 it is still in vogue to-day with certain modifications.

The Petzval lens consists of two pairs of lenses, each pair comprising a crown glass and a flint glass. These pairs are mounted in a tube at a relatively large separation. The modifications introduced consist mainly in changing the order of crown and flint glasses, in cementing or leaving them uncemented, and in using glasses developed comparatively recently. This lens can be made with quite large apertures, $F/2$ and $F/3$ being not unusual.

The construction is of a simple form. The central definition is frequently superb. The aperture is what is needed to have a large light-gathering power. The defect of this type of lens is that only a small field is covered.

An excellent example of the Petzval type is an Aldis lens designed for cinema projection work. This lens has an aperture of $F/2.2$ and with a focal length of 4 in. gives superb projection from a circle 1.2 in. in diameter. This result may be taken as a general rough guide. A projection lens will give excellent projection, at this aperture, from a circle of diameter not greater than one-third of the focal length. Naturally some lenses may have a larger covering power, but this result is true of the general run.

An anastigmat lens can best be described as comprising a number of component lenses packed together comparatively closely. The quality of definition given by modern anastigmats is astoundingly good over quite large fields even at large apertures. Designs have been patented for anastigmats working at about $F/2$, which claim to cover a field of diameter about twice the focal length.

The more normal type tends to be simpler and cheaper in construction than wide-angle, wide-aperture anastigmats, and this factor may be of considerable importance in the manufacture of television sets for the million.

An economical anastigmat is, for example, the Aldis 2 in. $F/3$ lens. Fig. 6 shows the construction.

This lens will give excellent definition over a circle of diameter about $1\frac{1}{2}$ in. to 2 in. Again, this result may be taken as typical of anastigmats, that are not specifically stated to be wide-angle lenses. A very good

guide is to assume that an anastigmat will give good projection from a field whose diameter is equal to the focal length of the lens. The exact field covered, after this guide has indicated the approximate focal length of the lens required, may be found from the makers' catalogues.

The advantage of the anastigmat over the projection lens is that for a given cathode-ray image and given

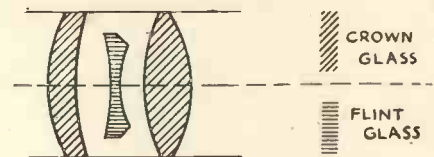

Fig. 6. 2-in. $F/3$ anastigmat.

magnification, there is a much smaller overall length, since a smaller focus lens may be used to cover the tube image. The disadvantage is that to obtain a lens working at the same aperture, and giving the same definition all over the field as a projection lens, may necessitate a rather more costly lens, such as those used in miniature cameras.

Only the user can decide, in each individual case, whether for a given cost, the light-gathering power outweighs the disadvantages of the larger throw of a projection lens; or whether, for a given light-gathering power, the increased cost of an anastigmat is justified. In most cases a good compromise would be to use an $F/3$ lens of the type shown by Fig. 6, which is not unduly costly and has a reasonably large aperture.

Television Receivers are Quite Safe

ONE of the earliest criticisms of the cathode-ray receiver when it became known that voltages of 3,000-6,000 were employed was the possibility of fatal accidents by shock. Voltages of this order were unknown in domestic use with the exception of certain apparatus of a quasi-medical nature which was known to be harmless.

An initial problem of designers therefore was to make the instrument quite safe in ordinary use and this was quite easily accomplished by making the interior or any live part accessible without first disconnecting from the mains. Of course, no piece of apparatus can be made proof

against deliberate interference, but the chances of shock to the ordinary user of a television receiver is certainly much less than with a vacuum cleaner and the results would in all probability be less dangerous.

Voltage is not the dangerous factor. Frequencies and the amount of current available are of much greater importance, providing the voltage is sufficient to force the current through the body. For example the voltage generated by the average car ignition system is of the order of 15,000 volts,

and yet nobody regards such a system as dangerous although it can give an unpleasant shock.

Comparatively low frequencies are the most dangerous and with these the body will only tolerate a small amount of current compared with extremely high frequencies. For example 50 mA. at 50 to 200 cycles can be dangerous, whereas 750 mA. at 100,000 cycles can be tolerated without injurious results.

The real danger points are the secondaries of the high-voltage power transformers and it is probable that it is only from these that any real harm would result except under exceptional conditions. Condenser discharge, generally speaking, is not dangerous, but it is capable of giving a most unpleasant shock.

Mention of "Television and Short-wave World" when corresponding with advertisers will ensure prompt attention.

THE DUMONT TELEVISION SYSTEM

EMPLOYING TRANSMITTED SCANNING IMPULSES

REASONING that it is desirable to provide for extension to pictures of even higher definition than are now accepted as standard without the necessity of rendering existing apparatus obsolete either at the transmitting or receiving end, the DuMont laboratories have evolved a television system which solves many of the problems entailed. Conversely, it is claimed that high-definition apparatus of this type can

synchronising and sweep-frequency controls are therefore unnecessary.

At first it may appear that the addition of these two sweep signals on two new channels seriously complicates the methods, but advantages result therefrom which more than offset the complication. Receiver control is simplified considerably and the design will permit of reception from numerous stations of differing degrees of definition.

receiver and there simply amplified to utilise directly for the scanning.

In this way the receiver will follow even quite radical changes in the scanning raster. The problem of maintaining synchronism no longer exists as no synchronising pulses are utilised at the receiver and there is no need for the complicated system of synchronising pulses with their provision for causing the interlace of scanning.

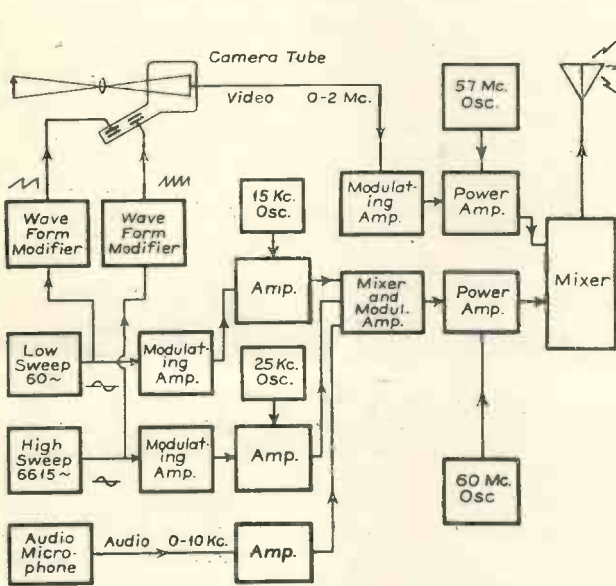

Fig. 1. Double carrier transmitter for four independent signals.

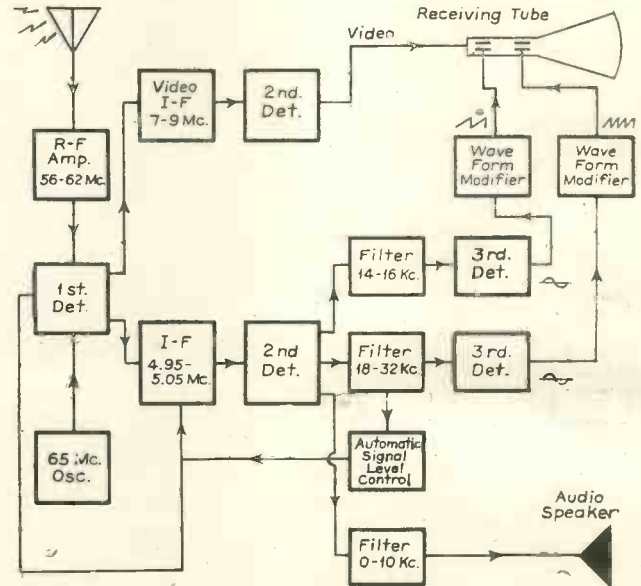

Fig. 2. Double carrier receiver.

be used for a lower definition without radical alteration.

Transmitted Scanning Impulses

The DuMont television system employs the actual transmission of the entire scanning signals for both horizontal and vertical deflection in addition to the conventional vision modulating signals and the associated audio-channel signals. The deflection signals are generated exclusively at the transmitting station and sent by means of a suitably designed carrier methods as independent signals to the receiver, thus simplifying the receiver considerably by making it unnecessary to employ local sweep oscillators for each receiver. Local

The complex equipment in any transmission system rightly belongs to the transmitter, leaving the receiver very simple to operate and free from critical circuits which might require frequent attention. It may be seen presently how many of these advantages are possible when utilising this new system.

In the DuMont system instead of the conventional practice of having a set of sweep-generating oscillators at the transmitter controlled by synchronising pulses, and having another set of sweep oscillators in each receiving unit, these synchronised by pulses sent out from the transmitter and filtered from the vision signals, one carefully controlled set of sweep generators is employed at the transmitting station. These sweep wave-form voltages are used to modulate auxiliary carriers in the transmission system, enabling the actual sweep wave forms to be picked up at the

Two-to-one interlaced scanning has been achieved quite acceptably with the synchronising pulse method although the receiving equipment is thereby complicated, but it is not very likely that higher interlace ratios can be employed by this method of remote control of oscillating circuits.

On the other hand, when the sweep oscillators of the master transmitter of this system have once been adjusted to the proper frequencies, interlace ratios of four or six are entirely practical, as the deflection circuits at the receiver are essentially connected directly with the transmitter oscillators and automatically remain in step with whatever system of scanning is being employed at the transmitter.

Four Signal Channels

The receiver has four signal channels, each of which is quite like

Details of this system were given in a paper read before The Institute of Radio Engineers, New York, by Thomas L. Goldsmith. We are indebted to "Communications," New York, for the information.

JULY, 1939

ordinary radio channels, though employing unique frequency characteristics. These channels require no adjustment after installation other than proper tuning for satisfactory audio reception whereupon the remaining signal channels are at once in adjustment. There may, of course, be necessity for brilliance controls associated with the cathode-ray tube, but in general the set will not be much more complicated to operate than the average broadcast receiver.

A primary advantage of the system is the practical possibility of using four-to-one or even six-to-one interlace, still maintaining sixty fields or fractional scans per second

sinusoidal wave shapes and are then modified to the rather conventional saw-tooth signals by means of a simple filter network at the receiver. A cathode-ray tube is desirable employing electrostatic deflection which very readily follows changes in the scanning system since electrostatic deflection plates have practically no frequency discriminating characteristics.

Fig. 1 shows a double-carrier transmitter for the necessary four independent signals. This system utilises two separate ultra-high-frequency carriers to transmit the signals.

The two carriers are in adjacent

will be desirable to provide black levels on the picture signals to eliminate undesirable portions of the return traces, but these blanking pulses need not be of greater height than just sufficient to cause extinction of the beam, for there is no need of their use for synchronising pulses, with the complex amplitude and frequency filtering at the receiver. With such a vision signal it is feasible to utilise full hundred per cent. modulation of the ultra-high-frequency carrier with efficient picture producing signal. It is unnecessary to sacrifice 20 to 25 per cent. of this very broad channel for the purpose of synchronising pulses.

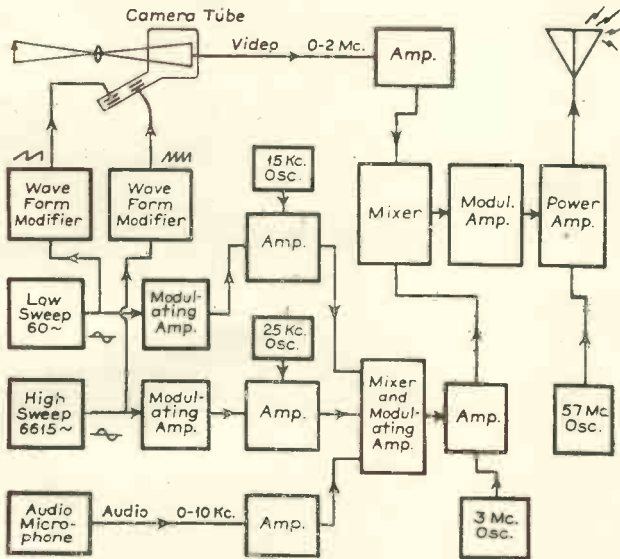

Fig. 3. Single carrier transmitter for four independent signals.

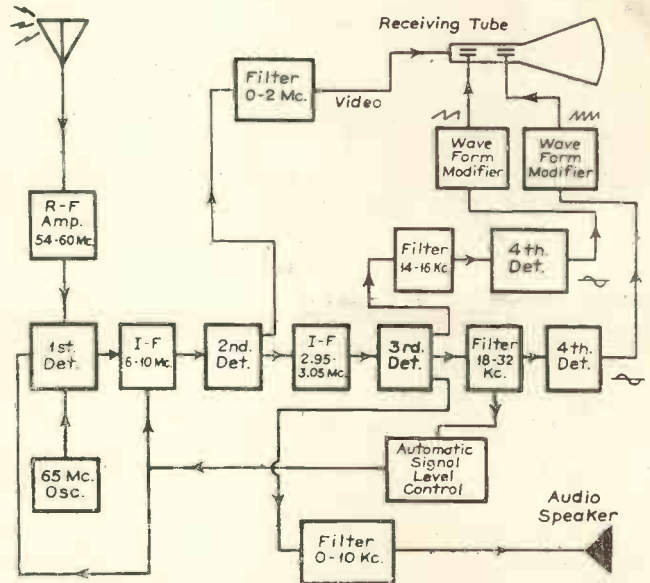

Fig. 4. Single carrier receiver.

in order to insure absence of flicker, but utilising a correspondingly lower frame or picture repetition frequency, by means of which a great reduction in signal band width is possible. Even including the extra bands required for the transmission of the independent sweep signals, the entire band necessary for a complete television transmission is reduced to one-half or less of the band width required for 441-line pictures utilising the two-to-one interlace of to-day with the tentative line and field frequencies being used, because of the reduction in the band width of video modulating signals.

The general system may best be illustrated by a specific example. In order to maintain simple frequency discriminating circuits, the sweep signals are transmitted in the form of

ultra-high-frequency channels to facilitate dual handling at the receiver. One carrier is modulated by the vision signal alone, and the other one is modulated by the three remaining signals, the sweeps and the audio in distinct narrow channels. These three signals are kept distinct from one another by the use of appropriate subcarriers.

The camera tube for converting the pictures into the so-called vision signals may assume several conventional forms, though very promising results have been obtained with the use of a special type of photoelectric mosaic tube employing electrostatic deflection. This type of deflection is considerably more desirable where it is planned to vary the style of scanning raster.

With certain types of scanning it

The sweep signal generators shown provide sinusoidal wave shapes of 60 cycles per second and 6,615 cycles per second respectively for the vertical and horizontal scanning. This type of signal is rather easily handled in selective-filter circuits, and can be modified by a simple resistance-capacity rectifier network into the more conventional saw-tooth waveform which is very efficient in accomplishing uniform coverage of the screen area.

It is necessary to provide a suitable and simple means of transmitting the sweep signals and the audio voltages independently. The low sweep is used to modulate the output of a 15-kilocycle oscillator. The high sweep in turn is used to modulate the output of a 25-kilocycle oscillator.

The audio signals, generated in a

SMALLER FREQUENCY BAND

conventional manner by microphone, supply the third channel which has a frequency band from 0 to 10 kilocycles. These three signals are combined and used to modulate the power output of a 60-megacycle carrier oscillator. The 57-megacycle carrier and the 60-megacycle carrier are subsequently fed to a radiating aerial system.

Fig. 2 shows the double-carrier receiver for use with this transmitting system. It accepts the signals with a radio-frequency stage having a band pass of 56 to 62 megacycles. The first detector mixes this compound signal with the output of a local 65-megacycle oscillator, and delivers the signals to tuned intermediate-frequency circuits.

The vision second detector receives only those potentials intended to modulate the grid of the cathode-ray tube. The other selectively tuned intermediate-frequency stage is followed by a second detector which delivers the three original signals through tuned filters and third detectors in the cases of the sweeps and directly through a filter to the loud-speaker in the case of the sound signals. Simple waveform modifying networks deliver the deflecting voltages to the plates of the cathode-ray tube.

Simplified Control

There are no critical local adjustments to be made to this receiver, after it is once lined up properly with regard to the filters. A single tuning control is sufficient for both channels. The problem of satisfactory automatic signal level control is easily solved since the output of the filter for the high-frequency sweep remains of constant strength and does not change at all as the picture subject matter varies. A circuit can be provided in the vision output to obtain brightness regulation of the picture with changes in the d-c background level of the picture signal.

With these band-pass systems in the receiver it can readily be seen that small variations in the scanning signals are immediately followed by the beam in the receiving tube to maintain faithful picture reproduction.

With a somewhat wider channel in each band, though keeping the same general principles, receiving sets may be produced having great flexibility

as to the types of scanning signals they may accept, and consequently a high-fidelity receiver can also be employed without any change to observe the transmission from a low-definition experimental station so long as each station employs identical sub-carriers and maintains uniform separation between its assigned carrier frequencies.

All the critical equipment is located at the transmitting station, leaving the receiver simple to operate and inexpensive as compared with circuits containing complete sweep oscillators with their associated control features.

Fig. 3 shows an alternative method of transmitting the four necessary signals for this television system. It employs only one ultra-high-frequency carrier. The two sweep signals have their subcarriers as before and a mixer combines the two modulated subcarriers with the audio-channel signals. This composite signal is used to modulate an intermediate subcarrier of three megacycles which can then be suitably combined with the output of the vision channel. Finally, the single ultra-high-frequency carrier is modulated and radiated.

This method offers certain advantages regarding the ultra-high frequencies. Design of a single aerial system is simplified when it is not required to radiate two carriers as in the first method, but merely to radiate the one carrier with its somewhat broader modulation. Only one ultra-high-frequency power amplifier is required.

The receiver for this single-carrier system is shown in Fig. 4. It utilises a conventional superheterodyne circuit through the second detector, except for the use of the broad band pass necessary for television reception. At this point a low-pass filter isolates the vision signals and feeds them to the cathode-ray-tube grid. The band-pass intermediate-frequency stage selects the composite signals still superimposed on the three-megacycle subcarrier which is then demodulated by the third detector.

The respective filters further isolate the signals and deliver the sweep signals through the fourth detectors and the sound signals to the loudspeaker.

Again the automatic signal-level control is taken from the channel of the high sweep frequency.

Advantages

It will be of interest to consider the important advantages of this system over other contemporary systems. Of major importance is the ability to transmit high-definition pictures with a reduced frequency band. This simplifies the requirements at both the transmitter and the receiver. It allows space for more television stations.

It makes it possible to transmit signals on carrier frequencies with hundreds of miles range, though it is well understood that fading and phase errors become more ominous with increased transmission distance. With a six-megacycle peak-modulating frequency it is essential to use ultra-short-wave carriers which are nearly limited to the optical horizon, but with the video peak frequencies halved, it is possible to utilise carriers with increased range.

It is important to point out here just how this video-frequency reduction is accomplished in this system without a sacrifice in definition. The system makes practical the use of interlace ratios as high as four and six. With the synchronising-pulse method of controlling local oscillators at the receiver, this is very difficult, if not absolutely unreliable. With proper equipment, the higher interlace patterns can be controlled at the transmitter, and the method described provides the identical scanning system at the receiving station.

Let us illustrate what is meant by an interlace ratio of four by a specific example. To maintain freedom from apparent flicker it is satisfactory to utilise fractional scanning at the rate of sixty vertical traverses or fields per second. If the horizontal scanning frequency is accurately enough controlled, the scanning can be made to occur so that the entire system of lines is completed at a repetition rate of fifteen per second.

The frame frequency is fifteen per second, providing fifteen completed pictures each second, yet the fractional scanning frequency is sufficiently high to maintain persistence of vision, and the frame frequency of fifteen is high enough to provide adequate continuity of motion of moving objects. By maintaining the field

(Continued on page 403)

"Television and Short-wave World" circulates in all parts of the world.

THE OSCILLOGRAPH FOR TELEVISION RECEIVER SERVICING

IT is becoming more generally realised that the cathode-ray oscillograph is the most comprehensive test instrument that has been devised. In the past its use has been confined to laboratories, but of late the instrument has been developed in such a manner as to render it suit-

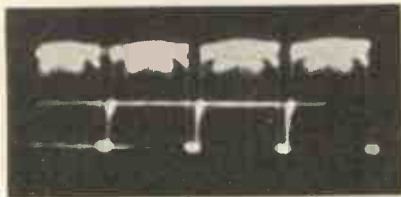

Fig. 1. Waveform across D.C. restoration diode load resistance. Time base frequency 2,531 c/s. able for an almost unlimited number of purposes and without requiring any very highly specialised knowledge in its use. The Mullard Wireless Service Co., Ltd., have appreciated this fact and have devoted considerable attention to the production of instruments of this class of a flexible and adaptable type. Two

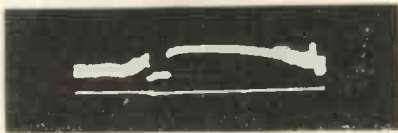

Fig. 2. Waveform across D.C. restoration diode load resistance. Time base frequency 50 c/s.

models, the GM3152 and the GM3155 have been developed primarily for the radio service engineer for visual circuit alignment and radio and television receiver servicing.

It will be appreciated that the

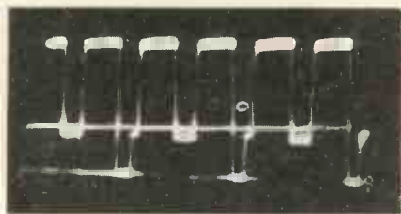

Fig. 3. Waveform of "cross signal." Time base frequency 3,375 c/s.

effect of each adjustment to a receiver shown visually by the response curve on the screen of the cathode-ray tube is of the utmost value in the location of faults and the causes of distortion.

Prior to the commercial develop-

ment of oscilloscopes the setting up of the necessary apparatus entailed a lot of work and special knowledge which was out of the question under ordinary circumstances. Such work is now eliminated by thoughtful design of the instrument and the cathode-ray oscillograph is no more difficult to use than the ordinary test instruments. A certain amount of knowledge in the operation of the cathode-ray oscilloscope is, of course, essential, but it is of a nature that can readily be acquired. In this connection the Mullard Company have issued an instruction book entitled "Radio and Television Receiver Servicing with Cathode-ray Oscillographs." It is quarto size, profusely illustrated with photographs and diagrams and the whole procedure of servicing is fully explained in the text. A nominal price of 2s. 10d. (C.O.D.) (2s. 6d. and 4d. postage) is charged for this book, and readers may obtain copies on application to the company at Century House, Shaftesbury Avenue, W.C.2.

As the text and photographs relating to television receiver servicing are of particular interest to readers of this journal, we have obtained the permission of the Mullard Company to publish a portion. These extracts, it will be understood, only represent a small fraction of the entire work, for in all the book contains close on seventy illustrations, and detailed instructions for locating all radio and television receiver faults.

Testing Synchronising Separator Circuits

Owing to the complexity of the television waveform it is not practical to use a signal generator for checking the operation of the synchronising circuit, so that it is necessary to make the tests on an actual transmission from Alexandra Palace.

Examination of the waveform across the D.C. restoration diode resistance (R_2 , Fig. 50) should reveal a waveform similar to Fig. 1. This oscillogram was photographed with a time base sweep frequency of 10,125

— = 2,531 c.p.s. Fig. 2 shows the waveform of a complete frame (time base frequency, 50 c/s). The actual waveform of the vision part of

the signal will be dependent on the picture detail at that moment being transmitted. The waveform of the "cross signal" which is radiated before a transmission is very useful for test purposes. It is shown in Fig. 3. The time base frequency in this

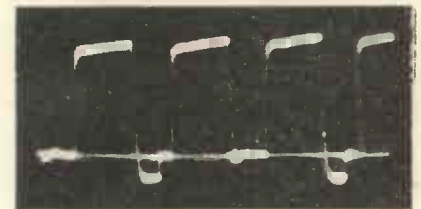

Fig. 4. Waveform of "cross signal" showing curved leading edges due to attenuation of the higher modulation frequencies. The ratio of "synch." to modulation is also reduced owing to a small input to the diode detector. Time base frequency 5,062 c/s.

case was 3,375 c.p.s., i.e., one-third of 10,125, which is the line frequency. If a satisfactory high frequency response is being obtained, the waveform should be quite rectangular as



Fig. 5. Oscillogram of line synchronising impulses showing the effect of the accentuation of the higher modulation frequencies. Time base frequency 2,531 c/s.

in the case of the synchronising pulses. A curved leading edge would indicate a poor H.F. response (see Fig. 4). Also in this oscillogram the ratio of the synchronising impulses to the picture modulation is reduced owing to the diode detector being



Fig. 6. Oscillogram of line synchronising pulses at the output from the separator valve. Time base frequency 2,531 c/s.

operated with a small input voltage. This would not have an adverse effect on the received picture.

A waveform which exhibits pronounced oscillation may be due to accentuation of the higher frequencies or to a poorly designed correction

choke in the anode circuit of VI. This effect is illustrated in the oscillogram of the line synchronising impulses shown in Fig. 5. A fault in the D.C. restoration circuit may result in the horizontal parts of the wave being curved. The waveform at the output from the synchronising separator should be substantially free from vision content. If this is not the case the circuits need adjustment. Fig.

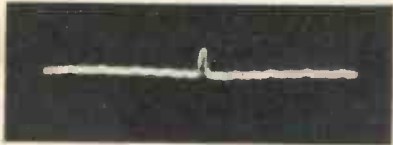

Fig. 7. Frame synchronising impulse after filter network. Time base frequency 50 c/s.

6 shows the waveform from the line synchronising output, and Fig. 7 the frame pulse after the filter circuit. Fig. 8 illustrates the effect of incorrect filter network component values.

Magnetic deflection is becoming more and more popular in television receivers owing to the considerable advantages the magnetic type of tube offers. For this reason more space will be devoted to the magnetic than to the electrostatic deflection type.



Fig. 8. Frame synchronising impulse with inadequate filtering. Time base frequency 50 c/s.

In order that a satisfactory picture may be received it is essential that the waveform of the deflection current (or deflection voltage in the case of electrostatic deflection) should conform to certain requirements. The current or voltage must rise (or fall) in a linear manner with respect to time. At the end of the frame scanning or forward stroke it must return to its original value in 5 per cent. of

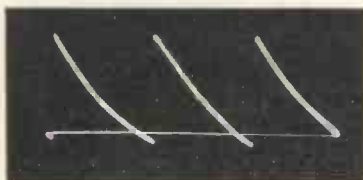

Fig. 9. Non-linear time base voltage,

the total frame period and 15 per cent. in the case of the line time base. A non-linear or curved saw-tooth voltage as shown in Fig. 9 results in

the picture being compressed or extended at one side of the picture or at the top or bottom according to which time base is at fault.

An insufficiently rapid line time base flyback will result in the left-hand side of the picture being folded over. A similar fault in the frame time base would cause flyback lines to be visible at the top of the picture.

Magnetic Deflection Circuits

Magnetic time bases usually consist of two valves for each time base (line and frame). The first valve which may be either a gas triode or a hard valve, provides a voltage of suitable waveform at the correct frequency for feeding the grid of the power output valve. The deflection coils which are located round the neck of the cathode ray tube are usually of the low impedance type fed by a step-down output transformer. Some receivers, however, use high impedance deflection coils for one or even both deflection circuits. The frequency of the frame time base should be 50 cycles per second and the line time base 10,125 cycles per second. The time bases are kept accurately in step with the time base generators at the transmitting station by means of the synchronising impulses already described.

In the case of electrostatic deflection the grids of the push-pull output valves are fed with a pure saw-tooth voltage, but for magnetic deflection it is not practical to design the necessary output transformer for feeding the deflection coils which will handle such a waveform without distortion. It is therefore customary to feed the grid of the output valve with a distorted waveform which will cancel the distortion occurring in the transformer. By suitable adjustment of the circuit values it is possible to obtain a scan sufficiently linear for all practical requirements. The oscillogram shown in Fig. 9 is of the voltage developed across a small resistance placed in series with a high impedance frame deflection coil (equivalent to deflection current). Considerable non-linearity is apparent, which is due to the capacity of the coupling condenser between the anode and the deflection coils being of too low a value. Fig. 10 shows the waveform obtained when this capacity was increased to a suitable value. Oscillogram Fig. 11 is of the voltage across the frame deflection coils. The circuit is highly damped by the anode

feed resistance of approximately 4,000 ohms, so that the waveform of the voltage retains its saw-tooth shape.

Fig. 12 shows the waveform of the voltage appearing across the low impedance line deflection coils. Owing to the inductive output circuit the voltage waveform bears little resemblance to a saw-tooth. The current waveform should, however, be saw-

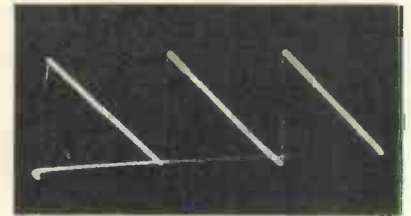

Fig. 10. Linear time base voltage.

tooth in shape, and may be observed by applying the oscillograph input to a resistance of, say, 25 ohms or less connected in series with the deflection coils. The voltage across the primary winding of the line output transformer reaches a very high value during the flyback period due to the sudden fall in anode current of the valve. The voltage does, in certain cases, attain a value as high as 3,000

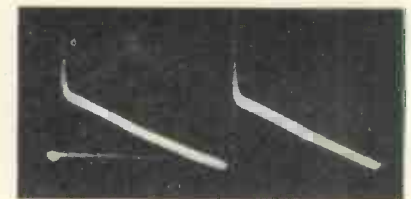

Fig. 11. Voltage across high impedance frame deflection coils.

volts, so that an attempt should not be made to observe the waveform across this winding. Fig. 13 shows the effect of the resistance in series with the charging condenser (gas triode time base circuit) having too high a value. Adjustment of this resistance within certain limits provides a means of correction for a non-linear deflection current in the coils.

"Form" correction circuits may

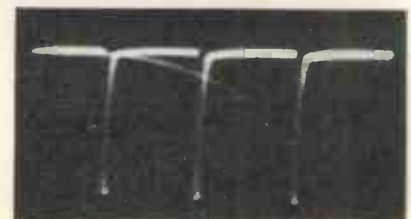

Fig. 12. Voltage across low impedance line deflection coils.

also be applied to the output transformer. (resistance and condenser in

JULY, 1939

series across secondary winding) or in the actual inter-valve coupling.

If either deflection circuit is not up to standard and the waveform appearing at the grid of the output valve is satisfactory, the fault will lie either in

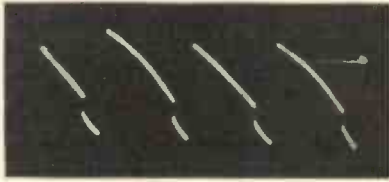

Fig. 13. Distorted time base voltage due to "flyback" resistance having too high a value.

the output stage, the output transformer, or in the deflection coils themselves. The amount of distortion

age at the grids of the push-pull valve is of a suitable value for the direct application to the deflection plates of the oscillograph. The voltages appearing on the grids of these valves should, of course, be equal and show a phase displacement of 180° .

The operation of the output valves is best ascertained by temporarily disconnecting one deflection plate of the television cathode ray tube and connecting to the final anode, and measuring the amplitude of the raster. Now by reverting to the original deflection plate connections the amplitude of the raster should be doubled (in vertical or horizontal direction according to which time base is under test). This measure-

Owing to the high input resistance of the deflection plate circuit of the cathode-ray oscillographs, types GM.3152 and GM.3155 it is possible to estimate with a reasonable degree



Fig. 14. Time base voltage with slow flyback stroke compared with Fig. 10.

of accuracy the E.H.T. voltages. The GM.3152 cathode ray oscillograph has an input resistance direct to deflection plates of approximately 2 megohms with the combination switch set to "external synchronising" and approximately .5 megohm when set to internal synchronising. The input resistance of the GM.3155 oscillograph is approximately 1.3 megohms.

The following is the procedure for ascertaining the H.T. voltage. Apply the input to the oscillograph, with switch set to "direct to plates," to the E.H.T. voltage via a series resistance of 50 megohms approximately (consisting of a number of carefully spaced and insulated resistors), and measure the vertical displacement of the time base line (see Fig. 15). If the deflection is excessive and results in the line being deflected right off the screen the value of the series resistance should be increased: conversely, if the deflection is too small for reliable measurement the series resistance must be reduced. Disconnect the input to the oscillograph and apply a voltage direct to the plates from an H.T. battery. Adjust this voltage by means of the tappings until a similar deflection is produced. The E.H.T. voltage may now be readily calculated by multiplying this H.T. voltage from the battery by the ratio of the potentiometer ($R_1 + R_2$ divided by R_2). For example, suppose R_1 is 50 megohms and R_2 is .5

$$\frac{R_1}{R_2} \text{ megohm, the ratio } \frac{R_1 + R_2}{R_2} = 100$$

approx. and if the H.T. voltage required to deflect the time base line by a similar amount to that produced by the E.H.T. voltage via the series resistance is 45 volts, the E.H.T. voltage will be $45 \times 100 = 4,500$ volts.

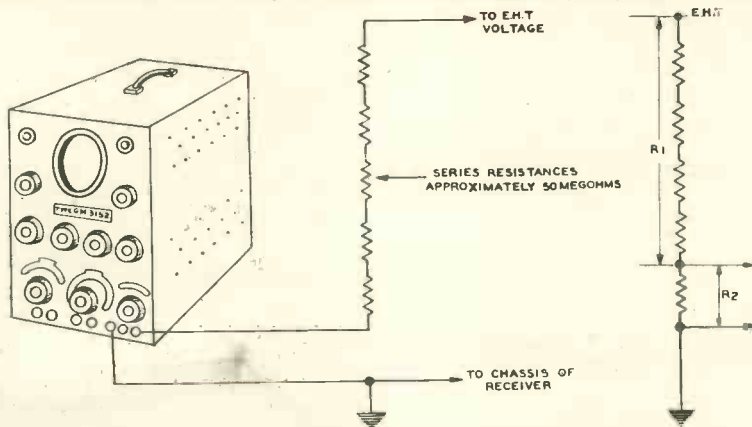

Fig. 15. Method of using cathode ray oscillographs GM.3152 or GM.3155 for measurement of EHT voltages.

which may be tolerated in the output valve is much less than that which passes almost unnoticed in the case of a radio receiver. It is therefore of paramount importance that the valve is operating on the straight portion of its characteristics and that there is no limiting either by grid current or due to the grid potential swinging near the cut off value. Before the anode voltage of the line output valve may be checked it will be necessary to put the saw-tooth voltage generator temporarily out of operation (taking care that the brightness on the television receiver is turned down so that a bright vertical line does not appear on the screen).

Electrostatic Deflection Circuits

It will not be possible to apply the deflection voltage directly to the cathode-ray oscillograph as the spot would be swept right off the screen and the centre portion of the waveform only would be visible. The volt-

ment may be verified by disconnecting the other deflection plate and observing whether the amplitude of the raster is similar to that obtained when working with the other deflection plate of the pair. A non-symmetrical deflection voltage will cause poor focus at the sides of the screen; the shape of the raster will also be distorted.

Measurement of E.H.T. voltages

The value of the final anode voltage of the television cathode ray tube will usually be of an order of 4,000 to 6,000 volts, and owing to the limited current available in these circuits it is essential that the measuring device should draw a negligible current or inaccurate readings will be obtained. The most suitable instrument is the electrostatic voltmeter. This instrument is, however, quite expensive and is of little use for ordinary radio receivers, as its scale readings are restricted to voltages of a high value.

A DIPOLE AERIAL WITH NEW FEATURES

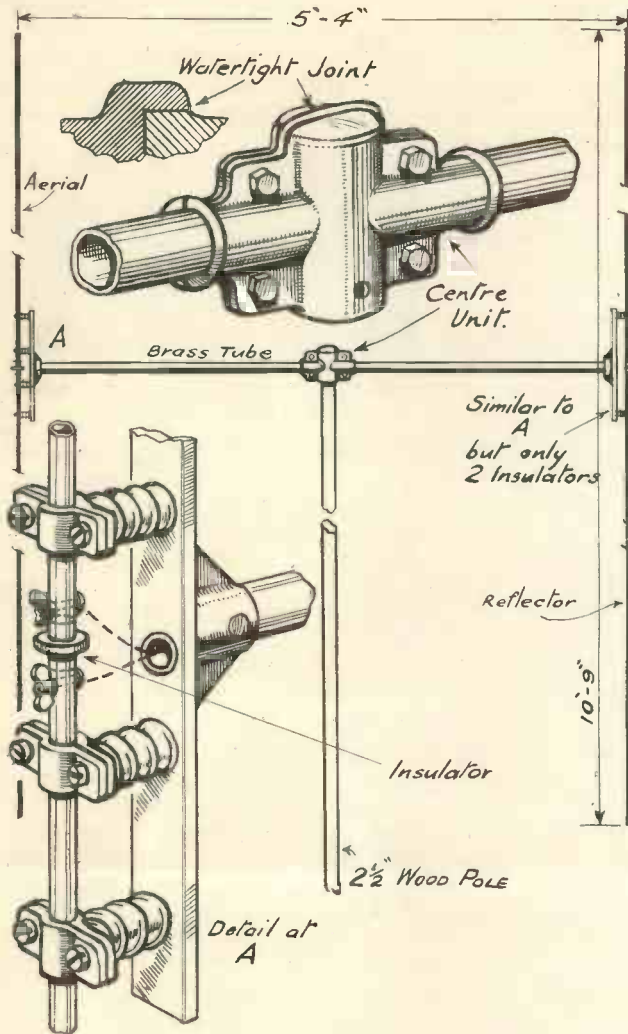

Sketch of the Buller dipole aerial and reflector and some of the constructional details.

thus preventing the ingress of water. At the ends of the tubular cross supports are two flat pieces of iron provided with sockets and securely riveted. On these are mounted the insulator aerial and reflector supports, four being provided for the aerial and two for the reflector. At the outer ends of the insulators split brass clamps are fitted to hold the aerial and reflector members.

The aerial and reflector consist of $\frac{3}{8}$ in. heavy gauge brass tube heavily coated with grey cellulose which should resist corrosion for a considerable time. Both aerial and reflector are in two pieces and a novel feature of the former is a steatite distance piece which fits into the ends of the tubes which are thus set at the correct distance apart for the proper impedance to match up the cable. One of the reflector members is provided with a spigot which fits into the end of the other and is secured with a set screw.

Fixing Method

Another novel feature of this aerial is the means provided for securing it to a chimney stack without drilling any holes or interfering in any way with the brickwork. Two galvanised iron corner brackets are fitted with clamps to grip the pole. These brackets are provided with hooked tensioning screws and a wire from each bracket is passed right round the chimney stack and drawn up tight by means of the screws, the wire at each corner of the chimney passing over metal plates provided

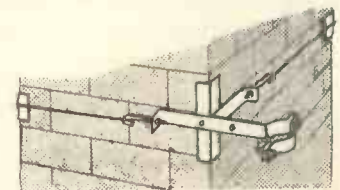

Method of fixing aerial to chimney stack.

with guides. Erection is thus a simple matter requiring no tool other than a spanner for tensioning the wires and there is no possibility of damaging the brickwork.

(Continued on page 403)

ALTHOUGH the dipole aerial with reflector has become more or less a standard article, experience has shown that unless due attention is paid to the mechanical design, it can be a source of trouble after a period of use. It is, of course, exposed to winds, temperature variations and atmospheric changes and these factors necessitate it being rigid and capable of withstanding a certain amount of expansion without detriment to the mounting of the aerial and reflector members. A source of trouble with early types in which wood was used was the fracturing of the insulating supports owing to the expansion and contraction of the wood.

Corrosion is another trouble and it is surprising to what extent this can take place after the aerial has been in an exposed position for some time. Also in the lightest breeze there is constant vibration and any weakness in the mountings soon leads to fracture.

The desiderata for the dipole aerial are, therefore, freedom from possibility of corrosion, rigidity and ability to withstand temperature changes. Bullers, Ltd., of 6 Lawrence Pountney Hill, E.C., who are contractors for overhead electric systems have kept these facts in mind in the design of a new dipole which they have recently put on the market. As the sketches show there are several novel features, some of which we understand are the subjects of patent applications. The aerial and reflector members are supported on a galvanised tubular cross member which fits into sockets on the mast cap and a novel feature is introduced in this latter. This is in two halves, provided with clamping bolts which not only secure the cap to the top of the mast but also clamps the tubular members which can easily be adjusted to enable reflector and aerial to be exactly parallel. One half of the mast cap is provided with a lip at the top which overlaps the other half

Scannings and Reflections

THE NEWSREELS

OPPPOSITION by cinema interests to the televising of the newsreels is increasing, and at a meeting of the Northern Branch of the Cinema Exhibitors' Association a recommendation to the General Council was passed that diffusion of the newsreels concerned should not be permitted.

TELEVISION AND LIGHT "GATES"

Following the Roderick-Armstrong fight for the world's welterweight championship at Harringay Arena, the question of allowing the televising of boxing matches has been raised again. Less than 5,000 went to see this fight, and according to Brig.-Gen. A. C. Critchley, the promoters lost about £8,000.

Opinion, however, among promoters differs and not all attribute the poor attendance on that occasion to broadcasting and television.

THE SCOPHONY BIG SCREEN

It is stated that Odeon Theatres, Ltd., have placed an order with Scophony, Ltd., for the equipment of all Odeon cinemas with television receiving apparatus. Sixty cinemas in London will be the first to be equipped, and it is understood that this will take from about 18 months to complete. There are about 300 Odeon theatres but, of course, there would be no point in equipping those until there was a local television service.

The chairman of Odeon Theatres, Ltd., Mr. Oscar Deutsch, is also a director of Scophony, Ltd.

ACTORS AND VISION

All members of the Actors' Equity Association of America are now required to submit offers and terms for television appearances for approval before appearing before the television camera.

AMERICAN RESPONSE

General Electric (U.S.A.) television engineers have been amazed at the popular response to the television

demonstrations in the G.E. exhibit building at the New York World's Fair.

The G.E. demonstration consists of a small studio, into which visitors are invited to be interviewed before a television camera, and a half a dozen receivers in darkened booths across the auditorium. People crowd in lines six deep in front of the glass window of the studio. Comments in the booths of the television receivers reveal that when visitors see their friends televised they have an urge to talk back to them—as though they were standing face to face.

PHONE LINES FOR TRANSMISSION

A telephone wire from Madison Square Garden, New York, where bicycle races were in progress, to the N.B.C. studios in Radio City, a distance of just over a mile, was experimented with by engineers of the National Broadcasting Co. recently for television transmission. It is stated that at this distance the results obtained were quite good. Use of telephone lines for short distances has, of course, been made by the B.B.C.

YORKSHIRE CINEMA TELEVISION

Arrangements have been made for the installation of television in a number of cinemas in Yorkshire.

These include the Yorkshire kinemas of Gaumont-British. In all probability, the New Victoria at Bradford will be the first of the halls owned by this group to be fitted.

WIMBLEDON TENNIS TOURNAMENT

Improved camera positions should give even better television pictures from the centre court at Wimbledon this year than in 1938 and 1937. Formerly the "shots" have been made from an oblique angle, but this time a "square on" view will be obtainable from a point opposite the Royal Box. In previous years one camera, used for occasional long shots, has been left unattended, but this year all the cameras will be

manned and will be brought frequently into circuit with rapid changes of lenses.

Television from Wimbledon will begin on July 1 and, as the all-important Finals Week proceeds, more and more play will be televised. On the last two days, July 7 and 8, cameras will be in continuous operation from 2.30 to 5 p.m. The finals to be televised will include the men's and ladies' singles, and the men's doubles.

DEPUTATION TO P.M.G.

Representations asking for the limitation of the transmission of television programmes constituted of dramatic, variety, music and singing items to prevent big screen production in public establishments were made to the Postmaster General last month by a deputation representing stage interests. The plea was unfair competition generally detrimental to the maintenance of the variety, theatrical and concert professions.

FILMS FOR A.P.

According to the *Motion Picture Herald* (U.S.A.) (May 20), the television director of the B.B.C. talked with various of the major distributors' executives to obtain from them permission to use some of their features. He had sought arrangements through the Motion Picture Producers and Distributors of America, which referred him to individual executives of member companies. Progress, if any, was not disclosed.

CROSLY TELEVISION

The Crosley Corporation (U.S.A.) has leased the entire 48th floor of Cincinnati's Carew Tower for construction of television studios. Carew Tower, 574 ft. high, will have an estimated service radius of 25 miles. The transmitter is rated at 1,000 watts, and work is progressing rapidly.

EMPIRE TOWER FOR TELEVISION?

Tower of Empire at Bellahouston Park, Glasgow, has been suggested

MORE SCANNINGS

as a television station. Mr. C. O. Stanley, chairman of the Television Development Committee, speaking at Peebles recently, however, said that it would be 10 years or thereabout if the present attitude of the authorities continued before Scotland had television. It was his personal opinion that the obstruction to provincial television was coming from the Post Office. He thought the Post Office had contracted a new disease—"cabbitis."

MISS RADIOLYMPIA, 1939

A contest has been organised by the Radio Manufacturers' Association to select the girl with the perfect radio and television personality to appear at Radiolympia—August 23 to September 2, 1939. The heats of this contest are being conducted at the leading seaside resorts, one night each week, from week commencing July 10 to week commencing August 14. The girl will be chosen for appearance, personality and microphone voice.

At the completion of the local heats, semi-finals will be held in large centres of population, such as London and Birmingham, to select twelve semi-finalists who will appear in London for final judging. The semi-finals and finals will be judged by a Committee of radio critics, film, stage and radio stars, and other well-known personalities.

DuMONT TELEVISION

Two new DuMont television transmitters are being finally tuned up to take the air shortly with experimental transmissions, while down in the spacious basement two television studios and a control room are rapidly taking definite form so that suitable programme material may be available to the DuMont television station, which was recently granted an experimental licence to operate within the 42,000-56,000 kc. band.

One studio is being devoted to direct pick-up programmes, and the second film pick-ups.

Two transmitters are available for simultaneous transmission within the allotted frequency band, permitting the handling of vision and sound components of a single programme, or the transmission of the same vision pick-up by the standard R.M.A. system and the DuMont system, for a direct comparison. Demonstrations will be available shortly, so that the

relative merits of these two systems may be ascertained under actual operating conditions. The DuMont system, which is described on another page in this issue, eliminates the need for sweep circuits at the receiving end.

The DuMont Laboratories, last month, filed application for three additional television transmitters. No. 1—A 50-watt mobile transmitter on 60-86 mc.; No. 2—A 1-kw. unit for 515 Madison Avenue (top floor), N.Y.C., on 60-86 mc.; No. 3—a 1-kw. unit for the National Press Buildings, Washington, D. C., on 42-56 mc. and 60-86 mc.

"HOME" TELEVISION ?

The *Milwaukee Journal* has applied to the Federal Communications Commission for permission to inaugurate an experimental television service to the public. The Journal Company's application is the *first-application* for the establishment of an experimental programme service for reception in the home as distinct from fundamental research or technical experiment. The Commission has previously issued a number of licences for technical experiment only.

NATIONAL SERVICE UNITS TO BE TELEVISED

Television cameras will pay a return visit to Hyde Park on July 2 for the march past of National Service units before His Majesty the King. The members of the parade will have come from all parts of the British Isles and will include detachments of the Army, Navy, Air Force, A.R.P. services, the Auxiliary Police and Nursing services. Incidentally, the parade will be His Majesty's first important public engagement after his return from America.

MUSIC BEE FOR TELEVISION

A Musical Bee is planned for the evening television programme on July 10 when two teams, part professional, part amateur, will be matched. With women ranged against the men, the contest will develop on the lines of a general musical knowledge bee in which competitors will not only have to guess tunes but identify strange instruments, translate obscure musical terms, recognise records played backwards, and solve other problems which

should not be too difficult to people who have a little more than a nodding acquaintance with music. The whole programme will be strongly visual in appeal, and even viewers who have no knowledge of music will, it is believed, extract a lot of enjoyment from this unusual programme.

TROOPING THE COLOUR BROADCAST

Five London cinemas reproduced the Trooping the Colour broadcast. The New Victoria, Marble Arch Pavilion and Tatler used Baird apparatus, and the Odeon, Leicester Square, and Monseigneur, Oxford Street, Scophony. All had audiences somewhat larger than usually attend. It has been generally conceded that the quality of the reproduction was the best ever on big screens, largely due to ideal weather conditions.

FOOTBALL TELEVISION

At the annual dinner of the Football League Secretaries' and Managers' Association Mr. Stanley R. Rous, secretary of the Football Association, declared that it would be a mistake for football people to stand against television and broadcasting. This may be an indication that some arrangement will be made to televise matches next season.

SCHOOL LESSONS BY TELEVISION

At Hurst House School, Staplehurst, Kent, the scholars are being given lessons with the assistance of a television receiver. News reels and the televising of events like "Trooping the Colour" and the departure of the King and Queen for Canada provide the subject matter for general knowledge teaching. These special lessons have been started by the headmaster, Mr. H. Farrington.

MR. GERALD COCK BACK FROM U.S.A.

Mr. Gerald Cock, B.B.C. Director of Television, who has returned from the U.S.A., where he has been inspecting the progress of television, addressing a gathering of the Radio Manufacturers' Association on his return, said: "England still leads the world in television, but American interests are watching us. The National Broadcasting Company, Columbia, the Film Industry, the New Deal itself, all these organisations with their vast resources are

AND MORE REFLECTIONS

waiting to take up television at the point to which we have brought it.

"It behoves this country to move forward in the television field at such a pace that we still continue to maintain our lead. If only this country will go on developing television, the rest of the world will come to us for television equipment, not only for receivers, but for transmission equipment itself. In every country of the world, except England, television is in the experimental stage. In this country it is already a practical proposition. We know we have a three years' lead on the others. It is up to nations with the object of helping us to maintain this lead while offering the results of our experience to other them to enjoy the facilities we already possess."

SANDOWN PARK

At the moment there does not appear to be any chance of the Eclipse Stakes being televised from Sandown Park on July 14 as was previously announced. The Jockey Club Stewards have refused permission for the race to be televised despite the fact that B.B.C. engineers had already surveyed the course and obtained permission from the Sandown Park authorities to instal the necessary equipment and cameras.

The attitude of the Jockey Club Stewards is to be deplored, as surely it cannot have any effect on the attendance at the race meeting, while from a technical aspect the transmission would have been highly successful as the course is a short one and lends itself to a complete transmission of the race without difficulty.

TELEVISION IN BLACKBURN

Philips' engineers at the new Blackburn factory are very optimistic about receiving television pictures there. If it is possible for them to erect an aerial 250 ft. above ground level and with directors and reflectors they feel there is a very good chance of satisfactory pictures being received. Their results are awaited with interest by readers who live considerably beyond the service area.

TELEVISION AT THE NEW YORK WORLD'S FAIR

American television was given quite a boost by the transmission of pictures of the King and Queen when

they visited the World's Fair. A commentator talking over one of the American short-wave stations was very optimistic regarding the possibilities of a rapid advance in American television and was using the King and Queen's visit to prove how important it is that television should be in every home in order that the ordinary viewer could be kept acquainted as to what was going on even if they were not able to see the events themselves.

LONG-DISTANCE AMERICAN TELEVISION

Contrary to the theory that television programmes can only be received at a limited distance from the transmitter, General Electric engineers in Schenectady using a standard console receiver picked the complete two-hour programme "teletcast" by N.B.C. from the Empire State Building. Both picture and sound were received exceptionally well despite the fact that the distance from the transmitter was 130 miles and the receiver was located approximately 8,000 ft. below "line of sight." This is believed to be an American record for reception of a regular broadcast television programme, although in this country and elsewhere, distances considerably in excess of 130 miles have been spanned. The test was made on May 26 and a group of engineers erected a temporary diamond directive aerial array. It was suspended from four masts, with the plane of a diamond parallel to and about 40 ft. above the ground. The aerial occupied a space on ground of about 300 by 600 ft. Tests were conducted close to the location chosen for the new high-power General Electric television station which is being put up in the Helderberg mountains, 12 miles from Schenectady.

GENERAL ELECTRIC U.S.A. RADIO-TELEVISION ACTIVITIES

A new department of the General Electric Company which will consolidate for the first time all radio, television, and related activities, has been established with headquarters at Bridgeport, Conn., effective immediately. Dr. W. R. G. Baker, for many years associated with G.E. activities in the radio field and until now chairman of the radio manage-

ment committee, has been named manager of the new unit, to be known as the radio and television department.

ANOTHER DEPUTATION

A deputation of radio dealers organised by the Radio and Television Traders' Federation met the Postmaster-General to explain the retailers' case for a new station at Birmingham and in other important provincial centres. It is hoped that the various deputations putting their views before the Postmaster-General will ultimately have the desired effect.

"A Dipole Aerial with New Features"

(continued from Page 400)

Except for the aerial and reflector members and the insulators the entire construction is in heavily galvanised iron and the assembly should be proof against weather conditions for a very long time. As clamps are used both for the mast supports and the mast cap directional setting is quite an easy matter. The electrical design conforms to accepted standards and the aerial may therefore be relied upon to be electrically efficient. As it is essential that the mast should fit the sockets this is included as part of the kit, its length being 12 ft.

"Du Mont Television System"

(continued from Page 396)

frequency of sixty and reducing the frame frequency to fifteen instead of thirty, as with the 441-line two-to-one interlaced pictures, the video frequency band is halved without sacrifice in either horizontal or vertical definition.

Use of single-side-band transmission is, of course, possible with this system which will reduce the required frequency band on the air to one-quarter of that of existing systems.

Another advantage is the assurance of synchronism if signals are received at all. There is no local adjustment of auxiliary controls. Furthermore, the receivers are capable of responding to several scanning systems in turn from different transmitting stations.

It is realised that this system can only stand on the merits of results of extensive field trials which are under way. DuMont laboratory tests have indicated that the system is entirely feasible.

MORE PROGRESS WITH THE "HOME" MECHANICAL RECEIVER

By J. H. JEFFREE

In preceding issues articles have appeared on the development of a home mechanical receiver. Considerable success has been obtained with the apparatus described, most of which it is hoped shortly to incorporate in a complete receiver.

PENDING the perfection of circuits for synchronising the newly-developed nine-ball motor-scanner from the received picture signals, a provisional circuit is given herewith which has been found to work, though it has the fault of occasionally letting the motor drop out of sync. if the controls are too suddenly altered. As a *driving* circuit for this motor, however, it will be found quite efficient, and the above defect appears to arise only from the swamping of the driving oscillation too suddenly by the control signal; its cure, therefore, should only be a matter of cleaning up the circuit arrangements. We have not found opportunity, unfortunately, to complete this in time for this month's issue.

It might, also, be preferred to substitute American type valves with 6.3 volt heaters for the first two valves, to keep the heater voltage uniform throughout the unit.

Points of interest in this circuit are the cathode coupling of V₂ to V₁ and the feedback network from V₃ to the grid of V₂. Both arise from the necessity of making an oscillator that can be varied from about 800 to 10,000 c.p.s. in a simple manner. Using two valves for the purpose, as here, there are several circuits that will achieve such a tuning range by

Driver unit for nine-ball high-speed scanner.

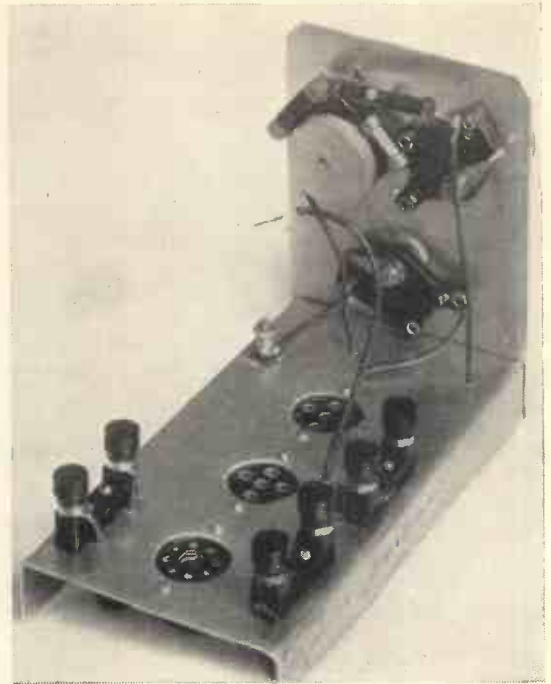

the variation of condensers and/or resistors, and that chosen is not claimed to have any special merits; most of them, however, have to be rather carefully designed, if such a range is to be fully covered with a little to spare. In the present circuit, the main point was found to be ensuring that the variable shunt capacity from G₂ to earth, which is the main variable factor involved in covering the range, should be reducible to as low a minimum value as possible. Even a few extra microfarads are enough to prevent easy tuning right up to 10,000 c.p.s. Therefore no additional couplings to this grid were permitted, and the sync. signals were injected via the cathode resistor. For the same reason a screened grid type is chosen for this valve (V₂) to reduce input capacity.

The curious feedback network improves the oscillation range, and the

variable resistor included in it is very convenient as a fine control of speed, as the main control, obtained by the condenser, is fairly coarse. A still further extension is obtainable by connecting a small condenser, approximately 20 micromicrofarads, in parallel with the 250,000 ohm resistor in this feed-back circuit.

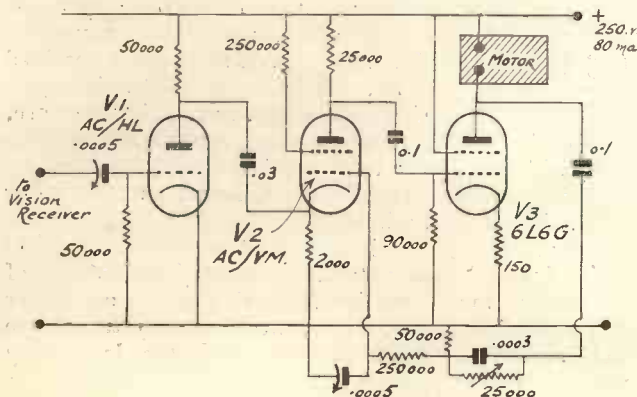

The circuit diagram of the high-speed scanner drive unit.

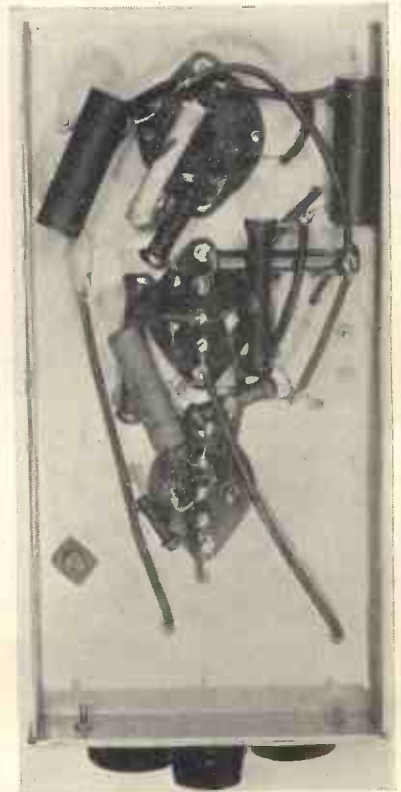

Underside view of scanner drive unit.

DRIVING THE MOTOR

Running the Motor

The motor has to be connected in the plate circuit of the 6L6G directly, as the magnetisation produced by the D.C. flowing in its windings is essential for its operation. The procedure

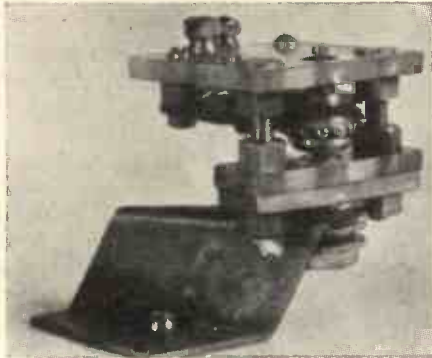

A photograph of the nine-ball scanner and motor.

in starting and running up is as follows: First, the oscillator controls (variable condenser and resistor) are both set to maximum, when the oscillator note should be audible from the motor polepieces. The starting knob of the motor is twirled briskly (right-handed, for the present arrangements) and the rotor should at once drop into rotation at a steady speed corresponding to the oscillator frequency. The controls are then turned towards minimum, gradually enough for the motor to follow; it is convenient to turn out first the condenser, which will take the speed fairly near to the desired 22,500 r.p.m., and then bring it right up with the resistor.

It was of interest to determine, in the course of this work, whether the motor remained exactly in step with the oscillator, as the speed was increased, or whether, as seemed possible, it lagged behind somewhat, and only caught up fully after the controls were fully set. To test this, signals from the driving oscillator were applied to the vision receiver, producing a vertical pattern on the screen, and it was found that even the most drastic interference with the motor could not, even momentarily, disturb this pattern to any appreciable extent.

With this particular circuit, at least, the oscillator and motor are locked together, in running, almost as if they were a single entity, and

this doubtless is the reason why it is so easy to vary the speed without risk of the motor dropping out. With other circuits the interlocking is not so complete, and it may be necessary, in the interests of effective synchronism, to sacrifice a little of this interlocking by some modification of circuit values. The present circuit is controlled so effectively, one may say, by its interlocking with the motor, that it does not very readily accept additional control from the picture signals; and it is thought that this may be the source of the minor difficulty arising in this connection.

When the correct speed is reached, control impulses are applied through the variable condenser in the grid circuit of V1. There are two points in the vision receiver from which signals may conveniently be drawn, via a condenser, for application to this grid; from the plate of the V.F. amplifier valve V6 (or the grid V7, which is equivalent) or from the circuits carrying the 10 mc/s oscillation that is fed to the light relay; for instance, from the outer terminal of the preset condenser (C22) in compartment 6. (See the May issue of this Journal, p. 275). From either of these points we get a signal in negative sense (as simple V.F. or modulated 10 mc/s respectively) which can be rectified at the grid of V1 in the present unit. If the amplitude of this signal is sufficient, the picture modulation will then be pushed below the grid base of this valve, and only the sync. impulses be passed on to V2.

So far, we have had better results with the use of the 10 mc/s oscillation for this purpose, which has only

the minor disadvantage, that care is desirable, by the use of a short lead, and perhaps screening, to avoid letting this oscillation stray too much into the preceding stages of the vision receiver. This is a matter for further experiment, and perhaps anyone who obtains one of these motors in the near future will record his results.

In any case, if the control impulses are applied gradually by turning up the variable condenser, the motor usually locks in without much trouble. It seems better to have it running at a little above correct speed, rather than below, before turning on the sync. impulses.

A photograph is shown of a driving unit to the circuit given, in which the two upper knobs are the speed controls and the lower, the sync. admittance condenser. Bakelite dielectric reaction-type condensers are advisable on account of their low minimum capacity.

Hunting

An important point in the design of such a motor as this is the avoidance of *hunting*. When, as in the present case, it is run with a circuit that locks itself to the motor, hunting is bound to be tied up with the behaviour of the circuit also. So far, it has been found reasonably steady, with circuits like the one given, but dependent to a noticeable extent on the circuit. Also, of course, imperfect separation of the sync. impulses from the picture, which is in the present case a question of the amplitude of the applied impulses, gives rise to something like hunting. Experiments are being continued on this point.

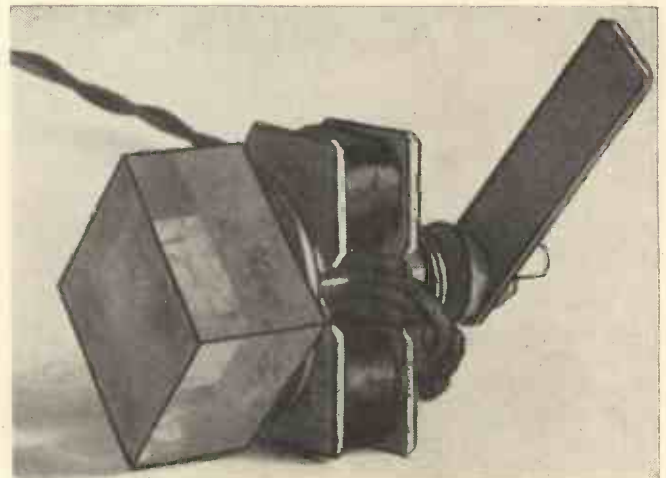

Photograph of slow-speed (frame) scanner and motor for 4-in. picture.

THE SLOW-SPEED SCANNER

The impression was unintentionally given, last month, that this motor might be home-constructed. Owing to the accuracy in certain details involved, and certain other technical points, that is hardly feasible even for the skilled amateur, without an unreasonable amount of preliminary work, and it is not proposed to give any directions for such attempts. The author is arranging for the manufacture of these motors, and they will be available through H. E. Sanders and Co. as mentioned last month. They are being supplied, for the mechanical set, on a bracket mounting for fixing, by a single bolt, to the optical frame described in the January, 1939, issue of this journal, in place of the mains-driven 67½ ball scanner and motor there specified.

Slow-speed Scanner

The slow scanner-motor is also illustrated with a four-sided plastic block scanner, of the type described in previous issues, for producing a 4-in. 135-line interlaced picture. It is of very simple construction, but the amateur worker is not likely to want to go to the trouble of fitting up the arrangements for producing the plastic block scanner. The motor part, however, comprises a rotor consisting of an eight-tooth wheel, 1 in. in diameter, cut out of 1/16 in. thick iron sheet, and pole-pieces made by bending up a length of 3/8 in. by 3/32 in. iron as shown in the picture, with windings of No. 32 enamelled wire (for operation off the 8 volt 50 cycle supply used to light the lamp).

There is only one point that is really important for success with this motor: there must be either a spring coupling of some sort between the rotor and the scanner, or between, at least, some two parts of the rotating system as a whole, or else a part of some sort running free, with a suitable degree of friction, on the rotating system. This is necessary to damp out disturbing impulses that would otherwise stimulate hunting or even throw the scanner out of synchronism. This point was explained in the August, 1938, issue of this journal. In the form now illustrated there is a free running brass disc, with a moment of inertia of the same order as that of the scanner block, which effectively keeps the system running smoothly.

Chance for Serious Experiment

With the availability of these two scanning units and the necessary lenses, the way has been opened for the experimenter to work seriously on mechanical television reception. The author does not wish to give the impression that he has offered here a finished and complete alternative to the cathode-ray tube type of receiver; it is not feasible, with individual work on an experimental scale, to offer the certainty of trouble-free, perfect results that has been achieved, with the cathode-ray type of receiver by years of research by many big companies. It is assumed, therefore, that anyone who merely wants a trouble-free television receiver will not bother with mechanical arrangements at all, until, if ever, the big companies have led the way with cheap mechanical sets. The experimenter, however, is in a different class; he wants interesting developments, and the chance to do a bit of research on his own, and it has been that desire that has stimulated the author to suggest the present arrangements. He is fairly well satisfied that they are actually practical means of receiving television programmes, and is going ahead to develop them further.

It is hoped, in the course of this development, to give shortly constructional details for a set using the scanners now developed, and the vision receiver, lenses and optical

frame previously described, but with the details of design cleaned up and the overall size cut down. The picture size of this set would be four inches, and care would be taken to provide for acceptable picture quality; not merely, as so far, for the simplest arrangement that will do the job at all.

As has already been stated, this idea has from the beginning been kept in mind, and the components described are such that improvements in quality are possible with them by slight additions and modifications. The only big departure that was necessary from the original scheme outlined a year ago has already been made, viz., the substitution of the new nine-ball synchronised scanner for the simple mains-driven type. The reduction in over-all size of the set is made possible by partly cutting the web B (see previous articles) of the optical bench, and bending this so that the lamp is brought nearer in and nearer the front; a mirror is then needed to reflect the light round this bend, to the light control, and in introducing this the opportunity will be taken to insert a small prismatic device for utilising the diffracted, instead of the direct beam, as hitherto, from the light relay, thus giving better contrast and gradation in the simplest possible manner. At the same time this will bring the picture closer to the centre of the receiver, improving the appearance considerably. None of these alterations will be difficult or expensive.

The Television Image

DR. F. SCHROETER, in discussing the acceptability of television pictures in *Telefunken Hausmitteilungen*, from the points of view of physics, physiology, and psychology formulates the following conclusions:

Psychologically and aesthetically absolute image size is not a decisive factor in combined television and sound broadcast reception.

Home television screen dimensions, for a 441 line interlaced image, should not exceed 12.4 in. by 10.4 in.

With the present number of scanning lines, large images are of value only in large rooms and in connection with proportionately extended viewing distances.

The normal contrast range satisfies all requirements, provided that stray light is excluded from the vicinity of the screen. Where stray light interferes, the brightness level in interlaced images is limited by flicker.

In rooms with interference from the lighting system the most satisfactory tone colour is produced by screens which fluoresce with strong white and some blue.

Television calls for high fidelity acoustical reproduction to be acceptable, just as do sound motion pictures.

Television is significant primarily for extending ordinary optical limits and thus enabling audiences to witness distant events as they are taking place.

A RECEIVER FOR TELEVISION SOUND

Last month a complete design for a vision receiver for local reception was given. This article describes the sound unit, the whole providing a low-cost efficient vision and sound combination

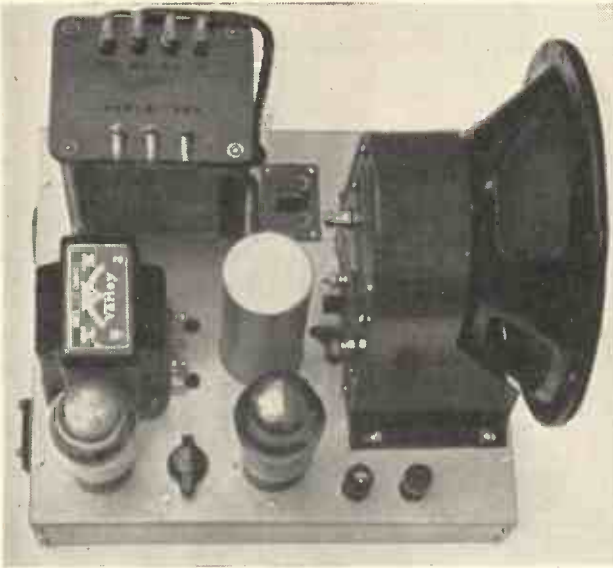

Fig. 12. The power pack, output stage and loudspeaker.

EQUIPMENT to provide the sound accompaniment to the programmes of the vision receivers described last month was designed for the same receiving conditions as the vision section. An adequate sensitivity margin is provided for reception at distances up to 20 miles or so. The inclusion of regeneration renders reception, at slightly impaired quality, possible at greater distances however. Again, as for the vision apparatus, the design is entirely conventional. In the first place this equipment consisted of a R.F. stage, a regenerative triode detector and a high mutual conductance output pentode. It transpired, however, that this arrangement had not quite the necessary gain and the regeneration control had to be advanced considerably to provide the requisite volume. Despite this fact, however, it is considered that such an arrangement will provide excellent results in the majority of cases up to distances of 20 miles.

Increasing Gain

It is a simple matter to amend the circuit given to these conditions should it be desired to employ this simpler arrangement. The valve V17 is omitted and the output terminal is connected directly to the 0.1 μ Fd. condenser blocking the grid of the output valve V18. Should the gain subsequently prove inadequate, it is a simple matter to include this additional stage as shown by the circuit diagram already referred to (Fig. 10). To avoid any confusion, it is pointed

out that the photographs reproduced (Figs. 11-15) show the sound receiver in its original form, that is as a three-valve receiver. The additional L.F. stage later added, was accommodated with very slight alterations in the amplifier chassis, the valve holder for this valve taking the place of the two input terminals shown in the photograph, Fig. 12, mounted adjacent to the loudspeaker. These terminals were then moved forward. Adequate space to accommodate the additional components exists beneath the chassis as is apparent from a glance at the photograph, Fig. 13.

The increase in gain provided by the additional stage is not fully required, and advantage of this fact is taken by including negative feedback to this stage, thereby overcoming the shortcomings of the pentode output valve. Furthermore, due to the high efficiency of this output valve, the amount of L.F. gain that can usefully be employed, unless somewhat elaborate decoupling is included to

preclude the possibility of hum or L.F. oscillation, is restricted. Negative feedback is thus rendered desirable even when ignoring the question of quality.

It will be seen that the apparatus consists of two units. The small unit comprising the R.F. and detector stages, the larger unit the output stage, and the L.F. coupling stage when this is employed. The power supply arrangements for both chassis are also included in this unit. The dimensions of these units are given in the drawings, Fig. 15.

Simple Construction

This method of construction is simpler and also permits the signal receiving section to be employed in conjunction with existing amplifiers or a normal broadcast receiving set. In the latter case it is only necessary to connect the two output terminals of the small unit to the pick-up ter-

Fig. 11. Interior view of R.F. and detector stages of sound receiver.

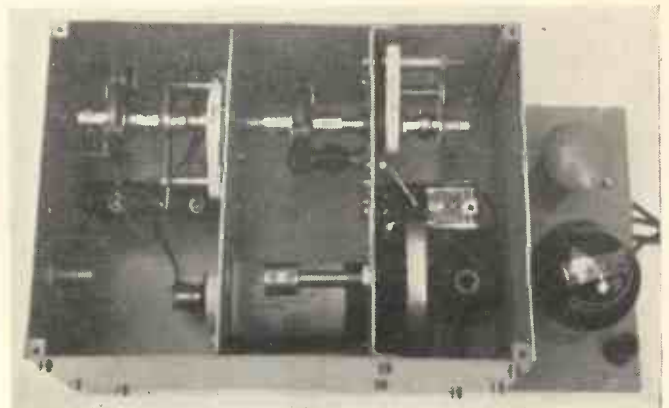

CIRCUIT OF SOUND RECEIVER

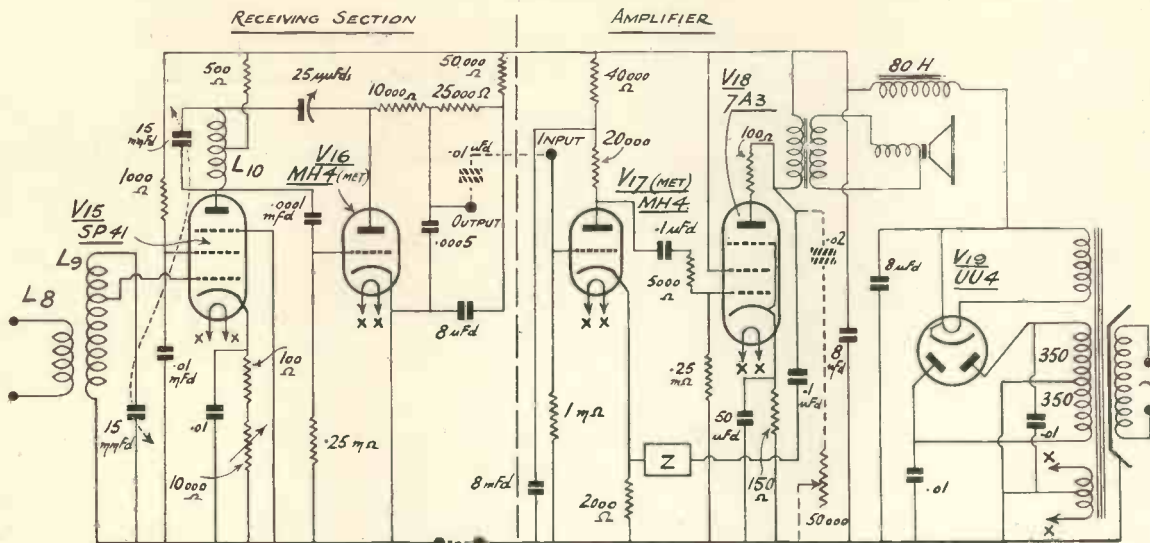
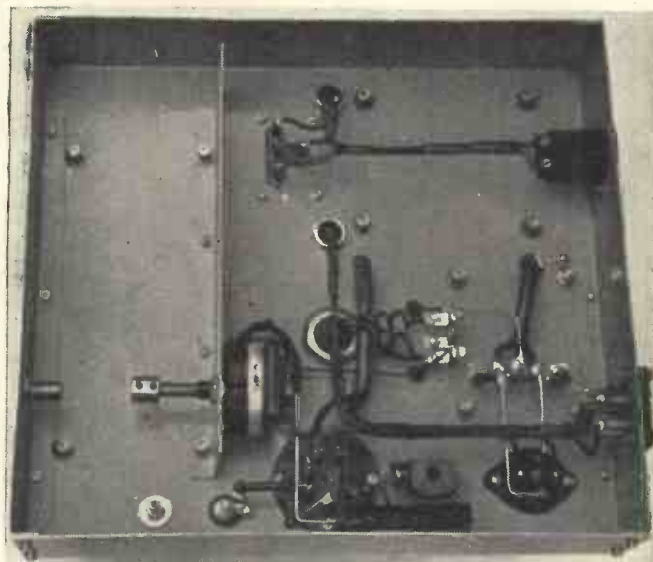

Fig. 10. Complete circuit of sound receiver.

minals of a broadcast receiver, the plate of the detector valve being connected through a blocking condenser to the live pick-up terminal, i.e., to the terminal connecting to the grid of the input valve. It is usually simple to determine which this is by touching each in turn, the live terminal being that which, upon being touched, causes hum in the speaker. The volume control is preferably turned well up, to increase the sensitivity, during this test.

A conventional filter is included in the plate circuit of the output valve to reduce the treble response. Such a filter will also mitigate harmonic distortion and tends to level the load characteristic. It is preferable when employing negative feedback to arrange for selective frequency discriminating circuits to be switched into the feedback circuit as an alternative to the above. No details of these circuits are included, however,

Fig. 13. Underside view of power unit and output stage.



in view of the desirability of keeping this description simple.

The speaker employed is a Celestion, but this item can be a matter for individual choice. The optimum load for the Brimar type 7A3 valve is in the region of 8.5 ohms, and any suitable speaker can be employed.

The picture definition provided by the vision unit is of a very high order, providing reasonable care is taken with the adjustments, particularly that of the condenser across the diode coupling coil. The necessary adjustments to the time base are simply effected in accordance with conventional methods which have been fully outlined in previous articles.

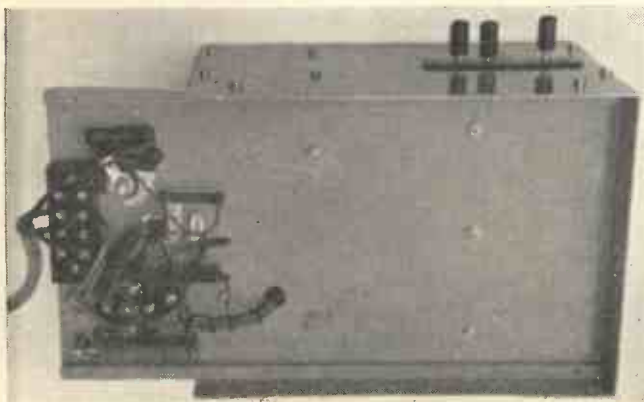

Fig. 14. Underside view of R.F. and detector stage unit.

Tuning in the case of the sound receiver is quite easily achieved. A trimmer is fitted to permit the tuning condenser to be ganged, but it is not really necessary, as it is a simple matter when only a single station is to be received to free the spindle coupling and adjust individually the two condensers when the coupling can be tightened. Should it not prove possible to secure oscillation, the capacity of the regeneration condenser

cerned, will largely depend upon the adjustment of the regeneration condenser. Accordingly, no more feedback than will provide sufficient volume and discrimination against the vision channel should be employed.

The circuit diagram of the vision unit power supply is given by Fig. 2b (May issue). It comprises a 250 volt H.T. supply for the vision and synchronising section. It will be obvious

a separately smoothed tapping from the H.T. circuit being the only additions necessary.

Aerial

It is perfectly feasible to employ a common aerial for sound and vision. The aerial terminals can be connected in series or in parallel depending upon the arrangement and layout of the units. Alternatively, quarter-wave matching sections isolating the units from one another can be used. These sections can conveniently consist of adjusted inductances if desired. As a further alternative small transformers can be employed. In general, such additional complications are unnecessary, and it is entirely satisfactory to connect the aerial terminals in series. Also in the vision unit's circuit diagram (p. 325, Fig. 2a) there is shown a resistance between L7 and the 7,500 ohms resistance. The inclusion of this item in the diagram is an error and no resistance is required in this position.

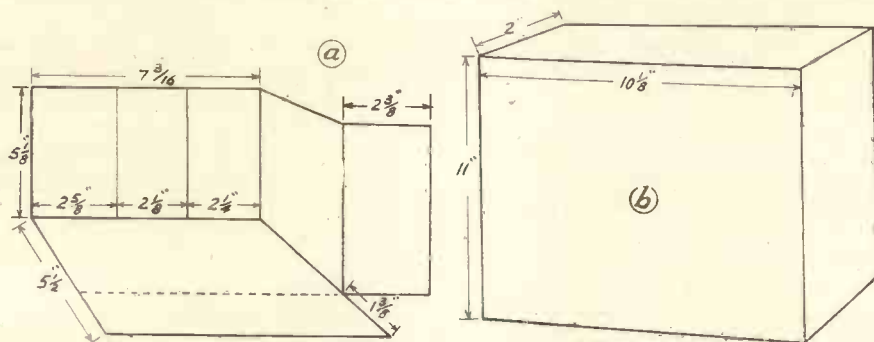

Fig. 15. Details of chassis construction.

can be increased. Again, for reception of a fixed frequency station it is convenient, should such a course be necessary, to parallel a small trimmer across the regeneration condenser. It should be observed, however, that the quality of reproduction, as far as the treble response at any rate is con-

that where an existing sound amplifier or a B.C.L. receiver is to be employed, in conjunction with the small signal receiving unit, that the power supply for this small unit can conveniently be provided by this supply unit an additional centre tapped L.T. winding for heater operation and

CORRECTION

It is regretted that a small error occurred in last month's article in this series. The terminal marked 'mod' in Fig. 6a should not be directly connected to the output terminal of the vision unit but should be isolated with a condenser of 0.5 uFd, capacity connected in series.

A NEW STUDIO LIGHTING SYSTEM

A NEW system of television studio lights has been installed in the N.B.C. Radio City television studios which does away with the necessity of using the heavy, heat-giving movie type "suns," "spots" and "broads." A complete pre-set system of lighting units, that formerly required the service of three men for several hours, can now be accomplished by one man in less than ten minutes.

Basically, the new system consists of many remotely controlled lighting units, suspended from the ceiling of the television studio. Each unit, of a bank of six lamps, may be raised and lowered, or tilted through a considerable angle, and swung through nearly a complete circle. Light may thus be focused on any desired spot in the studio. Remote control from the lighting engineer's desk at one end of the studio enables him to change the lighting set-up at any time during an actual broadcast without interfering with camera movement.

The new lighting units have effected a reduction in electrical load and a corresponding reduction in studio temperature.

One of the problems of studio lighting has been the supply of sufficient overall, illumination for the scenic sets used in a television show. Previously, television has followed a modified motion picture practice of setting individual light units in fixed overhead positions.

Provides Light "Flow"

The resulting compromises in distributing the available overall lighting made this system inadequate for television. Motion pictures are pro-

duced piecemeal and the film as finally released is assembled in the cutting room. A flexible lighting system is, therefore, not of great importance to the cinema industry. Television, however, follows stage and radio practice; the action flows continuously from beginning to end and the accompanying illumination must flow with it if acceptable photographic effects are to be achieved. The new N.B.C. system provides this necessary "flow" in the light accompaniment.

Light from the studio floor and from the sides of sets, used to "erase" undesirable shadows created by an overhead lighting system, is now supplied by lightweight and movable floor units, each supporting a bank of inside silvered lamps. A small lighting "dolly," mounted on wheels and bearing several lamps, furnishes the flexible element in this "modeling" illumination. Less than two feet in height, this dolly may be moved to within a few feet of an actor without appearing in the pictures.

Ensure obtaining "Television and Short-wave World" regularly by placing an order with your newsagent.

RECENT TELEVISION DEVELOPMENTS

A RECORD OF PATENTS AND PROGRESS
Specially Compiled for this Journal

Standard Telephones and Cables Ltd. :: Telefunken Ges fur drahtlose Telegraphie m.b.h. :: F. J. G. van den Bosch :: A. Carpmael and H. R. C. Van de Velde :: Baird Television Ltd., and E. G. O. Anderson :: J. D. McGee :: W. D. Wright

Transmitting Tubes (Patent No. 501,375.)

THE "mosaic-cell" screen of a television transmitter of the Iconoscope type is replaced by a photo-sensitive electrode consisting of a pair of thin metal sheets, placed back to back, with an intervening layer of insulating material. The sheets are perforated uniformly, one side being coated with a photo-sensitive substance, and the other with a layer of highly-resistant material.

The electrode is placed midway along the length of a cathode-ray tube, and the image to be televised is focused on to the photo-sensitive surface, which is then scanned by an electron stream from one end of the tube. The liberated electrons are projected on to an electron-multiplier arrangement at the other end of the tube, where they are amplified by secondary emission before passing out to the transmitter.—*Standard Telephones and Cables, Ltd.*

Television Cabinets (Patent No. 501,532.)

Relates to a cathode-ray television receiver in which the picture on the fluorescent screen of the tube T is reflected by a mirror M so that it is

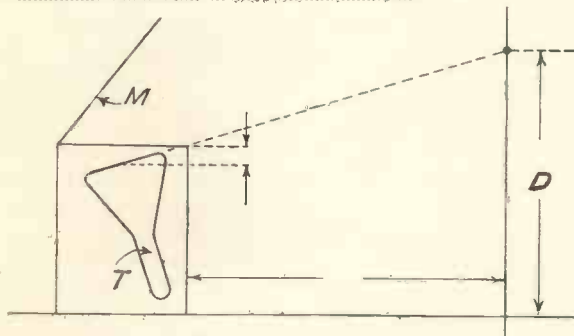

viewed indirectly. Although the inclination of the mirror can be varied, it is normally kept at a fixed angle when the set is in operation. The person using the set should not, of course, be able to see the fluorescent

screen at the same time as the reflected picture, since this would distract his attention. This, in turn, sets a limit to the height of the observer's eyes when looking at the received picture.

According to the invention, the cathode-ray tube, instead of being mounted vertically in the cabinet, is "set back" at the angle shown. For a cabinet of given height, this increases the viewing-area or elevation D over which the picture can be seen in the mirror without interference from the direct light of the fluorescent screen.—*Telefunken Ges für drahtlose Telegraphie m.b.h.*

Transparent Screens (Patent No. 501,816.)

Instead of the usual fluorescent screen a cathode-ray television receiver is fitted with a screen of zinc sulphide, on which the scanning-beam acts to set up local charges corresponding to the light-and-shade values

of the received picture. Mounted next to the screen is a flat disc-like chamber, containing iron particles suspended in paraffin. The light from a powerful lamp, mounted outside the tube, is focused through the zinc sulphide screen on to the paraffin chamber.

Normally the iron particles in the paraffin set themselves "higgledy-piggledy," so that they block out practically all the light from the lamp. But the static charges formed on the zinc sulphide by the action of the scanning-beam cause each of the iron particles to swing round and set themselves "end on" so as to afford free passage for the light. In other words the transparency of the paraffin chamber is varied locally, according to the picture intensity. Light from the lamp can therefore pass through and project an image of the picture on to a large viewing-screen mounted outside the cathode-ray tube.—*F. J. G. van den Bosch.*

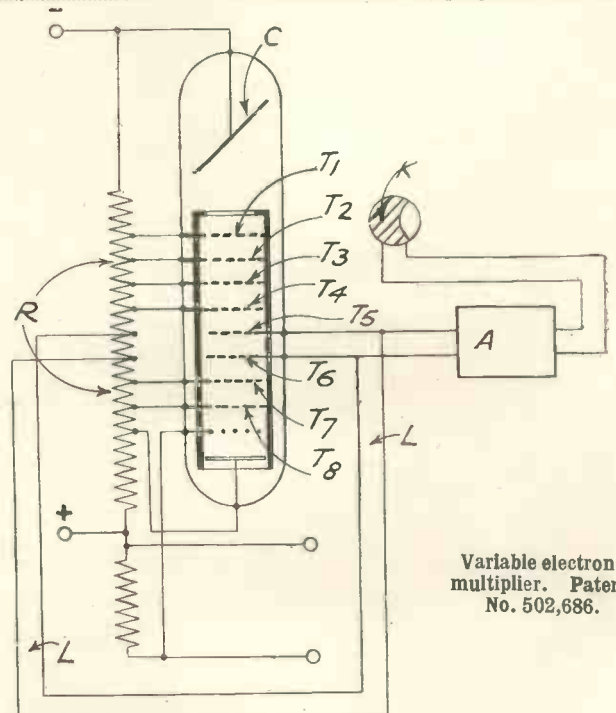

Arrangement of tube in cabinet. Patent No. 501,532.

Variable electron multiplier. Patent No. 502,686.

JULY, 1939

Television in Colour
(Patent No. 502,358.)

To produce television pictures in colour, the light from a powerful arc lamp is passed through three different "light-valves," set side by side, and provided with red, yellow and blue filters respectively. Each cell is of the "supersonic" type in which a peizo-electric crystal creates high-frequency waves in a liquid, which then causes interference fringes to be

shown. In parallel with the leads L is an amplifier A, which amplifies the light picked up by a cell K arranged to respond to the "background intensity" of the scene being televised. The effect of the auxiliary potential, so applied from the cell K to the electrodes T₅, T₆, automatically regulates the final output from the multiplier in the manner desired.—*Baird Television, Ltd., and E. G. O. Anderson.*

optical system consists of a lens L for producing an image in the plane P, P, and a diverging lens L₁ placed in the plane P, so that the combination produces an accurately-focused image on the convex surfaces which can then be placed directly in contact with the similarly-shaped surface of the photo-sensitive cathode.—*W. D. Wright.*

(Patent No. 501,966)
Television system in which signals from different scanning points can be mixed together.—*A. D. Blumlein.*

(Patent No. 502,696)
Construction of stationary mirroring, for scanning, in which all the mirror elements are held in position by pressure applied to the two end mirrors.—*E. Traub.*

(Patent No. 502,830)
Circuit for producing saw-toothed oscillations for use in scanning.—*Marconi's Wireless Telegraph Co., Ltd.*

(Patent No. 501,058)
Clear-cut focusing of the electron stream of a cathode-ray tube.—*C. S. Bull.*

(Patent No. 501,535)
Cathode ray television receiver in which a "flooding beam" of electrons is used in combination with the usual scanning-stream.—*Baird Television, Ltd., and T. C. Nuttall.*

(Patent No. 501,741)
Means for treating luminescent screen material so as to increase its resistance to burning.—*Marconi's Wireless Telegraph Co., Ltd.*

(Patent No. 501,919)
Electron-multiplier in which a "mirror action" is used to produce successive impacts of the main discharge-stream.—*H. G. Lubszynski and W. S. Brown.*

(Patent No. 501,931)
Magnetic lens system for focusing the electron stream in a cathode-ray tube.—*The British Thomson-Houston Co., Ltd.*

(Patent No. 494,145)
Cathode-ray receiver in which a grid electrode is scanned by an electron stream proportional to the intensity of the received signal, and controls the passage of a second electron stream on to a fluorescent surface.—*Radio-Akt. D. S. Loewe.*

(Patent No. 495,331)
Method of offsetting the inherent time-delay of circuits used in deriving synchronising-impulses from A.C. mains.—*Baird Television, Ltd., and V. A. Jones.*

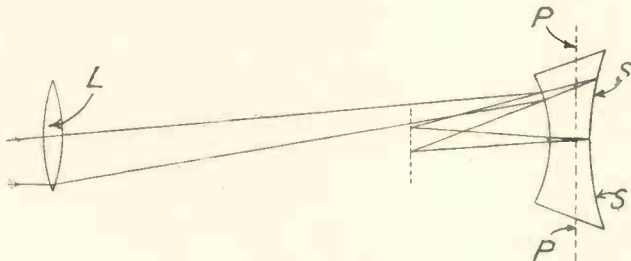

Method of avoiding loss of focus. Patent No. 502,975

set up in the path of the ray of light.

The three light cells are controlled in turn, so as to give what is, in effect, "interlaced" scanning for each of the primary colours. For this purpose a special type of a cathode-ray tube is used, in which the electron beam is continually swept over three different sections of a common anode.

Each of the three sections controls an amplifier to which the incoming signals are applied, so that these are fed in rapid succession first to the red, next to the yellow, and then to the blue "light valve." The different "scans" are finally reassembled on the viewing-screen by two rotating mirror-drums set at right-angles to each other.—*A. Carpmael and H. R. C. Van de Velde.*

"Variable" Electron - multiplier
(Patent No. 502,686.)

The Figure shows an electron-multiplier arranged for amplifying television signals. More particularly it allows the degree of amplification to be varied from time to time, in order, for example, to follow any slow changes that may occur in the average light-intensity of the "background" of the scene being televised.

Light from the picture is focused on the photo-sensitive cathode C of the electron-multiplier, the resulting stream being amplified by secondary emission from each of the "target" electrodes T₁ . . . T₈. Each of these carries a gradually-increasing positive voltage which is tapped off from a potentiometer R. The voltage on the two electrodes T₅, T₆ is, however, reversed by means of the leads L as

Multiple-spot Scanning

(Patent No. 502,796.)

A cathode-ray television receiver is arranged to produce several electron-streams, each separately controlled, so as to scan the screen in regular sequence, one after the other. The cathode or "gun" of the tube consists of a number of separate and mutually insulated strips, each acting as the source of one stream. The strips are arranged along the outside of a cylindrical heating-element with a filament running axially inside. A wire is connected to each strip through which separate control potentials are applied, to bring each into action in turn. Separate control grids may also be arranged in front of each emitter, so as to ensure that the screen is scanned by each of the streams in regular succession.—*J. D. McGee.*

Optical Focusing

(Patent No. 502,975.)

In certain forms of television transmitter tubes the electron-emitting surface is made curved, instead of flat, in order to avoid distortion of the image. In such cases the sensitised surface is usually transparent, and the optical image is projected on to its convex surface. The resulting electron emission, of course, takes place from the inner or convex surface.

This type of tube calls for an optical lens system of special design if the whole image—and not merely the axial rays—is to be truly focused. According to the invention, the

Telegossip

A Causerie of Fact, Comment and Criticism

THOSE seven hundred viewers who applied to the B.B.C. for invitation to the free Television Tea Party (which will have taken place at Broadcasting House by the time these words are read) may be interested to hear how Mr. Gerald Cock, the Television Director, chose the 150 guests. He placed all the letters in a waste paper basket, had them well stirred and then picked at random.

One of the most interesting applicants was a man who declared that he had been an invalid for thirteen years and during that time had never been able to go out to a cinema or theatre. Television is a God-send to such unfortunates. He proposed going to Broadcasting House in his invalid chair.

20,000 Receivers

There are now about 20,000 television set owners, according to semi-official estimates. So approximately one in thirty asked to go to the B.B.C. party, a very high proportion. The television audience is still to some extent a big family and viewers take a personal interest in the programmes, the staff and the problems of production. It was precisely the same among pioneer listeners in the 'twenties, but the broadcasting audience quickly grew to unmanageable proportions, whereas television moves slowly.

Curiouser and curiouser grows the situation regarding a Birmingham station. Last month, writing on excellent authority, I indicated that a favourable decision might be expected soon. Since then the Postmaster-General, who was greatly impressed by the arguments put before him by the Radio Manufacturers' deputation, has seen three other deputations representing the theatrical and cinema industries, putting the case for the opposition. It is reported that this has given him pause and that there will be no provincial television station without suitable safeguards for rival entertainments.

But I cannot believe that this is the real cause for deferring a decision. The Television Advisory Committee exists to advance television not to raise difficulties. A prominent leader of the music hall industry told me that every new entertainment affected theatre attendances at first,

but that eventually, when the novelty had worn off, people flowed back to the music halls in increased numbers. Every new type of entertainment seems to whet the appetite afresh and to stimulate the public demand to be amused. Mr. George Black, director of the General Theatre Corporation, was for years a strong opponent of broadcasting. Now he is an enthusiastic believer in its publicity value.

I believe that the reasons for delay have nothing to do with the clash of interests. The gear for the radio television link experiments, ordered by the Post Office from E.M.I., has not yet been delivered, and, I understand, is not expected to be ready before the end of the year. The fact is that the Post Office has such a vast amount of work on hand for the Defence Forces and the A.R.P. organisation that television has definitely taken a back seat. The Radio Manufacturers' Association should now press their campaign with renewed vigour. Peace-time development cannot be entirely submerged by preparation for war. In the so-called bloodless "war of nerves" nebulous fears should not be allowed to produce that creeping paralysis of the nation's life which our enemies would rejoice to see.

A.P. Staff

Nor has the financial difficulty been properly resolved. The R.M.A. "offer" to put up £100,000 "if the projected station were not a success" was couched in such vague terms as to be held valueless by official circles. The Advisory Committee, I believe, is much exercised over the possibility that Midland and Northern viewers may not be satisfied to draw all their programmes from London and may demand separate studios and Regional programmes. Now the staff of Alexandra Palace was recently increased to 450. In other words, for the present strictly limited service one-eighth of the total staff of the B.B.C. is employed. Roughly ten times as many employees are required for a television programme as for its equivalent in sound.

But the service must be allowed to grow and a review of the difficulties does not advance matters much. Officialdom must cease to boggle and act courageously and decisively.

Meanwhile staff expansion goes on. The B.B.C. has just recruited four new assistant studio managers and an outside broadcasting assistant. The assistant studio managers are Paul Chesterton, Peter Henschel, T. M. Jenkins, and Campbell Logan, and the new O.B. manager is G. dell Strother. All have had film and stage experience. Mr. dell Strother was an assistant director to Alexander Korda for four years.

D. H. Munro, just returned from New York, where he has been advising the Columbia television staff on their new service, is reticent about his visit because he says he does not want to seem patronising or discourteous to his late hosts. But the fact is that, as always at the start, organisation was at a very primitive stage. Columbia had two cameras and two telecine channels, but had omitted to make any provision for sound! However, that was soon corrected, and Mr. Munro produced one or two specimen programmes on a closed circuit. Regular programmes have not yet been started by Columbia.

Big-screen Developments

One of my most interesting television experiences this month was the big screen reproduction of *Trooping the Colour*. This I saw at the New Victoria which is only a short walking distance from the Horse Guards Parade. Some hundreds of people preferred to watch the television version at cinema prices rather than stand in the crowd and endure the June heat. I imagined at one time that television was playing tricks by making the long straight line of Guardsmen into a crescent. But Mr. Philip Dorté vigorously defended his transmission and he must really have it out with the Brigade of Guards, for I decline to take sides.

I thought I was used to big screen shows, but once again I was most impressed with this Baird achievement. On entering the theatre I felt that the most important improvement necessary is more light, and then, from the back of the theatre it would to the eye be almost indistinguishable from a cinema picture.

I am told that even big screen development is held up by the Advisory Committee's procrastination over a Birmingham station.

JULY, 1939

NARROW BAND PICTURE TRANSMISSION

A METHOD of transmission and reproduction of line images which do not necessitate great detail has been the subject of experiment in the U.S.A. with the object of using a comparatively narrow band width. Tests have shown that a drawing of a woman's head could be reproduced in outline with an equivalent total band width of approximately 2,600 cycles. This is made up of two bands, each 1,300 cycles wide. Analysis of a more complex image, such as that of an animated cartoon shows that such material could be transmitted and reproduced by the method within a total band width of 10 kc.

The illustrations shown by the author in explaining the system are each in the form of a closed loop in which the spot on the cathode-ray tube is made to traverse by applying simultaneously the proper voltages to the horizontal and vertical deflecting plates. The voltages are, of course, directly proportional to the x and y coordinates of the point of the drawing, taken along the path of the spot in the direction in which it moves.

The system therefore essentially resolves itself into the problem of making line drawings, determining the x and y coordinates for each point on this line, generating deflection voltages proportional to the x and y coordinates, and transmitting the two voltages simultaneously.

At the receiver they are re-assembled in such a manner that x and y displacement voltages are applied to the horizontal and vertical plates of the cathode-ray tube for the reproduction of the image.

The primary advantage of this method is that it enables certain types of drawings to be reproduced with much less band width than is necessary at the present time with the usual scanning method of television operation.

The two kinds of detail which will suffer most are straight portions and sharp bends. The overall shape and form of the image and the larger details are dependent on the lower frequencies which are present in the transmission band, and these frequencies are therefore the most important ones. If the bands include enough harmonic to reproduce the small detail, even in approximate

form, the larger details of general form will be reproduced with good fidelity.

The total band width necessary for satisfactory reproduction of a Walt Disney cartoon was judged to be 10,000 cycles, this total being made up of 5,000 cycles each for the x and y deflecting potentials.

A total band width of 10,000 cycles

is also adequate for about seven words of handwriting. The total band width for script is proportional to the total number of letters and spaces, or to the number of words of average length.

The type of images which are capable of transmission by this method include drawings, diagrams and maps, either with or without animation, animated cartoons, and script.

TELEVISION STUDIO TECHNIQUE

Lessons of Seven Years' Experience in the Don Lee Studios

IT has been found that real properties invariably televise satisfactorily, although suitable illumination may be required for emphasis. In painted properties, such as background, windows and fireplaces, the delineation of the object from the general tone of the background should be sharp, and the width of lines comprising the structures bold. A certain amount of defocusing is usually obtained on the background, often for the purpose of centring attention on the principal characters, who are in sharp focus, as is utilised in cinematography. The background properties are therefore televised in subdued tones as desired.

For multi-character scenes, the long shot is often used with complete settings, such as a room, which may assist in the story. If small items of interest are to be displayed, however, the scene may be modified from what would normally be a long shot to one showing only half or two-thirds of the principals involved. One scene may be changed into the other by moving the camera, or by moving the principals. On many scenes, a rather high camera is utilised, that is, the lens 4 or 5 feet from the floor. Changes from long shot to close-up may be made once or twice during an episode. Changes of scene are usually accomplished by panning, under which conditions, two sets are established on opposite sides of the general stage area.

Lighting

The technique of lighting for television appears to be one of the most fruitful in creating pleasing artistic effects. So-called "flat lighting" will give television pictures, but ones which have little interest and sparkle compared to those televised with more elaborate lighting. By flat lighting, of course, is meant that nearly all the light to illuminate the

scene comes from the front of the set and perhaps also from the top of the set at the front.

The advance technique appears to be only limited by the number of lighting units available, and the possibility of manoeuvring them as required for the changing conditions brought about by motion of the performers on the set. This problem is complicated by the fact that in television, illumination must be continuous for the total duration of the act. In motion picture technique, each portion of action may be made as a separate take and ample time allowed for skilful placement of the lights.

In the Don Lee studio, a portable switching panel is installed which gives control of individual or limited groups of all the lights utilised. With this device the lighting supervisor can vary the lighting considerably without touching any unit. This control is usually supplemented by changing diffusers, changing the angle of the unit, and/or change of position of mobile units by lighting assistants. A considerable number of the lighting units are fixed in position near the ceiling, each in the proper direction for usual action as has been determined by experiment. A few mobile floor units are utilised.

Hard back lighting has been found to be a very desirable component. This must be supplied by lens-reflector units. General lighting is properly supplied by lamps in dull finish reflectors and modeling lights for the face must be diffused with one or more diffusing screens.

The camera photo-electric tube suffers a form of overload similar to over-exposure, if the illumination on the subjects is too great. This usually occurs first on the faces of the performers and gives a "washed-out" effect, in which the sharpness of

the features are lost. This condition is eliminated by either reducing the amount or hardness of the light, or stopping down the lens aperture. Make-up is also a factor in this effect, and lighting, camera aperture and make-up must be correlated in order to achieve desirable results. It has further been found that the spectral characteristic of the light exercises an important effect on the resulting image. A pure white light is the ideal.

Use of Models

Cognisance is taken of the fact that large and elaborate sets are beyond the present scope of television economically, if not otherwise, and that physically impossible actions must not be imposed upon the cast. Through the use of miniatures, however, otherwise impossible action has been televised. In a recent episode, a considerable portion of the action took place in close shot with the characters in an aeroplane. Running out of petrol they go into a tail spin and crash on land. The first scene was taken with the characters and life-size properties. The nose dive was made by means of a miniature airplane, handled by wires, and the crash scene, previously set up on another set, was occupied by the characters during the transition through the miniature.

Sound Pick-up

Two methods of microphoning have been evolved, first, the boom or moving microphone method, wherein a comparatively light microphone boom is utilised and moved to keep the microphone reasonably close to the performers. The usual microphone position is overhead and in front of the performers and as close as possible without appearing in the picture.

The second method utilises up to four stationary microphones. These are arranged at strategic points on the scene of action, and the electrical change-over from one to another is accomplished by fader operation by the sound monitor supervisor. This method does not require production assistants for moving the microphone boom.

Make-up

Make-up is most important in long shots. In close-ups, street make-up is sufficient, although accentuated make-up may be utilised by increasing

the light intensity on the subject.

A base paint is utilised as a start. Eyebrows are accentuated with black or dark brown liner. Lipstick of a brownish-violet shade is applied. This colour has been found desirable after considerable tests in performance to the red lipstick, because the camera tube exhibits increased sensitivity in the red region of the spectrum, and because red light energy is particularly predominant in the incandescent illumination utilised.

Overall supervision of all the processes of television operation and production can be exercised by a suitably trained director, who observes the programme at a sight-sound television receiver located at a representative point in the service area of the

television station. He talks by telephone to the television studio supervisor, television transmitter control operator and possibly to other members of the operating staff. Defects in lighting, camera technique, microphoning or television control or transmitter adjustments are thus instantly apparent. Monitors are provided in the studio and also at the transmitter, the latter operating from an input which has been radiated. Following the complete broadcast, a written report is prepared by the director. This includes tabulation of various technical readings, the artistic observations on the merit of the camera shots and lighting, and a summary of the merit of the broadcast as a whole.

SPONSORED PROGRAMMES IN U.S.A.

WHILE it is expected that television will become an advertising medium in the U.S.A., the Federal Communications Commission has not yet licensed any television broadcasting station to operate commercially. The National Broadcasting Co. has not as yet planned any immediate sale of its time, but, of course, will expect eventually to make available certain hours of sponsored television programmes. In the meantime, it is following the policy of creating as much programme variety as possible in order to build up a fund of experience which will be of value to advertisers when the time comes for sponsored programmes.

Programme material already tried has included drama, variety and music and novelty, including ping-pong, fencing and animal acts. Full-length films, newsreels, and short films were also tried. In the field of education, programmes have been included embodying the microscope through which the "family life" of minute organisms was watched by the television audience and described by specialists on the subject, travelogues through various parts of the world, book reviews, dancing lessons, and science demonstrations. Experiments have been made with a mobile out-

door pick-up unit at various times to determine what may be done in the way of providing broadcasts of current events and outdoor athletic contests.

There has been collaboration with those industries whose products appear to lend themselves most readily to television exploitation. Experimental programmes have been worked out with advertisers in many of the major industries, including cars, fashions, jewelry, foods, steel, drugs, oil, tobacco and others.

Special observers have been employed whose task it has been to watch and chart the development of television in relation to its possibilities as an advertising medium. These men have developed exhaustive files of information on all phases of the medium and have explored its future possibilities from the economic and from the practical advertising standpoints, have made preliminary plans for the maintenance of proper statistical records, the measurement of reception conditions and a study of the psychological aspects of television advertising. They are also carefully studying the application of television programme technique to such problems as package design, commercial announcements, and dramatisations of the uses of products. Analysis has been made of the types of industries which may be expected to be able to use television most effectively and the functions to be performed by all those concerned in the production of commercial television programmes have been studied.

Mention of "Television and Short-wave World" when corresponding with advertisers will ensure prompt attention.

JULY, 1939

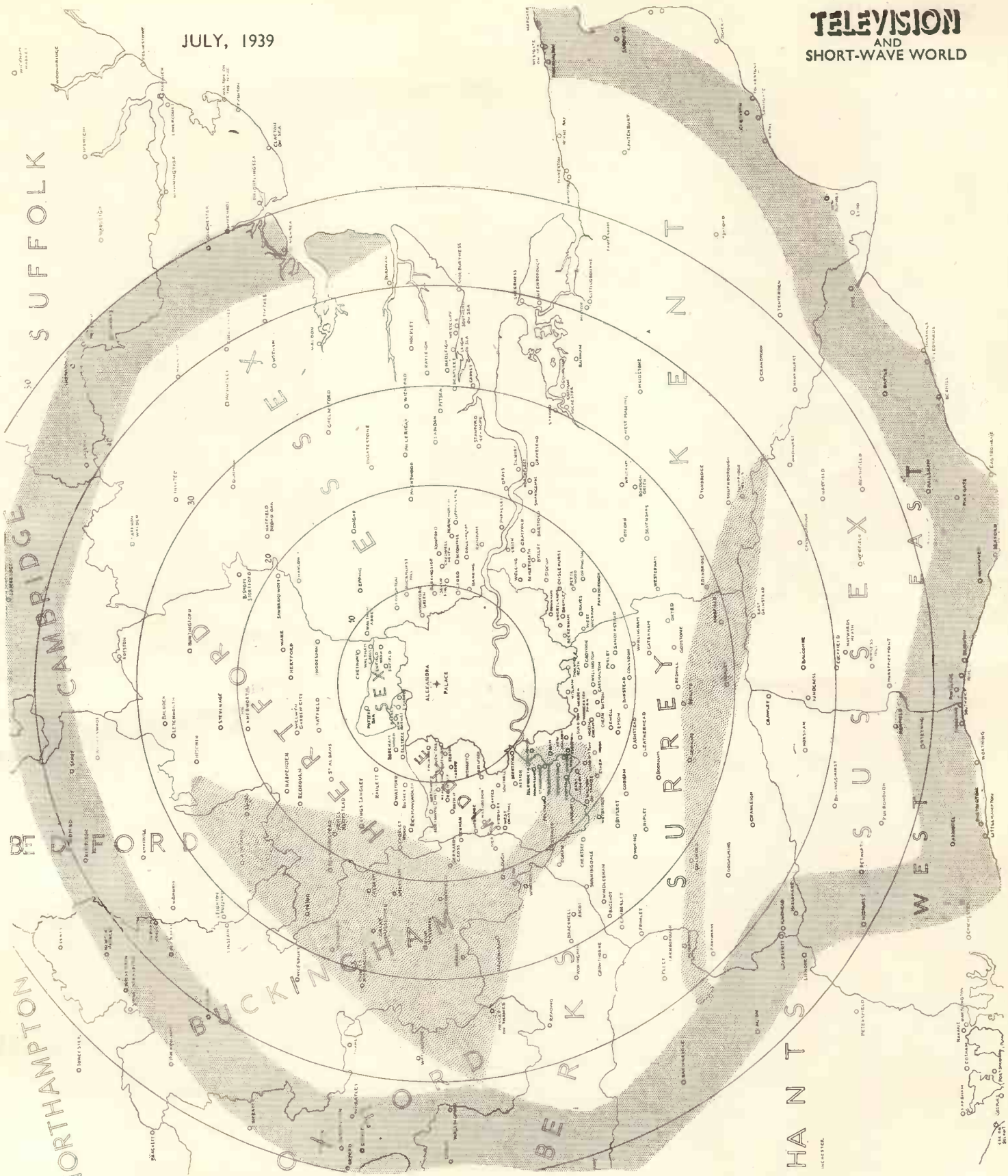

GOOD AND BAD PICTURE AREAS

This map, showing the area in which reliable reception can be obtained from the Alexandra Palace television station, has been compiled by the R.M.A. from exhaustive information supplied by television receiver manufacturers. Effective radius of the station is 40 miles.

It is, of course, impossible to lay down a hard and fast line between the area where reception is satisfactory and that where it is unsatisfactory. The outer shading (line) is the approximate boundary of the area in which consistently reliable reception is usually obtained. In exceptional circumstances reception is possible outside the area, particularly in favourable locations with very efficient aerial systems. The shading represents an area roughly five miles wide.

Within the inner shaded portion (coarse) reception is usually satisfactory, but difficulties may be experienced due to local conditions.

In localities of heavy road traffic, interference may be of sufficient strength to spoil otherwise satisfactory reception.

Large-size copies of this map (31 ins. by 28 ins.) can be obtained, price 2s. 6d., from the Radio Manufacturers' Association, 59, Russell Square, London, W.C.1.

Using the 6L6G and APP4G Valves

Tetrode and pentode valves have many advantages which make them suitable for amateur use. Perhaps the main feature is the small amount of drive needed so that multi-band transmitters can be made with the lowest number of stages.

TWO very useful valves are now being manufactured by the Tungfram Co., the first of which is a 6L6G marketed by Webbs Radio, and the second the APP4G obtainable through all normal channels.

The special 6L6G has a ceramic base and can be used as an R.F. power amplifier, or oscillator as required. To obtain optimum results the constants advised by the makers must be carefully adhered to. To this end the following data should be noted.

Constants for R.F. P.A. Class-B Telephony.

Carrier conditions per valve for maximum modulation factor of 1.
Anode voltage, 400 volts.
Anode current, 75 mA.
Anode dissipation, 30 watts.
Anode input, 40 watts.
Screen voltage, 250 volts.
Screen resistance, 17,000 ohms.
Screen current, 4 mA.
Screen dissipation, 1 watt.
D.C. grid current, 0.2 mA. approx.
D.C. grid voltage, -25 volts.
Peak R.F. grid voltage, 30 volts.
Driving power (approx.)*, 0.25 watts.
R.F. power output (approx.), 9 watts.

Additional output can be obtained when the valve is used as a class-C R.F. amplifier and modulated. The operating conditions are then as follows.

Carrier conditions per valve for use with a maximum modulation factor of 1.
Anode voltage, 325 volts 400 volts.
Anode current, 80 mA., 80 mA.
Anode dissipation, 11 watts, 13 watts.
Anode input, 26 watts, 32 watts.
Screen voltage, 225 volts, 225 volts.
Screen resistor,† 10,000 ohms, 16,000 ohms.
Screen current, 9 mA., 9 mA.
Screen dissipation, 2.0 watts, 2.0 watts.
D.C. grid current (approx.), 3 mA., 2 mA.
D.C. grid voltage, -45 volts, -50 volts.
Peak R.F. grid voltage, 70 volts, 70 volts.
Grid leak, 5,000 ohms, 10,000 ohms.
Driving power (approx.), 0.2 watts, 0.13 watts.
R.F. power output (approx.), 15 watts, 19 watts.

Maximum carrier power can, of course, be obtained when the valve is operated as a class-C amplifier for telegraphy. In such circumstances the

* At crest of A.F. cycle with modulation factor of 1.
† Connected to modulated anode voltage supply.

carrier power with only 400 volts H.T. is no less than 25 watts.

Key down conditions per valve without modulation.

Anode voltage, 400 volts.
Anode current (approx.), 95 mA.
Anode dissipation, 13 watts.
Anode input, 38 watts.
Screen voltage, 250 volts.
Screen resistance, 17,000 ohms.
Screen current, 9 mA.
Screen dissipation, 2.2 watts.
D.C. grid current (approx.), 2.5 mA.
D.C. grid voltage, -50 volts.
Peak R.F. grid voltage, 80 volts
Grid leak, 20,000 ohms.
Driving power (approx.), 0.18 watts.
R.F. power output (approx.), 25 watts.

A valve of quite a different type is the APP4G an ultra steep pentode with a top-cap grid connection and low inter-electrode capacities making it suitable for U.H.F. tri-tet, or C.O. working.

The suppressor grid is brought out to a separate pin allowing the valve to be used for suppressor grid modulation.

General characteristics are as follows.

Heater voltage }
Heater current }
Max. instantaneous peak anode voltage
Max. anode volts
Max. anode dissipation
Max. screen volts
Max. screen dissipation
Max. heater cathode potential difference
Mutual conductance }
Impedance }

Screen current, 4 mA.
Grid bias voltage, -6 volts.
Grid bias resistance, 150 ohms.
Optimum load, 7,000 ohms.
Power output at 5% harmonics, 3.5 watts.

One of the most popular uses for the APP4G is as a tri-tet crystal oscillator in which the second harmonic output is approximately 4 watts. Operating data for the oscillator-doubler conditions are as follows.

Condition as Oscillator Doubler (Tri-tet)

Anode voltage—250, 400 volts.
Anode current—25, 30 mA.
Anode dissipation—4.25, 8 watts.
Anode input—6.75, 12 watts.
Screen voltage—250, 200 volts.
Screen current—4.5, 8.0 mA.
Screen dissipation (approx.)—1.0, 1.5 watts.
Cathode resistance—200, 200 ohms.
Suppressor voltage (earthed)—-6.2, -7.5 volts.
Grid leak—30,000, 70,000 ohms.

Indirectly heated (A.C./D.C.) 4 volts } ±5%
2 amps }
550 volts
400 volts
9 watts
205 volts
1.5 watts
50 volts
10 mA./volts
50,000 ohms.

The above data is merely to indicate the limiting conditions for the operating limits are as follows.

Operating Conditions:

Anode voltage, 250 volts.
Anode current, 36 mA.
Screen voltage, 250 volts.

R.F. power output (approx.)—2.4 watts (2nd harmonic).
Crystal current—negligible, negligible.
As a fundamental oscillator 11 watts of R.F. can be obtained from two valves in push-pull with the following operating conditions.

<i>Condition as Fundamental Oscillator.</i>	<i>Single valve.</i>	<i>Push Pull.</i>
Anode voltage	400	400 volts.
Anode current	30	70 mA. (per pair)
Anode dissipation	6	17 watts (per pair)
Anode input	12	28 watts (per pair)
Screen voltage	200	240 volts
Screen current	5	10 mA. (per pair)
Screen dissipation (approx.)	1.0	2.4 watts (per pair)
Suppressor voltage	0	0 volts
Grid leak	50,000	50,000 ohms (each)
R.F. power output	6	11 watts (per pair)

Capacitances:

G1 to all other electrodes	12.92 μμF.
G1 to anode	1.04 μμF.
G3 to all other electrodes	10.5 μμF.
Anode to all other electrodes	9.55 μμF.
G1 to G3	1.62 μμF.

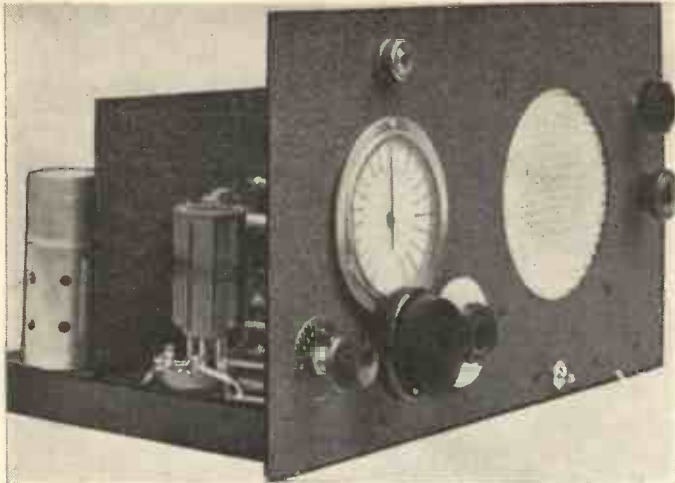

The loudspeaker has been built in but provision has been made for phones to be switched into circuit.

A Long-distance Short-wave Receiver

This receiver has been designed by Kenneth Jowers to provide a sensitive receiver for short-wave enthusiasts who require a receiver for transportable use

FOR some considerable time there has been an insistent demand for a sensitive and trouble-free battery-operated receiver which would provide a good performance on amateur bands and at the same time be suitable for reception of broadcast stations for those who were restricted to the use of one receiver.

There are many sets available at the present time for A.C. mains, but it does appear that while there are many readers who are completely without mains of any kind, they are rather ignored when it comes to the design of good battery sets. Many readers are still using one and two-valve receivers. This is due to the desire for battery economy, lack of designs of more ambitious sets, and to a lesser extent, total cost.

British Octals

Just recently, a range of valves has been introduced under the trade name of Mazda and these with octal bases and very low current heaters are ideal for amateur use. In addition, they are extremely economical and it is, therefore, possible to build an excellent four-valve set with a total anode current well within the capabilities of a medium type battery.

Battery sets are also in demand by those who participate in Field Days or who wish to have a set that can be taken from point to point for checking purposes. All these features have been borne in mind and I have built this set feeling that the readers who have written to me about such a set will be well looked after.

Although cost has been kept to a minimum the number of components and refinements have not been reduced so that the receiver does not do all that a good battery set should. Included are band-spreading, with ganged band-set and band-spread condensers, a combination of capacity- and resistance-

controlled reaction so that maximum efficiency can be obtained on all bands, and an intermediate L.F. stage driving a pentode valve in order to obtain maximum volume on weak signals. Naturally the pentode valve will be greatly overloaded on strong signals, but this is fully taken care of by means of a volume control in the grid circuit of the pentode.

The circuit of the receiver is shown on this page and all components have been keyed so as to line up with the values, etc., that are recommended.

The first coil is wound on a 4-pin former with a primary and secondary. One side of the primary is not earthed in the normal fashion so as to allow for a doublet aerial connection. However, when used with a Marconi aerial, the coupling coil can be earthed as indicated by the dotted connections.

The secondary of this coil is parallel tuned by two condensers. C₁ has a capacity of 160 mmfd. and is purely for band-setting; the second condenser

of the low-capacity type, actually 18 mmfd., is for tuning purposes. It will cover all bands except 160 metres which will have to be tuned in two steps.

Condensers C₁ and C₂ are ganged with C₅ and C₆. This scheme, of course, would only be satisfactory should the coils tuning these condensers be of exactly the same inductance with the same stray capacity in the circuit. This is practically impossible so that C₇ has also been included. This is a small mica trimmer and is mounted inside the coil former across the grid winding. It is used merely to balance the two circuits—aerial and detector-grid, so that condensers can be ganged without there being two tuning points.

Readers will appreciate that this means C₇ has to be duplicated for each band as the condenser is made part of the coil, but once adjusted need not be re-trimmed.

Selectivity

In order to obtain maximum gain a tuned transformer system is employed, which I have found to be more satisfactory than tuned grid which depends so much on the anode choke for its effi-

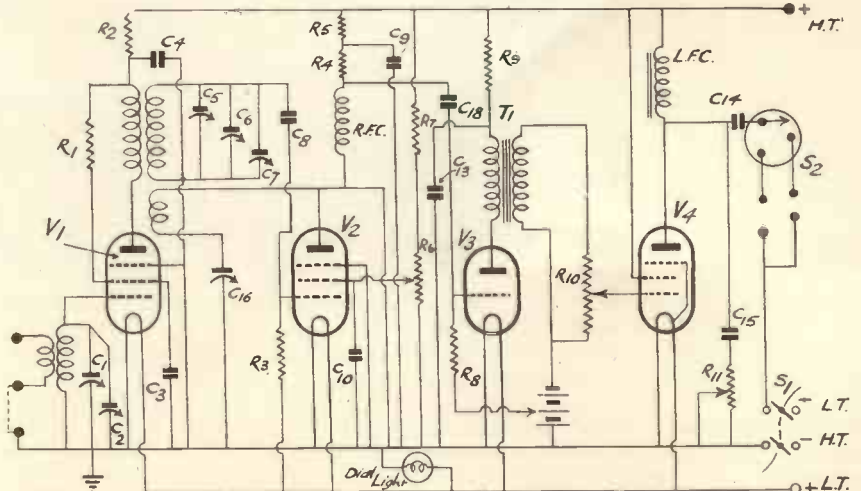

This theoretical circuit has the components marked with reference numbers so that the values are easily obtainable from the printed list.

Low Battery Current

ciency. In addition, the transformer can be obtained ready wound with reaction, primary and grid so making it hardly worth while to make coils especially for the set. However, these remarks do not apply to the aerial coil

The Detector

Next comes the design of the detector stage. Electron coupling causes complications such as a filament choke and

detector-anode circuit is the one specified.

While V_2 normally would provide sufficient output fully to load the L.F. pentode, on some of the weaker signals there might not be sufficient gain to load the loudspeaker, so to take care of this possibility an intermediate triode amplifier has been included and it really does repay for the slight extra expense. V_3 is resistance-capacity coupled in the normal way and arranged so as not to provide maximum gain but rather complete stability. It is then transformer coupled to the pentode valve with the volume control across the secondary of the transformer so as to limit the input to V_4 . A small loudspeaker has been built in, not because the average amateur likes a loudspeaker, but because as previously many readers will use this set for the reception of short-wave programmes. Also the Colonial reader has to be remembered for the receiver will work quite nicely on medium waves when selectivity is not of primary importance.

For ham use headphones are generally needed and to prevent D.C. current flowing through the windings of the headphones a choke-filter circuit has been included. Switch S_2 is one of the rotary radiogramophone switches which enables headphones or loudspeaker to be switched into circuit as required. This switch and the jack for the headphones is mounted on the rear lip of the chassis.

H.T. Current

As regards the valves used the total

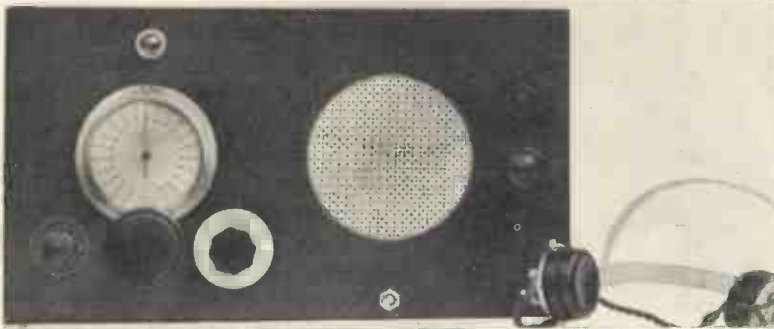

The left-hand control is reaction, in the centre tuner, to the right band-setting, while the switch underneath the loudspeaker breaks the power supply. The two right-hand controls are at the top screen voltage, underneath, audio gain.

for it is a big advantage to be able to use just the right number of turns on the primary in order to obtain the required degree of selectivity in various areas. Quite obviously if the receiver were used in open country the degree of selectivity required would be much less than if the set were used in a town such as Coventry, for example, where there are so many active transmitters. In the latter circumstances the number of turns on the primary can be reduced as the input circuit is reasonably selective.

In the anode circuit of the first valve is slight decoupling made up of R_2 , a resistance of 1,000 ohms, and a by-pass

non-standard coils. Capacity coupling is unsatisfactory on the higher frequency bands unless very great care is taken. In any case it is not to be recommended with a set of this kind which may be built by some readers without previous constructional knowledge. Also, I did not wish to use a triode valve as so much more output can be obtained from the modern pentode with a fixed grid base.

For this reason a combination of capacity and resistance controlled reaction was included. On the lower frequency bands, the screen voltage control R_6 can be left set and reaction controlled by C_{16} . But on the higher

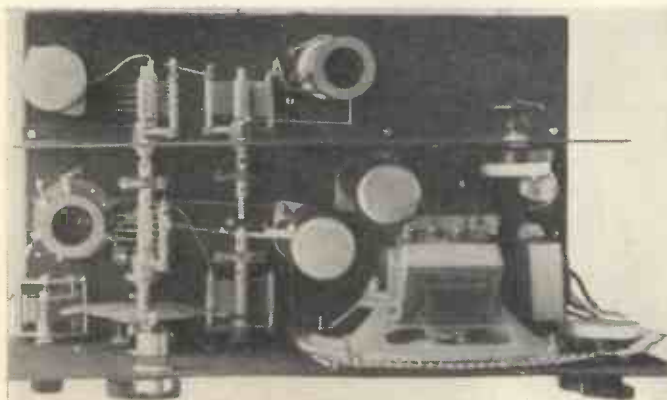

This plan view shows the layout of all the components. Carefully read the text to see how the circuit is wired.

condenser, C_4 , having a capacity of .01 mfd. It will also be noticed that the screen voltage is obtained by means of a fixed resistance instead of a potentiometer and if this resistance is tapped into the anode circuit on the low-voltage side of R_2 rather than directly to the H.T. supply.

frequency bands, C_{16} should be set in a position slightly below oscillation point and regeneration then controlled by R_6 . This provides extremely smooth control. On amateur bands which cover only a limited wavelength C_{16} need only be adjusted once for each band, provided the 'R.F. choke in the

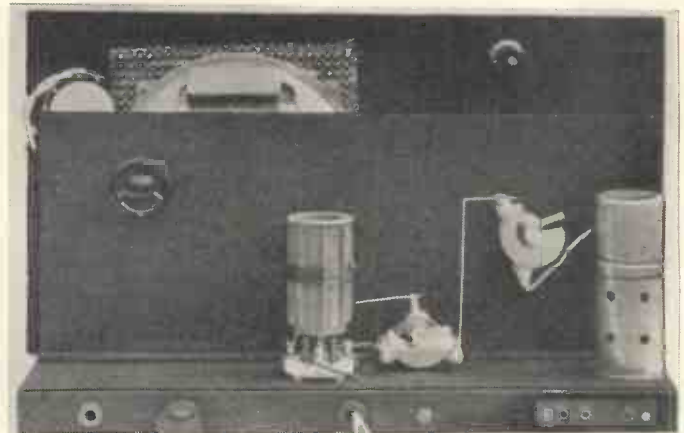

This is the simple R.F. stage. The knob shown controls tone correction circuit.

current consumption is 120 volts H.T. and is only very slightly over 9 mA., which is extremely good for a receiver of this kind with two audio stages. The first valve is a variable mu-pentode, type VP23, which has a slope of a little over 1 milliamp. per volt. In the detector position is an SP22 with a slope

Covers Ham Bands and Broadcast

of .9 mA. per volt followed by an HL23 low-current triode having a high amplification factor of 25, and finally, an economy pentode, type PEN25. This

large holes where they are rather unnecessary, the aerial coil and H.F. transformers are mounted on baseboard type holders. This does not affect the

holder, so care must be taken in the fittings of these two components so that the screen holes are at right angles to the valve holder holes. The inter-valve transformer T1 mounted on top of the chassis underneath the loudspeaker, with a filter choke close to the output pentode.

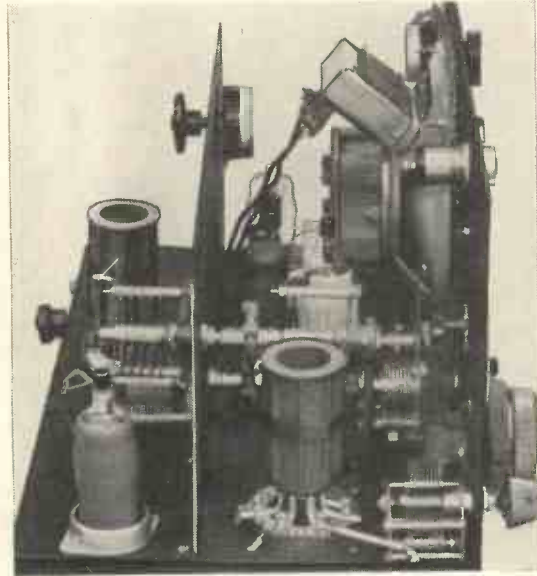

Metal shields for the first three valves have fixing holes rather larger than the valve sockets on to which they are supposed to mount. To overcome this the fixing holes for the valve holder and the fixing holes for the valve shields should be at right angles. Do not attempt to make one set of holes do for both valve holder and shield. It is also quite unnecessary to use a sub-chassis coil holder for the R.F. transformer. By mounting this holder on top of the chassis construction is simplified while the wiring is, if anything, kept shorter than if the contacts were below the chassis. Both the R.F. stage, detector R.F. transformer and tuning arrangements can quite clearly be seen from this illustration.

The under baseboard wiring is quite simple but will look rather untidy unless the battery leads are terminated in a small terminal block. Actually, I advise constructors to mount four double-ended soldering tags on a small length of bakelite and to mount this off the chassis on a Raymart SP pillar. L.T. and H.T. can then be terminated to these soldering tags and in turn to a Bulgin battery board.

After the receiver has been wired and checked, I advised constructors to remove the two connections to the primary of the H.F. transformer and to connect the aerial to this primary. Then adjust the detector and audio stages until maximum results are obtained. After this has been done to satisfaction, the primary can be reconnected into the circuit and the entire receiver used.

Condenser C7 must be most carefully adjusted for each waveband otherwise double hump tuning will result and a lack of overall gain. Normally, the receiver has been designed to cover from 15 metres up to 200 metres,

(Continued on page 440)

last valve provides approximately 400 milliwatts, ample for general use.

Panel and Chassis

As regards construction the panel is of aluminium finished black and cut so as to fit a standard 1034 Eddystone cabinet. Actually, the panel is 17 in. wide by 9 3/8 in. high. A 5 in. hole is cut for the loudspeaker and this should be arranged so as to allow 2 1/2 in. between the edge of the speaker and the edge of the panel to accommodate the audio volume control and the screen voltage control.

The final variable potentiometer is mounted on the screen which divides the detector from the R.F. portion.

On the extreme left-hand side of the panel comes reaction condenser C16, with the main tuner in the centre driving C2 and C6 and the band-setting control almost in the centre. Although the receiver is extremely compact no difficulty will be experienced in the construction providing this is done in the correct order. Of course, the condensers have to be mounted as shown in the illustration before any wiring can be put on. After which the aerial condensers and the screen on which they are mounted have to be temporarily removed, then it will be quite easy to wire up the detector and audio stages. The grid condenser C8 and grid leak R3 are mounted in the wiring, as can also be seen from the plan view.

In order to overcome the cutting of

wiring in any way which can still be kept reasonably short.

The valve screens do not quite fit the valve holders as regards the mounting holes, so unfortunately, two holes cannot be used for both screen and valve

A LONG DISTANCE BATTERY S.W. RECEIVER

CHASSIS, PANEL, CABINET.

- 1—Aluminium panel 17 x 9 3/8 finished black (Peto-Scott).
- 1—Aluminium chassis to specification finished black (Peto-Scott).
- 1—Screen to Specification (Peto-Scott).
- 1—Steel cabinet finished black type 1034 (Eddystone).

COILS.

- 1—Set type 959 (Eddystone).

COIL FORMS.

- 3—Type CF4 (Raymart).
- 2—Type CT4 (Raymart).

CHOKE, R.F.

- 1—Type CHN (Raymart).

CHOKE, L.F.

- 1—Type LF40 (Bulgin).

CONDENSERS, FIXED AND VARIABLE.

- 1—160 mmfd. type 1131 (Cr) (Eddystone).
- 1—18 mfd. type 1094 (C2) (Eddystone).
- 1—.01 mfd. type 4601/s (C3) (Dubilier).
- 1—.01 mfd. type 4601/s (C4) (Dubilier).
- 1—160 mmfd. type 1131 (C5) (Eddystone).
- 1—18 mfd. type 1094 (C6) (Eddystone).
- 1—3.30 mmfd. type SW95 (C7) (Bulgin).
- 1—.0001 mfd. type mica (C8) (Raymart).
- 1—1.0 mfd. type 4609/s (C9) (Dubilier).
- 1—.01 mfd. type 4601/s (C10) (Dubilier).
- 1—.001 mfd. type 690W (C11) (Dubilier).
- 1—.01 mfd. type 691W (C12) (Dubilier).
- 1—1.0 mfd. type 4609/s (C13) (Dubilier).
- 1—1.0 mfd. type 4609/s (C14) (Dubilier).
- 1—.01 mfd. type 4601/s (C15) (Dubilier).
- 1—.0002 mfd. type 957 (C16) (Eddystone).

DIAL.

- 1—Type 1070 (Eddystone).
- 1—Type 1097 (Eddystone).

EXTENSION OUTFITS.

- 2—Type 1008 (Eddystone).

HEADPHONES.

- 1—Pair type A (S.G. Brown).

HOLDERS, COIL.

- 1—Type 960 (Eddystone).
- 1—Type SW21 (Bulgin).

HOLDERS, VALVE.

- 4—Octal type VH56 (Bulgin).

JACK.

- 1—Type J1 (Bulgin).

PLUG.

- 1—Type P15 (Bulgin).

RESISTANCES, FIXED AND VARIABLE.

- 1—200,000 ohm type 1/2 watt (R1) (Dubilier).
- 1—1,000 ohm 1/2 watt (R2) (Bulgin).
- 1—3 megohm type 1/2 watt (R3) (Bulgin).
- 1—75,000 ohm type 1/2 watt (R4) (Bulgin).
- 1—25,000 ohm type 1/2 watt (R5) (Bulgin).
- 1—50,000 variable potentiometer type B (R6) (Dubilier).
- 1—25,000 ohm type 1 watt (R7) (Dubilier).
- 1—25 megohm type 1/2 watt (R8) (Bulgin).
- 1—5,000 ohm type 1 watt (R9) (Dubilier).
- 1—500,000 ohm variable potentiometer type B (R10) (Dubilier).
- 1—10,000 ohm variable potentiometer type B (R11) (Dubilier).

SWITCHES.

- 1—S88 (S1) (Bulgin).
- 1—S92 (S2) (Bulgin).

SUNDRIES.

- 3—Knobs type 1086 (Eddystone).
- 2—Type 1009 couplers (Eddystone).
- 1—Dial light type D9 (Bulgin).
- 1—4-way battery cable type BC2 (Bulgin).
- 1—A-E socket type X383 (Clix).
- 3—Valve screens type VS (Raymart).
- 2—Anode connectors (Bulgin).
- Loudspeaker Gauze (Peto-Scott).

TRANSFORMER.

- 1—Type LF33 (T1) (Bulgin).

ACCESSORIES

ACCUMULATOR.

- 1—S150 (Ever Ready).

BATTERY, H.T.

- 1—Super power (Siemens).

BATTERY G.B.

- 1—9 volt Winner (Ever Ready).

VALVES.

- 1—VP23 met. (V1) (Mazda).
- 1—SP22 met. (V2) (Mazda).
- 1—HL23 met. (V3) (Mazda).
- 1—PEN25 clear (V4) (Mazda).

Beam Aerials and S.W. Programmes

This article is part of a talk given over W₂XAD and W₂XAF by Boyd W. Bullock of the General Electric Co., New York, on the new G.E.C.S.W. stations. It will interest readers who may not realise why beam aerials are needed or how "Skip" affects S.W. transmissions

ONE of the vital considerations in international short wave broadcasting is the problem of providing the intended foreign audience with a signal which is sufficiently good to enable consistent and satisfactory reception of programmes.

In the first place, radio waves exhibit the characteristic of jumping off

most suitable vary with the seasons of the year, since with the changing seasons, not only do the hours of sunrise and sunset change, but also the angle at which sunlight passes through the atmosphere.

Both the Convention at Berne and the F.C.C. maintain engineering sections which continually study the com-

plex and changing problem of frequency (and power) assignments—the purpose being to permit as many stations as possible to operate within the relatively limited bounds of the radio spectrum—without undue interference with each other.

During recent years, W₂XAF has operated with a power output of 25 kilowatts, while about a year ago, W₂XAD went to 20 kilowatts.

Until the latter part of 1936, the broadcasting from W₂XAF and W₂XAD brought constant evidence of strong, consistently received signals in Central and South America. Then reports began to come in of interference by a growing number of other short-wave broadcast stations. Some of these were local Latin-American stations, while others were European.

The most consistently complained of was DJN, a station in Berlin, operating on 9,450 kc.—10 kc. higher than W₂XAF.

The nature of this interference was "side-band" interference—a form of trouble which occurs when two powerful signals are received which, although they may be working 10 kc. apart on adjacent channels, still become mixed. This effect occurs because the modulating or voice frequency which is super-

plex and changing problem of frequency (and power) assignments—the purpose being to permit as many stations as possible to operate within the relatively limited bounds of the radio spectrum—without undue interference with each other.

(Continued on page 447).

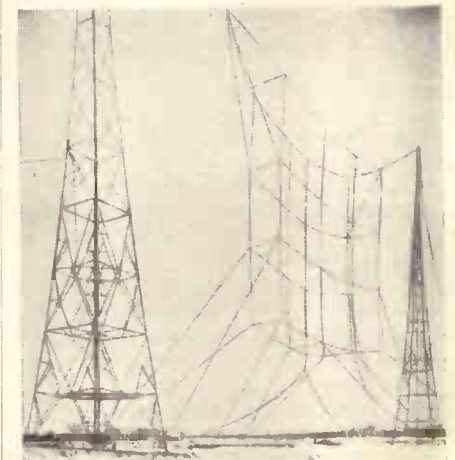

The Alexanderson beam array now used by many G.E.C. stations.



W6XBE which has been erected at Treasure Island, San Francisco, uses a 100 Kw amplifier and one of the new Alexanderson beam arrays. It is used to provide programmes for listeners in the Orient.

into space from the transmitting antenna and not returning to earth until considerable distance has been traversed. This behaviour becomes more pronounced and the effective distance greater as the frequency is increased, until, in the short-wave broadcast regions, "Skip distance," as it is called, becomes a very important factor.

Now, if "skip distance" for a given frequency remained constant, the problem of picking a frequency to reach a given area would be relatively simple. But "skip distance" varies widely for a given frequency—being affected by daylight and darkness, by the seasons, by such remote phenomena as sunspots, and by the direction (geographical bearing) of the line between transmitter and receiver. The general situation is that daylight decreases skip distance—and therefore effective range. A frequency such as 15,330 kc. (19 metres) band is good for broadcasting service to South America from Schenectady, N.Y., in the daytime—afternoon especially—but is not very suitable after dark. At night, frequencies in the 9,000 kc. (31 metres) band are much more effective. In the morning, the 21,000 kc. (13 metres) band is best.

Moreover, the portions of the day during which the above frequencies are

plex and changing problem of frequency (and power) assignments—the purpose being to permit as many stations as possible to operate within the relatively limited bounds of the radio spectrum—without undue interference with each other.

Many stations, of course, may be assigned the same frequency—but in such a case it has been deemed that geographical separation and limited power (and perhaps restrictions on the hours of operation) are sufficient to prevent interference and confusion harmful to the services of the individual station.

From the fact that the higher frequencies—those falling within the so-called short-wave region (1,600 kc. and up) and particularly those above 4,000 kc.—exhibit remarkable distance-covering ability, it is apparent that the problem of interference prevention becomes world-wide in scope.

In February and September of 1925, W₂XAF and W₂XAD were first licensed to the General Electric Company as experimental short-wave broadcast stations. Ever since that time, both stations have transmitted programmes for the benefit of listeners in other countries. During this period, their schedules have grown heavier, and more and more programme features

JULY, 1939

The ultra-high frequency transmitter described in this article is very simple to construct and was designed in the first place in the laboratories of Heintz and Kauf-

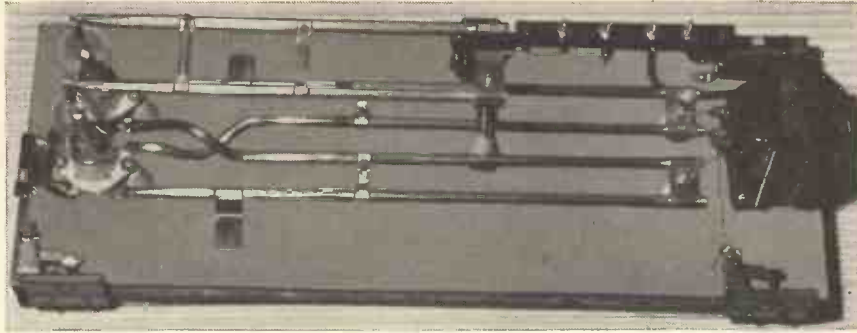

The layout of the valves and tuning lines are clearly shown in this illustration.

man, Limited, of San Francisco. They have supplied us with this information for the benefit of British Amateurs who are keen on U.H.F. working.

Building A One-Metre Oscillator

AMATEURS who are licensed to operate on the real ultra-high frequencies can undertake a considerable amount of interesting experimental work with quite low cost.

Most valve and component makers are now in a position to supply the

resistance. The wavelength is chosen by adjusting the position of the shorting bar on the anode bar tuning line. The closer this bar is brought to the valve the shorter becomes the wavelength to which the transmitter is tuned.

The limiting wavelength occurs

Excitation is controlled by the adjustment of the shorting bars on the filament line indicated in the sketch of the circuit. Proper adjustment can be observed by noting the grid current which varies directly with the excitation. The two shorting bars on each of the two filament lines should be kept approximately the same distance from the valves for obtaining optimum performance.

Radio-frequency power should preferably be taken by coupling to the anode lines. It is important that this be done in such a manner as to maintain a balance between the valves to the earth plane and to the load. If power is to be delivered to an electric light bulb or some type of dummy load it may be placed directly across the lines on the valve side of the shorting bar and very close to it. Loading can be increased by sliding the dummy load towards the valves.

If it is desired to deliver the R.F. power to a transmission line the loading may be varied by a degree of coupling to a loop or hairpin. Normal increases in loading will be accompanied by increased power outputs, increased anode currents, and decreased grid currents, while abnormal loading will cause decreases in power output and efficiency.

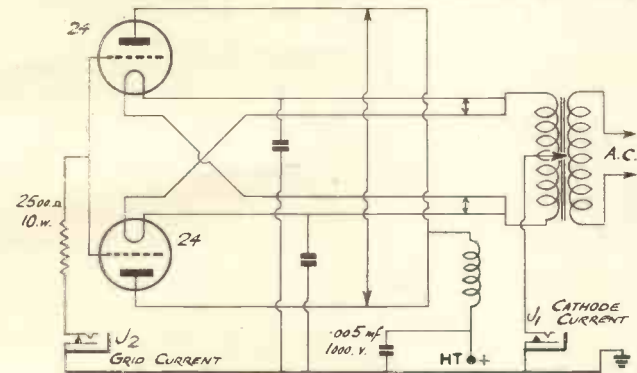

This theoretical circuit indicates the extreme simplicity of the U.H.F. transmitter and the limited number of components.

specialised gear needed although this generally means valves only.

The Heintz-Kaufman Co., of San Francisco, have produced an excellent U.H.F. valve in the HK-24 low-C triode which sells in this country for 24s. Two of these valves in push-pull on 1½ metres will provide a power output of 25 watts with an anode voltage of 800. The transmitter is very simple and can be built without difficulty by the amateur who has not had any experience of U.H.F. working. All the snags have been ironed out in the HK Laboratories while all the components needed are available in this country.

At the top of this page is an illustration of the transmitter showing the layout of the components and the tuned lines in the anode circuits. A wooden board is required for losses are taken care of by means of stand-off insulators.

Tuning Method

For wavelengths of between 1-1¼ metres the connections from grid to grid

must be a very heavy shorting bar of low when the shorting bar is placed directly across the anode terminals of the valves. With this adjustment the oscillator will operate at approximately 0.8 metre.

It will be seen that a second shorting bar is shown on the anode line. The purpose of this shorting bar is to detune the unused line and so prevent coupling of power into this portion of the circuit.

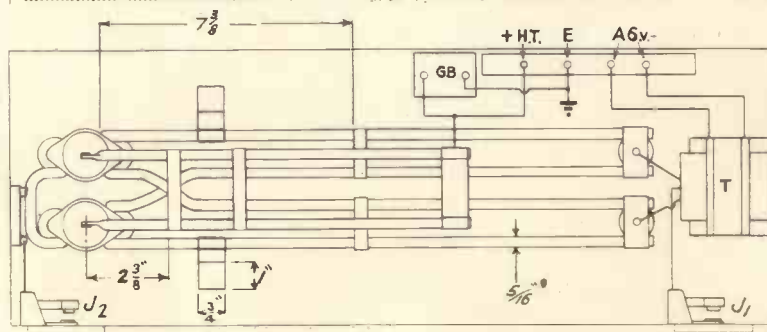

All the dimensions must be carefully adhered to and those of importance are given in this sketch.

When coupling with a loop at the end of the transmission line to deliver power to the aerial, care must be taken to see that the loop does not come in direct contact with the anode line as this will apply the high anode voltage to the aerial and transmission line circuit.

If proper care is taken a quarter-wave aerial may be directly coupled to the oscillator itself. It should be remembered, however, that this aerial will carry anode voltage and proper insulation should be provided. Another scheme is to isolate the feed line with low-capacity condensers of the air spaced type.

The quarter-wave aerial may be tapped directly on to the circuit near to the shorting bars on any of the line circuits. Heavier loading will be obtained as the point of contact on the quarter-wave radiator is moved closer to the valves.

A quarter-wave radiator becomes a very sensitive voltage indicating device when used in this way and will show due to the loading on the circuit much smaller voltages than the usual neon indicator.

In ultra-high frequency oscillators of this kind it is of the utmost importance to avoid radiation from the circuits themselves. As each portion of the circuit is an appreciable percentage of the radiated wavelength, it is possible that they may be subtracting R.F. power and

radiating on their own. Proper precautions must be taken to prevent such stray radiation. Stray radiation is best avoided by the balancing on all circuits to earth and by neutralising push-pull operation.

This means that each portion of the push-pull circuit must be equally balanced in their stray capacities with all other components. If this is not done the circuit will radiate power sensibly in proportion to the degree of unbalancing.

Power Supplies

For this reason the power supplies to the anode grid and filament are carefully located at mid-point because of the jumpers of their tuning line. Due to the physical arrangement of the two sets of filament tuned lines as shown in the illustration, it is difficult to balance them to the earth plane and to each other simultaneously. A good balance is accomplished by the use of small tabs, fastened to the outer members of each of the filament tuning lines. These tabs add capacity to the metal base or earth plane and serve to equalise the stray capacities of the opposite members to the adjoining filament tuning circuits.

The capacity of these tabs to the base should be adjusted for maximum R.F. output—at a given power input, so realising maximum efficiency

1 $\frac{1}{2}$ -1 $\frac{1}{2}$ Metre Operation

For the most efficient operation on these wavelengths, it is necessary to add a tuning line from grid to grid at the valve socket terminals. Such a line really exists under the previously described 1-metre conditions but it lies entirely within the valve and socket leads.

To control excitation, with a grid-tuning line added, both adjustments of the grid tuning line and the filament must be consistent. The results of these adjustments are observed by noting the grid current which varies in sympathy with changes in excitation. Adjustments are made for the proper value of grid current while other considerations in the adjustment of the oscillator are the same as for 1-metre operation.

The characteristics of the HK24 valve are as follows:—

- Filament voltage 6.3.
- Anode current (2 valves) 175 mA.
- Anode voltage 800.
- Grid current (2 valves) 18 mA.
- Grid resistor 2,500 ohms 10 watts.
- Power output 25 watts.

Power output is critical to anode voltage and grid current. Values given are optimum and using values higher or lower than those specified will result in lower power output and decreased efficiency.

SNOWDON 56 Mc TESTS

IN view of the success of the 56 mc. transmissions of GW6AA from Snowdon last September, a more ambitious series of tests has been arranged to take place in July, covering the week-end of the R.S.G.B. 56 mc. Field Day.

All transmissions will be crystal controlled, mainly C.W., and receivers for all types of transmissions will be used, although it is hoped that crystal controlled transmissions will predominate. A small petrol driven generator will be used to solve the problem of supplying light and power for operating the station over a period of several days.

The following aerial systems will be in operation:

1. A horizontally polarised fixed directional array beamed on London.
2. A vertically polarised rotatable beam array.
3. A wave-and-a-half vertical Franklin Uniform aerial.
4. A horizontal half-wave aerial running North-South.

Two days are to be set aside for the erection of the apparatus and aerial systems on the summit, but it should be understood that the success of the tests is largely dependent upon the weather conditions prevailing at the time. Even in summer, winds exceeding gale force are often experienced on

the summit of Snowdon, and squalls of rain and hail with terrific wind velocities occur without notice.

The operators will be on the summit from July 5 to July 10, but scheduled transmissions will not commence until 19.00 B.S.T., on Friday, the 7th. Automatic C.W. test calls of ten minutes' duration will be made at the following times: (all B.S.T.).

- Friday, July 7—19.00, 20.00, 21.00.
- Saturday, July 8—14.00, 16.00, 18.00, 20.00, 22.00.
- Sunday, July 9—10.00, 12.00, 14.00, 16.00, 18.00, 20.00, 22.00.

Reports of stations heard, and other details of general interest concerning the tests, will be given at the following times, telephony being used:—

- Friday, 7th—22.00.
- Saturday, 8th—17.00.
- Sunday, 9th—09.45, 20.00.

Call-signs of distant stations which have been heard, but not contacted, will be given in C.W. after each of these transmissions.

The main object of these tests is to investigate the radiation diagrams of the various aerial systems used, to compare with the theoretical, and with this object in mind, schedules are desired with stations equipped with field strength measuring apparatus (including receivers fitted with S meters, as

comparative figures only are required). The aerial system in use at that moment will be given out in each transmission, code groups being used for the C.W. transmissions, and these should be given in all reception reports, where possible. All such reports will be acknowledged, and will be much appreciated.

Schedules with C.W. over 150 miles from Snowdon are also desired, and anyone wishing to make schedules for these, or any tests they may wish to carry out during the period July 7-9, should write as soon as possible to David S. Mitchell, The Flagstaff, Colwyn Bay, North Wales.

Dollis Hill Radio Communication Society

The Hon. Secretary of this society is E. Eldridge, 79 Oxgate Gardens, Cricklewood, N.W.2, and he has sent us the following information on the society's activities. The last meeting of this society was on June 20 and normal meetings will recommence in September next. A portable transmitter was in operation on June 9 with both phone and C.W. on 14 Mc. with the call sign of the President—G6SKP.

Arrangements are being undertaken by G6SK, G6OV and G6KQ. Transport difficulties are not anticipated, as the site, to be determined, will be close to a coach service.

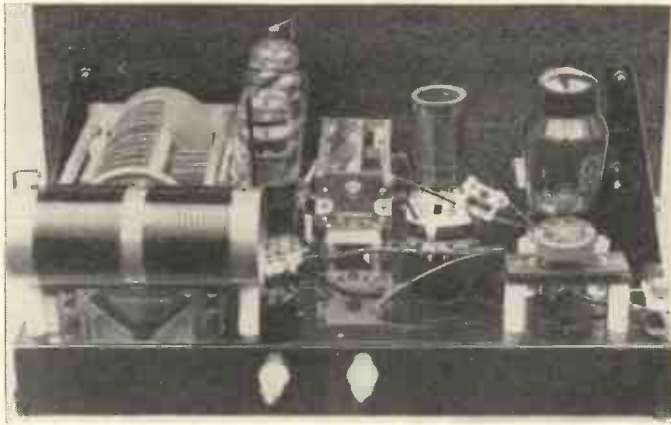

The transmitter ready for the untidy flexible wires. Notice the comparatively few components.

An All-British Tx. A Push-Pull KT8 Transmitter

This transmitter has been designed to provide an output of 75 watts on the 3.5 megacycle channel. The basic circuit, however, can be used on any amateur band and down to an output of approximately 25 watts. It is suitable for 4-band operation owing to the low amount of drive required by the KT8 valve.

4-Band Working

Our tests indicate that with an 80-metre crystal the final stage will operate on 80, 40, 20 and even 10 metres. On the later band, however, the crystal-oscillator is admittedly operating at maximum R.F. output, but not to such an extent that it causes excess crystal current.

It will be noticed that in the cathode circuit of the crystal-oscillator has been included an R.F. choke. This without its more conventional parallel condenser causes the oscillator to be slightly regenerative which gives a distinct increase in output on harmonics and at the same time reduces the crystal current.

As the output from the crystal-oscillator circuit can be as high as 15 watts capacity coupling between stages is not feasible. In addition, this type of coupling is not to be recommended particularly when a single ended circuit is coupled to a split circuit. For this reason, link coupling is absolutely essential for it does enable the amount

WE take great pleasure in describing a simple but efficient transmitter using British components throughout in which the performance is better than if any of the components, particularly valves, were of American design.

This transmitter was built in the first instance around the recently produced valves by G.E.C., the KT8 tetrodes which are somewhat similar to the American 807. Apparently, the original idea was to produce a valve directly interchangeable with the 807, but events have proved that the British KT8, while still being interchangeable, is distinctly better as regards mechanical design, R.F. output and what is very important to amateurs, price.

First of all, the data on the KT8 valve. It is an R.F. transmitting type tetrode with an indirectly heated channel, aligned grids which produce directed electron beams resulting in a very low screen current. The valve is suitable for use as an oscillator, frequency multiplier and power amplifier. The anode is brought out to a top cap, while the anode-grid capacity has been kept to the commendable low figure of 0.12 mmfd. Consequently, with careful design it is not necessary to neutralise these valves.

A 6.3 volt, 1.27 ampere heater is used, while the maximum anode voltage is 600 and the maximum screen voltage 300.

As used in this circuit, for Class C telegraphy, the anode current should not peak to more than 95 mA. and under these conditions an output of approximately 38 watts per valve is obtainable, resulting in an overall efficiency of 73 per cent.

If modulated, the anode voltage should be reduced to 475 volts and 250 volts to the screen. Provision must also be made to modulate both screen and anode simultaneously and at 14 mega-

cycles the R.F. output is approximately 30 watts per valve when working under Class C conditions.

In the first stage of the transmitter is a KT66, another Osram tetrode primarily designed for use in audio amplifiers, but which lends itself for inclusion in crystal-oscillator circuits in place of valves of the 6L6G type.

The KT66 is directly interchangeable with the 6L6G the only noticeable variation being a slightly higher heater current resulting in a greater total emission.

The circuit of the transmitter is shown on this page and it is extremely simple despite the fact that it will provide about 75 watts of carrier under normal conditions. The total amount of drive required is only about 1½ watts so that the regenerative oscillator provides ample output even if the final stage were to operate on frequencies far removed from the fundamental of the crystal.

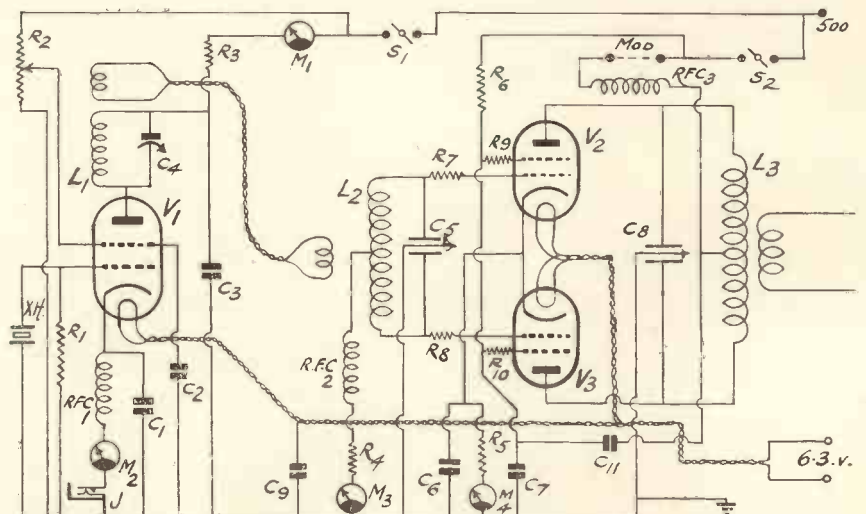

Complete theoretical circuit. Meters are recommended but are not essential.

Low Drive :: High Output

of drive to the KT8's to be reduced to the required value.

Constructors who have not had previous experience of tetrodes of this kind should be warned that over drive causes lack of efficiency and that should re-

Resistors R7 and 8 and the grid of the KT8 have a value of 50 ohms, and the resistors R9 and 10 in the screens 500 ohms. The by-pass condenser C7 is conventional and has a capacity of .002 mfd., while condenser C11, an in-

Coil Data

Next comes coil data; L1 and L2 are wound on 1½ in. formers of a conventional type, while L3 is wound on a 2½ in. former and mounted on Raymart insulating pillars. 20 gauge enamelled cover wire is used on L1 and L2 and 16 gauge enamelled covered wire on L3. The windings are as follows: 80 metres for L1, 38 turns close wound; L2 42 turns close wound and centre tapped; L3 56 turns close wound for 28 turns, half-inch gap and close wound for a further 28 turns. A single turn link is recommended around the centre of this coil for coupling to a remote aerial coil. On 40 metres 21 turns for L1, 30 turns for L2, 20 turns for L3 wound in two halves with a gap of half an inch between the centre turns.

As regards construction, owing to the fact that the chassis is of rather heavy gauge steel all the major components are mounted either on stand-off insulators or on top of the chassis so there is no need to cut large holes. The split stator tank condenser is mounted directly on to the chassis and the remaining two variable condensers are aligned up with it to provide a symmetrical panel layout.

Condenser C5 is raised off the chassis approximately half an inch, while C4 is mounted on an Eddystone adjustable bracket. Notice also the crystal holder. This is of the Q.C.C. type with an American base, but used in the circuit is an adaptor so that British or American crystal holders can be used at will.

A power unit providing 500 volts at 200 mA. is recommended with 2 filament windings.

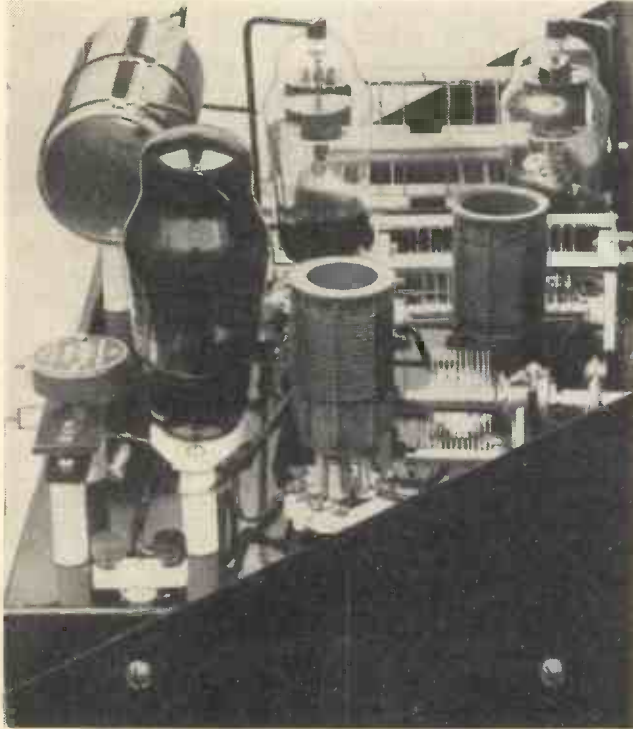

This side view of the chassis shows the crystal-oscillator circuit with the KT66 valve mounted in a holder on stand-off insulators.

sults in the first instance not be satisfactory do not endeavour to increase the drive for this only makes matters worse.

A fixed total grid current to the final stage of between 10 and 7 mA. should be obtained, which is the optimum working figure.

Owing to the low grid bias required there is no need to make use of a bias battery or bias pack. The grid bias is obtained by means of the total current flow across R5, a resistor having a value of 100 ohms, and the grid current across R4, a resistor of 10,000 ohms.

The resistor R5 is merely to prevent high anode current when drive is not applied, and is quite a precautionary measure.

The KT8 valves are very dicile to handle in the correct circuit, but they cannot be used in a circuit in which the layout does not lend itself to high efficiency. It must be remembered that KT8's have a slope of 6 milliamps per volt so that liberties cannot be taken with the circuit. Do not, however, obtain the idea that the KT8 valve is difficult to handle. With the circuit recommended they are as simple to use as slope triodes. Notice for example, the inclusion of resistors R7, R8, R9 and R10. These are most important and should in no circumstances be omitted.

novation, has a capacity of .001 mfd.

Both the heaters of the KT8's and the KT66's are run from the same voltage source and have one side by-passed to chassis by means of C9, a condenser of .01 mfd.

A PUSH PULL KT8 TRANSMITTER

CHASSIS AND PANEL.

- 2—Type 1109 (Eddystone).
- 2—Type 112 number 6 (Eddystone).
- 2—Pans type 1110 (Eddystone).

COIL FORM.

- 1—Type CF4 (Raymart).

COILS.

- 2—Specially wound to frequency (L1 and L3) (Peto-Scott).

CONDENSERS, FIXED.

- 1—.001 mfd. type 690W (C1) (Dubilier).
- 1—.002 mfd. type tubular 1,000 v. (C2) (Dubilier)
- 1—.002 mfd. type tubular 1,000 v. (C3) (Dubilier)
- 1—.00016 mfd. type TRO16T (C4) (Premier)
- 1—Type 1087 (G5) (Eddystone).
- 1—.002 mfd. type 4601/s (C6) (Dubilier).
- 1—.002 mfd. type 4601/s (C7) (Dubilier).
- 1—1080 (C8) (Eddystone).
- 1—.01 mfd. type 4601/s (C9) (Dubilier).
- 2—4 mfd. type LEG 650 v. (C10) (Dubilier).

CRYSTAL.

- 1—Standard type with enclosed holder type U (Q.C.C.).

CHOKES, R.F.

- 1—Type CHN (RFC1) (Raymart)
- 1—Type SW68 (RFC2) (Bulgin).
- 1—Type Pie-wound (RFC3) (Premier).

CHOKES, L.F.

- 1—Type 250 mA. 40 H. (Premier).

DIALS.

- 3—Standard indigraph (Peto-Scott).

DIAL LIGHT.

- 1—Type D9 (Bulgin).

EXTENSION OUTFIT.

- 1—Type 1008 (Eddystone).

HOLDERS, VALVE AND COIL.

- 1—Type SW21 (Bulgin).
- 1—Ceramic octal type X248 (Clix).
- 2—Ceramic 5-pin type X147 (Clix).
- 1—4-pin type X111 (Clix).

JACK AND PLUG.

- 1—Type J2 (Bulgin).
- 1—Type Pr5 (Bulgin).

KEY.

- 1—Bar type (Webb's Radio).

METERS.

- 1—0-100 mA (Premier).
- 1—0-10 mA (Premier).
- 1—0-150 mA (Premier).

PLUGS, SOCKETS, ETC.

- 12—Insulating pillars type SP (Raymart).

RESISTANCES, FIXED.

- 1—50,000 ohm type 1 watt (R1) (Dubilier)
- 1—20,000 ohm type PR 38 with extra clip (R2) (Bulgin).
- 1—2,000 ohm type - watt (R3) (Premier).
- 1—10,000 ohm type 4 watt (R4) (Premier).
- 1—100 ohm 20 watt (R5) (Bulgin).
- 1—10,000 ohm type 8 watt (R6) (Premier)
- 2—50-ohm type ¼ watt (R7 and R8) (Dubilier).
- 2—500-ohm type 1-watt (R9 and 10) (Dubilier).

SUNDRIES.

- 3—Terminal saddles type 1046 (Eddystone).

SWITCHES.

- 3—Type S80T (S1, S2 and S4) (Bulgin).
- 1—Type S88 (S3) (Bulgin).

TRANSFORMER.

- 1—Type SP503 (Premier).

VALVES.

- 1—KT-66 (V1) (Osram).
- 2—KT8 (V2 and V3) (Osram).
- 1—5Z3 (V4) (Hamrad).

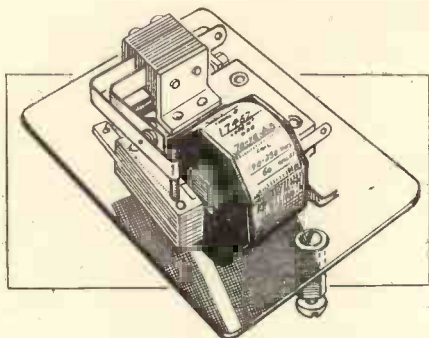

One of the Hamrad R.F. relays which operates from A.C. mains.

IT is rather surprising that with so many low-cost amplifiers available and the ease with which the average transmitter can be modulated to provide high-quality, that so much interest is devoted to C.W. It did appear at one time as if the number of amateurs operating purely on C.W. would slowly decrease, but on the contrary many stations which have in the past used telephony have now changed over to C.W. Consequently manufacturers and agents in this country are now handling a large amount of interesting gear for C.W. operators.

Relays

Relays for keying purposes are available from Hamrad Wholesale, varying in price from 13s. upwards. These relays sold under the trade name of "Guardian" are for R.F. make-and-break aerial change-over, etc., and run directly from an A.C. source. They are reliable with good contacts and will pass far more R.F. than is likely to be encountered in the average amateur station. An illustration of one of these relays is shown at the top of this page.

Webbs Radio also have a complete range of relays varying from simple types costing as little as 6s. 9d. up to the large Gordon heavy duty R.F. relays at 52s. This type of relay has a double-pole double-throw contact, runs from A.C. mains, and has the low power factor of .04 showing negligible loss at frequencies as high as 100 megacycles.

In the Ward-Leonard range, is a single-pole single-throw double break

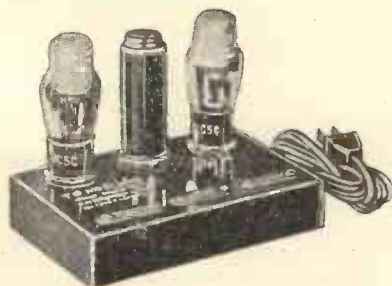

The McElroy audio oscillator.

Interesting New Equipment for Short-wave Experimenters

type for 110 volts A.C., priced at 23s. Also at Webbs Radio are a complete range of keys, etc., specially built for amateurs. The Junior Bug is now down in price to 17s. 6d. with a standard Bug at 37s. 6d. and the super model at 45s.

Those who are keen to learn C.W. should invest in one of the Mac practice sets which are complete at 19s. 6d., including a 1,000-cycle mechanical oscillator. This produces an excellent note very similar to C.W. picked up by a receiver and is ideal for code teaching.



This automatic sender can be purchased outright or hired for training purposes.

In addition, there is an audio oscillator mounted and housed in a bakelite case, and arranged for 2,000-ohm output or a 200-ohm connection for a low-impedance input to a modulator. Any number of components can be used with this oscillator and complete with two valves, ballast valve and line cord is only 32s. 6d. It will operate on A.C. or D.C. at any voltage between 110 and 250.

The McElroy automatic telegraphic equipment is probably the only gear of its kind in this country at the present time. There is an automatic sender, which is tested at 100 p.w.m. and guaranteed for 75 p.w.m. A light from an exciter lamp on to a photoelectric cell is interrupted by inked dots and dashes on ordinary recorded tape. The impulse is amplified to actuate a sensitive relay which delivers a keying output to work a local oscillator or transmitter. It is ideal for training operators for high-speed working and the equipment can be hired for as little as 7s. 6d. per week. For checking purposes there is the Mac re-

order which is the same price as the Mac Auto, that is £8. It is designed for direct coupling to the output of any radio receiver and is complete with input transformer and rectifier. It produces the conventional inked tape as used by telegraph companies.

It is possible to record efficiently up to 100 w.p.m. while tests have been made as high as 300 w.p.m. Designed to work with the Auto recorder is the tape puller at £3 7s. 6d., in which is built a heavy A.C. inductance motor which will not, of course, cause any interference.

There is no need to use large ungainly condensers in the average amateur low-power transmitter. Eddystone with their new range of miniature condensers, not to be confused with the original micro-condensers, have produced a range of components which are suitable for use in transmitters or receivers. They vary from the model 1094, having a maximum capacity of 18 mmfd. up to the model 1131, having a maximum capacity of 160 mmfd.

Readers will be interested to notice that the low-capacity condenser has a minimum of 3 mmfd. and the high-capacity condenser a minimum of 4.75 mfd. The model 1094 has a D.C. flash-over voltage of 3,500 and is priced at 3s. 9d.

The well-known air dielectric trimmer, model 978, has been modified so that it can be panel controlled by means of knob and dial. This condenser can be used to advantage in ultra-high frequency transmitters and in its modified form has the type number 1013. The minimum capacity is 3 mfd. and the maximum capacity 65 mfd.

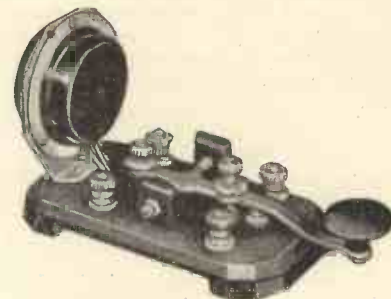

Mounted on this McElroy key is a 1,000 cycle mechanical oscillator.

A Good Key :: Band Switching :: Resistors

There is also the model 1132 which has a minimum capacity of 2 mfd. very wide spacing between plates and a maximum capacity of only 12 mmfd. It is priced at 4s., complete with knob and dial.

Improving the C.O.

By connecting a high-frequency choke in series with the cathode of the average pentode or tetrode oscillator a big increase in R.F. output can be obtained. However, the choke must be of the correct inductance otherwise the circuit will oscillate without the crystal in use. A suitable choke for this purpose we have found is the Eddystone 1066 which has a self capacity of 2.4 mmfd. and an inductance of 17.9 millihenries. It is fitted with fixing terminals and takes up very little space in the chassis. Those who are bothered with insufficient output from the C.O. are advised to try this idea and to use one of these chokes which only costs 2s.



These Eminent resistances carry very high currents but are extremely cheap.

A New Key

One of the nicest keys we have tried for a long time is the new Hamrad job which is priced at 11s. 8d., an odd sort of price, but all the same the key is a very good one. It is hand-made with polished silver contacts, but the main point about it is that it has tension springs on either side of the centre pivot. In this way, tension can be accurately adjusted and it is no overstatement to say that the average operator will find his sending speed increased with this key. It is possible to send more quickly than usual without difficulty or error.

Operators who are not too pleased with their sending and who are inclined to make errors in keying should try one of these new Hamrad keys for it will certainly bring about an improvement.

As crystals vary in size it is always advisable to use a holder which will take large square or round crystals. The Hamrad ceramic holder with hand

lapped plates will take crystals up to 1 in. square. These holders are priced at 7s. 6d. each and will fit ordinary



The main feature of this key is the double tension spring on either side of the centre pivot. sockets or valve holders. Alternative pins are supplied with the holder.

Webbs' Switches

Band switching is coming into fashion because so many operators recognise that with present conditions several frequencies must be available. In order to do this correctly, the switch embodied must have the very minimum amount of loss. For this purpose Webbs Radio are supplying an Ohmite switch. It is made of porcelain of vitreous enamel and is excellent for high voltages and high-frequency use. Each switch has three contacts so that three bands can be covered with one set of coils. Two or more switches can be ganged for tuning or control while they can be mounted on insulated brackets in order to reduce the capacity between switch and chassis. Complete with knob and mounting they are priced at 10s. 6d. and are suitable for power amplifiers and output circuits up to 1 kilowatt rating.

A complete transmitter, air tested, and providing an input of 10 watts is available from Premier Supply Stores. This transmitter is suitable for A.C. or D.C. mains operation, and on the 7 megacycle band is supplied with crystal and inductance.

Accessories have not been omitted in

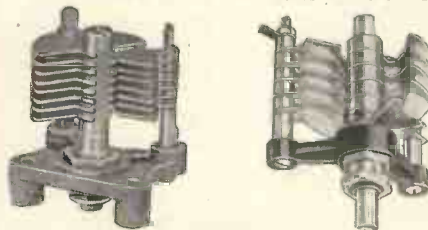

The Eddystone condenser on the left is mainly for trimming but can also be obtained complete with knob and dial. On the right is one of the new Eddystone microcondensers having a maximum capacity of 18-mmfd.

view of the low price for an 0-100 mA. meter is included and keying is arranged in the cathode of the oscillator. This transmitter can be modulated and a suitable amplifier is available which will also operate on A.C. or D.C. mains. A kit of parts is only £2, or wired and tested £2 15s. od.

To go with this amplifier there is a microphone of the Res pattern priced at £1, which has a low noise level and a frequency range of 45 to 7,500 cycles plus or minus 2 db.

KT8

It is quite a simple matter to make a transmitter covering several wavebands with only two valves, that is providing the right valves are used. The General Electric Co. are now in a position to supply the KT8 transmitting tetrode, a valve which does not normally require neutralising and which will provide a carrier power in the region of 40 watts. This valve has a 6.3 volt 1.27 ampere heater and is designed



For band switching the best low-loss switches are the Ohmite type available from Webbs Radio.

for a maximum voltage of 600 on the anode and 300 on the screen. The amount of drive required is very small indeed, being in the region of .5 to .75 watts. Consequently a single tri-tet oscillator would drive this valve on four wavebands from a single crystal. As a frequency multiplier on 14 megacycles, the output is in excess of 12 watts. It is priced at 22s. 6d. and is probably one of the best valves of its kind available to amateurs at the present time.

When using valves of the high-slope tetrode class it is important that the screen voltage be accurately obtained and be dependable. Resistances for this work are available from Hamrad, which vary from the 8-watt type at 11d. up to the 100-watt type at 3s. Another type is rated at 67 watts and in values of 250 ohms to 3,000 ohms is priced at 1s. 9d. This particular resistance is wound on a porcelain former so that it is extremely cheap at the price asked.

A Special Transformer

In our June issue we made brief reference on page 384 to the new Hamrad model 140 receiver which is now in full production. An illustration is shown on this page. It uses 12 valves excluding the rectifier, which are an 1851, 6J8, 6F6, two 6K7, two 6C5, two

have a 500-ohm secondary feeding into a 500-ohm line. This line is then terminated in the special Sound Sales transformer having a 500-ohm primary. The secondary can be tapped, as the one in the illustration, for 15 or 30 ohms so that loudspeakers can be con-

over to 6.3 valves with the minimum amount of trouble. These transformers are priced at 7s. 6d. each and fulfil quite a long-felt want.

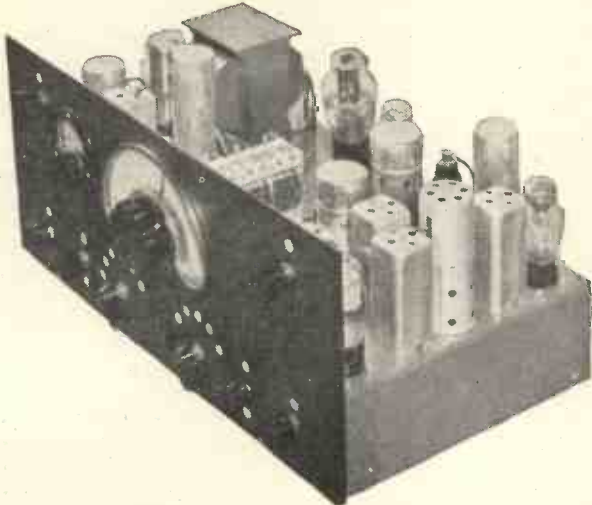

The new Hamrad 140 receiver which has a total of 13 valves and many unusual refinements. It has a particularly effective R meter which operates on both phone and C.W.

6F5, two 6H6, 6L6, 6J7 and 5Z4. Electrical band-spreading is included and the coverage is 9 to 600 metres, in five bands with an efficient high-frequency stage on all bands.

There are two intermediate-frequency stages at 465 kc. and variable selectivity. Variable delayed A.V.C., with separate valve amplifying the D.C. components. A special feature is an undelayed amplified R meter calibrated in R points which will read with or without A.V.C. on both phone and C.W.

Frequency drift is negligible due to a large extent to the use of a separate oscillator and frequency changer, while the crystal filter is arranged so that it can be used for telephony operation. There are two stages of audio, the final providing 6½ watts while high and low impedance outputs of 2,000, 15, 7½ and 1½ ohms are included. This receiver can be demonstrated by any of the Hamrad agents, and the price is £27 10s. od. with hire purchase if required.

Service engineers and those interested in public-address equipment should bear in mind the fact that Sound Sales, of Marlborough Road, London, N.19, manufacture excellent output transformers which solve a multitude of problems. It is always rather difficult quickly to erect a number of loudspeakers at a distance from the main amplifier, but by using the Sound Sales line transformer with a 500-ohm primary and tapped secondary this problem is overcome. It is suggested that the output transformer in the amplifier

connected in series, parallel or series-parallel.

Another interesting transformer made by this company is type E/US. This transformer provides an output of 6.3 volts with a 4-volt input, so that international octals or American valves can be used in receivers normally requiring British 4-volt valves. Alternatively, the voltage can be stepped down so allowing British valves to be used in American receivers.

As the maximum output is 3 amperes, amateurs using transmitting equipment with British valves can change

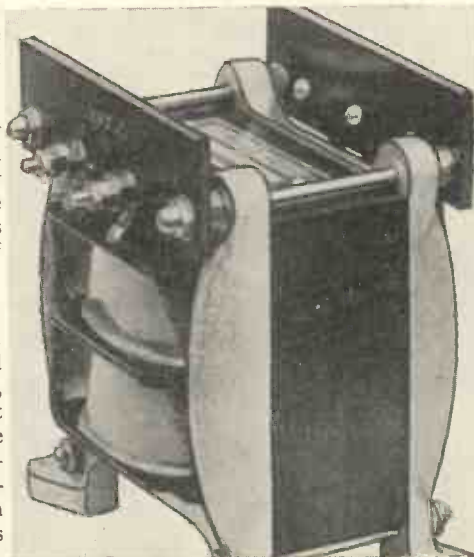

This is the Sound Sales line transformer which has so many uses as explained in the text.

Apparatus Described in Recent Issues

A NUMBER of our back issues are being repeatedly asked for by constructors. We have collated these requests and the more popular issues with the receivers, etc., to which they refer are listed below. Any of the issues can be obtained from our Back Number Department, price 2s., plus postage.

- Flat Tap Beam Antennas—Feb., 1938.
- 5 and 10 metre Transmitter—Feb. 1938.
- 2-valve Receiver for 10 metres—March, 1938.
- A 6L6G Speech Amplifier—July, 1938.
- Cheap Battery Charger—July, 1938.
- 15-watt Transmitter—July, 1938.
- Beginner's 2-valve Receiver—September, 1938.
- C.W.R. Transmitter—October, 1938.
- 5-8 metre Receiver—October, 1938.
- Single valve Transmitter—October, 1938.
- Battery-operated Transmitter—November, 1938.
- Building a Rotary Beam—December, 1938.
- A 6L6G-801 Transmitter—December, 1938.
- An A.C. 3-valve Receiver—December, 1938.
- A.C. Frequency Meter—January, 1938.
- Regenerative Pre-selector—February, 1939.
- 5-metre C.C. Tx.—March, 1939.
- Two-valve A.C. Short-waver—April, 1939.
- 8-valve Communication Receiver—May, 1939.

The Lawrence Thaw Trans-asiatic Expedition

Very complete radio equipment is being taken by this expedition which has been manufactured especially for them by the General Electric Co., Ltd., of America. It consists of two trucks housing four ultra-high frequency transmitters and communication type receivers, similar to police radio installations. Two medium high-frequency transmitters and receivers have also been installed, the whole being powered indirectly from car batteries. The antennas for ultra-high frequency use are of the quarter wave fish-pole type allowing for communication between four cars in motion. A 128 ft. antenna on 30 ft. collapsible poles is to be used for the medium high-frequency transmitters.



THE R.S.G.B. National Field Day

This information on N.F.D. has been compiled by F. L. Postlethwaite, G5KA, who next month will resume his very popular feature "Long Skip."

GM2SP and GM3GG operating the Scottish "D" 7-megacycle station.

ALTHOUGH the Goddess of DX (whoever she might be) did not unduly shower her gifts upon N.F.D. participants, the anti-cyclonic sunshine made up for this and helped considerably to liven up those operators suffering from aching wrists and "can't-keep-open" eye-lids.

A brief account of what was seen on a 180-mile tour covering most of the stations in districts 12, 13 and 14 may interest other participants.

District 13 hit upon the novel idea of arranging a 56 mc. link between their stations at Westerham, Kent; Warlingham, Surrey; and Dulwich Hamlet, S.E. Unfortunately the life of the link was short-lived as the converter at their 1.75 mc. station died on them and the natural thing to do was to grab the one from the 5-metre link station. Best DX worked by G2RCP, the 14 mc. station, was SU5AAP, CX2AJ, VK3QZ and W4FDJ. Both G2RCP and G3ZJP (the top band station) were situated in the same field, being but 50 yards away from each other at a location 600 ft. above sea level. DX was lacking at the 3.5 mc. station at Warlingham, but they did hear two or three W's and a VO. A different tale came from Dulwich Hamlet F.C. Ground,

where the crew at G2JBP accounted for W3, PY, CT2 and six HB portables on 7 mc.

From G6ZOP, Mill Hill, N.W.7, we came away with ideas of how DX *should* be worked. They accounted for W6DWW, VU2FOP, VU2AN, LU2DG and SU5AAP. This district's 3.5 mc. station claimed to be a really portable one! It was whispered to us that it could be assembled in 2 minutes, and had in fact been done in this time. The secret was a liberal supply of plugs and sockets! No DX had been worked here, but a contact had been made with all Scottish portables barring station "D." This remark came from a lot of the other 80 and 160 metre stations, and for those who don't already know, these two Scottish stations were not on. It took 2 hours to find the 7 mc. station of district 12. They were hidden away on the opposite bank of the River Lea, which necessitated a somewhat perilous boat crossing. How they got their gear across without getting drowned is still a source of wonder to us! The lack of DX by this station was probably accounted for by the low angle of radiation owing to the extremely marshy site they occupied.

G5RVP, the Essex 14 mc. station,

was situated near Danbury Common, the highest point in the country. Poor DX conditions were blamed for the low total of 19 contacts made. Perhaps they spent too much time eating those 12 eggs, 18 sausages and quantities of fried bread? A bright spot from their 7 mc. station at Thundersley was their system of having two receivers working with an ingenious push-button intercommunicating device to warn the transmitting operator when a suitable signal had been heard.

In a letter from GW6AA, we gather that they fully expect to run off with the top-band certificate. As it is against the wishes of the R.S.G.B. we are refraining from publishing their total score. GW6AA and G6GL each put in 16 hours of continuous operating at this station. Superhuman work was done at their 14 mc. station by G3YL (yes, she is a YL) who, apart from working some startling DX, did all the cooking, showed the OM's how to put up a tent, completely erected a mast with the aid of only one male, and climbed a tree to put up the receiving antenna. She didn't get a wink of sleep over the whole operating period, either! DX worked by this station included VU2, VE3, VK2, VK5, KA1 and numerous W's. Refinements at the camp included a petrol generating plant for lighting and accumulator charging, and a double-pole double-throw R.F. relay to put the TX on to either of two antennas.

Although several of the stations visited could not be called "portable," simplicity was the keynote throughout.



G4BZ, G8AB and G2CD who were behind the key at G8ABP near Harlow, Essex.



The Scottish "D" 7-megacycle station with (left to right) GM4HB, GM6SR, GM6LS and GM4FT.

JULY, 1939

The VK2NO 5-metre Crystal-exciter Unit

This 5-metre exciter is very simple and inexpensive to build and has proved most effective in Australia where it was designed by VK2NO.

ONE of the most prominent ultra-short wave workers, who has achieved some very fine results during the last few years, is Don B. Knock, VK2NO, known to our readers as the radio editor of the Australian publication, *The Bulletin*. In that journal he has published the data on his latest crystal-controlled exciter unit and in view of the fact that he uses this to drive his comparatively low-power final stage, the signal from which has been heard in this country, we feel sure it will interest our readers who are keen on U.H.F. experimental work.

The exciter can be used also as a phone or C.W. transmitter and provides a healthy carrier output of around 20-25 watts. There is no need to use comparatively fragile and expensive 10-metre crystals for with the recommended circuit and a 7-megacycle crystal it is quite possible to over drive the final 807.

Because the exciter has so much R.F. output to spare, it can be used to drive a medium power final push-pull stage using valves of the 35T or HK24 type. The circuit is shown in which a 42 oscillator is capacity-coupled to a 6L6G quadrupler in the usual way through a 100 mmfd. mica condenser. The anode coils are arranged end to end for inductive coupling. Where previously a small flash-lamp indicator in a 10-metre absorption meter showed only a slight glow the amplification of the 10-metre harmonic by reinforcing in this manner is such that the lamp burnt out as the 6L6G tank circuit was tuned to resonance.

An important point is that the R.F. choke in the anode feed to the oscillator and quadrupler must not be omitted or

the scheme is most unsatisfactory. An 807 was used in the final but in its place the new Osram KT8 will be found most satisfactory. It is capacity-coupled to the 6L6G quadrupler. As a series tuned doubler to 56 mc. the output is up to 25 watts with 500 volts H.T.

With the exception of the coil data all resistor and capacity values are shown in the circuit. Tuning condensers must have ceramic or high insulation and the same remarks, of course, apply to valve holders.

Coil data is approximately as follows: L₁ (oscillator-anode), 20 turns 14 gauge enamelled copper wire close wound 1 in. internal diameter. L₂ (quadrupler anode), 6 turns 14 gauge enamelled copper wire, 1 in. internal diameter wound to a length of 1½ in. L₃ (the series tuned doubler-anode), 10 turns of 12 s.w.g. enamelled copper wire close wound and ¾ in. diameter. All coils are wound on air and are made rigid by cementing strips of celluloid along the winding, after completion. Suitable coils ready wound are obtainable from Denco, of Clapton

As the 25 mmfd. tuning condenser in the L₃ circuit has the rotor at earth potential it can be of the close spaced variety although one of the most suitable condensers for English amateurs is the Eddystone model 1094. The 100 mmfd. condenser tuning the oscillator is obtainable from Raymart, while the quadrupler condenser is again an Eddystone 1094.

Series tuning in the 807 circuit has proved to be highly satisfactory, particularly as it enables such a high value of inductance to be used in the circuit. The exciter can be used with high efficiency on 10 metres by using the 807

as a buffer, or by doubling in the 6L6G stage and doubling to 10 metres in the final stage. The later method has the big advantage that the 807 as a doubler will not, of course, require any neutralising.

Although provision is made for a meter in the anode circuit of each valve, there is no reason why these meters should not be in a cathode in the more usual manner. This system has the advantage that there is less likelihood of damage resulting to these meters through mis-tuning when they are in the cathode circuit.

All R.F. chokes are of the Eddystone 1022 type, while the power supply provides 500 volts using a straightforward 83V rectifier. The anode current of the 42 oscillator is only 35 mA. and the frequency remains very steady owing to the fact that the screen voltage to the 42 is kept low by using a 100,000 ohm series resistor.

If complete stability is to be obtained, it is important that the crystal-oscillator is not driven too hard. Later types in valves, such as the 6F6 can be used in place of the 42 but there is very little, if any, decrease in R.F. output.

The author suggests that his own arrangement in the final stage should be considered. He uses the exciter to drive a pair of 801's in push-pull, while if further output is required the 801 can in turn drive a pair of 35T's.

An efficient exciter of this kind would be completely wasted unless it is used in an efficient radiating system. It has been found both by experimenters in this country and by VK2NO that the two-section W8JK beam is the most satisfactory and compact 5-metre array.

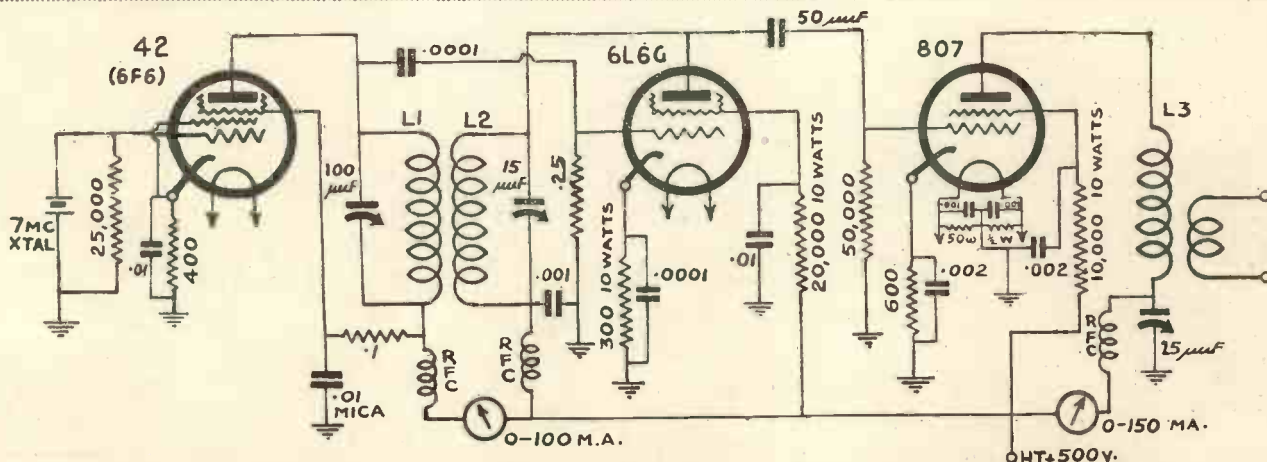

Only three stages are used in the exciter while the output is sufficient from the 807 to use the arrangement as a complete transmitter. A 6F6 can be substituted for the 42 if required.



A selection of Tungram 1.4 volt valves.

THE latest type of 1.4 volt valves are particularly useful when embodied in battery-operated low consumption receivers and amateurs would be well advised to consider this range of valves.

A small superheterodyne using four valves and a frame aerial will give a surprisingly good performance on amateur bands and can be built in such a way that it is truly portable and well worth carrying round on field days or for checking purposes.

A circuit of a suitable receiver is shown on this page. The first valve is a 1A7G pentagrid convertor with a 1.4 volt heater and a current of only 50 mA. The conversion conductance is approximately 250 while the maximum anode-screen and anode-grid voltage is 90. In fact this voltage will power the entire receiver. Total cathode current of the 1A7G is 2.4 mA, which is not excessive for a valve of this class.

The frame aerial is connected across the control grid-earth circuit of the first detector. In the control grid circuit of the oscillator is a parallel tuned grid coil and an air cored primary lightly coupled. Tuning is carried out by means of a 100 mmfd. condenser, but as it is practically impossible for amateurs accurately to track both the oscillator coil and the frame aerial condensers, it is essential to use additional padding.

In the case of the oscillator this can be a small condenser of the postage stamp type, but a condenser across the coil should preferably be a variable plate, an integral part of the aerial tuning condenser and adjustable from the front panel.

For normal frequencies the I.F. transformers should be 400/500 kc. the actual frequency being a matter of personal taste.

The second valve is an intermediate-frequency amplifier designated 1N5G, a straightforward pentode which requires 90 volts on both anode and

Using 1.4-volt Valves in a Frame Aerial Receiver

During the next few months there will be considerable outdoor activity and a portable receiver for ham bands will be useful for the average amateurs. How the new 1.4 volt midget valves can be used to advantage is explained in this article.

screen, has an amplification factor of 1,160, and a total current of 1.5 mA. This type of valve enables high gain to be obtained in the I.F. stage so that there is plenty of latitude if extra selectivity is needed.

Following the I.F. amplifier is a diode-triode used as a second detector, A.V.C., and audio amplifier. This is coupled in a conventional manner and the valve, a 1H5G, has an exceptionally low current of 14 mA. The triode section of this is capacity coupled to an output pentode type 1C5G with an anode current of 9.1 mA. for an output of 240 milliwatts.

It will be seen from this that the total consumption from the power of the receiver is only 13.14 mA. at 90 volts, with a total filament current of .2 ampere. The filament current can quite safely be taken from a dry cell of 1½ volts rating, but although not generally used it is an advantage to include a small series resistor to reduce the excess 10/100th volt supplied by the battery.

The frame aerial can be wound around a small chassis and need not be more than 1 ft. square for this will leave ample space for the receiver. The valves are of the midget type with a

maximum overall length of about 4 in. The single coil is of the plug-in type while special miniature I.F. transformers with iron cored coils are available for this circuit from Peto-Scott.

Of the controls, these merely consist of tuning condensers, audio gain integral with which is the two-pole on/off switch. With a little ingenuity the plug-in coil could be fitted to the side of the cabinet to facilitate easy waveband coverage.

By virtue of the large parallel tuning condensers three wavebands can be generally covered without coil changes so that if built for amateur use the receiver would cover 20, 40 and 80 metres, or with a little care 40, 80 and 160 metres. It is not recommended for 10-metre work as the frame aerial would not provide sufficient pick-up. Also parallel condensers have too high minimum capacity for efficient work on this wavelength.

The 100 mmfd. condensers are of the broadcast type and for convenience ganged together. A small loudspeaker about 5 in. in diameter is required and built in. No difficulty will be experienced with this as the valves are entirely free from microphony even when mounted close to the loudspeaker.

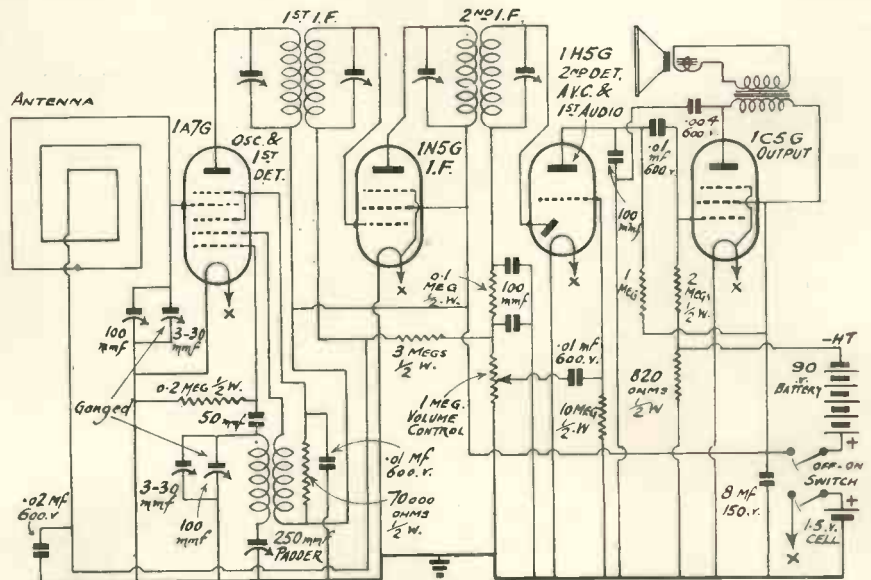

This complete circuit gives all values required but the coil and frame aerial have to be wound to the frequency required by the user.

The Short-wave Radio World

A CATHODE-RAY AERIAL PHASEMETER

IN the April issue of the American publication *Electronics* appeared a full description of cathode-ray equipment for the true phasing of aerial arrays.

This particular phasemeter has been designed for monitoring the operation of directional arrays and up to six elements can be accommodated. In

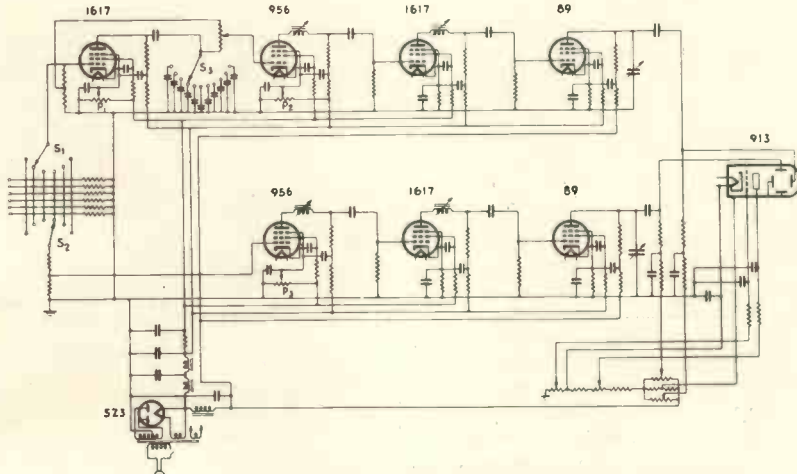

Fig. 1. The theoretical circuit of the C.R. phase meter.

addition, a V.T. voltmeter can also be used to check up the amplitude of aerial currents.

The meter is simple to use for the phase adjustment has only to be rotated until the straight line trace is obtained, after which the phase difference can be read off directly. Should two directional elements be in service the phase shifter can be left in position as it is only necessary to switch on the monitor and to observe the shape of the pattern.

The designer, John P. Taylor, states that with directive arrays the phasing network can be checked before erection, if the line impedance is known. This is done by feeding R.F. to one end of the network and using the phasemeter to read the phase difference between the input voltage and the voltage at the output of the network. As the meter has an input impedance of 80 ohms it can be used with standard coaxial lines. With this arrangement the cathode-ray tube is used in quite a straightforward manner. It is well known that when voltage is applied to the two pairs of plates having the same frequency and are in phase a straight line trace appears on the face of the tube. For small phase differences, trace becomes an ellipse enlarging to a circle for a 90-degree difference.

A Review of the Most Important Features of the World's Short-wave Developments

If a phase shifting device is connected in series with one voltage lead the phase of this voltage can be adjusted until a straight line trace is obtained. The phase shift introduced is then equal to the phase difference in question. In Fig. 1 can be seen the

theoretical circuit of the apparatus needed while in Fig. 2 is a practical diagram showing the application.

THE 1852 AS A MIXER

The new 1852 pentode valve although designed for R.F. and I.F. work is particularly suitable for use in mixer circuits. The circuit showing the changes necessary to instal the 1852 in an average communication receiver are

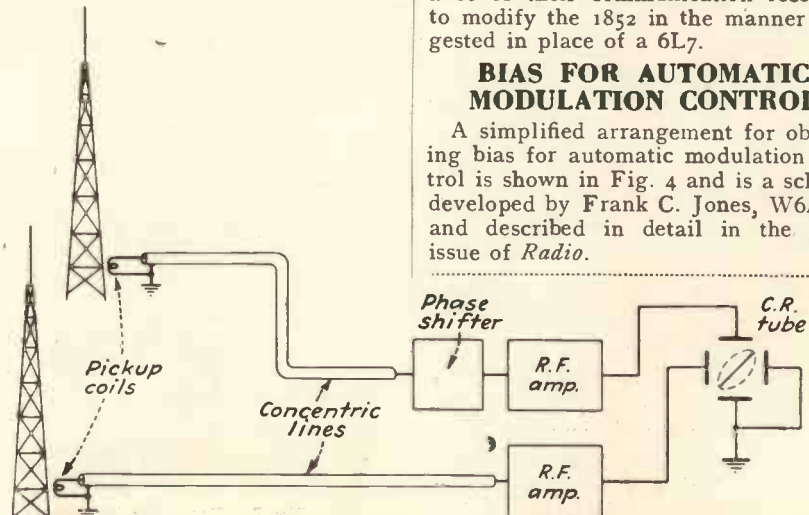

Fig. 2. The practical application can be appreciated from this diagram.

shown in Fig. 3. Only minor changes are required such as condenser, C5, being connected between the oscillator-anode and the mixer grid instead of between the oscillator-grid and the 6L7 normally used. The screen resistor R8 should also be changed to 100,000 ohms while additional by-pass condenser C is connected between cathode and earth. The suppressor grid of the 1852 is earthed and not connected to cathode which helps to better the image ratio.

A good R.F. oscillator is the 6J5 triode which is an evolution of the 6C5,

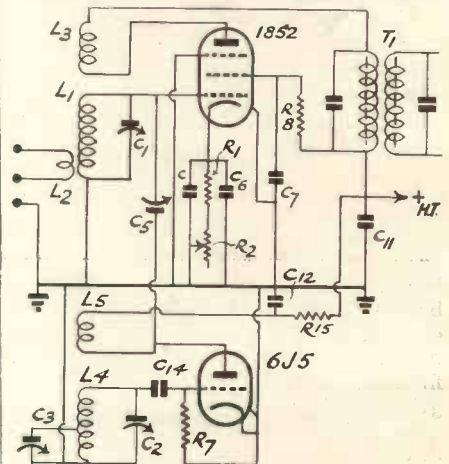

Fig. 3. An 1852 pentode can be used to advantage in mixer circuits.

but has a much lower input capacity. The values in the circuit are as follows:—C .002 mmfd., C5 mica trimmer, C6 and 7 .1 mfd., C11 .2 mfd., C12 .005 mfd., C14 100 mmfd., R1 300 ohms, R2 1,000 ohms, R7 150,000 ohms, R8 100,000 ohms, R15 15,000 ohms.

We can thoroughly recommend amateurs who wish to improve the performance of their communication receivers to modify the 1852 in the manner suggested in place of a 6L7.

BIAS FOR AUTOMATIC MODULATION CONTROL

A simplified arrangement for obtaining bias for automatic modulation control is shown in Fig. 4 and is a scheme developed by Frank C. Jones, W6AJF, and described in detail in the June issue of *Radio*.

A 5-metre Tx. :: One-valve Tx.

Automatic modulation control will undoubtedly before long be used in every amateur phone transmitter for it is realised that over modulation can cause havoc in the crowded telephony bands. Automatic modulation control is a system whereby a diode rectifier delivers automatic volume control to a valve in a speech amplifier in order to

should be adjusted for very exact neutralising. The complete scheme is shown in Fig. 5, but readers are referred to the original article which gives full data.

A CHEAP 1-VALVE TRANSMITTER

The newcomer will appreciate the

ents are of the standard broadcast type while the power pack has to deliver 375 volts at 90 mA.

The single coil in the anode circuit consists of 41 turns close wound on a 1½ in. diameter former or for 40 metres 21 turns spaced to a length of 2 in. on a 1½ in. former. The tank condenser is a 50 mmfd. midget and the fundamental crystal is always advisable. Complete circuit is shown in Fig. 6.

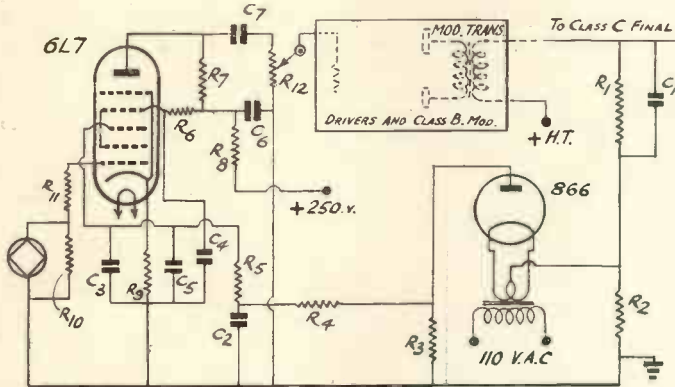

Fig. 4. Automatic modulation control is a very necessary refinement in order to prevent over modulation on crowded phone bands.

keep the gain constant. It is suggested by the designer that a valve of the 866 class be used in the diode circuit, having the anode connected via an R.F. filter into the suppressor or injection grid of a low level amplifier valve.

In this scheme no current flows through the diode at any time unless the cathode becomes more negative than the anode. When this occurs the class C stage is over modulated, since for 100 per cent. modulation the negative voltage audio peaks should equal positive D.C. voltage. When the diode cathode becomes more negative than the cathode current is low through the anode resistor to earth.

simplicity of a single valve transmitter published in the June *Radio*, which embodies one T-21 tetrode valve. It is for C.W. operation and covers the 80 and 40 metre bands, although the higher frequencies can also be used. The maximum output is 15 watts on 80 metres and approximately 12 watts on 40 metres so suiting recently licensed amateurs. The bulk of the compon-

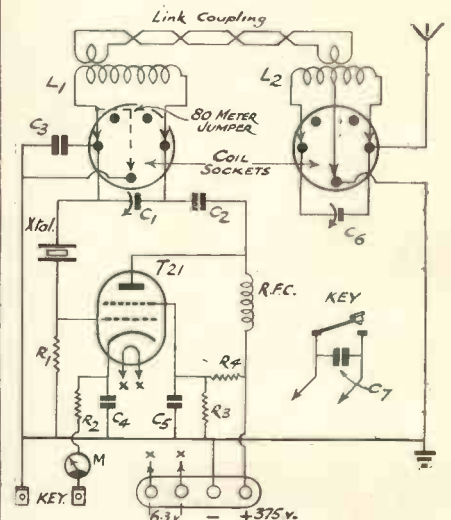

Fig. 6. A simple 1-valve beginner's transmitter.

AN INEXPENSIVE 5-METRE CRYSTAL CONTROL

A suppressor modulated transmitter using receiving type valves has been designed by N. W. Mix, W1IGL, and appears in the June issue of "Q.S.T." It uses a type 89 electron-coupled oscillator with the grid on 28 megacycles and the anode on 56 megacycles driving two 89's as push-pull 56 megacycle amplifiers. A carrier of 4 watts is obtainable and 100 per cent. modulation can be used without frequency modulation. The audio section consists of a high-gain single button microphone feeding into 6C6 and is R.F. coupled to a type 37 triode, the output from this being fed into the grid of the 89's. Neutralising of the 89's is essential as the grid-anode tuning is not sufficient to prevent oscillation. This neutralising is done by strips of copper around the outside of the valve and cross connecting the strips to the grids. They are held in place by a rubber band and

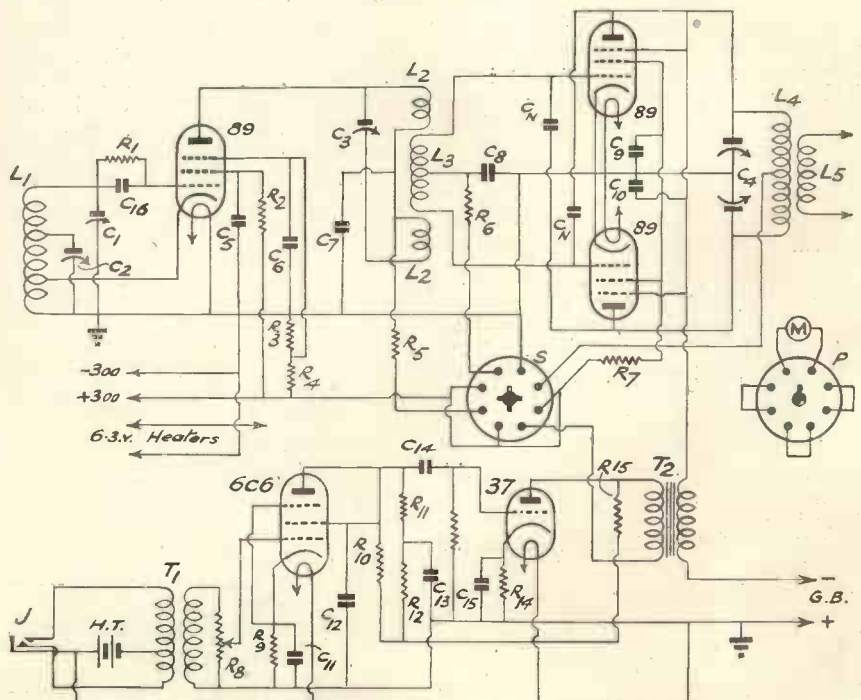
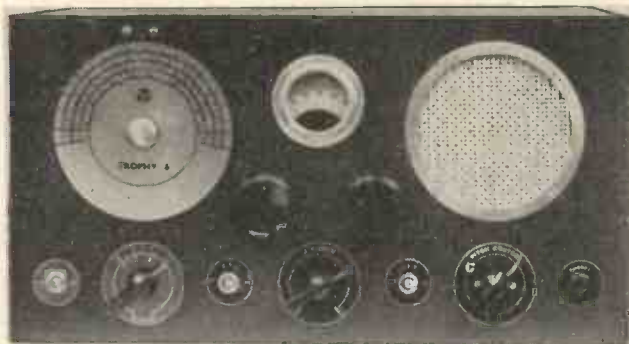

Fig. 5. Receiving type components are used throughout in this 5-metre transmitter which provides a carrier power of 4 watts.

The P.S.E.I. Trophy 6 Communication Receiver



All the controls are clearly marked while full electrical band-spreading is included.

AN interesting addition has just been made to the P.S.E.I. range of Trophy receivers, in the new Trophy 6, an inexpensive communication receiver which has been designed specifically for communication use amongst amateurs.

As the name indicates it is a 6-valver having four wavebands giving continuous coverage from 6.5 to 545 metres. A separate dial is provided to give electrical band-spreading which actuates on to a separate set of band-spreading condensers. The main dial is directly calibrated in frequencies and so arranged that each individual waveband is quite separate from its neighbour.

Amongst the refinements included are switchable automatic volume control, switchable beat-frequency oscillator, a B.F.O. pitch control, send-receive switch, built-in loudspeaker, phone jack and provision for a doublet or Marconi aerial.

The first valve in the receiver is a 6TH8 triode-hexode designed specifically for short-wave working. This is followed by a 6K7 intermediate-frequency amplifier, a 6Q7 double-diode triode detector A.V.C. control and first-audio amplifier, and in the output stage a 6V6 tetrode, a small edition of the 6L6, which provides approximately 2 watts. The beat-frequency oscillator, a 6C6, has an iron-cored coil with the pitch control actually being a movable iron core.

The first coil in the I.F. amplifier is also iron cored, the transformers being tuned to a frequency of 456 kc. and adjusted to give a maximum band width of 7 kc. This provides quite a high degree of selectivity and as much as can be expected with a small receiver of this kind.

Despite the high selectivity the average gain is excellent. Average sensitivity figure over all wavelengths is approximately 20 microvolts per metre with a peak on the 10-metre ham band of 15 microvolts per metre. A figure which compares very favourably with sets of a higher price.

On the lowest wavelength band, the oscillator circuit is highly efficient,

made so by the use of a tuned reaction winding to ensure even oscillation over the entire band. Consequently, amateurs will find that the band covering approximately 17-46 megacycles is unusually sensitive and that the television transmission can be received at long distances from the transmitter.

Noise level is particularly low, and even with the B.F.O. in circuit the rise in noise is barely worth mentioning; however, to adjust the amount of coupling between the B.F.O. and the incoming signal, one can merely reduce the value of the coupling condenser. This condenser is made up of two parallel wires which can be pulled apart to reduce coupling. However, this little modification is not really necessary unless the user is likely to concentrate on the reception of very weak signals.

Band number one practically covers 14.5 to 47 megacycles, so allowing a slight tolerance at either end of the band over the official figures. Band two covers 5 mc. to 18mc., band three 1.6 mc. to 5.5 mc., and band four .5 mc. to 1.75 mc.

The band-spread control with its separate dial is calibrated in single degrees from zero to 100 and on all amateur bands except 160 metres gives complete coverage without having to re-adjust the band-set condenser.

As can be seen from the illustration,

the number of controls have been kept at minimum and all these are carefully marked to show their exact use.

We have tested this instrument and found it highly satisfactory. On C.W. it provides an extremely stable note free from wobble or drift. The cabinet and chassis are of heavy gauge steel, so that on the 14 megacycle band, for example, the receiver can actually be moved about a bench without the signal beginning to wobble.

The base of the receiver comes off very simply exposing all the trimmers to view. The model tested was very accurately aligned, but there are always amateurs who feel they can improve on the manufacturer's setting. They will appreciate the ease with which the "works" can be seen.

On all amateur bands a representative selection of stations were obtained and even on the higher-frequency bands when conditions were bad signals were received. The instrument is excellent on the commercial channels of 13, 16, 19 metres, etc., while the gain appears to be rather peaked on the now popular C.W.R. and Service channels.

The cabinet size is 17½ by 9½ by 18½, and at 9½ gns. it is really excellent value for money. Full information on this receiver can be obtained from the P.S.E.I., Ltd., Pilot House, Stoke Newington Church Street, N.16, mentioning this journal.

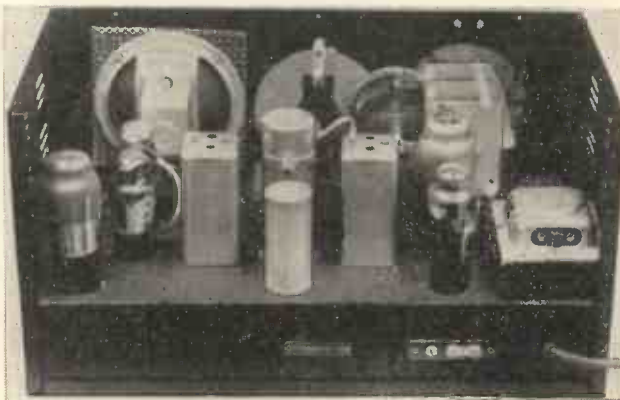

The back of the receiver comes away very easily exposing the main components to view. As can be seen a special band-spreading condenser is included.

Making the most of the S-valve Amateur-band Receiver

This receiver was first described in the May issue, but as many readers have asked for additional data on the operation, this short article has been prepared.

A CONSIDERABLE number of readers have asked for further details regarding this receiver so as to obtain the best possible results. As so many of these questions are of a similar type I hope to be able to deal with them in this short article.

A slight increase in gain can be obtained by altering the primary windings on the R.F. and mixer coils. This is a matter for experiment, but generally speaking the R.F. coil on 20 metres will stand a primary coil of four complete turns. On 10 metres the number of turns should be three or even four if the aerial in use is a short one. For the mixer coil try a primary winding of five turns on 20 metres and four turns on 10 metres.

Gain Controls

Some readers find that the gain control in both R.F. and I.F. stages are a little rough in operation. If this should be the case the variable resistances specified can be changed to 10,000 ohms each both having logarithmic patterns.

It is also possible to find two oscillator beats and the correct one to use is that having the lowest frequency. Here again a change can be made for it will sometimes be found that the high frequency beat will provide a better signal on the 10 and 20-metre bands. This, however, will tend to restrict the band-spreading. To overcome this one plate can be removed from each condenser allowing for a 170-degree coverage on the 20-metre amateur band.

All of these suggested alterations are quite unimportant but the additive effect is very considerable. It is also helpful to use a tuned aerial on each band. Those who are restricted to the use of one aerial should employ some sort of aerial coupling device for when the aerial is roughly tuned to the band in use the gain in signal strength can be as much as two R points. The transmitting amateur will probably have such a tuner already in operation in the transmitter so arrangements can easily be made to couple this tuner to the receiver.

A gain in the I.F. stages can be obtained by using as an I.F. amplifier the Mullard TSP4 pentode valve. Care must be taken in the wiring otherwise the stage may become unstable while at the same time the bias resistance must be altered to makers' requirements.

If the I.F. stage is made *controllably* unstable this also helps on weak stations. To do this remove some of the screened wire from the anode lead of the valve. Generally if about 2 in. of the covering is stripped off the stage will start to oscillate when the gain control is at maximum. In this way the last fraction of gain can be used.

The receiver will work down to 5-metres and put up a good performance on the television and amateur channels. However, it is important that the oscillator volts should be correct.

On 20 and 10 metres an oscillator voltage of 12 can be obtained without any trouble, but on 7 metres this will drop to about 7 volts and at 5 metres to 6 volts. However, it has been noticed that on the television band the performance is still good with the oscillator voltage down to 3 volts.

Very rarely does an amateur use all bands with the same degree of consist-

results can always be obtained on each band. It would be possible to arrange for one setting on the controls, but this would give average results on all bands without that peaking on individual bands which is now possible with this set.

The advantages of the three I.F. transformers was explained in the May issue. However, these transformers must be trimmed correctly and if possible with an oscillator and output meter. If test gear is not available, however, pick on a weak station and adjust the trimmers until the strongest signal is obtained. The trimmers should be adjusted in the correct order starting with VC13 and working back to VC7.

The B.F.O.

When listening to C.W. the output from the B.F.O. is hardly sufficient to beat up a very strong signal. This was

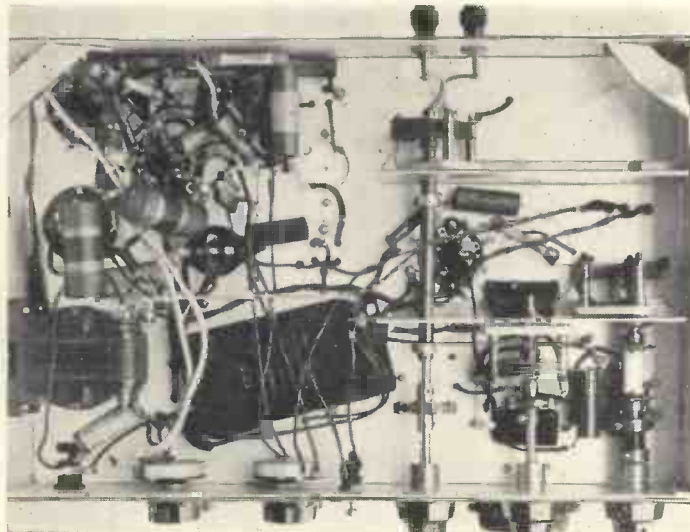

Most of the small condensers are fixed under the chassis including the band setting condensers.

ency. There are always one or two bands which are more popular. For this reason I suggest that the receiver be lined up for the most popular bands, for example, if the high-frequency bands are to be used arrange for the coupling condenser in the I.F. stage to be at minimum capacity for this will increase the selectivity without causing any decrease in overall gain. However, if the condenser is left set in the same position on the 160-metre band the signal strength will not be so great as if the coupling were tighter.

One of the advantages of a home built set is this versatility so the best

done in order to keep the noise level to a low level. Readers, however, who are prepared to put up with the increase in noise can make the B.F.O. more healthy by taking the lead from the anode of the B.F.O. valve direct to the diode anode in V4 blocking the D.C. voltage by means of a .00005-mfd. condenser in series with the lead. It should be pointed out, however, that strong signals can be heterodyned by merely reducing the R.F. gain.

If there are any points which I have not covered I shall be pleased to answer any letters if a stamped addressed envelope is sent with the letter.—J.T.R.

OSRAM

KT8

BEAM TETRODE



Type KT8

PRICE **22/6** EACH

Type KT66 price 15/- each

A New Transmitting Valve of outstanding interest for Amateurs

The Osram Valve type KT8 is a Radio Frequency Transmitting Tetrode having an indirectly heated cathode. It has aligned grids which produce directed electron beams resulting in a very low screen current. Thus the limit normally set by screen dissipation is largely removed. The valve is suitable for use as an Oscillator, Radio-frequency Amplifier or Frequency Multiplier for frequencies up to 60 Mc/S.

CHARACTERISTICS:

Heater voltage	6.3
Heater current	1.27 amp. approx.
Anode voltage	600 max.
Screen voltage	300 max.
Anode current	*95 mA. max.
Screen current	12 mA.
Anode dissipation	25 watts max.
Screen dissipation	3.5 watts max.
Anode input	57 watts max.
Grid driving power	0.5 to 1.5 watts
Mutual conductance	6.0 mA./volt

(measured at $E_a = 250$, $E_s = 250$, $I_a = 72$ mA)

* Under efficient Class C conditions.

Anode connected to top cap; British 5-Pin Base.

For Modulator, use OSRAM KT66. Output in Class AB₁ push pull, 32 watts audio; octal base.

Write for leaflets giving full technical and operative data to the Osram Valve Dept. of:
THE GENERAL ELECTRIC CO., LTD., Magnet House, Kingsway, London, W.C.2

Radio Society Activities

Will Hon. Secretaries of Radio Societies who wish for news to appear in this column please send the information before the 15th of the month.

Slade Radio

THIS society was perhaps one of the first in this country to organise Direction Finding Contests for amateur experimenters. They are now in the middle of a new series of contests which are being well attended. Test are being conducted on a scientific basis, using a formula to award points. A trophy is being presented to the winning team, which has been given to the club by the founder, Dr. C. H. Harcourt, M.B. The new hon. secretary is L. A. Griffiths, Esq., 47 Welwyndale Road, Erdington, Birmingham, who will be glad to send all details of the society to any interested reader living in the district.

Tonyrefail and District Radio Society

The hon. secretary of this society has now obtained his full transmitting call sign, GW3QB, and he is very keen to increase the number of members who are able to take part in field days and contests. Information can be obtained from E. Powell, Esq., 44 Pritchard Street, Tonyrefail, Glam. At the annual general meeting 2FRK, GW3QB, and GW3CR were elected chairman, secretary and treasurer respectively. It has been decided to hold the main Field Day on July 23, and members are now constructing apparatus and arranging duties. This contest is open to all members so that there is still time for intending members to join.

Eastbourne and District Radio Society

Recent lectures have dealt with radio from all angles including 5-metre aeriels and equipment, short-wave superhet receivers, commercial transmitters, and quality amplifiers. The hon. secretary of this society is T. G. R. Dowsett, 48 Grove Road, Eastbourne, Sussex, who can supply all data to intending members. Field days and outdoor contests have been arranged for the next few weeks and it is hoped that these will, as usual, be well attended.

Thames Valley Amateur Radio and Television Society

The T.V.A.R.T.S., whose headquarters are at the Albany Hotel, Station Yard, Twickenham, Middlesex, have found it necessary to effect a change in policy. Through lack of enthusiasm the old club was dissolved, but by approaching recently licensed amateurs a new club has been formed. This has a limited membership for those holding full radiating licences, artificial aerial licences and B.R.S. members of the R.S.G.B. The new club will still be known by the old name to avoid confusion. The main function of the

T.V.A.R.T.S. is to cater for those interested in short-wave transmission and to help as many members as possible obtain a radiating licence. A 3.5 mc. station was operated during the R.S.G.B. National Field Day for the third year in succession. The officers for the year are: President, G. H. Bilson, G6GB; secretary, D. R. Spearling, G3JG; treasurer, A. Mears, G8SM, assisted by G2NN, G5LC, G2GK, and G3GQ.

Wolverhampton S.W. Radio Society

During the past few weeks interest has been concentrated on 5-metre work with great success. Large numbers of



G5DR operating one of the R.S.G.B. National Field Day stations put up by the Cambridge group of amateurs.

amateurs have attended each 5-metre field day so that a special one has been organised for July 16. On these field days distances of up to 20 miles have been covered with reports from listening stations up to 35 miles. There are now four 5-metre stations active in Wolverhampton so that the next contest should be of particular interest. Full details can be obtained from the Hon. Secretary, W. H. Hill, G8BP, at the headquarters, 76 Darlington Street, Wolverhampton.

Wirral Amateur Transmitting and Short-wave Club

Meetings of members and interested amateurs are held on the last Wednesday of each month at 7.30 p.m. Membership at the moment is in excess of 45 including two full licences and several AA calls. Amateurs in the Wirral district are advised to get in touch with the secretary for this society has an interesting programme arranged including Morse classes and field days. A club magazine is also published. The hon. secretary is J. R. Williamson, 13 Harrow Grove, Bromborough, who will supply all details as to membership.

North Manchester Radio Society

Members of this society come from all parts of Manchester, for the headquarters are only two minutes from Prestwich Railway Station. Membership fee is 5s. per year plus a supplementary charge of 3d. at each official meeting attended. Club headquarters are open on Sunday afternoons for meetings, while a selection of radio magazines are available for the use of members which can be borrowed if required. Modern communication receivers are being demonstrated from time to time, while conducted tours and outdoor events have been scheduled. Headquarters are at 14 Fairfax Road, Prestwich, and the hon. secretary is R. Lawton, Esq., 10 Dalton Avenue, Thatch Leech Lane, Whitefield, Manchester.

The Woolwich and North Kent Amateur Transmitting Club

This society has just been formed and members are required. Any reader living in this area who is interested in amateur radio should get in touch with the hon. secretary, 33 Westergate Road, Upper Abbey Wood, S.E.2.

Southend and District Radio and Scientific Society

The next Field Day to be run under the auspices of the various societies whose names have previously been announced, is to take place on Sunday, July 9, and on this occasion will be organised by the Murphy Radio Club in the Welwyn district.

The last direction finding field day organised by the Romford Society was enjoyed by all. The organisers are to be congratulated on their choice of location, which introduced many unexpected difficulties. Enthusiasm is so great for these events that when one competitor was unable to find motor transport he dug an old bicycle out and during the day must have cycled over 50 miles with his equipment strapped on his back.

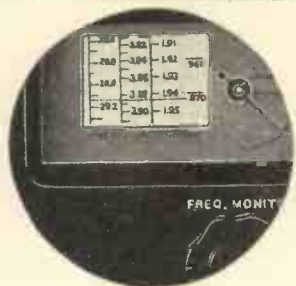

Spot Signals Scientifically!

WITH the NEW

HOWARD 460

COMMUNICATION RECEIVER

with built-in

FREQUENCY MONITOR AND
NOISE LIMITER

The NEW
Built-in MONITOR

Here's what it means to you!

- A self-contained frequency meter is built into this receiver which allows the exact frequency measurement of your own transmitter.
- It allows checking of the exact frequency of an incoming signal.
- It makes possible the location of the amateur bands with absolute accuracy.
- It makes it possible to re-set the dial to an exact pre-determined frequency so that you may be positive to return to any station which you have already worked.
- Allows you to set the dial on the exact frequency of a station which you wish to work.
- Accuracy is controlled by beating against an expensive broadcast station frequency equipment.

Other features :-

Ten tubes, noise limiter, moving coil "R" meter, 340 degrees of electrical band-spread, ceramic coil forms on high frequency bands, high frequency insulation on both tuning condensers, pre-selection on all hands from 43 m/c to 540 k/c, iron-cored I.F.'s, crystal filter, with iron-cored coupling transformer.

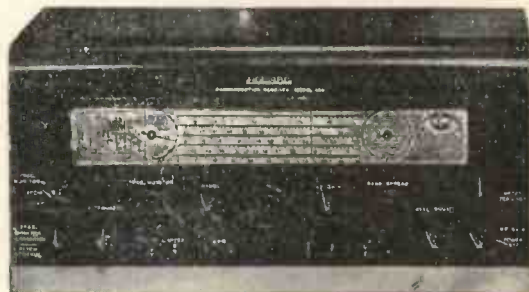

MODEL 460, with Frequency Monitor and 8-inch Dynamic Speaker in cabinet to match Receiver **£23 - 10 - 0**

MODEL 460, with Frequency Monitor, but with Crystal Filter and 8-inch Dynamic Speaker in cabinet to match Receiver **£25 - 10 - 0**

Model available has universal transformer.

Send for details of other Howard Models from 9½ gns.

HOWARD RADIO CO.

1731-35 Belmont Avenue,
CHICAGO, ILLINOIS, U.S.A.

RADIOMART

BRITISH HOWARD DISTRIBUTORS

G5NI Direct DISTRIBUTOR

IMPORTANT—

By buying from an Authorised Factory Distributor rather than a Company who purchases its merchandise in the open market, you get the latest instrument from the Factory and are registered with the Company as having purchased their merchandise. This ensures you maximum manufacturers' service after sale, and, in addition, the Distributor is supplied with the latest service bulletins in order that he, in turn, may pass on the advantages of such service. Remember, we are Authorised Distributors for the lines shown here and import direct from the respective Factories.

RADIOMART
G5NI (BHAM) LTD.

DIRECTORS: W. H. D. NIGHTINGALE L. NIGHTINGALE

FOR HOWARD

NATIONAL

HAMMARLUND

COLLINS R.M.E., Etc.

We are open to appoint a limited number of Distributors for the above lines and also "Raymart" short-wave components. Only firms capable of stocking and selling this merchandise are required.

THE SHORT-WAVE SPECIALISTS! The oldest importers of communication equipment. Direct Factory Authorised Distributors also for Bliley, Thordarson, Taylor, Raytheon, Elmac, Heintz & Kaufman Tubes, Hoyt Meters, Ohmite Resistors, Bassett Concentric Cable, etc., and we carry them in stock.

44, HOLLOWAY HEAD, BIRMINGHAM, I. Telephone: MIDLAND 3254

The Nursery Wavelengths

By G6

This provocative article has been written by a professional wireless engineer who holds a transmitting licence. He has been "off the air" for about ten years and, on returning, finds conditions so different that he puts forward suggestions for improvement.

I SUPPOSE that there is no Club, Lodge, Association, Society, or other group of men in existence that can, for sheer camaraderie equal the now large body of transmitting amateurs at home and abroad. They will go to no end of trouble, and often personal inconvenience, to help a transmitting friend.

But—I now prepare to duck—for sheer thoughtlessness and selfishness when on the air, some of the 'phone enthusiasts deserve to be put away into corrective institutions to be taught the elements of social conduct and restraint.

After about ten years' absence from the ether I come back and on the amateur bands I find that I have to try to inject my own modest attempts into nothing short of pandemonium.

Generally, the 'phone amateur ignores entirely what other people are doing. He scrambles for the desired contact among other scramblers in an uncontrolled din.

Another thing, if some of them could only realise that their voices are being reproduced at full strength not only in literally thousands of lounges, living rooms, and drawing rooms, but also in the laboratories of professional wireless engineers, they would blush with confusion and embarrassment.

To-day, nearly all wireless manufacturers offer all-wave sets and the voice of the amateur, like the broadcast artiste, can get into millions of homes.

There is the gentleman who talks about his school and his motor-car in a blasé old-school-tie style; the man whose domestic troubles have been brought to an end by divorce, and the cream of sententiousness in the voice of a gentleman who could, if you were there, prove to you by mathematics and a slide rule why his argument is sound though he is unable to put it into simple words.

The loudspeaker on which the latter was heard was damaged, I'm afraid, by books, transformers, a variable condenser, and a stool that were thrown at it by several professional wireless engineers whose feelings boiled above the cold atmosphere of the laboratory in which they were working.

Some amateurs on 'phone are entertaining; most of us have enjoyed, for example, the American lady, and the boys in Greece, but for every one gifted with a merry prattle there are dozens whose flat-voiced platitudes bring forth howls of derision from intelligent listeners.

I wonder how many transmitting amateurs know about the new family game called "Old Man Percentage"? This is useful on wet nights when ordinary broadcasting is a bit dull. The Bookie is selected, and he tunes in, on 20, 40, or 160 metres, to locate the six or seven most affectionate amateurs on the air. After a test period of listening, he states his prices and bets are laid by the family. One person takes down the transmissions completely. If he or she knows shorthand, so much the better, but they are usually laboured enough for longhand. The rest of the party meantime checks off each "old man" as it comes over. You know the sort of thing: "Thanks *old man* for your report. Yes, *old man*, I have gone up in frequency a bit *old man*, but I must say, *old man*, you are right outside the band. Yes, *old man*, no, *old man*, all right, *old man* . . ." and so on. Then we work out the percentage of *old mans* to the total words and the Bookie pays out on win and place bets.

I hate to spoil a good game, but really! . . .

A psychologist would say that these voluble radio telephonists reveal the existence of a repressed ego. Failing, perhaps, to find a means of self-expression in their daily lives, they come home at night and pour their troubles and their triumphs into the ether—so they think—for one man to hear, but unfortunately it comes back again with a shout where they least expect it. A great deal of it is as remote from the needs of experimental wireless as an office boy's usefulness is to the business success of his firm.

You may say, "Don't listen to it, then," and there's the rub. One has to, sometimes, if one wants to use the ether as well.

Ignoring altogether the subject matter of the transmissions, these voluble amateurs occupy too much ether and for far too long. As there is much more in fishing than catching fish, so there is far more in transmitting than making contacts.

Surely it should be the duty of each amateur to listen first upon and around the frequency he proposes to use. If it is being occupied by C.W. or telephony then he should refrain from transmitting until the others have finished. If the others should commit the crime of persistent occupation then they deserve to be jammed until things are straightened out.

"Ah!" says the ruthless DX seeker who is not limited by money or time, "if I were to wait until my channel were clear I should never do anything." So he applies for permission (sometimes) to use increased power and, in steps, reaches the maximum to shout everybody else down. Thus things get worse instead of better and it is no cause for surprise to learn that the Post Office comes down quickly on those who wander, with their infernal din, outside the band.

Behind all this sit, in dignity and skill, the C.W. amateurs. These gentlemen of the ether usually occupy no more than their allotted frequency, with a note pure and steady by crystal control (often an example to commercial and official stations), and for the minimum transmitting time. They do not leave a carrier whistling away while they think out the next thing to say, and their transmissions are rarely heard, and certainly not understood, by the listening public.

How often do we hear a clear, clean note coming over in unblemished Morse to the correct international procedure, suddenly blotted out by the familiar "Boo. . ." of the telephony carrier, dropping slightly in pitch as it settles down, and then the wash of modulation elbowing its way through the crowd.

It can be argued, of course, that this state of affairs stimulates progress in design; that here we have the reason for the highly selective communications receiver, but would it not be better, now that so many occupy the amateur bands, to adopt an Ether Code.

There is now a "First-Class Operators' Club" (F.O.C.) whose object is "To encourage and maintain a high standard of operating technique amongst British Radio Amateurs" from which it is obvious that members of the Club propose to adopt a gentlemanly code of behaviour in the use of the ether; a step in the right direction.

Applicants for membership of the group are invited to make suggestions which I have already done, and if a substantial backing is obtained, the Manager and Committee have promised their full support in putting the scheme into operation.

My suggestion is that we should adopt a semi-commercial procedure. We must start somewhere and the logical thing to do is to start with those who are most advanced. The C.W. amateur is more than half-way to

PREMIER 1939 RADIO

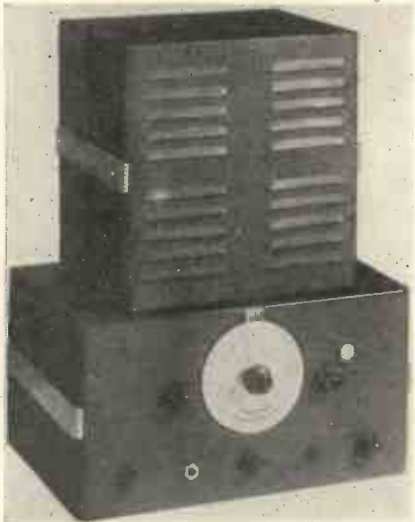

PREMIER 1939 "5. v. 5" COMMUNICATION RECEIVER

5-valve Superhet-covering, 12-2,000 metres in 5 wave bands.

- Beat Frequency Oscillator
- 2-Speed Band-Spread Control
- A.V.C. Switch
- Illuminated Band-Spread Dial
- Send-Receive Switch
- Iron-cored IF's
- Phone Jack
- Over 4-watts Output
- Illuminated Band-Spread Dial

Provision for single wire or Di-pole Aerial. International Octal Valves for 200-250 v. mains (A.C.). Built into Black Crackle Steel case providing complete screening 10½ in. Moving Coil Speaker in separate steel cabinet to match

Receiver. Complete with all tubes and Speaker **£8 - 8 - 0**

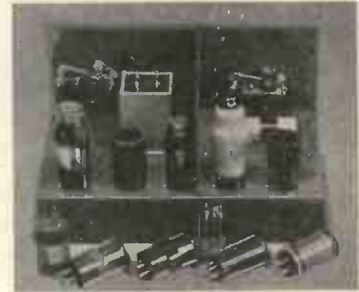

PREMIER SHORT-WAVE KITS

Complete to the last detail. All valves and coils are included as well as theoretical and wiring diagrams, and lucid instructions for building and working.

Each Kit uses plug-in Coils and the Coils supplied tune from 13 to 170 metres. All Kits are supplied with a steel chassis and Panel.

- 1 Valve Short-Wave Receiver or Adaptor Kit 17/6
- 2 Valve Short-Wave Receiver Kit 25/-
- 3 Valve Short-Wave Screen Grid and Pentode Kit 58/6

**HUGE REDUCTION IN PRICES
OF TRIAD AMERICAN VALVES
SEND FOR LIST**



PREMIER 3-60 WATT AMPLIFIERS

A NEW RANGE OF 7 HIGH FIDELITY PA AMPLIFIERS

Designed along the most modern lines and incorporating the very latest developments in radio technique, these amplifiers can be relied upon to give a continuous dependable performance.

All models up to 15 watts can be purchased in Kit form if desired, with the necessary straightforward diagrams and wiring instructions.

The 6-, 8-10 and 15-watt systems incorporate the new Premier Matchmaker Output Transformer, enabling any single or combination of speakers to be used. Two separate input channels are provided which can be mixed at any level. Built-in Pre-Amplifiers ensure that the gain is sufficient for any low-level crystal or velocity microphone.

The actual gain of the 6- and 15-watt units is over 100 decibels. A Tone Control is provided varying in all models, permitting compensation for varying acoustical conditions.

The 3-watt A.C. Amplifier has provision for energising a 2,500 ohm field speaker.

All amplifiers can be supplied with Matchmaker Modulation Output Transformers at the same price and are designed for 200-250 volt mains (A.C. Models 40-100 cycles).

	KIT with valves	Complete wired and tested
3-watt A.C.	£2 0 0	£2 15 0
3-watt A.C./D.C.	£2 0 0	£2 15 0
6-watt A.C.	£5 5 0	£6 0 0
8-10-watt A.C./D.C.	£4 10 0	£5 5 0
15-watt A.C.	£5 15 0	£7 0 0

Black Crackled Steel Cabinet (as illustrated) 15/- extra.

30-60 WATT A.C. AMPLIFIERS

are designed to cover as wide a utility range as possible. Housed in a steel case, the 6-stage circuit gives an undistorted output of 30 watts. Two additional beam power valves, for which sockets are already wired in circuit, enable the output to be increased to 60 watts. Alternative power supplies are available in steel cases to match the amplifier. Model A30 provides all necessary power for the 30-watt, and A60 for the 60-watt Amplifier. The 30-watt outfit can be increased

COMPLETE AMPLIFIER, with separate 30-watt Power Pack and 7 valves, in black crackle finish steel case **12 gns.**

to 60 watts at any time by substituting the A60 power supply for the A30. Three separate input channels, two of which can be mixed at any level, are provided. The Class AB1 output stage has negative feedback applied, enabling unusually high quality to be obtained. Carefully chosen component values and the use of resistance coupling throughout result in a flat response curve of from 30 to 11,000 cycles within 2 dB. The high level input channel has a gain of over 100 dB.

COMPLETE AMPLIFIER, with separate 60-watt Power Pack, and 9 valves **15 gns.**

ALL POST ORDERS to:—
Jubilee Works, 167, Lower Clapton
Road, London, E.5. Amherst 4723.

PREMIER RADIO

**CALLERS to:—Jubilee Works, or 165
Fleet St., E.C.4. Central 2833 or 50 High
St., Clapham, S.W.4. Macaulay 2381**

the desired goal and since most of them will be in sympathy with this plan, there is good reason to believe that the start will be a good one.

What we are going to do about the telephonists, especially those who completely blot us out for half-an-hour at a stretch with multi-plex, I do not know for the moment, but it will all come out in the wash, and those with commercial experience on that side will help, I feel sure.

On the C.W. side then, it is suggested that each member of the club should use a printed telegraph form in pads, roughly, as follows:—

FIRST-CLASS OPERATORS' CLUB.				
Date	Time sent	Words	Time recd.	Band
To :				
via				

Where contact is desired the station originating the message calls in the commercial fashion:

GIAA de GIZZ. F.O.C. MSG

the call signs being sent three times each. If no reply is forthcoming the call is repeated at a fixed period later.

When the station transmitting is heard, the station called replies: GIZZ de GIAA. K, and the message is sent in the usual way. Matters of QRM, QRN, and words missed are overcome in the commercial fashion until the recipient is able to give his R.

That contact is then completed as though a third person had written out the message. The channel becomes free for others, while the recipient writes out his reply with telegraphic brevity. In the meantime either the sender or receiver may accept or transmit messages from others in like form.

When the reply is ready the recipient of the first message now becomes the sender and, after calling and receiving K, sends his message in the same way. The form is ripped from the pad and impaled upon a spike file for reference, P.O. check, and agreement with the log-book is required.

I see nothing in this that runs counter to the Post Office requirements any more than Police regulations could be disregarded by the actions of a pedestrians' club, the members of which adopted a rigid and polished procedure

of keeping always to the right, stepping into the road at a Belisha crossing to indicate intention to cross, waiting for, say, six cars to pass, and then proceeding with hand uplifted.

With other minds to work on this to settle details something good should come of it, and surely we should get assistance from the Post Office on borderline points if any. Once in operation there are all sorts of things that could be done to bring the amateur bands out of the nursery where they are getting a bit too old to stay.

To relieve pressure on the present manager of the F.O.C., the Editor has

Active 5-metre Stations

Max. Buckwell, G5UK, whose QRA is Leigh-on-Sea, is now very active on 5 metres. The transmitter uses an 808 in the final, runs with an input of 90 watts, while his receiver is a superhet built especially for the 5-metre band, with acorn valves, and a signal strength meter. During the past few weeks he has worked and heard a large number of 5-metre stations and has supplied the following information for amateurs active on this band and also listeners who wish to check their receivers.

The following are the crystal frequencies of some of the better known short-wave stations.

kc.		kc.	
56,020	G5ZT	56,952	G6NU
56,020	G6TL	57,000	G5UK
56,070	G3CU	57,000	G5ZT
56,088	G6QC	57,084	G6TL
56,120	G2KI	57,200	G8KD
56,170	G6FL	57,240	G2KI
56,180	G5MA	57,300	G2MV
56,336	F8CT	57,400	G2OD
56,340	G6QZ	57,470	G8OS
56,360	G6PG	57,600	G6CW
56,400	G5AA	57,680	G5CD
56,400	G8MU	58,000	G2NH
56,520	G6QC	58,000	G8JV
56,704	G2KI	58,828	G8LY

The following stations have been heard but no frequencies are available, G5TX, G6VX, G5BY, G6FO.

In addition the following six stations have been worked but frequencies not obtained: G6DH, G6NC, G2AW, G2ZV, G6OT, G2LC.

G5UK operates every evening on 56 mc. immediately after the finish of the B.B.C. television programme. In addition he has a regular schedule at 7.30 B.S.T. and uses on all transmissions an automatic sender. He mentioned that at the present time 5-metre stations are best received between 22.000 and 23.15 B.S.T.

While on the topic of short-wave activities we should like to mention that G5TZ, in the Isle of Wight, is receiving Belgian and Dutch stations, but so far has not been able to work them. Signals, however, are reasonably consistent.

Edgware Short-wave Society

Arrangements are now well in hand for a 5-metre Field Day to be held by this society on July 2. Ten entrants are competing and G2QYP will be in charge of the transmitter to radiate each hour for five minutes. This station is also working on July 9 during the R.S.C.B. 5-metre Field Day.

Future meetings include a discussion on 5-metre Field Day apparatus.

kindly given his permission for letters and postcards of approval and criticism to be addressed to me as follows:

"Semi-commercial,"

c/o Television and Short-wave World.

Each one will be acknowledged briefly by card, the letter analysed and submitted to the F.O.C.

Do you agree?

"A Long Distance Short-Wave Receiver"

(Continued from page 419)

but recent tests have shown that it will provide quite reasonable gain on the 10-metre band provided the band-setting condensers are omitted. This merely means releasing two wires, one from each condenser. Actually, what happens is that the added capacity of C1, C2, C5, C6 and C7 is rather too high to allow of satisfactory 10-metre operation. For this reason, C1 and C5 are omitted on that band only.

During the past few weeks the 10-metre band has not been particularly lively, but signals have been received and when compared with reception on other receivers, this band appears to be quite satisfactory.

It is not advisable to consider this set suitable for medium wave broadcast reception except by Colonial users.



The finest key in the world at the price. Heavy cast parts. Balanced arm. Solid silver contacts. Ideal for the fast sender, 11/8.

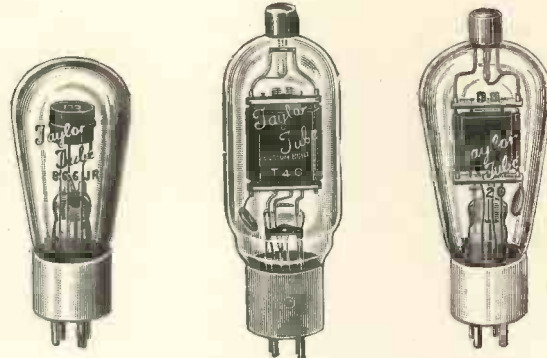

TAYLOR TUBES.

866 Jr. Mercury Rectifier ...	7/-	T40	24/-	T20	17/6
		TZ40	24/-	TZ20	17/6

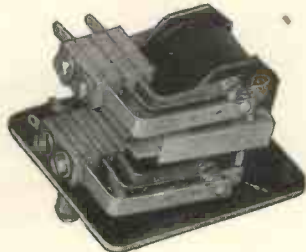

GUARDIAN RELAYS.

B100. Break-in relay. Coil for 230-volt operation. As illustrated, 33/-.
K100. Keying relay. Will handle 2,000 v. at 60 w.p.m., 24/-.
R100. R.F. relay. Useful for switching coils, crystals, etc. 13/-.

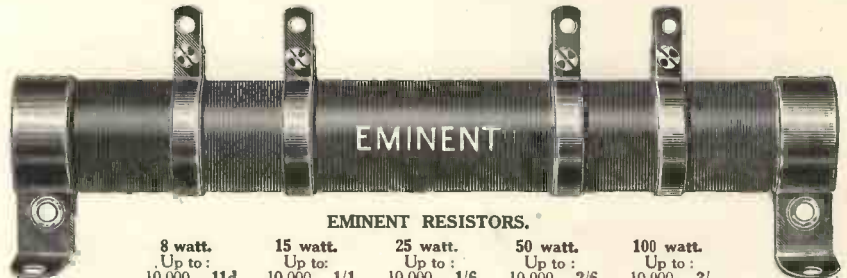

EMINENT RESISTORS.

8 watt.	15 watt.	25 watt.	50 watt.	100 watt.
Up to:	Up to:	Up to:	Up to:	Up to:
10,000 11d.	10,000 1/1	10,000 1/6	10,000 2/6	10,000 3/-
20,000 1/1	20,000 1/4	20,000 1/9	20,000 2/9	20,000 3/5
50,000 1/4	50,000 1/6	30,000 1/11	30,000 2/11	30,000 3/8
		40,000 2/1	40,000 3/-	40,000 4/-
		50,000 2/3	50,000 3/2	50,000 4/6

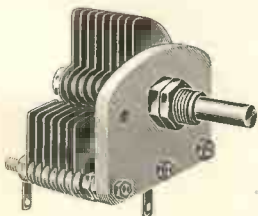

Frequenta ended, single end plate type. No. 275.

50 mmfd.	2/8
100 mmfd.	2/11
150 mmfd.	3/7

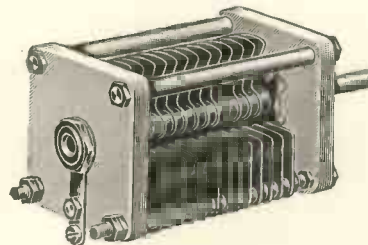

No. 370. As illustration. Silvered vanes. Working volts, 1,000.

25 mmfd.	4/9
50 mmfd.	5/-
100 mmfd.	5/11
150 mmfd.	6/10
200 mmfd.	10/-

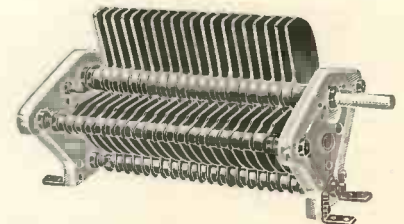

No. 400. The highest grade transmitting condenser on the market. Working volts 3,000. Extremely solid Frequenta ends. Frequenta extendible shafts.

150 mmfd.	28/-
250 mmfd.	33/-

We have stocks of Ham goods in immense variety. Most types of Raytheon RK types in actual stock. 1851's, 1852, 1853. Practically all Raytheon, Yale, Sylvania & Impex types also in stock. Sleeveings. Trolitul sheet and rod. Coil formers, Keys, Ceramic and Paxolin valveholders. Black crackle paint that works. Transformers, Chokes, Aerial wires in enamelled copper and copperweld. Thousands of small lines such as plugs, sockets, clips, washers, etc. Eidsons 7 Mc. crystals 10/6d. Eidsons ceramic crystal holders 7/6d. Electrolytic and paper condensers at the right prices. Send a penny stamp for June list. Good discounts to genuine traders.

HAMRAD WHOLESALE LTD., 32 ST. LAWRENCE TERRACE, W.10
LADbroke: 1166

With the Amateurs

Beam aerials, some hot news about new receivers, and new countries to work are discussed in this article by G5ZJ.

BEAM aerials are at last coming into their own in this country, probably due to the very bad conditions which make it essential that amateurs either greatly increase their power or the efficiency of the radiating



The rotary beam at G2FB.

systems. As a power increase of any importance is now impossible the only way of working DX particularly on telephony is by using high-gain narrow-angle rotary or fixed beams.

G2FB

A recently licensed station G2FB at Welwyn, Herts, is doing extremely well on 20-metre phone with an extremely low input. Many may think the station uses a "Californian kilowatt" or something like that for the DX worked by G2FB is really exceptional. However, I decided to go along and look at this station and found that the input really was low and that the explanation was to certain extent location but primarily the excellent results are due to antenna systems pure and simple.

A lattice mast has been erected and is used as a focal point for all antenna systems. In use at the present time are a fixed W8JK beam which is hung up well in the clear and does provide a good gain on 14 megacycles. Two half-waves in phase are also available and finally a rotating beam with close spaced reflector.

The tower on which the rotating beam is mounted is not very high but as the roof of the building is comparatively flat and is 70 ft. above ground the aerial is really in an advantageous position. By using the main lattice mast as a fixture for various aerial systems G2FB is able to erect simple aerials in practically almost any position he requires, for around the house are a large number of 70-80 ft. trees to which the

free end of the antenna systems could be connected.

I spent a most enjoyable evening with G5UMP at Mardley Hill, near Welwyn, where the 1.7 Mc. N.F.D. station was being operated. G5UMP did extremely well particularly in view of the fact that the input was only 7-8 watts, power being obtained from a vibrator converter. However, some really slick operating by G8DR and G5UM soon piled up the points. This location is ideal for 1.7 operation as a near-by tree is approximately 140 ft. away from the site selected for the station so that 132 ft. aerial could be used without trouble.

G5DR of Cambridge also had a good portable station for N.F.D. and had plenty of help both with the operating and the catering, the latter point being very much appreciated.

A general topic of conversation at recent ham meetings has been DX on 5 metres and all sorts of amateurs who normally keep to the L.F. bands are now considering what they can do about a transmitter for 5 metres. The Thornton Heath short-wave society are arranging a contest for 5-metre direction finding on July 9 and stations who are participating include G2DP, G2RD and G3FP.

It is very likely that these transmissions will be heard over fairly wide distances so that readers with suitable receivers are invited to listen. The secretary G2RD of 4 Nutfield Road, Thornton Heath, Surrey, will supply further data on this event.

A New Zone

VE5AHU is located 28 miles from the Arctic circle and is not just another VE5 station to be worked, for he tells

me that he is in zone one and for most European amateurs this would probably be a new zone to add to the list.

VY1AQ is very keen to work G stations and promises to QSL one hundred per cent. He uses a pair of TZ40's in Class C with 120 watts input, Class B

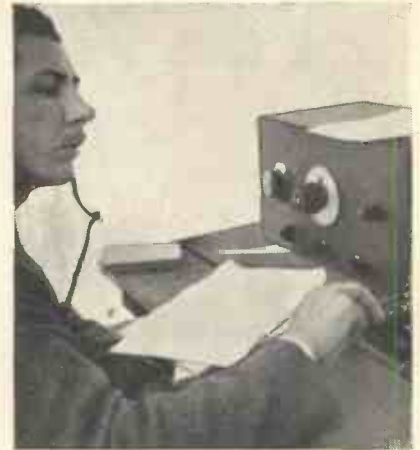

One of the operators at G5UMP was G8DR, here at the key.

modulated by RK15's and uses a matched impedance Y antenna. The receiver is a Hallicrafter SX16.

A New Hallicrafter

While talking about Hallicrafters, here is something that is really news. A receiver which is going to completely shake up the market as regards ham communication receivers. This set is the new Hallicrafter SX24, a nine valver that has everything. It covers 8-wave bands, from 8½ to 550 metres, has a crystal filter, built-in frequency monitor with a calibrated band-spread



National Field Day with the Cambridge group of amateurs under the direction of G5DR. Laurie Jones, G5JO, is also taking an active part in this station.



Principles and Practice of RADIO SERVICING

By H. J. HICKS

305 pages, 9 x 6, 212 illustrations. 18/- net

THIS book approaches radio servicing from the angle of showing how and why various circuits operate. The fundamental principles underlying amplifiers, detectors, power supplies, and other component parts of radio sets are carefully explained and the application of each point to set operation and set troubles discussed. Here is information that goes beyond rule-of-thumb methods—familiarises you with the engineering principles underlying the construction and function of radio parts and circuits, so that you can handle not just a few, but all kinds of troubles that may arise.

Theory and Applications of ELECTRON TUBES

By HERBERT J. REICH

670 pages, 9 x 6, illustrated. 30/- net

THE purpose of this important new book is to give the reader a sufficiently thorough grounding in the fundamental principles of electron tubes and associated circuits to enable him to apply electron tubes to the solution of new problems. The author has not attempted to discuss all applications of tubes to special problems but rather to cover basic principles and typical applications. At the same time, the book is exceptionally complete, including a wealth of material assembled and co-ordinated in a single volume.

Principles of ELECTRICITY and ELECTROMAGNETISM

By GAYLORD P. HARNWELL

619 pages, 9 x 6 illustrated. 30/- net

EMPHASISING the experimental and scientific rather than the mathematical or engineering aspects of the subject, this important new book is intended for advanced undergraduate or graduate courses in electricity and magnetism. In addition to the fundamental classical phenomena, elementary discussions of electronics and gas discharges have been included. It is assumed that the student is familiar with the elements of the subject of electricity and with the fundamental mechanical concepts of force and energy. A knowledge of the differential and integral calculus techniques is also pre-supposed.

McGRAW-HILL

Aldwych House,

London, W.C.2

HURRY!

In addition to our range of new Communication Receivers we have a very fine selection of shop-soiled and second-hand receivers and transmitters. We fully guarantee every item and we make a point of checking carefully the alignment, sensitivity and controls of every piece of apparatus before sale. We list below a small selection of receivers and transmitters, but suggest that you send for our free catalogue giving technical data on the entire range.

- NATIONAL NC-44, 10-550 metres, complete with speaker, perfect £14 - 0 - 0
- SERGEANT'S STREAMLINER 39, 10-550 metres, built-in speaker £8 - 0 - 0
- HALLICRAFTERS SUPER SKYRIDER, SX-16 5-550, metres, crystal £24 - 0 - 0
- RME-69, standard model, 10-550 metres, crystal, perfect £25 - 0 - 0
- NATIONAL NC-100, 10-550 metres, complete with speaker £25 - 0 - 0
- HARVEY UHX-10 TRANSMITTER, 5-160 metres, 3 crystals, A.C. pack £19 - 10 - 0
- SCOTT FIFTEEN, 15 tubes, 13-600 metres, 20 watts output £15 - 10 - 0
- HAMMARLUND SUPER-PRO, SP-120-X, 7½ to 240 metres, 12-in. speaker £55 - 0 - 0
- AMERICAN PRESTO RECORDING OUTFIT, in carrying case with special motor, cutting and play-back heads, amplifier, speaker and crystal microphone on floor stand £40 - 0 - 0
- TEMCO 100 TRANSMITTER, for 10, 20, 40 and 80 metres, complete with all coils, tubes and antenna matching network, 125 watts phone and 175 watts CW. A really super outfit. £75 - 0 - 0

ALL EDDYSTONE AND HAMRAD COMPONENTS, BROWN'S HEADPHONES, HYTRON TUBES, ETC.

SEND FOR FREE LIST TO :-

A.C.S. RADIO TECHNICAL MANAGER **G2NK**
16 GRAYS INN ROAD, LONDON, W.C.1
Telephone: HOLBORN 9894-5

WHERE THE HECK? DO THEY ALL GO?

The majority of Radio and Television Amateurs would be surprised to know the number of Transformers, Chokes, etc., that we produce during the year. If you made umpteen guesses it would be very difficult, even if you did arrive at the approximate number, to find the reason for such a large quantity and the ultimate destination of all these products.

Firstly, it would take pages and pages of "Television and Short-Wave World" to fully describe all the different types, but it is not so difficult to account for the quantity when you realise that we have a special section devoted to the design and production of Transformers, Chokes, etc., of all types which are supplied to Government Departments, Laboratories, Institutions, and a very large number of Amateurs and Radio enthusiasts throughout this country and abroad.

In view of the number of similar products it may seem to you a miracle that our sales are so high and that we keep it up all the year round—the answer—"ASK ANY OWNER OF A SOUND SALES PRODUCT."

In any case, why not let us send YOU our latest catalogue and Technical manual. PRICE 6d.

NOW READ THIS

This advertisement appeared in the JULY 1938 issue of this journal. The position is the same to-day.

Specified by the Experts
SOUND SALES

MARLBOROUGH RD.,
UPPER HOLLOWAY,
LONDON, N.19.



(Contractors to the
G.P.O., etc.)
Tel.: Archway 1661/2/3

New Tx Condensers

dial, a built-in noise limiter and is a receiver built entirely for A.C. mains. The price is only £21, so bringing it down to the low-price range. A full specification can be found on the back page of the cover.



G8DR and G5UM himself at the NFD station G5UMP.

Another item of news regarding Hallicrafters is a frequency meter that can be used to calibrate incoming or outgoing signals and crystals. It is extremely accurate, completely self-contained and is A.C. operated. The price, complete, £9.

Many amateurs have used the popular G.E.C. Home Broadcaster microphone, in fact on 40 metres every other station at some time or other seems to have invested in one of these little microphones. In view of its remarkable

success a new model has been produced providing an even better performance with low noise and is mounted in a bakelite case. It is provided with a base containing the battery and volume control and is supplied complete with 25 ft. of screened cable. The price remains unchanged at 1 gn.

G2JH

I listened to an interesting QSO on 40 metres between two stations, one of which is using the call sign G5ZJ, my own. This QSO went on for quite a long time and after it had completed, I called the pirate G5ZJ, but unfortunately there was no reply. There seems to be quite a lot of this pirating about, for J. K. Hankinson, G2JH, who only works on the ultra-high frequencies, is receiving a lot of cards regarding his supposed transmissions on 3.5 Mc. Any amateur who can supply information regarding the pirating of G2JH should send it to the real holder of this call sign at the address in the call book.

W2JKQ, W. P. Schweitzer, who is so well known to British amateurs via his 20-metre telephony, sailed on June 29 in the *President Wilson* with the U.S.A. Rifle Team which will be taking part in contests at Petersham this year. He is staying in London and hopes to contact some of the British amateurs he has worked over the air.

A very strong signal is being received in this country from VU2FA operated by Major Atkinson from Kasauli. The signal is actually R9 on the meter with a frequency of 14,092 Kc. and the QRA which is not in the call book is The Military Food Laboratories, Kasauli, Punjab, India. A new batch of crystals have just been sent out to VU2Fa, so in addition to 14092 he will be using 14016, 14024, 14044, 14060 and 14092 with a rhombic antenna.

A most consistent station from Georgetown, British Guiana was VP3LF, ex VP3AA. He is now off the air until next September, but who will be operating from various VP6 stations, as he is on holiday in Barbados.

ZD2B whom many amateurs think is a pirate station is actually fully licensed and can be heard on telephony at the L.F. end of the 20 metre band. He is using an electron-coupled oscillator and the station is actually operated by some engineers of the Royal Corps of Signals at Gibraltar. ZD2B will probably be a new country for British amateurs.

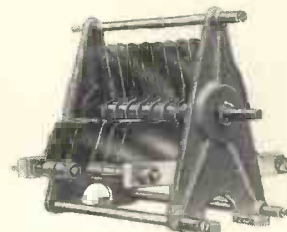

One of the new Raymart wide-gap condensers which are mentioned in the text.

I have just been trying some of Raymarts new transmitting condensers. They are certainly very robust and easy to mount. They are available in fixed Stator or single types in all the usual capacities from 50 mmfd. each station to 100 mmfd. each section and costing 17s. 6d. or 22s. 6d. They are of the 3,500 peak voltage type and a minimum spacing of .087 in. The single type of 100, 200 or 300 mmfd. are priced at 16s. 6d., 22s. 6d. and 27s. 6d. respectively, being of the 10,000 peak voltage type and with a plate spacing of .190 in.

Housewife

"AND HERE'S TO THE HOUSEWIFE THAT'S THRIFTY"

HANDY, BRIGHT and
SAVES YOU MONEY!

100 PAGES, 33 ARTICLES
AND FEATURES

6^D MONTHLY

Housewife is the first pocket-size magazine dedicated exclusively to the woman of the home. It caters for every aspect of the housewife's interest—her house, her children, her kitchen, her hobbies, her appearance, her social activities. No other monthly magazine of feminine appeal includes such a variety of subject matter treated from an essentially practical point of view and presented in such a highly condensed, yet readable form.

JULY ISSUE NOW ON SALE AT ALL NEWSAGENTS

PUBLISHED BY THE PROPRIETORS OF "TELEVISION & SHORT-WAVE WORLD"

VALVEHOLDERS

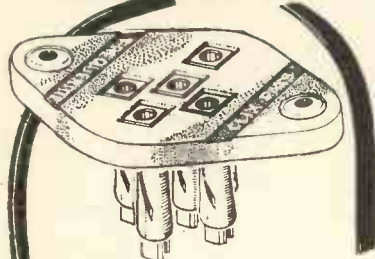

The CLIX valveholder range covers patterns to accept all the recognised English and American valves including the Midget and Acorn types.

As an alternative to the usual Paxolin Models there is a series with Frequentite CERAMIC plates specially suited for Television, Short-wave and other high-efficiency work.

"CLIX" specified by the designer of the KT8 TRANSMITTER described in this issue.

- 1 Ceramic octal type X248 1/3
- 2 Ceramic 5-pin type X147

11d. ea.

- 1 Lam-plastic base, 4-pin type XIII 5d.

All contact-tubes are of the CLIX RESILIENT type, machined from the solid (not stampings) and, by a process involving helical slotting, are given a stout resilience which guarantees perfect contact irrespective of the valve-pin construction.

CLIX Radio and Electrical Catalogue Free.

CONNECT WITH CLIX

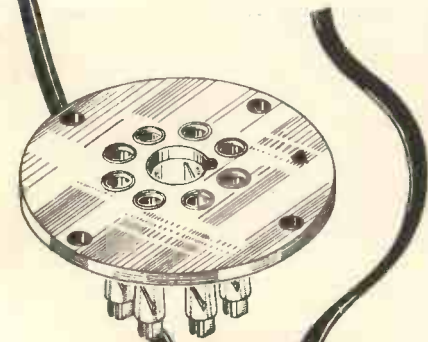

CLIX

British Mechanical Productions, Co., Ltd.,
79a, Rochester Row, London, S.W.1.

Hoddesdon and District Radio Society

During the last 160-metre Field Day organised by this Society stations worked included G8TM, G8TL, G8SK, G2WT, G6UT, and many others. The transmitter consisted of a crystal-oscillator and a power amplifier using a P.M.22A battery-operated valve on 1,940 Kc.

G5HO and 2SUU have been experimenting with kite aerials while on holiday in Ventnor. No London stations were heard on 160 m. in I.O.W., but a Weymouth station, G2XQ, was well received. Full information on this society can be obtained from the hon. secretary at Caxton House, High Street, Hoddesdon, Herts.

The Bromley and District Short-wave Society

The Bromley and District short-wave society is now well on its feet under the presidency of Mr. Miles, G2NK, so well known to the amateur radio fraternity. At the moment some 25 members have joined the society, giving a nucleus on which to build a more ambitious scale. The great demand for morse classes has been met by instruction under G8KV, and it is anticipated thus to help the AA members to a speedy full licence. At a recent meeting an interesting description of his special TRF receiver was given by 2FWV, followed by a practical demonstration of its capabilities on the amateur bands.

Weekly discussion meetings are held at the clubrooms at 191 High Street, Bromley. All interested in short wave radio in the district are invited to attend. Particulars of membership can be obtained on application to the Secretary, Mr. H. N. Holbrook, 191 High Street, Bromley, Kent.

CANDLER CAN HELP YOU!!!



All desiring to become proficient in Code work should fill in the Coupon below.

Candler Code Courses

have helped thousands to pass their full tests for securing licences, and have also helped numerous operators to greatly increase the w.p.m. speeds.

Three Famous Courses

Junior Scientific Code Course for beginners. Teacher all the necessary code fundamentals scientifically.

Advance High Speed Telegraphing for operators who want to increase their w.p.m. speed and improve their technique.

Telegraph Touch-type Writing for those who want to become expert in the use of the typewriter.

Terms: Cash or monthly payments
Fill in the coupon for FREE copy of the "BOOK OF FACTS"

COUPON	
NAME
ADDRESS
Post coupon in 1/2d. unsealed envelope to London Manager, (Room 55B), 121, KINGSWAY, LONDON, W.C.1 CANDLER SYSTEM CO. Candler System Co., Ashville, North Carolina, U.S.A.	

TROPHY Short Wave COMMUNICATION Type Receivers



All-British TROPHY Receivers satisfy a long-felt want. We believe (and the large number of TROPHYs now in regular use proves) that TROPHY Performance and Value feature combination, is definitely unbeatable. The scientific interest, listening thrills and entertainment provided by the short-waves make a reasonable demand—the use of a specially designed TROPHY. The 8-valve TROPHY A.C. Communication model (illustrated) has a continuous wave-range of 7 to 550 metres with R.F. on all 5 bands. Bandspreading is continuous and refinements include AVC and BFO switches separate Oscillator, Pitch control, Stand-by switch (for transmitters) and headphone jack. The TROPHY 8 is designed for use with a separate P.M. speaker. Cash price 12 gns. Terms: 15/6 deposit and 18 monthly payments of 15/6. Guaranteed, 12 months including valves. Matched Cabinet Speaker 2 Gns. extra.

TROPHY models from £5 15s.

See page 417 for special review on TROPHY 6 by Mr. Kenneth Jowers, S/W Editor. Demonstrations arranged at both branches below. Complete lists available post free.

PETO SCOTT CO. LTD.,
77 (T15) City Road, London, E.C.1. Tel. Clissold 9875
41 (T15) High Holborn, London, W.C.1. Tel. Holborn 3248

Universal Electrical Co.

221, CITY ROAD,
LONDON, E.C.1.

Telephone: CLERK 7030

- Photo Electric Cells, 15/- each.
- Mercury Relay Valves (American) for use with above valves if necessary, 10/- each.
- Champion Valves most types, 2/6 each.
- Transformers 110 to 230 volts, 12 volts input, 15/- each; 240 volts input, 6 volts output, 6/- each, suitable for trains and models.
- Claude-General Neon Transformers input 200/240, output 3,000 volts, .1 K.V.A., 10/- each.
- D.C. Electric Drills, 230 volts, 30/- each.
- Sliding resistances, 400 and 800 ohms, 7/6 each.
- Sets of "G.E.C." Filters, 5/- each.
- Anti-Interference Units, pair of H.F. Chokes and pair of .1 T.M.C. Condensers, 2/6 the set.
- New 30th H.P. Universal Motor, 200/250 volts, 27/6 each.
- American "Weston" Set Analyser, A.C./D.C., 1,000 ohms per volt, 2 Meters, £4/10/-.
- "Ferranti" Line Transformers, new, 6/- each.
- "Foster" Double Wound Transformers:
 - 110 to 230 volts 500 watts, 50/-
 - 110 to 230 volts 1,000 watts, 80/-
 - 110 to 230 volts 2,000 watts, 100/-
 - 110 to 230 volts 3,000 watts, 130/-
 - 110 to 230 volts 5,000 watts, 190/-
- Weston Milliamper Meters, 0-200, 15/- each.
 - " " 0-250 15/- "
 - " Ammeters " 0-30 15/- "
 - " D.C. Meters 0-2,500 15/- "

Building Television Receivers at home

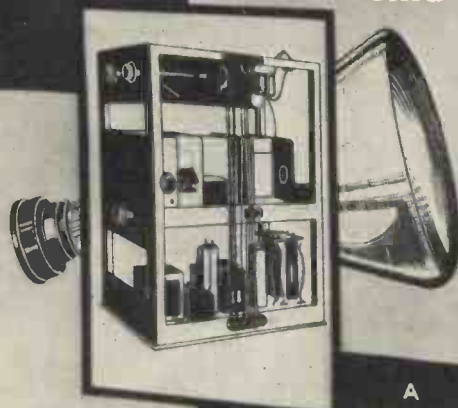

2/6
NET

A
PRACTICAL
HOME-CONSTRUCTOR
HANDBOOK
FOR EVERYBODY

**For the
Amateur Home
Constructor**

**A Simple &
Practical
Handbook**

“Building Television Receivers at Home”

Is a practical handbook giving precise instructions that will enable any amateur to build a Television Receiver guaranteed to produce pictures of present-day standards both as regards definition and brightness. Three designs are provided with a wide range of picture size and the constructional information and illustrations are in such simple detail that they can be understood and carried out quite easily by the average wireless amateur. Results are assured.

CONTENTS INCLUDE :

How a Television Receiver works
Receiver giving pictures up to 12 inches
The Time Base, Cathode-Ray Tube network and
Receiver Power Unit
Adjusting the Vision Receiver, the Tube and Time
Base Power Unit
Adjusting the Time Base
Adding refinements

Small-picture Receivers
Receiver giving a 4-inch picture. The simplest
Home-Built Televisor
Time Base for 4-inch Tube Receiver
The Power Units of the 4-inch Tube Receiver
Long Distance Reception
Simplified Receiver using a 1-inch Cathode-Ray
Tube

100 ILLUSTRATIONS

112 PAGES

2/6 net

OR

2/9 post paid

FROM ALL BOOKSELLERS

FROM THE PUBLISHERS

BERNARD JONES PUBLICATIONS LIMITED,

CHANSITOR HOUSE, CHANCERY LANE, LONDON, W.C.2

(Proprietors of “TELEVISION AND SHORT-WAVE WORLD”)

"Beam Aerials and S.W. Programmes."

(Continued from page 420)

imposed on the carrier frequency tends to widen out the carrier by an amount plus and minus the modulating frequency. Technically, a modulated carrier wave can be resolved into three component frequencies—one the fundamental carrier frequency, one the fundamental minus the modulating frequency, and the third the fundamental plus the modulating frequency.

It can be seen readily that when modulating frequencies go above 5,000 cycles (5 kc.), carriers separated by only 10 kc. will cross up. Modern high-fidelity modulation involves frequencies at least as high as 8 or 9 kc.

Because of the difference in direction, DJN could cover South America effectively by using a narrow beam—only 15 degrees wide. Right away, the DJN signal was powerful because most of its energy appeared to be crowded into this narrow beam.

As for the broadcasts from Schenectady, a much wider beam had to be used to properly spread out and cover the South American continent—with corresponding loss in signal strength even though higher power might be used in the antenna.

After a careful study of the situation and of the frequencies still available,

General Electric applied to the F.C.C. for certain new authorisations.

One of these was a power increase to 100 kilowatts for both W2XAF and W2XAD. Another was for the use by W2XAD of two additional frequencies, 9,550 kc. and 21,500 kc. Still a third was for permission to build an international broadcast station, Treasure Island at the Golden Gate Exposition in San Francisco, California, using call letters W6XBE.

W6XBE is completed, while the new 100-kilowatt amplifier at Schenectady will be ready in a short time. This amplifier, available to either W2XAF or W2XAD, utilises a newly developed tube particularly suited to high power at high frequencies.

While directive antennas, of the Alexanderson panel type, have been used for many years by W2XAF and W2XAD—particularly by the latter—the new plan contemplates the regular use of such antennas for all transmissions to particular countries or areas.

For instance, on the evening schedule to South America, a 30-degree beam from W2XAD on 9,550 kc. is centred on Rio de Janeiro, while W2XAF sends out a second such beam, on 9,530 kc., and adjacent to the 9,550 beam on the west. W2XAD thus specialises to the predominantly Portuguese half of South America.

A directive antenna at W6XBE en-

ables the new California station to serve the Orient effectively. Such transmission from this station encounters a far more favourable daylight-darkness situation on the Far Eastern circuit than could be possible from Schenectady.



FREQUENCY CONTROL UNITS

Ground to within 5 kc. of your specified frequency in the 7mc. amateur band, and supplied complete with official calibration certificate to an accuracy of 0.025%.



Specified for the
KTB
TRANSMITTER

described in this issue.

Q.C.C. Type S5.
The Standard X Cut
Crystal. Temp. Co-
efficient 23 cycles per
Mc. Max. R.F. crystal
current 100 mA.

PRICES:

Type S5 unit ... 20/-
Type S5 Crystal,
unmounted 15/-

Send 1/- d. stamp for our full price list of all types of quartz crystals and radio transmission components.

Type U Mount. A plug-in Mount (1/2 in. centres). Fitted with stainless steel electrodes and a smart nickel and black enamel cover plate ... 6/-
THE QUARTZ CRYSTAL CO., LTD.
Kingston Road, NEW MALDEN, Surrey.
Telephone: MALDEN 0334

GALPINS ELECTRICAL STORES

TERMS: Cash with Order or C.O.D. Charges extra

75, LEE HIGH ROAD, LEWISHAM, LONDON S.E.13

Telephone: LEE GREEN 5240

ERNEST TURNER & WESTON 2-in. dial moving coil milliampmeters, B.S. 1st grade 0 to 5 and 0 to 50, 10/6 each.
TELEGRAPH Morse inker complete with tapping key and sounder, fitted platinum contacts in first-class condition, £3 10s. Ditto, less tapping key, 50/- C/F. (The former is of later pattern.)
WESTINGHOUSE RECTIFIERS. L.T. 6 volt 2 amps. D.C. output, input 11 volts, in new condition, 10/- each.
"NEWTON" MOTOR GENERATORS, input 220 or 100 volt D.C. output, 500/750 volts 200 mA. D.C. output, 30/- C/F. Ditto, input 16 volts, 8 amps, output 35/- each. C/F.
D.C. MOTORS approx. 1/2 h.p., 50 volts shunt wound, 7/6, post 1/-.
DYNAMOS, all shunt wound and fully guaranteed, 220 volts 15 amps., £6 10s.; 220 volt, 10 amps., £3; 100 volt, 20 amps., £6 10s.; 80/90 volt 10 amps., £2 15s.; 25 volt, 8 amps., 32/6.
SWITCHBOARD VOLTMETERS, Everett Edgcombe, etc., 6-in. dial, moving coil, 0 to 300 volts, 15/-; 0 to 500 volts, 17/6; A.C. 0 to 250 volts, 15/-.
EX-R.A.F. DOUBLE WOUND GENERATORS, giving two outputs, 1,200 volts 100 mA., and 10 volts 4 amps., 15/- each, post 1/6.
"EPOCH" SUPER CINEMA MOVING COIL SPEAKERS, 6-volt field (less cone), 15/- C/F.
"STANDARD" TELEPHONE COPPER SCREENED 23 S.W.G. TELEPHONE WIRE, 100 yd. coils, 4/- All new.
ZENITH WIRE WOUND RESISTANCES (Vitroous) 5,000 ohm carry 170 mA., 10,000 ohm 50 mA., 2,500 ohm 170 mA., 750 ohm 300 mA., 255 ohm 500 mA., 1/- each Post 4d.
SILVERTOWN GALVANOMETERS, jewelled movement, very sensitive, 5/- each.
"SULLIVAN" TRANSMITTING CONDENSERS, variable, in glass tank, .0005 mf., and 001 mf., 7/6 each, post 1/-.
INSTRUMENT WIRE, 4 lb. reels of 20 G enamel, 6/- P/F; 15 lb. of 16 gauge enamel, 15/-, post 1/-; 7 lb. of 18 gauge D.C.C., 8/6, post 6d.; 7 lb. of 10 gauge D.C.C., 10/- P/F. All new wire.
A.C. INDUCTION MOTORS, all fully guaranteed, 1/2 h.p., 2,800 r.p.m. with starter, 60/- 1 h.p. Double Spindle 1,450 without starter, 50/-; 2 h.p. Double Spindle 1,450 r.p.m., complete with starter, £5. All for 200/250 volts 50 cy. 1 phase.
"MACKIE" ROTARY CONVERTORS, 80/120 volts D.C. input at 11 amps. Output 80/120 volts 6 1/2 amps., 1,000 cycles, £4 10s. each. C/Forward.
LARGE SCALE MOVING COIL MILLIAMMETERS, 0 to 10 and 100 mA., 7 in. dial, 25/-; 0 to 12 mA., 10 in. dial, 25/-; 0 to 15 mA., 4 in. dial, 15/-; 0 to 10 mA., 6 in. dial, 17/6; 0 to 18 mA., 5 in. dial, 15/-; 0 to 3,000 mA., hot wire 5 in. dial, 22/6; a Marconi Moving Coil, 250 to 1,500 voltmeter, 7 in. dial, 25/- All first grade meters.
"PHILIPS" MAINS TRANSFORMERS, 200/240 volts input, 2,000/0/2,000 volt 200 mA. output, with two L.T.'s, 22/6 each. C/Forward.
SMALL SPOT WELDING TRANSFORMERS, 200/230 volts input, 3-4 1/2 and 7 1/2 volts at 150/300 amps. output, 17/6. C/Forward.
NEON TRANSFORMERS, input 200/250 volts 50 cycles 1-phase output, 10,000 volts 10 mA., 12/6 each, post 1/- Ditto, 7,000 volts 8 mA., 10/-, post 1/- Ditto, 5,000 volts 5 mA., 7/6, post 1/- All brand new.)
THE "RACON" MOVING COIL HORN SPEAKER UNITS. 15-ohm Speech Coil 16 volt, fitted handle, 15 watts, 15/- each, post 1/6.

3,000-WATT AUTO TRANSFORMERS, 0 to 220 volts in steps of 10 volts. Useful as small arc welders. Fully guaranteed, 65/- each. C/F.
PHILIPS 10-WATT PRE-STAGE AMPLIFIERS, less valves (in good condition), 10/6 each. Post 1/6.
EX-NAVAL 1-VALVE BUZZER WAVEMETERS, 200/24,000 metres. Complete in solid teak case. Size: 15 x 10 x 8 (less valve). Turner unit enclosed in copper tank (Sullivan high note buzzer). Price, 7/6 each. C/F. Not sent C.O.D.
EVERSHED EX-R.A.F. HAND DRIVEN GENERATORS, with 2 outputs 800 volts 30 mA. and 6 volts 2 amps., 25/-, post 1/6.
VOLTAGE CHANGER AUTO TRANSFORMERS, 100/120 volts to 200/240 volts or vice versa, 250 watts, 17/6; 500 watts, 25/-; 1,000 watts, 37/6; 1,500 watts, 42/6 each C/F. All fully guaranteed.
MOVING COIL METER MOVEMENTS for recalibrating into multirange meters. Low mA. deflection. 2 1/2-in. dial, 5/- each; 4-in. and 6-in. dial, 6/- each. Post 1/- (Note: All these meters are by good makers—Elliott, E. Edgcombe, etc.)
ELECTRIC LIGHT CHECK METERS, 200/250 volts, 50 cy., 1 phase, 5 and 10 amps., 6/- each. P/F.
X-RAY TRANSFORMERS, by well-known makers, all fully guaranteed. 50 cycle mains, 40,000 volts, 10 mA., £5. 68,000 volts, 20 mA., £7 10s. 100,000 volts, 30 mA., £10 10s. All carriage forward.
A.C. MAINS RELAYS, 230 volts, trip at 1/2 amp. A few also at 400 volts, 7/6 each. Post 9d.
EX-R.A.F. ROTARY CONVERTORS. D.C. to D.C. 12 volts input, 500 volts 75/100 mA. output, brand new, 25/-, post 1/-; S.H. condition, 20/-, post 1/- Also a few with damaged brush, gear windings O.K., 10/- each, post 1/-.
SPOT WELDING TRANSFORMERS, 220/240 volts, 50 cy. 1 phase input 1/2 to 5 volts at 1 1/2 kilowatts. Makers, Foster, 45/- C/F.
EX-G.P.O. GLASS TOP RELAYS, Typ B. Useful as Keying Relays, 5/- each, post 6d. A few only that need points, which are easily fitted, 2/6 each. P/F.
MAINS SMOOTHING CONDENSERS. Philips 1 mf., 3,000 volt working, 5/- each, post free. Siemens, 4 mf., 1,500 v. test, 2/6 each. T.C.C. 4 mf. 300 v. A.C. w/kg., 2/- each. Standard Telephone 1 mf., 400 v. w/kg., 3 for 1/-, post 4d., or in lots of 100, 12/6, post 1/6. T.C.C. 2,000 mf., 12 v. w/kg., 3/- each.
ROTARY CONVERTOR, 220 D.C. to 150 volt A.C. 50 cy. 1 ph. 600 watts, with starter and step-up transformer to 200/240 volt, £4 10s. C/F. Another 100 volt D.C. input 70 volts A.C. 50 cy. 1 ph. output at 250 volts, 40/- C/F.
FERRANTI SPEAKER OUTPUT TRANSFORMERS, Type "A." ratio 7 1/2 to 1, pri. D.C. resist. 900 ohms, impd. 12,500 to 30,000. Type "B." ratio 24.9 to 1, pri. D.C. resist. 14,000 to 20,000 ohm, impd., over 111,000. Sec. D.C. resist. 13 ohms on both types. In new condition, 4/- each, post free.
P1 STANDARD TELEPHONE push-back connecting wire (new), 220-yard coils, 12/6, post 1/-.
"SAVAGE" MAINS TRANSFORMERS, 200/250 volts input 50 volt 8 amp. output, 12/6 each.
STANDARD TELEPHONE MAINS TRANSFORMERS, input 200/250 volts, output 250/0/250 volts 200 mA., 3 x 4 volt windings and a 50-volt winding, 12/6 each.
EVERETT-EDGUMBE Thermo Coupled R.F. Meters, 2 1/2-in. dial, 0 to 250 mA., 25/- 0 to 3 amp., 20/- each.
A few only Everett-Edgcombe Thermo Meters with Thermo burnt out, but moving coil reads only approx. 1 mA. A first-grade movement, 10/- each.

Two New Cossor Receivers

Two very interesting receivers have just been released by A. C. Cossor, Ltd., of Highbury Grove, N.5, and are now available through all their usual channels.

The first is a battery-operated super-het, including an ingenious system of press button tuning. Any one of 6 medium or long-wave stations can instantly be selected by pressing the appropriate button, while the pointer on the dial rotates to the correct wavelength. Buttons can be adjusted to cover any required station from the front of the receiver, so should at any time there be a change in station wavelengths the user of the receiver can re-adjust his own press buttons.

Four valves are included, a triode-heptode frequency-changer, designed to give high gain on short waves, a variable Mu pentode I.F. amplifier, double-diode-triode detector, audio amplifier and A.V.C. valve, and finally, a high-output economy pentode. The tuning range is 16.4 to 50 metres; 190 to 550 metres, and 820 to 2,200 metres. Some of the features include permeability iron cored I.F. transformer; iron cored pre-selector coils on medium and long wavelengths; automatic volume control; high "Q" coils; automatic grid bias and full vision dial calibrated with

over 40 station names. The price is 9 guineas, or £10 4s. 3d. complete with battery and accumulator. Hire purchase terms are available for this model number 33 receiver.

A larger receiver is the model 62, a five valve all-waver in console cabinet for A.C. mains. Valve sequence is similar to the previously mentioned battery set, except that the first valve is a triode-hexode frequency changer and the output valve is a triode designed to give extremely high quality. There is also, of course, the usual indirectly heated rectifying valve.

The console cabinet in walnut is 33½ in. high by 18½ in. wide and 11 in. deep. It has been acoustically designed in conjunction with an 8 in. high fidelity moving coil loudspeaker.

A switch plug for an extension loudspeaker and sockets for a gramophone pick-up are also included. There are three wavebands with this receiver to cover 16 to 2,150 metres, so that the receiver will tune in most of the impor-

tant short-wave channels as well as all medium and long-wave broadcast stations.

Selectivity is extremely high, a commendable feature in view of the congestion in medium waves at the present time. This selectivity is obtained partially to permeability tuned I.F. transformers, plus a large number of tuned circuits. Readers interested in a really good short-wave reception will be pleased with the performance of this receiver for it has extremely low noise level and is provided with a good slow-motion dial free from back-lash.

The receiver complete and ready for operation is priced at 11 guineas, or on hire-purchase terms.

The Sky-Pilot Aerial

Readers who are not able to erect a conventional horizontal aerial or who are troubled with interference should write to Messrs. Pilot Radio, of 31-33 Park Royal Road, London, N.W.10, for information on their new Sky-Pilot, an aerial of the vertical type which can be fitted to a pole or window frame. It is approximately 11 ft. long and is made up of four sections. The total weight is only 1½ lb. despite the fact that the aerial is made of tapering steel tubing cadmium plated. These aerials are very effective, and at the price asked, 21s., good value for money.

Ensure obtaining "Television and Short-wave World" regularly by placing an order with your newsagent.

A Free QSL SERVICE

AMONG the many privileges offered to members of the Radio Society of Great Britain, none is more appreciated than the free QSL Service instituted by the Society some 15 years ago.

Non-transmitting members are granted a B.R.S. (British Receiving Station) number on election which enables them to send and receive cards through the Bureau without giving direct reference to their names and addresses.

Full details of this exclusive R.S.G.B. Service will be forwarded on request.

The T & R BULLETIN

SINCE 1925 this Journal has brought to members of the R.S.G.B. the latest news of short wave interest. With the appearance of the July number, members will receive details of the Society's 14th Annual Convention to be held in London in September. In addition they will read many full length technical articles contributed by prominent members, whilst the DX Fraternity will find a new feature introduced under the title "Up and Down the Ham Bands."

A copy of this Issue, together with details of membership, will be sent to any interested reader sending P.O. for 1/- to,—

The Secretary-Editor,

R.S.G.B.,

73, Victoria Street, London, S.W.1



TELEVISION DEVELOPMENTS

Are you keeping abreast of modern television developments? Whether amateur or professional you *must* be in touch with the latest trend of research.

The Television Society enables you to meet fellow workers in the field of television, both in this country and abroad.

Founded some 10 years ago The Television Society provides a scientific and non-partisan platform for discussion on all aspects of the subject. Meetings are held monthly during the session (October-June) and are reported in full in the Society's Journal which is sent free to all members.

The Society's activities are shortly being enlarged to meet the growing interest in the subject and members will have a unique opportunity of furthering their knowledge by contact with well-known television engineers.

Full particulars of membership qualifications may be had from the Hon. General Secretary:—J. J. Denton, 17, Anerley Station Road, London, S.E.20.

THE TELEVISION SOCIETY

(Founded 1927)

President: Sir AMBROSE FLEMING, M.A., D.Sc., F.R.S.

OPPORTUNITIES SECTION

BUSINESS :: EQUIPMENT :: EMPLOYMENT :: MISCELLANEOUS

The charge for miscellaneous advertisements on this page is 12 words or less 2/-, and 2d. for every additional word. Single-column inch rate displayed, 12/6. All advertisements must be accompanied by remittance. Cheques and Postal Orders should be made payable to Bernard Jones Publications Ltd., and crossed, and should reach this office not later than the 15th of the month previous to date of issue.

WIRELESS LICENCES

According to preliminary figures issued by the Post Office there was an increase of paid licences during May of 21,143. A total of 450,830 licences were issued while 459,687 expired. Free licences to the Blind totalled 4,344, while 3,933 expired. It would be interesting to know why there was a drop in licence figures during April, but in any case it is satisfactory that this drop in licences has been arrested and the figures now show a slight increase.

The total number of licences in force at the present time is nearly 9 million, the official figure being 8,984,250.

NEW TELEVISION ANNOUNCER

Miss Olga Edwardes has been re-engaged by the B.B.C. as a temporary announcer from the period July 31 to September 2 to take the place of Miss Jasmine Bligh who will be on holiday during that time.

Eastbourne and District Radio Society.—Full information on the activities of this society can be obtained from the Hon. Sec., T. G. R. Dowsett, 48 Grove Road, Eastbourne, Sussex. The annual subscription is only 5s. and a wide selection of subjects are being dealt with by lectures in the coming season. We advise readers in that area to get in touch with the secretary

MECHANICAL - OPTICAL - TELEVISION

THE "JEFFREE" HIGH SPEED MOTOR
Valve Driven, Synchronised by Vision Signal,
Speeds at 22,500 Revs. Per/min.
DETAILS AND PRICES AVAILABLE
Oscillators for Motor or Light Modulation
Cells can be Supplied to Order.
Send Your Requirements to
H. E. SANDERS & CO. Tel.
4 Grays Inn Rd., London, W.C.1 Chancery 8778

INDEX TO ADVERTISERS

	PAGE
A.C.S., Ltd.	443
Automatic Coll Winder & Electrical Equipment Co., Ltd.	385
Belling & Lee, Ltd.	Cover ii
British Institute of Eng. Technology	Coveriii
British Mechanical Productions, Ltd.	445
Candler System Co.	445
Clix	445
Edison Swan Electric Co., Ltd.	386
Fluxite, Ltd.	Cover ii
Foyles, Ltd.	Coveriii
Galpins	447
General Electric Co., Ltd.	435
G5KA	Coverliii
Hamrad Wholesale, Ltd.	441
McGraw-Hill Publishing Co.	443
Marconi's Wireless Telegraph Co., Ltd.	Cover ii
Peto-Scott Co., Ltd.	445
Premier Supply Stores	439
Quartz Crystal Co., Ltd.	447
Radiomart	448
Radio Society of Great Britain	Coverliii
Sanders, H. E., & Co.	Coveriii
Sound Sales, Ltd.	443
Stratton & Co., Ltd.	385
Televisual Society, The	448
Universal Electrical Co.	445
Webb's Radio	Coveriv

FOYLES FOR RADIO BOOKS

Special Radio Department. New and secondhand books on radio and every other subject. Stock of nearly 3 000,000 volumes. Send for free catalogues.

★ **FOYLES** ★
113-125, CHARING CROSS RD., LONDON, W.C.2
Telephone: Gerrard 5660 (16 lines)

MISCELLANEOUS

ALL TYPES of Rotary Converters, electric motors, battery chargers, petrol electric generator sets, etc. in stock, new and second-hand.

A.C.-D.C. Conversion Units for Operating D.C. Receivers from A.C. Mains, 100 watts output, £2. 10; 150 watts output, £3. 10.

WARD, 46, Farringdon St., London, E.C.4. Tel. Holborn 9703.

LOUDSPEAKER repairs, British, American, any make, 24-hour service; moderate prices.—Sinclair Speakers, Alma Grove, Copenhagen Street, N.1.

WANTED—Baird Neon, 20" Disc, Kerr Cell, Drum, Etc. Box 26.

BOOKS

ALL WIRELESS and radio engineering books available on new terms as low as 2s. 6d. monthly. Write a card for details from, Phoenix, Chandos Place W.C.2.

ELECTRICAL SERVICE

CONVERTERS wanted and for sale, E.D.C.C., approximately 200 watts. Easco, 18, Brixton Road, S.W.9.

LOUDSPEAKERS

3,000 SPEAKERS P.M. and energised 4" to 14" including several Epoch 18". Sinclair Speakers, Alma Grove, Copenhagen Street, N.1

PATENT AND TRADE MARK AGENTS

GEE & CO., patents and trade marks throughout the world (H. T. P. Gee, Mem.R.S.G.B., A.M.I.R.E., etc.), Estab. 1905. 51-52, Chancery Lane, London, W.C.2 (2 doors from Government Patent Office). Phone: Holborn 4547 and 4548. Handbook free.

KINGS PATENT AGENCY LTD. (B. T. King, A.I.Mech.E. (2 BKT) Patent Agent) 146a, Queen Victoria Street, London, E.C.4. **ADVICE, Handbook and Consultations free.** Phone City 6161.

A HANDY REFERENCE LIBRARY

of books pertaining to his hobby is necessary to every "ham."

Those listed below will start you with your library :—

RADIO AMATEUR'S HANDBOOK 1939 edition contains 560 pages and 189 illustrations. Will solve all your transmitting and receiving problems. Price 5/6d. post free.

"**RADIO**" **HANDBOOK** 1939 edition, 600 pages, 7/- post free.

RADIO ANTENNA HANDBOOK 3/6d. post free.

RADIO TELEPHONY HANDBOOK 3/6d. post free.

HINTS AND KINKS 2/6d. post free.

"**RADIO**" **ZONE MAPS** 1/2d. post free.

RADIO PHYSICS COURSE 17/6d. post free.

CALLBOOKS. June issue. now on sale. Price 6/- post free.

G5KA, 41 Kinfauns Road, Goodmayes, Ilford, Essex.
Dept. T7

TELEVISION.

A NEW COURSE OF INSTRUCTION.

We have pleasure in announcing that our new "Television" Course has met with remarkable success. The enormous demand for the Course has shown, beyond any shadow of doubt, that it fills that long-felt need which we anticipated when we went to such trouble and expense in its preparation.

We shall be happy to send full details of this special "Television" Course on request. Particulars are also available of other Courses in all branches of Wireless, Television, Talking Picture Engineering, etc., and of the easiest way in which to prepare for the A.M.I.E.E., A.M.I.W.T., A.M.I.R.E., etc., Examinations.

We teach by correspondence, and guarantee "NO PASS—NO FEE." Our Technical Consultant is Professor A. M. Low.

Send for full particulars to-day. Free and without obligation.

THE BRITISH INSTITUTE OF ENGINEERING TECHNOLOGY
337, SHAKESPEARE HOUSE, 17/19, STRATFORD PLACE
LONDON W.1.

THE NEW HALLICRAFTER SKYRIDER DEFIANT

MODEL SX24

NINE VALVES

COMPLETE INSTRUMENT

£21 : 0 : 0

**HIRE PURCHASE FACILITIES
AVAILABLE**



It is not too difficult for an able radio engineer to create a receiver with outstanding performance—but to build this receiver and sell it at the low price of the Sky Rider DEFiant, that requires the kind of genius that seems to be found only in the Hallicrafters Laboratories.

The Sky Rider DEFiant offers performance that can be favourably compared to any receiver regardless of price. It has new features, like Built-in Frequency Meter Tuning, that are absolutely new. And in addition it has all the desirable features and qualities that are needed for outstanding amateur reception.

FREQUENCY METRE TUNING. The Band Spread Dial is accurately calibrated throughout the amateur bands, and, when once set, maintains a high degree of accuracy throughout the band, bringing in signals on their frequencies as indicated on the dial.

BUILT-IN NOISE LIMITER. The noise-limiting circuit is of recent development, highly efficient in reducing noise level on the ultra high frequencies. All leads are short and close to the noise-limiter tube for greater efficiency.

VARIABLE SELECTIVITY. A six position Variable Selectivity Switch is provided, offering a degree of variability suitable to all practical requirements for CW and phone. Selectivity positions are as follows: AVC off—Sharp Crystal, AVC off—Broad Crystal, AVC off—Sharp IF, AVC on—Broad Crystal, AVC on—Sharp IF, AVC on—Broad IF.

FREQUENCY STABILITY. By means of an especially developed circuit, variations in line voltage cause only a barely discernible change in oscillator frequency.

BATTERY OPERATION. In addition to the AC Power Supply, a power plug is provided at the rear of the chassis for the connection of a source of filament and high tension DC voltage supply for mobile or emergency operations.

BREAK-IN RELAY OPERATION. Terminals are provided on the rear panel for stand-by relay operation.

CRYSTAL FILTER. A Bliley Resonator Crystal in a new Hallicrafters low capacity crystal holder with a double balance bridge circuit allows a high degree of rejection of unwanted signal even when interfering signal is closely adjacent.

GENERAL COVERAGE—43.5 to .54 MC

4 BAND POSITIONS

Band 1— .54 to 1.73 MC

Band 3— 5.0 to 15.7 MC

Band 2—1.7 to 5.1 MC

Band 4—15.2 to 43.5 MC

BAND SPREAD CALIBRATION

80 Metre Amateur Band

20 Metre Amateur Band

40 Metre Amateur Band

10 Metre Amateur Band

9 TUBES

6SK7 r.f. amplifier

6SQ7 diode detector, AVC and first a.f. amplifier

6K8 first detector and oscillator.

6F6G power amplifier

6SK7 first i.f. amplifier

76 beat frequency oscillator

6SK7 second i.f. amplifier

76 rectifier

6H6 noise limiter

S METER calibrated in S units and DB.

CONTROLS

1—RF Gain

8—Bandspread Tuning Control

2—Band Switch

9—Tone Control Switch

3—Selectivity Switch

10—Automatic Noise Limiter Switch

4—Crystal Phasing

5—Audio-Gain

11—Send-Receive Switch

6—Pitch Control

12—BFO Switch

7—Main Tuning Control

MAIN TUNING DIAL. Directly Calibrated, Translucent Illuminated Dial.

ELECTRICAL BAND SPREAD. Directly Calibrated, Translucent Illuminated.

CABINET DIMENSIONS: 19½ ins. wide, 9½ ins. high, 10½ ins. deep.

WEBB'S RADIO, 14, Soho Street, London, W.1

PHONE: GERRARD 2089

SOLE DISTRIBUTORS FOR BRITISH ISLES OF HALLICRAFTER EQUIPMENT