

Television

and *SHORT-WAVE WORLD*

1/-

MONTHLY

DECEMBER, 1936

No. 106. Vol. ix.

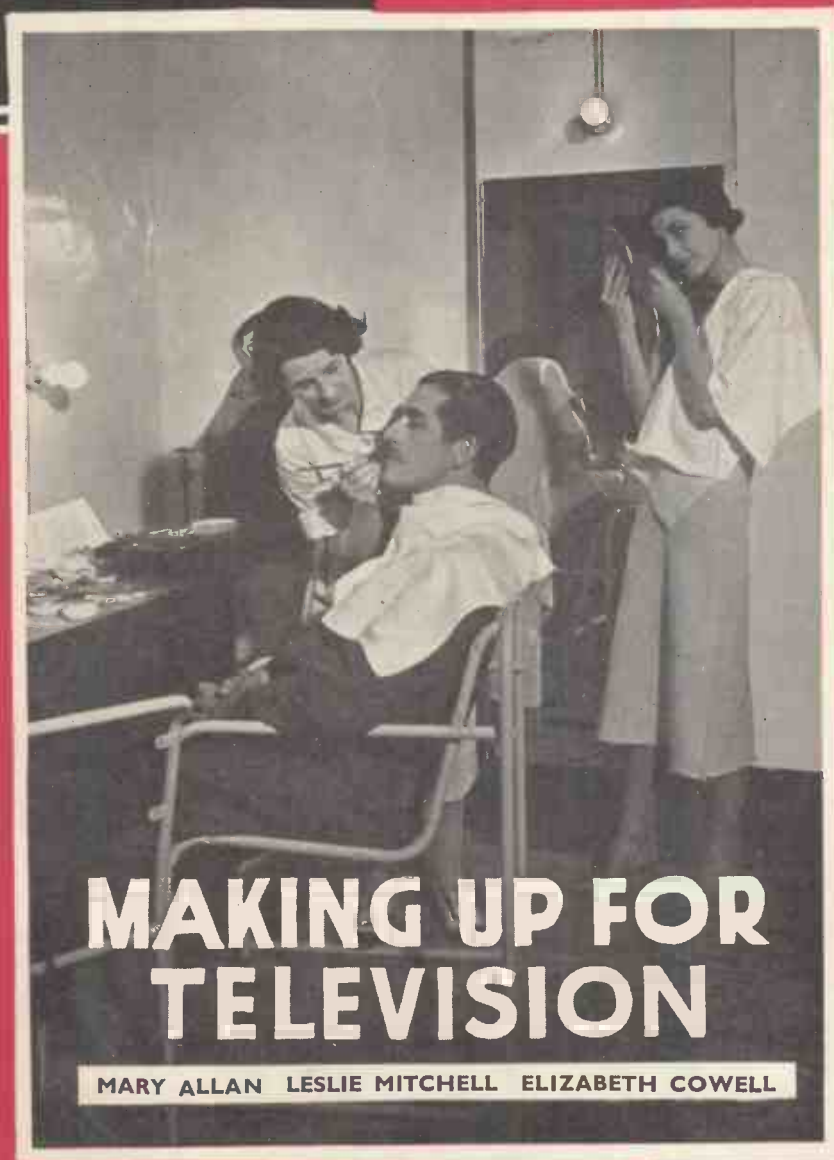

MAKING UP FOR TELEVISION

MARY ALLAN LESLIE MITCHELL ELIZABETH COWELL

TELEVISION RECEIVER

for you to

BUILD

AMATEUR-BANDS SUPER-HET "7"

FULL DETAILS

BERNARD JONES PUBLICATIONS LTD.
CHANSITOR HOUSE, CHANCERY LANE
LONDON W.C.2.

THE FIRST TELEVISION JOURNAL IN THE WORLD



**SPECIFY FERRANTI VALVES IN YOUR NEW SET—
FIT THEM AS REPLACEMENTS.**

Ferranti Valves are in use in hundreds of thousands, and some of the most successful World Radio Receivers use them. Full details are given in the new 27-page Valve Catalogue which may be obtained for 1½d. post free from **FERRANTI LTD., Radio Works, Moston, MANCHESTER, 10.**

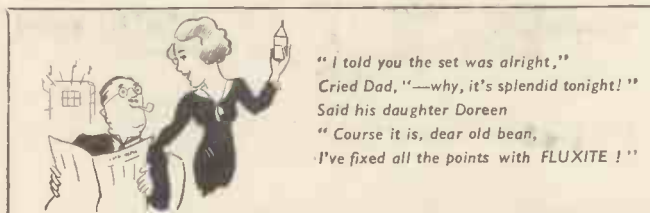

See that **FLUXITE** is always by you—in the house—garage—workshop—wherever speedy soldering is needed. Used for 30 years in government works and by leading engineers and manufacturers. Of Ironmongers—in tins, 4d., 8d., 1/4 and 2/8. Ask to see the **FLUXITE SMALL-SPACE SOLDERING SET**—compact but substantial—complete with full instructions, 7/6. Write for Free Book on the art of "soft" soldering and ask for Leaflet on **CASE-HARDENING STEEL and TEMPERING TOOLS** with **FLUXITE**

TO CYCLISTS! Your wheels will NOT keep round and true unless the spokes are tied with fine wire at the crossings and **SOLDERED**. This makes a much stronger wheel. It's simple—with **FLUXITE**—but **IMPORTANT**.

THE FLUXITE GUN

Is always ready to put Fluxite on the soldering job instantly. A little pressure places the right quantity on the right spot and one charging lasts for ages
Price 1/6.



ALL MECHANICS WILL HAVE

FLUXITE

IT SIMPLIFIES ALL SOLDERING

FLUXITE LTD. (Dept. T.V.), DRAGON WORKS, BERMONDSEY ST., S.E.1.



65 feet on bobbin in neat carton with technical information. No. 319. List price. **6/9**

**High Frequency
Low Impedance Feeder**

**FOUR TIMES BETTER THAN ORDINARY FLEX
Surge Impedance 72 ohms**

Designed to convey H.F. currents to or from half-wave dipole aerials in which feed is taken at aerial centre.

For transmission purposes, current carrying capacity 1.5 amps H.F.

When supplying a half wave dipole at 60% efficiency from transmitter, may be used for final stage power inputs not exceeding 200 watts.

No fibrous covering to absorb moisture; cable insulation will withstand very severe climatic conditions (it is not rubber).

Longer lengths available, but must be subject of special order.

Mains Interference Suppression

No aerial system can protect a receiver from interference conducted to it via the mains. For complete suppression, it is necessary to filter the mains before they reach the receiver,

SET LEAD SUPPRESSORS

(See illustration below)

These are three-stage choke and condenser filters, making it practicable to effect suppression close to a receiver. A child can plug in.

- 1211. Medium and Long Waves, ½-amp., 17/6
- 1256. Medium and Long Waves, 1-amp., 19/6
- 300. All-wave 1-amp., 21/-

Particularly useful for cutting out the residual snowstorm effect in Television reception.

Literature

FREE—"Wireless Without Crackling," folder; "Eliminate noise," folder; "Radio Spares and Connections," folder catalogue. Also: "Interference Suppression," book, 1s. 2d. post free; and "Radio and Electrical Accessories," 8d., post free.

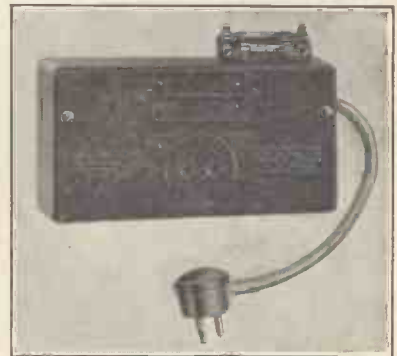

**BELLING-LEE
SUPPRESSION SERVICE**

Cambridge Arterial Road, Enfield, Middlesex.

TUBULAR CONDENSERS



A range of inexpensive tubular condensers, paper dielectric type having wire ends for connection. Specified in this issue for their reliability and efficiency. Rates 400v. D.C. workings, ± 10 per cent. accuracy.

P.C.405 .00005 μ F.	each.	P.C.205 .005 μ F.	6d.
P.C.301 .0001 ..		P.C.101 .01 ..	8d.
P.C.302 .0002 ..	} 4d.	P.C.105 .05 ..	9d.
P.C.303 .0003 ..		P.C.P1 .1 ..	10d.
P.C.305 .0005 ..		P.C.P25 .25 ..	1/-
P.C.201 .001 ..	6d.	P.C.P5 .5 ..	1/3

VOLUME CONTROLS



A compact 3-watt type Volume Control having a special wound element with non-corrodible wire. It will give perfect and smooth even control over a long period of use. Strongly made in dust-proof moulded bakelite case with terminals for connection.

V.C.21 500 Ω	} 3/-	V.C.32 10,000 Ω	} 3/6
V.C.24 1,000 Ω		V.C.34 25,000 Ω	
V.C.26 2,000 Ω	} each.	V.C.36 50,000 Ω	} each
V.C.29 5,000 Ω		C.V.40 100,000 Ω	

HIGH-VOLTAGE INSULATED VALVE TOP-CAP CONNECTOR



Fully Shock-proof, this new type of clip-on moulded bakelite connector is specially intended for Television apparatus and high-voltage rectifiers. Tested up to 20,000 volts. Takes 5 mm. cable.

LIST No. P.92. Price 9d. each (subject).

AMATEUR CONSTRUCTORS TELEVISION SET.

WE CAN SUPPLY EVERYTHING EXCEPT THE VALVES AND TUBE.

WHEN you build this high-definition Television receiver choose your components from the wide BULGIN RANGE.

You can then be confident that you are using the finest possible components; really efficient quality products backed by the Reputation of the Leading Radio Component Manufacturers.

Send the coupon below NOW for our new 116 page Catalogue.

RECOMMENDED AGAIN & AGAIN

BULGIN

QUALITY RADIO AND TELEVISION COMPONENTS

COUPON

To Messrs. A. F. Bulgin & Co., Ltd., Abbey Road, Barking, Essex.

Please send me Catalogue No. 156 "M" for which I enclose 3d. stamps.

NAME

ADDRESS

(Block Letters Please)

HALF - WATT RESISTORS

Nine times out of ten a resistor of $\frac{1}{2}$ watt ratings is sufficient for any position in a radio set. Bulgin $\frac{1}{2}$ watt Miniature Resistors are inexpensive, accurate and reliable—use them in your Television construction.



Available in the following values :-

		Price 6d. each			
100	1,000	4,000	10,000	30,000	200,000
150	1,500	5,000	12,500	40,000	250,000
200	2,000	6,000	15,000	50,000	300,000
250	2,500	7,000	17,500	75,000	400,000
300	3,000	8,000	20,000	100,000	500,000
400	4,000	9,000	25,000	150,000	750,000

1 meg. 2 meg. 3 meg. 5 meg. $\pm 10\%$

VALVE HOLDERS

For all the important positions in radio apparatus use Bulgin quality components, particularly as to valve-holders. Bulgin short-wave Valve-holders are ideal for use in Television sets, with their high insulation properties.

S.W.41 5-pin 9d. each.
S.W.42 7-pin 1/- each.

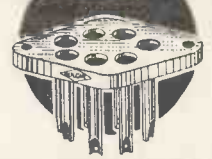

GROUP BOARDS

Made of cleanly stamped sheet bakelite and punched with rows of holes, these group-boards are ideal for grouping $\frac{1}{2}$ - and 1-watt resistors and condensers for speedy wiring. May be cut with scissors if necessary.

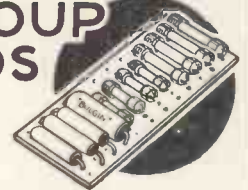

List No. C.34 6-way 3d. }
List No. C.35 12-way 6d. } each.
List No. C.36 24-way 1/- }

SPECIFIED for TELEVISION'S

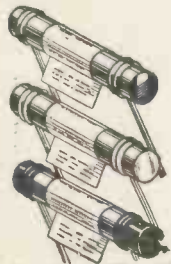

GUARANTEED VISION RECEIVER

Erie Resistors were used by the designers of the Television Cathode-Ray Receiver, and are specified without alternative. Experts know Erie reliability. Follow Television's advice—be sure to use Erie Resistors. From all radio dealers.

All values 1/- per watt. Hand Tested.

ERIE VOLUME CONTROL

Will not develop faults. Has Erie carbon resistance element, precision built. No hop-off noises. Tested to give smooth and positive contact for years of use. All values: 5,000 ohms to 2 meg-ohms.

3/6

With built-in mains switch, 5/-

ERIE RESISTORS

● FREE. Colour Code Chart & Technical details from THE RADIO RESISTOR Co., Ltd., 1, Golden Sq., London, W.1.

Specified by the Experts

SOUND SALES

TRANSFORMERS for TRANSMITTERS

For the H.T. Supply Section of the Beginners' Transmitter, the designer has chosen

SOUND SALES Type 500/120 Model Mains Transformer

- Primary 210, 230, 250 v. at 50 cycles.
- H.T. Sec. 500-5-500v. at 120 m.a.
- 2-0-2 v. at 3.5 amp.
- 2-0-2 v. at 2 amp.
- 2-0-2 v. at 5 amp.

PRICE 55/- EACH.

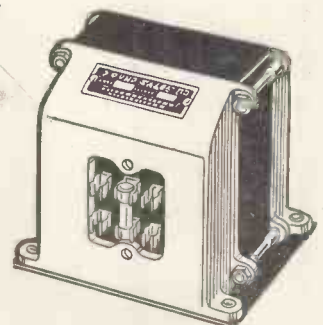

For complete range of Sound Sales Transformers, Chokes, etc., send for Illustrated Catalogue "T.S."

SOUND SALES LTD.

Marlborough Road, Upper Holloway, London, N.19
Phone: ARCHWAY 1661-2-3. (Contractors to the G.P.O., etc.)

Mullard

CATHODE RAY TUBES

Mullard have held for years a unique position as pioneers in the Radio industry. Mullard Master Valve reputation is upheld in the new field of Television by the Mullard Cathode Ray Tubes.



TYPE E46-12 FOR TELEVISION

Double Electrostatic Deflection

Sensitivity $\frac{650}{\nabla}$

Maximum Anode Volts 6,000 v.

Screen 12", White.

PRICE 15 GNS.

A full list of Mullard Cathode Ray Tubes for Television and other purposes will be supplied upon application and we invite trade enquiries and queries.

Mullard Wireless Service Co., Ltd., Mullard House, 225, Tottenham Court Road, London, W.1

TELEVISION

and SHORT-WAVE WORLD

Special Features

	PAGE
The Farnsworth Television Receiver ...	676
The Opening of Britain's First Television Service ...	677
Philco (U.S.A.) Television ...	680
Television in the Home ...	681
How to Operate the Cathode-ray Tube ...	683
Electron Multiplier Research ...	686
A New Photo-electric Element ...	692
Buyers Guide to Television Receivers ...	693
"Television's" Guaranteed Receiver ...	697
Recent Television Developments ...	709
The Amateur Bands Super-het 7 ...	711
Folded Duoblet Aerial ...	716
New Transmitting and Receiving Aerial System ...	718
Beginner's Transmitter ...	721
Transmitting for the Beginner ...	722
Pre-selector for Commercial Receivers ...	728
German Short-wave Transmitters ...	732
Building an Output Meter ...	734

COMMENT OF THE MONTH

The Programmes

AT this early stage it would be manifestly unfair unduly to criticise the programmes transmitted from Alexandra Palace, but we are only voicing a general opinion when we say that they do not come up to a standard which the degree of technical development warrants. It is realised that there will be a great deal to learn as regards presentation, and viewers are fully aware of this. Our chief grumble, however, concerns the cheese-paring policy that appears to have been adopted. On many occasions there have been intervals totalling over fifteen minutes in a brief hour's programme. It should be appreciated that owners of television receivers are not disposed to run a matter of twenty valves plus the cathode-ray tube merely to hear a few gramophone records; neither are they pleased to have to sit and look at the hands of a clock. If intervals are really necessary then it should be possible to make them more entertaining, or at least more informative.

Our second great grumble concerns the repetition of material that is presented. Particularly is this the case with films. Everybody has seen the film "Television Comes to London" so many times that the point of boredom has long been passed. We have also been satiated with the feature films which appear to crop up in practically every programme. These films are not topical and if repetition is necessary on the score of economy, then surely a greater variety should be available, which could be repeated at less frequent intervals. Repetition also appears to be creeping in in the case of artists. Repeat performances, unless they are given on the same day at different times, should not be necessary within such a brief period as a couple of weeks or so.

Timing appears to be a very haphazard business: rarely have the advertised features started to time and the result has been a considerable amount of general uncertainty if one wished to see some particular feature.

Another point is the apparent laxity of studio routine. Frequently, shadows of persons passing between some of the lights and the subject are visible, and on one occasion there appeared out-of-focus images of two persons in the background who were not in any way concerned with the subject. More contrast between the dress of artists and the studio background would be desirable: several presentations have suffered on this account, but in fairness we must say that more attention appears to have been given to the matter in the more recent transmissions.

TELEVISION AND SHORT-WAVE WORLD

Proprietors:

BERNARD JONES PUBLICATIONS, LTD.

Editor-in-Chief:

BERNARD E. JONES.

Editor:

H. CORBISHLEY.

Editorial, Advertising and Publishing Offices:

Chansitor House, 38, Chancery Lane, London, W.C.2.

Telephones: Holborn 6158, 6159

Telegrams: Beejapee, Holb., London.

Subscription Rates: Post paid to any part of the world—3 months, 3/6; 6 months, 6/9; 12 months 13/6.

Published Monthly—1/- net.

(Last Wednesday in every month for following month).

Contributions are invited and will be promptly considered. Correspondence should be addressed according to its nature, to the Editor, the Advertisement Manager, or the Publisher, "Television and Short-wave World," Chansitor House, Chancery Lane, London, W.C.2.

IMPORTANT

"Television and Short-wave World" is registered at the General Post Office, London, for transmission to Canada and Newfoundland by Magazine Post. Entered as Second-class mail matter, Boston, Mass.

THE FARNSWORTH TELEVISION RECEIVER

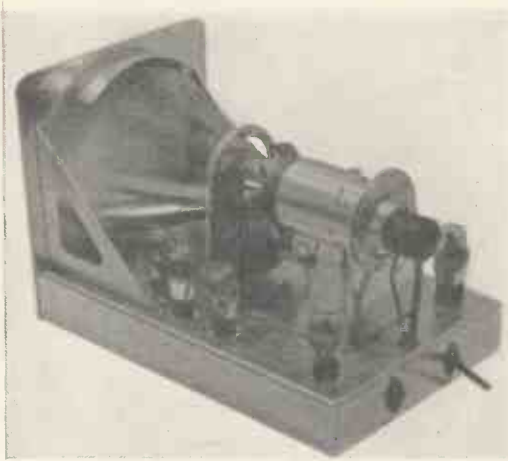

We are indebted to "Radio Engineering" (New York) for this description of the Farnsworth television receiver. An interesting feature is that acorn valves are used.

The cathode-ray tube showing the magnetic deflection coils. This unit is mounted in the top compartment of the cabinet.

ALTHOUGH development work is still in progress, Farnsworth Television, Inc., has felt justified in releasing the preliminary details of their television receiver. The circuit diagram is given here.

At first glance, the receiver circuits appear to be more or less conventional. In any event, the sound channel may be considered entirely so, except, as in the case of the vision channel, for the high intermediate frequency employed. The use of "acorn" valves in the sound channel is likewise unconventional.

It is apparent from the diagram

that the same oscillator functions to supply two intermediate frequencies—one, at 11.25 mc., for sound and the other, at 13.25 mc., for picture. Presumably, the requisite bandwidth for reasonably high audio quality can be obtained by the usual tuned-circuit i-f transformers, without the use of band-widening resistances such as will be seen shunted across the vision i-f transformers.

Crystal filters for intermediate frequencies as high as 13.25 mc. are not entirely feasible at the present state of the art, although the beautifully sharp cut-off of these filters, along

with their nearly square response characteristics, should offer an ideal solution to this problem if they could be built to function at these high frequencies—but more research work is necessary. Resonant line filters may have the same possibilities as i-f coupling elements.

It is of interest to note the high degree of smoothing necessary for the video circuit H.T. supply. While figures are not available, it is probably reasonable to assume that the three-section power supply filter gives an attenuation in excess of 70 db. to frequencies of 120 cycles and above.

The receiver is built on three chassis. At the top is the Oscillight unit, shown by the photograph.

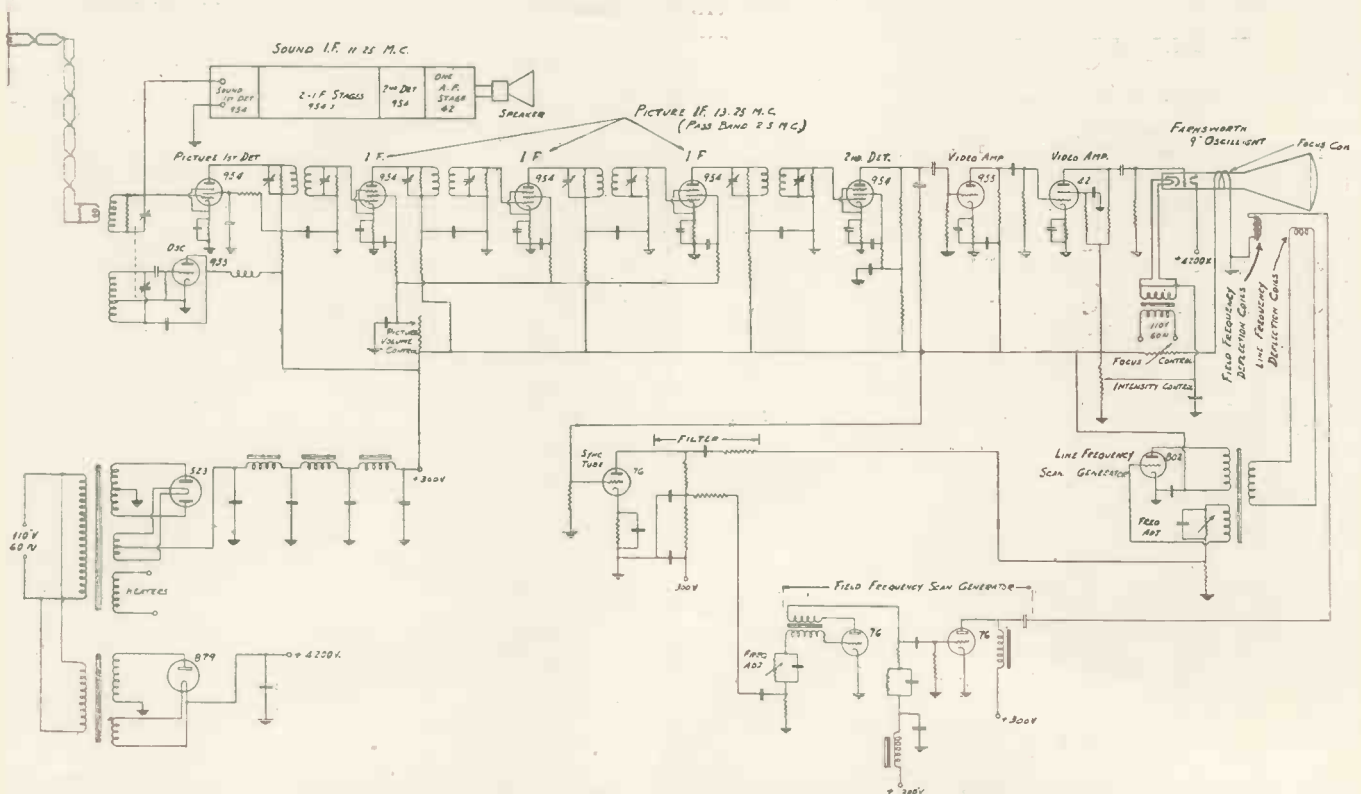

The circuit diagram of the Farnsworth vision and sound receiver. It is interesting to note that in the vision section acorn-type pentode valves are used in the first detector, three I.F. amplifying, and second detector stages. Acorn triodes are used in the oscillator and first low-frequency stages. The output valve is a conventional L.F. pentode. The 5-valve sound receiver, built on similar lines to the vision receiver, uses acorn valves in the first four stages with a small pentode in the final speech amplifier.



THE OPENING OF BRITAIN'S FIRST TELEVISION SERVICE

Britain's first television station was officially opened on Monday, November 2, at 3 p.m., and the service was inaugurated by the Postmaster-General, Major The Right Honourable G. C. Tryon. Speeches were delivered during the proceedings by the Chairman of the B.B.C. (Mr. R. C. Norman), the Postmaster-General (Major G. C. Tryon) and the Chairman of the Television Advisory Committee (Lord Selsdon).

THE opening ceremony was repeated, being first televised by the Baird system and later by the Marconi-E.M.I. system, a brief entertainment programme being interpolated between the two official opening ceremonies.

The Postmaster-General was introduced to the public by Mr. R. C. Norman who in the course of a brief speech said:—"We are met, some in this studio at the Alexandra Palace and others at viewing points miles away, to inaugurate the British Television Service. My first duty is to welcome you, Major Tryon, in the name of the British Broadcasting Corporation, and to say how happy we are that you should have done us the honour of performing the inaugural ceremony.

"We of the B.B.C. are proud that the Government should have decided to entrust us with the conduct of the new service. We are very conscious of the responsibilities which that decision imposes upon us. At this moment of the starting of television our first tribute must be to those whose brilliant and devoted research, whose gifts of design and craftsmanship have made television possible. We are honoured by the presence of some of them here to-day. We wish also to record, Lord Selsdon, the guidance and encouragement which we have received from the two Television Committees over which you have presided. As for the future, we know already that television is much more complicated than sound broadcasting. We are, however, confident that television, in its special combination of science and the arts, holds the promise of

unique, if still largely unchartered, opportunities of benefit and delight to the community.

"We are happy to think that some of its earliest opportunities will have as their setting the historic pageantry of next summer.

"The foresight which secured to this country a national system of broadcasting promises to secure for it also a flying start in the practice of television.

"At this moment the British Television Service is undoubtedly ahead of the rest of the world. Long may that lead be held. You may be assured that the B.B.C. will be resolute to maintain it.

"To-day's ceremony is a very simple programme. In every respect it will doubtless seem primitive a few years hence to those who are able to recall it. But we believe that these proceedings, for all their simplicity, will be remembered in the future as an historic occasion, not less momentous and not less rich in promise than the day, almost exactly fourteen years ago, when the British Broadcasting Company, as it then was, transmitted its first programme from Marconi House. In that belief, Mr. Postmaster-General, we asked you to take the leading part in this ceremony, and I now invite you to inaugurate the new service."

The Postmaster-General

Major Tryon said:—

"Lord Selsdon, Mr. Norman and all who are watching this ceremony from afar.

"It is a great privilege to be invited to inaugurate

PLANS FOR MORE STATIONS

the British Television Service. For we are launching to-day a venture that has a great future before it. For me, it is also a new and extremely interesting experience. Though I have had experience of speaking into the microphone many times, this is the first occasion on which I have faced the television camera.

"Few people would have dared, fourteen or even ten years ago, to prophesy that there would be nearly eight million holders of broadcasting receiving licences in the British Isles to-day. The popularity and success of our sound broadcasting service are due to the wisdom, foresight and courage of the Governors and staff of



Major the Right Hon. G. C. Tryon, the Postmaster-General, inaugurating the television service at Alexandra Palace

the British Broadcasting Corporation, to which the Government entrusted its conduct ten years ago. The Government of to-day is confident that the Corporation will devote themselves with equal energy, wisdom and zeal to developing television broadcasting in the best interest of the nation and that the future of the new service is safe in their hands.

"I was very glad, Mr. Norman, to hear your reference to the guidance and encouragement you have received from Lord Selsdon and the members of the Television Advisory Committee. We in the Post Office know well how unsparingly Lord Selsdon has devoted his great ability and high personal qualities to the public interest, both as Postmaster-General and on the Television Committees. I am very pleased that, under his guidance, the Post Office has been able to cooperate, through the Television Advisory Committee, in the development of this new service.

"I also should like to pay a tribute to all those who

have devoted their talents and their time to solving the very difficult problem of television. We owe it to their skill and their perseverance in research that television has passed from the region of theory to the realm of practice.

"As you have said, Mr. Norman, television broadcasting has great potentialities. Sound broadcasting has widened our outlook and increased our pleasure by bringing knowledge, music and entertainment within the reach of all. The complementary art of television contains within it vast possibilities of the enhancement and widening of the benefits we already enjoy from sound broadcasting.

"On behalf of my colleagues in the Government, I welcome the assurance that Great Britain is leading the world in the matter of television broadcasting, and, in inaugurating this new service, I confidently predict a great and successful future for it."

Lord Selsdon

Lord Selsdon said:—

"Mr. Postmaster-General, Mr. Norman and viewers: I stand before you as representing both the Television Committee, which originally investigated the possibilities of this new field, and also the Television Advisory Committee, which continues to advise regarding its development. My colleagues and I much appreciate what has been said about our work, and I only wish that time and space permitted them to appear before this instrument to-day. In their name I thank you.

"It has rightly been said that the potentialities of this new art are vast and it is possible, for instance, to conceive of its being applied not only to entertainment but also to education, commerce, the tracing of wanted or missing persons, and navigation by sea or air. All these and more will, no doubt, in due time be tested, and some of them will arrive. The patient industry of inventors has helped us so far; now we hope that the kindly interest of the public will help us further."

"From the technical point of view I wish to say that my Committee hopes to be able, after some experience of the working of the public service, definitely to recommend certain standards as to number of lines, frame frequency, and ratio of synchronising impulse to picture. Once these have been fixed the construction of receivers will be considerably simplified but, meanwhile, do not let any potential viewer delay ordering a receiving set for fear that a change in these standards may put it out of commission almost at once.

It is an essential feature of the development plans that for two years after the opening of any service area no such change will be made therein. For at least two years, therefore, today's receivers, without any radical alteration, will continue to receive Alexandra Palace transmissions.

Just how wide this London service area will prove to be is difficult to say with absolute certainty. Roughly speaking, it will cover Greater London with a population of about ten millions or, again roughly speaking, a radius of more than twenty miles with local variations. There may be some surprising extensions—for instance—I should be unwilling to lay heavy odds against a resident in Hindhead viewing the Coronation procession.

In the light of experience here we shall proceed with

DECEMBER, 1936

the location of a second and subsequent transmitting stations according as public interest justifies this course.

"Technically, Britain leads to-day, and we shall try, in the words of Sir Antony Gloster, to 'Keep our light so shining a little in front of the rest.' To-day's simple ceremony will live in History, and I am proud to have taken part in it."

The following accepted invitations to be present at the inaugural Ceremony:

- | | | |
|---------------------------------------|---|---|
| Major the Rt. Hon. G. C. Tryon, M.P. | } | H.M. Postmaster-General |
| Lt.-Col. A. G. Lee, O.B.E., M.C. | | General Post Office |
| The Rt. Hon. the Lord Selsdon, K.B.E. | } | Chairman, Television Advisory Committee |
| Sir Frank Smith, K.C.B., F.R.S. | | Television Advisory Committee |
| Colonel A. S. Angwyn, D.S.O., M.C. | } | Chairman, Marconi-E.M.I. Television Company |
| Mr. F. W. Phillips, C.M.G. | | Board of Directors, Marconi-E.M.I. Television Company |
| Mr. O. F. Brown | } | Chairman, Marconi-E.M.I. Television Company |
| Mr. J. Varley Roberts, M.C. | | Board of Directors, Baird Television, Ltd. |
| The Rt. Hon. the Lord Inverforth | } | Chairman, Baird Television, Ltd. |
| Mr. H. A. White | | Board of Directors, Baird Television, Ltd. |
| Mr. A. Clark | } | Chairman, Baird Television, Ltd. |
| Mr. L. Sterling | | Board of Directors, Baird Television, Ltd. |
| Mr. I. Shoenberg | } | Chairman, Baird Television, Ltd. |
| Mr. G. E. Condliffe | | Board of Directors, Baird Television, Ltd. |
| Mr. A. D. Blumlein | } | Chairman, Baird Television, Ltd. |
| Mr. C. O. Browne | | Board of Directors, Baird Television, Ltd. |
| Mr. N. E. Davis | } | Chairman, Baird Television, Ltd. |
| Sir Harry Greer, D.L., M.P. | | Board of Directors, Baird Television, Ltd. |
| Mr. Harry Clayton | } | Chairman, Baird Television, Ltd. |
| Mr. J. L. Baird | | Board of Directors, Baird Television, Ltd. |
| Major A. G. Church, D.S.O., M.C. | } | Chairman, Baird Television, Ltd. |
| Captain A. G. D. West | | Board of Directors, Baird Television, Ltd. |
| Captain W. J. Jarrard | } | Chairman, Baird Television, Ltd. |
| | | Board of Directors, Baird Television, Ltd. |

- | | | |
|--|---|---|
| Mr. T. M. C. Lance | } | Baird Television, Ltd. |
| Mr. B. Clapp | | Technical General Manager, Marconi Wireless Telegraph Co. |
| Mr. J. D. Percy | | Chairman, Radio Manufacturers' Association |
| Mr. B. D. L. Mogridge | | Radio Manufacturers' Association |
| Mr. C. E. Rickard, O.B.E. | | President, British Movie-tone News |
| Mr. Edward E. Rosen | } | London representative, Columbia Broadcasting System |
| Mr. L. M. Macqueen | | President, Institution of Electrical Engineers |
| Mr. D. Grant Strachan | } | Chairman, Alexandra Palace Trustees |
| Sir Gordon Craig | | Chairman, B.B.C. |
| Mr. César Saerchinger | } | B.B.C. |
| Mr. H. T. Young | | Board of Governors, |
| County Councillor E. J. Cawdron, J.P. | } | Director-General, B.B.C. |
| The Lord Rutherford, O.M., F.R.S. | | Deputy-Director-General, B.B.C. |
| Sir John Cadman, G.C.M.G., D.Sc. | } | Controller (Engineering), B.B.C. |
| Mr. R. C. Norman | | Controller (Administration), B.B.C. |
| Mrs. M. A. Hamilton | } | Controller (Programmes), B.B.C. |
| Caroline, Viscountess Bridgeman, D.B.E. | | Controller (Public Relations), B.B.C. |
| Sir J. C. W. Reith, G.B.E., D.C.L. | } | and other members of the B.B.C. staff. |
| Vice-Admiral Sir Charles Cawdron, C.B. | | |
| Sir Noel Ashbridge | } | |
| Mr. B. E. Nicolls | | |
| Mr. Cecil Graves, M.C. | } | |
| Sir Stephen Tallents, K.C.M.G., C.B., C.B.E. | | |

The S.A.R.R.L. International DX Competition

CAPTAIN S. THORPE, ZS1AH, has sent us the following information on the DX competition to run concurrently with the Johannesburg Jubilee Celebrations.

This Society have organised a contest on the same lines as the Melbourne Centenary Contest organised two years ago by Australian amateurs.

The *Rand Daily Mail* has donated a trophy for presentation to the highest amateur scorer outside the African zone. While certificates will also be awarded to the winner in each country, or prefix zone. In addition, the following countries have been sub-divided into amateur districts. United States W1-W9, Canadian VE1-5, Australian VK1-8, so that the highest scorer in each of these 23 districts will receive a certificate.

For the purpose of computing scores, African amateurs will multiply the total points obtained by the number of countries or prefix zones worked. The three above-mentioned countries will provide a possible multiplier of 23, in addition to all other countries worked.

DX countries outside Africa will multiply the points obtained for exchange of serial numbers by the number of

African zones worked:—Angola CR6, Belgium Congo ON4, Northern Rhodesia VQ2, Southern Rhodesia ZE1, Madagascar FB8, Reunion FR8, Mauritius VQ8, Tanganyika VQ3, and the Union of South Africa ZS1-6, ZT1-6, and ZU1-6, making a total of 27 zones or a multiplier of 27.

Only one contact is to be made between stations on each band, but if an exchange of serials is not effected on the first contact, the two stations may contact again to complete exchange.

Amateurs in South Africa will endeavour to establish contact with DX stations and to prove a satisfactory QSO a serial number of six figures must be sent to, and acknowledged by the DX operator.

This serial number will contain a report based on the RST system for the first three figures, the balance of the number comprising a self-assigned number of three figures to be used by these stations throughout the contest.

When a complete exchange of serial numbers has been effected, both operators claim two points, with four points on 10 metres only. It is anticipated that the 10-metre band will be very

active during the period of the contest, and to ensure that this band will carry its fair amount of traffic, double points are to be awarded.

The contest period is to run over four week-ends of January, 1937.

The *Rand Daily Mail* trophy will be presented to the DX operator outside South Africa who returns the highest score. No prior entry need be made, but each competitor must submit a log at the conclusion of the contest. Entries should be addressed to South African Radio League, Box 7028, Johannesburg, South Africa.

On November 28 a working model of the Coronation procession will be transmitted in "close-up," so as to provide a life-size impression of the Coronation coach and the troops on the march. Constructed by two brothers, Messrs. Edward and Frank Offord, the model is 13 feet in length and nearly 3 feet high. When it is set in operation a 150-yard section of Westminster is shown, with soldiers lining the pavement and dense crowds behind. In a few moments, to the accompaniment of martial music, the procession comes into view—bands, infantry, Life Guards, and finally, the Royal coach, with the King's Watermen bringing up the rear.

PHILCO (U.S.A.) TELEVISION

Unknown to the greater part of the television world The Philco Radio and Television Corporation, of Philadelphia, U.S.A., have been carrying out television research work for over eight years. Here is a brief account of a recent demonstration by this concern.

By Our American Correspondent

TELEVISION in the United States received a new impetus recently when the Philco Radio & Television Company gave a demonstration to the Press. This company has carried on experimental

at a frequency of 51 megacycles, while the frequency of the sound carrier was 54.25 megacycles. A channel width of 6 megacycles was used and the polarity of transmission was negative. The aspect ratio was 4 to 3, and the synchronising impulses were of the narrow vertical type, 20 per cent. of the vision signal was devoted to synchronising.

An interesting part of the demonstration was an interview via television between Boake Carter, a well known news commentator. Mr. Carter was seated in the Philco studio seven miles distant. He appeared upon the television receiver and through sound and vision made various comments on the news of the day. Then telephone communication was made with the room in which the demonstration was held, and Mr. Carter was interviewed by various people present.

The latest model comprises a sound and television receiver tuning over a frequency range of 42-86 megacycles. These receivers are separately tuned. A cathode-ray tube is used which is 12 inches in diameter and 19 inches long. This is placed in the cabinet in an upright position and the picture is seen through a mirror on the inner side of the half raised cover. Deflection is electromagnetic. The power supply units are placed in the bottom of the cabinet. The total number of valves is 36.

While the officials of the company refused to estimate the cost of the receiver, when offered to the public, a tentative figure of \$500 was suggested. The opinion is held that the costs of the first receivers was not



The Philco television receiver. The picture is observed in a mirror in the lid of the cabinet.



A rear view of the receiver with the back removed.

television work for eight years; a licence for visual broadcasting from station W3XE was obtained in 1932, and experimental broadcasts begun. Last month's demonstration used 345 lines, at sixty frames per second interlaced.

The Philco system presented nothing radically new in the use of the basic principles of electronic television. It is understood that Philco holds licences from the two outstanding American companies (Farnsworth and R.C.A.) which have done the basic research in this field. What Philco has done, and much credit is due its engineers for this achievement, has been to take these basic principles and work them up to a high degree of perfection.

The first part of the programme was received in the house of one of the engineers seven miles from the plant and studio. This was broadcast



It is claimed that this is an untouched photograph of a picture on the screen of a Philco receiver.

nearly so important as other figures in television, namely, the cost of programmes, transmission, etc.

Cossor Television Receivers.

In the article entitled "Television Receivers You Can Buy," which appeared in last month's issue on page 631, it was stated in a reference to the Cossor receivers that "a second receiver for those who already have a broadcast set" is available for 105 guineas—the Model 137 T. The inference is that this receiver is designed for television and the accompanying sound only, whereas actually it gives broadcast reception on medium and long waves in addition.

Model 237 T, which sells at 120 guineas, provides vision and sound for television and also broadcast reception on the medium and long waves. In addition this model has an automatic record changer and gramophone motor.

TELEVISION IN THE HOME

AERIAL INSTALLATION; OPERATION—AND SOME FIRST EXPERIENCES

By the Editor

THE prospective purchaser of a television receiver need have no concern regarding installation. Really the only vital matter is whether you have electric supply available. If you have, whether it be D.C. or A.C., then you can have a television receiver providing, of course, that you are within the service range of the Alexandra Palace.

My own choice was a G.E.C. receiver and before delivery was due I had schemed out what I thought would be the best aerial layout under the somewhat exacting conditions. However, I could have saved myself the trouble for the G.E.C. installation engineers came fully equipped to meet all manner of aerial conditions and proceeded forthwith to carry out a number of tests in order to arrive at the best arrangement.

The particular problem was that the house is situated on a main road which carries a heavy stream of motor traffic. In the first instance it was thought that by attaching the dipole aerial to a high chimney at the back of the house it would be sufficiently removed from the field of interference. This position meant that the aerial would be approximately sixty feet from the road and at a height of about thirty-five feet, a concentric feeder brought down the side of the house being used as a lead-in.

Preliminary tests with this arrangement did not satisfy the G.E.C. engineers and it was decided to remove the dipole to the greatest distance possible from the road. Incidentally it should be noted that even with the aerial in this first position, interference was not impossible to tolerate, but it was irritating when traffic was particularly heavy. Under the more ordinary conditions of suburban side roads it would be hardly observable, a fact which disposes of the point

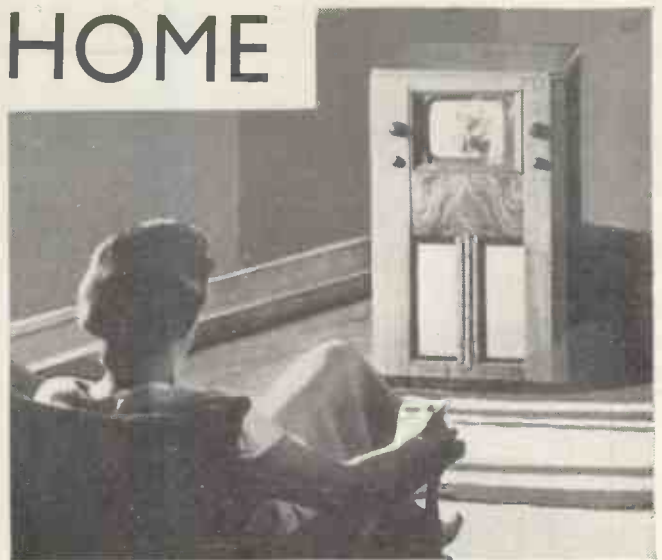

that under most ordinary conditions interference is likely to be troublesome. Even at its worst it affects the sound much more than the vision, or rather it would be more correct to say that it is more noticeable with sound than vision.

Cutting Out Interference

In order to instal the aerial at the greatest possible distance from the road, a mast with a dipole attached was erected at the extreme end of the garden. This mast was actually a large size in wireless masts and when erected the dipole was about forty feet above ground level. The lead from this was a concentric feeder brought down the mast and then carried along the top of the fence and at a few yards from the house taken up to and in the top of a ground-floor window.

When a preliminary test was made with this arrangement a remarkable improvement was immediately noticeable and it is now only on rare occasions that any serious interference is apparent. It is an evident fact that some makes of cars are more prone to cause

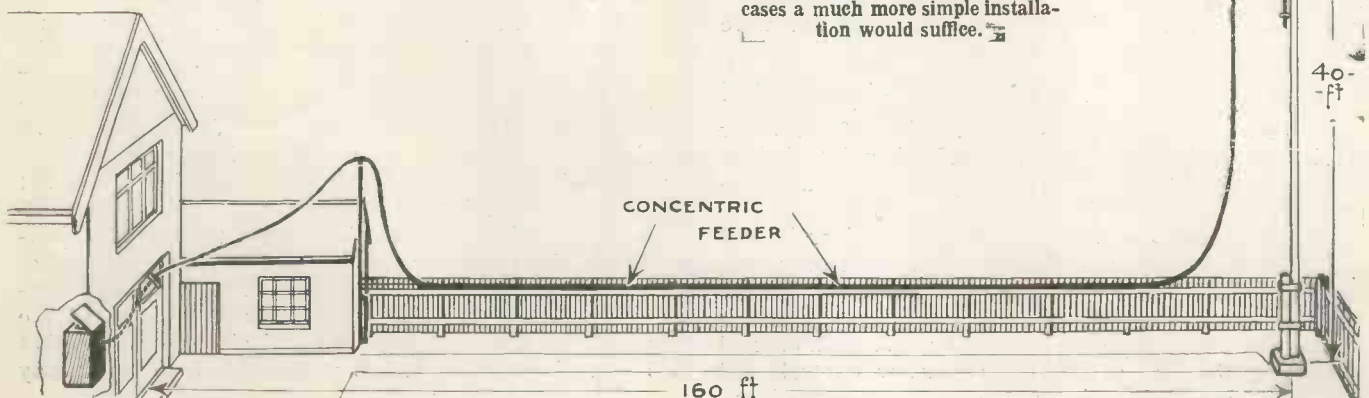

COMPLETE BROADCAST ENTERTAINMENT

interference than others. At a later date it is hoped to list these; observations so far indicate that the Ford 8 and the Riley are rather bad offenders, but as no detailed check has been made this opinion may have been formed purely by coincidence.

Although with this arrangement interference is practically nil, it is hoped later on to eliminate it altogether.

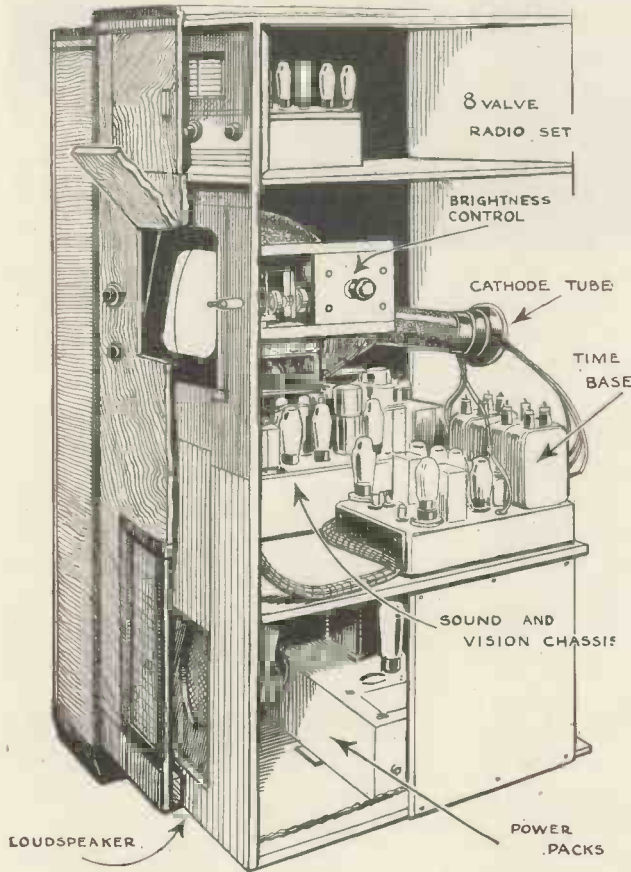

A cut-away view of the G.E.C. television receiver showing the arrangement of the various units. This is the model incorporating a short-medium- and long-wave receiver.

The G.E.C. engineers suggested several easily adaptable schemes. It was concluded that what little bit of remaining interference there was was being picked up on the feeder itself and therefore that if this were placed almost at ground level, instead of being on the top of the fence, further improvement would be effected. Alternatively the feeder could be buried in the ground; or another suggestion was the earthing of the outer casing of the feeder. From an academic point of view, rather than any practical necessity, it is hoped to experiment in this direction at a later date.

One naturally expects that when a receiver is first installed some little adjustment will be necessary, but this was not the case; an effort was made to complete the aerial installation during one of the test transmissions and after plugging in to the mains, tuning and adjusting the line and frame frequency controls (all perfectly simple operations), the picture appeared and

remained quite steady for the entire duration of the programme.

Perfect Safety

A great point has been made in the past regarding the dangerously high voltages that are used in a cathode-ray receiver. It cannot be too strongly stressed that there is not the slightest possibility of danger; a child could play with one for hours and not come to the slightest harm. Even if the back were removed, the connections are automatically broken and in ordinary use no high voltages are even remotely accessible.

As is well known the G.E.C. make two types of television receiver—one intended for the reception of sound and vision only from the Alexandra Palace and the other, which in addition to sound and vision reception of the Alexandra transmissions also incorporates a long, medium and short-wave receiver for sound transmissions. It was thought desirable to have the latter type as representing the last word in broadcast entertainment, though I must admit that my chief interest lies chiefly in the television section.

One master switch controls all receiver sections—to the left it switches on the long, medium and short waves; the first position to the right cuts out the broadcast sound and makes it suitable for reception of the Baird system (both vision and sound); a further turn to the right and it is suitable for the Marconi—E.M.I. system—again both vision and sound. Apart from the tuning knob of the broadcast receiver, usually this is the only control that need be touched, although there are tuning, volume, contrast and line and frame frequency controls for the television section mounted on the front of the cabinet.

The broadcast sound receiver is a separate receiver to all intents and purposes and is accommodated in the upper part of the cabinet. This is provided with the usual single-knob tuning, wavechange switch, and tone and silent tuning controls. Both this section and the end of the cathode-ray tube are enclosed by flush-fitting doors and externally the cathode-ray tube is further protected by a glass window.

A Complete Home Entertainer

The performance of this receiver is amazing. Practically any European broadcast transmission is available at full loudspeaker strength, and most short-wave stations also with full loudspeaker volume. The volume, when the control is turned full on, is sufficient to shake the house. No less amazing is the simplicity so far as operation is concerned. Although the complete receiver may be said to perform six functions it is as simple to operate as an ordinary wireless receiver.

At this early stage of television transmission it is but natural that variations should occur and on these occasions there is always the inclination to attempt adjustments of the receiver. It is noteworthy, however, that in no case has this been actually necessary and a reversion to the original setting at a later stage of the programme, when conditions had altered, proved that any variation that had occurred was not in any way due to the receiver.

FOR THE BEGINNER

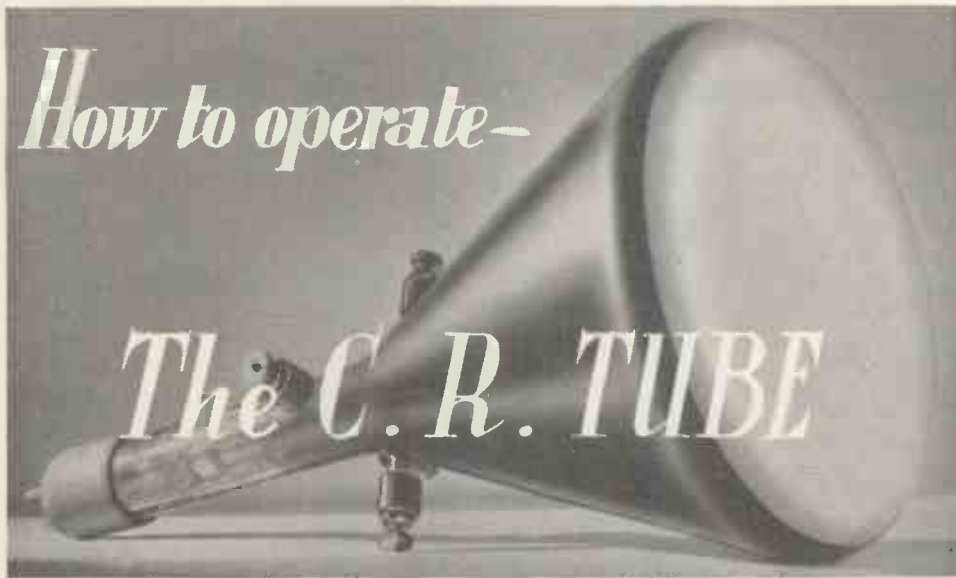

By A. F. Hollins, Mullard Technical Service Dept.

II—FOCUSING AND SPOT SIZE

IT is first of all necessary to realise that focusing and spot size, both of which have an important bearing upon the definition of a television picture or of the trace of some phenomenon which is being investigated by means of the cathode-ray tube, are two separate effects, although the effect of incorrect focus is, to some extent, similar to that of permitting an increase in spot size. Focusing being the major problem, it will be considered first.

There are three methods available for focusing cathode-rays, namely, gas focusing due to the effects of the residual gas within the envelope; electro-magnetic focusing; and electro-static focusing. All are of sufficient importance to justify detailed consideration and each has its own particular sphere of usefulness, although the two last mentioned, as applied to "hard" tubes, are of greater interest to readers of TELEVISION AND SHORT-WAVE WORLD; electro-static focusing, which is employed in the particular forms of tube under discussion must be dealt with in the greatest detail.

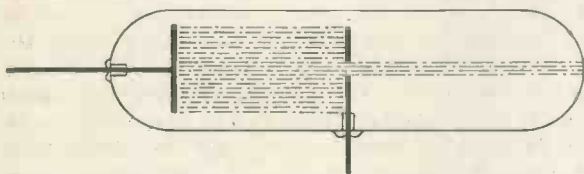

Fig. 1.—An early design of tube for producing a stream of electrons.

The various problems which arise will be more clearly understood by bearing in mind two of the fundamental facts concerning the cathode-rays, namely, that they emerge in straight lines normal to the cathode (in this respect they are, of course, analogous to light rays) and that they carry a negative charge. These two points are taken advantage of in all focusing devices as will be shown.

Gas Focusing

It should be remembered that the cathode-ray tube was evolved from the early "vacuum" tubes (in reality they contained considerable quantities of residual gases) which were made for the examination of electrical discharges. These tubes had cathodes of the cold emitter type and in many cases consisted merely of an evacuated glass tube with a flat electrode sealed in at each end. It was only when qualitative experiments gave place to quantitative research that any attempt was made to produce a "ray" in the sense of a pencil or concentrated beam of electrons.

Fig. 1 shows an early design of tube for producing an electron stream of small dimensions, and it should be noted that no attempt is made to concentrate the total emission from the cathode into a beam, all that is done is to cut off the more divergent parts of the beam, utilising only the area corresponding to the size of the aperture in the anode. The energy of the beam on the side

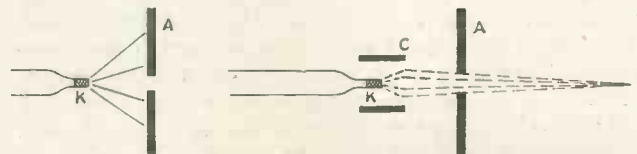

Fig. 2.—Two diagrams showing how the electron beam can be concentrated by the use of an electric field.

of the anode remote from the cathode is, therefore, but a fraction of that of the total emission, and an interesting parallel can be drawn by referring to the light value in a camera which is decreased by "stopping down."

Later the Braun tube was developed and from these early efforts the "soft" cathode-ray tube emerged in a form similar to that employed to-day. An electrode was introduced into the soft tube in the form of a

MAGNETIC FOCUSING

cylinder surrounding the cathode, its object being to concentrate the electron stream leaving the cathode, in order to ensure that practically the whole of it passed through the anode aperture.

Fig. 2 shows on the left how the electrons would be scattered in the absence of the cylinder, and on the right how the electrons are concentrated under the influence of the electric field inside the cylinder. It will be clear, therefore, that the potential applied to the cylinder controls not only the initial divergence, but also the intensity of the ray, and these two factors determine the sharpness and definition of the spot for a given type of tube structure and gas pressure.

But a still more important factor in concentrating the beam is the effect of the residual gas within the tube.

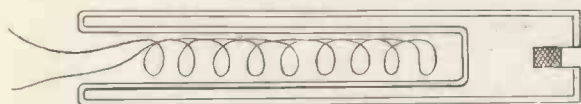

Fig. 3.—Diagram showing the arrangement of the emitting surface in a gas-focused tube.

A quantity of gas at a pressure of about 0.005 mm. is introduced into the bulb of a "soft" tube for two reasons. One is to permit the use of fairly low operating voltages of the order of 300 to 2,000 volts, and the other is for focusing the beam. The gas employed may be hydrogen, helium, neon or argon. While passing from the cathode to the anode the electrons "ionise" the gas atoms, that is to say, as the result of collisions between electrons and gas atoms, each of the latter is split up into a positive ion and one or more electrons. Now the positive ions have a far greater mass than electrons and their velocity is therefore much lower so that they remain in the path of the ray for a much longer time than the electrons. The positive ions therefore form a positive space charge in the centre of the ray and, because this charge exercises an attractive force on the electrons, the ray is concentrated. It is for this reason that the "soft" tubes are more correctly termed "gas-focused" tubes.

In the construction of gas-focused tubes precautions are taken to shield the emitting surface of the cathode from bombardment by the positive gas ions which would otherwise result in the rapid disintegration of the emitting material. One method of doing this is illustrated in Fig. 3, which shows a cathode in which the emitting surface is recessed within the body of the cathode structure. The form of heater winding adopted should also be noted.

Limitations of Gas-focused Tubes

Gas-focused tubes are entirely satisfactory for a large number of applications, but their performance is not ideal when very rapid deflection of the ray is required as in the investigation of high-frequency phenomena and in television. The reason is that under these conditions the ray does not remain in any one spot for a sufficient period to permit the formation of enough positive ions for satisfactory concentration, with the result that the image becomes blurred. For these types of applications, also, the gas-focused tube has the further disad-

vantage that the sharpness of the image is largely dependent upon the intensity of the ray. But as picture modulation in the present day form of television transmissions is introduced by varying the strength of the beam current, the focusing effect is being constantly varied, and with it the sharpness of the picture.

Two other effects characteristic of the gas-focused tube are first, the departure from linearity of the deflection characteristic when the field between the plates is reduced below a critical value, and the low value of the impedance between the deflecting plates due to the ionic current. However, both of these effects can be avoided either by modifying the normal construction of the tube or externally by adjustment of the electrical circuit connected to the tube.

Magnetic Focusing

Of the methods of focusing the beam in a cathode-ray tube of the highly evacuated type, magnetic focusing first demands attention. The basic principle employed is that if the tube is surrounded by a coil arranged with its axis co-incident with the path of the undeflected ray and a direct current is passed through the coil, the longitudinal magnetic field produced, acting upon all electrons which are not travelling exactly in the axial direction, compels them to follow curved paths. By correct location of the coil and correct adjustment of the magnetising current, these curved paths can be made such that electrons emitted from the cathode are brought to a focus at one particular point on the screen.

The following data are of interest in the correct application of magnetic focusing. Assuming that the focusing coil is in the form of a solenoid which is short in comparison with the length of the beam, and that the diameter of the beam as it enters the region of the coil is small, the ratio of the diameter of the spot at the screen

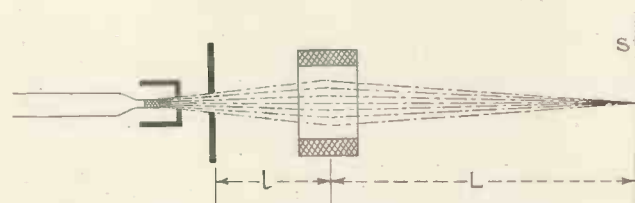

Fig. 4.—Diagram showing the principle of magnetic focusing.

to the diameter of the beam aperture of the anode will be L/l where: L is the distance from the centre of the coil to the screen and l is the distance from the centre of the coil to the anode as indicated in Fig. 4. Although, on this fact alone, it would appear that the coil should be as near the screen as possible, there is a conflicting factor in that as the coil approaches the screen, so the diameter of the beam at incidence at the coil increases, due to beam divergence. The electrons forming the outer edges of the beam will therefore have a different focal length from that of the innermost electrons, and a blurred spot will result, analogous to the spherical aberration experienced in an optical system. A compromise must therefore be effected between the distances L and l , the final decision depending upon the spot size required and the size of the beam aperture at the anode.

FOCUSING THE ELECTRON BEAM ELECTROSTATICALLY

The magnetising force required, that is to say the number of ampere-turns of the coil itself (number of turns multiplied by the magnetising current in amperes), can be computed approximately from the following formula:

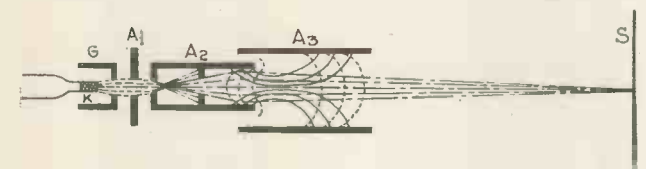

Fig. 5.—The arrangement of a 3-anode tube and their effect upon the electron beam.

$$N = \sqrt{\frac{V(l+L)d}{1 \times L}} \times 220$$

Where: N number of ampere-turns
V anode voltage in kilo-volts
L distance between centre of coil and screen in centimetres
l distance between centre of coil and anode, in centimetres
d mean diameter of coil in centimetres.

For a medium-sized tube the magnetising force will be of the order of 250 ampere-turns. In practice the number of ampere-turns may be considerably decreased by concentrating the magnetic field by means of an iron yoke terminating in an annular gap concentric with the neck of the tube.

Electro-static Focusing

It will have appeared, from the previous paragraphs, that electro-magnetic focusing has certain characteristics in common with the focusing of light by means of a lens; electro-static focusing also makes use of an electron-lens effect. The subject of electron-optics is too vast to be covered here, and it must suffice to explain that, by suitable shaping the electrodes, it is possible to produce an electro-static field of symmetrical shape such that electrons diverging from a given point are brought to a focus at some other point. As in magnetic focusing, the focal length and ultimate spot size are governed by the relative positions of the electrodes and the strength of the focusing field.

The photograph reproduced herewith (page 683) shows details of the electrode system of a Mullard cathode-ray tube, and attention is particularly drawn to the view showing a longitudinal section of the electron lens assembly which in this instance is that of a two-anode tube. Reference to Fig. 5, which shows the beam outline for a three-anode tube when adjusted for correct focus will facilitate appreciation of what actually takes place.

It will be observed that initially the beam is convergent at the second anode, which means, in effect, that the electron lens has something approximating to a point source of electrons upon which to operate. At the second anode the beam diverges again, but under the action of the electro-static field between the second and third anodes it again becomes convergent, being finally brought to a focus at the screen.

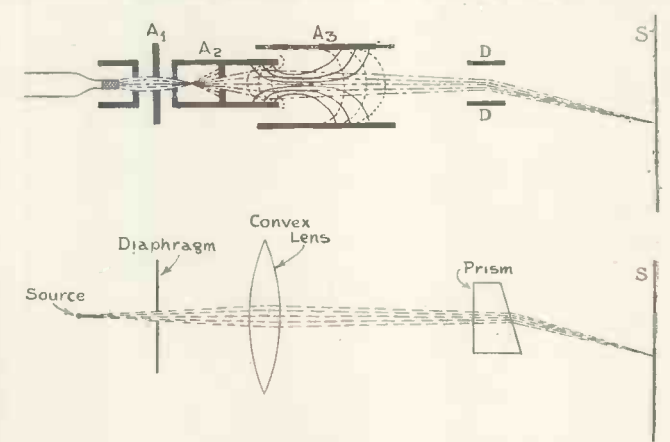

Fig. 7.—Two diagrams showing comparison between electronic and optical focusing.

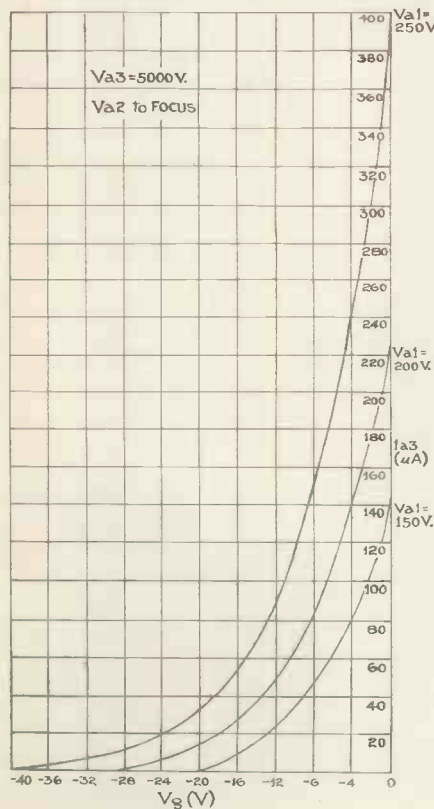

Fig. 6.—Curves showing the variation of beam current with variation of grid voltage for different values of V_{a1} .

Referring again to Fig. 5, the cathode, which approximates to a point source, provides the electron stream; surrounding it concentrically, and designed to produce a powerful controlling effect is the grid which introduces the necessary modulation of the beam current. Immediately in front of the grid is the first anode which provides the initial accelerating impetus and also acts in a similar way to the screening grid of a radio valve in that it ensures that the electro-static field of

(Continued on page 704)

ELECTRON MULTIPLIER RESEARCH

RESEARCH on the development of electron multipliers is being conducted in practically every electrical laboratory in the world and some results have recently been published of work undertaken by the German Post Office.

Experiments were made with a view to finding the most suitable metal for the targets—that is metal

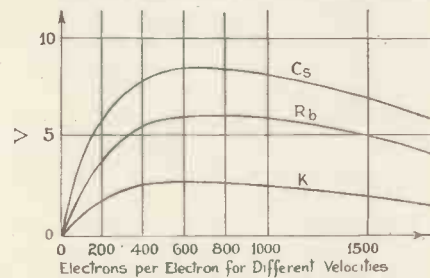

Fig. 1.—The number of secondary electrons produced at different voltages.

that would yield the greatest number of secondary electrons. Knowledge of photo-cell characteristics suggested that the alkali metals would be the most suitable, particularly cesium deposited on oxidised silver, with which a maximum of 8 to 10 electrons per electron is obtained at about 600 volts. Of other metals examined (gold, lead, iron, aluminium, sodium, copper, zinc, etc.) only magnesium was found to give a satisfactory yield.

Targets of finely meshed wire gauze, placed one behind the other, with a potential difference of 50 volts between them, were used; the elec-

trons set free at each electrode being concentrated by a magnetic field with lines of force perpendicular to the electrodes.

With gauze of threads, having 10,000 meshes per sq. cm., with about half the area occupied by threads, it is possible to obtain a magnification of about five per stage. The plate, at 400 volts, is made of wider mesh, and is followed by a series of grids with decreasing potentials (Fig. 2). Tubes giving an amplification of one million are now possible.

In the Farnsworth secondary emission multiplier the electrons are made to go back and forth between a single pair of targets receiving their potential from a high frequency electric field applied to the targets. Suppose that electrons are liberated by ultraviolet light at the moment the voltage of the second target goes from negative to positive values. If the time taken by the electron to cover the distance between the targets is exactly equal to $\frac{1}{2}$ period, the electron will be accelerated throughout its path by the electric field, and knock electrons off the second target which acted as anode. Three electrons are drawn to the first target during the second half of the period, and produce additional secondary electrons which repeat the cycle.

An electron which is set free by the light after the second target has reached a certain positive potential may make part of its lag good because it starts in a stronger field. Neglecting space charges and collisions, the

simple equations of motion show that as long as the lag does not exceed about one-sixth of the whole period of oscillation, the lag or phase difference with which the secondary electrons are set free decreases in each successive crop of electrons. When the lag becomes considerable the electron arrives in the wrong phase and is retained by the second target.

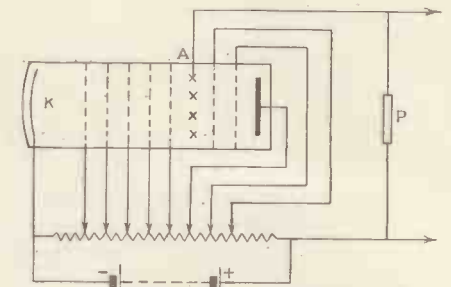

Fig. 2.—Diagram of mesh-type multiplier.

The electrons set free during the first third of the first half wave come gradually into step with the applied field; the velocity with which they arrive at the electrodes depends, of course, on the phase with which they started. The velocity of the electrons with a lag of 45 deg. is only about one-half the highest velocity. With a given tube the degree of amplification may be adjusted by increasing the frequency of the applied field, the cut-off being obtained for an increase of about 10 per cent., or by decreasing the amplitude.

"A Q.P.P. 70-WATT POWER AMPLIFIER."

We very much regret an error which appeared in the article in our November issue on page 658 under the caption "A Q.P.P. 70-Watt Power Amplifier," which contained the statement that "A suitable transformer for this purpose can be obtained from Mr. N. Partridge, of Messrs. Bryan Savage, who have had considerable experience with this type of work." It was our intention to say that Mr. Partridge or Messrs. Bryan Savage supplied this transformer, but a printer's slip made us say "of" instead of "or," our statement then carrying with it the inference that Mr.

Partridge was connected with Messrs. Bryan Savage. We are assured by Mr. Partridge that he carries on a business (entirely separate and apart from Messrs. Bryan Savage) as a specialist in the design and manufacture of transformers at King's Buildings, Dean Stanley Street, London, S.W.1. We apologise for the mistake.

Special Aerials for the Amateur

Now that the average amateur appreciates the need for an efficient aerial system there is considerable interest in low-loss cable for use as feeder lines. Most matched impedance aerials require a special cable if they are to work

effectively and up to the present not all the cable available in this country has been entirely satisfactory.

Messrs. Eves Radio, Ltd. of Wolverhampton, have supplied us with some very fine cable which from our tests seems to be entirely suitable for amateur use.

It is built up from two separate 1/064 solid conductors each double vulcanised, colour graded, twisted and then enclosed in a final heavy gauge waterproof covering. This cable sells at 4½d. per foot or 4d. per foot over 50 yard lengths.

Also available from the same source are the new RK35 valves and the Western Electric type WE316A transmitting acorns suitable for frequencies up to 750 megacycles. All publications of the A.R.R.L. including the 1937 Handbook are now available.

BAIRD TELEVISION LTD.

**WORLD PIONEERS & MANUFACTURERS OF
ALL TYPES OF TELEVISION EQUIPMENT**



PRICE 85 Gns.

BAIRD TELEVISION, LIMITED, announce that their "Televisor" receiving set Model T.5. is now ready for immediate delivery from stock.

Authorised dealers who have qualified for a Baird Certificate of Proficiency, have been appointed within the service area of the B.B.C. television station. A complete list will be supplied on written application to the Company at Crystal Palace.

"Televisor" receiving sets give a brilliant black and white picture 12" x 9" on the "Cathovisor" cathode ray tube, which is of unique design and guaranteed for a long life.

These Sets give results on both systems of transmission unequalled in size, detail, brilliance and colour, with the accompanying sound, and are operated on A.C. Mains, or on D.C. Mains with a suitable D.C./A.C. converter. The controls are extremely simple for either system.

"TELEVISOR" RECEIVERS MIRROR THE WORLD

Head Office :

**GREENER HOUSE,
66, HAYMARKET,
LONDON, S.W.1.**

'Phone : Whitehall 5454

TELEVISOR

REGISTERED TRADE MARK

Studios and Laboratories :

**CRYSTAL PALACE,
ANERLEY ROAD,
LONDON, S.E.19.**

'Phone : Sydenham 6030

TELEVISION

for the Home Constructor

TO-DAY, television, the new wonder of the age, is fast becoming generally available to the public and a fascinating new world of interest is presented to those for whom the home construction of radio sets has held so much attraction in the past. Television is bringing a living cinema to every fireside, and is opening up a vast and thrilling new field of home entertainment. During the coming months, there will be many historic features in the programmes. Already variety, news-reels, ballet, and novel illustrated talks are included. Soon there will be the thrill of seeing and hearing at the actual moment of occurrence events of the Coronation of King Edward, not to mention other great national occasions and such annual favourites as the Derby and the Boat Race.

WITH the establishment of regular B.B.C. programmes from the Alexandra Palace, BOSCH HALL have decided to offer a range of units which will enable the home constructor to enjoy excellent television at a considerable saving in cost. These units are designed to give good results within a radius of 50 miles of the Alexandra Palace, and are as easy to assemble as an ordinary radio set. Each unit is supplied with clear diagrams and instructions, and can be fitted into a cabinet of the purchaser's own selection.

Constructors have the choice of buying Vision or Sound Receivers, Time Base, or Power Pack Units, assembled and ready for linking up in one cabinet, or the complete kit of parts of each unit for home assembly. The instruments work on A.C. mains 100/240 volts, and the local voltage should be stated when ordering. All the material is of the finest quality and is British made throughout. Prices and particulars are given on the right, and the fullest information will be sent on request.

THESE units have been designed by Mr. Charles P. Hall, B.Sc., a Fellow of the Television Society, and one of the leading authorities on television matters. BOSCH HALL definitely guarantee that, providing the units are assembled in accordance with the simple directions, the results will give the utmost satisfaction. To help any constructor who experiences the slightest difficulty, the expert advice of the company's service bureau is freely available. This bureau has for its main object the encouragement of those amateur experimenters whose valuable work in the development of modern radio is widely acknowledged. Furthermore, by arrangement, sets assembled by constructors can be inspected and tested by a qualified engineer on a payment of a small charge.

Be one of the first to build your own television receiver. By making the instrument yourself, you will treble your enjoyment when you sit down to watch and hear the television programmes. Start now—write to-day for further particulars, gladly sent free on request.



Illustration above shows BOSCH HALL Vision and Sound Receiver Units. The Sound Receiver is the instrument on the right.

Vision and Sound Receivers

The BOSCH HALL Vision Receiver gives high definition on ultra short waves as used for the B.B.C. Alexandra Palace programmes. It embodies an amplitude filtering circuit dividing the synchronising signals and providing separate outputs for the Time Base and the Sound Unit. The instrument uses nine valves. The five-valve Sound Receiver gives perfect reproduction and remarkable ease of control with freedom from interference.

VISION RECEIVER: Chassis assembled, and complete with nine valves, £18 18s. 0d. Kit only, with drilled chassis, for home assembly, less valves, £8 15s. 6d.

SOUND RECEIVER: Chassis assembled, and complete with five valves, £14 14s. 0d. Kit only, with drilled chassis, for home assembly, less valves, £7 12s. 6d.

Time Base

Produces from B.B.C. transmissions a bright and distinct black and white picture, size, 10 in. by 7 in. Highly efficient scanning. Brilliance of image variable at will. Designed for vertical use with reflecting mirror. Chassis assembled, complete with six valves, £17 17s. 0d. Kit only, with drilled chassis, for home assembly, less valves £9 15s. 0d. Cathode-ray tube, extra, in both cases.



BOSCH HALL Time Base Unit, showing cathode-ray tube in position.

Power Pack

Incorporating potential divider unit for supplying H.T. to anodes of cathode-ray tube at 400, 1,250 and 4,000 volts, and negative grid bias of 150 volts. Built in metal screening box and fitted with safety switch. Operates on 100/240 volts, A.C. supply. Chassis assembled, complete £10 10s. 0d. Kit only, with drilled chassis, for home assembly, £6 6s. 0d.

INTERMEDIATE FREQUENCY UNITS for vision receivers, operating on wavelength of 7 megacycles, giving "flat top" response averaging 2 megacycles in bandwidth. Each, 10/-.

BOSCH HALL Television

BOSCH HALL LTD., FERRY ROAD, TEDDINGTON, MIDDLESEX. TELEPHONE KINGSTON 6556

Scannings and Reflections

TELEVISION DEMONSTRATIONS

DEMONSTRATIONS of television are being given to the public at a fairly large number of centres in London. The General Electric Co., Ltd., have two large demonstration theatres in Magnet House, Kingsway, where both the afternoon and evening programmes may be seen. H.M.V. have also two large theatres at their showrooms at 98 Clerkenwell Road. Baird Television give demonstrations at their offices in Greener House, Haymarket.

In addition to these manufacturers' demonstrations, several of the large stores are equipped with receivers. Among these are John Barnes, Finchley Road; Wallis's, of Holborn; Gamages, also of Holborn; Whiteley's, Westbourne Grove; Arding and Hobbs, St. John's Road, Clapham Junction; and Kennards, of Croydon and Wimbledon. Many wireless dealers are also giving demonstrations, and among these are E. Rogers and Sons, High Street, Weybridge, and Radio and Electrical Equipment Renters of the Parade, High Street, Watford. Weybridge, of course, is on the fringe of the estimated service area, but nevertheless reception there is excellent.

The Southern Railway are still giving demonstrations to railway ticket holders at Waterloo Station and the Science Museum demonstrations are also to be continued until further notice. The latter have created an enormous amount of interest and very many thousands of people have witnessed them.

RECEIVER SALES

The demand for television receivers has exceeded makers' expectations, and in every case it has been found necessary to make arrangements to increase the output. It was generally expected that the demand at first would be confined largely to stores and institutions, but there are sound indications that the public is becoming keenly interested, and many private sales are being effected. Many

people are delaying purchase in the expectation that with increased output prices will fall. Eventually this will be the case, but not until the demand warrants mass production methods on a fairly large scale. It must be remembered that a television receiver largely follows ordinary wireless practice and employs similar components and the production of a large part of the receiver is, therefore, based upon practice which has been gained over a number of years and on which there is little prospect of effecting a saving.

TRANSMISSION RANGE

Although no precise data is as yet available regarding the range of the Alexandra Palace transmissions, it is clear that, generally speaking, it is considerably in excess of that officially given. Pictures have been received as far distant as seventy-five miles and we have reports of reception at Leigh, approximately thirty-five miles away. Reception appears to be consistently good in the whole of Greater London and so far as we are aware no difficulties have been met with within a radius of thirty miles. It is understood that manufacturers of receivers are prepared to make tests of the suitability of location within reasonable distances.

TELEVISION ON TAP

Carrington House, a large block of flats in Mayfair, has been equipped for "bulk reception" of television signals and of ordinary broadcast programmes. The building contains seventy-three flats, each of which is fitted with plug points for television and radio reception. The residents of any of these flats can purchase a television and/or radio set in the confident knowledge that it will operate successfully and provide programmes quite free from interference.

Two aerials have been erected on the roof, both of which have been specially designed by E.M.I. Service, Ltd. That for broadcast programmes is matched to the transmission line which connects to the amplifier, whilst for the reception of the television

signals an aerial of the half-wave dipole type is employed. Leads from these aerials go direct to high-frequency amplifiers employed to magnify incoming signals and to meet the load imposed upon the line as well as to offsetting line losses.

A high frequency co-axial cable is employed for distribution. The outputs of the radio and television frequency amplifiers, in addition to being matched to the line impedance are mixed and the various frequencies superimposed on each other and carried over the same conductor. By correct attenuation and termination, reflections are avoided and a constant load maintained. At the outlets in the rooms, separation of the television and radio frequencies takes place and whichever service is desired can be taken from the appropriate sockets. Television reception, even in the ground floor flats, is as good as if each flat had its own aerial situated on the roof.

TELEVISION THE CORONATION

The Television Director has fully realised what an enormous boost would be given to television were it possible to televise the actual Coronation ceremony in Westminster Abbey. Such an event presents some very difficult problems at the present stage, but these problems are already being tackled and it is thought that they can be overcome. The two great difficulties are those of relaying the signals to the Alexandra Palace and the matter of adequate light. There are two possible solutions to the first—a special cable from the Abbey to Broadcasting House which would link up with the existing cable from there to the Alexandra Palace or the relaying of the signals by microwaves. Comparatively little experience has as yet been obtained with either method and both are undergoing investigation.

The question of light is one that concerns the authorities, who are not disposed to allow more than a certain maximum value and the point for the B.B.C. engineers in this matter is

MORE SCANNINGS

whether this value will suffice. It is understood that negotiations are proceeding with a view to getting this point settled and in the meantime experiments are being carried out. At the present time it is not possible to give any pronouncement one way or another, though the general indications are that the Coronation will be televised and that many thousands of people in the service range of the London transmitter will have the opportunity of seeing it.

NO TRANSMISSION CHANGES FOR TWO YEARS

The statement by Lord Selsdon at the opening of the television service that there will be no change in the standards used for transmission which would render existing receivers obsolete for at least two years is an important one for it will do much to stabilise production.

OUTSIDE BROADCASTS

The average viewer is quite unaware of the work entailed in an outside television broadcast even of the most ordinary kind. For example, the pictures of the North London Exhibition which were transmitted during the test period involved several days' work for the engineers and a staff of about twenty-five actually at the time of the transmission. Special lighting arrangements had to be made and this necessitated a portable cable system with men paying out the cables as the camera was moved from stand to stand; in addition there was the high-frequency cable connecting the camera to the transmitter to be handled so that the whole transmission provides a decidedly complicated job of work.

ALEXANDRA PALACE PROGRAMMES IN SOUTH AFRICA

It is reported that a Johannesburg amateur is regularly picking up the Alexandra Palace transmissions in that town. It is stated that he has heard the announcing and programmes since the middle of October. The vision sounds (synchronising) are also heard, but as no receiver is available it has been impossible to try to resolve the pictures. Other reports of freak long-distance reception have been received, but owing to the inconsistency it has never been possible to obtain verification.

THE LONDON-BIRMINGHAM CABLE

The task of laying the special coaxial cable between London and Birmingham is now completed. The cable contains four wires and in the first place use will be made of only two of these for trunk telephone communication, though it will be some weeks before the cable is put into actual use. No decision has as yet been made whether one of the channels will be used for television, though it is likely that tests will be made in the immediate future. The installation of a short-wave transmitter would be necessary, of course, before any service could be inaugurated in the Birmingham district and this would be a matter for the decision of the Television Advisory Committee in conjunction with the Post Office authorities.

BAIRD TELEVISION

Mr. Harry Clayton has been appointed joint managing director with Mr. John Logie Baird, of Baird Television, Ltd., and Mr. Ian Cremieu-Javal has joined the Board. Both Mr. Clayton and Mr. Cremieu-Javal are directors of the Gaulton-British technical subsidiaries and jointly responsible for their executive control.

Mr. Clayton is vice-chairman of Baird Television and is managing director of British Acoustic Films, a director of Bush Radio and of British Acoustic Marine Equipments.

THE DON LEE (U.S.A.) TRANSMISSIONS

Having experimented for several weeks with night time conditions, the Don Lee transmissions are now to be made at 4 o'clock on Sunday afternoons. The combined experimental broadcasts are put out via KHJ and W6XAO. KHJ broadcasts the sound accompaniment of the vision programme going out simultaneously from W6XAO. Both transmitters are located in the Don Lee Building at 7th and Bixel Streets, Los Angeles. The reason for the change of time is to obtain data regarding daylight transmission.

TELEVISION QUEUE IN KINGSWAY

The first television programme broadcast on Monday, November 2

was demonstrated by the G.E.C. at their offices in Kingsway. So many members of the public wished to see the demonstration that some time before 3 p.m., when the broadcast began a large queue stretched down Kingsway. Public demonstrations are being given daily (at 3 and 9 p.m.) at the G.E.C. offices until further notice.

TELEVISION PUBLIC ADDRESS

The value of television in conjunction with public address was shown during the Motor Show at Olympia. The occasion was the television broadcast by Sir Malcolm Campbell of a description of each of twelve cars selected by the Society of Motor Manufacturers and Traders and took place in the Exhibitors' Club. Four Marconiphone "701" television receivers were installed to convey to a selected audience Sir Malcolm's gestures and remarks. Altogether about 120 people witnessed the reception, each of whom saw everything perfectly. This is the largest number of persons ever to witness a regular television programme.

TELEVISION IN RUSSIA

Regular television transmissions organised by the Azerbaijan are being made in Baku. Demonstrations of reception are being made in a specially equipped studio. The broadcasts include such items as plastic dances, scenes from operas, news reels and readings by well-known writers. No information regarding the system used or the definition is available.

NEW S.W. REGULATIONS IN INDIA

Any short-wave amateur could, until just recently, obtain a transmitting licence in India on request without any technical examination or morse code test. This unfortunately allowed quite a number of non-technical operators to build or buy transmitting equipment without the specialised knowledge required. Now at the request of the majority of amateurs, stringent regulations have been put into force, so that before a licence is granted, several tests have to be undergone. Every intending operator must be able to pass a morse code test of 16 words per minute in conjunction with an examination covering radio theory, law and operating procedure.

AND MORE REFLECTIONS

AMATEUR RADIO IN PORTUGAL

Until further notice all amateur transmitting has been suspended in Portugal. Listening on short-waves is still permitted, but unless a station is actually being used for Government work, no transmitting is allowed. No reasons are given for this ban, but it is suggested that the better equipped amateur stations are temporarily to be taken over by the Government.

A similar ban still applies in Jugoslavia although it is not strictly enforced, but all the same, any amateur discovered using transmitting apparatus can, according to the rules and regulations, be shot. That, of course, is in theory.

SOCCER TELEVISION

Some idea as to the usefulness of the electron camera can be obtained from the recent broadcast of a football match from Berlin. The international match between Germany and Italy was televised and transmitted through the station at Wizeleben, near Berlin. Viewers were able to follow the whole match quite easily for results were claimed to be excellent.

ENTERTAINMENT TAX ON TELEVISION

The Performing Rights Society are claiming fees from owners of television apparatus used for public entertainment. Restaurants and the railway companies have already been approached, and as much as 20 guineas is being claimed from one particular restaurant. This sort of thing may tend to hold up television development if fees are to be required from small dealers staging demonstrations.

INCREASED RANGE ON 5 METRES

The television transmissions seem to be doing a lot of good to the amateurs interested in ultra short-wave reception. It has been found that simple directional arrays with reflectors increase signal strength as much as 50 per cent. These arrays, although not cut to length for 5 metres, are being used on the amateur band with great success. If further progress is made in this manner there is every possibility that 5-metre signals could be used to cover the whole country.

RECEPTION OF TELEVISION SOUND SIGNALS

Many listeners have built simple 1- and 2-valve receivers to pick-up the

television sound signals and report good results from well outside the official service area.

A listener in a basement flat in Gravesend reports loudspeaker reception with a 4-valve super-regenerative set coupled to an aerial 3 ft. long. Reception was obtained at Thorpe-ness with a 2-valve set on a standard 66 ft. aerial.

A radio dealer in Clacton coupled a standard 1-valve super-het converter to a broadcast set and picked up the signals at great strength. Many amateurs using conventional 5-metre 2-valve super-regenerative sets with additional tuning capacity to increase the tuning range to $7/8$ metres have heard the signals as far away as Ely, Bedford, Brighton and Hitchin. In many cases, however, a directional aerial was used.

THE SOUTH AFRICAN EXHIBITION

It seems to be getting quite a habit for short-waves to be used in collaboration with events of international importance. The South African Exhibition in Johannesburg is to relay a series of special programmes from the Exhibition to all parts of the world. The idea apparently is to bring before the world the value of South African products, so although direct advertising by radio in South Africa is not allowed, the Government seems to have found a simple way of advertising indirectly.

THE KING AND TELEVISION

Striking proof of the progress made in television is the announcement that television receivers are being installed at Buckingham Palace and Fort Belvedere. In view of the definite entertainment value now given by a modern television receiver, the King has decided to present at Christmas an additional television receiver to the servants at Buckingham Palace.

AMERICAN TELEVISION PROGRESS

America's answer to British television progress is the erection of four transmitters for public service work to be ready in 1937. Two transmitters are being built in New York, one in Philadelphia, and one in Hollywood. According to Mr. Philo T. Farnsworth 441 line systems will be used as compared with 240 and 405

lines in this country. No explanation is given as to how the New York stations will overcome the very serious attenuation of ultra short-wave television signals by the steel-built sky-scrapers, which has always presented a problem to American television engineers.

A TRAVELLING TELEVISION STATION

In view of the success of the Marconi-E.M.I. television system at the Alexandra Palace, the B.B.C. has placed an order with Marconi-E.M.I. for a travelling transmitting station equipped with Emitron cameras suitable for picking up direct scenes of both outdoor and indoor events.

This travelling station should greatly increase the scope and interest in the present programmes. According to Marconi-E.M.I., their Alexandra Palace station has more than fulfilled the contract specification.

"Television, A Guide for the Amateur," by Sydney A. Moseley and Herbert McKay, published by the Oxford University Press price 5s. net. This latest production of the University Press strikes a new note in television text books for it deals most completely with the fundamental principles of modern high-definition television in such a way that the man in the street, without technical training, can gain a very good idea as to how his new television receiver will work.

There are 12 chapters plus a section of television terms. These chapters include electron scanning and the Iconoscope, the electron image camera, light modulation, the cathode-ray tube, the modern cathode-ray receiver and a description of Baird and Marconi-E.M.I. television transmitters.

The book is very profusely illustrated with line drawings and no less than 31 plates, which are mainly full page. This book of 144 pages really does give in a concise form all the details needed by the average television enthusiast, looker-in, or constructor. The main defects with so many television manuals is the inclusion of too much data regarding out-of-date mechanical systems, but in this work, although a chapter is devoted to mechanical scanning, no references are made to old disc systems.

A NEW PHOTO-ELECTRIC ELEMENT

Details of a unit for the direct conversion of light into electrical energy.

THE Tungram Electric Lamp Works, Ltd., have produced a photo-electric element of the boundary layer type which possesses the property of delivering continuous electric current on being subjected to light and similar radiation. This type of element directly converts radiant energy into electrical energy without requiring any auxiliary source of power as is the case with the photo-electric cell and the ordinary selenium cell.

The Tungram light element consists of a metal disc upon which is

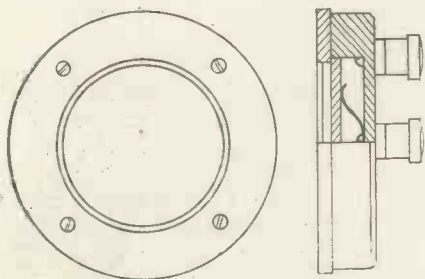

Fig. 1.—Elevation and part section of the Tungram light element.

deposited a layer of light-sensitive selenium, the layer being coated on its outer surface with an extremely thin transparent metal deposit.

The metal disc, and the metal surface coating with its metal ring which surrounds it, constitute the two poles of the light element which are connected to two terminals on the rear side of the housing.

These elements are produced in two sizes. Type S44 consists of a circular

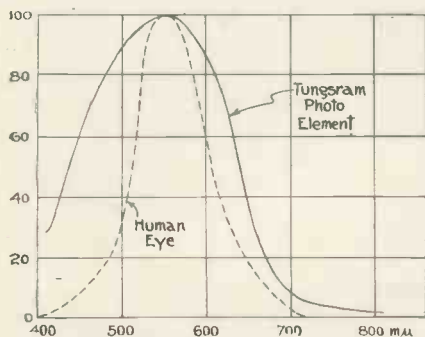

Fig. 2.—Output curve of type S44 photo-element when illuminated by 400 lux.

metal baseplate of 44 mm. diameter, and has useful working surface of 36 mm. diameter, i.e., 10 sq. c.m.

area (see Fig. 1). This type is particularly suitable for use as a photometer (Luxmeter) and are variable with or without external housing.

Type S244 is oblong and measures 22 × 44 mm.; its working area is 36.5 × 16 mm. or 5.8 sq. c.m. This latter type is chiefly intended for photographic exposure meters, and pocket photometers.

When using elements for objective photometry, it is of the greatest importance that the colour sensitivity curve of the device corresponds to that of the human eye. The close approximation of the Tungram light element to that of the human eye is shown in Fig. 2

The approximation of the two curves is quite sufficient when measuring artificial illumination of the type obtained from vacuum or gas-filled lamps; the figures obtained are practically independent of colour sensitivity. If a greater accuracy is required, it is possible to improve the curve of the photo-element considerably, by interposing light filters.

The curves can be made to almost coincide, by using liquid filters consisting of a 0.24 per cent. solution of potassium bichromate ($K_2Cr_2O_7$) and a 10 per cent. solution of copper sulphate ($CuSO_4$). Photometry of even highly coloured light sources (sodium, neon, mercury vapour, etc.) is possible with comparable accuracy to subjective measurements when using the above filter combination.

Photo-voltage and photo-current are shown as ordinates in Fig. 3 with reference to illumination. The open circuit voltage or e.m.f. (shown in Fig. 3 as a dotted line) rises rapidly at first, up to about 100 lux, then rises more slowly and achieves the very high value of .4 volt at 1,000 lux.

The photo-current is approximately .5 ma. per lux, and increases proportionately to illumination intensity with medium illumination, linearity being more accurate when the load resistance is small compared to the cell resistance.

In Fig. 3 curves are given of photo-current dependent on illumination for 0, 50 and 500 ohms load-resistance (galvanometer resistance). In view of the high resistance of the cell, the divergence from strict linearity, even

at 500 ohms load resistance, is very small. However, if better linearity is required, a galvanometer resistance of only a few hundred ohms is recommended. On the other hand, if it is desired to obtain optimum output from the cell, the external load should equal the internal resistance.

From Fig. 4, it will be seen how the output in micro-watts varies with external load resistance at a constant

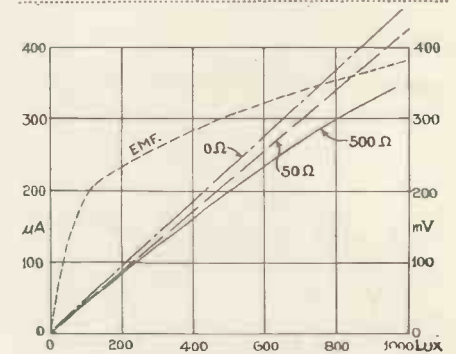

Fig. 3. Curves showing voltage and current with reference to illumination.

illumination (of 400 lux). The maximum is at 1,400 ohms, thus, at this illumination, the cell resistance has still the high value of 1,400 ohms, and the output has an appreciable value of 27 micro-watts. (In order to properly appreciate this power output, it should be mentioned that the motor of a D.C. ampere-hour counter requires approximately 4-5 micro-watts to move it; actually, it is quite possible to keep such a counter motor in continuous motion with a single photo-element suitably illuminated, despite the fact that the matching of

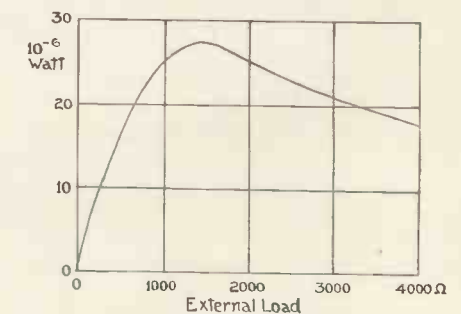

Fig. 4. Curve showing how output varies with load resistance

such a motor to the cell is a bad one, as the internal resistance of these motors is of the order of 50-60 ohms.

A Buyer's Guide TO Television Receivers

The information given below provides a complete guide to the television receivers which are on the market and available to the public. Omissions in the information indicate that at the time of going to press the required information was not available.

MAKER'S NAME : Baird Television, Ltd., Greener House, 66, Haymarket, London, S.W.1, in conjunction with Bush Radio Ltd., Chiswick, W.4, the latter firm supplying the sets through specially appointed dealers.

MODEL : T5.

PRICE : 85 guineas.

BRIEF SPECIFICATION : Suitable for reception of Baird 240- or E.M.I. 405-line pictures. Twenty valves are employed which include two rectifiers.

POWER SUPPLY : 200-250 volts A.C. The consumption is 240 watts. Instrument can be used on D.C. mains in conjunction with a suitable D.C. to A.C. converter.

DELIVERY : Immediate.

MAKER'S NAME : A. C. Cossor, Ltd., Cossor Works, 22, Highbury Grove, N.5.

MODEL : 137T.

PRICE : 105 guineas.



The Baird, model T5.



The Scophony Receiver.



The Cossor, model 137T

No alteration to the instrument need be made to receive 240- or 405-line pictures other than the manipulation of a single switch. The receiver is fitted with six controls, these being Picture Focus, Sound Volume, Picture Brightness, Vision Control, Contrast, Tuning. Detail Control.

PICTURE SIZE : 12 ins. by 9 ins.

CABINET : Vertical console 23 ins. wide 43 ins. high and 19 ins. deep, with the picture produced on a mirror inclined at an angle of 45 degrees to the cathode-ray tube which is vertically mounted beneath a safety glass window.

BRIEF SPECIFICATION : Suitable for reception of both Baird and E.M.I. systems with simultaneous reception of sound and vision or independent reception of the sound programme without vision. The complete receiver is made up of three chassis, being Tube and Time Base, Sound and Vision receivers, Power Packs and Loudspeaker. Provision has also been made for the use of a gramophone pick-up. A super-het receiver is used on medium and long wavelengths.

WAVE RANGE : 200 to 550, 800 to 2,000.

PICTURE SIZE : 10 ins. by 7½ ins. Black and white image. The picture is viewed directly on the end of the cathode-ray tube which is horizontal.

CABINET : Vertical console.

POWER SUPPLY : 200-240 volts 50-cycle A.C. mains. On D.C., a D.C. to A.C. converter is required.

DELIVERY : Immediate.

Ferranti and G.E.C. Receivers

MAKER'S NAME : A. C. Cossor, Ltd., Cossor Works, 22, Highbury Grove, N.5.

MODEL : 237T.

PRICE : 120 guineas.

BRIEF SPECIFICATION : As for the 137T, but includes an additional section with an automatic record changer and gramophone pick-up. A super-het receiver is used on medium and long waves.

WAVE RANGE : 200 to 550, 800 to 2000.

PICTURE SIZE : 10 ins. by 7 $\frac{3}{4}$ ins. Black and white image. The picture is viewed directly on the end of the cathode-ray tube.

CABINET : Vertical console.

POWER SUPPLY : 200-240 volts, 50-cycle A.C. mains. When used on D.C., a D.C. to A.C. converter is required.

DELIVERY : Immediate.

MAKER'S NAME : Ferranti, Ltd., Moston, Manchester, 10.

MODEL : Television sound and vision.

PRICE : 105 gns.

BRIEF SPECIFICATION : This instrument is similar to the previous model as regards reception of television. It includes, however, additional equipment for reception of short, medium and long wave programmes. A 14-in. tube is fitted as standard.

WAVE RANGE : Television sound and vision frequencies plus short, medium, and long wavelengths.

PICTURE SIZE : 10 ins. by 8 ins. viewed directly from the face of the tube, which is mounted horizontally.

CABINET : Console type but of special design.

POWER SUPPLY : 200-250 volts 50-cycle A.C., or from D.C. by means of a suitable rotary converter.

DELIVERY :

MAKER'S NAME : The General Electric Co., Ltd., Magnet House, Kingsway, W.C.2.

MODEL : BT3701.

PRICE : 95 guineas.

BRIEF SPECIFICATION : This is a high sensitivity 23-valve instrument employing a 12-in. cathode-ray tube and is suitable for reception of sound and



The G.E.C. model BT3702.



H.M.V., Model 901.



The Marconiphone Model 701.

BRIEF SPECIFICATION : 19 valves are used in this instrument which is suitable for the reception of E.M.I. or Baird television programmes. A feature of interest is the use of a cathode ray tube that is focused magnetically.

WAVE RANGE : Television sound and picture frequencies only.

PICTURE SIZE : 10 ins. by 8 ins. viewed directly from the face of the tube which is mounted horizontally

CABINET : Of the conventional console type.

POWER SUPPLY : 200-250 volts 50-cycle A.C., or from D.C. supply by means of a rotary converter.

DELIVERY :

MAKER'S NAME : Ferranti, Ltd., Moston, Manchester, 10.

MODEL : Television sound and vision and all-wave.

PRICE : 115 guineas.

vision on either 405- or 240-line vision systems. It consists of five units, these being Sound and Vision Amplifier, Double Time Base, Power Pack Cathode-ray Tube and Loudspeaker.

WAVE RANGE : Television sound and vision channels only.

PICTURE SIZE : 9 ins. by 7 ins. Viewed directly from the end of the cathode-ray tube, which is mounted almost horizontally.

CABINET : 39 $\frac{1}{2}$ ins. high, 24 ins. wide, 26 $\frac{1}{2}$ ins. deep.

POWER SUPPLY : A.C. mains 190-250 volts, 40-100 cycles. In conjunction with a D.C. to A.C. converter with a D.C. supply.

DELIVERY : Immediate.

MAKER'S NAME : The General Electric Co., Ltd., Magnet House, Kingsway, W.C.2.

MODEL : BT3702.

H.M.V., Marconiphone and Pye

PRICE : 120 guineas.**BRIEF SPECIFICATION** : A de-luxe receiver in which provision has been made for reception of short, medium, and long wavelengths, in addition to television sound and vision transmissions. The instrument is suitable for reception of 405- or 240-line systems.**WAVE RANGE** : Television sound and vision channels and short, medium, and long wavelengths.**PICTURE SIZE** : 9 ins. by 7 ins. Viewed directly from the face of the 12-in. tube, which is mounted almost horizontally.**CABINET** : Height 53 ins., width 30½ ins., depth 28½ ins.**POWER SUPPLY** : 190-250 volts, 40-100 cycles. A.C. mains. If used on D.C. supply, a D.C. to A.C. converter must be used.**DELIVERY** : Immediate.**MAKER'S NAME** : "His Master's Voice," 98, Clerkenwell Road, E.C.1.**MODEL** : 901.**PRICE** : 95 guineas.**BRIEF SPECIFICATION** : 22-valve instrument suitable for reception of Marconi-E.M.I. 405-line system or Baird 240-line transmissions. A 6-valve tuned R.F. receiver is pre-set for vision, while a 4-valve super-het. is used for sound.

A 12-in. Cathode-Ray tube gives a picture 10 ins. by 8 ins.

WAVE RANGE : Sound and vision channels only.**PICTURE SIZE** : 10 ins. by 8 ins. viewed in a mirror mounted at an angle of 45 degrees to a vertically mounted tube.**CABINET** : Figured Walnut.**POWER SUPPLY** : 200-250 volts, 50-60 cycles, A.C., or from D.C. mains by means of a rotary converter.**DELIVERY** : Immediate.**MAKER'S NAME** : "His Master's Voice," 98, Clerkenwell Road, E.C.1.**MODEL** : 900.**PRICE** : 120 guineas.**BRIEF SPECIFICATION** : Suitable for reception of Marconi-E.M.I. 405-line interlaced system or 240-line Baird transmission. On the vision side it is similar to the model 901, but in addition is suitable for reception of normal short-, medium-, and long-wave stations. Twenty-three valves are used.**WAVE RANGE** : 7-16, 16.7-51, 46-140, 185-560, 750-2,000.**PICTURE SIZE** : 10 ins. by 8 ins. viewed from a mirror mounted at an angle of 45 degrees to a vertically-mounted tube.**CABINET** : Figured Walnut.**POWER SUPPLY** : 200-250 volts, 50-60 cycles, A.C., or from D.C. mains by means of a rotary converter.**DELIVERY** : Immediate.**MAKER'S NAME** : The Marconiphone Co., Ltd., 210, Tottenham Court Road, W.1.**MODEL** : 702.**PRICE** : 95 guineas.**BRIEF SPECIFICATION** : This instrument is suitable for reception of Marconi-E.M.I. 405-line system, or 240-line Baird transmissions. It is made up of five units, these being Emiscope cathode-ray tube, 4-valve

super-het, sound receiver, a 6-valve tuned R.F. pre-set vision receiver, synchronising equipment, and power packs. A loud-speaker of the energised type gives an output of 3 watts.

WAVE RANGE : Television sound and vision channel only.**PICTURE SIZE** : 9½ ins. by 8 ins., viewed in a 45° mirror in the cabinet lid.**CABINET** : Height 37¾ ins., width 24¼ ins., depth 16¾ ins.**POWER SUPPLY** : 200-250 volts, 50 cycles A.C. Consumption, 230 watts. If used on D.C. mains a D.C. to A.C. converter is required.**DELIVERY** : Immediate.**MAKER'S NAME** : The Marconiphone Co., Ltd., 210, Tottenham Court Road, W.1.**MODEL** : 701.**PRICE** : 120 guineas.**BRIEF SPECIFICATION** : This receiver is suitable for 405-line Marconi-E.M.I. transmissions or 240-line Baird transmissions. It consists of five units, these being the Emiscope cathode-ray tube, All-wave Sound Receiver, Synchronising Equipment, Power packs, and a pre-set 6-valve tuned radio-frequency vision receiver.**WAVE RANGE** : 6.67 metres, 16.7-53, 46-140, 185-560, 750-2,250 metres.**PICTURE SIZE** : 10 ins. by 8 ins. Viewed via a large lens from a mirror mounted inside the cabinet at an angle of 45 degrees to the end of the tube, which is mounted vertically. A 12-in. tube is used and the picture is enlarged by means of a low-power lens.**CABINET** : Height 46½ ins., width 37½ ins., depth 20½ ins.**POWER SUPPLY** : 200-250 volts, 50-cycle A.C. Consumption, 260 watts. If used on D.C. mains, a D.C. to A.C. converter is required.**DELIVERY** :**MAKER'S NAME** : Pye Radio, Ltd., Africa House, Kingsway, W.C.2.**MODEL** : 4201.**PRICE** : 95 guineas.**BRIEF SPECIFICATION** : This instrument is for reception of television sound and vision transmissions and embodies receivers that are semi pre-set to the correct wavelength. The sound receiver is of the high-fidelity type with a response from 50 to 15,000 cycles. It is suitable for 405- or 240-lines**WAVE RANGE** : Television sound and vision channels only.**PICTURE SIZE** : 10 ins. by 8 ins.**CABINET** : An upright console. Picture is viewed directly from the end of the cathode-ray tube, which is horizontal.**POWER SUPPLY** : A.C. Mains.**DELIVERY** : Immediate.**MAKER'S NAME** : Pye Radio, Ltd., Africa House, Kingsway, W.C.2.**MODEL** : 4200.**PRICE** : 135 Guineas.**BRIEF SPECIFICATION** : The vision and sound channels are similar to the 4201, but embodies additional features such as an all-wave sound receiver and automatic record-changer.**WAVE RANGE** : Television sound and vision channels, plus 17-52, 200-550 and 900-2,000 metres.

THE TELEVISION ENGINEER

FORMATION OF ELECTRON LENSES BY MEANS OF RESISTANCE SPIRALS*

By Manfred von Ardenne

An electrostatic electron lens system is described in which the potential rise along the axis is influenced by changing the pitch of a high resistance spiral introduced into the interior of an isolating cylinder.

IN order to determine the properties of electron lenses, a knowledge of the potential variation along the axis is of great importance. In a work published lately¹ a suitable potential gradient along the axis was theoretically determined for the case of a spherically corrected weak single lens. In the following article a method is briefly described which is technically relatively easy to put into practice in order to achieve, with the help of resistance spirals of modified height of ascent, a previously deter-

mined potential gradient along the axis. In the case of a glass cylinder revolving with constant speed during preparation, the pitch of the spiral is controlled by regulation of the pivot impulse for the beam. With an electrode cylinder diameter of 5 cm. the pitch can, in practice, be varied in the relationship of about 1 : 10 without its becoming too great in comparison with the radius of the electrode cylinder. The possibilities for variation given here are insufficient for most problems set by electron-optical systems. To ascertain the required distribution of the pitch the arrangement in the electrolytic trough with ring electrodes, can be employed. In this case the ring electrodes are attached to an equally subdivided potential divider, and their mutual intervals, which correspond to the pitch, can be shifted in the electrolytic trough until the desired potential distribution along the axis is obtained.

The production of the resistance layer in spiral form has an advantage over the standard tapping method in that the required resistance values (order of magnitude 1 to 10 MΩ) are easily attainable. With suitable adjustment of the marker it is possible to describe remarkably even resistance bands of $\frac{1}{4}$ to $\frac{1}{2}$ mm. in breadth on the inner wall of glass cylinders. In the case of a glass cylinder revolving with constant speed during preparation, the pitch of the spiral is controlled by regulation of the pivot impulse for the beam. With an electrode cylinder diameter of 5 cm. the pitch can, in practice, be varied in the relationship of about 1 : 10 without its becoming too great in comparison with the radius of the electrode cylinder. The possibilities for variation given here are insufficient for most problems set by electron-optical systems. To ascertain the required distribution of the pitch the arrangement in the electrolytic trough with ring electrodes, can be employed. In this case the ring electrodes are attached to an equally subdivided potential divider, and their mutual intervals, which correspond to the pitch, can be shifted in the electrolytic trough until the desired potential distribution along the axis is obtained.

A simple procedure by which the momentary potential distribution along the axis can be recognised with little loss of time and compared with the desired distribution, is briefly described. A practical example of a resistance spiral with a constant pitch is shown in photograph. The method of preparing resistance spirals of variable pitch and high ohmic capacity was worked out by G. Otterbein.

Specialised Electrical Equipment and Television Unit

A NEW company under the name of Bosch Hall, Ltd., was formed on August 23 of this year with the object of manufacturing special electrical and scientific equipment such as oscillograph recording instruments designed to meet the requirements of particular cases, cardiographs, valve voltmeters handling frequencies up to 2 and 3 megacycles, direct-reading capacity bridges, etc., and in addition, special apparatus for television requirements such as units for laboratory use and for the amateur, including time bases, H.T. supply units, tube potentiometers, intermediate-frequency amplifiers covering a band width up to 2.5 megacycles for television, vision receivers and adaptors for the conversion of broadcast receivers to ultra-short wave use. The firm has also produced a complete television receiving equipment which will be marketed at £85. This employs 20 valves and a 12-in. tube giving a picture 10 ins. by 7 ins. Still another activity is the manufacture of a range of amplifiers for public-address work. This equipment is of sound design and construction and complete installations for public, commercial use and hospitals, etc., will be undertaken. The firm will welcome any opportunity for the design and supply of equipments which are not standard or are of a special nature.

The address of this new and enterprising concern is Ferry Road, Teddington, Middlesex.

Delivery of Television Receivers

Most of the commercial television receivers are now available from stock and usually installation can be made within two or three days. This is particularly the case with Baird, Cossor, G.E.C., H.M.V., Marconi-phone and Pye receivers, and with each of these the purchaser is entirely relieved of installation troubles.

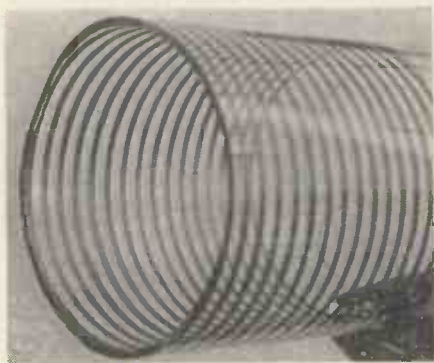

Resistance spiral of high ohmic capacity on the wall of a glass cylinder.

mined potential gradient along the axis.

Suitable potential gradients may be obtained with the electronic lens proposed by Knoll,² composed of individual parts which can be separately controlled. The potential to be associated with the individual ring electrodes is empirically ascertained by measurements on the three-dimensional model in an electrolytic trough. The practical execution of this kind of electronic lens in the vacuum tube appears to be sufficiently simple so long as the number of rings remain small. By employing a resis-

* Archiv fur Elektrotechnik Vol. 30 No. 9 1936

¹ Scherzer: Zeit: f: Physik 101 p. 25 1936

² Knoll: Arch: f: Elek: Vol. 28 No. 13 p. 7 1934

“TELEVISION’S” GUARANTEED CATHODE-RAY RECEIVER—III

THE CONTROL CHAIN, TUBE AND TIME BASE POWER PACKS AND SOUND RECEIVER

THIS receiver is the first high-definition model ever presented to the amateur constructor. Its construction and satisfactory performance have settled the question which has been debated for some months—whether it would be possible for the amateur to build his own television receiver.

When the design was first considered the particular needs of the amateur were kept in mind so that the construction would be within the ability of the average person who was possessed of a reasonable knowledge of wireless construction.

The complete receiver has been thoroughly tested on the Alexandra Park sound and vision transmissions and gives results comparable with commercially produced receivers.

THE potentiometer chain, of which the theoretical diagram is given on the next page, is assembled on a small sub-baseboard measuring 10 ins. by 4½ ins. mounted at the rear of the baseboard which holds the tube.

The values of the resistances and condensers are as follows:—

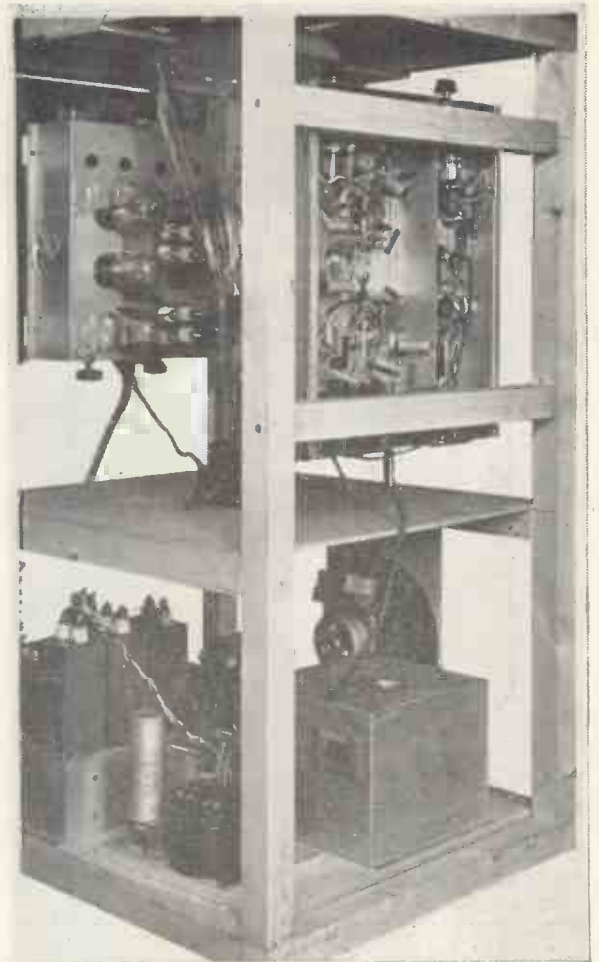

A view of the receiver showing the underside of the vision chassis. The power packs are at the bottom.

- | | |
|-----------------------|---------------------------|
| R1 2.0 megohms (2 W). | C1 0.5 mfd. 4,000 V. wkg. |
| R2 1.5 megohms | C2 1.0 mfd. 1,500 V. wkg. |
| R3 0.5 megohms | C3 1.0 mfd. 500 V. wkg. |
| R4 1.4 megohm | C4 1.0 mfd. 500 V. wkg. |
| R5 0.4 megohm | C5 0.1 mfd. 4,000 V. wkg. |
| R6 0.1 megohm | |
| R7 0.1 megohm | |
| R8 2.0 megohms (½ W). | |

The photographs show the method of assembly on the board, the resistance being mounted on a paxolin strip (a Bulgin 5-way group board is very suitable) held on top of the 0.5 mfd. condenser. The resistances R₃ and R₇, which control the focus and brilliance respectively,

“GUARANTEED”

The television receiver here described and illustrated has been designed and produced by experts working on our behalf for many months.

We guarantee that the picture which this receiver gives compares extremely well with that given by a high-class commercial receiver. It follows that if our readers faithfully follow our instructions in every respect they should produce a thoroughly satisfactory receiver, but certain points must be borne in mind. The reader who has never before had an opportunity of experimenting with a high-definition receiver cannot expect to obtain maximum results until he has acquired some little practical experience. Obviously, he must feel his way, just as he had to feel his way years ago when he started to build broadcast receivers at home.

The precise electrical values of the components is a big factor in success or failure. Those that we specify proved correct in our own receiver, but there is some amount of discrepancy occasionally between the rated values and the actual values of compo-

ents and slight variation of this kind is far more serious in a television receiver than in a sound receiver.

In spite of our great care to give all details accurately, it is difficult in dealing with a mass of tiny detail to prevent the creeping-in of some little omission or error; if anything of this sort has occurred in spite of all we have done to prevent it, we will take the first opportunity of publishing a correction.

Subject to the above and to the employment of sound material and components, our readers may, with every confidence, go ahead and build for themselves a first-class receiver which, within the range of the station will give a good account of the Alexandra Palace transmissions.

We guarantee that our instructions and designs are essentially practical and sound, so much so that we have been able to make an arrangement with a firm of television engineers by which they will, for a moderate fee, bring into working order any receiver which has been built precisely to the instructions here given and with which difficulty is experienced.

COMPLETING THE TIME BASE

are connected to the main chain by long leads and are mounted under the top panel of the cabinet when all is assembled.

The leads in the photograph have been left shorter than will actually be required and simply serve to show the way in which the potentiometers are arranged. The



A side view of the resistance chain.

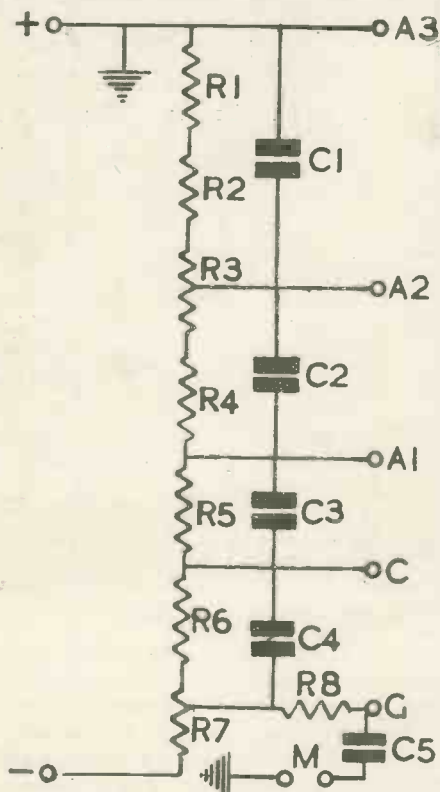

Circuit of H.T. resistance chain for Ediswan Tube. The values are given in the text.

H.T. supply from the unit is connected to the Belling-Lee terminal block shown on the left of the board. When soldering the resistances in place, be careful that there is no flux left between the ends of the wires which may cause leakage when dust settles on it. The connections to the tube socket may be made after the board has been screwed down on the main baseboard, and these can be taken from the appropriate condenser taps. The connections to the socket of the tube are given. When mounting, the socket should be turned so that the deflector plates are in their correct positions for vertical and horizontal scanning. The convention is to apply the horizontal scan to the "X" plates and the vertical to the "Y" plates. Sufficient slack must be left in the wiring to allow the tube to be turned when final truing up is made.

Modulation

The modulation leads, being at radio frequency, must be as short and neat as possible. Referring to the diagram again, it is seen that the modulation is applied to the terminals marked "M," one of which is earthed to chassis and the other connected through a condenser to the grid contact of the tube. This isolating condenser must be mounted as near the tube socket as possible on the baseboard in such a position that the leads from the receiver can be taken direct to one of its terminals. The resistance R8 is connected in the lead from the potentiometer to the grid of the tube, as near to the socket as possible.

Finishing the Time Base

One or two readers have pointed out that the con-

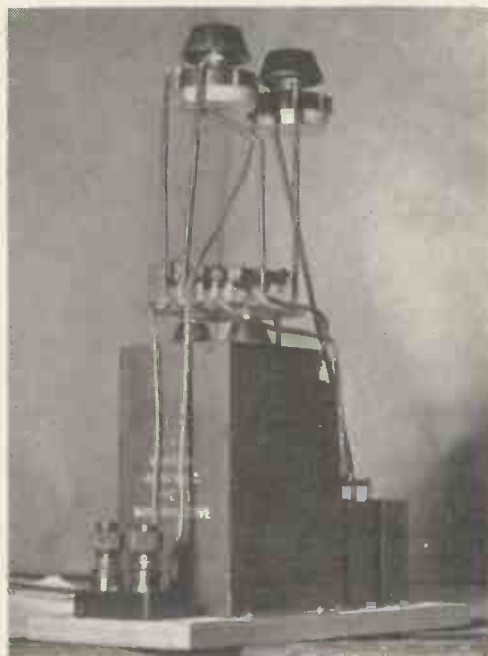

Another view of the resistance chain. The controls are mounted on the top panel of the framework.

nections to the changeover switch for the two transmissions were not shown in the theoretical diagram of the time base in last month's issue.

CHECKING THE TIME BASE

The omission was made to avoid complicating the diagram as the connection of the switch is that for a standard single-pole two-way. However, to make things clear, the diagram shows the connections to the switch and is numbered to correspond with the numbers on the photograph in last month's issue.

As a number of readers will probably have a stock of fixed resistances, it is pointed out that the high

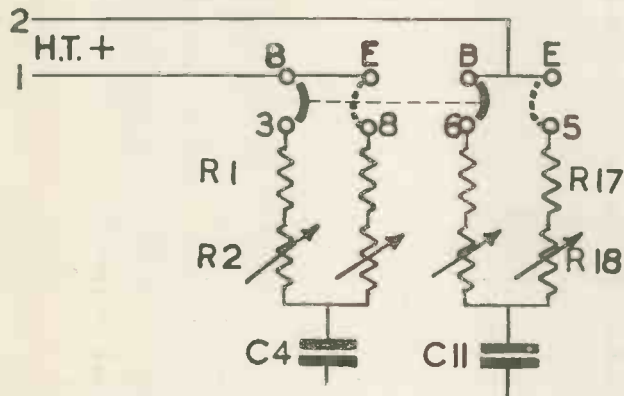

Circuit of changeover switch for Baird (B) and E.M.I. (E) systems. The numbers correspond to the photograph on p. 617 Nov. issue.

values such as $R_1 + R_2$ and $R_{17} + R_{18}$ can be made up of two or three lower values in series if desired. A spare mounting on each of the group boards will accommodate these resistances, and they should be left accessible at the last in case it is necessary to add a small value in series with the existing ones.

The correct operation of the time base depends on such a number of factors that it is impossible to give an approximate setting for the resistances. Variation in sensitivity between individual tubes will alter the overall amplitude and adjustment of this will in turn affect the frequency of the scan. Thus it may happen that the scanning frequency control is at the extreme end of its travel under certain conditions, and in this case it is preferable to alter the value of resistance in series with the variable portion to have sufficient adjustment in hand. The values given, however, are average for the type of tube used and in the majority of cases will cover both scanning frequencies satisfactorily.

Referring to the photograph of the time base on p. 617, the condenser nearest the centre of the chassis is that coupling the grid of one paraphase valve to the anode of the other. This is C6 in the theoretical diagram (0.1 mfd.). Its fellow, C13, is at right angles to it on the left of the centre.

Over on the right-hand side of the chassis against the flap are four 0.1 mfd. tubular condensers, two concealed by the ones above. These are C5, C7, C12, and C14, the feeds to the deflector plates. In front of the lower pair on the right-hand side are the charging condensers C3 and C4, also mounted one above the other. The remaining condensers, excluding the electrolytic, are C11 and C10, on the left-hand side of the chassis, of which the end of one can be seen going to the grid of the first AC/P.

The final wiring of the time base is done by fitting

the line frequency resistance on an insulated bracket over the switches. This is shown in the photograph (see p. 646 of last month's issue, line 16). The leads from the synchronising output cannot be connected until the receiver chassis is complete, but the absence of these will not affect the first check of the time base.

Preliminary Check

The testing of the scanning cannot be done without the tube and H.T. supply, but the time base can be usefully checked before fitting to make sure that nothing is missing.

In testing this and other cathode-ray tube circuits an electrostatic voltmeter is invaluable, but if this is not available, a milliammeter should be connected in each of the valve anode circuits in turn to make sure that they are receiving current. On switching on the time base supply unit the heaters should glow in all the valves and when the H.T. comes on a few seconds later a faint glow should appear in the anode space in the thyratrons. It should be possible to hear the line frequency thyatron and the note should alter as the velocity control is turned. It should also be affected by

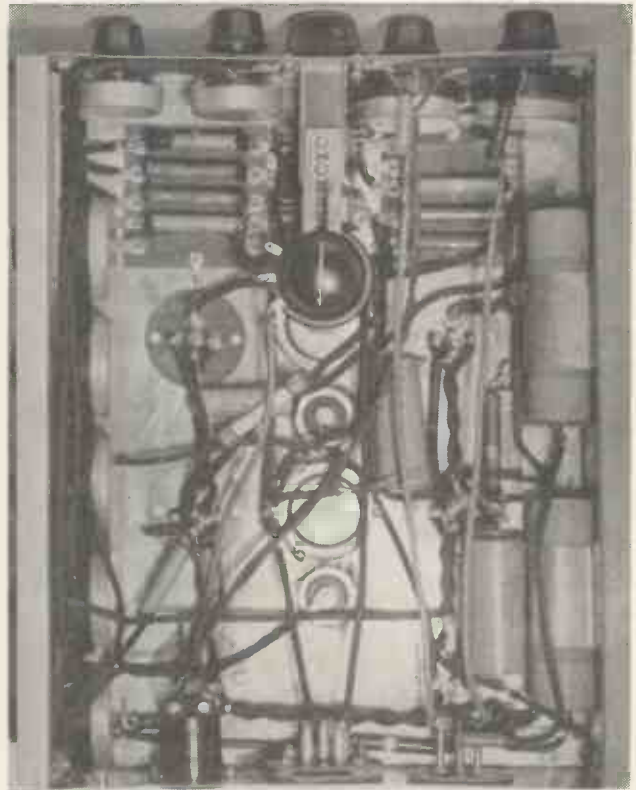

Underside view of time base chassis.

the bias control of the thyatron. The time base should be left running for a considerable time to make sure that no local heating develops due to accidental contact, and it can then be switched off and fixed to the battens.

Correction.—In the diagram of the time base chassis in last month's issue (p. 618) there was a discrepancy in the numbering of the holes. Holes 17 and 18 are for the AC/P's, and 15 and 16 for the electrolytic con-

POWER PACK FOR CATHODE-RAY TUBE

densers. The complete chassis as supplied has two further holes midway between 12 and 17 and 13 and 18 for the paraphase tapping resistances if required, although as pointed out in the text these are not always essential. The complete chassis is available from Burne Jones.

The Eddystone Microdenser, C12, specified in the list of parts as type 900/140, should have been given as 900/40, and these figures should be given when ordering.

Power Pack for Cathode-ray Tube

IN the May issue there was published a complete description of a 3,500-volt unit for exciting a cathode-ray tube. This unit utilised a high vacuum rectifier which allowed the filament and anode voltage to be switched together. Slight changes have been made in this unit, but they will not prevent those of our readers who built the one described then from employing it in conjunction with the "Guaranteed Receiver."

With the control panel used in the receiver a maximum of 4,000 volts D.C. is provided. This produces bright pictures and the time base is able to sweep the full picture area. This point is mentioned as the deflection sensitivity of the cathode-ray tube is a function of the final anode voltage applied.

No provision is made for the heating of the tube cathode heater as this has been taken care of in the

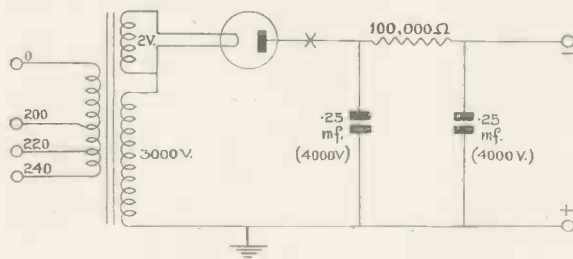

Circuit of cathode-ray tube power pack

time base power pack. The scheme of connection to the A.C. mains is such that the tube cathode heater is allowed to come up to temperature before the high voltage is applied.

The complete unit is enclosed inside a metal case so that a measure of protection is provided. However, it must be borne in mind that the voltage is very high and the utmost caution should be exercised both when building it to see that the insulation of connecting leads is good and when using the unit by not making any adjustment with the mains supply connected. There is no danger if these precautions are observed.

If reference is made to the circuit diagram it will be seen that the unit consists of a single-wave rectifier with a .25-mfd. 4,000-volt working reservoir condenser with further smoothing by 100,000 resistance and another .25-mfd. condenser. The positive of the D.C.

is earthed and the unit should not be used with the negative pole earthed.

The actual construction will be found quite easy. All the components are mounted on the shallow metal base which is supplied ready drilled. In the May issue a wooden baseboard was used, but this has been dispensed with by reversing the shallow metal base and mounting the components directly on to it.

The D.C. output is taken from the tops of the final smoothing condensers as opposed to the plug-and-socket arrangement of the unit described in the May issue. Heavily insulated leads should be taken to the ends of the control panel network through the hole in the top of the metal container that surrounds the completed unit.

The mains input is properly fused by using a Belling-Lee connector unit to which the mains tapping on the transformer are wired. The mains cord is taken through the bottom of the shallow base to the delay switch terminals on the time base unit.

Components for Cathode-ray Tube Power Pack.

TRANSFORMER.

1—Mains transformer (London Transformer Products, Ltd.).

CONDENSERS.

2—.25-mfd. 4,000-volt working (B.I. Mervyn).

SUNDRIES.

1—100,000-ohm, 1-watt resistance (Eric).

1—Chassis and cover (Mervyn).

1—5-pin valve holder baseboard type

(Bulgin).

1—Valve (Osram U16 or Mullard H.V.R.).

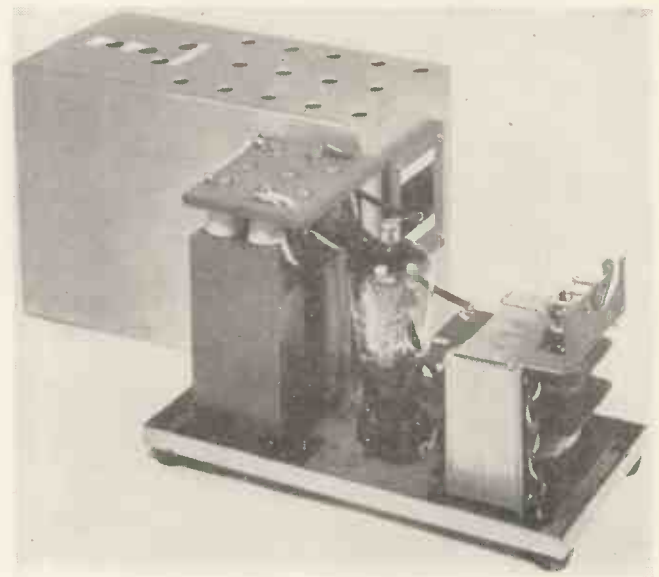

The cathode-ray tube power unit.

Several transformers made by W. Bryan Savage, Ltd., Sound Sales, Ltd., Keston Manufacturing Co., Ltd., and London Transformer Products, Ltd., have been tested and used as described over a period and have been found satisfactory.

The smoothing provided has, under most conditions, proved sufficient, but if hum is experienced it will be a simple matter to add more across the control panel network.

THE TIME BASE POWER PACK

The time base power pack provides, in addition to the H.T. and L.T. for the relays and valves, a 2 volt supply for the cathode ray tube and the thermal delay switching for the cathode ray exciter unit.

It is divided into two sections. One is for the actual time base and heater current for the cathode ray tube and the other is to provide the shift voltage to enable the picture to be properly centred on the screen.

This second unit is quite conventional and consists of a mains transformer, rectifier valve with an 8-plus-8 mfd. electrolytic condenser. No smoothing choke is

minimal on the heater transformer. It will be readily seen that if the input voltage on the mains connector is placed either at the 200-volt point or the 240-volt point the voltage across the other transformers will automatically become 220 volts. This is due to the fact that the primary of the heater transformer is acting as an auto-transformer for the others. In this way there is a reduction in cost and fewer leads to sort out and connect.

The circuit diagram shows the proper connections so that the power pack for the tube and shift voltage (which are external) have only to be connected to the

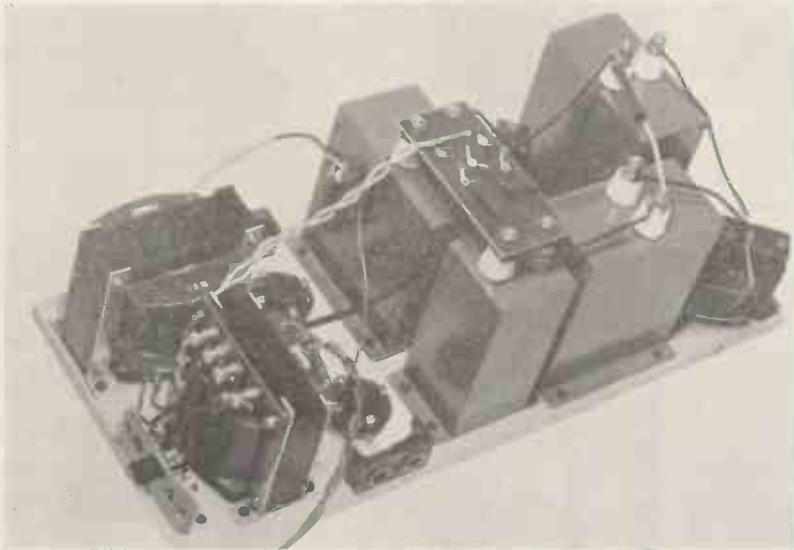

This photograph shows the completely assembled time base power pack.

employed but a $\frac{1}{4}$ -megohm resistance is substituted. There is such a small current draw that the expense of a choke is not warranted. This unit could conveniently be replaced by two small 120-volt H.T. batteries in series as its only purpose is to apply an additional voltage to the deflector plates of the cathode-ray tube for centring the picture. The advantage of using batteries is twofold: it represents a saving in cost and removes the possibility of introducing mains hum to the scanning deflectors.

Delayed Switching

The time base H.T. and heater supply has been designed with a dual mains transformer input so that the heaters (including the cathode-ray tube) are allowed to come up to operating temperature before the H.T. voltage is applied. As soon as the heaters have warmed up the thermal delay switch operates. This switches the mains transformer providing the H.T. to the time base. It also is arranged to switch the cathode-ray exciter unit.

Reference to the circuit diagram given in this issue shows terminals connected to the delay switch. The delay switch operates in the primary circuit of the mains transformers. These transformers are wound for 220 volts only, so that the connection to the mains via the delay switch is taken to the 220-volt ter-

appropriate terminals. (These are black and are on one side of the unit). On the opposite side of the unit are placed the red terminals. They are connected to the tube heater winding so that the current to heat the tube is readily obtainable.

The photograph shows clearly the positions of the various components allowing ample room for connecting up. The current for heaters and the two H.T. + and one H.T. - points are taken through the top of the cover. It will be noticed that the H.T., etc., to the time base is via a plug, the corresponding socket for which appears on the back of the time base chassis. Accordingly the leads from the plug for this must terminate and be anchored inside the power pack.

This is arranged by drilling four holes in a piece of bakelite to correspond with the terminals on the top of the 2-mfd. and first 8-mfd. condenser. This bakelite should be drilled with a further five holes so that the leads can be secured. It is then only necessary to solder the leads in their correct positions inside the power pack. Reference to the photograph shows this clearly.

Notice that the smoothing chokes have been placed in the negative lead. This then places the winding and core at the earth end, so minimising the risk of breakdown. However, if mains hum is experienced it may be reduced by placing them in the positive lead.

Components for TIME BASE POWER PACK

CHASSIS.

1—Special metal chassis and cover (Mervyn).

CONDENSERS, FIXED.

3—8-mfd. 1,000 volt (B.I.-Mervyn, or T.C.C.)

1—2-mfd. 1,000 volt (B.I.-Mervyn or T.C.C.)

1—8 plus 8-mfd. condenser (B.I.-Mervyn).

CHOKES, LOW-FREQUENCY.

2—100 henry 30 M/a (Keston Manufacturing Co.).

HOLDERS, VALVE.

3—5-pin type VH19 (Bulgin).

PLUGS, TERMINALS, ETC.

1—Plug top valve connector type 1,156 (Belling-Lee).

1—Fused voltage change input corrector type 1,088 (Belling-Lee).

2—Terminals type B red, (Belling-Lee).

2—Terminals type B black (Belling-Lee).

2—Terminal blocks type 1,039 (Belling-Lee).

RESISTANCES, FIXED.

1—.25 megohm type 1 watt (Erie).

1—2,000 ohm type 1 watt (Erie).

SUNDRIES.

Connecting leads, wire and sleeving.

1—Bakelite strip.

TRANSFORMERS, MAINS.

1—Filament transformer (Keston).

1—H.T. transformer (Keston).

1—Shift transformer (Keston).

VALVES.

1—MU₂ (Mazda).

1—DLS/1 (Mazda).

1—U.U.3. (Mazda).

BUILDING THE SOUND RECEIVER

The mains lead is taken through the bottom of the shallow metal base which will be found very convenient. Care should be taken to see that the leads coming out of the top cover are well protected so that the metal edge of the hole does not cut through the insulation.

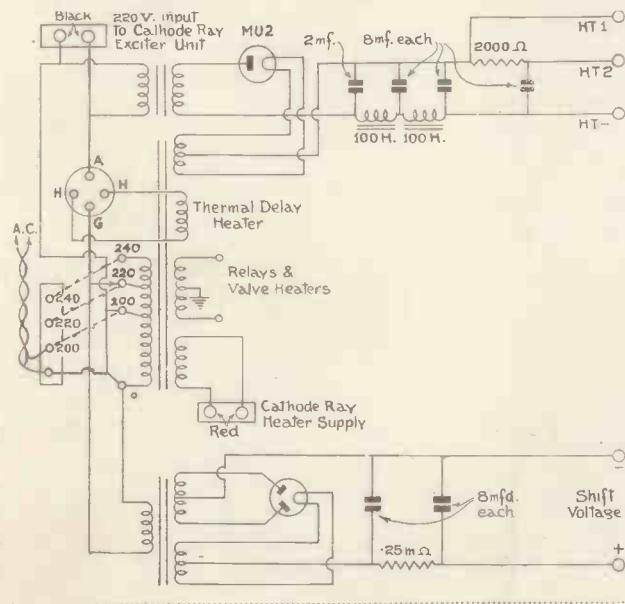

The Sound Receiver

The sound receiver is given complete in this issue and derives its power supply from the combined power pack already described. It comprises a TH4 triode hexode frequency changer feeding into one stage of I.F. amplification on approximately 115 kc. The output is rectified by a WX6 detector unit which is then amplified by one stage employing a Mazda AC2/Pen.

The I.F. transformers are not tuned by trimmers as it is not desired to have extreme selectivity or to have careful layout and wiring, to avoid instability. These untuned transformers together with the load of the Westector, provide a band width capable of taking care of high fidelity sound transmission on the ultra short-wave transmitter.

Where signal strength is very low the sensitivity may be increased by placing a small tuning condenser across one winding of an I.F. transformer: it may be wired directly with stiff wire and need not be mounted on the chassis. Normally this condenser is not required.

The frequency changer follows the design of the vision receiver except that the signal input is not tuned. It is unnecessary to tune this in any way as the coil specified acts as a choke.

The aerial may be any normal type, in fact the ordinary broadcast aerial can be used. Use a crocodile clip and place the aerial directly on to the grid end of the

TIME BASE POWER PACK

By the use of 100-henry smoothing chokes and ample capacity, all traces of hum have been eliminated. The mercury-vapour rectifying valve gives a high current output and enables a satisfactory voltage level to be maintained. A thermal delay switch prevents high voltage being applied to the rectifying valve until the filaments are completely warmed. This thermal delay switch has approximately a one minute time lag. On the right is a photograph showing a plan view of the Time Base Power Pack.

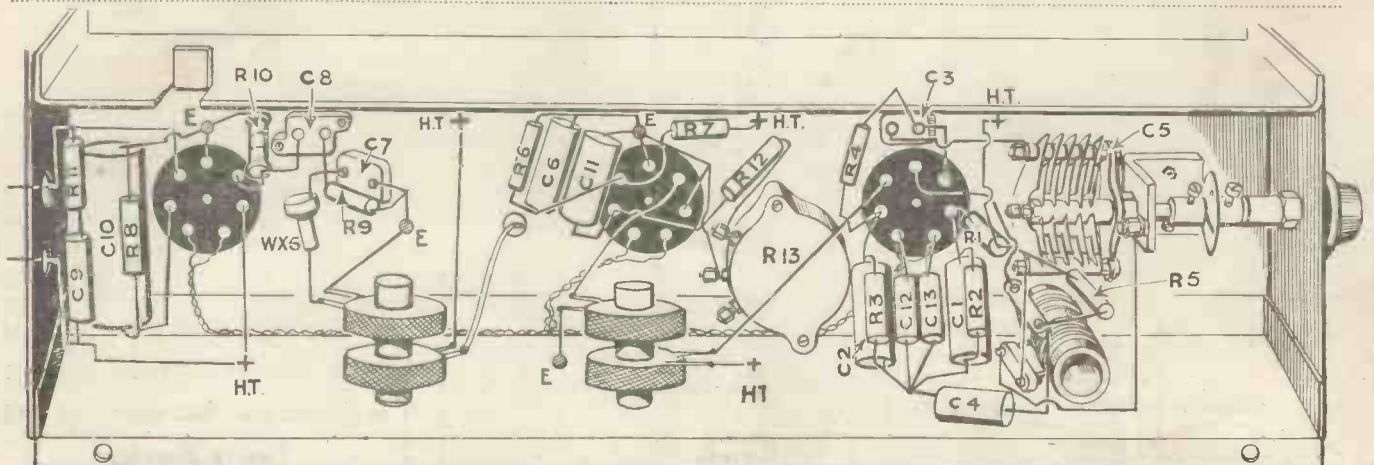
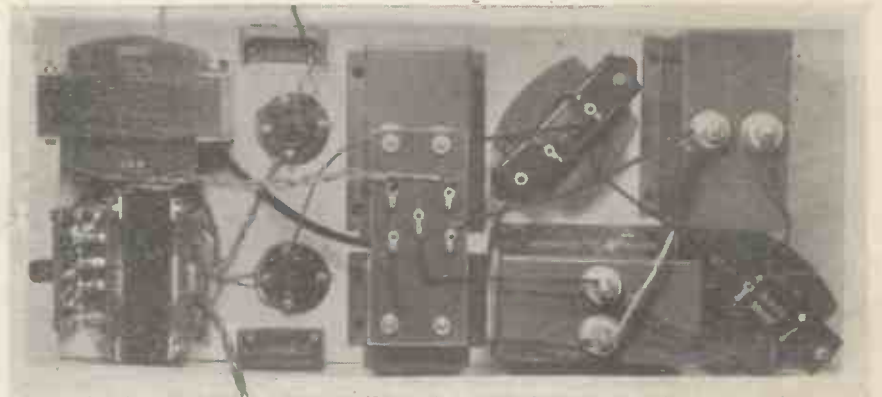
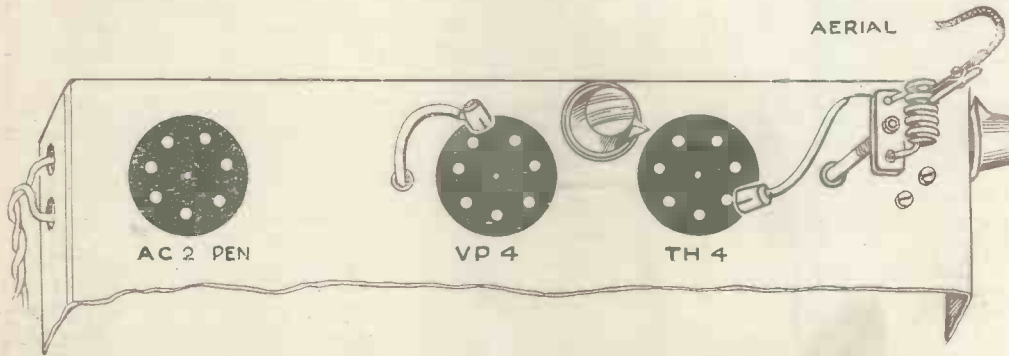

Diagram showing the principal components of the sound receiver and their arrangement on the section of the vision and sound chassis. This drawing shows the underside. Reference should be made to the two drawings on pages 613 and 614 in the November issue.

THE SOUND RECEIVER (Continued)

coil. If the noise level is very high, a reduction of outside noise pick up can be obtained by tapping the aerial down the turns of the grid coil. At short distances from Alexandra Palace it will be found that re-

in the chassis wiring and taken out through the two holes in the back. Notice that a pentode filter has been provided. The resistance used here is of the fixed type but an efficient tone control can be made of this



Drawing showing top of sound receiver section

ception at good strength is obtained on the direct pick up of the grid coil itself.

The wiring and method of mounting the components will be readily seen from the illustrations and will be found quite straightforward.

if made variable and its value increased to 30,000 ohms.

It will be necessary to cut the centre dividing plate of the chassis at approximately the position shown. This is easily carried out with a hacksaw. Make two cuts about 1/2 in. apart and 1/2 in. down: this will leave

An untuned input circuit is used in the Sound Receiver and this method has proved entirely satisfactory. Owing to this, all tuning is carried out by means of a single condenser. The one intermediate frequency circuit gives ample gain owing to the use of a high slope valve and comparatively low frequency I.F. transformers. Speech-output is in the order of 3.5 watts, when coupled up to a speaker of the specified type with a load of 7,000 ohms.

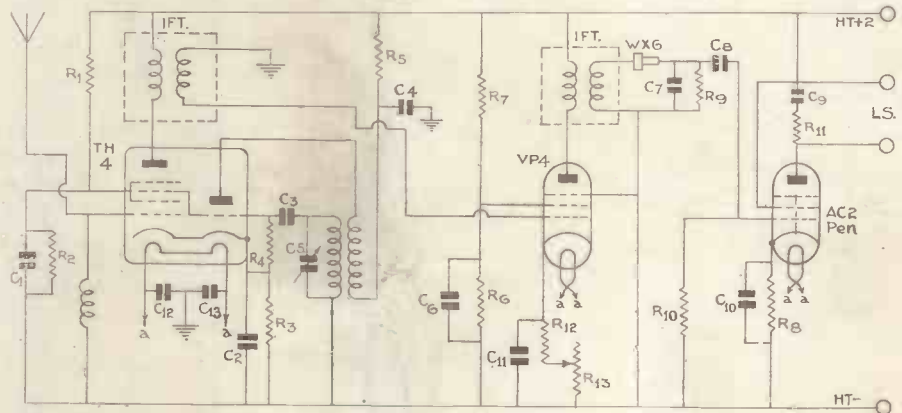

The output leads to the loudspeaker take the form of twisted flex soldered directly on to their correct points

a tongue which is then bent at right angles. The H.T. and L.T. leads to the sound section are taken via this slot and tied to the tongue so formed to secure them.

List of Components for Sound Receiver	
1—Westector WX6 (Westinghouse)	C 9—01 type 300 (T.C.C.).
RESISTANCES.	C10—50-mfd. 12-volt working type E.C.3 (Bulgin).
R 1—50,000 1 watt type (Erie)	C11—1 type PCP1 (Bulgin).
R 2—50,000 " "	C12—01 type 300 (T.C.C.).
R 3—200 " "	C13—01 type 300 (T.C.C.).
R 4—50,000 " "	COILS.
R 5—20,000 " "	L1—6 turns bare copper or Eddystone type 1050.
R 6—50,000 " "	L2—4 turns bare copper or Eddystone type 1050.
R 7—50,000 " "	L3—4 turns bare copper or Eddystone type 1050.
R 8—300 " "	TRANSFORMERS.
R 9—100,000 " "	2—I.F. transformers untuned (Varley BP95).
R10—1/2 megohm " "	LOUDSPEAKER.
R11—20,000 " "	1—W.B. Junior.
R12—100 " "	SUNDRIES.
R13—1,000 ohm potentiometer Bulgin	2—Valve top connectors (Belling & Lee), connecting wire and flex, etc.
CONDENSERS.	3—Seven pin-valveholders (Clix).
C 1—.1 type PCP1 (Bulgin).	VALVES.
C 2—.1 type PCP1 (Bulgin).	1—T.H.4 (Mullard).
C 3—.0001 type M (T.C.C.).	1—V.P.4 (Mullard).
C 4—.1 type PCP1 (Bulgin).	1—AC2/Pen (Mazda).
C 5—Variable type 900/40 with slow motion head No. 1012 (Eddystone).	
C 6—.1 type PCP1 (Bulgin).	
C 7—.0001 type M (T.C.C.).	
C 8—.01 type 300 (T.C.C.).	

When this sound receiver is first switched on and the station tuned in it will be noticed that when passing through the setting of the vision oscillator a beat note is produced. However, when both stations are tuned to their appropriate wavelengths no interference of any kind will be experienced between the two sections.

Next month we shall present
a Complete Summary of the
Entire Receiver

"How to Operate the Cathode-ray Tube"

(Continued from page 685)

the electron optical system remains constant. In this connection the family of characteristic curves, Fig. 6, showing the variation of the current to the third anode with variation of grid voltage, taken at different values of first anode voltage are of considerable interest. They show, among other things, that, as in the case of a screened grid valve, the available grid base may be controlled by the voltage applied to this electrode.

The Anode Diaphragm

The focusing anode has a diaphragm, the object of which is to intercept those electrons whose paths are too widely divergent to be brought to a good focus, and this has the effect of minimising the "spherical aberration" effect.

The main electron lens effect in this tube, as stated, takes place between the second and third anodes, and the focal length can be adjusted through a wide range by varying the ratio between the voltages applied to these two electrodes. Since, however, the optimum focal length is fixed by the position of the fluorescent screen, the ratio of the second and third anode voltages is also fixed, and is virtually independent of the magnitude of the applied voltages within the working range. For the Mullard tube in question this ratio is approximately 1 to 5.

The Beam Outline

Further consideration of the beam outline or the shape of the "beam envelope" as the voltage of the second anode is varied between values above and below the optimum value illustrates still more clearly the analogy between the optical and electron lens effects. Commencing with a constant third anode voltage and a second anode voltage which is several hundred volts too high for correct focus, i.e., with too weak a focusing field, the beam will be found to be divergent. If the second anode voltage is now gradually reduced, the beam will become less and less divergent, finally becoming first a parallel beam, and then more and more convergent until, at the correct value of second anode voltage, it is brought to a focus at the screen. If the second anode voltage is further reduced, that is, the focusing field is made too strong, the focal point will recede from the screen toward the third anode, and at the same time the diameter of the beam at the new focal point will be decreased, much in the same way that very great concentration of the sun's heat rays can be obtained with a burning glass.

Screen Distance

Now it is obvious that it is desirable to obtain the smallest possible spot size at the screen, and in view of the effect described above, it may be suggested that the distance between the final anode and the screen should be reduced and a higher value of electro-static field be used for focusing. But if this were done, the deflection sensitivity of the tube would be very greatly reduced since, as has been shown in a previous article,

the deflection sensitivity is largely dependent upon the distance between the deflection plates and the screen. In this matter, therefore, as in many others, the tube manufacturer has to design the electrode system as the best possible compromise between the optimum requirements for the individual characteristics.

Before leaving this section of the subject, reference should be made to Fig. 7 which shows above the effects on the electron stream due to the various electrodes, and below the effects upon a light beam due to various optical devices. The paths in the two cases are identical, and it is clear that the first anode may be considered mainly as a diaphragm, the second and third anodes as having the effect of a convex lens, and the deflector plates as acting in a similar way to a prism.

Spot Size

It has been shown that, due to the fact that the cathode-rays are propagated in straight lines and are amenable to various controls analogous to those which produce changes in the direction of light rays, the beam can be brought to a focus on the fluorescent screen. If the cathode-rays behaved exactly like light, the definition of the image on the screen would be dependent solely upon the accuracy of focusing. But unlike light, the electrons comprising the cathode-ray beam carry negative charges, and therefore mutually repel each other, with the result that there is a tendency of the beam to spread so that the ultimate spot size increases. It will be clear that for a given tube structure the higher the electron content of the beam, that is the greater the beam current, the greater will be the beam diameter at the screen. On the other hand, an increase in beam velocity (governed by the final anode voltage), will decrease the space-charge effect in the beam and thus reduce the "angle of spread."

These facts can be summed up in the statement that for a given value of beam current the focal spot at the screen will tend to become smaller with an increase in final anode voltage, while for a fixed value of anode voltage the spot size increases with an increase in the beam current.

Obtaining Good Definition

Thus, where a high degree of definition is required, as in television or for making very accurate measurements, a low beam current and high final anode voltage are indicated. On the other hand, it was shown in the previous article that for maximum deflection sensitivity a low final anode voltage is called for. These two sets of conditions are in direct conflict, and when considered in conjunction with the third requirement, namely, adequate screen brightness, present another problem in the art of compromise. For the screen brightness increases with both beam current and final anode voltage, although the anode voltage exercises the greater influence in this connection.

In view of the mutual opposition of the optimum operating conditions for spot size (or definition) and deflection sensitivity, it is necessary to strike a balance depending upon actual requirements, and the maximum screen brightness attainable is then fixed by the conditions demanded to satisfy the first two requirements.

STUDIO & SCREEN

A MONTHLY CAUSERIE

on Television Personalities and Topics

by **K. P. HUNT**
Editor of "Radio Pictorial"

ON with the show! Television programmes of excellent quality are now on the air every day, for, as all readers know, a definite landmark in radio history was made at the beginning of November, when the ceremonial transmissions officially inaugurating the first regular television service were broadcast.

It is sufficient, at this comparatively late date, merely to record that this important debut went off without hitch of any kind, and certainly it provided a convincing demonstration of the high efficiency of the organisation which Gerald Cock, the B.B.C.'s popular Director of Television, has so carefully built up, and of the personal abilities of many members of his staff.

I do not suppose, however, that many of the thousands of "lookers" realised the split-second timing which was necessary for the success of this official first broadcast, so let me begin by giving you a little sidelight which reveals how precisely the individual items had to be dovetailed into the whole.

While Leslie Mitchell, the television announcer, was finishing his introduction given in the Baird spotlight studio, Mr. Norman, chairman of the B.B.C., had begun about half a minute before to address the same unseen audience via the Baird intermediate-film system. As readers know, the latter system is not instantaneous television, for a slight time lag occurs between the event and the distant viewer's sight of it on the receiving screen, during which the film is being developed. Matters were so well timed that no interval was apparent, and the change-over from the spotlight studio to the intermediate-film system did not interrupt the continuity of the programme.

I am told that the Baird engineers took quite elaborate precautions against any breakdown and had one of their much-discussed electron cameras trained upon the speakers most of the time, so that in the event

of accident it would be brought into action without delay.

If everything that I have heard recently about this Baird electron camera is correct, its advantages will be many. I was told at Alexandra Palace the other day, however, that there are still some details which need perfecting and this is proceeding rapidly.



Rosalind Wade, brilliant tap dancer of "Dancing Daughters" fame, appeared recently on the television screen.

The Marconi-E.M.I. transmission, which formed the second inaugural programme, was an equally pronounced success.

* * *

Everyone at Alexandra Palace was genuinely pleased to see Sir John Reith, the B.B.C.'s Director-General, at the opening ceremony; but I think many members of the general public were a trifle disappointed that he did not take an active part in the broadcast. His apparent aloofness on this occasion, as on others, tends to give an impression that he is somewhat removed from the great mass of people for whom he is catering—a supposi-

tion, of course, which is entirely wrong—for Sir John has shown a great personal interest in television since its very beginning, and has impressed most people at Alexandra Palace, as at Broadcasting House, with what, for want of a better term, I may call his "sense of humanity."

For instance, I spotted Sir John in the canteen at Ally Pally, mixing freely among some of the lowest paid members of the staff. This canteen is not a large one, but it has a tremendously high ceiling. The thing that struck me most about it was that surely this popular staff restaurant must be the noisiest in London! For some reason every little noise is echoed in a most disconcerting manner. If you tap a spoon upon one of the tables, you hear a greatly magnified echo coming back to you from all directions.

Sir John was there with Major Tryon, the Postmaster-General, John Logie Baird, and numerous other celebrities.

* * *

Gerald Cock has pretty well recovered from his recent illness. The latest member of the staff to be smitten low is "Bumps" Greenbaum, popular conductor of the Television Orchestra. "Bumps" was the hero of an incident a couple of weeks ago when, threatened with severe gastric trouble, he set out for the Palace to conduct the television orchestra for Vaughan Williams' ballet.

But from what I gathered, he practically collapsed in the studio. There were frantic telephone calls to Broadcasting House for Leslie Woodgate, who hurriedly arrived by car and conducted the orchestra for both afternoon and evening performances.

When I visited Alexandra Palace the other day I found that "Bumps" was still off duty, but was told he was considerably better. He was then able to talk and walk, and was making a satisfactory recovery.

SOME OLD FAVOURITES

And now to get away for a moment from the serious note, for it must not be supposed there is no laughter or excitement at Ally Pally.

Here is a true story. The incident happened during a television broadcast the other Saturday by Mr. David Seth-Smith, the well known curator of the Zoological Gardens, London, who, of course, is exceedingly well known to ordinary broadcast listeners as "The Zoo Man." One of the exhibits he brought from the Zoo to show on the television screen was that highly accomplished and talkative bird known to all visitors to the Zoo as "Cocky."

Now it appears that Mr. Gerald Cock "has a way" with animals and birds. They quickly make friends with him, and there seems to be some subtle psychic affinity beyond my power to explain.

On the occasion of Mr. Seth Smith's programme, this clever cockatoo boldly perched upon the D. Tel.'s shoulder. Then, turning its head knowingly towards the great White Chief, shrieked out: "Kiss Cocky! Kiss Cocky!"

Later on, so I was told, the D. Tel. had a friendly old chimpanzee nestling in his arm as affectionately as a baby.

* * *

Mr. D. H. Munro, the Productions Manager at Ally Pally, is still keeping things humming. Now that organisation is more complete, he is finding it possible to take a hand himself in production work, one of his first self-appointed tasks being the Sokolova programme. This was a solo performance by the great dancer, for she was not supported by the usual *corps de ballet*. I dare say many of Sokolova's old television friends were pleased indeed to see her back on the screen.

As we all know, Sokolova was responsible for the first television ballet in the old 30-line days, and for many which succeeded it. What is not so widely known, however, is that Sokolova arranged the dances for numerous other celebrated dancers who graced the television screen during Eustace Robb's regime.

* * *

Writing about the old 30-line reminds me to point out that quite a number of the more distinguished artists who made a hit in the ante-

deluvian era of the science are now scheduled for an appearance under the high-definition system. Laurie Devine, who was known in the old days as the "Television Ballerina," is, I am glad to say, shortly to make an appearance.

This is a wise and generous gesture on the part of Mr. Munro, for there can be little doubt that these popular favourites of yesterday contributed in no small measure by their enthusiasm and painstaking preliminary work to the success of the 30-line programmes and to the development of studio technique, all of which, notwithstanding some statements now made to the contrary, laid the real foundation of present-day practice. Does it not seem only fair that, if their performances can be modified to-day to suit the new requirements, the previous efforts of these pioneers on behalf of television generally should now meet with the reward they merit and an opportunity be given them to demonstrate their talents afresh?

Mr. Munro confided to me that the only reason he has not used them before is that until the regular television service began, it was not fair to put into the programmes any established performers whose reputation might not be enhanced by an appearance under conditions which were purely experimental. Those considerations do not apply now.

* * *

The other producers have had an equally busy time during the month. Cecil Lewis is still mainly engaged upon the development of the O.B. side of the work, and Dallas Bower, Stephen Thomas, and Cecil Madden have all been responsible for some exceedingly creditable transmissions.

Stephen Thomas, I gather, is to be mainly responsible for television ballet productions, and in this direction, of course, his long experience of similar work in all parts of the world will stand him in great stead.

Dallas Bower scored a notable success with his Masked Theatre feature in the middle of the month, when Pamela Watson, Yolande Proctor and Alex Passavant—who are players from the Mask Theatre, Linden Gardens—performed a number of mimes to music, mostly by Stravinsky, which was rendered with great charm by the television orchestra.

I was privileged the other day to spend a most interesting hour watching Dallas Bower rehearsing the first public presentation of "Mr. Pickwick," Albert Coates' new three-act opera, adapted from the "Pickwick Papers," by Charles Dickens.

The stage show itself, which is dedicated to "lovers of Dickens all over the world," was produced last week at the Royal Opera House, Covent Garden, by Vladimir Rosing who, by the way, is father of the talented Val Rosing, formerly a vocalist with Henry Hall and the B.B.C. Dance Orchestra.

Some idea of the activity at Ally Pally will be gleaned when I explain that the morning rehearsal which I witnessed was the only rehearsal for the television programme proper due the same afternoon. The Marconi-E.M.I. studio was an indescribably hectic hive of busy preparations.

One of the Alexandra Palace officials perched me right at the back of the studio, behind the orchestra and well out of everyone's way, but from that vantage point I was able unobtrusively to survey and hear everything that was going on.

Looking over the heads of the orchestra, in the immediate foreground, was the famous Albert Coates himself, composer of the music, who was then making a personal visit to Alexandra Palace to conduct the Television Orchestra.



Albert Coates conducted the Television orchestra when his new opera "Mr. Pickwick" was produced at Alexandra Palace. Here he is seen discussing the score with William Parsons ("Mr. Pickwick")

WATCHING A REHEARSAL



Lisa Minghetti, who featured in "Starlight." This is a reproduction of a painting of her by Philip de Laszlo, the celebrated artist.

Dressed in a very comfortable-looking jacket and wearing a soft collar and bow, this respected veteran of the musical world seemed easily to be the most unperturbed and unexcited person among the fifty or sixty people crammed into the studio.

Out of the corner of my eye, so to speak, I watched Coates conducting with that unconscious aplomb which proclaims the true master. But even

he became a wee bit worried about the right moments to come in with the music. You see, he was mostly facing the orchestra, and naturally could not see what the artists right at the other end of the studio were doing.

I noticed a small flashlight bulb at the side of the studio, operated from the producer's gallery above and behind me. Owing to the crowd of people in the studio, however, someone had to stand between the light and Mr. Coates and repeat the signal to him. In the same way, someone else stood at the far end of the studio in front of the artists, beating time to the music, with one eye on Mr. Coates and the other on the artists. Thus for the best part of the performance there were two conductors.

The "action" was going on at the far end of the studio, where the three Marconi-E.M.I. Emitron cameras were trained upon two scenes arranged at right-angles to each other. For "Mr. Pickwick" a revolving stage was also devised, and altogether it was possible to present four distinct scenes—Mrs. Bardell's Parlour, Courtyard and Interior of the Inn, and the Fleet Prison.

The general rehearsal procedure appeared to be that the players went through the performance bit by bit while Dallas Bower examined the

effectiveness of the setting and appearance on the screen in the control gallery. His voice filled the studio every few seconds, for it was reproduced by a loudspeaker just above my head. Most of his instructions were to Peter Bax, the stage manager, who answered back via the artists' microphone, which projected on a long movable arm to a position a few feet above the actors' heads.

"Move the table three inches up stage," shouted Mr. Bower. And this was done.

"Keep closer to the table, Mr. Pickwick," bellowed the voice again.

"Mark the position of that chair."

These and similar remarks went on all the time, and at length I began to realise that a producer's job at Ally Pally is no sinecure, but one which demands not only the necessary experience and skill, but nerves of steel.

When the positions of everything in each shot, animate and inanimate, had been determined and duly marked, the players went through a complete rehearsal.

Peter began the proceedings by blowing his whistle, which to me had a slightly humorous aspect. Everybody present immediately was frozen into statuesque silence. We all looked up at the indicator on the wall, which was flashing the words: "Vision On," "Sound On."



Stephen Thomas.



Dallas Bower.



Ben Lyon.

Last month, on pages 639 and 640, we inadvertently appended incorrect descriptions to two photographs which appeared on those pages. The first photograph, which was of Mr. Stephen Thomas, was described as being that of Mr. Dallas Bower, and the second one, which was stated to be Stephen Thomas, was actually a photograph of Ben Lyon. Stephen Thomas and Dallas Bower are, of course B.B.C. producers at Alexandra Palace, whereas Ben Lyon featured in the November 3rd programme with Bebe Daniels. Our sincere apologies are offered to the gentlemen concerned.

TELEVISION AND CINEMA COMPARISONS

This was the first time that stage scenery was used. One of the painted backcloths, which was supported from the ceiling on a long rafter of wood, was furled up and hoisted out of sight with the celerity of a sailing ship crew. Then another one slid down from the heavens in an equally efficient manner, and meantime the cameras were shooting the players at right-angles to the scenery that was being changed. The new scene was in position and ready in the nick of time.

And so this rehearsal went on, everything happening in a wonderfully clever way which made me just stand entranced and marvel at it all.

The person who I admired most of all was Peter Bax. He was the link between producer Dallas Bower up above, and the performers and assistants on the stage. Questions and instructions were shot at him with machine-gun-like rapidity, and on each occasion this very patient man did precisely as he was told, and walked quietly to the suspended microphone to reply to anything that Mr. Dallas Bower had asked. I came away with the settled impression that whatever salary a television stage manager gets, the job is worth double!

Among the distinguished cast in the television version of "Mr. Pickwick" must be mentioned William Parsons (Pickwick) and Dennis Noble (Mr. Weller).

* * *

Rosalind Wade's first appearance in the new programmes was notable for dancing fans. Miss Wade controls a large organisation which supplies dancing troupes all over Europe, and she is known colloquially as "Britain's Ziegfeld." One of her star troupes, known as "Rosalind Wade's Dancing Daughters," appeared weekly in the aural broadcast programmes for a long period. She was televised by the 30-line system.

Miss Wade's programme at the beginning of November was a demonstration of three different rhythms in tap dancing, incorporating (1) the Soft Shoe (which used to be known as the Schottische), (2) Rhythm and Swing, and (3) Buck and Wing.

* * *

Where television scores over ordinary broadcasting has been repeatedly demonstrated during the month, for it is surprising how many topical

events and news items require the visual element for their proper portrayal. For instance, viewers saw a fine display of Champion Alsations, which were brought from the Metropolitan and Essex Canine Society's show, while gardeners who possess a television receiver will have been delighted with the sight they got of the prize blooms brought from the National Chrysanthemum Society's show.

An attempt was also made to televise a "pre-view" of pictures and sculpture from various forthcoming exhibitions, but there are colour problems yet to solve in this connection.

* * *

One of the month's television performers who can fairly claim to have made a big hit is Arthur Prince, the ventriloquist, and his intelligent doll Jim. I think the television screen is particularly kind to a ventriloquist, because the definition is not sufficiently perfect to enable any very slight movement of the lips to be seen, although no one could detect Arthur Prince's lips moving anyhow.

The principal movie-people televised during the month were Bebe Daniels and Ben Lyon, the well-known Hollywood stars, who acted a

sketch which was quite funny, and sang in a charming manner.

* * *

One or two people have expressed the opinion to me that they did not think it wise for the B.B.C. to have too many people on the television screen who also were frequently seen on the cinema screen: it is no novelty.

But I do not think this criticism is sound. There is a difference between seeing even such a well known favourite as Bebe Daniels on the television screen and seeing her at the cinema, although I must confess the difference is more psychological than factual. You get that feeling when you see them at the cinema that it is a mechanical reproduction and definitely not real, but when you see them on the television screen, especially in close-ups, and you notice all those little peculiarities and mannerisms which are largely eliminated in the final version of any film, you perceive and enjoy a really intimate acquaintance with the characters which I personally have never felt when looking at a cinema screen.

The biggest success in the month's programmes, however, was Henry Hall, who looks like becoming as universal a favourite on the television screen as he is in aural broadcasting. His television performance with the B.B.C. Dance Orchestra was exceedingly good, and proved that Henry is as great a showman as a musician. Dan Donovan, the vocalist, deserves a word of congratulation for the notable part he played in making the band's television appearance such a huge success.

The general criticism of the month's television programmes seems to be that the fare offered to television viewers has been rather dull if considered from the entertainment angle. Leonard Henry, the well-known radio comedian, who was featured in "Starlight" in the middle of the month, when he did a gas-mask act, proved to be one of the liveliest items, but there is room for a general brightening up.

I mentioned this opinion to several officials at Alexandra Palace during my visits there and was assured that, in the programmes scheduled for the early future, this matter already has been given careful attention, and that a much better balance of different types of programme material may be expected.



Laurie Devine, the "Television Ballerina," one of the old favourites shortly to reappear on the television screen.

RECENT TELEVISION DEVELOPMENTS

A RECORD OF PATENTS AND PROGRESS *Specially Compiled for this Journal*

Patentees :—Marconi's Wireless Telegraph Co. Ltd., H. M. Dowsett and R. Cadzow
F. S. Turner :: Telfunken Ges für drahtlose Telegraphie :: Marconi's Wireless Telegraph
Co. Ltd., and A. A. Linsell.

Electron Multipliers (Patent No. 451,724.)

Self-sustained oscillations are produced in a tube containing two cathodes K, K₁ coated with highly-emissive substance, such as silver-caesium-hydride. A ring-anode A is placed midway between the two cathodes, and a strong magnetic field is directed along the axis of the tube by an external magnet N, S.

Electrons, set free, say, from the cathode K, are attracted towards the positive anode A, and the resulting current automatically produces a

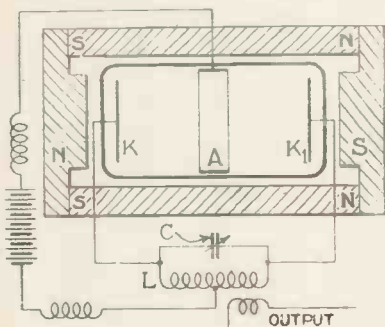

Electron Multiplier. Patent No. 451,724

voltage in the coil L of the tuned circuit L, C. This accelerates the electrons so that they reach the opposite cathode K₁ with sufficient speed to produce secondary emission there. The electrons so liberated are attracted back, in turn, towards the first cathode K, where they again set free fresh electrons. The process is repeated indefinitely, until the oscillations in the circuit L C build up to the full capacity of the tube. The field from the magnet NS helps to focus and sweep the electrons through the ring-anode A.—Farnsworth Television Inc.

Cathode-Ray Screens (Patent No. 452,368.)

The ordinary fluorescent screen is replaced by a thin sheet, M, of metal which is separately heated from

a battery B, as shown, from one side of the tube. The pre-heating is such that the screen just fails to glow, but the impact of the electron stream from the cathode C of the tube, is sufficient to raise it to incandescence and thus reproduce the picture in visible form. Only the edge of the metal screen M is shown in the pic-

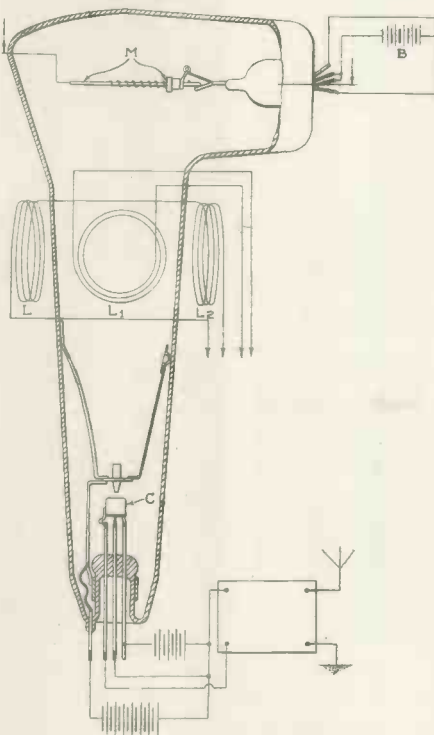

Cathode-ray tube for projection. Patent No. 452,368

ture, as the flat part faces towards the source of the electron stream. The usual scanning voltages are applied to deflecting coils L, L₁, L₂. The intensity of the image produced by incandescence is sufficient to allow the use of magnifying lenses, which project the picture on to a much larger viewing-screen situated outside the glass bulb.—F. S. Turner.

**Our Policy
"The Development of
Television."**

Television Receivers (Patent No. 452,148.)

One of the most expensive items in a television receiver is the cathode-ray tube, the cost of which increases with its size. The figure shows how a spherical mirror can be used in combination with a comparatively small tube to produce a clear picture 18 in. square.

The cathode tube T is inserted through an opening in the centre of the mirror R so that the latter faces

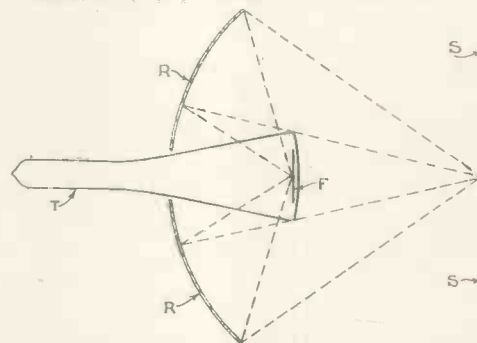

Combination of mirror and cathode-ray tube for projection. Patent 452,148.

the active side of the fluorescent screen F. As each scanning spot is formed, the light from it is picked up from all parts of the surface of the mirror, and reflected back on to a single point on the viewing screen S. In this way the mirror makes the best possible use of the limited fluorescent light available, and produces an enlarged picture of high definition.—Marconi's Wireless Telegraph Co., Ltd.; H. M. Dowsett; and R. Cadzow.

Enlarging the Picture (Patent No. 453,043.)

In order to throw a magnified image of the received picture on to an external viewing screen, the bulb end of the cathode-ray tube receiver is formed as a plano-concave lens. The fluorescent material is coated over the plane surface of the lens, and a simple

objective glass is then all that is required to project the televised picture, corrected for field-curvature, on to the final viewing screen.—*Telefunken Ges für drahtlose Telegraphie.*

A Super-regenerative Receiver
(Patent No. 453,135.)

The super-regenerative circuit is highly sensitive, and although its selectivity is not very critical, this is of small importance when working on the ultra-short wave-band, where there is little congestion.

The figure shows an arrangement in which two super-regenerative

the cathode-ray tube are connected to the time-base circuit which produces the synchronising or scanning voltages, but by depressing a push-button switch, this connection is broken and the deflecting plates are thrown across a resistance in the plate circuit of the first detector valve of the superhet circuit used to handle the sound part of the programme. The voltage developed across this resistance varies with strength of the carrier-wave, and the corresponding deflection of the electron stream in the cathode-ray tube shows when the circuits are accurately in tune with the

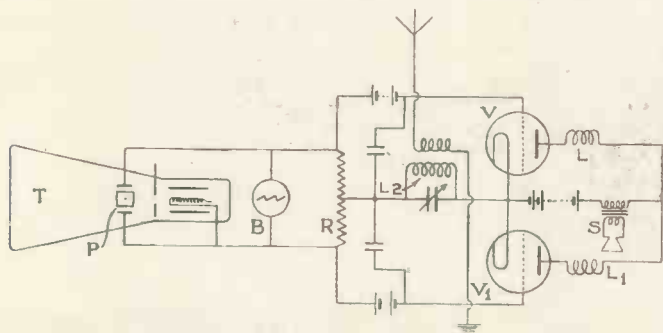

Circuit of super-regenerative receiver for television. Patent No. 453,135

valves are used for receiving the sound programme, the necessary "quenching" oscillations being conveniently derived from one of the scanning-frequencies used for the cathode-ray tube T which handles the picture signals. The two plate coils L, L1 of the push-pull valves V, V1 are back-coupled to the common input coil L2, so as to bring the valves to the verge of self-oscillation. The quenching frequency which prevents the valves from "boiling over" is applied to the grids from a resistance R shunted across the time-base circuit, shown diagrammatically at B. This is, of course, a necessary part of the equipment of the cathode-ray tube receiver T, and is used primarily to supply synchronising voltages to the deflecting plates P. Sound signals are reproduced in the loud speaker S, whilst the picture is seen on the fluorescent screen of the tube T.—*Marconi's Wireless Telegraph Co., Ltd., and A. A. Linsell.*

Tuning Indicators for Television Sets
(Patent No. 453,499.)

The cathode-ray tube used for reproducing the picture in a combined sound-and-television set serves also to indicate when the circuits of the receiver are accurately in tune.

Normally the deflecting-plates of

incoming signal.—*Marconi's Wireless Telegraph Co., Ltd., and A. A. Linsell.*

Summary of Other Television Patents

(Patent No. 447,046.)

Modulating television signals on an ultra-short carrier wave.—(*Radio Akt. D. S. Loewe.*)

(Patent No. 447,070.)

Preventing the cross-current from the electron stream to the deflecting electrodes of a cathode-ray tube.—(*Radio Akt. D. S. Loewe.*)

(Patent No. 438,905.)

Interleaved scanning-system for a film which has been specially prepared by compressing the picture detail in the direction of motion of the film.—(*C. O. Browne.*)

(Patent No. 440,087.)

Electron-optical arrangement of electrodes for focusing the stream in a cathode-ray tube.—(*Fernseh Akt.*)

(Patent No. 451,745.)

Electrode arrangement in a cathode-ray tube used for interleaved scanning.—(*Radio-Akt. D. S. Loewe.*)

(Patent No. 452,650.)
Producing clear-cut images in a cathode-ray tube utilising electrostatic deflection-control.—(*Radio-Akt. D. S. Loewe.*)

(Patent No. 452,715.)
Preventing reaction effects in a short-wave television receiver of the super-het type.—(*Radio-Akt. D. S. Loewe.*)

(Patent No. 452,844.)
Focusing the electron stream prior to the point where it is deflected by the scanning plates in a cathode-ray tube.—(*Radio-Akt. D. S. Loewe.*)

(Patent No. 453,223.)
Arrangements for focusing the electron stream in a cathode-ray tube.—(*Radio-Akt. D. S. Loewe.*)

(Patent No. 453,462.)
System for distributing television programmes to a number of stations linked together by a telephone line.—(*Electrical Research Products, Inc.*)

(Patent No. 453,496.)
Arrangement of electrodes and their mounting in a cathode-ray tube television receiver.—(*General Electric Co., Ltd., and G. W. Seager.*)

(Patent No. 454,256.)
Direction-finding system in which the bearings of a ship from a distant beacon station are indicated by television signals.—(*Marconi's Wireless Telegraph Co., Ltd.; R. J. Kemp; and D. L. Plaistowe.*)

(Patent No. 454,258.)
Electron "gun" construction for a cathode-ray tube.—(*Marconi's Wireless Telegraph Co., Ltd.; G. M. Wright; and G. F. Brett.*)

(Patent No. 453,886.)
Amplifier for handling television signals covering a wide band of frequencies.—(*Radio-Akt. D. S. Loewe.*)

"Televisor"

Messrs. Baird Television, Ltd., ask us to point out that the word "Televisor" is copyright and is used by the Baird Company as their trade mark. The word is so aptly descriptive of a television receiver that writers sometimes make the mistake of using it for any type of television receiver, whereas it is a coined word only applicable to Baird productions. In the Baird advertisement on page 623 of last month's issue a printer's error showed the word without inverted commas in the line—"Televisor" Receivers Mirror the World.

Read
Television and Short-wave World
Regularly

No longer is patience needed when tuning in long distance stations. This dial is ideal for

amateur bands giving perfect band-spreading, in addition to being calibrated in frequencies.

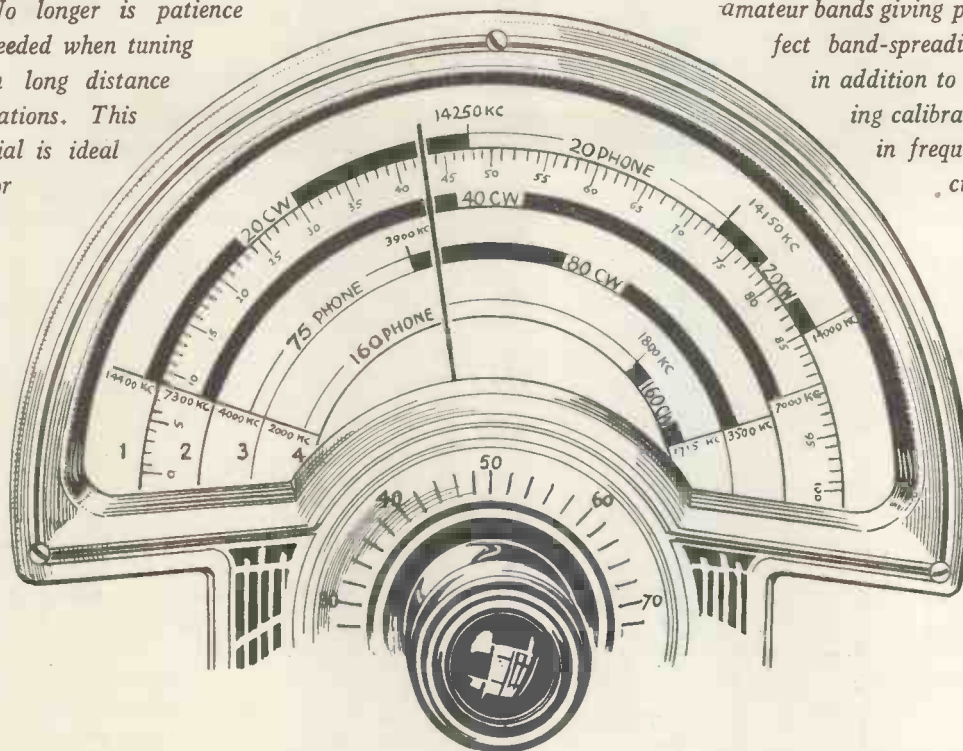

Amateur Bands Super-het 7

We have great pleasure in introducing a second amateur receiver embodying a special Tobe tuner. It has been designed by Kenneth Jowers in collaboration with Tobe Deutschmann Corporation of America. It is the nearest receiver, so far described in this country, to the large American commercial communication receivers. Two tuners are available, one for amateur bands and the other for wavelengths between 12.5 and 550 metres. These tuners are interchangeable without altering the wiring in any way.

ALMOST every amateur at some period or another finds the need for a multi-valve communication type of receiver with effective band-spreading, A.V.C., and other essential refinements. Congestion on amateur bands being so bad at the present time, a multi-valve receiver is almost a necessity. I hear of amateurs who still use simple two-valvers and claim world-wide reception, and while this is undoubtedly so, there can be no question but that the simple two-valver does fall down very badly when high selectivity coupled with extreme sensitivity are required.

In the September issue was published an 8-valve Tobe Amateur Super-het receiver which has proved to be ideal for use in this country. The designers of the tuner suggested that I adapted their 7-valve circuit to use British components so that the advantages of this star communication receiver would be available to British amateurs.

Such a receiver was designed in the latter part of July and tests showed that it was comparable in performance with any commercial receiver on the market. Readers who had constructed similar receivers from advance information supplied, even went so far as to say that

owing to the extremely low background noise level, the Super-het 7 was better than most American multi-valve communication receivers.

In order to prove whether this was so the original model was shipped to America and put through its paces by a well-known American amateur. The report was highly satisfactory in every respect, showing that the receiver was fully capable of giving a good account of itself in the 20-metre American phone band.

After this test it was handed over to the research staff of Tobe Deutschmann Corporation, who put it through the most stringent tests for selectivity, sensitivity on all bands and noise level.

The circuit in its present form is a good one. It is infinitely more simple than the 8-valver previously described, and at the same time, by careful choice of components, price has been reduced to a very reasonable level.

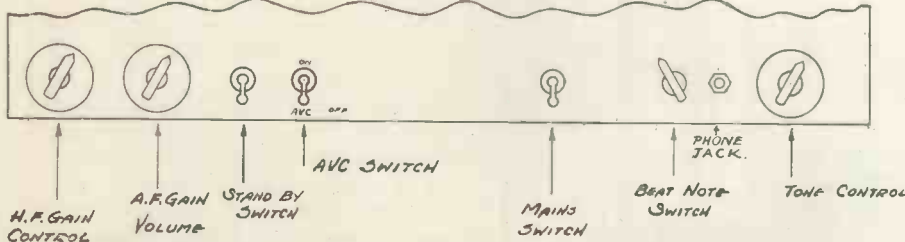

The controls are arranged so as to keep the connections as short as possible.

The Band Width

The secret of the success of this receiver is the Tobe 35H tuner, consisting

The R.F. Stage :: B.F.O. :: Low Noise Level

of the coil and tuning condenser for a highly selective aerial circuit, a stage of R.F. amplification on all bands, and an oscillator circuit. A 6-gang 4-point switch changes wavebands as required, and this switch short circuits all coils, including primaries, secondaries and

be omitted then the I.F. circuit can be made to oscillate.

Baseplate and panel are already drilled so that assembly is relatively simple, but it is advisable to mount all the valve holders with their shields first. The same fixing bolts are used to

screen between primary and secondary, which helps to reduce any noise which might be fed into the receiver from the lighting circuit.

An added precaution against modulation hum is the use of .05-mfd. condenser from one side of the primary to chassis.

Mount the I.F. transformers so that the variable selectivity adjusting screws are in such a position that they can be

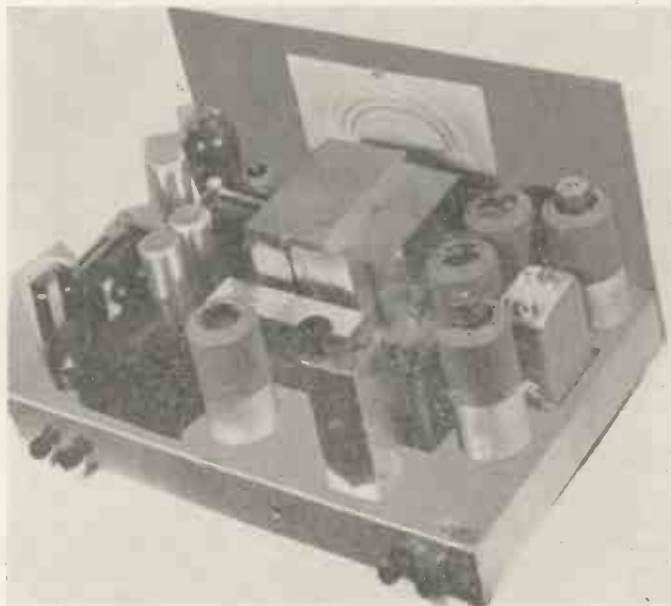

A standard Tobe B.F.O. unit can be seen in the foreground of this picture. An air-spaced trimmer is mounted in the top of the can.

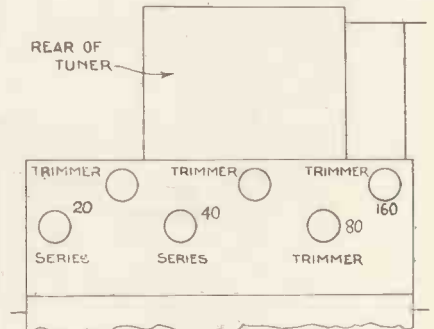

Trimming is most important. This is the position of the various preset condensers which are discussed in the text.

reaction windings, which are not employed in the circuit actually in use. This, of course, eliminates any resonant effects which would produce dead spots in the tuning range.

The tuner is so arranged that the amateur bands are in the middle of the dial and cover over two-thirds of the scale. The balance of the scale on either side is for foreign amateur and adjacent channel reception.

Constructors who have any doubt as to their ability to construct this receiver should have their doubts set at rest by the fact that only seven connections need be made to the tuner, which is completely wired and lined up by the makers.

Circuit Used

A superheterodyne circuit is used, consisting of a peaked aerial circuit, a stage of R.F. amplification, a band-pass intermediate frequency amplifier, diode detection, automatic volume control, B.F.O., high slope pentode and rectifier. Two single-pole single-throw switches are provided so that the A.V.C. can be switched off and the B.F.O. switched on when required. In the cathode circuit of the I.F. amplifier is a 10,000-ohm volume control so arranged that maximum sensitivity is obtained without the circuit going into oscillation. If the 50,000-ohm resistance in series with this volume control

fix holders and shields. Then mount the mains transformer and connect up the various filaments, the leads to the mains, not forgetting the electrostatic

easily adjusted. Wire up the leads to the I.F. transformer, making them as short as possible and with reasonably stiff wire.

All resistances and by-pass condensers should then be soldered in place. These small components are nearly all

Components for the Amateur Bands Super-het 7.

CHASSIS.

- 1—Aluminium 18 in. by 12 in. by 2 in. 14 gauge (B.T.S.).
- 1—Aluminium panel 18 in. by 10 in. 16 gauge (B.T.S.).

CHOKES, LOW-FREQUENCY.

- 2—Type WW/C1 (Sound Sales).

CONDENSERS, FIXED.

- 4—1-mfd. type tubular (Bulgin).
- 1—.01-mfd. type tubular (Bulgin).
- 6—.05-mfd. type tubular (Bulgin).
- 2—.001-mfd. type tubular (Bulgin).
- 1—.002-mfd. type tubular (Bulgin).
- 1—.005-mfd. type tubular (Bulgin).
- 3—.0001-mfd. type tubular (Bulgin).
- 3—8-mfd. type 802 electrolytic (T.C.C.).
- 1—10-mfd. type FT electrolytic (T.C.C.).
- 1—50-mfd. type FT electrolytic (T.C.C.).

HOLDERS, VALVE.

- 1—6-pin type V4 American (Clix).
- 1—7-pin type V4 American (Clix).
- 3—7-pin type V2 (Clix).
- 2—4-pin type V1 (Clix).

LOUD-SPEAKER.

- 1—Type 37J (W.B.).

OSCILLATOR, BEAT FREQUENCY.

- 1—Beat frequency oscillator air tuned type 456 (Eves Radio or Raymart).

PLUGS, TERMINALS, ETC.

- 4—Terminals type B marked Aerial, Earth, L.S.—, L.S.+ (Belling-Lee).
- 3—Anode connectors type 1224 (Belling-Lee).
- 1—Jack type J2 (Bulgin).

RESISTANCES, FIXED.

- 1—150-ohm ½ watt (Erie).
- 1—200-ohm ½ watt (Erie).
- 1—250-ohm ½ watt (Erie).
- 1—400-ohm ½ watt (Erie).
- 3—1,000-ohm ½ watt (Erie).
- 1—2,500-ohm 1 watt (Erie).
- 1—5,000-ohm 1 watt (Erie).
- 1—20,000-ohm ½ watt (Erie).

RESISTANCES, VARIABLE.

- 2—10,000-ohm potentiometers (Dubilier).
- 1—500,000-ohm potentiometers (Dubilier).

SCREENS.

- 4—Valve screens open-top type (Colvena).
- 1—Valve screen closed-top type (Colvena).

SUNDRIES.

- 48—6BA round head bolts with nuts and washers (Peto-Scott).
- 3—K58 knobs (Bulgin).
- 3—IP8 dials (Bulgin).
- 3—coils of quickwrye (Bulgin).

SWITCHES.

- 3—S80T (Bulgin).
- 1—S91 (Bulgin).

TRANSFORMERS, INTERMEDIATE FREQUENCY.

- 2—Type BP95 (Varley).

TRANSFORMER, MAINS.

- 1—Special type TAC giving 270-0-270 volts. 2-0-2 volts. 3.15-0-3.15 volts. 2-0-2 volts (B.T.S.).

TUNING UNIT.

- 1—Tobe Deutschmann tuner type H for amateur bands or standard all-wave (Eves Radio or Raymart).

VALVES.

- 1—6D6 American type (Premier Supply Stores).
- 1—6A7 American type (Premier Supply Stores).
- 1—VMP4G Met (Osram).
- 1—MHD4 Met (Osram).
- 1—ML4 Met (Osram).
- 1—AC2/Pen (Mazda).
- 1—UUI20/350 (Mazda).

Construction :: Insulating the Tuner

localised so as to keep wiring short. The exact positions can be seen from the sub-baseplate illustration.

Controls

The volume controls and switches are in front of the chassis and should be temporarily mounted and wired up.

which must be placed between the main chassis and the tuner. In addition to the grommit, an insulated washer is furnished and placed on the other side of the chassis before the metal washer is put in position.

It is most essential that the tuner be entirely insulated from the main chas-

mounted the coil switch and tuning condenser shaft should extend through the panel. The holes for these two shafts should be sufficiently large so that there is ample clearance between the shafts and the panel. Otherwise, chassis currents might be sent up if the tuner were earthed at more than one point.

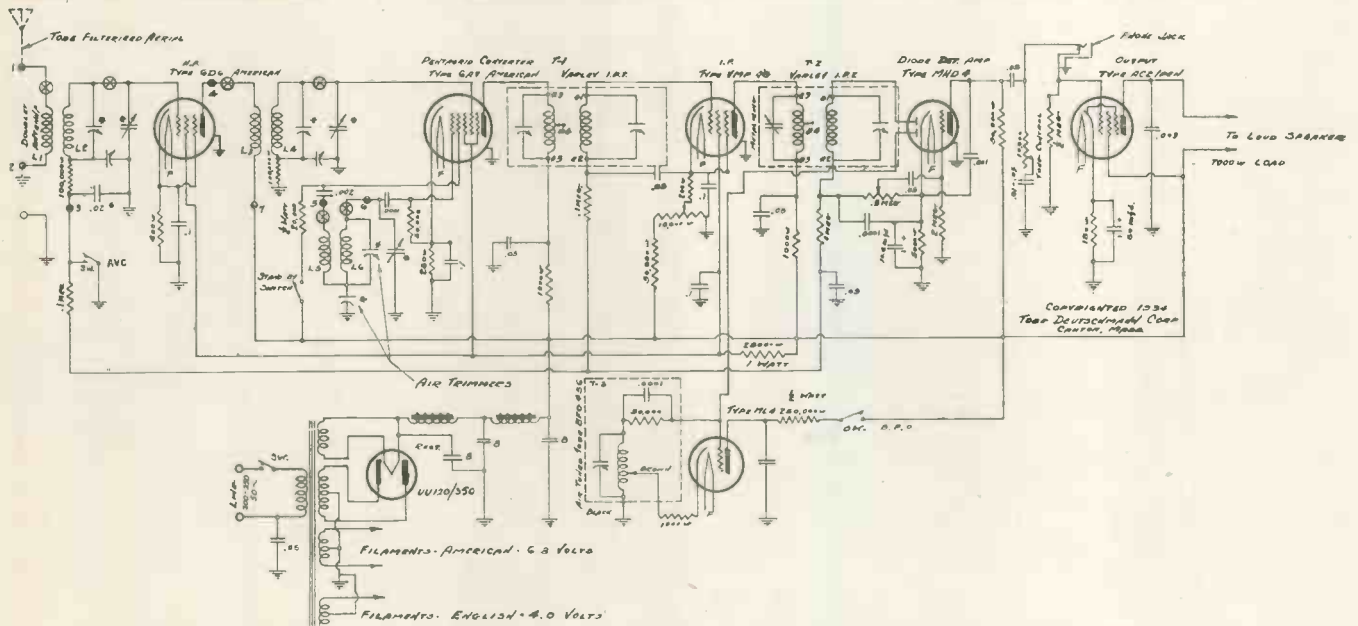

This receiver has been greatly simplified for components have been kept down to the minimum. The first two valves and tuning coils are ready wired in the factory.

This mounting, of course, will have to be removed when the front panel is fitted, for the controls help to hold the panel in position. All wiring possible should then be done before the actual tuner is fitted into position. This tuner is mounted on soft rubber grommits,

so it will be seen that the purpose of the rubber grommits is two-fold, for not only do they insulate the tuner from the main chassis, but they also give a cushioning effect which tends to reduce mechanical acoustical feed-back which could be caused by vibration of the condenser plates, due to sound waves from the loudspeaker.

There are three leads from the tuning pack to the high-frequency side of the circuit. One is from the anode of the 6D6, while the other two are from grid 1 and grid 2 of the 6A7 detector oscillator. These condensers should be mounted in a vertical position on the valve holder and connected by heavy wire to the tuner. The purpose of this heavy wire is to keep the leads from vibrating mechanically, so changing the frequency of the oscillator. It will be noticed that the tuner has a heavy flexible metal lead soldered to it, the free end of which has to be soldered to the main chassis. In this way the tuner is earthed in one point only.

Next, mount the front panel, but before it is put in place, be sure to fix the long pointer and collar on the shaft of the tuning condenser. Two volume controls, tone corrector, toggle switches and phone jack, are then mounted in place. When the panel is correctly

Mounted the calibrated dial calls for a little care. It has been slotted so that the base fits over the main tuning shaft, but it should be so mounted on 6 B.A. bolts so that it is set back from the panel

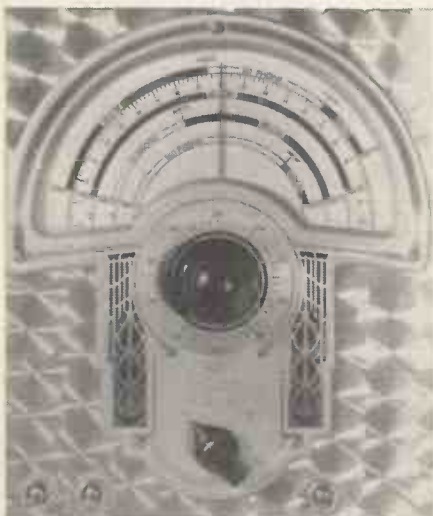

The Tobe control panel. Four-waveband switching with full bandsread on the four most popular amateur channels.

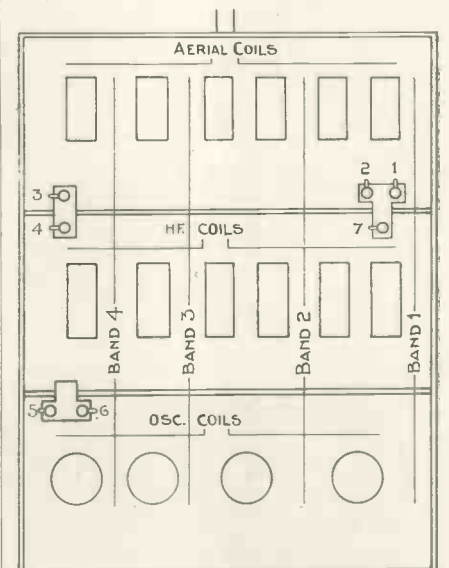

Only seven connections are made to the tuner. The various points of contact are shown in this illustration.

Matching the Tuning Circuits

sufficiently to clear the rotating cursor.

To obtain the correct position for the large tuning pointer, turn the tuning knob until the condenser plates are fully in mesh. Bring the pointer exactly in line with No. 100 on the dial and tighten up the set screws.

After carefully checking the wiring of the receiver it can then be tested

Signals should be received right away, for no matter how much out of adjustment the I.F. transformers are, the sensitivity is sufficient for one or two stations to be heard.

It is essential that an insulated screwdriver be used to line-up the I.F. transformers. These should be adjusted to a frequency of 456 kc., which means that

ple way in which the receiver can be correctly adjusted.

1. Remove aerial lead.
2. Turn volume control to a point of maximum sensitivity.
3. Turn tone control to give maximum high note response.
4. Set selector switch on the fourth waveband.

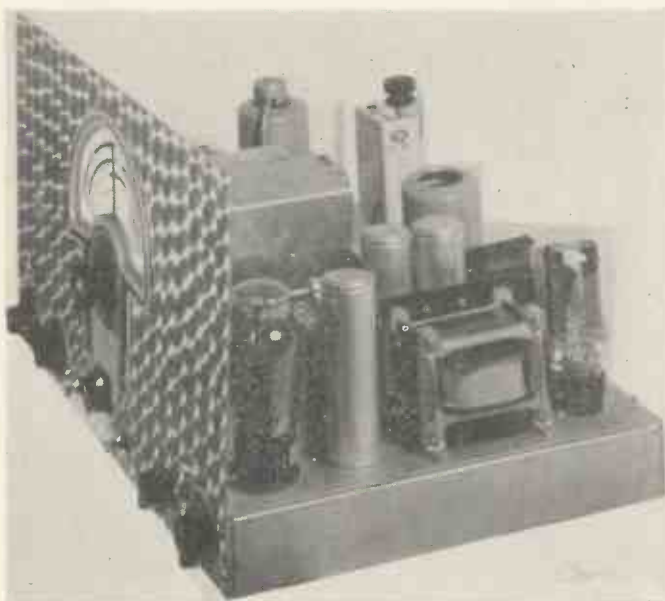

The power pack and output valve are all mounted together at this end of the chassis.

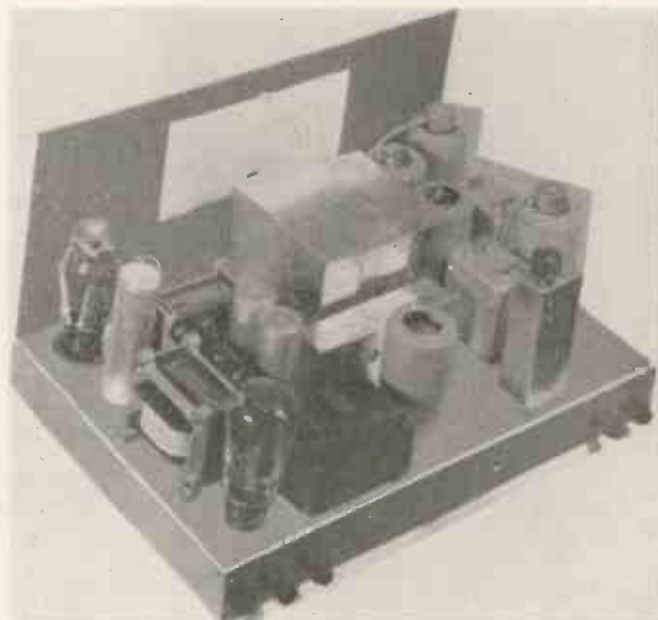

Notice how all the leads are kept beneath the base-plate.

under normal conditions. Before switching on, however, make quite sure that the loudspeaker is connected, otherwise there will be an open circuit in the final stage, so causing a big voltage rise.

the parallel capacity across primary and secondary must be increased.

Very few amateurs have a signal generator or an output meter of any kind, so for such readers, here is a sim-

5. Turn on automatic volume control.
6. Set tuning condensers so that no signals are received.

The I.F. transformer feeding the detector should be aligned first. The secondary and primary parallel condensers should be adjusted until maximum hiss is obtained, after which the preceding two transformers should be treated in a similar way. When these three transformers are all brought into line, a certain amount of hiss will be noticed, even with the radio frequency amplifying valve out of circuit. Also, the I.F. amplifier should not oscillate with the volume control fully advanced.

After the I.F. amplifier has been correctly adjusted, slight readjustments may be necessary to the trimming and padding condensers in the tuner itself. The aerial should be disconnected and the tuning condensers set almost at minimum, with the band switch on band four. This throws into circuit the coils for band four as shown in the illustration.

With the volume control set at maximum and the B.F.O. out of circuit, the aerial and R.F. coil trimmers should be adjusted for maximum hiss, the oscillator coil trimmer being left set. After band four has been adjusted, repeat this trimming on band three.

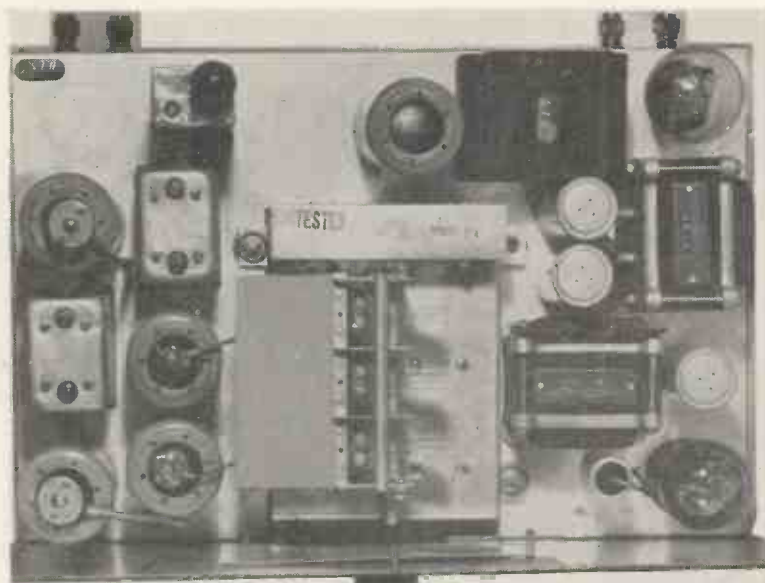

The cover over the condenser unit has been removed for the purpose of this illustration. Although the leads are kept short there is no cramping of components.

Trimming :: Adjusting Band Limits

Bands two and one have series as well as trimmer condensers. The trimming condensers are mounted directly above the coils and have one terminal connected to a switch point. The aerial and R.F. trimmers should then be adjusted for maximum noise.

Adjusting band one needs more care,

Connect the standard aerial to the receiver and turn the band selector switch to position four and tune in a signal somewhere near the high-frequency end of the band. If the frequency of the station is known, then the oscillator circuit tuning condensers can be adjusted until the receiver tunes accu-

be found above coils one and two. On these bands, however, readjust trimming condensers of the R.F. and aerial coils after making adjustments to the oscillator trimmers.

After making all these adjustments to the high-frequency limits of the amateur band, the next step is to bring the low-frequency limits of bands one and two in line with the markings of the dial. To do this it is necessary to make adjustments to the oscillator series condensers of bands one and two. Bands three and four need not be adjusted in this way, for the low-frequency limits are automatically brought into line

Readers wishing to examine the Tobe tuner can obtain demonstrations by making an appointment with the following firms.

Messrs. Eves Radio, 11, Lichfield Street, Wolverhampton.

Messrs. A. C. S. Ltd., 52/54, Widmore Road, Bromley, Kent.

Messrs. Radio Mart, 44, Holloway Head, Birmingham, 1.

The original receiver can be heard under working conditions in our laboratories at Cowslip Hill, Letchworth, providing appointments are made.

with the markings of the dial. To do this it is necessary to make adjustments to the oscillator series condensers of bands one and two. Bands three and four need not be adjusted in this way, for the low-frequency limits are automatically brought into line when the padders were previously adjusted.

The B.F.O.

The beat-frequency oscillator is entirely built and adjusted by the makers, and designed to give a 1,000-cycle note.

(Continued on page 727)

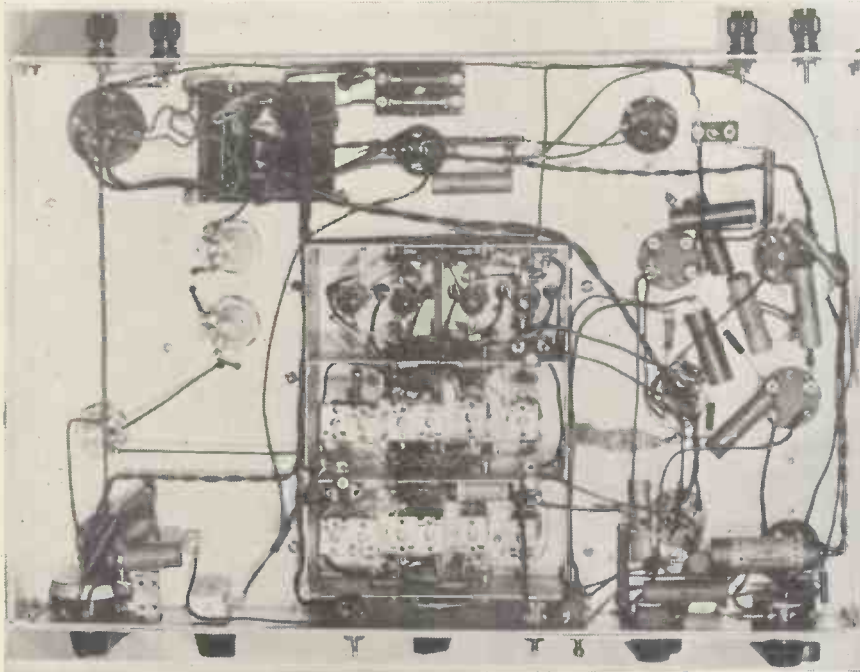

Considering that the receiver uses 7 valves wiring has been kept very simple. All trimming in the coil unit can be done with the receiver upside down.

for owing to the low noise level it is sometimes necessary to connect a small piece of wire to the aerial terminal to obtain sufficient background level. The trimmers should then be adjusted as for band two.

After these adjustments, the next step is to check up the padding condensers for bands three and four and the series condensers for bands one and two. First, adjust the tuning condenser near to maximum capacity. Then with the selector switch on band four, the padding condenser for this band should be rotated. Actually the padding condenser adjustment for bands three and four extend through the rear of the tuner, the band four padder being the lower one. With the aerial again disconnected, adjust this padder for maximum noise. Similar performance has to be carried out on the remaining series or padding condensers.

So far no adjustments have been made on the trimming of series condensers in the oscillator circuit for these change the frequency to which the receiver is tuned. If it is necessary slightly to shift the tuning range so that the amateur bands are correct as to frequency, small adjustments have to be made to the oscillator circuit.

rately. This process can also be repeated on band three.

To change the position of the high-frequency ends of bands one and two, the trimming condensers should be carefully adjusted. These condensers will

On the I.F. transformers are two air spaced trimmers. These should be adjusted with wooden screw-drivers.



A Folded Doublet Antenna

By G2IS and G6DT

THAT refrigerator was the final cause of it. We could put up with the mush from automobiles, violet-ray sets, etc., etc., but the refrigerator was more than human nerves could put up with. Punctually every hour it crashed into operation and ran for five minutes. During those five minutes all signals—even R₉ plus commercials—were blotted out.

The obvious solution was a doublet clear of the "mush level" and low im-

always came back to the fact that you can't hang one end of an antenna on nothing—and still the QRN busily QRN'd. During the investigation we discovered that a mast could be fitted outside the dormer window of the operating room. "—but you can't hang a doublet on a single mast!" said a visiting amateur helpfully.

That set us thinking: "Why not fold the doublet? It probably won't work but it's worth a try" But it did work!

The materials were cheap and easily obtainable. The mast was made up of fifteen foot lengths of 1 in. x 1 in. straight grained pine. A length of 1 in. x 1 in. made each of the four corner members of the mast. Cross pieces of 1 in. x 1 in. were nailed every two feet as bracing and to give even spacing (Fig. 1). The foot was finished off with a piece of 1/2 in. board.

The top cross arms were made of two selected 8 ft. lengths of 1 in. x 1 in. The arms were dovetailed and fitted to the mast top, as shown in Fig. 2. The length of the cross member must be accurate as this determines the final length of the doublet.

Fixing

The mast and cross arms were given a coat of paint and while this was drying a bracket was fitted to one side of the frame of the operating room window. This bracket was to support the foot of the mast. A beading was nailed around the top of the bracket to prevent the foot of the mast from "walking" under wind pressure. A heavy U-shaped iron strap was prepared to secure the mast to the top of the window frame.

When the paint was dry, small porcelain stand-off insulators were fitted to the cross arms, as shown in Fig. 3. The insulators carry the wire making up the doublet proper, and should be fitted exactly as shown in the drawing.

Fig. 3 also shows how the wire should be run on the insulators. 16-gauge enamelled wire should be used and stretched tight and even, as these wires not only serve as antenna but also brace the cross arms. The inner ends of the two halves of the doublet are soldered to a twisted pair feeder of 16-gauge rubber-covered wire. The joints at the

top of the feeders should be well covered with tar or Chatterton's compound to prevent insulation failure due to capillary attraction. The length of wire of each half of the doublet will work out at slightly over 16 ft. 6 ins.

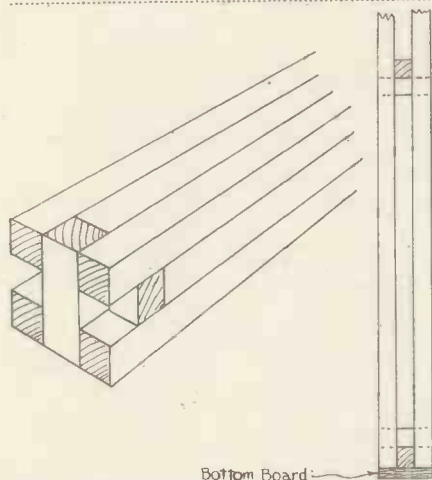

Fig. 1. This shows a perspective and a side view of the bottom board.

pedance, transposed feeder line. The station is on the top floor of a house with a completely unclimbable roof. The garden is too narrow to run a doublet "thwart ships." The doublet could not be run down the garden as it would be parallel to the transmitting antenna, and anyhow it was impossible to get a good feeder run to the receiver.

Reams of paper were expended in an attempt to find some means of fitting in 33 feet of wire in doublet form. We

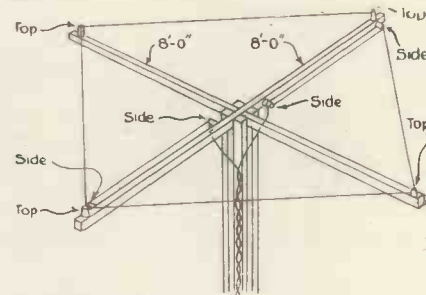

Fig. 3. The antenna is slung in this manner and is fed with a twisted pair.

The work of getting the mast into position was started with misgiving as it looked a flimsy structure. It proved quite strong, however, and surprisingly light and was easily worked into position and made fast with the U-strap. The feeders were brought down the side of the mast and into the receiver by the most direct possible route and all sharp bends were avoided. Fig. 4 shows the assembly in position.

(Continued on page 725)

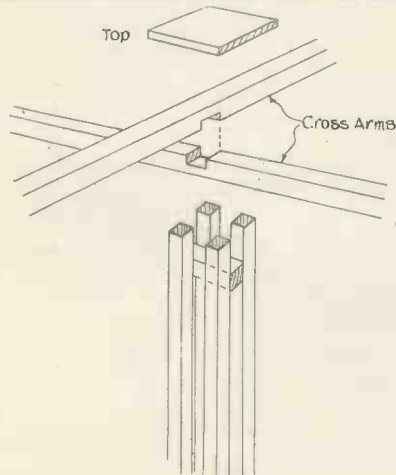

Fig. 2. Exploded perspective showing top cross bar assembly.

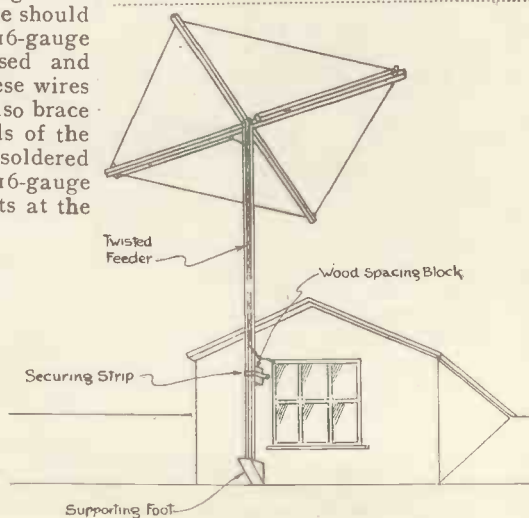

Fig. 4. The aerial can be used in almost any location and can be adapted for ultra-high frequencies.

Osram Valves

and

GASFILLED RELAYS

for the
"TELEVISION" Cathode Ray
Receiver



Screened high
Slope Pentode
Slope 10ma/volt
Anode grid cap-
acity 0.3mmfd.

SPECIFIED

MSP4	-	Screen Pentode	-	12/6
X41	-	Triode-Hexode Frequency changer	-	15/-
D42	-	Single diode	-	10/-

Other types specially suitable for Television receivers—

OSRAM

N43	-	Low capacity high slope output Pentode	-	25/-
U16	-	High voltage C.R. Tube rectifier	-	20/-
U17	-	Rectifier for C.R. Tube and time base circuits	-	20/-
GT1B	-	Gasfilled relay (Argonfilled) for time base circuits	-	20/-

Full technical data on all the above valves available on application

A New Transmitting and Receiving Aerial System

By F. R. W. Strafford G2TD

The aerial system described in this article has been designed as a solution to one of the greatest problems of the low powered transmitting amateur who wishes to make the most of his meagre power allocation. Although primarily designed for 14 megacycle operation it may be adapted to the other wavebands by the simple expedient of proportioning the length and height figures given for 14 megacycles.

A VERY careful study of the elementary half-wave doublet, Fig. 1, with non-radiating feeders preferably of the low-impedance twisted

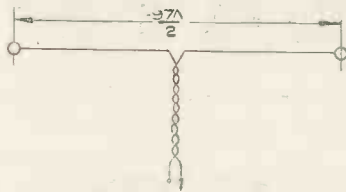

Fig. 1a.—Elementary half wave horizontal doublet.

pair, indicates that the best height from the ground for general European and DX working is one half wavelength, or approximately 33 feet. If the ground is of the very chalky or stony type the aerial may be as low as one quarter wavelength or 16 feet on 14 megacycles, since the image patterns due to ground reflections are then much about the same.

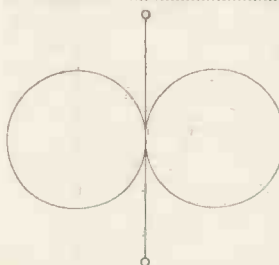

Fig. 1b.—Equatorial Polar Distribution of Field strength of elementary half wave doublet.

The chief disadvantage of the simple half-wave doublet is its directional behaviour, since the polar distribution is as shown in Fig. 1b. An aerial system of this type, which, due to the geography of the writer's garden, is located due east and west, will provide very good contact with Europe, Africa and

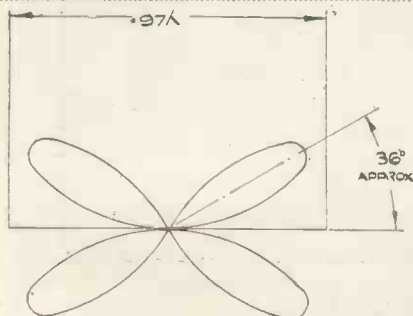

Fig. 2.—Equatorial polar field strength distribution for full wave horizontal aerial.

India, but is extremely erratic and generally poor for America (particularly the U.S.A.). This is quite natural since the theory is fully established in practice not only by amateurs but also by communication companies.

An aerial of this type could be arranged to rotate on some form of mechanical structure so that directional characteristics might be changed at will, purely by a change in the

and this means that a 60 ft. mast is practically essential even at 14 megacycles.

The Full Aerial

The foregoing indicates the reason why a full-wave aerial (66 ft.) on 14 megacycles appears to be so popular. Apart from its useful low-angle radiation components when it is located one

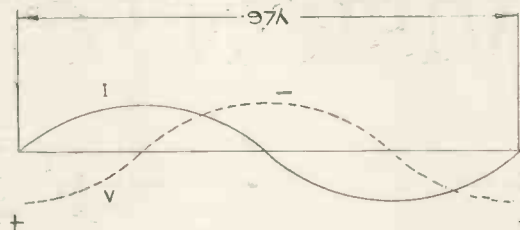

Fig. 3a.—Elementary full-wave aerial.

geometry of the aerial system as a whole. While this method is often favoured abroad it is generally a little too expensive to put into operation in this country and would probably not be favoured by the vendors of houses in the garden estates of to-day.

The amateur must therefore consider means whereby directional effects may be obtained by simple and economical

half wavelength from the ground level, its directivity is modified to that shown in Fig. 2, in which it can be seen that

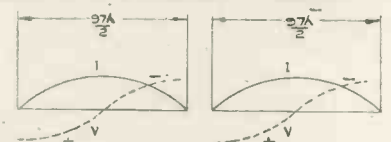

Fig. 4a.—Two half-waves energised in base.

four directive lobes are produced and this arrangement is often used for American DX by those whose garden runs due east and west and to whom the half-wave doublet is practically useless in this direction (see Fig. 1b).

On the other hand it is also clear that little or no signal is transmitted at right angles to this aerial system. If a full-wave aerial could be arranged in which the directivity could be changed at will from that shown in Fig. 2 to that in Fig. 1b, a great improvement would have been made. The new "Vari-phase" aerial system, as it is to be known, not only achieves this result, but actually provides double the field strength of a simple half-wave doublet when it is adjusted to transmit maximum signals at right angles to its own

(Continued on page 720)

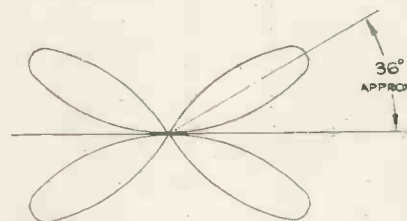

Fig. 3b.—Voltage and current distribution of elementary full wave horizontal aerial and equatorial polar field strength distribution.

electrical methods. A vertical aerial is omni-directional, thus distributing its energy uniformly in all directions. This is not economical, particularly for low powered transmitters, since the resultant field strength at points located on a circle of which the aerial is at the centre are relatively weak. Tests over long periods also indicate that simple half-wave vertical aerials are not very efficient for general low power use even when conditions are good unless the aerial is very well clear of the ground,

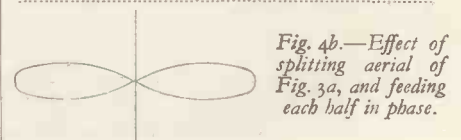

Fig. 4b.—Effect of splitting aerial of Fig. 3a, and feeding each half in phase.



EDDYSTONE EXCELLENCE

for PLUS PERFORMANCE



PRECISION 4" SLOW MOTION DIAL.

An accurate and powerful drive for high-class test and laboratory equipment or transmitters. 5/64" thick brass scale silver plated, with machine-cut graduations. 6 to 1 reduction ratio. Large control knob. Can be supplied with 1/2" M. or F.M. fitting.

No. 1069
Price 15/-.

H.F. LEAD THROUGH INSULATOR.

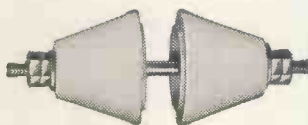

For carrying H.F. leads through metal baseboards with minimum loss. Glazed Frequentite Insulator Cones. 4BA Brass Rod Conductor. Cones 1 1/8" long. 1 1/8" max. diam. No. 1018. Price 2/-.



POINTER KNOB AND DIAL.

A direct control comprising satin finish aluminium dial engraved 0-100°, with elegant shaped bakelite pointer knob. For 1/4" spindles only. No. 1027. Price 1/3.

ULTRA S.W. INTERCHANGEABLE COILS.

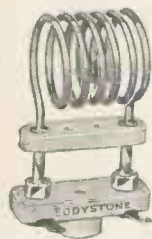

Wound with 14 gauge high conductivity copper wire, heavily silver plated. A separate Frequentite base with silver-plated sockets provides easy and efficient coil changing. No. 1050.

3 Turns	1/6
4 " " " " " "	1/6
5 " " " " " "	1/7
6 " " " " " "	1/8
8 " " " " " "	1/10
Frequency Base for above	
No. 1051	1/-

SPLIT STATOR CONDENSER.

Heavy brass construction, plates with polished edges, soldered together. Insulated bearings. Screened non-inductive pigtail. Frequentite insulation. Capacity—One side: Min. 5 m.mfd. Max. 40 m.mfd. Two sides in parallel: Min. 10 m.mfd. Max. 80 m.mfd. As series gap: Min. 3 m.mfd. Max. 20 m.mfd. No. 1033 Price 12/6



NEUTRALISING CONDENSER



Of solid construction, with turned brass plates, screw adjustment. Frequentite insulating pillars, mounted on cast base. Ideal for Eimac 150 T. and similar valves. Capacity: 2.5 to 5 m.mfd. No. 1067 Price 12/6

FULL of INTEREST to SHORT-WAVE ENTHUSIASTS

Illustrated constructional articles for building simple S.W. battery sets; battery and A.C. mains superhet. S.W. receivers with A.V.C.; Ultra S.W. Radio Telephone; Transceiver; S.W. Converters; Crystal-controlled Amateur Bands Transmitter, etc. From your Radio Dealer, W. H. Smith & Son, or from Stratton & Co., Eddystone Works, Birmingham, 5, London service—Webb's, 14, Soho Street, W.1.

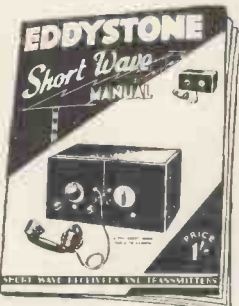

EDDYSTONE 1937 SHORT WAVE MANUAL

ULTRA SHORT-WAVE H.F. CHOKES



These chokes are single layer space wound on DL-9 formers, and have an exceedingly low self-capacity, 23-10 metres. No. 1011. D.C. Resistance 1.3 ohms. 2.5 to 10m. Price 1/3
No. 1021. D.C. Resistance 0.4 ohms. 2.5 to 8m. Price 1/3

IRON CORED FILAMENT CHOKE



For use in filament circuit of battery operated Superhet Receivers using electron coupled oscillator. No. 1062. Price 3/6.

BANDSPREAD TUNING OUTFIT. Devised to simplify station selection.



The Tank condenser unit has a capacity range of 10 X 14 m.mfd., achieved by a patented step by step device. Complete with scale and knob.

Tank Unit: Cat. No. 1042. ... Price 6/-



In parallel with the Tank capacity is the slow motion Bandspread Trimmer condenser, with a capacity slightly greater than each step by step of the Tank condenser. Complete with dial Trimmer Unit

Cat. No. 1043 ... Price 6/6

SEND FOR ILLUSTRATED COMPONENT LIST — FREE ON APPLICATION

EDDYSTONE SHORT WAVE COMPONENTS

How the Aerial Radiates

:: Coupling

direction. The new system is, therefore (a) as good as a normal full-wave aerial at one setting, and (b) twice as good as a half-wave doublet at the other setting.

This change in directivity is achieved by suitably phasing the current distribution in the aerial.

Consider an elementary full-wave aerial as depicted in Fig. 3a. The full line shows the current distribution while the dotted line represents voltage distribution (the polarity is also shown).

centre impedance (about 80 ohms) of the half-wave section of the aerial. Secondly, the inherent high-frequency losses are quite large and much useful power is absorbed in the feeders and not radiated by the aerial.

A New 75-ohm Feeder

A feeder for specific use with half-wave transmitting and receiving aerials has now been produced by Messrs. Bel-

Figs. 5 and 6. The termination of the aerial requires special attention. It is not wise to splay the ends of the feeder for reflection losses may occur and the author also finds that small radio plugs and sockets are better than double-pole double-throw switches since they enable the phase switching to be achieved with minimum splaying of cable connections. A double-pole double-throw switch is, of course, necessary to change from transmitter to receiver, but here again the wire of the feeder should be splayed as little as possible and connections should be symmetrical in length.

Also the feeder must be used throughout, right to the input circuit of the receiver or coupling coil of the transmitter.

Coupling Methods

The transmitter coupling coil may consist of three complete hank-wound turns of insulated solid wire the diameter being equal to the final stage tank coil. The coupling coil is then pushed between the two turns of the tank coil nearest the plus H.T. end and coupled until the stage is normally loaded as with any other type of aerial.

The author's aerial runs due east and west. With the half waves in phase South Africa reports an increase from R3 to R6/7, one doublet only giving R5.

With two half waves out of phase W station reports an increase from R2 to R6.

The advantage of this system is also strikingly apparent when used for reception. Practically every station received will be found much stronger on one phasing arrangement than the other and in many cases QRM from another station will be practically eliminated.

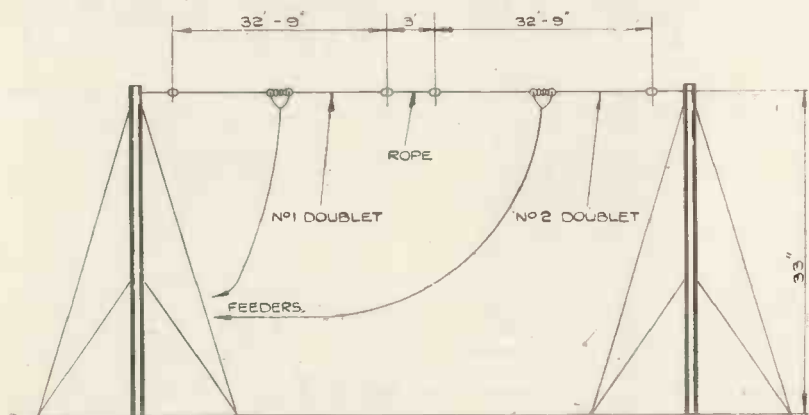

Fig. 5.—Typical aerial installation for 14.3 M.C.

This figure shows that the current distribution in each half-wave element of the wire is out of phase. Fig. 3b is the polar distribution of the field strength transmitted (or received) by such a system due to the particular current distribution along its length.

Suppose now the aerial is split into two half waves so that they are end on and without the tips touching, and supposing each half wave is energised in phase. The current and voltage distribution in each half-wave section are shown in Fig. 4a and are now seen to be in phase with one another. Now study the polar distribution of the field strength (Fig. 4b) and notice how the signal is concentrated in a direction at right angles to the wire. This is even greater than that shown in Fig. 1b for the simple half-wave doublet, and is the means of producing twice the signal strength (for either transmission or reception) along the lines of maximum strength as compared with a simple doublet.

Now this change of the phase of the current in each half-wave section of the aerial may be readily achieved by the use of two feeders of the low-impedance twisted type arranged in the centre of each half-wave section. Ordinary lighting flex, cab tyre, v.i.r., etc., for this purpose is known to be used, but is not really suitable for two reasons. Firstly, the surge impedance is of the order of 120 to 150 ohms and does not match the

ling & Lee, Ltd., in which the inherent losses on 14 megacycles are only 1 db. per 100 feet. Furthermore the surge impedance is exactly 75 ohms. With a total feeder length of 100 feet on the experimental aerial at the author's station the losses are quite negligible.

Having erected two simple end-on centre-fed doublets the twin feeders are brought into the transmitter and connected in series. By reversing one feeder the phase is reversed in one aerial

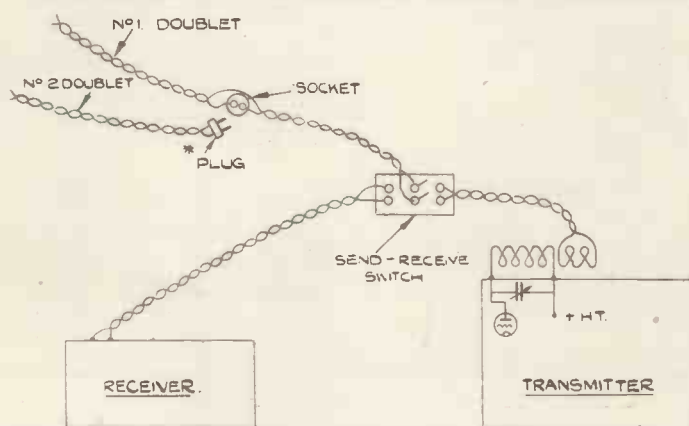

Fig. 6.—* Reverse plug to change directivity of aerial system arrangement for feeder termination and phase changing.

so that the polar pattern is changed as from Fig. 3b to Fig. 4b and is thus simply achieved in the transmitting room.

A practical arrangement for operation on 14.3 megacycles is shown in

This is particularly noticeable when the two half waves are in phase, thus producing a strong narrow beam and cutting out reception from a very large

(Continued on page 725.)

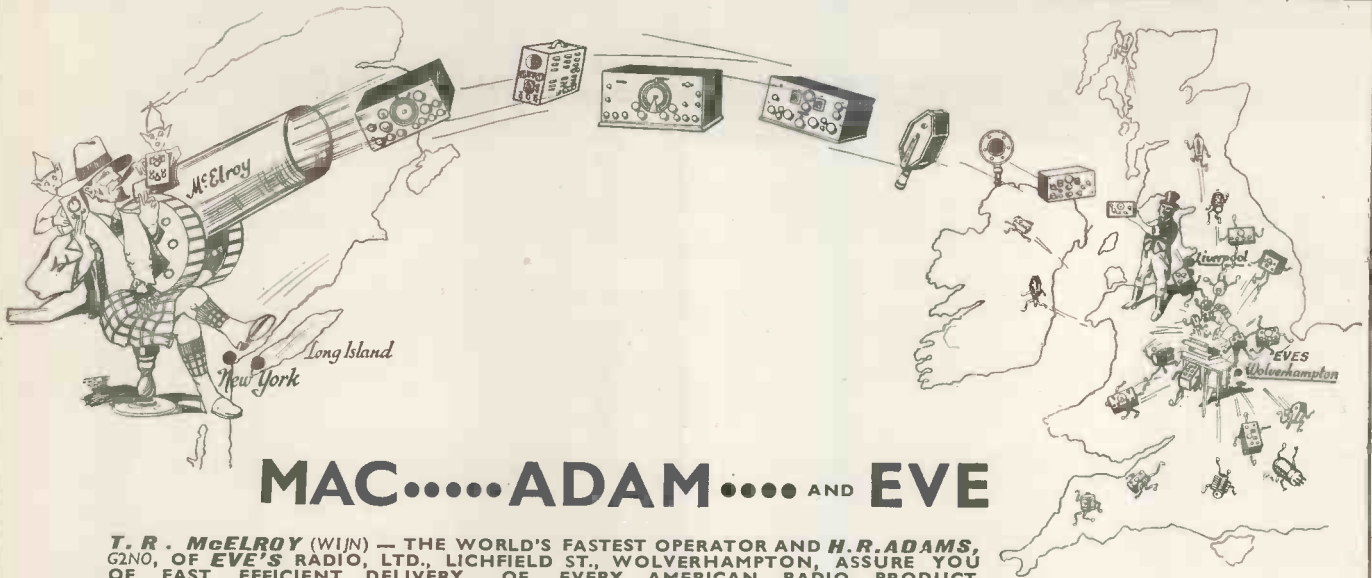

MAC...ADAM...AND EVE

T. R. McELROY (W1JN) — THE WORLD'S FASTEST OPERATOR AND **H. R. ADAMS, G2NO**, OF **EVE'S RADIO, LTD.**, LICHFIELD ST., WOLVERHAMPTON, ASSURE YOU OF FAST EFFICIENT DELIVERY OF EVERY AMERICAN RADIO PRODUCT.

CONSULT EVES THEY WILL TEMPT YOU

ALL RECEIVERS OFFERED ARE BUILT FOR 230 VOLT 50 CYCLE MAINS INPUT

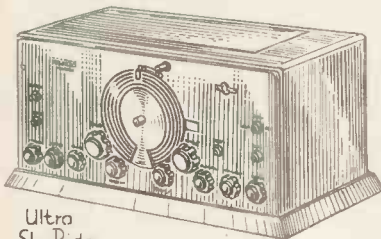

Ultra Sky Rider

THE ULTRA SKY RIDER

- 3.9 to 53 metres.
- Built-in Noise Silencer.
- 1,600 K.C. Iron-Core Air-Trimmed I.F. Transformers.
- Electro-Mechanical Band Spread.
- 338 Degree Dial.
- Direct Calibration Tuning—No Charts or Tables.
- Individual Coils for each band.
- Generous Isolantite Insulation.
- 100 K.C. Expansion.

AMATEUR NET PRICE, £34 0s. 0d.

THE NEW 1937 SUPER SKY RIDER

- 11 Tubes—10 of them metal.
- 40 M.C. to 535 K.C. in 5 Bands.
- 338 degree main tuning dial.
- Electro-Mechanical Band Spread.
- 14 Watts Undistorted Output.
- Direct Calibration Tuning—No Charts or Tables.

AMATEUR NET PRICE, £31 0s. 0d.

- Field Strength Indicator.
- Improved 10 metre performance.
- Single Signal Crystal Action.
- 465 K. C. Iron Core I.F. for improved selectivity.
- Ceramic Insulation.

CRYSTAL GATE MODEL.

THE SKY BUDDY



Sky Buddy

- 18 to 555 metres (16.5 Mc.-544 Kc.) Three Bands.
- Combined I.F. and Beat Frequency Oscillator.
- 5 tubes do the work of 8.
- Automatic Volume Control—with on-off switch.
- Greater Band spread—36 to 1.
- Bands changed with switch.
- Improved tuning control—no backlash.
- Direct reading calibrated dial.
- Single tuning control.
- Built-in power supply.
- Built-in speaker.

AMATEUR NET PRICE, £9 0s. 0d.

STANDARD FEATURES ON EVERY RME-69

- Planetary Vernier Dial Drive.
- Full Electrical Band-Spread.
- Individual Dial Operation.
- Six Band Tuning Range.
- Calibrated Microvolt-R Meter.
- Built-in Monitor Circuit.
- Fixed Coupling I.F. Transformers.
- Six Volt Tubes.
- Crystal Filter Circuit.

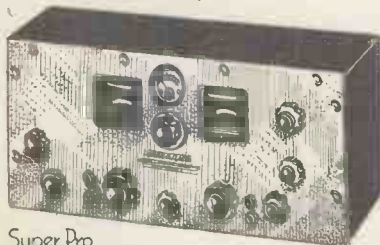

Super Pro

RME69

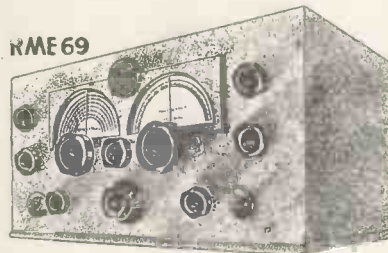

AMATEUR NET PRICE £38. SPEAKER, £2 10s. 0d.

THE WORLD'S MASTERPIECE

Hammarlunds Super Pro. Surpasses any other receiver. 6 models. SPIO—Super-pro. with xtal Gate and 10" Speaker.
AMATEUR NET PRICE, £65 0s. 0d.



KITS AND TUNERS ALL WAVE OR AMATEUR BANDS ONLY

COMPLETE 7-TUBE KIT with Metal Tubes and Power Unit, £12 10s. (or 30/- and 12 payments of 20/-).

TOBE AMATEUR BAND TUNER, air trimmed. £6 10s.

OTHER NEW LINES. All in stock.

A.R.R.L. 1937 HANDBOOK, just released 5/3 (post free)

A.R.R.L. WORLD MAP, 30" x 40". See "Q.S.T." Nov. 6/3 (post free)

PHILIPS WORLD GLOBE, 12" diam. 17/6

NEW TUBES

TAYLOR, T55, 45/-, T200, £6. RK35, 45/-, RK25, 27/6.

AMPEREX HF100, 65/-.

RATHEON 6L6, 6E5, 695, 7/6.

NATIONAL Octal Base, 2/-.

NATIONAL 50-watt socket, 7/-.

ACORN TUBES

954, 35/6 ; 955, 27/6 ; 956, 35/6.

1937 McELROY BUG 35/-

JOHNSON 6" Spreaders' 6d. each

TOBE 2 mfd.2,000 v. W.K.G. UTC Class B and Varimatch Transformers in stock.

HARVEY 80T Transmitters.

WEATHERPROOF Twisted Pair Transmission Line. 2 No.12 Copper Conductors, V.I.R. impregnated outer covering—British made—5,000 megohm grade. 4d. per Foot.

Send 4d. for Complete List "T"

PHONE Orders direct to G2NO. WOLVERHAMPTON 22886

Office Hours: Mon., Tues., 9 a.m.-7.30 p.m.; Wed., Friday, Sat., 9 a.m.-8 p.m.; Thurs., 9-1 p.m. Remember, after 7 p.m., a Trunk Call costs you only 1/-.

EVES RADIO LTD.
11, LICHFIELD STREET,
WOLVERHAMPTON:

A Beginner's Transmitter

By KENNETH JOWERS

In the November issue were given the constructional details of the crystal oscillator stage. How this stage functions and the constructional data on the power amplifier and power pack sections are given in this article.

MOST beginners will find it simpler to build the transmitter high-tension supply before completing the wiring of the push-pull power amplifier stage. It is most im-

of 4 volts at 3 amps., is mounted on the third rack. This consists of a Sound Sales transformer of their standard 500-volt type, plus a 100 ma. 30-henry smoothing choke and two 4-mfd., paper type condensers. This is wired as shown in the theoretical diagram.

This output is taken directly out to the crystal-oscillator anode circuit through the 0-50 ma. meter—mounted on the same rack as the power pack—a 10,000-ohm resistance and circuit breaking toggle switch.

Connections can be made either by twisted flex directly from point to point or to terminal saddles which give a much neater appearance. Similarly with the filament supply, this should be taken up directly from the filament winding on the mains transformer and wired to the three valve holders on the transmitter rack which are all in parallel.

By this time the constructor should have made the crystal oscillator anode coil which consists of 20 turns of 18-gauge enamel-covered wire wound on a 4-pin threaded former. Switch on the H.T. supply and unless the crystal oscillator stage is already tuned to resonance the anode current will be almost 50 ma.

C.O. Tuning

The C.O. condenser should be adjusted very quickly when it will be found that directly the anode circuit is tuned to the same frequency as that of the crystal, there will be a rapid drop in the current. With the original transmitter the C.O. anode current was approximately 46 ma. off tune, dropping to only 4 ma. at resonance. Of course, this current will increase when the P.A. stage is drawing properly, but that will be dealt with later.

The C.O. tuning should be carefully adjusted to give minimum anode current and to this end it is advisable to experiment with the value of grid leak. 25,000 ohms seems to be correct for the 0-15/400 valve, but if the characteristics of individual valves change, it may be possible to increase the efficiency of the C.O. stage by adjusting the value of the leak.

A looped lamp will come in most useful at this stage for it is a certain method of indicating just when the C.O. stage is accurately tuned.

Obtain a bulb holder such as the Bul-

gin type F5 and use with it a 4-volt flash lamp bulb. Connect across the two contacts a single loop of wire preferably about 12 or 14 gauge, cover the wire with heavy sleeving and it is then ready for use. This loop should be held above the C.O. anode coil and when it is correctly tuned the lamp will light up, the brilliancy depending on how close it is to the coil and the approximate output from the crystal stage. It is a good plan to fix this looped lamp above the coil and adjust the various components in the C.O. stage until maximum light in the bulb is obtained.

The P.A. Stage

With the C.O. working smoothly, construction of the push-pull output stage can be started. The most difficult job is the building of split-stator condensers. These are made up from four double-spaced Eddystone transmitting condensers plus two lengths of 2 B.A. brass studding, some nuts, and a pair of insulated brackets.

In the end of these Eddystone condensers is a countersunk 2 B.A. screw, which should be removed and in its place fitted about 2 ins. of 2 B.A. studding. It is locked in position with 2

(Continued on page 724)

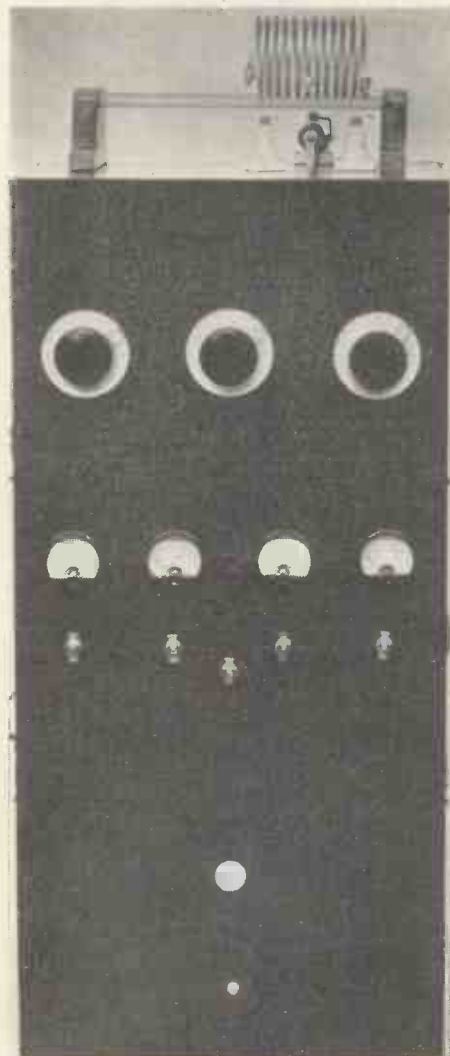

The transmitter is now completed and morse signals can be radiated. The bottom section of the rack is to hold the speech amplifier.

portant that the crystal oscillator works smoothly and gives a reasonably high radio-frequency output. Unless the C.O. is correctly adjusted at this stage, the transmitter will never be entirely satisfactory.

The power pack, which gives 500 volts at 120 ma. and a filament supply

Components for A BEGINNER'S TRANSMITTER

Power Amplifier Section

CHOKES, HIGH-FREQUENCY.

- 1—1022 type (Eddystone).
- 2—Type 1010 (Eddystone).

COILS.

- 1—7-pin form type CT7 home wound (Raymart).
- 2—14-turn type 514 (Eddystone).

CONDENSERS, FIXED.

- 1—.01 type 4421 (Dubilier).
- 1—.002 type 620 (Dubilier).

CONDENSERS, VARIABLE.

- 4—.0001-mfd. type 979 (Eddystone).

DIALS.

- 2—Type 1026 (Eddystone).

HOLDERS, VALVE.

- 1—7-pin baseboard mounting ceramic (B.T.S.).
- 2—5-pin baseboard mounting ceramic (B.T.S.).

METERS.

- 2—0-50 M/a type 2 in. flush mounting (Ferranti)

PLUGS, TERMINALS, ETC.

- 1—5-way terminal saddle type 997 (Eddystone).

RESISTANCES, FIXED.

- 2—10,000 ohm type 1 watt (Erie).
- 1—2,500 ohm type 3 watt (Erie).

SUNDRIES.

- 2—Stand-off insulators type ST (Raymart).

- 2—12 in. lengths ½ in. glass tubing (Peto Scott).

- 1—60 volt standard capacity H.T. battery

(Vidor)

- 1—12 in. length 2 B.D. brass studding (Peto

Scott).

SWITCHES.

- 2—Type S80T (Bulgin).

VALVES.

- 2—RFP15 (362).

MERVYN SPECIFIED

FOR

'TELEVISION'S GUARANTEED'

CATHODE RAY RECEIVER

CONDENSERS.

8-mfd. 1,000v. working	18/6 each.
2-mfd. 1,000v. „	7/6 „
.25-mfd. 4,000v. „	9/- „
.1 Tubular 2,000v.	3/6 „
8 + 8-mfd. (for shift unit)	7/- „

4,000 volt unit complete, ready for use, smoothed output £4 10s.

A special built up control panel to Mervyn Standards cost only 48/-

VISION RECEIVER.

The radio section of a complete set proved on B.B.C. transmission. Ready for use, 8—BVA valves including power pack £16 10s.

FREE

A BLUEPRINT of a new, reasonably priced amplified double time base, giving all values and detailed prices.

Send this coupon and 3d. in stamps for postage and despatch with your name and address.

All apparatus is obtainable through your dealer. In case of difficulty send your order direct to :—

THE MERVYN SOUND and VISION CO., LTD.

4, HOLBORN PLACE, LONDON, W.C.1

Telephone: HOLborn 7709

Managing Director : W. J. NOBBS, F.T.S., A.M.I.R.E.

You want the best condensers



have them!



ULTRA SHORT-WAVE SINGLE
Capacities 15 mmf., 30 mmf., '00004, '0001, '00015
Price 3/9
With Slow-Motion Action
1/- extra.

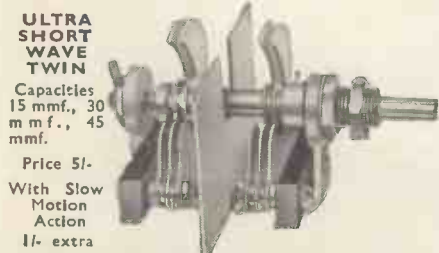

ULTRA SHORT-WAVE TWIN
Capacities 15 mmf., 30 mmf., 45 mmf.
Price 5/-
With Slow-Motion Action
1/- extra

JACKSON BROTHERS (London) Ltd.
72, St. Thomas St., S.E.1. Telephone: Hop.1837.

CLIX

V1 - V2 - V4

Whatever the circuit or type of valve to be chosen, there is always a CLIX Valveholder to carry out its important duty to the entire satisfaction of the designer and constructor.

The three types illustrated are specified for the

"AMATEUR BANDS SUPER-HET 7"

You can rely upon Clix for long and faithful service.

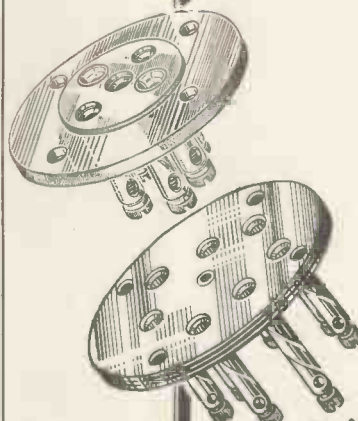

Send for our two latest Folders "T.S."

Yours faithfully

LECTRO LINX LIMITED

79^A ROCHESTER ROW, LONDON S.W.1.

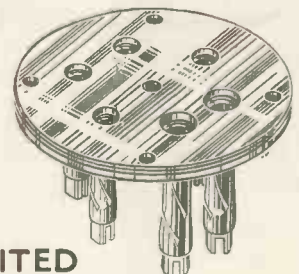

A Beginner's Transmitter Continued from page 722 :: Link Coupling :: H.T. Supply

B.A. nuts. The other end of this studding terminates in a flexible coupler which joins on to the rotor of a second variable condenser. This second condenser is mounted on an adjustable bracket, and providing the studding is correctly locked in position and the second condenser is absolutely in line with the first one mounted on the panel, the two condensers will rotate in step without any slip or backlash. This is about the cheapest way of obtaining a double-spaced split stator condenser.

Components of a Beginner's Transmitter. H.T. Supply Section.

- CHOKE, LOW-FREQUENCY.**
1—100-m/a. 30 henry (B.T.S.).
- CONDENSERS, FIXED.**
2—4-mfd. type 17939 (Dubilier).
- HOLDER, VALVE.**
1—SW21 (Bulgin).
- SUNDRIES.**
1—Double fuse holder with 1 amp. fuses, type F11 (Bulgin).
- SWITCH.**
1—S80T (Bulgin).
- TRANSFORMER, MAINS.**
1—To specification, giving 500-0-500 120 m/a.; 2-0-2 3 amps.; 2-0-2 2.5 amps. (Sound Sales).
- VALVE.**
1—R4A (Ferranti).

Two such condensers are needed, one in the grid and one in the anode circuit. The rotors are automatically earthed via the panel, but this connection is not to be relied upon, so join both rotors to a common earth point on the chassis as explained in the preceding issue.

A 7-pin valve holder is needed to take the link coupled grid coil and this should be bolted to the chassis as near as possible to the split-stator grid condenser, so keeping the grid leads comparatively short. The centre tap of

this coil is joined to a 1010 type Eddy-stone choke, which feeds into a 10,000-ohm grid leak and the grid bias battery. The junction of the high-frequency choke and 10,000-ohm resistance is bypassed to earth with a .002-mfd. condenser. The earthy side of this condenser does not go to the nearest point on the chassis but to the common earth connection as used by the rotors of the two tuning condensers.

Link coupling between the C.O. and P.A. grid circuit is most effective. Wind a single turn of 1-mm. flexible wire around the H.T. end of the C.O. coil terminating at the pins on the coil which would normally be used for filaments. Connect the filament terminals on the C.O. coil holder to the filament terminals on the P.A. grid coil holder by means of about 6 ins. of lamp flex.

Then wind the P.A. grid coil. Owing to the fact that the split-stator condenser has a capacity of only .00005-mfd. this coil has more turns than is usual for a 40-metre coil. It needs no less than 26 turns of 18-gauge enamel-covered wire wound on a Raymart 7-pin threaded former. These windings will be more or less correct, but, it may be necessary to take off a turn or two or increase a turn or two according to the way the transmitter has been wired.

This coil is centre tapped, the tapping being taken into the former and to the nearest convenient pin. The link coupling is again one turn of 1-mm. flexible wire which is wound around the centre of the coil and actually tied very tightly with a knot. The ends of this single loop are terminated at what would normally be the filament pins on the coil holder.

At this point it is well to mention that in no circumstances need the link coupling be increased beyond one turn. If insufficient radiation is obtained, do not jump to the conclusion that there

is insufficient drive due to too small a coupling coil. The pentode valves



In the centre rack are the power packs one for the transmitter and the other for the speech amplifier.

chosen require very little drive, and if they are overdriven the efficiency and radiation decreases very rapidly, so that with one turn coupling and low radiation, look elsewhere for the trouble.

The screens of the pentodes are coupled together and by-passed to the common earth point by a .01-mfd. condenser and this lead between the actual screens and the condenser should be very short. It is advisable to use a wire end tubular condenser so that the screen lead is only about 1/2 in. long.

Voltage to the screen of the pentodes comes from the main 500-volt supply, but is reduced to the correct value by means of a 2,500-ohm resistance. This resistance plus the 50 ma. Ferranti meter and circuit-breaking switch are all mounted on the power pack chassis.

Both of these valves are suppressor-grid modulated; the beginner will appreciate that this is not the most efficient method, but it only requires a very small amount of audio to give a reasonably high percentage of modulation. An alternative system whereby the valves can be anode modulated will be described later on, but whether this system is used is a matter of personal taste.

Strap the suppressor grids together and for the time being connect them directly to the common earth point, for

(Continued on page 726)

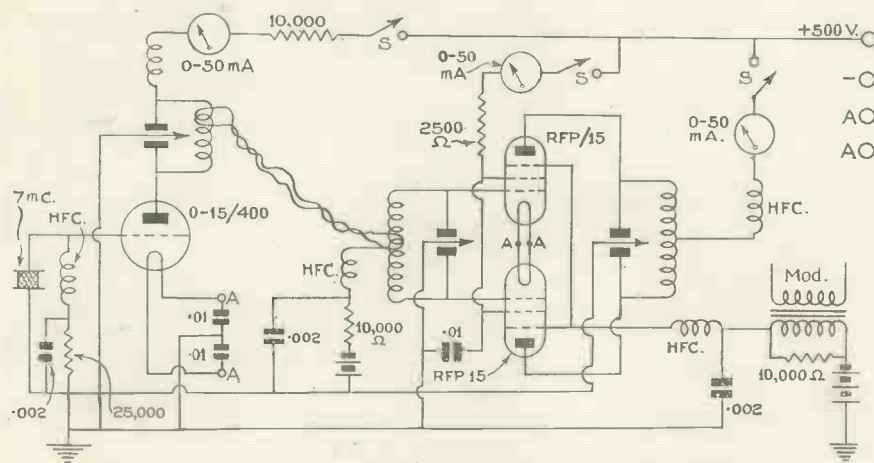

Until the modulator has been built the suppressor grids should be connected to earth.

DECEMBER, 1936

"A Folded Doublet Aerial"

(Continued from page 715)

The feeder was terminated in a simple inductance coupled to the grid coil of the first R.F. valve. Only a small amount of "cut and try" was necessary to establish the optimum value for this inductance as it is not at all critical.

A careful series of tests over a period of several weeks showed that our friend the refrigerator was now R1 minus. Signals from quarters of the world we had never heard before rolled in and the antenna also proved notably omnidirectional. Although the doublet is cut for 20 metres yet reception is better on 40 metres with the doublet than with the 99-ft. transmitting antenna.

There is no reason why this type of folded doublet should not be used on higher frequencies in either the vertical or the horizontal plane.

It would, of course, be desirable to have a higher mast. There is no reason why the type of construction outlined should be adhered to. Those who can fit a good husky builder's pole with this antenna at the top will be more fortunate.

For all the lightness of its construction—the original "tower" has been in position for some months quite unshaken by gales.

"A New Transmitting and Receiving Aerial System"

(Continued from page 720)

If a British amateur is fortunate enough to possess a garden which runs approximately north-east by south-west it is a simple matter to arrange the aerial so that the projection at right angles to it lies on a great circle route bearing to New York. With the two half waves in phase this should provide plenty of 10-watt DX in this direction and for reception purposes European QRM will be at a minimum.

When listening to stations it is generally noticed that the best phasing condition for reception also holds for transmission, but exceptions are noted to occur particularly on DX to Australia and W6, etc. It is generally best, therefore, to change the phase during transmission to check this in any doubt.

Concluding, the author is of the opinion that this aerial system represents a distinct advance because of its general and simple adaptability. Theoretically there is nothing novel in that it is well known and used by many commercial companies in a far more elegant and ambitious manner than here described. But for all-round use it will definitely supersede half- or full-wave Zepp systems together with half-wave centre-fed doublets or Hertz systems, particularly if the direction of the wire must unavoidably lie east and west.

PREMIER SUPPLY STORES

— THE LARGEST RADIO MAIL ORDER HOUSE IN EUROPE —

Get our Quotation for Your Short Wave and Television Gear

Offer the following Set Manufacturers' Brand New Surplus Goods at a Fraction of the Original Cost; all goods guaranteed perfect; carr. paid over 5/-; under 5/- postage 6d. extra. Orders under 5/- cannot be sent C.O.D.

All Post Orders to— **Jubilee Works, 167, Lower Clapton Rd., London, E.5**

Callers, As Usual, to 20-22, HIGH ST., CLAPHAM, S.W.4 (Macaulay 2381) 'Phone: Amherst 4723
And 165 & 165a, FLEET ST., E.C.4 (Next door to Anderton's Hotel) Central 2833

VALVES.
MAINS VALVES, famous Europa 4 v. A.C. types 4/6 each. HL, L., S.G., Var.-Mu-S.G., H.F.-Pens., Var.-Mu-H.F. Pens. 1, 3 and 4-watt A.C. directly-heated output Pentodes. Full-wave rectifiers, 250 v. 60 m.a. A.C./D.C. types. 20-volt 18 amp. S.G., Var.-Mu-S.G., H., HL, Power, pen. Following Types all 5/6 each. Full-wave rectifiers, 350 v. 120 m.a. and 500 v. 120 m.a. 2½ watt indirectly-heated Pentodes. Frequency Changers, Octodes and Heptodes.
BATTERY VALVES, 2 volts H.F., L.F., 2/3. Power, Super-Power, 2/9. S.G., Var.-Mu-S.G., 4- or 5-pin Pentodes, H.F. Pens., V.-Mu-H.F. Pens., 5/-, Class B, 3/6.
AMERICAN VALVES, Genuine American HYTRON and TRIODE first-grade Valves, 3 months' guarantee. All types, including 6D6 and 6A7, specified for the "Amateur Band Super-Het. Seven," 5/6 each. 210 and 250, 8/6 each. New Metal-glass Valves, all types, 6/6 each. Genuine American DUOTRON Valves, all types, 3/6 each; with Valve holder 5/6 each.
VALVE HOLDERS for all above types, 6d. each. Octa-Bases, 9d. each.

SHORT-WAVE COILS 4- or 6-pin types. 13-26, 22-47, 41-94, 78-170 metres, 1/9 each with circuit. Special set of 3 S.W. Coils (4 pin), 14-150 metres, 4/-, with circuit. Premier 3-band S.W. Coil, 11-25, 19-43, 38-86 metres. Simplifies S.W. receiver construction, suitable any type circuit, 2/6.
COIL FORMERS, in finest plastic material, 1½ in. low-loss ribbed 4- or 6-pin, 1/- each.
SUPER CERAMIC CONDENSERS, S.L. .00016 .0001, 2/9 each; double-spaced, .00005, .000025, .000015, 3/- each. Suitable for Band-Spreading. All brass with integral slow motion, .00015 tuning, 3/9; .00015 reaction, 2/9. British Radiophone 2-gang .00016, 5/6.
H.F. CHOKES, S.W. 10-200 metres, 9d.; S.W. screened 1/6; standard screened 180-2,000 metres, 1/6.
SUPER CERAMIC "FREQUENTITE" valve holders 4-, 5-, 7-pin chassis or baseboard, 6d.

SHORT WAVE KITS.

SHORT-WAVE KIT for 1-valve receiver or adaptor, complete with chassis, 4 coils, 14-150 metres, condensers, circuit and all parts, 12/6. **VALVE GIVEN FREE!**
DELUXE MODEL, 17/6. **SUPERHET CONVERTER KIT** 13/6.
SUPERHET CONVERTER KIT FOR ANY A.C. MAINS RECEIVER, 20/-. **A.C. VALVE GIVEN FREE!**
2-VALVE S.W. KIT, 19/6. **VALVES GIVEN FREE!**
3-VALVE S.W. KIT, S.G. Det. and Pen., 42/-. **VALVES GIVEN FREE!**
ALL-WAVE "ALL-WORLD RANGE" 3-valve Kit 12-2,000 metres in 4 wavebands without coil changing, complete kit of parts with 3 valves, S.G., H.F., det. and pentode (2 volts); 50/-. Q.P.P. Model, 6/6 extra.
BAND-PASS TUNING PACK, comprising set of Telsen 3-gang iron-cored coils with switching, mounted on steel chassis with 3-gang condenser, illuminated disc-drive and 4 valve holders. 25/- the lot. All Mains or Battery circuit. **FREE.**
LISSEN ALL-WAVE COILS, 12-2,000-metres complete with switching and wiring diagram, 12/6.

MAINS TRANSFORMERS.

PREMIER wire-end type with screened primaries, tapped 200-250 v. Centre-tapped Filaments. Guaranteed one year. H.T. 8 & 9 or H.T. 10 with 4 v. 4 a. C.T. and 4 v. 1 a. C.T., 8/6. 250-250 v. 60 m.a., 4 v. 1 a., 4 v. 2 a. and 4 v. 4 a. all C.T., 8/6. 350-350 v. 120 m.a., 4 v. 1 a., 4 v. 2 a. and 4 v. 4 a., all C.T., 10/6. Any of these transformers with engraved panel and N.P. terminals 1/6 extra. 500-500 v. 150 m.a., 4 v. 2-3 a., 4 v. 2-3 a., 4 v. 2-3 a., 4 v. 3-4 a., all C.T., 17/6; Super Model, 19/6. **AUTO TRANSFORMERS**, step up or down, 60 watts, 7/6; 100 watts, 10/-.
Special **PREMIER TRANSFORMER** for the "Amateur Band Super-Het. Seven," giving 270-0-270, 80 m.a., 2-0-2.4 a., 2-0-2.2.5 a., 3.15-0-3.15 .6 a. Wire ends, 11/-, or with terminals, 12/6.
SMOOTHING CHOKES, 25 m.a., 2/9; 40 m.a., 4/-; 60 m.a., 5/6; 150 m.a., 10/6. 2,500 ohms, 60 m.a. Speaker Replacement Chokes, 5/6.
MILLIAMMETERS, moving-iron, flush 2½ in., all ranges from 0-10, 5/9. Visual tuning, 6 or 12 m.a., 5/9. Moving-coil meters, 2½ in. 0-1 m.a., 18/6. 3½ in. 0-1 m.a., 22/6. Multipliers, 1/- each.
PREMIER FILAMENT TRANSFORMERS. Primaries tapped 200-250 v. Secondaries all C.T., 4 v. 3 a., 7/6; 4 v. 5 a., 8/6; 10 v. 3 a., 10/6; 14 v. 4 a., 10/6; 7.5 v. 3 a., 7/6; 6 v. 3 a., 7/6; 2.5 v. 8 a., 7/6; 6.3 v. 3 a., 7/6; 5 v. 3 a., 7/6.

PREMIER AMPLIFIER KITS.

3-WATT A.C. AMPLIFIER, 2-stage for mike or pick-up, complete kit of parts with 3 valves; 40/-.
7-WATT A.C./D.C. AMPLIFIER, 3-stage, high-gain, push-pull output. Complete kit of parts with 5 specially matched valves, £4 4s.
10-WATT 3-stage A.C. Amplifier Kit with 5 valves, £5 5s.
20-WATT 3-stage A.C. Amplifier Kit with 5 valves, £8 8s.
PREMIER (Reisz Pattern) Transverse-current MIKE, High Output, Straight Line Response, 30/-, Transformer 5/-. **Table Stand**, 7/6.
TRANSFORMERS, latest type Telsen R.G.4 (list 12/6), 2/9. Lissen Hypernik Q.P.P. (list 12/6), 3/6. Push-Pull Input Transformers by prominent manufacturers, 4/6. Output Transformers for Power, Pentode, or Push-Pull, 2/6. Multi-Ratio, 4/6.
ELIMINATOR KITS for A.C. mains, 150 v. 25 m.a., 15/-, tapped S.G., det. and output. Complete Kit with long-life valve rectifier (replacement cost only 2/-).
PREMIER L.T. CHARGER KITS for A.C. mains, including Westinghouse Rectifiers and Tapped Mains Transformers. 8 volts at ½ amp., 14/6; 8 volts 1 a., 17/6; 15 volts 1 a., 19/-; 15 + 15 volts 1 a., 37/6; 15 + 15 + 15 volts 1 a., 50/-; 8 volts 2 a., 29/6.
TELSEN iron-cored screened coils, W.349, 4/- each. Electric **SOLDERING IRONS**, 200-250 v., A.C./D.C. 2/3.

MOVING COIL SPEAKERS.

MAGNAVOX, Mains energised, "154," 7-in. cone, 2,500 ohms 4 watts, 12/6; "152," 9-in. cone, 2,500 ohms, 17/6; "152 Magna," 9-in. cone, 2,500 ohms, 6 watts, 37/6. Magnavox P.M.s.—"154," 7-in. cone, 16/6; "252," 9-in. cone, 22/6. Reliable P.M.s., 10/6.
ROLA latest type P.M.s., 18/6. **KB 7-in.** mains energised, 1,500 or 2,500 ohms, 7/9. **GOODMANS'** 8-in. mains energised, 1,000 ohms field, 10/6 each.
DIALS—Clarion illuminated S.W. slow-motion Dial with 2-in. knob, 2/-. **Premier All-Wave 2-speed Dial**, full vision straight-line, dual ratios 10-1 and 150-1, 6/6, with escutcheon.
POTENTIOMETERS by well-known makers. All values up to 1 meg, 2/-; with switch, 2/6.
ELECTROLYTICS U.S.A. 4, 8 or 12 mfd. 530 v. peak, 1/9 each. **Dubilier**, 4 or 8 mfd. 500 v. 3/-; 50 mfd. 50 v. 1/9; 25 mfd. 25 v. 1/-. T.C.C. 4 or 8 mfd. 650 v. 4/-; 15 mfd. 50 or 100 v. 1/-; 50 mfd. 12 v. 1/6 mfd. 50 v. 6d.
PAPER CONDENSERS, W.E., 250 v. working 4 mf. 2/-, 2 mf. 1/-, 1 mf. 6d.; 350 v. working 4 mf. 2/6, 2 mf. 1/6, Dubilier 500 v. working 4 mf. 4/-; 800 v. 4 mf. 6/-; Vego 450 v. working 1 mf. 1/-, 2 mf. 1/9, 4 mf. 3/-; 700 v. working 2 mf. 2/-, 4 mf. 3/6.
GRAMOPHONE MOTORS. Collaro Gramophone Unit, consisting of A.C. motor, 100-250 v. high quality pick-up and volume control 45/-; Collaro motor only, 30/-; Collaro Universal Gramophone Motor, 100-250 v., A.C./D.C., with high quality pick-up and volume control, 67/6; Collaro Universal Motor only, 49/6; Edison Bell double spring motors, including turntable and all fittings, 15/-; Cosmocord Gramo unit, comprising A.C. motor, pick-up, and volume control (list 55/-), 35/9.
TUBULAR CONDENSERS, non-inductive, all values up to 5 mfd. 6d. each.
Wire-end RESISTORS, any value, 1 watt, 6d.; 4 watts, 1/-; 8 watts, 1/6; 15 watts, 2/-; 25 watts, 2/6 each. Reliable **MORSE KEYS** with Morse Code engraved on bakelite base, 2/- each.
BUZZERS, Bakelite case 1/6; "Loud-tone," 2/6 each. Super Quality lightweight **HEADPHONES**, 3/9 pair.

HAVE YOU HAD OUR LATEST GIANT ILLUSTRATED CATALOGUE AND VALVE LIST? IF NOT, SEND 4d. IN STAMPS FOR THIS AMAZING LIST OF BARGAINS!

"The Amateur Bands Super-Het 7"

(Continued from page 715)

As the capacity of the wiring differs from chassis to chassis, it is necessary to readjust the B.F.O. to give the correct note. The adjusting screw for the B.F.O. is on the top of the metal container. With the set operating, tune in a station and turn on the B.F.O. If the oscillator is adjusted to the correct frequency, a beat note or high pitched whistle will be heard. If it is not adjusted correctly this can be attended to by means of the control knob on the top of the container. The pitch of the note can be varied by this adjustment to suit operators' individual tastes.

Those amateurs who have a signal generator capable of providing an accurate frequency of 456 kc., should adjust the receiver in the following way. Connect the output of the generator between chassis and the cap of the detector-oscillator valve. This will apply a signal to the grid of this valve which in no way upsets the adjustments of the I.F. circuit. The I.F. transformers can then be lined up to give maximum output on the valve voltmeter.

The bands covered by this receiver are extremely small and generally the calibration of an ordinary amateur signal generator is not sufficiently accurate to allow wavelength calibration of the tuning range of the receiver. Alignment may be made on band four, however, as previously described, by connecting the output of the signal generator to chassis and through a .0002-mfd. condenser to the aerial terminal of the receiver. With bands one, two and three, however, a non-inductive resistance of 400 ohms should be used instead of the .0002-mfd. condenser.

Due to variations in the wiring, as well as possible variations in the B.F.O. valve, harmonics may be noticeable. In such circumstances the cathode lead to the earthy end of the grid coil should be broken and a 1,000-ohm resistance inserted, so biasing the B.F.O. valve, and reducing the output.

An All-wave Model

The 35H tuner used in this circuit must be clearly understood to be suitable for the 20, 40, 80 and 160-metre amateur bands. Constructors needing an all-wave receiver of a conventional type should substitute for the 35H tuner a type 35. This tuner is absolutely interchangeable without any alteration, so that the same remarks apply to the users of a 35 tuner as to the 35H tuner. The band coverage, however, on the 35 tuner is 1.5 to .55 mc., 3.8 to 1.5 mc., 9 to 3.5 mc., and 22 to 9 mc.

With this tuner, a simple form of band-spreading is obtained owing to the use of a separate dial and pointer. Users of the 35 tuner who will probably not be interested in morse code reception, can omit the beat-frequency oscillator, so reducing the number of valves

and the total cost.

A phone jack has been incorporated in the resistance coupled stage between the detector and pentode output valve. This is a very necessary feature for real DX reception, although the impression must not be gained that the receiver is unsuited to loudspeaker reception. Generally speaking, there is no need for a phone jack, but amateurs interested in reception of weak C.W. stations will find the phone jack of great use.

The receiver will bring in amateur and commercial stations at very great strength, and owing to a specially designed A.V.C. action, signals that would

otherwise fade are kept at a reasonable level.

The controls on the front panel from left to right are as follows: High-frequency gain control, low-frequency gain control, stand-by switch, then a switch for A.V.C., main switch, beat note switch, phone jack and continuously variable tone corrector.

With the mains transformer it will be noticed that the centre tap of the filament and high-voltage windings are automatically connected to the chassis of the transformer by the makers. This means that there are two less wires to

(Concluded on page 736)



Old-fashioned reproduction may not be actively objectionable, but its insidious habit of sapping the life from a good programme can, unnoticed, rob you of the enthusiastic enjoyment radio should provide.

Radio as it should be—radio as it can be—radio as heard through the 1937 Stentorian—gives a degree of sparkling entertainment that will make you look forward to the evening programmes. Ask your dealer about this—the greatest single step forward in commercial reproducers ever made. He will gladly demonstrate—to-day!



See how little this realism costs:—

Chassis Models
37S ... 42/- 37B ... 23/6
37J ... 32/6 37M ... 17/6
Cabinet models from 29/6

Models from 39/6, or hire purchase terms from

7/6
down

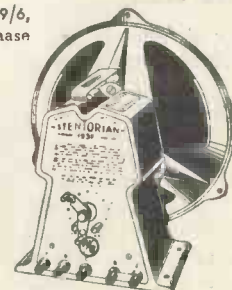

1937 STENTORIAN
The *NEW* speaker with the *NEW* realism

WHITELEY ELECTRICAL RADIO CO., LTD., (Vision Dept.), MANSFIELD, NOTTS.

By A. C. Weston

A Pre-selector for Commercial Receivers

Any all-wave receiver that is not working effectively on short-waves can be improved considerably by the addition of a single-stage pre-selector as described below.

A CONSIDERABLE number of last year's all-wave receivers are not giving the results expected on short wavebands. In many cases this is due to the omission of a high-frequency stage in front of the first detector, or to the use of an inefficient detector-oscillator circuit.

A number of commercial instruments, while giving satisfactory volume from comparatively loud and easily heard commercial stations, are quite useless when the receiver is needed to pick up very short-wave amateur transmissions, or some of the long-distance commercial stations.

It can safely be claimed that in every instance the signal strength can be almost doubled and the noise level de-

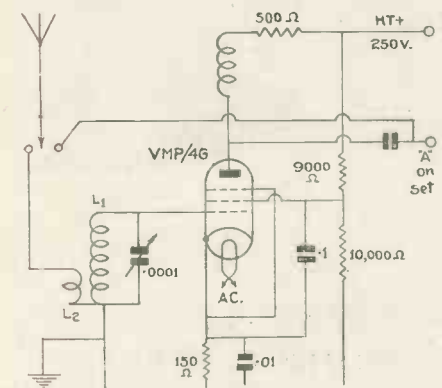

Fig. 1.—A simple but effective unit can be made from these standard components. The value of screen potentiometer is most critical.

creased by the use of an efficient pre-selector or high-frequency stage. Even receivers embodying one high-frequency stage can still further be improved by the use of a pre-selector with regeneration. With such receivers selectivity is also increased by careful use of regeneration.

A Tuned Grid Unit

There are two types of pre-selector that can be used by the average listener, which are so fool-proof that they cannot fail to give the desired increase in performance. The most simple unit is shown in Fig. 1. It consists of a high-frequency pentode used in a simple tuned-grid circuit.

The unit must be built in a small metal box if maximum results are to be obtained. A suitable box, complete with lid, can be obtained from Messrs. Burne-Jones, and although this is only approximately 6 in. by 6 in. it houses all

the components without difficulty. A condenser of .0001-mfd. is used to tune the grid circuit. In this unit the aerial coil is a standard 4-pin plug-in coil in which the reaction winding is used as an aerial coupler. The whole of the coil is tuned and is across the grid-cathode circuit of a VMP4G pentode valve.

A Special Choke

The external anode impedance with the VMP4G is most important, so for that reason a good high-frequency choke is needed. A suitable component in this particular circuit is the Eddystone 983, which is already screened. The valve must be enclosed in a small valve screen of the Colvern type despite the fact that it is already metallised. A screen of at least 3 in. diameter must also be used completely to encase the aerial coil.

If these precautions are taken the pre-selector will give a high stage gain and be completely stable under all conditions.

The component values are most important, for otherwise the maximum gain will not be obtained. It is assumed that the high-tension and filament supplies will be tapped off the parent receiver. There is usually sufficient to spare to stand this slight extra load, and, as most receivers use an H.T. voltage of 250, the component values have been based on that voltage.

Obtaining Screen Voltage

To obtain maximum gain, the screening voltage has to be reasonably accurate in respect of the anode voltage. With the VMP4G, approximately 100 to 110 volts, is the most satisfactory figure, and this is obtained by means of a potentiometer across the mains supply. The top half of this potentiometer consists of a 9,000-ohm resistance, with a 10,000-ohm in the low voltage side.

The screen must be by-passed to earth, or rather to cathode, by means of a .1-mfd. condenser. It has been noticed that when the negative side of the screened by-pass condenser is taken to chassis, slight instability occurs, so for this reason a particular note of how the suppressor grid and other earthy returns are taken to the cathode rather than the chassis.

Slight bias is required on this pentode if the valve is to work on the correct portion of its curve, and this bias is obtained by means of a fixed resistance of 150 ohms in series with the cathode and

shunted with a .01 condenser. These fixed condensers can all be of the tubular type and mounted in the wiring.

That completes the construction of the unit with the exception of two points. First, the output from the amplifier to the parent receiver. A screened lead connects the anode of the VMP4G to one side of a .005-mfd. fixed condenser. The other side of this condenser is then taken to the aerial terminal on the main receiver.

Aerial Switching

Aerial and earth connections on the main receiver are connected to aerial

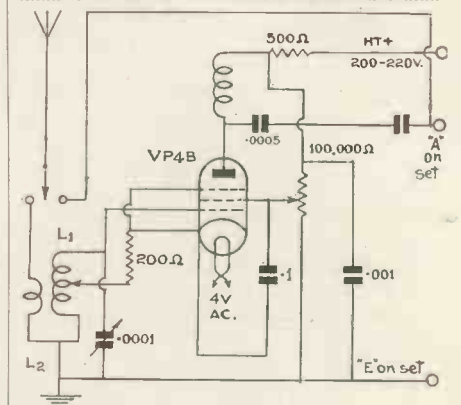

Fig. 2.—The electron coupled coil must be home-made, otherwise all the components are standard. Regeneration is controlled by means of the variable screen voltage potentiometer.

and earth terminals on the pre-selector, which simply leaves the aerial switching to be discussed. As it is unlikely that the pre-selector will be required on medium and long waves, there must be some provision made so that it can be switched out of circuit without having to disconnect the unit entirely.

A simple single-pole change-over switch of the type normally used in a gramophone pick-up circuit is ideal for the purpose. This is mounted on the left-hand side of the amplifier cabinet and has the aerial lead taken to the centre pole. The second contact is then taken to the coupling coil in the amplifier by means of a short lead, the third connection going to the receiver side of the .0005-mfd. coupling condenser.

This enables the operator to switch the aerial either to the main receiver or to the pre-selector. There is no need to worry about the earth contact as this is made automatically through the amplifier.

(Continued on page 730)

WESTINGHOUSE

The

ALL-METAL WAY

FOR

RADIO AND TELEVISION

- H.T. & L.T. SUPPLY
- TRICKLE CHARGING
- OPERATION of MOVING COIL LOUDSPEAKERS
- DETECTION, A.V.C., etc., etc.



Send 3d. to Dept. T. for a copy of "The All Metal Way, 1937."
WESTINGHOUSE BRAKE & SIGNAL CO., LTD.
 82, York Road, King's Cross, London, N.1



A USEFUL XMAS GIFT



for HANDYMEN

The usefulness of a Solon Electric Soldering Iron goes on indefinitely. Your mechanically-minded friends will appreciate the handiness of a Solon. Sturdily built to give long service and constant maximum heat. Wearing parts easily replaced. Sold complete with Instruction Book, Resin Coated Solder, 6 ft. twin Flex and Standard Lamp-holder Adaptor.

7/6
65 watts.

Industrial Types.
 65 watts 9/6
 With pencil bit 10/6
 125 watts 22/6
 240 watts 37/6

Made to Home Office requirements. Fitted with 3-core tough rubber flex—provision for earth connection.

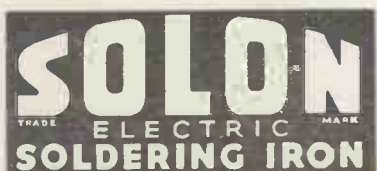

W. T. Henley's Telegraph Works Co. Ltd.
 (Dept. 57 YAB) Holborn Viaduct, London, E.C.1.

STABILOVOLT

THE SOLUTION TO UNSTABLE SUPPLY VOLTAGE

The Stabilovolt tube is a voltage dividing potentiometer and voltage regulator. The voltages tapped are independent to a precision of about .1% from the supply voltage variations, 1-2% from the varying current intensities, 1-2% from the varying one another. Currents up to 200 mA, voltages of unlimited values subdivided into parts of 70 volts each. Light weight, small size, simple and safe in operation. Stabilovolt tubes from £r. 16.0. to £62. Iron Barretters for use with above from 16s. to £1.7.6. Full particulars from:—

MARCONI'S

WIRELESS TELEGRAPH CO. LTD.
 Electra House, Victoria Embankment, London, W.C.2.

(Continued from page 728.)

Amateurs who wish to receive 10-, 20-, 40- and 80-metre stations on B.C.L. type of receivers will be well advised to consider the electron-coupled circuit shown in Fig. 2. This is very similar in construction to the tuned grid amplifier when it comes to screening and using short-leads, but component values are not exactly the same. A very good valve in this circuit is the Tungstram VP4B which has the grid brought out to the top cap so that it can be taken directly to the tuning condenser by means of a lead about 1½ in. long. In this way the amplifier can be used quite satisfactorily and will give high gain even on 10 metres. It will be noticed that the cathode is taken to a tap on the grid coil so that regeneration can be obtained by changing the impedance of the valve as the screening voltage is varied.

This tapping point is very critical, so for that reason the coils have to be home constructed. A tuning condenser of .001-mfd. should again be used unless it is desired to use the amplifier on restricted wavebands, in which case .000025-mfd. will give a wider band-spread. This will mean a slight increase in the inductance of the coils, but no variation in cathode tap point.

A coil covering 15 to 31 metres can be constructed in the following way. Use a Raymart 4-pin threaded former and wind on four turns for L₁, two turns for L₂, with the cathode tapped on three-quarters of a turn from the earthy-end. For the 20-46 metre band, use nine turns on L₁, four turns, L₂, with the cathode tap 1½ turns from the earthy end. A coil for 45-98 metres needs 22 turns for L₁, 10 turns for L₂, and the cathode tapped on three complete turns from the earthy end.

It is difficult to give the constructional data for a 10-metre coil, for this will depend on the method of screening and the length of wiring, but in the original unit L₁ was 2½ turns, L₂ slightly under one turn, and the cathode was tapped on half-a-turn from the earthy end.

Signal strength on amateur stations can be increased from R3-4 to R7 and 8 and even 9, by using this pre-selector with regeneration. In addition, providing both pre-selector and parent receiver are well shielded, it will increase the possibility of duplex working. Amateurs who find commercial receivers having harmonics in amateur bands will notice that the use of a pre-selector attenuates the strength of these harmonics and occasionally wipes them out entirely.

For those who prefer to use a separate high-tension supply a simple half-wave metal rectifier of the Westinghouse H type can be used directly from the mains without transformer. No smoothing is required other than a small resistance and 2-mfd. condenser. The current output from such a rectifier is comparatively small, but it is sufficient to feed a simple valve of the VMP4G or VP4B types.

SOME NEW S.W. COMPONENTS

We have been testing a new range of components of a startlingly original type introduced by Messrs. Lissen, Ltd. Two components will be of particular interest to our short-wave and transmitting readers. First, a four-range rotary coil unit designed to operate on four bands from 4.8-91 metres. Any of the four bands can be selected by means of a rotary switch; losses have been kept down to a very low minimum by the use of ceramic insulation. The switch contacts are nickel and self-cleaning. The price is 15s. 6d., while an extra coil for 75-175 metres costs but 2s. 6d.

The Lissen slow-motion dial is divided into 1,000 divisions. Actually



A feature of this coil unit is the low loss and simple switching.

the scale is in 10 divisions, each division being sub-divided into 100 divisions, so giving accurate readings. The drive reduction is 25-1, while special spring gears eliminate all trace of back lash.

A special double-wound low resistance H.F. choke for filament circuits has also been introduced. It has a resistance of less than .05 ohm and costs



Short-wave listeners will appreciate this dial which has a 25/1 reduction.

2s. 6d. A standard H.F. choke for anode or grid circuit use is priced at

2s., and has an inductance of 100 microhenries.

Two types of low-loss condensers are available both with a minimum capacity of 5 mmfd., and guaranteed noiseless down to 5 metres. They have ceramic end pieces and brass vanes soldered to the supporting rods. The first model with a capacity of .00016 is priced at 7s. 6d., while the .00002 mfd. costs 5s. 6d.

RADIO SOCIETY NOTES

The Radio, Physical and Television Society.

Weekly meetings of this society are being held on Friday evenings at 8 p.m. This society is very active, holding field days and arranging visits to prominent radio manufacturers. Plans are being prepared for a 2½-metre and 50-centimetre field day in the near future. Fifteen members hold transmitting licences, so that the society is really active.

Full information can be obtained from the Hon. Secretary, M. E. Arnold, 12 Nassau Road, Barnes, S.W.13.

THE INTERNATIONAL SHORT-WAVE CLUB

Members of this Society are not merely confined to London as provincial Chapters are springing up in various parts of the country. A monthly magazine, "International Short-wave Radio," is supplied free to members who have paid the total annual subscription of 5s. This booklet gives a wealth of information on commercial short-wave programme broadcasters and also details of interest to all short-wave enthusiasts.

The London Chapter meets at the R.A.C.S. Hall, Cavendish Grove, Wandsworth Road, S.W.8, every Friday except the second in the month. Morse instruction starts at 7.30 and is usually of 45 minutes' duration.

Lectures are arranged on all phases of short-waves, both for the listener and the transmitter, while television for the constructor is now being fostered. Amongst the members are several active transmitting amateurs who assist members in obtaining licences for transmitting. Readers in the Brighton area should now get in touch with the secretary of the latest branch, Mr. John Bennett, 205 Braeside Avenue, Brighton, 6.

The Manchester Chapter is organised by Mr. H. Wild, 1 Elm Street, Middleton, Manchester, while a very strong unit in the Channel Islands is under the guidance of Mr. F. S. de Pavoux, 8, Upper Canichers, St. Peter Port, Guernsey.

Full information can be obtained from the Secretary, A. E. Bear, Esq., 100 Adams Gardens Estate, S.E.16.

Be your own Service Engineer



The D.C. AvoMinor
Current
 0-6 m/amps.
 0-30 "
 0-120 "
Voltage
 0-6 volts
 0-12 volts
 0-120 volts
 0-240 volts
 0-300 volts
 0-600 volts
Resistance
 0-10,000 ohms
 0-60,000 ohms
 0-1,200,000 "
 0-3 megohms



The UNIVERSAL AVOMINOR. £5

D.C. VOLTS	A.C. VOLTS
0-75 millivolts	0-5 volts
0-5 volts	0-25 "
0-25 "	0-100 "
0-100 "	0-250 "
0-250 "	0-500 "
0-500 "	
MILLIAMPS	RESISTANCE
0-2.5 milliamps	0-20,000 ohms
0-15 "	0-100,000 "
0-25 "	0-500,000 "
0-100 "	0-2 megohms
0-500 "	0-5 "
	0-10 "

BRITISH MADE

The AVOMINOR

EVERY TEST —with ACCURACY

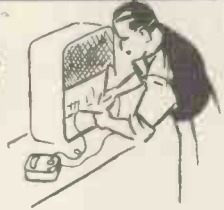

All receivers develop faults and the reception you get is consequently impaired. You need an AvoMinor—for then any and every defect can be speedily traced.

Mind you, it is essential to have an accurate testing meter! The two AvoMinors are combination meters of high accuracy. Each model covers a wide field of measurement in current, voltage and resistance, enabling you to make every test to valves, circuits, components, batteries and power units.

Remember—it's accuracy that matters! For providing accurate testing facilities the AvoMinors are unrivalled.

All good radio shops supply the AvoMinors.

FULLY DESCRIPTIVE PAMPHLETS POST FREE.

McGraw-Hill

PRACTICAL RADIO COMMUNICATION

Principles — Systems — Equipment — Operation — Including Short-wave and Ultra-short-wave Radio

By ARTHUR R. NILSON, Lieutenant (Technicist) (Communications) U.S.N.R. (Retired), and J. L. HORNING, formerly Radio Instructor, Guggenheim School of Aeronautics, New York University. 754 pages, 6 x 9, 435 illustrations, flexible 30/-

Provides effective radio school and home-study material for prospective and experienced radio operators of all classes. Covers the principles of radio, radio equipment and power apparatus as applied to radio broadcasting, marine, police, aeronautical and amateur radio. Includes the entire spectrum of radio wave lengths—ultra-short, short, medium, and long. Covers the requirements of all classes of radio operator licence examinations.

MEASUREMENTS IN RADIO ENGINEERING

By FREDERICK EMMONS TERMAN, Associate Professor of Electrical Engineering, Stanford University. 400 pages, 6 x 9, 208 illustrations 24/-

A comprehensive engineering discussion of the measuring problems commonly encountered by radio engineers. Gathers together information on measuring techniques and measuring equipment, giving considerable attention to the principles involved in the design and construction of laboratory equipment, and emphasising those methods which experience has shown to be the most practical, which require the minimum of equipment, and which are least likely of error.

RADIO ENGINEERING HANDBOOK

Editor-in-chief: KEITH HENNEY, Editor, *Electronics*, assisted by a staff of 28 specialists. Second edition. 850 pages, 4½ x 7, fully illustrated, flexible 30/-

A thorough revision of this authoritative handbook for radio engineers, bringing all material up to date, including much new information and providing additional illustrations and charts. The book offers the engineer technical data on all fields and aspects of radio engineering from discussion of electric and magnetic circuits to sound pictures and aircraft radio.

RADIO RECEIVING AND TELEVISION TUBES

Including Applications for Distant Control of Industrial Processes and Precision Measurements

By JAMES A. MOYER, Director of University Extension, Massachusetts Department of Education; Member of Federal Commission on Radio Education, and JOHN F. WOSTREL, Instructor in Radio Engineering, and Supervisor in Charge of Industrial Subjects, Division of University Extension, Massachusetts Department of Education. Third edition. 635 pages, 5½ x 8, 485 illustrations 24/-

A practical manual describing the action of vacuum and gaseous tubes and their use in radio receivers and for numerous industrial purposes. This edition marks a thorough revision and enlargement of the book, giving special attention to tubes in electric television systems, ultra-short-wave tubes, and developments indicating the trend of tube design and application.

McGraw-Hill Publishing Co., Ltd.
 Aldwych House London, W.C.2

The Automatic Coil Winder & Electrical Equipment Co., Ltd.
 Winder House, Douglas Street, London, S.W.1. Telephone: Victoria 3404-7



GERMAN SHORT-WAVE TRANSMITTERS

Short-wave programmes from Germany are receivable all over the World. The stations operate for more than 20 hours a day and English short-wave listeners can take advantage of the fine programmes transmitted.

This is the German "Broadcasting House" from where all the studio programmes originate.

AMERICAN listeners with their all-wave receivers make a special point of tuning in to the special programmes intended for North America, transmitted by Zeesen station, DJB. Owing to the efficient system of directional aerials now in use at Zeesen the German short-wave stations are being heard at great strength in North America and other parts of the world.

The Zeesen stations can be used with beam aerials that are directed on New Zealand, San Francisco, Cape Town, Buenos Aires, etc., and even though the input is only 7 kilowatts, reliable reception is assured.

Slung between the tall lattice masts at Zeesen are six highly directed beam aerials. They are arranged in such a way that a line drawn from the zone to be served, such as North America, will meet the centre of the aerial exactly at right angles.

In order that the whole of the radiation can be concentrated in one direction, reflectors are placed behind the aerial to stop any radiation in the reverse direction.

By increasing the power and omitting the reflector, two directional transmission becomes possible. For example, an aerial beamed on South America will also be suitable for transmission to East Asia in the opposite direction.

For this reason listeners to any of the German short-wave stations will hear announcements regarding programmes being heard in certain zones. So far aerials have been erected that will concentrate all the transmitted energy into North, Central and South America, Africa, The Far East, and South Asia.

Programmes for North America are the most popular owing to the number of all-wave receivers in use, and the National Broadcasting Company in America regularly exchange programmes with the German Broadcasting Company.

Every afternoon at 1 p.m. DJL starts its regular schedule for short-wave listeners in North America. It carries on till 2 p.m., after which there is a break until 9.50 when DJC, on 49.83 metres, and DJD, on 25.49 metres, come on the air. On Sundays DJB puts out special programmes at ten minutes past four, closing down at twenty-five minutes

past five. As these programmes are for English speaking peoples they are announced in English and are not strictly of a German type. For example, on November 26 there is to be a very good talk for the short-wave amateur. It will be of the semi-technical type which is so useful to those who make a hobby of short-waves. November 27 is to be an American evening, while on the 29th there is an hour's concert by a German Army band. This type of programme is very popular in America.

Two stations at least are set aside to serve the various zones. For example, South Asia is served by DJA on 31.38 metres, with DJB on 19.74 metres, as the alternative. East Asia is more fortunate and can pick up transmissions from DJN, 31.5 metres, DJE 16.89 metres, or DJQ, 19.63 metres. By using three widely different wavelengths lis-

Broadcasting House in Berlin is in full use all night, for after the normal German programmes are closed down foreign listeners in all parts of the world are being catered for.

As the conditions vary very quickly it is not really possible to give the exact radiating times, for these have to be changed without notice. It has been discovered, however, that certain stations are 100 per cent. reliable and can be received in this country sufficiently well to be of entertainment value. Make a note of the following stations and the zones they serve, for during the week some really fine programmes can be picked up. DJC, North America on 49.83 metres; DJN, Central America, 31.45 metres; DJA, South America, 31.38 metres; DJC, Africa, 49.83 metres; DJD, Africa, 25.49 metres; DJA, East Asia, 31.38 metres; DJN, South Asia and Australia, 31.45 metres; DJB, South Asia and Australia, 19.74 metres.

All these programmes are announced in English in addition to German,



By the use of beam aerials of this type the German programmes can be directed to any part of the world ensuring good reception with only a low-power transmitter.

teners in East Asia are assured of being able to hear the German programmes.

DJQ and DJN serve South America, while DJL, DJB and DJD are beamed on North America. The wavelengths of these stations vary, but are generally 19.85 metres, 19.74 metres, and 25.49 metres respectively. Two stations only have been found sufficient fully to serve Central America. DJB works on 19.56 metres and DJA on 31.38 metres, and Zeesen programmes are being picked up in Mexico and Argentine more like local broadcasters.

French or Spanish, while if anyone is sufficiently interested, a postcard to Dr. Herbert Schroeder, German Short-wave Station, Unter den Linden 56, Berlin, N.W.7, will bring the complete programmes for a month entirely free of charge. These programmes are sent out all over the world to regular listeners, who make a point of tuning in the German short-wave stations just as they would their own local broadcasters.

This habit of listening to Germany has not grown to any extent in this country owing to the fact that there are not the same number of all-wave receivers as in certain other parts of the world, neither is it appreciated that programmes are announced in English and are suitable for English listeners.

**READ TELEVISION
& SHORT-WAVE WORLD
REGULARLY**

*How much do you know
about Television?*

TELEVIEWING

Everyman's Guide to Television

ERNEST H. ROBINSON

Foreword by GERALD COCK, M.V.O.

This most valuable book, the "last word" in Television, has been completely revised and brought up-to-date in the light of the most modern developments.

"Sober and accurate and can be recommended to non-technical readers"—*TIMES*. "A most comprehensive book, describing nearly all the successful systems in use today"—*SUNDAY TIMES*. "The work is comprehensive, and the reader, even if he lacks scientific knowledge, will find no stumbling block in the way of gaining an understanding of television"—*WORLD RADIO*.

Illustrated 6/- net
SELWYN & BLOUNT

For Television's
**GUARANTEED CATHODE RAY
RECEIVER . . .**

the designer specifies a
**SAVAGE GUARANTEED MAINS
TRANSFORMER**

Once again, Savage Guaranteed Transformers have been specified for a Television circuit. Generosity of design, good regulation and freedom from over-heating are the outstanding characteristics of Savage Transformers. You cannot do better than follow Television's lead.

200-250, 50 cycles,
screened primary, 300-0-
300, 120 mA., 4 v.,
2 amps., centre-tapped
4 v., 8½ amps., centre-
tapped 4 v., 4 amps,
centre-tapped Type
TA2. Price, 46/-.



Input, 4 v., 50 cycles;
Secondary 4 v. 1 amp.
Insulated for 3,000 v.
working, Type TA1.
Price 12/-.

W BRYAN
SAVAGE
LIMITED.

Westmorland Rd., London, N.W.9: Phone: COLindale 7131

TELEVISION.

A NEW COURSE OF INSTRUCTION,

We have pleasure in announcing that our new "Television" Course has met with remarkable success. The enormous demand for the Course has shown, beyond any shadow of doubt, that it fills that long-felt need which we anticipated when we went to such trouble and expense in its preparation.

We shall be happy to send full details of this special "Television" Course on request. Particulars are also available of other Courses in all branches of Wireless, Television, Talking Picture Engineering, etc., and of the easiest way in which to prepare for the A.M.I.E.E., A.M.I.W.T., A.M.I.R.E., etc., Examinations.

We teach by correspondence, and guarantee "NO PASS—NO FEE." Our Technical Consultant is Professor A. M. Low.

Send for full particulars to-day. Free and without obligation.

THE BRITISH INSTITUTE OF ENGINEERING TECHNOLOGY
337, SHAKESPEARE HOUSE, 17/19, STRATFORD PLACE,
LONDON, W.1.

"TELEVISION'S" GUARANTEED CATHODE-RAY RECEIVER

SOUND AND VISION CHASSIS (METAL)
TO DESIGNER'S SPECIFICATION

Price 7/6

POWER PACK METAL PROTECTING CASE

Price 10/-

TIME BASE CHASSIS TO SPECIFICATION

Price 10/-

Makers of upwards of 30,000 sets for the use of the blind.

BURNE-JONES & CO., LTD.

309/317, Borough High Street, LONDON, S.E.1.

Telephone: Hop 0495.

362

ACPX 4a - 9/0d.

Filament Volts	4
Filament Amps.	1.0
Amp. Factor	6
Impedance (Ohms)	...	1,200	
Mutual Conductance mA/V	...	5.0	
Anode Dissipation (Max.)	15

When used as LF output valve the anode should be loaded with 2,500 ohms and the undistorted output will be 3 watts.

When used as modulation feed for the RFP 15 or RFP 60, the bias may be increased and less anode current used, 25mA at 200 volts being sufficient to feed the RFP 15 and 30 mA at 300 volts for the RFP 60.

When used as oscillator the anode voltage should be fed through a breakdown resistance of not less than 4,000 ohms, as otherwise owing to the high maximum emission of this valve, the anode current rises to an excessive value and consequently damps out the grid circuit, before the grid leak can set up the necessary bias. A variable grid leak should be used.

FULL LISTS POST FREE FROM

362 RADIO VALVE CO. LTD.
324/6 Liverpool Road,
Highbury, LONDON, N.7.
TEL. : NORTH 1853.

Building An Output Meter

By John Lucas, G2HK

Many short-wave listeners need a simple meter so that accurate checks can be made on signal strength. In this article the advantages of a valve voltmeter are discussed.

WHENEVER there is a meeting of short-wave amateurs one topic always comes up for discussion. How to give more accurate signal strength readings, or alternatively what means of simple measurement can be used.

It is very difficult to give accurate R strength reports, for so much depends on the operator and the type of receiver in use. It is also nearly impossible to differentiate between R8 and R9 and quite impossible to give any useful

This entails a fair amount of work on the part of the constructor and no little expenditure of cash.

While a valve voltmeter used in the normal way across the output circuit has little value, as the voltage reading depends on the condition of the L.F. amplifier, a meter of this kind can be put to considerable use in obtaining comparative check reports.

I have in mind one particular instance where a station was able to render very great service to a fellow ex-

receiver is then adjusted to give maximum output and the reading on the meter duly noted. If this reading is recorded in the log book a report can be made to transmitting stations giving an accurate indication of their transmissions even though the reports may be made only monthly.

It is impossible to carry in mind for a period of a week or so the strength of any one station, and then to give a comparative report. Only by using a meter and obtaining a reading can the report be accurate.

Building such a meter is simplicity itself. The valve works on the Class B principle whereby there is no output or anode current until the signal is applied to the grid circuit. Then anode current increases in sympathy with the amount of input to the grid.

It is important that the unit be soundly constructed, for any variations will upset the readings so destroying its utility.

A valve of the LP2 type is used with an anode voltage of 36. An 0.1 milliammeter is connected in series with the anode of the valve and the positive side of the H.T. battery. Remember that the negative pole on the meter is connected to the anode of the valve. In the grid circuit a 500-1,000-ohm resistance is connected between the actual grid of the valve and the moving arm of a 50,000-ohm potentiometer.

This potentiometer is of the type having a switch as an integral part, and it is connected in parallel with a 16-volt bias battery. Notice that the switch is connected in series with one side of the potentiometer and the positive side of the battery so that the potentiometer

(Continued on page 735)

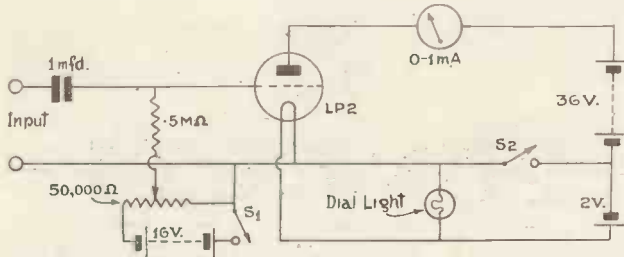

All these components can be mounted in a small metal box approximately 6 ins. by 6 ins. The meter should be mounted so that it can be switched into circuit with the minimum of delay.

readings on large receivers of the Super Pro type when the volume control is rarely more than one-third of the way on.

Most amateurs already are aware how easy it is to obtain R9 reports on 40- and 160-metre bands, and very rarely is it possible to check these reports. From time to time I have received R9 and R9 plus reports from listening stations 100 miles away, and this leads me to consider just what sort of reports the listener would give to a local station, say, 5 miles away.

The only way accurately to give reports is to use a field strength meter or a microvolt meter such as is fitted to the new American amateur receivers.

perimeter by the use of a single valve-meter. The signal was picked up with the volume control fixed, so giving a steady reading on the meter. Alterations were made at the transmitting end and increases or decreases duly noted. Changes in signal strength which were absolutely inaudible, when noted on the meter, so that ultimately the combination of experiments gave a total increase in signal strength of over 40 per cent.

Several advanced listening stations in this country are now using valve voltmeters of the type shown above. The idea is to connect it in parallel with the loudspeaker and to have a switch that will cut out the speaker and leave in the voltmeter as required. The

TELEVISION ENGINEER

required in London laboratory for development of U.S.W. vision receivers, h.f. measurements, etc.

ACTUAL TELEVISION EXPERIENCE
ESSENTIAL

Write stating age, qualifications, experience and salary required, to Box No. 10 c/o "Television."

AUTHORITATIVE TRAINING

Write to-day for "The Engineer's Guide to Success"—Free—containing the widest choice of Engineering Courses in the world—over 200—covering all branches, including Television, Radio, Electrical, Mechanical Engineering, etc.—and showing how to become A.M.I.Mech.E., A.M.I.E.E., A.Rad.A., A.M.I.W.T., B.Sc.(Eng.), etc. The T.I.G.B. guarantees training until successful. Mention branch, post or qualification that interests you.



The Technological Institute of Great Britain, 160, Temple Bar House, London, E.C.4.
200 COURSES (Founded 1917. 19,000 Successes.)

can be taken out of circuit when the valve voltmeter is not in use. This prevents a continuous drain from the grid bias cell.

In series with the grid input lead is a 1-mfd. blocking condenser, its object being to prevent any D.C. voltage accidentally being applied to the grid of the valve.

A dial light is rather a luxury, but I have found it necessary to prevent the meter being left on when not in use.

Once the meter has been adjusted there is no need to make any further alterations. Decide upon the loudest signal one is likely to hear and adjust the H.T. supply so that this signal causes a full-scale deflection of 1 ma. This is done by a combination adjustment of H.T. and bias voltage. Bias voltage, of course, is easily varied by means of the 50,000-ohm potentiometer.

If an A.C. voltmeter is obtainable or can be loaned it is an excellent plan accurately to calibrate the valve voltmeter in volts input.

Connect a potentiometer across the filament winding of a mains transformer giving 4 volts, or if a higher voltage is used connect two filament windings in series. Join an A.C. voltmeter across the sliding arm of the potentiometer and to one side of the filament winding and check to see that the voltage is exactly 4 or 8 as the case may be. Then apply this voltage to the input circuit of the valve voltmeter and notice the amount of deflection obtained.

By varying the voltage from the transformer which is checked by the A.C. meter and then transferring it to the valve voltmeter, the latter instrument can be accurately calibrated in input volts. This enables the operator to give any transmitting station a most useful report on signal strength.

In no circumstances should H.T. or L.T. be obtained from the supply mains, for it is most difficult to eliminate all traces of hum. This will cause slight ripple in the reading and make the meter inaccurate on low inputs.

Constructors who need a more sensitive instrument for the checking of long-distance stations can substitute a screen grid valve for the triode, making sure to obtain the correct screen voltage by means of a variable potentiometer.

Eddystone Welded Steel Cabinets

Owing to the demand for steel cabinets as used in the Amateur Communication receiver described in the November issue, Messrs. Stratton & Co., Ltd., makers of Eddystone steel cabinet is 17 in. wide, 9½ in. deep and large type 1034 cabinet to 18s. 6d. This cabinet is 17 in. wide, 9½ in. deep and 9¾ in. high, complete with hinged lid, so it is really excellent value for money. A smaller cabinet, type 1033, size 8½ in. wide, by 9½ in. deep by 9¾ in. high is priced at 12s. 6d.

GALPINS

ELECTRICAL STORES

75, LEE HIGH ROAD,
LEWISHAM, LONDON, S.E.13

TELE. : LEE GREEN 5240

Cash with Order or C.O.D.

TWO-INCH SPARK COIL, complete in case, with all fittings, 17/6; one-inch spark coil in case, with condenser, but no contact breaker, 2/6. Post 6d.

TRANSMITTING VARIABLE CONDENSERS, .0005 m. glass case type, 12/6.

FLUORESCENT SCREEN, 17 x 14 in., framed, as new and complete with protected mounting frame, £3 10s. C/F.

X-RAY TUBES, new condition, with Tungsten Target, 15/-; with Platinum Target, 20/- C/F. Packing free.

UNIVERSAL MOTORS, A.C. or D.C., approx. ½ h.p., 200/250 v. for baby cines, television, or any small power work, 10/6. Post 6d.

MORSE PRACTICE SET, complete on wood base; heavy brass G.P.O. morse key, complete with contacts; high class buzzer and 4½ volt battery, in complete working order. Not a toy, but a serious practice set, ready for immediate use, price 3/- Post 6d.

EX-R.A.F. MORSE KEYS, fully adjustable, price 2/6. Post 6d.

WESTERN ELECTRIC MICROPHONES, solid back type, very sensitive, 2/6 each.

MICROPHONE TRANSFORMERS, high ratio, finest quality, 2/6 each.

ELECTRIC LIGHT CHECK METERS, Maker "Ferranti." 1 kilowatt-hour type, 200/250 v. single phase, 50 cycle for subletting, etc., 6/- each. Post 1/-.

MULTIPLE SWITCH, with sensitive actuating Relay, as new, ex. automatic Phones, 4/6 each.

DYNAMOS for Lighting or Charging, all shunt wound, fully guaranteed. 150 v. 1 a., 17/6; 100 v. 3 a., compound, 30/-; 200 v. 3 a., compound 50/-; 20 v. 5 a., compound, 30/-; Aero dynamos, 12 v. 8 a., 10/-, all C/F.

CHARGING RESISTANCES or Shunt Regulators. Stud, switcharm type, 12/6 each, to suit your requirements.

C.A.V. AUTOMATIC CHARGING CUT-OUTS, suit any voltage, 7/6 each.

ISENTHAL VARIABLE RESISTANCE, to carry 10 to 15 amps., fitted 0 to 15 a/meter and Pilot Lamp, as new, 17/- C/F.

G.P.O. GLASS TOP RELAYS, Type B, highly sensitive, 7/6 each.

DUPEX TELEGRAPH MORSE KEYS, send-and-receive type, 12/6.

G.P.O. GALVANOMETERS, in vertical polished mahogany case, 5/- each. Post 6d.

BRIDGE TYPE GALVOS., horizontal type, super sensitive, fully calibrated scale, price 7/6. Post 6d.

BELLING ELECTRIC FIRES, 200/250 volts 2 kW., 2- or 3-bar type, in good condition, 15/- C/F.

EXIDE, 2-volt, 30/60 a.h. unspillable Accumulators, type 3PZ3. Guaranteed sound. 2/6 each. Post 1/-.

MOVING COIL-METER Movements for recalibrating into multirange meters, 5/6 each.

"WESTON" & TURNER 2½ in. Dial Moving Coil Milliamps Meters, 250 mA, 12/6; 3½ in. dial, 0 to 500 mA, 15/- Thermo Ampmeters, 0 to 1½ a., 0 to 12 a., 15/-; 2½ in. dial. All as new.

FILAMENT TRANSFORMERS, 220 v. input, 20 v. 32 amps. out, 35/- C/F. H.T. Smoothing Choke, 25/-.

DIMMER SWITCH for 12 volt control, suitable for regulating electric trams, 12 v. lighting, etc., 2/6 each.

R.A.F. CHARGING CUT-OUTS also fitted voltage regulators, fully adjustable, suitable for 12 to 20 volt charging dynamos, price 2/- Post 6d.

EX-R.A.F. SEARCHLIGHT, 12 in. dia. beam arc type, as new, power 2 kW., £5. C/F.

MAINS CHOKES, 20 and 30 hy., 40, 60, 80 mA, 1/3, 1/9 and 2/6 each. Microphone Buttons, 9d. each. Automatic Telephone Dials, 2/6 each. Cartridge Type Resistances, 600, 5,000, 10,000, 20,000, 50,000 ohms, 9d. each. W/E 1,000 single Earphones, 1/3 each. H/and, 9d. each. T.C.C. 2 mf. Condensers, 250 v. working, 9d. each. Mains Power Packs, 2 x 2 mfs., 2 x 20 hy. Chokes, 3/-.

BIRMINGHAM RADIOMART SHORT-WAVE SPECIALISTS

We have pleasure in announcing that the 1936-7 Editions of the

RAYMART

MANUAL & CATALOGUE

are now ready for distribution.



CATALOGUE FOR 1937

Enlarged to three times its previous size and now the largest and most comprehensive wholly Shortwave Catalogue published but still only 1½d. Post free.

SHORT-WAVE MANUAL (48 PAGES)

RAYMART SHORT-WAVE MANUAL contains 48 Pages of practical circuits and data on Shortwave Receivers, transmitters, modulators, transceivers, etc., including information on transmitting licences, "class B" modulation, aeriels, etc. Price with Catalogue 6d. or 7½d. post free.

RAYMART SPECIFIED IN THIS ISSUE.

TOBE TUNER Amateur Bands. Complete with amateur band-spread dial, £6 10

OSCILLATOR, beat frequency. Type B.F.O. Price 10/6.

COILFORM 7-pin (unwound) machine threaded to fit 7-pin valveholder. Type CT7, 2/-.

STAND-OFF INSULATORS. Glazed insulators with nickel-plated terminals. Type ST., 3d. each.

RADIOMART (G5NI)

44, HOLLOWAY HEAD, BIRMINGHAM, 1. Tel. : MID. 3254

Book Review.

"Television with Cathode-Rays"
(Pacific Radio Publishing Co., Inc., San Francisco, Calif.)

The operating principles of the cathode-ray tube and its application to television are explained in terms which can be understood by amateurs.

The main treatment starts with the practical use of the cathode-ray tube as a voltmeter. The fundamental theory of electrostatic effects, including capacitive reactance, of electromagnetic and high-frequency resistance effects including inductive reactance.

The concept of radiation is then developed from the electron theory and applied to the formation of optical images. This is the basis for an account of the action of electron lenses and of photo-electric and fluorescent effects as applied in television. The discussion is confined to the systems developed by Zworykin and by Farnsworth. The price is \$2.75.

"The Amateur Bands-super-het 7"

(Continued from page 727)

be put on by the constructor. As there is no L.F. transformer the possibility of hum pick-up by induction from the mains transformer does not arise so that, as regards the low-frequency side of the receiver, no trouble will be experienced with hum. To make quite sure of this point, however, the smoothing is more complete than with the commercial receiver, consisting of two low resistance smoothing chokes and three 8-mfd. condensers. The value of this additional smoothing is very noticeable when headphones are used, for even with very weak stations and the sensitivity of the receiver at maximum, there is no trace of hum.

"TELEVISION OPTICS"

L. M. MYERS (Sir Isaac Pitman & Sons.)

330 pp. including Bibliography, 214 Figs., 30s. net.

Contents:

- Theory of image formation.
- Photometry.
- The Kerr Effect.
- Mechanical and Electron Optical scanning systems.
- Nomograms for Kerr Cell working.

Here is a successful attempt to give the theory underlying the design of the optical side of television transmitters and receivers and those engaged in research on the subject will find something of interest in every chapter. It may be thought, in light of modern technique, that the Kerr Cell is given undue prominence (no less than 66 pages are devoted to the Kerr effect and points connected with it), but it must be remembered that Mr. Myers has made a special study of this branch of television.

The chapter on electron-optical scanning systems deals with the deflection of the cathode ray in the conventional way and proceeds to consider the intermediate film receiver with the problems of light intensity, speed, etc., involved. The theory of the Farnsworth multiplier is also given in simple terms.

Although the publishers say that the book is "noteworthy for the simplicity of its mathematical analysis," it is not intended for those who have not thoroughly mastered the principles of trigonometry and the calculus.

Mr. Myers is to be congratulated on this book, which will give optics the place it deserves in the science of television. G.P.



PIEZO QUARTZ CRYSTALS

A Q.C.C. 7 Mc. (40-m.) Crystal was specified for the following transmitters described in the November issue.

Standard

Type 7 Mc.

15/-

Post Paid.

SINGLE VALVE CLASS B TRANSMITTER

AND

THE BEGINNERS' TRANSMITTER

Our New 1936-37 Catalogue of short-wave transmitter and receiver components, sent post free for 1½d. stamp.

THE QUARTZ CRYSTAL CO., LTD.

63 & 71, Kingston Road, New Malden, Surrey

Telephone: MALDEN 0334.

"NEW HEALTH"

The Family Health Magazine

MONTHLY
6d.

ARE YOU UP TO DATE?

No amateur radio enthusiast can afford to remain out of touch with Modern Development.

The R.S.G.B., for 12 years, have through the T. & R. Bulletin placed before members the latest short wave and ultra short wave information.

Note the Principal Contents of the November issue

The design of an All-mains Crystal Gate Receiver. Experimental work with Aerials. A simple automatic Morse Sender. A Transverse Current Microphone. B.E.R.U. Contest, 1937, etc.

Special Features

The 28 and 56 Mc Bands. The Month on the Air.

A GUIDE TO AMATEUR RADIO.

Over 12,000 copies of the new and enlarged 4th Edition of this comprehensive handbook were sold in four weeks.

ORDER YOUR COPY TO-DAY.

Price 8d. post free or 1/6 post free with a copy of the October issue T. & R. Bulletin.

All communications to Secretary, (Dept. SW 11) Radio Society of Great Britain, 53, VICTORIA STREET, S.W.1.

THE TELEVISION SOCIETY

President: Sir AMBROSE FLEMING, M.A., D.Sc., F.R.S.

Founded in 1927 for the furtherance of Study and Research in Television and allied Photo-electric Problems.

Ordinary Fellows are elected on a Certificate of Recommendation signed by Two Ordinary Fellows, the Proposer certifying his personal knowledge of the Candidate. The Admission Fee for Fellows is half-a-guinea, payable at the time of election, the Annual Subscription is £1, payable on election, and subsequently in advance on January 1st in each year, but the Annual Subscription may be compounded at any time by the payment of Ten Guineas.

Any person over 21, interested in Television, may be eligible for the Associate Membership without technical qualifications, but must give some evidence of interest in the subject as shall satisfy the Committee. For Associate Members the Entrance Fee is 5/-, payable at the time of election, with Annual Subscription 15/-, payable in advance on January 1st in each year.

Student Members.—The Council has arranged for the entrance of persons under the age of 21 as Student Members, with Entrance Fee 2/6 and Annual Subscription 10/-, payable as above.

The Ordinary Meetings are held in London on the second Wednesday of the month (October to May inclusive) at 7 p.m. The business of the meetings includes the reading and discussion of papers. A Summer Meeting is usually held, and affords Members the opportunity of inspecting laboratories, works, etc. A Research Committee and the preparation of an Index of Current Literature are active branches of the Society's work.

The Journal of the Television Society

is published three times a year. All members are entitled to a copy; and it is also sold to Non-Members, at an annual subscription of 15/- post free.

Forms of proposal for Membership, and further information regarding the Society, may be obtained on application to the General Secretary, J. J. Denton, 25, Lisburne Road, Hampstead, London, N.W.3.

WE CAN SUPPLY
All first specified parts for the
CLASS A HIGH FIDELITY
AMPLIFIER

£26 Carriage Paid. Cash with order or C.O.D.
UNIVERSAL AMPLIFIERS.

6-8 Watts undistorted output
£6 10 0. Carr. Paid. Cash with order
or C.O.D.

A.C. Double Push-Pull R.C.C. Coupled.
AMPLIFIER.

Undistorted output 5-Watts.
£7 5 0. Carr. Paid. Cash with order
or C.O.D.

We can supply an equivalent for any British type of Valve at an appreciably lower price. These valves are Guaranteed for a period of 6 months from date of purchase and the performance to be in no way inferior to that of the original valve.

Send for comprehensive List "T.S."

CHAS. F. WARD,

46, Farringdon Street, London, E.C.4.
Telephone: Holborn 9703.

FOYLES

BOOKSELLERS TO THE WORLD
Stock of nearly three million new and second-hand volumes. Catalogues free on mentioning your interests.

119-125 Charing Cross Rd., London, W.C.2.
Telephone: Gerrard 5660(12 lines)

HARMONY HOUSE
SOUND AND SERVICE

(Prop: Walter Johnson)

Manufacturers and designers of specialised transmitting and receiving equipment, including the building of all equipment described in the constructional articles of this magazine. Let us know your requirements, and we will submit quotation by return, together with further particulars of our constructional services.

116, Cambridge Road, Southport
Telephone: 8621.

G2IN G5ZI

We supply the Components for the **GUARANTEED CATHODE RAY RECEIVER.** Send to us for Quotations and Technical advice.

XMAS OFFER to Students and Experimenters. A few only. **DISC RECEIVER** Kits complete, with **GRAMOPHONE VISION RECORD**, price, 42/-, post 1/6. **RECORD** only, 10/6, post 9d. **ULTRA SHORT WAVE RECEIVER**, 5-10 metres, 3 Valve, Battery model complete with valves, price £4.

Handbook, Television up to Date, with details of modern practice, price 2/6, post 4d.
H. E. SANDERS & CO., 4, Grays Inn Road
London, W.C.1. Tele: Chancery 8778.

INDEX TO ADVERTISERS

	PAGE
Automatic Coil Winder	731
Baird Television	687
Belling & Lee, Ltd.	Cover ii
Bosch Hall, Ltd.	688
British Institute of Engineering Technology	733
Bulgin, A. F., & Co., Ltd.	673
Burne-Jones	733
Dumont Electric Co., Inc.	Cover iii
Edison Swan Electric Co., Ltd.	Cover iv
Eves Radio	721
Ferranti, Ltd.	Cover ii
Foyle's	Cover iii
Fluxite, Ltd.	Cover ii
Galpin's	735
General Electric Co., Ltd.	717
G5KA	Cover iii
Harmony House Sound & Service	Cover iii
Henley, W. T.	729
International Telephone Corporation	734
Jackson Bros.	723
Lectro Linx, Ltd.	723
Marconi, Ltd.	729
McGraw-Hill Publishing Co.	731
Mervyn Sound & Vision Co.	723
Mullard	674
Premier Supply Stores	725
Quartz Crystal Co.	736
Radio Resistor Co.	673
362 Radio Valve Co.	733
Radio Society of Great Britain	736
Raymart Manufacturing Co.	735
Sanders, H. E., & Co.	Cover iii
Savage, Bryan	733
Selwyn & Blount, Ltd.	733
Sound Sales, Ltd.	673
Stratton & Co., Ltd.	719
Technological Institute of Gt. Britain	734
Television Society	736
Ward, Chas. F.	Cover iii
Westinghouse Brake & Signal Co.	729
Whiteley Electrical Radio Co., Ltd.	727

MISCELLANEOUS
ADVERTISEMENTS

The charge for advertisements in these columns is 12 words or less 2/-, and 2d. for every additional word. All advertisements must be accompanied by remittance. Cheques and Postal Orders should be made payable to Bernard Jones Publications Ltd., and crossed, and should reach this office not later than the 15th of the month previous to date of issue.

JOHN SALTER of Featherstone Buildings, Holborn, W.C. Pioneer, since 1927, of Television components, will be pleased to hear from old friends and new customers requiring up-to-date apparatus.

"REVOLUTIONARY."—New theory, experiments, book; no mathematics. Post free, 1/1.—D'Arcy Ford, Gandy Street, Exeter.

BARGAINS in High-Class Electrical Measuring Instruments. Elliott Moving Coil Voltmeter, scale 15,000 volts less external resistance, price 37/6. Weston 0-4-40 Voltmeter, 6 in. scale, resistance 2,500 ohms per volt, B.P.O. standard, price, £2 each. Condensers, standard N.P.L. tested, mahogany cabinet of eight banks of condensers, total 39.375 mf., new condition, list price £20, few only, price £5 each. Many high-class Laboratory Instruments suitable for research. Inspection invited.—H. E. Sanders & Co., 4, Grays Inn Road, London, W.C.1. Tele.: Chancery 8778.

PATENT AND TRADE
MARK AGENTS

GEE & CO. (Estab. 1905), patents and trade marks throughout the world (H. T. P. Gee, Mem.R.S.G.B., A.M.I.R.E., etc.), 51-52, Chancery Lane, London, W.C.2 (2 doors from Government Patent Office.) Phone: Holborn 4547 (2 lines). Handbook free.

KINGS PATENT AGENCY LTD. (B. T. King, Patent Agent) 146a, Queen Victoria Street, London, E.C.4. **ADVICE**, Handbook and Consultations free Phone City 6161.

PATENTS-DESIGNS-TRADE MARKS
HASELTINE, LAKE & CO.,

Chartered Patent Agents,
28, SOUTHAMPTON BUILDINGS,
CHANCERY LANE, W.C.2.
Telephone AND AT Tel. Address
Hol. 5611 NEW YORK "Scopo, London."

"TELEVISION"
and SHORT-WAVE WORLD"
COUPON
FOR FREE INQUIRY SERVICE

Name _____

Address _____

December, 1936

NOTICE

LARGE AMERICAN MANUFACTURER OF RADIO CONDENSERS DESIRES ENGLISH CONNECTION, TO MAKE SAME PRODUCTS UNDER PATENT PROTECTION ON ROYALTY BASIS. PRESENT PRODUCTION 35,000 PER DAY, USED BY U.S.A. GOVERNMENT. WRITE TO:

DUMONT ELEC. CO., INC.
514-516 BROADWAY, NEW YORK, U.S.A.

1937 EDITION

of the

Radio Amateurs
Handbook

Now 544 Pages **5/6** Post Free

G5KA, 41 Kinfauns Road,
GOODMAYES, ESSEX (Dept. T)

TELEVISION DEVELOPMENTS

A NEW LARGE DIAMETER TUBE FOR TELEVISION REPRODUCTION



TYPE 12H TUBE

The Ediswan Type 12H tube has a screen diameter of 12" giving a television picture 10" x 7½" without distortion.

The screen is of special material giving a close approximation to a black-and-white picture.

Specification:

Indirectly heated high vacuum tube.

Heater Volts - - - 2.0

3rd Anode Volts - - - 6000

2nd Anode Volts - - - 1200

1st Anode Volts - - - 150-400

Sensitivity (mm./V.) - - - 950/V*

*V = anode volts

List Price £15. 15. 0

● We also supply
HIGH VACUUM RECTIFIERS
GAS-FILLED RELAYS
MERCURY VAPOUR RELAYS
for Television Scanning
circuits.

ENTIRELY BRITISH MADE

EDISWAN RADIO VALVES

THE EDISON SWAN ELECTRIC CO. LTD.  155 CHARING CROSS RD., LONDON, W.C.2

R.E.299

USED BY ALL GOVERNMENT DEPARTMENTS