

NEWS OF THE COMING SERVICE

TELEVISION

THE FIRST TELEVISION JOURNAL IN THE WORLD

and SHORT-WAVE WORLD

MONTHLY 1/-

FEBRUARY, 1936

No. 96. Vol. ix.

BERNARD JONES PUBLICATIONS LTD.,
CHANSITOR HOUSE, CHANCERY LANE,
LONDON, W.C.2.

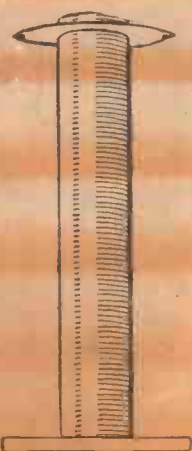
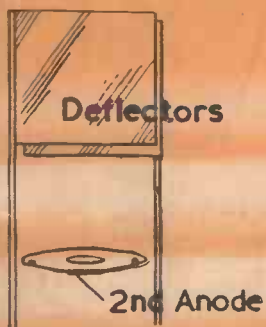

HOW THE CATHODE-RAY TUBE WORKS

SIMPLY EXPLAINED IN PICTURE

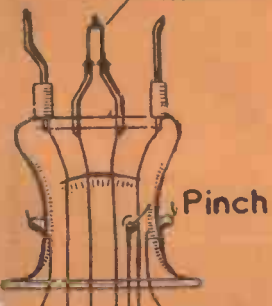

BROADCAST SHORT-WAVE THREE

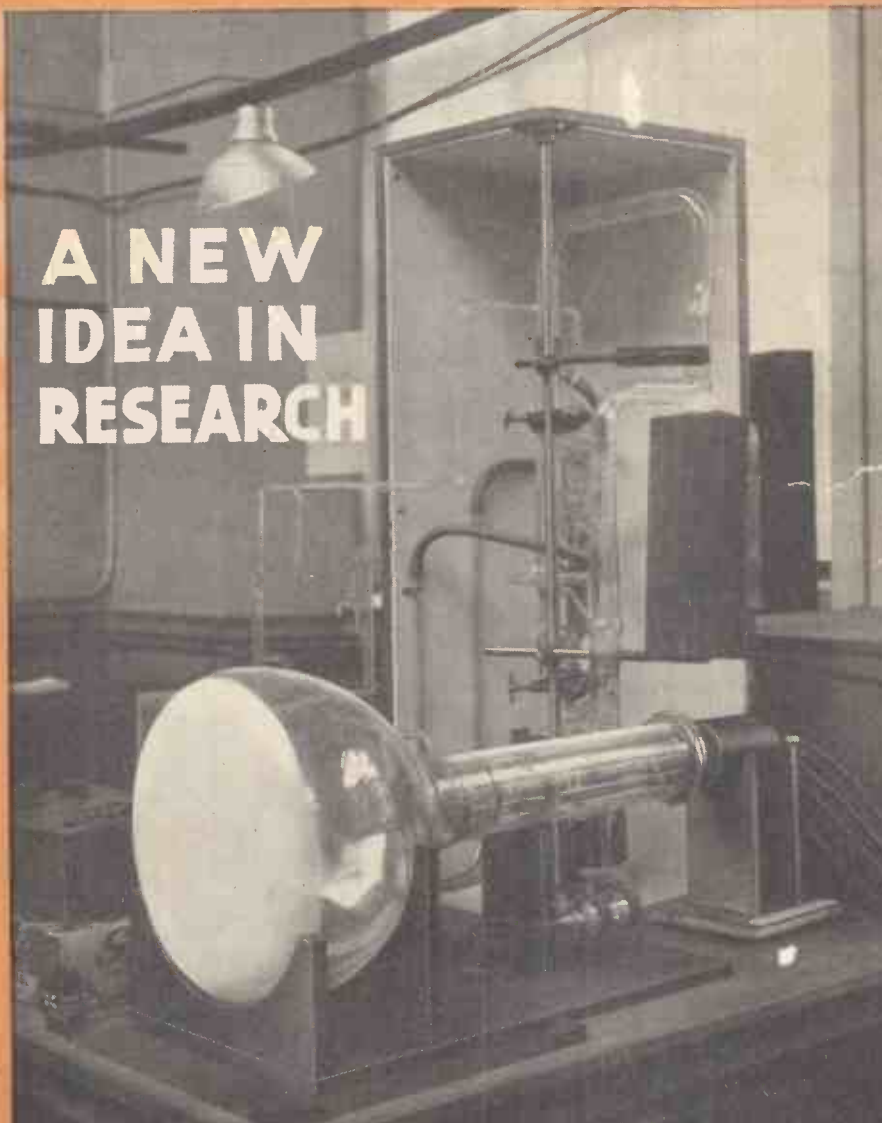

A NEW IDEA IN RESEARCH

G.E.C.'s DEMOUNTABLE C.R. TUBE



"I'm better connected than most,"
Said Miss Rady O. Sett, "I can boast
A Pure FLUXITE strain
Which indicates brain
I now have a very high post."

See that FLUXITE is always by you—in the house—garage—workshop—wherever speedy soldering is needed. Used for 30 years in government works and by leading engineers and manufacturers. Of Ironmongers—in tins, 4d., 8d., 1/4 and 2/8. Ask to see the FLUXITE SMALL-SPACE SOLDERING SET—compact but substantial—complete with full instructions, 7/6. Write for Free Book on the art of "soft" soldering and ask for Leaflet on CASE-HARDENING, STEEL and TEMPERING TOOLS with FLUXITE

TO CYCLISTS! Your wheels will NOT keep round and true unless the spokes are tied with fine wire at the crossings and SOLDERED. This makes a much stronger wheel. It's simple—with FLUXITE—but IMPORTANT

THE FLUXITE GUN

Is always ready to put fluxite on the soldering job instantly. A little pressure places the right quantity on the right spot and one charging lasts for ages
Price 1/6.

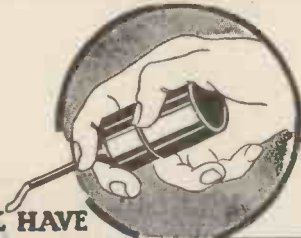

ALL MECHANICS WILL HAVE

FLUXITE

IT SIMPLIFIES ALL SOLDERING

FLUXITE LTD. (Dept. T.V.), DRAGON WORKS, BERMONDSEY ST., S E 1

A NEW VALVE ——— for
efficient Short Wave frequency
conversion.

The
OSRAM
X 41

Price each
20/-



WRITE FOR
PARTICULARS

1. Almost complete absence of inter-action between Triode (oscillator) and Hexode (mixer) sections.
2. High conversion gain due to high Impedance. This also means less damping on the tuned circuit.
3. High mutual conductance in Oscillator section. This assists in simplifying coil design and by reduction of coupling required reduces "squegging" and uneven oscillation.

Osram
Valves
MADE IN
ENGLAND

Advt. of The General Electric Co., Ltd., Magnet House, Kingsway, London, W.C.2.

BELLING-LEE
FOR EVERY RADIO CONNECTION

Standard Indications



Every indication you are likely to require for Television or Short Wave work.

Plug Top Valve Connectors



"B" Type Terminal
No. 1001
6d.



No. 1167 3d.

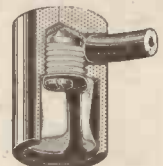

No. 1156 4d.



Low Loss Valve Hood and Connection

No. 1224
8d.

RADIO CONNECTIONS

INTERFERENCE SUPPRESSORS
SAFETY DEVICES
DICRUS, ETC.



Spade Terminal
1025. 2d. each.



"Midget"
No. 1019
2d.



"Bowspring"
No. 1112
1 1/2d.

BELLING & LEE LTD
CAMBRIDGE ARTERIAL ROAD, ENFIELD, MIDDLESEX

Please send,
free, your

Complete Catalogue, "Radio Connections."

Name.....
Address.....
[Tel. 2-36]



CHOPPED SIGNALS

You know how sharp tuning can be at 5 metres; the slightest touch, and—if you suffer from hand capacity, the slightest move—and it's gone. If you have never used a quench circuit you certainly should. The super-audible oscillation enables the detector valve proper to be operated in condition, and broadens

the most sensitive the tuning.
List No. S.W.46, double-wound quench coil ... 3/9
Instruction Sheet giving circuits Free upon request.

ALL WAVE SWITCHES

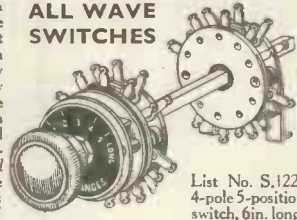

List No. S.122 4-pole 5-position switch, 6in. long, with snap action locator unit.

Price 8/- each

ALL WAVE COILS



The present vogue for all-wave working will continue; it will grow and grow. If you want to be up-to-date, and to receive short-waves as well, without adaptors or additional apparatus, you want these coils. 15—95 metres, and Broadcast, and Long. The tuning condenser must be two-gang, '0005μF., untracked, and a heptode f.c. valve is always used. The I.F. is 465-450 k.c./s.

List No. C.52, Aerial Coil each 8/9
List No. C.53, Oscillator Coil

STAND OFF! KEEP YOUR DISTANCE

One has to treat the higher radio-frequencies with some respect. They refuse to be herded and shoved about by "any old wiring," and low inter-wiring capacity becomes a thing of some importance, and most necessary for the best results. Again, Bulgin comes to the Experimenter's aid with inexpensive efficient STAND-OFF INSULATORS.



"STAND-OFFS"
Universal for baseboard- or wall- or chassis-mounting. Made of low-loss porcelain with accurate metal insert and screw*. Height, 2 in. overall.
List No. S.W.45, 6.B.A.* } 4 1/2 d.
List No. S.W.49, 4.B.A.* } 2 each

A CHOKE—WHICH DOES!

The self capacity is most important. At 5 metres, the reactance of 1μF. is 2,600Ω; of 10μF., only 260Ω! You see what proportions shunt paths and strays assume; here are two special H.F. chokes.



List No. S.W.68, 36 d.c.Ω, 2,100μH., s.c.=0.5 μμF.,* max. mA. = 2/- each 167.
List No. S.W.69, 360 d.c.Ω, 15,000 μH., s.c.= 2/9 0.85 μμF.,* max. mA. = 52. each
* Not wired into apparatus.

RECOMMENDED AGAIN & AGAIN

BULGIN

QUALITY RADIO AND TELEVISION COMPONENTS

COUPON

To Messrs. A. F. Bulgin & Co., Ltd., Abbey Road, Barking, Essex.

Please send me Catalogue No. 155 "M" for which I enclose 3d. stamps

NAME.....

ADDRESS.....

(BLOCK LETTERS PLEASE)

FULL

FOR THE LOWEST POSSIBLE LOSSES air is still the best of all di-electrics. It doesn't change. These special fixed condensers are accurately spaced, and have low H.F. resistance. Microphony is minimised by the special construction.

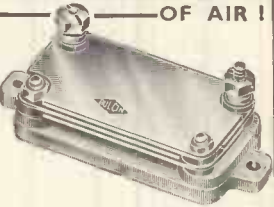

List No.	μμF.	List No.	μμF.	List No.	μμF.
S.W.74	11.0 1/-	S.W.77	45.0 1/9	S.W.80	80.0 2/6
S.W.75	22.5 1/3	S.W.78	57.0 2/-	S.W.81	91.0 2/9
S.W.76	34.0 1/6	S.W.79	68.5 2/3	S.W.82	102.0 3/-

FULL

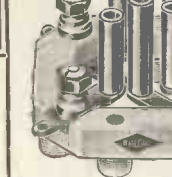

BASEBOARD TYPES:
List No. S.W.21, 5-pin 1/6 each.
List No. S.W.51, 7-pin 2/3

HOLD IT

When you've got your signal, hold it. You can't do so with inferior or high-loss components. We make strong and really low-loss valve-holders using "Frequentite," and we silver-plate all the contacts.

CHASSIS TYPES:
List No. S.W.41, 5-pin 9d. each.
List No. S.W.42, 7-pin 1/-

EASY WIRING

All Clix components, in addition to giving Perfect Contact, are easy to wire; for instance, in Clix Chassis Mounting Valveholders the centre socket of the 5-pin and two sockets of the 7-pin type are made longer than the others; this reduces the possibility of short-circuits and adds to the ease of wiring.

- All the following Clix contacts are Specified for the "SHORT-WAVE THREE"
- Valveholders, Type V5 7-pin 4-pin 7d., 5-pin 8d.
 - Solid Plugs, 2d.
 - Wander Plugs, H.T. or G.B. 1 1/2 d.
 - Spade Terminals, Small 1 1/2 d., Large 2d.
 - Insulated Sockets 2 1/2 d.

Clix "Master" Wander Plugs and Spade Terminals are simply and efficiently wired, and the special wire-to-wire wiring device makes for certain and lasting contact.

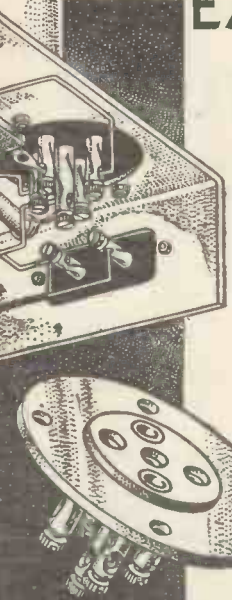

LECTRO LINX LIMITED

79a Rochester Row, London, S.W.1



VALVES for your RADIO

(Battery, A.C. Mains and Universal Types)

FOR BROADCAST or SHORT WAVES

FERRANTI CATHODE RAY TUBES

for TELEVISION and INDUSTRIAL USE
FINEST DEFINITION and LONGEST LIFE
Working Voltage 1000/6000. Cathode 1 volt. 3 amps.

FERRANTI LTD.
RADIO WORKS, MOSTON, MANCHESTER, 10



FOR SHORT WAVE WORK YOU NEED STEADY H.T.

SPECIFIED FOR THE
H.T. SUPPLY FOR THE
**AMATEUR
COMMUNICATION
RECEIVER**
TYPE H.T. 12
200 VOLT. 30 m/A
17/6



For DX work you need every aid ever devised to ensure maximum efficiency. Your efforts may be completely nullified by unsuitable H.T. supply. For instance, when using critical reaction, stability depends entirely on steady anode voltage. You must have noticed that contributors to this journal repeatedly specify Westinghouse Metal Rectifiers for H.T. supply, as it is the most reliable, unvarying and lasting instrument available. "The All-Metal Way, 1936" will give you full details and numerous suitable circuits.

COUPON

Please send me a copy of the "The All-Metal Way, 1936," for which I enclose 3d. in stamps.

WESTINGHOUSE BRAKE & SIGNAL Co. Ltd.
82, York Road, King's Cross, London, N.I.

Name.....

Address.....



T. Feb. 36

Quick fault-tracing DEMANDS ACCURATE TESTING



British made

- CURRENT**
0-6 milliamps
0-30 "
0-120 "
VOLTAGE
0-6 volts
0-12 "
0-60 "
0-120 "
0-300 "
0-600 "
RESISTANCE
0-10,000 ohms
0-60,000 "
0-1,200,000 "
0-3 megohms

The D.C.
AVOMINOR
40/-
Deferred Terms
if desired.

Even the smallest degree of distortion in television calls for immediate remedy. Slight faults which might pass unnoticed in radio become, in television, glaringly apparent imperfections. More than ever is an accurate testing meter of first importance—vital to perfect reception.

The world-famous D.C.

AVOMINOR

Regd. Trade Mark

is 13 accurate instruments in one. Circuits, valves, components, batteries and power units can all be tested quickly and easily. In handsome case, with leads, interchangeable crocodile clips, testing prods and instruction booklet.

The UNIVERSAL AVOMINOR

gives 22 different ranges of readings. The best of A.C. and D.C. meters. 3-inch scale. Total resistance 200,000 ohms. Complete with leads, crocodile clips, testing prods and instruction booklet.

THE AUTOMATIC COIL WINDER & ELECTRICAL EQUIPMENT CO., LTD.,
Winder House, Douglas Street, London, S.W.1.
Telephone: Victoria 3404-7.

The UNIVERSAL AVOMINOR

- | | |
|--------------------|-------------------|
| D.C. VOLTS | A.C. VOLTS |
| 0-75 millivolts | 0-5 volts |
| 0-5 volts | 0-25 " |
| 0-25 " | 0-100 " |
| 0-100 " | 0-250 " |
| 0-250 " | 0-500 " |
| 0-500 " | |
| F MILLIAMPS | RESISTANCE |
| 0-2.5 milliamps | 0-20,000 ohms |
| 0-5 " | 0-100,000 " |
| 0-25 " | 0-500,000 " |
| 0-100 " | 0-2 megohms |
| 0-500 " | 0-5 " |
| | 0-10 " |



£5

Deferred Terms if desired.

● Send for fully descriptive folders, post free.

It helps us if you mention "Television and Short-wave World."

TELEVISION

and SHORT-WAVE WORLD

Special Features

	PAGE
How the Cathode-ray Tube Works ...	69
Latest Developments in Electron Multipliers ...	71
Light-sensitive Cell Circuits ...	73
Electronics at the Physical Society's Exhibition ...	77
Digests and Data ...	80
Broadcast Short-wave Three ...	83
Transmission for the Beginner ...	86
Development of the Scanning Circuit for Cathode-ray Television ...	91
Recent Television Developments ...	93
Valve Couplings for Television Frequencies ...	95
Parabolic Reflectors for Short Waves... ..	98
Design of an Amplifier for Oscillograph ...	99
Amateur Communication Receiver ...	101
Recent Ultra-short Wave Developments ...	104
Principles and Practice of Electron Optics ...	108
Multi-band Aerial for High Frequencies ...	113
Amplifier for the Det.-8 Transmitter... ..	115
Adding a Crystal Filter ...	117
Simple 5-meter Directional Array ...	118

COMMENT OF THE MONTH

George V.

WITH profound regret we place on record the death of George V, the King and Friend of English people throughout the world. All have learnt to know him as a man of broad mind and generous heart; as one who so ordered his life that in everything he did he strove to serve the interests of the countries and peoples over which he reigned; as, in short, the Father of His People. It fell to his lot to see the most amazing scientific development in the world's history. Ordered progress had in him a true friend, and we of TELEVISION AND SHORT-WAVE WORLD—its Editors, its Staff, and its Readers—have reason to mourn his passing.

George the King goes. Edward comes. The King is dead. Long live the King.

And the King who comes has a knowledge of men and things; an understanding, or an earnest desire to arrive at an understanding, of the world's problems; and much more than a nodding acquaintance with the scientific spirit of the age. It is highly probable that he is the only King alive who has spent many hours in watching a television demonstration and in enquiring into the whys and wherefores of the method and apparatus employed. He has spent the years of his youth and of his still early manhood in learning of his fellow men that he might the better rule them when his time came. He has already earned the confidence of the English people who, with respect and warm cordiality, bid him welcome to the Throne.

A New Service for our Readers.

THE reviews and summaries of the television patents which we publish each month by special permission of H.M. Stationery Office provide a concise and valuable record of progress and developments, and the many letters we receive regarding these indicate that they are very much appreciated by our readers. Equally, valuable sources of information showing the trend of development are the many authoritative articles which appear in the English, American and Continental technical journals. In very many cases these articles are isolated features which in all probability would not come to the notice of our readers, so it is our intention in future to publish abstracts of all those on television and allied subjects, together with full details of the origin. This, we hope, will enable readers to keep informed of the latest theory and practice. It should be noted that the length of the abstract will not necessarily be an indication of the quality of the article, and that the reviews are entirely unbiased and are issued for the sole purpose of giving our readers a résumé of current television literature. The first series appears in this issue.

TELEVISION AND SHORT-WAVE WORLD

Proprietors:

BERNARD JONES PUBLICATIONS, LTD.

Editor-in-Chief:

BERNARD E. JONES.

Editor:

H. CORBISHLEY.

Editorial, Advertising and Publishing Offices:

Chansitor House, 38, Chancery Lane, London, W.C.2.

Telephones: Holborn 6158, 6159

Telegrams: Beejapee, Holb., London.

Subscription Rates: Post paid to any part of the world—3 months, 3/6; 6 months, 6/9; 12 months, 13/6.

Published Monthly—1/- net.

(Last Wednesday in every month for following month).

Contributions are invited and will be promptly considered. Correspondence should be addressed according to its nature, to the Editor, the Advertisement Manager, or the Publisher, "Television and Short-wave World," Chansitor House, Chancery Lane, London, W.C.2.

IMPORTANT

"Television and Short-wave World" is registered at the General Post Office, London, for transmission to Canada and Newfoundland by Magazine Post.

HOW THE CATHODE-RAY TUBE WORKS

SIMPLY EXPLAINED
IN PICTURE

A pictorial explanation of the construction and working of the Cathode-ray Tube, showing how it is used in the production of a television image.

On the right is a photograph of the electrode assembly of a cathode-ray tube and the diagrams which appear on this and the two following pages show the positions and functions of the various parts.

FIG. 1.—The electrodes of the tube have been separated to show the assembly.

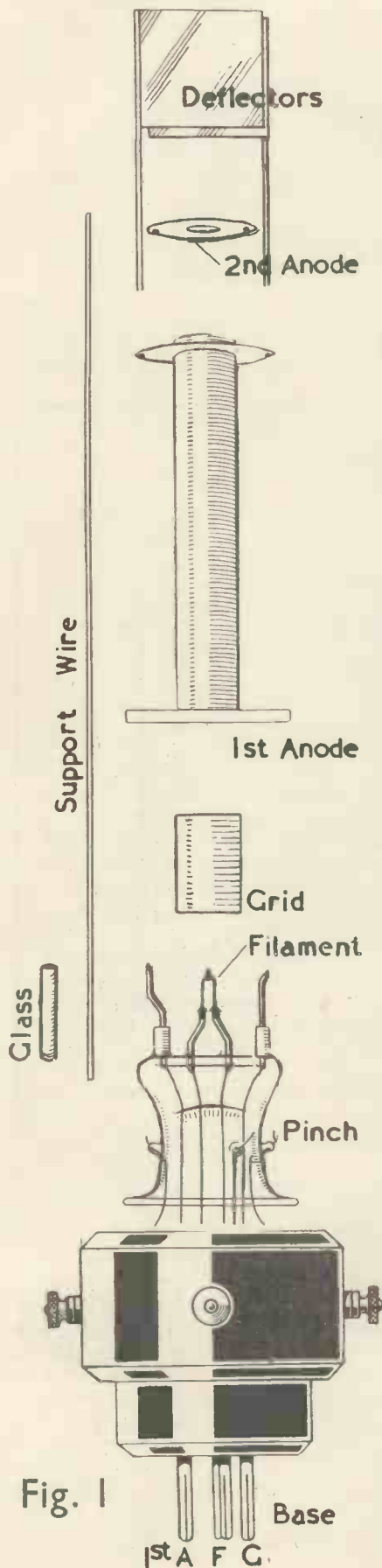

Fig. 1

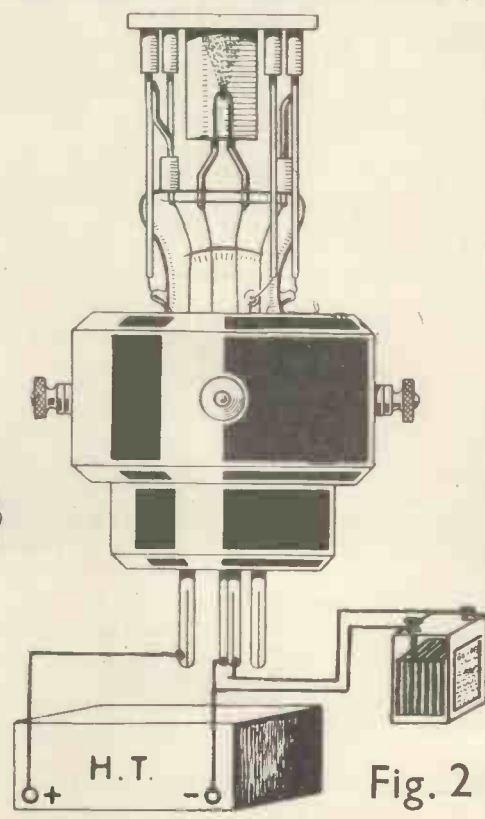
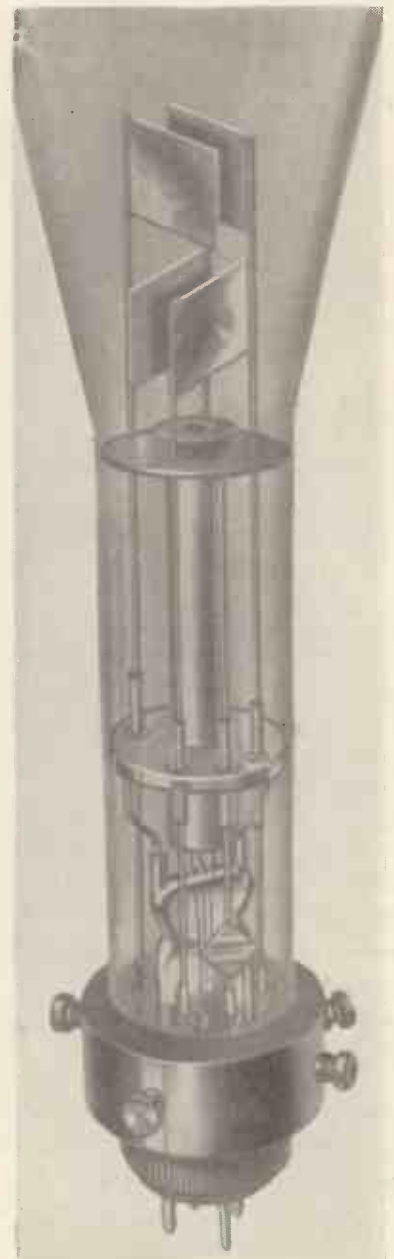
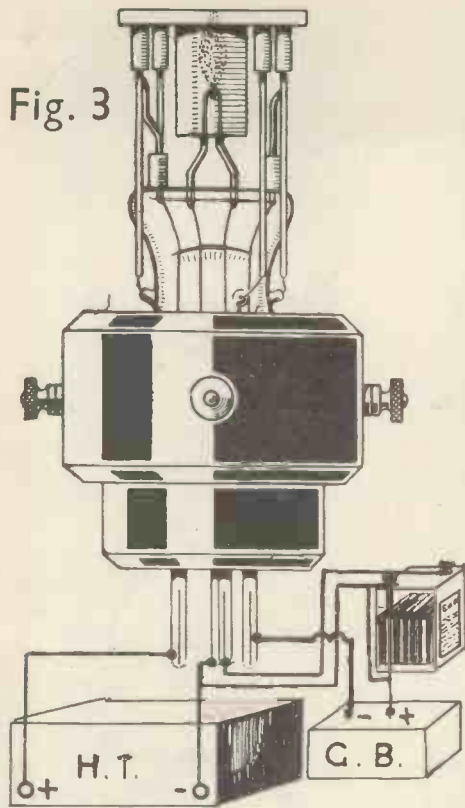

Fig. 2



This is an actual photograph of the electrode system of the Edison cathode-ray tube.

The *pinch* carries a filament, the source of electrons, a cylindrical electrode called the *grid*, from its resemblance to the grid of an ordinary valve, and the *first anode* which is a flat disc pierced with a small hole in its centre. The first anode is extended by the cylinder shown and at its end is mounted the *second anode*, a flat disc with a larger hole in its centre. Sometimes another anode is mounted above this one.



Finally there are the deflector plates, two pairs of flat plates fixed above the second anode, the plates of each pair being parallel to each other. The two pairs are at right angles to each other. Only one pair of plates is shown in Fig. 1 for simplicity.

The electrodes are mounted on the support wires which are held rigidly in place by glass insulating sleeves and mica bushes. The supports are connected to the small wires round the side of the pinch, which pass through the glass and are joined to the terminals of the base.

FIG. 2.—When the filament is connected to an L.T. battery and a positive potential is connected to the first anode, electrons leave the filament and pass to the anode. Owing to their high speed some will pass through the hole in the anode, but the majority will flow to the metal and form an anode current as in the thermionic valve.

FIG. 3.—If a negative bias is applied to the grid or control electrode, it will have

the effect of compressing the electron stream so that more electrons pass through the hole in the anode and very few remain on the metal. This makes the tube more efficient. If the grid bias is increased sufficiently the stream will be cut off altogether, and it is this property of the grid which is used in producing the black-and-white shades of the television picture.

FIG. 4.—Here the electrons have passed through the hole in the anode and are proceeding up the tube. As they pass up they tend to get further and further apart instead of remaining in a compact jet, and it is necessary to bring them back to a thin line to form a small spot on the

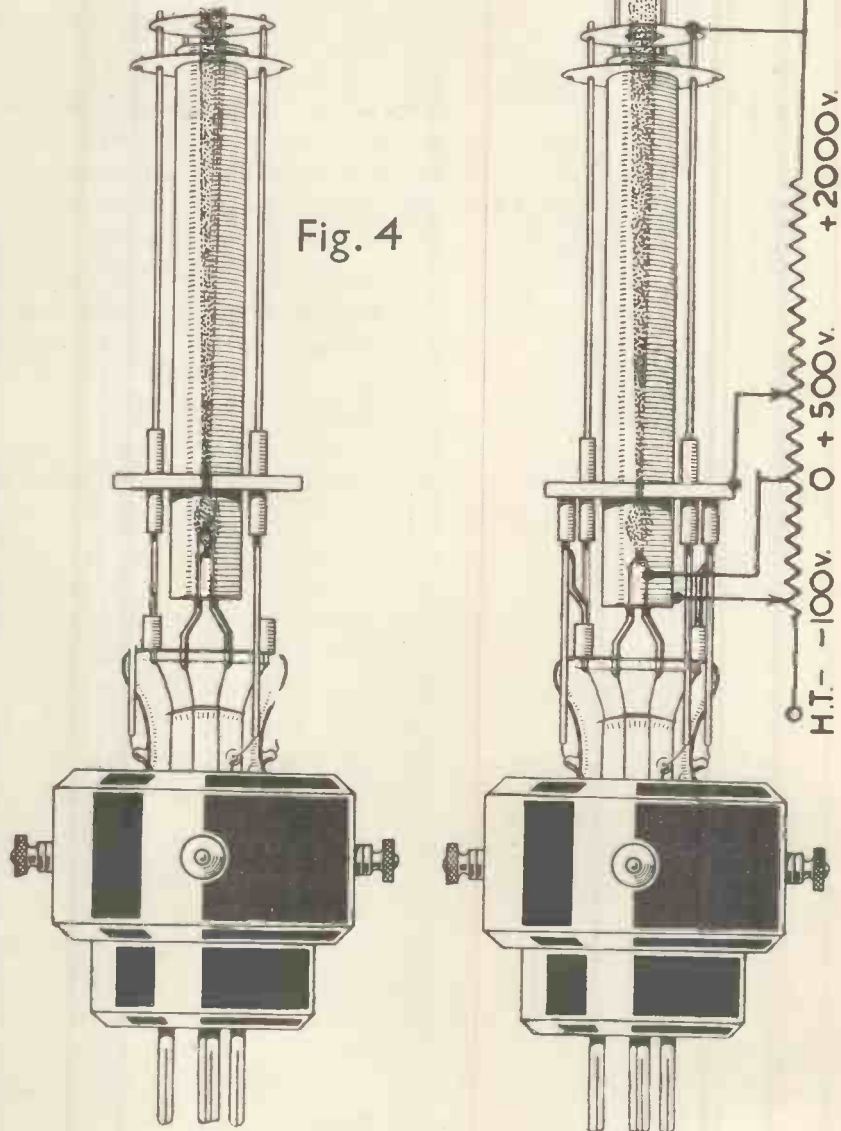

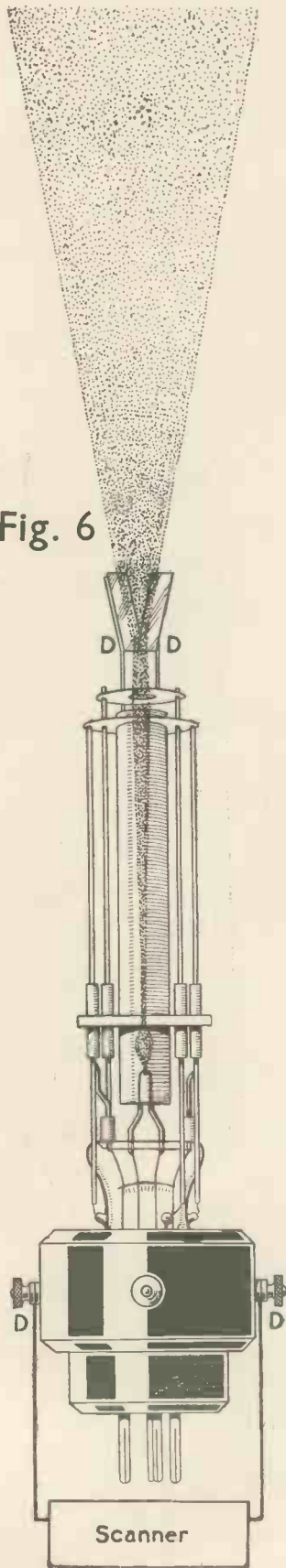

Fig. 6

end of the tube. This is done by applying a high potential to the *second anode*, which is seen at the end of the cylinder. The electric field between the second and first anodes compresses the electrons so that they are focused on the screen as in Fig. 5.

FIG. 5.—The H.T. potentials for focusing the beam are obtained from a chain of resistances connected across a high-tension supply. The tapings are shown at the side of the diagram, the grid being negative to the cathode and the anodes increasingly positive. The values will vary with each type of tube. In this diagram one pair of deflector plates is seen above the second anode, and if an alternating potential is applied to these plates the beam will be deflected as it passes through them.

FIG. 6.—A rapidly changing potential is applied to the deflector plates from the scanning circuit, and the beam is spread out as it passes through the plates DD. To produce a high-definition (240) line screen on the end of the tube the beam has to be moved across the screen in $1/6000$ of a second. The scanner is designed to produce this deflection regularly and uniformly in one direction, while a similar circuit moves the beam in a direction at right angles to this at a rate of 25 times per second (25 pictures per second).

FIG. 7.—Here the beam is acted on by both pairs of deflector plates and is drawing the line screen on the end of the tube. The compound on the end of the tube fluoresces where the electrons strike it and a series of white lines are drawn as a framework on which the picture is reproduced.

The last stage is to apply the signal from the television receiver to the grid of the tube as the beam is swinging to and fro, and thus modulate the intensity of the lines as they are drawn. The black and white patches then form the picture if they occur in the same sequence as in the transmitter.

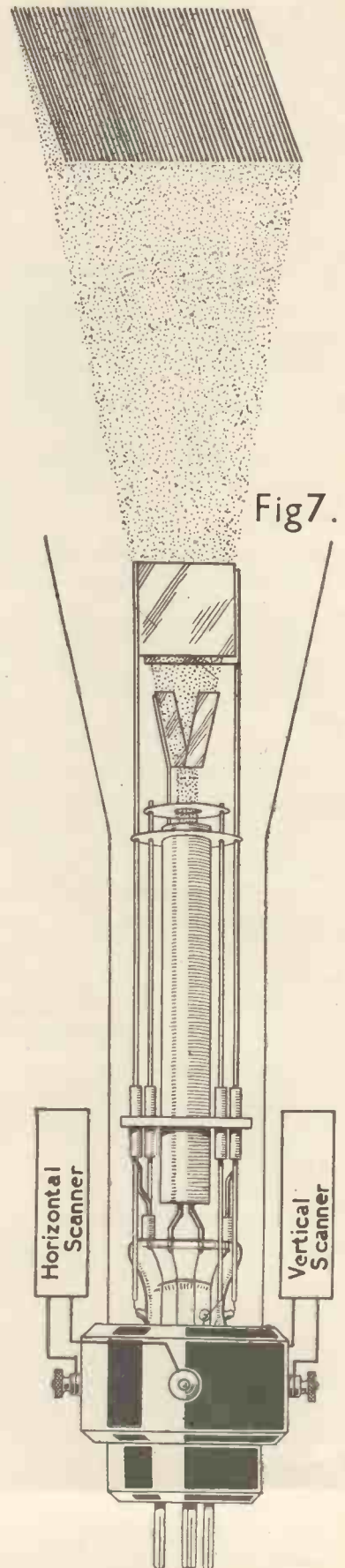

Fig 7.

THE LATEST DEVELOPMENTS IN ELECTRON MULTIPLIERS

By G. Baldwin Banks.

IN a recent article in this journal* the electron multiplier as used by Farnsworth was described. Mention was made of the vast possibilities of this method of amplifying weak electron currents with special

trons which are prevented from leaving the surface by the attraction of the conductor. A certain amount of work has to be done to remove an electron from the surface of the conductor and this is called the work

is a photo-electric cathode, P_1 , P_2 , and P_3 being secondary emitting plates. P_5 is the anode. The operation of the device is as follows: Light falls on the photo-electric cathode P_1 and releases a weak stream of electrons which are accelerated to P_2 by a potential of about 500 volts. As a result of the impact of this primary electron stream, five to ten times the number of electrons are released from P_2 , and these are accelerated towards P_3 . The process goes on until the amplified electron stream is finally collected at the anode P_5 . Caesium on silver oxide was used for both photo and secondary emitting electrodes, but different processes of preparation and activation were used in each case.

A disadvantage arising in this form of multiplier was caused by the non-directional emission of the secondary electrons, resulting in dispersion of the electron beam whereby losses occurred due to the charging up of the walls of the tube.

Focusing the Electron Beam

This was eliminated by arranging electron lenses along the tube between successive plates. These lenses may be either magnetic or electrostatic and they serve to restrict the electrons to a beam.

Fig. 2 shows a more recent arrangement where the secondary emitting electrodes are so shaped to form electrostatic lenses concentrating the beam without any further agency being required. Although the tube shown has only three stages of multiplication, tubes have been made with as many as ten successive stages. With such tubes, amplification of more than one million has been obtained.

Zworykin recently demonstrated a multiplier tube before the American Institute of Radio Engineers, using as a light source a gas-filled discharge tube modulated by a signal obtained from a gramophone record. The multiplier tube was some distance away from this light source, and a large loud speaker was connected directly in the anode circuit of

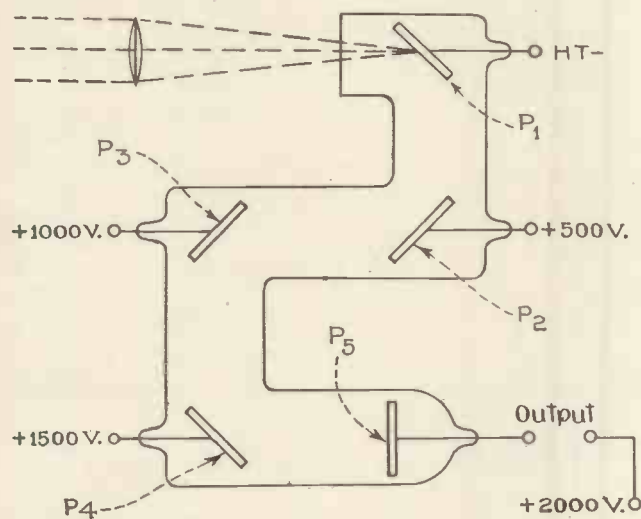

Fig. 1. This is a development of the electron multiplier by Zworykin, but it had the disadvantage that there was dispersion of the electron beam with consequent loss.

reference to mechanical television transmitters.

Hitherto, transmitters using mechanical scanning have been at a disadvantage as far as high-definition television was concerned as the light available is insufficient to excite photo-electric currents of the magnitude required for amplification.

The limit of amplification in thermionic valve amplifiers is reached when the input signal is less than the parasitic noises due to sporadic variations in cathode emission and other effects. With the electron multiplier, very great amplification can be obtained because the signal to noise ratio is more than 50 times that of the valve amplifier.

Electron Multiplication

The principle underlying the electron multiplier is concerned with secondary emission. Conductors contain a great number of free elec-

trons. Some conductors, such as the alkali metals, have low values of work function and it is a comparatively easy matter to release electrons from their surfaces. Light will do this as in photo-electric cells. Similarly if a stream of fast-moving electrons is caused to impinge on an electrode coated with an alkali metal a greater number of secondary electrons are formed. Each primary electron may release as many as ten secondaries. These secondaries may be caused to impinge on another alkali metal surface and in their turn release further secondaries and so on, until a very great amplification is obtained. It will be seen that the amplification

$$A = S^n$$

where S is the number of secondaries released by an impacting electron. n is the number of successive impacts.

The Zworykin Multiplier

Fig. 1 shows the arrangement of a form of Zworykin multiplier. P^1

* The Electron Multiplier and Mechanical Television. Television and Short Wave World, May 1935. (See also Dec. issue).

the former. The output was sufficient to work the speaker at great volume without any other amplification. Although the primary photo-electric current was only a few thousandths of a micro-ampere the output was several milliamps.

It is almost certain that the electron multiplier will be adapted for the sound reproduction of talking films. This would result in the partial or complete elimination of the thermionic valve amplifiers (always a potential source of breakdown) and a very

great simplification of the reproducing gear.

Radio is likely to benefit greatly because secondary emission principles may be used to amplify thermionic as well as photo-electric currents. If the photo-electric cathode P_1 in Fig. 1 be replaced by a system comprising a thermionic cathode and one or more grids the tube becomes a thermionic valve with enormous amplifying power. One multiplier may be equivalent to a five valve amplifier. Furthermore, a point of very great importance is that as there are no coupling circuits the amplification will be practically constant at all frequencies. Similarly a tube of this type will function perfectly as a direct current amplifier.

One disadvantage in the use of the multiplier tube is the high voltage required for its operation, which amounts to 500 volts per stage, a ten-stage multiplier requiring 5,000 volts. It may, however, be possible to reduce the stage voltage required and further development in the field of secondary emission amplification will be awaited with interest.

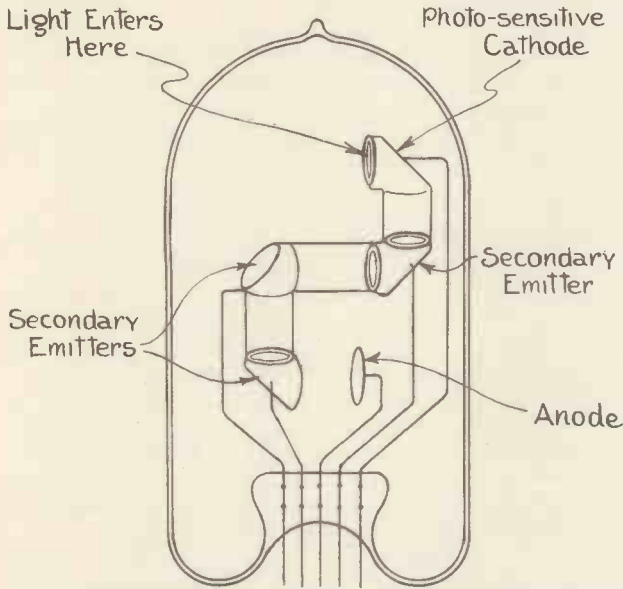

Fig. 2. This is a later arrangement of the Zworykin multiplier in which the secondary emitting electrodes are shaped to form electrostatic lenses.

Neutralising the P.A. Stage

By J. H. Crewe

NEUTRALISING a sub or power amplifier stage is most important if the station is going to be a stable one and free from a tendency to oscillate. Newcomers are not always happy about the proper way to neutralise and are inclined to overlook the most important point, much to the re-

addition to having to withstand a considerable amount of R.F. it has a high D.C. potential to buffer.

Neutralising of an amplifier is necessary in order to prevent self-oscillation. This oscillation occurs owing to the energy fed back via the anode-to-grid capacity of the valve. The energy in the anode circuit is many times that in the grid circuit and self-oscillation results even if only a small section of the anode energy is applied to the grid.

The capacity feed-back through the valve is neutralised by tapping the anode or grid coils so that the voltages at each end of whichever coil is split are equalised but opposite in polarity with respect to the centre of the coil which is at earth potential as far as R.F. is concerned.

Both ends of the split tank circuit are then connected to the hot end of the other tank circuit. In other words, when using anode neutralisation, both ends of the anode tank are connected to the grid of the valve, one end by valve capacity, and the other to an external capacity which should be equal to the valve capacity. This is clearly shown in Fig. 1, the external capacity being C_n .

It will be well appreciated from this that two feed-back voltages are applied to the grid, but because they are equal

and opposite the net voltage is always zero, making the effective grid voltage (A.C.) independent of the R.F. in the anode circuit.

Grid neutralising is often used to advantage. The circuits are shown in Figs. 2 and 3. These are fundamentally similar with the exception that in Fig. 2 series feed is used and in Fig. 3 parallel feed.

In both these circuits the grid coil is split and not the anode tank coil. This means that a high R.F. anode voltage is applied simultaneously to both ends of the grid coil. For this reason there is no potential difference between the

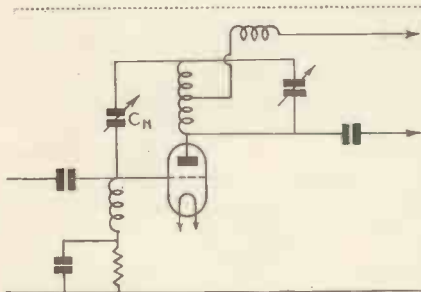

Fig. 1.—This is the popular anode arrangement. The balancing condenser is C_n .

gret of other stations and local broadcast listeners.

Anode neutralising is undoubtedly the most popular. The circuit is shown in Fig. 1. It is perfectly conventional; the only point to be remembered is that the neutralising condenser is virtually between H.T. positive and earth so in

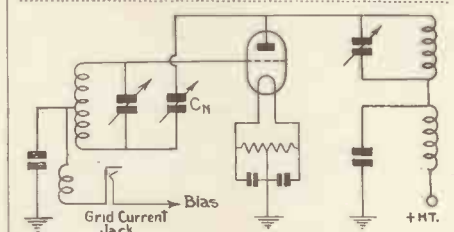

Fig. 2.—A grid neutralising condenser is connected in this way.

two ends of the grid tank caused by feed-back from the anode tank and the effective net grid voltage is again independent of the anode circuit.

Grid neutralising is always preferable when link coupling is used between stages, for it makes possible the use of cheaper variable condensers.

(Continued on page 112).

LIGHT - SENSITIVE CELL CIRCUITS

This series of circuits has been compiled from various sources, notably "Radio-Craft" and "Electronics" (New York) to which journals we acknowledge our indebtedness. We believe this is the first time such a complete range has been published.

LIGHT-SENSITIVE cells are playing a continuously increasing part in industry, but even so it is evident that only a compar-

ment and is suitable for operation on either A.C. or D.C. No gridleak is provided, and there is no necessity for maintaining any particular potential

unnecessary. Fig. 2 shows the same circuit for A.C. operation only.

When two or more stages are used, the valves must be coupled together as there must be a means for transferring the energy from the plate circuit of the first valve into the grid circuit of the second. There are three types of coupling employed, namely, resistance coupling, transformer coupling and direct coupling.

An example of direct coupling is

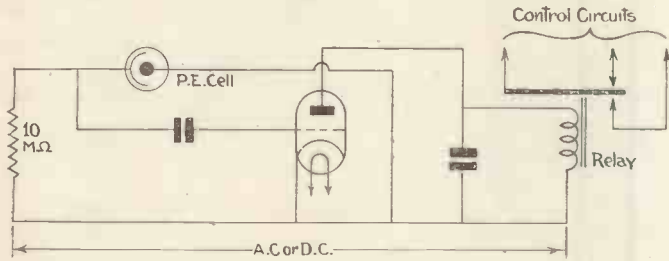

Fig. 1.—A trigger circuit suitable for operation from A.C. or D.C.

tively few of the possibilities of this device have as yet been put into practical form and that many other applications are likely to eventuate. The

on the grid; the grid assumes its own negative potential. Actual trial of this circuit has proved that it is probably the most sensitive combination

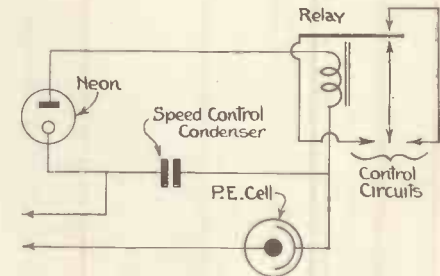

Fig. 4.—A neon tube controlled circuit.

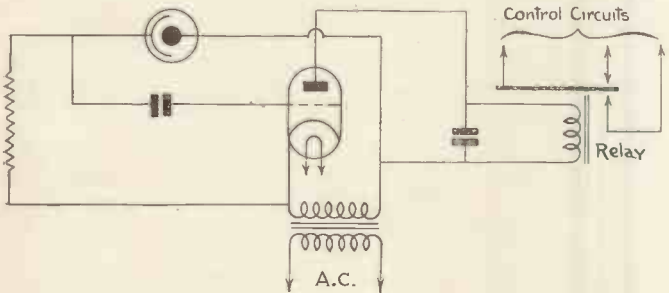

Fig. 2.—The same circuit as Fig. 1 for A.C. operation only.

circuits given below should prove of use to those who wish to develop further uses of the photo-cell.

Fig. 1 is a "trigger" arrange-

possible for any three-electrode valve. If used on A.C., a condenser must be shunted across the relay to prevent chatter, but if used on D.C. this is

illustrated by Fig. 3. It will be noted that the plate of the first valve is connected directly to the grid of the second, therefore, the potential of

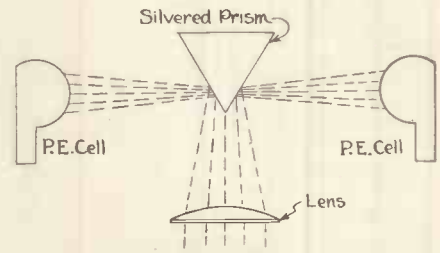

Fig. 5.—A method of translating light into mechanical motion.

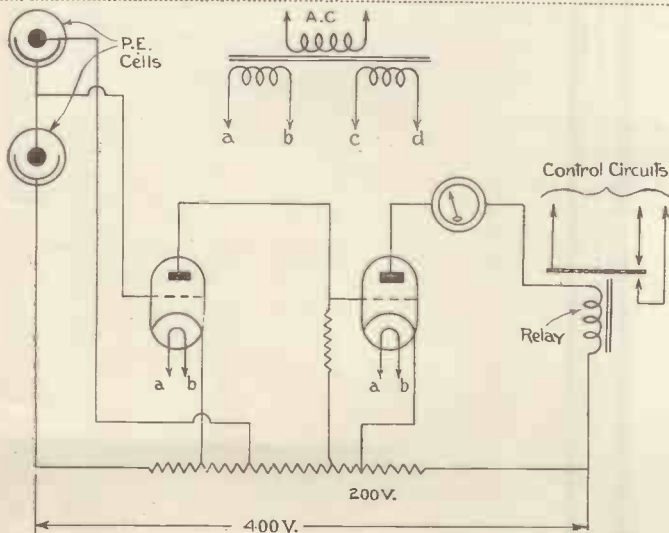

Fig. 3.—An example of direct coupling.

the plate will maintain the potential at the grid of the second valve at the same value. The various voltages employed are taken from the voltage divider shown. The proper voltage conditions on the elements of both valves must be maintained.

Supposing that the plate of the first valve receives its potential from the mid-point of the divider, which is 200 volts; resistor R then serves as the plate load and its value should be about 50,000 ohms. The potential of

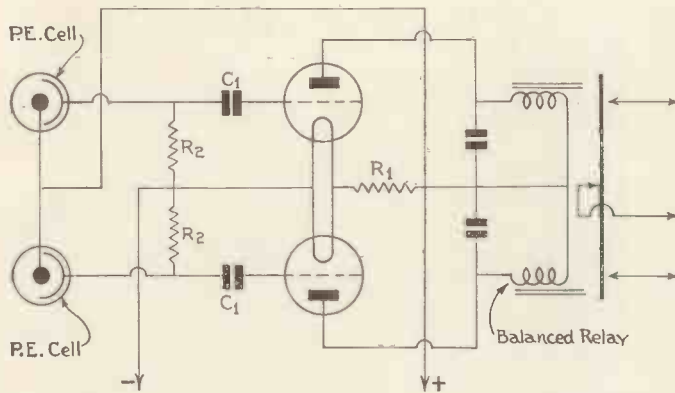

Fig. 6.—Circuit for push-pull operation of relay.

the plate will then be approximately 100 volts (100 volt drop in potential existing across the resistor R). The grid of the second valve also has a potential of 100 volts. The grid bias of the first valve is taken

shown, will result in large changes in the anode current of the second valve. As far as the action is concerned, the output of the second valve will be exactly the same as the output of a one-valve amplifier, except that it will have this added sensitivity.

If applied to a colour matching device, this arrangement is capable of detecting differences in colour or in light intensity, which are far beyond detection by the human eye. It is important that a separate voltage supply be provided for the two filaments, otherwise a leakage will occur

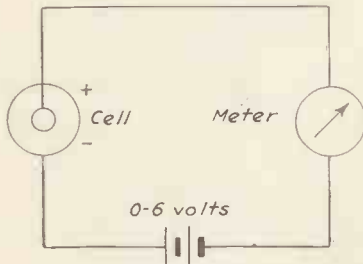

Fig. 7.—Simple circuits using dry cells with light cells.

directly from the voltage divider. The characteristic of the first valve should be such that the cathode should be approximately 15 volts positive with respect to the grid. Since the grid of the second valve is at 100 volts potential, the cathode is then connected to the voltage divider at approximately 115 volts, which will be on the positive side of the plate tap for the first valve as shown.

Very minute changes in the light intensity falling on either of the cells

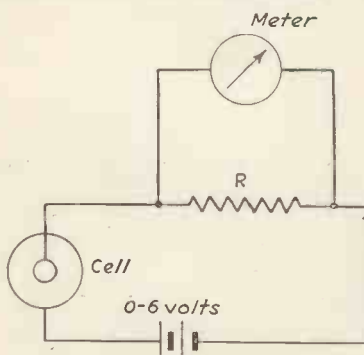

Fig. 8.—Another simple circuit employing a dry cell.

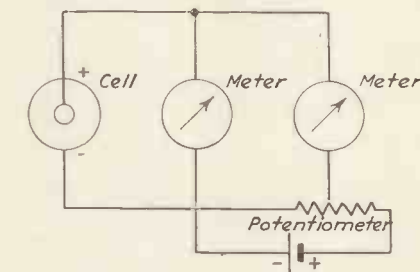

Fig. 9.—Use of potentiometer to buck out dark current. "Journal of Scientific Instruments," April, 1934, p. 125.

between cathode and filament which can cause breakdown in the tube.

Fig. 4 illustrates a useful circuit in which a neon tube is involved. The cell shown is connected in series with a source of supply and a condenser, which may be of any value depending on the speed of operation desired.

As the condenser in the circuit re-

ceives its charge, the potential across its dielectric increases until it reaches the spill-over voltage of the neon tube. At this instant current passes through the tube, thus energising the relay which is connected in series with it and, at the same time, discharging the condenser, thus causing the cycle to repeat.

The speed with which this pulsation takes place is dependent on the capacity of the condenser, which value may range from .005-mfd. to

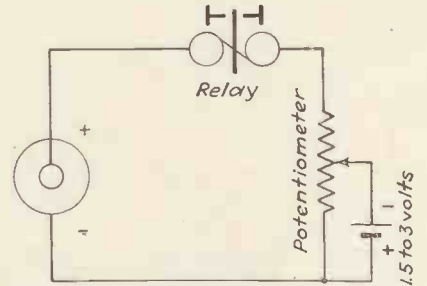

Fig. 10.—Bias circuit to balance out dark current. Taken from "Die Lichtempfindliche Zelle" of H. Geffken, H. Richter and J. Winkelmann.

1-mfd. or more; it is also dependent on the resistance of the cell. The intensity of the light striking the cell may, therefore, be measured by the speed of pulsation of the neon tube and relay.

If the cell is not subjected to a continuous light intensity, but rather to various frequencies (even constantly changing frequencies), the device serves as an "integrator," thus adding up, say, a large number of small flickers of light on the cell or a few large flickers; or even a combination of the two. The conditions may be made such that several pulsations will take place on a single brilliant flicker, while any number of small flickers may be required to cause the same spill-over.

If the condenser value in this circuit is small, its ability to store current is likewise small and it may not

OUR POLICY
The Development
of
TELEVISION

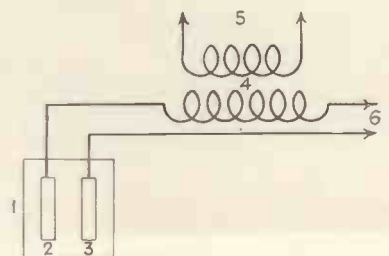

Fig. 11.—Fessenden's Patent 1,899,026, doing away with selenium inertia.

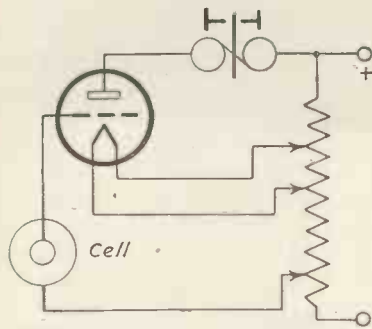

Fig. 12.—Amplifying circuit of Geffken, Richter, and Winkelmann.

be capable of operating a heavy relay.
Light and Motion.

Fig. 5 shows a method by which very small motions of a spot of light can be translated into mechanical motion. In this figure there is a triangular mirror, such as the surface of a prism, having two sides

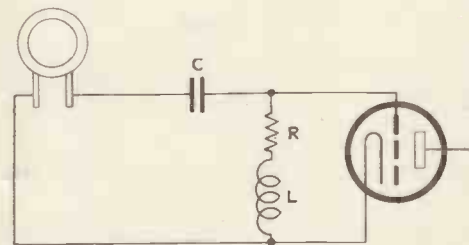

Fig. 13.—A recent amplifier circuit from J. H. Roe. "Review of Scientific Instruments," Vol. 5, p. 441, 1934.

silvered. Light coming from any remote source is collected by the lens and brought to a focus in a line, rather than at a point as in the case of the ordinary lens. Two photo-

cells face the silvered surface of the prism, so that they receive reflected light. If the focused line of light falls directly on the points of the prism, the energy will be reflected on either side with equal intensity, thus energising both cells equally. If this line moves either to the right or left, even the most infinitesimal amount, there is a difference of the light intensity received by the two cells.

If they are employed in a circuit (such as that of Fig. 3), and the circuit is balanced, when this line falls exactly on the point of the prism, then any motion of the line away from dead-centre will result in loss of balance in the circuit, and an indication of its direction.

Providing the cells and the mirror are mounted on the same movable base this combination can be made to

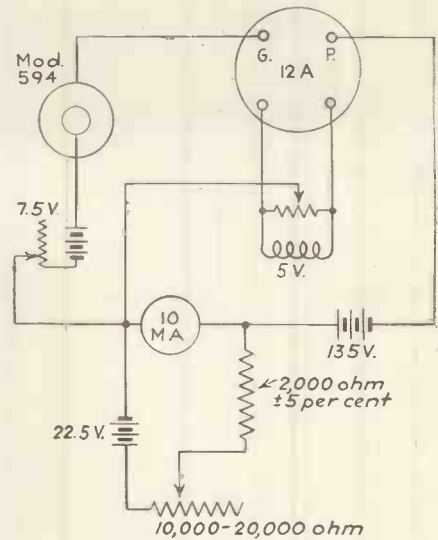

Fig. 14.—Amplifier used with Weston cell. 20 foot-candles will produce an output change of 150 microamperes.

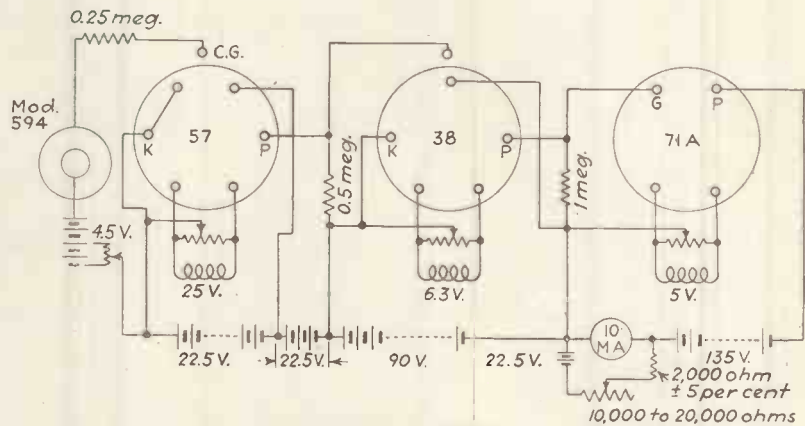

Fig. 16.—Three-stage amplifier for Weston type of cell, one-half foot-candle produces 10 milliamperes current change.

follow the motion of the line by having the circuit control motors or other devices to effect this motion. This illus-

tration applies to constructions in either a horizontal or vertical plane.

It is by such a system that mechanical robots follow the direction of a flash-light beam or that the astronomer can mechanically follow the sun.

Fig. 6 illustrates two simple impulse circuits connected in push-pull, both operating the same relay. The fulcrum of the relay armature is at the centre rather than at the conventional end. A magnetic coil in each circuit exerts attraction on opposite ends of the armature.

With the construction shown, both coils are continually energised unless there is an instantaneous change in the light flux on either cell. With a change in flux, one or the other coils will release, providing both cells are not simultaneously affected. Since both are energised, the armature will remain against that coil to which it is nearer.

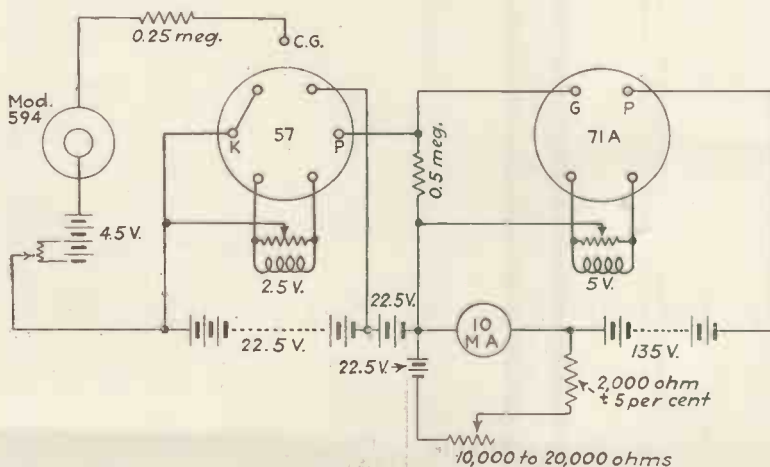

Fig. 15.—Two-stage amplifier for dry-type cells, producing a change of 5 ma with 5 foot-candles of illumination.

SELF-GENERATING PHOTO-CELL CIRCUITS

This principle is often applied in instruments, the motion of the indicating needle intercepting the light striking the cells as it moves from low to high, or vice versa. If the apparatus is arranged to control whatever the needle is giving indication of, then an automatic control between the limits as determined by the spacing of the cells, is obtained.

Self-generating Cells.

Figs. 7 to 16 show circuits employing self-generating cells and they are from a number published in the December issue of *Electronics*. With these circuits it is immaterial which type of cell is concerned, whether of the dry type consisting of a translucent film of metal depending upon contact potential between the metals to conduct the photo-potential, or the type in which a liquid conveys the photo-potential.

Figs. 7 and 8 show cells of these types used in series with applied potentials. For example, in Fig. 7 the cell is connected in series with an e.m.f. up to say 6 volts supplied by batteries. In Fig. 9 and 10 a bucking potential is utilised to balance out the "dark current" so that it will not interfere with the proper working of the circuit, or reading of an instrument.

In Fig. 11 the inertia period of a selenium cell is eliminated, according to R. A. Fessenden, the inventor (U.S. Patent 1,899,026, February 28, 1933). Here the selenium film is at 1 and the electrodes at 2 and 3, in this case two pieces of copper wire $\frac{1}{2}$ in. long. Here the inventor claims a new discovery as follows. If a current of very high frequency (50,000 cycles is referred to in the patent) is connected to the circuit, its rate of flow will depend upon the capacity of the cell which varies with light intensity. But the flow of current will be much greater than if a D.C. circuit is used, and there will be far less time lag ($1/100,000$ second or less). Fessenden states that such a circuit could be used for television purposes.

Various attempts have been made to amplify the voltage or current variations produced in the output of the self-generating type of cell. Fig. 12 taken from Geffken and Richter's book *Lichtempfindliche Zelle* is a typical circuit.

A recent contribution in the use of these types of cells with amplifier circuits for audio frequency purposes is accredited to Roe. The circuit he recommends is seen in Fig. 13. The value of the capacity, resistance and inductance is a function of the frequency response desired. Below frequencies of 1,000 cycles, the capacity of C is 20 mfd.

The circuits in Figs. 14 to 16 are contributions of Weston engineers. They are arranged for the amplification of direct currents and require continuous potentials and no condenser or chokes can be used. The heating of filaments may be by means of individually insulated transform-

ing on the straight line portion of the valve characteristics.

In this circuit particular care must be taken to solder, or otherwise make perfect, all joints. The circuit will usually need to be turned on one-half-hour before use, in order to reach thermal and electrical equilibrium. Line voltage fluctuations on the filament transformers frequently result in drifting.

A Simple Amplifier

A simple photo-cell amplifier having a good characteristic from 10 to 20,000 cycles can be made up as shown by Fig. 17. The total gain is

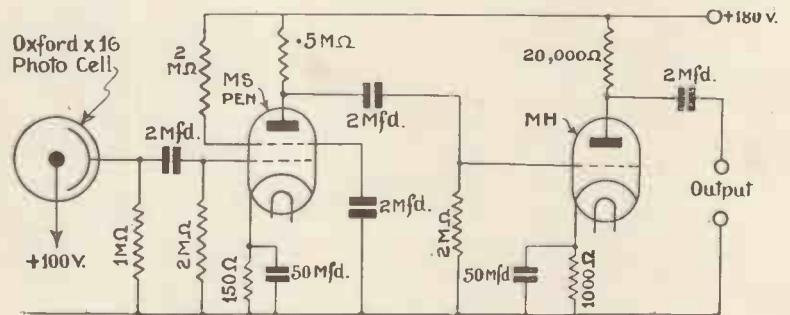

Fig. 17.—A simple amplifier with good characteristics from 10 to 20,000 cycles.

ers, although for stability accumulators are recommended.

In general, the selection of valves resistors, and voltages in these diagrams has been such as to give the largest possible amplification with reasonable stability. A $\frac{1}{2}$ -megohm resistance is shown in series with the cells; this reduces the gain but slightly since the valves are voltage-operated, and serves to safeguard the cell against discharges of various kinds, either due to the amplifier or to accident.

In Fig. 11 a potentiometer is shown across a dry cell for adjusting the initial grid voltage to bring the output current to a value of 3 or 4 milliamperes. This is most desirable since best results are had when work-

about 5,000, and the amplifier will develop a peak voltage of 5 to 10 at the output with a scanning disc in front of the photo-cell and a 200-watt lamp at a distance of 3 to 5 ft.

The cathodes are heated by a 4-volt battery. Mains heating is not satisfactory. The amplifier and the photo-cell must each be enclosed in a metal case and the lead from the photo-cell to the first grid should be as short as possible.

The Tottenham Short-wave Club.

After a period of inactivity owing to unforeseen obstacles, the above club is now prepared to welcome members who are interested in taking part in the arrangements for the season. These include working a series of field days and also experiments to be carried out at the meetings. Further particulars can be obtained from L. Woodhouse, 57 Pembury Road, Bruce Grove, Tottenham, N.17.

BINDING CASES
AND INDEXES
for 1935 are now available.
Price 2/9 post free.

ELECTRONICS AT THE PHYSICAL SOCIETY'S EXHIBITION

THE 26th annual exhibition of the Physical Society at the Imperial College, which concluded on January 9, was, unlike previous years, confined to visitors who had received invitation tickets. This action on the part of the Council was probably dictated by the wish to

instruments and apparatus for research. No research work in television or television apparatus was shown with the exception of the educational display described below, but there were many instruments to interest the radio enthusiast, of which we can only give a brief summary.

vacuum tubes specially designed for television were shown, together with apparatus for research on wave-forms, frequency stabilisation, and internal combustion engines!

The 10-in. tube of the Ediswan Company is shown in Fig. 1. This is available at a list price of £12 net and has a screen giving a creamy fluorescence for reproducing "black-and-white" pictures. The H.T. voltage required is approximately 3,500, and the cathode is indirectly heated from a 2 volt winding on the transformer.

Also on this stand were transmitting valves of 250 and 500 watts dissipation specially designed for short-wave working down to 5 metres, together with a new power amplifier, the ES.100, of 100 watts dissipation, in a hard glass bulb.

Another large cathode-ray tube with a 13-in. screen was seen on the Cossor Company's stand in company with an interesting range of complete cathode-ray tube equipments. Readers will remember that a portable equipment made by Cossor was on view at Olympia last year. The portable mains-operated unit shown in Fig. 2 has now been added to the range, and includes a valve ampli-

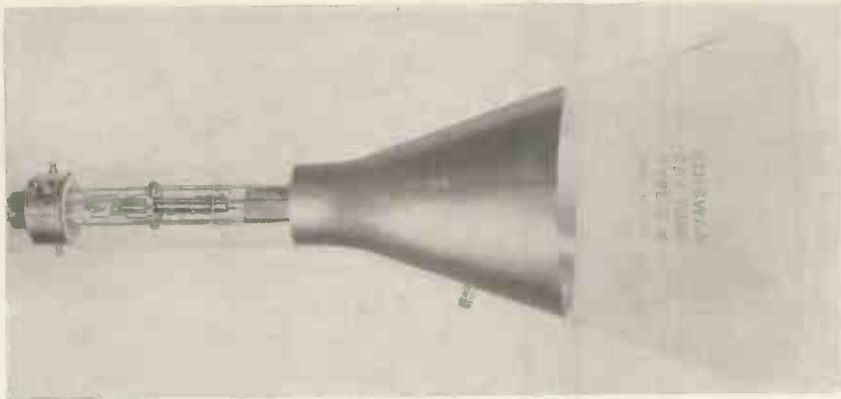

Fig. 1.—The Ediswan 10 in. tube for television, giving black-and-white pictures.

avoid any tendency to commercialisation of the exhibition and to confine it to *bona fide* scientific workers, but it must have deprived many readers from seeing a representative collection of some of the finest British in-

It is interesting to note the rapid development of cathode-ray tubes and apparatus as exemplified by the stands of the Cossor Co., Ediswan Co. and Standard Telephones. A number of large diameter high-



Fig. 2 (left).—Cossor mains operated oscillograph with self-contained valve amplifier.



Fig. 3 (right). — Oscillator for use in ganging I.F. stages in receivers.

fier to increase the sensitivity of the deflecting system. The time-base frequency covers 2 cycles per second to 300 kc. per second and waves of as high a frequency as 100 megacycles can be observed. The price complete is £75.

oscillograph to determine the response curves of I.F. stages or overall receiver performance. The oscillator covers all the normal bands from 90 kc. to 20 mc. and the frequency can be varied over ± 15 kc in exact synchronism with the sweep voltage applied to the horizontal deflector plates. The oscillator can also be modulated externally or at 400 cycles from an internal source, and is thus useful as a signal generator (Fig. 3).

The cathode-ray tube has proved of the greatest use in mechanical engineering in showing the performance of internal combustion engines. The pressure variations in the cylinder are translated into electrical impulses either by a quartz crystal or by discs of resistance material which alter under compression. The pressure unit is made up in a convenient form and screwed into the cylinder head, leads being taken to the tube deflector plates. The horizontal movement of the beam is made proportional to the piston displacement and is obtained from a timing device connected to the engine shaft. The Cossor electronic engine indicator is sufficiently robust to enable it to be used for testing aircraft engines in flight.

A similar indicator equipment was being demonstrated by Standard Telephones on an air compressor (Fig. 4).

The tube can be seen at the top of the photograph, surrounded by a hood to shield it against glare, while

below it is the control unit. The pressure units can be seen at the top of the cylinder head with wires leading to the equipment.

A different type of cathode-ray apparatus is that shown in Fig. 5, manufactured by Messrs. Tinsley. The tube is designed by M. Szegho and the principles of its operation were described in a recent paper before the Institution of Electrical Engineers* by the designer, Prof. Parker Smith, and Mr. Bradshaw. The cathode is "cold," i.e., does not operate at red heat, and the electron stream is produced by the application of a very high potential to the anode. The beam is focused by a magnetic coil. One of the advantages claimed for the tube is long life due to the special construction of the cathode. This is in the form of a sphere of aluminium which is loosely held and can be rotated by tapping the tube. When the surface of the cathode becomes damaged by the electron discharge it is a simple matter to present a new portion of the sphere to the anode. For fuller details the paper referred to below should be consulted.

Very interesting exhibits were found in the research section, where the Post Office had taken considerable space to demonstrate their new loud-speaking telephone. The microphone and receiving loudspeaker are mounted together as one unit, and speech is clearly audible although the

* Journal I.E.E. Vol. 76, p. 656, 1935.



Fig. 4.—The oscillograph equipment used as an engine indicator (Messrs. Standard Telephones & Cables).

The same company were exhibiting a new form of "ganging" oscillator for use in conjunction with the



Fig. 5.—Cold cathode oscillograph of special design made by Messrs. Tinsley.

Fig. 6.—"Electron-Optica Bench" (G.E.C.) with vacuum pump for investigating cathode ray tube performance.

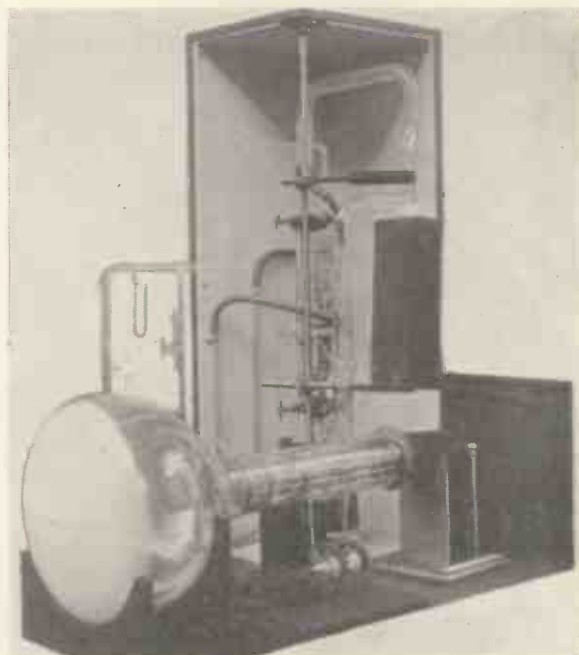
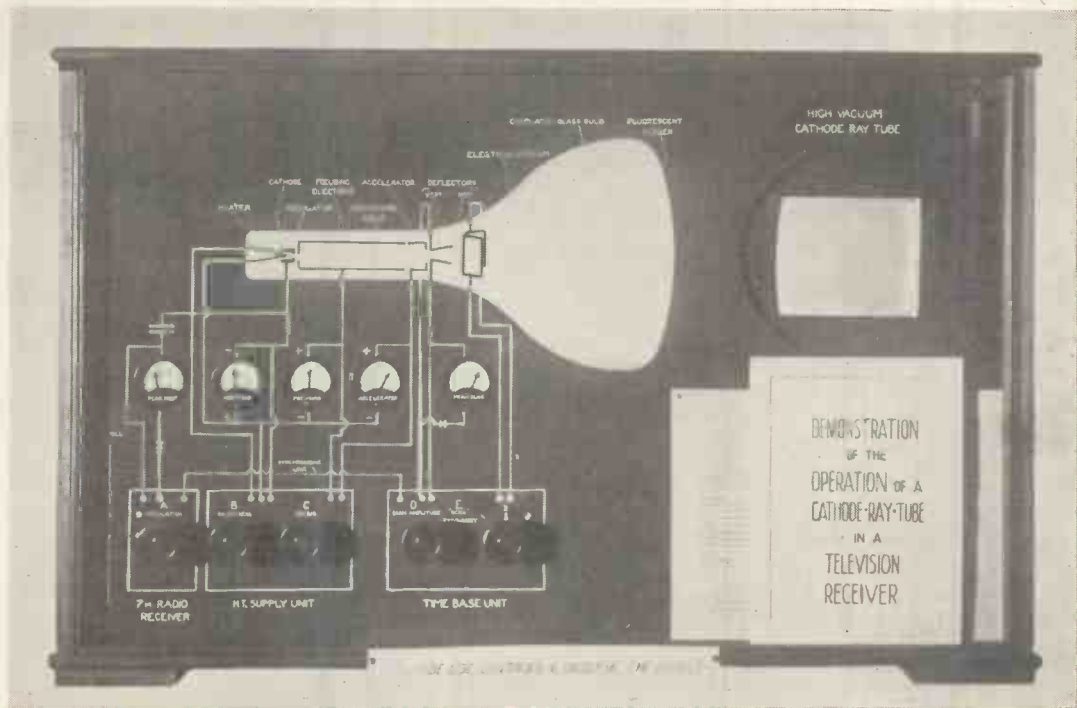

Fig. 7. — Television demonstration board made by the General Electric Co. to show the principles of cathode ray television.



speaker is standing some two feet away and lowering his voice.

The intricate apparatus which comprises the "talking clock" was also on view. It will be remembered that the "girl with the golden voice" spent many hours in recording the time for reproduction on demand by telephone subscribers. The sounds are recorded on a series of glass discs through which light is shone on the conventional photo-cell arrangement. One disc is devoted to the utterance of the hour, the next the even minutes, and finally seconds. The formula heard on the telephone is "At the third stroke it will be . . . hours, . . . minutes and . . . seconds," followed by three pips.

In this section Messrs. Ferranti had an ingenious mechanical model to demonstrate the action of an amplifying valve circuit, and a model of a transmission line to show the various factors which affect the quality of transmitted speech,

The British Thomson-Houston Company in addition to showing the effect of fluorescent materials in mercury vapour discharge lamps had an improved stroboscopic lamp which gave remarkable results. The lamp illuminated three discs rotating at high speed on which were painted various patterns. The characteristics of the vapour lamp which illuminated them were such that they gave the impression of being abso-

lutely stationary, and in one case it was possible to read faint pencil writing on the disc while it was running at several thousand r.p.m.

The General Electric Co. had two exhibits in the research section of interest to the television enthusiast. The first was an "electron-optical bench" which is shown in the photograph of Fig. 6. A cathode-ray tube with a ground glass joint at the lower end of the neck is attached to a mercury vapour pump which maintains a constant high vacuum. The electrodes of the tube are made adjustable and removable so that any combination or spacing can be tried. Twelve rods pass up the tube, making contact with the various electrodes and these are connected to terminals in the base of the tube. The apparatus was designed for investigation into electrode systems and for studying various fluorescent materials, and can be opened up, altered and repumped in the short time of 30 minutes.

The television demonstration board shown in Fig. 7 is another product of the Wembley Research Laboratory of the G.E.C. and is intended for educational work to show the principles of cathode-ray television reproduction. As the photograph shows a large section of a cathode-ray tube is outlined against a black board and the various circuits connected to it are shown diagrammati-

cally by white lines. The controls on the front of the apparatus are arranged to operate a 12-in. tube of which the screen is seen at the right of the board. The behaviour of the real tube is illustrated by the working model, the various potentials being indicated by the meters shown below the tube.

A realistic imitation of the electron beam is produced in the sectional model and the changes effected by the controls can be seen simultaneously on both the real screen and the model. The following operations were illustrated:

Modulation, brightness, focus, picture size, picture and line frequency. It is hard to conceive a more effective demonstration that this working model and it is to be hoped that similar ones will be available for instructional work in the radio industry.

Space does not permit a detailed description of the remainder of the exhibits—the new Kodak "Pola" screen which eliminates glare from objects in front of a camera—precision variable condensers by Sullivan—apparatus for every kind of receiver test by E. K. Cole, and many others. It is hoped that many readers will have the opportunity of visiting this unique scientific exhibition next year and seeing for themselves the way in which British manufacturers keep in the front of the field of radio and engineering development.

DIGESTS AND DATA

ABSTRACTS FROM AUTHORITATIVE CONTRIBUTIONS ON TELEVISION IN THE WORLD'S PRESS

SPECIALLY COMPILED FOR THIS JOURNAL

The Ionosphere, Skip distances of Radio waves, and the Propagation of Micro-waves. By E. O. Hulbert. *Proc. Inst. Rad. Engineers. Vol. 23, No. 12, Page 1492.*

A detailed description of the Ionosphere is given based on the recent measurement of the National Bureau of Standards and the Department of Terrestrial Magnetism of the Carnegie Institution. The main world-wide features of the Ionosphere are as follows:—

“The E and F₁ regions are fairly simple, they lie at about 100 and 200

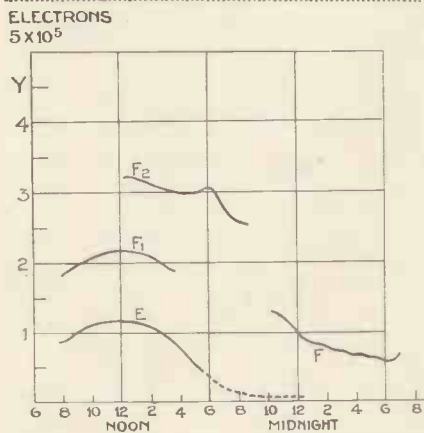

kilometre levels, respectively. The density of ionisation of each is a maximum directly under the sun, so that the E region fades away in the night and the F₁ region is swallowed up on the twilight meridian by the descending F₂ region. The F₂ region is more complicated, it bulges out towards the sun, being 300 to 400 kilometres away from the surface of the earth at its most lofty point, and sinks back to a 250 kilometre level in the twilight zone. Its density of ionisation is always greater and more variable than that of the E and F₁ regions. In tropical latitudes its density of ionisation has two maximum, an irregular one around 10 a.m. and a larger, smoother one, near sunset; in temperate latitudes there is single

maximum in winter and in summer there are two maxima similar to the tropical case, except that often the morning maximum is ill-defined. During the night, apart from irregular ups and downs, the F ionisation density diminishes at all latitudes except for a recrudescence in the small hours of winter morning in temperate latitudes.” The accompanying figure shows the ionosphere at Washington, September, 1933.

It is indicated by theory that successful micro-ray communication up to a distance of 200 kilometres, is due to defraction of the waves over the bulge of the earth and to temperature gradients in the lower atmosphere.

Ultra Short Wave Propagation over Land. By C. R. Burrows, A. Decino and L. E. Hunt. *Proc. Inst. Rad. Engineers. Vol. 23, No. 12, Page 1507.*

It is deduced from theoretical considerations that for ultra-short wave propagation, over level territory, the received field should equal 4π times the product of the aerial heights divided by the product of the wavelength and the distance times the field that would be received for transmission in free space.

This expression was checked experimentally for horizontal polarisation, aerial heights between 2 and 25 metres at frequencies between 17 and 150 megacycles for two distances, namely, 9.4 and 26.3 kilometres. The results obtained from these experiments show that in the absence of detailed information with regard to the transmission path, the formula gives the probable value of the field. It is stated that deviations of an actual path from the ideal should cause proportional deviations in the received field from that calculated by the formula. A mean of the deviations for the two paths mentioned was taken and found to be between three and four decibels.

At very high frequencies and longer distances additional attenuation is introduced. At the distance $d = 5 \times 10^4 \lambda^{2/3}$ metres. It is indicated by theory that the curvature of the earth will reduce the field strength by a factor of about two, beyond this “shadow distance” by the factor $2ka/\pi \sqrt{d^3/\lambda}$ where ka is the effective radius of the earth with refraction and λ is the wavelength, all in metres. That is, the received field is inversely proportional to the seven-halves power of the distance.

A New Receiving System for the Ultra High Frequencies. (In two parts.) By Ross A. Hull. *Q.S.T. Vol. 19, No. 11, Page 10 and No. 12, Page 31.*

This circuit, which has been called “the super-infragenerator,” consists of a cross between a super-regen. and a super-het. incorporating all the good qualities of these two types of receivers and apparently none of the bad, that is to say, it has all the desirable characteristics of a mush-less super-regenerator, together with the adjustable high selectivity of a super-heterodyne.

A New Radio Transmission Phenomena. *Q.S.T. Vol. 19, No. 12, Page 21.*

It is reported here that Dr. J. H. Dellinger, who is chief of the Radio Section of the National Bureau of Standards, has recently called attention to a newly observed periodic variation in radio transmission. This phenomena consists of the complete eradication of all high-frequency long-distance radio signals on the illuminated side of the earth for a period of about 15 minutes, at fairly regular intervals of about 54 days, this is, twice the period of rotation of the sun. This phenomenon was observed on March 20, May 12, July 6, and August 30, 1935.

A very compact rotatable, remote-controlled directional aerial is des-

DIGESTS AND DATA FOR THE TELEVISION ENGINEER

cribed. It is claimed for this system that not only does it give a real gain in transmission, but also that it lessens interference correspondingly when used for receptions.

Complete constructional details are given and also field strength patterns which indicate a high performance, are included.

An All-around 14 Mc. Signal Squirrel. By M. P. Mims. Q.S.T. Vol. 19, No. 12, Page 12.

A method is given of expressing the merit of coils or condensers by sharpness or resonance of the circuit in which they constitute one reactive element. A description is given of the more usual type of intermediate-frequency transformer assemblies and formulae are included for predicting gain and selectivity. A detailed description of a method for obtaining high-fidelity is given.

Photo-radio Apparatus and Operating Technique Improvements. By J. L. Callahan, J. N. Whittaker, & H. Shore. Proc. Inst. Rad. Engineers. Vol. 23, No. 12, Page 1441.

In the introduction to this paper a brief review of the inception and progress of photo-radio up to 1928 is given. Improvements to terminal equipment are described whereby greater fidelity of half-tone transmission over long-distance radio circuits are obtainable.

Distortion in the radio circuit is discussed and methods are suggested for compensation.

Each part of the system is dealt with separately, i.e., the synchronis-

ing apparatus, frequency standard and optical system, etc.

At the end of the paper is an appendix in which is given an analysis of facsimile keying.

Light Sensitive Cell Circuits. Electronics. Vol. 8. No. 12. Page 36.

This article is a collection of material in the possession of Mr. Samuel Wein, who is well-known in America for his extensive library on the photo-electric art. The photo-voltaic cell is described throughout this paper, 13 circuits being given in all. Aspects dealt with include self-generating cells in series with applied potentials, methods of avoiding C bias, and amplifiers for selenium and similar type cells.

The Advantage of Inclining the Deflecting Plates in a C.R. Oscillograph. By W. E. Benham. Wireless Engineer, Vol. 13. No. 148. Page 10.

This consists of a mathematical paper that shows larger deflections of a cathode-ray beam may be obtained by inclining the deflector plates to one another.

In the case where the plates are parallel, the expression for the maximum deflection that can be obtained on the screen is given as

$$\gamma = \frac{V}{2V_1} \frac{Ll}{d} \quad (L \gg l)$$

where V equals deflecting voltage.

V₁ equals gun voltage.

L equals distance of screen from the deflector plates.

l equals length of deflector plate.

d equals separation.

If the deflector plates are inclined at an angle β to the normal direction of the beam, the expression

$$\gamma = \frac{LV}{4V_1 \tan \beta} \log \left(1 + 2 \frac{l}{d} \tan \beta \right)$$

is given as the maximum deflection on the fluorescent screen.

Phase Distortion in Television. By R. G. Shiffenbauer. The Wireless Engineer. Vol. 13. No. 148. Page 21.

This article represents a part of the material that resulted from work that was carried out in 1933 and 1934 in the V.E.I. (All Union Electrical Institute), in order to study distortions to television pictures due to the transmission channels.

It is well known that the transmission of an image may be regarded as the transmission of varying frequency oscillations which have at every given moment a definite phase and amplitude ratio. Of course, when this ratio is destroyed, the distortion is introduced into the received picture.

This article is devoted entirely to the study of the phase distortions at the lowest frequencies that are encountered in the television picture.

The author in his conclusion states that the aim of the experimental work was not to work out universal limits for phase distortions in television, but to throw additional light on to the problem of the influence on the image of phase distortion created in the transmission channels, and to give a method of determining limits for each individual case according to the characteristics of the modulated light source.

REFERENCES OF RECENT LITERATURE

Short and Ultra-Short Waves

Transmission and Reception of Centimeter Waves.—By I. Wolff, E. G. Linder and R. A. Braden. Proc. I.R.E., Vol. 23, No. 1, Page 11.

* * *

Ultra-short Waves in Urban Territory.—C. Burrows, L. E. Hunt, and A. Decino. Elect. Eng., Vol. 54, No. 1, Page 115.

* * *

7-Metre Broadcasting—One Year's Experience at WBen-W8XH.—Electronics, Vol. 8, No. 4, Page 114.

Notes on Propagation at a Wavelength of 73 Centimetres.—By B. Trebor and R. W. George. Proc. I.R.E., Vol. 23, No. 5, Page 461.

* * *

Further Results of a Study of Ultra-short Wave Transmission Phenomena.—By C. R. Englund, A. B. Crawford and W. W. Mumford. Bell System Technical Journal, Vol. 14, No. 3, Page 369.

* * *

Radio Propagation over Spherical Earth.—By C. R. Burroughs. Bell System Technical Journal, Vol. 14, No. 3, Page 477.

The Single Side-band Short-wave System for Transatlantic Telephony.—By F. A. Polkinghorn and N. F. Schlaack. Bell System Technical Journal, Vol. 14, No. 3, Page 489.

* * *

On Super-regeneration of an Ultra-short Wave Receiver.—By Hikosaburo Ataka. Proc. I.R.E., Vol. 23, No. 8, Page 841.

* * *

An Unattended Ultra-short Wave Radiotelephone System.—By N. F. Schlaack and F. A. Polkinghorn. Proc. I.R.E., Vol. 23, No. 11, Page 1,275.

Micro Waves: The Propagation of Electro Magnetic Waves Below One Metre.—By R. W. Corkling. Journal Television Society, Vol. 2, Series 2, No. 1, Page 1.

Aerials

Horizontal Rhombic Antennas.—By E. Bruce, A. C. Beck and L. R. Lowry. Proc. I.R.E., Vol. 23, No. 1, Page 24.

On the Impedance of a Vertical Half-wave Antenna Above an Earth of Finite Conductivity.—By W. L. Barrow. Proc. I.R.E., Vol. 23, No. 2, Page 150.

More on the Practical Operation of Transmitting Antennas.—By W. S. Potter and H. C. Goodman. Q.S.T., Vol. 19, No. 4, Page 21.

Experiments with Directivity Steering for Facing Reduction.—By E. Bruce and A. C. Beck. Bell System Technical Journal, Vol. 14, No. 2, Page 195.

The V-Doublet Noise-reducing Receiving Antenna.—By H. A. Crossland. Journal Q.S.T., Vol. 19, No. 5, Page 29.

A Broadcast Antenna for "Low Angle" Radiation.—By J. W. Labus. Proc. I.R.E., Vol. 23, No. 8, Page 935.

Ultra High Frequency Antenna Terminations.—By W. C. Tinus. Electronics, Vol. 8, No. 8, Page 239.

Antenna Terminations.—By C. G. Dietsch. Electronics, Vol. 8, No. 9, Page 280.

Cathode-ray Tubes

A Method of Electrostatically Biasing the Beam of a High Speed C.R. Oscillograph.—By J. L. Miller and J. E. L. Robinson. Journal I.E.E., Vol. 77, No. 466, Page 567.

Development of C.R. Tubes for Oscillographic Purposes.—By R. T. Orth, P. A. Richards and L. B. Headrick. Proc. I.R.E., Vol. 23, No. 11, Page 1,308.

Luminescent Materials for Cathode-ray Tubes.—By T. B. Perkins and H. W. Kaufmann. Proc. I.R.E., Vol. 23, No. 11, Page 1,324.

C. R. Tube Terminology.—By T. B. Perkins. Proc. I.R.E., Vol. 23, No. 11, Page 1,334.

Valves

Mixing Valves.—By M. J. O. Strutt. Vol. 12, No. 137, Page 59. Wireless Engineer.

The Operation of Superheterodyne First Detector Valves.—Journal I.E.E., Vol. 76, No. 458, Page 227.

Oscillations in a Split Anode Magnetron.—By K. Posthumus. Wireless Engineer, Vol. 12, No. 138, Page 126.

Vacuum Tubes for Generating above One Hundred Megacycles.—By C. E. Fay and A. L. Samuel. Proc. I.R.E., Vol. 23, No. 3, Page 199.

Acorn Type Pentode Announced.—Q.S.T., Vol. 19, No. 5, Page 42.

The Time of Flight of Electrons in a Cylindrical Diode.—Wireless Engineer, Vol. 12, No. 141, Page 310.—By C. L. Fortescue.

Recent Developments in Miniature Tubes.—By B. Salzberg and D. G. Burnside. Proc. I.R.E., Vol. 23, No. 10, Page 1,125.

Television Systems

Television Transmitting Plant.—Electronics, Vol. 8, No. 9, Page 294.

Disc Television in Japan.—Electronics, Vol. 8, No. 10, Page 392.

High Frequencies

The Behaviour of High Resistances at High Frequencies.—By O. S. Puckle. Wireless Engineer, Vol. 12, No. 141, Page 303.

Electrical Measurements at Ultra High Frequencies.—By R. King. Proc. I.R.E., Vol. 23, No. 8, Page 885.

R. F. Insulator Voltage Limits.—By R. Lee. Electronics, Vol. 8, No. 10, Page 353.

The Stability of Inductance Coils for Radio Frequencies.—By H. A. Thomas (N.P.L.). Journal I.E.E., Vol. 77, No. 467, Page 702.

Receivers

Whistling Notes in Superheterodyne Receivers.—By N. J. O. Strutt. Wireless Engineer, Vol. 12, No. 139, Page 194.

Image Suppression in Super-Het. Receivers.—By H. A. Wheeler. Proc. I.R.E., Vol. 23, No. 6, Page 569.

Interfering Responses in Super-Heterodynes.—By H. K. Morgan. Proc. I.R.E., Vol. 23, No. 10, Page 1,164.

Measuring Apparatus

The Development of a Sensitive Precision Wattmeter for the Measurement of Very Small Powers.—By N. H. Searby. Journal I.E.E., Vol. 76, No. 458, Page 205.

A Wattmeter for Communication Circuits.—By K. R. Eldredge. Elect. Engineering, Vol. 54, No. 3, Page 279.

A Peak Volt Meter.—Review Sci. Inst., Vol. 6, No. 6, Page 169.

Miscellaneous

Wide Band Transmission over Balanced Circuits.—By A. B. Clark. Elect. Eng., Vol. 54, No. 1, Page 27.

The Secondary Emission Phototube.—By H. Iams and B. Salzberg. Proc. I.R.E., Vol. 23, No. 1, Page 55.

Barkhausen-Kurz Oscillator Operation with Positive Plate Potentials.—By L. F. Dytrt. Proc. I.R.E., Vol. 23, No. 3, Page 241.

Crystal Oscillators for Radio Transmitters.—By C. R. Booth and E. J. C. Dixon. Wireless Eng., Vol. 12, No. 139, Page 194.

The Transient Aspect of Wide-band Amplifiers.—By O. S. Puckle. Wireless Engineer, Vol. 12, No. 140, Page 251.

Assymetric Side-band Broadcast Transmission.—By P. P. Eckersley. Journal I.E.E., Vol. 77, No. 466, Page 517.

Reducing V.R.M. on 56 Mc.—By C. F. Padlock. Q.S.T., Vol. 19, No. 10, Page 27.

60 Mc. M.O.P.A.—By C. J. Franks. Electronics, Vol. 8, No. 10, Page 375.

The Steady-state Response of a Net-work to a Periodic Driving Force of Arbitrary Shape, and Applications to Television Circuits.—Proc. I.R.E., Vol. 23, No. 11, Page 1,393.

The Broadcast Short-wave Three

We have no hesitation in recommending to our readers this I-V-I receiver for battery operation. It has been designed by NORMAN BRANDON, 2BZN, and is the receiver he now uses when compiling short-wave reports.

IT is my opinion that a three-valve receiver, providing it is carefully built, will suit the majority when it comes to picking up short-wave broadcast programmes. Admittedly more valves give more gain but I am not at all sure as to whether more valves mean more stations, which is really what is wanted.

A three-valve receiver that has been carefully built, not only from the technical aspect, but from the practical point of view, takes a lot of beating. As a general rule I am rather inclined to devote more time to the building of a receiver than to the initial design.

No set can be of any use if tuning is tricky and the dial readings change from day to day. Hand capacity is another defect which cannot be tolerated, while any movement of components or metal chassis invariably spoils tuning.

Several of my latest receivers have

remained of the set. One band-setting condenser and a reaction condenser are fitted to the panel so that the rotors automatically make negative contact. All these small points assist in making an efficient receiver. The panel is more or less self-supporting, but as the slightest movement means capacity change two large panel brackets make sure that it cannot at any time move even a fraction of an inch.

The chassis is made up of a sheet of aluminium 14 by 10 by $1\frac{1}{2}$ ins. 18-gauge metal is quite rigid, but at the same time can be bent without any difficulty, so for that reason any practical set-builder should be able to make up the screen, etc., from the sheet metal.

I have come to the conclusion that several controls on a short-wave set are not a disadvantage. There are six on this Broadcast Three, and all of these can be seen in Fig. 3. On the left is

an aerial preset condenser a coupling coil L1 has been adjusted to give an average degree of selectivity. It is, of course, quite an easy matter to increase or decrease the number of turns on L1 to decrease or increase the selectivity. L2 is tuned with a .0001-mfd. condenser and has a .000025-micro-mfd. band-spreading condenser in parallel with it.

The first valve is a high-frequency pentode of the screened type which has its suppressor grid internally connected. I have used this valve not only for its high sensitivity but because it is interchangeable with any screened-grid valve on the market.

From the 210SPT is connected an un-screened H.F. choke, which is beneath the baseplate, and a .00005-mfd. base-board mounting pre-set. This pre-set should be screwed fully in to give maximum capacity unless the receiver is to be used more or less permanently on

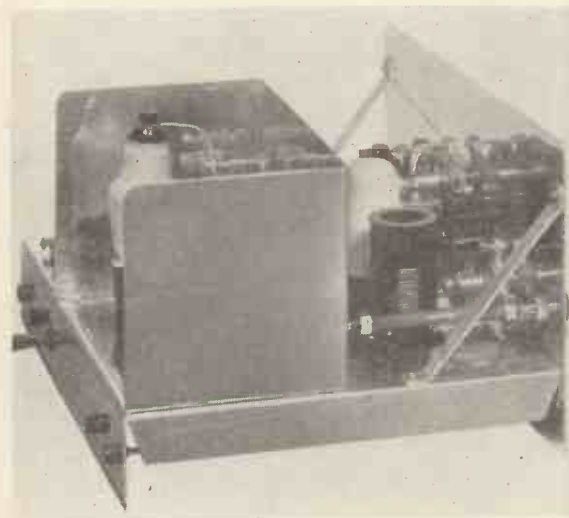

Fig. 1.—This gives a good idea as to the way the receiver has been constructed.

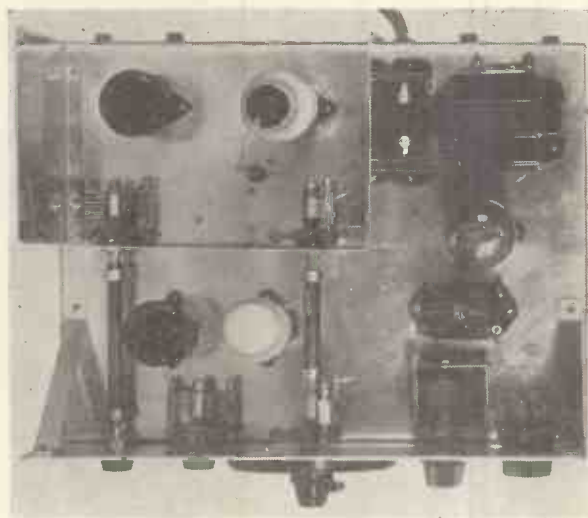

Fig. 2.—Notice the clean layout and complete screening.

been built up on a metal chassis with individual screens, as shown in Fig. 1. In this way one screen gives complete screening between the H.F. and detector and H.F. and L.F. stages. The H.F. pentode, band-spread, and band-setting condensers and aerial transformer are all enclosed within one screen, as shown in Fig. 2. The whole of the baseplate is aluminium as is the panel for this gives almost complete screening for the detector, ensuring total stability.

As the low-frequency stage is to the right of the high-frequency valve this is again effectively shielded from the

the aerial band-setter, then the grid band-setter, the master tuner for band-spreading any narrow band of wavelengths, then reaction and an L.F. volume control. The on-off switch, breaking L.T. positive is of the toggle type and is fitted below the main tuning dial.

Beneath the chassis are the H.F. chokes, small tubular condensers, wire-end resistances, coupling and decoupling condensers. The Raymart H.F. choke can clearly be seen in Fig. 4.

The circuit is more or less conventional, but has one or two little points which need emphasising. Instead of

the higher-frequency bands. For example at 10 and 20 metres this condenser should be adjusted to give level oscillation in the detector stage.

The output from the coupling condenser is fed into L4, which is exactly the same as L2. I have found, however, that according to the way the receiver has been wired, L4 occasionally requires one or two turns less than L2. So if the band-setting condensers do not match up a point to remember is that turns can be removed from L4 until the condensers are correctly balanced.

Reinartz regeneration is used and the

circuit consists of a .0002-mfd. variable condenser, with slow motion drive, plus L₃. One side of L₃ is connected to the anode of the detector, the other side going to earth through the reaction condenser.

L₄ is tuned with a .0001 condenser and has a .000025 band-spreading condenser ganged up with the aerial band-spreader. The idea is that the two separate condensers should be set to a

high-tension side by a .001 condenser. As an intervalve transformer an R.I. Hypermu has been used having a ratio of 1.4. For decoupling a resistance of 40,000 ohms and a condenser of .1 microfarad were found to be satisfactory.

Bias batteries are rather a nuisance for they take up a lot of room and upset the appearance of a good receiver. To overcome the use of this battery, I

put but I do feel that battery economy is rather more important than excessive volume in a short-wave set. [When used as shown with a 7,000-ohm resistance in its auxiliary grid circuit decoupled with a .1-mfd. condenser, maximum output with minimum current is obtained.

A choke-filter output circuit enables headphones to be used without fear of shock, while partial tone correction is



Fig. 3.—These six controls are fully explained in the text.

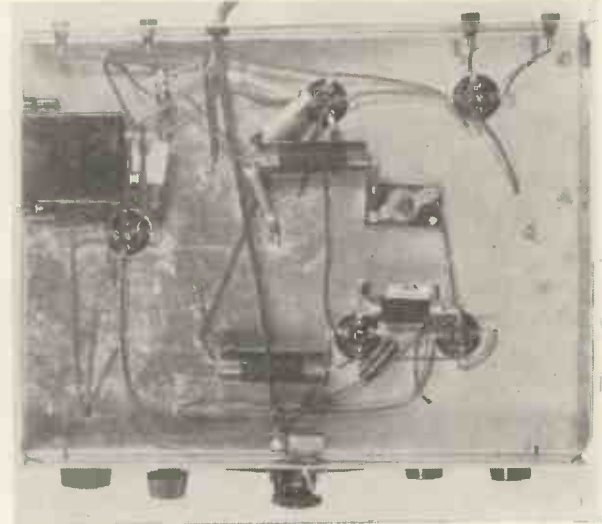

Fig. 4.—Remember to fix all under baseboard components before starting on the remainder of the receiver.

metre or so below the required waveband having the band-spreading condenser set at zero, that is minimum capacity. The required waveband is then tuned by means of the two small ganged condensers so giving the flat tuning required.

Do use an HL2 metallised valve for, from my tests, it gives a very high output with a complete absence of microphony. To obtain smooth reaction on all wavebands it is important to keep to the detector-anode circuit. From Fig. 5 it can be seen that the anode H.F. choke is by-passed on its anode side by a .0001 condenser and on its

have included automatic grid-bias and this is obtained by connecting a 500-ohm resistance between H.T. negative and L.T. negative shunted with a 1-mfd. condenser.

A noise-free volume control is essential on a short-wave receiver, so to make quite sure of this I have used a half-megohm potentiometer across the secondary of the L.F. transformer. There is no appreciable current flow in this circuit, so providing the control is a reasonably good one it will be completely noiseless. The output valve is a Pen-220, a low-current pentode. Unfortunately low-current means low out-

obtained by using a .002 condenser across the output circuit. It is important that the 20-henry low-frequency choke be of the low resistance type for as there is only 120 volts available a percentage of this will be lost across the choke if it is a cheap one and of high resistance.

Two tuning coils are required for each waveband. Fig. 6 shows how the coils should be connected in the coil forms. If the specified B.T.S. coil forms are used no difficulty will be experienced in obtaining the correct spacing, for these forms are grooved nine turns to the inch. The actual wiring data can be obtained from Fig. 7. Take, as an example, the first coil, using L₁ and L₂. For the 20-metre band L₁ consists of three turns and L₂ of seven turns. By decreasing the gap between the windings the receiver can be used on the 160-metre band where approximately 35 turns are required for L₂ and L₄ and 12 turns for L₁ and L₃.

Stations on the 10-metre band can be received, but the number of turns on the coils varies with each receiver. In the original model L₂ and L₄ were two turns each wound at the bottom of the former. L₁ was 1½ turns and L₃ three turns. It can be seen from this that the receiver is really universal and suitable for the reception of both amateur and broadcast stations on all wavebands.

Construction should not present any

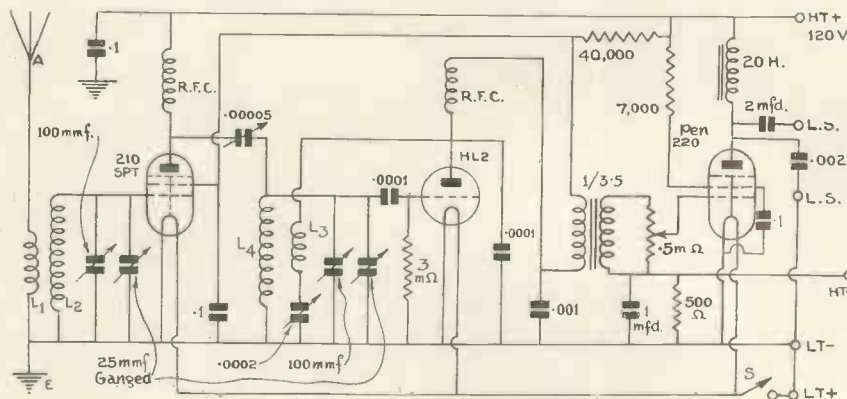

Fig. 5.—The theoretical circuit is more or less self-explanatory and follows conventional practice.

difficulty. First of all drill the panel with a twist drill and fix the brackets. Then mark out the positions for the major components, drill the fixing holes and cut out the five holes to take valve and coil holders. These holes should be cut with a carpenter's centre bit.

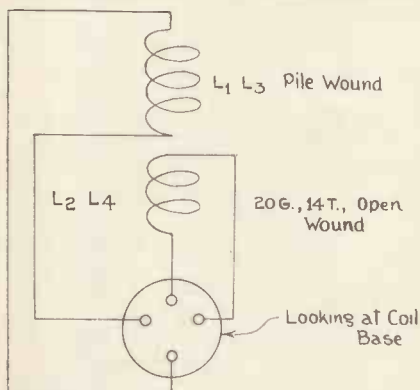

Fig. 6.—Both coils are wound to these connections. This diagram shows the positions looking at the coil base.

The four insulated sockets at the rear of the chassis should then be mounted, also the ebonite bush which takes the four-way battery cord, which can be seen in Figs. 1 and 4. The H.F. screen should be very carefully made with a half-inch lip inside for fixing. This can be seen quite clearly in Fig. 2.

This screen should then be drilled to take the aerial band-setting and band-spreading condensers. The band-setter is coupled to the panel by means of an extension spindle, while the band-spreader is linked up to the second band-spreader in the detector circuit. This can also be seen in Fig. 2.

Do not forget the little components

beneath the baseplate. These should be fitted in the early stages, otherwise they may come underneath a component on top of the baseboard which would cause difficulty. The components referred to can be seen in Fig. 4.

A screened wire is used to connect the high-frequency choke to the top of the H.F. pentode. This goes down through the chassis via a small insulating bush. It can be seen quite clearly in Fig. 2. Although the wiring can be carried out without a soldering iron I do advise all wires to be soldered for it does make quite sure that the wiring will remain tight. A lot of background noise is often caused through loose connections.

As it stands the receiver is quite suitable for use with a mains unit while the extra high-tension from such a unit will not upset the receiver in any way. Neither will the bias resistance value have to be altered, for this, within limits, is self-adjusting.

If a high-tension battery is used pick one that will stand an output of about 12 milliamps, for this will then give reliable service. The consumption from the accumulator is only .4 of an ampere so that a small cell will be entirely satisfactory.

The aerial should be of the inverted L type if possible and approximately 40/50 feet long, while the earth wire should be as short as possible so making a low-resistance aerial system. It

	28-60	13-30	36-96
L ₁	5	3	28
L ₂	13	7	23
L ₃	6	4	8
L ₄	13	7	23

Fig. 7.—Here are the winding details for three wavebands. How to wind the coils for two other wavebands is given in the text.

is surprising how much these results can be improved by using an efficient aerial and earth.

Owing to the construction once a station has been received it will always come in at approximately the same position so that it can be logged for future reference. Commercial stations broadcasting programmes of entertainment value can be heard on all the normal wavebands, with sufficient volume to work a loudspeaker.

I feel sure that the beginner to short-waves or the amateur experienced in short-wave listening will find this little receiver of great use.

A Meter for Short-wave Work

THE Weston Instrument Company's Model 425 thermo-couple ammeter should be of interest to short-wave amateurs and research workers requiring accurate measurement of high-frequency current. It is a 2½-in. instrument in a bakelite case, similar in appearance to their well-known Model 301, and can be obtained in two types:

- Standard max. frequency 80 mc.
- Low loss max. frequency 100 mc.

The low-loss type is capable of use on higher frequencies for a given range than the standard pattern.

Typical ranges and prices are as follows:

Range.	Standard.	Price.		Low Loss.	Price.	
		£	s. d.		£	s. d.
500 mA.	80 MC.	3	8 0	100 MC.	4	13 0
1.0 Amp.	30 MC.	2	18 0	85 MC.	4	3 0
2.5 Amp.	10 MC.	2	18 0	28 MC.	4	3 0
5.0 Amp.	4 MC.	2	18 9	9 MC.	4	3 0

Low-range milliammeters are also available. The accuracy of the standard meters is 2 per cent., and that of the low-loss pattern 2 per cent. when used within the "standard" frequency range. Above this they are 5 per cent., which is more than sufficient for aerial current measurements. These meters are neat in appearance and weigh only 8 ozs. The name Weston is sufficient guarantee of their quality and performance. The maker's address is Kingston By-Pass, Surrey.

The Surrey Radio Contact Club

G5GQ, B. G. Wardman, is to deliver a lecture before the Surrey Radio Contact Club at the Railway Bell Hotel, West Croydon, on February 11, at 8 p.m. The lecture is entitled "High Efficiency Transmitters," which should appeal to all interested in short-wave propagation. G5GQ is well known as an active transmitter and for his work in connection with screen-grid and other multi-electrode valves.

COMPONENTS FOR THE BROADCAST SHORT-WAVE THREE

CHASSIS.

- 1—Aluminium 14 in. by 10 in. by 1½ in., 18-gauge (Scientific Supply Stores).
- 1—Aluminium screen 8½ in. by 4½ in. by 5 in., 18-gauge (Scientific Supply Stores).
- 1—Panel 14 in. by 7 in., 18-gauge (Scientific Supply Stores).

COIL FORMS.

- 6—Standard 4-pin (B.T.S.).
- CONDENSERS, FIXED.**
- 3—1-mfd. type tubular (Dubilier).
- 1—1-mfd. type BB (Dubilier).
- 1—2-mfd. type BB (Dubilier).
- 2—.001-mfd. type 665 (Dubilier).
- 1—.001-mfd. type 665 (Dubilier).
- 1—.002-mfd. type 665 (Dubilier).
- CONDENSERS, VARIABLE.**
- 2—.001-mfd. type 900 (Eddystone).
- 2—.00025-mfd. type 900 (Eddystone).
- 1—.0002-mfd. type 957 (Eddystone).
- 1—.0005-mfd. baseboard trimmer (J.B.).

CHOKES, HIGH-FREQUENCY.

- 2—Type CHP (Raymart).

CHOKES, LOW-FREQUENCY.

- 1—Type B8 (Ferranti).

DIALS, SLOW-MOTION.

- 1—Type standard (B.T.S.).

HOLDERS, VALVE.

- 4—4-pin type V5, less terminals (Clix).
- 1—5-pin type V5, less terminals (Clix).

PLUGS, TERMINALS, ETC.

- 4—Insulated plugs and sockets types 11 and 12 (Clix).
- 2—Wander plugs marked H.T. pos., H.T. neg. type 14 (Clix).
- 2—Spade terminals type 4 marked L.T. pos., L.T. neg. (Clix).

RESISTANCES, FIXED.

- 1—40,000-ohm. type HW 32 (Bulgin).
- 1—3-megohm type HW 35 (Bulgin).
- 1—7,000-ohm. type HW 12 (Bulgin).
- 1—500-ohm. type WE 2 (Bulgin).

RESISTANCES, VARIABLE.

- 1—5-megohm potentiometer type SL (Erie).

SUNDRIES.

- 2—Panel brackets type PB3 (Bulgin).
- 2—Moulded knobs type K58 (Bulgin).
- 2—Dials type 1032 (Eddystone).
- 2—Extension shafts type 1008 (Eddystone).
- 1—Micro-denser ganging piece (Eddystone).
- 1—Coil screened wire WS 2 (Bulgin).
- 1—4-way battery cord type BC 2 (Bulgin).
- Connecting wire and sleeving (Goltone).
- Small quantity 6 BA nuts and bolts (Scientific Supply Stores).
- 1—Insulating pillar type 1019 (Eddystone).

SWITCH.

- 1—Type S80 (Bulgin).

TRANSFORMER, LOW-FREQUENCY.

- 1—Type Hyper-Mu 1/3.5 (R.I.).

ACCESSORIES.

ACCUMULATOR.

- 1—Type DFG (Exide).

HIGH-TENSION BATTERY.

- 1—Type standard 120-volt (Vidor).

HEAD-PHONES.

- 1—Pair 2,000-ohm. (Ericsson).

LOUD-SPEAKER.

- 1—Type Baby (W.B.).

VALVES.

- 1—210 SPT met. (Cossor).
- 1—HL2 met. (Mazda).
- 1—Pen 220 (Mazda).

Transmission for the Beginner

By Kenneth Jowers

This is the second article in this series for the beginner. The first article giving fundamental circuits appeared on page 731 of the December, 1935, issue.

IT is surprising how many amateurs are still without any source of mains supply, either A.C. or D.C. Consequently the simple circuits published from time to time for mains operation are of little interest to these readers.

After experimenting with a very simple battery-operated portable transmitter, I realised that the circuit would probably interest those who would like to experiment with short-distance trans-

The high-frequency choke and 15,000-ohm resistance across the crystal are of the ordinary receiving type, which will probably be on hand already. Then comes the oscillator valve. This should be of the PM2DX or L2 type.

L1 is the anode coil tuned by a .00025 condenser. This circuit should be tuned to the frequency of the crystal. Actually a plug-in 40-metre coil,

this circuit so that one milliamp. meter will do for two purposes, but if a spare meter reading from 0-10 milliamps. is available this can be connected permanently in circuit in place of the jack.

The junction of L1 and the high-frequency choke is connected to earth through a .002-mfd. fixed condenser of the 250-volt working mica-dielectric tag type. The condenser from the anode of the PM2DX to the grid of the P625 is of a similar type.

Notice that in the grid circuit of the P625 there is a high-frequency choke in series with a grid bias battery, whereas in the oscillator circuit a fixed resistance takes the place of the bias battery. Actually bias can be obtained automatically in both circuits but for the amateur who is not experienced a bias battery is much more convenient in the beginning. L2 is another 40-metre coil but should preferably be made of 20-gauge tinned copper wire on a 2½-in. former. These dimensions are not at all critical providing the coil will tune to 40 metres. Ten turns of 20-gauge wire spaced about an ⅛ in. will do excellently. A tapping is taken from the exact centre to one side of the high-frequency choke which is by-passed to earth with a .002 condenser.

From the H.T. side of this coil a .000025 midget condenser is connected to the grid of the P625.

In normal circumstances L3 is loosely coupled to L2 and connected to a transmitting aerial, cut to wavelength. As, however, this transmitter is intended

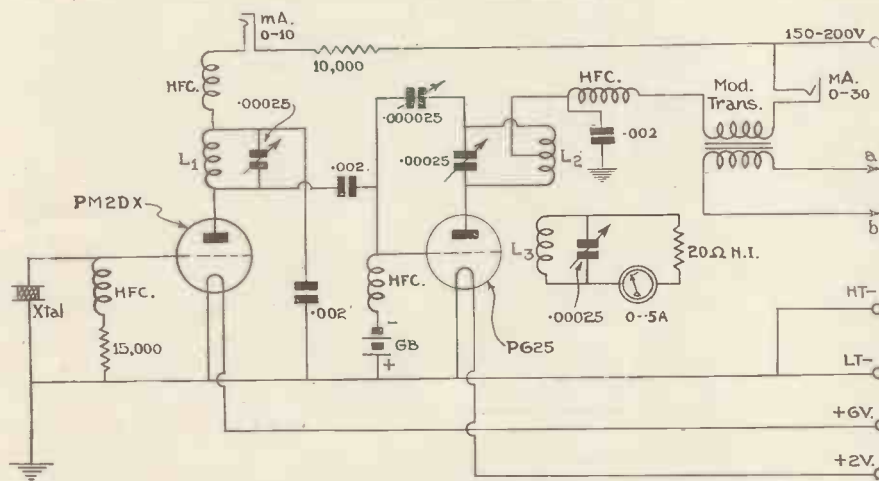

Fig. 1.—Only two valves are used in the transmitter circuit and these are inexpensive.

mission. There must be quite a number of short-wave fans who are not sufficiently interested to study for a full transmitting licence, but at the same time would like to know a little more about signal propagation.

The transmitter to be described uses two valves plus three valves in the speech amplifier circuit. Fig. 1 gives the actual line-up for the transmitter. It consists of a crystal, to determine the frequency, a medium-impedance triode valve as an oscillator and a triode valve of the P625 class as a power amplifier. The crystal is rather an expensive component costing anything between 15s. and 30s., but it really is most important that it be used, otherwise the frequency can never be relied upon. A licence to build this transmitter for use with an artificial aerial can be obtained from the Post Office for 10s. It can be used on 160, 40 and 20 metres, but as little experimental work can be done on 20 metres I advise amateurs to concentrate on 160 or 40. Assuming that the 40-metre band is decided upon, purchase a crystal, suitably mounted, within the wave-band allocated by the Post Office.

which can be obtained from B.T.S. or Eddystone, will be found quite suitable, while the .00025-mfd. condenser is of the type normally found in a broadcast receiver. The high-frequency

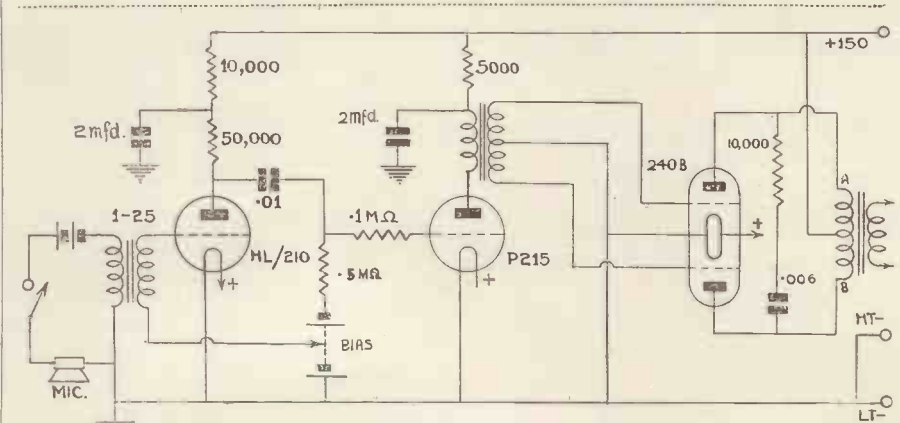

Fig. 2.—This is the speech amplifier and modulator circuit. The output valve is of the class-B type.

choke in the anode circuit of the oscillator is also of the receiving type. A plug and jack has been arranged in

for those not having a full licence, an artificial aerial must be included if any

(Continued on page 89.)

Scannings and Reflections

By THE LOOKER

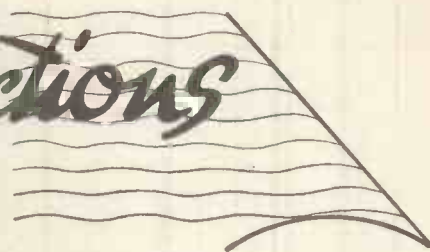

Justifying the Service

IN the course of a conversation with Sir Noel Ashbridge, the B.B.C.'s Chief Engineer, the other day, a most interesting point was raised. If a costly experimental service had to be justified by sales of television receivers, it is questionable whether, in the early months, the service could be maintained. Speaking in general terms, there are no receivers in the hands of the public capable of receiving high-definition television. The manufacturers are working more or less in secret at the moment and getting ready, but it is idle to pretend that there is any appreciable number of adequate receivers ready at this moment to receive broadcast television. Sir Noel told me, however, that in his opinion, the experimental service will be justified for some considerable time irrespective of sales. The service itself, if it is on the right lines, will create the demand for the receivers, and with the demand will soon come the supply. This is in the natural order of things; give the public something to look at, they will naturally want to see it and the means of seeing it will promptly come in the ordinary course of commerce.

The Question of Range

Sir Noel Ashbridge says that the range of London's television station can be safely put at 25 miles. Very safely indeed, I should say. But he points out that reception is certain to be patchy and there will be spots within the 25-mile range where reception will be poor and, just as surely, places well out of the 25 miles where reception will be good.

The Choice of System

As everybody knows, the introductory service will be worked by two systems—the Baird and Marconi-E.M.I.—operating in alternate weeks. But it does not follow that these are the only systems which the B.B.C. will try. The choice or change of system is entirely one for the Television Committee under

whose general instruction the B.B.C. is working. In the course of conversation, Sir Noel Ashbridge made the point that if any new systems are developed it is probable that they will be tried out in the provinces, although as far as present intentions go it is not proposed to erect any provincial stations until the B.B.C. has had a full year's experience at the Alexandra Palace.

By the way, both of the initial systems of transmission will use the same sound transmitter and, of course, the same transmitting aerial. Work on the erection of the aerial-mast is just beginning. The internal alterations to the Alexandra Palace are all but complete and the first of the gear is about to be installed. I learn that Baird's are building their plant at the Crystal Palace, and Marconi-E.M.I. are building theirs at Hayes, Middlesex, and at the Marconi works, Chelmsford.

A Television Party

There was a television party at the London Press Club a couple of months or so ago, as readers of TELEVISION AND SHORT-WAVE WORLD will remember. Now I hear that Lady Selsden, whose husband is Chairman of the Television Committee, is proposing to give a private television party at a date to be chosen in the very early weeks of the experimental service.

"Make-up" for Televising

Mlle. Suzanne Bridoux, who was the first lady to be televised from the new Paris-P.T.T. television station, says that blondes and people with angular faces "go over" badly. Angular faces throw shadows which give the effect of side-whiskers, which reminds me that two or three years ago television had the trick of adding a moustache to people possessing a rather prominent nose. Mlle. Bridoux says that the technique of make-up has altered in the last two years; then, all she did was to accentuate the line of the lips and eyes with the same pencil—rouge—which, she

says, caused the lips to show white when transmitted. After that, green eyes and lips were tried. Experimenting is still going on, but at the moment the popular make-up consists of violet lips, red eyelids, dark red complexion, eyes elongated outwards, dark eyebrows. Apparently, the cheeks are not touched-up with rouge.

"Visiogenic"

Mlle. Bridoux says that the most "visiogenic" face (the B.B.C. calls it the "photogenic" face) is round, with a dark complexion and dark eyes. "Television is capricious," says she, "and it is not always the most beautiful women who televise the best."

The Coming Programmes

Many statements have been published of the B.B.C.'s intentions with regard to the television programmes, but at the moment all programmes put forward are merely suggestions in which there is the element of guessing and it is quite certain that there will be considerable modification brought about by circumstances and experience. Obviously, there can be no thought of any standardised programme for the whole country until very considerable working experience has been obtained.

Renewal of German Service

On January 15 the German Broadcasting Company re-opened their regular high-definition television service in Berlin. Sight is broadcast on 6.772 metres and sound on 7.053 metres. Programmes consist of direct television of light entertainment by well-known artists and of excerpts from latest film releases together with actuality films. Definition is 180 lines and the number of frames per second remains at 25. The addition of direct television which permits of the transmission of head-and-shoulder pictures of one person or the two heads of two persons greatly enhances the entertainment value of the programme. The German Post-Office, which is now solely

MORE SCANNINGS

responsible for the entire technical side of the service, intend fitting a new type of photo-cell to the direct television apparatus within the next few weeks and this will permit of groups of up to three people being televised.

The opening programme, which lasted about an hour and a half, featured the well-known German "compère" and humorist Willi Schaeffers, Else Elster treated listeners to the latest popular songs whilst Carl de Vogt provided entertainment with songs which he accompanied himself on his lute. In contrast to the Paris television broadcasts, the direct television apparatus used does not require the thousands of candle-power of light. The person to be televised sits in a small, dark cabin, and only notices a slight flicker as the scanning ray passes over his head and shoulders.

Experimental

The authorities have publicly declared that the television service is *purely experimental*, but that they hope the public will make full use of the free facilities provided in eleven public televieing rooms in various parts of the city to witness the programmes. These are broadcast daily from 8 p.m. to 9 p.m. and are repeated from 9 p.m. to 10 p.m. To accustom Berlin listeners to ultra-short-wave broadcasting ordinary sound programmes relayed from the Deutschlandsender are broadcast daily from 5 p.m. to 7.30 p.m. and from 10 p.m. to midnight. (Berlin local time).

Receivers are not available to the public at the present moment in view of the various technical improvements which it is hoped to realise in the course of the year. Higher definition is aimed at and the question of interlaced scanning is under consideration.

Foreigners Excluded from Viewing German Television

The Telefunken Company was able to complete the two new German high-definition television transmitters to take the place of those destroyed by the fire last August, in three months' time. On December 23 these were handed over by the German Post Office to the Ministry for Propaganda for operation by the Broadcasting Company. Foreign

press representatives were excluded from those invited to witness the proceedings in some of the Berlin public televieing rooms. The German Ministry of Posts stated that this was owing to reasons of German national defence.

The transmitters are situated at the foot of the Berlin-Witzleben radio tower and vision is broadcast on 6.772 metres, sound on 7.053 metres. The pictures are of 180-line definition with 25 frames per second. The power of the transmitter is the same as that of the old Witzleben installation, about 16 kW anode dissipation in the last stage.

The German Broadcasting Company's extended high-definition programme service was officially inaugurated on January 15, 1936. The Deputy Director of German Transmissions, Herr Boese, who is in charge of the programmes, has appointed a well-known Berlin actress as television announcer. Scenes scanned directly will be broadcast as well as films.

Film Interests Apprehensive

As I have already pointed out in earlier issues, the film interests are somewhat apprehensive regarding the effect of television on their industry—very prematurely, as I think—and they have arranged to restrict the broadcasting of feature films, but we understand there has been no actual contact between the B.B.C. and the interests concerned. The B.B.C. does not wish to televise long films, its present intention being to put over three-minute excerpts. But the possibility is borne in mind of the B.B.C. having to make its own arrangements for the production of suitable films should there be difficulty in obtaining these from the usual sources. The making of films for the special purpose of television would prove an extremely costly business. The estimate is from £1 to £2 per foot, and it is thought that to cover the field thoroughly the annual cost of specially produced films might approximate £120,000 per annum.

Will Television Borrow Much from the Films

I hear that D. H. Munro, the television production manager, is going to study film production at Shep-

herds Bush, and I am led to wonder if there is not a tendency to regard film production and television as being too similar. We must not forget that in television one has to present the programmes continuously while in film production a scene rarely lasts more than a minute or so, with colossal breaks in which all apparatus can be arranged.

Quality of Sound Broadcast

Sir Noel Ashbridge told me that the sound broadcast from the Alexandra Palace will be of better quality than the ordinary B.B.C. broadcast, but made the point that the *received* quality must be dependent upon the design of the receiver, and in the case of the ultra-short-waves, which will be employed in the Alexandra Palace transmission, this design raises some very difficult problems owing to the high frequencies involved.

Starting Date

The latest information bears out the statement made many months ago in TELEVISION AND SHORT-WAVE WORLD—and, by the way, made by TELEVISION AND SHORT-WAVE WORLD alone—that the new station will be in going order in March, when the first tests will be made. The B.B.C. expresses its opinion that the progress so far made indicates that this date will be kept. Provisionally, a test period of two months has been allowed for and there is every hope that the full service will be in operation not later than June.

In Sweden

Sweden, taking its systems and apparatus from the German Telefunken, is erecting a 12-kilowatt ultra-short-wave transmitter for television, and purely experimental transmissions are expected within the next few months.

In the U.S.A.

I learn from the American *Radio Craft* that National Broadcast Chain engineers have been dismantling the old television equipment in the tower of the Empire State Building, preparatory to installing new and modern equipment which will shortly be in operation. The plan calls for the manufacture of some 500 receivers of four different designs (giving 9 in. × 10 in. pictures) which will be placed in research outposts

AND MORE REFLECTIONS

and the homes of observers to facilitate a complete check on the system. It is expected that one of the four designs will be chosen for manufacturing purposes. The images will be sent out over a 15 kW transmitter on a wavelength of about 6 metres.

Viewing Rooms

The B.B.C.'s present intention is three transmission periods each day, namely, 3 p.m. to 4 p.m. in the afternoon, 6.15 p.m. to 7.15 p.m., and 9.30 p.m. to 10.30 p.m.—three hours in all, and the B.B.C. are inviting the big stores, newspapers, radio manufacturers, etc., to arrange viewing rooms each accommodating about 20 people, where the public can taste the quality of the new service. And the B.B.C. propose to adapt the programme accordingly by introducing as many topicalities as possible in their programme. It is hoped that at least 20 or 30 of these viewing rooms will be at the service of the London public.

The Photo-cell for Testing Oil

A new use for the photo-electric cell is the testing of oil that has been used in motor cars.

Oil in a crank case is subject to many sources of contamination, such as carbon, metallic particles, road grit and sludges from the breakdown of the oil itself. When this contamination reaches a certain point the oil should be drained and replaced. In the new device a sample of the oil is placed between two colour filters located a certain distance apart. A source of light illuminates this uniform section of oil, the amount of

light that penetrates to reach the light-sensitive surface being read on a meter, and according to the reading, it is claimed, the conditions of the oil can be ascertained.

"Some Television Developments"

Under this title Mr. Geoffrey Parr, a member of the Edison Swan technical staff, and a well-known contributor to TELEVISION AND SHORT-WAVE WORLD, addressed the Midland Radio Luncheon Club at Birmingham recently. His address ranged generally over the subject of television, but in view of the special character of his audience had particular reference to servicing.

Dr. Zworykin Coming to London

Dr. V. K. Zworykin, inventor of the electron multiplier and television "electric eye," developed by the Radio Corporation of America with which the Marconi-E.M.I. is associated, has responded to a cabled invitation of the Institution of Electrical Engineers to lecture before the Wireless Section in London on February 5, states *Wireless World*. Dr. Zworykin had intended to deal with the applications of electrical and optical systems, but it is hoped that he will be induced to discuss his electron multiplier. This is his second visit to London.

Still 30-line in Australia

Many inquiries are being received by the trade from abroad for tele-

vision apparatus, particularly transmitters of a simple type. Australia appears to be specially interested and one experimental station is in operation there. The system is a duplicate of the B.B.C. 30-line 12-pictures per second and the station is in the old Brisbane Observatory Tower and operates for an hour each day on 151 metres.

Secret Facsimile Transmission

A method of secret facsimile transmission for telephone lines and radio was announced last month by the famous French television pioneer—Edouard Belin. He has presented his invention to the French War Department and guarantees that messages, even though they are intercepted by wire tapping or radio reception, will be so garbled that they will be absolutely incomprehensible to the unauthorised receiver.

Physical Society's Exhibition

As usual this proved a most interesting event, although unfortunately no television was exhibited, but only cathode-ray tubes and associated equipment. As one interested in television I spent most of the time at the exhibit of Kodak's Pola Screen, a gelatine type of filter which obscures polarised light. Two sections of the screen can be used like a pair of Nicol prisms. Unfortunately, the Pola Screen appears to have arrived rather late for television unless there is a revival of the Kerr cell light valve. However, bear it in mind the next time you want to produce polarised light.

"Transmission for the Beginner"

(Continued from page 86).

serious experiments are to be undertaken. L₃ should be a coil of the same dimensions as L₂ but without the centre tap. It is tuned with a 00025-mfd. condenser and has a 20-ohm non-inductive resistance and a ½-amp. hot-wire meter in series across the coil. In this way R.F. can be measured just as if it were being sent out.

If the transmitter is to be used on 160 metres no alterations need be made except that L₁, L₂ and L₃ have to be much larger and suitable for this waveband. As a guide, approximately 35-turns will be required on a former of about 2½-in. diameter. The four high-frequency chokes can be home-built without any difficulty. An article describing the construction of suitable

chokes was published on page 212 of the April, 1935, issue. Suitable coils were described on page 611 of the October issue, while those who wish to save 15s. by making their own crystal holder will find just how to do this on page 488 of the August issue.

The use of P625 is suggested simply because it is such a stable valve and it is economical in use. However, it would not mean any alterations to use a smaller valve, such as the P240 type.

The amplifier for this transmitter is quite simple and follows conventional receiver practice. It consists of a carbon microphone with its own built-in transformer coupled to an HL/210 triode valve. This is R.C. coupled to a P215 used as a driver valve for a Cossor 240B amplifier. With this circuit more or less full modulation will

be obtained with quite a reasonable current consumption. Before connecting the amplifier to the transmitter connect the loudspeaker across the points marked A and B and check for quality. If this is satisfactory then the points marked A and B should be connected as shown. Actually the output transformer has its secondary connected in series with the H.T. supply to the P625. Do not get confused and imagine that two transformers are necessary.

This transmitter is suitable for use from H.T. accumulators or large-capacity dry batteries, but of course those who have D.C. mains or an A.C. mains unit available can obtain even more satisfactory results. A maximum output of about 6 watts can be obtained which is ample for most experiments.

PHILIPS PHOTO-ELECTRIC CELLS

WITH NOTES ON CELL CHARACTERISTICS AND OPERATION



Philips' Vacuum Cell.

etc.); this metallic coating emits electrons when light impinges upon it. Should the potential of one electrode be positive compared with that of the other, a flow of electrons will occur from the less positive electrode to the other—the anode.

The Vacuum Cell

The anode current of the vacuum cell is dependent only on the intensity of the impinging light. The fact that the relation between anode current and the light—i.e., the sensitivity—is constant with anode potentials from 70 volts upwards, renders vacuum cells particularly suitable for accurate measurement and for use in photo-electric amplifiers.

The Gas-filled Cell

In a gas-filled cell, collisions occur between the gas particles and the electrons emitted by the cathode. As soon as the latter have attained a certain velocity, further electrons will be liberated from the gas-particles and will pass to the anode; each denuded gas particle, having become a positive ion, passes to the cathode.

The value of the anode voltage determines whether, after the first impact, the secondary electrons have sufficient velocity to atomise in their turn the gas particles, etc. The collisions increase in number as the anode voltages is raised and, at the same time, the number of ions having sufficient velocity to separate elec-

trons from the cathode, on collision therewith, increases.

If this tertiary production of electrons is equal to the primary flow which produced the ions, a continuous electron-current, limited only by the resistance of the circuit, will ensue; a glow discharge will then occur in the cell, or, with small resistances, an arc discharge. These phenomena have a detrimental effect upon the photo-electric cell and, therefore, an anode-voltage which may not be exceeded is fixed for each gas-filled cell. In addition, a resistance of about .1 megohm is to be connected in order to afford protection against arc discharges. These actions, of course,

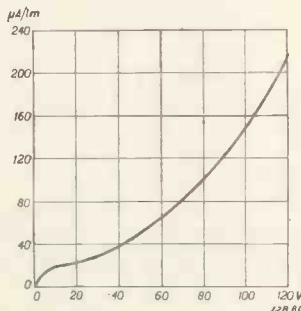

Curve showing sensitivity as a function of anode potential.

are common to all photo-cells of this type.

The diagram indicates to what a high degree the sensitivity of the gas-filled cell increases when the anode voltage is raised. A potential of 100 volts may safely be applied on the anode without having any detrimental effect on the life of the cell. A voltage of 120 is permissible when the lighting is faint (under .02 lumen). In order to facilitate adjustment it is advisable to make the anode voltage adjustable by means of a potentiometer. If the cell has been exposed to light for a considerable period its sensitivity may have decreased. Such decrease will be of a temporary nature, however, as the cell recovers entirely when placed in the dark.

It will be clear that the gas-filled

cell exhibits much higher sensitivity than the vacuum cell if the loads are equal. For this reason it is suitable for purposes which call for large variations in photo-electric current, rather than a high degree of accuracy.

The sensitivity of photo-electric cells is not identical over the whole range of the spectrum, but is always greatest in one particular wavelength band. When the cell has a potassium coated cathode it is especially sensitive to green light (5,400 Å); with caesium coating it is chiefly sensitive to infrared (7,000 Å). It is, therefore, necessary to consider the colour of the light which will fall on the cathode when selecting the type of cell to be used. The sensitivity of the Philips photo-electric cell is based on a colour-temperature of 2,600° K.

The photo-electric cathode is able to follow light-fluctuations of almost any speed. The vacuum cell has a very small self-capacity and has therefore practically no inertia; the inertia of the gas-filled cell is somewhat greater, but it can efficiently follow fluctuations of 10⁵ Hz.



Philips' Gas-filled Cell.

Bulgin Anode Connectors.

SEVERAL new anode connectors have been added to the already extensive Bulgin range of gadgets. Model P41 is a simple clip-on adaptor to which a wire can be clamped or soldered. It has been priced at twopence for three. A similar type of connector, but fitted with an insulated sleeve, costs 1d. and is designated the P43. A third model, fitted with a screw-head and called the P66, costs 3d.

Two further top connectors are available for plug-top valves, one with a shallow cap to prevent short-circuits through metal coating, and the second with a deep cap so an earth return can be made through the coating when required. They have been designated P64 and P65 respectively and cost 6d.

THE DEVELOPMENT OF THE SCANNING CIRCUIT FOR CATHODE-RAY TELEVISION—III.

By G. Parr.

SYMMETRICAL DEFLECTION

WE have already seen that the deflecting potential to produce a full scan on the screen must be of the order of 500 volts in a high vacuum tube.* In the scanning circuits previously shown this potential is developed across the condenser and applied between the plates, one of which is connected to the final accelerating electrode. The other plate will therefore fluctuate in potential by some 500 volts above or below that of the accelerator, depending on the connections. The beam in passing through the electrode system

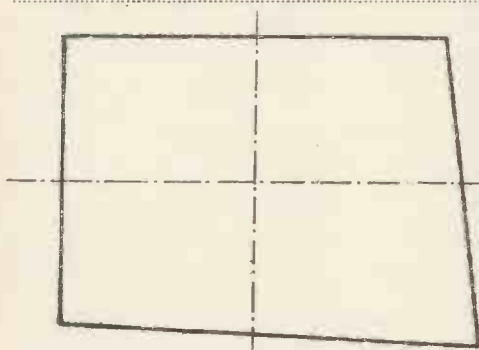

Fig. 1.—If the deflecting voltage is not symmetrical the line screen becomes distorted into the trapezium shown in the outline.

The deflector plates are mounted as close together and as close to the last anode as possible in order to obtain the utmost sensitivity of the tube. When both pairs of plates have a high deflecting potential applied to them there is an interaction which takes place between them which can be considered as a kind of "cross-modulation." The deflecting potential on one pair will influence the beam as it passes through the other pair with a resulting distortion of the deflection in one plane or the other.

This fault is usually known as "trapezium" distortion as the scanning lines instead of forming a perfect rectangle tend to open at one corner and form a trapezium shown in Fig. 1.

There are thus three defects in the high-vacuum tube which give rise to distortion of the scanning lines and they can only be overcome by modifying the potential applied to the deflector plates so that no plate is at an excessive voltage above or below the anode. This can be done by making the deflecting circuit symmetrical so that the potential on each plate rises and falls by the same amount with respect to the anode, i.e., the deflector volts are applied by means of a push-pull circuit which has its centre point connected to the anode.

This ensures that the mean potential at any instant is zero with respect to the anode and there is no tendency to distort the scan.

Push-pull

The push-pull circuit is essential for high-definition scanning in which every small defect in the line screen

is focused by the electric field between the anodes or accelerators, and the sharpness of the line depends on the adjustment of the potentials on these. If now the beam emerges from the final anode and then passes through the space between the plates it is necessarily affected by the potential between the plates, particularly as this potential may be 500 volts above that of the anode. The deflecting potential will thus tend to undo the focusing action of the field between the anodes and the line will become blurred towards the end where the beam passes close to the plate. This defocusing action of the plates is unavoidable in high-vacuum tubes since the whole focus of the beam is due to the arrangement of electrostatic fields in the tube and the least unbalance in these fields will spoil their effect.

It is not, however, confined only to high-vacuum tubes but is also present in gas-focused tubes although to a less degree. This is on account of the lower deflecting potential which is usually required by the latter. Whereas in the high-vacuum tube the deflecting potential may be as high as 1/5th that of the final accelerator it seldom exceeds 1/8th or 1/10th in the gas tube.

Beam Sensitivity

A second effect which is produced by the high potential on the plates is the alteration in sensitivity of the beam over different portions of the screen. As the beam approaches the deflecting plate the velocity which it has acquired on passing through the anodes may be reduced with a consequent increase in sensitivity.

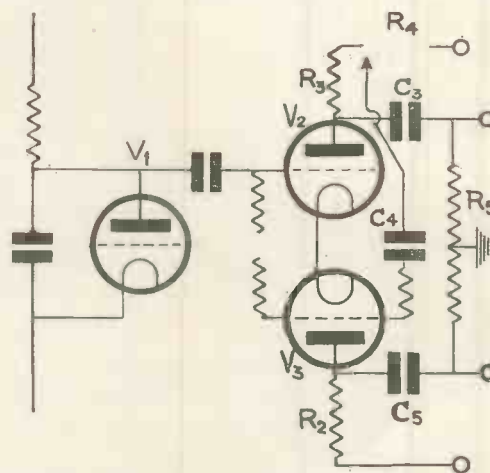

Fig. 2.—A method of producing symmetrical scanning by using a paraphase output stage.

becomes of importance, and accordingly our next step is to design a symmetrical arrangement to connect on to the existing relay.

* January, 1936 issue, p. 30, col. 2.

A typical simple arrangement is shown in Fig. 2. The discharge valve V_1 is connected to the grid of a power valve V_2 through the usual resistance condenser coupling. The output of this triode is fed to one of the plates through the condenser C_3 . Opposite the triode is mounted the second valve V_3 , forming the push-pull pair and the grid of this valve is fed from a resistance in the anode circuit of V_2 across which a small

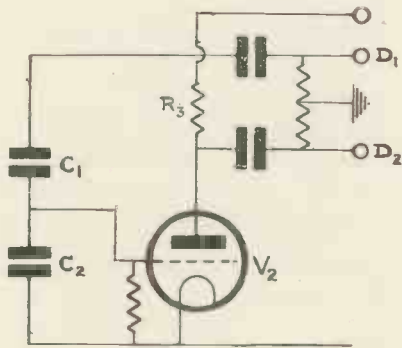

Fig. 3.—Economy is obtained by using one valve to provide half the scanning voltage out of phase with the other half.

fraction of the scanning voltage is developed. The grid is isolated by the condenser C_4 . Finally the other deflecting plate is connected to the anode of V_3 through an isolating condenser C_5 of the same value as C_3 . This method of connection will be recognised by experimenters as the familiar paraphase connection for output valves and it is an easy matter in the particular circuit shown to obtain distortionless output as only one frequency is involved. The deflector plates which must always be connected to closed circuits are joined by the resistance R_5 , the centre point of which is connected to the anode of the tube. This resistance is very high, of the order of 5-10 megohms and the load on the output valves is negligible. The resistances R_3 and R_4 are chosen so that the voltage developed across R_4 is equal to the grid swing required for the valve V_3 , and $R_3 + R_4$ together equal R_2 .

The details of the resistances and valves will be discussed in a later article, but meanwhile we may consider one or two alternative ways of obtaining the desired phase difference in the output stage. There is no objection, for example, in applying the voltage developed across the relay direct to one of the deflector plates and thus saving an output valve. This is shown in Fig. 3 in which it is seen that one plate of the pair (D_1) is connected direct to the relay.

To provide a potential of the opposite sense for the other plate, part of the condenser voltage is divided by inserting a small condenser C_2 in series with the main condenser C_1 .

The value of this condenser is arrived at as follows: The potential developed across the phase shifting valve V_2 must be equal to that across the condenser C_1 in order to give a symmetrical deflection on the plates. The signal voltage applied to V_2 grid is therefore the potential of C_1 divided by M where M is the total gain in voltage obtained from the valve V_2 . (M depends on the anode resistance and magnification of the valve, etc.) The voltage applied to the grid is therefore $1/M$ th that of the condenser C_1 and the value of C_2 must therefore be $1/M$ th that of C_1 . This circuit which is used by the Cossor Company is more economical

than the one just described and when the correct adjustments have been made gives equally satisfactory results. It is sometimes necessary to compensate for loss in the high frequencies caused by a high anode resistance R_3 and this can be done by inserting a small resistance in series with the condenser potentiometer C_1C_2 .

A Symmetrical Method

A third method which is truly symmetrical is that shown in Fig. 4. The main charging condenser has its resistance divided into two equal parts R_1 and R_2 and the output voltage is connected directly to the grids of the push-pull output stage, the centre point being connected to the anode as before.

This circuit has the advantage that no adjustment of the input to the grid of the second valve is required as in the paraphase circuit, and the slight adjustment made to R_2 to obtain correct scanning frequency will not seriously upset the symmetry of the arrangement.

It may be thought that these circuits involving two valves are extravagant in anode current but since the load is negligible very high anode resistances are used with the twofold advantage of a long straight portion of the valve characteristic and quite low current consumption.

Apart from the symmetrical scanning obtained from the circuits of Fig. 2 and Fig. 4 these have the additional merit that the voltage to which the condenser charges before the relay strikes is kept very low. The voltage required to be applied to the grids of the output valves is of the order of 15-30 and this ensures that the charging curve of the condenser is perfectly linear with moderate voltages. Gas-filled relays behave better at high frequencies if the striking potential is kept low and for a scanning frequency of 10,000 per second it is not advisable to exceed a striking voltage of 100. With a control ratio of 20-1 which is an

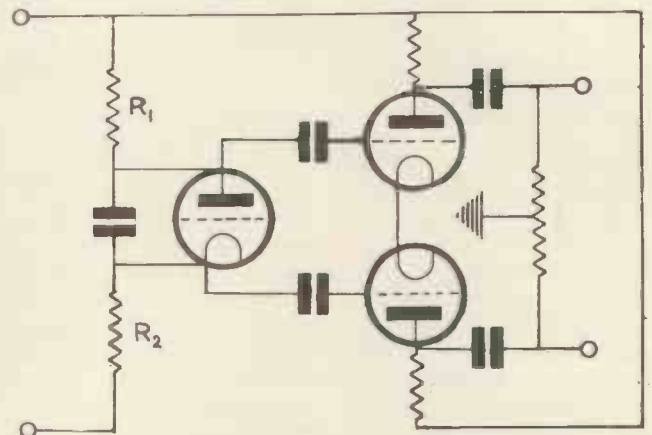

Fig. 4.—A symmetrical circuit avoiding the use of paraphase.

average figure the grid bias of the relay is approximately 1 volt, and this can be obtained from a self-bias resistance connected in the main condenser circuit.

Only the essential details of the circuits have been shown in the figures, and in the next article the design of a symmetrical scanning circuit will be dealt with in detail.

RECENT TELEVISION DEVELOPMENTS

A RECORD OF PATENTS AND PROGRESS *Specially Compiled for this Journal*

Patentees:—*J. D. Percy and Baird Television, Ltd.* :: *Cie de Compteurs* :: *Marconi's Wireless Telegraphy Co., Ltd.*, *L. E. Q. Walker and W. E. Bonham* :: *Radio Akt. D. S. Loewe* :: *C. S. Agate* :: *A. C. Cosser, Ltd.* :: *Telefunken Co.*

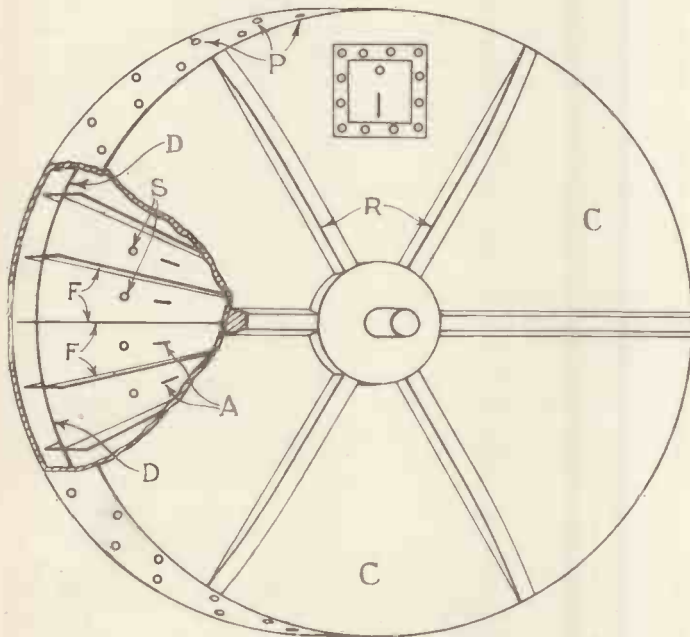

Casing for high-definition scanning disc. Patent No. 435,637.

is automatically adapted to the transparency or tone-value of the particular part of the film being scanned.

As shown in the drawing, the spot of light S on the screen of the cathode-ray tube C is focused at S₁ on the film F, which is continually fed forward at a constant rate. The resulting current produced in the P.E. cell P is amplified at A, and part of the rectified voltage is fed back, and applied through a resistance R to the control electrode W, where it automatically regulates the intensity of the spot S as the background tone-value of the film changes. A carrier-wave is superposed on the picture signals by applying high-frequency impulses to the electrode W from a valve generator V. Deflecting voltages are fed to the electrodes D, D₁ from the leads L.—(*Cie des Compteurs.*)

Modulating Systems (Patent No. 435,814.)

One method of modulation used in cathode-ray television is to cause the electron stream to traverse the fluorescent screen at constant speed and to regulate its intensity by the picture signals. Another method is to keep the stream at constant intensity, and

Scanning Discs

(Patent No. 435,637.)

In high-definition work difficulty is experienced when driving a scanning-disc at speeds of the order of 6,000 revs. per minute owing to the effect of air-friction. It has already been proposed to overcome this difficulty by enclosing the disc inside an evacuated casing.

As an alternative method the scanning disc D is formed with radial fins F which force the air inside the casing C out through small apertures P formed in its periphery. The fins are so placed that they do not interfere with the passage of light through the spiral scanning holes S, or through the synchronising apertures A. The casing is strengthened by external ribs R.—(*J. D. Percy and Baird Television, Ltd.*)

Film Television

(Patent No. 435,749.)

The film to be televised is scanned

at high speed by the spot of light formed on the screen of a cathode-ray tube, and part of the resulting signal voltage is rectified and fed back to the control electrode of the tube, so that the brilliance of the scanning spot

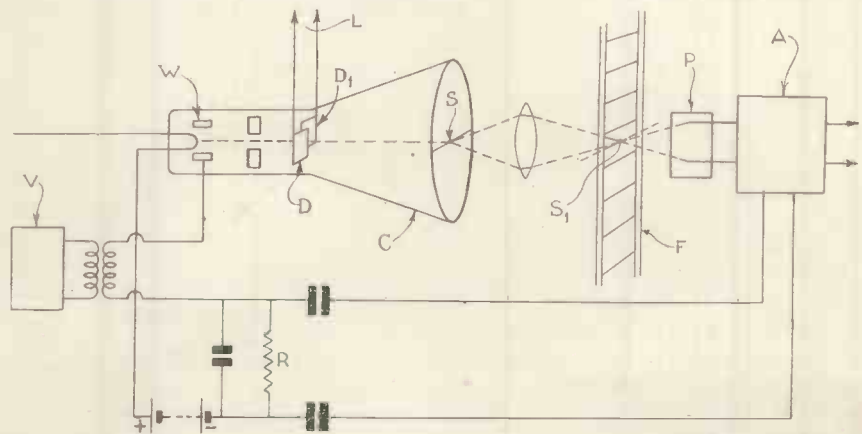

Method of televising films. Patent No. 435,749.

The information and illustrations on this page are given with permission of the Controller of H.M. Stationery Office.

to apply the picture signals so as to increase or decrease the speed at which it passes over the surface of the fluorescent screen.

The method now put forward is to cause the area of the spot formed on the screen to vary in sympathy with the received signals, so that for dark signals the area is small, whilst for high-light signals it is large. The

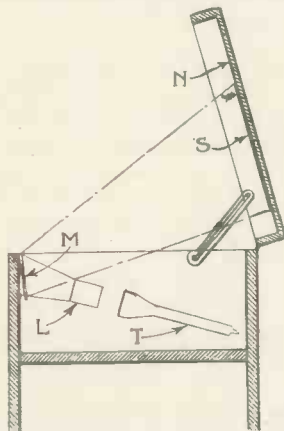

Arrangement of viewing screen in cabinet. Patent No. 436,301.

total intensity of the spot is kept constant at all times. The required result is secured by applying the picture signals so as to vary the voltage of the first anode and the screen in opposite directions, in accordance with a given formula.—(Marconi's Wireless Telegraph Co., Ltd., L. E. Q. Walker, and W. E. Benham.)

Simplified Synchronising
(Patent No. 436,142.)

Instead of producing the necessary synchronising voltages independently at each receiver, they are distributed from a central transmitter on a separate carrier-wave from that used to radiate the picture signals.

Oscillations of line and frame frequency are superposed on a single carrier-wave, and at the receiving end are rectified and passed through suitable filter-circuits to the control electrodes of the cathode-ray tube. The synchronising carrier wave is preferably not far removed in frequency from the picture-signal carrier. This helps to simplify the receiving circuits, and at the same time avoids the possibility of the two waves being subjected to different types of atmospheric interference.—(Radio-Akt. D. S. Loewe.)

Viewing Screens
(Patent No. 436,301.)

In a television cabinet the cathode-ray tube T is arranged in a shallow

compartment normally closed in by the lid N. During reception the lid is swung back to a practically-vertical position, as shown, and the picture appearing on the fluorescent screen is then focused by a lens L on to a mirror M, which reflects it forward to a sheet S mounted conveniently for observation on the inside of the lid. The sheet S consists of white or silver-coloured paper or cloth. The mirror M may be mounted on a drawer slide which can be moved out so as to increase the length of the light path between the tube T and the viewing screen.—(C. S. Agate.)

Preventing Halo Effects

(Patent No. 436,543.)

When the fluorescent light produced on the screen of a cathode-ray tube is viewed from outside, a considerable amount of internal reflection occurs at the air-glass boundary. The light so reflected may set up halo effects which tend to blur the clearness of the picture. In order to prevent this, the wall of the tube near the screen is made hollow, and the space is filled with a transparent fluid whose index of refraction is the same as that of glass, so that the

capacity coupling C₁, C₂ between the line-deflecting-coil L and the frame deflecting-coil L₁ can then be balanced out by suitably adjusting the position of the tapping point P.—(Telefunken Co.)

Summary of Other Television Patents

(Patent No. 435,574.)

Increasing the ratio of signal strength to interference when amplifying photo-electric currents.—(D. M. Johnstone and Baird Television, Ltd.)

(Patent No. 435,623.)

Varying the characteristic relations between the modulating voltage and the electron current in a cathode-ray tube.—(L. F. Broadway and W. F. Tedham.)

(Patent No. 435,639.)

Compensating distortion due to the varying brightness of the spot on the fluorescent screen of a cathode-ray receiver.—(General Electric Co., Ltd., and D. C. Espley.)

(Patent No. 435,815.)

Kerr-cell circuit in which high-frequency attenuation due to the capacity of the cell is eliminated.—(Marconi's Wireless Telegraph Co., Ltd., and E. F. Goodenough.)

Using magnetic deflecting coils for cathode beam. Patent No. 436,622.

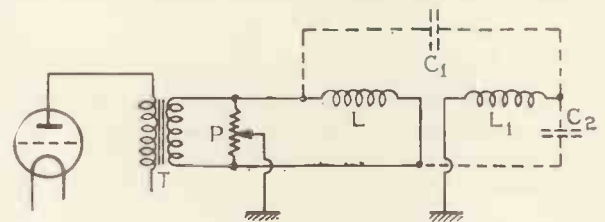

(Patent No. 436,160.)

Television system in which the light-source consists of the fluorescent effect produced by the electron stream of a cathode-ray tube.—(C. Lorenz Akt.)

(Patent No. 436,189.)

Cathode-ray tube in which the electrostatic deflecting-plates are made with bent-back ends in order to correct picture distortion.—(Telefunken Co.)

(Patent No. 436,314.)

Electrode arrangement in a cathode-ray tube receiver designed to eliminate the so-called "white cross" effect on the fluorescent screen.—(Fernseh Akt.)

(Patent No. 436,650.)

Producing synchronising signals with a steep wave-front and interspersing them between the picture signals.—(G. B. Banks and Baird Television, Ltd.)

Cathode-ray Receivers

(Patent No. 436,622.)

A difficulty which is not at first sight apparent will sometimes cause unsatisfactory performance in a cathode-ray tube of the kind using magnetic deflecting-coils. It is due to capacity coupling between the two pairs of coils, which, in spite of the coils being set at right angles, tends to cause currents of line-scanning frequency to pass into the frame-control coil, and vice versa.

To prevent this, the secondary winding of the transformer T feeding, say, the line-deflection coil shown at L is tapped at P to ground. The

The information and illustrations on this page are given with permission of the Controller of H.M. Stationery Office.

VALVE COUPLINGS FOR TELEVISION FREQUENCIES

By
J. Beardsall.

DETAILS OF A NEW METHOD

THE recently published specifications of the Baird and Marconi E.M.I. television systems mention the frequency of 2 megacycles as the maximum transmitted. Even with 30-line television one had to pay more attention to amplifier technique than was demanded by sound requirements, but the maximum frequency

of a resistance-coupled valve-amplifying stage. (The anode resistance is shown connected to earth instead of H.T.+ as only A.C. conditions are being considered, and from their aspect it is the same thing.) Since the only purpose of C_3 and R_2 is to keep the direct H.T. voltage on the anode from getting on to the succeeding

they will offer an alternative path for the anode current, thus reducing the effective resistance, and hence the amplification.

In order to make our amplification the same up to the highest frequency we desire to pass, we must arrange that the attenuation due to the shunting effect of C_1 and C_2 does not be-

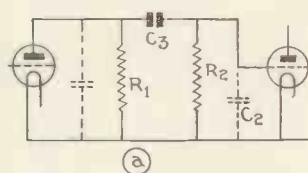

Fig. 1a.—Simple resistance-coupling circuit (omitting H.T. battery).

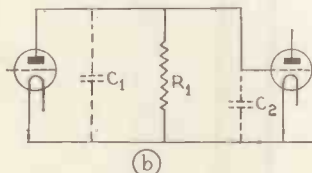

Fig. 1b.—Same circuit as it appears to high frequencies (i.e., omitting C_3 and R_2).

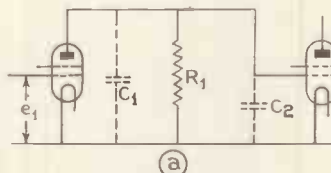

Fig. 2a.—The use of screen-grid valves reduces the value of C_2 .

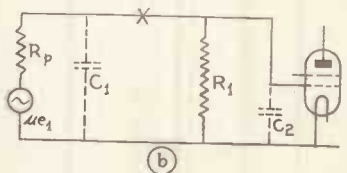

Fig. 2b.—Equivalent circuit of (a). R_p is internal resistance of valve.

was then only some 13,000 cycles and could be amplified successfully without employing any unorthodox circuits. Two million cycles, however, is a very big jump from thirteen thousand, and at first the prospect might discourage the most ardent amateur. We have, however, been expecting a big extension of the frequency-band for some time, and arming ourselves with suitable methods for coping with it.

grid, but at the same time to pass all the frequencies required, and since R_2 can be made very much larger than R_1 so that it has no effect on the amplification, we can, for present purposes, redraw the circuit leaving out these two components, as in Fig. 1 (b).

The capacities C_1 and C_2 shown by dotted lines represent stray wiring capacities as well as, and chiefly, the anode-cathode capacity of the first

come appreciable except beyond the working range. This is done by making C_1 and C_2 as small as possible by careful choice of valves, attention to wiring, etc. If this is not sufficient R_1 must be reduced in value until it is small compared with the shunting reactance of C_1 and C_2 at the maximum frequency we are concerned with. This, however, reduces, at the same time, the amplification of the valve stage and there-

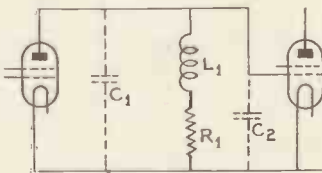

Fig. 3.—The inductance in series with R_1 counterbalances the effect of C_1 and C_2 and improves the response at higher frequencies.

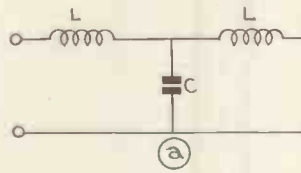

Fig. 4a.—A π -section "low-pass" filter.

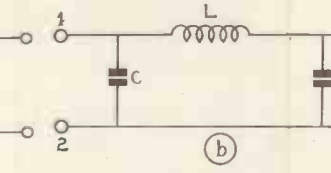

Fig. 4b.—A π -section "low-pass" filter.

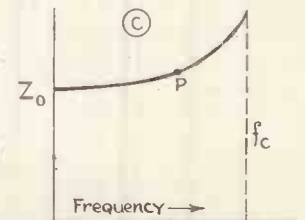

Fig. 4c.—Showing variation of characteristic impedance with frequency for case of π -section.

Let us consider the main lines of attack which have so far been adopted. (For the present discussion the extreme low frequency end of the band can be neglected, as we learnt all about it in the 30-line days; high-definition television has widened the band in the high-frequency direction.) Fig. 1 (a) is a simple circuit

valve and the input capacity of the second. The input capacity includes not only the grid-cathode capacity of the valve but usually a substantial addition to it due to the "Miller effect." At low frequencies these capacities, which are in parallel with each other, are negligible, but it will be apparent that at high frequencies

fore cannot be pursued too far. With a maximum frequency of 13,000 cycles and with valves of the AC/HL type the stage gain at this frequency is barely 1 per cent. less than at low frequencies if the anode resistance of both valves is 100,000 ohms. This gives a gain of 32. In television there is also the phase angle to look

after and with the conditions just mentioned this is 7.6 degrees.

With a simple resistance-coupled stage of this sort we may expect to get quite reasonable amplification, by the process of lowering R_1 , up to about 200,000 cycles. With the same valves as before and an anode resistance of 5,500 ohms the amplification is only 2 per cent. down at this frequency compared with lower ones, but at all frequencies it is considerably lower than before, being now only 11, compared with 32 for the previous case. This might be called the limit of economical amplification using triode valves and simple resistance coupling.

The next step in our progress to

quencies its reactance acting in the opposite sense to that of the shunting capacities will tend to neutralise their effect and keep the effective anode impedance constant (see Fig. 3). (How to calculate the size of inductance for any amplitude or phase angle tolerances at any maximum frequency was fully demonstrated by E. Robinson, Proc. I.R.E., June, 1933.)

This is a good forward step and a logical method which could with advantage be applied to all the previous conditions discussed, in each case allowing more amplification per stage. However, it is particularly welcome at the frequency we have arrived at and enable us to leap im-

has been a résumé of methods in fairly general use.

First, let us review the nature of simple "low-pass" filters. In Fig. 4 are two kinds of low-pass filter, (a) being known as a "T section," and (b) as a " π section." As the latter is the kind most applicable to our purposes we will confine ourselves to that only. The characteristic impedance of the network generally denoted by Z_0 , is that impedance which, if placed across the terminals 3 and 4, makes the impedance between 1 and 2 the same. Up to a certain frequency this impedance is a pure resistance, though it differs for every frequency. The frequency at which it ceases to be a pure resistance is

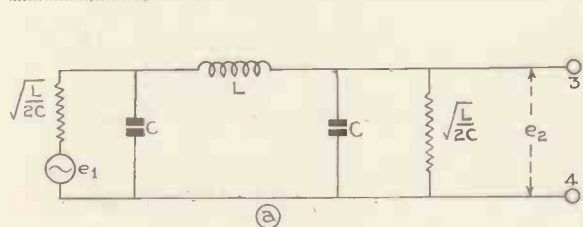

Fig. 5a.—Section matched to generator resistance and terminated in its characteristic impedance.

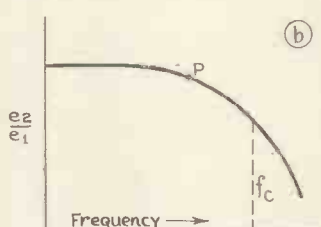

Fig. 5b.—Showing how response varies with frequency for conditions of (a).

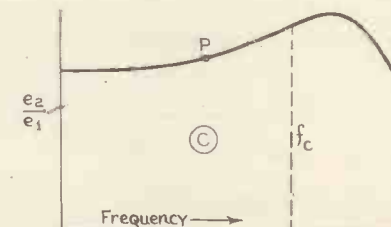

Fig. 5c.—Showing how response varies with frequency when generator resistance is much greater than characteristic impedance.

higher frequency amplification is to substitute screen-grid valves in place of the triodes (Fig. 2). Although they have slightly larger anode-cathode or grid-cathode inter-electrode capacities, the grid-anode capacity is only about 1/1,000th that of triodes, and so the "Miller effect" is practically eliminated. Thus the total capacity appearing in parallel with the anode resistance is lowered. The amplification will be $G \times R_1$, where G equals mutual conductance in amps. per volt, since the valve impedance will be incomparably higher than the anode load; so a valve with a high value for G must be chosen. With a valve of the screened pentode type and an anode resistance of 3,600 ohms we can now get the same amplification as before, but the maximum frequency, for the same tolerance has been pushed up to 400,000 cycles.

However, we are still some way from our objective of 2 megacycles and we have reached a point where we cannot reduce either the anode resistance or the shunting capacities. What next? We can insert in series with R_1 an inductance L , which must be small enough to have no effect at low frequencies, but at higher fre-

quencies, for the same amplification, there is a difference of only 3 per cent. compared with lower frequencies.

Note that I said "difference of 3 per cent.," for with this arrangement the amplification actually rises until it reaches a maximum at the resonant frequency of C_1 and C_2 in parallel with L_1 and R_1 . We can only make use of the lower frequency side of the circuit characteristic and in practice it is just about as important to keep the amplification from rising as from falling at higher frequencies. So at a million cycles it would appear that another check has occurred. We could, of course, as in previous cases, reduce R_1 and L_1 and extend the frequency range further, but the loss of amplification would be very serious.

Fortunately, we are not at checkmate yet, and it is proposed now to describe the final method which will transport us to our 2 million cycle destination. As it is a recent innovation and particulars have not so far been published we will discuss it in more detail than we have given to the earlier part of our story which

called the "cut-off" frequency, denoted by f_0 . This is equal to

$$f_0 = \frac{1}{\pi \sqrt{2LC}}$$

Up to f_0 the variation of Z_0 with frequency has the form given by the curve of Fig. 4 (c), which shows that at low frequencies up to, say, that corresponding to the point P on the curve the characteristic impedance is substantially constant. At

these frequencies it is equal to $\sqrt{\frac{L}{2C}}$.

If, therefore, we connect between 3 and 4 a resistance equal to $\sqrt{\frac{L}{2C}}$ and

connect between 1 and 2 a generator with the same impedance and voltage e_1 , Fig. 5 (a), the ratio of the output voltage, e_2 , across the terminals 3 and 4 divided by the input voltage, e_1 , for different frequencies, follows the form of the curve in Fig. 5 (b). If, however, the generator has a very much higher impedance, say, at least

10 times, than Z_0 , the form of $\frac{e_2}{e_1}$ is

shown by Fig. 5 (c).

In both cases, from where the response ceases to be substantially

FEBRUARY, 1936

linear, that is to say at approximately the point P, the resultant altered

value of $\frac{e_2}{e_1}$ is called the "mismatch-error," because it would not occur if Z_0 were the same at all frequencies. But we could arrange

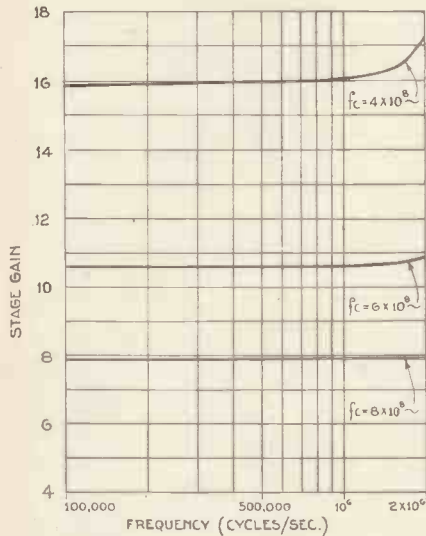

Fig. 6. Showing how stage-gain varies with frequency for different values of "cut-off" frequency.

that the maximum frequency we care about, which we will call f_m , occurs at the point P, up to which the output e_2 is nearly the same at all frequencies.

Again considering now the question of coupling one valve to another, if we take the equivalent circuit of Fig. 2 (a) shown in Fig. 2 (b), open the circuit at the point X and insert an inductance we have a precisely similar network to that of Fig. 5 (a), i.e., a low-pass filter, but having a high resistance source of supply, the latter being the internal resistance of the valve. So we have evolved another method of valve coupling, though whether it is necessarily superior to the other methods is not immediately obvious.

It should be noted that in a conventional low-pass filter the condensers at each end are equal in value. In the case of a valve coupling circuit, where we make use of the inherent valve and wiring capacities, this is not always so, although in practice C_1 and C_2 are found to be approximately the same. If there is a big difference, the smaller capacity can always be made equal to the

larger by a small parallel trimming condenser.

The process of designing a filter coupling of this type is as follows: Estimate the value of C_1 and C_2 : decide on f_0 (this will be several times

f_m): calculate L from $f_0 = \frac{1}{\sqrt{2LC}}$; calculate $Z_0 \left(= \sqrt{\frac{L}{2C}} \right)$, which be-

comes the value for R_1 . At low frequencies the amplification will be $G R_1$, and f_0 must be chosen so that the amplification is nearly the same at f_m .

As an example of a practical case let $f_m = 2,000,000$ cycles per second: Assume $C_1 = C_2 = 7.5 \mu\text{fd}$.: let $f_c = 6 \times 10^6$ cycles per second, whence by calculation $L = 187 \mu\text{H}$, and $R_1 = 3,500$ ohms. The gain will

be, at low frequencies, if $g = \frac{3}{1,000}$,

10.5. We do not know what the gain is at 2 megacycles without further calculation. This is rather involved and it will perhaps be more useful for present purposes merely to give the results. The middle curve of Fig. 6 shows how the amplification, under the conditions of the example just quoted, varies with frequency; it will be seen that this variation is very slight, being only 2 per cent. up at 2 megacycles compared with 100,000, below which the

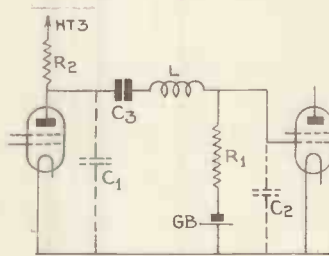

Fig. 8.—Complete circuit of "filter-coupled" amplifying stage for giving level response up to 2 megacycles.

graph does not extend, as it would still be a straight line.

Other curves are shown also illustrating the performance with different values for f_0 . As with all other methods of coupling, the greater the amplification is made at low frequencies the more it falls off in proportion at the higher frequencies. At any rate, we can get amplification of nearly 11 with less percentage deviation at the maximum working fre-

quency of 2 megacycles than was obtained by another type of coupling at only one million cycles, so it would seem that this sort of coupling may be useful in the near future.

A matter which cannot be overlooked in television is that of phase angle, referred to earlier. Neither

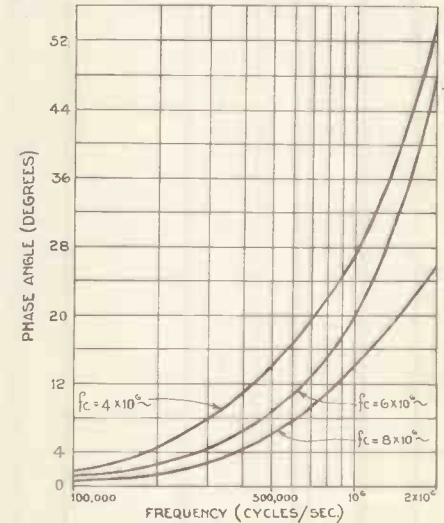

Fig. 7.—Showing how phase angle varies with frequency for different values of "cut-off" frequency, using the "filter-coupling" method.

the Baird nor E.M.I. companies have so far published details as to the phase angles which can be allowed at different frequencies before distortion is noticeable, but I show in Fig. 7 the phase angles, plotted against frequency, for the three cases of f_0 in Fig. 6, and according to the limit of tolerance allowed, the values of f_0 , R_1 , and hence the amplification, can be chosen.

It will be noted that the values of the inductance L fall within reasonable sizes, e.g., in the case quoted of $f_0 = 6 \times 10^6$ cycles, when L equalled $187 \mu\text{H}$. The latter is a size easily constructed, or purchased for that matter, and with ordinary care could be made with negligible self-capacity, so that the effective inductance is still $187 \mu\text{H}$, or very nearly so, at 2 megacycles. In Fig. 8 is given a complete circuit diagram of one stage of "filter-coupled" amplification. R_2 is an anode feed resistance, high compared with R_1 , whose only purpose is to provide the anode with H.T. voltage, while that of C_3 is to block the latter from the grid of the second valve. It will need to be at least 100 mfd. in order to preserve the extreme low frequencies, but with electrolytic condensers this is not unduly costly.

Parabolic Reflectors For Ultra-short Waves

THE simplest device that will send out a beam in one direction is a parabolic reflector. The radiating (or receiving) aerial is located at the focus of the parabola and the energy is sent out in a similar manner to light from a searchlight.

There is a physical difference, however. The mirror surface in a searchlight is a paraboloid of revolution, whilst the reflecting surface in a beam transmitter is a parabolic cylinder, formed by bending a sheet of metal of high electrical conductivity into the form of a parabola.

Basic Function of Parabolic Reflectors

If a plane wave front enters the parabola so that the wave front is at right

vertical aerial without reflector decreases directly as the distance.

Constructional Data

A sheet of copper $\lambda/2$ wide and 1.3λ long is the principal item required. This is bent over two equal wooden forms cut into the shape of parabolas of correct form factor. The graph of Fig. 1 assists in this. A half of the parabola only is given since each half is symmetrical.

The radiating aerial should be $\lambda/2$ long and may be secured to two wood pieces at the foci of the wooden parabolas. It is desirable to cut slots about the foci to permit the varying of the position of the aerial in an axial direction. The nominal position for the

at the focus as before. Each rod is a duplicate of the aerial, since it is tuned

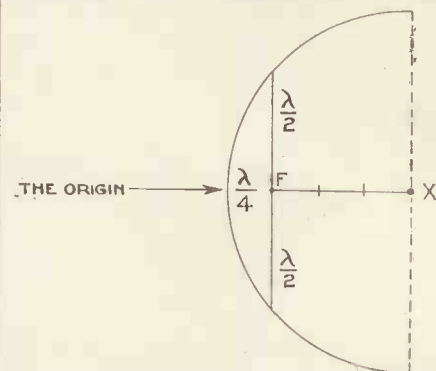

Fig. 2.—A cross section of a parabolic cylinder having an axial depth of $1/\lambda$ from the origin to the termination X.

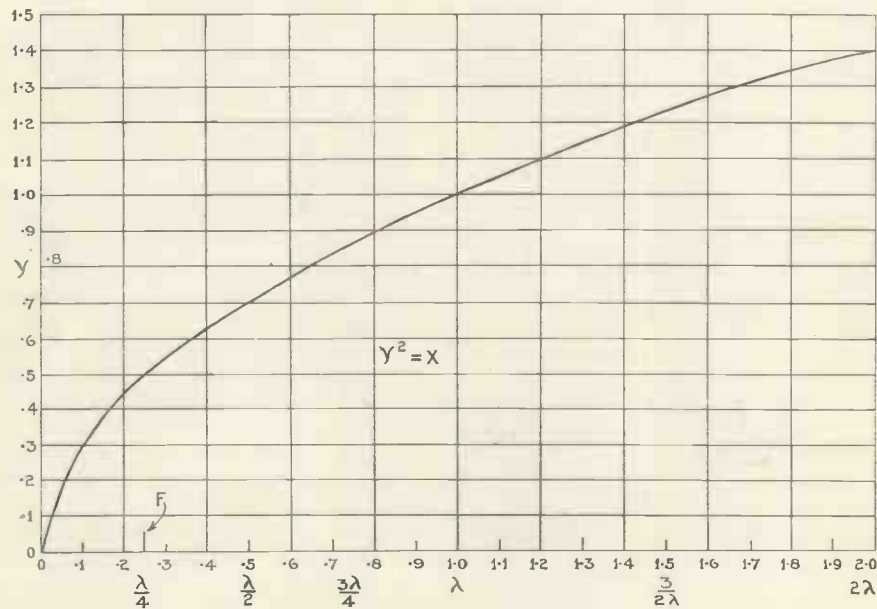

Fig. 1.—One half of a parabola having an axial depth of 2λ . The focus F is $\lambda/4$ from the origin.

angles with the axis of the parabola, or so that the direction of propagation is parallel with it, all the waves will converge at the focus. Also, if a point source of wave motion is located at the focus, the wave front of waves will be plane.

From this it will be appreciated that a minimum amount of attenuation occurs. Losses in the transmission medium are, of course, unaffected. This summarises the great advantage of the parabolic reflector, since it is well known that an electric wave from a

aerial is $\lambda/4$ from the origin, but slight adjustments should be made to attain a position giving maximum forward radiation.

Rod Reflectors

It is not absolutely essential to have a solid sheet of metal for the reflector. A number of $\lambda/2$ rods, spaced less than $\lambda/4$ as measured along the arc, all parallel with the aerial and in parabolic form is a good arrangement. Such is illustrated in Fig. 5. The aerial is placed

to the same frequency. It should be noted that the length of the aerial and each rod is more correctly .47 than $\lambda/2$. There are two methods of supporting the rods. One is to support them between a pair of wooden parabolas. Such tends to give mechanical strength but since in this position the supports are at voltage maximum, dielectric losses are greater than in the second system. This is to support the rods by a single parabola frame situated in the centre where it is in the position of maximum

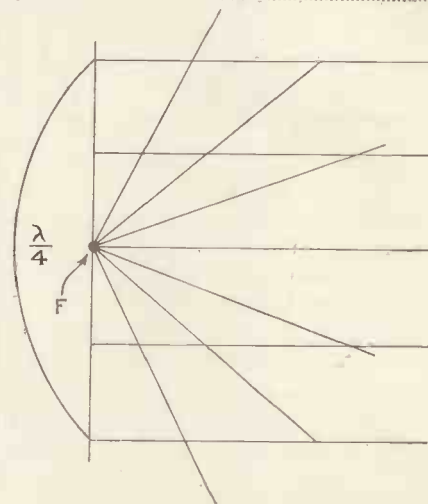

Fig. 3.—A parabolic reflector terminating at the focus, axial depth $\lambda/4$.

current and minimum voltage. The various diagrams illustrate these points.

(Continued on page 112.)

THE DESIGN OF AN AMPLIFIER FOR THE CATHODE-RAY OSCILLOGRAPH

A translation of an article by Manfred von Ardenne.

Manfred von Ardenne is as well known in this country as in Germany for his research in cathode-ray tubes and in television. The following article is a translated abstract from the German paper "Elektrotechnische Zeitschrift" and is of interest to television workers as the requirements of the amplifier approximate very closely to those for picture reproduction.

Summary

THE amplifier described is intended for constant voltage amplification of about 1,000 over a frequency range of 0.2 cycle to 2 megacycles. In later models the amplification was increased to 2,000. The available voltage output is 500, which is sufficient to produce ample

tions. In a number of cases of low-frequency technique, but still more in work in the medium and high frequencies, potentials of fractions of a volt only are available. Since the deflection sensitivity of the present-day cathode-ray apparatus is from 0.1 to 1 mm./V, potentials of this order cannot be recorded directly. If oscillograms which make full use of the

calculated from the quotient of the accelerating potential of the tube and the measuring potential at its disposal) but must above all permit of no distortions of the wave-form of the applied potential. The requirements of a universally applicable oscillograph amplifier are much greater than those for the construction of an amplifier for electro-acoustic pur-

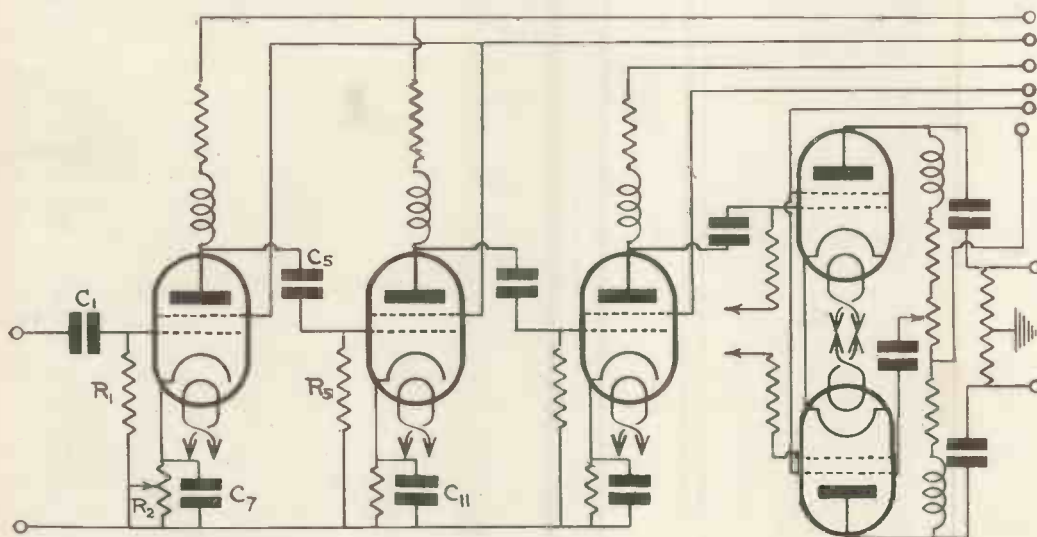

Fig. 1.—Theoretical circuit of amplifier to give wide frequency response.

deflection of the beam in a high-vacuum cathode-ray tube. The final stage is paraphase to give symmetrical deflection.

[Editor's Note: The voltage output is intended for deflection and not for modulation of the beam.]

The aim of present developments in the field of cathode-ray oscillography is to improve the recording of high frequency phenomena with increased spot intensity, i.e., to improve the "writing speed" of the beam. This development is logical, for one of the chief advantages of the cathode-ray oscillograph as compared with mechanical oscillographs lies in this very fundamental suitability for high frequency investiga-

tion. The possible writing definition, as desired, then deflecting potentials of some 100 volts are necessary.

The author has already pointed out in earlier publications the advisability of inserting aperiodic amplifiers in order to increase sensitivity, and has given the conditions which are required of an oscillograph amplifier in particular.

The Requirements of an Oscillograph Amplifier

An amplifier to increase the sensitivity of cathode-ray oscillographs must not only possess the necessary degree of amplification (which is cal-

culated from the quotient of the accelerating potential of the tube and the measuring potential at its disposal) but must above all permit of no distortions of the wave-form of the applied potential. The requirements of a universally applicable oscillograph amplifier are much greater than those for the construction of an amplifier for electro-acoustic pur-

poses and those of high frequency technique. They even exceed the already very extensive requirements of the latest television technique. Distortions of the oscillogram by the amplifier may arise from irregular frequency response and phase shift, in addition to amplitude distortion. Faults through frequency and phase distortions are only absent when the amplifier possesses a uniform response to all the frequencies which are contained in the applied wave. In almost all measurements undertaken by cathode-ray oscillographs frequency components under 1 cycle and frequency components above 10⁶ cycles are very rare. An amplifier which shows a constant amplification

over this wide frequency range should, therefore, be quite suitable for use in connection with oscillographs.

Oscillogram distortions through irregular amplitude responses are to be expected in the last stage and that previous to it, for obvious reasons. These two stages must be so designed that the above-mentioned potential under investigation can be applied undistorted.

The simultaneous fulfilment of the various requirements quoted is only made possible by the use of a speci-

time-constant with an extension of the frequency range in the lower values, but this has two disadvantages:

The coupling capacities become so high that they tend to react unfavourably on the high-frequency response.

At very low frequencies (of the order of 0.2 per sec.) the temperature inertia of the grid of the output valve causes it to alternately heat and cool as the signal voltage swings from a low to a high negative bias value.

The resistance R_2 alters the work-

cycles. The final stage consists of two screen-grid valves of new construction with specially designed grids.

The use of push-pull in the final stage was decided on for the following reasons:

The potential amplitude available is doubled, which is important in view of the low value of anode resistance used.

The cathode-ray tube requires a symmetrical deflection in order to preserve the sharpness of the spot at high frequencies.

The grid of the paraphase valve is fed from the resistance in the anode of the other valve as shown in Fig. 1, and owing to the low self-capacity of the circuit there is no phase shift at even the highest frequencies.

C_7 and C_{11} , the by-pass condensers in the cathode circuits are so chosen that the bias resistances are shunted at the high frequencies above 10^5 cycles. The result of this is an increase in amplification of as much as 50 per cent., according to the stage. The time-constant of the condensers and bias resistances is about 1.5 to 3 times that of the anode resistance and stray capacity. The improvement in high-frequency response by this adjustment is shown in the diagram of Fig. 2b.

Construction.

To ensure the shortest possible connections between the anode of one stage and the grid of the succeeding stage the valves are mounted "head-to-tail" the centre valve being inverted. Screens are inserted between the valves, and in this construction the grid-anode capacity is so low that it has no appreciable effect on the response of the amplifier.

The response curve is shown in the diagram of Fig. 2a, and it is seen that the amplifier is uniform in response over a range from 0.5 cycle to a megacycle with an amplification of about 1,000.

The degree of amplification and the wide frequency response of amplifiers of this type make them particularly suitable for cathode-ray apparatus, and various investigations can be undertaken such as surges in cables, transmission lines and physiological measurements.

In the latter case the amplification of this particular unit is insufficient and it will be necessary to add a one or two stage amplifier as a separate unit.

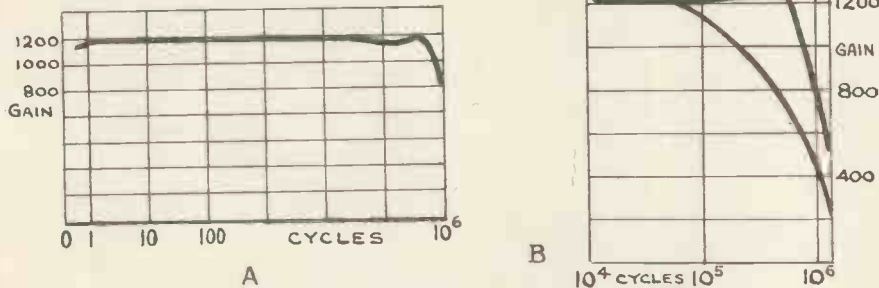

Fig. 2.—(a) The overall response curve of the amplifier of Fig. 1. The gain is given in arbitrary units.

Fig. 2.—(b) The effect of the by-pass condensers in the cathode circuit on the H.F. response.

ally constructed amplifier. The chief characteristics of this construction, which has arisen in connection with development work in television, is discussed in the following:

Amplifier Circuit

The circuit for an amplifier covering 0.5 to 1 megacycle is shown diagrammatically in Fig. 1. Five screen-grid valves of high slope are employed. The H.T. supply is obtained from a rectifier unit containing a glow potential divider for stabilising the H.T. The effect of slow mains voltage fluctuations could only be minimised by the use of a special circuit owing to the high amplification of the low frequencies. The remaining interference on the output side is below 1 to $1\frac{1}{2}$ per cent. of the undistorted output voltage.

By using several glow potential stabilisers and the usual decoupling arrangements the back coupling due to the resistance of the H.T. unit is reduced and there is no tendency to "motor-boat."

The time-constant of the grid coupling circuits R_1C_1 , R_2C_2 , etc., amounts to 20 seconds. It is, of course, possible to use a still higher

ing point of the variable- μ valve used in the first stage, and an electrolytic condenser of 1,000 mfd. is used as a by-pass for the low frequency.

By taking care to use a low-capacity layout and by using suitably placed screens the various stray valve and circuit capacities (especially the grid-anode capacity) can be kept at a very low figure. The actual capacity of the amplifier is in the region of 35 cm. To offset the loss in the upper frequencies caused by this stray capacity, small chokes are inserted in each anode circuit between the resistance and the anode. The value of the choke is adjusted to give a straight line amplification up to 10^6

BINDING CASES AND INDEXES FOR 1935.

Binding cases and indexes for the 1935 volume of "Television and Short-Wave World" are now available. The cases are full brown cloth with stiff boards lettered in gold. The price, including the index, is 2/9 post free. Indexes may be obtained separately and the price is 6d. post free. Orders should be addressed—

BERNARD JONES PUBLICATIONS, LTD.,
CHANSITOR HOUSE,
37/38 CHANCERY LANE, LONDON, W.C.2
and should be accompanied by the remittance.

The Amateur Communication Receiver

In the January issue was described a four-valve receiver of high efficiency. In this article the designer, Kenneth Jowers, presents some interesting experiments for the amateur wishing to make the most of this receiver.

SINCE the Communication Receiver was first designed, it has been in continual use on all amateur bands. Several little features have been embodied which, in my opinion, are a distinct asset. I do consider that the slight extra cost is worth while, particularly as the receiver is one that will last for a long time and not have to be rebuilt in a few months or so.

First of all to get the most out of the Pen220A, the H.T. voltage should be approximately 160. Under such conditions the total anode current of the receiver is at least 25 milliamps., which is rather prohibitive. A very fine performance can be obtained with a lower voltage but even so the anode current will again be approximately 15 milliamps.

A power pack has been built which gives a maximum voltage of 200 at 30 milliamps. with entire freedom from hum, and also 4 volts at 3 amperes which will probably come in useful, should the receiver need modifying at any time to use a mains-driven output valve.

Fig. 1 gives the circuit for this power pack. It consists of a T-7-A transformer giving 135 volts to an H.T.12 metal rectifier. Two paper type 4-mfd. condensers are in the voltage doubling circuit while a 30-milliamp. choke and an 8-mfd. condenser form the filter circuit. As the output of 200 volts is obviously too high, a Varley 10,000-ohm

power potentiometer is used to control this so that the correct output is obtained.

From the illustrations the layout of this power pack can be obtained. It is quite straightforward and is built on a 10 in. by 8 in. by 3 in. chassis with the

The use of a larger L.F. transformer is another undoubted advantage. I have included a Ferranti AF6 transformer in place of the original Varley so as to obtain an increase in audio gain. Whether or not the high increase in cost is worth while is a matter

Fig. 1.—This power pack is completely silent in operation even when reaction is pushed to the limit.

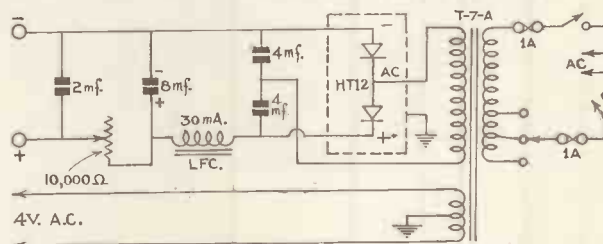

top covered with zinc foil. Insulated terminals are used for connecting while the variable resistance can be seen on the right-hand side. A double-pole double-throw toggle switch entirely disconnects the mains from the unit when it is not in use.

This type of mains unit does not cause any modulation hum. It is noticed that with certain types of eliminator

for consideration, but I do feel that as two or three more stations can be heard by using a more expensive component, then the additional cost is worth while.

Another alteration made was to include yet another variable resistance. It will be remembered that the voltage for the detector and for the screens of the two H.F. pentodes was obtained by means of a variable resistance. This

COMPONENTS FOR H.T. SUPPLY FOR THE AMATEUR COMMUNICATION RECEIVER

CHASSIS.

1—Wood to specification (Peto-Scott).

CONDENSERS, FIXED.

2—4-mfd. type BB (Dubilier).

1—8-mfd. type o82r (Dubilier).

1—2-mfd. type BB (Dubilier).

CHOKE, LOW-FREQUENCY.

1—Type HT 12 (Wearite).

FUSE AND HOLDER.

2—1-amp. baseboard (Microfuse)

TERMINALS.

2—Insulated terminals marked H.T. pos. and H.T. neg., type B (Belling-Lee).

2—Insulated terminals marked L.T., AC, type B (Belling-Lee).

1—Insulated terminal marked E, type B (Belling-Lee).

RECTIFIER.

1—Metal type HT 12 (Westinghouse).

RESISTANCE, VARIABLE.

1—10,000-ohm. type power potentiometer (Varley)

SUNDRIES.

Quantity of single insulated wire for connecting.

1—Mains plug and socket type P2r (Bulgin).

SWITCH.

1—Two-pole toggle type S88 (Bulgin).

TRANSFORMER, MAINS.

1—Type T-7-A (Wearite).

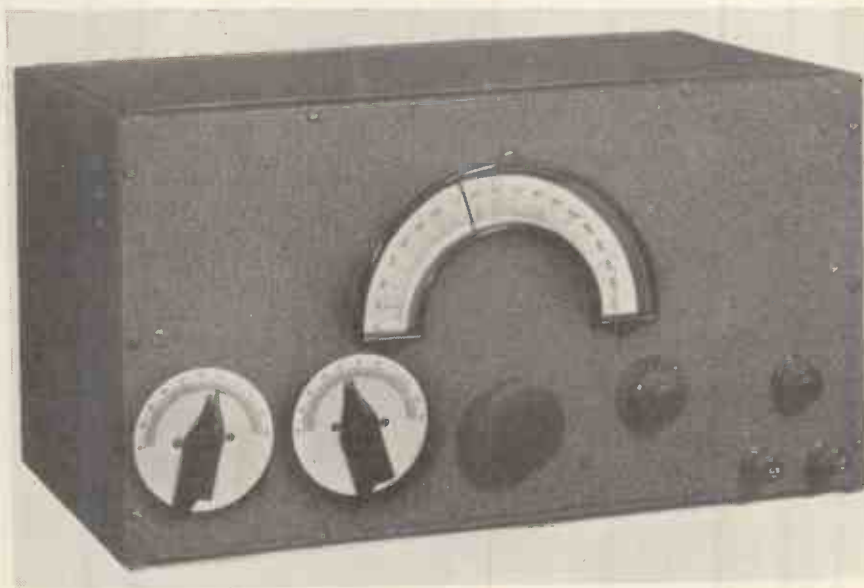

The steel case prevents all hand capacity and decreases stray pick-up.

the reaction cannot be pushed to the maximum level owing to hum being introduced. Fortunately this does not occur when using the Westinghouse metal rectifier, so results from the receiver are greatly improved.

arrangement works very well indeed as 70 volts is the correct maximum for these circuits. However, if a valve is obtained that is completely free from microphony, then the voltage on the detector can be increased to about 120.

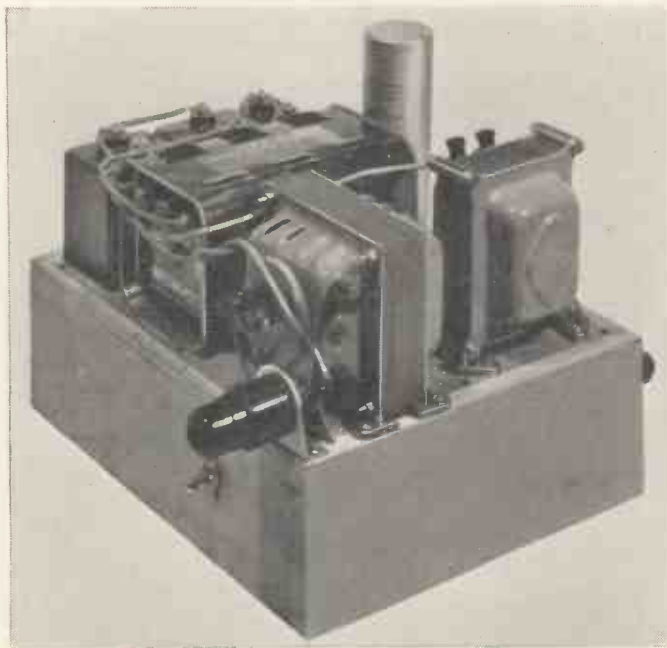

Note that the components are mounted on a wooden chassis faced with zinc foil.

voltage on the detector valve can be increased to a maximum on higher wavelengths and reduced to give

ADDITIONAL COMPONENTS FOR THE AMATEUR COMMUNICATIONS RECEIVER

- CONDENSER, FIXED.**
1—.0001 type mica (Dubilier).
CONDENSER, VARIABLE.
1—.0002-mfd. type 957 (Eddystone).
RESISTANCE, FIXED.
1—1 megohm type 1-watt (Bulgin).
RESISTANCE, VARIABLE.
1—250,000-ohm. (Erie).
TUNING METER.
1—0.1 m/a type flush mounting (Leslie Dixon).

smooth oscillation on the lower wavelengths.

On 160-metres the .00015 series aerial condenser can be omitted if the station is weak and extreme selectivity is unnecessary. The quickest way to do this is simply to bend the tip of the end rotor plate so that when the condenser is fully in mesh this one rotor plate shorts on to the end stator plate.

An R-strength meter is a refinement generally found only on commercial or American receivers. Owing to the use

or 130 to advantage. This, however, cannot be done with the existing system.

To overcome this the 50,000-ohm resistance is now used to control the detector voltage only as can be seen from the modified circuit. It is mounted on the screen to the right of the aerial band-pass condenser. It is essential that this resistance be of the isolated spindle type, otherwise bushes will be required. Owing to the decrease in current flow after the detector circuit has been detached from the pentode circuit the 50,000-ohm resistance is no longer of any use, so a .25-megohm has been used instead. This causes the minimum amount of change in circuit design.

By means of these alterations the

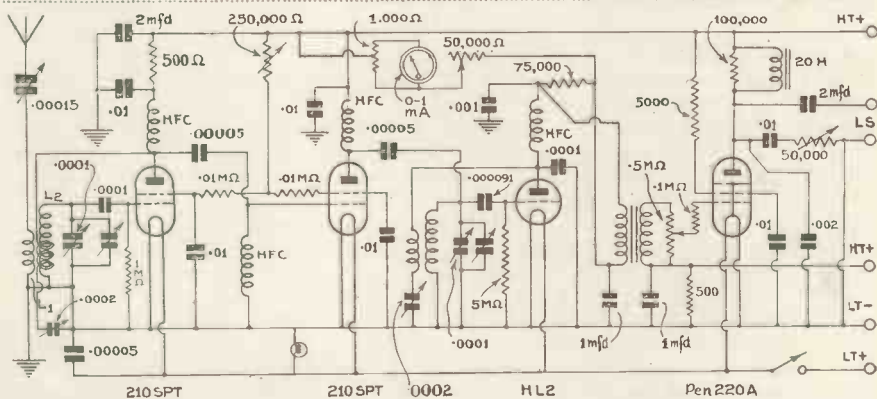

Compare this with the original circuit published last month. The suggested additions will then be apparent.

AMATEUR COMMUNICATION RECEIVER.

- BASEPLATE.**
1—20-gauge zinc 16½ in. by 9½ in. (Peto-Scott).
1—½ in. wood 16½ in. by 9½ in. (Peto-Scott).
CABINET.
1—type 1034 (Eddystone).
CONDENSERS, FIXED.
6—.01-mfd. type 411 (Dubilier).
1—.0001-mfd. type 665 (Dubilier).
1—.001-mfd. type 4511 (Dubilier).
1—.002-mfd. type 4511 (Dubilier).
2—2-mfd. type BB (Dubilier).
2—1-mfd. type 4513 (Dubilier).
1—SW81-.00001 mmfd. (Bulgin).
CONDENSERS, VARIABLE.
1—.0002-mfd. type 957 (Eddystone).
2—.00015-mfd. type 900 with coupling pieces (Eddystone).
2—.0001-mfd. type 1054 with quarter spindles (J.B.).
2—.0005-mfd. type 1087 pre-set (J.B.).
1—.00015-mfd. type 1053 with quarter spindle (J.B.).
COILS.
2—sets of four-pin type 932 (Eddystone).
CHOKES, HIGH-FREQUENCY.
2—type CHN National (Raymart).
2—screen H.F. P.A. with spade tags (Wearite).
CHOKES, LOW-FREQUENCY.
1—Ni-choke II (Varley).
DIALS.
2—3-inch type 1027 (Eddystone).
1—wide-vision 973 (Eddystone).
HOLDERS, VALVE.
5—four-pin chassis-type less terminals (Clix).
1—five-pin chassis-type less terminals (Clix).

- PLUGS, TERMINALS.**
4—terminals type B marked Aerial, Earth, L.S. pos. L.S. neg. (Belling Lec).
2—Wander plugs marked H.T. pos., H.T. neg. (Clix).
2—spade terminals marked L.T. pos., L.T. neg. (Clix).
RESISTANCES, FIXED.
2—10,000-ohm type HW 15 (Bulgin).
1—500-ohm. type HW2 (Bulgin).
1—5-megohm type HW 36 (Bulgin).
2—100,000-ohms. type HW25 (Bulgin).
1—75,000-ohm. type HW24 (Bulgin).
1—5,000-ohm. type HW10 (Bulgin).
1—500-ohm. type WE10 (Bulgin).
RESISTANCES, VARIABLE.
1—50,000-ohm. potentiometer (Erie).
1—500,000-ohm. potentiometer with switch (Erie).
1—50,000-ohm potentiometer (B.T.S.).
SUNDRIES.
1—D9 dial light with one B206 bulb (Bulgin).
2—aluminium screens to specification (Peto-Scott)
2—extension control knobs type 1008 (Eddystone).
2—large panel brackets (Bulgin).
TRANSFORMER, L.F.
1—Nictel type DP22 (Varley).
ACCESSORIES.
ACCUMULATOR.
1—2-volt 45-ampere (Exide).
BATTERY.
1—super 120-volt (Vidor).
VALVES.
2—210SPT met 4-pin (Cossor).
1—HL2 met (Ediswan).
1—Pen. 220A. (Ediswan).

of two high-frequency stages sufficient gain is obtained successfully to actuate a meter of this type. As can be seen from the theoretical circuit an 0.1 milliamp. meter is connected in the anode of a detector valve. A potentiometer connected across the meter is shunted so that with the aerial disconnected no anode current is registered.

Immediately a station is received the rectified speech currents are shown on this meter, which, of course, will vary according to the strength of signal. By tuning in the loudest station heard and calling that R9 plus, the input should be reduced in steps so that the meter reading decreases in ten steps equal to R1 and R9 plus. After that immediately a station is heard a definite R strength can be given without any need to guess the approximate strength.

I have used a meter of this kind now for several months and it is very nice to be able to tell a station that he is one R up or one R down on his transmission of two months previously just taking that one example.

Extreme selectivity can be obtained on this receiver, particularly with C.W., if regeneration is employed in the H.F. stage. A .0002 type 900 Eddystone condenser is mounted in the left-hand side of the steel case, the actual metal around the hole being cleaned, so that the rotor automatically makes contact. About 15 turns of thin cotton-covered wire are wound around the grid coil in the pentode circuit and one end of this winding is taken to the .0002 condenser and the other end taken directly to the valve. A small amount of regeneration does, as a general rule, increase signal strength by as much as two points.

All these little features may sound trivial but even though the receiver was extremely good in its original state considerably more amplification is now being obtained. The only disadvantage is perhaps the number of controls, although this is a controversial point.

At the moment experiments are being conducted as to the advisability of adapting the input circuit to suit a doublet aerial, for many readers are finding the extreme sensitivity a disadvantage owing to the close proximity of motors, tramcars, etc. Further information on this point will be given in a subsequent issue.

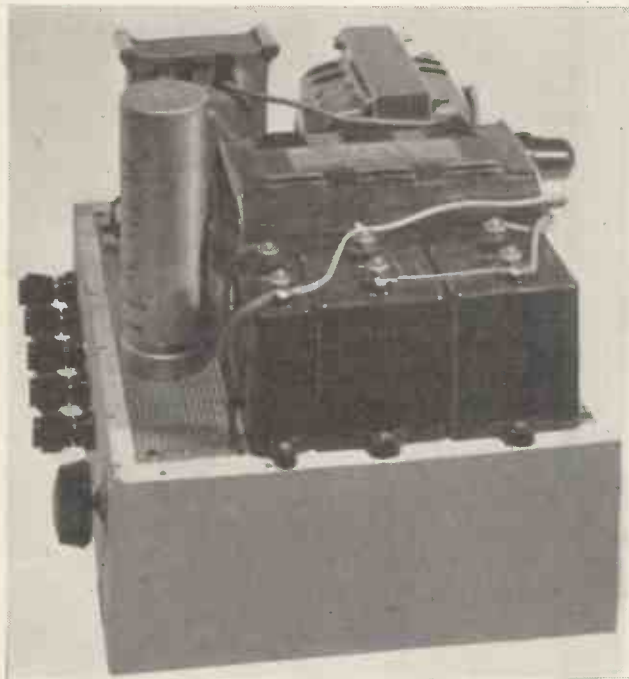

All H.T. and L.T. connections are brought out to terminals. The maximum H.T. can be varied by means of a variable resistance. If a small pentode is used decrease the output to the rectifier so as to reduce the D.C. output

31.8	COCH	Havana, 16.00-17.00, 21.00-23.00, 01.00-02.00.
34.29	ZCK	Hongkong, 04.30-06.15, 09.00-15.00.
42.37	VP3MR	Georgetown, irregular.
41.18	CR6AA	Lobito, Wed., Sat., 19.30-21.30.
46.0	YV6RV	Valencia Ven., 17.00-18.00, 23.00-03.00.
47.05	YV4RC	Caracas Ven., 21.30-03.00.
47.5	HIZ	Santo Domingo, 21.40-22.40.
48.78	C3RO	Winnipeg, 00.00-05.00, Sat. to 06.00.
48.86	W8XK	Pittsburgh, 02.00-06.00.
48.92	COCD	Havana, 23.00-05.00.
49.18	W9XF	Chicago, Sun., Tues. Thurs., Fri., 02.00-07.00. Mon., Wed., Sat., 06.00-07.00.
49.18	WSXAL	Boundbrook, N.J., Mon., Wed., Sat., 23.00-06.00.
49.26	VE9GW	Bowmanville, 22.30-04.00.
49.37	VQ7LO	Nairobi, Sun., 16.00-19.00, Mon. to Fri., 10.45-11.15, 16.30-19.30, Tues. and Thurs., 13.30-14.30, Sat., 16.00-20.00.
49.33	W9XAA	Chicago, 16.00-02.00.
49.50	OXY	Skamlebach, 18.00-11.30.
49.50	W3XAL	Philadelphia, 01.00-04.00.
49.50	W8XAL	Cincinnati, 05.00-06.45, 11.50-04.50, Sun., 13.00-01.00, and 04.00-07.00.
49.67	PRA8	Pennambruo, 22.00-00.30.
49.67	W1XAZ	Boston, Mass., 00.15-02.15.
49.75	VE9CA	Culgany, Thurs., 15.00-08.00, Sun., 18.00-06.00.
49.75	HP5B	Panama City, 17.00-18.00, 01.00-03.00.
49.92	COCO	Havana, 21.00-23.00, 01.00-03.00.
49.95	HJ3ABH	Bogaret, irregular.
50.00	XEBT	Mexico City, 00.00-09.00.
50.16	HIX	Santo Domingo, daily, from 12.00.
50.60	HJ4ABE	Medelien, 16.00-17.00, 23.00-03.00.
51.28	YV5RMO	Maracaibo, 22.00-02.00.
51.50	TIGPH	San Jose, 00.00-04.00.
51.80	YV2RC	Caracas, 15.30-17.30, 23.00-03.00.

50 Short-wave Stations for February

Supplied by 2 BZN.

M.				25.4	W2XE	Wayne, N.J., 23.00-01.00.
13.39	W8XK	Pittsburgh, 12.00-14.00.		25.6	CJRX	Winnipeg, 00.00-05.00. Sat. to 06.00.
15.93	PLE	Bandoeng, Tues., Thurs., Sat., 15.00-15.30.		27.93	JVM	Tokio, Mon., Thurs., 21.00-22.00.
16.87	W3XAL	Boundbrook, N.J., 14.00-22.00.		29.24	PMN	Bandoeng, Sun., 12.00-15.00.
19.56	W2XAD	Schenectady, N.Y., 10.00-20.00, Sat. to 22.00.		31.28	VK2ME	Sydney, Sun., 06.00-08.00, 10.00-16.00.
19.64	W2XE	Wayne, N.J., 16.00-23.00.		31.32	VK3LR	Lyndhurst, 08.15-12.30 Sun., 03.00-12.30.
19.72	W8XK	Pittsburgh, 14.00-00.00.		31.32	W3XAU	Philadelphia, 17.00-01.00.
20.55	JVH	Nasaki, Tues., Friday, 19.00-20.00.		31.35	W1XK	Millis, Mass., 11.00-05.00.
22.94	VUD	Suva, 06.30-07.30.		31.36	VUB	Bombay, Sun., 17.30-18.30. Thurs. and Sat., 16.30-17.30.
24.52	TFJ	Reykjavik, Sun., 18.40-19.00.		31.56	PRF5	Rio de Janeiro, 22.30-23.15.
25.27	W8XK	Pittsburgh, 00.00-05.00.				

These short-wave stations all radiate programmes of entertainment and can be received on almost any efficient receiver. Actually all of the stations listed have been heard during the first few days of this year by many of our readers.

RECENT ULTRA-SHORT WAVE DEVELOPMENTS

By "Microwave"

WITH SIMPLIFIED EXPLANATIONS

ONE of the most notable scientific developments of the moment is the technique of ultra-short-wave radio. Its uses cannot yet be said to be clearly defined. Two claimants have put in an appearance, Medicine and Communication. The difference in the nature of their claims seems to be in the matter of power. It does not seem likely that very large amounts of power at wavelengths below 10 metres will be needed for communication purposes, and the amount of power required to run such services seems to decrease with the wavelength, perhaps partly on account of the consequently increasing facility in use of highly directive and concentrative radiating systems. The main technical problem here is that of frequency stability. For medical purposes, on the other hand, comparatively large amounts of power may be needed, and this may become a nice technical problem at the very short wavelengths (below 1 metre).



Fig. 1. This S.W. 501 has a graphite anode and a thoriated tungsten filament.

With the prospects now of "markets" for ultra-short waves, research is going ahead, and some commercial forms of equipment both for medical and communication use have appeared upon the market, with promises of further working possibilities. Let us review what has been done recently.

From the point of view of the communication engineer, the problems fall into two categories: (a) generation, and (b) detection, of ultra-short waves.— The medical man's troubles are divided into: (a) generation, and (b) application. Perhaps the latter sentence contains a misstatement, for he (the medico) will leave the problems of generation to the engineer.

The most notable advances have been in regard to the design and construction of valves for use at these ultra-high frequencies. The main trouble with earlier power-generating valves was in connection with the seals for the electrode conductors. The currents carried by the leads passing through the seals, at normal communication frequencies, were little greater in magnitude than the pure d.c. or l.f. supplies to the electrodes, so that leads and seals designed to carry the filament heating and anode d.c. supplies were easily able to carry the small amounts of superimposed h.f.

or audio-frequency current. A simple series of computations will serve to illustrate this point.

As a fair estimate, a small power valve to operate at an anode voltage of 500 will have a grid-to-anode interelectrode capacity of 5 micromicrofarads, on the average. If such a valve is operated as an oscillator or amplifier under "class C" conditions, the peak value of the alternating voltage impressed between grid and anode will be at least equal to the d.c. anode voltage, and therefore equal in r.m.s. value to the anode voltage multiplied by $1/\sqrt{2}$, in the present case = 350 volts approximately. The effective impedance between grid and anode = $1/\omega C$, where C denotes the grid-anode interelectrode capacity, so that the resulting current, which must be carried by the seals in addition to the normal operating currents is, in the present case, = $350 \omega C$ in amperes (ω denotes the usual $2\pi \times$ frequency). Let us see what this amounts to at three representative frequencies with which a power valve (of unspecified type other than as above mentioned) might be called upon to deal:—

- (1) Frequency = 1,000 c.p.s. (i.e., a mean value of audio-frequency).
- (2) Frequency = 300 kc. (i.e., wavelength = 1,000 metres, a mean radio-frequency).
- (3) Frequency = 300 megacycles (i.e., wavelength = 1 metre, a mean ultra-high frequency).

The results for the three cases mentioned are:—*

- (1) 1.1×10^{-6} amperes (i.e., 1.1 microamperes).
- (2) 3.3×10^{-3} amperes (i.e., 3.3 milliamperes).
- (3) 3.3 amperes

Safety Margins

In most valves designed to work either as power amplifiers or oscillators at this anode voltage, the grid and anode seals are designed to carry not more than one or two amperes at the most, and this leaves a wide margin of safety under normal operating conditions as the above figures show, the superimposed a.c. component of the anode current in the first two cases being quite negligible.

There is the further fact that the resistance of the leads in the seals is much greater than the d.c. resistance at the ultra-high frequencies, so that the heating effect of the superimposed current is much greater than would be indicated by the mere comparative value of the current, even allowing for the fact that the heat generated in the seals is, of course, proportional to the

* These figures apply to the "displacement current" due to the interelectrode capacities only. In the first two cases this is negligible in comparison with the a.c. component of the conduction current, which latter in a valve of this type would amount to some 50 milliamperes or so.

FEATURES OF ULTRA-SHORT WAVE VALVES

square of the current value. Including the effect of the very high frequency, the thermal strain on the seals is likely to be proportional to the fourth or higher power of the operating frequency.

Thus it is that the first thing that strikes one about a well-designed modern valve for very-high-frequency work is the substantial nature of the electrode leads and seals. A typical form of construction is shown in Fig. 1. All the leads consist of stout rods, as short as they can conveniently be made, the anode and grid being supported entirely by their stout leads. This form of construction results in a grid-anode interelectrode capacity of 2.5 micromicrofarads, as against about 9 micromicrofarads for a normally constructed valve of the same power-handling capacity. The comparative figures for the inductance of the grid and anode leads are respectively .08 and .14 microhenries respectively. This type of valve is capable of operating down to about 1 metre with reasonable efficiency, giving an output of about 10 watts at this wavelength.

Having reduced the inherent capacities and inductances as far as possible, there still remains another factor tending to hinder operation at the very high frequencies. This is the phenomenon known as "transit time." The speed of the electrons which constitute the anode current ("space current") is finite, and directly proportional to the anode voltage, and is given by the simple formula:—

$$v = 6.0 \sqrt{V} \times 10^7 \text{ centimetres per second}$$

where V is the anode voltage. In the case of the valve which has just been described, the cathode-anode distance is approximately 1 centimetre, and the optimum operating voltage at the higher frequencies is about 700 volts. Consequently the time taken for an average electron to travel from the cathode to the anode is 0.63×10^{-9} seconds. If this transit time corresponds with a half-time period of oscillation, the result will be that the static field between the electrodes will have commenced to reverse just as the electrons which started their journey from the cathode surface arrive at the anode surface, so that theoretically they will just fail to arrive in time.

Frequency

Limits

This constitutes an absolute limit to the frequency at which the valve will operate. In practice, the limit due to this cause is reached before the "half-time-period"—"transit time" condition is reached due to the decreasing efficiency on this account. If we accept the theoretical limitation in the case of the valve under discussion, the limit works out at 790 megacycles (i.e., $\lambda = 38$ centimetres). The practical limit is about half this frequency, about 350 megacycles ($\lambda = 87$ cms.). With good modern circuit design, the transit time limitation comes into operation first, before that of circuit conditions, or rather the two are interdependent, for the following reasons:—

There are two possible methods of reducing transit time troubles. (a) Reduce the interelectrode spacing to reduce the transit distance; (b) increase the anode

voltage, to increase the electron velocity; (c) combine (a) and (b).

Considering these (a) must inevitably result in reducing the size of the electrodes, and therefore their power handling capacity, or alternatively increasing their interelectrode capacities and so setting an upper limit to the frequency on account of these high capacities loading the output circuit.

(b) If the anode voltage is increased, the anode power dissipation increases as the square of the anode voltage, if the anode current is allowed to increase in proportion. But for a valve of given permissible anode dissipation the anode current must be restricted under these latter conditions in order to keep the dissipation down. This involves the use of an effective control-grid, that is, one with close mesh. The inevitable result is a valve with a high magnification factor, and therefore a high anode resistance, rendering circuit-impedance matching at the highest frequencies difficult or impossible. The effect of the close-mesh grid is also to slightly increase the important grid-anode interelectrode capacity.

(c) In the most successful types of valve, recently developed, the method has been adopted of reducing the size and spacing of the electrodes as far as possible, making the grid and anode of highly refractory material (e.g., tungsten or graphite). These efforts have been very promising. The limit is then set by the permissible temperature of the grid or anode (whichever first reaches the temperature at which it itself commences to emit). With a triode of this type, about the size of a walnut overall, an output of from 3 to 8 watts at wavelengths of between $\frac{1}{2}$ and 1 metre is obtainable. The problem of obtaining really considerable power at the very high frequencies is discussed later.

Reduced Sizes

The policy of reducing the physical dimensions of the valve is particularly useful from the reception point of view. Whilst by a variety of methods, to be discussed later, it is possible to make valves of considerable physical size operate at very high frequencies (e.g., a 20-kilowatt water-cooled valve operating at 100 megacycles) there is under these conditions not much possibility of delicate control such as is needed for reception, because the majority of the oscillating circuit is within the structure of the valve itself, and therefore usually inaccessible. The very small ("acorn type") valve, however, allows the majority of the circuit to be built up outside the valve, as in normal radio practice (except for the necessarily small dimensions of the circuit elements) thus allowing for mechanical control of frequency and regeneration. Miniature tetrodes and pentodes built up on this principle are capable of giving a useful stage gain at frequencies up to 150 megacycles ($\lambda = 2$ metres). It seems probable that from the reception point of view this type of valve will be a predominant factor.

(To be concluded next month.)

THE TRANSMISSION AND RECEPTION OF MICRO-WAVES*

By C. G. Lemon, F.Ph.Soc., A.M.I.R.E.

THE whole range of electromagnetic waves on a logarithmic scale is shown in Fig. 1. The range of the so-called quasi-optical waves lies between 10 metres and 0.0008 millimetre. This is bounded by commercial waves on the one side

cal reflector, we see that reflectors on fairly long "short-wave" transmitters are very inefficient.

In the lower part of the quasi-optical range we can use systems similar to the optical ones, but even at 50 cms. we get into trouble, because, to

Producing Quasi-optical Waves

Fig. 2 indicates the various ways of producing quasi-optical waves. Using special types of valves and connected in the Colpitts fashion, oscillations have been produced down to 0.5 metre. The negative resistance circuit (dynatron, etc.) cannot be made to oscillate much below 10 metres owing to the difficulty of building resonating circuits with a sufficiently high impedance. The usual reaction circuit cannot produce waves much shorter than 1 metre owing to the time taken by an electron to get from one electrode to the other.

A solution to the difficulty was first found by H. Barkhausen, and he actually uses the time taken by the electron in its movements within the valve to produce the ultra-high-frequency oscillations.

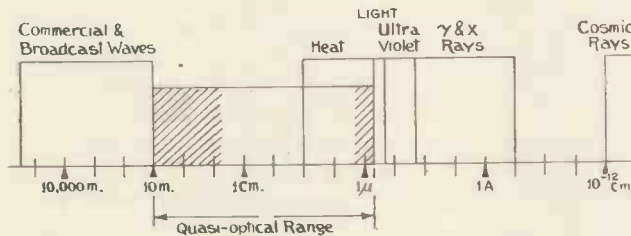

Fig. 1.—The spectrum of radiant energy. The quasi-optical range is shown shaded.

and visible light on the other. However, only the two shaded parts can be used for comparative purposes. These two parts have the ranges 10 m. to 5 cms. and 0.7 to 2.0 μ .

A characteristic of the quasi-optical waves is their straight line propagation. Between the transmitter and the receiver there is only line propagation and therefore the phenomenon of fading is unknown. The possibility of concentrating the radiated energy is another important feature.

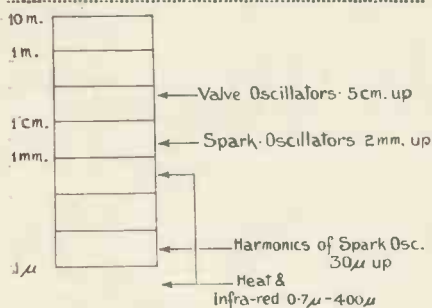

Fig. 2.—Diagram showing methods of producing quasi-optical waves.

Concentration can, of course, be carried out by reflecting systems. However, comparing the gain of 30-50 times for a 20-metre commercial station to that of 10^4 to 10^5 for an opti-

cal reflector, we see that reflectors on fairly long "short-wave" transmitters are very inefficient.

A further characteristic is that the

Fig. 3.—A simple electron oscillator.

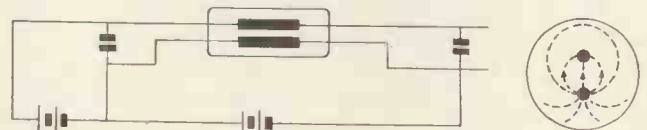

noise level at quasi-optical frequencies is extremely low compared to the lower frequencies. They do not appear in man-made devices as in the broadcast range. In fact even Dame Nature seems to have difficulty in starting these high frequencies.

Wavelengths above 5 cms. do not appear to be influenced by atmospheric conditions. Below 5 cms., however, the humidity of the air, and especially the CO_2 content of the atmosphere, absorbs the radiations.

Below 3 cms. there is no appreciable radiation in the atmosphere, this being absorbed and scattered in the vicinity of the generator. As we progress lower still in wavelengths, we find that radiation starts again only at the shorter heat waves, infra red and visible light.

A cloud of electrons travels around the electrodes inside the valve, charging and discharging them, and so producing varying voltages that can be applied to outside circuits and radiators. By

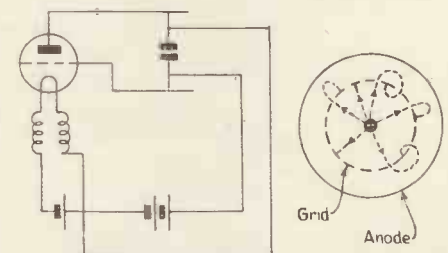

Fig. 4.—Barkhausen electron oscillator.

this method it is possible to produce oscillations down to 3 cms. Wavelengths down to 3 metres can fairly easily be produced by the use of ordin-

* A Lecture delivered at the I.E.E., London, on September 27, 1935.

ary valves, provided small valves are used and the required power is low.

If it is desired to use higher frequencies or obtain a larger output, many difficulties arise, the most serious being insufficient protection from overheating at the points where the electrodes are sealed into the bulb. Another point is the alteration of frequency as the valve warms up. Below

quency generated. In this way the varying voltages produced on the anode are communicated to the external circuit.

The Barkhausen Circuit

The circuit used by Barkhausen for generating electron oscillations is shown in Fig. 4. The types of valves

from the anode varies the potential of the anode in accordance with the frequency of the periodic path.

A lecher wire system coupled to the anode and grid enables the electron oscillations to appear external to the valve. Again, the frequency of the electron oscillations is mainly determined by the applied voltages. The output from a valve connected in the

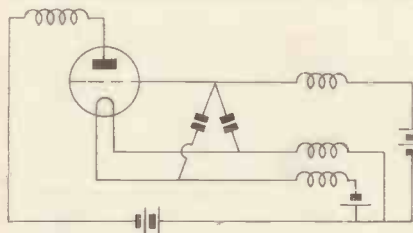
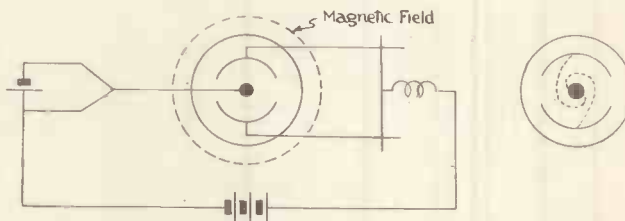

Fig. 5 (left).—Grid-filament electron oscillator.
Fig. 6 (right).—Magnetron electron oscillator.



one metre the Barkhausen method of producing oscillations has to be utilised.

The simplest form of electron oscillator is shown in Fig. 3a. This consists of two filaments in an evacuated container, one filament being able to emit electrons when heated. Applying a suitable potential, the electrostatic field is as shown in Fig. 3b. Most of the electrons will hit the other filament (anode), but some of them will not hit the anode at all, passing completely around. As the distance of these latter electrons on their periodic path around the anode varies, a change of voltage will be periodically produced and in this manner gives rise to what we call electron oscillations.

The frequency of these electron oscillations is mainly controlled by the applied voltages, the lecher wire system being so tuned and adjusted to have a high impedance at the fre-

quency of the periodic path. The grid is connected to a high positive potential and the anode to zero or a negative potential. Electrons emitted by the filament go in straight lines to the positive grid, but a fairly large number pass through the interstices of the grid, find themselves in a negative region due to the anode, and thence reverse their direction and return to the grid. Again, a number of these returning electrons miss the grid and pass through into the positive region between filament and grid, are caught up in the primary stream, and repeat the periodic path. This cloud of electrons approaching and receding

Barkhausen fashion cannot be made to exceed 0.1 watt, owing to the amount of heat that can be dissipated by the anode.

Fig. 5 shows another type of electron oscillator. The lecher wire system is connected between the grid and filament. This enables the power output to be slightly increased.

The magnetron oscillator is capable of producing a large power output than that given by the conventional Barkhausen circuit. The circuit is shown by Fig. 6. The magnetron consists of a straight filament surrounded by two halves of a cylindrical anode. A powerful magnetic field is arranged in line with the filament. The electrons are twisted from their straight paths to the anodes by the application of the magnetic field and this causes the electrons to take periodic paths, thus giving rise to the electron oscillations (Fig. 6b).

R.T.S.

THE South Hants R.T.S. held a meeting at the Schoolroom, Outram Road, Southsea, on January 8, when Mr. Shearston, B.R.S. 1,907, lectured on "High-fidelity Gramophone Reproduction." In the course of the lecture Mr. Shearston gave details of gramophone amplifier and pick-up characteristics with special reference to selective correction of frequency response.

Cardiff Transmitters Society.—This Society has been formed by local members of the R.S.G.B. and meetings are held every other Thursday, at 8 p.m., at Barry's Hotel, St. Mary Street, Cardiff. The next meeting will be on February 6. Further information can be obtained from the Hon. Secretary, 132 Clare Road, Cardiff.

The next meeting of the North Manchester Radio Society is on February 7 at the British Legion, Elms Street, Bury New Road, Whitefield, near Manchester. A lecture is to be given on Dagenite batteries. Further lectures are to follow on February 14, 21, 28 and March 6, by representatives of E. K. Cole, Ferranti, etc. On February 19, a dance is to be held at the Ritz, Whitforth Street, details of which can be obtained from Mr. R. Lawton, 10 Dalton Avenue, Thatch Leach Lane, Whitefield.

Ralph Stranger's Science Review

Some of the readers of TELEVISION AND SHORT-WAVE WORLD may not be

aware of the publication of a new journal entirely devoted to general science. In the scientific sense the scope of Ralph Stranger's *Science Review* is extremely wide and includes such subjects as radio, astronomy, microscopy, chemistry, mathematics, optics, electricity, etc., etc., so presented that their study is progressive in order that the novice may benefit equally with the advanced student. All the articles are contributed by well-known authorities on the particular subjects, and the February issue includes articles by the Astronomer Royal, Dr. C. Bernard Childs, Professor Carl Störmer, etc. For the serious student *Science Review* provides a wealth of information in an easily assimilated form. It is published monthly, price 1s., and the February issue is now on sale.

THE PRINCIPLES AND PRACTICE OF ELECTRON OPTICS

By N. Levin, Ph.D., A.R.C.S., D.I.C.

This is the Second of a series of articles describing in an easily understood manner the principles and practice of electron optics, a new branch of electronics which is becoming of great importance.

IN last month's article it was shown that a beam of electrons tends to move in a straight line in a uniform field, that is, a field the strength of which is constant. In general, however, the field is not uniform and the strength varies from point to point. It is necessary at this stage to define the field strength in a slightly different form. Previously it was stated that

$$E = -\frac{V}{d}$$

where V is the potential difference between two points separated by a distance d . If these two points are

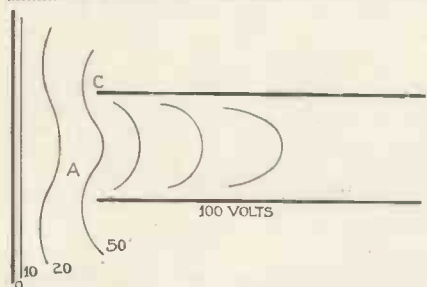

Fig. 1.—Diagram explaining the focusing of an electron beam.

brought very close together, then both V and d become very small, but E remains a finite value, that is, generally, the field strength has some value other than zero or infinity.

If we now taken a third point on the same straight line very close to one of the first two, then in a non-uniform field the difference of potential between the first and the second points will not be the same as that between the second and the third, although the two distances will be equal. Therefore the two field strengths will be unequal and the complete field will be non-uniform. The line joining the three points is always chosen to be the principal axis of the system and distances along it measured from some fixed point or origin are denoted by z . With this notation, field strength is defined by

$$E = -\frac{dV}{dz}$$

where dV is the potential difference between any two points very close together and dz is the distance between them measured along the axis.

In the case of the electrode arrangements used in cathode-ray tubes, the system is invariably perfectly symmetrical about the principal axis, disregarding for the time being the deflecting plates. We have, therefore, only one other point to consider. Suppose we have an open cylinder at a certain potential V_0 surrounding the axis. Then, at the edge of the cylinder, but on the axis, the potential will not be V_0 but some other value determined by the conditions in the neighbourhood of the cylinder. For example, Fig. 1 shows approximately the equipotentials existing between a plate at zero potential and a cylinder at, say, 100 volts. At the point A, the potential is probably about 25 volts whilst at C it is 100. This is very important and is in fact the entire reason why a beam of electrons is focused at all.

Since the system is symmetrical about the axis, we can define the field completely by introducing only one other factor, namely, the radius r or distance of any point from the axis. Clearly, then, if we wish to define the field strength at right angles to the axis in the direction of r , we write,

$$E = -\frac{dV}{dr}$$

To distinguish between the two values of E , we denote the axial strength by E_z and the radial by E_r . The combined effects of the two strengths at any point represent the total field strength at that point. In a perfectly general system which is not in any way symmetrical, there are, of course, three directions to consider, but that need not concern us and will be omitted in order to avoid unnecessary complications.

We have now to consider what is the effect of any field, uniform or otherwise, on a beam of electrons. First of all, any electron travelling along the axis will remain on the axis, since all the forces tending to push

or pull it off must be balanced out, as the system is symmetrical. Its velocity will vary according to the axial potentials, but it will not leave the axis. It is clear now why this axis is called the principal axis. Further, it defines the position of the spot on the screen and also explains why some electrons always reach the screen, providing the grid is not so negative as to cause the electrons to turn back. This actually can be considered as corresponding to the case of reflection. It has often been asked, why do not the electrons go to the anode with the highest potential? In practice, if this anode is an open-ended cylinder, it rarely, if ever, takes any direct electrons at all!

An electron travelling at an angle to the axis meets with quite a different state of affairs. There will be two field strengths acting on it and

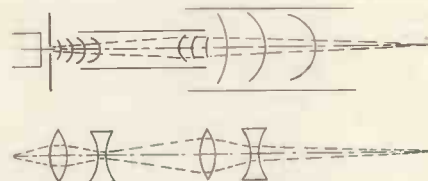

Fig. 2.—Effect of two co-axial cylinders.

each will exert a force. The electron will always move towards the screen, but owing to the varying radial force, its distance from the axis will change. Hence on its way to the screen it may change its direction several times, sometimes pointing towards the axis and sometimes away from it. The system is designed so that its final direction is towards the axis when we want a small bright spot.

Fig. 2 illustrates the equipotentials and the paths of the electrons in Zworykin's arrangements of two co-axial cylinders at increasing potentials. More modern systems have an electrode between the two cylinders at zero potential. This will be discussed in greater detail later.

It can now be seen that when an electron enters a field of force at an

ELECTRON OPTICS AND OPTICAL EQUIVALENTS

angle to the axis its direction is changed. To use an optical term the path is refracted or bent. If the field is non-uniform the path is continuously bent, or refracted in a curve. A simple case to consider is the bending at the boundary between two uniform fields of zero intensity, but at different potentials. We shall assume the hypothetical case of a sharp demarcation between the two fields and moreover the boundary will be considered to be straight, which, of course, is unusual in practice. This method can be developed for practically every optical phenomenon, such as reflection and refraction at the surfaces of a lens, prism or glass block. Knoll and Ruska have tested the optical analogy between a beam of electrons in a field of force and a beam of light for all these effects and have found them substantiated in every particular. They used as boundary surfaces two grids close together as shown in Fig. 2 of the first article last month.

Only the simple case will be discussed as these grid surfaces are not used in practice owing to their high current absorption and the distortion at the edges of wires in the grid. Zworykin has compared these grids with a badly polished glass surface full of pits and holes.

Fig. 3 shows the path of an electron travelling with velocity v in a uniform field of zero intensity the potential of which is V . On crossing the boundary into another field of zero intensity but at a different potential V' it is bent or refracted. If V' is greater than V the path is bent towards the normal. The velocity will now be v' . The components of the initial velocity are v_x , parallel to the surface, and v_z perpendicular to the surface or parallel to the axis. The corresponding components of the final velocity are v'_x and v'_z . Let i and i' be the angles the two paths make with the normal. Then we have

$$\sin i = \frac{v_x}{v} \text{ and } \sin i' = \frac{v'_x}{v'}$$

Now there is no force on the electron parallel to the surface. Hence the velocity in this direction is unchanged. As indicated in the diagram, the components v_x and v'_x are equal. Only the components at right angles to the boundary are changed. Therefore

$$\frac{\sin i}{\sin i'} = \frac{v_x/v}{v'_x/v'} = \frac{v'}{v}$$

The velocity of the electron is known from the fact that its energy is all kinetic and that this energy is derived from the potential of the field in which it is moving. Thus we have

$$\frac{1}{2} mv^2 = eV$$

where e is the charge on the electron and m is its mass. Therefore

$$\frac{\sin i}{\sin i'} = \sqrt{\frac{V'}{V}}$$

The optical equivalent of this formula is

$$\frac{\sin i}{\sin i'} = \frac{n'}{n}$$

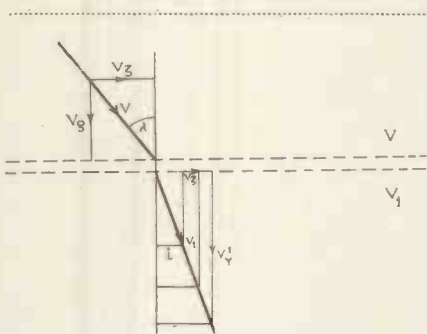

Fig. 3.—Diagram showing alteration of electron path in field of different intensity.

where n and n' are the refractive indices of the two media with reference to a beam of light.

The relation between these two formulæ is obvious and very important, since it is the foundation for the whole subject of electron optics. It means that in any optical formula we can replace the ratio of the refractive indices by the square root of the ratio of the potentials. For example, the optical relation between the object and image distances of a lens is

$$\frac{n'}{l'} - \frac{n}{l} = \frac{n' - n}{f'}$$

where l is the distance of the object from the lens, l' is the distance of the image from the lens and f' is the focal length of the lens on the image side. The electron optical formula can therefore be written immediately as

$$\frac{\sqrt{V'}}{l'} - \frac{\sqrt{V}}{l} = \frac{\sqrt{V'} - \sqrt{V}}{f'}$$

This particular equation relates to a thin lens, which is very often a sufficient approximation in ordinary optics. It is very seldom true for the electrical case, where we must take account of the thickness. However, the more accurate formula can be de-

rived and the transformation will still hold. Moreover although the focal length for the electrostatic or electromagnetic lens may be obtained in an entirely different way from the glass lens, the same formula for the object and image distances will apply.

One more important feature must be discussed before we proceed to the practical formulæ for the focal lengths of electrostatic and electromagnetic lenses and their application in the design of a cathode-ray tube. The ratio of the refractive indices for ordinary substances is always about 1.5. Very special cases exist where it is greater, but these are never practical. However much higher values can be realised electrically since

$$\sqrt{\frac{V'}{V}}$$

can be in practice as high as 10. This shows at once that the power of an electrical lens may be considerably greater than that of a glass lens. Use has been made of this fact to produce an electron microscope which will project on a fluorescent screen a greatly enlarged image of an electron emitting or transmitting surface, and it is hoped that magnifications will be obtained greater than any yet given by either the ordinary or even the ultra-violet microscope.

(To be Continued).

Sir Oswald Stoll and Television.

Discussing the future of entertainment with a representative of the *Evening News* recently, Sir Oswald Stoll referred to television and the part it is likely to play in the following words:—

“Just think of one of the manifold activities of the entertainment industry of the future. Television is coming—and quickly. Don't think of it just as wireless.

“I look forward to the day when a show played in the Coliseum at 11 a.m. will be shown simultaneously in Melbourne at 9 p.m., in Tokio at 8 p.m., at Hongkong at 7 p.m., in Calcutta at 5 p.m. Our normal evening shows, too, will be just right for matinee time in New York.

“Television, ultimately, will make that possible. The show will not be just a film, but stereoscopic, colour, sound—everything just as it is shown in the Coliseum. And mark you, that will happen within a very few years.”

Photo-electric
Cells

Our Readers' Views

Decline in
Inventions

Appreciation

Correspondence is invited. The Editor does not necessarily agree with views expressed by readers which are published on this page.

Five-metre
Transmission

Photo-electric Cells

SIR,

With reference to the article on photo-electric cells which appeared on page 50 of your issue for January, 1936, we should like to call your attention to a statement which is made in the first column on this page concerning the sensitivity of the caesium type gas-filled photo-cells.

The emission of 15 microamps. per lumen is extremely low for a gas-filled cell, and for the type we manufacture, which is shown in the first illustration, the sensitivity at the working voltage under a gas magnification of 10 is at least 75 microamps. per lumen and may be three or four times this figure.

The statement, therefore, is rather misleading, particularly when referred to the gas-filled type of cell. Although the figure would be correct as an average one for a vacuum cell, we are now producing regularly vacuum cells which have a sensitivity of 25 to 35 microamps. per lumen, some going up to as high as 50.

THE GENERAL ELECTRIC CO., LTD.,
R. C. WALKER
(Osram Photo-cell Department).

Decline in Inventions in 1935

SIR,

We regret to have to report a decline in the number of patents applied for during the year 1935. It is estimated that approximately 36,100 applications for patents on inventions will have been filed by the end of 1935, as compared with 37,409 in 1934. Figures for several previous years are as follows:—36,117 in 1931, 37,052 in 1932, and 36,734 in 1933, the peak being 39,898 in 1929.

The number of patents applied for has by some people been regarded as an indication of the state of industry, but this is evidently not a sound view to take seeing that notwithstanding the continued improvement in trade during the present year, fewer patents have been applied for during this period.

During the present year we have found that activity persists in inventions relating to sensitising dyes used for photographic purposes, whilst in the radio industry there has been continued activity in connection with

short-wave receiving sets and components, possibly in view of the prospect of commercial broadcast television. The effort which has been made by the authorities to secure greater road safety has been reflected in the many patent applications which have been taken out in respect of speed indicating devices, road signals, etc.

GEE & Co. (London, W.C.2).

Appreciation

SIR,

Allow me to congratulate you on your fine publication TELEVISION AND SHORT-WAVE WORLD.

I am a "new recruit" to your large number of subscribers, your November issue being, unfortunately, the first I have had the pleasure of reading. I have read almost every wireless and television book on the market, but find yours the best of all, as it is so instructive and easily understood by the non-technical wireless fans. I will be very proud to join your "Constructors' Circle" and to wear the membership badge. I have placed a regular order with my news-agent.

H. HASTINGS (London, S.E.)

Mr. Eustace Robb

SIR,

In the last few months we have heard a great deal about the B.B.C.'s plans for the new television studios, and have had intimate details about the private and public lives of the staff who are to direct the wonderful programmes which are promised to the public.

One name, however, seems to be conspicuous by its absence, and that is the name of Mr. Eustace Robb. Can it be that the B.B.C. have already forgotten the wonderful work which Mr. Robb did in organising practically single-handed, and often I believe in the face of opposition, the programmes which used to delight us in the old 30-line days? Surely it was not too much to expect that such pioneer work should have been rewarded by appointing Mr. Robb to a high position in the new personnel, but so far his name has not even been mentioned.

I do not know anything about the

policy of the B.B.C., and it is quite possible that Mr. Robb has already declined the honours which the grateful Corporation have no doubt wished to thrust on him, but I think that the majority of your readers would join with me in paying a tribute to one who has been responsible for their entertainment in the past, and to assure him that his name will not be forgotten.

J. W. STEEVENS (Highgate).

Five-metre Transmission

SIR,

I cannot see how any amateurs could say that my report on the 2PB 5-metre transmission was inaccurate. It was accurate, and I would have them know that I have a written QSL from Mr. J. F. Stone, B.R.S. 2,038, of 91 Erskine Hill, N.W.11, to the effect that he heard my five-metre transmission on a one-valve super-regen. Please publish this as it confirms the Portsmouth-London contact. That 2PB was working without authority does not alter this Portsmouth five-metre record. I have the B.R.S. 2038 report before me now. He gave me QSA 4/5, T9, R4 with the remarks fb O.M.

On Tuesday, December 3, at 10 a.m., I asked if any 40-metre phone station which could listen on five-metres would co-operate. G2PB said if I would give him five minutes to rig up his 56-mc. superhet he would listen in. Meanwhile he said he would put on a record which he did. Then he came on and said he was ready. I then sent phone and one C.W. high note on 5.18 metres for ten minutes. He answered on 40 metres and described the transmission perfectly. On a subsequent second test he had a two-valve super-regen. put on without aerial and heard me O.K. I understood him to say that he used to operate in Devonport but was now in London. He said he was sorry he could not send on 56-mc. We carried on until after 11.30. Next morning B.R.S. 2,038 sent his report which verified the London contact. According to his talks and report 2PB is well versed in these matters. Please emphasise the B.R.S. 2,038 written verification—it

is important. My only fears are that this publicity will get some well-intentioned person into trouble. By the way, have you noticed that he has not been on since then? He announced himself as G2 Paris Brussels. I have my ideas on the location of 2PB and am following up. About 2PB not being allowed to work on 40; this can be met by saying that we are not allowed to work on 30-metres but there is nothing to stop us from dropping down to that to help someone we may hear calling, if we care to risk it!

ALBERT PARSONS (G6PU).
Municipal College, Portsmouth.

a switch is incorporated on the metal panel to provide the wave-band switching. The tuning condenser has brass vanes and the end plates are of a special low-loss high-frequency material. The reaction condenser has brass vanes and is fitted with a 9-1 slow motion drive. When used with an ordinary broadcast set having at least one H.F. valve stage (pretuned to 1,800 metres) it is an efficient self-oscillating converter and makes an ideal short-wave super heterodyne.

The second short-wave unit is an

A.C. mains type triode heptode pre-selector amplifying converter covering 13-52 metres. The triode heptode pre-selector amplifying converter can be used with practically any type of receiver and is operated from the A.C. mains. It has its own filament transformer. High-tension is obtained from the broadcast set with which it is used in conjunction. It may be operated several feet away from the broadcast set. This is priced at 70s.

An illustrated list will be sent on request.

Television Kits for Home Construction.

APPRECIATING that a demand will shortly arise for units for high-definition television receivers, the Mervyn Sound & Vision Co., Ltd., have developed several of these in more or less complete form so that home-constructors will be able to purchase component parts or units of any part of the receiver. Included in the complete units are a 3,000-volt high-tension unit, a double time-base and a 7-valve vision receiver.

The high tension unit has an output of 3,000 volts and includes a winding for the tube heater for A.C. mains. It is complete in cadmium plated steel chassis including rectifier valve. This is completely assembled and ready for use, and the price is £6 os. od.

The double time-base is in kit form without valves and relays, but including cadmium plated steel chassis. The price of this is £6 10s. od. An H.T. and L.T. unit to operate the above can be supplied complete with thermal delay switch, etc., at an additional charge.

The vision receiver has seven valves, single dial control, and incorporates separate output for synchronising. This is completely assembled on a cadmium plated steel chassis, employing a triode heptode valve. The price of the complete receiver ready for operation is £16 10s. od.

In addition to the above the Mervyn Co. have developed two ordinary short-wave units. One of these is a converter adaptor for either mains or battery operation which is available in a metal case without valve at 42s. This is assembled ready for use. This unit employs a special coil and

When to Listen for Short-wave Stations during FEBRUARY

By C. J. Greenaway—G2LC.

G.M.T.	3.5 mc.	7 mc.	14 mc.
0100	W1	SU; YI; ZB1	
0300	W3		
0400	W3, 4	W1, 3, 5	
0500	W1, 2, 3, 4	W1, 2, 3, 8	
0600	W1, 2, 3	W2, 3, 8	
0700	W1, 2, 3, 8	HC; SU; W2, 3, 4, 8; ZL	W9; ZL
0800	W1, 3	CN; FA8; HH; VK; VP4; W1, 2, 3, 4, 6, 8, 9; ZL	FA8; SU; YI; ZL FA8; SU; YI; ZD; ZL
0900		VK; ZL	FA8; SU; VK; VU; YI; ZB1; ZC6; ZD; ZL
1000			FA8; SU; VK; YI; ZB1; ZC6; ZD; ZL
1100			VK; VP2, 5, 6; W2
1200			FA8; SU; VE1, 2, 3; VK; VP5, 6; VS6;
1300			W1, 2, 3, 8, 9; YI VE2; VK; VP5; VQ4; VS8; VU; W2, 3, 8, 9; YI; ZD
1400			FA8; SU; PK; VE1, 2; VQ4; W2, 3, 8, 9; YI; ZD
1500		KA; VK; VS6	PK; VE2, 3; VQ3; W1, 8, 9; ZD
1600		FA8; KA; VK; VS6, 7; VU; ZL	VE1, 2; W1, 2, 3, 8, 9; ZD; ZS-U
1700		VK; VS7; VU	FA8; W1, 2, 3, 4, 8, 9; ZS-U
1800		VK; VQ4; VS7; VU; YI; ZB1; ZC6; ZS- U	VE2; W1, 2, 8, 9
1900		SU; VK; VQ3, 4; VS7; VU; ZB1; ZD; ZE1; ZS-U	TI; VE2, 4, 5; W1, 2, 8, 9
2000		FA8; SU; VK; VE1; VS7; VU; W1, 2; YI; ZB1; ZS-U	FA8; VE2, 4, 5; W1, 2, 3, 8
2100		CN; FA8; SU; VE1; VK; VU; W1, 2, 8; YI; ZB1; ZC1; ZS- U	VE2, 4, 5
2200		FA8; SU; K4; VE1; VP5, 6; VQ4; W1, 2, 3, 4, 8, 9; YI; ZB1; ZE1; VU	
2300		CM; FA8; K4; TI; VK; W1, 2, 3, 4, 8, 9; ZB1	
2400	W1	W1, 2, 3, 8	

"Parabolic Reflectors for Ultra-short Waves"

(Continued from page 98)

Technical Discussion

It is usual to find the aerial placed at the focus at a point $\lambda/4$ from the origin, but an increase in this direction

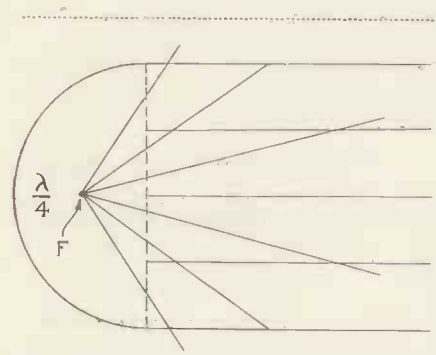

Fig. 4.—This reflector is $\lambda/2$ deep. The measured radiation was 39 per cent. divergently; 61 per cent. in a parallel beam.

results in an increased sharpness of beam.

When the aerial is energised each of the reflector rods (or solid reflector) is also set in oscillation. Refer to Fig. 5. Since the distance BD is equal to $\lambda/4$ the radiation from B reaches the aperture in phase with the direct radiation from the aerial D. Moreover, the dis-

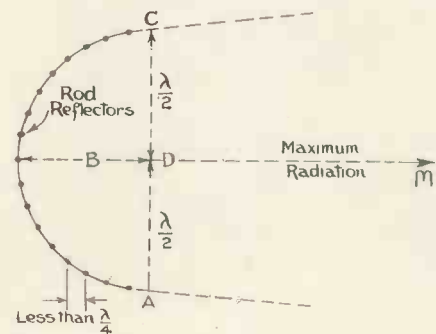

Fig. 5.—A parabolic reflector consists of resonant conductors spaced less than $\lambda/4$ in the parabola. Each conductor should have the same natural frequency as the radiating aerial.

tance DF \times FH, which is the distance from a rod to the aerial added to that from the rod to the aperture, is equal to DB \times BD. Thus the radiation from all sources and from the aerial will assist it along the line of maximum radiation BDM.

It has been stated that by increasing the depth of the reflector, an increased sharpness of beam is obtained. The following figures gives the results obtained for depths of $\lambda/2$, $3/4$ and 1.

$\lambda/2$	Divergent radiation.	Reflected radiation.
$4\lambda/3$	39%	61%
1	33 $\frac{1}{2}$ %	66 $\frac{1}{2}$ %
	30%	70%

The improvement in the sharpness of the beam is not proportional to the increase in the depth of the reflector. There seems no point in increasing the depth to more than $\lambda/2$.

Top Band Frequency Register

MANY new stations have been added to this list during January while one or two stations have altered their frequencies. There are, however, still a number of stations, whose frequencies are not listed, and we shall be glad to receive these in time for publication in the next issue.

Frequency.		Frequency.	
1726	G6GO	1780	6BO
1735	6BO	1780	6HD
1740	5HO	1781.5	5VS
1740.8	5ZJ	1782	5RT
1742	5WL	1784	5IJ
1750	2WK	1785.5	5ZT
1752	2KL	1785.5	6IF
1753	6KV	1787.5	2XP
1754	6ZR	1788.5	2GG
1754	6GO	1790	5UM
1755	6PY	1790	2SN
1756	2AO	1791	5AK
1757	6YU	1792	2QM
1759.5	5JW	1794	5JU
1759.5	2KT	1795	2UY
1760	5AR	1800	6TL
1760	5BM	1801.5	5LL
1762.5	2ZN	1802.9	5ZJ
1764	5NW	1806	5MM
1765	5ZQ	1810	6BQ
1766	2WO	1810	2LD
1766	5JO	1810	5PP
1768	6PL	1815	2DQ
1769	5GC	1818.5	2OG
1769.5	5FI	1824.5	2WG
1770	5PR	1824.5	6UJ
1773.1	5BC	1830	5KG
1774	6SO	1830	6QB
1774.5	6NU	1836.5	6RQ
1776.4	5YW	1840	2JU
1775	6ZQ	1844	6VD
1776.4	5YW	1849	5CJ
1777	2JG	1850	2CD
1780	6BO	1850	5OC
1780	5RI	1850	2HF
1780	5BK	1850	2SR
1780	6QI	1850	6UD

Frequency.		Frequency.	
1850	6VD	1910.5	2GG
1852	2KV	1913.5	2UJ
1857	6TQ	1916	5VT
1857	2CF	1921.7	2OV
1860	6QM	1925	6CT
1861	2KL	1925	6UU
1862	6WY	1930	5OD
1869	2PS	1936.6	5IL
1870	2PL	1940	6PA
1870	2LC	1950	6KD
1870	5RI	1950	5GL
1870.5	2WT	1950	5SZ
1874.5	2XP	1954	2GG
1875	6WF	1960	5UK
1881	6FV	1961	5OQ
1884	5KJ	1961	2UJ
1888	2XC	1965.5	5LL
1890	2MI	1970	6UT
1893	5RD	1975	6OM
1899	5XF	1980	6KV
1900	2PK	1988	5WW
1905	6QA	1990	6AU
1920	2NO		

"Neutralising the P.A. Stage"

(Continued from page 72.)

Neutralising is carried out in the following way. In a perfectly neutral-

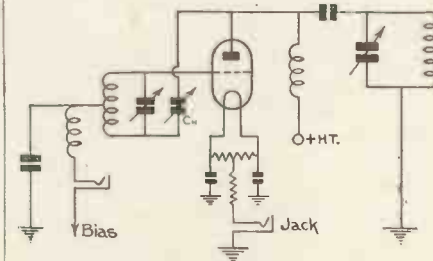

Fig. 3.—Another advantage of parallel feed is that the tuning condenser is at earth potential.

ised amplifier there is no coupling from the plate to the grid circuit. With the anode voltage removed from the stage being neutralised the R.F. input to the grid of that valve should be increased to maximum. Some form of R.F. indicator such as a thermo-galvanometer, neon tube, or looped lamp should be coupled to the anode coil. If the valve is not properly neutralised there will be an indication of R.F. in the anode circuit when the circuit is tuned to resonance even though the H.T. is switched off. The neutralising condenser should then be carefully adjusted until all trace of R.F. has vanished from the anode circuit. Make quite sure of this by readjusting the parallel anode condenser a matter of a degree or so.

Neutralising a push-pull stage requires the same system. Each valve is neutralised separately and has its own separate neutralising condenser which should be adjusted until the last trace of R.F. from the tank coil has been removed.

**READ TELEVISION
& SHORT-WAVE WORLD
REGULARLY**

A Multi-band Aerial For High Frequencies

By arrangement with the Collins Radio Co. of Cedar Rapids U.S.A. we are able to publish the details of the new Collins aerial system. Many European amateurs have been waiting for this information after working the few favoured American Stations using the new Collins aerial during its early experimental stages

A HIGH-FREQUENCY antenna and associated transmission line, capable of efficient operation over a wide range of frequencies, has been urgently needed. Amateurs are rarely fortunate enough to have sufficient space for erecting more than one antenna, and commercial high-frequency stations are also frequently located in restricted quarters where separate antennas for each channel cannot be used.

The ordinary high-frequency antenna consists of a doublet operated at its fundamental (the length equal to one-half wavelength) or at a harmonic. Such antennas are popularly classified by the type of feeder system employed, such as "Centre Fed," "End Fed or Zeppelin," "Single-wire Hertz," "Matched Impedance with Y connected Feeders," etc. Only by connecting the feeders into the centre of the doublet can the antenna and feeder system be kept electrically symmetrical as the frequency is varied. Unfortunately the impedance at the centre of the antenna changes with the frequency, and any ordinary arrangement for matching the transmission impedance to the antenna impedance can be effective at only one frequency. Furthermore, the effective electrical height (which may be different from the physical height above ground) has a marked effect upon the antenna resistance, and an impedance matching system which is effective at only one value of antenna impedance cannot be counted on to give correct energy transfer to the antenna unless it is adjusted for each particular installation.

The problem, then, resolves itself into the designing of a transmission line which operates efficiently over a wide range of terminating or antenna impedances. The usual two-wire line, constructed of two No. 12 wires spaced about six inches and having a characteristic impedance of about 600 ohms, is not satisfactory for this purpose. For example, such a line one-quarter wavelength long connected to the centre of a one-half wavelength doublet will not be terminated in its characteristic impedance of 600 ohms, but in the antenna resistance of about 75 ohms, and due to the properties of such a line the input impedance at the transmitter end will be about 5,000 ohms. An input impedance as high as 5,000 ohms is undesir-

able because it is difficult to transfer power to it, because a slight capacity unbalance will cause serious radiation from the line, and because line losses are high due to poor power factor, i.e., pronounced standing waves.

In practice the impedance at the centre of a horizontal antenna varies between 75 ohms and 1,200 ohms as the frequency is varied. The lower values occur when the antenna length is one-

100 feet long terminated in either 70 or 1,200 ohms.

Frequency.	Efficiency.
3,000 kc.	98.5%
7,000 ks.	98%
14,000 ks.	97%

By way of comparison it is interesting to note that a 100-foot twisted pair transmission line of popular make has the following efficiency when terminated in its characteristic impedance:

TABLE I.

TYPE	A	B	C	D	E	F	G
Antenna Length—feet	136	136	275.5	250	67	67	103
Feeder Length—feet	66	115	99	122	65	98	82.5
Frequency Range M.C.	3.7- 4.0 7.0- 7.3 14.0-14.4	3.7- 4.0 14.0-14.4	1.7- 2.0 3.7- 4.0 7.0- 7.3 14.0-14.4	1.7-2.0 3.7-4.0	7.0- 7.3 14.0-14.4 28.0-29.0	7.0- 7.3 14.0-14.4 28.0-29.0	3.7- 4.0 7.0- 7.3 14.0-14.4
Nominal Input Impedance	1,200 Ω All Bands	75 Ω All Bands	1,200 Ω 160-80- 20m. 75% 40m	1,200 Ω All Bands	75Ω 40m 1,200 Ω 20m. 10m	1,200 Ω All Bands	1,200 Ω All Bands

half wavelength, three one-half wavelengths, five one-half wavelengths, etc., and the impedance is highest for frequencies making the antenna length one or more full wavelengths long.

If a transmission line with a characteristic impedance of 300 ohms (the geometric mean between 75 and 1,200) is used, the standing waves will be a minimum at all frequencies, and the input impedance will remain at all times a manageable value not exceeding 1,200 ohms. A 300-ohm line can be constructed of two ¼-in. tubes spaced 1½ ins. by means of ceramic blocks at intervals of about 20 ins. The blocks can be located by crimping the tube slightly on either side of the block. A 50-foot copper line of this type weighs 10.9 lbs. and is not difficult to support from the centre of the antenna. If necessary, aluminium instead of copper tubing may be used to reduce the load on the antenna supports when the vertical part of the transmission line is greater than 50 feet. A line so constructed has surprisingly low loss.

The following excerpts indicate the minimum efficiency obtained for a line

Frequency.	Efficiency.
3,000 kc.	95%
7,000 kc.	84%
14,000 kc.	68%

Of course, an antenna with twisted pair feeders can only be used on one band.

A 600-ohm two-wire line 100 feet long terminated in 70 ohms has the following efficiency when properly balanced:

Frequency.	Efficiency.
3,000 kc.	94%
7,000 kc.	92%
14,000 kc.	89%

In practice, slight unbalances in a 600-ohm line materially reduce the efficiency, whereas the 300-ohm line is not so susceptible to loss in efficiency.

In view of the above information it is seen that an antenna can be made to work very efficiently over a wide frequency range, and with any antenna impedance between 75 and 1,200 ohms by the simple expedient of using a specially constructed transmission line.

Several different models of such an antenna system are possible and Table I shows representative combination designed for use on amateur bands. In

each of the arrangements shown in Table I the length of the multi-band transmission line is so chosen that the reactance at the transmitter end is negligible and the line can be coupled to the output tank circuit of the transmitter by a simple pick-up coil. An impedance matching network need not be used provided the number of turns in the pick-up coil is continuously adjustable.

In cases when it is not convenient to use a transmission line as long as is shown in Table I it is, of course, entirely practicable to reduce the length of the line to a convenient value and

and k is the number of half-wave-lengths. Thus, for two or more frequencies integral value of k should be chosen to give approximately the same length and the exact length should be that for the highest frequency.

For example, consider type A antenna. At 14,300 kc. and $k=4$ or a two wavelength antenna the length is 136 ft. This length is also correct for $f = 7,050$ and $k=2$ or $f = 3,440$ and $k=1$. The frequency range of the amateur bands may be tolerated by this length even though the transmission line be terminated in an antenna impedance not a pure resistance.

mitters happen to be located nearer the end than the centre of the antenna and the transmission line is shorter if it is connected to the end of the doublet. The Zepp. antenna is an inherently unbalanced system (Zepp. feeders balanced for equal currents are not balanced for equal phase and vice-versa) and a considerable portion of the energy is unavoidably radiated from the feeders, which radiation may or may not be useful for transmission. The multi-band system just described should receive preference over the Zepp. arrangement even if the transmitter is close to one end of the antenna, be-

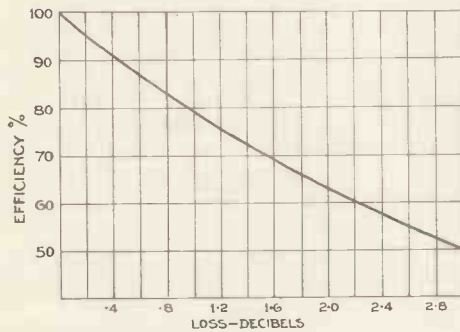

The illustration on the left shows the loss in decibels due to impedance mismatch. On the right 1 equals 12 gauge hard drawn copper, 2 equals 1/4-in. copper tubing and 3 equals 1/4-in. aluminium.

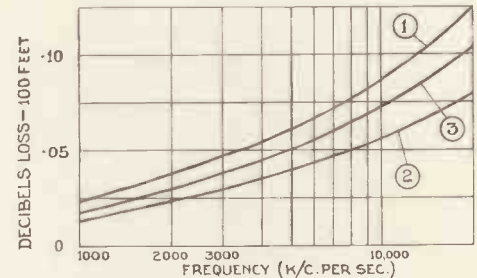

build up the equivalent electrical length by inserting an impedance matching network between the transmitter and the line. When such a network is used the line can be made any length and then the only important dimension is the antenna itself. A precaution which must be observed, however, is that the transmission line should not be $\frac{1}{8}$, $\frac{3}{8}$, $\frac{5}{8}$, etc., wavelength long at any of the operating frequencies.

If the line happens to be cut to a length equivalent to an odd number of $\frac{1}{8}$ wavelengths, trouble may be encountered due to the network transmitting not only the fundamental frequency but also harmonic frequencies. This difficulty can be overcome by proper adjustment of the impedance matching network, but in general it is better to avoid these specific lengths.

Table I can be used for designing multi-band antennas for amateur use. It will be noticed that the antenna lengths shown are an even number of one-quarter wavelengths long at the lowest and highest frequencies.

In the case of antennas for 14,000 kc. and 4,000 kc. operation the frequencies are not harmonically related, but the lengths are chosen for the highest frequency, and they are also approximately right for the lower frequency where small variations in length do not represent very large percentages of a wavelength.

In designing similar systems for other groups of frequencies, the antenna length should be $(k \cdot 0.5) 492,000/f$ feet where f is the frequency in kilocycles

The feeder length should be determined by the relation $234,000 m/f$ feet where f is the frequency in kilocycles and m is the number of quarter-wavelengths. That is, the 66 ft. feeder of type A antenna is one wavelength at 14,200 kc., a half-wavelength at 7,100 kc., and one-quarter wavelength at 3,550 kc.

A slight variation from the above procedure is indicated in type G. In



The feeders should be faced with ceramic insulators and wherever possible held in position by large stand-off insulators.

this antenna the length of 103 feet is $1\frac{1}{4}$ wavelengths at 14,100 kc. and approximately $\frac{3}{4}$ and $\frac{3}{8}$ wavelengths on the 40 and 80-metre bands. The feeder length of 82.5 feet is $1\frac{1}{4}$ wavelengths at 14,200 kc. and approximately $\frac{3}{8}$ and $5/16$ wavelengths at the 40 and 80 metre bands. That is, on 40 and 80 metres the transmission line is terminated in an impedance largely reactive, but is of such length that the impedance at the input to the transmission line is approximately a pure resistance. The loss in the transmission line is slightly larger under this condition, but this antenna may be used successfully where space is a factor.

Many amateurs are using so-called Zepp. antennas rather than antennas fed at the centre because their trans-

cause the additional loss introduced by running the transmission line horizontally to a point under the centre of the antenna, then vertically to the antenna itself will be entirely negligible, and probably will be considerably less than the loss in Zepp. feeders. The multi-band antenna is readily supported by suitable stand-off insulators and can be carried around corners by making bends having a minimum radius of about 10 inches. It is entirely feasible to double back the line in trombone fashion, if desired, to obtain a length which will obviate the use of an impedance matching network.

160-metre Activities.

DX results on 160 metres seem to be improving. It is well known that the Swiss station HB9T is being well received using phone and CW on a frequency of approximately 1815 kc. A new station that turned up during the 1.7 mc. contests is FA8BG, in Algeria, who was working 6SY at R5. W1BB is one of the most reliable top band American stations although B.R.S. 1,295 tells us that several W1's and W2's are being heard on the top band.

New stations active include G2DT, of 55 Dafforne Road, Upper Tooting, S.W.17, who would appreciate reports on his 160-metre CW. Other stations heard include 5JO, 6BQ, 6TL, 2UY, and an unlisted station 6MM, who we believe is something to do with Croydon aerodrome. The Irish station E16F is another newcomer.

An Amplifier for the Det.-8 Transmitter

In the October issue we described a simple transmitter using the new Marconi-Osram Det-8 pentode valve. In response to many requests we herewith give details of a simple amplifier for suppressor-grid modulation with the Det-8.

AS only one-watt of audio is required fully to modulate a Det.-8 power amplifier the problem of constructing a simple speech amplifier is quite simple.

This low wattage rules out little troubles such as A.C. ripple, high anode voltage and the use of expensive apparatus. An ML4 type of valve will give one-watt output with quite good quality, so that a two-stage amplifier will be more than enough.

We have built a simple speech amplifier unit which any amateur can construct from components of conventional type. Assuming the microphone to be of the carbon type having a comparatively high output, this can be fed directly into the grid of the first valve through a transformer having a ratio of 1-25. In the primary of this transformer is a 4½-volt energising battery with a switch in one pole so that it can be cut out of circuit when not actually required. It must be remembered that in a circuit of this kind there will be a continuous drain upon the energising battery unless the circuit is broken.

Circuit and Components.

The first valve is a special Mullard 904V which has a very high amplification factor and consequently the ideal valve to follow a microphone. It is noiseless in operation and is biased in its cathode circuit. With 200 volts applied, plus a 10,000-ohm decoupling resistance, the cathode bias resistance must have a value of 250 ohms.

So as to make the most of the H.F. filter circuit it is essential that the anode of the 904V be by-passed to cathode by means of a .0001-mfd. fixed condenser. Notice that in this circuit the by-pass condenser goes to cathode and not to negative or earth.

The inter-valve transformer should have as high a ratio as possible, but unless it is an expensive one do not use a ratio higher than 1-5. Unfortunately cheap transformers obtain their high ratio by reduction of primary turns which leads to poor quality owing to the low inductance. A transformer of the Ferranti type AF6 can be used to advantage for instead of reducing primary turns the secondary turns are increased to give the higher ratio.

As a modulating valve use a Marconi-Osram ML4 or Mazda AC/P.

Again bias is obtained by means of a resistance in the cathode circuit. To obtain maximum bass response use a high value bias condenser of at least 50 mfd.

The output of the ML4 is fed into a 1-1 output transformer the secondary of which is connected in series with the suppressor grid of the Det.-8 power amplifier. In use it may be found that a slight negative bias between the lower end, that is B of the secondary and earth will give better results, but this is a matter for experiment.

Owing to the low voltage no special components are required. We suggest that the amplifier be built upon a small

of the Erie one-watt type, while the output transformer should be capable of withstanding a steady anode current of approximately 25 milliamps.

We have not shown in the circuit any H.T. equipment, for as 200 volts at 30 milliamps. only are required many standard mains units will be suitable. Alternately a tapping can be taken from the mains unit that supplies the actual transmitter.

For those who intend to build a separate power pack we recommend a Westinghouse rectifier of the HT12 type such as is described elsewhere in this issue, for use with the Amateur Communication Receiver.

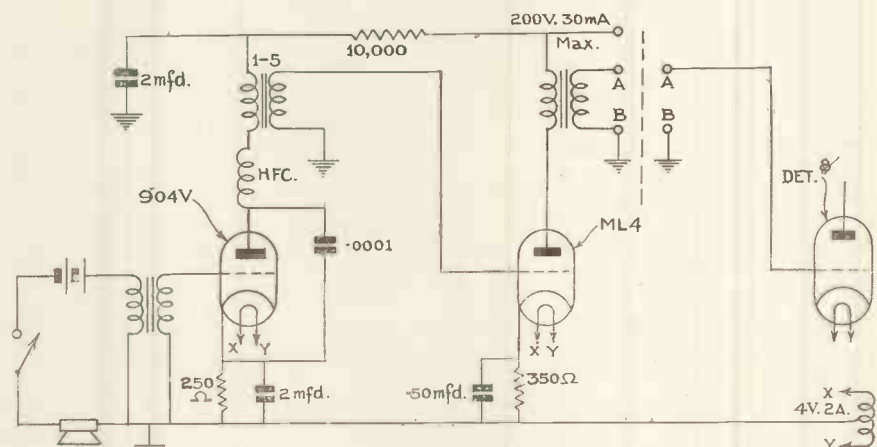

The circuit of the simple amplifier for suppressor-grid modulation.

aluminium or zinc chassis having a sub-compartment of about one inch in depth. In this way, valve holders of the chassis type can be used while small electrolytic condensers can be mounted on the chassis, so making contact to the negative pole automatically. The small anode by-pass condenser in the 904V circuit should be of the tubular type and connected directly across anode and cathode of the valve holder. Both bias resistances need only be

When building the Det.-8 transmitter and speech amplifier we recommend the construction of three small aluminium chassis, one to take the two-stage transmitter, another for the speech amplifier and the third for the power pack. It is then quite a simple matter to construct a wooden frame to take the three chassis so making a very neat and efficient transmitter for the beginner.

To those who do not wish to go to the expense of buying new or special valves such as the 904V, a circuit can be adapted to take an AC/HL type of valve in the first case and a pentode as the modulator. The lower gain in the first case will not be noticed owing to the smaller input required by a pentode. This alternative valve line-up is, of course, a matter of personal taste.

READ TELEVISION
& SHORT-WAVE WORLD
REGULARLY

High-fidelity Paraphase Amplifier

By A. C. Weston.

A HIGH quality amplifier for use with a loud-speaker or for modulation purposes is not so difficult as perhaps might be imagined before the subject has been thoroughly investigated.

A large number of amateurs use valves of the PX4 or PP5/400 class and obtain only very ordinary reproduction with a response curve full of peaks and troughs. Two valves such as the PP3/250 type will give an undistorted

sary accurately to match the triode output valves if a separate heater winding is used for each valve. Bias voltages are then independent and each valve will automatically work at the correct point of its characteristic. The reverse-phase feed to the lower valve of the input pair is obtained from the potentiometer R8 in the anode circuit of the top valve.

For accurate push-pull operation this potentiometer must be adjusted in the

tage of top-note loss is almost inevitable.

For 5/6 watt output V1 should be of the AC/HL type, and V2 a PP3/250's. In such conditions R12 and R13 should be 700 ohms while the H.T. required need only be 280 volts. For 12-watt output use the same input valves but two PP5/400's in the push-pull stage. It will then be necessary to make R12 and R13 500 ohms.

This amplifier will give its full rated output with an r.m.s. input of 1-volt, so that a head amplifier will be necessary for microphone use. When used as a modulator the output transformer can still be retained, the secondary being connected in the anode circuit of the power amplifier. To retain the characteristics of the amplifier it is most important that the secondary be capable of handling the P.A. anode current without any trace of saturation.

The following components will be required:—

- C1 and 2, 2-mfd.
- C3, 6 and 7, 50-mfd.
- C4 and 5, .1-mfd.
- R1, .5-megohm.
- R2 and 6, 10,000-ohms.
- R3, 5, 50,000 ohms.
- R4, 500-ohms.
- R7 and 9, .25-megohm.
- R8, 30,000-ohms.
- R10 and 11, 5,000-ohms.
- R12 and 13, as specified in text.

Owing to the omission of intervalve transformer and other sources of hum pick-up, the amplifier is naturally extremely silent in operation, while the use of push-pull also helps in this respect. It is suggested that the amplifier be made on a metal chassis with a standard power pack as a separate unit.

For maximum gain and output the high-tension required is 400 volts at 130 milliamps., but as the standard valve only gives 120 milliamps. the maximum output cannot always be obtained.

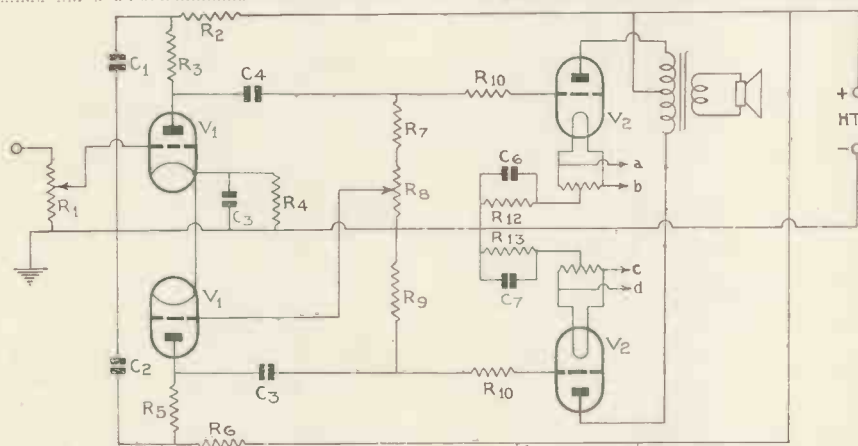

The cost of an amplifier of this type is particularly low owing to the omission of the low-frequency transformer and chokes.

output of 5/6 watts and at the same time provide an almost uniform response from 20-1,000 cycles. This is more than enough fully to modulate a 10-watt carrier with almost perfect quality if the microphone used is a good one.

A higher output of up to 12 watts can be obtained by using a pair of PP5/400's even though the applied anode voltage does not exceed 400. The theoretical circuit on this page gives the arrangement for the high-fidelity paraphase amplifier. It is not neces-

sary following way. Insert a pair of headphones, through an isolating transformer, in the H.T. feed to the output valves, and apply a constant frequency note to the grid of the first valve. This potentiometer should then be adjusted until the output from the headphones is reduced to the lowest level.

The upper frequency register is governed to a great extent by the efficiency of the output transformer which should be of generous core dimension. It should also be remembered that with Heising modulation a certain per-

A New A.R.R.L. Handbook

THE Radio Amateur's Handbook for 1936 is even more comprehensive than its predecessors. It is made up of 480 pages and 500 line drawings and charts covering every phase of amateur radio. All the sections have been revised while new chapters dealing with modern practice have been introduced. The special chapter dealing with 5, 2½ and 1¼ metre transmission is of particular interest.

Those amateurs who use American valves should make a special note of the 30-page chapter of the American valves with their characteristics, operating data and base connections.

In the receiver section there are several excellent super-regenerative and superhet receivers, designed specifically for amateur use. A new note is struck with the introduction of Acorn valves, while matched impedance aerial

systems for reception are dealt with at length.

The fundamental theory will be of particular use to the beginner for a sound grounding in radio technicalities is essential to all those who ultimately wish to take up transmission.

Published by the American Radio Relay League in West Hartford, Connecticut, U.S.A., it costs one dollar fifteen cents with a paper cover, or two dollars fifty cents with a linen cover, both post free.

Adding a Crystal Filter

By Malcolm Harvey

Many amateurs have asked for some simple means of embodying a crystal gate in their superhet receivers. This information should enable the practical amateur, who can build his own coils, to embody this very necessary refinement with the minimum of trouble.

A QUARTZ crystal filter was first used by Dr. Robinson in his Stenode receiver where it proved a most successful method of obtaining extremely high selectivity. Amateurs did not take very favourably to the arrangement owing to the fact that the extreme selectivity caused so much top note attenuation that the receiver was rendered useless for phone work unless a complicated top note booster in the L.F. stage was included.

Since the original design of the Stenode, modifications have been made to the crystal gate circuit so that it is now a practicable proposition that should be used by all serious experimenters.

A quartz crystal cut on certain axes and ground with faces parallel oscillates at a frequency governed by the dimensions of the crystal. It is actually a single frequency resonator. In order

a very high impedance to all other frequencies. In Fig. 1 can be seen the circuit similar to the one used in the Comet-Pro receiver, which includes many good features.

The mixer stage is fed through the primary of an I.F. transformer, but instead of having a conventional tuned secondary, loosely coupled to the primary, a smaller untuned winding closely coupled to the primary is used.

An ordinary tuned circuit has an impedance of about 100,000 ohms and maximum transfer of energy results when primary and secondary are of equal impedance. If an ordinary tuned secondary feeds into the crystal, the crystal will have to have an impedance of about 100,000 ohms, whereas in practice a crystal of 451.5 kc. has a resistance of only 9,036 ohms. The formula for finding the resistance of an X-cut crystal is approximately as follows:

The lower impedance winding must be centre tapped so it is necessary to use 79 turns on either side of centre. These coils should be wound in the same direction with the inside leads of one winding and the outside lead of the other tied together. They should both be wound directly over the primary with Litz wire if obtainable. When the impedance is stepped-down to match the crystal the voltage is accordingly stepped-down so that on the output winding there must be another 79 turns wound in the same manner, so affording the necessary step-up ratio.

The opposite half of the input winding is for the purpose of supplying a voltage equal and opposite which is applied through the phasing condenser or selectivity control across the crystal. This condenser is used for neutralising the capacity of the crystal holder, which is effectively in parallel with the crystal.

As is well known parallel resonance has the opposite effect of crystal resonance, that is it offers high impedance to the resonant frequency and low impedance to all other frequencies, an effect which would cancel the incoming signal. However, this defect can be used to advantage, for by adjusting the capacity of the selectivity control the selectivity can be increased or decreased as required. Maximum selectivity being only used for CW reception, while minimum selectivity will allow for fair phone quality. High quality with a crystal filter means top note booster in the L.F. stage but a suitable booster can be obtained from Messrs. Belling & Lee.

A crystal filter should usually be followed by two stages of I.F. amplification with the usual tuned circuits so as to give the proper degree of amplification and selectivity. The tuned circuits are essential to eliminate the slight peaks on either side of resonance in crystal filtered circuits.

Crystals suitable for this type of circuit can be obtained from the Quartz Crystal Co., Malden, Surrey, and can be ground to match up with the frequency of the I.F. transformers already in use.

To obtain the most from a crystal gate circuit the I.F. transformers must be correctly aligned. Many of the commercial units which appear to be correct in a straightforward circuit have to be adapted by the addition of a small capacity or the removal of the trimmers.

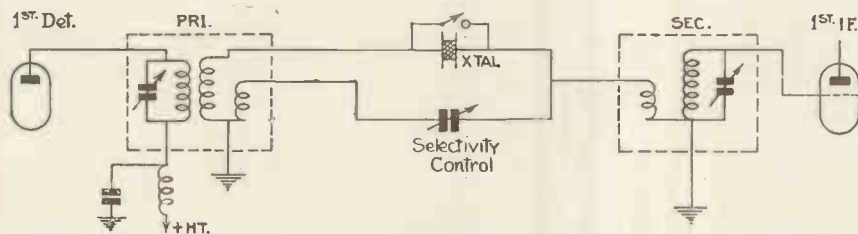

Fig. 1.—To improve selectivity a small variable coupling condenser can be inserted between the crystal and the following coupling coil.

to illustrate the function of a resonator, remove the crystal from its position in the circuit as shown in Fig. 1 and replace it with its electrical equivalent that is, a coil and condenser. Taking an easy example, a crystal that oscillates at 451.5 kilocycles, has an equivalent inductance of 3.5 henries and a capacity of less than 1/10 of a microfarad. The effective Q of such a circuit is well over 1,000. Realising that the Q of the circuit governs the shape of the resonant curve such a circuit has a very narrow shoulder and a sharply peaked resonating point. It is impossible to obtain such a curve from any combination of inductance and capacity for the quartz crystal alone possesses these unique properties.

Again comparing the quartz resonator to a tuned circuit the crystal has all the properties of a series-resonant circuit. This type of circuit offers a very low impedance to the resonant frequency while at the same time presents

$$R = 130,000 \frac{t}{lw}$$

where R = resistance, t, the thickness of the crystal, l, length of crystal, and w, width of crystal. From this it can be seen that the resistance of crystals is not always the same for it must vary according to the physical dimensions. Incidentally when using the above formula the dimensions are in centimetres.

In order to obtain the proper impedance matching the first I.F. transformer should have an impedance step-down ratio of 10-1, this means that the turns ratio would be the square-root of 10 or 3.16-1.

The typical matching transformer of these characteristics has on the average a primary of 250 turns. This may not always be correct but it will serve to illustrate the point. 250 divided by 3.16 is equal to 79.1 turns which is the correct value for the low-impedance coil.

A Simple 5-metre Directional Array

By R. J. Hagerty, W6JMI.

This special aerial is applicable to both transmission and reception. It gives a decided increase in signal strength so that low power stations should have a better chance of equalling results that can normally be obtained only with high power.

FEW amateurs realise the possibilities of a simple directional aerial. Unfortunately it is only as the higher frequencies are approached that it becomes physically possible to build

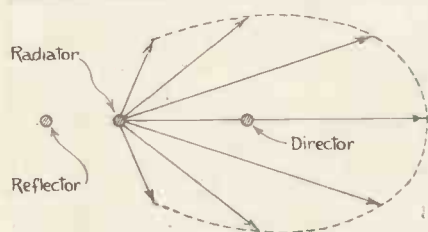

Fig. 1. This gives a clear indication of the field strength pattern.

such an array, but in contrast to this it is on the five-metre band that they specially prove their value. For instance when pointed in the required direction, this aerial system has raised the signal strength an average of two R's over both short and long distances. This is equivalent to quadrupling the power input to the transmitter which means a very great deal to a ten-watt licence holder. In addition it works equally well when coupled to a receiver. Many signals that can only be received

to R4 with a directional aerial not correctly in line.

Most amateurs wish to work in one direction. This aerial is ideal for that purpose for it is not too sharp so as to confine one's activities into one defined point, but gives good radiation over a reasonable arc. The field strength pattern is similar to Fig. 1 where it can be seen that there is a decided gain in the direction to which it is pointed. In addition it works equally as well as a standard aerial to stations on either side of the directive point, but has a nullifying effect on stations in the opposite direction.

Directional Array Construction

Full constructional details can be obtained from Fig. 2. The aerial is designed to resonate in the middle of the five-metre band so for that reason the dimensions and spacings are quite critical. The whole array is suspended on heavy rope which should be treated to make it weatherproof. A similar rope is fixed to the base of the aerial in order to keep the whole structure taut. On account of the rigidity it is desirable to make the rods of $\frac{1}{4}$ -in. copper tubing or something similar.

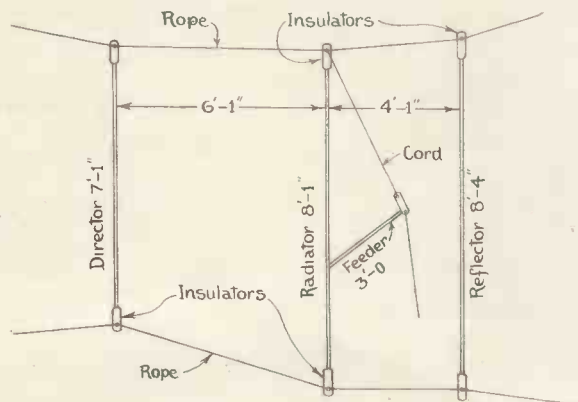

Fig. 2. The dimensions given are for an aerial to resonate in the middle of the 5 metre band. If a special frequency is to be used the lengths should be changed accordingly. To obtain the correct length use the conventional aerial formulae.

R3 on a conventional or doublet aerial come R5 with the directive array.

It should also be remembered that a directional aerial helps to eliminate QRM or interference. A station which is R9 on an ordinary aerial will drop

A single wire feeder can be of any length and is attached at a point $13\frac{3}{8}$ in. from the centre or 2 ft. $10\frac{7}{8}$ in. from one end of the aerial rod. It should run at right angles from the rod, a distance of at least 3 ft. A convenient

way of supporting is shown in Fig. 3 where the 3-foot section is again made of $\frac{1}{4}$ -in. tubing and at the far end by means of a cord.

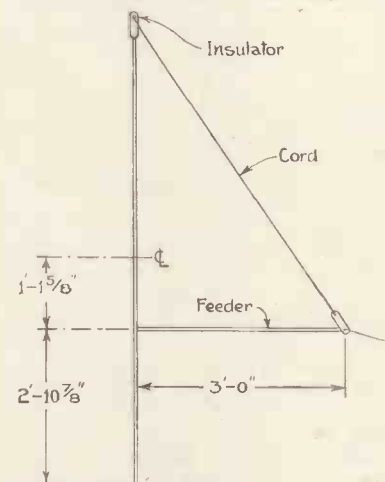

Fig. 3. The feeder can be of any length but the tapping point is most important. This feeder should be supported as shown.

In addition to running at right angles from the aerial rod the feeders should also run at right angles to the plane of the aerial, as shown in Fig. 4. The bottom end can be attached in any conventional way.

Unlike the majority of directional aerals, this arrangement is inexpensive and is not troublesome to con-

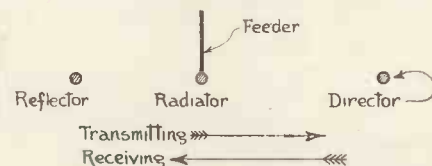

Fig. 4. Feeders should run at right angles to the plane of the aerial.

struct. The improved results more than amply repay the time spent. To make the most of an aerial of this type it must be erected well above local buildings. As it is quite light no trouble will be found in fixing the array above the house from wooden supports.

The Short-wave Radio World

Valves in Parallel

IT is often desirable to use two valves in parallel at both audio and radio frequencies. This method of operation is prone to cause parasitic oscillation unless precautions are taken. The common type of parasitic oscillation can be effectively prevented by shunting a metalised resistance of 100 ohms with a small high-frequency choke.

This choke should consist of about 10 turns of 22-gauge enamel wire wound to a diameter of approximately half an inch.

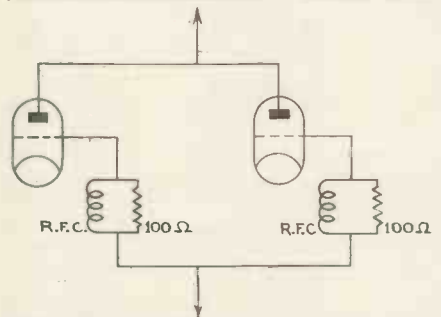

This system is applicable to almost any type of output operating at either radio or audio frequencies.

After a little experiment it is quite feasible to wire the high-frequency choke on to the metalised resistance, but that of course means considerably more turns. Further details can be found in "Radio Annual."

Condenser Capacity and Leakage Tester

Service engineers will find this type of tester of the utmost value. As is known, condensers by their very nature are one of the most variable parts of a radio receiver. Condenser testers can be made in two styles, one measuring the reactance to alteration current as an indication of capacity and the other measuring leakage irrespective of capacity. Both these methods of testing condensers are important and for that reason we have published these details obtained from the "Thordarson Guide" of a unit which combines an efficient leakage tester with a bridge method of balancing the reactance of one condenser against another for comparative measurement.

While the accuracy of this test depends largely upon the comparison standard, the possibility of error in selecting a standard unit is no greater than the error occasioned by a slight drift of voltage or frequency while using a metered type of capacity tester. The standard units of capacity should be checked against two meter-type capacity testers while leakage test further reduces possibility of error in capacity.

The Wheatstone bridge principle is

A Review of the most Important Features of the World's Short-wave Literature.

employed in the capacity measuring portion of this tester. A calibrated potentiometer indicates the ratio between the capacity of an unknown condenser and the capacity of the known standard built into the tester. The scale of the potentiometer is calibrated both in ratio and actual units of capacity.

The test voltage should be any power source of 50 cycles and 200 volts or more, while an L.F. oscillator could supply the testing signal. Headphones are the simplest and most satisfactory means of identifying the potentiometer position which must be set to cancel out the note heard in the headphones.

When testing electrolytic condensers, the first test is for leakage. A source of polarising voltage from the rectifier tube of any receiver should be connected, while any D.C. potential between 90 and the maximum D.C. working voltage of the condenser may be used. Upon completing the circuit the neon bulb will glow brightly. If the condenser under test is good and has low leakage the glow in the bulb will become dim in ten or fifteen seconds. Then the switch shunting the light should be closed and the condenser measured for capacity.

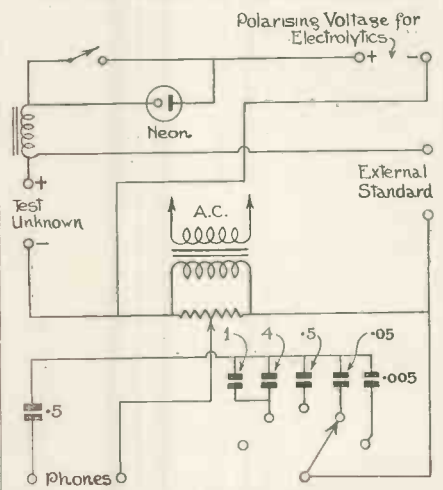

The service engineer will find this tester of great use. The components required are of conventional type.

Power-level Meter

Accurate measurements of L.F. voltage or power are most conveniently made by means of thermo-couple or copper-oxide meters. Thermo-couple milliamp. or voltmeters have the advantage that the readings are substan-

tially independent of frequency, but on the other hand are delicate, slow-moving, and require frequent calibration for reliable results. The copper-oxide meter has none of these disadvantages but the frequency of the voltage measured is within definite limits.

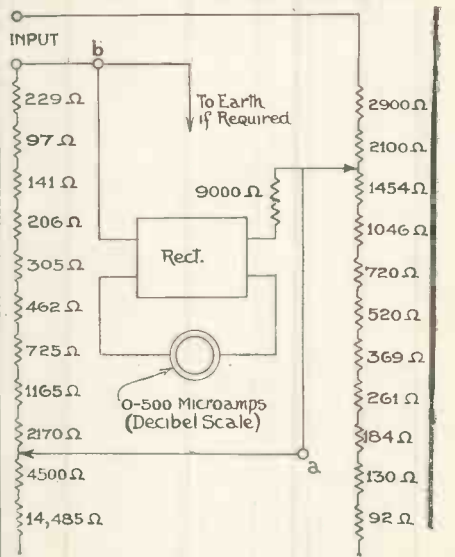

Low-voltage fixed resistors can be used to make up the potential divider.

In order to use a copper-oxide meter the usual procedure is to insert enough series resistance in circuit to raise the range of the instrument to the required value, just as in a D.C. voltmeter. If more than one range is required a corresponding number of increased multipliers must be used.

This scheme, however, introduces inaccuracies owing to the peculiarities of the copper-oxide meter. The resistance of a copper-oxide rectifier is inversely proportional to the current through the rectifier, that is, the resistance decreases as the current increases. So for large readings the resistance of the rectifier is small and the value of the series multiplier for any particular range comparatively large.

These difficulties have been overcome in quite a simple way and a meter has been designed to give reasonably accurate decibel readings. The technical data can be obtained from January issue of "Radiocraft."

Grid Bias from the Mains

Valves in class-A/B do not operate on the linear portion of their plate current-grid voltage curves, as with class-A. As the signal on the grid increases, the average value of the plate current increases, so ruling out the normal automatic bias system. For such circuits the bias voltage must be independent of changes in the anode current.

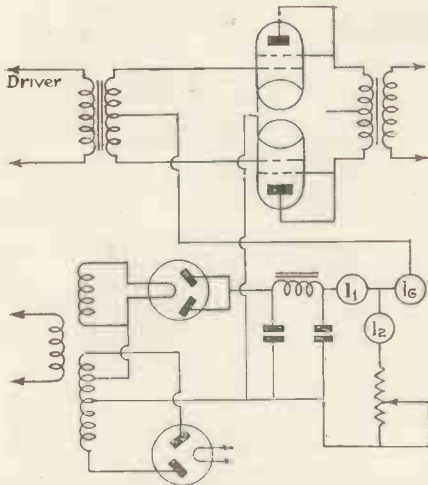

Class A-B amplification is only satisfactory if the bias supply is independent of anode current variations.

By the use of a high variable resistance between the plates of the rectifier and the filter chokes a satisfactory fixed bias supply is obtained. This type of supply will operate quite satisfactorily where grid current does not flow at any level within the rating of the valve. The circuit shown in Fig. 4 is self-explanatory; but further details can be obtained from the January number of "Q.S.T."

A Tuned Receiving Aerial

McMurdo Silver, the well-known radio designer, has described an inter-

esting tuned aerial in the December number of *All-Wave Radio*. Although the circuit shown here may seem complicated it is actually quite simple to erect as most of the tuned circuits and input coils can be in a small case beside the receiver.

In operation the .000365 tuning condenser has to be set once only just to give maximum gain on the particular band in use. The dial reading can be noted and, as with an all-wave receiver with five bands, five positions will be required, this is not a difficult proposition. As the most important part of an all-wave set is the effectiveness of

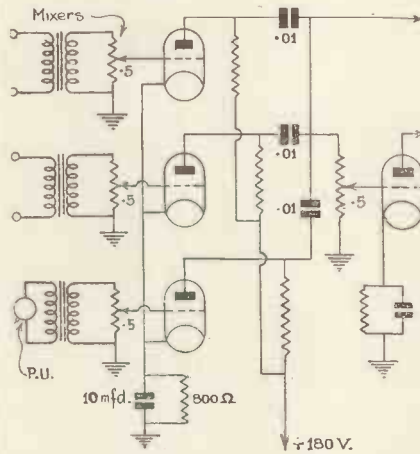

A mixer circuit of this type enables two microphones and the pick-up to be connected at the same time.

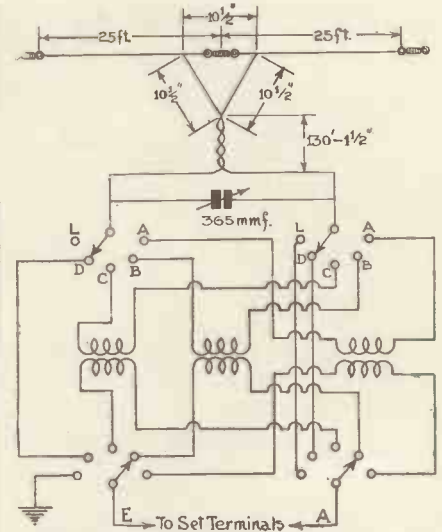

McMurdo Silver designed this aerial for use with the new Silver all-wave receiver.

the aerial we confidently recommend this set to our readers.

A Novel Mixing System

W5BLW has sent us a very interesting circuit for coupling up the speech amplifier to a pick-up and one or more microphones. A pick-up and two microphones can be left permanently in circuit, for adjustment of the potentiometers does not cause any mutual variation in signal level. The input valves are of the indirectly heated HL type.

Pentodes as Audio Amplifiers

By 2 B D N

MOST amateurs realise the need for having high-gain audio amplifiers if maximum DX is to be maintained. The most important valve in a speech amplifier is the one immediately following the microphone. The triode valve of the high-slope type is a partial solution to this problem but it is inclined to be microphonic if the anode voltage is increased beyond a certain level.

Screened-grid valves give a very great output with small input when used as audio amplifiers but, owing to the difficulty in arriving at the correct screen and anode voltages to give optimum gain many amateurs prefer to go back to the simple triode valve plus head-amplifier.

With my own transmitter I use a Reisz microphone of the low output type and I have been in continual difficulty in finding a simple means of boosting the output.

Originally a single stage bend amplifier gave a fair increase in gain, but this was ultimately changed over to a two-stage amplifier. This arrangement followed by two stages of resist-

ance-coupled amplification feeding into a 60-watt triode gives terrific gain. However, I have now, after considerable experiment, found an R.F. pen-

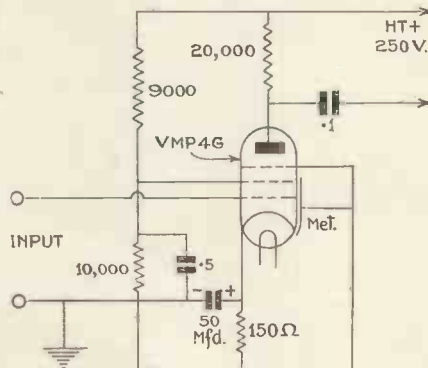

A detector valve, pick-up, or microphone can be fed directly into the grid of the VMP4G.

tode that gives such a high degree of amplification that the microphone and head amplifier can be entirely omitted. This valve is the Marconi/Osram

VMP4G. It is supplied with a seven-pin base and the following characteristics. Filament voltage 4, filament current 1-amp., maximum anode voltage 150, maximum screened voltage 100, controlled grid voltage -2 minimum, slope 2.7 milliamps. per volt.

The circuit is shown here. It is quite conventional but unless the resistance network is strictly adhered to the gain drops to a very low value. It is very difficult indeed to arrive at the correct values and for this reason amateurs are rather inclined to overlook the advantages of this particular kind of valve.

With an input voltage of 200 the resistance values are as follows: Anode 20,000 ohms, cathode 250 ohms, the screen network should consist of 9,000 ohms for the top half and 10,000 in the lower half.

This valve can be embodied into practically any amplifying circuit but if further decoupling is embodied in the anode circuit the H.T. voltage will have to be increased to allow for further voltage drop, which will also mean adjusting the screened grid resistance network. Half a volt input to the grid of the VMP4G will be sufficient fully to load an output valve of the PX25 or PP5/400 types.

IT PAYS TO BUY THE BEST



ADJUSTABLE BRACKET.
A strong baseboard bracket for mounting components controlled by an extension rod. Has adjustable (2 1/2" to 3 1/2") slide of DL-9 H.F. insulation. No. 1007. Price 1/6.



EXTENSION CONTROL OUTFIT.
Ample length adjustment is obtainable with the 4" non-warp precision-drawn insulating tube and 3" brass rod provided in this outfit. Complete with panel-bush and nut. No. 1008. Price 1/3.



BAR INSULATOR.
An ultra high frequency insulator for strain or spacer purposes, made from Frequentite. Slotted ends for feeders with 2" spacing. No. 1017. Price 4 1/2 d. each.

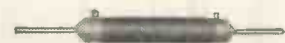

ULTRA SHORT-WAVE H.F. CHOKES.
These chokes are single layer space wound on DL-9 formers, and have an exceedingly low self-capacity. 2 1/2-10 metres. No. 1011. D.C. Resistance 1.3 ohms. Price 1/3. No. 1021. D.C. Resistance 0.4 ohms. Price 1/3.

INSULATING PILLARS.

Invaluable for mounting components in ultra short-wave receivers. White DL-10 insulations 7/16" diameter. Long 6BA adjustable screw shank at top. N.P. Metal foot. No. 1028. 2 1/2" high 6d. each. No. 1029. 1 1/2" high 4 1/2 d. each.



MIDGET INSULATOR.
Made from Frequentite for high frequency work, with N.P. metal parts. 1" overall height. No. 1019. Price 4 1/2 d. each.

UNIVERSAL S.W. VALVEHOLDER.

A low loss holder for above or below baseboard use. The valve enters the contacts from either side. There is no measurable increase of self-capacity to that already in the valve base. DL-9. H.F. dielectric, one-piece noiseless contacts. No. 1015. 4-pin, 1/3. No. 1016. 5-pin, 1/5. No. 1024. 7-pin, 1/8.



EDDYSTONE MICRODENSER (No. 900).
For Ultra Short Waves from 5-10 metres D.L.9 insulation. Low series resistance at high frequencies. Noiseless operation. 15 m.mfd. 3/9. 40 m.mfd. 4/3. 100 m.mfd. 5/-.

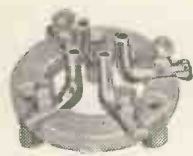

LOW LOSS VALVE HOLDER
Suitable for all high frequency requirements. Frequentite base, one piece metal sockets, lowest self capacity. No. 949. 4 pin 1/5. No. 950. 5 pin 1/8.



ULTRA SHORT-WAVE COILS.
The coils are wound with 14g. copper wire, heavily silver plated. The mean diameter is 3/8". A Frequentite base is used for mounting purposes. No. 1020. 3-turns, 1/6. 4-turns, 1/6. 5-turns, 1/7. 6-turns, 1/8. 8-turns, 1/10.

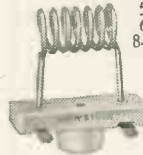

FLEXIBLE COUPLER
Free from back-lash but very flexible, this coupler banishes alignment troubles. DL-9 H.F. insulation. For 1/2" spindles. No. 1009. Price 1/6.

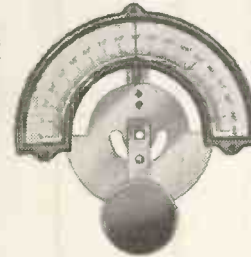

WIDE VISION VERNIER DIAL.
A precision dial for all purposes where accuracy and smoothness of tuning are required. 22:1 ratio entirely free from back-lash. Black bakelite escutcheon. 0-180° dial with travelling pointer. No. 973. Price 10/6.

EDDYSTONE SHORT WAVE COMPONENTS

STRATTON & CO., LTD. Bromsgrove Street, BIRMINGHAM. LONDON Service Depot: Webb's Radio Stores, 14 Soho Street, Oxford Street, W.1

MIKES and "MIDGETS"



XSG Actual Size.

"On test Hivac 'Midget' Valves proved to be the most satisfactory ones available, and gave a thoroughly satisfactory performance when used in a two-stage Microphone Amplifier." Vide: *Television and Short-wave World.*

Specified for the "MIDGET-VALVE] HEAD AMPLIFIER"

HERE IS THE HIVAC RANGE OF MIDGET VALVES:—

XSG Screen Grid	15/6
XL For L.F. Stages	10/6
XD Detector	10/6
XP Power	12/6
XY Pentode type	15/6

"HIVAC FOR THE SHORT-WAVE THREE"
HP 215...10/6. D 210...3/9. Y 220...10/6.



Hivac Valve Guide T.S. gives details of our full range.

THE HIGH VACUUM VALVE CO., LTD.
113 - 117, Farringdon Road, :: London, E.C.1.

The AMATEUR COMMUNICATION RECEIVER uses

WEARITE COMPONENTS



The **WEARITE L.F. CHOKE** TYPE H.T.12
A constant inductance choke of 20 Henries, 75 m.a. and 400 ohms resistance **10/6**



The **WEARITE T.7A MAINS TRANSFORMER**
135v tapped at 110v and 80v at 50 m.a. 2-0-2 at 3-4 amps. With input selector as shown. **20/-**

Ask for full details of the Universal 'UNIGEN' Coils to modernize your set. Price **5/-**

POST THIS COUPON NOW FOR NEW WEARITE BOOK

To Messrs. Wright & Weaire, Ltd. 740 High Rd., Tottenham, London, N.17
Please send me a copy of your NEW and REVISED book (V.735) of Wearite components and technical data, also "black" prints of NEW series of circuits.
NAME
ADDRESS.....
TEL. 2/36

Commercial Receivers for the Short-waves: No. 9.



This is one of the few receivers that covers all wavelengths from 13 to 2000 meters.

MANY of the so-called all-wave radio sets on the market at the moment are incorrectly designated for they miss out one wide waveband. The Invicta model AW56 is, however, a genuine all-waver, as it has five distinct wavebands, split up into the following sections, 13-27, 25-75, 75-200, 200-550, and 800-2,000 metres. It will be seen from this that the only wavelengths missing are the unimportant shipping bands between 550 and 800 metres.

Five valves are used, excluding the mains rectifier and the circuit is made up in the following way. First an FC4 octode frequency changer followed by a VP4B intermediate-frequency amplifier, and a 2D4A double-diode acting as a speech detector and A.V.C. control operating on the I.F. and first detector stages. A 354V triode follows

Invicta All-Wave Radio

the double-diode and feeds into a Pen4VA steep-slope pentode. An IW3 full-wave valve rectifier provides d.c. voltage.

An intermediate-frequency of 465 kc. is used which appears to be a wise choice in view of the low noise level and absence of second-channel interference.

A noiseless manual volume-control is provided and this operates in the L.F. stage after the first triode amplifier. A tone control which can be operated from the front of the receiver minimises heterodyne interference and noise level.

Amateurs will find this receiver very satisfactory for general use. All amateur bands are covered and although the 20- and 40-metres bands have a somewhat restricted tuning range the amount of movement of the indicating cursor is much greater than normally experienced with commercial all-wave receivers.

A two-speed tuning drive enables all bands to be searched very quickly, while the slow motion drive is invaluable after stations have once been discovered. It is a matter of seconds to go from 160 to 20 metres by means of the fast drive and then to cover the band with the slow-motion drive.

Hum level is so low that headphones can be used if required on the short-wave bands.

Two sockets are provided for an external loud-speaker of a 2-ohm type, but these sockets are suitable for either headphones or loudspeaker use. The internal loudspeaker is of the energised type and fitted with a 10-inch cone of the new curved shape. Reproduction is

extremely good so that the inclusion of short-waves has not by any means detracted from the performance on medium and long waves.

We have used the receiver extensively in our experiments and have obtained very satisfactory results on all amateur bands down to 20 metres. The inclusion of top band coils is of great importance for it is one of the few receivers to consider the requirements of short-wave amateurs.

During the 80-metre contest a considerable number of stations were received on the loudspeaker. 20-metre amateurs will be heard with reasonable reliability while commercial broadcasters down to 13 metres have been heard from time to time. The normal commercial stations on the 16, 19 and higher wavebands are, of course, receivable almost every day. On medium and long waves the results are fully up to standard, selectivity being at least 9 kilocycles; back-ground noise is low and quality above reproach.

For 15 guineas we consider this to be excellent value for money.

Technical Data

Model—A.W.56.

Price—15 guineas.

Valve specification—Octode frequency changer (Mullard FC4), V.M. I.F. amplifier (Mullard VP4B), diode detector and A.V.C. control (Mullard 2D4A), triode amplifier (Mullard 354V), pentode output (Mullard Pen4VA), and indirectly-heated full-wave valve rectifier (Mullard IW3).

Makers—United Radio Manufacturers, Ltd., Parkhurst Road, N.7.

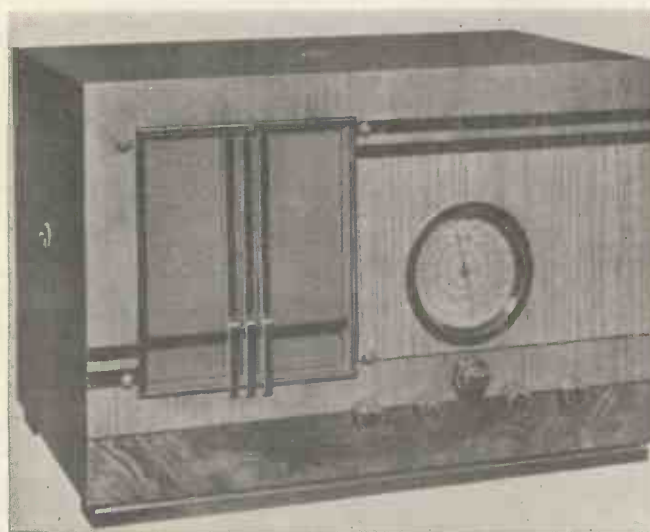

Marconiphone 345

MARCONIPHONE have now released their star 1936 receiver model 345. This is a six-valve super-het covering between 16.5 and 2,200 metres in four wavebands. The two short-wave bands cover 16.5 to 140 metres without a gap, medium waves 185 to 560 metres, and long waves 750 to 2,200 metres.

All valves used are the latest type, including a VMP4G signal-frequency amplifier, X41 triode hexode, VMP4G I.F. amplifier, MHD4 double-diode-triode second detector, N41 pentode and U12 rectifier.

Owing to the special intermediate-frequency the receiver is entirely free from image reception at all wavelengths, while delayed automatic volume control gives maximum sensitivity on weak signals.

A feature that the short-wave listener will appreciate is the inclusion of two separate tone correctors so that bass and treble can be varied independently. Its price is 17½ guineas and the makers are Marconiphone Co., Ltd., Tottenham Court Road, W.1.

E. J. GALPIN

75, LEE HIGH ROAD, LEWISHAM, LONDON, S.E.13
GOVERNMENT SURPLUS, ELECTRICAL AND RADIO

Cash with order or C.O.D. (charges extra).

ALL GOODS Three days approval from date of delivery.

CROMPTON DYNAMO 50/75 v., 30 a., £4/10/0 ; DYNAMO 100 v., 10 a., £3/10/0 ; DYNAMO 50/75 v., 12 a., £3/5/0 ; DYNAMO 40 v., 15 a., £3 ; WORKSHOP Dynamo 12 v., 8 a., 17/6 ; AREO Dynamos 12 v., 8 a., 12/6 ; AUTOMATIC Charging Cut-outs, 7/6 ; SHUNT Regulators or Charging Resistances, 12/6 ; X-RAY COIL, 17 in. spark, 70/- ; MERCURY BREAK to suit fitted with motor drive, 50/- ; FLUORESCENT Screen 12 in. by 9 in., 25/- ; SWITCHBOARD with all fittings for X-Ray Coil control, 45/- ; 2 in. Spark Coil complete, 17/6 ; G.P.O. Microphones, 3/6 ; RELAYS, 2 m/a. working, 7/6 ; VERTICAL Galvas, 5/- ; P.A. MICROPHONE, Moving Coil, complete in case with transformer, £3/10/0 ; 3½ watt AMPLIFIER, two-stage, R.C. Coupled, U.D.O., complete with 3 Valves, A.C. Mains working, £4 ; THREE STAGE P.A. AMPLIFIER, High Grade, R.C. Coupled, 12 watt, U.D.O., complete with Valves, A.C. Mains working, £9 ; PORTABLE AMPLIFIERS for Dance Halls, etc., universal, A.C./D.C., 7 watt, U.D.O., complete in cabinet with Gramo. Motor, Pick-up, Loudspeaker and Moving Coil Microphone, £19/0/0 ; COLLARO Induction Gramo. Motors, 220A.C., 12 in. table and stop, new, 31/- ; ROLA, P.M. Speakers, type FR56, new, 16/6 ; ROTHERMEL Brush Piezo Electric Speakers, type 9SS, new, 22/6 ; PHILLIPS Mains transformers, 220 v. input, 500 v., 100 m/a. and 4 v., 4 a. centre tapped, 5/9 ; WAVE METER 50 to 200 metres, 12/6 ; MARCONI Magnetic Detector, 35/- ; PHILLIPS MAINS Chokes, 30 henrys, 80 m/a., 3/- ; STANDARD G.P.O. Morse Tapping Keys, 5/6 ; 7 v. AMPLIFIER, ex-R.A.F., no Valves, 12/6 ; MOVING COIL Movements for recalibration, 5/- ; LOOSE COUPLED Tuners, ex-Naval, 100 to 5,000 metres, 8/6 ; TRANSMITTING Variable Condensers, glass case, .000S, 13/6 ; ELECTRIC CHECK METERS for light or power mains, 200/250 v., 50 cycle, single phase, watt-hour type, 7/- ; BRIDGE Condensers, 10 capacities, .004 to 1½ mf., total 4 mf., 1,000 v. working, 15/- ; TANGYE BELLS, 6 in. gong, 4 to 12 v., battery working, ironclad, 5/6 ; RESISTANCE MATS, 2 ft. square, 700 ohms, 26-gauge wire, good earth mat, 5/6 ; BELL TRANSFORMERS 200/250 v., A.C., to 3, 5 or 8 v., 3/9.

LARGE STOCKS OF EX-GOVERNMENT RECEIVERS, COMPONENTS, METERS AND ELECTRICAL ACCESSORIES
ON VIEW, CHEAPEST FIRM IN ENGLAND.

TELEVISION.

A NEW COURSE OF INSTRUCTION.

We have pleasure in announcing that our new "Television" Course has met with remarkable success. The enormous demand for the Course has shown, beyond any shadow of doubt, that it fills that long-felt need which we anticipated when we went to such trouble and expense in its preparation.

We shall be happy to send full details of this special "Television" Course on request. Particulars are also available of other Courses in all branches of Wireless, Television, Talking Picture Engineering, etc., and of the easiest way in which to prepare for the A.M.I.E.E., A.M.I.W.T., A.M.I.R.E., etc., Examinations.

We teach by correspondence, and guarantee 'NO PASS—NO FEE.' Our Technical Consultant is Professor A. M. Low.

Send for full particulars to-day. Free and without obligation.

THE BRITISH INSTITUTE OF ENGINEERING TECHNOLOGY,
Recently removed to greatly enlarged premises at
337, SHAKESPEARE HOUSE, 17/19, STRATFORD PLACE,
LONDON, W.1.

PIEZO QUARTZ CRYSTALS



1.7mc, 3.5mc, and 7.0mc. Amateur bands

Power Type

Standard Type

£1 post free

15/- post free

Ground to within 5 Kcs. of your specified frequency, and supplied complete with official certificate of frequency.

CRYSTAL HOLDERS—

Type A, Open Electrodes, 4s. 6d. post free.

Type B, Totally enclosed and dustproof, 10s. 0d. post free.

Send a 1½d. stamp to-day, for our new 1936 catalogue of short wave transmitter and receiver components.

THE QUARTZ CRYSTAL CO.,

63 & 71, KINGSTON ROAD, NEW MALDEN, SURREY

Telephone: MALDEN 0334.

MERVYN

PIONEERS OF SHORT WAVE APPARATUS AND COMPONENTS AND 50/- TELEVISION

Make your present receiver all-wave and tour the world. Italy, America, Australia, received on your present speaker.

SUPER SPECIFICATION INCLUDES:
Slow Motion Tuning, 13-52 metres, switching wavechange. In Metal Case (less valve).

A.C. Mains or Battery Models 42/-

Send or phone HOLborn 6332,
for free descriptive leaflet.

NOW POPULARISE
WORLD SHORT-WAVE RECEPTION
with the 1936 SHORT-WAVE CONVERTER
ADAPTER PRICE 42/-

READY FOR IMMEDIATE DELIVERY

MERVYN SOUND & VISION CO., LTD.

Television and Short-wave Specialists

4 HOLBORN PLACE : LONDON : W.C.1

Heard on the Short Waves

By Kenneth Jowers.

IN America short-wave reception is technically two years in advance of Europe, that is, as far as amateurs are concerned, that is why England has not yet realised just how reliable reception of long distance stations can be. Some indication as to how the American listeners react to short-wave reception is contained in a letter from the Hotel Waldorf-Astoria in New York. This hotel is equipped with not only the conventional medium-wave radio but with the most complete short-wave equipment.

The Western Electric have installed eight different short-wave receivers so that 2,000 guests have the choice of eight different foreign short-wave programmes.

The reliability of these programmes can be gauged from the fact that daily programmes are printed in advance and supplied to each guest. A special aerial system has been erected between the towers of the hotel and these have been designed to give maximum pick-up between 12 and 50 metres with minimum noise level.

A world transmission is to be started by K.R.O., the Society whose programmes are often heard through

Huizen and Hilversum. These new programmes are being radiated through Eindhoven, PHOHI, starting on Sunday, February 16. Time tables have been arranged as follows. For Japan and India, 12.30-1.30 p.m.; Dutch Indies, 1.45-2.45 p.m.; Africa, 6-7 p.m.; Central America, northern parts of South America, midnight-1 a.m.

On Wednesday, February 5, Mr. S. W. J. Butters, G6UB, will deliver a lecture entitled "The Development of Radio Telephony" before the members of the South London and District Radio Transmitters Society. The lecture will be held at the Brotherhood Hall, Knights Hill, West Norwood, S.E.27, and begins at 8 p.m. Further information can be obtained from G6IO.

Readers in South Wales will be glad to hear of the formation of a radio society in Newport. It is to be known as the Newport and District Short-wave Society and monthly meetings are to be held at the Queen's Hotel. Membership is open to all readers living in the district and there is no subscription. Further information can be obtained from the Hon. Secretary, G2JL, at Palmyra Place, Newport, Mon.

Another good sign of the increas-

ing popularity of short-wave listening is the launching of really good all-wave receivers by the more prominent set-makers. Ferranti, for example, have a complete range of four receivers ranging from a 9½-guinea A.C. Three to an A.C. Superhet at £13 18s. od., and an all-wave radio-gramophone at 17 guineas. This last receiver will surely be one of the best bargains available.

Marconiphone and H.M.V. also have a six-valve all-wave super model 345 costing 17½ guineas. This receiver, in addition to normal broadcasting tunes between 15.5 to 140 metres.

Philco have increased their range by introducing two more all-wave radio-gramophones, both of which are suitable for amateur requirements.

Truphonic Radio also have an all-wave super tuning between 15 and 60 metres, while Pye have two models both of which are extremely efficient.

Not many amateurs will be using 250 watts, but for those who will, Tung-ram have introduced a valve with an oxide heater giving an R.F. output of 250 to 700 watts. The filament consumption is 2.5 amps. at 11 volts while the maximum anode voltage is 2,000. The A.C. resistance is 2,500 ohms with a slope of 9 milliamps. per volt.

One or two readers have queried the frequencies allocated for amateur use. Actually the sending frequency should

(Continued on page 127).

362

FOLLOWING THE UNPRECEDENTED DEMAND FOR THE 362 RFP 50, AND THE NUMEROUS REQUESTS FOR A SMALLER VALVE OF THE SAME CLASS WE HAVE DECIDED TO MANUFACTURE AN

RFP 15.

A 15 WATT OUTPUT H.F. PENTODE

For further particulars,
see next month's issue.

THE 362 RADIO VALVE CO., LTD.
STONEHAM ROAD, CLAPTON, E.5.
TEL: CLISSOLD 6607.

THE TELEVISION SOCIETY

President: Sir AMBROSE FLEMING, M.A., D.Sc., F.R.S.

Founded in 1927 for the furtherance of Study and Research in Television and allied Photo-electric Problems.

Ordinary Fellows are elected on a Certificate of Recommendation signed by Two Ordinary Fellows, the Proposer certifying his personal knowledge of the Candidate. The Admission Fee for Fellows is half-a-guinea, payable at the time of election, the Annual Subscription is £1, payable on election, and subsequently in advance on January 1st in each year, but the Annual Subscription may be compounded at any time by the payment of Ten Guineas.

Any person over 21, interested in Television, may be eligible for the Associate Membership without technical qualifications, but must give some evidence of interest in the subject as shall satisfy the Committee. For Associate Members the Entrance Fee is 5/-, payable at the time of election, with Annual Subscription 15/-, payable in advance on January 1st in each year.

Student Members.—The Council has arranged for the entrance of persons under the age of 21 as Student Members, with Entrance Fee 2/6 and Annual Subscription 10/-, payable as above.

The Ordinary Meetings are held in London on the second Wednesday of the month (October to May inclusive) at 7 p.m. The business of the meetings includes the reading and discussion of papers. A Summer Meeting is usually held, and affords Members the opportunity of inspecting laboratories, works, etc. A Research Committee and the preparation of An Index of Current Literature are active branches of the Society's work.

The Journal of the Television Society

is published three times a year. All members are entitled to a copy; and it is also sold to Non-Members, at an annual subscription of 15/- post free.

Forms of proposal for Membership, and further information regarding the Society, may be obtained on application to the Business Secretary, J. J. Denton, 25, Lisburne Road, Hampstead, London, N.W.3.

TELEVISION AND SHORT-WAVE WORLD KITS

ALL PARTS EXACTLY TO "TELEVISION" SPECIFICATION.
ALL, OR ANY, OF THE COMPONENTS SUPPLIED AS REQUIRED.

BROADCAST SHORT-WAVE THREE

COMPLETE KIT OF PARTS (less Valves, Batteries, etc.), £5 11s.
Valves £1 15s. 6d. extra. Batteries 15s. extra. Phones, 12s. 6d. extra.

		s.	d.			s.	d.
1	Aluminium Chassis	1	B.T.S. Slow Motion Dial	...	5 0
1	" Screen	...	4 6	4	Clix 4-pin Valve Holders	...	1 8
1	" Panel	1	Clix 5-pin	...	1 6
6	B.T.S. Coil Formers	...	13 6	8	Clix Plugs, Spades, etc.	...	1 9
3	Dubilier 0.1 mf. Condensers	...	4 0	4	Bulgin Fixed Resistances	...	2 0
1	Dubilier BB 1 mf.	...	2 6	1	Erie 0.5 meg. Pot/meter	...	3 6
1	Dubilier BB 2 mf.	...	3 6	2	Bulgin PB3 Brackets	...	3 0
2	Dubilier 665 0.0001 mf.	...	1 0	2	Bulgin K58 Knobs	...	1 4
1	Dubilier 665 0.001 mf.	...	1 3	2	Eddystone 1032 Dials	...	1 8
1	Dubilier 665 0.002 mf.	...	1 3	2	Eddystone 1008 Ext. Shafts	...	2 6
2	Eddystone 900 0.0001 mf. Variable Condenser	...	10 0	1	Eddystone Coupler	...	1 6
2	Eddystone 900 0.00025 mf.	...	8 0	1	Bulgin WS2 Coil of Wire	...	6
1	Eddystone 957 0.0002 mf.	...	6 6	1	Bulgin BC2 Battery Cord	...	1 3
1	J.B. 0.00005 mf. Trimmer	...	1 0	1	Wire, Slewing, screws, etc.	...	2 0
2	Raymart CHP Chokes	...	1 6	1	Eddystone 1019 Pillar	...	4 ½
1	Ferranti B8 L.F. Choke	...	8 0	1	Bulgin S80 Switch	...	1 6
				1	R.I. Transformer 3½/1	...	15 6

AMATEUR COMMUNICATION RECEIVER (Battery Band-Spread 2-V-1)
COMPLETE KIT, (January Issue) £7-10-0
including zinc base-plate, and 4 coils (less Valves and Cabinet)
Valves £2 9s. 0d. extra. Eddystone Cabinet, £1 5s. 0d. extra.

H. T. UNIT for AMATEUR COMMUNICATION RECEIVER
(Battery Band-Spread 2-V-1)
COMPLETE KIT, including Baseboard £4-15-0

Scientific Supply Stores (Wireless) Ltd.
126, Newington Causeway, London, S.E.1. Phone: HOP 1800

AUTO TRANSFORMERS



A safe, sure and simple way to convert your 200-220-240 receiver to work from 100/110 volt mains, or vice versa, is to connect a suitable Sound Sales Auto-Transformer in the Mains lead. For the average 3-valve mains set, use one rated at 60 watts; for a 3-valve radiogram, use one rated at 100 watts.

60 watt totally enclosed type 15/-
100 watt ditto 22/- 200 watt ditto 42/-

Specified by  the Experts.

SOUND SALES

SOUND SALES LIMITED

Marlborough Road, Upper Holloway, London, N. 19.
Phone: ARCHWAY 1661-2-3. (Contractor to the G.P.O., etc.)



The Solon Electric Soldering Iron has the strongest heating element obtainable. Clamped in contact with the bit, it concentrates all heat. None is wasted. The Solon simplifies soldering. It is quicker, easier, more economical and more efficient. Plug in—solder in three minutes.

7/6

65 WATTS
125 Watts 22/6
240 Watts 37/6

Use a

SOLO
ELECTRIC
SOLDERING IRON

W. T. Henley's Telegraph Works Co. Ltd., Dept. 25, YAB.
Holborn Viaduct, London, E.C.1

B.T.S.

SHORT WAVE and TELEVISION COMPONENTS

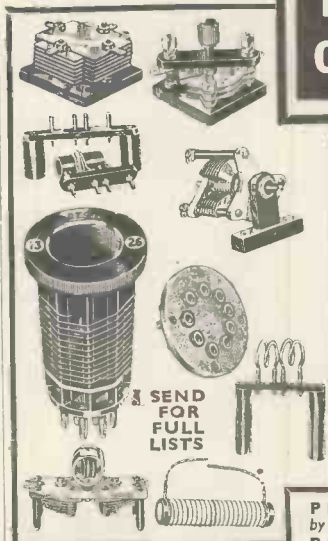

DESIGNED by experts whose exhaustive experiments and research have produced components unrivalled for reliability, efficiency and quality. B.T.S. are fully confident that they offer components not only technically perfect and absolutely reliable, but reasonably priced and within the means of all. Illustrated here is a small selection only of the range of B.T.S. Components obtainable from all good Dealers.

Send for complete illustrated catalogue of Components and Adaptor-Converters.

SEND FOR FULL LISTS

PRODUCED by SPECIALISTS. PREFERRED by EXPERTS.

SPECIFIED BROADCAST SHORT 3 WAVE

6 B.T.S. Standard 4 pin Coil Formers, Type KF4 each 2s. 3d.
1 B.T.S. Standard Slow Motion Dial, 5s.

FROM ALL GOOD DEALERS.

B.T.S.

BRITISH TELEVISION SUPPLIES, LTD.
8-10, Charing Cross Road, London, W.C.2.

The ONLY
PUBLICATION
with FULL
LUXEMBOURG
and RADIO
NORMANDY
PROGRAMMES

Don't let your Sunday listening be doleful. There are hours and hours of bright and cheerful entertainment to be had from the powerful Continental stations that broadcast special programmes in English for listeners in this country.

Each week in "Radio Pictorial" you will find full details of the *complete week's English* programmes from Luxembourg, Radio Normandy, Paris, etc. *In no other paper can you obtain this exclusive programme information.*

Besides this invaluable help to brighter listening you will find in "Radio Pictorial" pages of glorious pictures of radio stars, exclusive articles on their home life, their hobbies; all the latest radio news and gossip. In fact, "Radio Pictorial" is the paper that every keen listener and radio fan should read every week. It is read in countless thousands of homes throughout the country—week in and week out. Why not get your newsagent to deliver "Radio Pictorial" every Friday and make your listening more enjoyable?

RADIO PICTORIAL

Every Friday—Price 3d.—OF ALL NEWSAGENTS

"Heard on the Short Waves"

(Continued from page 124.)

be within the following limits which represent a tolerance of 5 kc.: 1720-1995 kc., 7005-7295 kc., 14005-14395 kc., 28005-29995 ks., and 56005-59995 kc.

B.R.S. 1,353, S. Bradbury, of Bradford, has sent me a list of phone stations heard on the 14, 7 and 3.5 mc. bands. Since June 16, 1933, he has heard no less than 2,474 stations from 42 countries. The receivers used are 1-V-1, and 1-V-2, both battery operated. This log shows what can be done with reasonably simple apparatus.

Conditions on the 20-metre amateur band have been variable during the past week or so. At one period stations were being heard alternate evenings quite regularly, but on the whole conditions for DX have not been good.

The 40-metre band has been very congested and after about 4 o'clock G stations have been fading out completely. A considerable amount of DX, however, has been done on this band and many G's have worked VK, ZL, J, W6 and so on.

I listened in to G6WU, who was giving some details about a new method of obtaining regeneration in his receiver. It appears that he coupled a coil between the suppressor grid of an R.F. pentode and the control grid, which apparently increased both selectivity and sensitivity to a great extent. I have not tried the idea but in any case it seems well worth a little experiment.

As regards the commercial broadcasters some of the better known stations have been coming over very well. W8XX, on 13.93 metres, has been a most reliable signal about lunch-time.

W3XAL has also been received at fair strength, but the best of these stations is without question W2XAD. Rome, on 49.46 metres, has been putting out a strong signal and the news bulletin in English at approximately 12.15 a.m. is well worth hearing. W9XF was logged at 6.15 a.m. three mornings running at full loudspeaker strength while W8XAL was almost as strong.

PMN, in Java, on the 29-metre channel, was good loudspeaker strength for the first three Sundays in January and came in usually round about 3 p.m. VK3LR was heard twice relaying 2BL, but the signal strength was not good.

While checking the 10-metre band W8XX was heard on about 9.75 metres. This was apparently the second harmonic. The 10-metre amateur band, by the way, is very good at the moment and better than the 20-metre band has been for a long time.

I had not realised before just how effective an L.F. pentode can be as a crystal oscillator. Of course, some of them are not so good, but an AC/Pen works excellently. Those amateurs who are prejudiced in favour of the old LS5B and DE5B types will be well advised to consider the virtues of a pentode C.O.

The 160-metre band is most effective these days. HB9T is still coming over R5/6 on schedule with 6GO. As can be seen from the top band crystal frequency register the number of stations on this band is steadily increasing. Newcomers include 6SO, who used to be 2AKA, and 2LC ex-2BWP. The mystery of the reception of 6PU by 2PB on 5-metres still remains unsolved for it now appears that 2PB is the call sign allocated to the B.B.C. Probably this call was being pirated.

Calls Heard

W9DXX, A. R. Bourke, Chicago, Illinois. (14-metre C.W.)

CM2AF, 2DO, 2FG, 2WB, CM6AA, 6AD, 8CK, HP1A, K4BA, K5AC, 5AF, 5AH, K6AQ, K7UA, LU7AZ, NY2AB, VE1AE, 1IP, 2AI, 2CR, 2DG, 2EE, 2JB, 2LM, 3ACS, 3AGL, 3AB, 3QM, 3DM, 3SD, 3UW, 4AEI, 4DP, 4FD, 4PH, 4PQ, 4TR, 4UM, 5EAV, 5GI, 5HC, 5HR, VK2MY, VP1JR, VP9R, X1CM, 1KM, YN1AA, ZS6AL, ZT6Z.

(7 Mc. CW.)

CM2RN, EA8AC, K6KVX, LU3DX, VP4BC, VE2CJ, 4BF, 4PG, 4PQ, 4VG, 4YL.

2ANT, D. A. J. Edwards, Sutton-Coldfield, Warwick. (3.5-Mc. Phone.)

CO8YB, VE1BO, 1CR, 1EI, VO1I, W1ADM, 1AHJ, 1VES, 1BIO, 1BVP, 1BWP, 1PD, 2AU, 2HS, 2HYP,

2JP, 3ADL, 3BWH, 3CRO, 3DRY, 3FJU, 4AVH, 8AOM, 8AY, 8JOE, 9ALP, 9BEO, 9BIY.

(14-Mc. Phone.)

HI5X, HI7G, K4DDH, K4SA, LA2Y, LU1EX, LU4BL, LU5CZ, LU6AP, OE1CM, OK2AK, NY1OP, PY2BA, SM5SD, SP1CF, SU1RK, TI3AV, VE3LL, VE3NC, VK2LB, VK3BD, VP2CD, W4BLH, 4WK, 4IB, 4PW, 4WT.

W9FM, E. H. Conklin, Weaton, Illinois. (28-Mc. CW.)

F8CT, 8KJ, 8VS, G2HG, 5BY, 6DH, 6NF, 6UB, HB9J, OK1AW, PAOFX.

B.E.R.S. 195, E. W. Trebilcock, Tennant Creek, North Australia.

(7-Mc. CW.)

G2MI, 2NN, 2QU, 5JM, 5XT, 6FS, 6LX, 6QZ, 6RQ, 6UI, 6US, 6VP.

(Continued on next page.)

Tele-viewing

Everyman's Guide to Television

By **ERNEST H. ROBINSON**

Foreword by

GERALD COCK

Director of Television of the B.B.C.

a non-technical and popular book by an expert

Time & Tide.

"An admirable introduction to the subject . . . certainly to be recommended"

World Radio.

"A welcome contribution"

Times.

"Can be recommended to non-technical readers"

Electrician.

"[By] one of the few technical writers who could deal successfully with such a task"

Sunday Times.

"A most comprehensive book, describing nearly all the successful systems in use to-day"

Daily Herald.

"Of absorbing interest"

6/- Illustrated.

SELWYN & BLOUNT

"Calls Heard"

(Continued from preceding page)

W8FDA, S. Yutz, Pottsville, Penn.
(28-Mc. CW.)

G2HB, 2HG, 5BY, 5LA, 6DH, 6NF,
OK1AA, ON4AC, ON4AU, PAOQQ,
D4ARR.

B.R.S. 1,847, J. A. Jagger, Guildford,
Surrey. (28-Mc. Phone.)

VE2WE, W1AJS, 1INC, 2AOG,
2BCR, 2HFS, 2BY, 2CBG, 2AV, 3FAR,
3AIR, 5AHJ.

(28-Mc. CW.)

F8BC, FF8MQ, X2C, ZE1JN,
ZE1JU, K5AC, LU1EP, VK3MR,
VE2EE, VE3AEL, 3MJ, 3WA,
VE5HC, YR5JS, D4GWF, 4ARR,
4ORT, 4MDN, W1GZE, 1FPR, 1CMX,
1DVH, 1WV, 1ZB, 1DQD, 1AHI,
2DTB, 2SZ, 2EMV, 2BSR, 2JN, 3BIW,
3EDP, 3EPR, 4AGP, 5DNV, 6JNR,
8LEA, 8CRA, 8KTW, 8IIL, 9BPU,
9EF, 9FLH, 9PST, 9KPW, 9ARN.

B.R.S. 1,333, S. Bradbury, Bradford
Yorks. 14-Mc. Phone.)

W1IMG, 1GJS, 1CRW, 1CMD,
2FYD, 2ELS, 2BST, 4AOG, LA1G, 2Z,
4N, OZ1I, HB9B.

(7-Mc. Phone.)

EI2G, 2J, 5D, 6G, 6F, 7G, 8G, 9G,
GI5MZ, 2KR.

(3.5-Mc. Phone)

W1LI, 1BES, 1FVO, 1MF, 1AW,
1FVJ, 1BYH, 1EDW, 1BNO, 1CPX,
W2GYY, 2KR, 2AHU, 2JP, 2HL,
2BHG, 2BAJ, 2AU, 2BJT, 3AVR,
3EOY, 3BPO, 3EFS, 4AZR, 4BRG,
4ANU, 4ALH, 4OVQ, 4AVH, 4NN,
8ABS, 8AAM, 9PCJ, OZ7SS.

B.R.S. 1484, M. G. Bourke, Jersey, Ci.
(1.17-Mc. Phone.)

G6GO, 2XC, 5MM, 5ZJ, 2AO, 2OV,
6FV, 5YA, 5OC, 5FI, 5GL, 2KT, 2IN,
6KV, 5IL, 2WG, 2UJ, 6AU, 5OD, 5UJ,
5CJ, 5PW, 5VT, 5JO, W1AIL.

(3.5-Mc. Phone)

W2HS, 2DLY, 2DGD, 2JP, 3DQ,
3PP, 3BWG, 3DRY, 3EFS, 3EOZ,
8BWH, 8AAM.

(7-Mc. CW)

J5CC, LY1ZB, YM4AC, HAF1G,
U1BC, VK7RC, OE3AH.

(7-Mc. Phone.)

EI2J, 7G, 8G, VP3MR, LX1AS.

(28-Mc. Phone.)

W2BCR, 3AUG, 3TC, 3ZX, 3AIR,
8FYC.

J. H. Clark, Tankerton, Kent.
(3.5-Mc. Phone.)

W1ADM, 1RA, 1FC, 1CRW, 1JM,
1GYR, 1CIW, 1CDX, 2HOH, 2IBQ,
2AU, 2JP, 3EOZ, 3DK, 3DQ, 3DKX,

3EFF, 3AGY, 3CNY, 4EC, 8KIR,
EI6F, VE1CA, VE1DN, VE1DO.

(14-Mc. Phone.)

OE1FH, EA3ER, VE1DQ, VE1CR,
1EX, 1GR, 1DR, 2CA, 3BG, 3HF, 3HC,
K4SA, CO6OM, HI7G, HI5X, 1PKM,
OZ1I, EA8AF, 8AV, OH2NE, VP2CD,
VP9R, LA2I, BO1I.

**Slow Morse Transmission
for February**

THE following slow morse trans-
missions have been arranged for
R.S.G.B. members. Please send
reception reports to the stations con-
cerned.

Feb.	2	Sunday	00.00	1769	G5GC
"	2	"	09.00	1860	G6QM
"	2	"	09.30	1785	G5BK
"	2	"	11.00	7104	G6PJ
"	2	"	11.15	1810	G6GC
"	6	Thursday	23.00	1930	G6AU
"	9	Sunday	00.00	1769	G5GC
"	9	"	09.00	1860	G6QM
"	9	"	09.30	1785	G5BK
"	9	"	11.00	7104	G6PJ
"	9	"	11.15	1810	G6GC
"	13	Thursday	23.00	1930	G6AU
"	16	Sunday	00.00	1769	G5GC
"	166	"	09.00	1860	G6QM

**MAKE AMATEUR RADIO
YOUR HOBBY
FOR 1936**

But begin right.

Join the R.S.G.B. and keep in touch with
Members all over the world.

Co-operate with and secure the advice and help
of Fellow Members. Have the Official Monthly
Journal "The T. & R. Bulletin" sent you
Free and Post-paid every month. Come to
the Lectures, Outings and District Meetings
and keep in touch with the latest Short-wave
Developments.

An Application form for Membership and a
copy of the 100 Page Book "A Guide to
Amateur Radio" will be sent you for postal-
order or stamps to the value of 8d.

Write to the Secretary (Dept. S.W.11).

RADIO SOCIETY OF GREAT BRITAIN
53, Victoria St. London S.W.1.

**AN
ENTIRELY NEW SCIENTIFIC
JOURNAL**

Ralph Stranger's
**SCIENCE
REVIEW**

OFFICIAL ORGAN OF THE WORLD-
WIDE RADIO RESEARCH LEAGUE
AND THE INTERNATIONAL SHORT-
WAVE CLUB

A monthly periodical devoted to modern
scientific research and progress

**THE FEBRUARY ISSUE
IS NOW ON SALE**

Monthly 1/-



B T C
means
Better Television
Coming
meanwhile
ALL-WAVE
Your Present Set
FROM 30/-
 Descriptive leaflet free
BENNETT
TELEVISION CO.
REDHILL

TELEVISION UP TO

Send for the VERY LATEST Handbook DEFINITION TELEVISION, dealing with MODE RAY, TIME BASES, 240 and TRANSMISSION and RECEPTION. leading experimenters are reading this post extra, 4d.

H. E. SANDERS & CO., 4, Grays In.
 London, W.C.1. Phone: Chancery 5.

We can supply the
COMPLETE KIT OF PARTS
VALVES AND SPEAKER

for that proved excellent receiver

THE "ADVANCE
ALL-WAVER"

£9-10-0 Cash or C.O.D.
 Carriage Paid

KIT of specified components for the

"UNIVERSAL MAINS
SHORT-WAVE THREE"

£6-15-0 Cash or C.O.D. Carriage Paid.

All Kits also supplied on H.P. Terms.

Complete List T.S. of Radio Apparatus. Free.

CHAS. F. WARD

46 Farringdon Street, London, E.C.4

Telephone: Holborn 9703

THE CONSTRUCTORS'
CIRCLE

Application for Membership

To be filled in and sent with a stamped envelope for reply to the Editor, "Television and Short-wave World," Chansitor House, Chancery Lane, London, W.C.2.

- (1) I already subscribe to your journal at the address below.
- (2) I have placed a regular order for TELEVISION and SHORT WAVE WORLD with my book-sellers, Messrs.....

*

 and desire to be enrolled as a member of the TELEVISION and SHORT WAVE WORLD. "Constructors' Circle."

Please send membership badge free of charge to

Name (in block letters)

Address

.....

*Strike out lines not applicable.

"TELEVISION COUPON
and SHORT-WAVE WORLD."
FOR FREE INQUIRY SERVICE

Name

Address

February, 1936

FOYLES

BOOKSELLERS TO THE WORLD
 Stock of nearly three million new and second-hand volumes. Catalogues free on mentioning interests.

119-125 Charing Cross Rd., London, W
 Telephone: Gerrard 5660 (12 lines)

RALPH STRANGER'S
Science Review

1/-

February Issue Now on Sale.



EDISWAN

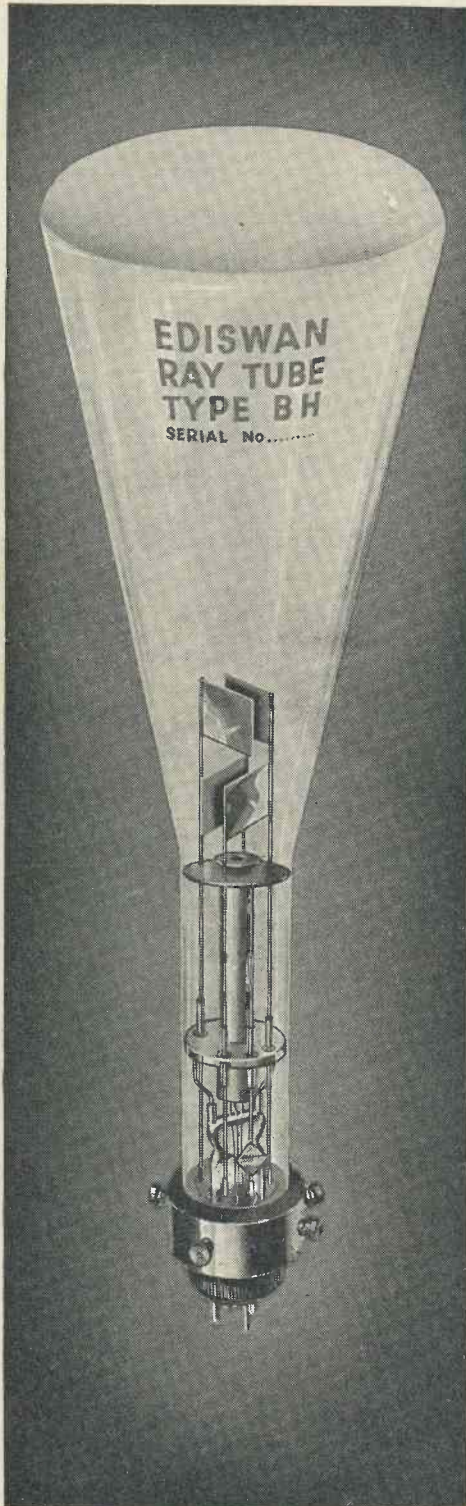

Television developments

Here is the Cathode Ray Tube specially developed for television reception. Ediswan have been associated with the application of Cathode Ray Tubes to television from the commencement and have kept to the front with the most recent improvements.

Ediswan High Vacuum Cathode Ray Tubes are made in two sizes:

Prices

Type AH - £10.10.0 Type BH - £8.8.0

All have special screens giving a black-and-white image. Green or Blue screens can be supplied without extra charge.

We also manufacture:

- Mercury Vapour Rectifiers
- High Vacuum Diodes
- Transmitting Valves for ultra-short waves
- Grid controlled discharge tubes for time bases

These have been specially developed for line-scanning circuits.

Full information on the tube and its associated circuits can be obtained on application to the Technical Service Department, at the address below.

ENTIRELY BRITISH MADE

EDISWAN RADIO VALVES

THE EDISON SWAN ELECTRIC CO. LTD.



155 CHARING CROSS RD., LONDON, W.C.2

USED BY ALL GOVERNMENT DEPARTMENTS