

BUILDING VISION RECEIVER

: :

BAIRD NEW BIG-SCREEN SYSTEM

Television

and SHORT-WAVE WORLD

1/-

MONTHLY

JANUARY, 1937

No. 107. Vol. x.

G.E.C. ENGINEER EXPLAINS

**ELECTRONIC
TELEVISION**
IN SIMPLE LANGUAGE



**Special
Short-wave
Features:—**

**10-METRE
ACORN-VALVE
RECEIVER**

**INEXPENSIVE
4-VALVE
ALL-WAVE SET**

BERNARD JONES PUBLICATIONS LTD.
CHANSITOR HOUSE, CHANCERY LANE
LONDON W.C.2.

THE FIRST TELEVISION JOURNAL IN THE WORLD

TELEVISION

and SHORT-WAVE WORLD

Special Features

	Page
Electronic Television	4
Faults in Television Receivers ...	10
Problems of Photographing Television	17
Universal Cathode-ray Tube Equip- ment	19
Cathode-ray Tube Research at Ediswan Laboratories	23
Baird Big-screen Television	26
TELEVISION'S Guaranteed Cathode- ray Receiver	30
Controls of a Television Receiver ...	37
4-valve All-wave Receiver	39
Autodyne Aerial Coupler	42
Stable Components in Short-wave Practice	47
10-metre Acorn-valve Receiver ...	49
Beginner's Transmitter	52

COMMENT OF THE MONTH

Things To Come

WILL our readers mark and keep for reference the information given below. Possibly it may not be necessary to turn back to it for two or three years, but on the other hand, before the year is out it may prove to have been intelligent and informed anticipation.

The success of purely electrical systems of television in which there are no mechanical moving parts has been such during the past year as to put the mechanical systems somewhat into the shade. There are many keen students and followers of the art who regret this, particularly, of course, the home constructor who feels, rightly or wrongly, that the mechanical system offers him better opportunities than the electrical systems.

There are many people who think that mechanical systems are impracticable for high-definition television, in other words that they have had their day. But is a new day coming?

From a long conversation which we had this month with a manufacturer who is thoroughly conversant with American practice, and has toured Europe with the single object of discovering the present state of the television art, we must conclude that there are some big surprises in store, and that both on the Continent and in the United States, and very probably here in Great Britain, there are mechanical and mechanical-cum-electrical systems which one day will put up a fierce competition with the purely electrical systems. Our informant, whose experience is such that his opinions are worthy of all consideration, tells us that there is on the way a mechanical system lacking nothing in definition and capable of giving a wall-size picture with, to use his own words, "light to spare."

We repeat, mark this statement and file it for reference.

The First Home-constructed Receiver

WE direct our readers' attention to the extract from a letter regarding our Guaranteed Cathode-ray Receiver which appears on page 30 of this issue. If proof were needed of the ability of the amateur to construct his own receiver here it is; the results that our correspondent is getting he describes as "nothing short of a miracle" and his remarks amply bear out our guarantee that, properly constructed, the receiver will give a very fine performance.

In this issue a complete summary of the construction details is given which will be helpful if considered in conjunction with the detailed information already published. This section concludes the constructional details, but in future issues these will be amplified and information given on adjustment, operation and any modifications which may, in the course of the rigorous testing which the receiver is undergoing, seem desirable.

TELEVISION AND SHORT-WAVE WORLD

Proprietors :
BERNARD JONES PUBLICATIONS, LTD
Editor-in-Chief :
BERNARD E. JONES.
Editor :
H. CORBISHLEY.
Editorial, Advertising and Publishing
Offices :

Chansitor House, 38, Chancery Lane,
London, W.C.2.

Telephones : Holborn 6158, 6159
Telegrams : Beejapee, Holb., London.

Subscription Rates : Post paid to any
part of the world—3 months, 3/6;
6 months, 6/9; 12 months 13/6.

Published Monthly—1/- net.
(Last Wednesday in every month for
following month).

Contributions are invited and will be promptly considered. Correspondence should be addressed according to its nature, to the Editor, the Advertisement Manager, or the Publisher, "Television and Short-wave World," Chansitor House, Chancery Lane, London, W.C.2.

IMPORTANT

"Television and Short-wave World" is registered at the General Post Office, London, for transmission to Canada and Newfoundland by Magazine Post. Entered as Second-class mail matter, Boston, Mass.

ELECTRONIC TELEVISION

A PRACTICAL OUTLINE IN SIMPLE TERMS

By G. C. MARRIS,* B.Sc., M.I.E.E, of the G.E.C. Research Dept.

We wish to acknowledge our indebtedness to Mr. Marris in allowing us to publish this paper read before The Joint Meeting of the Association of Supervising Engineers and The Institution of Engineers in Charge and also to the G.E.C. for placing at our disposal the illustrations accompanying the article and the many courtesies received from them during its preparation for publication.

THE first problem that arises in television is that of "scanning"; in other words, that of translating the picture, point by point, into an electrical current.

The retina of the human eye contains some millions

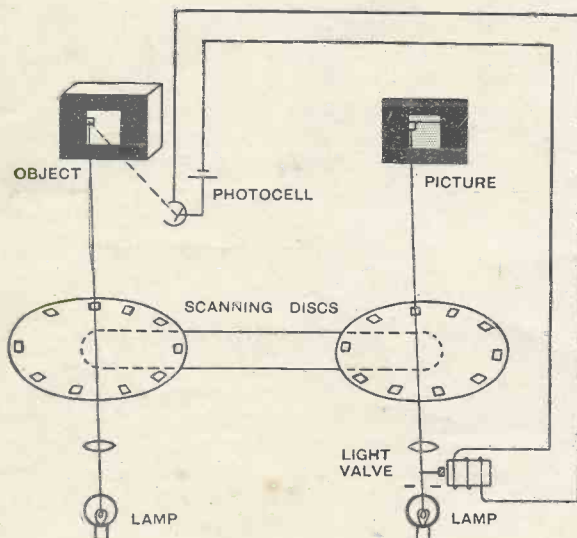

Fig. 1.—Diagram showing the elementary principle of television.

of minute cones, each sensitive to light, and capable of conveying a separate message by a separate nerve to the brain. To give the brain a picture it is not necessary to excite all those cones simultaneously. If that were the case television would be impossible, because one could not provide millions of wires or radio links between the picture to be sent and the eye of the distant beholder, each wire responsible for one bit of the picture.

Fortunately each cone has, so to speak, a memory lasting about $1/25$ of a second, and practical television consists in using that period of $1/25$ of a second for the transmitter to look separately at minute areas of the picture one after another in regular sequence. As it does so it sends an electrical impulse by wire or radio to the receiver. This electric current impulse is converted, according to its strength, into a spot of

light in the receiver which has auxiliary apparatus, called a "time base," to direct the spot to the same part of the picture that the transmitter is viewing at the moment.

In a $1/25$ second or less, then, the whole picture is transmitted once and the process starts again. By this time the scene may have changed, but it is known from the experience of the cinema, which works with pictures changed every $1/24$ second, that a satisfactory appearance of continuity is thus obtained. With this elementary explanation of the general idea we can proceed to discuss the technical devices used and problems that have been overcome.

The Photoelectric Cell

In the chain of apparatus, starting with transmission, the first item is the device for converting the brightness of each picture point into an electric current proportional to the brightness. For this purpose the now well known photoelectric cell is used. It is extremely simple. It consists of an evacuated glass bulb with an internal mirror-like deposit of potassium or caesium metal, and a metal plate supported in the centre. It is connected to a high-tension battery, and when light falls on the internal surface electrons are released from it; in other words a current flows and the magnitude of the current depends on the brightness of the light. It may be called, therefore, one element of an electric eye.

Its limitation for television purposes is in its lack of sensitivity; a candle, a foot away from a normal cell might give $1/3$ of a microampere (10 microamperes per lumen). Recent developments of so-called secon-

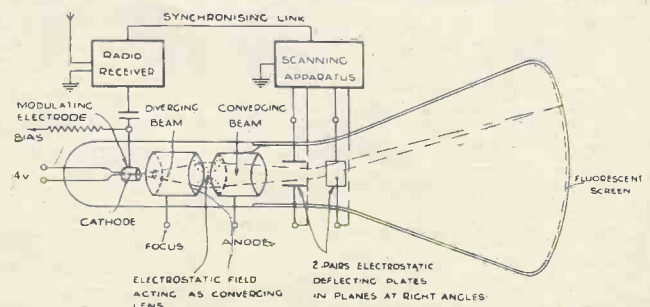

Fig. 2.—Schematic diagram of cathode-ray tube.

*The photograph on the cover of this issue is not that of Mr. Marris, the author of this article.

THE ELEMENTS OF TELEVISION

dary-emission photocells have been very useful for television, giving a sensitivity 4 or 5 times greater.

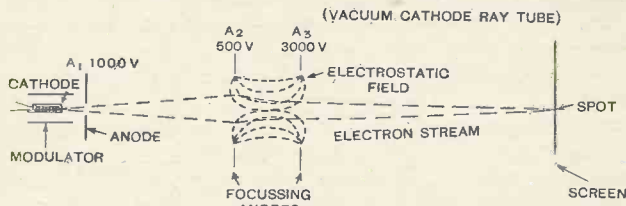

Fig. 3.—Electrostatic focusing of the cathode-ray beam.

Principle of Scanning

Scanning is simple in theory but difficult in practice.

If we look at a page of print and move the point of a pencil under the lines, we are making the pencil move in the way characteristic of television scanning; a steady movement along a line, a quick snap back and slightly downwards to the next line, and so on to the end of the page. We shall have scanned the page in so many lines, say 40, in perhaps one minute; that is, in television language, 40-line definition, and one picture frame per minute.

The muscles that move the pencil correspond to the television time base, or synchronised disc, and it will be clear that there are two motions at right angles, one along the lines, pretty fast, one down the page much slower with a quick flick back after each line, and after each page. It will be clear also that if we make the motion of the pencil a little slantwise, the downwards movement can be a steady one till the end of the page is reached. This is what is done.

We must have, therefore, a high-frequency scan and a low-frequency scan. For 400 lines the first is 10,000 periods per second, and the low-frequency 50 periods for interlaced pictures. The speed of travel of the spot across a receiver screen is therefore about 2 miles a second in the horizontal direction.

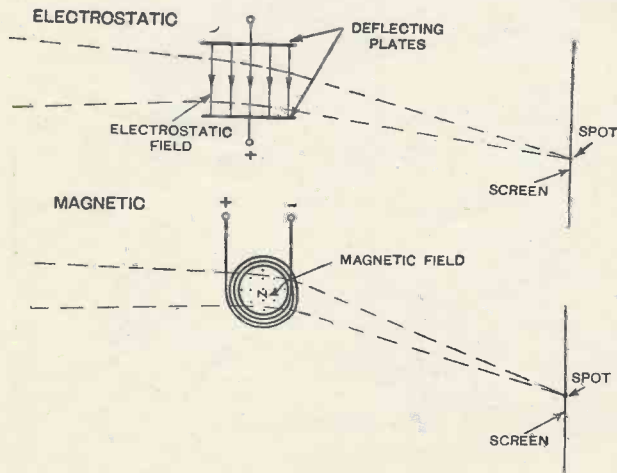

Fig. 4.—Diagrams showing the two methods of deflecting the cathode beam.

Scanning by Disc

Scanning by disc, invented by Nipkow in 1884, has been developed rapidly in the last three or four years, and is one practicable way of obtaining high definition.

A disc much larger than the picture is rotated in front of it. The disc has small holes near the edge arranged in a spiral. The picture is illuminated as brightly as possible, and the light reflected from it passes through the hole which is opposite the picture at the moment, and is focused on the photo-cell.

The holes are so arranged that the first passes across the top line of the picture, looking at a strip as wide as the diameter of the hole, and when it gets to the end the second hole starts again at the beginning, but being on a spiral is one line lower. For 400-line defi-

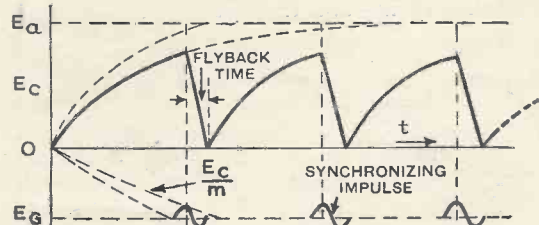
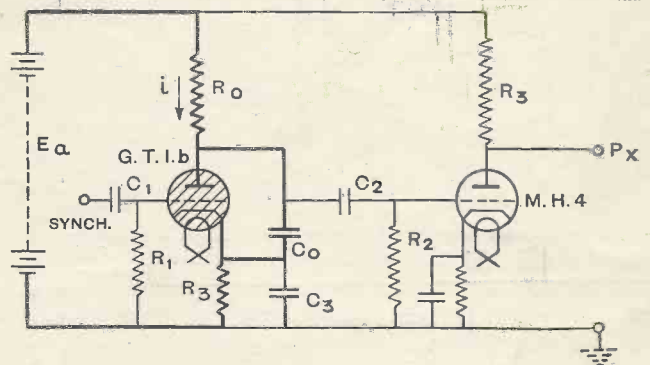

Fig. 5.—Time base circuit using gas-filled relay and (below) the saw-toothed wave form produced.

inition the hole must be so small that its diameter is 1/400 of the length of the picture, and there must be 400 holes coming into place one below the other in turn. The photo-cell then looks only at a spot 1/160,000 of the picture area at once, and sends a current corresponding to the brightness of that spot. Since the picture must be viewed 25 times a second to preserve continuity we may have 25 x 160,000 current variations per second, or a vision frequency as it is called of 2 million complete periods per second, if every spot of the picture is of different brightness from the next.

Fig. 1 show in symbolic fashion a complete television system. The current from the photo-cell varies the light from a lamp which shines on to a screen. Between lamp and screen is a similar disc of spiral holes, which rotates in exact synchronism with the first, so that a point of the screen is illuminated corresponding to that which the photo-cell is viewing at the moment. Such a method of reception was the basis of the old Baird 30-line television. It is impracticable for high definition because of the mechanical difficulties of the

HOW THE CATHODE-RAY TUBE WORKS

discs, and the impossibility of getting enough controlled light.

Before describing the cathode-ray tube, which is the modern alternative, it must be explained that if such a

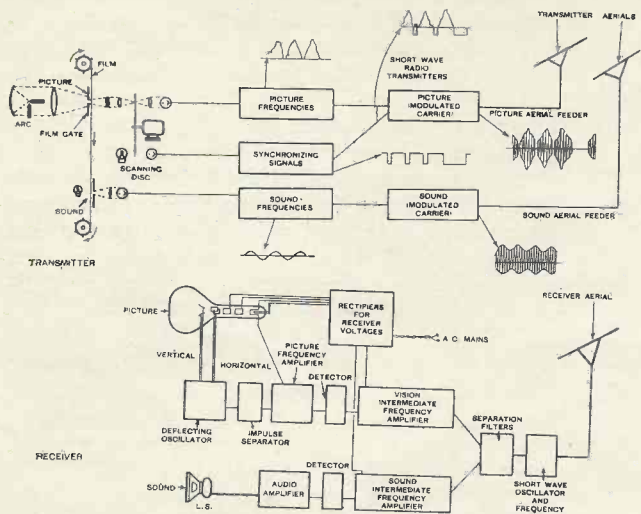

Fig. 6.—Schematic diagram of complete television system employing a disc transmitter and cathode-ray tube receiver.

disc is used to transmit from a film, the holes need not be in a spiral, as the downward scan can be provided by steadily winding the film through.

The Cathode-ray Tube

Everyone is aware that there exist phosphorescent or luminescent materials such as are used on luminous watch faces. Certain of these substances, notably zinc sulphide and calcium silicate, give an intense light if they are bombarded by high-speed electrons. In the cathode-ray tube a beam or ray of these electrons is produced and caused to bombard luminescent powder deposited on the large, almost flat, end of a big flask shape bulb which is highly evacuated. (See Fig. 2.)

In order to use this idea for television it is necessary for the electron beam to be small enough to make on the screen a bright point, of size corresponding to the size of the point seen by the transmitting photo-cell.

Then the electrons must be accelerated with sufficient voltage to get the spot bright, and their number must be varied according to whether any spot of the picture is dark or bright. Finally the beam must be made to strike in turn every portion of the screen. That is, the beam must be made to scan the picture, line by line, as did the pencil in our illustration of the perusal of a printed

page; and then start all over again, in exact synchronism with the transmitter disc or other scanning device.

In modern cathode-ray tubes for television, these requirements have been achieved with a great deal of success.

The electrons are produced from a hot cathode just as in a valve. The number that escape towards the screen is controlled by a thin metal cylinder, known, in honour of its inventor, as the Wehnelt cylinder, which acts like the grid of a valve. To it is applied the photo-cell current, after being radiated by the transmitter, and amplified and detected by the receiver, so that, in effect, the photo-cell current, by varying the output of electrons, varies the brightness of the received spot at that moment.

The electrons are accelerated in the direction of the screen by the cylinders and disc A_1 , A_2 , A_3 (Fig. 3), to which positive voltages of, say, 1,000, 500 and 3,000 are applied, and the arrangement is such that a narrow beam is formed.

After leaving this portion of the electrode system, often called the gun, the beam passes between metal deflector plates. Since electrons are charges of electricity they can be deflected by sufficient voltages, say, about 1,000 volts, applied to these metal plates. One pair of plates deflects the beam rapidly sideways for the high-frequency scan, the other more slowly for the low-frequency scan. The deflecting voltages are produced by the receiver time bases described below. The ray can also be deflected by a magnetic field (see Fig. 4).

One type of electron optical lens is formed by two discs with a hole in the middle through which the beam passes. The first disc is at 500 volts and the second 3,000 volts. There will be an electrostatic field between them as indicated by the dotted lines, the direction of force on an electron being from left to right. An electron, on reaching the field near the 500-volt plate, will receive an impulse causing it to move inwards along the line of force; when it gets near the 3,000-volt plate

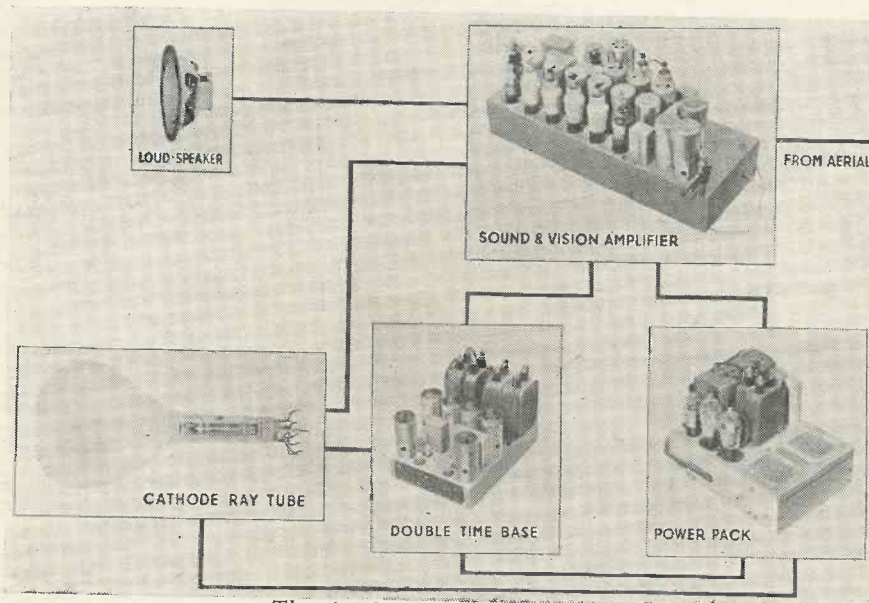

The units of a G.E.C. cathode-ray receiver.

HOW THE CATHODE BEAM IS DEFLECTED

it will receive an equal outward impulse, but by this time it will have speeded up enormously, say, from 7,000 to 18,000 miles per second, therefore the outward impulse has little effect, and it proceeds on its new path converging to form a spot with all the others. An alternative method of focusing is by a magnetic field.

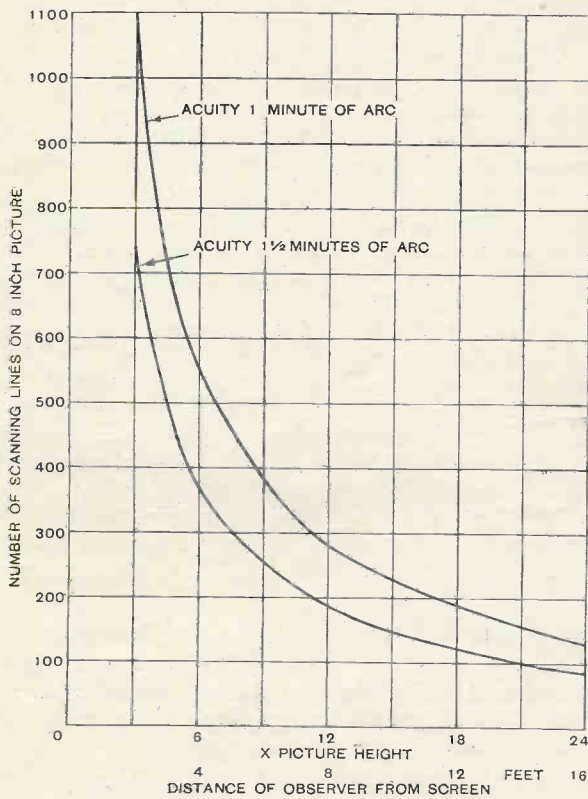

Fig. 7.—Curves showing suitable viewing distances.

Here we touch on the real problems of cathode-ray tube research. To form the perfect spot, to deflect it without changing its shape or brightness, and to change its brightness without changing its position or size, and to make it still brighter—these are the difficulties.

The fine pictures obtained are a proof of the success with which the work has so far been attended, but there is still more to be done, and in the G.E.C. Research Departments we have many devices for accurately tracing electrostatic fields, and for obtaining cross sections of a spot. The diagram of the perfect spot should be a rectangle.

Brightness

The cathode-ray tube has already exceeded the brightness of the average home cinema screen. This is in part due to research carried out on the fluorescent powders of which the screen is composed. The zinc and calcium salts used require to be of extreme purity with exceedingly minute, but accurate, amounts, perhaps 1/1,000 of one per cent. of added metallic salts.

Time Base Circuits

Many of the electrical circuits of a television receiver can be called elaborations of broadcast receiver technique, but the time base circuits are something quite new.

The method is to generate a voltage rising as linearly as possible to its maximum in the necessary time, e.g., to 1,000 volts in 1/10,000 of a second for the horizontal scan of a typical electrostatically deflected tube. Thus the beam is steadily deflected from beginning to end of a line. Some trigger device must be incorporated so that at the end of this period the voltage returns to zero, as nearly as possible instantaneously. This discharge period is called the "fly-back."

The rising voltage is readily obtained by charging a condenser through a resistance, and the type of relay known as a gas-discharge relay is a very convenient trigger. It resembles in some ways a triode valve, but instead of a vacuum is filled with vapour such as mercury, or for television purposes, where high frequencies are involved, with rare gases such as neon and argon.

With these two devices the necessary linear rise and rapid flyback can be obtained, giving the so-called "saw-tooth" wave form, repeating itself with extreme accuracy of timing. But the wave must be not only kept at the same frequency as the transmitter;

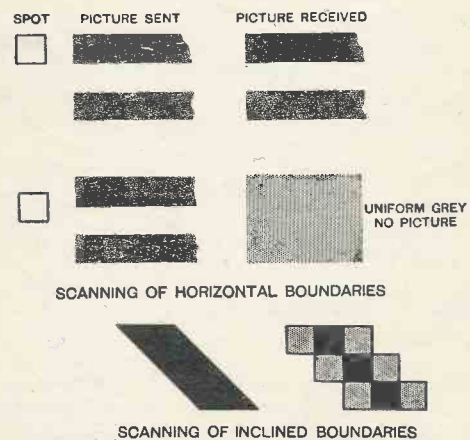
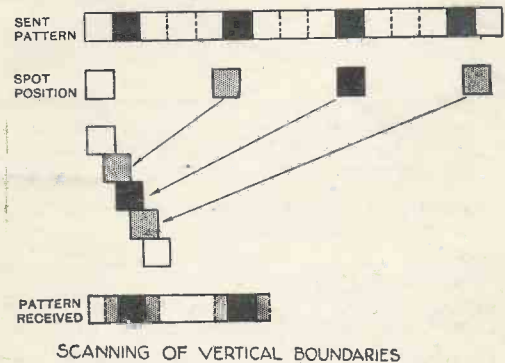

Figs. 8. and 9.—Diagrams showing the cause of aperture distortion.

THE COMPLETE TELEVISION SYSTEM

it must be actually in step so that each line and picture begins in the right place. To achieve this a locking, or synchronising signal is sent out by the transmitter at the end of each line and each picture. This signal is received, and filtered out by the receiver and keeps the time base in step. Here again the gas-filled relay proves its value, for it can be run a little too slow, and the synchronising signal applied to its grid will hurry it up each time.

Exactly how these operations are accomplished will be apparent by following the diagram (Fig. 5).

The shaded valve is a gas-filled relay which is in parallel to the condenser C_0 . The battery or other H.T. supply E_a charges C_0 through resistance R_0 , values of C_0 and R_0 being chosen so that, for example, in the low-frequency time base, it takes about $1/25$ second for C_0 to reach full volts. The charging current, flowing also through the bias resistance, R_3 and smoothed by condenser C_3 keeps at a steady negative

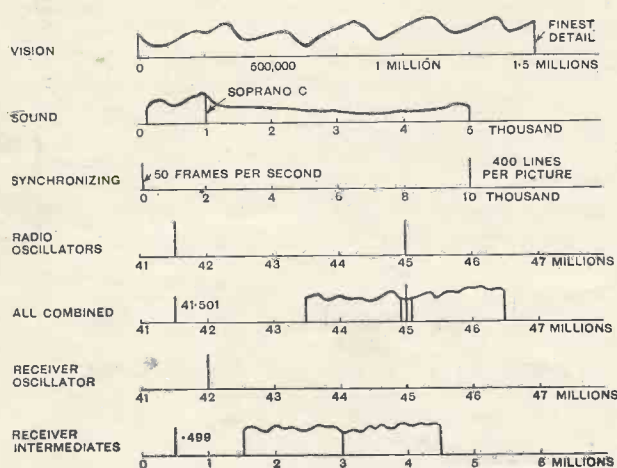

Fig. 10.—Frequencies in cycles per second used in complete sound and vision system.

potential E_g which prevents any current flowing between anode and cathode of the relay. However, the characteristics of the relay are such that when the condenser, and therefore the anode voltage, rise beyond a certain value approximately to E_a , the grid then loses control, there is an immediate and rapid flash over in the relay, the condenser is discharged, and the process starts again giving the wave form shown in the lower diagram. By making the time of charge a little too slow, as shown in the thick line, we can control the time base from the synchronising signal. This is applied to the grid of the relay and just gives the grid the extra voltage which, combined with the anode volts, is sufficient to cause the discharge.

Complete Television System

The pieces of apparatus described above, together with some devices adapted from normal broadcast receiver design, form a complete television system which is shown in outline by Fig. 6.

On the extreme left is the high efficiency carbon arc throwing an image of the film on to the holes in the rotating disc, through which the picture scanning photo-cell looks. The film also passes through the usual sound head of the talking film type where another photo-cell picks up the recorded sound.

The disc also contains a number of slits, one for each hole, which give a flash of light into the third, or synchronising photo-cell, after each line of the picture has been scanned.

Following first, the picture signal received from the picture photo-cell, it is seen to be amplified, joined by the synchronising signal, and then passed to the radio transmitter where it is converted to a 7-metre wave and radiated.

The vision signal is shown roughly triangular, plotted as amplitude vertically against time. This represents a line, white at the middle, shading to black at the edges. The synchronising signal is opposite in sign, and when added to the picture gives the wave form in modulator and radio transmitter as sketched. This is known as synchronisation by a signal "blacker than black." That is to say, the receiving screen is adjusted to be black when the picture signal is at a value above zero. The synchronising signal causes the aerial and radiated energy to drop further, actually to zero, or below the level required to give black. The longer synchronising signal is sent at the end of each picture from another photo-cell, or from 50-cycle mains.

Sound passes through amplifier and transmitter as in normal broadcast on a wavelength 41.5 megacycles.

Sound and vision each on its own wavelength are radiated and picked up by the single aerial connected to the receiver.

In the latter they may be first amplified together, and then conducted to an oscillator, more informatively called a frequency changer, which performs the combined function of separating sound and vision, and at the same time converting them to the comparatively low frequencies of three million (vision) and $\frac{1}{2}$ million (sound) which are more easily handled and amplified.

Radio engineers will, of course, recognise this as a simplified statement of the superheterodyne method. It is a method of frequency conversion by beating one frequency against another, and using resonant circuits to separate out the resulting beat frequency which, by a suitable choice of one of the oscillators, can be made appropriate to one's purpose.

Sound then pursues its course to the loud speaker as in a broadcast receiver.

The vision and synchronising signals after amplification again have their frequency changed downwards, so that they are now the original frequencies arising as the product of the picture detail multiplied by scanning speed. This process is known as demodulation, or detection, and is quite simple. After this a simple device consisting of an overloaded valve and resonant circuit separates the synchronising signals from the picture, and leads them to the time base, which they lock in step. The picture signal carries on to the con-

AN EXPLANATION OF APERTURE DISTORTION

trolling electrode on the cathode-ray tube and varies the brightness of the ray.

We must now consider what size of spot or number of lines ought to be used in television, in order to obtain a good picture. If the standard full-size cinema picture is taken as an ideal, we have to admit at once that it is beyond present-day television technique, and television engineers can only do their best.

However, it is very important to decide what this ideal quality is in terms of electrical and optical quantities, in order to see how nearly it can be achieved.

Vision

The most sensitive spot in the retina of the eye is nearly a millimetre in diameter and it consists mainly of little cones, each of which seems able to communicate with the brain and which are 0.003 mm. apart.

As the focal length of the eye is 22 mm. we easily calculate that the eye cannot separate objects less than 28 seconds of angle apart. Actually about one minute of angle seems nearer the fact for a normal eye. This means distinguishing 0.15 mm. at 50 cms. distance or, say, 1/25 in. at a distance of 10 ft.

The best lenses used in taking cinema pictures will not give a perfect image of a point; the smallest element of image they can produce is about 30 thousandths of a millimetre. On standard cine film of 22 mm. by 16 mm., this corresponds to about 800-line definition, or on home cine size, about 400 line.

Fig. 7 shows the distance which an observer must be from a screen in order that each line of the number per inch indicated may subtend the given angle at his eye. For curve B, for example, if the picture is 240-line and 6 inch height, it must be viewed from 7 ft.

We are, therefore, then 14 times the height of the picture away. The situation of the best seats in picture houses suggest that this is rather too far away; a ratio of between 4:1 and 8:1 is said to be best. It is easy to be too theoretical on this subject and only practical tests can really decide.

If we go closer we shall notice the absence of detail that we are accustomed to, and it is no good enlarging the picture for we shall merely have to go further away. On the other hand, if we take the 400-line case, we can go as close as 4 ft., and then shall be more nearly in the position of a good seat.

Perfect 400-line definition would seem, therefore, a very reasonable figure, and, as mentioned above, corresponds to the definition of first-class home cinema equipment.

Limitations of Scanning

Everyone is aware that modern illustrations are reproduced in books by printing a series of dots of smaller or greater size, but always the same distance apart.

In a similar way the detail given by a television system is limited by the distance apart, and number of the holes in the disc, which determines the number of lines in the picture. In the Inconoscope, it is the size of the electron beam that is the limitation.

Figs. 8 and 9 show how this limit operates to produce what is called "aperture distortion," and is visible as

loss of detail. In the first it is seen that the sharp vertical boundaries between black and white in the original picture become a little grey, because the spot is large enough to overlap the boundary, and at the critical instant of change-over is at half brightness.

If a horizontal boundary happens to occur which the spot overlaps, it disappears completely and a diagonal becomes ragged.

The smaller the spot, and therefore the greater the number of lines, the less is the amount of this particular distortion. In fact, the spot cannot distinguish in a picture any detail smaller than itself.

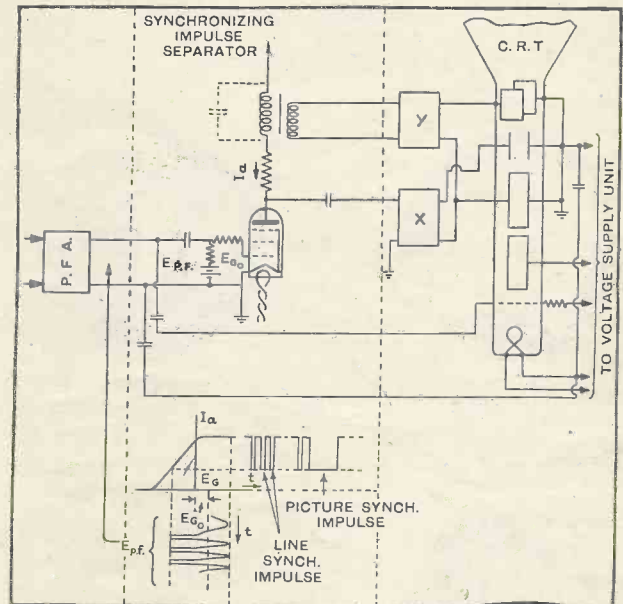

Fig. 11.—Suitable arrangements for separating the synchronizing impulses from the picture signals in a receiver.

Frequency Range

We are now in a position to consider the electrical frequencies necessary in a television system. Let us choose the 400 lines; we require also to be able to distinguish 400 equal changes of detail, in the extreme case from full black to full white, along the line. The spot size must be 1/400 of a line, and since the pair "black-white" constitute a full cycle of the electric current, we find that with such a spot size the current will be changing at a maximum rate of

$$F = \frac{(\text{lines})^2 \text{ by pictures per sec. by width of picture}}{\text{height of picture by 2.}}$$

Taking the 400-line case it is seen that a maximum frequency of 2,700,000 cycles per second is required for a picture 1/3 wider than it is high. This frequency is more than twice as high as that of medium wave broadcast, and explains why much higher frequencies, ultra short wavelengths, must be used as the carrier wave of a television transmitter.

If, in the interests of economy in receiver and transmitter construction, or to leave more space "on the air," we restrict the maximum frequency, we reduce

(Continued on page 36)

FAULTS IN TELEVISION RECEIVERS AND THEIR CAUSES

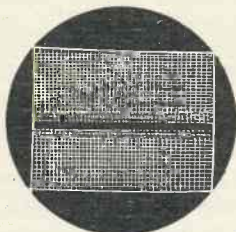

50 FRAMES

Hum on grid of Cathode-ray tube. Faulty smoothing or decoupling, or pickup in leads.

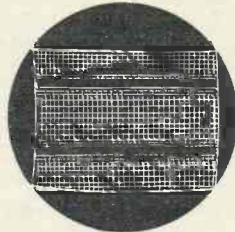

25 FRAMES

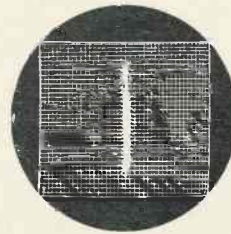

Line scan disconnected. Faulty valves or disconnection in scan unit.

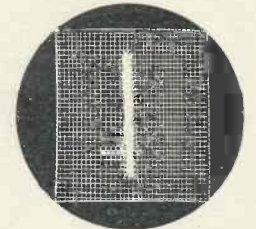

Frame scan disconnected. Faulty valves or disconnection in scan unit.

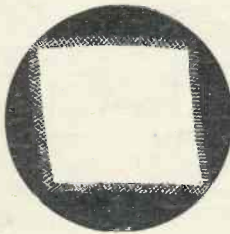

Hum on deflector coils. Faulty smoothing.

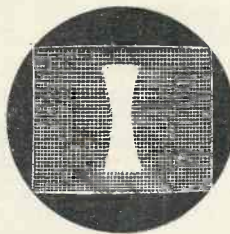

Line scan deflector coils in opposition. Reverse one coil.

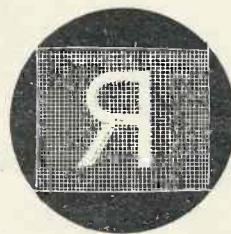

Line scan connected left for right. Reverse leads of deflector coils.

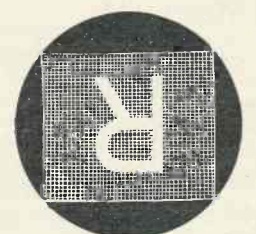

Frame scan reversed. Reverse leads.

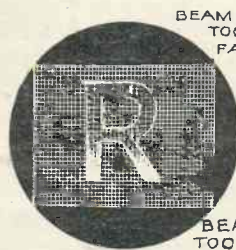

BEAM TOO FAST

BEAM TOO SLOW

Non-linear pulse in frame scan. Probably saw tooth generator pulse.

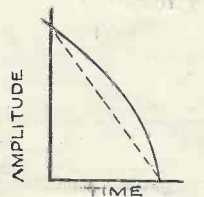

--- CORRECT
— INCORRECT

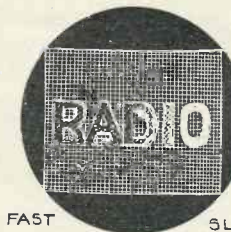

FAST

SLOW

Non-linear pulse in line scan. Faulty valve in line scan unit.

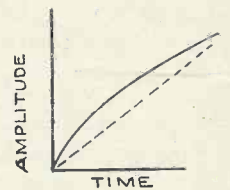

--- CORRECT
— INCORRECT

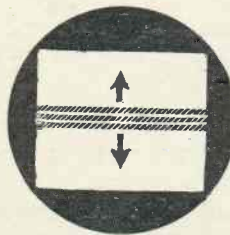

LINES MOVE UP OR DOWN

No frame hold. Fault in frame scan synchronising unit.

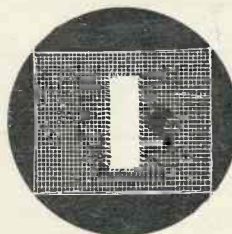

Insufficient line amplitude. Faulty valve or low H.T. to line scan unit.

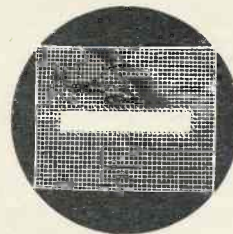

Insufficient frame amplitude. Faulty valve or low H.T. to frame scan unit.

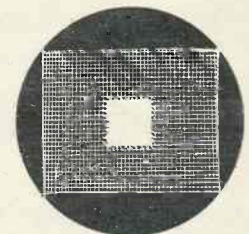

Both amplitudes small. Low H.T. to scan units. Faulty rectifier valve.

The sketches above are intended to give an approximate idea of the most obvious faults in a television receiver which are made apparent on the screen. They should not be interpreted too literally as in some instances the same effects might be produced in other ways.

Scannings and Reflections

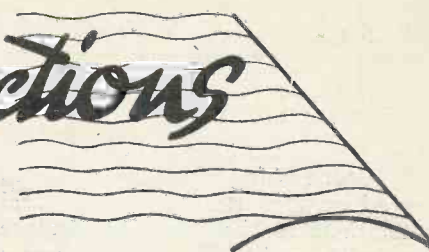

WHILE THE PALACE BURNED

The Crystal Palace was, of course, clearly visible from the Alexandra Palace, and it seemed rough luck on the Baird engineers, who still assist the Alexandra Palace staff, to have to carry on with their job while their headquarters were being gutted. It must have been a difficult matter for them to have to concentrate under such conditions.

THE GALE DAMAGE

As regular lookers-in know, a very high wind put television off the air on December 14th. Both sets of aerials were damaged. The horizontal arms which carry the aerial arrays are hinged in the centre and these appeared to be bent upwards owing to the stays having broken. Efforts were immediately made to remedy the defect, and the ordinary B.B.C. engineers in spite of the high winds climbed the mast to make an inspection of the damage and actually succeeded in repairing the lower aerial, which is used for the sound transmissions, so that an announcement could be put out at 9 p.m.

As the repairs had to be continued after dark some high power studio lamps were used to illuminate the mast which looked most impressive under the floodlight effect, a point the B.B.C. could well bear in mind for the coming Coronation decorations. The gales also took its toll of windows, large quantities of broken glass being strewn around the ground about the south-east tower.

THE MISSING ANNOUNCER

Feminine lookers-in are wondering where all the dresses are that the lady announcers were reported to have had. On the evening transmissions, two evening dresses appear with great regularity. While on the subject of announcers, one can't help thinking that the programme people don't seem quite to know what to do with them. Sometimes they are seen for every announcement and then for a time they are just voices. Surely the former method is correct considering they were selected for their appearance.

TRANSATLANTIC TELEVISION

International interest has been aroused among radio engineers by a statement just made by Marchese Marconi that television will soon span the Atlantic. Actually, television signals from Germany have been picked up in New York.

"We have maintained communication across the Atlantic on short-wave lengths," said a G.E.C. research engineer, "and are exploring the possibility of ultra short-wave transmission for long distance broadcast for television."

"We know that a broadcast on 15 metres can get across the Atlantic, but the objection to using this band for television is largely one of cost. Television takes up too much space in the ether. If television were broadcast from this country to America, the space would have to be obtained at the expense of normal wireless telephony communications. Telephony bands are only 10,000 cycles per second apart, whereas television bands are 1,000,000 cycles per second apart and as much as 3,000,000 cycles for very high definition.

"The growing use of wireless telephony will make it practically impossible for enough space on the wavelengths now in use to be sacrificed, except perhaps for 90-line television requiring 100,000 cycles per second, which might give a just satisfactory close-up of one person. From the beginning of television, therefore, we have been experimenting on short wavelengths, and it is quite possible we may be able to broadcast internationally pictures of a full 400-line definition in the future."

IMPROVED SOUND

A great improvement has been recently noticed in the quality of the sound side of the Baird system transmissions. This, of course, is due to the fact that the Baird electron camera is being extensively used and in consequence the sound is direct, like normal broadcasting. Previously, most of it was first recorded on the film in the Baird intermediate film system which, like all recording de-

vices, does not show up too well compared with a direct system. In passing it might be mentioned that the Baird sound equipment was designed by Mr. Ingham, who, prior to joining the company, was a B.B.C. research engineer.

THE B.B.C. CHARTER AND TELEVISION

In the drafts of the Royal Charter for the B.B.C., which comes into operation on January 1, the introduction of television has necessitated a new clause. The Corporation is authorised to produce, manufacture or otherwise acquire films, film material and apparatus for use with films, and to employ such films and apparatus in connection with the Corporation's broadcasting service. There is a proviso that the films may not be used for any purpose other than television.

THE BAIRD ELECTRON CAMERA

The Baird Company are to be congratulated on the steady improvement they have effected in their electron camera transmissions. At first the pictures were rather ragged, but it has been noticeable that the whole series with this system show a record of difficulties overcome, and at the time of writing they leave very little to be desired. The flexibility of this system compared with the intermediate film system, of course, needs no comment, and it has been a matter of general wonder that it was not adopted from the outset for the Baird Company had this system working perfectly in their laboratories some months ago.

TECHNICAL POSSIBILITIES

During the afternoon session of the recent anti-aircraft defences transmission one of the large reflectors of a searchlight was removed to show it to lookers-in and for a few moments it was turned to such an angle as to give a wonderful reflected view of the aerial mast. Incidentally, the two transmissions showed what can be done technically with television, and great praise is due to the engineering staff responsible. From an enter-

MORE SCANNINGS

tainment point of view it was, however, hardly worth while.

A LIFT AT A.P.

The one thing that appeared to have been forgotten in the structural alterations to the Alexandra Palace was a lift, and there have been many complaints from both staff and artists because of the omission. However, work has now been undertaken on the installation of a lift and its erection is well on the way.

PROGRAMME TECHNIQUE

There has been considerable improvement in programme technique during the past month and no doubt the use by the Baird Company of electronic scanning has done much to facilitate this by enabling the intervals, which were due to the necessity of changing the film, etc., to be almost entirely eliminated. It has also been noticeable that there has been less interference in the transmissions by the intrusion of people or their shadows who were not actually intended to be in the picture.

THE BAIRD BIG SCREEN

Mr. J. L. Baird is to be congratulated on his achievement of producing a really big television picture. A picture of an area of about fifty sq. ft. is no mean accomplishment and from the technical description which appears on other pages of this issue it is clear that he has tackled the problem on original lines. The installation at the Dominion Theatre in Tottenham Court Road is a permanent one. Actually, practically nothing can be seen of the gear, for in order to comply with the L.C.C. regulations it is entirely boxed up in metal cases, and these and flexible metal tubes carrying the cables are all that can be seen. In operation the gear is almost silent and all that can be heard is the faint whirr of the motor, which is easily drowned by the loud-speaker.

N.B.C. TELEVISION

The first large-scale television show was recently staged in New York, when the National Broadcasting Company gave a demonstration to about two hundred people in a room in Radio City. The transmission was made from the top of the Empire State Building.

TELEVISION IN THE HOUSE OF COMMONS

Two television sets have been installed in the Grand Committee room

of the House of Commons, and M.P.'s can now watch the televising of theatrical scenes, wrestling, dancing, and other entertainments. Mr. Ramsay MacDonald has announced that television developments are being watched in view of the suggestion that the Coronation ceremony in Westminster Abbey might be televised. The B.B.C. obtained the approval of the Speaker to instal television in the House.

TELEVISION JARGON

At the annual dinner of the London and Home Counties branch of the Cinematograph Exhibitors' Association, the Postmaster-General, Major Tryon, protested against the new jargon of television. He objected to being "televised," and still more to describing the people who watched the result as "viewers." He added that impartial experts assured him that British television was the best in the world.

Another speaker (Mr. Philip Guedalla) said: "I see references to a 'television hostess.' What can this be but a long-distance chorus girl."

THEATRES AND TELEVISION

At the annual meeting of the Provincial Entertainments Proprietors' and Managers' Association, the members received a deputation from the Musicians' Union, to discuss various aspects of the situation arising from the B.B.C. monopoly of television.

The annual report states: "A problem that will shortly loom largely is that of television and its handling by the B.B.C. One section of the entertainments industry already sees danger looming in the shape of the powers with which the great Corporation may be endowed."

Further references to the situation are made in the report of the Parliamentary Agents, which is appended. This states: "The B.B.C. Charter for the next ten years is shortly to be laid before Parliament, and it is expected to be on much the same lines as the original Charter. In view of the development of television, efforts have been made by theatrical interests to persuade the Postmaster-General to make special provision for their future protection."

ALEXANDRA PALACE IN SOUTH AFRICA

There does not seem to be any limit to the range of the A.P. television

sound transmission. Yet another reader, Mr. G. C. J. Angilly, regularly picks up both sound and vision signals in Cape Town. The receiver used is a simple super-regenerative type using two valves only. These long-distance reports lead one to hope that before very long the actual guaranteed service area may greatly exceed the present estimated range.

TELEVISION PROGRAMMES

It is understood that the Radio Manufacturers' Association is to approach the B.B.C. with a request that the programmes should be improved. It is claimed that dissatisfaction amongst manufacturers and traders is causing a decline in sales. It is hoped, in addition, that the hours of transmission will be increased early in the New Year.

TELEVISION IN THE THEATRE

Over £350,000 is involved in the new Prince of Wales Theatre. It is to be equipped with television projection apparatus so that important items can be flashed on the screen, while normal radio will also play its part.

AMATEUR 5-METRE ACTIVITIES

Amateurs in this country are doing some wonderful work on 5 metres and are proving beyond all doubt that this wavelength has not a limited range as is generally accepted. American signals have been picked up in South Wales, Essex, and also in North France. A North African station has been logged in London, while several German amateurs are able to send out signals over several hundred miles. What the ultimate range of these signals will be one cannot forecast, for rumours are prevalent that a New Zealand 5-metre signal has been picked up in this country.

BETTER AMERICAN TELEVISION

The Radio Corporation of America have concluded a series of successful experiments with 343-line pictures and are now turning their attention to better definition.

Agreement has been reached between several companies, including R.C.A., Philco, Farnsworth and Don Lee, to increase the frequency to 441 lines. These companies will all transmit signals that can be picked up on one particular type of receiver. The price of these receivers has still been maintained at a little over £100.

RECENT TELEVISION DEVELOPMENTS

A RECORD OF PATENTS AND PROGRESS *Specially Compiled for this Journal*

Patentees:—Marconi's Wireless Telegraph Co., Ltd. :: H. M. Dowsett and L. E. Q. Walker
L. R. Merdler and Baird Television Ltd. :: W. S. Brown

Kerr Cells

(Patent No. 453,136.)

When using multi-electrode Kerr cells for receiving television signals, the difficulty arises that the inter-electrode capacity tends to by-pass the higher signal frequencies, and so leads to a falling-off in the quality of the picture. To avoid this, the

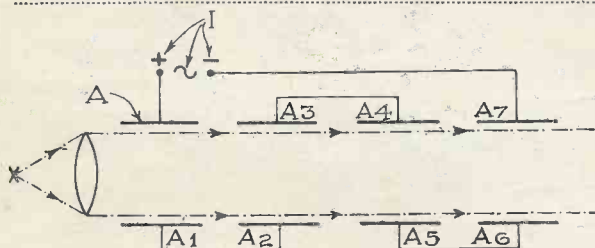

Multi-electrode Kerr cell Patent No. 453,136.

electrodes are connected in series with each other, so that their overall capacity is much reduced.

As shown in the diagram, the signal is applied across the terminals I and the series circuit is from electrode A through the cell to electrode A1. The latter is connected, as shown, to electrode A2, the circuit proceeding through the cell to A3, thence to A4, and so on to the last electrode A7, which is connected to the opposite terminal of the input I. Although the voltage required to produce a given variation of light intensity is doubled, the capacity of the cell is divided by four, and high-frequency losses are correspondingly reduced.—Marconi's Wireless Telegraph Co., Ltd., H. M. Dowsett and L. E. Q. Walker.

Television Amplifiers

(Patent No. 453,847.)

The coil L in the anode circuit of the first I.F. valve V of a superhet receiver for television signals is tuned to the lower limit of the frequency band, whilst the coil L1 in the grid circuit of the next valve V1 is tuned to the upper limit. A third coil L2, mutually coupled to the other two, is tuned to the middle of the frequency band. Each of the tuned circuits is damped by a parallel resistance R,

R1, R2. The coupling gives a uniform response over the whole of the frequency band to be passed, with a sharp cut-off at both ends.—L. R. Merdler and Baird Television, Ltd.

Television Cameras

(Patent No. 454,422.)

In the Iconoscope form of television "camera," the picture to be trans-

mitted is first focused on to the photo-sensitive electrode of a cathode-ray tube, and the resulting "electric image" is then discharged by scanning the electrode with the electron stream from the "gun" part of the tube. Usually, the sensitive surface of the electrode faces at least partly

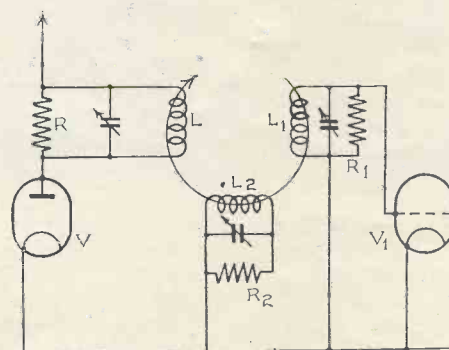

Television amplifier circuit Patent No. 453,847.

towards the gun or cathode end of the tube, and the picture is projected on to it from the same end. But it would obviously be more convenient to be able to focus the picture on to the outer face of the electrode, i.e., the one which is seen from the bulb end of the tube.

This, however, gives rise to diffi-

culties, because the sensitive electrode is formed by covering a thin sheet of aluminium with a layer of aluminium oxide on which a large number of sensitive caesium globules are deposited. The globules are insulated from each other and from the aluminium backing by the oxide layer. Now if the sensitised layer is deposited on the surface nearest the bulb, so that it faces away from the scanning stream, it is obvious that the electrons must first penetrate the aluminium backing-plate before they can discharge the sensitised globules and so produce the signal currents.

To overcome the difficulty, the electrode as a whole is made impervious to the scanning stream, but is provided with a large number of small metal "plugs," which extend through, from the scanned surface to the opposite face, and are sensitised at the end on which the picture is focused.—Marconi's Wireless Telegraph Co., Ltd.

Cathode-ray Tubes

(Patent No. 454,486.)

The mosaic-cell electrode on which the picture to be transmitted is first focused is usually set at an angle to the "gun" of the cathode-ray tube, so as to allow the electron stream from the latter to scan and discharge the same surface that receives the picture. This arrangement is liable to cause the base-line both of the line and picture scanning frequencies to "wander," and to become "saw-toothed" instead of straight. In addition, it gives rise to parasitic disturbances at the framing frequency.

According to the invention these effects are overcome by disposing an auxiliary electrode system between the gun part of the tube and the photo-electric screen. Suitable biasing potentials are applied to the extra electrodes in order to produce a "compensating" potential gradient, which minimises the spurious effects already mentioned.—W. S. Brown.

BAIRD LABORATORIES DESTROYED IN CRYSTAL PALACE FIRE

THE disastrous fire which almost completely destroyed the Crystal Palace on the night of November 30th extended to the Baird laboratories, which occupied a considerable area of the south-west corner of the Palace; the whole of the laboratory equipment was destroyed.

As is well known, the Baird Company have conducted all their recent research work at the Palace and that portion occupied by them had been structurally altered internally to provide a complete television transmitting station, the aerial being on the south west tower with the remainder of the premises equipped with studios

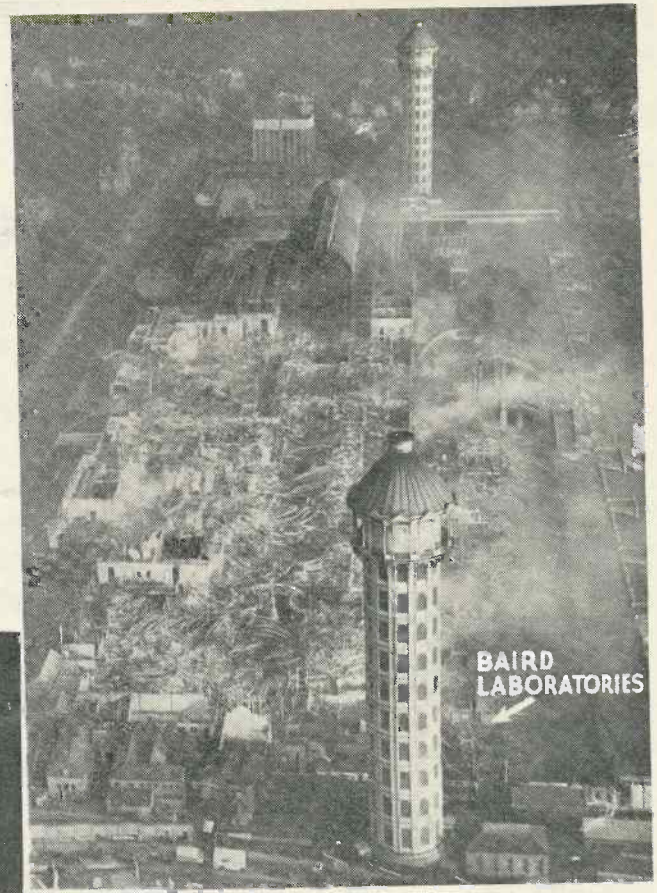

The photograph on the left was taken during the height of the conflagration and it shows approximately that part of the Palace which was occupied by the Baird laboratories. Fortunately, the receiving set, production department escaped the full force of the blaze and comparatively little damage was done here. The photograph above was taken at 9 a.m. on the morning after the fire and it will be seen that the Baird laboratories are on the fringe of the destruction.

and research, production and servicing departments.

During the progress of the fire it was thought that no part of the Baird premises would escape, and there were fears that the south-west tower, which was adjacent to the Baird premises and supported the aerial, would collapse. Investigation when the fire had been got under control, however, revealed that although the administrative offices, research department and studios had been entirely gutted, the production and servicing departments had escaped almost unscathed.

The official announcement made by the Baird Company respecting the damage done is as follows:

"Although a considerable amount of property was damaged by the fire, an inspection carried out by our experts revealed that the receiving sets production department escaped the full force of the blaze. In addition, the servicing and testing departments were undamaged, and consequently the deliveries of sets to

the public will not be effected. The directors wish to state that the regular daily transmissions of television programmes by the B.B.C. from Alexandra Palace, which during this week are being radiated by means of the Baird system, will not be affected in any way."

It was announced later that the Baird Company's property and equipment at the Crystal Palace was fully covered by insurance.

We understand that the Baird Company are already negotiating for new premises where large scale production of their receivers and transmitting gear could be undertaken.

At one time there was a considerable prospect that the Crystal Palace would be used as the site for the B.B.C. London television station and now, as events have turned out, it seems fortunate that the Palace was not selected, otherwise we might at this date have been without television.

BAIRD TELEVISION LTD.

**WORLD PIONEERS & MANUFACTURERS OF
ALL TYPES OF TELEVISION EQUIPMENT**

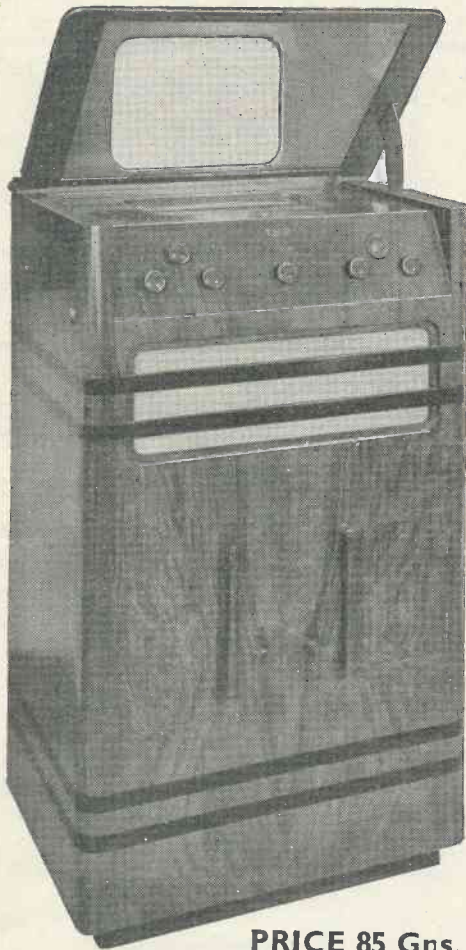

PRICE 85 Gns.

BAIRD TELEVISION LTD. announce that although a considerable amount of property was damaged by the Crystal Palace fire, the "Televisor" Receiving Set Production Department, together with the Servicing and Testing Departments, are unaffected. In consequence, there is no delivery delay with "Televisor" receiving set Model T.5.

Authorised dealers who have qualified for a Baird Certificate of Proficiency, have been appointed within the service area of the B.B.C. television station. A complete list will be supplied on written application.

"Televisor" receiving sets give a brilliant black and white picture 12" x 9" on the "Cathovisor" cathode ray tube, which is of unique design and guaranteed for a long life. These Sets give results on both systems of transmission unequalled in size, detail, brilliance and colour, with the accompanying sound, and are operated on A.C. Mains, or on D.C. Mains with a suitable D.C./A.C. converter. The controls are extremely simple for either system.

"TELEVISOR" RECEIVERS MIRROR THE WORLD

Head Office :

**GREENER HOUSE,
66, HAYMARKET,
LONDON, S.W.1.**

'Phone : Whitehall 5454

TELEVISOR

REGISTERED TRADE MARK

Laboratories :

**CRYSTAL PALACE,
ANERLEY ROAD,
LONDON, S.E.19.**

'Phone : Sydenham 6030



EDDYSTONE EXCELLENCE

for PLUS PERFORMANCE

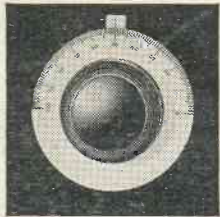

No. 1069
Price 15/-

PRECISION 4" SLOW MOTION DIAL.

An accurate and powerful drive for high-class test and laboratory equipment or transmitters. 5/64" thick brass 4" scale silver plated, with machine-cut graduations. 6 to 1 reduction ratio. Large control knob. Can be supplied with 1/4" M. or F.M. fitting.

H.F. LEAD THROUGH INSULATOR.

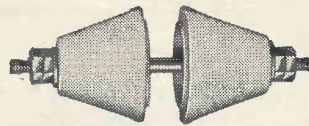

For carrying H.F. leads through metal baseboards with minimum loss. Glazed Frequentite Insulator Cones. 4BA Brass Rod Conductor. Cones 1 1/8" long. 1 3/8" max. diam. No. 1018. Price 2/-.



POINTER KNOB AND DIAL.
A direct control comprising 3" satin finish aluminium dial engraved 0-100°, with elegant shaped bakelite pointer knob. For 1/2" spindles only. No. 1027. Price 1/3.

ULTRA S.W. INTERCHANGEABLE COILS.



Wound with 14 gauge high conductivity copper wire, heavily silver plated. A separate Frequentite base with silver-plated sockets provides easy and efficient coil changing. No. 1050.

3 Turns ...	1/6
4 " " " " " "	1/6
5 " " " " " "	1/7
6 " " " " " "	1/8
8 " " " " " "	1/10

Frequentite Base for above
No. 1051 ... 1/-

SPLIT STATOR CONDENSER.

Heavy brass construction, plates with polished edges, soldered together. Insulated bearings. Screened non-inductive pigtail. Frequentite insulation. Capacity—One side: Min. 5 m.mfd. Max. 40 m.mfd. Two sides in parallel: Min. 10 m.mfd. Max. 80 m.mfd. As series gap: Min. 3 m.mfd. Max. 20 m.mfd. No. 1068 Price 12/6

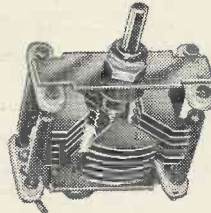

NEUTRALISING CONDENSER

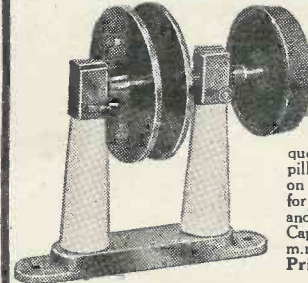

Of solid construction, with turned brass plates, screw adjustment. Frequentite insulating pillars, mounted on cast base. Ideal for Eimac 150 T. and similar valves. Capacity: 3 to 12 m.mfd. No. 1067 Price 12/6

FULL of INTEREST to SHORT-WAVE ENTHUSIASTS

Illustrated constructional articles for building simple S.W. battery sets; battery and A.C. mains superhet. S.W. receivers with A.V.C.; Ultra S.W. Radio Telephone; Transceiver; S.W. Converters; Crystal-controlled Amateur Bands Transmitter, etc. From your Radio Dealer, W. H. Smith & Son, or from Stratton & Co., Eddystone Works, Birmingham, 5. London service:—Webb's, 14, Soho Street, W. 1.

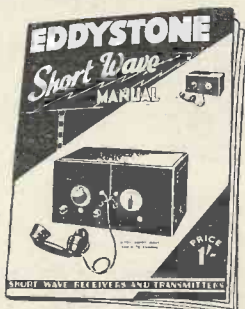

EDDYSTONE 1937 SHORT WAVE MANUAL

ULTRA SHORT-WAVE H.F. CHOKES



These chokes are single layer space wound on DL-9 formers, and have an exceedingly low self-capacity. 2 1/2-10 metres. No. 1011. D.C. Resistance 1.3 ohms. 2.5 to 10m. Price 1/3
No. 1021. D.C. Resistance 0.4 ohms. 2.5 to 8m. Price 1/3

IRON CORED FILAMENT CHOKE



For use in filament circuit of battery operated Superhet Receivers using electron coupled oscillator. No. 1062. Price 3/6.

BANDSPREAD TUNING OUTFIT. Devised to simplify station selection.

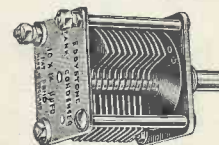

The Tank condenser unit has a capacity range of 10 x 14 m.mfd., achieved by a patented step by step device. Complete with scale and knob.

Tank Unit: Cat. No. 1042. ... Price 6/-

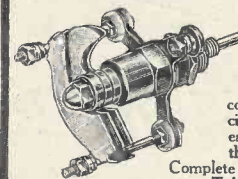

In parallel with the Tank capacity is the slow motion Bandspread Trimmer condenser, with a capacity slightly greater than each step by step of the Tank condenser. Complete with dial Trimmer Unit Cat. No. 1043 ... Price 6/6

SEND FOR NEW ILLUSTRATED COMPONENT LIST—FREE ON APPLICATION

EDDYSTONE SHORT WAVE COMPONENTS

STRATTON & CO., LTD., Bromsgrove Street, BIRMINGHAM;

LONDON Service: Webb's Radio Stores, 14, Soho Street, Oxford St., W. 1

THE PROBLEMS OF PHOTOGRAPHING TELEVISION

By R. C. Hanner

There are difficulties in photographing a television picture which are not immediately apparent. This article describes these difficulties and explains how they may be overcome.

AMONGST all the publicity which the press in general has given to television very few attempts have been made to reproduce the image of the television screen and pictures which have been published

ledge of how the picture is formed. The photographer looking at a television screen of the cathode-ray type generally forms the opinion that there is a reasonable amount of light available to take a picture, which is true, but he is not generally aware of the fact that only a very small area of the scene is illuminated at any given instant, and that which looks like a well illuminated area is, in reality, only darkness.

Now to explain this more fully let us inspect some actual figures, taking the Baird system first. This is a 240-line picture with a picture-frequency of 25 per second, that is to say a spot of light draws 240 lines across the end of the cathode-ray tube, 25 times per second, the actual size of the spot of light, if everything is correctly set, being .00013 of the area (including synchronising) of the television image.

Now let us see how much time is spent in drawing, say, one line. 240 lines are drawn in .04 second, therefore one line in .0016 second, and as there are the equivalent of 320 spots of light in one line the time taken for one spot to travel its own length is .000005 second. Simply put, all this

1/2,000,000 second, that is to say, a total of 1/80,000 a second, which is not much compared with the usual photographic exposures.

In the Marconi-E.M.I. system, the period of exposure is less. In this



The B.B.C. Test Transmission visual announcement. This shows receiving tube rather too heavily biased, giving a very heavy black and white effect. Note how the M. & I. on E.M.I. are cut off, owing to the curvature of the receiving tube. Exposure three sec. F/8 Kodak super sensitive pan. film.

show marked signs of retouching or faking. Photographers, professional and amateur alike, have tried to get pictures, but with far from satisfactory results.



One of the lady announcers. This is an example of watching one's chance. It was noticed that the announcer kept looking down at her script and an effort was made to photograph directly she looked down. Unfortunately the exposure was just too long and traces of movement have spoilt what might have been a very good result, the eyes being recorded mostly cast down though the shutter was not quite closed when the eyes were looking at the camera. Exposure 2 record F/2.9 S.S. pan. Kodak film.

system 405 lines are used on 25 pictures per second though the system of scanning is different. 202½ lines scan



Left: The tube biased to about correct brightness for ordinary viewing. Again note slight cut off in brilliancy of the I in E.M.I. Another effect is also noticeable, namely, the white edge on right of picture; this white edge appears to be present in varying degree in all M.-E.M.I. pictures.

Right: Tube biased rather too brightly for photographing two tones black and white. The general curvature and angle of the Marconi-E.M.I. are due to two effects, one, curvature of tube, two local timing circuits not quite adjusted to incoming synchronising signal.



One of the greatest stumbling blocks to the average photographer, who wishes to photograph a television image, is a complete lack of know-

means is that if one opens a camera shutter for one second the actual time the photographic emulsion is exposed will be 25 short exposures of

half the total area of the image in 1/50 of a second while the second half is scanned in another 1/50 second, the two halves being interlaced.

In this system the time taken for one spot of light to travel its own length is .00000017, so a one-second shutter exposure gives the emulsion an exposure equal to 1/250,000 second. On the surface these figures seem to make the photography of a

slowly than 1/10 of a second without blur, so one is rather limited to subject from an ordinary transmission and much patience is required to get

the picture appears, to the eye, to become flat. The shadows are lightened but the high lights do not get proportionately brighter so the gamma is reduced. This is desirable from a photographer's point of view, as the average television picture is



Leslie Mitchel. Television announcer just about to make an announcement. An example of getting a picture before the subject moves. Exposure half sec. F/2.9 Kodak super S. pan. film. The white shading where the black suit cuts the picture edge appears in most pictures on one of the systems of television.



This picture must be one of the best known scenes to television experimenters, having been used for testing purposes by the Baird Company for nearly two years. The picture is from a loop of film and the artist slowly turns her head, faces the looker-in and then with great rapidity turns her face left. The subject gives photographers a chance to know what is coming, and though the subject is never quite still a one sec. exposure with a F/2.9 lens S.S. pan. Kodak film recorded the picture. In the original the scanning lines can be seen. The four faint horizontal lines are produced by the scanning disc at the transmitter, which rotates four times per picture.



Elizabeth Cowell taken as she looked down to read announcement. Spots on nose and mouth photographic blemishes. This picture is another example of what can be done if the right moment is chosen. Exposure 1/10 sec. F/2.9 Kodak S.S. pan. film.

television image impossible. Luckily the light of a cathode-ray tube is very intense and it is quite possible to get a printable negative with a shutter speed of one second using a suitable camera and emulsion. Shutter speeds of 1/10 second have produced very thin negatives, while exposures of 1.5 to 2 seconds give ample exposure.

The lens must be fast, the writer uses a Dallmeyer F/2.9 Pentac lens and Kodak super sensitive panchromatic film, developed in a normal metal-hydroquinous developer.

Unfortunately, though ample ex-

a satisfactory picture. Often announcers are comparatively still at the beginning or end of a transmission. The same applies, though to a lesser extent, with artists. Sometimes test transmissions are made when somebody sits in a chair reading for some minutes on end. There is definitely as much luck in choosing the right time to expose as in any gambling game yet invented.

generally tonally distorted (if in no other way) by an excessively high gamma. This tendency for a high gamma or contrasty pictures is found in the moving picture, especially a few years ago, and in most amateurs' snapshots and, broadly speaking, most people prefer it, so it cannot be considered detrimental to a television picture.

The three prints of a B.B.C. caption card transmitted prior to the opening of the station clearly illustrate the effect of adjusting the picture brightness. The third would produce the best setting for photographing average scenes, though ob-

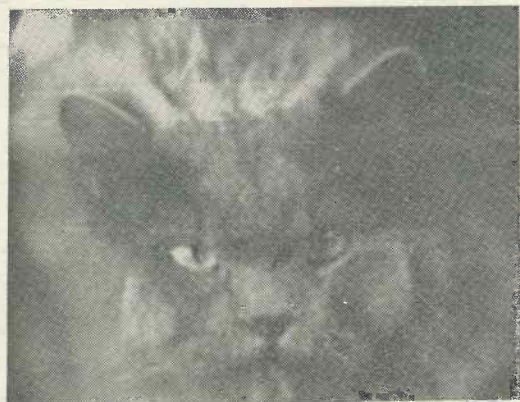

Left: This close up was from a news reel recently televised. In the original the scanning lines are most clearly marked. The mark between the eyes is a piece of faulty emulsion. Exposure 1/10 sec. F/2.9 Ilford hypersensitive plate.

Right: Scene from "Mari-gold." Rather an imperfect result due to contrasting studio lighting and running the receiving tube with the general "brightness" too low for photographing. Original shows scanning lines. Exposure 1/10 sec F/2.9 Ilford hypersensitive pan. plate.



posure is easily obtained, most of the television screens contain fairly rapid movement, which produces a blurred result when adequately exposed. Few scenes televised could in the ordinary way be photographed much more

Another big factor in successful television photography is the brightness at which the cathode-ray tube is operated. Obviously the brighter the tube the shorter the exposure. If the brightness of a tube is increased,

viously for a caption a strong contrast is best.

There is also another problem in photographing a television image which must be mentioned, namely,

(Continued at foot of page 25)

A "UNIVERSAL" CATHODE-RAY TUBE EQUIPMENT

The first of a short series of articles describing the construction of a complete cathode-ray tube equipment which will prove of great use to the serious experimenter. The "professional" appearance of the unit will add to its value as a permanent laboratory appliance.

THE cathode-ray equipment about to be described is intended to make a tube of large or medium diameter serve both as a television reproducer or as a laboratory instrument for all the various purposes to which it can be put. It must be pointed out at the start that the construction of such an equipment requires more care than that sometimes bestowed on an experimental layout, and in addition it is assumed that the experimenter has a reasonably well-equipped workshop for the various metal-working jobs involved in assembling the unit. A certain degree of flexibility is allowed in the choice of components, consistent with quality and size, and where alternatives are not desirable this is clearly indicated in the text.

General Layout

The equipment is assembled on an "Eddystone" transmitter chassis and occupies two racks, the lower containing the H.T. controls for the tube and an external A.C. supply unit and the upper a double time-base unit which can be adapted for wave-form observations or for scanning at any range of speed up to 400 lines and 50 pictures per second. With the exception of the "input" terminals all connections to the unit are made at the back by means of flexible leads, which arrangement makes for neatness when working.

One of the advantages of an all-metal construction is the efficient shielding provided against mains interference, a point of particular importance in high-speed

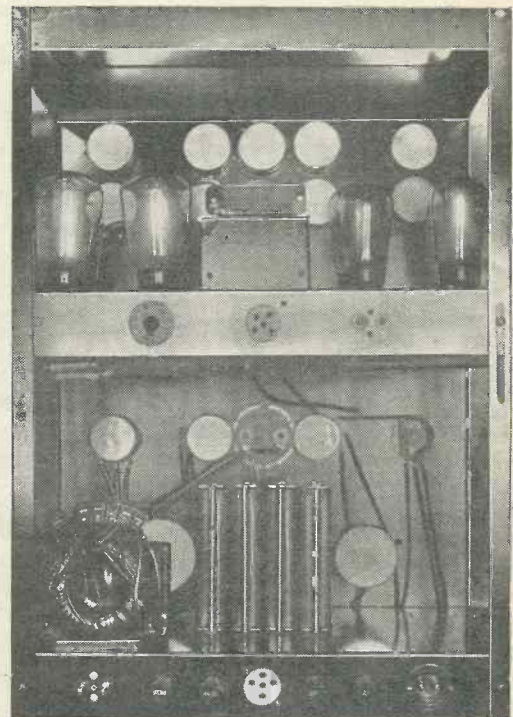

Rear view of equipment showing assembly in rack.

scanning. The risk of shock from any part of the equipment is minimised by the fact that the H.T.+ is permanently connected to chassis and the high voltage leads are under the lower rack out of reach of accidental contact. On the other hand the use of an earthed H.T.+ supply necessitates the careful insulation of parts which are at a lower potential, and this is done by the use of special high-tension cable for the wiring and by fitting paxolin bushes for the various controls which project through the front of the panel. Parts which require special attention will be mentioned as the construction proceeds.

Chassis and Panel

As said above, the chassis is an Eddystone 3-tier transmitting rack (Cat. No. 1047) which can be obtained from C. Webb, of Soho Street, or direct from the manufacturers, Messrs. Stratton & Co., of Bromsgrove Street, Birmingham. When unpacking, care must be taken not to scratch the enamel finish of the panel or the chassis; all marking out should be done with the panel resting on a padded surface of paper or felt. The chassis racks are ready drilled for joining to the panel and uprights and note must be taken of the position of these holes when marking out so that the outlet sockets are on the true back of the racks. The front edge of the rack which fits against the panel is undrilled.

Design of H.T. Unit

The supply for the tube and the time-base is obtained from separate transformers and rectifiers mounted in shielded boxes away from the equipment and connected to it by the flexible leads mentioned above. It is not proposed to deal in detail with the requirements of the rectifier units as these are standard practice and have been described already in this journal (see May issue).

The question of the voltage available will also have

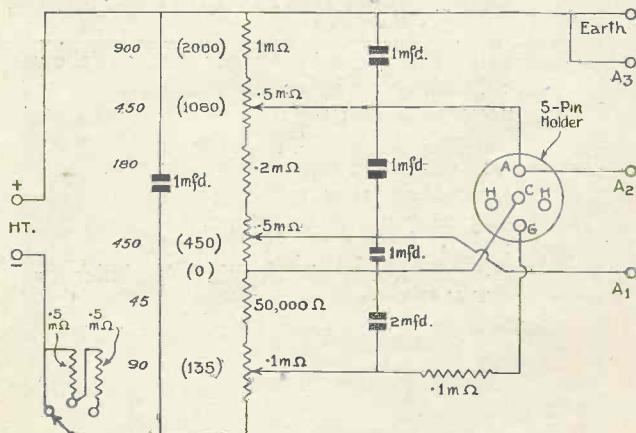
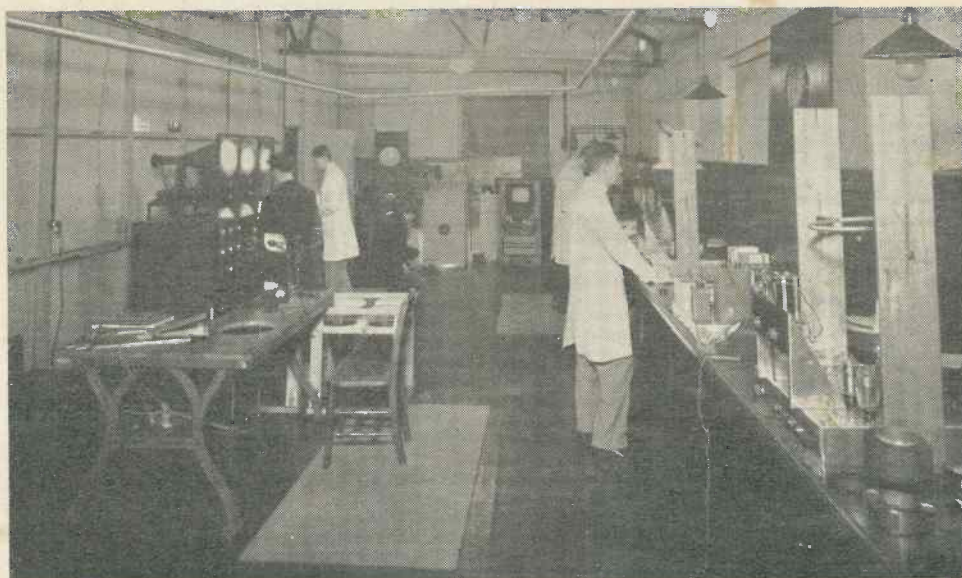

Fig. 1.—Circuit diagram of resistance chain.

This photograph shows the cathode-ray tube test department at the Ponders End Works of the Ediswan Co



The two test receivers are at the far end and to the left of these is a monitoring panel. On the left is the tube life test rack.

CATHODE-RAY TUBE RESEARCH AT THE EDISWAN LABORATORIES

ONE of the first concerns to realise the potentialities of the cathode-ray tube was the Edison Swan Electric Co., Ltd., and for very many years now they have conducted intensive research into the many problems that were involved. Originally this work was carried out in the special valve department at Ponders End Works, but progress in television has rendered necessary a separate laboratory devoted entirely to this highly specialised work. It is interesting to note that the laboratory is but a few steps from the original building in which Sir J. A. Fleming produced the first radio valve.

Television has also necessitated the development of some special receivers and also an experimental scanning equipment in order that the tubes may be tested under actual working conditions. This latter is a complete film transmitter, provided with an associated monitoring panel, which can be linked by line with any apparatus which it is desired to test. The laboratory is thus quite independent of the B.B.C. transmissions and development work can proceed all day.

Ediswan C.R. Tubes

The range of Ediswan cathode-ray tubes consists of the types 5H, 7H, 10H and 12H having screen diameters of 5, 7, 10 and 12 inches respectively. The 5H and 7H are intended for ordinary cathode-ray oscillograph work or in monitoring positions in connection with television transmitters or experimental scanning equipments. The 10H and 12H are essentially for use in domestic television receivers. They have been designed to give bright, well defined black and white pictures, similar in tone to the modern cinema picture. All tubes incorporate two pairs of deflector plates for electrostatic deflection of the electron beam. The

latest types of high vacuum tubes possess high luminosity screens, improved focusing properties, freedom

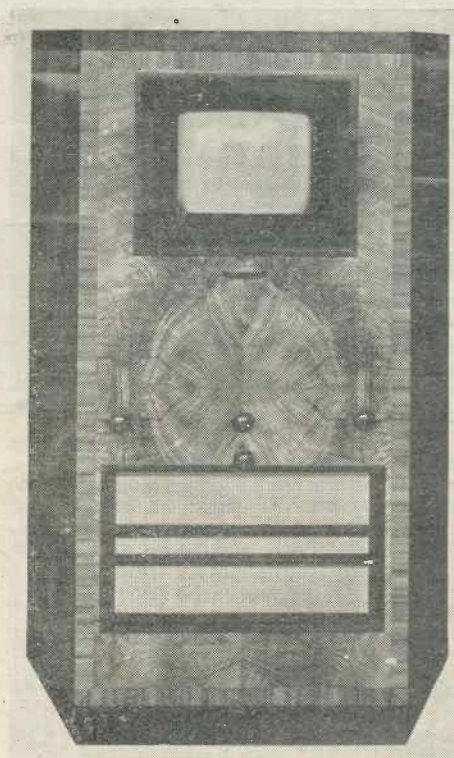

Test Receiver No. 2 designed to give the highest fidelity irrespective of cost.

from cathode disintegration due to ionic bombardment, and improved modulation characteristics so necessary for satisfactory television picture reproduction.

DETAILS OF THE EDISWAN TEST RECEIVERS

The actual manufacture of the tubes is carried out in the special valve factory (with the exception of the blowing of the glass bulbs, which is done at the B.T.-H. Co.'s works). The electrodes, etc., which constitute the "working" parts of the tube come from the presses and are hand assembled with the aid of jigs. All parts are held securely in their correct positions by spot welding. Mica separators and insulators are used throughout to secure rigid and accurate alignment of all the electrodes. The nickel cathode is of the indirectly-heated type and is coated with a barium compound. The coating is at the top end of the cylinder and not along the sides as in the ordinary radio valve.

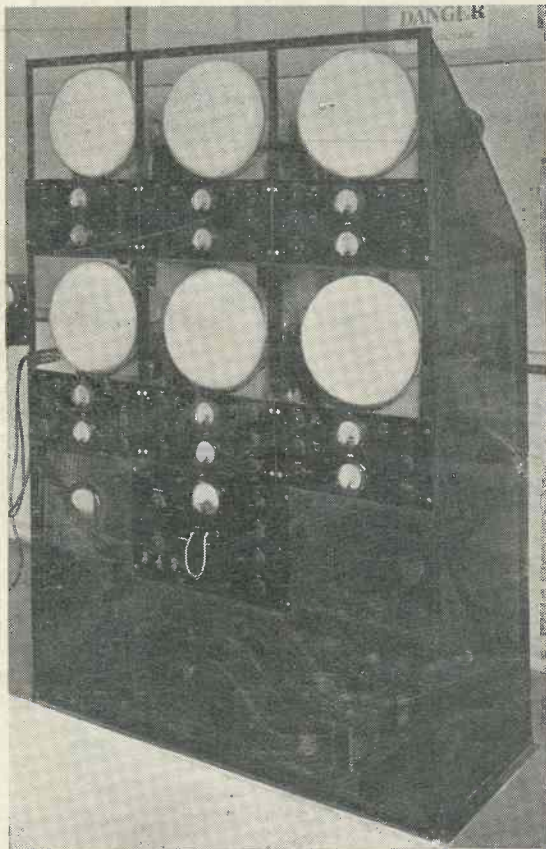

Tube life test rack. Tubes are taken from each batch produced and run under actual television conditions at full operating voltage until the tubes are destroyed. Recent improvements have resulted in an increased length of tube life.

The complete electrode assembly is mounted on a glass pinch similar to that in a radio valve and the whole unit is placed in the bulb and sealed off in a rotary sealing machine. The tube is then exhausted on a specially designed rotary exhaust machine which automatically applies the necessary high temperature for baking out occluded gases. The necessary voltage is also applied to the heater to activate and outgas the cathode.

After the activation of the cathode, H.F. heating is employed to volatilise the barium getter to ensure that there shall be no deterioration in performance during the life of the tube due to further liberation of gases. The cap is then fixed to the tube with special cement

and the leads insulated and connected to their proper contacts.

The rigorous tests to which the tubes are subjected include the checking of the cathode emission, screen brightness, shape of raster or scan modulation characteristics, cathode heater voltage and current, and shift of scan with grid control. Care is also taken to see that the variations in anode volts for spot focus are within prescribed limits. All tubes are tested at excessively high voltages to ensure that no breakdown or flash-over can occur when the tube is in normal use. A number of tubes are taken from each batch produced and run under television scanning conditions at full operating voltages and current on the life test rack.

Special Test Receivers

Three special receivers have been designed in order that the tubes and associated components can be tested under actual working conditions that would be met with in practice. In addition to the tubes these components consist of receiving valves, rectifiers, thyatrons, transformers and loudspeakers, all of which are produced by the Ediswan Company and its associated companies.

We were enabled to see these receivers working both from the Alexandra Palace transmissions and by line from the laboratory transmitter. It was of particular interest to note the difference in reproduction between each type, though this difference was only slight: each receiver gave really excellent results. It should be noted that the Ediswan Co. do not propose to market a receiver, the models shown being used solely for test purposes.

As these receivers differ so radically it will be of interest to describe them in some detail.

Receiver No. 1 (an experimental panel model) was designed and tested nine months before television transmissions were available by modulating a local 45 mc. oscillator from a film scanner using 240 lines and 25 frames per second.

It was originally fitted with a 7-in. tube, which was subsequently replaced with a 10-in. and then a 12-in. tube as at present.

At first it was designed to receive only television pictures by the Baird system, but is now suitable for reception on both Baird and E.M.I. systems. It is used in the laboratory for monitoring purposes and as a standby for demonstration purposes. It operates on the super-heterodyne principle.

Receiver No. 2 (an experimental cabinet model) is radically different from No. 1 receiver. The objective in this set was to attain the highest fidelity in the picture reproduction irrespective of the cost, so that it could be used as a standard and by means of which other less costly (commercial) sets or circuits could be compared. In this set, sensitivity was sacrificed to "quality" in the vision section which employs six band-pass circuits tuned to give substantially uniform amplification to the vision carrier, the side band frequencies, i.e., 45 ± 2 mc. The R.F. amplifier is followed by a special diode detector and one D.C. type video amplifier stage which is connected directly to the

JANUARY, 1937

control electrode of the cathode-ray tube, thus controlling directly the D.C. bias on which is superimposed the modulating video (picture) frequencies.

The sound receiver works on the super-heterodyne principle but is connected to a common aerial through a low impedance transmission line. It employs a frequency changer, two I.F. stages (1 mc.), second detector amplifier (DD triode) and two power amplifiers arranged in push-pull.

The audio response is substantially uniform between 50 and 10,000 c.p.s. Advantage is taken of this high sound quality by using dual high-fidelity speakers for sound reproduction.

Including the time base circuit, which employs relaxation oscillators for both line and frame and two paraphase connected amplifiers, there are 25 valves used in all. It should be mentioned that this set was completed and tested before television transmissions were available by means of locally modulated oscillators and special impulse generators which were designed to simulate the synchronising impulses which are now transmitted by the Baird and Marconi-E.M.I. systems respectively. It may also be mentioned that pictures from this set were demonstrated to the public at Radio Olympia for 10 days. The set worked consistently well without any re-adjustment having to be made, and has been in use daily at the laboratory ever since.

Receiver No. 3 is a domestic cabinet model designed to indicate how far the circuit could be simplified, the number of valves reduced, operation simplified, and overall dimensions reduced, without material effect on either picture or sound reproducing qualities.

A major change was the mounting of the cathode-ray tube vertically and viewing the picture indirectly by means of a special mirror. This arrangement enables the overall size of the cabinet to be reduced.

The vision channel comprises a frequency changer type AC/TH.1, which converts the vision carrier frequency to an I.F. of 4.5 mc. Three band-pass I.F. stages pass a band width of over 2 mc. using two AC/SP.3 amplifiers followed by a midget diode type Vg25, second detector.

The resultant vision modulating frequencies are amplified through a two-stage video amplifier employing AC/SP.3 valves. The video amplifier is resistance-capacity coupled and choke connected to amplify uniformly the full range of video frequencies up to 2 mc. A diode is associated with the output stage to regulate

automatically the average brightness of the picture by the application of a D.C. component together with the picture modulating impulses to the cathode-ray tube control electrode.

In the sound channel the common frequency changing valve converts the sound carrier frequency to an I.F. of 1 mc. A filter in the anode circuit of the F.C. completely separates the sound and vision I.F. Three band-pass circuits are used to allow the full range of sound modulating frequencies only to be passed to the combined second detector amplifier. Two AC/S.2 PEN and one DD/PEN valves are used in the sound receiver.

Time Base and Synchronising Filter Circuits

The synchronising impulses are fed from the output stage of the video amplifier through a separating and phase reversing valve type AC/TP.

The "line" and "frame" impulses are then applied to two relaxation oscillators, T.31 Thyratrons, respectively. The latter generate the "line" and "frame" saw-tooth impulses which are amplified through two paraphase-connected amplifiers employing two AC/P valves respectively, and then applied to the horizontal (line) and vertical (frame) electrostatic deflecting plates of a 12-in. cathode-ray tube.

The rectifiers consist of a half-wave MU2 (mercury) rectifier which delivers approximately 5,000 volts D.C. to the final anode of the cathode-ray tube. Another, which employs two MU2 rectifiers (full wave) and delivers approximately 1,100 volts D.C. to the time base circuit, and another which supplies 280 volts D.C. to the sound and vision receivers and uses one UU4 full-wave rectifier.

Pre-set controls are provided for initially adjusting focus, picture ratio, line and frame speeds, and amplitudes, and control grid bias. The gain control on the vision channel enables the picture contrast to be adjusted by the user. The set is tuned in automatically to the vision carrier by tuning the local oscillator until the sound carrier is heard.

At Ponders End this receiver is used with both gain controls nearly to minimum when connected to a half-wave dipole at ground level. Its measured sensitivity is approximately 200 uV, and this input will fully modulate a 12-in. cathode-ray tube with a grid base of between 15 and 20 volts peak.

Problems of Photographing Television

(Continued from page 18)

synchronisation. Modern high-definition television is synchronised to a high degree of perfection, when the eye is the judge, but over periods of, say, two seconds quite a lot of unsteadiness is sometimes noticeable in a receiver as seen by a camera. So that when the artist is still, with ample exposure and sharp focusing, and the result is blurred, unsteady synchronism was probably the cause. A good photograph of a television image should show the scanning lines on close inspection.

Earlier it was mentioned that in the Marconi-E.M.I. system the scanning is interlaced. Sometimes receivers do not interlace properly, with the result that the scanning lines are very clearly marked, definition is reduced, but generally speaking photographically the intensity is doubled. In such a case the picture appears apparently more exposed than others for a given exposure.

Those who use electronic exposure meters will find that the more sensitive type will give a reading of the average cathode-ray tube of such an order as to indicate an exposure of about one second at F/3 with an H. & D. speed of 1,000. The colour of

the light, of course, plays an important part, the greenish tubes are more actinic than the black and white or sepia tubes. This apparent increase in actinic value may, of course, be due to "afterglow" of the fluorescent screen, which will naturally increase the exposure in some cases quite a considerable amount, and in every case increases the apparent exposure to some extent.

It is hoped that having pointed out the reasons for the difficulty of photographing a television image, photographers will attack the problem with renewed vigour, as good photographs of television images are few and far between.

BAIRD BIG-SCREEN TELEVISION

A NEW MECHANICAL DEVELOPMENT BY MR. J. L. BAIRD.



Mr. J. L. Baird in the projector room at the Dominion Theatre, Tottenham Court Road.

IT has been known for some time that Mr. J. L. Baird has been working in his private laboratory upon the development of television apparatus for the production of large pictures suitable for use in cinemas and other places where the audiences would be large. On Sunday, December 6, Mr. Baird gave a private demonstration of what he had accomplished.

The present purpose of this apparatus is to show a greatly enlarged image of a lecturer or entertainer to his audience. The microphone enables the speaker to be heard throughout the largest auditorium. The Baird television screen magnifies his image as the microphone magnifies his voice and enables him to be seen clearly from any part of a large hall.

The demonstration was given at the Dominion Theatre, Tottenham Court Road, and the speakers and performers were transmitted by land line from a room in the top of the building. The system is, however, applicable to wireless transmission, and experimental tests have already been made between the Dominion Theatre and the Crystal Palace.

It had, as a matter of fact, been intended to give the demonstration by means of an experimental radiation from the Crystal Palace, but unfortunately the recent fire destroyed a portion of the Baird experimental transmitting equipment, and made this impossible. It should be understood that this mass viewing equipment is not intended for receiving entertainment programmes broadcast by the B.B.C. as except by permission, no B.B.C. programmes can be presented to viewers publicly. The Dominion Theatre will, however, be in a position to make its own arrangements to use the "Super Screen" for its own purposes by means of a private transmission, so that any event which the management would like to cover could be presented to an audience. In the cinema itself, artists can, of course, be put on the screen at a moment's notice.

In apparatus of this kind there are two essentials—

adequate light and a sufficiently large screen. With both these Mr. Baird has attained a large measure of success. The size of the screen, which is entirely covered by the picture, is 8 feet by 6 feet 6 inches which, although it falls short of the cinema screen, is of sufficient size to be seen clearly by the average theatre audience from any part of the house. The picture as shown is not so bright as the average cinema picture, but nevertheless, considering its size, it shows remark-

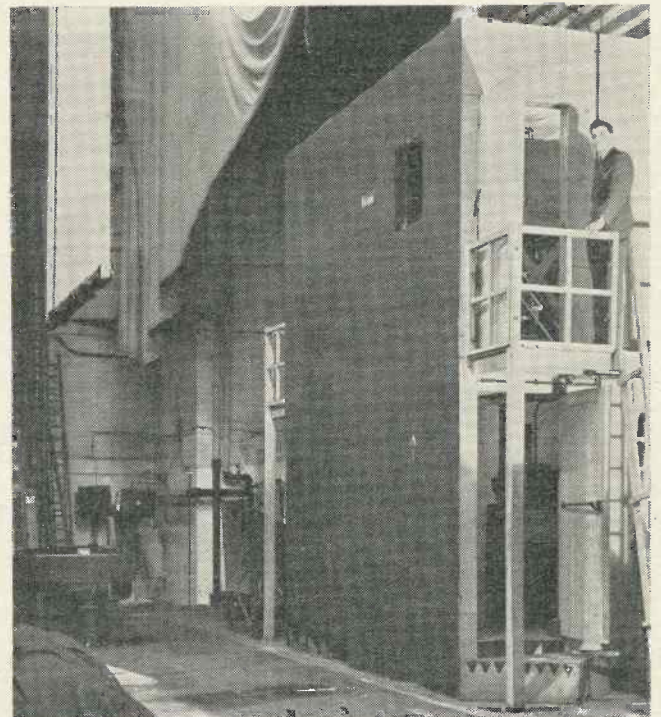

A view behind the scenes at the Dominion Theatre, showing the projector.

able progress. Only head-and-shoulders close ups were transmitted as the space available in the small transmitting room at the top of the building would only admit of this, but there seems no reason why external views should not be possible provided the required amount of detail was not excessive. The definition is 120 lines vertical scanning and a vertical picture.

The success of the system is largely due to the scanning system employed, which has many novel features. One important result of this is that although the picture frequency is only $16\frac{2}{3}$ per second there is practically no flicker which is due to the multi-mesh method of scanning.

Multi-mesh Scanning

In the Baird multi-mesh scanning system, a secondary field is formed made up of two or more primary interlaced scans. This secondary scan is then repeated a number of times, being displaced at each repetition. In the particular form used in the present apparatus, the secondary scan consists of two 20-lines inter-meshed to form a scan of 40-lines. This 40-line field is then repeated three times, in each case laterally displaced to interlace with the other fields and form a final field of 120-lines. This system gives the following advantages over straight scanning:

- (1) The frame frequency is very much higher, being the same as the frequency of the primary 20-line scan. Thus, the communication channel may have a much higher low-frequency cut off.
- (2) Flicker is considerably reduced.
- (3) By using a scanning spot such that the secondary scan completely fills the field, a great increase in light efficiency is obtained with relatively small loss in definition.
- (4) An optical system of great simplicity and very high efficiency can be employed.

The Transmitter

The transmitter consists of a slow-speed slotted disc in combination with a high-speed mirror drum. The crater of an arc lamp is focused on a slot in the diaphragm in front of which the disc revolves. The slots in the disc, as they pass over the slot in the diaphragm, form an aperture which moves backwards and forwards as the disc revolves. The light from this aperture passes through a lens on to a mirror drum which projects the rapidly moving spot of light over the scene being transmitted. As the drum revolves, the screen is covered by a succession of strips, the number of slots and the number of mirrors in the drum, together with their relative speeds, determining the number of lines in the picture. By choosing a suitable combination, any desired number of lines can be obtained.

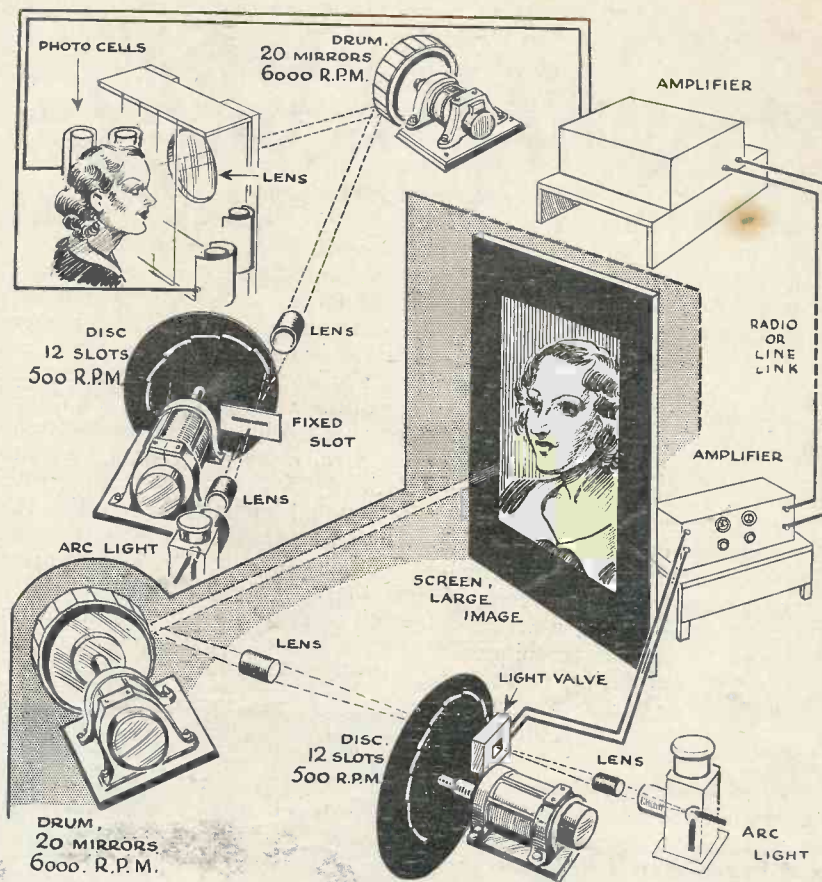

Schematic drawing of the Baird Multi-mesh mechanical transmitting and receiving system.

The present apparatus gives a field with 120 lines, the disc having twelve radial slots and revolving at 500 r.p.m., while the drum has 20 mirrors and revolves at 6,000 r.p.m. This gives a picture frequency of $16\frac{2}{3}$ per second.

The type of field used at the transmitter is such that the spots do not overlap.

Pick-up is by the usual system of photo-electric cell as with the ordinary spotlight system.

The Receiver

The scanning arrangements of the receiver are identical with those of the transmitter. An arc lamp is used as the light source, and a Kerr cell forms the light valve. The scanning system is shown by the diagram above, and it will be observed that the scanning spot is enlarged so that the secondary scan completely fills the field. By this means a substantial increase of light is obtained with a relatively small loss in detail.

It is interesting to note that the Baird Multi-mesh system is a modification of the intermeshed system originally used by Mr. Baird as far back as 1923, his original apparatus, now in the South Kensington Museum, utilised a similar slotted disc, but in this original apparatus a lens disc was used in place of the present mirror drum. The system was abandoned at that time as for low definition work a complex system

(Continued at foot of next page).

STUDIO & SCREEN

A MONTHLY CAUSERIE on Television Personalities and Topics

by K. P. HUNT

Editor of "Radio Pictorial"

PULLING pictures out of the air is something of which you don't seem to tire. I have already discovered that I can always 'phone up those friends of mine who possess a television receiver any time between 9 p.m. and 10 p.m. and be certain of catching them in! A man with a television receiver is never out when programmes are on.

Before commenting on the principal programmes of the month, I should first mention that a welcome improvement in studio technique is being effected, and during December in particular one or two changes have been made of a fundamental character.

The most important of these came into operation early in the month and was nothing less than the total elimination of intervals between programme items. After the introduction of this innovation, the effect was that each successive shot or change of material slides continuously, not abruptly, into the one succeeding it.

An official at Alexandra Palace gave me as his opinion that this elimination of programme intervals constitutes one of the most important advances in studio technique made since the high-definition programmes began. He explained to me that there is more in this development than at first might be supposed. It has, for example, largely reduced the eye fatigue which previously was caused by those abrupt changes of scene and screen tone which were inseparable from the old arrangement

of definite intervals. The new scheme also appeases the lookers' natural impatience to see more, and has abolished that subconscious feeling of dissatisfaction which, although not aroused by a break in the ordinary aural radio programmes, is most distinctly evident when looking at an interrupted programme on the television screen.

This same B.B.C. official informed me that, speaking approximately, as much as one-quarter of the time that television was on the air was consumed under the old arrangements



Miss Marietta Serle, who has had television experience in Holland.

by intervals. He pointed out that, in consequence, the new non-stop regime has greatly increased the

amount of work for the B.B.C.'s staff.

* * *

The other major innovation at Alexandra Palace during the month has been the introduction of the Baird electron camera into actual studio transmissions.

And that reminds me to point out what a tremendously lucky thing it was that two of these electron cameras happened to be at Alexandra Palace when the recent disastrous fire took place at the Crystal Palace. One of the Baird Company's officials told me that all the other cameras which were housed at Crystal Palace were destroyed in the conflagration.

"It was purely providential," he added, "that we happened to have two of the cameras at 'Ally Pally.'" These two cameras, I gathered, are the only two of the adopted kind in existence in this country.

* * *

Notwithstanding the introduction of the electron camera, notable efforts have been made during the month to improve the working of the intermediate film system, from the studio point of view.

One of the drawbacks of this system which was experienced early in the old programme and which caused some dissatisfaction, was that after about 16 minutes the spool of film ran out and an interval necessarily had to occur. At times this caused considerable difficulty at the studio end, because it meant break-

"Baird Big-Screen Television"

(Continued from page 27)

of scanning unduly complicated the apparatus at a time when television technique was not sufficiently developed to utilise its advantages. When the introduction of ultra short waves opened out the possibility of high definition television, work was recommenced with the multi-mesh system as far back as 1929.

The system can be used for cathode-ray reception and electronic transmitters, and experimental work in this direction is now going on. In Mr. Baird's own words:—

"The multi-mesh system has certain advantages over

straight scanning and simple interlacing as at present used, and experimental work in its development is being actively proceeded with. This, in effect, means that we are experimenting with a new system of television which has marked potential advantages over those in use at present."

At the demonstration at the Dominion Theatre various artists were introduced by Mr. Will Hay, and finally Mr. Baird appeared and answered questions relating to the system, the questions being put to him via a telephone which was available in the auditorium. The present apparatus is of the fixed focus type and in order to ensure that artists kept at the proper distance from the scanner wires were stretched across at face level.

PROGRAMME PERSONALITIES

ing into performances in an inconvenient manner, resulting in uncompleted turns, and generally upsetting the programmes.

The innovation which completely removes these objections was put into operation at the Palace on December 14. Briefly, the idea is that the reels now installed accommodate film rather more than double the length of the old reels. This permits a continuous showing, I am told, of about 39 minutes.

Lookers who enjoyed the transmissions of "Picture Page" may not have known that the interruptions were caused in this manner, and the improvement I have mentioned as beginning in the middle of December means that a complete variety programme can now be broadcast on the intermediate film system without the interpolation as hitherto of excerpts from the spotlight studio. Mentioning "Picture Page," reminds me to say that it is still probably the most popular regular feature.



Leslie Sarony, other half of the "Two Leslies," made a bit on the television screen.

Reviewing the programmes generally, a successful effort has been made during the month to brighten up the fare, and everyone has noticed that there has been much more fun in the programmes. I should mention in passing that Claude Dampier (the "Professional Idiot") gave an extremely amusing broadcast; Leonard Henry's humorous performance was very choice; Flotsam and Jetsam also put up another remarkably fine show. Leonard Henry, by the way, tells me he is very keen about television. Ordinary broadcast listeners who remember the "Aspidistras" found them doubly funny when seen on the television

screen. These clever performers did a similar act in Mid-Victorian setting in the B.B.C.'s old 30-line studio. Bruce Bairnsfather also put over a noteworthy programme.

One of the prominent television debutantes of the month was Marietta Serle, a pretty Dutch girl from Amsterdam where she has been estab-



Bransby Williams, famous character actor, who was televised as "Scrooge" on Christmas Eve.

lished five years as a teacher of singing and diction. She is also attached to the Conservatory of The Hague. During this time she has been a regular broadcaster in Holland, Belgium, Switzerland, Luxembourg and France.

The Philips' concern at Eindhoven, Holland, chose her as their television personality for demonstration purposes, and she had the distinction of appearing at demonstrations of the



Anne Ziegler, the well-known broadcasting star, who made her first television appearance last month.

Philips' system before Princess Juliana of Holland, Prince Bernhard, and many Dutch and foreign television committees.

I met Marietta during her visit to England on the afternoon of her first television programme. She is a

charming girl, and convinced me of her versatility by singing in Dutch, French, English and German, accompanied by her guitar. I thought she had gone back to Amsterdam on the day following, but was surprised to get a telephone message from her, saying that after getting all her bags packed and being on the point of departure, she had received an urgent summons from Alexandra Palace to do another programme before she left!

* * *

Guila Bustabo, the 16-year-old girl violinist, was televised twice during December. She has given recitals all over the world and is regarded as a prodigy. She wears her hair down her back, I am told, and cut rather a distinctive figure at the Palace.

Harry Pringle was responsible for the television Christmas party, which included a number of veteran variety artists. The titbit on Christmas Eve, however, seemed to me to be Bransby Williams, who was televised as



Leslie Holmes, of the "Two Leslies," made a successful debut in television last month.

"Scrooge." He is famous for the wonderful Dickens impersonations, which he has been doing for years, both on the stage and aural radio.

The television programme on Boxing Day afternoon was also notable, and I was glad to see that Sutherland Felce, who is known as "The Radio Joker," appeared in this. This was his third appearance in television last month. He was televised twice recently with Henry Hall, but is not a stranger to television as he spent a good deal of time in the B.B.C.'s old 30-line studio, from which he was televised about 20 times.

(Continued on page 62)

"TELEVISION'S" GUARANTEED CATHODE-RAY RECEIVER

SUMMARY OF LAYOUT AND
COMPONENTS WITH
COMPLETE CIRCUIT DIAGRAM

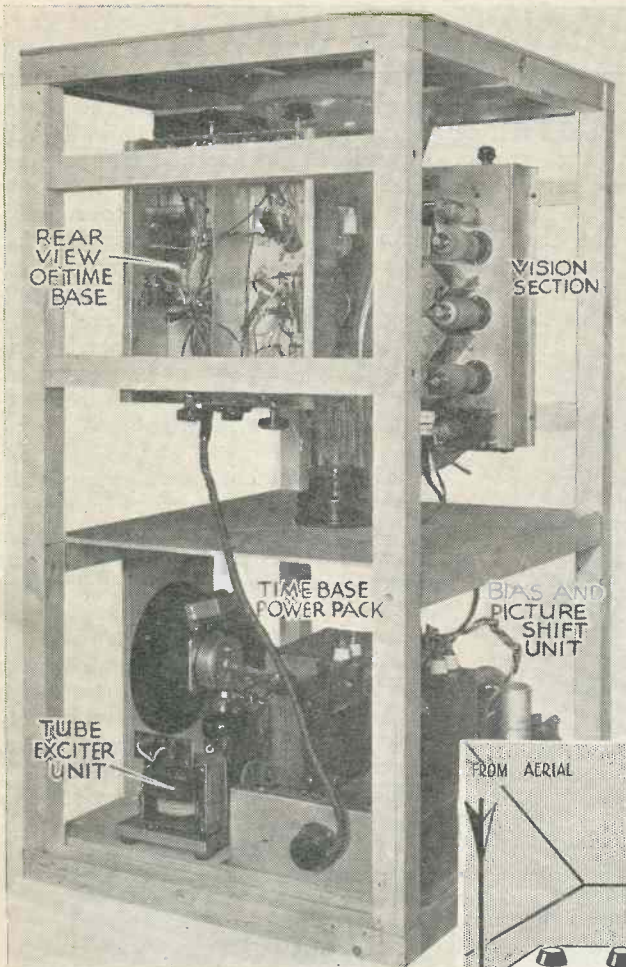

WHAT A READER SAYS

"RECEPTION NOTHING
SHORT OF A MIRACLE"

Gentlemen,

I feel that I should like to congratulate you for placing the public in the possession of details for constructing receiving apparatus.

Having some experience of the low-definition that preceded this service, I consider the reception to be had on the set that you describe as nothing short of a miracle. I had taken the "guaranteed" with a grain of salt, but I must apologise on this score, as I can quite understand your confidence in your protégé.

The short-wave reception of music and speech appears to me to be better, both in clarity and lack of interference, than the majority of long and medium-wave broadcasts. As far as the vision side is concerned, the simplicity of control (particularly noticeable after the old days of synchronising trouble) is very surprising, as once the picture is obtained it remains in position and requires practically no subsequent adjustment.

It is a magnificent hobby for those people with a mechanical, or electrical, bent; and I doubt if anything within the last decade has arisen which will so appeal to the old-time wireless fan in its wide ground for experimental work.

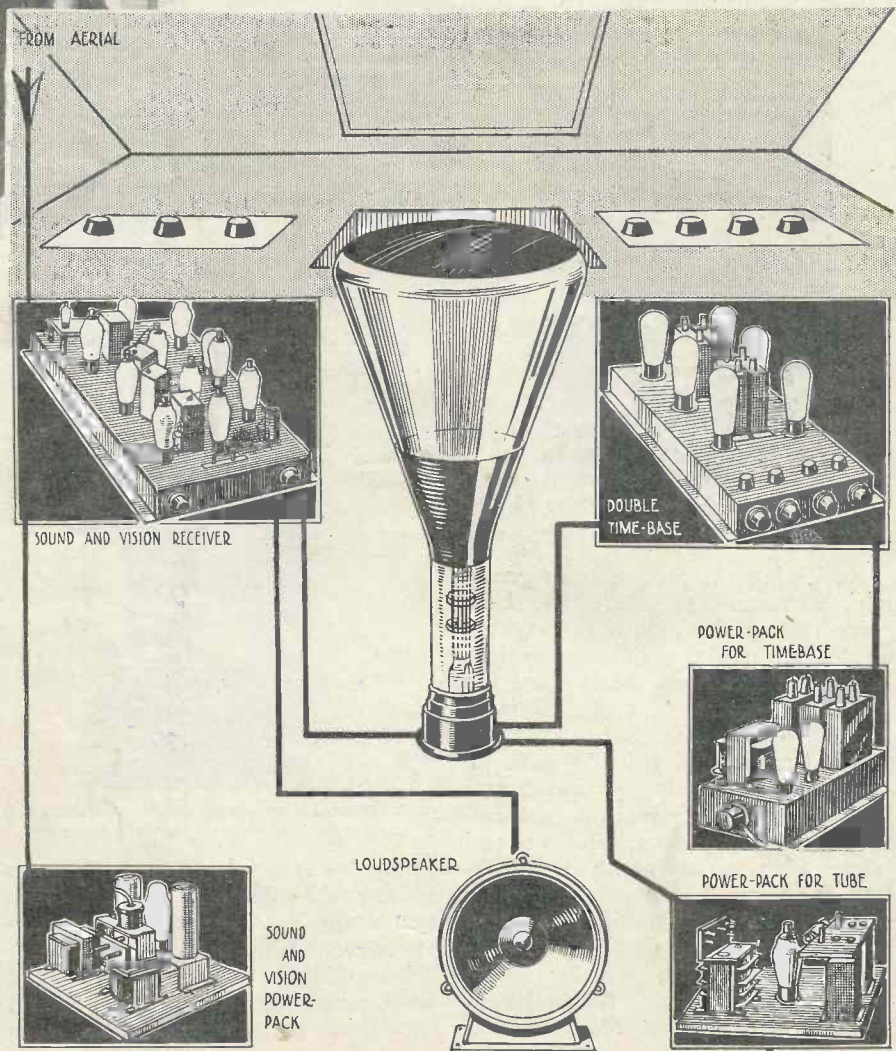

COMPLETE LISTS OF COMPONENTS USED

COMPONENTS FOR VISION RECEIVER

CHASSIS.

1—To specification (Burne Jones).

CONDENSERS, FIXED AND VARIABLE.

- 2—30 m.mfd. trimmers type 1023 (C) (Eddystone).
- 1—.1 type PCPr (C1) (Bulgin).
- 1—.1 type PCPr (C2) (Bulgin).
- 1—.1 type PCPr (C3) (Bulgin).
- 1—.0005 type M (C4) (T.C.C.).
- 1—.1 type PCPr (C5) (Bulgin).
- 1—.1 type PCPr (C6) (Bulgin).
- 1—.0001 type M (C7) (T.C.C.).
- 1—.1 type PCPr (C8) (Bulgin).
- 1—.1 type PCPr (C9) (Bulgin).
- 1—.1 type PCPr (C10) (Bulgin).
- 1—.1 type PCPr (C11) (Bulgin).
- 1—900/40 (C12) Eddystone).
- 1—.1 type PCPr (C13) (Bulgin).
- 1—.1 type PCPr (C14) (Bulgin).
- 1—.1 type PCPr (C15) (Bulgin).
- 1—.1 type PCPr (C16) (Bulgin).
- 1—.1 type PCPr (C17) (Bulgin).
- 1—.1 type PCPr (C18) (Bulgin).
- 1—.0001 type M (C20) (T.C.C.).
- 1—.1 type PCPr (C21) (Bulgin).
- 1—.1 type PCPr (C22) (Bulgin).
- 1—.01 type 300 (C23) (T.C.C.).
- 1—.01 type 300 (C24) (T.C.C.).

COILS.

- 1—6 turn type 1050 (1) (Eddystone).
- 1—6 turn type 1050 (3) (Eddystone).
- 1—4 turn type 1050 (4) (Eddystone).
- 1—4 turn type 1050 (5) (Eddystone).

CHOKES, HIGH-FREQUENCY.

1—Type T.U.S.I. (2) (Mervyn).

HOLDERS, VALVE.

7—Chassis mounting type standard, 7-pin (Clix).

4—Chassis mounting type standard, 4-pin (Clix).

PLUGS, TERMINALS, ETC.

1—Aerial connecting plug type 1047 (Belling Lee).

3 terminals type B (Belling Lee).

1—10 point plug type 1251 (Belling Lee).

RESISTANCES, FIXED AND VARIABLE.

- 1—50,000 ohm type 1 watt (R1) (Erie).
- 1—50,000 ohm type 1 watt (R2) (Erie).
- 1—100 ohm type 1 watt (R3) (Erie).
- 1—1,000 ohm type 1 watt (R4) (Erie).
- 1—50,000 ohm type 1 watt (R5) (Erie).
- 1—50,000 ohm type 1 watt (R6) (Erie).
- 1—200 ohm type 1 watt (R7) (Erie).
- 1—1,000 ohm type 1 watt (R8) (Erie).
- 1—100 ohm type 1 watt (R9) (Erie).
- 1—10,000 ohm variable potentiometer (R10) (Bulgin).
- 1—1,000 ohm type 1 watt (R11) (Erie).
- 1—250 ohm type 1 watt (R12) (Erie).
- 1—1,000 ohm type 1 watt (R13) (Erie).
- 1—250 ohm type 1 watt (R14) (Erie).
- 1—1,000 ohm type 1 watt (R15) (Erie).
- 1—250 ohm type 1 watt (R16) (Erie).
- 1—1,000 ohm type 1 watt (R17) (Erie).
- 1—10,000 ohm type 1 watt (R18) (Erie).
- 1—50,000 ohm type 1 watt (R19) (Erie).
- 1—10,000 ohm type 1 watt (R20) (Erie).
- 1—20,000 ohm type 1 watt (R21) (Erie).
- 1—300 ohm type 1 watt (R22) (Erie).
- 1—20,000 ohm type 1 watt (R23) (Erie).
- 1—50,000 ohm type 1 watt (R24) (Erie).
- 1—50,000 ohm type 1 watt (R25) (Erie).

SUNDRIES.

1—Bracket for condenser drive (Mervyn).

1—Cord cable (Mervyn).

TRANSFORMERS, I.F.

4—Special shielded type TrF1 (Mervyn).

1—Special shielded type TrF2 (Mervyn).

VALVES.

2—MSP4 (Osram or Marconi).

1—X41 (Osram or Marconi).

4—TSP4 (Mullard).

1—D42 Osram.

COMPONENTS FOR SOUND RECEIVER

1—Westector WX6 (Westinghouse)

RESISTANCES.

- R 1—50,000 1 watt type (Erie)
- R 2—50,000 " " "
- R 3—200 " " "
- R 4—50,000 " " "
- R 5—20,000 " " "
- R 6—50,000 " " "
- R 7—50,000 " " "
- R 8—300 " " "
- R 9—100,000 " " "
- R10— $\frac{1}{2}$ megohm " " "
- R11—20,000 " " "
- R12—100 " " "
- R13—10,000 ohm potentiometer Bulgin

CONDENSERS.

- C 1—.1 type PCP1 (Bulgin).
- C 2—.1 type PCP1 (Bulgin).
- C 3—.0001 type M (T.C.C.).
- C 4—.1 type PCP1 (Bulgin)
- C 5—Variable type 900/40 with slow motion head No. 1012 (Eddystone).
- C 6—.1 type PCP1 (Bulgin).
- C 7—.0001 type M (T.C.C.).
- C 8—.01 type 300 (T.C.C.).

C 9—.01 type 300 (T.C.C.).

C10—50-mfd. 12-volt working type E.C.3 (Bulgin).

C11—.1 type PCPr (Bulgin).

C12—.01 type 300 (T.C.C.).

C13—.01 type 300 (T.C.C.).

COILS.

- L1—8 turns bare copper or Eddystone type 1050.
- L2—4 turns bare copper or Eddystone type 1050.
- L3—4 turns bare copper or Eddystone type 1050.

TRANSFORMERS.

2—I.F. transformer suntuoned 115 Kc (Varley)

LOUDSPEAKER.

1—37J (W.B.)

SUNDRIES.

- 2—Valve top connectors (Belling & Lee) connecting wire and flex, etc.
- 3—Seven pin-valveholders (Clix).

VALVES.

- 1—T.H.4 (Mullard).
- 1—V.P.4 (Mullard).
- 1—AC2/Pen (Mazda).

Components for POWER UNIT OF VISION AND SOUND RECEIVERS

BASEBOARD.

1—Wooden baseboard to specification (Mervyn).

CASE.

1—Metal protecting case (Burne Jones).

CONDENSERS, FIXED.

- 1—4 mfd. electrolytic type DWL 1764 (Hunt).
- 1—8 plus 8 mfd. electrolytic type DWL 2657 (Hunt).

CHOKE, LOW-FREQUENCY.

1—Split choke 50 henry 120 Ma (Sound Sales).

HOLDER, VALVE.

1—4-pin chassis mounting type standard (Clix).

PLUGS, TERMINALS, ETC.

- 1—Mains input connector type 1014 (Belling Lee)
- 1—Bracket complete with 10 point (Belling Lee) socket (Mervyn).

SUNDRIES.

1—Bracket for valve and electrolytic condenser (Mervyn).

TRANSFORMER, MAINS.

1—Special to specification (Bryan Savage).

VALVE.

- 1—U 12 (Marconi).
- 1—DSL/1 (Ediswan)

COMPONENTS FOR SCANNING CIRCUITS

FIXED RESISTANCES— One Watt (Dubilier).

- 3—1-megohm
- 1—200,000-ohm
- 3—150,000-ohm
- 1—100,000-ohm
- 1—500,000-ohm
- 1—85,000-ohm
- 1—30,000-ohm
- 1—20,000-ohm
- 1—15,000-ohm
- 1—10,000-ohm
- 1—5,500-ohm

Half Watt (Bulgin).

- 4—5-megohm
- 4—2-megohm.

POTENTIOMETERS

(Reliance).

- 2—2.0-megohm
- 2—0.5-megohm
- 2—0.1-megohm
- 2—50,000-ohm
- 2—100,000-ohm special with centre tap.

CONDENSERS (Dubilier).

- 2—Type 4001 50-mfd. 12-v. working.
- 1—Type 3004 50-mfd. 50-v. working.
- 1—Type 3016 12-mfd. 50-v. working.

B.I. (Mervyn)

- 4—0.1-mfd. 2,000-v. working, tubular
- 2—0.1-mfd. 1,000-v. working, tubular.
- 2—0.001-mfd. 1,000-v. working, tubular.
- 1—0.1-mfd. 1,000-v. working, tubular.
- 1—0.005-mfd. 1,000-v. working, tubular.

VALVE HOLDERS.

- 6—Chassis mounting 5-pin (Bulgin).

SUNDRIES.

- 1—5-pin plug and socket type 1260 (Belling-Lee).
- 1—Type P.20 Mains connector (Bulgin).
- 1—Type SW41 5-pin socket (Bulgin).
- 1—Type P.3 5-pin plug (Bulgin).
- 2—Bulgin S.81 B. switches
- 2—Bulgin C.31 group boards
- 2—Valve top caps (Bulgin).

VALVES.

- 2—T.31 Thyratrons (Mazda) or Ediswan HE/A.C.I.
- 4—A.C./P. (Mazda)

(Components continued on page 33)

THE COMPLETE CIRCUIT DIAGRAM OF "TELEVISION"

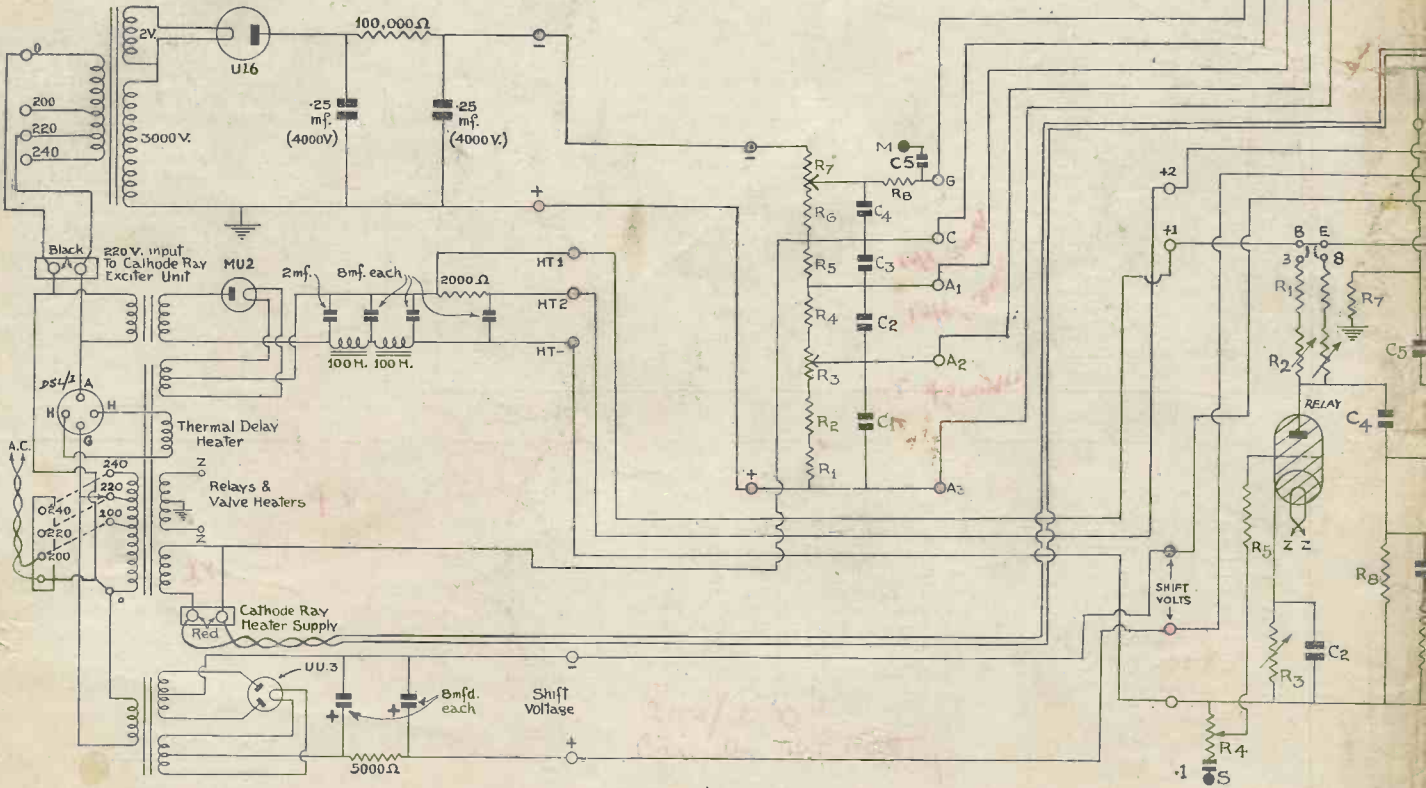
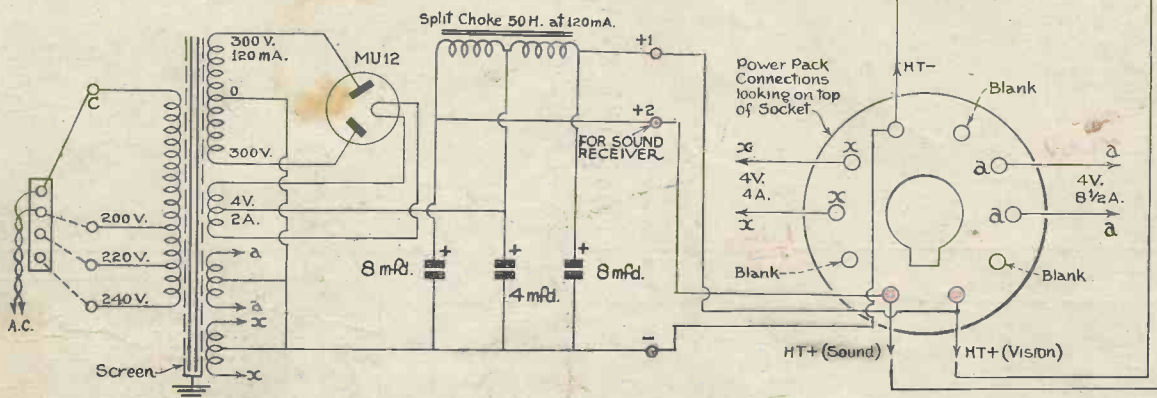
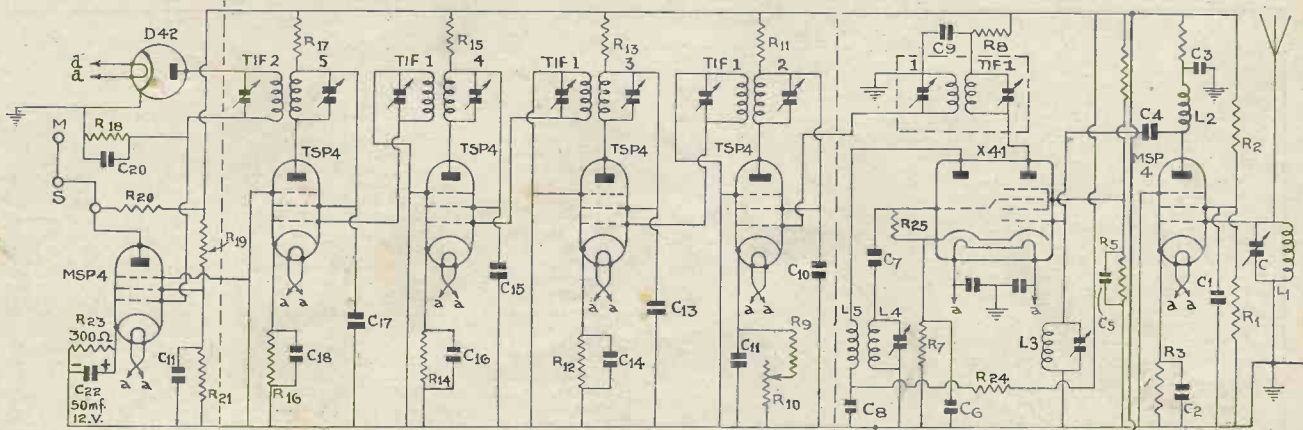

COMPLETE CIRCUIT DIAGRAM OF "TELEVISION'S" GUARANTEED CATHOD

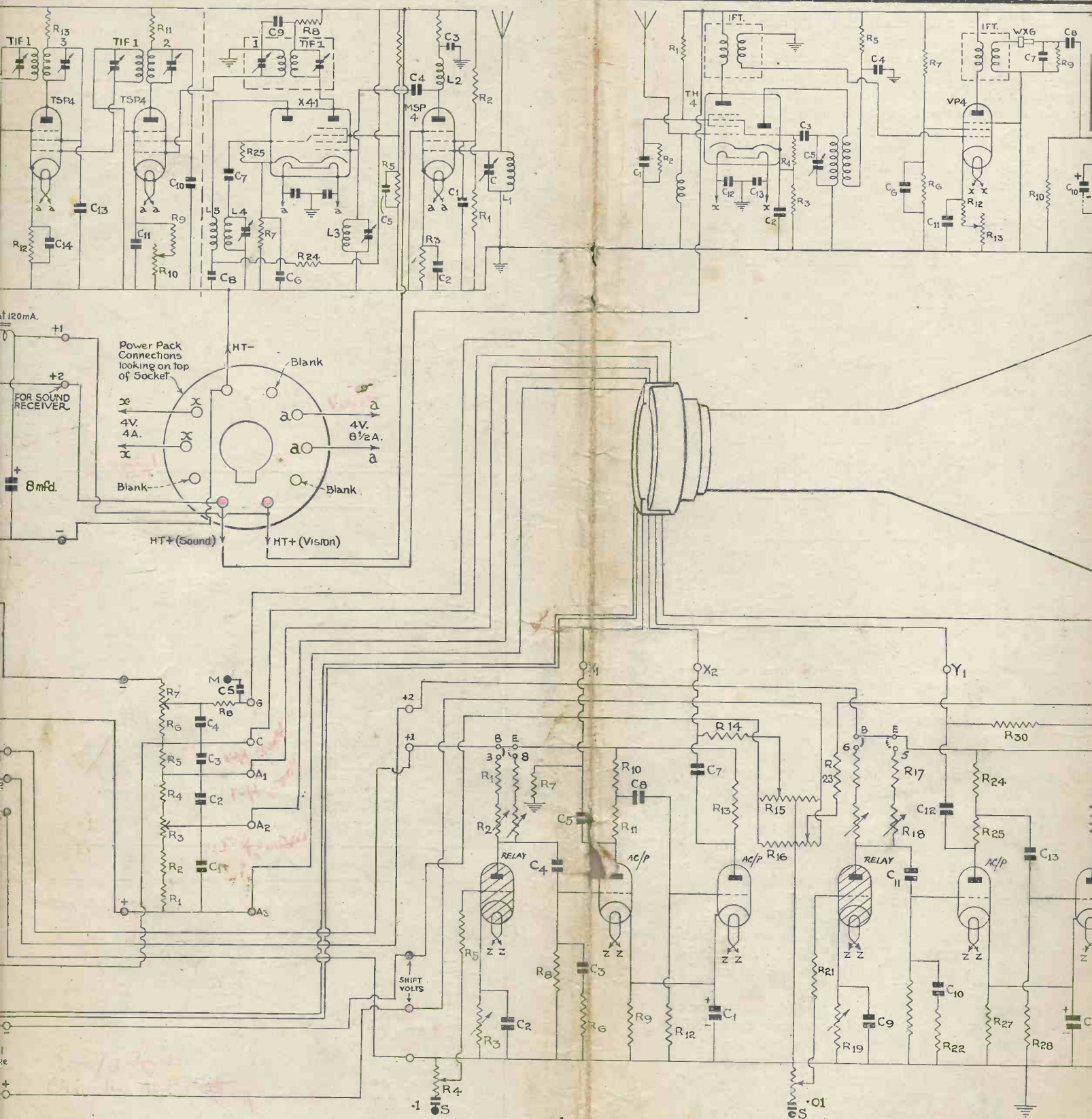

TELEVISION'S" GUARANTEED CATHODE-RAY RECEIVER

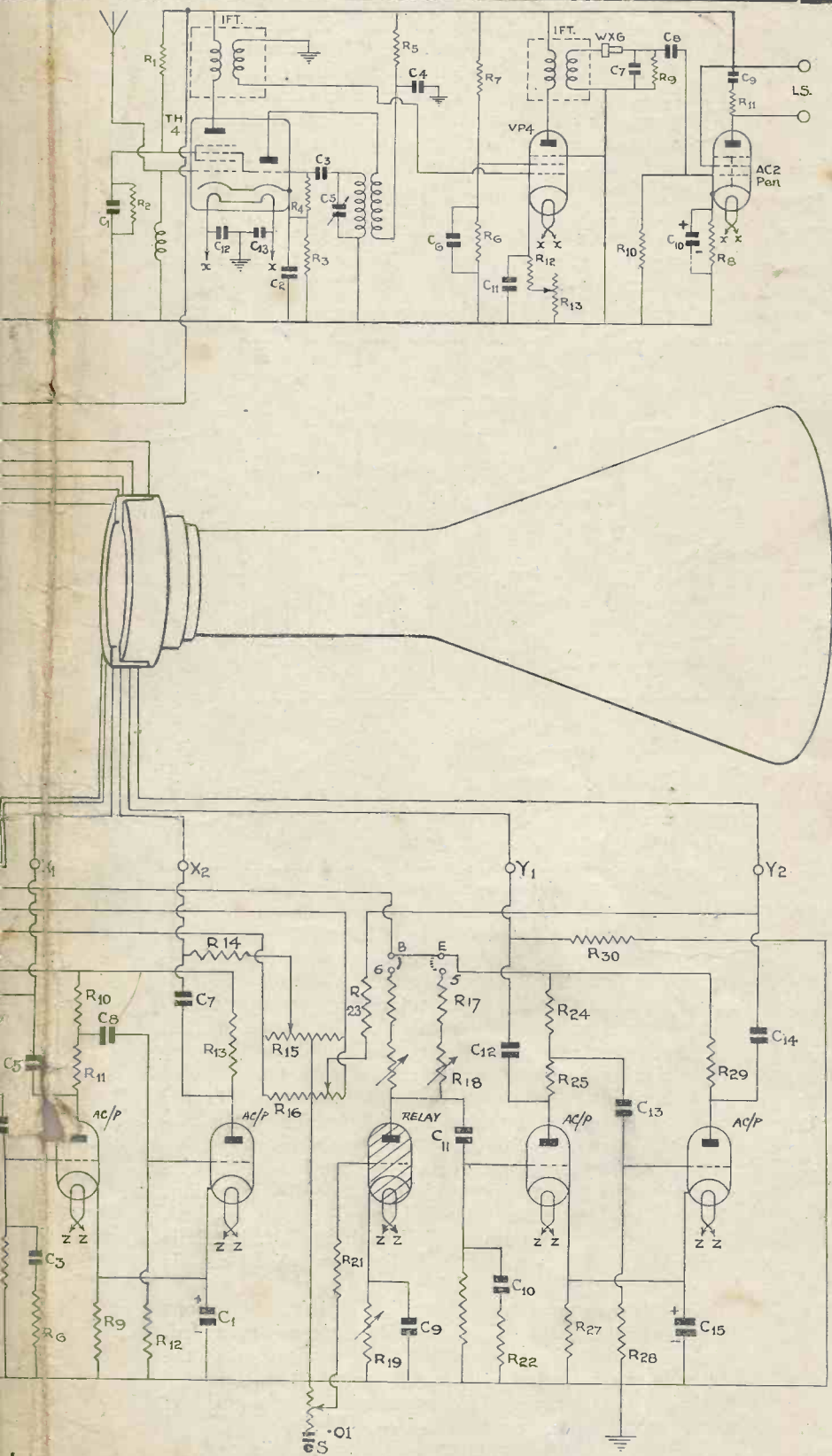

Components continued from page 31

Components for
TIME BASE POWER PACK

CHASSIS.

1—Special metal chassis and cover (Mervyn).

CONDENSERS, FIXED.

3—8-mfd. 1,000 volt (B.I.-Mervyn, or T.C.C.).

1—2-mfd. 1,000 volt (B.I.-Mervyn or T.C.C.).

1—8 plus 8-mfd. condenser (B.I.-Mervyn).

CHOKES, LOW-FREQUENCY.

2—100 henry 30 M/a (Keston Manufacturing Co.).

HOLDERS, VALVE.

3—5-pin type VH19 (Bulgin).

PLUGS, TERMINALS, ETC.

1—Plug top valve connector type 1156 (Belling-Lee).

1—Fused voltage-change input connector type 1088 (Belling-Lee).

2—Terminals type B red (Belling-Lee).

2—Terminals type B black (Belling-Lee).

2—Terminal blocks type 1039 (Belling-Lee).

RESISTANCES, FIXED.

1—5,000 ohm type 1 watt (Erie).

1—2,000 ohm type 1 watt (Erie).

SUNDRIES.

Connecting leads, wire and sleeving.

1—Bakelite strip.

TRANSFORMERS, MAINS.

1—Filament transformer (Keston).

1—H.T. transformer (Keston).

1—Shift transformer (Keston).

VALVES.

1—MU2 (Mazda).

1—DSL/1 (Mazda).

1—U.U.3 (Mazda).

Components for

CATHODE-RAY TUBE POWER PACK.

TRANSFORMER.

1—Mains transformer (London Transformer Products, Ltd.).

CONDENSERS.

2—.25-mfd. 4,000-volt working (B.I.-Mervyn)

SUNDRIES.

1—1000,000-ohm, 1-watt resistance (Erie).

1—Chassis and cover (Mervyn).

1—5-pin valve holder baseboard type (Bulgin)

1—Valve (Osram U16 or Mullard H.V.R.).

Components for

RESISTANCE CHAIN.

R1 2.0 megohms (2 W).

R2 1.5 megohms

R3 0.5 megohm

R4 1.0 megohm

R5 0.4 megohm

R6 0.1 megohm

R7 0.1 megohm

R8 2.0 megohms (1/4 W).

C1 0.5 mfd. 4,000 V. wkg.

C2 1.0 mfd. 1,500 V. wkg.

C3 1.0 mfd. 500 V. wkg.

"Television and Short-Wave World," January, 1937.

AN ALTERNATIVE TIME BASE FOR THE RECEIVER

AS an alternative to the time base that was described last month a second one has been developed with which simplification at many points has been possible, though it follows the usual type of circuit. With simplification it has been possible to reduce the cost.

As will be seen from the photographs the tube is mounted on the time base chassis and this therefore will entail some modification to the complete receiver; also battery bias is employed and owing to the position of the tube the time base is not so readily accessible for

third anode. It will be seen that simplification has taken place at this vital point with the consequent reduction in the number of components, construction time and cost. The reduction in components and necessary wiring allows the wiring to be carried out carefully. It must be realised that anti-capacity wiring and spacing should be employed in order to ensure that the "fly-back" time is not unduly prolonged, otherwise the picture on the left-hand side will be cut off. Where the flyback time is too long it is possible to "loose" five or ten per cent. of the picture. This point will be dealt with later.

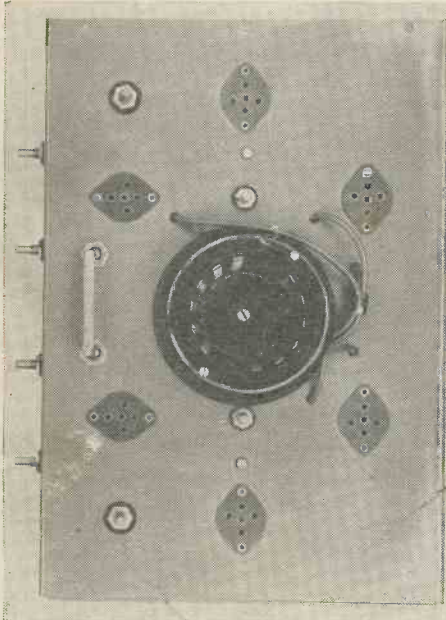

Top view of time base

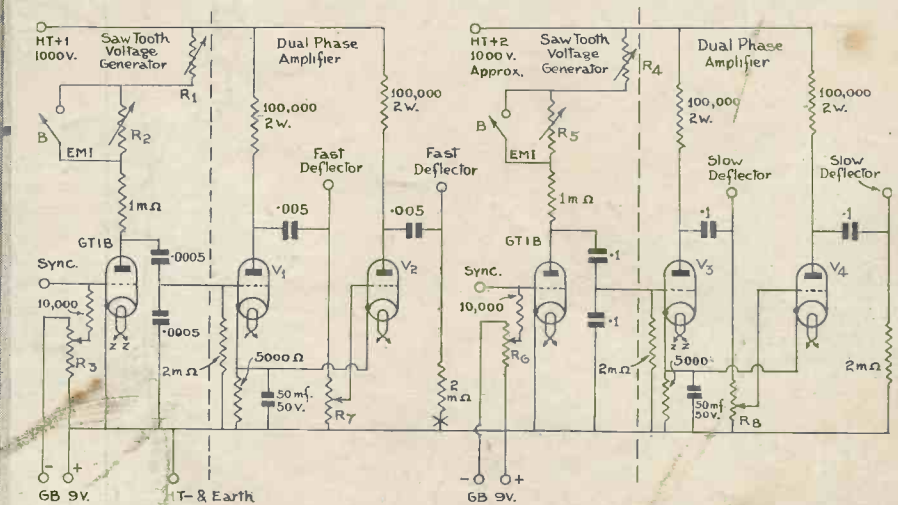

The circuit of the alternative time base

experimental purposes. It may be used in our Guaranteed receiver with safety, particularly as the same power pack will be entirely satisfactory and if the construction is carried out as described no trouble should be experienced.

In its present form it is designed for double electrostatic deflection and for use with a cathode-ray tube that has its third or final anode earthed. (The Guaranteed Receiver is of this type.) It therefore should not be used in any other way.

The design is by W. J. Nobbs, F.I.S., A.M.I.R.E., and the complete kit is available from the Mervyn Sound & Vision Co., Ltd.

Special Features

Before proceeding to the construction certain features should be pointed out.

In the first place, entirely disregard the gas discharge circuit and examine the amplifiers. It will be seen that both sections (frame and line) are identical with the exception of coupling condenser. The description of one section, therefore, will cover both.

In the second place phase inversion is taken care of by tapping off part of the voltage on the resistance used to return the deflectors to the cathode-ray tube

Thirdly, bias for the deflector plates is not provided, as under normal conditions the picture can be centred by adjustment of the condenser values connecting the deflector plates to the valve anodes. This method is only useful when the picture is not too far out of position. The alternative is to connect the appropriate return to a potentiometer across the H.T. supply. This simply means that if the deflector from the first valve, when joined to the centre point of the potentiometer, places the picture further off centre it will be necessary only to take the first deflector return to its proper point and connect the second deflector to the centre of the potentiometer. An adjustment will then bring the picture into correct position.

This potentiometer is connected with stiff wire directly into the wiring and is then self-supporting. Once the adjustment is made it need not be touched. This component is not supplied with the kit, but it is available at a low cost. It is light in weight and is easily supported in the wiring.

Complete separation of both line and frame sections is necessary and accordingly a metal screen is provided.

A single hole is provided on the chassis so that the cathode-ray tube holder can be mounted and rotated to bring the scanning field square with the cabinet mounting.

The chassis can be mounted either vertically or horizontally, which gives the choice of either viewing the pictures directly on the end of the tube or via a mirror

JANUARY, 1937

In considering the gas discharge tube circuits it will be noticed that they follow conventional form with one or two variations. The amplifiers are designed to give a high voltage linear output so that the gas discharge relays may be operated at low anode voltages.

Taking the anode circuit it will be seen that the series "charging resistances" are in two sections, one section of which can be shorted out. It is then only necessary to provide one variable control for one system and a further variable control in the shorted-out section for the other system. The charging condenser is in two parts and the centre is taken to the grid of the first amplifying stage.

The gas discharge tube grid circuit employs a fixed

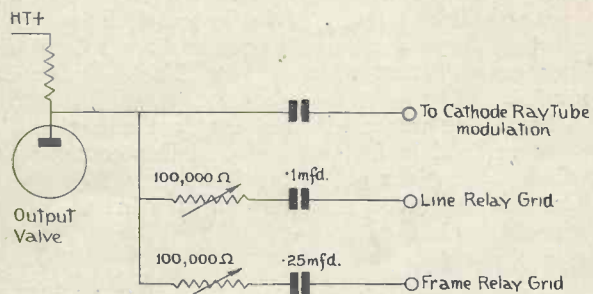

Connections for simple synchronising the double time base

resistance of low value with the return taken to a potentiometer across a separate bias supply. The simplest form is a grid bias battery although a mains-operated unit may be used. It is unwise to employ self bias or obtain the required 9 volts in the negative lead by a dropping resistance. Both these schemes may be used, but the disadvantages considerably outweigh the advantages. This point should be kept in mind as it has an important bearing on simple operation.

Synchronising of the picture is obtained in a simple way. Although there are many ways in which it can be achieved with perfect results they all require careful adjustment. The method that will be shown later will prove entirely stable for long periods and as it is so simple it is the best for all initial work.

It has been stressed that the amplifying side be examined separately from the gas-discharge tube circuits. If the complete circuit is always viewed from this angle no confusion should ever exist if and when it is decided to experiment with hard valve "saw-toothed" wave form generators.

It will be seen now that we have two circuits, one a "saw-toothed" wave form generator (provided by the gas-discharge tube) and an amplifier (provided by the dual phase valves.)

The H.T. supply to each complete section is separate in order to prevent mutual coupling via the H.T. supply. If the two complete sections are not kept separate it will be almost impossible to obtain an interlaced picture to the E.M.I. transmission. Even when the circuits are perfectly decoupled it is difficult to maintain the interlacing.

Construction

To proceed to the constructional work. The steel chassis is provided with the valve holders as well as the charging potentiometers, bias controls and phase

reversing potentiometers mounted. For convenience these are marked by letters which co-related with the list of components.

Wire all the heaters 3 to each section with twisted leads in the usual manner.

Work on the amplifiers should be undertaken first. The bias resistance and its condenser should be soldered into position. Solder the grid leaks in position and the

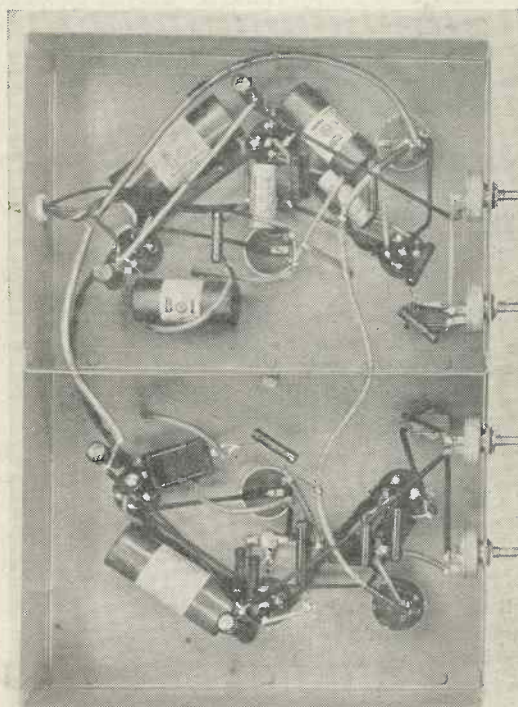

Underside view of alternative time base

phase reversal potentiometer connections. Next the anode resistances and the deflection condensers; note that heavy rubber leads should join the deflector condensers to the cathode-ray tube base, the leads being taken through the holes provided. Do all the under chassis wiring and push the deflector leads through the holes in the chassis. They can then be soldered on when the chassis is turned over. The remaining connections will not be difficult and examination of the wiring in the photographs should make clear any point that may be doubtful.

The circuit diagram has been drawn so that each stage is clearly shown. When the wiring is complete examine it very carefully to see that no mistakes have been made and that all connections are secure.

Operation

When satisfied that everything is in order insert the valves and gas-discharge relays in the correct holders and switch on the H.T. and L.T., not forgetting to connect a 9-volt bias battery. If all connections have been made correctly alteration of the controls should result in a change in pitch of the gas-discharge tubes as the noise can usually be heard via the valves. To make quite sure a pair of telephones may be connected to the valve anodes and earthed via a .1 mfd. condenser. The "saw-toothed" voltage generated should now be clearly heard.

Next month: Complete adjustment and operation of both time bases

“ ELECTRONIC TELEVISION ” (Continued from page 9)

the detail accordingly. The Alexandra Palace transmissions are somewhat restricted in this manner even on 400 lines.

So much for the highest frequency. What is the lowest frequency? It is, as a matter of fact, zero, that is in electrical language d.c. and almost as difficult to transmit and amplify by radio apparatus as is a very high frequency.

It is not difficult to see why zero frequency is necessary. It is really the average brightness of a picture which may change very slowly from scene to scene, for example, if there is a sunny scene, a cloud may come up, taking perhaps 20 seconds to darken the picture, or, in other words, the system must record a change taking place at the rate of 1/20th of a cycle per second. Not only the rapid change from black to white must be transmitted, but also the steady “ d.c. component ” corresponding to the background. An actual picture is not as a rule so simple, and its d.c. component is determined by the general average light of the whole picture.

If the picture is a “ still ” picture, it is easily proved that the d.c. component remains constant, and the next lowest frequency that may have to be transmitted is that of the picture repetition 25 cycles per second.

A “ close up ” of someone speaking is very nearly a still picture for the purpose of this argument, and it will be seen that for such pictures we might eliminate all frequencies below 25 per second. This would simplify apparatus, and might conceivably be used if television were operated as an adjunct to the ordinary telephone service between subscribers.

However, if the picture is moving, the average intensity may change at any lower frequency and this change must be faithfully transmitted.

Fig. 10 shows the frequencies in different parts of the system. The top line represents the frequencies in cycles per second that might be present in a picture when converted to electric current; as we have just argued, they may be from zero to 1½ million and of varying amplitude.

Sound accompanying the picture needs only the range from, say, 50 to 10,000 cycles. The synchronising signal comes at the end of every line 10,000 per second, and again of longer duration at the end of every picture, 25 per second.

At the transmitter these sound and vision frequencies are made to vary the true radio frequency which is to be radiated. The radiated waves which carry the sound and vision are respectively 41.5 and 45 million cycles, and the next line indicates how the necessity of carrying the sound and vision modifies these waves so that they overlap the neighbouring frequencies, producing what are known as side bands. The sound band is too narrow to be shown on this scale.

The receiver has an oscillator tuned to 42 million cycles. Just as two tuning forks a little out of tune make a low-frequency beat note, so the receiver gives us two electrical beat frequencies, one for sound, one for vision, which we can separate by resonant circuits, each to do its own job.

Synchronising Impulse Separator

Fig. 11 shows a circuit which can be used in the receiver to separate the synchronising impulse from the

picture. The pentode valve with a high impedance in the grid circuit has an input output curve which flattens off. It is adjusted so that it is completely loaded to the flattening point by black. A portion of the combined signal is tapped off, but in the anode of the valve only the synchronising signal appears, and is transmitted to the time base. The picture cannot get through to cause false synchronisation because it is lost in the flat top of the curve.

Contrast

It is important to know what range of contrast is necessary in television. In outdoor scenes, the range is about 50,000 to 1, but the eye does not observe all these at once as it adjusts itself by accommodation to the mean brightness and can then see perhaps a brightness 1 per cent of that as not quite black—upper limit doubtful.

A home cine works with less contrast ratio than this, say, 60:1, and in fact a good deal less contrast even down to 25:1 gives pretty good results.

Cathode-ray tubes are operated at a better contrast range than this.

Flicker

The light from a cinema picture or a television screen is essentially intermittent, and unless the pictures are repeated frequently enough, they flicker badly. The frequency necessary for repetition to avoid flicker, depends entirely on the brightness.

In interlacing methods 25 pictures per second are still shown, but each picture is scanned twice, missing alternate strips the first time and looking at them the second.

Iconoscope

The photo-electric cell has been described as a device passing an electrical current which depends on the light falling on it.

An Iconoscope (image viewer) makes use of the idea of combining a great many such cells together by depositing on a plate minute globules of caesium metal. Such a mosaic may contain several million globules. It is placed inside the evacuated bulb and connected in an electrical circuit so that each globule forms a little condenser between itself and the conducting back plate.

An electron beam is made to scan it, and the picture to be transmitted is focused on it. In the dark, the beam electrons each time they reach a globule, charge it up to a definite voltage (determined by secondary emission); all little cells reach a steady potential. Wherever there is light on the plate from the image, photo electrons go to the anode making the plate more positive. Next time the beam comes, it gives up some electrons to this patch which has lost them and so causes an impulse of electricity in the amplifier connected in the circuit.

The extreme importance of the Iconoscope arises from the fact that the light from the image can do its job of releasing photo-electrons all the time, while the electron beam itself is away scanning some other part of the picture. The beam returns every 50th of a second, say, but is actually dwelling on a picture point for only ½ millionth of a second each. In nearly every other system, the photo-cell is only allowed to look at the object for the time taken to scan one picture element.

THE CONTROLS OF A TELEVISION RECEIVER—AND HOW THEY ARE USED

WITH PARTICULAR REFERENCE TO
THE G.E.C. RECEIVER

THE control of a television receiver may be considered under two headings—(1) the operation of the controls which enable a picture to be obtained either by the Baird or Marconi-E.M.I. systems, and (2) the setting of the pre-set subsidiary controls which, once adjusted, will only require resetting with some alterations of conditions.

The former controls are readily accessible on the front of the cabinet and it may be said at once that their adjustment is quite as simple as with any broadcast

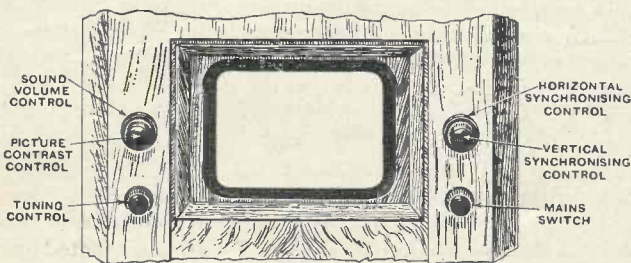

This drawing shows the normal controls on the G.E.C. receiver.

receiver. It follows, therefore, that anyone who can tune an ordinary wireless receiver will be able to master the control of a television receiver after five minutes' experience with it. Another point is that once the receiver has been adjusted it can be put into use at a future time by the mere turning of the on/off switch.

This latter statement perhaps needs a little qualification for my personal experience has been that there is a slight variation in the transmissions that calls for a little adjustment of the controls if the best results are to be obtained. In any case, however, the mere act of switching on will produce a picture and the further adjustment which may be desirable is quite a simple matter. This means that any member of a family will be able to make full use of the receiver.

The following notes are based upon experience with the G.E.C. (Model B.T.3702) television and all-wave receiver. The latter, of course, although contained in the same cabinet, is quite distinct from both the sound



The veriest novice can secure excellent pictures with the G.E.C. receiver.

and vision sections of the television receiver so the following remarks deal primarily with this.

The Simple Controls

The main control is the 4-position on/off switch (see Fig. 1), which from the normal "off" position can be moved into one position in an anti-clockwise direction and into two positions clockwise, again from the normal "off" position. The anti-clockwise movement switches on the all-wave radio receiver and the clockwise movement switches "on" for the reception first of the Baird system and in the second position of the Marconi-E.M.I. system. As remarked before, providing that the receiver is properly adjusted, the operation of this switch will produce a picture when a transmission is taking place.

When this switch is operated, after a few moments a spot of light appears on the screen and quickly begins to move to produce the scan, the amplitude of movement being small at first, but steadily increasing in both horizontal and vertical directions until the entire screen is covered. If there is no transmission on, the intensity of the light gradually decreases until the scan is barely

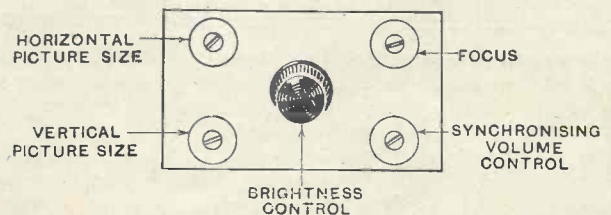

The "Brightness" and four preset controls are accessible through a small door in the side of the cabinet.

visible and the screen becomes almost entirely dark. If, however, a transmission is taking place then the pic-

TUNING FOR BEST RESULTS

ture quickly begins to form, and before the screen is completely covered by the scanning lines it is possible to observe the details. After the screen is entirely covered the picture slips a few frames and then automatically centres itself and after this it will remain rock steady for the entire duration of the programme.

The second control is for tuning both the sound and vision signals. With the G.E.C. receiver the tuning of the sound signals is much more critical than that of vision, and therefore when the sound is tuned in, the vision is also automatically correctly tuned; the latter can be received beyond the limits of the sound on either side. A stop is provided on this control so that, in any case, the tuning can never be much out of adjustment.

A sound volume control is provided for the sound part

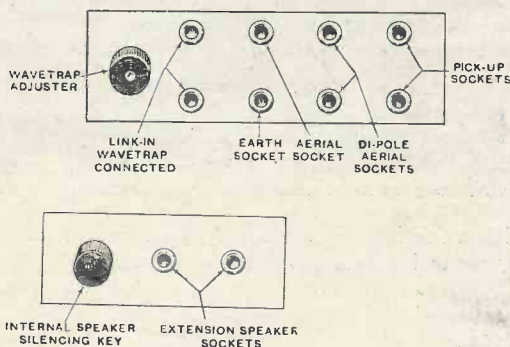

These are the terminal panels on the back of the cabinet. Connections are made by plugs.

of the television signals and with this the volume can be varied from a whisper to full volume.

Concentric with the sound volume control is a picture contrast control which is the vision equivalent of the sound volume control. Rotation of this in an anti-clockwise direction decreases the brightness of the screen, but increases the contrast. It will be appreciated that the operation of this control, although not essential, is very useful when the contrasts in the transmission are not sufficiently great, as for instance in the case of a light costume against a light background, or during the transmission of a film of a somewhat flat character.

On the other side of the cabinet are the line and frame synchronising controls, which rarely require touching. These two controls are concentric, but are intended for separate operation. As a rule they only require adjustment after having switched from one system to the

other, and the effect of turning one or the other of these two controls becomes at once so apparent by the appearance and movement of the picture that one cannot fail to get them into proper adjustment quite easily. To those who had experience of the old 30-line transmissions with the picture hunting up and down, the synchronising of the G.E.C. receiver is a revelation—a slight touch to the controls and the picture remains rock steady for the entire duration of the programme.

Subsidiary Controls

The controls which have been mentioned above are the only ones which it is *essential* to operate under any conditions whatever, and it speaks well for the design of the receiver that with these simple adjustments such perfect results and steady pictures can be ensured.

There are five subsidiary controls in the G.E.C. receiver and these are mounted on a panel which is accessible through a small door in the side of the cabinet. Only one of these—the brightness control—is intended for hand operation. The remaining four can only be adjusted by means of a tool, and they are set by the manufacturers and are not intended to be touched except in some such event as the cathode-ray tube being changed. These controls are: (1) the horizontal picture size, (2) the vertical picture size, (3) focus, (4) synchronising volume control.

The G.E.C. receiver has already secured for itself the reputation of providing exceedingly good definition; usually the picture can be examined at very close quarters and found to contain amazing detail, in fact more than would be thought theoretically possible. It is by what might be termed the finer "nuances" of control that full advantage may be taken of this and my experience has shown that by careful adjustment of the brightness control (which is the only hand-operated subsidiary control) in conjunction with the contrast control the full resources of the instrument can be secured.

One may sum up the whole matter of television receiver control by saying that the merest tyro cannot fail to obtain excellent pictures after five minutes' experience, but that the finest results are dependent upon a certain amount of acquaintance with the receiver and a little practice in its operation. It is interesting to note that the modern television receiver is "foolproof" in so far as its control is concerned—that is misuse of the controls cannot in any way damage the receiver, and the user, despite the high voltages that are employed; is not exposed to the slightest risk of shock.—H.C.

Components for the Television Constructor

EXPERIMENTERS and students interested in high- and low-definition should make a note that Messrs. H. E. Sanders and Co., of 4 Gray's Inn Road, W.C., are able to supply apparatus for 30.240 and 405 line reception and transmission.

They also have a complete stock of measuring instruments by well-known makers at very low prices. For the

advanced worker galvos, Wheatstone bridges, impedance bridges, oscillographs, etc., are available at remarkably low prices.

We strongly advise readers interested in such instruments and apparatus to get in touch with Messrs. H. E. Sanders, who are one of the few firms catering for the scientific experimenter.

Meters suitable for transmitting work are also available and readers will be able to obtain high grade instruments at a fraction of their original cost.

The British Short-Wave League

This league has now been active for nearly a year, during which time the membership has increased to over 400. Transmitting members include SU1KG, W4UP, W6NDF, W2IXY, G5LP, G6GR, G12CC, and G6LX and G6PD, who act as technical advisers.

Full information can be obtained from F. A. Beane, Esq., Ridgewell, Essex, who will supply a specimen copy of the "Short-Wave Review," for 2d., post free.

Mullard

CATHODE RAY TUBES

Mullard have held for years a unique position as pioneers in the Radio industry. Mullard Master Valve reputation is upheld in the new field of Television by the Mullard Cathode Ray Tubes.



TYPE E46-12 FOR TELEVISION

Double Electrostatic Deflection

Sensitivity 650/v

Maximum Anode Volts 6,000 v.

Screen 12" White.

PRICE 15 GNS.

A full list of Mullard Cathode Ray Tubes for Television and other purposes will be supplied upon application and we invite trade enquiries and queries.

Mullard Wireless Service Co., Ltd., Mullard House, 225, Tottenham Court Road, London, W.1