

MARCH 1969 2s 6d

# tape recorder

---

PEAK LIMITERS IN  
THEORY AND PRACTICE

---

MATCHING MICROPHONES  
AND MIXERS

---

A NEW METHOD OF  
SLIDE CHANGING

---

REVIEWS: TRUVOX PD202  
TAPE UNIT AND FICORD  
CAPACITOR MICROPHONES

---

WHAT'S IN A BRAKE?

---

CONSTRUCT A STEREO  
MICROPHONE WINDSHIELD

---

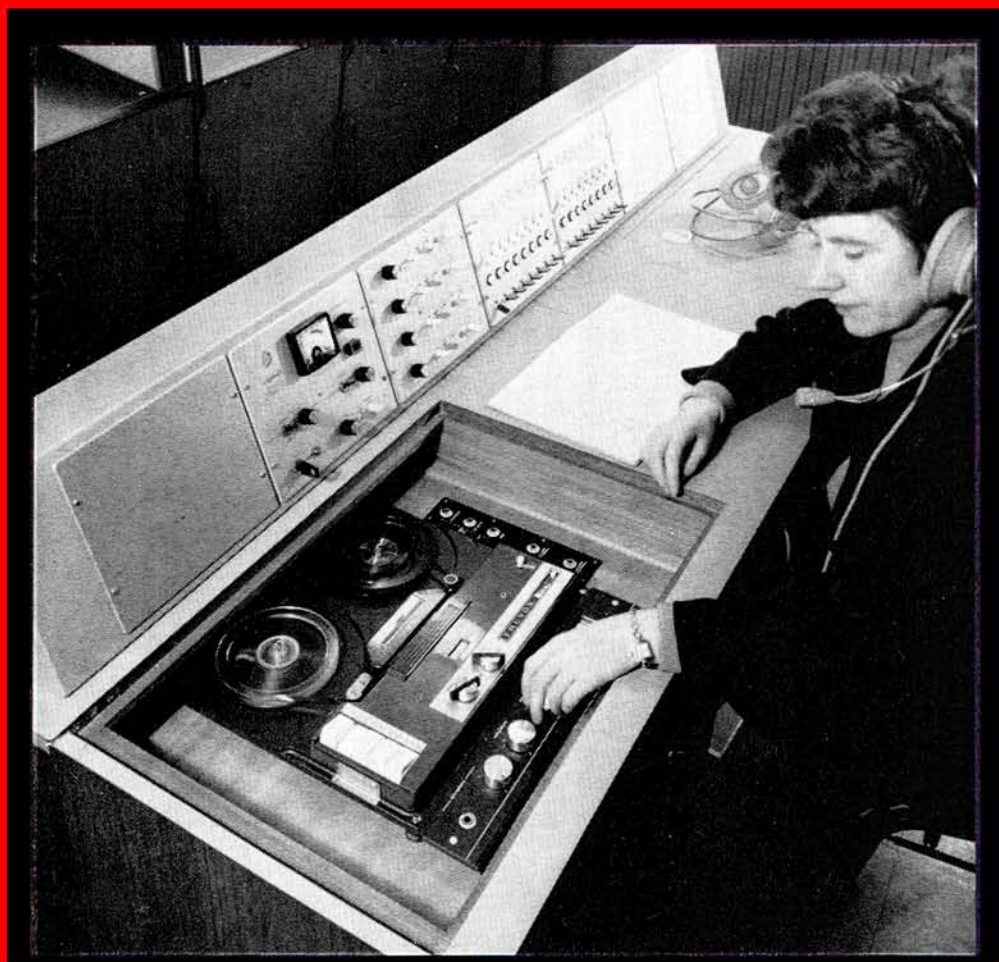



# Bang & Olufsen— for those who consider design and quality before price.

Bang & Olufsen audio equipment is made for those who consider design and quality first. There is a wide range of radios, record players, amplifiers, loudspeakers and radiograms, all designed to give unprecedented pleasure to ear and eye. Your B & O dealer will advise you how to start a system that will give you enjoyment for the years ahead. Here is just one selection.

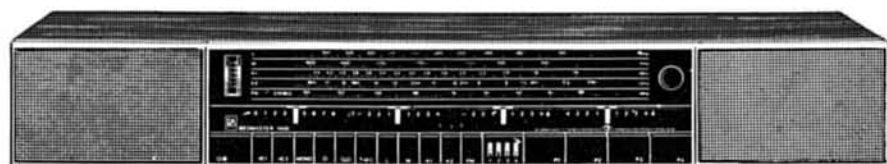

BEOMASTER 1400K



BEOGRAM 1000

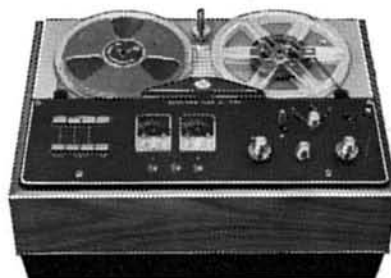

BEOCORD 1500 DE LUXE

**BEOMASTER 1400K** A sophisticated and versatile five waveband stereo radio receiver/audio amplifier. Completely modern in Danish styling, this new Beomaster is available with or without built-in pressure chamber loudspeakers—making it a complete table radio of the highest quality, or a central unit in a comprehensive stereo audio system. Five wavebands cover F.M., Long, Medium, Shortwave 1 (66—200m) and Shortwave 2 with bandsread (16—49). Special features

include 4 pre-tunable pushbuttons in the F.M. waveband, giving instant programme selection, and a built-in decoder for stereo radio broadcasts. Facilities for using gramophone, tape recorder and two sets of stereo loudspeakers via the high quality stereo amplifier, which gives an output of 15 watts per stereo channel. Available in teak or rosewood finish, to match other equipment in the Bang & Olufsen range.

**BEOGRAM 1000** A stereo transcription turntable unit mounted on a suspended shockproof plinth and featuring the world famous ST/L 15° tone arm, hydraulic lowering device and SP7 cartridge with diamond stylus. Specially engineered speed selector with vernier adjustment. Available in teak or rosewood finish.

**BEOCORD 1500 DE LUXE** stereo/mono tape recording deck. Working through a quality radio/amplifier—such as Beomaster 1400—with tape recorder connexion, the Beocord 1500 gives the facilities of a complete tape recording system. Available in teak or rosewood finish.

Fully descriptive literature is available from your B & O dealer or direct from  
**Bang & Olufsen United Kingdom Division, Eastbrook Road, Gloucester. Telephone: 0452 21591**  
 London Showrooms: 70/71 Welbeck Street, London, W.1. Telephone: 01-486 2144

# Ferrograph Series 7 - a lifetime of recording

Ferrograph Tape Recorders have been famous ever since 1949. A lifetime's experience of making fine recorders goes into every one of Ferrograph's brilliant new Series 7.

And there is a lifetime's recording *in* every Ferrograph instrument. Many of the earliest Ferrographs are giving perfect service today, nearly twenty years later. You can be sure your Ferrograph will do the same for you. It will give dependable service for many, many years to come. It will keep its value. It will need the minimum of service. Spare parts will remain available for a lifetime's recording. That's how Ferrograph got its name.

Available in Mono, and in Stereo with and without end amplifiers; combining a unique range of 30 recording facilities, including:

- All silicon solid-state electronics with FET input stages and wide input overload margins.
- Vertical or horizontal operation.
- Unit construction: The 3 individual units i.e. tape deck, power unit and amplifier complex are mounted on a single frame easily removable from cabinet for service or installation in other cabinets or racks.
- 3 motors (no belts). 3 tape speeds.
- Variable speed spooling control for easy indexing and editing.
- Electrical deck operation allowing pre-setting for time-switch starting without need for machine to be previously powered.
- Provision for instantaneous stop/start by electrical remote control.
- Single lever-knob deck operation with pause position.
- Independent press-to-record button for safety and to permit click-free recording and insertions.
- 8½" reel capacity.
- Endless loop cassette facility.
- Internal loud speakers (2)—1 each channel on stereo, 2 phased on mono.
- 4 digit, one-press re-set, gear-driven index counter.
- 2 inputs per channel with independent mixing (ability to mix 4 inputs into one channel on stereo machine).
- Signal level meter for each channel operative on playback as well as record.
- Tape/original switching through to output stages.
- Re-record facility on stereo models for multi-play, echo effects etc, without external connections.
- Meters switchable to read 100 kHz bias and erase supply with accessible preset adjustment.
- Three outputs per channel i.e. (1) line out—level response. (2) line out—after tone controls. (3) power output—8-15 ohms.
- Power output 10W per channel.
- Independent tone controls giving full lift and cut to both bass and treble each channel.
- Retractable carrying handle permitting carrying by one or two persons.



U.K. Retail prices from £150 incl. P.T.

See and hear Ferrograph Series 7 recorders at your local Ferrograph stockist, or post coupon for details and address of nearest Ferrograph specialist (or ring 01-589 4485)

the tape recorder with  
the hearing-is-believing sound



## FERROGRAPH

To the Ferrograph Co Ltd, Mercury House, 195 Knightsbridge, London SW7  
Please send me FREE brochure on Ferrograph Series 7 Tape Recorders  Please  
OR send me the new Ferrograph Manual, for which I enclose £1  tick

NAME .....

ADDRESS .....

TR



# SONY

**Strictly on the record...** the TC-230 stereo tape recorder from Sony will make you wonder why you put up with anything less. Three speeds, four tracks, split lid speaker system, stereo/mono recording and playback, front panel selection of tape/mic, tuner or disc inputs—and another big plus—SONY research.

*Recommended retail price £121:11:9*

The TC-230W, a variant of the same model, has a superb oiled walnut case and optional matching speakers.

*Recommended retail price £110:4:9.*  
Optional, pair SS-23 speakers:  
£31:17:0.

**SPECIFICATIONS.** Recording system: 4-track stereo/mono recording and playback. Power requirements: AC 60W, 100, 110, 117, 125, 220, 240V. 50, 60 Hz. Reels 7in(18 cm) or smaller. Tape speed: 7 1/2 ips, 3 3/4 ips, 1 7/8 ips. Frequency response: 40-18,000 Hz at 7 1/2 ips. 40-12,000 Hz at 3 3/4 ips. 40-6,000 Hz at 1 7/8 ips. Signal-to-noise ratio: Better than 46 dB. Wow & Flutter: Less than 0.17% at 7 1/2 ips, Less than 0.3% At 3 3/4 ips, Less than 0.4% at 1 7/8 ips. Harmonic distortion: Less than 3% at 0 dB line output. Level indication: Two VU meters. Power output: 4W x 2. Inputs: Rec/PB connector: impedance approx 600 ohms. Microphone inputs: sensitivity -75 dB (0.14mV). impedance 600 ohms. Phono inputs: sensitivity -52.5 dB (2 mV). Tuner (auxiliary) inputs: sensitivity -25 dB(44mV). impedance approx. 100K ohms. Outputs: Line outputs: output level PB 3 dB (1.1V). rec. 1 dB (0.87V). load impedance 10K ohms. External speaker outputs: 11.3 dB (2.83V). impedance 8 ohms. Headphone outputs: impedance 8 ohms or more. Rec/PB connector: impedance approx. 3.5K ohms. **Heads:** PP30-4202LN, EF18-2902H. **Transistors:** 2SC402 x 10, 2SC401 x 8, 2SD28 x 4, 2SB383 x 2. **Diodes:** FR-1P x 2, 1T22 x 2. **Dimensions:** 17"(W) x 9 1/2"(H) x 14"(D). **Weight:** 29 lbs. (13 kgs.). **Accessories:** 2 microphones (F-45), Empty reel (R-7A), connection cord (RK-56), head cleaning ribbon, motor pulley, pre-recorded 5" reel demonstration tape. **Optional accessories:** Telephone pick-up (TP-4S), microphone mixer (MX-6S), stereo headset (DR-3A, DR-3C).



**SONY**  
RESEARCH MAKES THE DIFFERENCE  
Sony (UK) Limited  
Ascot Road, Bedford, Middlesex.



INCORPORATING  
SOUND AND CINE

**EDITOR**  
JOHN CRABBE

**DEPUTY EDITOR**  
DAVID KIRK

**ADVERTISEMENT MANAGER**  
ROBIN WELLS

Editorial and Advertising Offices:  
LINK HOUSE,  
DINGWALL AVENUE,  
CROYDON, CR9 2TA  
Telephone: 01-686 2599

© Link House Publications Ltd., 1969  
All rights reserved

## COVER PICTURE

Adjusting the Truvox master tape deck on the new Cybervox Language Laboratory at Stockwell College.

## SUBSCRIPTION RATES

Annual home and overseas subscription rates to *Tape Recorder* and its associated journal *Hi-Fi News* are 36s, and 47s, respectively. USA \$4.30 & \$5.60. Six-month subscriptions are 18s. (*Tape Recorder*) and 24s. (*Hi-Fi News*), from Link House Publications Ltd., Dingwall Avenue, Croydon CR9 2TA.

*Tape Recorder* is published on the 14th of the preceding month unless that date falls on a Sunday, when it appears on the Saturday.

COLOUR TELEVISION receivers produce dangerous quantities of X-rays. Alternatively, colour television receivers produce safe quantities of X-rays. You pay your money and you accept whichever opinion you happen to find agreeable. The other day, Agfa-Gevaert came up with the news that colour television equipment *does not* erase magnetic tape, implying that we all believed it did. The discovery should please colour VTR manufacturers.

Popular fallacies can be very entertaining when they fall within your own field of specialisation. The problem of tape storage, if it is a problem, puzzles many experienced recording enthusiasts. We were told once of a gentleman so sensitive to magnetic fields that he would neither carry tape recordings on the Underground, nor on a public bus save at the extreme upper rear of the vehicle. He avoided motor cars like the plague (don't we all?), fearing the magnetism of the internal combustion engine.

Reader M.V. (page 127) has a more sensible idea of tape storage realities. He appreciates that only relatively strong magnetic fields at very close proximity—two or three centimetres from a high-flux loudspeaker—will have any immediate audible effect on a recording. Even low coercivity domestic tapes are remarkably tenacious: we recently tried erasing a Kodak Quadruple Play tape with a Ferrograph head degausser and, even with the two in contact, failed to erase any part of the reel. The degree of print-through, however, proved colossal. Given a very narrow hub diameter, this technique will provide an effective echo in homes where three-head recorders are not available.

If tape recordings are at all temporary in nature, the danger of erasure comes from the owner of the recordings, not from his loudspeakers. Every domestic possession comes under review during the annual spring clean: written records are filtered and destroyed, worn clothes disposed of, old furniture dismantled. Gramophone records are less prone to disposal for the simple reason that they are generally expensive. Tape recordings, however, are in many homes under constant threat of erasure. One might calculate the life expectancy of such a recording in terms of the coating retentivity under temperate storage conditions. On a domestic scale, though, the calculation should in our view be based on the plain statistical risk of deliberate erasure, which in turn relates to the importance of the recorded material and either the wealth or the enthusiasm of the recordist.

Accepting that our own fingers are the most dangerous influence on our tape recordings, we have only to find a shield against accidental or thoughtless erasure. The cassette brigade have simply to remove plastic erase pips from their recordings; the rest of us must adopt a more subtle solution. Defacing spools is one technique, titling storage cases is another. Our own solution is to change the leaders

from yellow, the conventional colour, to red. Red being customarily the trailer colour, we are then obliged to think carefully before recording over it. Quarter-track stereo or  $\frac{1}{2}$ -track mono tapes require more concentration than full-track recordings, but the principle is much the same.

This discourse would be incomplete without reference to the maintenance of tape-heads. Like pickup styli, erase, record and play heads should be cleared of dust and grit before every session. Unlike styli, the heads must also be degaussed, even on recorders with self-degaussing facilities. The latter, relying on gradually fading bias, only degauss the erase and record heads. Replay heads can be just as prone to residual magnetism from the tape or from switching transients.

Returning to head cleaning, we find that nature has provided us with a plentiful supply of oxide-removing fluid—spit. This material is used professionally for heads, pinch-wheels and capstans. There is a drawback, of course: the editorial handkerchief used when the fluid was first demonstrated to us twelve months ago is still, after at least 30 routine washes, heavily stained with oxide.

## FEATURE ARTICLES

- 96 A NEW METHOD OF SLIDE CHANGING  
By Gordon J. King
- 99 THE ART OF GOOD MATCHING—Part 2  
By Anthony Eden
- 104 FLIGHT R2 TO HONG KONG  
By P. G. de Bourcier
- 107 PEAK LIMITERS IN THEORY AND PRACTICE  
By W. H. Myall
- 109 A WINDSHIELD FOR A STEREO PAIR  
By M. G. Skeet
- 110 WHAT'S IN A BRAKE ?  
By William Henry

## REGULAR ITEMS

- 95 WORLD OF TAPE
- 102 TAPE RECORDER SERVICE  
By H. W. Hellyer
- 113 CLOSED CIRCUIT  
By Richard Golding
- 115 SOUND WORKSHOP  
By F. C. Judd
- 127 READERS' PROBLEMS
- 129 ANIMAL SOUND  
By Cyril Grange

## EQUIPMENT REVIEWS

- 116 TRUVOX PD202 STEREO TAPE UNIT  
By A. Tutchings
- 119 FI-CORD 600 AND 650 CAPACITOR MICROPHONES  
By A. Tutchings and Peter Bastin
- 123 GRIPEX CLEANING FLUID  
By H. W. Hellyer

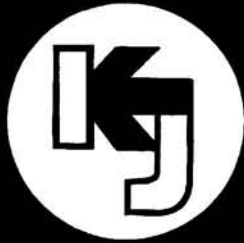

# K. J. ENTERPRISES

BRITAIN'S PREMIER MAIL-ORDER AUDIO SPECIALISTS

Immediate despatch on Advertised Lines.

Send Cash with Order.

DISCOUNT BARGAINS ★ VAST STOCKS OF TAPE & EQUIPMENT ★ REFUND GUARANTEE.

## BRANDED TAPES

**20% OFF**  
**BASF—EMI—GRUNDIG**  
**PHILIPS—SCOTCH—AGFA**

Brand new, Fully Guaranteed and in normal manufacturer's pack

STANDARD PLAY	LIST PRICE	OUR PRICE	DOUBLE PLAY	LIST PRICE	OUR PRICE
5" 600' } Except Agfa	22/2	18/-	3" 300' Not Scotch	14/3	11/6
5½" 900' }	29/5	24/-	3" 400' Scotch only	16/7	13/3
7" 1200' }	36/7	29/6	4" 600' }	26/-	21/-
<b>LONG PLAY</b>			4½" 900' Agfa, BASF only	31/-	25/-
3" 210' Not Scotch	9/3	7/6	5" 1200' }	43/2	35/-
3" 300' Scotch only	9/7	7/9	*5½" 1800' }	56/11	46/-
4" 450' }	14/9	12/-	*7" 2400' }	79/-	63/6
4½" 600' BASF, Agfa only	22/-	18/-	10" 4600' Agfa, only	140/9	112/9
*5½" 900' }	29/2	23/9	<b>TRIPLE PLAY</b>		
*5½" 1200' }	36/5	29/6	3" 450' Not Scotch	22/3	18/-
*7" 1800' }	51/7	41/9	3" 600' Scotch only	24/10	19/9
8½" 2400' BASF, Scotch	74/-	59/6	4" 900' }	40/-	32/3
10" 3280' Agfa only	85/9	68/9	*4½" 1200' Agfa, BASF only	50/-	40/3
10" 3600' BASF only	96/6	77/6	5" 1800' Not Scotch	67/2	54/-
10½" 4200' Agfa, BASF only	113/6	91/6	5½" 2400' } Agfa, BASF	91/4	73/6
			7" 3600' } -only	116/6	93/6
<b>SCOTCH DYNARANGE (L/P)</b>			<b>QUADRUPLE PLAY</b>		
5" 900' }	32/8	26/3	3" 600' }	37/-	29/6
5½" 1200' }	41/-	33/-	3" 800' } Kodak only	46/3	37/-
7" 1800' }	58/1	46/6	4" 1200' }	64/6	51/6
8½" 2400' (Metal Reel)	84/3	67/6	<b>COMPACT CASSETTES</b>		
<b>BASF PES.35 L/P Low Noise</b>			C.60	17/6	14/3
5" 900' }	36/10	29/9	C.90	25/-	20/3
5½" 1200' }	45/6	35/6	C.120	33/6	27/-
7" 1800' }	63/-	50/9			
10" 3600' }	115/-	91/-			

Postage and packing 2/6. Orders over £3 post free

## AMPEX TAPE—SAVE 30%

A special offer of top quality, premium grade, mylar (Polyester) base tape with Full Leader and Stop Foil. Boxed and Fully guaranteed.

TYPE	DESCRIPTION	LIST PRICE	ONE	THREE	SIX
541-12	1150' on 5½" reel Long Play	35/-	24/6	71/-	137/-
551-12	1200' on 5" reel Double Play	42/-	29/6	86/-	166/-
551-16	1650' on 5½" reel Double Play	55/-	33/6	97/6	189/-
551-24	2400' on 7" reel Double Play	77/6	49/6	145/6	285/-

POST & PACKING 2/6. ORDERS OVER £3 POST FREE.

## FERROGRAPH TAPE — 20% OFF

Brand New. Fully guaranteed and in normal manufacturer's pack.

	LIST PRICE	ONE	THREE	SIX
BN7 1,200' on 7" reel (Dynarange)	50/-	40/-	117/6	230/-
BN8 1,800' on 8½" reel (Dynarange)	71/-	57/-	168/-	330/-
BL7 1,800' on 7" reel (Dynarange)	70/-	56/-	165/-	324/-
BL8 2,400' on 8½" reel (Dynarange)	90/-	72/-	213/-	420/-

Post and Packing 2/6. ORDERS OVER £3 POST FREE

## SENSATIONAL NEW HALF PRICE OFFER!

A bulk purchase of top quality Recording Tape manufactured by one of the Country's leading makers. A polyester based tape with superlife black coating. Polythene wrapped and fully guaranteed. Available while stocks last in one size only.

	NORMAL VALUE	ONE	THREE	SIX
1800' on 7" reel Long Play	50/-	26/6	78/-	150/-

POST & PACKING 2/6. ORDERS OVER £3 POST FREE

## K. J. ENTERPRISES

17 THE BRIDGE, WEALDSTONE, MIDDLESEX (Opposite Harrow and Wealdstone Station). 01-427 7758. Showroom hours: 9.30a.m. - 5.30p.m. Closed Lunch 12.30 - 1.30p.m. Close 1p.m. Saturday.

## ILFORD - ZONAL TAPE

**40% OFF!**



### NEW KJ SPECTACULAR

From the Motion Picture & Magnetic Products Division of ILFORD LTD. we are proud to present a New Stupendous BARGAIN OFFER!! Never before have you been offered such a breathtaking opportunity. ILFORD-ZONAL premium grade magnetic tape (extensively used by the B.B.C.) at a terrific reduction of 40% Brand New, Boxed, Fully Guaranteed and complete with leaders, trailers and stop foil. **UNIQUE TO KJ**

DESCRIPTION	LIST PRICE	ONE	THREE	SIX
900' on 5" reel Long play P.V.C.	29/1	17/6	50/6	96/6
1200' on 5½" reel Long play P.V.C.	36/1	22/6	65/-	125/-
1800' on 7" Long play P.V.C.	51/4	29/6	86/-	165/-
1200' on 5" reel Double Play (Polyester)	43/1	27/9	81/-	157/6
1800' on 5½" reel Double Play (Polyester)	56/1	36/-	105/-	204/-
2400' on 7" reel Double Play (Polyester)	78/10	49/6	145/6	285/-

Orders over £3 post free

SPECIALISTS in PHILIPS, GRUNDIG, FERGUSON, SANYO & EAGLE EQUIPMENT

## BARGAIN OF THE MONTH

### PHILIPS 4 TRACK TAPE RECORDER

SAVE £7-15-0!

LIST PRICE £48-12-0 OUR PRICE **£40-17-0**



Carriage 10/-

Superb reproduction, elegantly designed with all the well known Philips features. The N4307 is simple to operate and will give hours of listening pleasure.

MODEL N4307

### SPECIFICATION

Freq. Response 60-14,000 Hz. Signal to noise 45 dB. Wow and Flutter ±0.25%. Output Power 2 watts. Inputs Mic, 2 mV, Radio/Diode 2 mV. Gram. 100 mV. Power Supply Mains 110/250 v. Dimensions 16½" x 11½" x 5½".

- 50 cps (adaptable for 60 cps) ● Superb wood cabinet
- Mono recording and playback at 3½ i.p.s.
- Monitoring facilities ● Position indicator
- Tone control ● Socket for direct recording from mic/record player
- Complete with microphone, tape and spool

**FREE**

Our New 100 page illustrated catalogue sent entirely FREE on request. Britain's most specialised comprehensive range of recording tape, Accessories and Audio equipment. 20,000 reels of tape always in stock with reductions ranging up to 50%.

### BBC ENGINEERING APPOINTMENTS

THREE NEW APPOINTMENTS in the Engineering Departments have been made by the BBC. Dr. R. D. A. Maurice succeeds Mr. G. G. Gouriet as Head of Research Department. Dr. Maurice joined the Research Department in 1939 and later transferred to the Television Group, of which he became head in 1958. Mr. Gouriet joined the BBC in 1937 but became technical director of Wayne Kerr Laboratories from 1958 until his return in August 1964. His new post is that of chief engineer, Research and Development. Mr. D. R. Morse has been appointed chief engineer, Capital Projects, and will co-ordinate the work of the Building Department and the two Planning and Installation Departments (Studios and Transmitters). He joined the Corporation in 1947 and has previously been Head of Film Unit and Head of Television Studio Section.

### TWO-SPEED CASSETTE RECORDER

AMPEX, FISHER, SCOTT and Harman-Kardon are among major American audio-equipment manufacturers now marketing recorders based on the Philips cassette system. Hitherto this equipment has restricted itself to 4.75 cm/s but Teac of Japan will shortly introduce a two-speed model operating at 9.5 and 4.75 cm/s. Philips, meanwhile, are reported to be developing an endless-loop cartridge; similar work is being undertaken in Japan by Sony and TDK.

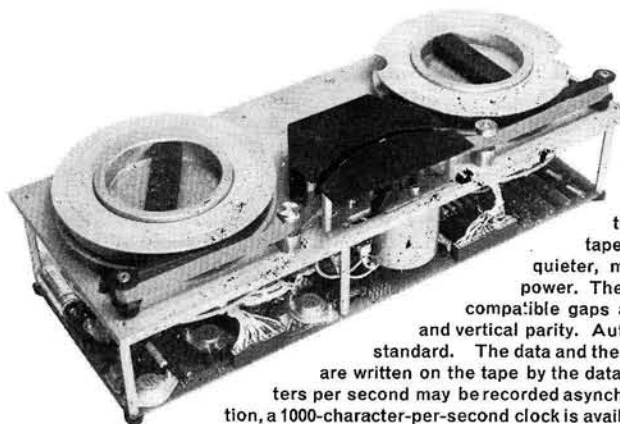

Asynchronous digital data can be recorded directly on IBM-compatible magnetic tape with the new Model 60 incremental tape recorder introduced by Cipher of San Diego. Any random data source, such as a keyboard, a transmission device or a digital voltmeter, may be coupled to the Model 60. In operation, the recorder is similar to a paper tape punch but stores more data, is quieter, more reliable, and consumes less power. The recorder generates all the IBM-compatible gaps and markings, including horizontal and vertical parity. Automatic load forward and rewind are standard. The data and the internally generated vertical parity are written on the tape by the data enter command. Up to 500 characters per second may be recorded asynchronously. For synchronous operation, a 1000-character-per-second clock is available to time the data on to the tape.

**SLOUGH AMATEUR RECORDING CONTEST 1969**  
DETAILS OF THE Slough Festival '69 amateur tape recording contest are now available from the General Secretary, *Community Centre, Farnham Road, Slough, Buckinghamshire*. The contest is divided into two classes, the first encompassing 'sound snapshots, interviews, interesting or historic sounds, and on the spot reports'. The second comprises 'music, live vocal or instrumental performances'. Maximum duration in either section is five minutes, recorded in one direction (mono, stereo or duoplay) at 19 or 9.5 cm/s. White or coloured leaders and trailers should be fitted. All aspects of the production must be the work of the entrants, though commercially recorded or broadcast material may be included if written permission is obtained from the relevant source and submitted with each tape.

All tapes will be returned to entrants after the adjudication, provided adequate return postage plus a gummed addressed label are

submitted by each entrant. Adjudication will take place at *Pinewood Studios, Iver Heath, Buckinghamshire* on May 9th, 7.30 p.m. Closing date for entries is March 30th. A fee of 2s. 6d. must be included with each tape.

### AEROSOL ALTERNATIVE TO CARBON-TETRACHLORIDE

A LOW-TOXICITY ALTERNATIVE to carbon-tetrachloride cleaning fluid has been developed by *Automation Facilities Ltd., Oxford Avenue, Trading Estate, Slough*. Electronic components, connectors, communications and recording equipment, and most insulating plastics may be flushed with the *Ultracene*. The liquid evaporates to leave no residue and can be used to clean normally inaccessible assemblies.

### COSMOCORD REORGANISATION

DEMAND FOR COSMOCORD electronic equipment has grown to a level beyond the capabilities of the existing group. A new electronic instrument division has been formed to meet this situation, headed by Mr Brian Lowe with Mr Ian Campbell as sales manager. Overall charge of the group will rest with Mr Dennis Archer, general manager of the Electro-Acoustic Division. The new division will specialise in sound level test equipment, ear defenders, accelerometers, transducers and bearing analysers.



### RADFORD BREAK WITH TECHNOMARK

THE MARKETING LINK between Radford Electronics Ltd. and Technomark Ltd. has been broken, the two companies announce, and all Radford activities are now being directed from their *Ashton Vale Road, Bristol 3*, premises. Technomark continue to represent Bang and Olufsen.

### HOFFNUNG RECORDINGS REQUIRED FOR ANNIVERSARY BROADCAST

THE TENTH ANNIVERSARY of Gerard Hoffnung's death will be marked in September by a BBC programme of his work. Mr. Ian Horsbrugh, *5 Claremont Road, Twickenham, Middlesex*, has been commissioned to prepare the programme and would like to contact any readers possessing tapes of live or broadcast Hoffnung material.

### MAURICE RETIRES FROM LUSTRAPHONE

MR. J. MAURICE has retired from his post as Managing Director of Lustraphone Ltd. and is succeeded by Mr. Ronald L. Glaisher. Mr. Maurice remains on the Board in a consultative capacity. Mr. George R. Pontzen, Technical Manager, has also been appointed to the Lustraphone Board.

### A NEW LOW IN AUDIO TAPE SPEED

A BROADCAST MONITORING tape recorder developed by the Tape-Athon Corporation operates at 9 mm/s. Over 400 hours recording capacity is provided by using 27 cm spools of TP tape. Frequency response is claimed to be 200 Hz - 3 kHz  $\pm 3$  dB with a signal-to-noise ratio of 38 dB. The recorder was seen recently at the Audio Engineering Society Convention in Washington.

### NEXT MONTH

TEN PAIRS OF HEADPHONES will be examined and compared by Anthony Eden, John Fisher and David Robinson in the April Tape Recorder. K. R. Wicks commences a series entitled *The Sound Studio* while Terence Melville describes, for constructors, a silicon-transistor stereo tape amplifier. The theory of 'phasing' (or 'skying') aroused some interest when outlined by L. Hayward in January. Terence Mendoza returns to this subject in a practical article *Producing Demonstration Tapes*.

### FILM LIBRARY ACQUIRES 'THE TIMELESS TRACK'

A BASF FILM 'The Timeless Track' has been added to the Sound Services Film Library. The 25-minute colour film illustrates the versatility of magnetic tape in sound reproduction, art, instrumentation and teaching. It was judged the best company promotion film at the tenth New York International Film and Television Festival in 1967 and was shown at the London Audio Fair. The film is free on loan from *Sound Services Ltd., Kingston Road, Merton Park, London, S.W.19*. Borrowers are asked to quote the reference number 146 2293-1.

### MYALL BREAK WITH CARSTON

ORDERS AND ENQUIRIES concerning the Myall Wow and Flutter Meter should now be addressed direct to *W. H. Myall, 35 Villiers Road, Watford, Hertfordshire* and not Carston Electronics.



# A NEW METHOD OF SLIDE CHANGING

BY GORDON J. KING

**T**HE method of synchronising slide changes to taped commentary by recording pulses on a separate track is well known. There are quite a few devices of this kind commercially available, and most of them work well and consistently when correctly set-up, adjusted and operated. Basically, they comprise electronics and sometimes the head unit for creating the pulse and for triggering the projector solenoid on replay each time a recorded pulse passes the head. In some units the tape from the recorder is re-routed to pass the head assembly. This means that the unit has to be carefully placed by, or fitted to, the parent recorder. A  $\frac{1}{2}$ -track recorder would utilise one track for the commentary and the other exclusively for the pulses, the former handled normally by the recorder and the latter by the synchronising device. Similarly, a  $\frac{1}{4}$ -track recorder could have two tracks for commentaries and two for corresponding pulses.

It is possible to record the controlling pulses on the same track as the commentary, but for educational applications this is not particularly desirable, since the slide-changing 'bleeps' can be singularly distracting. Moreover, this scheme yields more complications in terms of filtering the superimposed pulses from the commentary. Attempts have been made to record sub- or ultra-sonic pulses on the commentary tracks, but again, this idea also produces various complications.

It was my job to design a synchroniser which neither used up a track solely for the pulses nor required them to be superimposed on the commentary or programme tracks, and this is a story about the design and development of such a device, which has now become known as the *AVD Automatic Sliding-Changing Control Unit\**. The original requirement was for a slide/sound system offering greater economy and flexibility over the classic cine-film/sound system for industrial applications. The system was fundamentally required for use with tape recorders, but the desirability of it having potential for possible use with disc records in addition to tape records was stressed.

The overall design also had to accommodate high-speed dubbing of tape records for reproduction purposes, and this factor alone excluded the use of HF control pulses, since at high dubbing speeds these slide out of the system's passband! The possibility of utilising sub-sonic pulses on the commentary tracks—thereby yielding disc record compatibility—was explored, but after a while this idea was abandoned owing to unreliability of operation resulting from spurious sub-sonic noises in all systems of amplification and record replay, especially where the record is a disc.

In certain areas of industry involved in educating its personnel in the arts of selling, operating and maintaining technical and quasi-technical equipment, the cine-film/sound

system of communication can become very costly, especially where the industry is world-wide and is engaged in a relatively young science in which new developments can change several aspects of its wares virtually overnight. A film depicting in part, say, a critical adjustment in a complex electronic or mechanical system could be rendered wholly useless by the advent of a new development. Thus, to retain the same mode of audio-visual communication the affected industry would be obliged to process and distribute an updated film.

It is now being realised by educationists that communication almost as complete as with cine-film and sound is achieved when the display is a still picture (e.g., projected slide) provided it is well defined, preferably in colour and accompanied by good quality sound. Industry and education are thus investigating slide and tape (or disc) partnerships as an alternative to the high potential costs of cine-film and sound. Only a tiny fraction of the costs of updating a whole film sequence are incurred in replacing a few slides and a recorded commentary at each point of communication.

At the design stage of the synchronising device—in addition to the factors already mentioned—it was therefore necessary to take into account the possible integration into the master tape of updated commentary to suit new or replaced slides. Clearly, the recording of pulses in any form or on any track would have severely inhibited this requirement of the system, even if not the others. After a great deal of experimentation and thought it was decided to use 'silence' rather than audio pulses for slide-changing control. This scheme was found to satisfy completely all the requirements, and had the great advantage of being very simple in both application and operation, easily making it possible for any tape recorder, disc-player or, indeed, human speaker to evoke a slide change merely by the introduction of a deliberate pause. Modifications to the master tape are particularly facilitated, since a pause (or silence) demands no more effort than splicing leader tape of suitable pause length between the commentary sections, and then dubbing off at high speed any number of reproductions for field use. The prepared master tape can also be used for processing disc records if needed, and these, of course, will also carry the slide-changing pause information. For domestic use, the pauses can also be applied to the tape by a different method, explained later.

The synchronising unit thus had to be designed to translate the deliberately introduced pauses into switching pulses of suitable shape and speed for accurately triggering the slide projector, while adequately discriminating against natural pauses in the commentary, to provide pause-time adjustment—from less than one second to several seconds to match the pause period adopted in the recording—and

to give automatic repetitive switching at the pause-time rate to trigger a projector as an extra facility, thereby making it possible to put the slide changing of any automatic projector under the self-running control of the synchronising unit with or without sound accompaniment.

A simplified block diagram of the scheme eventually evolved is shown in fig. 1. Signal from a tape recorder or alternative source is fed to an amplifier incorporating amplitude limiting, and thence to a signal rectifier and discriminator from whence a switching pulse is derived each time a deliberate pause occurs in the commentary when the timing circuits are adjusted to match the pause period. This switching pulse activates the switching circuits which yield in return a switching pulse suitable for working any type of automatic slide projector. Such a projector normally has a remote press button which has to be manually depressed for each slide change, and a socket is fitted on many of the latest models to take the control lead of a synchroniser. If it is required to employ a projector not equipped with such a socket, then it is necessary to bring out a pair of wires in parallel with the manual push-button or to abandon the manual control completely and, when required, restore to manual operation by pressing the manual slide-change button which is present on the front panel of the unit (see fig. 3).

Fig. 2 gives a graphical interpretation of the fundamental action of the device at the occurrence of a deliberate pause, shown in the top track of the tape at (a). This results in a fall in voltage at the integrator followed by a rise when the commentary continues, as shown at (b). The timing circuits are geared into the resulting pulse period and, at the switching threshold, the circuit triggers and an electro-mechanical (via a relay) feedback condition creates the steeply rising, narrow switching pulse shown at (c), which is of an ideal form for cycling the projector. With zero input signal, it is this feedback condition which sustains the repetitive switching action at the pause-time rate, referred to earlier.

The front of the device is pictured in fig. 3. At the top of the panel is the pause-time switch and below the auto on/off toggle switch which, in the off position, allows the slides stacked in the projector to be changed manually by the press-button in the top left-hand corner. The signal input jack socket is positioned in the bottom left-hand corner, and in the opposite corner the switching output socket for connection to the projector. Above this is the mains on/off indicator lamp.

Figs 4 and 5 show respective top and bottom views of the inside of the unit, and from these the relative simplicity of the design will be appreciated. The unit is mains-powered, which is one of the reasons why the active

(continued on page 101)

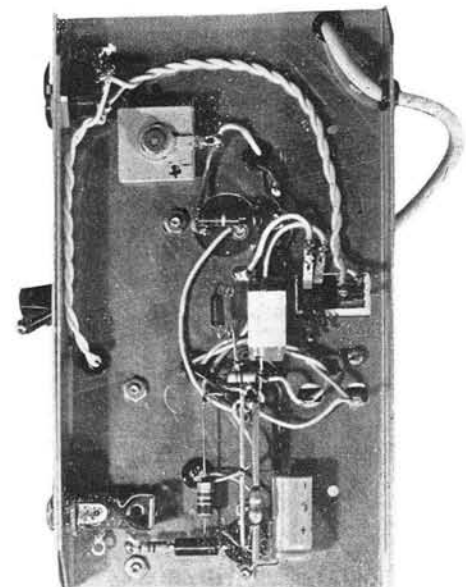
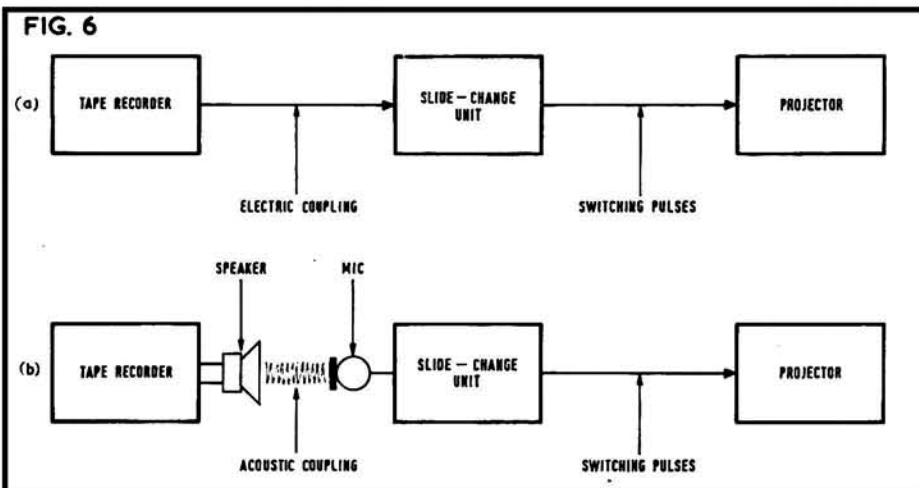
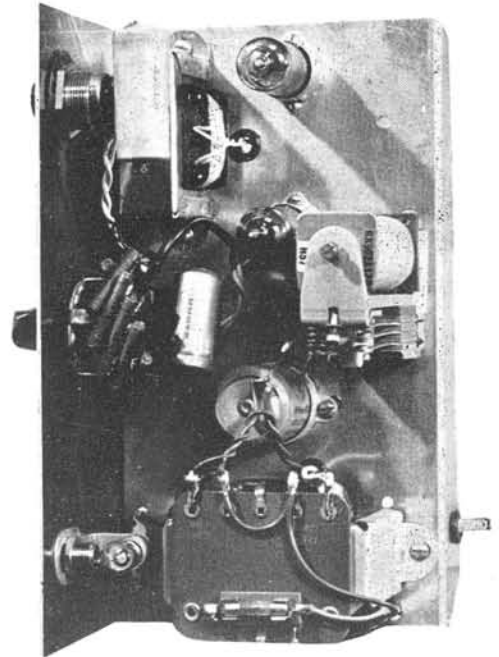
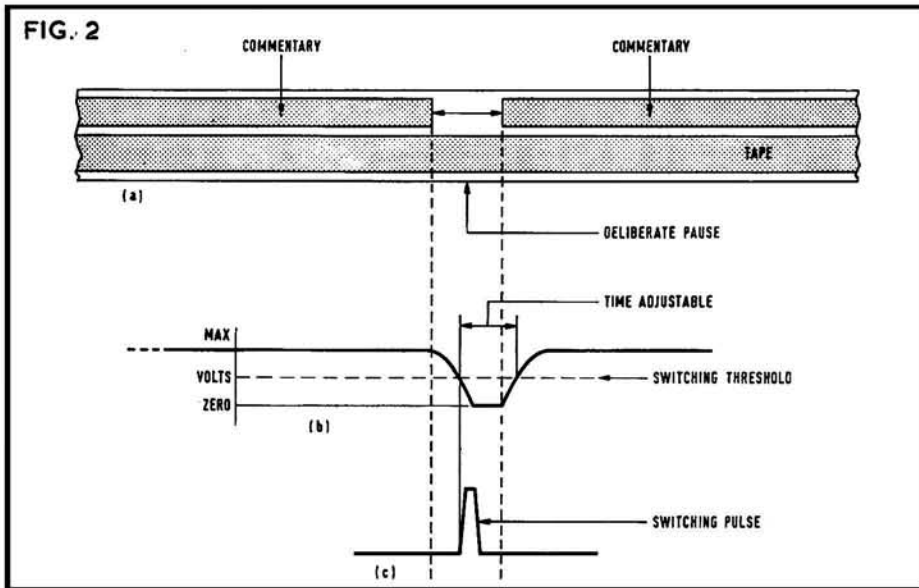
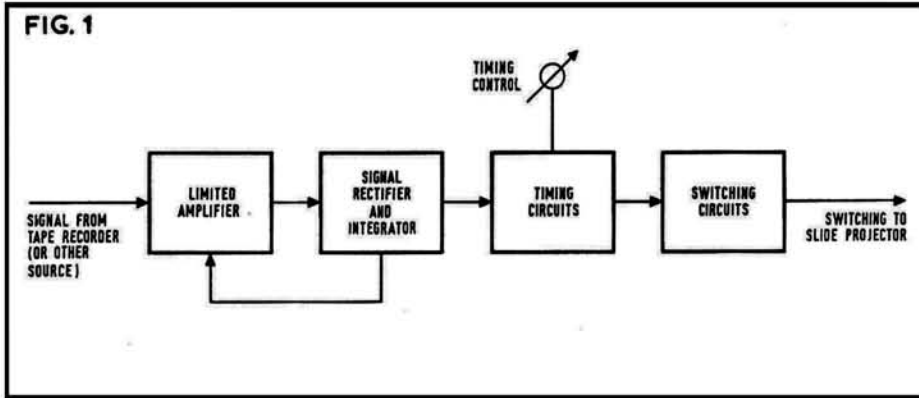



# This is a page of hi-fi news.

Into the world of Hi-Fi, now and again there comes a product that represents terrific value to the enthusiast.

Such a product is the Grundig TK247 de luxe Stereo tape recorder.

Never before have so many professional features been incorporated in a machine at a price the amateur enthusiast can afford.

Permit us to dangle the specifications in front of you.

Four track, full stereo record and playback to Hi-Fi standard.

Independent record/playback controls and tone control.

Facilities for in-put mixing, super-imposition, multiplay and

echo effects. Also monitoring via ear-phones, automatic tape-stop, parallel track operation, tape inching, and a tape joining channel.

More?

Right. Plated steel chassis and frame ensure perfect mechanical alignment.

Tape pressure band prevents drop-outs.

Double-action safety clutch. Easily modified for 60Hz mains operation. Amplifier hinges for easy servicing.

Two tape speeds give up to eight hours playing time.

Less than 0.15% wow and flutter.

Twin-edged illuminated VU level meter.

Two  $6\frac{3}{4} \times 3\frac{3}{4}$ " high-quality elliptical speakers with two-inch tweeters.

It is  $17\frac{1}{2} \times 13 \times 7\frac{3}{4}$ " and weighs 30 lbs.

Quite a tape recorder for anybody.

Please send me details of the Grundig TK 247 de luxe.

Name .....

Address .....

.....

.....

.....

**GRUNDIG**

Dept. T.R.1 Grundig (Great Britain) Ltd., Sydenham, S.E.26.



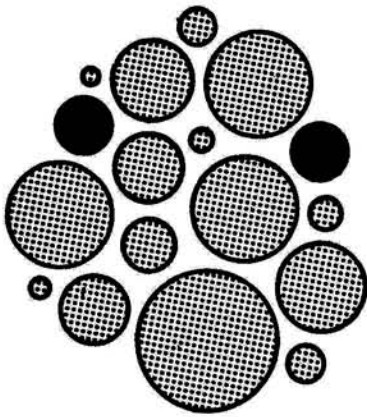

# THE ART OF GOOD MATCHING

## PART 2

BY ANTHONY EDEN\*

LAST month we looked at some of the more important problems concerning the matching of a microphone into a mixer or tape recorder. This month we shall be considering some of the factors relevant to choosing a mixer, so that it meets the requirements of the microphone and the tape recorder.

A microphone mixer is used where it is desired to mix the signals from several microphones and then feed the resultant signal into a tape recorder. Furthermore, a mixer may sometimes be used where the microphone input of the tape recorder does not have sufficient sensitivity to be fully loaded by a microphone (we considered this problem last month). If several microphones are to be mixed without any amplification of the incoming voltages, we call this a *passive* mixer. Passive mixers are available commercially but they do have certain limitations in their use. They have a high input impedance (50 K) and inherently at minimum attenuation they drop the signal by about 12 dB. To overcome this effect a number of manufacturers have added a transistor amplification stage with a voltage gain of about 18 dB, thus giving overall about 6 dB of gain. However, with such mixers the signal-to-noise ratio is generally poor and crosstalk between channels can be a problem. Such mixers increase the very problem that one is trying to overcome, namely that of amplifying a low level signal from a microphone before it is attenuated by the mixer network. For this reason most studio mixers amplify the signal from the microphone before the incoming signals are mixed. It is this first stage of amplification that poses nearly all the design problems and it may be for this reason that

few really successful commercial mixers exist at a reasonable price.

There are four main points to look for whilst comparing one microphone mixer with another. This assumes that manufacturers have given a true and fair specification of their mixer. Unfortunately this is sometimes not the case and furthermore manufacturers quote the specification in such a misleading way that it becomes meaningless. The four main points to consider are:

- (1) The frequency response.
- (2) The input sensitivity and impedance.
- (3) The signal/noise ratio.
- (4) Distortion and overload factors.

The first point is the one most widely quoted by manufacturers, as with transistors it is possible to obtain a frequency response stretching from 20 Hz to 20 kHz, and one would not expect the frequency response to be more than 2 dB down at these points. With valve microphone amplifiers it is rather more difficult to obtain a good bass response and 3 dB down at 30 Hz and 20 kHz is quite acceptable. It should be pointed out that there are very few microphones capable of making use of the full frequency response of a good mixer.

The second point concerns the input sensitivity and impedance of each microphone amplifier. We saw last month how an increase in the microphone impedance was accompanied by an increase in the microphone output voltage (for the same sound pressure). The converse of this obviously applies with a mixer. We should expect a high input impedance amplifier to be less sensitive than a low input impedance amplifier and, if a switch is provided to match two or three input impedances, we should expect approximately the following: a 600-ohm input to have 20 dB (10 times) greater sensitivity than a 50 K input, and a 30/60-ohm input to have about 12 dB (four times) greater sensitivity than a 600 ohm input. The sensitivity of the input stage will be decided by the type of microphone to be used, but two general points here may be worth noting. Firstly, if 200-ohm microphones are to be used, they will normally be matched into the 600-ohm input stage of a transistor microphone amplifier, but remember that it is the sensitivities of the microphone and input that should be matched up. The sensitivity of the microphone at 1 dyne/cm<sup>2</sup> (1  $\mu$ B) is a good general guide for a typical sound pressure level. For example, the sensitivity of the Grampian 18/4 mixer requiring 0.8 mV input at 600 ohms will not be sufficient if fed by a 200-ohm AKG D19C producing 250  $\mu$ V (ref. 1  $\mu$ B) (incidentally the 600-ohm version of the Grampian DP4 is also insufficient for this input—and the DP4 is considered a highly sensitive microphone). The result of having too low a voltage source to drive the input stage results in increased noise but we shall return to this

problem again. The second general point worth remembering is that ribbon microphones produce a lower output voltage than corresponding dynamic microphones. If possible, therefore, it is beneficial to use 600-ohm impedance ribbon microphones which, at this impedance, produce a useful voltage output of about 150  $\mu$ V. There are few available transistor mixers on the market that can successfully amplify signals of 50  $\mu$ V produced by the average 30-ohm ribbon microphone, without the introduction of appreciable noise. Incidentally, the same problem arises with many transistorised tape recorders. The microphone amplifier is not sensitive enough to amplify 30-ohm ribbon microphones without introducing considerable noise. If you wish to use an existing 30-ohm ribbon microphone (i.e. the Reslo RBT, VRT or Grampian GR2/L) then a step-up transformer from 30 ohms to 600 ohms (Grampian G7/LM unbalanced or G16/LM balanced) will give sufficient signal to load fully the input of, say, the Revox A77 (150  $\mu$ V) or the Ferrograph Series 7 (150  $\mu$ V).

The third and most important single factor, when considering buying a mixer, is that of noise. It is also the manufacturer's figure quoting signal-to-noise ratio that most easily deceives potential customers. For the moment, let us ignore claims of good signal-to-noise ratio. Basically, we require a mixer that will accept a signal from the microphone, amplify it and pass that signal on to a tape recorder. We know that a tape recorder will produce some noise and it is reasonable to expect that the mixer will produce less noise than the tape recorder. What then should be our criteria, in technical terms, for assessing the noise performance of a mixer? If we consider that 1  $\mu$ B of sound pressure represents an average sound level (the *peak* value of a normal voice, speaking at a distance of 1 metre from the microphone), then we expect the microphone to convert this into a voltage which would be amplified by the mixer and fed into a tape recorder with, for example, a peak signal-to-noise ratio of 55 dB. Since we are concerned with the peak voltage level that can be recorded on to tape, we are also concerned with the peak pressure of a person's voice. We should thus expect the mixer not to impair the signal-to-noise ratio of the tape recorder. This is a tight specification to meet but at least it translates manufacturers' data into meaningful terms and attempts to answer the question 'Will this microphone, linked to this mixer, cope with the kind of work that I wish to do?' The recording of orchestras and soloists are examples where a really good signal-to-noise ratio may be essential if serious recording is envisaged. To help us translate manufacturer's data into something more meaningful in physical terms consider fig. 1.

On an average signal, the microphone pro-

(continued on page 101)

# now... fabulous FREE OFFERS

with superb

## AKAI

Tape Recorders  
from  
R.E.W

All on Interest Free Terms, one-third cash price deposit, balance over 12 months!



**FREE!** SPECIAL OFFER with each machine — FREE ACCESSORY KIT (value £12 18s.) PLUS FREE pair of Stereo Headphones, value £6. 10s. 0d.!

**AKAI 1710W Stereo Tape Recorder (left).** The Shield Type Head for High S/N Ratio. 4-track stereo/monaural recording and playback. 3-speeds (1½, 3½ and 7½ ips (15 ips optional)). Automatic shut off. Pause lever. Tape cleaner. Tape shifter in fast forward/rewind operation. 4 hours maximum stereo recording capacity with a 1,200 feet tape. DIN jack, Stereo headphone jack. 3-digit index counter with reset button, VU meters. Finely oil-finished wooden cabinet. £109.

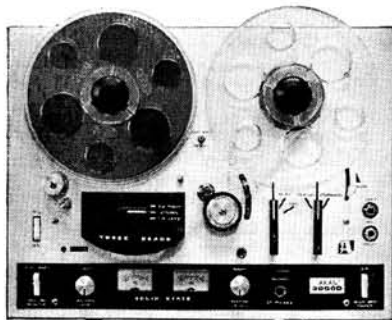

**FREE!**

SPECIAL OFFER with every deck FREE pair of Stereo Headphones listed at £6 10s. PLUS FREE COVER —PLUS TWO FREE MICROPHONES listed at 6 gns.

**AKAI 3000D 4-Track Stereo Tape Deck (above).** High Quality Three Heads System. 4-track stereo/monaural recording and playback. For playback, the 3000D requires external power amplifier and speakers. 2-speeds (3½ and 7½ ips). Three heads (erase, recording and playback heads). All silicon transistor pre-amplifier. Automatic shut off, Pause lever. Tape cleaner. DIN jack. Stereo headphone jack. 3-digit index counter with reset button. VU meters. Beautifully grained wooden cabinet. £99 10s.

Also the following superb Akai machines at opportunity prices:

**X355 CROSS-FIELD HEAD RECORDER**, our price £270 (list £331). Few left only!

**1800 8-TRACK CARTRIDGE/REEL TO REEL STEREO RECORDER** £158.

**X1800 S.D. CROSS-FIELD HEAD 8-TRACK CARTRIDGE/REEL TO REEL STEREO RECORDER** £201.

**X150D CROSS-FIELD HEAD HI-FI TAPE UNIT**, our price £106 (list £130).

**XV PORTABLE AC/DC CROSS-FIELD HEAD STEREO RECORDER** £180.

**FREE!** SENSATIONAL OFFER to every purchaser of the M9, a FREE pair of Wharfedale Super Lynton Speakers currently valued at no less than £41 4s. 0d.!

**AKAI M9 High Fidelity Stereo Tape Recorder (right)** Cross-field Head. All Silicon Transistor Amplifier. 4-track stereo/monaural recording and playback. 3 speeds (1½, 3½ and 7½ ips) plus 15 ips with 15 ips adaptor kit. Hysteresis synchronous 2-speed motor. Wide Cross-field frequency response. All silicon transistor amplifier. Sound on sound. Automatic shut off, Automatic stop. Bass switch. Tape shifter in fast forward/rewind operation. Finely oil-finished wooden cabinet or vinyl leather wooden cabinet. £195.

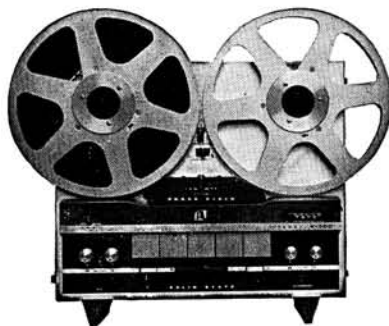

**AKAI X-300.** List price £263 18s. 3d. **OUR PRICE** only 179 gns. 10½" Reel Studio Type Stereo Tape Recorder (right). (No Belts . . . Direct Driven Capstan.) Cross-field Head. Solid state amplifier. 4-track stereo/monaural recording and playback. 2-speeds (3½, 7½ and 15 ips optional). 4-heads (erase, recording, playback/monitor plus bias heads). 3 outer rotor motors (hysteresis synchronous 2-speed motor for direct driven capstan, two torque motors for fast forward and rewind). 50 watts solid state amplifier. Sound over sound. Automatic stop, Automatic shut off. Specially 90 kc Biased for recording of FM multiplex.

**R.E.W.**

**R.E.W. (EARLSFIELD) LTD.** ★ LEADERS IN MAIL ORDER HI-FI

● HEADQUARTER SHOWROOMS AND MAIL ORDER:

DEPT. T.R., 266-8 UPPER TOOTING ROAD, LONDON, S.W.17 Tel: 01-672 4471/2 & 9175

● WEST END SHOWROOMS: 146 CHARING CROSS ROAD, LONDON, W.C.2 Tel: 01-836 3365 (opposite Astoria Cinema)

duces only 250  $\mu\text{V}$  and thus in the mixer this signal will be amplified to 0.387 V. But at the output terminals we also produce -65 dB of noise relative to 0.775 V which is equivalent to 400  $\mu\text{V}$ . Thus the signal-to-noise voltage ratio is  $0.387 \div 0.0004$  or about 970:1 which is about 59 dB. (We can obtain this figure much more simply by saying that the microphone produces half the input sensitivity of the mixer and a voltage ratio of 2:1 is equivalent to 6 dB. Thus the signal-to-noise ratio is 6 dB worse than that quoted, namely 59 dB.) Since the Revox 736 has a signal-to-noise ratio of 55 dB we may consider this an excellent mixer, assuming the manufacturer's data is correct. One final point to check up on—ensure that, at reduced input to the mixer, sufficient voltage can still be delivered to the tape recorder. In this case, there is no problem, for on the 736 the radio input has a sensitivity of 50 mV and the mixer is delivering nearly 400 mV. If, instead of the Grampian DP4 microphone, we had used a ribbon microphone of the Grampian GR2/M type with an output voltage of 145  $\mu\text{V}$ , then the signal-to-noise ratio of the mixer would be worsened by a further 5 dB. Even then on paper at least, this mixer would appear to be very satisfactory!

If a valve mixer is being considered, the quoted signal-to-noise ratio is again slightly misleading—but for different reasons! All valve microphone mixers are inherently high input impedance devices and the signal-to-noise ratio is quoted on this basis. For example the Mullard designed input mixer described in *Circuits for Audio Amplifiers* is quoted as having a signal-to-noise ratio of 50 dB on the microphone channels with a 3 mV input signal at about 2 M impedance. For all low and medium impedance microphones, a step-up transformer will be required. Now transformers do introduce some noise into the input but, excluding hum which is a separate problem, the introduced noise is less than a corresponding amplifier stage for the same voltage increase. Typically, transformers introduce about 0.5 dB to 1 dB of noise (due to the random movement of electrons set up by the resistance of the windings).

My own measurements on a Ferrograph transformer with a 1:65 step-up indicate an increase in noise level of about 0.8 dB. Hum is by far the largest problem with microphone transformers and good Mu-metal screening is essential. From the above we can see that linking up this transformer to the Mullard mixer has worsened the signal-to-noise ratio to about 49 dB. On the other hand, we have increased the input sensitivity to the mixer from 3 mV to  $3 \text{ mV} \div 65$ , or 46  $\mu\text{V}$ . Now, if we have a microphone producing, at 60 ohms impedance, an output of 100  $\mu\text{V}$ , (for example the AKG D19C), we can readily see that we have an overall signal-to-noise ratio of about 55 dB (i.e. an improvement in the designer's specification of about 5 dB). Although transformers that are properly screened are quite expensive, they do offer a method of increasing very low signal levels without any appreciable increase in noise. Against this advantage, there is the difficulty of obtaining a wide flat frequency response using a transformer input stage. In order to obtain a good bass response, the inductance of the transformer must be sufficiently large and the interwinding capacitance at the top end of the frequency range presents a problem, especially with a very high turns ratio (hence the 1:100 turns ratio limit). Transformer input stages are also sometimes used in conjunction with transistor microphone amplifiers, and a well designed input transformer and first stage amplifier would appear to offer the best compromise of all the design considerations.

The last point to be considered when comparing microphone mixers is that of the

distortion level of the mixer. Low level amplifiers in general have fairly constant distortion up to a given level, after which the distortion will rise fairly rapidly. A typical distortion figure at the rated input level is about 0.2%. This figure should be well below the maximum distortion level of a tape recorder which is normally 3%, and a number of semi-professional tape recorders at 100% modulation level produce a distortion level of under 1%. The maximum signal that a microphone input stage will take before the onset of serious distortion (normally 5%) is a figure not often stated by manufacturers. However, it should be emphasised that the input stage is likely to overload long before the microphone starts to distort the signal. Consider the AKG D202 microphone for a distortion level of 0.5% the microphone will accept 500  $\mu\text{B}$ . Since the sensitivity is quoted as 0.16 mV/ $\mu\text{B}$  this means that a pressure of 500  $\mu\text{B}$  will produce (500 x 0.16) mV of output i.e. 80 mV; and at 200 ohms impedance! Obviously, it is not reasonable to expect any microphone amplifier to accept such a high level of input, and a resistive pad would be used to attenuate the signal, but it does emphasise the kind of output levels that can be produced by a microphone. A good amplifier can stand an overload of about 40 dB, but many mixers will overload with more than about 25 dB (i.e. an 18 times voltage overload).

This then concludes our investigation into the specification data for a microphone mixer. The author is always willing to discuss problems on microphones and mixers—but please enclose a stamped addressed envelope!

FIG. 1

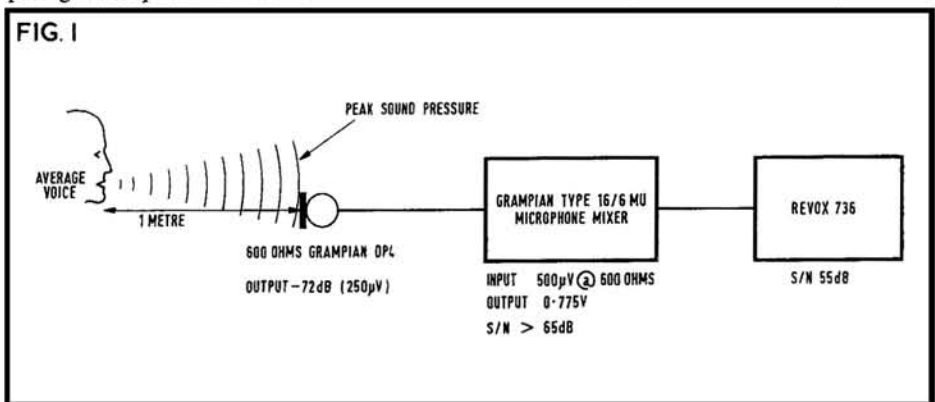

**SLIDE CHANGING CONTINUED**

elements are valves instead of transistors; another is that feedback is 50 Hz mains derived, this being more suitable for valves than transistors. However, there is no reason why the device could not be transistorised, battery-powered if required, and an exercise is in hand to produce such a counterpart.

Now, unlike the more conventional run of synchronisers, the pause-operated AVD unit can be electrically or acoustically connected to any sound source with the minimum amount of trouble, as shown in fig. 6. At (a) the coupling of signal from the tape recorder, for instance, to the unit is electric, and the signal can be obtained either at low impedance from an extension loud-speaker socket or at high impedance from a monitor socket. At (b)

the coupling is acoustic, and here a microphone is used at the input of the unit to pick up sound from the speaker of the partnering audio equipment (e.g., tape recorder or record player) or, indeed, from a human speaker! As long as the deliberate pauses in the commentary have a longer time period than the natural pauses and match the pause-time setting on the unit, then a slide change will result only during a deliberate pause and not during a natural pause.

In practice, slight differences between the time periods of the pauses on one commentary tape are of little moment, and this is handy from the domestic point of view when a commentary tape is being programmed to give the required slide changes merely by ceasing to talk. For example, with a projector, tape recorder and sync unit set up as in fig. 6 and

with the sync unit switched to manual, commentary can be recorded in the usual way to match the slide while it is being projected. At the end of the commentary for that particular slide, the manual change button on the sync unit is depressed and care is taken to avoid recording during the time that the slide is changing. Immediately the next slide is projected the commentary is resumed, and by this technique the tape is automatically programmed to change the slides—simply by using the time taken for the projector to cycle from one slide to the next as a measure of pause time.

The pause system obviously lends itself to stereo working, which is difficult—often almost impossible—to achieve by separate track synchronising.

\*Audio Vision Developments (Oxford) Limited, Abbey Street, Eynsham, Oxford. Subject of British Patent.



**FIG. 1** TRUVOX 100

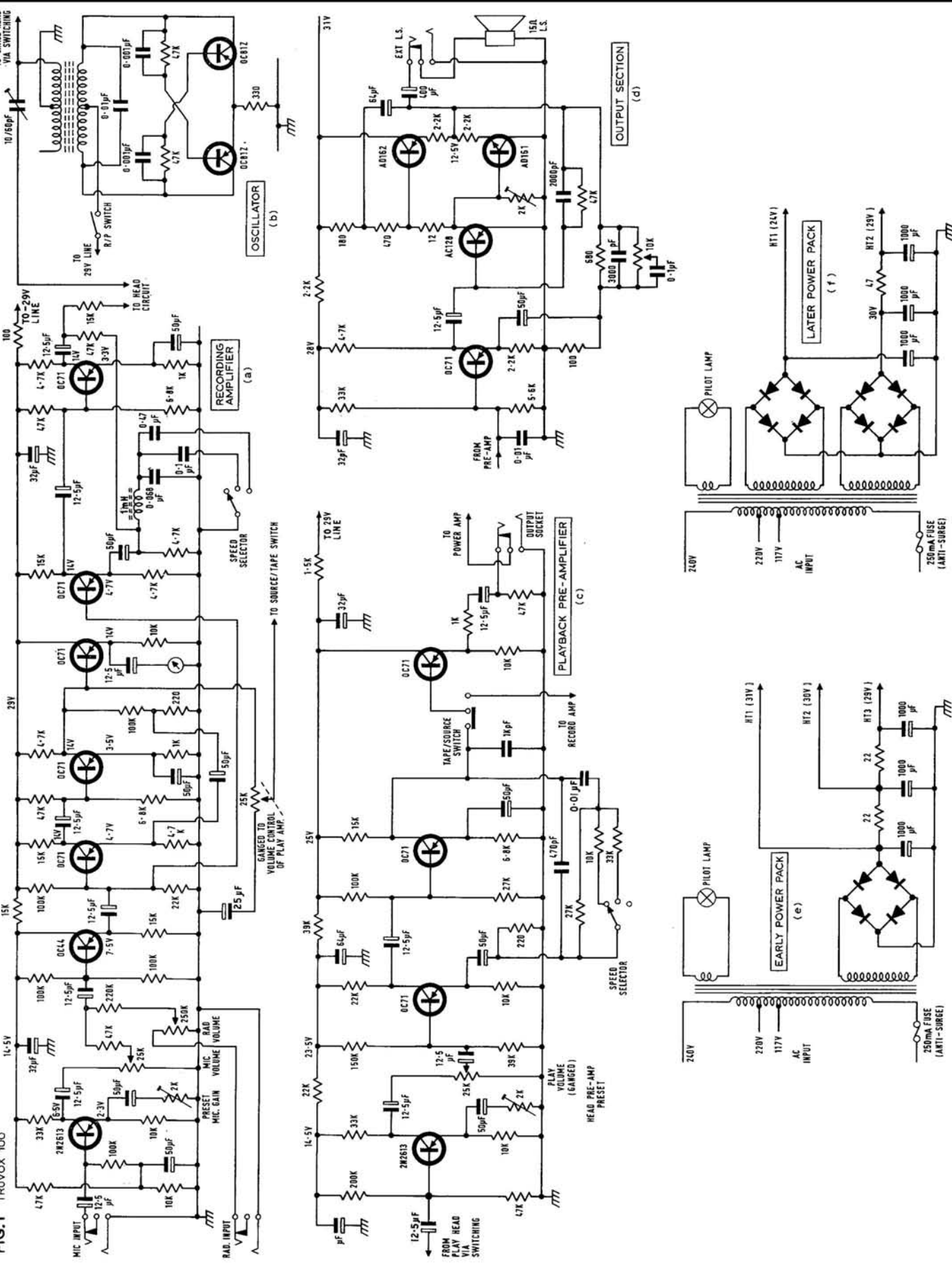

THIS month, the pleasure of fulfilling a long-standing promise. Next, probably, the uneasy task of explaining why many others of equal importance have not been kept. You can't win 'em all.

It is a long time since we took a close look at the Truvox range of machines, and then we were concerned as much with mechanical matters as with the circuit. Despite the Editor's kind offer to let Mr. Tutchings do some of my work for me—Alec to review a machine while I refer to his published circuit—I must crave the first page for a circuit of the basic 100. Whereas Alec is concerned with pristine newness, this section must concentrate on models that have been around long enough to gather a few barnacles. The *Series 100* saw the light of day in March 1965, and quite a lot has happened at Truvox (and *to* Truvox, I may add), since that auspicious day.

A Series, to this firm, denotes a collection of models with the same basic design, but differing in facilities. Fundamental specifications are the same. The last figure of the model number will be 2 or 4, indicating the number of tracks, and the prefix R means complete tape recorder, whereas PD stands for deck with preamps only. In addition, this range carries an RB variation, a rather more opulent, and higher priced, model with teak finish instead of the familiar grey PVC covering. This finish will be better known now since Truvox introduced low-fi (surely an advertising blunder, inviting adverse quips) with the *Series 50*. The RB models have the snob name *Belgravia*, but are the same as the standard models in all respects that concern us.

Decks are similar to the 90 series, with only minor modifications, principally concerning the key structure and assembly. The main deck difference is in the head mounting and structure, with its three-head formation. The machines with which we are dealing at present are mono, whereas the PD models, which we shall have to leave for this month, are stereo units with a number of circuit variations.

### THREE SPEEDS

Before delving too deeply, let us run through the basic specifications, if only to show what the owner is hoping to get for his nearly £100. All the decks are three speed, 19, 9.5, 4.75 cm/s, and take an 18 cm maximum spool. Fast winding in either direction, for a 1200 ft tape is stated to be one minute. One would expect this with a three-motor machine, but in practice I have found wide variations, especially where the voltage of the mains supply is widely differing from the tapping. As these models only offer two choices (for each principal mains supply—further choice includes tappings at 100-120 V). The rather close rating of the mains transformer, plus the heavy demands of the motor, militate against using the primary of the mains transformer as an auto-transformer (remember Colin Brad-dock's hints about the Brenell?)—there may be a risk of slow running under adverse conditions. Capstan motors of this series are designed to operate at 220 V AC.

If the conditions are known, and will remain constant, it is sometimes possible to experiment with values of power factor capacitor to ensure constant take-up, but inadvisable unless you must. As one of the questions that has

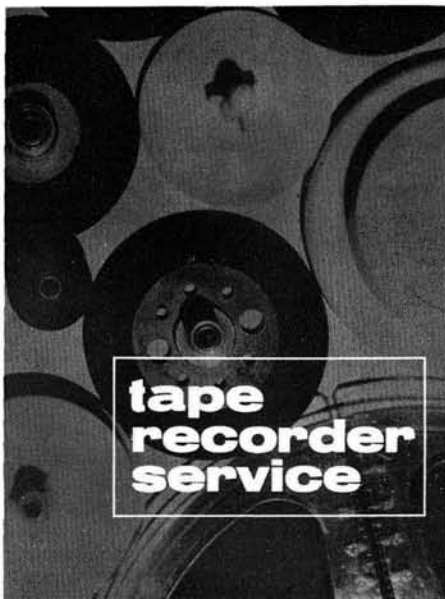

## TRUVOX SERIES 100

BY H. W. HELLYER

prompted this article requires details of the motor switching and associated deck wiring, let us leave this subject until more space is available. Too often, your correspondent is accused of digression.

Frequency response of all the models in this range is the same, and is specified as 30 Hz-17 kHz $\pm$ 2 dB at 19 cm/s; 40 Hz-10 kHz $\pm$ 2 dB at 9.5 cm/s; 40 Hz-8 kHz $\pm$ 3 dB at 4.75 cm/s. These figures do not tell the whole story, and this is another point we shall have to consider when we talk about response checking.

Signal-to-noise ratio of the  $\frac{1}{2}$ -track models is 50 dB, and of  $\frac{1}{4}$ -track models 47 dB. (Greater



than 50 or 47 dB is usually stated—except in some of the advertising literature, where some unlucky copywriter guessed wrong and turned the small arrow on its wrong side.) But let us not be snide . . . given that heads are kept clean, and the material of those horrible pressure pads is now changed for something a little more suitable, the overall s/n ratio can be kept to quite respectable proportions. It could certainly be improved by the use of more modern transistors. (See page 116!—Ed.) Circuits with such stalwarts as the OC71 and OC44 have a strangely old-fashioned look—and sound.

Next specification point worth mentioning is the output power, which, in the case of the 'full' models is 5 W. Actually, although the front of the grille is the same squared plastic (honeycomb grille, I suppose you could call it) as used in the *Series 40*, and familiar from the enterprising advertising that Truvox employ, a good lower register is achieved and the ultimate sound is quite pleasing. When the PD models are linked in to an audio system, with the added advantage of stereo, it takes a lot of beating. The output from these models is 1 V at a rated impedance of 100 ohms. This is, of course, the output from an emitter follower, with the same circuit configuration as at the External Amplifier output of fig. 1. In fact, except for minor differences, the circuits are identical, making servicing quite a simple matter.

### CONVENIENT AND ACCESSIBLE

Let us go on record here and now as saying that the whole of the electrical layout and design of these models has evolved with a view to easy circuit tracing and testing and is, in the main, quite convenient and accessible. There are, it is true, some awkward components, such as the power pack filters, tucked away under the mains transformer mounting bracket, where even a test prod on the solder tag is not a feasible proposition; but it takes very little head-scratching to find alternative test points. This is made much easier for us by the laudable practice of marking component identification numbers on the printed panels. As is the nature of things, many of these numbers are obscured by the components. But there, you can't have everything. At least, having struggled to remove a precious resistor, you will know which wrong one it was.

The other good point relevant to this servicing practice is the marking of interconnecting tag points. Although our circuits have deliberately been redrawn to save space, and these tag-point numbers omitted, it should be fairly evident that the interconnection of printed circuit panels could prove a headache for someone tracing faults through for the first time on any apparatus. Truvox cater very sensibly for the owner or service engineer who has to find his way around. There are one or two small discrepancies on the circuit, which, as drawn in the manual, leave the output section and the oscillator positive return lines floating about in mid-air.

While on the subject, it should be mentioned that this circuit has a positive polarity to chassis, the *p-n-p* transistors being used in their normal (common-emitter) mode in most cases. In practice, you will find that the tag No. 30 on the oscillator sub-panel is used as  
(continued on page 125)

# Flight R2 to Hong Kong

P. G. de Bourcier

**D**URING the outbound flight, we will be showing you a film about Hong Kong. Shortly after take-off, you will hear the sound from the engines decrease considerably: this is a normal feature of the noise abatement procedure used in the climb-out. We will be taking off in about one minute, so will you please ensure now that your seats are in the upright position, and that your seat belts are fastened.'

The development of air travel has made the hostess's customary pre-departure briefing familiar to many people—but it is usually heard in the confines of an aircraft cabin, rather than in a spacious modern church hall: this article will describe a simulated flight to the Far East to meet a missionary at work, presented recently at Epsom Methodist Church. Authenticity was made possible by the extensive use of recorded sound, and I am prompted to describe the flight to answer the recent pleas in 'Column Speaker' (November *Tape Recorder*) for news of creative amateur projects; if it gives you ideas for comparable enterprises, so much the better.

The pattern originated eight years ago. In 1960, World Refugee Year, a group of young people at EMC decided to present a fundraising project with a difference, a simulated flight to several places around the world at which there were refugee problems. At each destination, the local situation was described with films, slides, or stage-work. Sound effects on board the 'aircraft' were provided by a 78 RPM commercial disc (1), and one live microphone off-stage. This project (R1) was remarkably successful, perhaps partly because the television habit had not yet developed its present grip and an amateur presentation did not have to approach professional standards to draw a respectably large audience.

This summer, one member of the 1960 group, now a minister, came back to Epsom on furlough from his work in Hong Kong, and the present group leaders met to devise a good way for him to meet as many people as possible and put them in the picture about his work.

Recollections of the WRY evening provided the clue, and I was called in to 'fly' the aeroplane again and to look after the provision of the sound effects. This was an excellent opportunity to put my recorders to constructive use, and the immediate problem was to decide how to achieve the greatest possible realism with a brick-built aeroplane that couldn't get off the ground. In 1960 we had made do as best we could with the limited facilities then available, but this time I felt that we had no right to settle for anything less than a high standard: much more comprehensive facilities were available, and the group's ability to get good support had grown in part from aiming to keep its presentations that bit better than the average. If you

want to do your audience justice, this is the only way to work. (I should perhaps point out that the group is still a young people's one, with older help called in for particular occasions—it was on that basis that I was asked to help this time.)

The format we settled on was this: a quarter of an hour before takeoff, the passengers check in at a subsidiary hall, see fig. 1, the departure lounge (airport hubbub recorded at Heathrow, Terminal 3, with passenger calls for BOAC, QANTAS and other Far East flights, and our R2 calls added at intervals). Leaving the reception desk, passengers are conducted by uniformed cabin staff through the walkway and foyer (outdoor airport noises, aircraft taxiing, distant take-offs), into the aircraft (light music from cabin speakers at the front, the various hums associated with an aircraft about to start up audible from the rear). Eight minutes before take-off the engines start in turn, at the rear; the music fades, and the hostess briefs the passengers from the stage, using a live microphone to the front speakers. In the meantime the aircraft taxis out (variations of engine note). The briefing is timed carefully so that the hostess sits down a minute or so before take-off remembering that, once the tapes are running, the departure cannot be delayed for tardy passengers. During the take-off (engine roar from the rear), the cabin darkens, and the curtains close: a projection screen is run into position behind them, and as soon as it is ready and the engines have been throttled back the hostess, now out of sight, announces the film. The film starts, and the cabin sounds fade right out, the curtains open to clear the screen, and the passengers see a 25 minute film about modern-day Hong Kong.

Just before the film ends, cabin taxiing-in sounds become evident at the rear; at the finish of the film the hostess steps in front of the screen and announces that we have arrived at Hong Kong, and that the cabin staff will escort the passengers to the airport terminal where the minister and his wife will meet them. The passengers disembark back to the first hall, now laid out with seating and equipment ready for a talk-with-slides presentation, which the minister and his wife give in the form of a tour of centres of interest in Hong Kong.

At the end of the tour, the minister puts the passengers in the care of the airline staff again, to return to the aircraft for the flight home. Music and sounds at this juncture are as for the first embarkation but the hostess's briefing is much shorter, announcing that after take-off, supper will be served on the homebound flight. When the take-off roar has faded, music comes in again at the front speakers, and the cabin staff get busy serving the meal.

When the passengers are finishing their supper, the 'landing tape' is started. This brings in engine in-flight sounds at the rear, and a captain's announcement at the front—'We have just crossed the English Channel

and are descending under the control of London Radar. To keep you in the picture as to where we are during the final stages of the approach, we will be feeding into the cabin loudspeakers the directions from the radar talkdown controller . . . we will be landing at Heathrow in nine minutes.' After a few minutes of in-flight sound only, while the cabin staff clear up, the talkdown comes in at the front—not usual airline practice, but helpful in this context to make people feel that a real landing is imminent. At 'GCA touchdown, touchdown now', the engines moan down to idle, straightaway open up to the roar of reverse thrust that is maintained until the aircraft has slowed down, and then come back to taxiing RPM. The hostess announces our arrival at Heathrow—'Those of you who are expecting transport home will find it waiting in the airport car-park'. The engines wind down to a standstill, and the production staff heave a sigh of relief!

So much for the plan. What of the actual recordings? We will take these in the order in which the passengers hear them, first of all the 'airport hubbub' in the departure lounge. Recording the original sound presents no problems to anyone with a portable recorder, if he is prepared to put up with a stare or two. I took my Sony TC-800 (bought on the strength of the *Tape Recorder* 'road test') to Heathrow, put the microphone on a seat beside me and read a book for half an hour. The general public are sufficiently wary of the unusual that no-one came near enough for any one conversation to appear recognisably on the recording. Airport loudspeaker calls are very boomy, at least at Heathrow. Gatwick ones are clearer but their content would have been unsuitable for R2 purposes. To get something akin to equivalent ambience for the R2 passenger calls, while retaining enough clarity to ensure that our passengers would comprehend and respond to them, these calls were recorded by installing the announcer and microphone in a bathroom. Even then, it was necessary to add some extra echo on the mains recorder. These announcements were then dubbed onto Track 2 of the Heathrow tape, at carefully timed intervals; three preliminary calls were used, and one 'final call'. This latter was made in the still polite, but slightly exasperated, tone of an announcer a little hardened by having to spend all day chivvying passengers along (no disrespect intended to anyone, there, rather my sympathy!). The final master tape was copied by parallel playback to give a single-track working copy.

I had intended to record the outdoor sounds for the foyer on the same visit to Heathrow, but I goofed and left the windshield at home, with the inevitable consequences. Instead, a substitute tape was made up from recordings already available. This was better than the live recording would have been, because it allowed one extra touch of finesse that would not have been easy the live way. One set of engine starts



was so timed that, as the last passengers came towards and into the aircraft, they would hear properly synchronised sounds outside and inside the aeroplane. An engine was starting as they came 'up the steps', then inside the cabin they would hear the 'same' engine continuing to wind up, but now sounding suitably muffled.

The aircraft interior sounds took the most work to prepare, because of the amount of editing required to get the original tapes down to the necessary timing, without introducing any sudden discontinuities of engine power in the process. Here I have a confession to make. I am not usually keen on reading how someone else has made a special recording, if he has had access to opportunities or elaborate equipment not available to myself as a layman and amateur recordist. It leaves me with a 'so what—I couldn't do that' feeling; and the aim of this article is to prompt you to use the facilities you have, not to frustrate you with tales of another persons' better fortune. Even so, I must admit that getting in-flight recordings was straightforward for me, because my job is flying transport aircraft. Even though, once in a while, well-accredited people not in the business are able to get access to aircraft, as witness 'The Sound of Weymouth', in the

(continued on page 114)

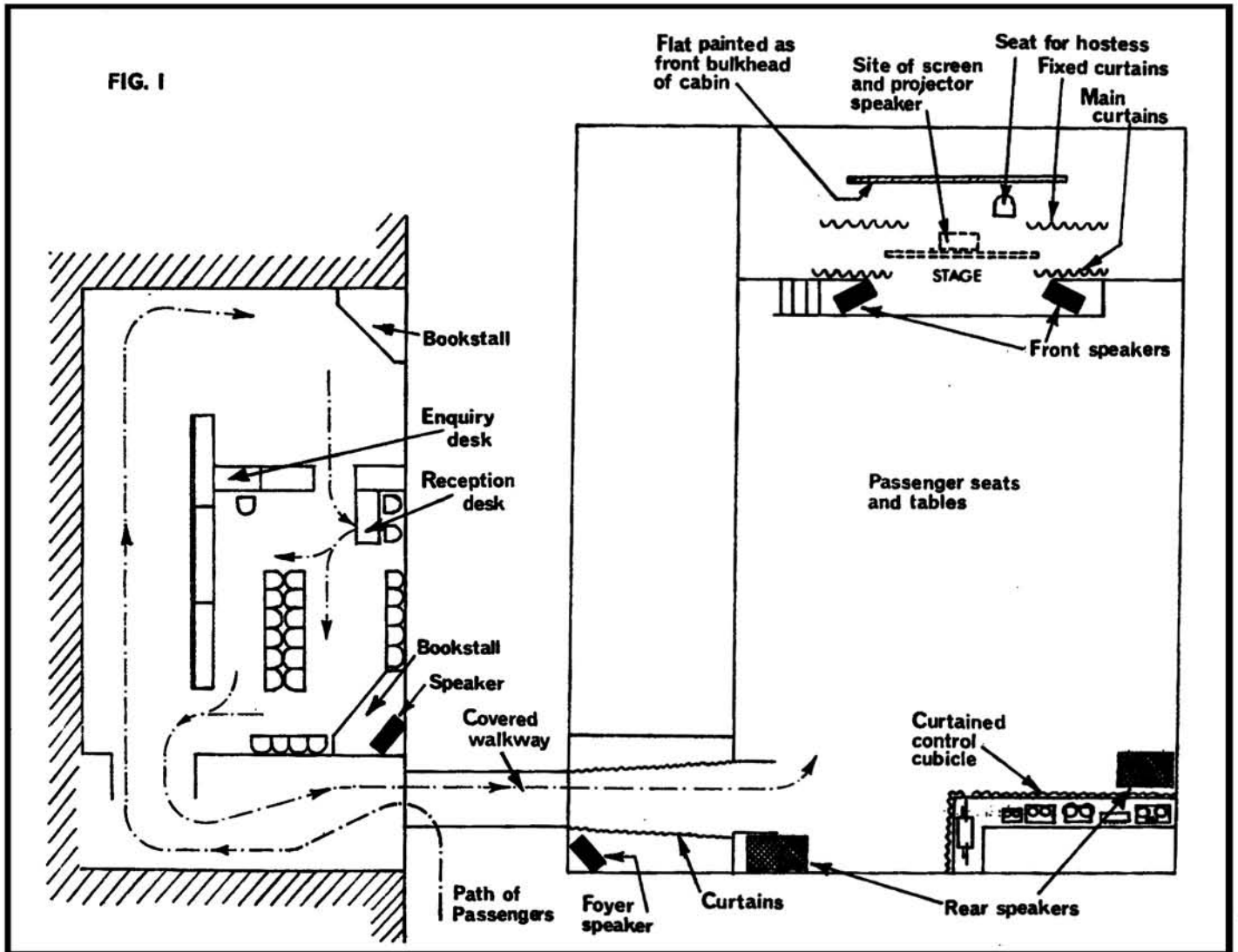
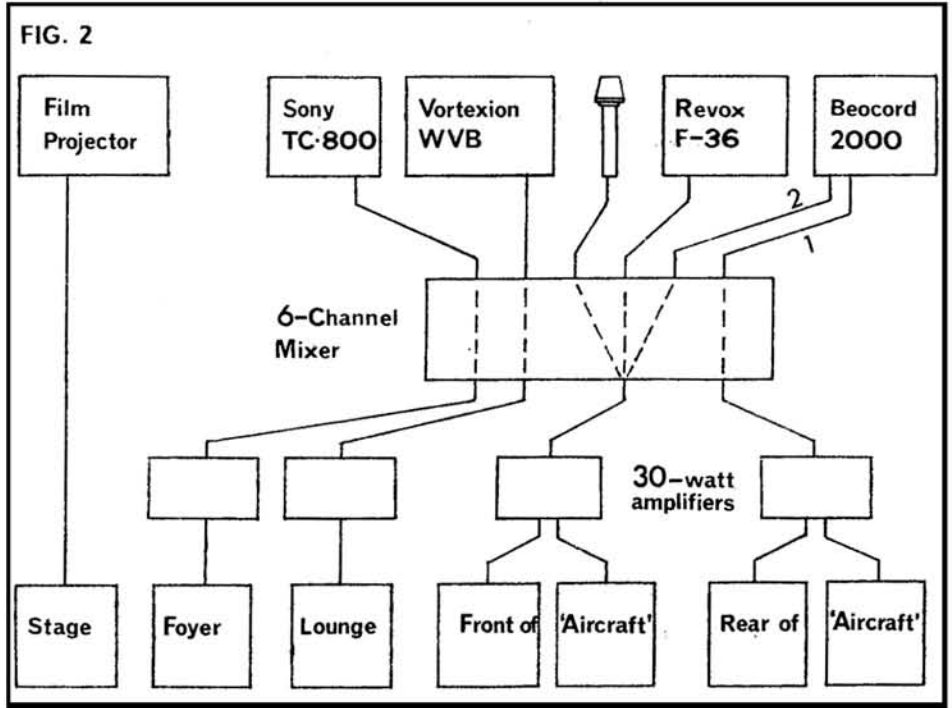

# HEATHKIT offer the Best Selection of Hi-Fi Equipment in this CATALOGUE

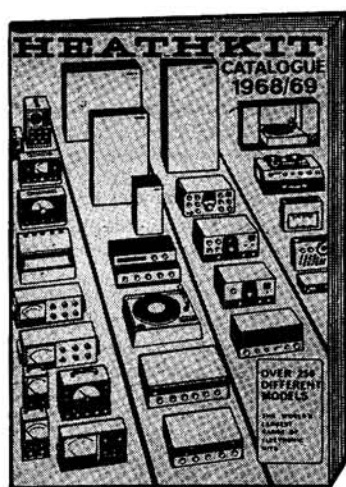

it's  
**FREE**  
on  
request

- STEREO AMPLIFIERS
- STEREO RECEIVERS
- STEREO FM TUNERS
- SPEAKER SYSTEMS
- STEREO TAPE RECORDER
- GARRARD PLAYERS
- SHURE CARTRIDGES

and many other domestic and hobby models including Stereo Record Players, Transistor radios, Car Radios, SW Receivers, Audio test and service equipment. All available as kits or factory assembled ready to use models.



DAYSTROM LTD., Dept HT-3 GLOUCESTER, GL2 6EE  
Tel.: 24951

Please send me  FREE COLOUR CATALOGUE

Name .....

Address .....

# AKG smooth microphones with smooth performance

AKG offers you a range of microphones that look good, sound better, and give unrivalled performance at an economic price. Choose from:



### AKG D-200

Dynamic two-way cardioid microphone with smooth frequency response superbly suited to fidelity recordings. Very strong and rugged metal construction complete with quick release pivot stand adaptor.



### AKG D-202

High-quality, dynamic. Two-way cardioid design — separate high- and low-frequency systems in a single housing for powerful directional performance and level frequency response. Minimum feedback. With unique housing design.

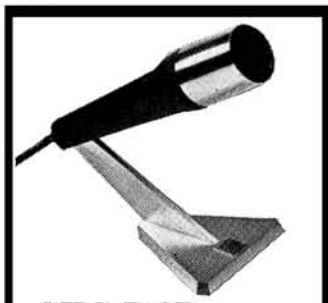

### AKG D-9D

Dynamic omnidirectional microphone to give sensitivity and style at extremely low cost. Level response over wide frequency range. Elegant styling—robust construction with metal grill and plastic body complete with attractive table stand.

Find out more about AKG mikes from



Politechna (London) Ltd. 182-184 Campden Hill Road,  
London, W.8. 24 Hr. Telephone: 01-727 0711 Telex: 23894

# AKG microphones

# PEAK LIMITERS IN THEORY & PRACTICE

By W. H. Myall

THE coincidence of several events during the past few months, together with the scarcity of printed matter on the subject of peak limiting, has prompted my putting forward some views on the subject, together with the results of a few experiments, both from the technical and aesthetic angles.

I should like to refer to Peter Bastin's article 'Recording for Disc' which appeared in September 1968 *Tape Recorder*. At the time of reading this, I had already spent several months on a project which I would expect to be the very answer to one of the points raised in the article.

The relevant paragraph is at the end of page 421 for those who have kept the copy. For those who do not have access, it concerns the necessity for requesting a singer to sway back from the microphone when hitting those particularly resonant notes which find their way to the record-level meter umpteen dB up on anything that has gone before, resulting, on replay, in a ghastly and probably familiar blasting sound, unless one is quick enough to turn down the record-level control by the right amount and at the precise moment. This demands considerable practice and an intimate knowledge of just what to expect and when.

Peter Bastin goes on 'I don't think there is any real answer to this particular problem'. Now I am not a dedicated sound recordist, either professionally or as an amateur; my interest revolves mainly around the mechanics of the business but, from a purely technical viewpoint, the type of limiting I have in mind would seem to be the complete answer to this problem. In fact I could almost go as far as to say that I thought these resonant notes were put in by arrangement between the composer of the aria or whatever it is and the manufacturers of peak limiters, to their mutual benefit.

Aesthetically I have no complaints either, but I hasten to add, I may not have the musician's critical ear.

It would be interesting to have Peter Bastin's reasons for discounting the peak limiter. I suspect it must be either on the score of cost, and some are quite prohibitive, or that their shortcomings outweigh their advantages.

The particular problem of Peter Bastin's I regard as one of the lesser tasks because the overload neither starts nor ends abruptly.

A far more difficult one would be a quiet passage of music punctuated by a revolver shot. If, in this instance, one was conscious of the

music level rising immediately after the shot, then the recovery time of the limiter would need to be shorter. Fortunately, such extreme cases are not frequent.

I doubt whether the 'screaming soprano' would even be aware that the occasional note was of *quite* such a large amplitude, let alone intentional.

As with most, if not all, sound producing devices, the human voice has its resonant frequencies and a little thought will at least show how a singer *could* be unaware of the fact, or at best, unable to do anything about it, if indeed anything needs to be done in the usual way.

Resonance, as we know, occurs at a particular frequency and therefore tends towards a sinusoidal waveform. Now it is a characteristic of pure tones that they do not have the same apparent volume as a complex wave of comparable amplitude.

If there is any doubt about this, the reader may like to try the following two experiments. Record, first, a pure tone at a very low level on the tape and follow this with a musical programme at about the same level.

On playing this back, the volume of sound from the sine wave, as judged relative to the noise level, will probably lead you to the conclusion that the musical passage to follow will be quite useless. My experience was that this was not borne out due to the greater apparent volume from the second recording. The second experiment consists of whistling a tune into a microphone connected via an amplifier to an oscilloscope. The whistle produced by the human lips is particularly unmusical and the oscilloscope shows why . . . it is almost a pure sinewave. Continue whistling. Sooner or later you will hit a particular note whose amplitude is much greater than the rest (if you have no luck, try changing the key . . . or the tune). The thing to notice is that the apparent volume is not nearly as much greater as the display would lead you to expect.

I should add that these conclusions are my own and are, of course, open to question.

Assuming they do have a sound foundation, their relevance to our screaming soprano will be obvious. The action of a limiter in this case, whilst reducing the distortion which would otherwise result from the overload, would not even demand much payment in terms of dynamic range because the considerable reduction in recorded amplitude would not be matched by a similar reduction in apparent volume.

The project in question was to be a small transistorised peak limiter primarily intended for use with portable battery recorders.

This is the type of recorder which most

frequently meets with the unrehearsed programme material; location work, outdoor interviews and the like and in which it is difficult or impossible to know what is going to happen.

One solution is to record at a low level, but we all know the penalty for that . . . high noise. And it is not the complete answer anyway.

Although it takes care of the fellow with the fog horn voice, there is often another who cannot then be heard at all. We have all seen the television interviewer thrusting his mic forward to catch something from an unexpected and feeble voice in the crowd.

On occasions like this, dynamic range runs a poor second to intelligibility and easy listening. I mention dynamic range here because this is the price demanded by a peak limiter for its services.

Before we start getting at cross purposes it may be as well to explain what a peak limiter does or, to be quite accurate, what I think it should do. At least we shall all be on the same rack.

There are several terms in use to describe various devices whose gain or attenuation is a function of their input. Volume compressor, record-level clamp, automatic record level or AGC, even the highly descriptive 'curve bender'. Let's see where peak limiter fits in with this little lot.

Commence with a normal tape recorder devoid of any such attachments. The standards to which these conform (more or less) are such as to ensure an output, on replay, which is a faithful reproduction of the input. It is the linear relationship between input and output amplitudes which concern us here.

If we plot this input/output relationship we shall get a straight line as shown AB in fig. 1.

Let us now apply a small single tone input and increase this in discrete steps, turning down the record-level control at each step in order that the output amplitude at each step shall be proportional to the log of the input amplitude. (It would be very tedious, if at all practical actually to do this, but we can still pursue the argument.)

The logarithmic law is not significant but will suffice for our purpose. Let us repeat this process until the tape loading approaches peak record level.

A plot of these points will then be found to fall on a curve such as AC. We can be quite certain that all the points *do* fall on the curve because there is virtually no limit to the number of steps we can take and how close together the points become.

Note that the means by which we found this  
(continued overleaf)



curve is significant. We increased the input in discrete steps, adjusting the amplifier gain at each step. In other words, the input amplitude was constant as each measurement was made.

Although the curve AC is a plot of input against output, it is not a recording characteristic. If it were, we should have distortion because, as we all know, we go to great lengths to ensure that this is straight. If we were to plot the instantaneous values of input against output at each or any step we should in fact get a straight line.

The instantaneous signal voltages can be regarded as operating along the straight line ON, tangential to the curve AC at the point P. The point P is found by erecting a perpendicular from a point on the input axis indicating the input amplitude at any particular step.

The slope of the line ON represents the amplifier gain and can be regarded as 'rocking' on the curve AC and taking up a different position at each discrete input step.

What we have shown so far is that it is possible to produce an output whose amplitude is not linear with the input and yet is otherwise a perfect reproduction, namely quite distortionless.

Unfortunately, this is only true because we have been taking measurements at discrete steps and whilst the input amplitude was constant.

If we now repeat the exercise, now using an input whose amplitude is increasing slowly but continually, measuring the output amplitude at intervals of time, we shall get a similar curve to that of AC, but this time the output will not be distortionless.

The signal voltage is still moving along the line AB but, as the input is increasing, the line is rotating clockwise and maintaining contact with the curve AC. The signal voltage therefore moves on a curve.

The conclusion to be drawn is that a change of amplitude is inevitably accompanied by distortion of the waveform.

Fortunately, the prospects for volume compression, or variants of it, are not nearly as bleak as they may seem at the moment.

Who, for example, would say that he can actually hear the increase in distortion as he changes the volume of his radio or audio installation.

Before pursuing this further, let us consider the terms 'compressor,' 'limiter,' etc. It should be clear that these refer to 'bending' of the straight line AB according to some law or other. The curve we produced (AC) results from a progressive and non-linear reduction of amplifier gain as the input increases, and operates over the whole of the input range. Such a device would be called a 'compressor', or, if used in reverse, that is, an increase in gain with an increase in input, an 'expander'.

The curve of a peak limiter would come somewhere between the straight line AB and the curve AC.

The general idea is that over the greater part of the input range, say up to 6 dB below peak record level, the gain should be constant, the limiter playing no part at all. Input levels above this range would find the straight line moving over to become similar to the curve

AC, thus compressing the louder passages of programme material in much the same way as the volume compressor.

By a suitable choice of curve, as much as 20 dB can be comfortably compressed into that final 6 dB below peak record level.

What about the automatic record-level device intended, no doubt, to make the record-level control obsolete?

The significant difference here is one of time constants. Instead of the gain being re-adjusted from one instant to another, it takes rather a prolonged period of low signal level, following a high one, before the full gain is restored. I believe Alec Tutchings reviewed a recorder which took several minutes to recover from a loud passage.

However, let us not forget the title under which we are writing and get back to the peak limiter. We found earlier that we could change the amplitude of a signal at the price of a certain amount of distortion. Provided we make the change slowly, the distortion is so minute as to be negligible. If we make the change rapidly, the distortion is much greater but is offset to some extent by the fact that the period of the change, and of the distortion, is shorter.

One of the earliest decisions that needs to be made before developing a peak limiter concerns the desirable period of attack and recovery. Here the aesthetic angle becomes dominant. The demands have to be met or we are wasting our time.

In the same way as motion pictures take advantage of the human eye's inability to recognise a brief interruption in its appreciation of an illuminated scene, so we can take similar advantage of shortcomings in the ear.

If we attempt to combat the most difficult job the limiter could be called upon to do and can meet with something even less than complete success, then the lesser tasks will take care of themselves.

Bearing in mind that it is the overloading signal itself which has to control the gain of

the amplifier, we cannot reasonably expect the control to be fully effective in less time than the period of 0.25 cycle of the overloading frequency.

If we take, as a start, 5 kHz as the highest frequency which is likely to give overloading problems (higher frequencies are not likely to be encountered at large amplitudes) we arrive at 50  $\mu$ S as a suitable attack. If, on account of the ear's insensitivity to events occupying such a short space of time, we can afford to lengthen this period, then so much the better.

The view has been expressed that this can safely be extended (80 times) to about 4 mS but my own humble ear, however tolerant, is not so sure.

There remains now the period for recovery. This is the period over which the reduced gain is restored to the level it had prior to the arrival of the overload.

This is, again, a question of how long we can afford to make it, from the technical angle, and how short it simply must be, from the aesthetic one.

If we make it too long we are going to be conscious of the volume level having dropped suddenly (generally known as a 'hole'). So we have to look once again at the ear's degree of perception . . . or rather lack of it . . . to see just how long we can afford to make it. The answer I came up with is about 50 mS.

One may wonder why we are so concerned at not making either the attack or the recovery any shorter than absolutely necessary. The reason is that these short time constants are not easily achieved over a wide bandwidth, say, 40 Hz to 5 kHz with consistently low distortion, thus the longer we can afford to make them the easier the task becomes.

One may also wonder at the large ratio between the two; 1000:1. The only explanation I can suggest is that the ear becomes numbed by a loud sound, taking a little time to recover its perception of a lower level of sound.

Let us take a peak limiter with such a  
(continued on page 114)

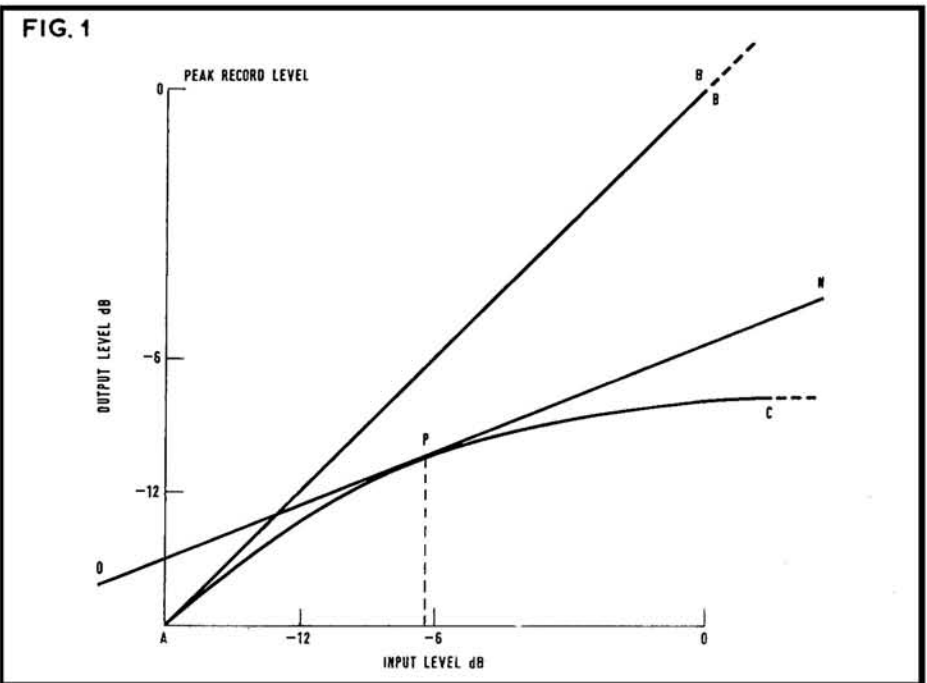

# A WINDSHIELD FOR A STEREO PAIR

BY M. G. SKEET

**F**EW microphones, as supplied, have the necessary protection from the wind to give reliable results if used out of doors. To suit a Ficord *IA*, modified to record stereo,\* a stereo microphone with the following features was required:

Wind protection.

Single hand operation, freeing the other hand for recorder control.

Immunity from noises produced as a result of being hand held.

Low cost and good performance in terms of frequency range and stereo separation.

As a London Microphone Company *LM200* cardioid mono microphone was already in use, another was purchased. Taped together with axes at 90°, both are suspended using a rubber band inside a shield constructed from four 15.3 cm flour sieves with ladies' stockings as the membrane protection medium. The result is larger than perhaps desirable but all the requirements are met, especially the third. The suspension also means that vibrations produced by the wind on the shield are not transmitted to the microphone body. This proved to be the disadvantage of a previous windshield design for a mono cardioid microphone which was sensitive to handling noises.

The best procedure for construction is as follows:

Tape together the microphones, axes at 90°, as shown in fig. 2. The leads are taped back along the body to reduce their effective length. All the tape used in the prototype was *Rotunda PIB (Polysisobutylene)*. This is a self amalgamating tape and the 25.4 mm wide type was used.

The rear pair of sieves are shown in the background of fig. 3. The rear inner sieve has the eyes and handle cut off flush with the rim. The rim of the rear outer sieve is removed; the mesh does not fray. Soldered all round the cut edges is a length of tinned copper wire of some 20 SWG. A number of layers of material from ladies stockings are imprisoned between the inner and outer sieves. The number of layers depends on the conflicting requirements of wind protection and the effect on high frequency response. The prototype has six layers of 15 denier material. The outer sieve is held to the inner by passing short lengths of 25 SWG wire through the two meshes and twisting the ends. Excess stocking material is then trimmed.

The microphones are eventually to be suspended inside the front pair of sieves and fixed to a handle. Fig. 4 shows three eyes on

the rim of the inner sieve. These are modified from the two wire eyes and handle already on the sieve when purchased. Inside the inner sieve, 20 SWG wire is soldered to provide support for the rubber band. These are placed adjacent to the outside eyes. The leads from the microphones have to pass through the shield. This can be done by making an oval tube from tin plate and fixing with solder assisted by a couple of bindings of 25 SWG tinned copper wire. This is shown in figs. 4 and 5. A close up of the lower microphone suspension hook is also shown in fig. 5. The outer front sieve should have the rim removed and the edge wired as previously described. It is necessary to cut the mesh and divert this wire around the point where, when the sieves are assembled, the cable exit tube abuts against the outer sieve. The front half of the shield is completed when the stocking material is put between the sieves and they are wired together.

The microphone suspension is shown in fig. 6 and a single rubber band is passed over the hooks and around the microphone bodies. Large stationers should be able to supply a band with material 8 mm wide by 2 mm thick and 12.7 cm long when folded flat. Tension is controlled by binding with 20 SWG wire as shown. The microphone leads (less plugs!) have previously been passed through the exit tube. To de-couple the microphone from any vibrations transmitted up the leads, the latter are taped to the exit tube both inside and outside the shield. It is essential that the microphones take up the correct attitude within the shield—not pointing up or down and not biased left or right by either the suspension or the leads.

The halves of the shield are taped together using the excellent self amalgamating tape. This should be stretched to half width as it is applied.

The handle in fig. 7 was quickly made of 3.6 cm x 3.6 cm hard wood some 13 cm long. Taped to this were the three shield supports. These were made of suitably bent bicycle mud-guard stay wire. The supports were tightly taped to the eyes on the shield. To make things more manageable the two leads were taped along the underside of the handle.

When fitting plugs to the leads take note of the colours of the conductors to ensure correct phasing of the microphones. In use, the microphone should not be moved during recording. Moving a stereo pair plays havoc with mobile and static sound sources. The microphones have proved to provide realistic stereo information. Left and right channel separation is restricted by the front and rear discrimination of the microphones chosen.

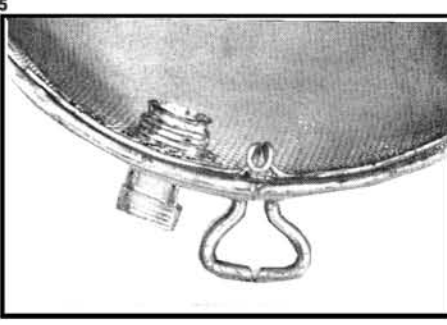
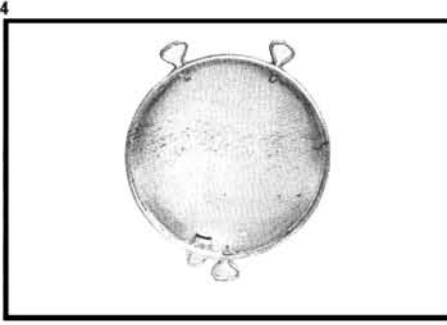
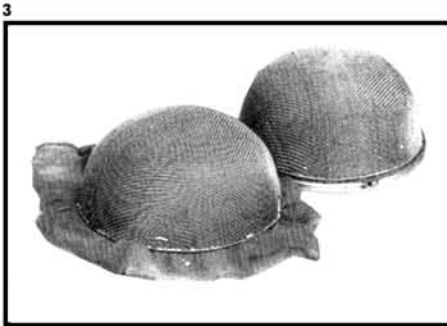
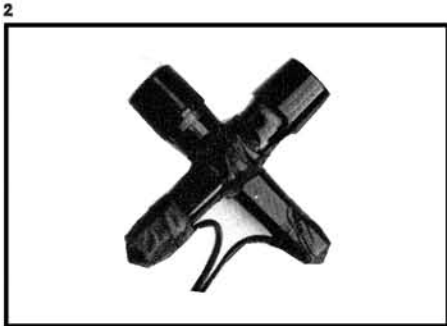

\*Constructional feature in preparation

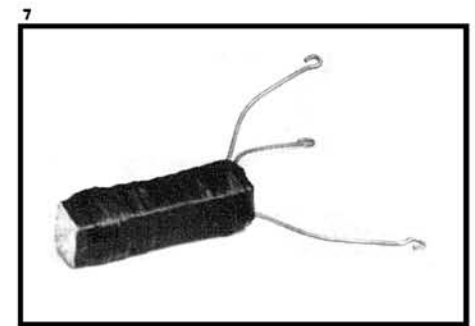
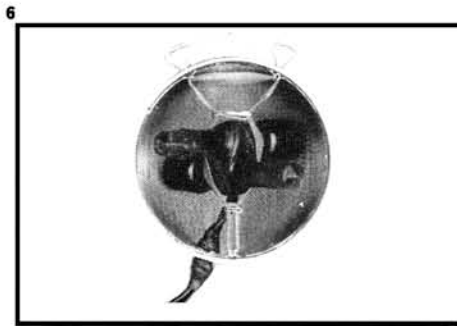

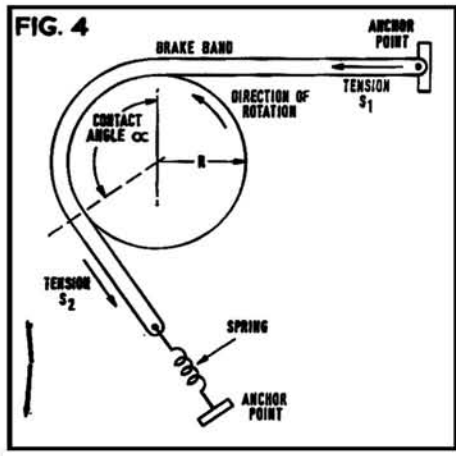
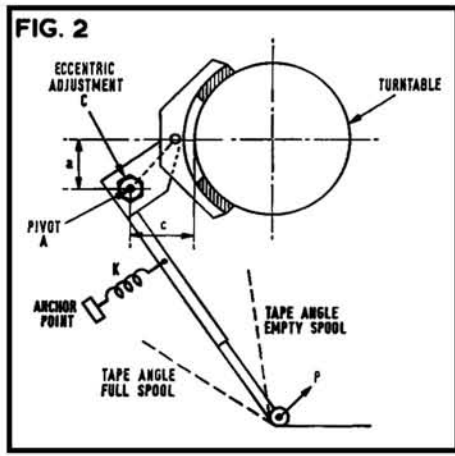
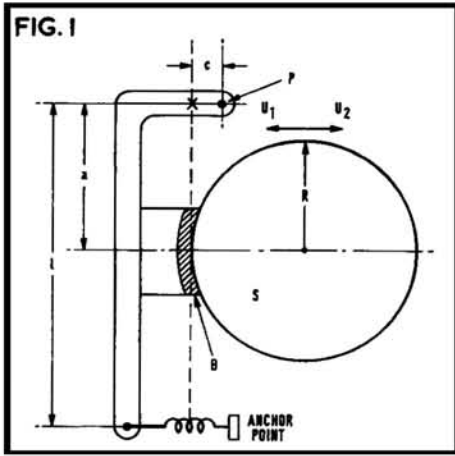

# WHAT'S IN A BRAKE?

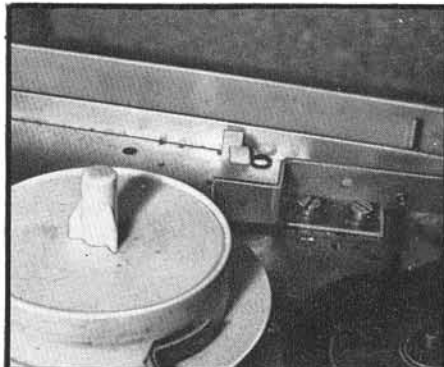

A

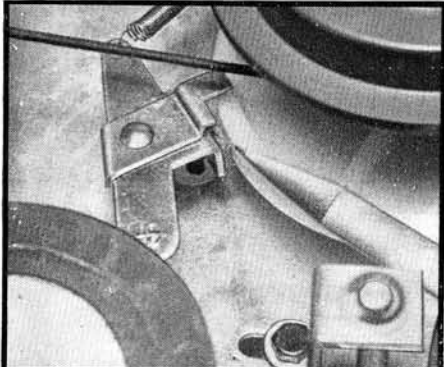

B

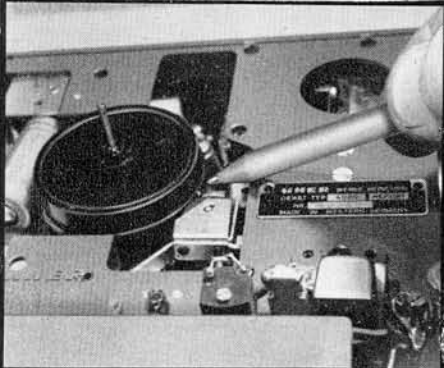
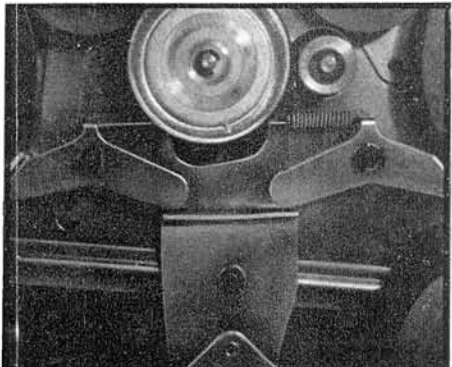

D



E

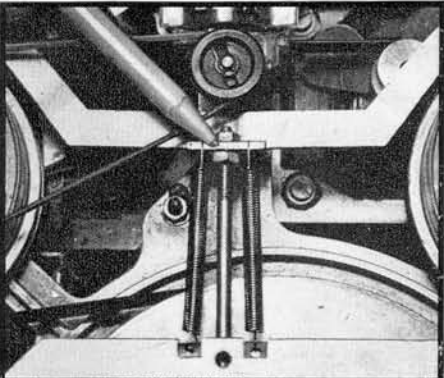
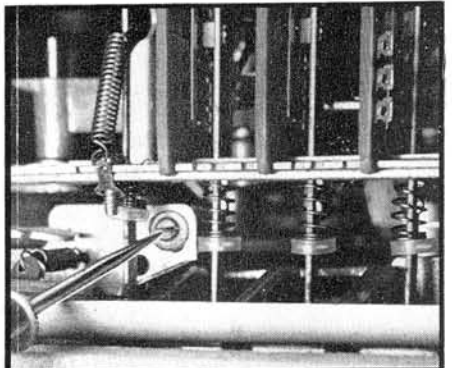

G

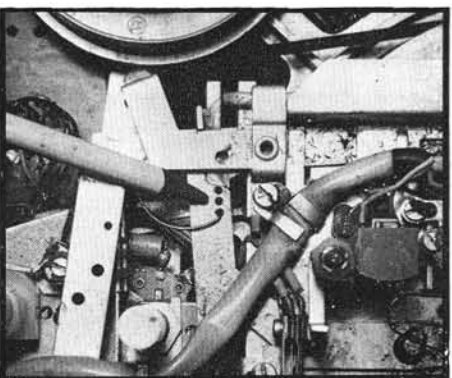

H

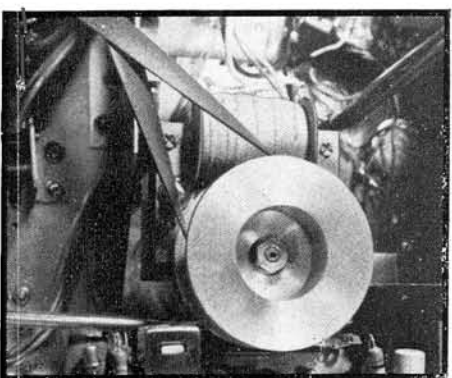



**W**ELL, it's obvious, isn't it? A brake is simply a device to stop something from moving.

True, but there is all the difference in the world between a decent servo brake and a hob-nailed boot stuck between the spokes of a wheel. With tape recorders, the problems are raised by the varying torques of the spools, plus the fact that they have to be braked at slow and fast basic speeds and in forward or backward rotation. A fairly delicate tape is being driven by the capstan pinch, fed from the reservoir spool and taken up by the winding spool; it is important that no tape spillage should occur when the tape halts, nor any jerking that could cause stretching or even breakage. During fast wind in either direction it becomes even more difficult to time the applied braking pressure so that these troubles can be avoided. Brakes can therefore be of quite carefully thought-out design, although appearing simple in operation.

A look at some of the popular methods used by various tape recorder manufacturers should give us an insight into the problems of braking. In passing, it may also help us solve some of the tricky faults that beset so many machines. When we consider braking, we must remember that there are two types: the *operational brake* that applies a varying tension to the tape as it runs, and the *stopping brake*, whose only function is to bring the tape to a halt. More accurately, to bring the *spools* to a halt, for the tape itself is often handled individually, as we shall see. In the first class the many different methods of clutching can be included, and some of these we have already discussed in detail ('What's In a Clutch?' August and September 1968).

Static brakes can be essentially simple. Perhaps the simplest, if least used, is the fixed pad of some earlier Grundig models, where the spool carriers themselves moved sideways when the function knob was turned, braking the spools momentarily *between* functions. Allied to the double clutching of these models, this apparently rough-and-ready method proved surprisingly effective. We had less trouble with braking on the older models than with many later designs—but of course, the winding time was much longer, the spools rotated fairly slowly, torque was not so great. The only real adjustment was the exact positioning of the brake pad in relation to the edge of the spool, made possible by the simple expedient of an elongated fixing hole.

Other 'brute force' methods include the cork, composition, rubber or felt pad mounted on an arm which is spring loaded to engage the spool carrier when the mechanism is in the STOP mode, and held off by lever action when the tape runs. The only adjustment on many of these is an alteration of the pad's position. This can only be achieved in such basic designs as the BSR or Thorn decks by a bending of the mounting arm. The usual trouble—when it did occur—was hardening of the brake pads, which allowed a small amount of slippage. To bend the arm as a compensation for this fault is a mistake. The answer is replacement of the brake pad. It is important to use the right material: no use cutting up Auntie's felt hat for a brake pad if Uncle's cork leg would have been more appropriate! Even on the slow-running decks, the torque at the

## BY WILLIAM HENRY

**Fig. 1** Servo-action brake. The differential is obtained by the position of pivot and brake pad relative to the spool carrier.

**Fig. 2** An operational brake that maintains partial restriction as the spool turns, determined by the amount of tape spooled. The 'hard on' action is differential by virtue of the shape and position of the brake arm.

**Fig. 4** Servo action by rubber or fabric brake band is effective with high-speed mechanisms. The wrap angle is important.

- A** Simple peripheral brake as used by Philips.
- B** Magnavox 363 brake is uncomplicated but depends on firmness of spindle and bracket; see the cross-headed nail type of fixing, which can loosen.
- C** Thorn-Ferguson example of the fairly popular swivel arms with common hold-off principle. Some differential action can be provided by bending the lip of the hold-off lever, as shown accentuated here.
- D** On many battery portables, the brakes are simple pads, there being very little torque to overcome. The Uher 4000 uses a roller mounted in a pivoted bracket to supply friction.
- E** The idea of a roller is capable of some refinement and a form of servo action can be seen in this type, where the roller either slips or wedges as the lower spool section rotates.
- F** Brake adjustments may be hidden, as in this example beneath the keys of the Collaro Studio deck.
- G** The popular Philips threaded rod and locknut brake adjustment. The fact that it has to be augmented by bending the end of the brake lever is typical of Philips!
- H** Auxiliary brakes take many forms and this example of a sprung and lockable arm with a small peripheral pad is by Philips. Adjustment involves locating the spring in alternative holes, as indicated by the pencil.
- I** True servo operation is only obtained when the rotational speed is controlled. This entails some braking action all the time and in this Sony VTR example the heavy brake coil is shown mounted adjacent to the main drum. To stop quickly, a heavy current passes, imposing a strong flux in the opposite direction to rotation. Speed is continually monitored and the deceleration is very even.

**Fig. 3** Simple differential action can be obtained by using a tongue of pliant material which follows the direction of rotation as the brake is applied.

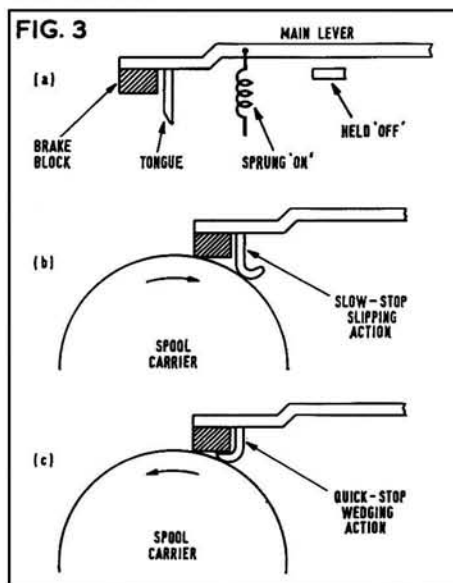

beginning of a fast wind is enough to spill off tape from a badly braked spool.

The spring, on many of these models, acts between the two brake levers, holding them towards each other, and is thus on the opposite side of the brake lever pivot. Sluggish action can be caused by a weakened spring, but this is not a common fault. The hold-off action, too, is quite positive, dependent mostly on a direct thrust of an angled lever, and the only real adjustment is the setting of the lever to initiate the holding off action. If this is too premature, the pinch-wheel pressure takes over and some spillage followed by a clutch jerk, and the 'hiccup' of the first notes of a recording will be the result. Too late an action can cause tape stretch and scuffing.

These peripheral pad brakes are found on many designs where modest cost was the criterion. They are quite effective, seldom give trouble, and permit little adjustment. As a compensation, their action is obvious on immediate inspection, and they need not occupy too much of our space here.

Moving on a step from these, we find the types of brake that impose a modified differential action. We have already mentioned the fact that the supply spool is braked slightly before the take-up spool, to prevent tape spillage. This means that first there must be some sort of adjustment to determine exact brake position, and second, that this adjustment can also take into account the direction of motion. Although these adjustments may appear straightforward, they often need a good deal of calculation and experiment, as anyone who has attempted to build a tape deck can verify. (Pause for rueful memories.)

Letting someone else do the work, we may quote the example of one type of servo brake, as used in Telefunken designs, and described in admirable detail in H. Schroder's book, *Tape Recorder Servicing Mechanics* (Iliffe, 21s.). Using the example of a shoe brake, Mr. Schroder goes into revealing design details. The system is as shown in fig. 1, where the brake B is shaped to have an intimate contact with the spool carrier S, in this case the left-hand turntable.

Stopping time depends on the rewind speed, the moments of inertia of the spools, and the braking moment, which is adjusted. There is a limit to this brake moment, imposed by the tensile strength of the tape which is to be used. The brake is designed to try and wedge itself on in the supply direction, so the position of the arm pivot P will be determined by the type of brake employed. Ratio of braking moments between left and right direction of travel is determined by the contact or wedge angle and the co-efficient of friction (hence the need to use the correct material). A ratio of about 1:1.5 or 1:2 is reckoned to be enough for domestic machines, while studio models that use this type of brake (and many use vastly different systems) is more like 1:3.

The important point to note in this design is the exact position of the pivot. If it were at X then it would lie on the tangent of the spool and the braking moment would be equal for rotation in either direction. By angling the arm, using a spring at the lower end and altering the pivot point, precedence is given to the R-U<sup>1</sup> braking moment. If we also consider

(continued overleaf)

the length of the arm and the strength of the spring, we can work out the exact braking moment, thus:

$$Md \text{ (braking moment)} = R \times K \frac{a}{l} \left( \frac{1}{\mu} + \frac{c}{a} \right)$$

where  $\mu$  is the co-efficient of friction.

This leads us on to the more involved types of brake that combine operational retarding with stop action, and Telefunken are once more a prime example of the method. Harsh words have been spoken about these 'operational' brakes, especially in the servicing articles, but when all is set up properly, they are remarkably effective.

Fig. 2 shows the basic layout, also with a supply (left-hand) spool as an example. The brake lever pivots at A, and the pressure of the brake shoe against the turntable is determined by the spring K. The eccentric bushing C alters the ratio of the braking moments. When the machine is running, the tape acts on the pin P to oppose the pull of spring K, and the amount of tape on the spool will alter the angle so that there is constant tape tension. On stopping, there should be no spillage at all. The distance c is the important factor here, and for a servo ratio of 2:1 we note that  $a = 3 \mu c$ . We, the users, can do little about a and c, but the frictional coefficient depends very much upon the way we have maintained our tape recorders, and the operational tension depends on our setting of the eccentric cam.

Servo brakes need not be quite so complex, however, and on many Philips machines we will find a compromise system that again, when all is in order, works very well. By making the brake in two parts, with a flexible 'tongue' and a direct action pad, the direction of rotation of the spool can determine the locking action. As fig. 3 shows, the tongue bands with the turning spool as the brake approaches the ON position b, and when the spool is rotating in a supply direction, i.e. left spool anti-clockwise, as in c, the tongue 'locks' sooner and a greater braking action is obtained. Unfortunately, with these brakes, bending of the levers is often the only available adjustment, and some discrepancies can occur.

Grundig have a clever differential method with their last-generation models. By using a lightly sprung, pivoted plastic piece, they manage to achieve both the locking action and the direct brake pressure in one go—but the action of such brakes again depends on the exact positioning of levers and rods, and adjustment comes down to adroit use of pliers or a bending rod, and depends very much on experience.

Perhaps the best method of servo braking is the brake band that imposes servo action by virtue of its shape. The Collaro *Studio* deck was a prime example of this, and when these fabric brake bands were clean, and the drums in good order, the halting action from a very fast wind could be smooth and efficient. Experience was necessary to halt the spools at the required point, and editing is by no means easy.

The principle is as shown in fig. 4, where the same nomenclature as before is employed.

The contact and wrap angles are important design factors and the coefficient of friction depends very much on the 'polishing' action to which the fabric band has been subjected. On the *Studio*, minute aluminium particles could easily become embedded in the fabric and reduce the brake efficiency. This was especially noticeable when clumsy tightening of spools had scarred the edge of the screw access hole, and on more than one occasion brake drums have had to be 'skimmed' to regain correct brake action.

It has already been mentioned in servicing articles, but can bear repeating, that the clamping of the *Studio* drums to the motor spindles is a weak point. Removing the drums, sawing a vertical cut in the shaft cylinder, cleaning, refitting and tightening so that the screws make a good marriage with the cylinder and shaft: this is the answer to the problem of sluggish rewind at low torque.

Servo types are not always fabric bands that clamp with varying pressure according to the direction of rotation on a smooth metal brake drum. The obvious variation, a steel band clamping on a tyred drum, is used extensively by Revox, and even at the high peripheral torques of the larger spooled models, we get very little bother with brakes. But an 'editing stop' from fast wind motion is still not a feasible proposition, and our friends at Ferrograph have come up with the solution of a controlled rewind speed on their *Model 7* machines. This is by no means a new idea; professional recording machines have used motor control for years, and in the early days, even the 'ordinary' machines attempted some kind of control.

The Reps modification of the *Studio* deck, to add a really usable pause function—even though it was unfinished by the absence of a lock function—became a useful device for manually controlling rewind speed and braking at the precise required moment. Even Robuk, for all their failings, used a kind of cord and spring control at the braked spool that provided a controlled deceleration. Brake bands were used, but with a much smaller angle of wrap than we have seen illustrated, and with sprung lever holding-off positions. The adjustment was by locknuts on a stop bolt, and the main operating lever reached right across the underside of the *K10* deck. To complicate matters, the pivots of the brake actuating arms were themselves variable, giving a fine degree of adjustment. They were on fairly long arms, held at a point roughly level with the downward (or forward) side of the brake drum and midway between stop bolt and brake band. The outer ends of the arms clamped under a crossbar, tightened down with another locknut device, and by swivelling these arms, a variation of pivot place could be obtained.

#### SELF-DEFEATING

It seems likely that Telefunken wished they had thought of this first—the ultimate in brake angle adjustment! But, in practice, such fine adjustments defeat themselves, and one of the troubles we always experienced with the Motek deck, with its one minute rewind for a 1200 ft (400 metre) length of tape on an 18 cm spool was a tendency for tape to crease and jam between the flange and the spooled wrap every time someone operated the keys with less than optimum confidence. But the example

serves to show that servo brakes are by no means an innovation.

To be fair, the halting of tape from fast winding is asking rather a lot of a machine. One design with a good reputation, no less than the Brenell, also employs the system outlined above, without those movable pivots but with the stop-bolt device, and their motors on the early *Mark 5* decks achieved a frightening 45 seconds for an 18 cm spool of Standard Play tape. The control, however, being a knob which had to be firmly centralised, was quite positive, and once we became used to selecting our stopping point well in advance, was no great bother to the user. In fact, we Brenell fans had fun in achieving a beautifully controlled stop by turning the knob to neutral, then to the opposite wind and quickly back again, to obtain a smoothly controlled opposed-torque stop, *a la* Revox (or Ferrograph)!

#### FUNCTION TO FUNCTION

There was, of course, the stabiliser brake on the old Brenell deck, acting on the feed drum to maintain good tape tension, and this could complicate matters when things go wrong. As this is supposed to be a practical article, may I say that the best method of servicing is always to work from function to function. That is, make sure first the transport is correct, and this would include the operation of stabiliser or retarding brakes, and only then to proceed to the rewind or fast forward function to adjust or manipulate brake action. Even though the complaint be of erratic rewind, for instance, this method of investigation can pay dividends. One tends to overlook the influence of subsidiary factors on the main function. To give another instance, the influence of Grundig pressure spring clutching on the brake action. If you fly straight to the brakes and test rewind the end result is spilled tape, unless you have first made sure that the basic transport system during PLAY is correct. Solve your braking problems on PLAY first, and you will often find that you have cured the rewind fault as well. Our earlier example of the Philips method should underline this advice.

Carrying this argument to its ultimate, we come to the type of machine that has no brakes at all—and here we need look no further than the example of the Tandberg clutching method, illustrated and spoken about in our dissertation on clutches.

By providing an opposing torque, the maker solves his braking problem. Not always ours, for stopping any of these machines from fast winding to edit becomes a matter of experience and an adroit twitch of the thumbs.

On computer mechanisms, where such an operation is a critical design parameter, we find that the solution of the clutch problem is also the answer to the brake conundrum, and in the end, quite simple spool brakes can be used, despite the very high speeds of winding. What you gain in simplicity in one direction, you have to pay in complication in another, and we find that the tape drive is very finely controlled, and the tape itself is allowed a very large loop between spool and head channel. The two favourite methods are (a) reservoir drums, and (b) spring-tension servo mechanisms.

Method (a) entails the tape being allowed to  
(continued on page 123)



ONE meets an amazing diversity of equipment when moving around the smaller CCTV installations and sometimes a lack of planning is evident, whether through lack of ready money at the right time or inability to forecast future requirements. One studio I visited recently, and one concerned with training students for broadcast television, seemed to be quite proud of the fact that nearly every leading manufacturer had contributed something to their stock of equipment. Briefly, there were two very good broadcast cameras of different makes, standing on wheeled tripods, and three small industrial vidicon cameras on fixed tripods. All very new and quite expensive. There was a good zoom lens to compensate somewhat for the lack of a pedestal but there was hardly any room in the studio to use it efficiently. Furthermore, the versatility of the two excellent broadcast cameras was limited by the very small two-channel vision mixer which had no provision for effects. Added to this was the obvious limitation of the VTR department. The equipment consisted of a Sony 50 mm helical-scan as master, and an Ikegami 25 mm helical-scan which was used for exercises with the industrial cameras. Hardly the apparatus to give experience in broadcast videotaping with transverse-scan machines. But one must not be too severe. The unit had started as a small CCTV using industrial equipment and then, suddenly, someone had decided to upgrade the situation to meet the tremendous expansion that CCTV has seen over the past few years. The result was that the programme had grown out of all proportion to the original intention. This sort of situation is not uncommon, and may be met with more frequently as more authorities become further involved without fully understanding all the implications.

Happy indeed is the authority who understands what it is all about and has the money to go about things in the right way. One of these is Glasgow University who have contracted EMI Electronics to equip their new TV programme origination studio at Southpark House. The studio carries four EMI 201 vidicon camera channels; two cameras have zoom lenses, one a four-lens turret, and one is used in a telecine system based on the EMI Type 401 that is to be seen in many broadcast studios. Other equipment includes a production control desk with special-effects generator, a solid-state vision-mixing and switching system, an eight-channel sound-mixer, a quadruplex videotape recorder, and full sound reproduction facilities.

Even when a very tight budget is involved, sensible planning and a clear-cut perspective can solve many seemingly impossible difficulties. Take the case of the Motion Picture Department of the Ravensbourne College of Art, Bromley, Kent. The head of department, Bob Butler, and chief engineer, John Lisney, were drawn from the television industry and had experience in film production.

From the outset their programme had been laid down for them. They were to train students for careers in film and television, and running simultaneously with this course of study would be a course for technical operators, these students being trained so that they would be able to work in professional film or television as operators or engineers (see May

1968 *Tape Recorder*). These requirements dictated the type of equipment to be used. For example, if one is to train a student to operate a broadcast television camera, it is of little use to practise his technique with a small industrial camera on a lightweight tripod. He needs a professional camera and, in order to track accurately, a heavy-duty, well-balanced camera mount and pedestal. These considerations seemed sensible but money was lacking to buy new equipment. For these reasons further technical decisions had to be made. The Ravensbourne CCTV system would use a 405 line standard, the main installation would be monochrome equipment to start with and the staff would use their contacts in film and television in order to buy the best possible second-hand equipment at reasonable prices.

The cameras required would have facilities which one would not expect to find on industrial cameras and would incorporate the following:

A turret that could take a zoom lens when required.

The lenses on the turret to be so mounted that a wide-angle lens could be set up with a narrow-angle lens without obstructing the wide-angle field.

A continuously variable density neutral filter controlled by the vision engineer, so that the amount of light falling on the tube may be controlled without altering the depth of field.

The cameraman's monitor to be switchable by the vision engineer so that a superimposition of the cameraman's own picture and that of another camera could be seen, thus allowing captions to be lined up.

Three talkback systems:

Camera to producer only.

Camera and vision engineer only.

Omnibus talkback—general system for whole crew.

Needless to say there was some hard bargaining before the first four cameras arrived but the purchase was most satisfactory. A vision-mixer was then installed, of Marconi design and incorporating eight channels, three of which could be switched by the vision engineer to receive a remote source. 'The problem of remote source or the switching of non-sync vision is also an important aspect of television', said John Lisney. 'In actual practice, a CCTV system does not usually involve a problem of this nature but at Ravensbourne we simulate these conditions by using the Mobile TV Unit or a VTR as a remote source and we are therefore concerned with the problem of slaving'. The mixer incorporates a vision cutting system, lap-dissolve, superimposition of three images, wipes, and electronic effects.

For the audio system they were able to obtain a Pye 16-channel audio mixer designed specifically for television and this has all the facilities normally found in a broadcast studio—group fades, pre-fade listen, foldback and so on. An audio jack field is incorporated to give the system maximum flexibility. The sound control room also has tape and disc replay facilities so that effects music can be added to the programme sound. When the studio opened, the sound room had to be capable of producing a soundtrack for a TV programme and prepare pre-mixed material on 6.25 mm inch tape for later use in television or

# CLOSED CIRCUIT

BY RICHARD GOLDING

## PLANNING A CLOSED CIRCUIT TELEVISION SYSTEM Part One

film soundtrack. This second requirement would not normally be carried out in a TV sound control room and it is intended to remove this facility from this area and incorporate it in the new studio complex due for completion in the near future. This will take the form of sound-dubbing equipment with the Ampex 351, at present doing the job in the sound control room, working in conjunction with a new stereo mixer with provision for control of 35 and 16 mm magnetic track recorders.

The main equipment requirement of the production control gallery was monitors. It was decided to hire 15 x 35 cm monitors for cameras one, two, three and four, telecine, and remote source previewing. These monitors had to be capable of running on an external sync feed. For example, if camera four is not used for a particular production then its monitor could 'free-run' and distract or annoy the production crew. By running all monitors on a continuous synchronisation feed they are stable at all times. Two switchable preview lines are incorporated in the vision-mixer, these being displayed on 52 cm monitors together with the transmission monitor which displays the mixer output. Preview line one is solely for the use of the director. On this monitor he requires the shot he is about to use, while the T/X monitor shows the shot actually in use. The director is thus only concerned with two monitors. The second preview monitor is available for the rest of the production crew, particularly the vision mixer who may be concerned with setting up complicated effects before they are actually

(continued overleaf)



## CLOSED CIRCUIT CONTINUED

used. Sitting next to the vision mixer is the technical director who is responsible for all technical matters in the production. He has his own preview line where, by pressing a button, he is able to assess the technical performance of cameras, mixer, sound levels, etc. He also has control of the master pulse generator and slaving facilities.

The pulse generator is important for picture stability. The synchronising pulses control the number of lines per frame and the number of frames per second of the cameras and monitors. If a monitor receives signals from only one camera, this camera can very well generate its own pulses and feed them with the picture signal as a composite signal to the monitor, but if the monitor receives signals from several cameras then the sync pulses should all have the same frequency, otherwise picture instability can result when switching from one channel to another.

Other equipment obtained included a Pye

Vidicon Crossfire Telecine capable of showing 35 and 16 mm film and slides. It also has a separate control console with waveform display monitoring, and sound level meters; therefore, the telecine operator has all the normal facilities at his command and is able to perform his duties in a professional manner.

'As far as transmission goes', said Lisney, 'it was out of the question for us to have a television transmitter. But, since we are primarily concerned with training operators for studio complexes, it was thought satisfactory to cover the transmission aspect in theory only. We were then left with the necessity to record the signal on videotape or picture film. We had in our possession first a Philips helical-scan VTR but, while being very useful for its mobility and low running costs, it was unsuitable for the following reasons:

'The inability to edit the recorded material meant that an important aspect of videotape technique could not be used or demonstrated.

'The incompatibility of the machine meant that students could not show their work to prospective employers.

'The technical operators would receive no

experience at all of broadcast VTR work.

'For these reasons it was decided to seek a second-hand Ampex transverse-scan VTR. We were able to buy an Ampex 1000X which, although requiring a great deal of servicing, now gives excellent results and partially solves our problems. We are now building a control console for this machine giving all the normal level and waveform monitoring facilities to be found in a professional VTR installation.'

While I was at Ravensbourne, a second transverse-scan Ampex was being installed, and plans for the department's colour phase were being initiated. A flying-spot scanner has been obtained for colour slides with the necessary 625 line pulse generation equipment and also high definition colour monitors and a shadow mask receiver. Lisney still needs cameras, coding and colour matrixing to complete the equipment.

The Ravensbourne CCTV system is obviously no copy of the BBC TV Centre but it does perform a similar function on a smaller scale, and this is what it has been designed for from the start. By recognising its limitations it has achieved outstanding success in its own field.

## FLIGHT TO HONG KONG CONTINUED

January 1968 *Tape Recorder*. But remember that the ear can be deceived quite easily, given patience and ingenuity, where this type of sound is concerned. You could do the job with exterior sounds of a single aircraft recorded at a not-too-busy airport, suitably edited, and re-recorded loudspeaker-to-microphone through some thicknesses of cloth, to simulate the effect of cabin soundproofing. Keep in mind as well the airliner you have at home, the family Hoover. Let me slip in one note of warning: do not be tempted to smuggle a portable recorder on to an ordinary commercial flight without authority—you will get into serious trouble, and it could endanger the aircraft.

Once your in-flight sounds are ready, you

can add embellishments like the captain's talk to the passengers, a radar talkdown, and so on. If you decide to use a talkdown, it is almost easier to make one up than to use the real thing, provided that your prospective passengers are unlikely to detect non-authenticity. For R2 I used a recording made direct from an aircraft intercom system. This gave me an evening's work cutting out references to the callsign, which was nothing like 'R2', and tidying-up any poorly enunciated words which would have been incomprehensible to the audience. The artistic licence involved in using a talkdown at all was justified because it built up that sense of expectancy which most passengers feel on a real flight approaching the landing. The captain's talk and the talkdown were put on Track 2 of the landing sounds tape and left unmixed, to give, on playback,

synchronised but separate speech and sounds at the front and rear of the aircraft respectively.

Finally, the diagram of our playback set-up will interest those who enjoy looking at equipment for its own sake. Most of the gear was provided by *Erase\**, a local recording firm, without whose help the production would have had to be limited to a much-reduced scale. But as I said at the start of this article, the object of it has not been to impress anyone with the amount of machinery we used; it has been purely to describe one very satisfying essay in creative taping. Our 'flight' carried 125 fare-paying passengers but, if describing it gives you an idea which culminates in a free flight for the family one winter evening in the living-room, it will have served its purpose.

\*Erase (exclusive recording and sound effects), 72 Phyllis Avenue, New Malden, Surrey.

## PEAK LIMITER CONTINUED

specification and see how it behaves in practice, what we gain and what price we have to pay (for the gains, not the limiter).

We have a typical musical programme, and are recording at so many dB below peak record-level. Along comes an unexpected crash of cymbals, say, +20 dB. As the transient wavefront moves rapidly through the region -6 dB to 0 dB, the gain is rapidly reducing. The signal reaches its +20 dB peak. The recorded crash is still below 0 dB on the tape. In fact, everything being recorded has gone down in amplitude on the tape. The whole event has taken about 50  $\mu$ S. The cymbal crash dies away and the gain restores as quickly. 50 mS later both the programme material and the limiter gain are back to normal, coincident ideally, with our ears' recovery from the intended abuse.

It goes without saying that, had the overload been a screaming soprano, the limiter gain would have remained low for as long as the scream continued.

The distortion we discovered earlier occurs only during the brief intervals in which the

limiter gain is changing. It is again fortunate that these intervals coincide, in one case with the arrival of a loud passage and in the other, at a time when our ears are a little numb and not quite up to their job. How can we be so lucky? Almost as though providence had foreseen the eventual necessity for such flaws in our makeup.

What penalties can there be left for the benefits we are receiving. Well, we suffer a loss of dynamic range of course. If we are going to compress 20 dB into 6 dB we cannot get away from the fact that 14 dB has been lost. But we do not *have* to make full use of the limiter's capabilities unless the situation demands it.

One can think of many types of programme material in which the dynamic range is of little importance. In fact, where loud and quiet voices alternate, such as in play acting perhaps, or unrehearsed interviews, a compression of the extremes can be helpful.

Another interesting aspect which may sometimes be overlooked is that since we do not have to make so much allowance for the occasional loud passages when setting the record-level, we can set it higher than we should

otherwise have done. What we gain is an equivalent improvement in signal-to-noise ratio during the quieter passages where it is most appreciated.

Looked at from the other direction, we are recording the quieter passages at a higher level on the tape. The effect is quite noticeable. The impression one gets is of having moved quite close with cupped ear to a speaking person.

It is no new experience with modern equipment to be able to hear the radio announcer take in a breath, but how many have heard him look at the clock?

In all seriousness however, I have to admit to being biased but, having experienced the advantages of recording via a peak limiter, I should no more consider recording without it than would any recordist relish working with his mic wrapped in a woollen vest.

*Note:* The frequency range 40 Hz to 5 kHz mentioned above is put forward as a reasonable range over which the full limiting action should be available. The pass-band of such a device would need to extend to at least 15 kHz and perhaps a bit lower than 40 Hz as well.



Wout Steenhuis in his multi-track music workshop. Some of his auxiliary equipment, like the small mixer in the foreground, is home constructed.



A corner of the BBC Radiophonics Workshop. The audio signal generators are coupled to a keyboard system providing varying degrees of attack and decay.

# sound workshop

F. C. JUDD INTRODUCES A NEW COLUMN FOR CONSTRUCTORS

'SOUND Workshop' suggests either a place in which to practise sound recording and its various applications, electronic music for instance, or a place in which to design, construct and test different kinds of audio equipment. The title is an appropriate one for this column and was in fact adopted to cover both of the classifications mentioned above. 'Sound Workshop' also suggests activity beyond the scope of a single tape recorder and a few simple accessories.

Constructional work has its own special requirements and these depend largely on what you intend building. The real advantage is low cost, of course, and quite often a home constructed piece of equipment can be better tailored to specific needs. The most essential item for constructional work, other than the usual small working tools, is a multi-range volt/amp/ohm-meter. Desirable items are an audio signal generator with sine and square-wave output and a valve voltmeter or its transistorised equivalent. Also desirable, but not a luxury for the dedicated worker who aims to build a wide variety of equipment and carry out much experimental work, is an oscilloscope.

The range and type of audio and test equipment that can be successfully home constructed, depends entirely on technical knowledge and skill with tools. It is one thing to construct a neat piece of equipment but quite another proving whether or not it works satisfactorily. Circuits published in technical journals and books are not always accurate or proven and much time can be wasted looking for a fault that doesn't really exist. On the other hand, a perfectly good circuit may refuse to work at all simply because of a wrong or faulty component, or an error in wiring. It is here that

technical knowledge, with experience in using test equipment, becomes essential.

Be suspicious of surplus, cut price or bargain offer components (and complete equipment) unless you are certain about the quality and suitability.

Whilst on the subject of building I should mention kits of parts that are supplied complete with components, printed circuit boards, pre-drilled panels and case. Kits are a fairly safe and easy method of home construction for those whose technical knowledge and workshop facilities are limited and one can still save money.

There is also the problem of space in which to put the equipment and still leave room for expansion. The ideal of course is a spare room and preferably one furthest from traffic noise if you live by a busy main road. If the room is small, plenty of wide shelves on the walls will accommodate all the smaller items of equipment that might otherwise occupy valuable bench space.

As I mentioned earlier, much of the equipment will depend on the kind of work you intend doing. I am fortunate in having a separate workshop for design and constructional work in electronics and audio but none of the equipment in this or the recording workshop is so permanently installed that it cannot be moved and used in either. All arrangements for interconnecting are therefore as flexible as possible. A large number of screened leads fitted to different kinds of plugs allow for the connection of any one piece of equipment to another.

A Sound Workshop need not be equipped to cater for every kind of recording. For instance the documentary, actuality and interview enthusiast may have no special interest in

electronic sounds and music other than for background music and effects. His essential equipment might therefore consist of one or two mains operated tape recorders, a battery operated portable for outdoor work, a disc transcription unit from which to take music and effects, a stock of common sound effects records and perhaps a small library of effects on tape recorded at opportune moments. These, plus the small accessories such as a tape splicer, supplies of leader and splicing tape, should cover most requirements for work that need not be far short of professional in quality (depending on the equipment) and in presentation.

Sound tracks for colour slides and cine film require much the same facilities aside from any special equipment necessary for automatic slide changing or for synchronising a cine projector with a tape recorder. A stock of sound effects and so-called 'mood music' records are of course both valuable.

For multi-track (track-to-track) music production the requirements are more specialised, not only with regard to the recording equipment but also musical instruments and musical ability. I speak here of proper musical arrangements with suitable instruments and not of pseudo electronic cum musique concrete concoctions, derived from random sounds produced with or without musical instruments. One has only to listen to the work of Wout Steenhuis to hear what can be accomplished in the field of multi-track music.

Electronic music now takes many forms requiring equipment ranging from a tape recorder and a few basic sound sources (audio signal generators) to an entire recording studio with every conceivable kind of sound source

(continued on page 123)

FIG. 1 TRUVOX PD 202/4 CIRCUIT DIAGRAM

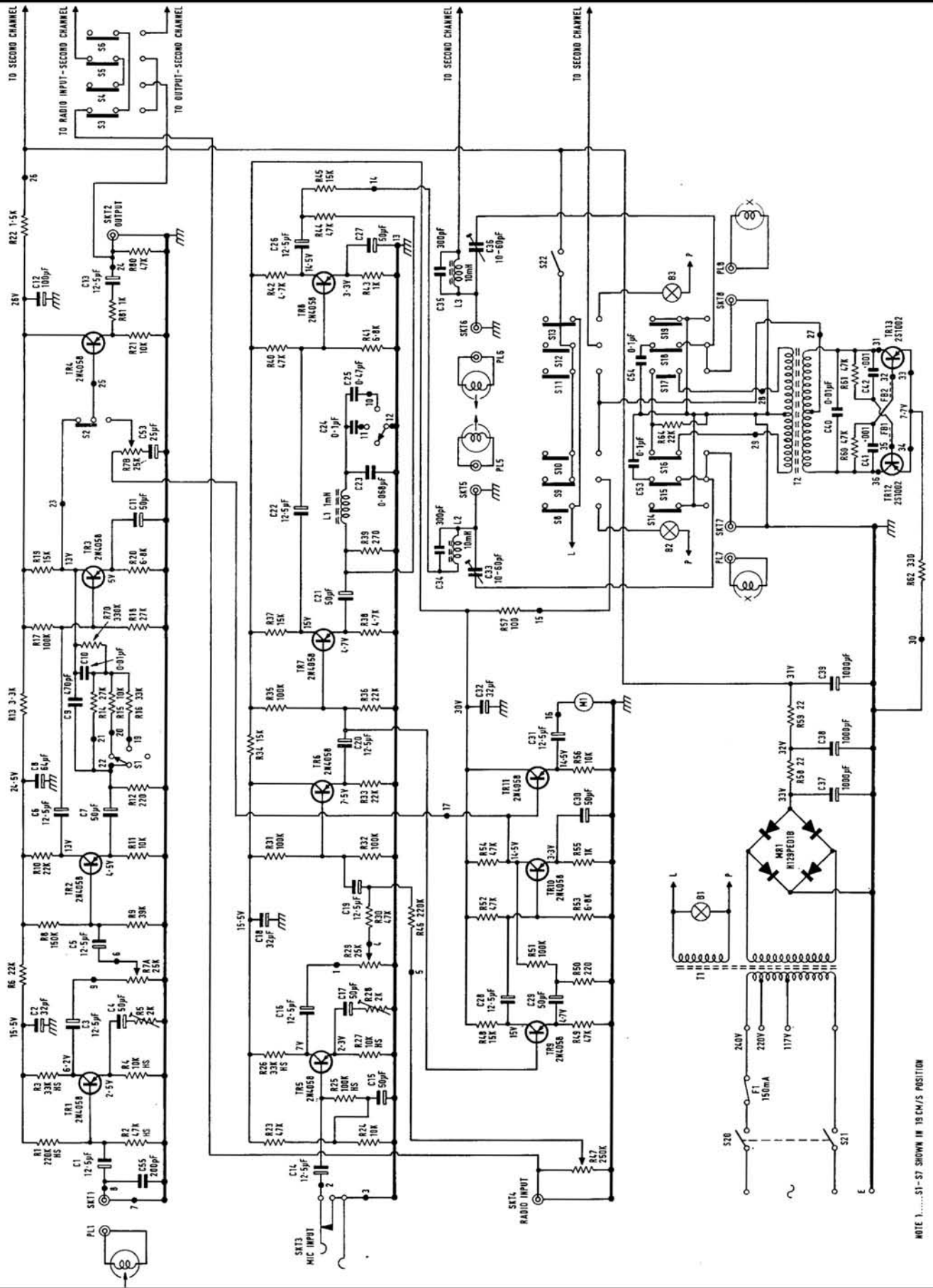

NOTE 1.....S1-S7 SHOWN IN "RECORD" POSITION  
 NOTE 2.....SECOND RECORD-REPLAY CHANNEL IDENTICAL TO THAT SHOWN  
 NOTE 3.....ALL VOLTAGES SHOWN WITH BOTH CHANNELS IN "RECORD" POSITION



# equipment reviews

## TRUVOX PD202 STEREO TAPE UNIT



**MANUFACTURER'S SPECIFICATION** (19 cm/s). Half-track stereo tape unit. **Wow and flutter:** 0.1%. **Frequency response:** 30 Hz - 17 kHz  $\pm$  2 dB. **Equalisation:** 70  $\mu$ S. **Signal-to-noise ratio:** 50 dB. **Oscillator Frequency:** 90 kHz. **Inputs:** 1 mV at 50 K (microphone); 50 mV at 100 K (line). **Output:** 1V maximum at 100 ohms. **Tape speeds:** 19, 9.5 and 4.75 cm/s. **Spool Capacity:** 18 cm. **Level Indicators:** Illuminated VU meters. **Dimensions:** 41 x 43 x 21 cm. (w x l x h). **Weight:** 28 lb. (12.5 kg). **Price:** £147 17s. 4d including £27 2s. 4d. purchase tax. **Manufacturer:** Truvox Ltd., Shore Road, Hythe, Southampton, Hampshire.

I AM glad to say I consider myself to be simple minded. By this I mean that if I see a design or project getting simpler and simpler as time goes on I know we are on the right track. If, on the other hand, I find things getting complicated, I tend to start again with a different approach. I feel sure that the designer of the electronic circuits shown in fig. 1 has the same ideas. The circuit diagram uses a sequence of simple basic circuits where each transistor does only one job at a time, with the further simplification that the same type of transistor (2N4058) is used in all record, play and meter circuits; only in the bias/erase oscillator circuit is a heavier duty 2S1002 transistor used.

Each preamplifier circuit for record or play is fitted with a pre-set emitter bypass control so that the gain may be set to a pre-determined level. The gain of the main playback amplifier (Tr2-Tr3) is stabilised by heavy AC feedback and gain variations in individual transistors can only affect extremely low frequencies where the feedback is least. The feedback time constants are selected by switching R14-15-16 in combination with C10. C9 reduces the gain at very high frequencies where bias pick up may be troublesome. Tr4 is an emitter follower to provide a low impedance line output; it contributes no gain to the circuit.

Tr6 is also an emitter follower which again acts as an impedance transformer to provide a high input impedance for the radio-microphone resistive mixer circuit. Tr7 and Tr8 act as the main recording amplifier with heavy negative feedback via R44 at medium and low frequencies which is reduced at the high frequency series resonance of L1-C23-4-5 to give the requisite sharp high frequency pre-emphasis required for recording.

It should be noted that a completely separate amplifier is used to feed the record level meter, and that the input of this amplifier is fed from the low impedance output of Tr6 so that the meter does not register the violent high note pre-emphasis of the record amplifier. The meter is a self contained VU meter with its own full wave rectifier and mechanical time constants. It is fed from the low output impedance of Tr11 emitter follower.

The line output emitter-follower input can

also be switched to the output of the meter amplifier for monitoring the unequalised record signal.

The bias/erase oscillator is a simple push-pull cross coupled oscillator with a 'long tail pair' common emitter resistor R62 to equalise the currents of Tr12-13 to give the all important symmetrical output waveform free of any even harmonic or DC component which may cause noise. The switching circuits above the oscillator look rather complicated, but R64 and C53-54 are switched in as required to

maintain a constant amplitude and frequency for any combination of erase and record heads which may be connected for mono, stereo of track to track transfer as required.

The controls and microphone input jacks are arranged on two shallow panels below the deck with separate microphone, radio and play gain controls for each track. Push keys below the VU meters allow for monitoring of either or both tracks and for transfer from tracks 1-2 or 2-1 plus mixing with a further incoming signal. (continued on page 119)

**FIG. 2** TRUVOX PD202 RECORD / PLAY WOW AND FLUTTER

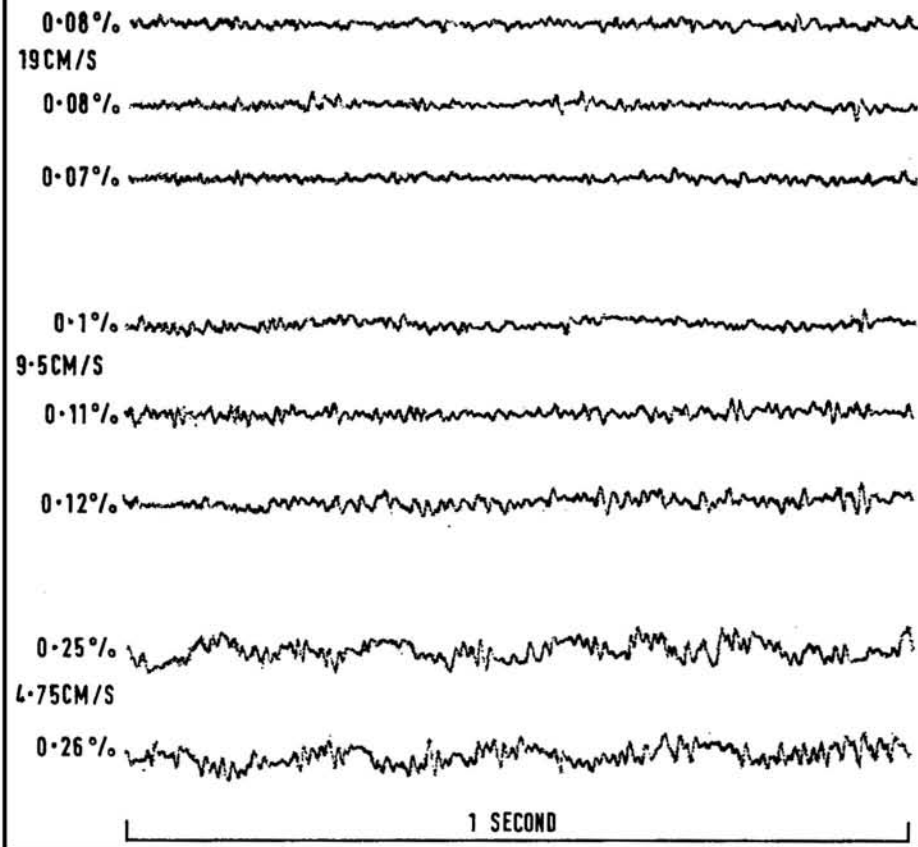

# CHILTON

**This month we give details of the Chilton Stereo Portable Recorder, which can be the basis of a Hi-Fi set-up**

- ★ Provision for microphone, radio and low output magnetic cartridge.
- ★ As an amplifier only with Baxandall Bass and Treble controls.
- ★ 10 watts R.M.S. per channel and fully protected by stabilised supply.
- ★ 4 Loudspeakers in rattle free cabinet (2 each side).
- ★ Solenoid controlled mechanism.
- ★ Quiet running deck, very cool even with prolonged use.
- ★ Fully transistorised on 10 printed circuit boards.
- ★ 3 head system and three speeds—19, 9.5, 4.75 cm/s

We respectfully suggest you have a demonstration, as volume and quality of reproduction are both impressive.

Finish—Charcoal grey with stainless steel trim.

Weight—38 lb.

Recommended price: 141 Gns. incl. pt.  
Chassis version from 124 Gns. incl. pt.

Magnetic Tapes Ltd., Chilton Works,  
Garden Road, Richmond, Surrey  
Telephone : 01-876-7957



# UP TO 50% OFF!

## BRITAIN'S ONLY TAPE RECORDER MART

specialising in the SALE, EXCHANGE and PURCHASE of every make of high quality Tape Recorder. Brenell, Ferrograph, Ampex, B & O, etc., we have the lot!

Fantastic savings of up to 50 per cent off original list prices for Personal Callers only. Our stocks change daily—call today—well over 100 models to choose from—all guaranteed you pay no tax on secondhand machines.

## TYPICAL BARGAINS

ALL WITH 3 MONTHS WRITTEN GUARANTEE  
(Note: M= Mono, S=Stereo, BP=Battery Portable, 4=4 track, 2=2 track)

AKAI M8 (S/4) ... ..	Our price ONLY 79 gns.
BRENELL Mk 5 (M/2) ... ..	Our price ONLY 39 gns.
FERROGRAPH 5AN (M2) ... ..	Our price ONLY 59 gns.
GRUNDIG TK6 (BP/M/2) ... ..	Our price ONLY 35 gns.
GRUNDIG TK20 (M/2) ... ..	Our price ONLY 15 gns.
GRUNDIG TK30 (M/2) ... ..	Our price ONLY 29 gns.
GRUNDIG TM60 (S/2) ... ..	Our price ONLY 39 gns.
GRUNDIG TK41 (M/4) ... ..	Our price ONLY 35 gns.
GRUNDIG TK40 (M/2) ... ..	Our price ONLY 35 gns.
GRUNDIG TM46 (S/4) ... ..	Our price ONLY 49 gns.
PHILIPS EL3301 (BP/M/2) ... ..	Our price ONLY 17 gns.
PHILIPS EL3536 (S/4) ... ..	Our price ONLY 45 gns.
REPS R10 (M/2) ... ..	Our price ONLY 35 gns.
REPS R10 (M/4) ... ..	Our price ONLY 35 gns.
TELEFUNKEN 75 (M/2) ... ..	Our price ONLY 19 gns.

NOTE:—THESE ARE NOW EVEN BETTER VALUE AS YOU PAY NO TAX ON SECONDHAND RECORDERS.

AKAI M6 (2/4) ... ..	Our price ONLY 62 gns.
AKAI M7 (S/4) ... ..	Our price ONLY 69 gns.
AKAI 1710W (S/4) Brand New List £109 17 3	Our price ONLY 85 gns.
BRENELL STB2 TAPE UNIT (S/2) ... ..	Our price ONLY 89 gns.
FERROGRAPH 4/AN (M/2) ... ..	Our price ONLY 49 gns.
FERROGRAPH 631 (M/2) ... ..	Our price ONLY 69 gns.
GRUNDIG TK46 (S/4) ... ..	Our price ONLY 52 gns.
GRUNDIG TK340 (S/4) ... ..	Our price ONLY 75 gns.
REVOX E36 (S/4) ... ..	Our price ONLY 69 gns.
REVOX 736 (S/2) ... ..	Our price ONLY 85 gns.
SANYO MR929 (S/4) Brand New List £95 10	Our price ONLY 79 gns.
SANYO MR939 (S/4) ... ..	Our price ONLY 72 gns.
SONY TC260 (S/4) Brand New ... ..	Our price ONLY 79 gns.
SONY TC500 (S/4) ... ..	Our price ONLY 59 gns.
TANDBERG 1241 (S/4) ... ..	Our price ONLY 69 gns.
TELEFUNKEN 97 (S/4) ... ..	Our price ONLY 49 gns.
TELEFUNKEN 204E (S/4) ... ..	Our price ONLY 69 gns.
TELEFUNKEN 204E (S/4) Brand New ... ..	Our price ONLY 95 gns.
TELEFUNKEN 85KL (M/2) ... ..	Our price ONLY 39 gns.
VORTEXION WVB (M/2) ... ..	Our price ONLY 55 gns.

### PERSONAL CALLERS ONLY

### NEW TAPE RECORDERS

We also stock every make and model of New Tape Recorder plus a complete range of accessories.

— Part of the NuSound Organisation —

# THE TAPE RECORDER MART

242/4 PENTONVILLE ROAD, LONDON, N.1

(200 YDS. KINGS CROSS)

TERminus 8200

(HALF DAY THURSDAY)

The spring loaded record/play switch is mounted on the deck plate and it is of course released from the record position whenever the stop key is depressed.

The tape position indicator clocks up 20 digits for ten turns of the right-hand take-up reel.

Wind and rewind is fast due to the three motor deck design, and an 18 cm 1800 ft reel of LP tape can be wound or rewound in 75 seconds.

Tape transport is smooth and clean with play-only wow from a wobble-free test tape at 0.025% (19 cm/s) and 0.045% at (9.5 cm/s). Play-only wow and flutter readings were 0.035% and 0.065% respectively. This guarantees virtually wobble-free reproduction of professionally recorded tapes.

The cumulative record-play wow and flutter readings are slightly higher with mean readings of 0.08%, 0.11% and 0.25% at 19, 9.5 and 4.75 cm/s respectively. The

120 Hz amounting to 5 dB at 40 Hz at each speed. System noise, with no tape passing the heads, was 48 dB (unweighted) below peak recording level.

Nominal peak recording level (32 mV/mm) from reference tape gave 3 V RMS output from the line socket at full gain with distortion at 2.4%. The same level recorded on the machine showed exactly 4% total distortion. This peak recording level corresponded to a level 10 dB above the 0 dB reading on the VU meter.

Test recordings at -6 dB on the VU meter gave the responses of fig. 4. It will be seen that high note pre-emphasis is close to that required for CCIR 70 and 140  $\mu$ S characteristics, but that a slight bass rise, similar to that specified for the NAB recording characteristic, has been applied at frequencies below 120 Hz. The resultant responses are sensibly level from 60 Hz to 20 kHz, 10 kHz and 5 kHz at 19, 9.5 and 4.75 cm/s respectively. These responses are of the kind to be expected with proper biasing of normal tape. The tape used for these recording tests was BASF LGS 35.

barely be heard below the slight tape hiss and transistor system noise.

COMMENT

A machine such as this will obviously suit an existing audio installation with external power amplifiers and wide range speakers. The emitter-follower low impedance line outputs allow long connecting leads to the power amplifiers, and the relatively high output level should overcome any hum problems due to common earths or electromagnetic pick up.

The monitor switches allow instantaneous comparison of the recorded signal with the incoming signal and, as is usual with well designed recorders, it is very difficult to spot the changeover at the two higher speeds. The carefully equalised responses, the separate record and play heads, and the balanced erase and bias waveform combine to give very low tape noise, and tape transport wobble is only faintly audible at the lowest speed of 4.75 cm/s, which would rarely be used for anything other than speech or quiet background music recording.

To return to a point made in a previous review, the low impedance line outputs allow excellent headphone monitoring during record or play if the impedance of the headset is 200 ohms or higher. The power requirements of most good quality headsets can be measured in milliwatts, but there are a few of American and Japanese origin with 15 - 30 ohms impedance which are designed to be fed from normal power amplifiers.

In the PD202 your hard-earned money goes into good mechanical engineering and well designed electronic circuits free of gimmicks and gadgets which are seldom used and which contribute little to the performance of a machine.

A Tutchings.

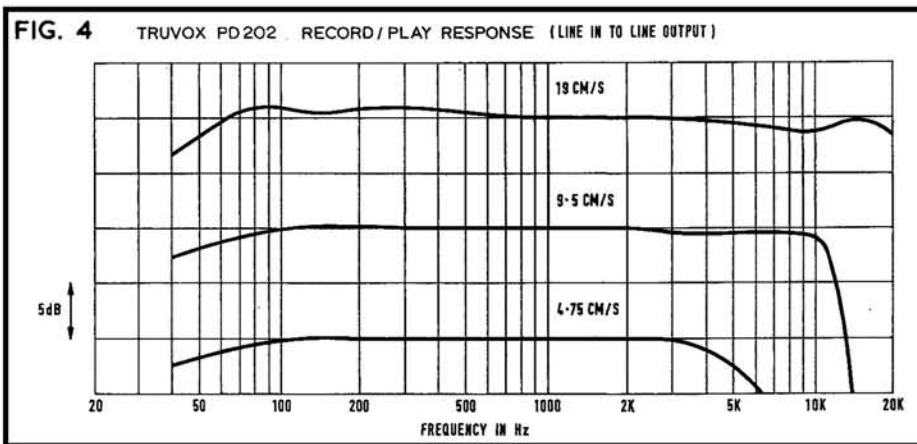
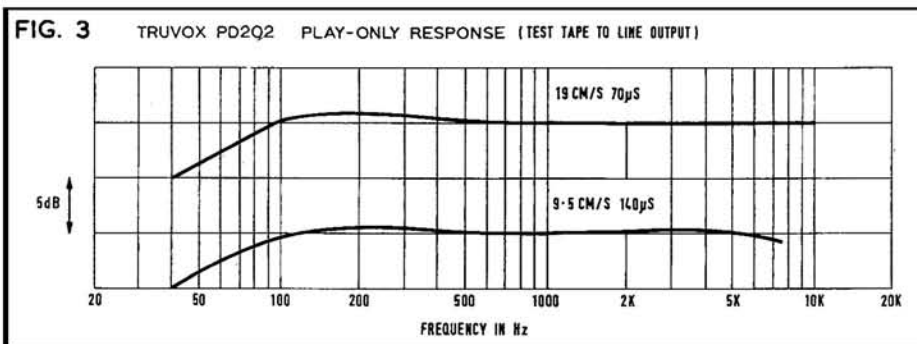

fluttergrams of fig. 2 show no cyclic wobble at the two higher speeds but a slight 4 Hz wobble is evident at the lowest speed of 4.75 cm/s.

The slightly higher flutter, compared to the test tape, is almost certainly due to the fact that the record head is further from the drive capstan than the play head and the increased flutter is due to friction effects on guides, heads and pressure pads acting on a slightly longer length of tape.

The playback responses from 70 and 140  $\mu$ S test tapes are level within a fraction of a dB from 120 Hz to the highest frequencies on the test tapes with a slight bass roll-off below

Unweighted tape noise after erasing peak recording level at 1 kHz varied between 46 and 50 dB below peak level. It may seem peculiar to find erased noise below system noise, but this is explained when it is realised that some of the system noise is low level mains hum, and the same slight hum is recorded on the tape with all controls at zero. It is the beat between the record and play hum which causes the cyclical  $\pm 2$  dB variation as the record and play hums come in and out of step.

The weighted signal-to-noise ratio is better than 55 dB and the hum in fact can

FI-CORD 600 AND 650 CAPACITOR MICROPHONES

**MANUFACTURER'S SPECIFICATION.** Fi-Cord FC600: Omnidirectional capacitor microphone. Impedance: 200 ohms. Sensitivity: 1.5 mV/ $\mu$ B. Price: £20 3s. Fi-Cord FC650: Cardioid capacitor microphone. Impedance: 200 ohms. Sensitivity: 1.5 mV/ $\mu$ B. Price: £26 16s. Battery power unit: £6 19s. 6d. Mains/battery power unit: £9 13s. Manufacturer: Fi-Cord International Ltd., Charlwoods Road, East Grinstead, Sussex.

THE power unit can be used with either microphone and is contained in a small steel case measuring approximately 13 x 13 x 5 cm with an output jack socket and red pilot lamp on the front face and a 2 metre mains and 6 metre mic lead attached to the rear. The back panel also carries a mains fuse and holder. Inside there is a small power transformer, a half-wave rectifier, smoothing capacitor and sundry voltage dropping resistors to provide 65 V DC to polarise the microphone and power the FET contained in the microphone case.

The FC600 suffered from very heavy low frequency noise comparable to speech level at

(continued on page 121)



# THE CITY TAPE RECORDER CENTRE

**228 BISHOPSGATE  
LONDON E.C.2.**

Telephone: 01-247 2609

Opposite Liverpool Street Station

Hours of Business:

MONDAY to FRIDAY — 9 a.m. to 6 p.m.

Closed all day Saturday

**OPEN SUNDAY**

10 a.m. to 2 p.m.

Part of the NuSound Organisation

At the City Tape Recorder Centre you can see one of the finest selections of tape recorders on display in London. Every leading make and model from Akai to Vortexion.

We are easy to get to being almost opposite Liverpool St. Station and remember we are the only tape recorder specialists in Great Britain open on Sunday!

Do your weekly rush shopping on Saturday with your wife and visit us on Sunday at your leisure!



**NOW IN STOCK**

The very latest B & O 2030K DE LUXE. Featuring semi-professional specification—a fully transistorised stereo/mono recorder with 4 track record and replay facilities and many more special features. Price £158.73.

Our manager Bob Hookings is a keen tape recording enthusiast. Bang & Olufsen's are his speciality, having used B & O equipment for several years his knowledge of this wonderful range is second to none. He is able to give personal callers his expert advice (please avoid telephoning) not only on B. & O. but on any other recorder suitable to your individual requirements and pocket.



- ★ GENEROUS PART EXCHANGES
- ★ FREE AFTER SALES SERVICING
- ★ UNEEATABLE SPECIAL OFFERS
- ★ EXPERT STAFF EXPERT ADVICE

**THE BANG & OLUFSEN SPECIALISTS**

*When in the city — call in at the city!*



## GOLDRING-LENCO VV7 PREAMPLIFIER!



Stereo or mono amplifier too insensitive for today's high quality magnetic cartridges? No magnetic cartridge input? The Goldring-Lenco VV7 Stereo-Equaliser-Preamplifier provides a simple and wholly effective answer. Small enough to mount with a couple of screws under your turntable, it raises the very low output from the finest magnetic cartridges more than enough to ensure full output from any low-gain amplifier—and even from a modest tape-recorder! Correct equalisation is automatic!

### Specification

Sensitivity suitable for all magnetic cartridges

- \* Gain of approx. 100 times (40dB @ 1 kHz) \* Mains powered
- \* Equalisation RIAA (BSI 1928) \* Signal to noise greater than 60 dB
- \* 2 silicon transistor stages per channel
- \* Fully shielded against electrostatic and electromagnetic fields
- \* Size 4 3/4" x 2" x 1 1/2" \* Weight 6 oz. \* Simple to connect.

**GOLDRING-LENCO VV7 PREAMPLIFIER £8.10.0.**



Goldring Manufacturing Co. (GREAT BRITAIN) Ltd.,  
486-488 High Rd., Leytonstone, London, E.11. Tel: Leytonstone 8343

# RECORD BUYERS NEED AUDIO

## RECORD REVIEW

WHY? BECAUSE it has the most expert and forthright panel of reviewers in the business. A record buyer can save time and money by studying ARR first. And if he's extra busy he need only look at the

ratings—exclusive to AUDIO RECORD REVIEW. Only 2s. 6d. at bookstalls or by post from AUDIO RECORD REVIEW, Heathcock Court, Strand, London, W.C.2. Every month on the 1st.

about 30 cm distance. It is well known that the slightest amount of moisture around the 100 M input circuit or microphone capsule could cause such noise, so the microphone was placed in a drying cupboard for several hours with no perceptible improvement.

A 200 Hz high-pass filter reduced the noise very considerably so that the response above 250 Hz could be measured accurately. The response below 250 Hz was measured at a higher sound level with some averaging of the meter readings to eliminate occasional LF noise kicks.

The solid line curve of fig. 1 shows the axial response with sound approaching the end face of the tubular microphone case. It will be seen that there is a diaphragm cavity resonance at 7-8 kHz which peaks the response by 5 dB. The slight bass rise in a microphone of this type is usually due to a change in stiffness of the air film under the diaphragm as it changes from adiabatic to isothermal working conditions; in other words, the heat generated by compressing the air can leak away during each cycle of a low frequency alternating pressure, so that the stiffness of the air film falls at low frequencies.

The dotted curve of fig. 1 shows the high frequency response when sound approaches the side of the microphone.

The crosses show the noise levels measured in one octave bands relative to the output for one  $\mu\text{B}$  sound level on the right-hand dB scale.

The left-hand dB scale represents sound level above standard reference of 0.0002  $\mu\text{B}$  and, if the noise response is weighted by the IEC 'A' curve to the ear's response at low listening level becomes a noise loudness of 60 phons.

Most measurement and broadcast microphones have self generated noise levels of about 20 phons, which is comparable to the airborne noise in a quiet broadcast studio.

The sensitivity of this microphone was slightly above specification at 1.7 mV/ $\mu\text{B}$ , so that the high noise level is obviously due to a faulty semiconductor within the microphone itself.

The FC650 cardioid microphone showed a much lower noise at 45 phons when weighted to the IEC 'A' curve, but one-octave filtering showed the characteristic 'red noise' of the field effect transistor with increased noise at low frequencies. The sensitivity was below specification at 0.8 mV/ $\mu\text{B}$  and this further spoils the signal-to-noise ratio. A noise only 30 dB below mean programme level would be considered poor for a medium priced tape recorder and it is nowhere near good enough for a microphone in this price category.

The frequency response of the FC650 is much improved, particularly at 90° sound incidence, and the front-to-back ratio is better than 12 dB down to 500 Hz, falling to 10 dB at low frequencies.

COMMENT

The high noise levels of both these microphones can be traced directly to two primary causes: the use of poor quality FETs, and low sensitivity due to the use of low polarising voltage. A good quality measuring microphone using a stretched metal diaphragm, will stand a polarising voltage of 200 V and generate

FIG. 1 FI-CORD FC600 CAPACITOR MICROPHONE (200 OHMS IMPEDANCE)

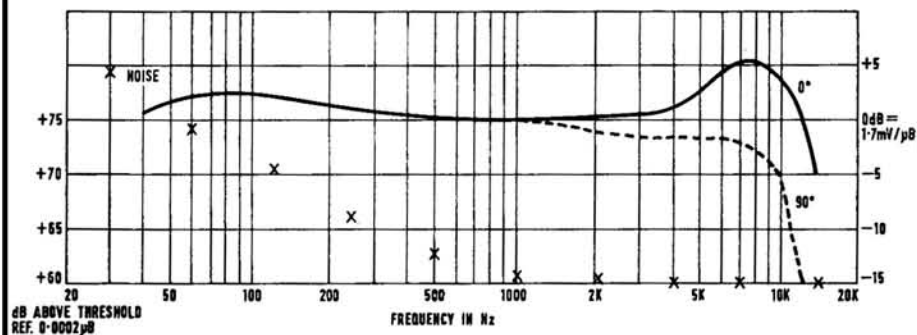
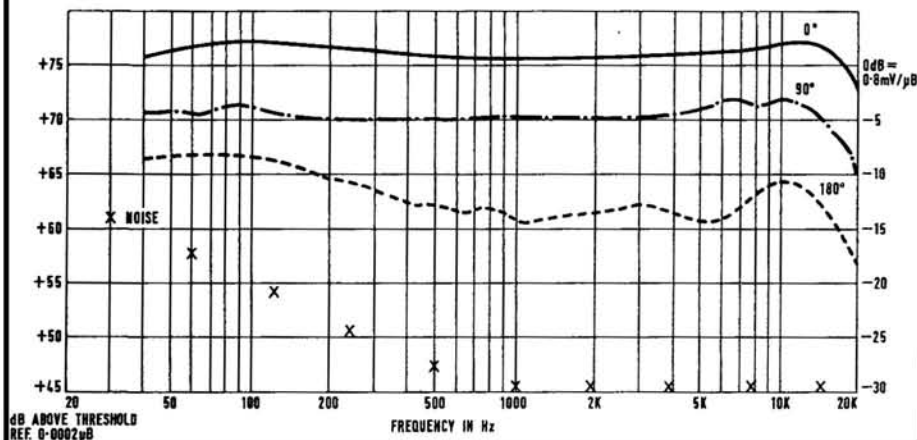

FIG. 2 FI-CORD FC650 CAPACITOR MICROPHONE (200 OHMS IMPEDANCE)



an output of 5 mV for a 26 mm diameter unit. The lowered sensitivity of the microphones under test is proportional to the drop in voltage to 65 V but this is inevitable with the relatively soft plastic diaphragms used in these microphones which would be pulled against the back plate by a higher polarising voltage.

Mechanically these microphones are very robust and the FC600 defied all my efforts to get inside to investigate the internal circuitry.

The frequency responses of each type of microphone are excellent, and the rather high noise levels would not stop them being used for fairly high level sound pick-up, in orchestral recording for example.

I would welcome the opportunity of testing another pair of these units, as I suspect that the combination of high FET noise and low capsule sensitivity may not be typical, but I can only report my findings on the microphones submitted for review.

A. Tutchings.

FIELD TRIAL

TO me, a capacitor microphone signified an outlay of about £100 and I was pleasantly surprised, at the last Audio Fair, to find two of these microphones costing less than £30 each. The FC600 is a slim candle-shaped microphone, finished in satin steel and weighing only 3.75 oz. The cable connects by means of a DIN socket with attendant connector ring.

The plug must be pushed well home or the connector-ring does not engage.

The power unit for mains operation is a small grey metal box with a jack socket for microphone/recorder connection. The microphone lead is already firmly attached. A red light glows encouragingly when switched on. The unit has a tendency toward mechanical hum, so keep it well away from the microphone. This should be easy, as Fi-Cord have provided a 6 metre lead.

I tried the FC600 with a Ferrograph 5AN at 19 cm/s. The results were every bit as good as at the Audio Fair (I rather suspected that the exhibition amplifier might have been just a little 'encouraging'; but it was not). The quality of voice was full-bodied with a very satisfactory bass which did not boom. Optimum results were obtained at a speaking distance of about 30 cm and very good results at a metre. The breathiness I associate with the big professional capacitors is absent, although I detected a slight background hiss

(continued on page 123)



Fi-Cord 600 (left) and 650.

# The big new name in Stereo



A range for the enthusiast. Tape decks and recorders . . . matching amplifiers and tuners . . . AM/FM stereo receivers . . . solid state record players with AM/FM radio . . . solid state modular stereo components with automatic record changers. All specialist designed for sound perfection.

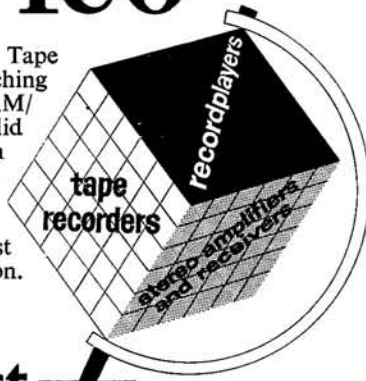

## Pick of the world's best

### MODEL AST 103 EH

Bookshelf type solid state micro-component stereo amplifier. 24w R.M.S. Tape monitoring switch. Stereo headphone jack. Frequency response 30-20,000Hz. Wooden Cabinet.



### MODEL FRS 103 EH

Matching solid state AM/FM multiplex tuner with AFC.

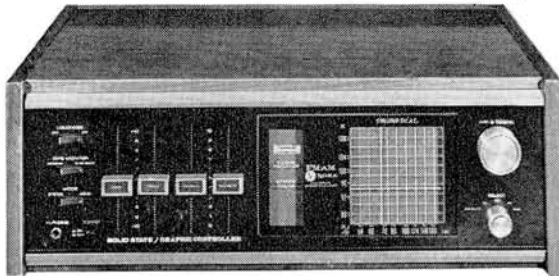

### MODEL AST 140 E

AM/FM stereo tuner/amplifier. Output 36w R.M.S. Automatic stereo switching with stereo radar. Advanced cross tuning with fine tuning indicator. Graphic controls for bass, treble and volume. Frequency response 20-20,000Hz. Speaker selector, protection indicator and many outstanding features and specifications.

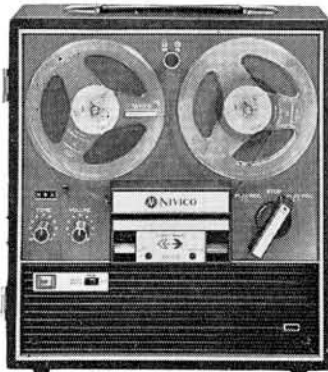

### MODEL TR 171 U

Solid state 2-speed 2-track Tape Recorder. 5" reel. Reverse track recording/playback system. Instant stop. Automatic volume control. Tone control. Speaker monitor. Tape counter. 100-240v AC. The sign of quality and technical advancement

**JVC Nivico**  
(Victor Company of Japan Ltd.)



For full details write to the sole U.K. Distributors  
**DENHAM & MORLEY (OVERSEAS) LTD.**,  
Denmore House, 173/175 Cleveland Street,  
London, W.1. Tel: 01-387 3656/7/8

## OPENING the BIBLE

by Stuart Allen

Principal of Wilson Street Chapel, London E.C.2  
(Non-denominational)

A series of HALF-HOUR TAPE RECORDED ADDRESSES at 1½ ips, 4 track, on 5 inch spools. The first twelve addresses are available for £1 from:—

**Mr. B. MARPLE (TR), 20 Rowley Gardens, Littleover, DERBY, DE3 7GF**

Money refunded if not satisfactory

WE SPECIALISE IN BRAND NEW

### TOP QUALITY BRITISH P.V.C. MYLAR & POLYESTER RECORDING TAPES WITH FITTED LEADERS, Etc., EX 3"

Thanks to bulk purchase we can offer tensilised HI-FI tapes, manufactured by a British firm of world repute. All boxed individually (sealed if required) in polythene. Our tapes are not to be confused with imported sub-standard or used tapes. Full-money refund if not delighted.

This month: "DRY SPLICE" (3/9) given FREE with every order.

Std.		L.P.		D.P.		Boxed			
Length	ea. 3 for	Length	ea. 3 for	Length	ea. 3 for	empty sps			
3" 150'	2/-	5/9	3" 220'	2/6	7/-	3" 400'	4/6	13/-	3" 7d.
4" 300'	4/-	10/-	4" 450'	5/-	14/-	4" 600'	6/9	19/6	4" 1/8
5" 600'	6/-	17/6	5" 900'	8/-	23/6	5" 1200'	12/6	37/-	5" 1/9
5½" 900'	7/-	20/6	5½" 1200'	10/6	30/6	5½" 1800'	17/-	50/-	5½" 1/9
7" 1200'	9/-	25/6	7" 1800'	13/-	38/6	7" 2400'	21/-	61/-	7" 2/-

All orders despatched by return. Postage and Packing 1/9 per order.

**STARMAN TAPES, 421 Staines Road, Bedfont, Middlesex**

## YOU CAN HAVE GOOD SOUND EQUIPMENT

if you choose



Gramplan Reproducers Ltd. Hanworth Trading Estate, Feltham, Middlesex



To all TAPE Recordists: P.V.C. & Polyester Tapes  
**BUY BRITISH**  
YOU SAVE MONEY AND



SAVE THE POUND  
"A STERLING IDEA"  
I place this second order after having complete satisfaction with previous tapes distributed by your company. The playbacks are crystal clear and I am sure no better results could be obtained by other dearer brands on the market.

Yours sincerely,  
W. S., Hants.

	3"	5"	5½"	7"
<b>New</b>				
Standard Play each 3 for	150' 2/- 5/9	600' 6/- 17/6	900' 7/- 20/6	1200' 9/- 25/6
Long Play each 3 for	240' 2/9 7/9	900' 8/- 23/6	1200' 10/6 30/6	1800' 13/- 38/6
Double Play each 3 for	300' 4/6 13/-	1200' 12/6 37/-	1800' 17/- 50/-	2400' 21/- 61/-

Free List full Range of Triple-Play

**Mora Trading Co. (TRS/2)**  
Mora Works, Mora Road, N.W.2

Postage 1/9 per order  
Posted the same day  
Money-back gtd.



which was probably attributable to the impedance difference between the Ferrograph at 1 M and the microphone at 200 ohms.

The FC650 is a capacitor microphone with similar circuitry and performance to the FC600 but is fitted with a directional capsule producing a cardioid polar pattern. It is also

fitted with a permanent windshield. Tests on similar equipment demonstrated that whilst this microphone is excellent in performance, its sensitivity and top frequencies are not so good as with the FC600. I found that whereas I could record quite comfortably on my Ferrographs at a control setting of 6½ for the FC600, I had to shove the control up to about 8 to get similar results with the FC650. Whether or not this is due to the metal windshield, I would not know. The FC650 costs £26.16.0.

Both microphones are beautifully finished, professional in both appearance and performance. They are light, unobtrusive and easily-handled. Technically, I think that they are the best thing that has happened in the amateur microphone world. The performance of the cheaper FC600 is outstanding, producing a rich, authentic and quite frightening realism to the recorded voice. If you want a darned good microphone, I suggest that you flog your bike and buy one of these. **Peter Bastin.**

## GRIPEX CLEANING FLUID

**MANUFACTURER'S SPECIFICATION.** Anti-slip dressing for drive belts and idler wheels. Price: 5s. per 1 fluid ounce bottle. Manufacturer: Colton & Co. (Lapidaries) Ltd., The Crescent, Wimbledon, London S.W.19.



A COUPLE of months ago the Editor passed a small bottle over to me and said: 'Try this'. It took a considerable amount of self-control to stifle the automatic rejoinder, but I am glad I did! The small bottle contained a graphite solution with a volatile carrier, and in the screw-top was a tiny brush. Its purpose? To bring back to life those jaded rubber surfaces of belt and idler that are so often the first signs of ageing in a tape recorder.

It has taken a couple of months to test the results, because time is one of the factors of any evaluation of anti-wear efficiency. Of its short-term effects, I could give an immediate report. It works. Applied to the rewind idler of a Grundig TK14, the edge of a slightly polished Magnavox 363 idler, or the take-up roller of a Sony TC350, it made all the difference between reluctant operation and a firm, responsive action. And the effect did not wear off within days.

Next move was to investigate its drying time, and we found that leaving the Colton Dressing to dry for ten minutes after application was

enough in a normal workshop temperature but it was important during that time to move no dressed surface and to guard against dust. The dressing dries into a new surface, and any trapped grit will give unwanted roughness. The new surface, though very thin, is still pliable, and if both driving and driven surface are treated, the eventual result is a drive engagement helped by a kind of stiction effect.

Pursuing this, we tried its action on brake surfaces, and found that it gave some assistance to fabricated servo brakes, as used on the Collare Studio deck, provided they had not worn too badly. The common fault when these begin to wear is fabric 'polish' and the dressing overcame this very well.

At five bob a bottle, this dressing is a bargain. It has been in constant use in our workshop for the past two months, and the 1 fluid ounce bottle is still half-full. It will now go on our regular list of orders for 'workshop aids'. For the home user, one small bottle will probably last as long as his machine—as long as he doesn't leave the top off. **H. W. Hellyer.**

## SOUND WORKSHOP CONTINUED

(mostly in keyboard form), filters, curve benders, compressors, reverberation units, 8-track recorders and even computers. However, it is still a fascinating subject with the tape recorder as the media for composition and

reproduction. A workshop with two tape recorders, a mixer, a few specialised items of equipment and one or two basic sound sources, is a good foundation for those inclined towards creating new and unusual sounds, musical or otherwise.

In conclusion may I say that I look forward to contributing to 'Sound Workshop' with

articles covering the more practical side of the different fields of recording and with constructional features concerned with equipment useful and usable in these fields. My plan is to alternate between practical and constructional. Next month, therefore, I will deal with something constructional and an asset to any sound workshop.

## WHAT'S IN A BRAKE ? CONTINUED

drop into reservoir tanks from the feed spool, and between capstan and take-up spool, so that an appreciable amount of tape can be run to and fro by the capstan action. The motors are controlled, and a variable position detector tells the motor how much torque to apply to maintain the status quo. These reel buffers control the motors, and servo mechanisms can be simple rheostats or, as is more usual with modern designs, transistor-controlled supply devices. The inertia of the slack tape is very low, so stopping and starting can be rapid. But, more important than this, the acceleration of the spools can be slower, as the amount of the tape held in the buffers is not critical.

The alternative (b) is a development of the Telefunken system, where the tape runs over movable pins. In the case of the computer tape-handling mechanism, the pins are doubled up in a zig-zag pattern, with one section mounted on a pivoted arm, whose position governs the motor and controls the torque. There are refinements of both designs, includ-

ing a vacuum-tension method that manages to get the best of both worlds. They need not bother us—but they lead to the point with which we do need to concern ourselves. This is the provision of a tape brake.

When spools are controlled, and tape is allowed a little less tension between reel and tape head guide system, some method of tape braking will be needed. This may be the simple pressure pad, whose prime function is to cut down flutter (but whose actual effect is often to introduce it). The tape must be controlled between the entry of the head channel and the capstan spindle. Not so important, but nevertheless desirable, is control between capstan spindle and take-up, to prevent some of that wandering which causes irregular tensions. Tape guides are the first thought, and we find many instances of accurately machined guides whose position helps maintain tape tension as well as keeping the tape from vertical wandering or skewing.

But a refinement of the sprung pin technique, used for a different purpose, is the swivelling guide, as exemplified by B & O, and now well

known. Its other title, 'tape slack absorber' is self-explanatory, and its careful maintenance, freedom from grit in the running surfaces, and any deposits that tend to build up in the flanges, need very little emphasis. But also important, and less often observed, is the freedom of the guide arm to swivel. There must be instant response to the change in tension of the tape. Springs have to balance correctly, and the arm pivot is as important as the guide pivot.

Rotating guides, long-feed guides, head pressure pads, guide pressure pads and other members of the sound channel family of devices—not forgetting the pressure roller itself—must wait for a later day before we can take up more space discussing them. In the foregoing notes, however, I hope it has come out clearly that the braking system is not just a separate entity. Very often, even on quite modest machines, its correct operation is tied up with the other tape handling sections. Servicing tape recorders is an electro-mechanical operation, which must always be regarded as a whole. To employ sporting parlance, watch that follow-through.



# ONE WAY TO SATISFACTION

4-TRACK STEREO/ MONO	Deposit		12. Monthly Payments		Cash Price				
	£	s. d.	£	s. d.	£	s. d.			
Philips EL3312...	16	19	10	4	3	4	66	19	10
Ferguson 3232 ...	22	18	3	5	14	7	91	13	0
Sony TC200 ...	23	15	0	5	18	9	95	0	0
Sanyo MR929 ...	24	0	0	6	0	0	96	0	0
Philips EL3555...	25	19	4	6	5	8	101	19	4
Aiwa TP1012 ...	26	0	0	6	8	2	102	18	0
Akai 1710W ...	27	17	3	6	16	8	109	17	3
Sanyo MR939 ...	28	0	0	6	16	8	110	0	0
Sony TC260 ...	29	5	0	7	5	0	116	5	0
Tandberg 12/21/41	31	10	0	7	17	6	126	0	0
Philips EL 4408	33	16	8	8	6	8	133	16	8
Telefunken 204 'E'	34	12	5	8	10	0	136	12	5
Beocord 2000K	39	10	0	9	13	4	155	10	0
Beocord 2000T	40	10	0	10	2	6	162	0	0
Sony TC350 ...	41	10	0	10	6	3	162	5	0
Ferrograph 722/4	46	15	0	11	10	5	185	0	0
Akai M9 ...	49	3	5	12	3	4	195	3	5

STEREO TAPE UNITS									
	£	s.	d.	£	s.	d.			
Sanyo MR-801 ...	20	0	0	4	13	4	78	0	0
Sony TC250A ...	20	10	0	4	18	4	79	10	0
Akai 3000D ...	26	11	4	6	11	8	105	11	4
Sony TC350 ...	27	5	0	6	16	3	109	0	0
Beocord 1500 ...	31	10	0	7	11	8	122	10	0
Tandberg 62/64X	36	18	0	9	0	0	144	18	0
Ferrograph 702/70440	6	8		10	0	0	160	6	8

4-TRACK MONAURAL									
	£	s.	d.	£	s.	d.			
Grundig TK140	11	14	6	2	18	4	46	14	6
Philips EL4305	11	17	9	2	16	8	45	17	9

4-TRACK MONAURAL	Deposit		12. Monthly Payments		Cash Price				
	£	s. d.	£	s. d.	£	s. d.			
Ferguson 3226 ...	11	10	0	2	16	8	45	10	0
Telefunken 201	11	18	9	2	19	7	47	13	9
Ferguson 3228 ...	11	19	0	3	0	0	47	19	0
Philips EL4306	14	1	8	3	10	0	56	1	8
Ferguson 3230 ...	14	13	0	3	13	2	58	13	0
Ferguson 3216 ...	16	19	0	4	0	0	64	19	0
REPS M10 ...	18	18	0	4	14	6	75	18	0
Wyndor									
Vanguard	18	18	0	4	14	6	75	18	0
Truvox R54 ...	18	18	3	4	14	11	75	17	3
Tandberg 1526...	20	19	0	5	3	4	82	19	0
Truvox R204 ...	31	14	2	7	15	0	124	14	2

MAINS TWIN TRACK									
	£	s.	d.	£	s.	d.			
Fidelity Playtime	7	18	6	1	16	8	29	18	6
Ferguson 3224 ...	8	6	0	2	1	4	33	2	0
Grundig TK120 ...	9	17	6	2	9	2	39	7	6
Philips EL3310	10	5	10	2	11	5	41	2	10
Tandberg 1521 ...	18	19	6	4	10	0	72	19	6
Truvox R52 ...	18	18	3	4	14	11	75	17	3
Beocord 1100 ...	24	10	0	6	2	6	98	0	0
Brenell Mk. V/3									
Sed.	26	17	9	6	10	0	104	17	9
Brenell MkV/3Mtr	28	0	2	7	0	0	112	0	2
Truvox R202 ...	31	14	2	7	15	0	124	14	2
Brenell V/3/M...	32	16	8	8	5	0	131	16	8
Ferrograph 713	33	18	4	8	9	7	135	18	4
Ferrograph 713/H	35	16	8	8	16	8	141	16	8

INTEREST FREE H.P. TERMS. OPEN SATURDAY 6 p.m. FRIDAY 6.30 p.m. IF UNABLE TO CALL WRITE FOR BROCHURES. PART EXCHANGES. ALSO 18 AND 24 MONTHLY TERMS

## SPECIAL OFFER! SAVE £100

### AKAI X-355 Outstanding features:-

- ★ 3 speeds, 3 $\frac{1}{2}$ , 7 $\frac{1}{2}$  and 15 i.p.s.
  - ★ 4 Heads—Erase, Record, Playback/Monitor plus Crossfield
  - ★ 2 Loudspeakers
  - ★ 3 Motors
  - ★ 40 Watts undistorted all transistor Amplifier
  - ★ Automatic Reverse. Automatic Repeat
  - ★ Auto Stop/Shut Off. Sound-on-Sound, Reverberation.
  - ★ 10 $\frac{1}{2}$ " Reel Adaptable.
  - ★ Vertical or Horizontal Operation. 2 or 4 track models available.
- BRAND NEW. MAKERS GUARANTEE.**  
Present List Price £331.8.6 — £231.0.0  
Deposit £58.0.0 and 18 monthly payments £11.4.9.  
(H.P. Price £256.19.0)

### AKAI X-300

- ★ Speeds 3 $\frac{1}{2}$ , 7 $\frac{1}{2}$  and 15 i.p.s. Optional
  - ★ 4 Heads—Erase, Record, Playback/Monitor plus Crossfield.
  - ★ 2 Loudspeakers
  - ★ 40 Watts undistorted all transistor Amplifier
  - ★ Sound-over-Sound. Auto Stop. Auto Shut-off
  - ★ 10 $\frac{1}{2}$ " Spool capacity. 4 Digit Counter 2 or 4-track models available.
- BRAND NEW. MAKERS GUARANTEE.**  
Present List Price £263.18.3 — £193.10.0  
Deposit £48.10.0 and 18 monthly payments £9.5.4.  
(H.P. Price £225.5.0)
- LIMITED SUPPLIES**

# THE RECORDER CO

*this is the name*

(DEPT. R) 186-188 WEST END LANE, WEST HAMPSTEAD, LONDON, NW6;  
Telephone: 01-794 4977

We are happy to announce that we can now supply

## BRAND NEW BRITISH & GERMAN RECORDING TAPES

P.V.C. POLYESTER & MYLAR

Both manufactured by world reputable British and German firms. Fitted with leaders and stop foils. Not rejects or sub-standard in any way—tapes are splice free and are boxed. Remember: full refund plus postage should goods not meet with your full approval.

Standard Play	Length	English price	German price
3"	150'	2/6	2/-
4"	300'	4/-	3/6
5"	600'	9/-	6/6
5 $\frac{1}{2}$ "	900'	11/6	8/-
7"	1200'	16/-	10/-
Long Play			
3"	220'	3/-	2/6
4"	450'	6/-	5/-
5"	900'	11/6	9/-
5 $\frac{1}{2}$ "	1200'	16/-	10/6
7"	1800'	23/-	14/-
Double Play			
3"	400'	6/-	4/-
4"	600'	8/6	7/-
5"	1200'	21/-	13/-
5 $\frac{1}{2}$ "	1800'	24/-	17/-
7"	2400'	39/-	22/-

EMPTY SPOOLS: 3" 9d. 5" 2/-. 5 $\frac{1}{2}$ " 2/3. 7" 2/6.

**N. WALKER Ltd.**

28 Linkcroft Ave., Ashford, Middx. Phone: 53020

## A couple of things for the record.



Everybody has heard of Grundig Tape recorders. But not everyone is quite so wise about Grundig tapes and accessories. But they're the best. And we don't mind what machine you use them on. You'll still notice the difference. Then there's our mikes. Superb quality studio standard. Moving-coil, omni or directional. For reasonable prices. If you're keen on your sound equipment, Grundig accessories will bring out the best in what you've got.

**GRUNDIG**

Write for the name and address of your nearest Grundig Accessories specialist.

Grundig (Great Britain) Ltd., London S.E.26.  
A Member of the British Industrial Holdings Group

## TAPE RECORDER SERVICE CONTINUED

a common return line, and even the screened outer of the lead to the erase is returned to this point—a fact you will soon have occasion to learn if you forget to refit it.

The oscillator has quite a high frequency—90 kHz—but is not adjustable for frequency or amplitude. The only real adjustment in the circuit is the bias preset capacitor. This is mounted, very nicely, at the front vertical face of the oscillator section, just beneath the meter. So bias adjustment requires only the removal of the four cross-headed fixing screws and tilting of the deck. Measurement of bias, and of the voltage across the erase head which gives a good indication of the oscillator's efficiency, is easily done at the head wiring tags to the rear of the sound channel. A valve-voltmeter is used, and a word of warning to the unwary is needed, both as regards this test and any others on transistorised circuits. Avoid at all costs the inadvertent short-circuiting of the test probes. A short when testing the erase voltage, for example, does this oscillator no good at all. And the snag may be that not only will the matched pair of OC81Z transistors be damaged, but, by their over-running, the oscillator transformer also could be temporarily over-run. It is wound on a ferrite toroidal core with fine wire, and it is hardly fair to expect such a component to withstand a lot of abuse.

This remark is necessary, if only as a warning to those who make a practice of rattling through the meter selector switches while connected to the circuit under test, and with that circuit in its operating condition. Having made the mistake once of switching a multi-meter and forcing a hefty transient through the early circuits of an audio amplifier, with the result that an emitter resistor far away in another part of the circuit changed its value in protest, I feel qualified to do a Cassandra. It may be more tedious to switch off, or disconnect, before switching ranges—but not half so tedious as changing a transistor or component that was in good order before we got at it.

### OSCILLATOR MEASUREMENTS

Once again, I have transgressed and wandered from the main subject. Oscillator measurements: across the erase head we should get a VVM reading of better than 50 V RMS, and across the record head the bias voltage should be adjusted to round about 25 V, to suit the tape of course. For the  $\frac{1}{2}$ -track models, switching tracks should certainly make no more than a 3 dB difference. Waveform checks can be made by connecting an oscilloscope across a load resistor (22 K) between points 29 and 30, that is between the transformer side of the bias preset and chassis, which is effectively across the erase head. In practice, you will get a better waveform at the tag board than on the connecting points behind the heads, because of stray capacitances, switch and lead losses and so on. To be quite sure, disconnect the take-off lead and measure directly across the load, but remember that this tests only the oscillator and not the most vulnerable items, erase heads and track switches. I have never had any real bother

with the Bogen heads fitted in most of these models, but on earlier types using a different head, easily identifiable by its metal-clad mounting and taller construction, loss of oscillator power was often traceable to the erase head, which drained the strength away. There is no cure save replacement.

Keeping to the specifications, but using them to indicate servicing procedure—which appears to be a useful formula—we come to the response and sensitivity of the amplifier proper. Input and output figures are as follows: 1 mV at 50 K (microphone), 50 mV at 100 K (gram), 1 V at 100 ohms (preamplifier output), 5 W at 15 ohms (speaker output). (Headphone output is also 1 V at 100 ohms.) The quick test is to insert a 1 kHz signal into the microphone socket when, with gain controls at maximum and 0.5 mV injected, the VU meter should indicate 0 dB. At the gram socket, the sensitivity should be better than 50 mV for the same indication. This input should then produce an output of 1 V at the feed to the power amplifier, i.e. the EXT AMP socket. Preset adjustment is available for each input.

### WORD OF PRAISE

A word of praise may be inserted here: everyone is going great guns with DIN sockets and a multitude of simultaneous connections—in the present instance, Truvox stick to the solid, robust and uncomplicated standard jacks. I love them for it.

The foregoing tests the record amplifier and we are left with the playback preamp to test. Reduce the signal until the VU meter gives a -10 dB indication. I would advise turning the gain control down a bit when making tests that involve recording, rather than simply winding back the signal generator input. This gives the best noise conditions, i.e. best protection against noise, and avoids some of the peak saturation effects that are possible without the operator being able to guard against them, especially when the only means of measurement is a simple VU meter. (This argument has been aired a few times in these pages: there is no need for me to repeat it. Keep the gain down and the signal up when recording is a pretty good general guide. The only real exception is to guard against overloaded inputs on certain automatic machines, which will handle the signal, squash it down to correct modulation level, but distort it in the process.)

After which whopping parenthesis, we may resume playback tests. Having recorded this -10 dB signal, note the input settings and volume control settings which produce the meter reading and, while still recording, check the output with a VVM. Respool and replay, using the tape source switch all the time with the controls at different gain setting as often as you like, provided the same level is attained on recording, and note that the same reading should be obtained on Tape as on Source. There is a playback preamp preset for initial adjustment, and I am afraid this demands a maximum volume control setting for a good result. These tests are at spot frequency, of course, and we then have to check the frequency response figures, giving the oscillator bias trimmer a little tickle to sharpen up the response at the HF end at 19 cm/s. Figures have already been given.

## Your Tape Dealer

LONDON AREA

FOR ALL LEADING  
AUDIO EQUIPMENT

**hifi**

Classical Records  
by Mail Service

hampstead  
**HIGH FIDELITY**

91a Heath Street,  
Hampstead, N.W.3.  
Tel. HAMPstead 6377

**HAVEN**  
196-198 SOUTH EALING RD.  
**HI-FI** LONDON  
W.5  
Tel. 01-560 0194

**LASKY'S  
RADIO**

Stockists for all the leading makes of Tape Equipment  
207 EDGWARE ROAD, W.2. Tel.: PAD 3271  
118 EDGWARE ROAD, W.2. Tel.: PAD 9789  
33 TOTTENHAM CT. RD., W.1 Tel.: MUS 2605  
42 TOTTENHAM CT. RD., W.1 Tel.: LAN 2573  
152/3 FLEET STREET, E.C.4. Tel.: FLE 2833

**TAPE RECORDER HI-FI CENTRE  
(SHEEN) LTD**

SPECIALISTS IN TAPE RECORDERS, ACCESSORIES,  
HI-FI EQUIPMENT

YOUR CENTRE FOR FRIENDLY HELP, SALES AND  
SERVICE

3 & 4 STATION PARADE Open until 8 p.m. on Fridays  
SHEEN LANE, SHEEN FRC/SPECT 0985  
LONDON, S.W.14 Opposite Mortlake Station, S.R.

### CHESHIRE

go scandinavian hi-fi . . .

Bang & Olufsen, Tandberg, Arena, Dynatron, Radford,  
Sony, Philips, Quad, Leak, Fisher, Sanyo, Pioneer, Akai,  
Sansui, Wharfedale, Armstrong, Rogers, Ferrograph,  
Trio, Dual, Bryan, Normende, Eddystone, Goodmans,  
Braun, etc.

the hi-fi and tape recorder lounge

● EXPERT STAFF ● ADVICE SERVICE ● PART EXCHANGE  
● Home Demos ● After Sales Service ● Comparator Demos

GREEN LANE, WILMSLOW, CHES. SK9 1LR  
Ring Wilmslow 24766 and ask for Mr. Bird  
Closed Weds. except by appointment

FOR ALL YOUR REQUIREMENTS . . .

**CHARLESWORTH'S**  
OF CREWE LTD.

Head Office : 14 Hightown, Crewe. Tel. 3327

**Hi-Fi CENTRE: 28 HIGHTOWN, CREWE**

Technical Division : 19 Ludford Street, Crewe



THIS WONDERFUL MONO OR STEREO

# MUSIC TAPE

**FREE!** WITH EVERY 7" REEL OF 1 mil POLYESTER



This offer is made to enable you to verify the excellent quality of RECOTAPE RECORDING TAPE and to enjoy the superb quality of the fascinating music on the 40 minute CORONET music tape at something under half the normal cost. The reel of Polyester base recording tape and the Music Tape would normally cost you more than 99s., they are yours for 45s. post and packing FREE. If you want the MONO music tape in 3½ ips, 2 track you should send only 40s. This represents exceptional value because the reel of raw tape is of high oxide potency, giving excellent signal strength and low noise. Especially effective lubrication protects your heads and assures squeal free travel. The music tape is duplicated by a new process giving full frequency range, even at 3½ ips. Don't believe us, try our reel of tape against any other you have, no matter what the cost. Compare the music tape with any other at any price.

This fascinating music tape brings over 40 minutes of delightful music in the popular Tijuana manner. It is played by The Borderlanders, eight versatile musicians with exciting arrangements of such established favourites as A Taste of Honey; La Cucaracha; Lonely Bull; Mexican Hat Dance; Carta Blanca; Spanish Flea; Quit Hornin In; Zorba The Greek; La Golondrina; Tijuana Express; Border Town; What Now My Love; and Whipped Cream. A truly representative collection of tunes that have become everybody's favourites.

This is a full sound spectrum recording and will demonstrate how good your equipment can sound. Tijuana Party is available in 4-track STEREO 7½ ips and 2-track MONO 3½ ips, don't forget to state which you require on the coupon below.

Send today for this exciting offer . . . 45s. for Stereo, only 40s. for Mono, including a 1,800ft. reel of 1 mil. Polyester Base Recording Tape.



**GUARANTEE.** If you do not agree that this offer represents good value or you feel that it falls short of what you expected, just return the two tapes to us, within seven days, and we undertake to refund your full purchase price, plus the postage cost incurred in sending it back to us.

Recommended Retail Prices			
	STANDARD PLAY	LONG PLAY	DOUBLE PLAY
5"	19/-	24/-	37/6
5½"	24/-	30/-	51/-
7"	30/-	42/-	63/-

**THE LOWEST PRICED HIGH QUALITY RECORDING TAPE**  
Made in the U.S.A.

**POST THIS COUPON TO DAY**

To: RECOTAPE RECORDINGS LIMITED,  
36, High Street, Salisbury, Wilts.

Please mail to me, at the address below, one 7" 1800ft. reel of Polyester Base RECOTAPE Recording Tape together with one copy of TIJUANA PARTY. I enclose cheque/P.O. 45/- for 4 Track Stereo, 7½ ips—40/- for 2 Track Mono 3½ ips. (Please delete as inapplicable).

NAME .....

ADDRESS .....

TR309

## Have you noticed it too?

With so many shops to choose from, there must be excellent reasons why people prefer to buy more and more from Francis of Streatham. Perhaps you would care to find out by calling or writing to us about your requirements in tape and hi-fi equipment too. (S.a.e. with written enquiries please.)

## EVERYTHING IN RECORDERS AND HI-FI ON THE BEST OF TERMS

- ★ VERY LARGE STOCKS OF EQUIPMENT AND ACCESSORIES
- ★ NO EXTRA FOR CREDIT UP TO 18 MONTHS
- ★ FREE SERVICE DURING GUARANTEE PERIOD—OWN SERVICE DEPT.

We are TANDBERG specialists and carry full stocks of these famous products.

Also FERROGRAPH, VORTEXION, AKAI, PHILIPS, ETC., ETC.

**FOR A FAIR and DEPENDABLE DEAL—BUY IT FROM**

**SPECIAL OFFER OF WORLD FAMOUS 'SHAMROCK' TAPE**

Brand new, top quality polyester.

2400', 7"	... 25/-
1800', 7"	... 21/-
1200', 7" or 5½" or 5"	... 15/-
900', 5"	... 12/6
600', 5"	... 10/-

P. and P. 1/6 per reel. Orders over £3 post free. Cash with order please.

## FRANCIS OF STREATHAM

169-173 STREATHAM HIGH ROAD, LONDON, S.W.16

Between St. Leonard's Church and Streatham Station

Phone: 01-769 0466: 01-769 0192

Please note our only address Free Car Park, Prentis Road nearby  
**OPEN ALL DAY SATURDAY—EARLY CLOSING WEDNESDAY**

**FULLY GUARANTEED**

Size Base	Standard		Long	
	P.V.C.		P.V.C.	
3"	150'	2/6	225'	3/3
4"	300'	4/3	450'	5/6
5"	600'	8/9	900'	10/3
5½"	900'	10/6	1200'	12/6
7"	1200'	12/6	1800'	17/9

Size Base	Double		Triple	
	POLYESTER			
3"	300'	4/6	600'	9/3
4"	600'	8/6	900'	13/3
5"	1200'	15/9	1800'	23/6
5½"	1800'	19/9	2400'	29/9
7"	2400'	22/6	3600'	39/9

Factory Fresh. Superb Quality. Leaders, Trailers and Stop Foils on all sizes 5" and above. We supply many local authorities and professional recording studios. May we supply you? P. & P. 2/6 per order. S.A.E. Full Lists.

**LEDA TAPES (D), 30 BAKER ST., LONDON, W.1.**  
Phone: 01-226 7004

## RAPID RECORDING SERVICE

L.P.'s from your own tapes. Master discs and pressings. Recording Studio, Multi-channel facilities for transfer to 8 or 16 mm film tracks. Sound effects library on discs.

Associated Company  
**EDUCATIONAL RECORDINGS LTD.**

### MEMORY TRAINING.

Are you the victim of "I forgot" or "I don't remember". Time, money and success can be gained by the possessor of a good memory. A bad memory brings about missed opportunities, lack of advancement and failure. Our Psycho-tape No. ST/9 will develop your mental powers in such a way that you will remember lists of words, telephone numbers, names, facts and figures.

Send for particulars of this and 20 other tapes on self-improvement. Distributors of the Cassette battery/mains Sleep-o-matic Unit. Pillow speakers. Time clocks.

Publications:—"Sleep-learning. Its Theory, Application and Technique".  
"Mental Power through Sleep-suggestion".

Brochures from:—

**RAPID RECORDING SERVICE**

21 Bishops Close, London, E.17

## readers' problems



Readers encountering trouble with their tape equipment are invited to write to the editorial office for advice, marking their envelopes 'Readers' Problems—Tape'. Replies will be sent by post and items of general interest may also be published in this column at a later date. This service does not, however, include requests for information about manufacturers' products when this is obviously obtainable from the makers themselves. Queries must be reasonably short and to the point, limited to one subject whenever possible. In no circumstances should such letters be confused with references to matters requiring attention from other departments at this address. We cannot undertake to answer readers' queries by telephone.

### MEASURING HF BIAS

Dear Sir, I have a Model 8 Avometer which is fitted with a 50  $\mu$ A FSD movement. There are provisions for AC measurements in the audio range but, with an upper limit of 10 kHz, it is not possible to use this for checking tape head bias and erase voltages. Is it possible to construct a simple rectifying probe which can be used to give reliable voltage measurements on the DC range.

Your faithfully, R.C.C., Birmingham 13.

It is certainly possible to design a probe suitable for responding above audio; right into the VHF spectrum if needs be. This would not solve your problem, though.

For adequate measurement of HF signal, a valve voltmeter is needed which has an impedance of about 10 M across its input terminals and responds towards full-scale with a signal as low as 3 mV. Even a movement sensitivity of 50  $\mu$ A, when corrected for the probe, would fail to provide the sensitivity you need for HF bias measurements, for these are usually made with the circuit operating normally, across a low value resistor in series with the signal current path. The voltage developed across this resistor is very small, as you will appreciate.

If you wish to experiment with a simple probe, use four germanium diodes in a bridge circuit.

### SLITTING COMPUTER TAPE

Dear Sir, I have recently been able to acquire a number of reels of 12.5 mm computer tape which I wish to slit for use on a conventional 6.25 mm tape recorder. Having tried to do this myself, without success, I should be grateful if any of your readers, or yourself, could suggest a practical method of slitting.

The first thing to remember is not to try to get two 6.25 mm tapes out of one 12.5 mm one. Tape always wanders about during a slitting process, and you will succeed only in ruining the lot.

The professionals tackle this job with the simplest possible device—two razor blades mounted the right distance apart ( $6.25 \pm 0.05$  mm edge to edge) in a metal block with a curved surface. The corners of the blades should protrude around 3 mm above the block, with the cutting edge at about a 45° slope in the direction of the tape movement. For your purposes, it would probably be best to make the block in three sections and sandwich the blades between them.

In addition to this, you will need a mounted spindle for the 12.5 mm reel with a brake which will give a constant tape tension of around 200-400 gm, a mounted spindle for the 6.25 mm reel with either a handle or a low-g geared drive motor, and two mounted spindles for the bobbins which must take off the selvages under light tension. Two guides will also help.

When you get to the actual slitting, after the inevitable trials to make adjustments, slit with the tape coating up, otherwise the blades and slots will get clogged with oxide; don't rush it; and—most important—once you've started, don't stop until you get to the end.

### STORING TAPE NEAR ELECTRICAL EQUIPMENT

Dear Sir, I am thinking of storing tape immediately beneath my recorder. This means that my Uher Royal Stereo would be separated only by a wooden shelf. Do the internal loudspeakers and motor present a danger? I normally use Agfa PE DP and TP, stored vertically in plastic containers. I presume these offer no protection from magnetic radiations. In the same order of thought, does the motor of a Dual 1006 turntable constitute a danger? The only separation would be 3 cm for the shelf thickness. I thought of placing a metal plate between the bottom of the recorder and top of the reels. Mu-metal is very expensive; does it need a connection to ground and are there any alternative materials?

Yours faithfully, M.V., Antwerp, Belgium.

The short answer to your question is that, in our opinion, you will not be in danger of affecting your tapes if they are stored in the positions you describe. However, you can of course make quite sure, for your own peace of mind, by testing a reel with recordings of no value in the critical storage positions. If it is affected, you will hear a momentary fall in HF response, and possibly also a rise in the background noise, whenever tape from the topmost part of the reel as stored passes the playback head.

If you do notice an effect, the most efficient way of overcoming it is to increase the spacing between the tapes and the source of magnetic field; this decreases the effect in proportion to the square of the distance. That is, doubling the distance will reduce the effect to one-quarter, trebling it to one-ninth, and so on, and you will find there will be a critical distance at which the effect suddenly disappears altogether.

Should greater spacing be impracticable, Mu-metal sheet is the next best cure. It is ideally best used in the form of a cup round the source of magnetic field, but in practice the

(continued overleaf)

## Your Tape Dealer

CHESHIRE (contd)

### VIDEO AND HI-FI STUDIO

Hire or Buy	Listen to the Best
★ Cameras	★ Bryan
★ Monitors	★ Truvox
★ Video Tape Recorders	★ Leak
★ Ampex	★ Goodmans
★ Ikegami	★ Goldring
★ G.E.C.	★ Thorens
★ Loewe Opta	★ Eagle
FULL SERVICE OFFERED	★ ETC.

Holiday Bros. (A.V.) Ltd. 61b Shaw Heath Stockport

### DEVON

#### THE SOUTH WEST

### Tom Molland Ltd.

Invite you to visit their well-equipped Demonstration Theatre and compare all the leading makes of Hi-Fi and Tape Equipment at

110 CORNWALL STREET, PLYMOUTH

Telephone 69285

Immediate delivery to ALL Areas

### ESSEX

EPPING — ESSEX  
CHEW & OSBORNE LTD.  
148 HIGH ST. TEL: 4242

AKAI — AMPEX — ARENA — ARMSTRONG — AUDIO TECHNICA — B & O — BRYAN — CELESTON FERROGRAPH — FISHER — GARRARD — GOLDRING GOODMANS — HACKER — KEF — LEAK — LOWTHER PHILIPS — QUAD — RADFORD — REVOX — ROGERS SHURE — SONY — THORENS — TRUVOX WHARFEDALE — WYNDSOR  
Home and Showroom Demonstrations:  
After Sales Service — H.P. Facilities  
Equipment and Records by post

### GLOUCESTERSHIRE

## Sound Selection

OF BRISTOL

Tape Recorder and Hi-Fi Specialists (Demonstration Room)

361-363 GLOUCESTER ROAD, BRISTOL 7. Tel. 41181

REVOX SPECIALISTS

### HAMPSHIRE

## High Fidelity Specialists

Hamilton Electronics (Southampton) Ltd.  
35 London Road, Southampton. Phone: 28622 3Lines

FORRESTER'S  
**NATIONAL RADIO SUPPLIES LTD.**

70-72 HOLDENHURST ROAD  
BOURNEMOUTH HANTS

Largest hi-fi and radio component store in the south Tel: 25232

## Your Tape Dealer

HERTFORDSHIRE

**WATFORD**  
High Fidelity Centre  
at **RADIOLUX Ltd.**  
36 WOODLANDS PARADE, HIGH ST.  
WATFORD (opposite the pond)  
WATFORD 29734, 41029  
IF IT'S GOOD—WE STOCK IT!  
Demonstrations in our Stereo Theatre. Also home  
demonstrations with no obligation.

LANCASHIRE

**STOCKPORT AUDIO CENTRE**  
FINEST IN NORTH WEST

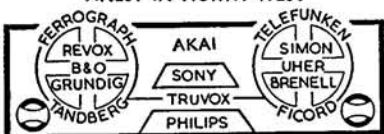

★ ALL MODELS ON COMPARISON DEMONSTRATION  
★ EVENING DEMONSTRATIONS BY APPOINTMENT  
**FAIRBOTHAM & CO. LTD.,**  
58-62 Lower Hillgate, STO 4872

**BOLTON**

Specialists in  
High Fidelity Sound

**H. D. KIRK**  
*Stereolectrics*  
LIMITED

203 St. George's Road  
Phone 23093

**BOLTON**

**J. SMITH & SON**

HI-FI EQUIPMENT — STEREOGRAMS  
TAPE RECORDERS — 2 SHOWROOMS  
B & O, Dynatron, Hacker, Quad, Leak, Radford,  
Armstrong, Ferrograph, Revox, Truvox, Uher,  
Decca, Garrard, Thorens, Goodmans, KEF, etc.  
Comparator Dems — Closed all Tuesday  
Specialists in 'SOUND' for 36 years

184 THE ROCK, BURY Tel: 1242

ST. HELENS

**HAROLD STOTT LTD.**

Hi-Fi Consultant

Tape Recorder Specialist. Agents  
for all leading makes including Akai  
B & O, Revox, Sony, etc. Advice and  
demonstrations given willingly.

18 Westfield Street, St. Helens

NORTHUMBERLAND

SOUND EQUIPMENT SPECIALISTS

**Morton**  
**sound** Tel. 2-6902  
20142  
12 OXFORD STREET

NEWCASTLE UPON TYNE 1

## Your Tape Dealer

NOTTINGHAMSHIRE

**Nottingham Tape Recorder Ltd.**

**BURTON ST.** 2 mins. Victoria Station

Specialists in all the best makes of

● TAPE RECORDERS ● AMPLIFIERS ●  
● HI-FI DISC EQUIPMENT ●

Telephone: Nottingham 45222

OXFORDSHIRE

**Westwoods**

for the

TAPE RECORDER

of your choice

46 George Street

Oxford 47783

SHROPSHIRE

**SHREWSBURY'S NEW SOUND CENTRE**

Ferrograph-Leak-Akai-Rogers-Goodman etc.

HEAR THEM IN OUR DEMONSTRATION STUDIO

OPEN ALL DAY  
TUESDAY-SATURDAY

**AVON**

**Hi-Fi Ltd.**

13 WYLE COP.

Tel. 55166

(facing the famous Lion Hotel)

SURREY

FARNHAM

SURREY

- ★ Stockists of all good Hi-Fi apparatus.
- ★ Comparative demonstrations.
- ★ We offer a real after sales service.
- ★ Easiest of terms
- ★ No parking problems.

**Lloyd & Keyworth Ltd.**

THE RECORD SHOP

26-27 DOWNING STREET, FARNHAM  
SURREY Telephone: Farnham 5534

SURREY AND HAMPSHIRE'S HI-FI SPECIALISTS

**CROYDON'S**

TAPE RECORDER CENTRE

All leading makes in stock, Hi-Fi equipment, cabi-  
nets, etc. Service agents for AKAI Tape Recorders

**SPALDING ELECTRICAL LTD.,**  
352/354 Lower Addiscombe Road,  
CROYDON.

Addiscombe 1231/2040

SUSSEX

WORTHING, SUSSEX

Stocking Ferrograph, Revox, Sony,  
Tandberg, Truvox, Philips, EMI, Luxor,  
etc., on fully comparative Demonstration

**BOWERS & WILKINS LTD.**

1 Becket Bldgs., Littlehampton Road,  
Worthing 5142

READERS' PROBLEMS CONTINUED

motors may well get much too hot if enclosed in this way. Try using a sheet of Mu-metal about 1 mm thick and about twice the width of the motor all round, fixed to, say, the bottom cover of the unit under the motor, but not interfering with any ventilation holes provided. You should take care that the plate does not 'conduct' the magnetic field into the sensitive preamplifier parts of the recorder. The plate should be earthed, not because this will make it more effective but because no audio equipment works well near large unattached masses of metal.

The field from the loudspeaker is even less likely to affect your tapes than that from the motor but, if it does, a simple flat plate will usually not be enough because the field is a direct one, not an alternating one as found near the motor (the field due to the energising current which produces the actual sound output is very much smaller than the steady field from the permanent magnet). In this case the Mu-metal will have to be arranged to shunt the stray field back into the loudspeaker's own magnetic circuit. It will be best to consult your local engineer about this.

Less efficient alternatives to Mu-metal are Swedish Iron or ordinary annealed soft iron. Steel or hard iron should be avoided because they may themselves become permanently magnetised. Non-magnetic metals will not help at all, unless they are very thick.

You are quite right in supposing that the plastic reel cases will not help. Professionals who wish to protect recordings from magnetic fields use round soft-iron tins like those sometimes used for cine films when they are sent from place to place.

As a final thought, if your stored reels of tape are no nearer to the loudspeaker and motors than they are when actually being used on the tape recorder, then you should certainly be safe.

UHER 4400 METER

Dear Sir, I would be grateful for your advice on a problem concerning my Uher 4400 Stereo Report. The right-hand meter differs in characteristic from the left, except on steady tones. I am loathe to return the recorder under guarantee as there are no other faults.

Yours faithfully, G.C.P., Castle Bromwich.

The trouble would appear to be nothing more than a sluggish meter movement. This is most likely as a common level signal records and indicates correctly on a test tone. The only other possibility is an error in the time constant of the meter feed signal circuit, preventing the meter from responding quite as quickly as it should to transients—or, to be more accurate, fairly rapid changes in level.

The matter can be proved by simply transposing the connections to the meters while feeding a paralleled input (i.e., same level at any given instant to each channel). Then, if the right-hand meter is still sluggish, it is obviously the meter itself that is to blame—and you should certainly get it changed within the guarantee period. These meters are a trifle pricey!





BY CYRIL GRANGE

HAVING overcome machine faults, the problem of concentrating the song into the microphone arises. The ideal arrangement is a parabolic reflector on a pan and tilt stand using a moving-coil microphone fitted with a wind shield.

The reflector must be so designed that it will collect the preferred sound waves and focus them on to the microphone. I have tried all sorts of reflectors—an enamel electric light shade, the top of a dustbin, a kitchen mixing bowl but none did the job properly so I don't want you to waste time experimenting.

Grampian produce a reflector specifically designed to concentrate sound from a distant source to a focal point where the microphone is sited. This aluminium appliance is 61 cm in diameter and 13 cm deep. Grampian state that in their experiments with frequencies over 1 kHz contained within a 25 cm angle from the focal point, the loss is not greater than 5 dB and with angles wider than 51 cm the reflection is up to 20 dB.

Moreover they state that, when recording a sound 30 metres distant, the sensitivity of the microphone is increased by 14 dB over a frequency range of 500 Hz to 5 kHz.

The microphone must have a small frontal area to keep the sound pattern to a narrow angle. Grampian suggest their small dynamic microphone with a modified acoustic filter.

Another microphone I have found excellent for shape and size (12 x 4.5 cm) is the dynamic cardioid LM200 of the London Microphone Company. This and other cardioid patterns have been used with success when a reflector was not available.

Three of our residents of the thrush family will be in full song during March and their renderings are so fine that much appreciation can be expected on playback.

The first is the blackbird, accepted by many folk as the songster unsurpassed by any other bird. It is a garden and farm bird, easy to find, and is an early starter (along with the robin) although it packs up promptly at dusk.

Its song is frequently confused with that of the thrush, and is best described as a series of short varied warbles along with the most wonderful flute-like sounds—loud, clear and liquid. You will be interested to find that its

song continues while the bird flies from tree to tree.

I suggest that you make a tape of *all* the songs and sounds of the blackbird. In excitement it utters a sharp 'mink-mink-mink' which comes over well on the tape; in alarm it is the familiar 'tchuck-tchuck' repeated maybe up to ten times with two or three changes to 'towelatweet'. It sings in the rain and snow.

You may hear his usually lengthy argument with a fellow 100 metres away in a wood and if you can get both, the commentary can be amusing but don't turn up the sound knob to get a louder song from the wood. The effect of distance must be maintained and the recording indicator must be disregarded for a moment or two.

I would hope for a hawk to fly over so that a whole series of alarm calls can be recorded. The blackbird's alarm is uttered at 6 kHz. I have found, in the early summer when the migrant garden warblers have returned, that they will see danger before many other birds but their calls will immediately alert the blackbirds who will take up the warning with much energy.

And if you can fix the microphone near to a nest of nearly fledged youngsters you may hear their rather lovely 'ree ree ree ree'—the preliminary to the song proper. So your tape will be complete!

You can distinguish the song of the thrush from that of the blackbird because it repeats a phrase or phrases. It has been rendered as 'Did he do it?' repeated several times followed by 'You did, you did, you did'. When excited there will be a whole fusillade of 'ptick, ptick, ptick'. The song thrush talks when he sings with a 'Stick to it—stick to it' or 'get up' and 'be quick, be quick'.

The mistle thrush or 'storm cock' sings from the tree top in all weathers and all seasons. It is a vigorous loud oft-repeated song usually of three phrases which has been described as 'Do it quick, quick, quick' followed by 'teeawti awti-awti' ending with 'pweee, pweee, pweee'. Most difficult to explain but you cannot mistake the beautiful spotted breast as he gives his loud song sitting on the tallest tree he can find. I have heard often its alarm note which sounds something like 'charr'.

The song frequency is between 1.5 kHz and 7 kHz and its song can be loud enough for careful recording 100 metres distant. Some two years ago I experienced the killing of a blackbird by a mistle thrush and can only suppose that it mistook the blackbird's songs and noises for those of rival of its own species.

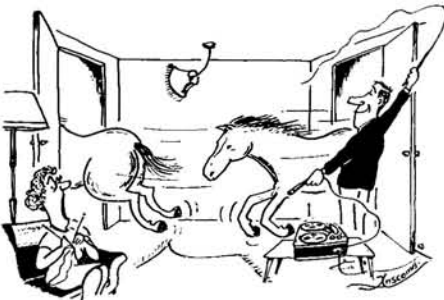

'Can't you use coconut shells like everyone else?'

## Your Tape Dealer

WARWICKSHIRE

**BIRMINGHAM**  
**TAPE RECORDER CENTRE**  
266 BROAD STREET, BIRMINGHAM 1  
(Opposite Bingley Hall)

Most leading makes high fidelity equipment  
Part exchanges welcomed  
Telephone Midland 2680

**Coventry's 100% tape recorder and hi-fi specialists for service and sales.**

Akai — Ampex — Bang & Olufsen —  
Ferrograph — Leak — National —  
Radford — Revox — Sony —  
Tandberg — Truvox — Wyndors

**Coventry Tape Recorder Service**  
33 King William Street, Coventry  
Telephone Coventry 29668

## GRIFFIN RADIO LTD

(the high fidelity people)

Fullly comprehensive stocks and advisory service for

**Monaural and Stereophonic High Fidelity, Radio, Tape and Disc Equipment**

94 BRISTOL STREET  
BIRMINGHAM 5 Telephone MID 1359

YORKSHIRE

## TAPE RECORDER CENTRE (HALIFAX)

For all the best in Tape Recorders and Hi-Fi Sales and Service

30 King Cross Street,  
Halifax Phone 66832

**REVOX**  
Specialists

SCOTLAND

## GLASGOW

Scotland's Leading Tape Recorder, Video and Hi-Fi Specialists

**G. H. STEELE LTD.**

Hear true Hi-Fi sound on our 22 speaker comparator system. 14 Hi-Fi combinations ready for demonstration.

SONY VIDEO CENTRE

Agents for: Armstrong, Leak, Fisher, Rogers, Quad, B & O, Goldring, Garrard, Thorens, Connoisseur, Goodmans, Wharfedale, Kef, Celestion, Decca, Truvox, Philips, Sony, Arena, Revox, Tandberg, Brenell, Ferrograph, Akai, Uher, Grundig.

CREDIT TERMS — PART EXCHANGES  
Repairs and Servicing Tel. Douglas 7124

141 St Georges Road, Glasgow C3

## Recording Studios

**mjb** recording and transcription service

Mono and Stereo records, latest cutting methods, automatic varigroove, feedback cutter heads, limiters and equalisers, techniques hitherto available only to the professional, facilitating high undistorted cutting levels and extended playing times even from amateur recordings. Booklet available.

45 HIGH STREET  
BURNHAM  
BERKS

Tel. 61303

# CLASSIFIED ADVERTISEMENTS

Advertisements for this section must be pre-paid. The rate is 6d. per word (private) minimum 7s. 6d. Box Nos. 1s. 6d. extra. Trade rates 1s. per word, minimum 15s., Box Nos. 2s. 6d. extra. Copy and remittance for advertisements in **APRIL 1969** issue must reach these offices by **17th FEBRUARY** addressed to: The Advertisement Manager, Tape Recorder, Link House, Dingwall Avenue, Croydon CR9 2TA.

Replies to Box Nos. should be addressed to the Advertisement Manager, Tape Recorder, Link House, Dingwall Avenue, Croydon CR9 2TA, and the Box No. quoted on the outside of the envelope. The district after Box No. indicates its locality.

## SITUATIONS VACANT

**Hi-Fi and Tape Recorder salesman** required by R.E.W. (Earlsfield) Ltd., at their Tooting branch. Good pay and conditions. Apply the Manager, 266 Upper Tooting Road, London S.W.17. Tel. 01-672 9175 or 672 8267.

## MISCELLANEOUS

**Repairs.** Our modern service department equipped with the latest test equipment (including a wow and flutter meter and multiple Stereo Signal Generator) is able to repair Hi-Fi and Tape Recording equipment to manufacturer's standards. Telesonic Ltd., 92 Tottenham Court Road, London, W.1. 01-636-8177.

**Skilled** tape recorder repairs carried out by expert personnel of many years' experience backed by extensive test equipment: Wow and flutter meter, audio valve voltmeter, audio generator, oscilloscope, etc., with final test performance figures quoted if required—Ferrograph specialists. Tape Recorder Centre, Tel-Lee-Radio, 220 The Broadway, Wimbledon, S.W.19. 01-542-4946.

## FOR SALE—PRIVATE

**Grampian** Disc-Cutting Machine. 33, 45, 78 r.p.m. 56lb. turntable. Perfect order. £250. Black, Heathfield, South Bank, Hassocks, Sussex.

**Four track**, three speed stereo tape deck, preamplifiers and power supply, particularly suitable for 'building in'. Custom built (circuits available), extensive facilities, £55. Woodhouse, 46 Foxhill Court, Leeds LS16 5PN.

**Akai 910**, 4 track, 2 speed high fidelity tape recorder £45 o.n.o. D. Jack, 101 Stainton Grove, Barnard Castle, Durham.

## FOR SALE—TRADE

**Absolutely free**, huge catalogue listing pre-recorded mono and stereo tapes. Many carrying a discount of as much as 30%. Don't buy another tape until you've seen this new list. Send 4d stamp to BCM/tapes unlimited, London, W.C.1.

**Blackburn** has Lancashire's leading Hi-Fidelity/Tape Recorder stockists and Electronic Engineers at Holdings Audio Centre, Mincing Lane/Derwent Street, Blackburn (Tel. 59595).

**Always be careful** (and money-wise) before buying quality equipment. Send your requirement list to Audio Supply Association for evaluation and quotation. See below . . .

**If quality matters** consult first our 70-page photographically illustrated catalogue (5/6) and equipment housing guide (1/6). Members enjoy unbiased advisory service, preferential terms. Membership 7/6. Our associates also manufacture records from your own tapes, or record the Master at our studios (Steinway Grand). Bulk terms for choirs, fund-raising. Please specify requirements. Audio Supply Association, 18 Blenheim Road, London, W.4.

**Absolutely genuine.** Up to 50% off retail prices of Recording Tape. Up to 25% off pre-recorded tapes including cassettes. Up to 25% off Hi-Fi equipment. Send 6d stamp for full details to: BCM/tape unlimited, London, W.C.1.

### FERROGRAPH and TANDBERG

Tape Recorders for immediate delivery, exchange photographic/Hi-Fi equipment

**HOLDINGS PHOTO/AUDIO CENTRE**  
39/41 Mincing Lane, Blackburn. Tel. 59595

## STUDIO FACILITIES

**Studio Sound Recording Studios.** Recording and disc transcription service. Latest high-level cutting techniques. Mono and stereo records. Exceptional quality obtained from amateur recordings. Members A.P.R.S. 31-36 Hermitage Road, Hitchin, Herts. Telephone Hitchin 4537.

**Your tapes to disc.** 7in. 45—25/-, 10in. L.P. —55/-, 12in. L.P.—65/-. 4-day postal service Masters and Vinylite pressings. Top professional quality. S.A.E. photo leaflet: Dero Studios, High Bank, Hawk Street, Carnforth, Lancs.

**Rapid Recording Service.** L.P.s from your own tapes. Master discs and pressings. Demo discs. Mobile recordings. Multi-channel facilities for transfer to 8 and 16 mm film tracks. Sound effects library on discs. Brochure on request from:—Rapid Recording Service, 21 Bishop's Close, London, E.17.

**Your own tapes transferred on to discs.** Send for details: R. J. Foley Tape to Disc Service, 112 Beach Road, Scratby, Great Yarmouth, Norfolk.

**J & B Recordings.** Tape to disc—latest high level disc cutting, all speeds. Mastering pressings, studio, mobile. 14 Willows Avenue, Morden, Surrey. MITcham 9952.

**Graham Clark Records.** Tape to disc-pressings. 23 The Grove, Walton-on-Thames, Surrey. Tel. Walton 25627.

## TAPE EXCHANGE

**Tapeworm's Stereo International.** This is for the stereo and hi-fi people. S.A.E. for details. 4 Queens Road, Maidstone, Kent.

**Tapeworm's International Club.** The Club that offers so much for so little. Established 10 years now. S.A.E. for details. 4 Queens Road, Maidstone, Kent.

**Tapespondents.** Free sound magazine. Details free. Far and Wide Recording Club, Eccles, Maidstone, Kent. S.A.E. please.

**Firm Friendships** for only threepence per week! Over 700 lads and lassies are waiting to speak to YOU! Join Worldwide Tapetalk, 35 The Gardens, Harrow.

## WANTED

**Lee Electronics.** The Tape Recorder and Hi-Fi Specialists wish to purchase good quality Tape and Hi-Fi Equipment for cash. 400 Edgware Road, W.2. Phone PAD 5521.

**Highest prices offered** for good quality Tape Recorders and Hi-Fi. R.E.W., 266 Upper Tooting Road, London, S.W.17.

**Good Quality Tape Recorders purchased for cash.** Telephone 01-472 2185.

**Portable** Tape Recorder wanted for 15-year old boy battery/mains preferred. Particulars to Hill, 7 Antons Road, Pensby, Wirral, Cheshire L61 9PT.

## POST THIS COUPON FOR A REGULAR COPY OF TAPE RECORDER

Subscription Department, TAPE RECORDER, Link House, Dingwall Avenue, Croydon, CR9 2TA.

Please send me a copy of each issue of TAPE RECORDER for ..... months commencing with the ..... issue for which I enclose remittance of £.....s.....d.

Name .....

Address .....

..... T.R.

Great Britain 36/- (12 months) 18/- (6 months). Overseas 38/6 (12 months) 19/6 (6 months)



# LUXOR

brings you the  
Swinging Sound  
from Sweden



**MP613 MALAR**

Stereo Tape Recorder—4-track, 3-speed. Frequency response:  $7\frac{1}{2}$  i.p.s. 50—19,000 c/s.  $3\frac{1}{2}$  i.p.s. 50—12,000 c/s.  $1\frac{3}{4}$  i.p.s. 80—6,000 c/s. Output 4 watts mono, 2 x 2 watts stereo. Automatic stop, three position speaker switch. Dual volume control. Four push buttons: recording (special lock prevents erasing) radio, gramophone and microphone. Three position channel selector. High speed rewind. Instant stop. Pause control. Built-in four-channel mixer, multi playback, synchro playback. Combination head, fine laminated Fe-Ni-core, range 50 dB. Max. 7" reel. Available in teak or rosewood with transparent dust cover. Size  $15\frac{1}{2}$ " x  $12\frac{1}{2}$ " x 7".

*For name and address of nearest stockist phone or write*

**LUXITONE**

84 Bolsover Street, London W.1.  
Telephone 01-636 2901 (4 lines)



Hi-Fi and tape recorder enthusiasts...

# AUDIO ANNUAL '69 is out now! 7/6

Brim-full as usual of informative articles by the leading authorities in your particular field.

Main features include: ★ A lifetime of audio  
★ The end of inner-groove distortion ★ Waveforms  
and musical quality ★ Problems of the record reviewer  
★ Monitoring loudspeakers and their design  
★ Basis of modern audio units

**PLUS** authoritative reviews of hi-fi and tape equipment.

A LINK HOUSE GROUP PUBLICATION

Obtainable at your local newsagent/bookseller. If you can't get a copy, we can send you one for 7/6. Send to: Link House, Dingwall Ave., Croydon CR9 2TA

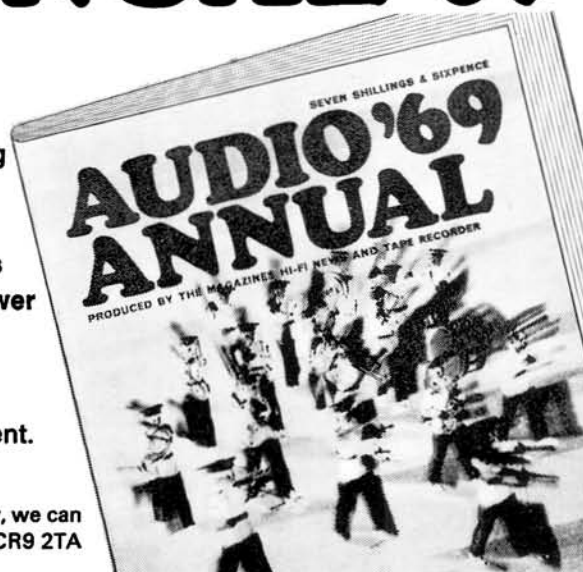



# Akai can think of 24 reasons why you should go for the new M-9 stereo tape recorder

- ★ 4-track stereo/monaural recording and playback
- ★ 3 speeds (1 $\frac{7}{8}$ , 3 $\frac{3}{4}$  and 7 $\frac{1}{2}$  ips) plus 15 ips with 15 ips adaptor kit
- ★ 3 heads . . . CROSS-FIELD HEAD SYSTEM (Erase, recording playback and bias heads)
- ★ Hysteresis synchronous 2-speed motor
- ★ High capacity 40W MUSIC POWER all silicon transistor amplifier
- ★ Shield Type head for high S/N ratio
- ★ Wide CROSS-FIELD frequency response
- ★ Sound on Sound
- ★ Automatic shut-off, Automatic stop
- ★ Automatic pinch wheel release, Automatic lever release
- ★ Two lever system for sure operation and robust construction
- ★ Track selector knob for simple selection between stereo and monaural
- ★ Instant stop control with start button
- ★ Tape cleaner with release button
- ★ Recording mode switch
- ★ Tone controls
- ★ Bass switch
- ★ Equalizer for each tape speed
- ★ Tape shifter in fast forward/rewind operation
- ★ DIN jack, Stereo headphone jacks
- ★ Four digit index counter with reset button, VU meters
- ★ Finely oil-finished wooden cabinet
- ★ Vertical and horizontal operation
- ★ Universal voltage selector (From 100V to 240V; 50/60 cps)

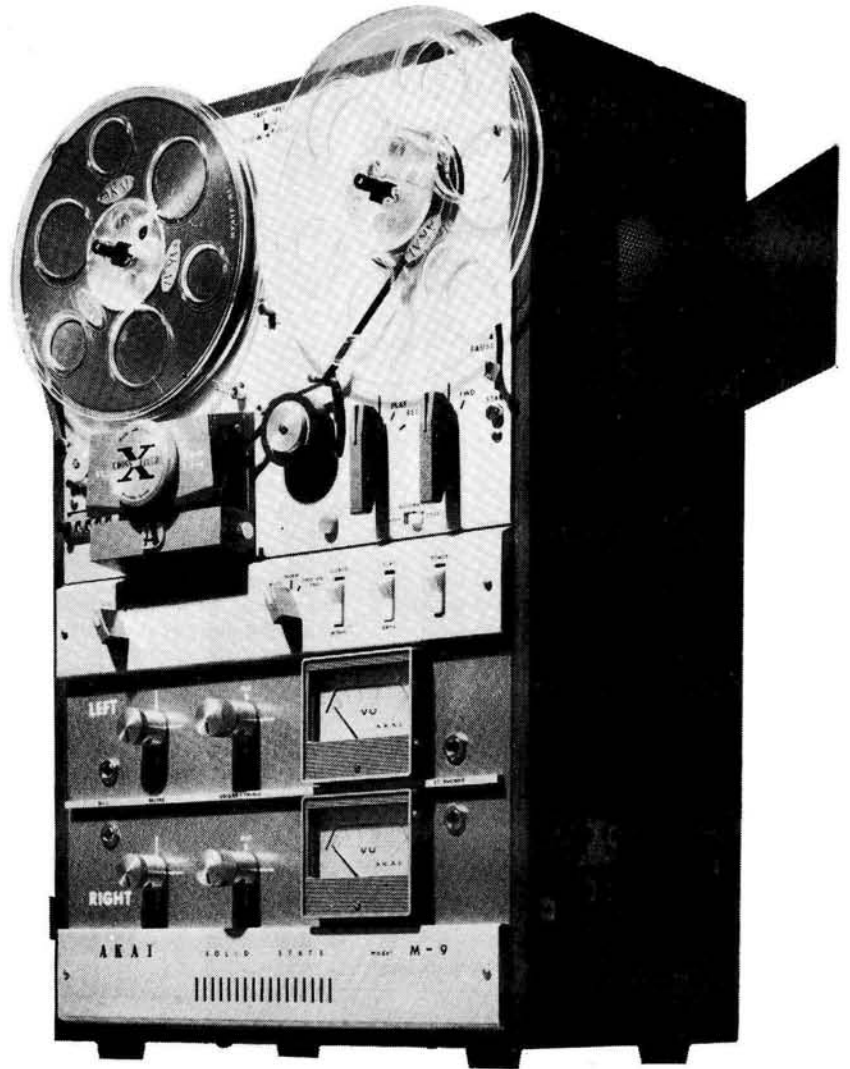

but you will probably choose it simply because it's the best.

**AKAI**

**PULLIN**  
PHOTOGRAPHIC

(A Company within the Rank Organisation)

To: PULLIN PHOTOGRAPHIC DEPT. TR 1  
11 Aintree Road, Perivale, Middx.

Please send me details of the

NAME .....

ADDRESS .....