

JANUARY 1969 2/6d

tape recorder

TWO-WAY TAPE
TRANSPORT

CROSS-FIELD BIAS

A TONE SOURCE AND
LINE-UP METER

DOCTORING POPS

TWENTY YEARS IN
A STUDIO

TANDBERG 11 REVIEW

A PLAIN MAN'S GUIDE
TO MULTI-TRACK

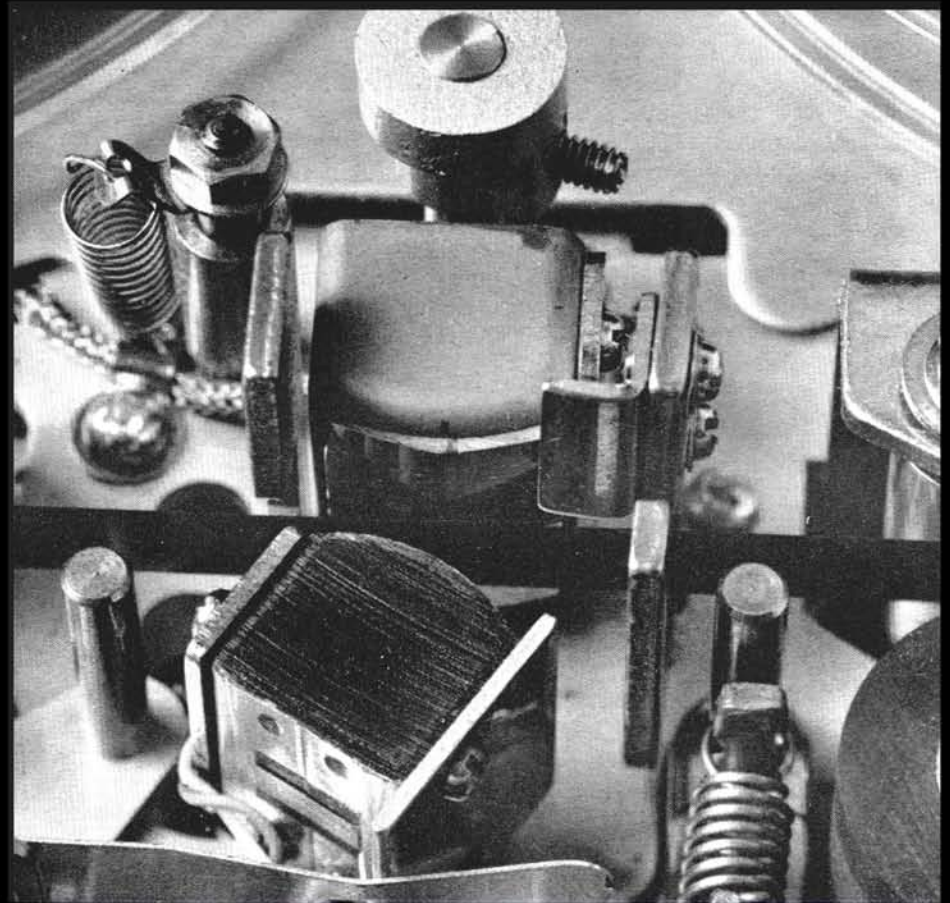

This box contains the best value-for-money Recording-Tape you can buy . . .

Here's why...

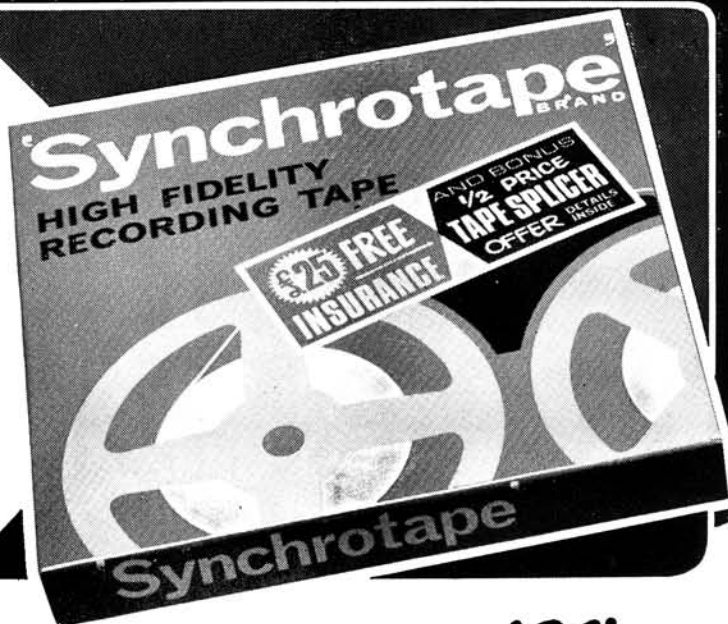

*** Synchronotape costs less.**

A British-made high-fidelity Recording Tape incorporating so many "plus" features and at the most competitive price.

*** Synchronotape's quality specification.**

Only the finest quality PVC and Polyester base materials are used. No stretching, no snapping, no deterioration of recordings in storage.

*** Synchronotape is so easy to use.**

Practically all sizes have coloured leaders, trailers and metallic stop-foils. Perfect for 2 or 4 track, mono or stereo.

*** Synchronotape is unconditionally guaranteed—against any defect whatsoever.**

*** Synchronotape has all the extras built in.**

Film-sealed rigid boxes, colour-coded and clearly labelled . . . a 12-page booklet containing useful tape recording data and the Synchronotape Recording Log.

PLUS

Up to £25 Free Insurance on your tape recorder against loss by fire or theft.

Special Tape Splicer offer. Collect three coupons from Synchronotape packs and for 7/6 get a superb Adastra "Instant Cut & Trim" tape splicer.

The Synchronotape '21' range

SIZE	STANDARD	LONG	DOUBLE	TRIPLE
BASE	P.V.C.		POLYESTER/P.V.C.	
2 1/4"		200' - 5/9d.	300' - 8/9d.	
3"	150' - 4/9d.	225' - 6/3d.	300' - 8/9d.	450' - 13/9d.
4"		450' - 12/-	600' - 18/-	900' - 27/-
5"	600' - 15/-	900' - 18/6d.	1200' - 28/6d.	1800' - 45/-
5 1/2"	900' - 18/6d.	1200' - 22/6d.	1800' - 36/-	2400' - 57/6d.
7"	1200' - 22/6d.	1800' - 28/6d.	2400' - 48/-	3600' - 75/-

NEW Synchronotape Editing Kit ...

ONLY 29/6 PLUS 6/6 P.T.



NEW Synchronotape Editing Kit ... only 29/6. (+6/6 P.T.) Here's big value for every tape enthusiast ... a "must" for editing and library compiling.

Packed in a see-through, crush-proof box, the Synchronotape Editing Kit comprises: ● The Adastra "Instant Cut & Trim" tape splicer. ● 4 reels of coloured leader tapes (each reel 45 ft.) ● 1 reel of metallic stop-foil (approx. 22 ft.) ● 1 reel self-adhesive jointing tape (18 ft.) ● 6 coloured tape securing clips. ● 24 self-adhesive labels. ● Synchronotape 12-page booklet with instructions, tape recording information, technical data and recording log.

BRITISH MADE
Synchronotape

Ferrograph Series 7 - the simple recorder with thirty recording facilities

The Ferrograph Series 7 Tape Recorder is many instruments in one: If you just want to record without going into technicalities, it is the *simplest* instrument, handled by setting one or two basic controls. If, however, you need a recorder for hard, professional work, the Ferrograph will do it for you 24 hours a day, year in year out (that's why important communications centres specify it). If you need your recorder to produce the most complex effects, the Ferrograph recorder gives you a greater range of facilities than any other.

Available in Mono, and in Stereo with and without end amplifiers, embodying a unique range of recording facilities, including:

- All silicon solid-state electronics with FET input stages and wide input overload margins.
- Vertical or horizontal operation.
- Unit construction: The 3 individual units i.e. tape deck, power unit and amplifier complex are mounted on a single frame easily removable from cabinet for service or installation in other cabinets or racks.
- 3 motors (no belts). 3 tape speeds.
- Variable speed spooling control for easy indexing and editing.
- Electrical deck operation allowing pre-setting for time-switch starting without need for machine to be previously powered.
- Provision for instantaneous stop/start by electrical remote control.
- Single lever-knob deck operation with pause position.
- Independent press-to-record button for safety and to permit click-free recording and insertions.
- 8½" reel capacity.
- Endless loop cassette facility.
- Internal loud speakers (2)—1 each channel on stereo, 2 phased on mono.
- 4 digit, one-press re-set, gear-driven index counter.
- 2 inputs per channel with independent mixing (ability to mix 4 inputs into one channel on stereo machine).
- Signal level meter for each channel operative on playback as well as record.
- Tape/original switching through to output stages.
- Re-record facility on stereo models for multi-play, echo effects etc, without external connections.
- Meters switchable to read 100 kHz bias and erase supply with accessible preset adjustment.
- Three outputs per channel i.e. (1) line out—level response. (2) line out—after tone controls. (3) power output—8-15 ohms.



- Power output 10W per channel.
- Independent tone controls giving full lift and cut to both bass and treble each channel.
- Retractable carrying handle permitting carrying by one or two persons.

U.K. Retail prices from £150 incl. P.T.

See and hear Ferrograph Series 7 recorders at your local Ferrograph stockist, or post coupon for details and address of nearest Ferrograph specialist (or ring 01-589 4485)



FERROGRAPH

To the Ferrograph Co Ltd, Mercury House, 195 Knightsbridge, London SW7
Please send me FREE brochure on Ferrograph Series 7 Tape Recorders Please
OR send me the new Ferrograph Manual, for which I enclose £1 tick

NAME

ADDRESS

TR

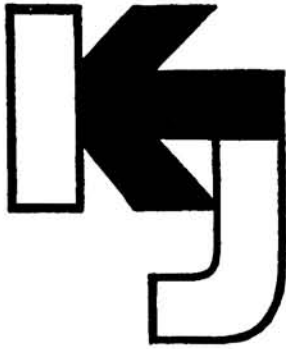

K. J. ENTERPRISES *for tapes*

UP TO 40% OFF

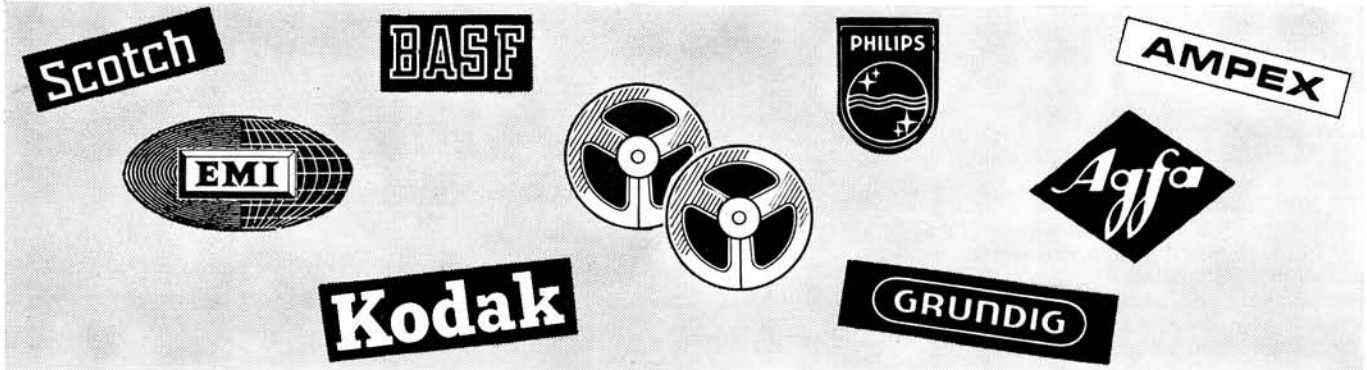

BRANDED TAPE

**BASF—EMI—GRUNDIG
PHILIPS—SCOTCH
AGFA**

Brand new, Fully Guaranteed and in normal manufacturer's pack

STANDARD PLAY	LIST PRICE	OUR PRICE	DOUBLE PLAY	LIST PRICE	OUR PRICE
5" 600' } Except Agfa	22/2	18/-	3" 300' Not Scotch	14/3	11/6
5 1/2" 900' }	29/5	24/-	3" 400' Scotch only	16/7	13/6
7" 1200' }	36/7	29/6	4" 600'	26/-	21/-
LONG PLAY			4 1/2" 900' Agfa, BASF only	31/-	25/-
3" 210' Not Scotch	9/3	7/6	5" 1200'	43/2	35/-
3" 300' Scotch only	9/7	7/9	*5 1/2" 1800'	56/11	46/-
4" 450'	14/9	12/-	*7" 2400'	79/-	63/6
4 1/2" 600' BASF, Agfa only	22/-	18/-	10" 4600' Agfa only	140/9	112/9
*5" 900'	29/2	23/9	TRIPLE PLAY		
*5 1/2" 1200'	36/5	29/6	3" 450' Not Scotch	22/3	18/-
*7" 1800'	51/7	41/9	3" 600' Scotch only	24/10	19/9
8 1/2" 2400' BASF, Scotch	74/-	59/6	4" 900'	40/-	32/3
10" 3280' Agfa only	85/9	68/9	*4 1/2" 1200' Agfa, BASF only	50/-	40/3
10" 3600' BASF only	96/6	77/6	5" 1800' Not Scotch	67/2	54/-
10 1/2" 4200' Agfa, BASF only	113/6	91/6	5 1/2" 2400' Agfa, BASF	91/4	73/6
			7" 3600' } only	116/6	93/6
SCOTCH DYNARANGE (L/P)			QUADRUPLE PLAY		
5" 900'	32/8	26/3	3" 600'	37/-	29/6
5 1/2" 1200'	41/-	33/-	3 1/2" 800' } Kodak only	46/3	37/-
7" 1800'	58/1	46/6	4" 1200'	64/6	51/6
8 1/2" 2400' (Metal Reel)	84/3	67/6	COMPACT CASSETTES		
BASF PES.35 L/P Low Noise			C.60	17/6	14/3
5" 900'	36/10	29/9	C.90	25/-	20/3
5 1/2" 1200'	45/6	35/6	C.120	33/6	27/-
7" 1800'	63/-	50/9			
10" 3600'	115/-	91/-			

Postage and packing 2/6. Orders over £3 post free

ILFORD - ZONAL TAPE

40% OFF!



NEW KJ SPECTACULAR

From the Motion Picture & Magnetic Products Division of ILFORD LTD. we are proud to present a New Scupendous **BARGAIN OFFER!** Never before have you been offered such a breathtaking opportunity. **ILFORD-ZONAL** premium grade magnetic tape (extensively used by the B.B.C.) at a terrific reduction of 40%! Brand New, Boxed, Fully Guaranteed and complete with leaders, trailers and stop foil. **UNIQUE TO KJ**

DESCRIPTION	LIST PRICE	ONE	THREE	SIX
900' on 5" reel Long Play P.V.C.	29/11	17/6	50/6	96/6
1200' on 5 1/2" reel Long Play P.V.C.	36/1	22/6	65/-	125/-
1800' on 7" reel Long Play P.V.C.	51/4	29/6	86/-	165/-
1200' on 5" reel Double Play (Polyester)	43/1	27/9	81/-	157/6
1800' on 5 1/2" reel Double Play (Polyester)	56/1	36/-	105/-	204/-
2400' on 7" reel Double Play (Polyester)	78/10	49/6	145/6	285/-

Orders over £3 post free
Post and Packing 2/6.

AMPEX TAPE—SAVE 30%

A special offer of top quality, premium grade, mylar (Polyester) base tape with Full Leader and Stop Foil. Boxed and Fully guaranteed.

TYPE	DESCRIPTION	LIST PRICE	ONE	THREE	SIX
541-12	1150' on 5 1/2" reel Long Play	35/-	24/6	71/-	137/-
551-12	1200' on 5" reel Double Play	42/-	29/6	86/-	166/-
551-16	1650' on 5 1/2" reel Double Play	55/-	33/6	97/6	189/-
551-24	2400' on 7" reel Double Play	77/6	49/6	145/6	285/-

POST & PACKING 2/6. ORDERS OVER £3 POST FREE.

**K. J. ENTERPRISES, (Dept. T.R.), 17 The Bridge,
Britain's premier mail-order audio specialists**

and hi-fi discount bargains— free catalogue

Name

Address

K. J. ENTERPRISES, 17 THE BRIDGE, WEALDSTONE, MIDDX. (Dept. TR)

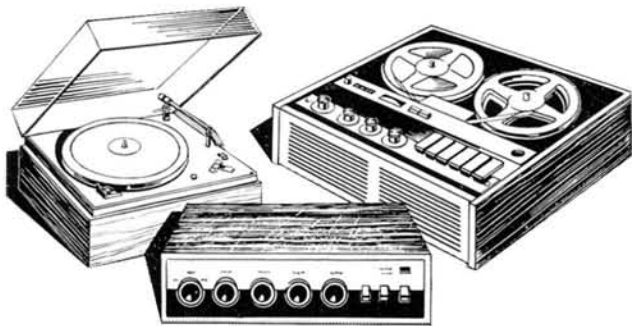

**TAPE RECORDERS
and
AUDIO EQUIPMENT**

By the following manufacturers:

- | | | |
|------------|-----------|-------------|
| ACOUSTICAL | ADC | AKG |
| ARMSTRONG | CELESTION | CONNOISSEUR |
| DECCA | EAGLE | ELAC |
| FERGUSON | GARRARD | GOLDRING |
| GOODMANS | GRAMPIAN | GRUNDIG |
| KEF | LEAK | ORTOFON |
| PHILIPS | ROGERS | RESLO |
| SANYO | SHURE | S.M.E. |
| SONOTONE | THORENS | W.B. |
| WHARFEDALE | | |

and many others—send for FREE CATALOGUE



**NOW FROM KJ THE FULL RANGE OF
MUSICASSETTES**

AVAILABLE BY RETURN POST
SEND FOR FREE CATALOGUE

BARGAINS OF THE MONTH

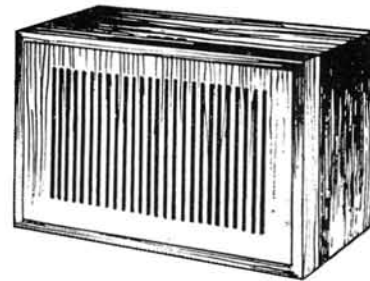

SONOTONE "SOLENT"

SAVE £6.10.0 on this SPEAKER SYSTEM

The fabulous bookshelf speaker system designed and manufactured by Plessey, one of the country's largest electronic groups. Acoustically designed two-speaker system with crossover network.

THIS OFFER REMAINS OPEN ONLY WHILE STOCKS LAST !

Technical Specification
Cabinet Size 14" x 9" x 8 1/2"
Woofer 6 1/2", 10,000 Gauss, 1" pole.
Tweeter, 3 1/2" Acoustically loaded
Frequency response 40—20,000 cps.
Power Handling 12 watts.
Impedance 8 - 15 Ohms. (4 ohm. if specified)
Scandinavian style finish.

WHAT THE REVIEWERS SAID:
"Recommended without reservation for this category of Loudspeaker". David Phillips and Donald Aldous.
"Sonotone 'Solent' deserves to reach a wide Public". John Borwick.
"A worthy member of the Hi-Fi family". R. L. West.

ORIGINAL LIST PRICE £18.0.0

Our Price Only £11.10.0

CARRIAGE 10/- EXTRA PER UNIT

FINEST LOUDSPEAKER VALUE ANYWHERE !

**SPECIAL OFFER
COMPACT CASSETTES
at HALF PRICE**



Compact Cassettes with 60 and 90 minutes playing time. Brand New and packed in normal plastic library box. Available at this exceptional price.

- | | |
|---------------|---------------|
| MC. 60 | MC. 90 |
| 1 for 10/6 | 1 for 14/- |
| 3 for 30/- | 3 for 40/6 |
| 6 for 55/6 | 6 for 78/- |
| 12 for 105/- | 12 for 150/- |

Standard pattern to fit
Philips, Stella, Elizabethan
Dansette, Sanyo, etc.

Post and Packing 2/6. Orders over £3 Post Free.

Wealdstone, Middlesex

Tel: 01-427 7758

Return of post service on advertised lines



The new
EMITAPE *Affonic*
range of
low noise tape



don't buy any tape—buy
EMITAPE



EMITAPE LIMITED
HAYES MIDDLESEX
ENGLAND

INCORPORATING
SOUND AND CINE

EDITOR

JOHN CRABBE

DEPUTY EDITOR

DAVID KIRK

ADVERTISEMENT MANAGER

ROBIN WELLS

Editorial and Advertising Offices:
LINK HOUSE,
DINGWALL AVENUE,
CROYDON, CR9 2TA
Telephone: 01-686 2599

© Link House Publications Ltd., 1968
All rights reserved

COVER PICTURE

Two forms of cross-field bias are currently being manufactured for the domestic consumer. One, developed by Tandberg, is examined on page 22. The other is produced by Akai and may here be seen in the form adopted on the X5 stereo battery recorder.

SUBSCRIPTION RATES

Annual subscription rates to *Tape Recorder* and its associated journal *Hi-Fi News* are 36s. and 47s. respectively. Overseas subscriptions are 38s. 6d. (U.S.A. \$4.60) for *Tape Recorder* and 48s. 6d. (U.S.A. \$5.80) for *Hi-Fi News*, from Link House Publications Ltd., Dingwall Avenue, Croydon, CR9 2TA.

Tape Recorder is published on the 14th of the preceding month unless that date falls on a Sunday, when it appears on the Saturday.

COMPETITION IN THE domestic tape recorder market has become so great that many manufacturers no longer feel able to sell a straightforward recording and reproducing mechanism. To render their product more competitive than the rest, they are resorting increasingly to gimmicks, sometimes under the guise of technical refinement. In the early days of domestic recording, the main sales points were reliability (directly proportional to weight) and versatility. The recorders of today, however, despite greater electronic and mechanical complexity, three and sometimes four tape heads, and a three- or fourfold range of tape speeds, are often less suited to recording than the *Mark Ones* from which they were evolved.

Take cross-field bias. Two companies are currently marketing this system domestically, at a very substantial cost to the consumer, though neither has proved the system to be audibly superior to their own conventionally biased designs at 19 cm/s. The improvement, they claim, comes at lower speeds—9.5, 4.75 and even 2.375 cm/s—which are unusable to the discerning consumer and will remain so until tape coating and deck engineering standards are raised.

Bi-directional replay demands an additional capstan and pinch-wheel (or at least an inertial guide) but the additional transport and timing components in the Akai 360, for example, might be construed as worth the extra cost. Bi-directional recording, on the other hand, demands at least four heads (ideally six), and bites so deeply into the manufacturer's budget that, if he wishes to keep the equipment within reach of the domestic consumer, the actual recording system and tape transport must be paired down to a minimum. The resultant performance, forwards or backwards, is in our recent experience below the standards demanded by critical audio enthusiasts.

Automatic gain control, previously confined to the cheapest of 'absolute beginner' domestics, has now been introduced to comparatively expensive stereo recorders. Since the object of the audio recording exercise is, usually, to reproduce sound exactly as it was originally heard, any gain adjustment during recording or replay will detract from reality. The BBC limit the dynamic range of their broadcasts as a compromise to satisfy AM listeners, to the incidental 'benefit' of FM listeners with domestic recording equipment. A similar situation, for one reason or another, applies to commercial tapes and to many discs. Live recordists, however, have no cause to ride roughshod over a performer's style; if a human or automatic device sets out to turn *fff* and *ppp* passages into a continuous *mf*, the result will be a bore even if the signal-to-noise ratio is held at optimum.

It is easy to underestimate the dynamic range capability of a 19 cm/s domestic recorder, though decent live music recording is within the capabilities of the Tandbergs, Sonys and

Telefunksens of this world. Anything with an accurate PPM or magic-eye, adjusted during rehearsal to touch the peak position on *fff* passages, may be left for the entire subsequent recording without further setting. If the *ppp* disappears into tape hiss, as it probably will on full-scale orchestral music at speeds below 38 cm/s on all but the best recorders, this is really no problem. In real life, such niceties are often lost beneath the crumpling of crisp packets, and in any case few amateur performers will require 60 dB dynamic range.

We are still awaiting the day when the 'semi-domestic' manufacturers will earn a 'semi-professional' reputation for their equipment by adding 38 cm/s to their basic 19 and 9.5 cm/s, leaving 4.75 to the cassettes. The popular argument put up against 38 cm/s by manufacturers is the difficulty of designing a tape transport that would accommodate 27 cm spools, implying that an 18 cm capacity is insufficient. An 18 cm reel of DP tape will run for 30 minutes without interruption, which is adequate for anything an amateur is likely to meet. Or is professional quality just another gimmick?

FEATURE ARTICLES

- 11 DOCTORING POPS
By L. Hayward
- 12 TWENTY YEARS IN A STUDIO
By A. D. Marsh
- 15 ANOTHER DIMENSION
By Peter Turner
- 16 AN INTEGRATED TONE SOURCE AND LINE-UP METER
By John Fisher
- 19 A PLAIN MAN'S GUIDE TO MULTI-TRACK
By Peter Bastin
- 22 CROSS-FIELD BIAS
By Fritjof Brodtkorb
- 27 TWO-WAY TAPE TRANSPORT
By Vivian Capel
- 33 A TAPE RECORDIST'S BOOKSHELF

REGULAR ITEMS

- 9 WORLD OF TAPE
- 30 TAPE RECORDER SERVICE
By H. W. Hellyer
- 38 READERS' PROBLEMS
- 41 ANIMAL SOUND
By Cyril Grange

EQUIPMENT REVIEWS

- 34 TANDBERG SERIES 11
By A. Tutchings



This is a page of hi-fi news.

Into the world of Hi-Fi, now and again there comes a product that represents terrific value to the enthusiast.

Such a product is the Grundig TK247 de luxe Stereo tape recorder.

Never before have so many professional features been incorporated in a machine at a price the amateur enthusiast can afford.

Permit us to dangle the specifications in front of you.

Four track, full stereo record and playback to Hi-Fi standard.

Independent record/playback controls and tone control.

Facilities for in-put mixing, super-imposition, multiplay and

echo effects. Also monitoring via ear-phones, automatic tape-stop, parallel track operation, tape inching, and a tape joining channel.

More?

Right. Plated steel chassis and frame ensure perfect mechanical alignment.

Tape pressure band prevents drop-outs.

Double-action safety clutch. Easily modified for 60Hz mains operation. Amplifier hinges for easy servicing.

Two tape speeds give up to eight hours playing time.

Less than 0.15% wow and flutter.

Twin-edged illuminated VU level meter.

Two $6\frac{3}{4} \times 3\frac{3}{4}$ " high-quality elliptical speakers with two-inch tweeters.

It is $17\frac{1}{2} \times 13 \times 7\frac{3}{4}$ " and weighs 30 lbs.

Quite a tape recorder for anybody.

Please send me details of the Grundig TK 247 de luxe.

Name

Address

.....
.....

GRUNDIG

Dept. T.R.1 Grundig (Great Britain) Ltd., Sydenham, S.E.26.

FAST VIDEOTAPE COPYING

HIGH-SPEED copying of video tape recordings has never been a practical proposition as the frequencies involved become unmanageable. An IEE report by W. T. Frost (IBM) and E. T. Hatley (Data Disc Inc.) describes the experimental application of contact printing to video, based on a principle long known to be effective in audio. An hour long programme recorded at 19 cm/s linear tape speed on a helical-scan recorder was successfully dubbed in three minutes at a linear velocity of 380 cm/s. An alloy-particle tape with a 500 Oersted coercivity was used for the master recording, being printed in an HF bias field on to a 300 Oersted Fe_2O_3 tape. Bias was supplied from a 5 mm gap head. Quality of the experimental copies showed a reduction of up to 3 dB in tape output compared with a normal second generation recording.

BBC PURCHASE HIGH-SPEED DUPLICATOR

THE BBC have purchased their first high-speed tape copying system, manufactured by Philips, for use in the external services at Bush House. Hitherto all copying has been undertaken at the original speed but the new system will copy eight times faster. Exhaustive comparison is said to have shown no discernible difference in quality between master and copy. Playing times are kept within very tight limits.

1969 AUDIO FAIR

OCTOBER at Olympia, time and venue of this year's London Audio Fair. The format will be markedly different from previous years, when hotel bedrooms have provided the necessary acoustic isolation between one exhibitor and another. Each demonstration will be housed in a 20 x 16 ft booth under an 8 ft ceiling, further display space being provided elsewhere in the exhibition hall. The hall will be shared with the Photo-Cine Fair, which itself offers much of relevance to tape

PAINTON EXPORT CONFERENCE

DIRECTORS of the Overseas Painton Companies met in Northampton during October for the 1968 Export Conference. The three-day seminar covered all aspects of

recording. (Ampex and Precision Instruments are among past participants.) A charge of 4s per head will be made to the public, covering both exhibitions.

A trade and press preview will be held from 11 a.m. until 4 p.m. on Thursday October 16, general opening being at 4 p.m. until 9. The hall will be open from 10 a.m. to 9 p.m. on Friday, Saturday and Tuesday, closing one hour early at 8 p.m. on Wednesday. On Monday, October 20, it will open at 2 p.m. until 9. The hall will be closed on the Sunday. These dates, incidentally, are concurrent with the Earls Court Motor Show.

COSMOCORD PRICE REDUCTION

RECOMMENDED price of the *Mic 91* microphone, introduced to supersede the *Mic 40*, has been reduced to 35s. The unit is an omni-directional crystal with integral table stand. Frequency range is 40 Hz-7 kHz, sensitivity being -50 dB ref. 1V/Dyne/cm² (3.2 mV) at 1 kHz. Nominal capacitance at 20°C is 1.15 kpF.

LYONS MOVE SOUTH

A CHANGE of premises for Douglas A. Lyons & Associates Ltd., agents for Bouyer public address equipment and Lem microphones. The company now occupies 8 *Ryecotes Mead, Dulwich Common, London SE21*. (Telephone: 01-693 2855.)

SONY MOVE WEST

AFTER a brief stay in Wigmore Street, Sony have now moved to new premises in Middlesex. All communications should be addressed to *Sony (UK) Ltd., Clockhouse Lane, 11 Ascot Road, Bedford, Middlesex*. (Telephone: Ashford 50021/6.)

ACOUSTIC LOCK PATENTED BY SPERRY RAND

AN acoustic lock capable of remembering a specific human voice has been developed by the Sperry Rand Corporation. The memory takes an unusual form, comprising a bundle of

export trade promotion relating to the electronic component manufacturers within the group. A tour of the Elcom factory was included in the itinerary, the party being pictured watching final testing of an audio mixer.



optic fibres capable of vibrating at audio frequencies when actuated by piezo-electric vibrator. The latter is coupled mechanically or electrically to a microphone which could be mounted on a door. Light from an electric filament passes through the fibres to two masks, photographically prepared to pass maximum light when a predetermined code word is spoken by a selected person. The light falls on a photocell which operates a relay. A further 'sceptron' is incorporated to prevent the system from switching when louder sounds, with all the command frequencies at operating intensity, are applied. Facilities exist for handling two or more voices in sequence.

HANIMEX TO IMPORT TOSHIBA

AGENCY for Toshiba audio equipment has been secured by *Hanimex (UK) Ltd., Hanimex House, 15-24 Great Dover Street, London SE1*. The products of this Japanese manufacturer vary from a £103 19s 4-track stereo recorder, through disc reproducers, loudspeakers and amplifiers, to the £7 19s 6d *HR-80* stereo headphones.

APRS ADDRESS

THE address of the Association of Professional Recording Studios was quoted incorrectly in our December issue. This is *47 Wattendon Road, Kenley, Surrey*, not Wallendon Road as stated.

PHILIPS EXTEND SERVICE NETWORK

ANEW branch of the Philips/Pye servicing organisation has been opened in Edinburgh. Enlarged premises at *2 Abbey Lane, Abbey Hill, Edinburgh 8* (Telephone: 031-661 1296) replace the former *Combined Electronic Services* depot at St. Stephens. All regions of Scotland will be covered from the city, with the exception of Dumfriesshire, Kirkcudbrightshire, Wigtown, Ayrshire, Renfrewshire, Dunbartonshire, Argyllshire and Lanarkshire. These counties will be covered by the Hamilton branch of CES.

NEXT MONTH

THE WORLD ON RECORD, in our February issue, describes the application of tape equipment at the BBC Monitoring Service and is contributed by a member of the Caversham staff, John Fisher. Anthony Eden covers the practical side of microphone matching while constructors are offered an inexpensive microphone boom by J. S. Frost.

now... **fabulous** FREE OFFERS

with superb

AKAI

Tape Recorders
from
R.E.W.

All on Interest Free Terms, one-third cash price deposit, balance over 12 months!



FREE! SPECIAL OFFER with each machine — FREE ACCESSORY KIT (value £12 18s.) PLUS FREE pair of Stereo Headphones, value £6. 10s. 0d.!

AKAI 1710W Stereo Tape Recorder (left). The Shield Type Head for High S/N Ratio. 4-track stereo/monaural recording and playback. 3-speeds (1½, 3½ and 7½ ips (15 ips optional)). Automatic shut off. Pause lever. Tape cleaner. Tape shifter in fast forward/rewind operation. 4 hours maximum stereo recording capacity with a 1,200 feet tape. DIN jack, Stereo headphone jack. 3-digit index counter with reset button, VU meters. Finely oil-finished wooden cabinet. £109.

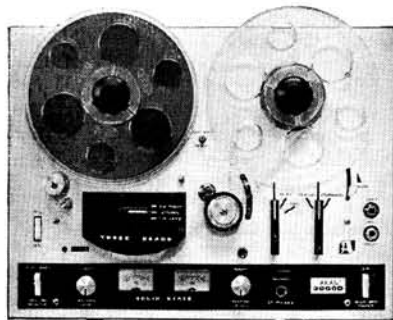

FREE! SPECIAL OFFER with every deck FREE pair of Stereo Headphones listed at £6 10s. PLUS FREE COVER —PLUS TWO FREE MICROPHONES listed at 6 gns.

AKAI 3000D 4-Track Stereo Tape Deck (above). High Quality Three Heads System. 4-track stereo/monaural recording and playback. For playback, the 3000D requires external power amplifier and speakers. 2-speeds (3½ and 7½ ips). Three heads (erase, recording and playback heads). All silicon transistor pre-amplifier. Automatic shut off, Pause lever. Tape cleaner. DIN jack. Stereo headphone jack. 3-digit index counter with reset button. VU meters. Beautifully grained wooden cabinet. £99 10s.

Also the following superb Akai machines at opportunity prices:

X355 CROSS-FIELD HEAD RECORDER, our price £270 (list £331). Few left only!

1800 8-TRACK CARTRIDGE/REEL TO REEL STEREO RECORDER £158.

X1800 S.D. CROSS-FIELD HEAD 8-TRACK CARTRIDGE/REEL TO REEL STEREO RECORDER £201.

X150D CROSS-FIELD HEAD HI-FI TAPE UNIT, our price £106 (list £130).

XV PORTABLE AC/DC CROSS-FIELD HEAD STEREO RECORDER £180.

FREE! SENSATIONAL OFFER to every purchaser of the M9, a FREE pair of Wharfedale Super Lynton Speakers currently valued at no less than £41 4s. 0d.!

AKAI M9 High Fidelity Stereo Tape Recorder (right) Cross-field Head. All Silicon Transistor Amplifier. 4-track stereo/monaural recording and playback. 3 speeds (1½, 3½ and 7½ ips) plus 15 ips with 15 ips adaptor kit. Hysteresis synchronous 2-speed motor. Wide Cross-field frequency response. All silicon transistor amplifier. Sound on sound. Automatic shut off, Automatic stop. Bass switch. Tape shifter in fast forward/rewind operation. Finely oil-finished wooden cabinet or vinyl leather wooden cabinet. £195.

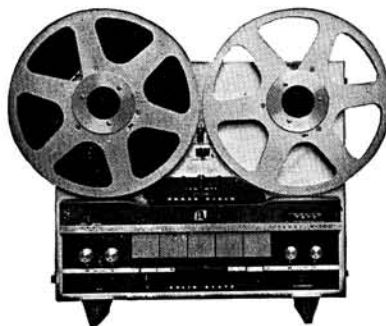

AKAI X-300. List price £263 18s. 3d. **OUR PRICE** only 179 gns. 10½" Reel Studio Type Stereo Tape Recorder (right). (No Belts . . . Direct Driven Capstan.) Cross-field Head. Solid state amplifier. 4-track stereo/monaural recording and playback. 2-speeds (3½, 7½ and 15 ips optional). 4-heads (erase, recording, playback/monitor plus bias heads). 3 outer rotor motors (hysteresis synchronous 2-speed motor for direct driven capstan, two torque motors for fast forward and rewind). 50 watts solid state amplifier. Sound over sound. Automatic stop, Automatic shut off. Specially 90 kc Biased for recording of FM multiplex.

R.E.W.

R.E.W. (EARLSFIELD) LTD.

★ LEADERS IN MAIL ORDER HI-FI

● HEADQUARTER SHOWROOMS AND MAIL ORDER:

DEPT. T.R., 266-8 UPPER TOOTING ROAD, LONDON, S.W.17

Tel: 01-672 4471/2 & 9175

● WEST END SHOWROOMS: 146 CHARING CROSS ROAD, LONDON, W.C.2

Tel: 01-836 3365 (opposite Astoria Cinema)

DOCTORING POPS

L. HAYWARD* DESCRIBES TECHNIQUES FOR PRODUCING PHASING EFFECTS

THE term 'phasing' is used by recording engineers to describe an effect now being applied to some popular music. The sound is not easy to describe but resembles the fading heard on some distant radio transmissions. This effect can be brought about by introducing a notch in the frequency response of the recording equipment. If this notch is moved up and down the spectrum (fig. 1), the desired effect will be achieved.

The equipment required to accomplish this effect would be complex if based on electronic techniques. The four methods to be described are quite simple, requiring only conventional tape recording equipment, and form the basis of equipment employed in studios.

A really simple and effective method requires two recorders, each of which must be capable of simultaneous playback while recording. The inputs and outputs are combined and are in phase; if this is not so the outputs will cancel each other. With the machines running, one of the tapes should be slowed slightly by placing the thumb on the supply reel. If a signal is being presented to the inputs, portions of the frequency spectrum will be cancelled as the tape slows and regains speed.

The system in fig. 2 is based on a single stereo recorder. (Some models have only a limited azimuth adjustment and may therefore not be quite satisfactory.) The input is fed to both channels and, while the tape is running, the azimuth of the recording head is moved from vertical to one side and back. If the recorder has off-tape monitor facilities, the effect can be heard while the azimuth is shifted. In the case of machines with an integrated record/playback head, the tape must be rewound first.

In both cases the outputs must be combined, preferably by parallel connection of the upper and lower track heads, so that as the head is adjusted the phase advance or retardation will cause cancellation of parts of the spectrum. Moving the record head slightly off azimuth will cause the high frequencies to be cancelled, while a large azimuth shift causes cancelling at the lower frequencies.

Fig. 3 is probably the best method of all, since sufficient longitudinal movement can be obtained to cover the full audio spectrum. Some engineering will be required, however, since normal tape transport systems are not designed to allow longitudinal adjustment of heads. The operation is the same as in fig. 2 except that the head is moved from side to side instead of being rocked through azimuth.

On reflection, an easier method of obtaining the effect would be to alter the tape travel distance instead of the head spacing (fig. 4). The original idea of using two machines, for the record, was suggested to me by the BBC Radiophonics Workshop.

It should be noted that the tape speed in all cases should not be below 19 cm/s and that results are most satisfactory on recordings with a wide bandwidth.

*Haybridge Electronics

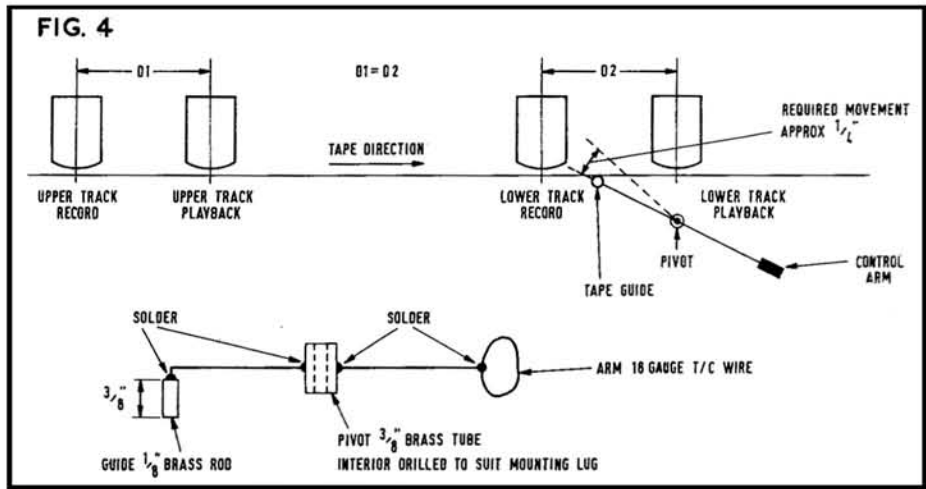
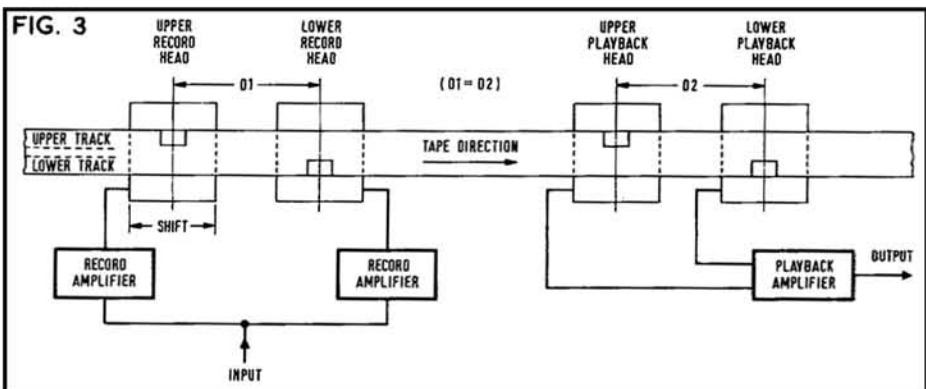
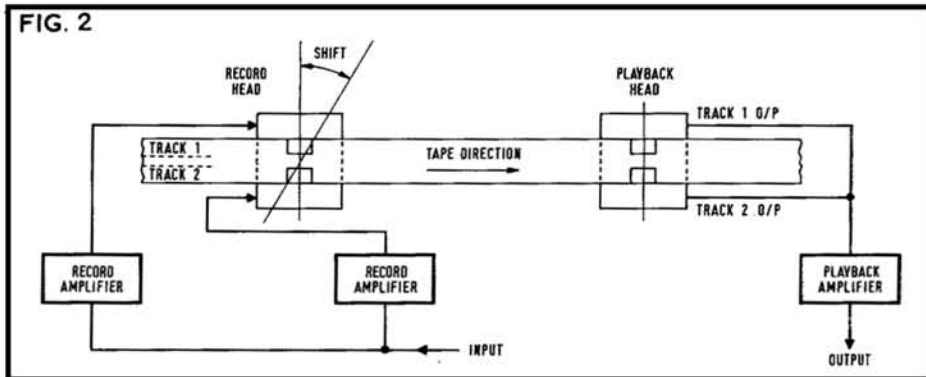
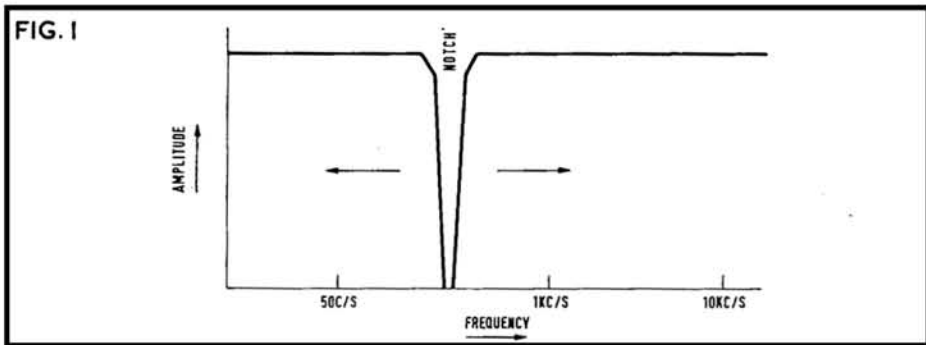

20 years in a studio

TWO DECADES OF TAPE TO
DISC TRANSCRIPTION
RECALLED BY A. D. MARSH*

TWENTY years ago, the writer purchased his first disc cutter—£90 *new*—a well made machine by MSS. It was hard work in those days with no tape masters. Microphones went direct to discs and recording a stage show of 2.5 hours meant twenty 30.5 cm discs. Now tape reigns supreme for the initial recording and specialised tape to disc transfer systems have been evolved.

The system I shall now describe is a modern stereo/mono disc cutting unit costing well in excess of £90, namely more than £6,000. In order to obtain full value from this capital, work has to be done for other studios and record companies, in addition to the thousands of records cut each year for domestic clients wanting a permanent and durable disc copy from their tapes. Additionally, work comes from our own studio bookings, to convert 'live' music to master tapes and thence to discs, as 'demo' discs for performers or Masters (special oversize discs) for producing vinylite pressings.

Songwriters also use the studio facilities to have their songs taped, possibly with a professional backing group or band, or the song sung by a professional vocalist—vocal and backings on separate tracks so that the same vocal can be used with better or large backing later if required.

As a recent example, a singer came over from Germany and we taped him using piano accompaniment—taping this first as he was not the world's greatest pianist—then adding his excellent voice to the piano track. Then agents became interested, the singer being back in Germany, so we added a group backing to the original voice, masking the piano track. The result is a super voice with good strong modern backing—still on separate tracks for individual use if required.

These are normal studio operations, but for readers who think of music as the sole prero-

gative of a recording studio they might be surprised to learn of a few of the regular 'non-musical' works involved: burglar alarms, lectures, hypnosis, court evidence, trains, birds and animals, heart beats, army gun bangs (soldiers must know our guns sound different to the enemy), till and customer training for chain store staff, theatre inserts, messages, marriage proposals, birthday greeting and even a signature tune, last week, for a caravan manufacturer.

Now for the disc-cutting. Although semi-automatic, this is a complex operation and firstly a description of the machine, known as a disc cutting lathe. It is in fact a lathe, with cutterhead mounted on a moving sled, and a massive turntable at one end. There are now only two systems in the world—Neumann in Europe and Scully in USA, both basically similar machines—evolved after nearly 50 years specialisation.

We have two Neumann lathes and describe this make.

First there is the basic lathe, massive castings, precision bearings, fine machining. The 40 cm turntable is also massive, 65 lb of flywheel, and driven by an even more massive 112 lb motor, actually four motors in one, a rotor for each of the three-speeds and a starter motor which runs the others up to synchronous speed. These rotors run at turntable speed, which means no gears or friction drives. This stands on the floor and connects to the turntable by an oil coupling, holding over a pint of oil, which effectively isolates the turntable from any possible motor vibrations while the flywheel turntable smoothes out speed fluctuations. Prior to stereo, a centre clamp held the blank disc onto the turntable, the disc surface being protected by a rubber mat, but this clamp caused very slight 'dishing' of the blank disc which would not allow accurate stereo grooving. To avoid this, the disc is now held down by air suction.

The cast iron turntable is topped by a 2.5 cm thick alloy plate, drilled with air holes and passages and fed to a motor and suction pump, with valves to blank off the air holes that are outside the disc diameter in use. The disc is held firmly by suction onto the

ribbed, soft alloy surface, smooth enough to avoid surface damage to the disc.

This suction system also removes the swarf or thread cut from the groove, which is sucked up by a tube, flattened to fit just behind the cutting stylus and thence to a large jar with a filter on the suction side.

The 0.25 h.p. motor and pump is situated outside the cutting room to avoid noise and vibration and is lubricated by drip feed as it runs non-stop 8-12 hours per day. Finally, we have the moving sled, running across the turntable from outside to inside, carrying the cutter head, this sled being driven by another motor in the variable pitch drive unit situated on the right of the lathe bed, at the opposite end to the turntable.

The cutter heads are plugged into the cutter head suspension unit, a rectangular device, carried on the sled arm, allowing interchange from mono to stereo heads as required, the connections being made by two six-pronged plugs carrying the main drive coil current, the feedback coil current and the stylus heater current.

This suspension unit also carries the solenoids which raise the head after use, micro switches and an oil dashpot to damp out vertical oscillations.

It also has a ring magnet with its surrounding coil, which rises and falls in opposition to the head and enables electrical adjustment of the depth of cut, during the actual cutting operation, this being controlled by either the tape signal via advance head or pre-set electrically.

This suspension unit is most precisely made to avoid maladjustment and possible damage to the expensive cutterheads, the stereo head costs over £1200 and the monitor head a mere £500. Amplifiers to drive these add another £2500.

The tiny cutting stylus must also not be damaged, being only 6.25 mm long, made from selected ruby or sapphire, ground to a chisel shape and wound with a tiny heater coil. This comprises some five turns of Nichrome wire to give a quiet cut without tearing the lacquer—the hot knife through butter principle. DC is used to avoid inter-



ference with the other head coils as the stereo head has five coils in close proximity.

As the main drive coils are driven by two 60 W amplifiers, the heads are drilled to allow helium gas to be fed to the head coils to dissipate the heat generated during high level cutting, especially of 'pop' discs. Another safety device is a circuit breaker which disconnects the cutterhead coils above a selected audio level.

We now have to move the cutterhead across the disc with the utmost precision as the width of a microgroove is less than a human hair, yet this drive must speed up to give 1 groove per cm for run-off spiral or slow down to give 100 g/cm for quiet passages. A ratio of 100:1, and this necessitates a very special motor with small diameter rotor for almost instantaneous acceleration, and a feedback sensing circuit to give freedom from speed variation and cogging over this wide speed range.

This drive is done by the variable pitch control unit which contains the above motor and controls, also relays, synchronous timing motor and push buttons for operation of the run in, band and run-off spirals.

This latter operation is interesting—on pushing the final run off button, the sled is speeded up to give the wide run off spiral and released at a selected point, depending on side duration and record label size to be used.

On release, it stops the pitch motor which allows the head to cut the final static locking groove—the timing motor is now started and by an arrangement of cams, microswitches and relays, the following sequence occurs:

It times the final groove to just over one revolution at 33 or 45 r.p.m. pre-selected.

As the groove cuts in on itself to complete the locking groove, a solenoid lifts the cutterhead, disconnects the main coil current, cuts the stylus heat, stops the tape machine by remote control, switches off and resets for another operation.

This final groove also has a greater depth of cut, automatically applied. During these push button operations, the meter, indicating the groove pitch in use, has to be protected to avoid overload and this is done by a zener diode. Amplifiers in use for transfer of tape to disc are as follows:—

Tape head replay amplifier and extra head replay amplifier for pitch control. Line amp to bring these to 600 ohms.

Tape amplifier for monitoring off tape via loudspeakers.

Limiter amplifier to control overloads and maintaining average level.

Equalising and filtering networks—tone controls.

Treble limiter to avoid groove distortion and protect cutterhead.

Main (200 W) studio playback amplifier connected by patchboard to any source in studio.

Playback amplifier from cutterhead feedback coil showing signal being cut.

Playback amplifier from pickup tracking the disc, actual signal off groove.

Feedback amplifier to monitor and control cutterhead damping.

Main cutterhead drive amplifiers—60 W mono and 120 W stereo.

For stereo cutting most of these are duplicated. We have more than 20 amplifiers working,

transistor or valve, to suit each purpose.

One problem is the high cost, around £10,000 per cutting system, since many studios using outdated and converted cutters are unable to consider this installation, especially if an outlay has been made on a four or eight channel tape installation. It now seems that specialisation is the answer with studios concentrating on tape work from live performances, and the discs being cut by disc cutting specialists.

Let us now follow the progress of a domestic tape, say a Wedding or Choir, one of hundreds sent in annually. After being carefully opened, checked and accounted, a job card is issued, filed and booked for an available machine. This can be $\frac{1}{4}$ -track, $\frac{1}{2}$ -track or full-track, mono or stereo, at any tape speed. Might even be a little Philips cassette.

In its turn, a few days later, the tape becomes due for transfer and it is fitted on to the selected tape machine, customer's instructions read and noted, then played back to check level and quality of recorded material. This tape machine is then connected via patch panel (a small telephone exchange) to the disc cutting system allocated.

This entails line amplifier and VU meter, full range limiter, treble limiter, equaliser and main gain controls to peak programme meters prior to the main cutterhead drive amplifiers.

A blank disc is placed on the turntable, air valves having been selected, and the suction system started, then the massive turntable is rotated and settles down to its selected speed, whilst the cutterhead carriage is moved into place over the edge of the disc.

The illuminated microscope is swung round so that it scans the grooves immediately after they have been cut. A quick check along a row of illuminated lights indicates that the whole system is connected ready for use.

Helium gas on, check flow indicator ball, lead screw engaged, lower the cutter head; a quick puff to ensure the swarf thread goes up the suction tube and we are off.

The first push button is now pressed to cut the run-in groove, this being deeper than the modulated grooves to ensure on playback

that the pickup is guided safely into the modulated grooves. After checking in the microscope that the groove depth is okay for first two revolutions, the tape is started by remote control from the lathe and levels are set to suit the programme material, previously decided on a playback check of the tape. (Often a short test cut is made on a spare disc.)

The VU meters are sitting nicely at 0 VU (100% modulation), controlled by the fast action limiters whose meters read gain reduction of the peaks and there are several other meters to keep an eye on—stylus heater current, depth of cut meter, groove per cm meter and, of course the main cutter head current meters.

When the first inter-item band is required, a button is pressed for the four to six second pauses to give the scroll between items, either to tape leaders or fade cues supplied by customer. Domestic tapes are not able to control the automatic banding mechanism as are commercial and professional studio tapes which have been carefully edited. Pitch is varying all the time according to the music/material, being cut-coarse pitch (wide groove spacing) for loud passages, fine (closely spaced) grooves for quiet passages.

Turnover break is chosen by timing limit or cue, the main gain faded, the run-off spiral and locking band operation carried out as detailed earlier and finally the record removed for playback check, visual check, and passed for labels, sleeving, packing and posting back to customer, with his tape.

I would mention that the machine shown in the photos is adapted, with the help of Neumann and their agents Bauch, to suit this specialised tape to disc work, to cope with all sorts, sizes, speeds, tracks and quality of domestic and semi-professional tapes, with manual or semi-automatic operation at all times, but with automatic operation when required.

Much credit for this goes to our engineers, especially chief engineer Gerald Crompton, who is responsible for the design and modifications in response to ideas specified by the writer and operator. I also took the photos!

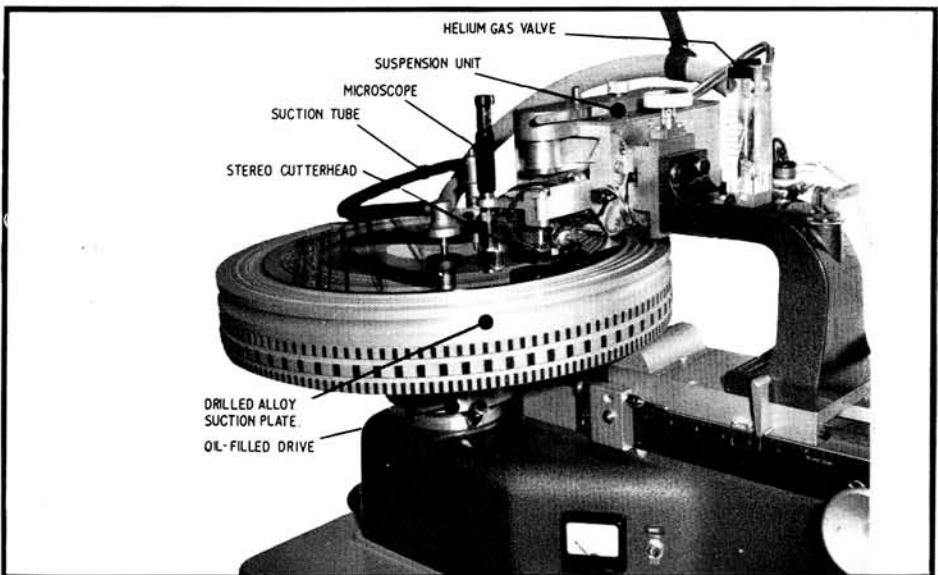

Akai can think of 24 reasons why you should go for the new M-9 stereo tape recorder

- ★ 4-track stereo/monaural recording and playback
- ★ 3 speeds (1 $\frac{7}{8}$, 3 $\frac{3}{4}$ and 7 $\frac{1}{2}$ ips) plus 15 ips with 15 ips adaptor kit
- ★ 3 heads . . . CROSS-FIELD HEAD SYSTEM (Erase, recording playback and bias heads)
- ★ Hysteresis synchronous 2-speed motor
- ★ High capacity 40W MUSIC POWER all silicon transistor amplifier
- ★ Shield Type head for high S/N ratio
- ★ Wide CROSS-FIELD frequency response
- ★ Sound on Sound
- ★ Automatic shut-off, Automatic stop
- ★ Automatic pinch wheel release, Automatic lever release
- ★ Two lever system for sure operation and robust construction
- ★ Track selector knob for simple selection between stereo and monaural
- ★ Instant stop control with start button
- ★ Tape cleaner with release button
- ★ Recording mode switch
- ★ Tone controls
- ★ Bass switch
- ★ Equalizer for each tape speed
- ★ Tape shifter in fast forward/rewind operation
- ★ DIN jack, Stereo headphone jacks
- ★ Four digit index counter with reset button, VU meters
- ★ Finely oil-finished wooden cabinet
- ★ Vertical and horizontal operation
- ★ Universal voltage selector (From 100V to 240V; 50/60 cps)

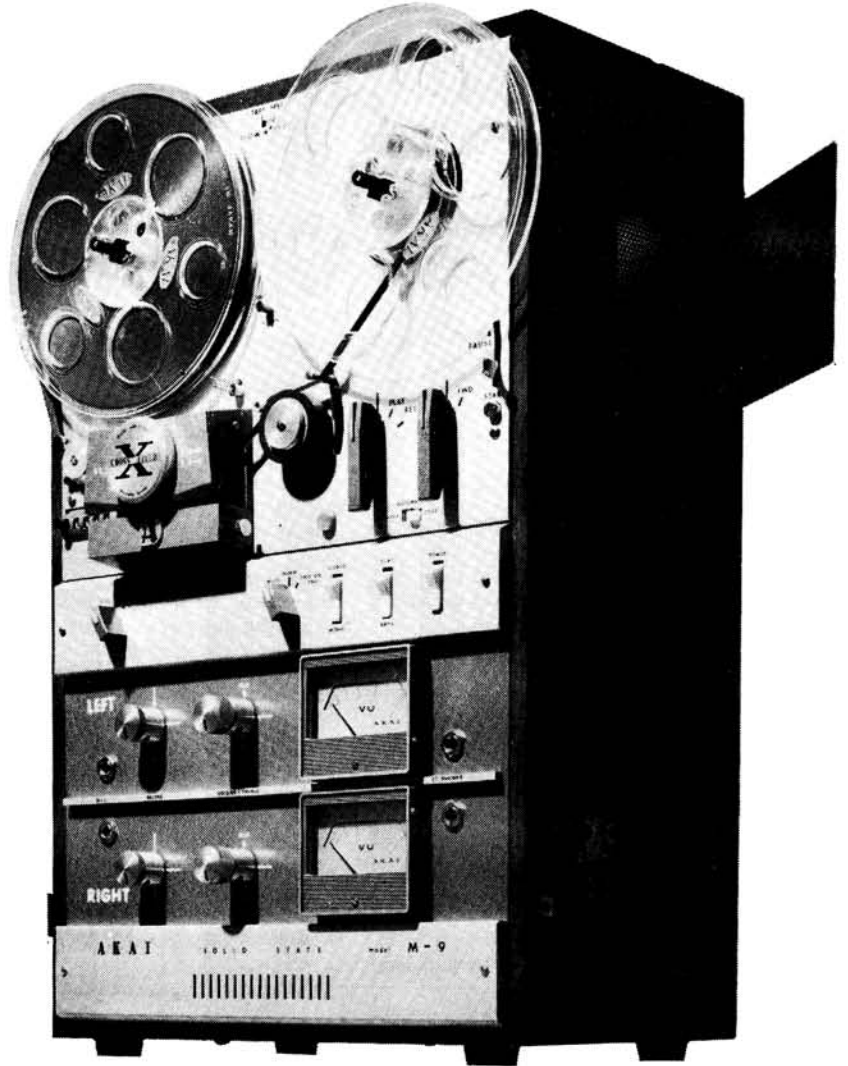

but you will probably choose it simply because it's the best.

AKAI

PULLIN
PHOTOGRAPHIC

(A Company within the Rank Organisation)

To: PULLIN PHOTOGRAPHIC DEPT. TR 1
11 Aintree Road, Perivale, Middx.

Please send me details of the

NAME

ADDRESS

ANOTHER DIMENSION

BY PETER TURNER

FROM the numbers who pursue both hobbies, there must be something in common between sound recording and photography. The most important is that both tend to be expensive, unfortunately. Though the man behind the microphone is as crucial as the man behind the camera, and though some really good results can be achieved with modest equipment, the best demands the best, for those capable of making use of it. There seems no hope of the war with one's bank manager being brought to an end, especially with all these confounded journals telling one about the latest marvels.

Astronomical numbers of photographs are shot by amateurs each year and the number grows steadily. I wish I thought that the consumption of tape was equally large but I do not. Too many recorder-owners buy hardly a reel of tape other than the one they buy with their machine; but it is also true that many camera-owners shoot only a spool or two on their annual holiday. That is all perfectly fair, of course; but is it sensible to give £100 for a recorder or a camera (and thousands do) merely to sit and look at the thing? I suppose that most people get a camera, or a recorder for that matter, in the first place in order to make those beloved, sentimental records of places and people they have known: of occasions in the family, of events in their lives like birthdays and weddings. I am all for it; but, unless they happen to be dear to me too, I don't want to share the results.

There are few bores worse than the slide- or tape-bore: the chap who is always on the lookout for victims, who can never get anybody into his home without whipping out the projector or the recorder, and treating his unhappy guests to 'us in front of St. Mark's', 'Aunt Mabel on the Bridge of Sighs', the sound of the boat 'as we left for Cherbourg', baby's first words—the list is endless and the prospect daunting. Have such people any friends left?

But suppose that, instead of droning away for ten-minutes-a-slide all the way from St. Albans to Skye, we edit the slides into a sequence and accompany it with a well-made commentary on tape: the fewest possible words, with a background of suitable music and of sound-effects recorded on the spot? At once we enter a different world: such a show can be thoroughly enjoyable, because to both slides and tape there is added a new dimension. The boredom is gone.

To give an example: not long ago I was treated to a cine-show about a holiday in Greece. The films were run through exactly as

they had been shot: no attempt at selection, no editing, just chatter from the proud begetter of the tedium. After an hour of it I was all in and just dying to get back in my car and go home to some good music. Then once again, on the opening night of the last National Federation of Gramophone Societies' festival at Hoddesdon, I was treated to a show about Greece, this time by the president and his son, superbly put together with that apparent lack of effort which is the feature of all that is well done. Instead of being bored, I was enthralled; and what is more I ended up knowing something about Greece, its people and their music.

My conviction is that the tape-and-slide show is more effective than any but the very best cine and it is a great deal easier to do. To begin with, the slide can be presented for exactly the right length of time, and can be assimilated far more thoroughly than a sequence in cine, which tends to be too restless and too brief. Not that one should ever keep a slide on for many seconds; but there is a precise time needed in order to absorb each one, and that time differs from slide to slide: about ten seconds is a good basis.

Now, clearly, in a case like this, it is the visual content which is primary: the sound should be the echo of the sense. Therefore one starts by selecting and editing the slides; and there is a great deal to this. One needs first a *subject*. I have just been doing one on 'A Small World', to explain which it is necessary to know that my wife and I share a passion for the Cotswold countryside in which we have the good fortune to live. Over the years we have assembled thousands of yards of tape and hundreds of photographs on local life, all captured within a few miles of our home. What we wanted to do was give a short picture of our small world: about 20 minutes. That meant rigorous selection; and we decided not to try to include too much. We ended with the idea—very conventional—of showing the Cotswolds through the four seasons.

Where to end is obviously as important as where to start; and we thought that if we ended with our small world on the threshold of another spring, we should send our audience (the Cotswold Tape Recording Society in this instance) away with a mood suited to the winter in which the show would take place. Therefore we had to begin with high summer—when, of course, the orchids which are the great treasure of the Cotswold beechwoods would be coming on, and continuing through to autumn with the lady's tresses and the helleborines. Then through the colours of autumn to the bareness of winter—in some

ways the best time of all to see Cotswold; and so to spring, with the early celandines, anemones and coltsfoot, including the pasque flower—*pulsatilla vulgaris*—which reaches its most westerly distribution in Gloucestershire.

That decided, and the slides selected, we had to make the commentary. A commentary has much in common with a good interview: one needs to say just precisely what is wanted and no more: to avoid all padding and repetition. Economy is the master-word. But to do it well is far from easy: initially I made the error of saying too little, so that the slide-changes were too rapid. One has to aim at the right number of words to accompany each slide, not being afraid of the odd silence here and there, giving time for the viewers to take in the point one is making, but always changing before they begin to hope for release. We had also to remember that though botany is the most interesting thing in the world to us, it would not be to most of the people we were trying to entertain—though we did happen to know that our chairman's wife is pretty knowledgeable, so that gaffes were to be avoided too!

I mentioned silences. The problem then had to be faced of whether or not we should fill them with music. I happen to think that society is terrified of silence to the point where we tend to think that something must be going on all the time, whatever we are doing; silence is one of the loveliest things in life, and hard to come by these days. In the form we presented it, we had music continuing quietly throughout the show, whether speech was also present or not. Later I scrapped that tape, and did it again with no music—bearing in mind one of our chairman's acidulated and entirely inoffensive remarks that he wondered why I had not turned the gramophone off while I made the tape!

The question of a musical background is a difficult one. We all know those television documentaries which are ruined by everlasting melody in the background, turned up to deafening volume whenever the speech stops. You may like it that way; but it seems to me that if it is to be done at all it needs to be done supremely well and that, short of excellence, music is best left out. There is also the everlasting bugbear of copyright; and I for one am not happy about just getting away with it. There are indeed special records of mood music which can be used for the purpose; but they are few and the tunes so well-known by now that they tend to be recognised and turn up all over the place. I prefer none to that.

Music does complicate the job too unless
(continued on page 29)

AN INTEGRATED TONE SOURCE AND LINE-UP METER

BY JOHN FISHER

THIS article will describe a variable-frequency constant-amplitude tone source and RF generator, and an accurate line-up meter. Used together they are an invaluable aid to adjustment of the bias and frequency response of a tape recorder, for response and balance measurement, fault finding in AF and some RF equipment and also for comparative noise-level measurements.

The unit to be described was built on the following principles:

It should provide a variable sinewave signal of constant amplitude from 20 Hz to 20 kHz.

It should be capable of providing a sinewave output to 2 MHz.

It should be capable of measuring accurately ± 3 dB about a reference level, to at least 0.5 dB accuracy.

It should feed, and be switchable between, two channels and a reference level.

It should have a low impedance source and a high input impedance.

It should be portable and battery operated.

It should be economical to operate and inexpensive to build.

The oscillator is a conventional variable Wien Bridge type. The operation of the original circuit on which it is based (which used low frequency germanium transistors) has been described in detail in the Mullard *Handbook of Transistor Circuits* and only the variations from the original design need be dealt with here. The circuit has been rearranged to suit inexpensive modern HF silicon transistors, which allow the output to be extended to a little over 2 MHz for adjustment of IFs etc. At the same time the circuit has been inverted in polarity so that all but one of the transistors can be inexpensive *n-p-n* types.

The first two transistors form a linear amplifying stage which drives the bridge via an emitter-follower buffer, with positive feedback from the bridge to the base of the first transistor, and negative feedback via the R53 thermistor to stabilise the output amplitude. The thermistor is a special low thermal capacity type for use in circuits such as this. An additional emitter follower buffer provides a very low output impedance for the feed to the 1 K output level control. The output

(duplicated on two jacks) is fed via a 330-ohm resistor to protect the transistor against shorts at maximum setting of the control.

A preset output to the meter is provided: this is adjusted at 1 kHz and provides a reference level against which the output of equipment on test can be compared, whilst simultaneously indicating the error within the test equipment at that frequency.

A 10 K + 10 K reverse log pot is suitable for the Wien Bridge control (scaling conventionally) or a 10 K + 10 K log pot can be used (with the scale reversed). A linear pot is unsuitable as it will cramp the scale at higher frequencies. The connections are made to the 'low resistance' end of the track and the slider (the other end of the track is shorted to the slider). The frequency will be highest at the minimum resistance setting. Moulded carbon track pots are preferable for the bridge and other pots.

The switched capacitors were mounted directly on to the switch tags, forming two busbars at the back with the leads of the two largest capacitors. For the AF range the capacitors should be 1% (polyester) types, or selected and trimmed using a capacitance bridge to within this tolerance. The calibration will then be correct for the three ranges. The values for the two higher ranges should be adjusted on test to give the right

frequency according to the calibrations of the AF range. Due to stray capacitances, the values will almost certainly need to be about 5% below nominal on the 0.1 MHz range and possibly 5-10% down on the MHz range. Calibration is relatively simple and is described later.

The metering circuit is very simple and quite effective. One half of the selector switch selects the output from the two jacks (or from the reference level) and the signal passes to the preset sensitivity control. The output from the slider goes to the second half of the switch which selects this output or the output from the reference level preset on the oscillator. The signal passes to the gate of a Field Effect Transistor which provides voltage gain, and is capacitor coupled to a voltage-doubler diode/transistor arrangement which provides the rectified-AC drive to the meter stage. The small capacitors are effective at higher frequencies where the electrolytics are less effective due to stray inductance.

The rectified signal feeds an unbiased *n-p-n* transistor. The base-emitter voltage provides a threshold level: below this the transistor virtually does not conduct, and above the threshold the current rises rapidly, giving the required expanded decibel scale. The current through the meter is limited by the collector load resistor and the OA5 diode: emission of the latter will result in opening of the scale at the top, without serious risk of damage to the meter with a 9 V supply (the resistor should be increased for a higher voltage supply, as there is a considerable surge on switching on, and the stage can be inadvertently overdriven on testing). The capacitor across the meter provides HF correction to about 50 kHz or so. The transistor used in the prototype was a 2N3827, red selection, many other small signal *n-p-n* silicon transistors would do. The calibration will depend to some extent on individual samples of transistor.

The meter is available independent of the associated circuitry for use as a straight 1000 μ A unit via the jack socket below the meter.

A switched 600 ohm 1% resistor provides 600 ohm loading of the input when required, and the jacks are wired so that either two contact (unbalanced) or three contact floating circuits can be tested.

Apart from the capacitors in the bridge and

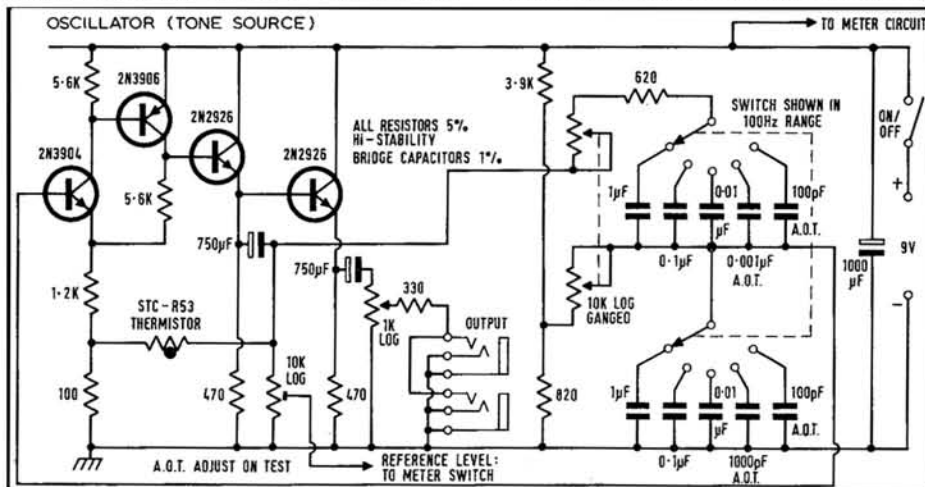

the input terminating resistor, all components are mounted on two Vero-boards and one miniature tag strip. The meter amplifier and oscillator are each built on 6.6 x 2.8 cm Vero-boards, one of the smallest standard sizes; the decoupling capacitor and thermistor are mounted on the tagboard. The boards and tags are mounted on insulated standoffs on the 16 SWG back panel of the case, with flexible connections to the rest of the components on the front panel. The rest of the case is also of 16 SWG aluminium (finished with a *Brillo Pad*), with carrying handle and rubber sucker feet.

The power supply is a 9 V *PP9* battery, and the drain is not enough to make this expensive with normal regular use. The unit should of course be switched off when not required, to avoid polarisation and running down of the battery. Increasing the supply to 12 V makes a very small increase in output amplitude and negligible change in frequency. The effect on distortion is at least inaudible. Reduction of the supply voltage below about 7 V will cause distortion and then failure of the circuit to oscillate properly.

The prototype unit used a 1 mA moving-coil 65 ohm 8.3 cm square knife-edge pointer Sifam *M303* meter, scaled 0-1000 (μ A). The case is easily opened for rescaling. Other suitable types are the Ernest Turner *642* or *6425* clear front, with a knife edge pointer to order. If the unit is calibrated with another meter of precisely the same sensitivity and resistance, and the (dB, μ A) readings are noted, Turners can supply meters calibrated in dB to constructors' specifications. Since the meters will almost inevitably have some very small differences, the protecting diode at least should be omitted as variations in meter resistance will affect the top end of the scale when this is present; there will be a residual error due to the small meter-current tolerances, and it would be over-optimistic to retain calibrations below 0.5 dB. It is a relatively simple matter to add the second scale oneself using Letraset or Dry Print lettering and lining, and this would normally be the most accurate proposition for anyone with patience and reasonably steady hands. I have ascertained that it is a relatively simple matter to remove the clear front of these Turner meters: the safest way is to insert the V of a wire paperclip under each of two adjacent retaining lugs on the clear plastic front, and the front

can then be eased off from the corner between the lugs. In this way there should be no damage to the meter casing or risk of scratching or crazing. Use of a screwdriver or similar tool is definitely not recommended. The meters should be ordered calibrated 0-1000 μ A, no title, with knife edge pointer if the fine calibration between ± 0.5 is to be attempted. For further details, contact Ernest Turner Electrical Instruments, Chiltern Works, High Wycombe, Buckinghamshire, stating the purpose for which the meter is required. The type *642* costs 87s. 9d. basic, and the *6425* costs 93s. 9d. The less expensive type *641* (55.63 mm square) costing 77s. 9d. could also be used, but it is a little small for this purpose and the larger sizes are worth the little extra cost.

Calibration is most easily carried out with an oscilloscope, or with an amplifier and loudspeaker, tuning for beat frequencies against a known source. In the absence of an accurate standard tone source, the spot frequencies put out by the BBC on FM test transmissions on the Third programme frequencies after close down can be used as a check. Details of the tones used are published from time to time.

A test record such as the EMI *STR100* gives a large number of spot frequencies to a reasonable degree of accuracy provided a strobe check is used and the turntable speed is adjusted to suit (why is it that the accuracy of the frequencies on such records at nominal speed is rarely if ever given?). If necessary the record could be played at 45 RPM to provide other frequencies, though I find this alarming. The frequencies can be marked directly on the dial in pencil, and later improved with Letraset or a mapping pen and black copying ink. I find it very difficult to tune for beats above 10kHz (where a lot of frequencies are provided on such test records) without an oscilloscope, and prefer to calibrate from lower frequencies. One can cross-check frequencies from one range to the other, and provided the capacitors are correctly chosen, the calibration should hold good over all the ranges. Suitable 1% capacitors are available from Duxford Electronics, Duxford, Cambridgeshire, who can also supply the other capacitors and miniature 5% carbon film resistors.

For higher frequencies, the Long Wave 'Light Programme' provides a standard for



200 kHz. The oscillator should radiate sufficient signal at 200 kHz to silence an accurately tuned transistor radio (by operating the AGC circuit with high level 'carrier') when at the right frequency, if the radio is placed a couple of centimetres away from the front of the unit. Heterodyne whistles will be produced on either side of the frequency. A 1 MHz check is provided by the Droitwich home service transmitter on 1088 kHz or the London Home Service (Brookmans Park) on 908 kHz. *Radio 3* is broadcast on 647 kHz and on 1546 kHz, while *Radio 1* on 1214 kHz provides a further check. When using the oscillator on the higher frequencies, a screened lead should be used and care must be taken not to radiate too much signal as this could cause interference and contravene GPO regulations.

In the prototype, the oscillator output was measured, externally, as being well within ± 0.2 dB and possibly better, from 14.5 Hz (the lower limit) to about 40 kHz. This of course cannot be guaranteed for every oscillator built to this design! But it does seem to work nicely. Output at 2 MHz was about 2 dB down at the oscillator jack, as measured on an oscilloscope. Waveform is good at all frequencies, distortion should be well under 1%.

The meter circuit is slightly more frequency conscious: with the small correction capacitor in circuit across the meter, the response is + 0.1, - 0.15 dB from 20 Hz to 20 kHz (to the limits of the calibration gear), - 3 dB is at 200 kHz, a performance which is adequate for most audio purposes. Care must be taken to keep down external losses in lead capacitances when taking measurements at high frequencies. The meter needle vibrates alarmingly at the lowest frequencies where it tries to follow the rectified wave-form, but the mean can easily be seen.

The meter was calibrated against a standard instrument with 0.1 dB calibrations. As a precaution the series of readings for the calibration graph were taken several times, averaged and plotted, and the final calibration was made from this. Finite resolution of

(continued on page 26)

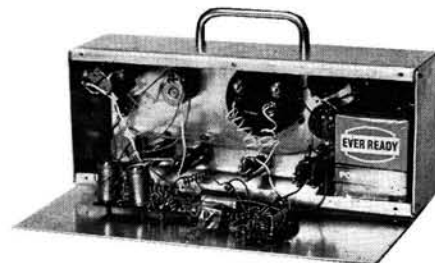
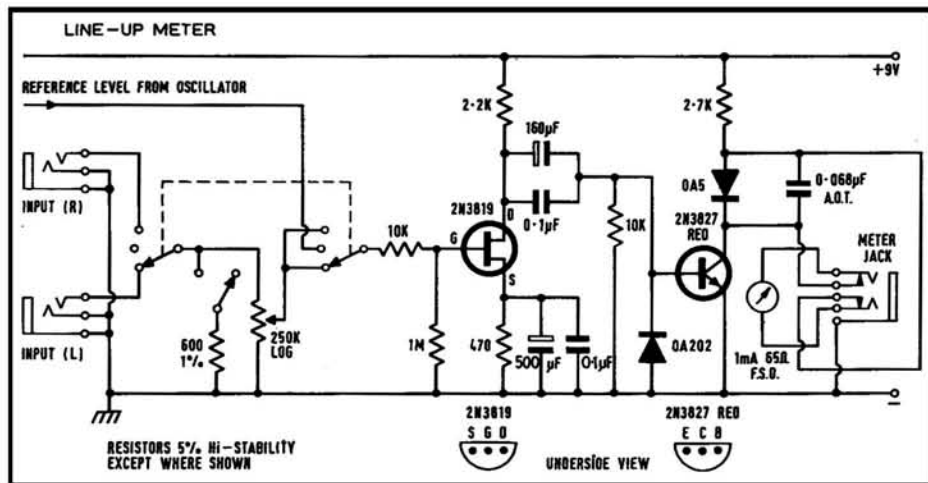

CHILTON

DESIGN NOTES (Number 2)

By Tom Reps*

Wow and Flutter:

As the ear is very sensitive to change in pitch, even the untrained listener will object more to wobble than to restricted frequency response or distortion. Considerable thought in the design of the Chilton 100S has been given to the maintenance of low wow and flutter, even with prolonged use. With this in mind, engineering tolerances are held to very small limits, and special equipment was manufactured to maintain these tolerances on a commercial production basis. For example, the most important components in the tape recorder are the flywheel and capstan shaft, therefore tolerances better than normally associated with precision engineering practice have to be achieved. To reach this standard, high chrome tool steel is specially hardened to reduce stresses, and ground between lapped centres and finely honed to achieve a mirror finish and roundness less than 25 microinches, which with production spreads, maintains a wobble figure well under .1% RMS at 19 cm/s, although in practice 10 to 15 microinches are being achieved, giving the remarkable performance of .05%. The flywheel mass is machine turned from mild steel, and nickel plated.

The capstan is only part of the story, however, as special attention must be given to motor vibration, pinch and idler wheels, etc., and by under-running the hysteresis synchronous motor at approximately 20% above its synchronous fallout voltage, a marked reduction in flutter can be achieved. The brass three-step motor pulley is bonded to the motor shaft, not fixed with grub screws, giving a maximum runout of $\pm .00025$, ensuring minimum flutter on the slowest speeds where the fly-wheel is least effective.

Wow has been reduced to a minimum by the use of constant density polyurethane on the idler and pinch wheels, and accurately ground for maximum concentricity. The playback head has been placed close to the capstan shaft to reduce flutter, and pressure pads are not used on the record or play heads. Providing the runout on the tension rollers does not exceed $\pm .0005$, wow is not measurably introduced from this source. In fact, the use of rollers reduces flutter, especially when the feed spool is nearly empty.

Above all, the tape mechanism must be robustly constructed to prevent distortion of the mechanism in use and transit; therefore double deck $\frac{1}{4}$ in. high tensile Dural plate, fixed into a formed 14 gauge aluminium cradle, achieving a high strength-to-weight ratio, is utilised.

Your guarantee is that we would not manufacture any product in which we do not have complete confidence.

*Magnetic Tapes Ltd.

Available in chassis or portable forms from £124 gns. incl. P.T.

Magnetic Tapes Ltd., Chilton Works,
Garden Road, Richmond, Surrey

Telephone : 01-876-7957

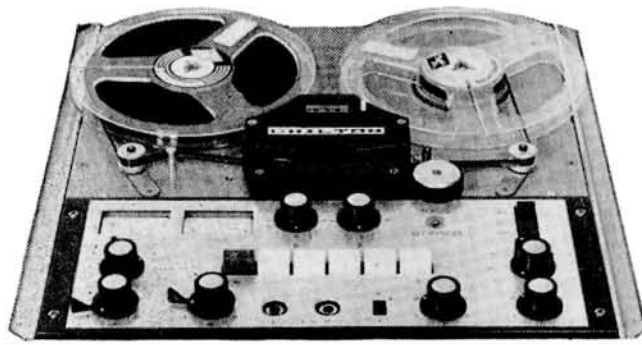

RESLOSOUND microphones

Precision engineered give the sensitive acoustic performance required today

BRING YOU ADDED SALES VOLUME

CPD2

Cardioid Pencil Dynamic Microphone—improved version of the well known Reslo CPD microphone. Most suitable for:

High quality music recording, general sound reinforcement, loud close singing or speaking if used with an amplifier incorporating reasonable bass cut.

Frequency response is smooth over the range 70 c/s to 16 Kc/s. Rear response better than 20 dB below the front from 100 c/s to 1 Kc/s and over 14 dB from 1 Kc/s to 16 Kc/s dropping to 30 dB at upper presence frequencies.

Impedance values : CPD2/L-30/50 ohms. or 600 ohms.

Supplied with 18' of dual impedance cable. .. £17/15/0

CPD2/M—200 to 300 ohms. .. £17/10/0

CPD2/H—30/50 ohms or Hi-Z.

Appropriate cable set to order £17/15/0

MPD2

Small hand model microphone fitted with 6 yds. of directly connected cable.

Frequency response smoothly maintained over the range of 50 c/s to 15,000 c/s.

Polar response omni directional.

MPD2/L .. £5 10 0

MPD2/H .. £6 10 0

UDI

An improved uni-directional high output or stand, dynamic microphone (super cardioid) incorporating an internal anti-pop filter. Supplied in black presentation case, and with 18' of directly connected screened cable.

Frequency response : — 10 dB at 100 c/s — 4 dB at 15 Kc/s ref. 1 Kc/s. Well maintained over the range 100 c/s to 16 Kc/s.

Sensitivity : (hi-Z) 58 dB below 1 V/dyne/cm².

UDI/L (50 or 600 ohms) .. £19 10 0

UDI/M (200-300 ohms) .. £19 5 0

UDI/H (High Impedance only) .. £19 10 0



In addition to their World famous series of bi-directional and cardioid Ribbon Microphones Reslo manufacture a complete range of public address amplifiers and loudspeakers—line source and reflex horns.

Write or telephone for full particulars.



RESLOSOUND LIMITED
SPRING GARDENS, LONDON ROAD,
ROMFORD, ESSEX

Tel. Romford 61926 (3 lines). Telex: 25356

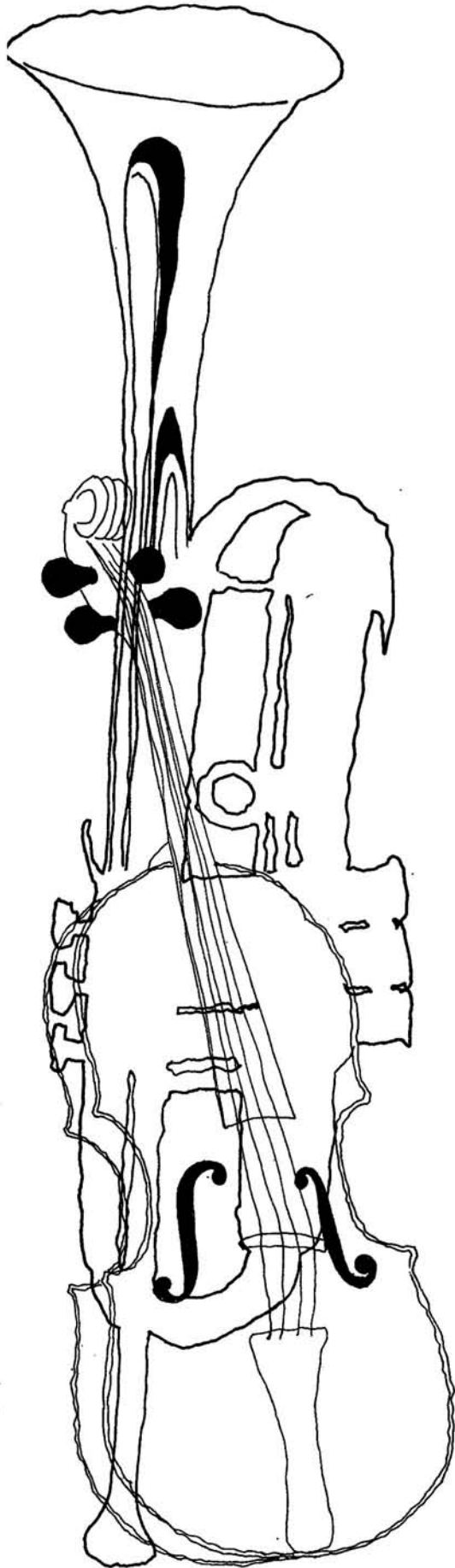

ARTICLES on multi-track music have appeared in the technical press with surprising regularity and one would think that little remains to be said on the subject. The various facets of technique and quality-plus or quality-minus have been aired and everyone from professional to enthusiastic amateur has had a go. Including me. However, little has been said about the various tricks one can get up to in order to produce interesting and original sounds.

Most multi-track fans go for the conventional stuff—two or more instruments playing a recognisable tune in more or less perfect harmony. This can produce an interesting piece of music which sounds exactly like two or more people playing simultaneously—and nothing else. I know of only one multi-tracker who has ever produced conventional stuff in an original and interesting guise—Les Paul. He's had many imitators and although it is said that imitation is the sincerest form of flattery, I heartily disagree with this in the field of music. Consequently, in my humble efforts, I try to produce something different—a different sound, a different approach. I rarely play conventional stuff for the simple reason that it has all been done before—and usually very much better.

I once produced a piece of 'music' which consisted almost entirely of mouth noises; plops, squelches, raspberries and hisses. This was produced by playing a rhythm loop at half speed, recording the assorted oralytics with occasional clonks on a wineglass, reverberating it and replaying at double speed. This appealed as a piece of original composition and has been broadcast more than once. The same sort of approach can be used with instruments.

Probably the most-recorded instrument in multi-track work is the electric guitar. Its value is largely the fact that it can be plugged straight into a recorder. It also has the advantage of several 'voices'. Normally, the lead is plugged into the microphone input of the recorder and the volume control on the guitar adjusted so that the signal through the guitar is at maximum when the recorder's input gain is about 60% advanced. The guitar may or may not have bass controls on it; not that these things are necessary. My earlier work in this field was all done on a very cheap and very simple guitar, which not only had extremely grotty controls but bits missing from it. Nevertheless, recordings made on it are indistinguishable from those made on my current guitar which cost about four times as much.

One important fact should be remembered. You must be able to play the instrument. Not like the two women talking; one said: 'I'm getting very worried. Our Sid hasn't got a booking yet and he's been learning his guitar for over two days now'. In fact, if you want to really create an impression as a multi-tracker you should be a multi-instrumentalist. Hoping not to give an impression of bigboncess, I use nine instruments in my studio—guitar, trumpet, glockenspiel, mini-organ, drums, a sort of keyboard harmonica and odd things such as an ocarina, a recorder and a swanee flute. All these are useful at some time or another; I do not profess to be an expert on them all, but I can make the necessary noises when I think they are needed. Quite in addition to playing them straight, there are all sorts

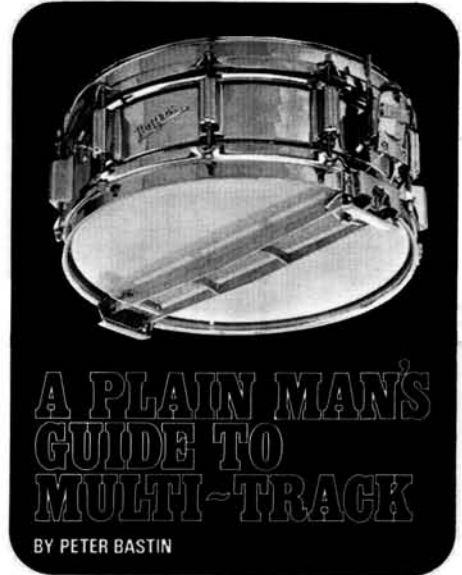

of wheezes to get different sounds out of them.

A guitar can be played mute, either with a muting device or by damping at the bridge with the heel of the right hand. It can be played Hawaiian style and a solid can be played disconnected, very close to the microphone, producing a harpsichord effect. The bass string can be slackened off and used as a super-duper contra-bass; extreme reverberation can be added in order to produce a liquid sound—a difficult but interesting technique. It can be recorded at one speed and played back at another and a drumming effect can be produced by thumping the muted strings lightly.

The glockenspiel is like a small vibraphone and consists of metal keys suspended over a highly-efficient sounding-chamber. It is played with hammers of either hard or soft consistency and the thing has a damper to mute the keys. I use the glockenspiel a good deal and find that fast jazz work comes over well if the instrument is played with the damper on and hard wooden hammers used. This produces an appropriately incisive sound. Played with soft hammers, unmuted, it is ideal for dreamy stuff but you have to watch out for loss of quality in dubbing. By and large, it will only copy once. A nifty effect can be created by striking the muted keys with soft hammers, leaving the hammers resting on the keys to absorb all overtones and decay. This produces a most interesting plopping kind of music.

You can't muck about much with a trumpet. This is a pure-tone instrument and must be respected as such. I find that it is nearly always advisable to play this through a reverberation unit; otherwise, the sound quality can be extremely dead unless you are recording in lively acoustics. Mutes should be used to vary the tonal range and one producing a tight 'squeezed-up' sound is recommended. Full blast on a trumpet in a home studio is not the best way to influence people and make friends. By the way, watch it if you use a close-microphone technique: valve noises can be objectionable to some listeners.

The 'mini-organ' I use is somewhat similar
(continued on page 21)



ONE WAY TO SATISFACTION

4-TRACK STEREO/MONO

	Deposit		12 Monthly Payments		Cash Price				
	£	s. d.	£	s. d.	£	s. d.			
Philips EL3312...	16	19	10	4	3	4	66	19	10
Ferguson 3232...	22	18	3	5	14	7	91	13	0
Sony TC200...	23	15	0	5	18	9	95	0	0
Sanyo MR929...	24	0	0	6	0	0	96	0	0
Philips EL3555...	25	19	4	6	5	8	101	19	4
Aiwa TP1012...	26	0	0	6	8	2	102	18	0
Akai I710W...	27	17	3	6	16	8	109	17	3
Sanyo MR939...	28	0	0	6	16	8	110	0	0
Sony TC260...	29	5	0	7	5	0	116	5	0
Tandberg 12/21/41 31	10	0	0	7	17	6	126	0	0
Philips EL4408...	33	16	8	8	6	8	133	16	8
Telefunken 204 *E	34	12	5	8	10	0	136	12	5
Beocord 2000K	39	10	0	9	13	4	155	10	0
Beocord 2000T	40	10	0	10	2	6	162	0	0
Sony TC530...	41	10	0	10	6	3	165	5	0
Ferrograph 722/4	46	15	0	11	10	5	185	0	0
Akai M9...	49	3	5	12	3	4	195	3	5

STEREO TAPE UNITS

Sanyo MR-801...	20	0	0	4	13	4	78	0	0
Sony TC250A...	20	10	0	4	18	4	79	10	0
Akai 3000D...	26	11	4	6	11	8	105	11	4
Sony TC350...	27	5	0	6	16	3	109	0	0
Beocord 1500...	31	10	0	7	11	8	122	10	0
Tandberg 62/64X	36	18	0	9	0	0	144	18	0
Ferrograph 702/70440	6	8	10	0	0	0	160	6	8

4-TRACK MONAURAL

Grundig TK140	11	14	6	2	18	4	46	14	6
Philips EL4305...	11	17	9	2	16	8	45	17	9

4-TRACK MONAURAL

	Deposit		12 Monthly Payments		Cash Price				
	£	s. d.	£	s. d.	£	s. d.			
Ferguson 3226...	11	10	0	2	16	8	45	10	0
Telefunken 201	11	18	9	2	19	7	47	13	9
Ferguson 3228...	11	19	0	3	0	0	47	19	0
Philips EL4306...	14	1	8	3	10	0	56	1	8
Ferguson 3230...	14	13	0	3	13	2	58	13	0
Ferguson 3216...	16	19	0	4	0	0	64	19	0
REPS M10	18	18	0	4	14	6	75	12	0
Wyndor									
Vanguard	18	18	0	4	14	6	75	12	0
Truvox R54...	18	18	3	4	14	11	75	17	3
Tandberg 1526...	20	19	0	5	3	4	82	19	0
Truvox R204...	31	14	2	7	15	0	124	14	2

MAINS TWIN TRACK

Fidelity Playtime	7	18	6	1	16	8	29	18	6
Ferguson 3224...	8	6	0	2	1	4	33	2	0
Grundig TK120	9	17	6	2	9	2	39	7	6
Philips EL3310...	10	5	10	2	11	5	41	2	10
Tandberg 1521...	18	19	6	4	10	0	72	19	6
Truvox R52...	18	18	3	4	14	11	75	17	3
Beocord 1100...	24	10	0	6	2	6	98	0	0
Brenell Mk. V/3									
Std.	26	17	9	6	10	0	104	17	9
Brenell MkV/3Mtr28	0	2	7	0	0	0	112	0	2
Truvox R202...	31	14	2	7	15	0	124	14	2
Brenell V/3/M...	32	16	8	8	5	0	131	16	8
Ferrograph 713	33	18	4	8	9	7	135	13	4
Ferrograph 713/H	35	16	8	8	16	8	141	16	8

INTEREST FREE H.P. TERMS. OPEN SATURDAY 6 p.m. FRIDAY 6.30 p.m. IF UNABLE TO CALL WRITE FOR BROCHURES. PART EXCHANGES. ALSO 18 AND 24 MONTHLY TERMS

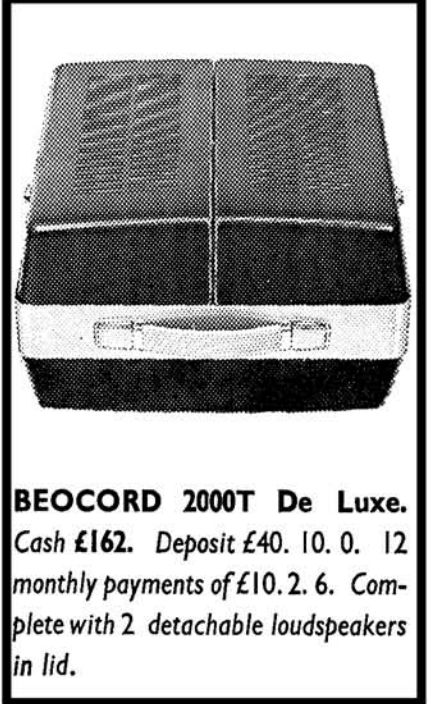

BECORD 2000T De Luxe.
Cash £162. Deposit £40. 10. 0. 12 monthly payments of £10. 2. 6. Complete with 2 detachable loudspeakers in lid.

THE RECORDER CO

this is the name

(DEPT. R) 186-188 WEST END LANE, WEST HAMPSTEAD, LONDON, NW6
Telephone: 01-794 4977

Bib AUDIO ACCESSORIES the perfect gifts for enthusiasts

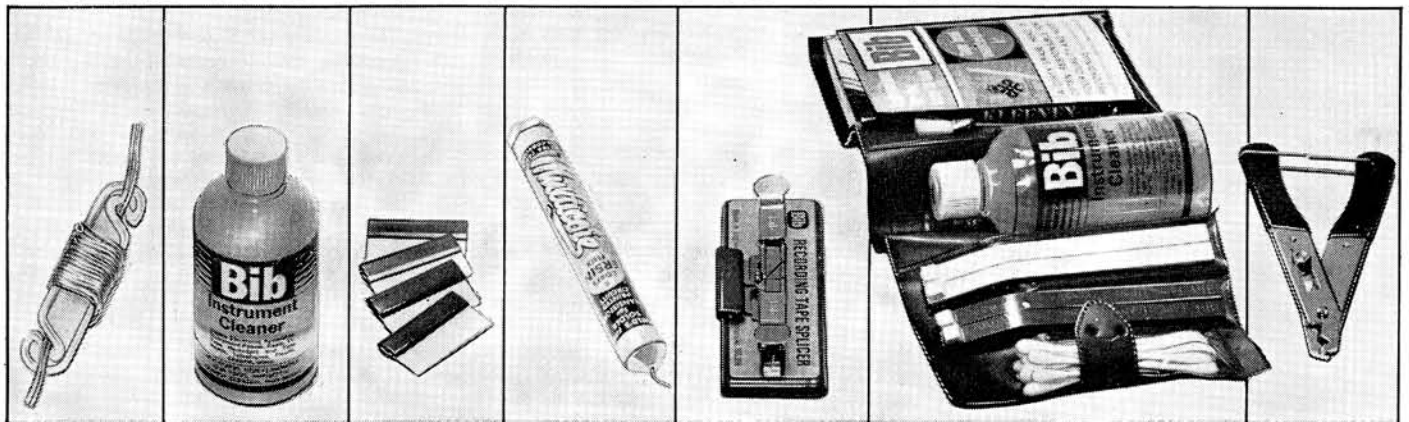

Flex Shortener

Shorten without cutting, audio cables and flexes. Made of unbreakable plastic. Packet of 4 Bib Flex Shorteners 2/6.

Instrument Cleaner

Cleans record players, tape recorders, metal plastic and glass. Anti-static and non-flammable. Bib Instrument Cleaner. 4 oz. bottle. 4/6.

Precision Tape Cutters Size M

Set of four stainless steel cutters, with special plastic grips, for all types of magnetic recording tape. 2/11d. inc. P.T.

Ersin Multicore Solder. Size 15 Dispenser

Solder easily plugs and cables with 5-core Ersin Multicore Solder. Size 15 Dispenser contains 21 ft. of 60/40 22 s.w.g solder 3/-.

Recording Tape Splicer

Invaluable for precise and easy splicing and also for accurate tape editing. Fitted with clamps for holding tape while splicing diagonal or butt splices. Chrome-plated on special non-slip base, complete with razor cutter. 19/6d.

Tape Head Maintenance Kit

The technical editors of the leading audio journals have undertaken comprehensive tests of this kit and recommend it unreservedly. Saves repair costs, ensures better recording and reproduction of reel and cassette recorders. Bib Tape Head Maintenance Kit has 2 each applicator and Polisher tools, 10 applicator and Polisher sticks. Double-ended brush, packet of tissues, and bottle of Bib Instrument Cleaner in plastic wallet. 17/- inc. P.T. Replacements available.

Automatic Opening Wire Stripper & Cutter.

Fitted with automatic opening spring for quick flex and cable stripping. Screw adjusts for different wire sizes. Plastic covered handles with locking ring. 8/6d.

All prices are recommended retail. Obtainable from most audio stockists. If in difficulty send cash with 1/- for postage and packing for orders less than 10/- and 2/6 for orders above 10/- (U.K. only) to:

Bib Division, Multicore Solders Ltd., Hemel Hempstead, Herts.

to the one described by Fred Judd recently. It is a transistorised job with amplifier and vibrato stages and can be played through a loudspeaker, unamplified externally, or directly into a recorder. This is a very useful instrument but suffers from the fact that it does not play chords. If an aspiring multi-tracker asked my advice on the subject of electronic keyboard instruments, I think that I would advise him to wait until he could buy a commercially-produced instrument which will do anything he wants. The smallest Philips electronic organ and the Lowther *Organino* are good value as these things go.

Drums can present something of a problem in noise and space. The best solution is an abbreviated kit which may not necessarily diminish the noise but most certainly reduces space requirements. I use a de-dingled tambourine as a snare drum, as tom-toms and as bongos. Wire brushes and deft fingers supply the labour force. A cymbal, drilled with small holes and loose rivets inserted, makes an excellent-sounding hissy-crash, so long as you take great care in positioning the microphone. If you are not careful, you will end up with the most awful rattly donging. Electronic rhythm units have been on the market for two or three years now but prices have been hellishly high until recently. Eagle now do a *Rhythm Master* for just under £70, a silicon transistor gadget giving a mixture of nine basic rhythms. Waltz, swing, surfin, twist, bossanova, samba, rumba, mambo and cha-cha are selected by pressing one of a row of push buttons. Tempo is governed by a continuously-variable control, a similar knob varying output level.

The unit feeds into the line socket of the recorder, giving a clear signal without the usual transistor hiss. Tempo varies from about 100 beats per minute to a rate far beyond the needs of any human musician. The bass beat is quite incisive at lower tempos but falls off a little as tempo is increased. There is not, I might add, any Chipmunk larking about; the pitch of the drumming remains constant in all control positions.

I found that the best results are obtained by using rhythms at the lower speeds but this is purely a matter of individual taste. There is no halt or pause in the rhythm if a new button is pressed in mid-performance and no electrical click when the neutralising button is operated. By careful selection, you can produce a horrifying, enormously fast sound rather like a bunch of riveters swamped in a sea of white noise. The quality of sound is very crisp and will copy several times before becoming fuzzy. Most of my own rhythms, recorded on conventional percussion instruments, tend to swamp or become slushy or over-tippy when dubbed more than three times.

An interesting result can be obtained by playing the rhythm through a reverberation channel and adding the melody 'dry' afterwards. This produces a very pleasing effect of audio perspective—the rhythm somewhere over there and the solo instrument right up to the microphone. Alternatively, you can record the whole caboose dry and reverberate it on dubbing.

The keyboard harmonica is a long thing, rather like a king-sized bar of chocolate, with

keys. You blow down one end and a sort of reedy harmonica/accordion/harmonium tone results. There is a valve thing at one end—possibly to remove surplus spit—and if you wag this about carefully, you can produce a very reasonable vibrato. This instrument has many uses and can sound extremely effective when played back at double speed.

The ocarina is like a small fat submarine and has a sweet high-pitched flutish tone. And you can't play any tricks at all with it. The swanee flute is an intriguing and useful bit of nonsense. It is a sort of hefty metal flute with a plunger which you move up and down to get the note you want—in rather the same way a trombone works.

In addition to the various little gimmicks attached to the actual playing of these instruments, it is fairly easy to create further tone colours technically. Filter circuits, tinny microphones, wah-wah pedals, fuzz boxes, boosters, repeat-echo and a dozen more tricks can be used to create different sounds. Toilet paper inserted in a piano between the hammers and the strings was one of the tricks I learned at school and I believe it is still used today in a modified form. Recording speeds are probably the best medium of straightforward contrast. A tune can be recorded at, say, 9.5 cm/s, played back at 19 cm/s and mixed with a new track. The resultant recording is of the principal statement plus a 'busy' counter-melody—all at 19 cm/s.

CHIPMUNK FURORE

Chipmunks created a chipmunk-sized furore some years ago. This technique, in fact, is very easy to achieve for the home recordist. All you need is a record-player (and a record), a tape recorder and half an hour's peace. Put on your record—preferably of an orchestra arrangement of a popular tune—setting the speed on the player at half the speed of the record—i.e., 16 RPM for a 33 RPM. Record into the machine at 9.5 cm/s, singing the words to the music—rather a weary and difficult operation. Play back at 19 cm/s and you have a true recording of the music plus a squeaky little voice singing the tune. This, of course, is very fundamental and you can go much further in developing the technique. The principles of multi-speed multi-track recording are exactly the same.

Lest anyone should think that it all sounds dead easy, let me issue a note of warning. Considerable skill is necessary in balancing one track against the other and considerable skill is also necessary in arranging the music itself. Nothing sounds more deadly than three choruses of a popular tune, ground out in strict and soggy tempo by two or three conventional instruments, without any attempt to create tone colour.

Let's take an example. The selected tune is *Anything Goes*, a simple and uncomplicated melody with plenty of opportunity for tonal variations. Three choruses are decided upon—normally the most acceptable length for a popular tune. The first eight bars are stated in an uncomplicated way, either with a lead instrument, backed with figures or chords, or by the ensemble (a group of instruments). The middle eight should be taken by the reverse of the first eight, i.e., solo instrument if the first eight bars are by the ensemble. The last eight

are taken by the same instrumentation as the first eight. Then comes a bridge passage, which may or may not change the key, followed by a complete chorus in variation. This may take the form of ad lib jazz variations or even a complete change of idiom such as waltz tempo or smooth stuff. The last chorus, following a bridge passage and change of key (usually to the dominant) should, again, be stated boldly with some subtle variations which do not in any way interfere with the expression of the music. The middle eight can be dolled-up even more but the return to the last eight bars should be simple, bold and, preferably, by the ensemble. The use of introductions and codas should not be forgotten. Modern pop music dispenses with introductions of any note and the codas are just not there. The disc usually fades away, giving the impression that they just don't know how to stop together. Watch a mimed TV performance by a pop group and note how ludicrous it is to see them hammering away when the music has faded. A similar effect occurs in *The Planets* at the end of Neptune!

The techniques I have rambled on about are but a few of those used in the professional field. Here, the whole range of electronics can be brought into play—filters, compressors and the whole boiling. A dull song by an even duller and dimmer singer can be brought to shimmering life by the addition of reverberation, double-tracking and phasing (see page 11). Even a 60-piece orchestra can be added after the drip has gone home to his supper. If the singer is flat, variable-speed equipment can bring him back on pitch. Listen to some pre-war recordings and compare them with some of the better modern recordings and you will have to admit that the tricks and electronics are worth while.

So far as the amateur is concerned, the best and most useful piece of equipment I could advise him to get would be a reverberation unit. This adds colour and atmosphere to all types of recording and its use for music cannot be over-emphasised. There are two basic types; the multiple-head unit which replays from one or a combination of several heads spaced along the tape-loop or magnetic drum, and the spring-line type. The former presents opportunity for all sorts of effects, such as echo and repeat-echo (as distinct from reverberation) but has a tendency to go wrong at the wrong moment. The tape can break or a mechanical fault can develop. I have had three of this type and all have suffered from temperamental electronics and noise. The motor and transport system can be very noisy, a factor not recognised by the manufacturers who make the things principally for the pop scene where a little noise from an electronic gadget couldn't possibly be heard above the general racket. In fact, I would strongly advise any enthusiast not to buy a reverberator from any musical-instrument manufacturer.

The reverberator I have now is a Grampian spring-line unit which produces pure reverberation. No whizzy effects are possible, but the quality of the reverberation is excellent. These are used professionally, which is as good a recommendation as you can get. The unit before that was one based on a revolving magnetic drum.

On the point of when to reverberate, Gramp-
(continued on page 26)

AN ALTERNATIVE SYSTEM OF MAGNETIC RECORDING

BY FRITJOF BRODTKORB

cross-field bias

As lower tape speeds become more common for sound reproduction from magnetic tape, the difficulties in maintaining a satisfactory dynamic range are accentuated. The limitations are imposed partly by the increased relative noise level associated with a reduction of the tape speed, and partly by the increased pre-emphasis required for obtaining a given frequency range at a satisfactory signal-to-noise ratio.

Based on the work done at the tape recorder laboratory of Tandbergs Radiofabrik A/S, the recent development in these fields will be treated in this article.

The tape recording technique developed rapidly during and shortly after the second world war, when plastic tape with a coating of magnetic material was introduced, opening the possibility for application of high frequency biasing.

The magnetising process is inherently non-linear. If the tape is magnetised by the signal alone, the resulting signal played back from the tape will be severely distorted. In the early days of magnetic recording, steel wire was used as the medium. It was then found that the distortion could be reduced by exposing the wire to a DC magnetic field superimposed on the signal field during recording. However, this resulted in strong background noise from the wire during playback.

A great step forward was taken when the DC magnetic field was replaced by a high frequency alternating field, as plastic tape coated with a thin magnetic layer became available. When such a tape is exposed to a magnetic field simultaneously excited by the signal and the high frequency bias, virtually distortionless reproduction at a very low noise level is obtained.

An important limitation is imposed by self-erasure occurring in the recording zone when the tape wavelength of the programme signal approaches the width of the recording zone. More precisely, the magnetic field will be completely or partly cancelled when the extension of the recording zone along the trailing edge of the recording gap becomes greater than, or equal to, half the wavelength of the signal to be recorded. At a tape speed of 19 cm/s, the critical wavelength corresponds to fairly high frequencies which are of no significance to reproduction of speech and music. At 9.5 and 4.75 cm/s, however, the cancelling effect occurs within the useful frequency range when conventional recording technique is used. It is therefore desirable to make the recording zone as narrow as possible in order to record at short wavelengths.

Several methods have been applied to accomplish this. Firstly, the design of the

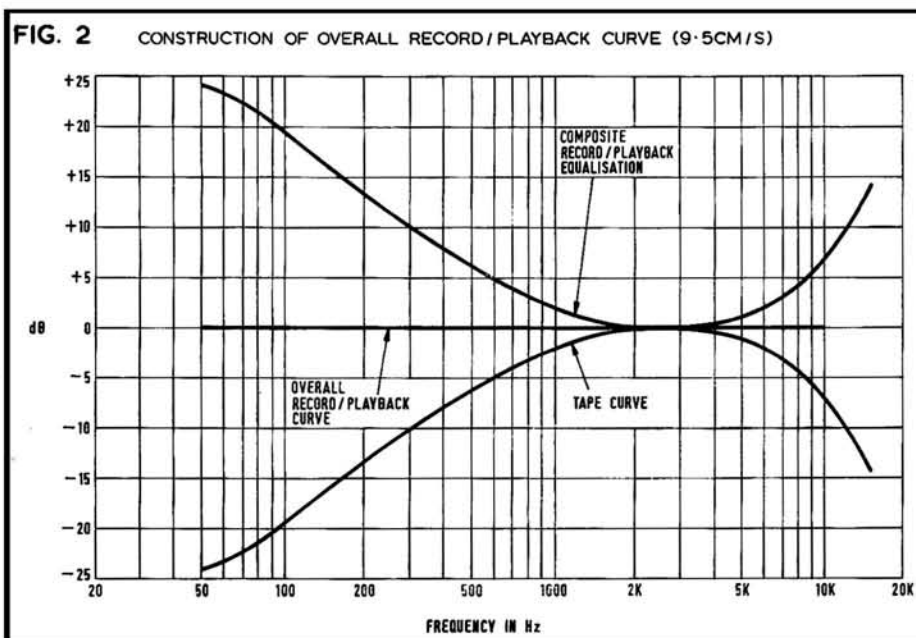
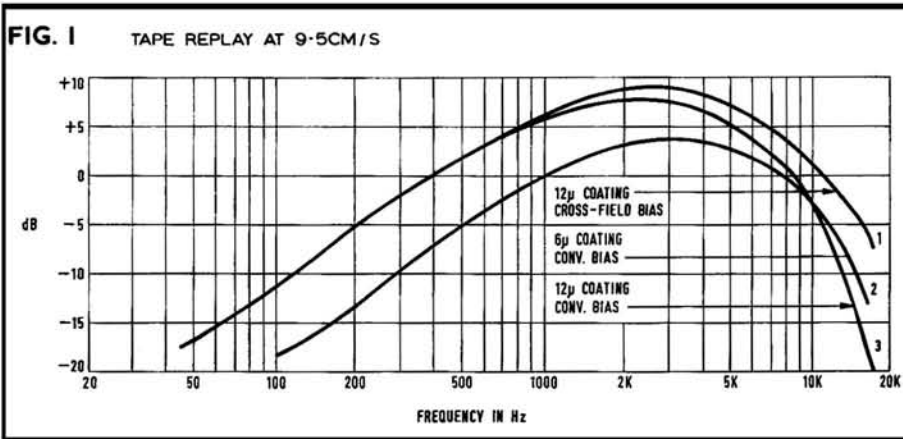

AN ALTERNATIVE SYSTEM OF MAGNETIC RECORDING

* Fritjof Brodtkorb was born in Norway in 1912 and graduated in 1938 as an electrical engineer at the Norwegian Technical University in Trondheim. He has been employed at Tandbergs Radiofabrikk A/S, Oslo, since 1939. The first years he worked in the development laboratory and later he was responsible for the quality control department including the technical information service to the market. He has been engaged in development of loudspeakers and new products in the educational field. He is today chief engineer in the electro-acoustical products division at Tandberg.

recording head has been improved, resulting in a narrowing of the recording zone. Secondly, it has been found that the frequency range can be extended by using tape with a thinner magnetic coating—the so-called triple-play tape. This is unfortunately accompanied by a reduction of the maximum available playback signal amplitude and consequently a relative increase of the tape noise. Finally, a new recording system—cross-field bias—has been developed, giving a similar extension of the frequency range also for normal coating thickness—long-play tape—without any increase of the tape noise.

The recording zone will contract if the bias amplitude is reduced on a normal-thickness tape. If the signal amplitude is maintained, this will cause distortion at the deepest parts of the coating where the bias becomes insufficient. This effect prevails at the more important medium and lower frequencies. In order to avoid this distortion, the signal amplitude must be correspondingly decreased so as to have the same depth of penetration for the signal and bias fields. This will in turn reduce the available playback signal amplitude. It is thus obvious that recording at reduced bias utilises the magnetic coating poorly, reduces useful signal level relative to the tape noise, and has furthermore the drawback that inhomogeneities in the coating are accentuated in the form of signal dropout.

Generally it can be stated that the available recorded signal amplitude is dependent on the bulk of magnetic material being excited. In the lower and middle frequency range, the signal increases proportionally to the coating thickness for all tapes in current use. The noise level is mainly determined by the surface structure of the tape and is therefore practically constant when the thickness of the tape is varied.

A possible method for increasing the bulk of material being magnetised would be to increase the width of the track—for instance from $\frac{1}{4}$ -track to $\frac{1}{2}$ -track. This will increase the signal amplitude by 6 dB. The noise will increase only by 3 dB because of its random frequency and phase relationships. The net gain in signal-to-noise ratio is therefore 3 dB for a doubling of the track width.

In order to benefit from the possibilities associated with reduced bias and thereby narrower recording zone, thinner tapes with reduced coating thickness have been produced. These tapes will give a weaker signal in the lower and middle frequency range, whereas the higher frequencies will have larger amplitudes than those obtained with a thick coating,

(continued on page 25)

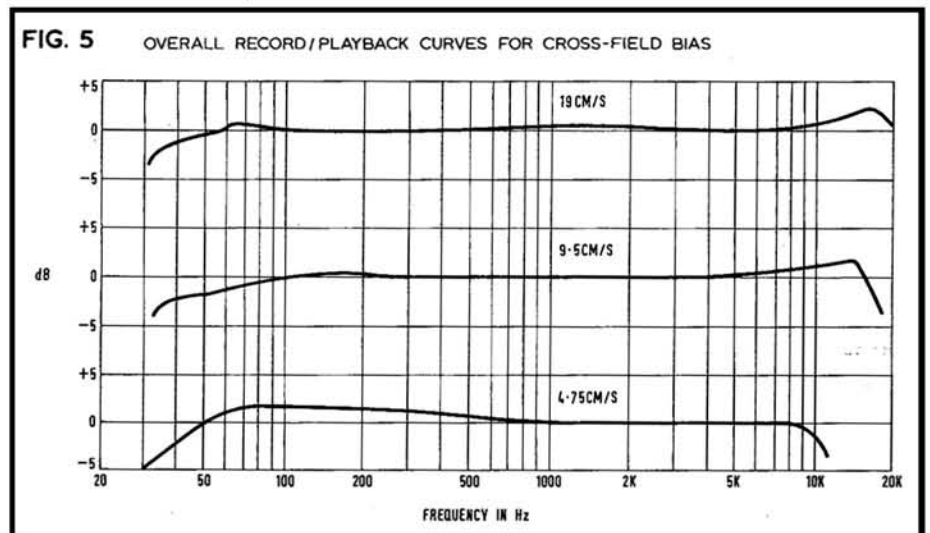
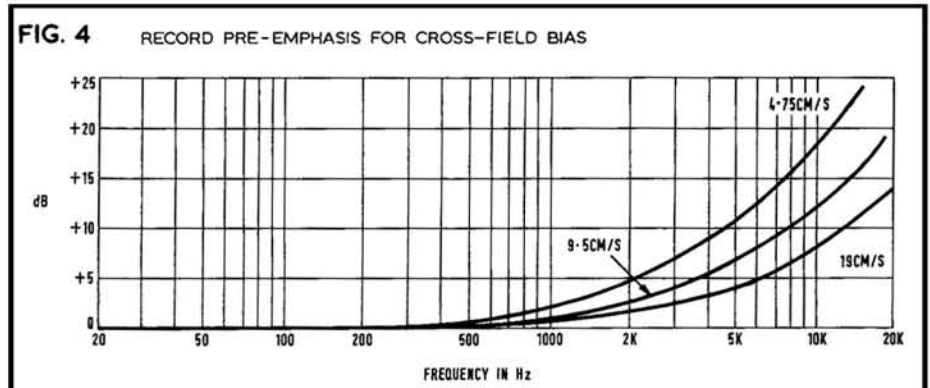
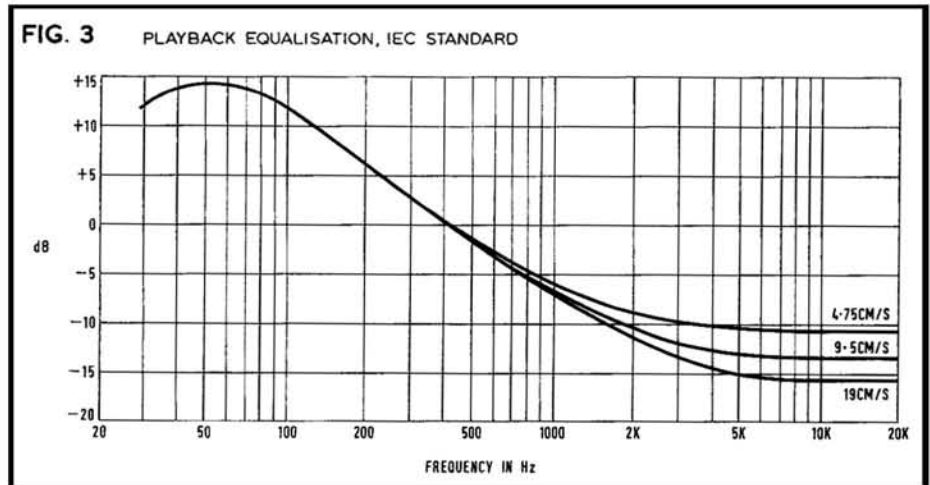

Look what HEATHKIT offer in their LATEST CATALOGUE



Top Value in Stereo Receivers

The natural transparent sound only transistors can give, plus Stereo FM, two-preamplifiers and two power amplifiers in one compact unit. Prices as low as from £39 in kit form.



Send
for Your
FREE
CATALOGUE
... To-day!



Stereo Tape Recorder, STR-1

Where else can you buy a complete stereo system including loudspeakers for only £58 in kit form.



Top Value in Loudspeaker Systems

The Cotswold MFS (illustrated) is one of many systems offering outstanding performance for price. Only £28.12.0 in kit form.

AND OF COURSE GARRARD PLAYER UNITS PLUS SHURE CARTRIDGES.



DAYSTROM LTD., Dept. HT-1, Gloucester.

Please send FREE CATALOGUE tick

NAME

ADDRESS

Prices and specifications subject to change without prior notice.

Made in England

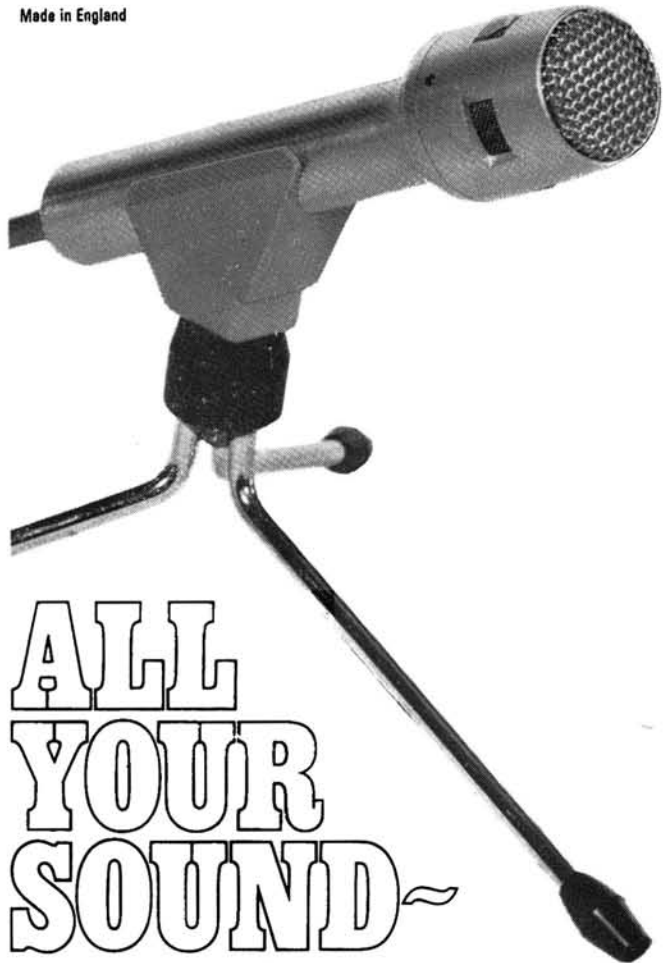

ALL YOUR SOUND~ With the NEW LM 300 from London Microphone

Latest release in the range of LM Microphones is the most sophisticated design yet. The robust, metal construction with its good back-to-front discrimination is ideal for speech reinforcement systems and recordings.

Recommended retail price from £12 including built-in cable, depending on impedances.

For details of the LM300 and other superb microphones in the LM range, please ring or write to:

London Microphone Company Ltd

182-4 Campden Hill Road, London W.8. Telephone: 01-727 0711 Telex: 23894

zone. Consequently the frequency range is extended upwards, accompanied by a general decrease in signal level. A wider frequency range is thus obtained in return for poorer signal-to-noise ratio.

Fig. 1 shows how the signal amplitude varies as a function of frequency for tapes with thick and thin coating. Curve 3 represents the thick tape with a coating of $12\ \mu$ (long-play tape) whereas curve 2 represents the thin triple-play tape with $6\ \mu$ coating thickness. Both tapes have been biased at optimum (i.e. maximum available signal amplitude occurring at 600 Hz for 9.5 cm/s). The curves have been plotted using conventional recording technique at a tape speed of 9.5 cm/s and show the tape characteristic for constant signal recording current when played back through a flat response amplifier. This enables the relative response for the two categories of tape to be read directly in decibels.

As shown, curves 2 and 3 intersect at 10 kHz. At frequencies below the crossover, the thinner coating gives a loss of approximately 6 dB as compared to the thick coating. If the tape is run at half the speed, the crossover frequency is also reduced by the same amount to 5 kHz. By switching to the thin tape coating, the amplitudes of the higher frequencies are not reduced and it will appear that a 6 dB gain at higher frequencies has been achieved as compared to the lower frequencies. This, however, is gained at the sacrifice of signal-to-noise ratio in the most important frequency range where a corresponding attenuation occurs, a very unfortunate occurrence as the S/N already represents a serious restriction on good sound reproduction.

The ideal solution would be to extend the frequency range at a given tape speed without deteriorating the signal-to-noise ratio. This is possible by application of the cross-field bias recording technique.

In conventional recording, the bias is superimposed on the signal in the recording head. With the crossfield technique, an extra bias field penetrates from a head located at the opposite side of the tape with its gap pointing towards the front of the recording head. The recording zone on the tape is confined to an

area around the trailing edge of the record head gap. In this zone the bias field comprises two components. One originates from the field between the two headfronts, and the other from the stray field across the gap of the recording head. At the trailing edge of the head gap the two fields are in opposition and will partly cancel. The resulting bias field gradient along the tape increases and the recording zone becomes narrower. The critical frequency for self-erasing is thereby moved upwards, and even a thick tape coating is completely penetrated by the bias field at lower and middle frequencies. An improvement of frequency response has thus been achieved with no sacrifice of other requirements.

The improvement can be found from fig. 1, where curve 1 shows the frequency response for crossfield recording on long play tape. Comparing with curve 3 representing the same conditions for conventional bias, we find that the two techniques at a tape speed of 9.5 cm/s give equal amplitudes up to 1 kHz, where the curves diverge and show a difference of 5 dB in favour of the cross-field technique at 10 kHz. It can thus be stated that the cross-field technique gives the same signal amplitude at lower and middle frequencies compared with conventional recording, and a significant signal improvement at higher frequencies.

If we compare the curve for cross-field recording on long-play tape (curve 1) with curve 2 representing conventional recording on triple-play tape we find the curves virtually in parallel with one another, with the latter 6 dB down. This means that the frequency range for cross-field biased long-play tape with $12\ \mu$ coating is the same as that obtained of triple-play tape ($6\ \mu$ coating) using conventional biasing. The gain in signal-to-noise ratio, however, is directly expressed by the distance between the two curves, i.e. 6 dB.

As already described, there are today two ways of extending the frequency range at low tape speeds. One way is to make the recording zone narrower by reducing the bias. This implies the use of thinner tape, leading to a subsequent decrease of the signal level and a corresponding increase of the relative noise level. The other possibility is to contract the recording zone by means of cross-field bias, whereby the thick tape can be used and the low noise level maintained.

Before discussing the design guidelines for cross-field biasing it is necessary to review how the frequency characteristics of a tape recorder arise. Fig. 1 shows that the frequency response of the head and the tape alone is far from being flat. The amplitude drops off radically at the upper and lower extremes of the frequency range. At lower frequencies, the amplitude rolls off at a slope of 6 dB/octave because recording has been done with a constant magnetic field. At the upper end, the signal drop is caused by the previously mentioned wavelength losses together with head and tape losses.

In order to compensate for this, the gain of record and playback amplifiers are increased at both ends of the frequency range. See fig. 2.

In the lower frequency range, to the left of the tape curve peak, the playback amplifier gain is increased by 6 dB per octave down, compensating for the negative slope of the tape curve shown in fig. 2. The location of the peak

depends on the tape speed. Therefore the break frequency for the playback amplifier is set individually for each tape speed (see fig. 3). The 3 dB points for the frequency curves are determined by time-constants specified in the international IEC standard as follows:

19 cm/s : 70 μ S (corresponding to 3 dB at 2.26 kHz)

9.5 cm/s : 90 μ S (corresponding to 3 dB at 1.77 kHz)

4.75 cm/s : 120 μ S (corresponding to 3 dB at 1.33 kHz)

The drop off at the upper end of the tape curve is caused by recording losses which can hardly be compensated for during playback, because a severe increase of the tape noise would then result. In this frequency range, therefore, the signal level is raised before recording, thereby increasing the distance between signal and noise. This is the so-called pre-emphasis, which is not restricted by international standards. It is up to the manufacturer to develop and improve the recording technique freely, and he can choose recording process and pre-emphasis as desired. The only requirement is that the signal be reproduced correctly using the standard playback curve.

If a reasonable quality is to be maintained, the tolerable amount of HF pre-emphasis with respect to the medium frequency amplitudes is limited. The consequence of pre-emphasis is that the tape recorder will require a reduced signal level in the pre-emphasised range in order not to cause tape saturation. A less pronounced pre-emphasis gives a wider safety margin against overload phenomena. For this reason, the required pre-emphasis for obtaining the specified frequency characteristics of a tape recorder should always be stated. A flat frequency response up to 10 kHz attained by 10 dB pre-emphasis gives a far better dynamic range than if 20 dB pre-emphasis were used for the same achievement.

Generally, the frequency distribution of music and speech shows that the amplitudes diminish with increasing frequencies, and it is fair to presume signal levels 10 dB down at 10 kHz as compared to 1 kHz. It will therefore be tolerable to increase the signal 10 dB at 10 kHz with little risk of tape saturation. This is supported by the fact that all FM broadcast programmes are submitted to such correction before transmission. The purpose is also, in this case, to raise the signal out of the background noise.

A limit of 10 dB pre-emphasis at 10 kHz is not any longer an exaggerated quality requirement. The more modern types of music have in fact so much sound energy within the higher frequency range that the pre-emphasis presents a risk of tape saturation unless the overall recording level is decreased, which will again lead to a less favourable signal-to-noise ratio.

If a maximum limit of 10 dB pre-emphasis is taken as a reference in spite of the above comments, it is interesting to compare what can be achieved at 19, 9.5 and 4.75 cm/s by application of cross-field biasing, with the results obtained by using thinner tape coating. We have already found that the tape curves for the two cases are virtually parallel to one another. Therefore the pre-emphasis curves will be equal. Thick magnetic coating gives the highest signal level and consequently the best signal-to-noise ratio. (continued overleaf)

Close-up of the Tandberg 6X cross-field system. Bias head in foreground.

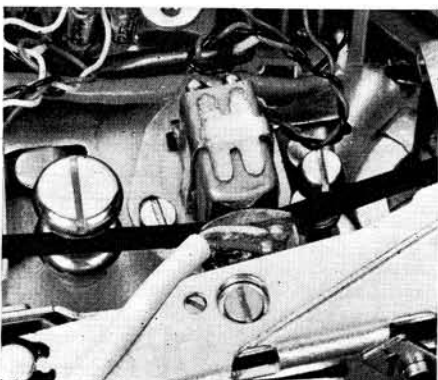

CROSS-FIELD BIAS CONTINUED

As previously mentioned, recording losses associated with the width of the recording zone will not occur at 19 cm/s. This applies to cross-field as well as conventional bias in the relevant frequency range. At this speed, however, other frequency-dependent losses necessitate a pre-emphasis of 8 dB. This means that the established 10 dB pre-emphasis limit is nearly reached. Because the self-erasing problem within the desired frequency range at 19 cm/s does not arise, the cross-field will not alter the overall situation at this tape speed.

Tape speed	Pre-emphasis	Tape noise level (long-play tape, cross-field bias)	Tape noise level (triple-play tape, conventional bias)
19 cm/s	8 dB	0 dB	+6 dB
9.5 cm/s	12 dB	+2 dB	+8 dB
4.75 cm/s	18 dB	+4 dB	+10 dB

The use of thinner tape will, however, give 6 dB increase in tape noise without any advantages in return.

If the tape speed is reduced to 9.5 cm/s, the wavelength-dependent losses begin to appear. Conventional bias and thick tape require 20 dB pre-emphasis at 10 kHz. With cross-field, these losses can be reduced to a magnitude where only 12 dB pre-emphasis at 10 kHz is required. It can thus be stated that, owing to the new technique, one has succeeded in keeping the wavelength losses at a level low enough to obtain a frequency response at 9.5 cm/s approximately equal to the one at 19 cm/s for conventional technique. This has been achieved without having to exaggerate pre-emphasis (fig. 4). The tape noise will, however, increase by 2 dB because of the higher playback amplification required for a given signal level in the range from 2 kHz and upwards at 9.5 cm/s (see fig. 3).

At 4.75 cm/s, a still greater profit is gained by the new technique. A pre-emphasis which compensates for the recording losses up to 10 kHz will with cross-field bias have to be 18 dB, which is nearly the same as needed for 9.5 cm/s by conventional biasing. Again 2 dB more noise will have to be accepted because of increased playback amplifier gain from 13 kHz and upwards. In other words this will give only 4 dB more relative noise than is the case at 19 cm/s.

Table 1 gives a summary of playback data for cross-field recording on thick tape and conventional recording on thin tape. Standard IEC playback curves are assumed. Cross-field recording on long-play tape at 19 cm/s is taken as the reference for tape noise.

Fig. 5 shows the resulting frequency curves obtained with the pre-emphasis and tape noise given in Table 1 when the cross-field technique is used for thick tapes.

The greatest advantage obtained by using cross-field recording on thick tape instead of conventional recording on thin tape, is the reduction of tape noise. From the table it can be found that cross-field is 6 dB better in this respect at all three tape speeds.

It may be of some interest to know the relative increase of the tape noise when the

tape speed is reduced from 19 cm/s to 4.75 cm/s. Taking the tabulated data for cross-field as a reference, we find that the tape noise will increase by 4 dB for both cross-field and conventional bias due to the higher playback gain required at low tape speeds.

Furthermore, the tape speed reduction requires a 10 dB higher pre-emphasis in order to maintain the frequency response up to 10 kHz. Hence the overload safety margin in the upper frequency range is correspondingly reduced. The 8 dB pre-emphasis at 19 cm/s will allow a programme of the previously mentioned standard spectral sound energy distribution to be recorded at maximum level

in the lower and middle frequency range, with no risk of saturation at high frequencies.

At the reduced speed a pre-emphasis of 18 dB is required, and under the same conditions as above, the recording level at lower and middle frequencies must be reduced by 10 dB in order to avoid saturation at high frequencies. The tape noise will then increase by a corres-

GUIDE TO MULTI-TRACK CONTINUED

ian advise that the session should be recorded 'dry' and reverberation added when dubbing, since over-reverberation on original material cannot be removed. If you have two matched recorders, there is virtually no loss in quality if you dub from one to the other via the reverberator and you can keep on messing about until you get the right degree of reverberation.

The aim in multi-track work, or music of

any description, should be to produce an interesting sound. Music may sound deadly recorded in the boxroom but, if you reverberate it, it can sound quite astonishing. By the same token, a piece of original multi-track music can be made to sparkle if some of the many effects available or possible are used, always assuming a good basic tune. It is not unethical to play a chorus on a row of tuned buckets or bits of wood nailed to a sounding-board. At the moment, I'm collecting old WC pans for a piece of music to be called *Night Boat to Flushing*.

ponding amount. The increased tape noise at low tape speeds consists of one fixed amount caused by the augmented playback amplification and another amount variable from 0 to 10 dB depending on the energy distribution of the programme. The latter noise contribution is the same for cross-field recording on thick tape as for conventional recording on thin tape, because the pre-emphasis is the same in the two cases.

If the recorder has an instrument indicating the maximum tolerable signal amplitude at any frequency, the operator will automatically set the record level according to the loudest tones. If the sound energy is concentrated at high frequencies, one will therefore reduce the record level and the relative tape noise will increase.

In conclusion, it can be stated that, with cross-field bias, a 19 cm/s to 4.75 cm/s speed reduction is accompanied by a possible tape noise increase from a minimum of 4 dB to 14 dB (4+10) depending on sound energy distribution. The corresponding figures, when switching from cross-field recording at 19 cm/s to conventional recording on thin tape at 4.75 cm/s are from 10 dB to 20 dB (10+10).

These points clearly show how important it is to consider frequency range, pre-emphasis and tape noise as a whole when judging the quality of a tape recorder. Furthermore, these requirements must be considered in relation to the particular programme to be reproduced.

STONE SOURCE AND LINE-UP METER CONTINUED

some external controls made it difficult to get the 0.1 dB calibration readings spot on each time and exactly repeatable, so the precaution was worthwhile. Use of this standard instrument greatly simplified the plotting of the 0.1 dB points over the first ± 0.5 dB, but this could be attempted from an accurate calibration graph having only 0.5 dB steps plotted, with reasonable success. If one has no access to a reliable standard instrument, the alternative is to make up a precision attenuator (useful in any case) from 1%

resistors in 0.5 dB steps and calibrate from this.

The voltage ratio (and therefore resistor ratio) is given by:

$$N = 20 \log_{10} (E_2/E_1)$$

Where N is the number of dB.

It might be useful to build in a precision attenuator as an alternative to the continuously variable output of the unit.

Meter scale markings were carried out using the lining-up lines of Letraset to mark the fine graduations.

The instrument grew over a period, after the author had become envious of and inseparable from the professional equivalent of this unit which occupied a fair amount of rack space in its sanctuary. Once built, it spent a further useful period of making measurements with the aid of the calibration curve until at last it was completed and the final Dymo lettering added to the front panel. It is now used before every serious recording to check biasing of the tape and frequency response. It is also proving its worth in checking the performance of other items of equipment and tracking down nasties in

(continued on page 40)

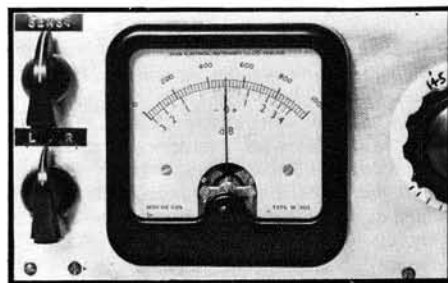

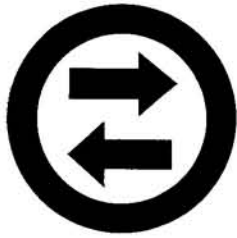

two-way tape transport

BY VIVIAN CAPEL

IN the early days of domestic tape recording, a mere decade ago, several manufacturers developed bi-directional mechanisms to automate the process of ($\frac{1}{2}$ -track) track changing. When $\frac{1}{4}$ -track reared its head, Grundig, Collaro, Simon and the rest gave up the idea and concentrated on improving performance in one direction only.

Realising that $\frac{1}{4}$ -track stereo could be regarded as a $\frac{1}{2}$ -track programme, for this purpose, Ampex, Akai, Teac and National have lately re-introduced the system. A Sony version is also in the offing. The Akai X-355 relied on a weighted flywheel to cajole the tape back across the heads, the capstan and pinch wheel pushing from the rear, while Akai and National endeavoured to seal the tape between two capstans.

At first thought it may appear that such an arrangement would give rise to some knotty practical difficulties. It is almost impossible to manufacture two capstans and flywheels that are of identical size. Even if well within the normal manufacturing tolerances, if the left-hand capstan were only microscopically larger, a loop could develop between the two capstans near the end of a long tape, with disastrous results.

The problem is resolved by deliberately arranging for the right-hand capstan (during normal left-to-right running) to rotate about 1% faster than the left. In fact, it is this speed difference that gives the system the several advantages claimed by the makers, as well as swamping small differences in capstan size.

The main effect of running the leading capstan at a faster speed than the lagging one is that the tape is held taut across the heads, reducing the pressure needed from the pressure pads, thereby resulting in reduced wear. One further advantage is that creases and wrinkles in the tape are ironed out by the first capstan and pinch wheel and they are prevented from re-forming by the tension between the capstans. Thus dropout from this cause is theoretically almost eliminated.

It is well known that the long-term speed of the tape, from beginning to end, can vary due to the increasing back-tension from the paying-out reel as it slowly empties. A feature of the dual-capstan arrangement is that the pre-head capstan acts as a buffer, and the tension across the heads, because it is due solely to the speed difference between capstans, is not dependent on the supply reel. Thus the speed from beginning to end of the tape should be uniform.

Of particular interest is the effect on wow and flutter performance. Figures quoted by the makers are 0.09% RMS at 19 cm/s compared with 0.1% on comparable National models with single-capstan drive (!).

So much for the advantages of the system.

Some readers may feel a bit dubious about the multiplicity of moving parts. Each one, motor, capstan, flywheel and pinch wheel inevitably contributes some degree of wow and flutter.

The minor irregularities introduced by each can often be seen in Alec Tutchings' review fluttergrams of particular instruments, with which readers will be familiar.

After an initial period of use, the wobble performance of a recorder can actually improve as microscopic irregularities in spindles and bearings due to machining, are worn off. The instrument in fact becomes run-in. This effect, incidentally, can sometimes be demonstrated with a gramophone turntable, when the run-down time, from the moment of switching off and the moment the turntable stops, is found to be longer after a period of use than when new.

Another point which some will wonder

about is the effect on the tape of being stretched between the two capstans. It is true that a measure of stretch is imposed in other machines by means of back tension from the supply reel or by a pressure pad on the supply guide, but in these cases there is some 'give', allowing the tape to be pulled away by the capstan. In other words it is a matter of tautness rather than stretch. When the tape is being gripped by two capstans with their pinch wheels, there is no give, and the tape must be subject to actual stretching.

Stretching is not a major problem in practice, however, as the tape itself speeds up the feed capstan when the feed drive falls below the speed of the take-up capstan. This causes mechanical oscillation, however, which manifests itself as flutter or, at worse, acute 'drop-out'.

We will take a look now at the mechanics involved in the dual capstan system. Matters are apparently complicated by the manual and automatic reverse feature. When the tape has come to its end, instead of turning over to record the other tracks, the direction is reversed and another set of heads come into circuit to line up with the lower track positions. The reversal is accomplished by means of a metal foil at the end of the tape which operates a relay to effect the switching in a similar way to the foil-operated automatic stop that is incorporated in some models. Alternatively, the reverse can be initiated at any tape position manually.

As the leading capstan runs faster than the lagging one, matters must be reversed when the tape runs the other way. The left-hand one is now the leading capstan and must therefore run faster. At first thought it would appear that this could only be accomplished by a complicated drive system from the motor to the two flywheels, but in actual fact the arrangement is very simple, although it may not be too easy to understand how it works.

Drive is by means of a single belt which passes round the motor spindle and the two flywheels as shown in fig. 1. The flywheels are equal sized (within normal manufacturing tolerances) yet when running in the direction shown, flywheel B will run faster than flywheel A without any braking or belt slipping. If the rotational direction is reversed, then flywheel A will run faster.

The explanation for this apparent paradox is in the loading of the belt, varying tensions at different points of its circuit, and its elasticity.

Firstly, consider the section of the belt from the motor to flywheel B. This is the point of maximum tension because it is pulling the load of both flywheels. The section between the flywheels is only pulling the load of the flywheel A, so tension here will be approximately half

(continued on page 29)

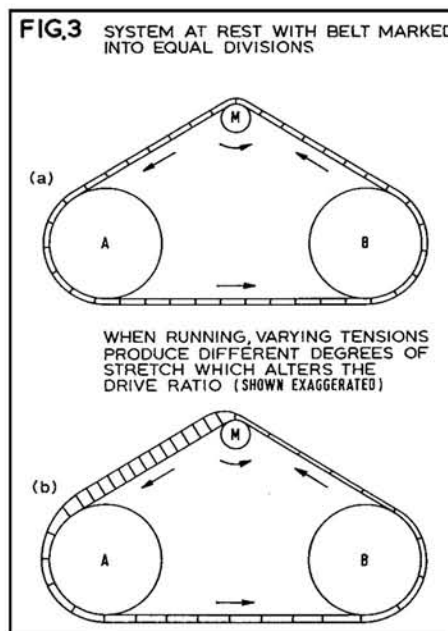
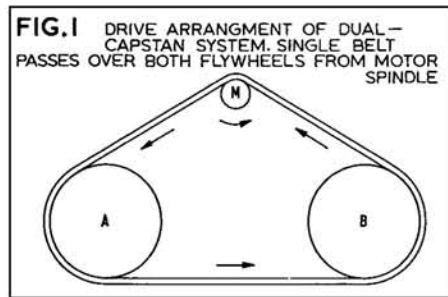

The big new name in Stereo

JVC NIVICO

A range for the enthusiast. Tape decks and recorders . . . matching amplifiers and tuners . . . AM/FM stereo receivers . . . solid state record players with AM/FM radio . . . solid state modular stereo components with automatic record changers. All specialist designed for sound perfection.

Pick of the world's best

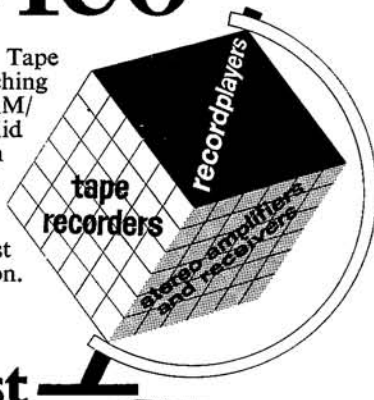

MODEL AST 103 EH

Bookshelf type solid state micro-component stereo amplifier. 24w R.M.S. Tape monitoring switch. Stereo headphone jack. Frequency response 30-20,000Hz. Wooden Cabinet.

MODEL FRS 103 EH

Matching solid state AM/FM multiplex tuner with AFC.

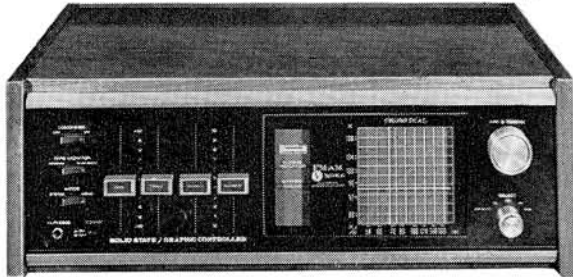

MODEL AST 140 E

AM/FM stereo tuner/amplifier. Output 36w R.M.S. Automatic stereo switching with stereo radar. Advanced cross tuning with fine tuning indicator. Graphic controls for bass, treble and volume. Frequency response 20-20,000Hz. Speaker selector, protection indicator and many outstanding features and specifications.

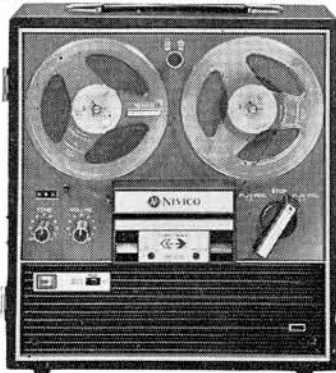

MODEL TR 171 U

Solid state 2-speed 2-track Tape Recorder. 5" reel. Reverse track recording/playback system. Instant stop. Automatic volume control. Tone control. Speaker monitor. Tape counter. 100-240v AC. The sign of quality and technical advancement

JVC Nivico
(Victor Company of Japan Ltd.)



For full details write to the sole U.K. Distributors
DENHAM & MORLEY (OVERSEAS) LTD.,
Denmore House, 173/175 Cleveland Street,
London, W.1. Tel: 01-387 3656/7/8

UP TO 50% OFF!

BRITAIN'S ONLY TAPE RECORDER MART

specialising in the SALE, EXCHANGE and PURCHASE of every make of high quality Tape Recorder. Brenell, Ferrograph, Ampex, B & O, etc., we have the lot! Fantastic savings of up to 50 per cent off original list prices for Personal Callers only. Our stocks change daily—call today—well over 100 models to choose from—all guaranteed you pay no tax on secondhand machines.

TYPICAL BARGAINS

ALL WITH 3 MONTHS WRITTEN GUARANTEE
(Note: M=Mono, S=Stereo. BP=Battery Portable, 4=4 track, 2=2 track)

ROBUK RK3 (M/2) ...	Our price ONLY 15 gns.
GRUNDIG TK20 (M/2) ...	Our price ONLY 15 gns.
PHILIPS EL3301 (BP/M/2) ...	Our price ONLY 17 gns.
TELEFUNKEN 75 (M/2) ...	Our price ONLY 19 gns.
BRENELL 3 STAR (M/2) ...	Our price ONLY 19 gns.
GRUNDIG TK30 (M/2) ...	Our price ONLY 29 gns.
STELLA ST9112 (Battery Mains Cassette)	
Brand New List £42 8 8	Our price ONLY 29½ gns.
REPS R10 (M/2) ...	Our price ONLY 35 gns.
GRUNDIG TK6 (BP/M/2) ...	Our price ONLY 35 gns.
BUTOBA MTS (BP/M/2) ...	Our price ONLY 35 gns.
REPS R10 (M/4) ...	Our price ONLY 35 gns.
BRENELL Mk 5 (M/2) ...	Our price ONLY 39 gns.
GRUNDIG TM60 (S/2) ...	Our price ONLY 39 gns.
PHILIPS EL3536 (S/4) ...	Our price ONLY 45 gns.

NOTE:—THESE ARE NOW EVEN BETTER VALUE AS YOU PAY NO TAX ON SECONDHAND RECORDERS.

FERROGRAPH 4/AN (M/2) ...	Our price ONLY 49 gns.
TELEFUNKEN 97 (S/4) ...	Our price ONLY 49 gns.
TRUVOX R102 (M/2) ...	Our price ONLY 49 gns.
GRUNDIG TK46 (S/4) ...	Our price ONLY 52 gns.
VORTEXION WV8 (M/2) ...	Our price ONLY 55 gns.
SONY TC500 (S/4) ...	Our price ONLY 59 gns.
TRUVOX PDI04 (S/4) ...	Our price ONLY 59 gns.
AKAI M6 (2/4) ...	Our price ONLY 62 gns.
FERROGRAPH 631 (M/2) ...	Our price ONLY 69 gns.
REVOX E36 (S/4) ...	Our price ONLY 69 gns.
AKAI M7 (S/4) ...	Our price ONLY 69 gns.
TELEFUNKEN 204E (S/4) ...	Our price ONLY 69 gns.
TANDBERG I241 (S/4) ...	Our price ONLY 69 gns.
SANYO MR939 (S/4) ...	Our price ONLY 72 gns.
GRUNDIG TK340 (S/4) ...	Our price ONLY 75 gns.
SANYO MR929 (S/4) Brand New List £95 10	Our price ONLY 79 gns.
SONY TC260 (S/4) Brand New ...	Our price ONLY 79 gns.
AKAI I710W (S/4) Brand New List £109 17 3	Our price ONLY 85 gns.
BRENELL STB2 TAPE UNIT (S/2) ...	Our price ONLY 89 gns.
TELEFUNKEN 204E (S/4) Brand New ...	Our price ONLY 95 gns.

PERSONAL CALLERS ONLY

NEW TAPE RECORDERS

We also stock every make and model of New Tape Recorder plus a complete range of accessories.

Part of the NuSound Organisation

THE TAPE RECORDER MART

242/4 PENTONVILLE ROAD, LONDON, N.1

(200 YDS. KINGS CROSS) TERMINUS 8200 (HALF DAY THURSDAY)

FIG. 1 TANDBERG SERIES 8 (1/4-TRACK)

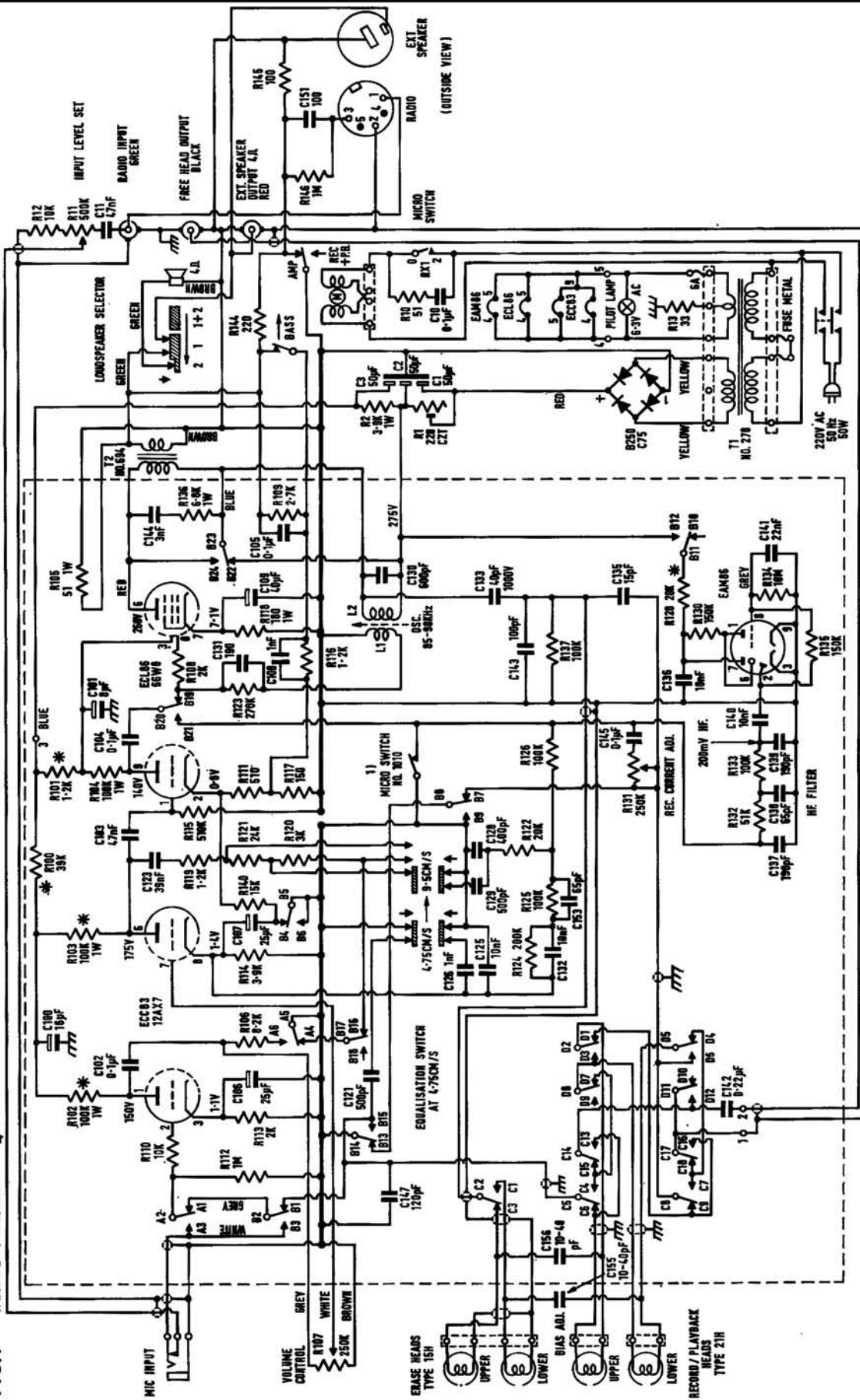

* CARBON RESISTORS

1) TO PREVENT DC PULSES TO PASS THROUGH THE REC./PLAY HEAD, THIS MICRO SWITCH MUST SHORTCUT BEFORE ANY OTHER CONTACTS ARE MADE WHEN THE 0 SWITCH MOVES FROM 'RECORD' TO 'PLAY'

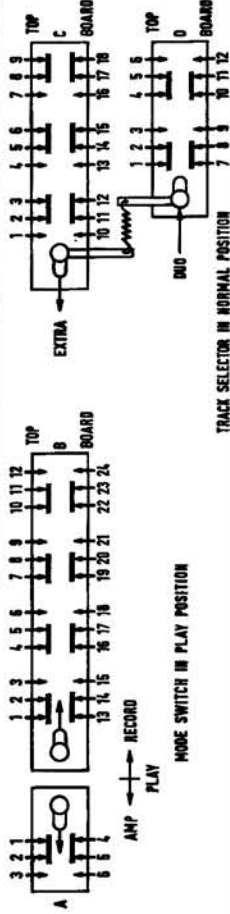

MODE SWITCH IN PLAY POSITION

TRACK SELECTOR IN NORMAL POSITION

The pressure pad is a felt mounted on a brass spring which is simply clipped to a bracket. This bracket, on a spring-loaded arm, is actuated by the tongue on the end of the pressure arm, with a swivel bracket transferring the motion. The inward pressure, however, depends not on this tongue but on the spring at the left. Any temptation to adjust by altering the angle of the tongue will upset the pause action. To check, first note that there is 0.5 mm clearance between this tongue and the delrin button of the stop-start lever (on decks where this is fitted) when in the running position. The normal check on this tongued section should also include the clearance for the pressure roller spindle: the right-hand end of the section should have a 1 mm clearance, when the pressure roller is engaged, and should hold off the roller by 0.5 mm from the capstan spindle when *stop* is selected. The small tongue at the front right is bent to achieve this.

After these adjustments have been checked, the clearance at the erase head end can be tested, and then the inward pressure which, if it can be measured easily, should be 75-100 gm with the machine running. Alteration by bending the spring slightly can bring this back to rights but always check that the pad has not hardened with dust and oxide accumulation before making mechanical alterations. This is so often the real cause of the fault that I risk sticking my neck out to the extent of saying flutter can often be traced to this simple defect—always providing that clutch adjustments are in order.

SPIRIT SOLVENT

Methylated spirit is not a good cure-all in this instance. Both here, and in the case of those felt rings and discs that so many makers glue to the undersides of turntables for clutch action, methylated spirit can act as solvent to the adhesive. The result may not be apparent until the pad dries out, when it will lie askew, or come off altogether. I have found that the Bib cleaning fluid, though less drastic in its action, needing a little more patient application, does a far better job. But it must be stressed that regular cleaning of the head channel, including a 'dust-off' at the erase pad, will save the more drastic operation.

Before plunging gaily into the main subject, allow me to mention another point that has been raised—the case of the singing belt.

Several times I have had to change Tandberg belts, not because they have failed to operate the clutch drums but because of a singing noise that can develop. On one of these machines I had this week, this symptom had crept in, and, although the owner, probably growing resigned, had not complained, a dressing with Gripex was tried, and has, to date, effected a cure. This preparation, by Colton Audio Products, is a treatment for rubber drive surfaces, quite cheap at 5s for a bottle that should last a long time. A review will appear after sufficient testing time has been given but, if the Editor will allow me a bracketing shot, this recommendation should serve.

And so to the main business—the *Series 8* and *Series 9*. We can treat these together because the circuits are basically similar, and the decks are virtually the same, following on the already well-established design. The *8* covers models *82* and *84*, half- and quarter-track machines, and the *823-843* range with a

different cabinet and top plate. From our point of view, the single title 'Series' will cover our argument, and the circuit of fig. 1, the quarter-track version, includes all the particular examples to which we need refer. The *9* is rather different in styling, particularly in the rounded cabinet shape and the loudspeaker grille but the circuit and deck are so nearly that of the *8* that we need not make any special reference to it.

IMPORTANT DIFFERENCE

There is one important difference, however, and this is the motor. The *8* uses a shaded pole and the *9* a capacitor-start type. This also brings in the other important change, the fitting of a 'tape-end' switch (to which reference has been made in previous articles) to the *Series 9*. And while on the subject of differences, let us note one subtle point about the *921* and *922* that can lead one astray during servicing unless the circuit is studied. This is the method of rectifying the heater supply to the *ECC83* to reduce hum. This is simply a small *E20* rectifier in series with a 1.6 ohm resistor, decoupled with a 4,000 μ F electrolytic, taken from the hot side of the heater supply and giving the section of the filament that heats the preamplifier stage, a DC voltage of approximately 5.9 V. When testing, care must be taken over this, and if the valve has failed, this rectifier must be checked. The improvement this makes is quite noticeable, and, in fact, the signal-to-noise ratio of the *92*, at 56 dB (tape recorded to 5% distortion) is several dB better than the *82*. This leads to the other small difference that may sway one or two people toward the *Series 9*.

The *8* specifies quite baldly a 40 Hz-12 kHz frequency range at 9.5 cm/s. At ± 2 dB the closer figure of 60 Hz-10 kHz will be measured.

(continued overleaf)

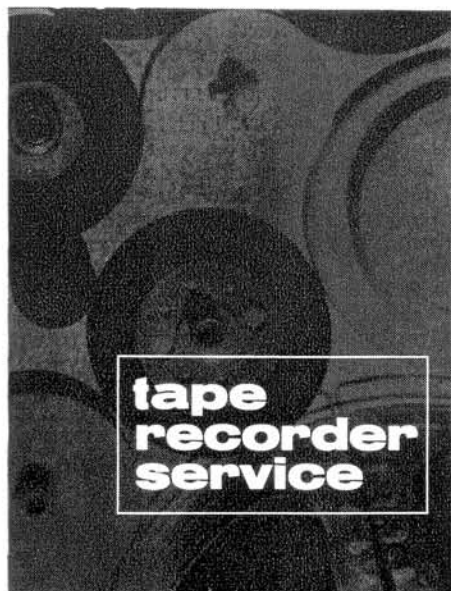

TANDBERG SERIES 8 AND 9

BY H. W. HELLYER

IT is always the same: as soon as one says 'Oh, no, it won't rain,' the stuff pelts down in buckets. I had no sooner posted off the manuscript of the last contribution than two Tandbergs arrived at my workshop bench with an insidious and virtually untraceable flutter.

In both cases, the trouble originated with the pressure pad against the erase head. Fig. 3 of our last article should have shown the structure of the pressure arm assembly clearly enough to save taking up space with drawings this time but a few additional words of description may help.

FIG. 2

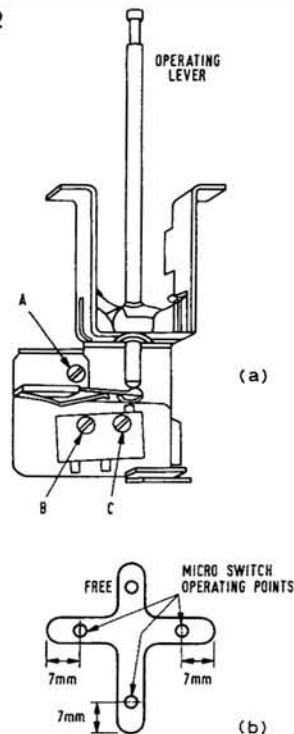



And at the slow speed of 4.75 cm/s, the respectable figure of 40 Hz-7 kHz (± 2 dB, 80 Hz-5 kHz) will be obtained. But the *Series 9* at the slower speed has a trifle less bass, yet in the *amplifier* mode it has the much wider response of 30 Hz-20 kHz ± 2 dB against the 40 Hz-16 kHz of the *8*. Add this small extension to the provision of 19 cm/s, essential to the enthusiast, plus faster rewinding, and the *9* certainly has the edge on the *8*. Nevertheless, if anyone has an *8* going cheap, I'd be happy to relieve him of his burden!

Taking the circuit stage by stage, we find both models with a similar preamp, quite conventional, with the type of isolating microphone jack and preset potentiometer for line input level adjustment that should be normal fitting on any decent machine, yet is too often omitted. Look out for possible noise generation with noisy controls, and check by shorting the pot while attenuating the applied signal. Note the possibility of poor socket contacts, and a deformed microphone shorting blade if intermittent level is the trouble.

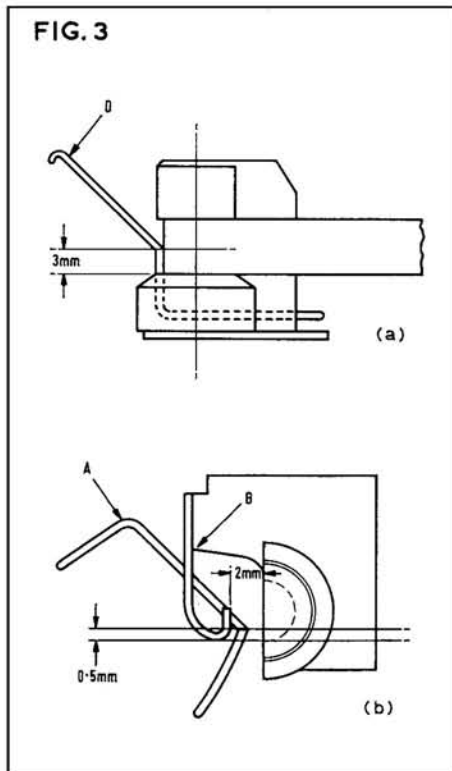

The main amplifier is also interchangeable from our point of view, except for changes of capacitor across the heads, different heads being used in the two ranges. These capacitors are used to resonate the head circuit, giving a bit of HF peaking on playback. For recording, a series capacitor and adjustable recording current resistor keep conditions constant. The main amplifier is a two-stage circuit, based upon the second half of the *ECC83* and the triode section of the *ECL86*, and with equalisation during playback over the *ECC83* stage. For recording pre-emphasis, a negative feedback loop over both stages is switched in, and a record monitor output is available on all models except the *84* range (where the appropriate socket is employed instead for the free head output). If criticism could be offered, it would be that such a small extra expenditure would have enabled the owner to have what must be a necessary facility of off-tape monitoring on these models as well. However, it is no great hardship to add three components and a phono socket, and the circuit given will serve as a guide.

The output stage is no great shakes, and the bass switch method of tone control is no more than a concession to style. But this is of no moment, when machines of this quality are considered, for the deck and preamps, the oscillator, indicator, etc., are what matters, the output stage, except for its doubling function as oscillator, serving as no more than a playback monitor.

A 3 W output is all you can expect to get from the *ECL86* pentode, although with the 51-ohm protector resistor removed and a little reshuffling of the selector switch it is possible to squeeze a little more. Such practices are to be deplored.

On the subject of protector resistors—a sore point with me, having just completed a 20-pair loudspeaker comparator, completely protected at amplifier switches and loudspeaker sockets—it is worth mentioning that the rated power output is not needed, nor is the exact impedance, when choosing the shunt resistor. In the first place, rated full power is rarely developed, and then for brief spells only; hardly long enough to warm up the average 5 W wirewound job. In the second place, loudspeaker impedance is an arbitrary value, and at the higher frequencies the impedance can be several hundred ohms, so a compromise value in a convenient preferred range of modest wattage will do the job of guarding the transformer and output valve quite satisfactorily.

PENTODE OSCILLATOR

As an oscillator, the *ECL86* pentode of the Tandberg circuit operates very well. The frequency is on the high side, all to the good. Resonance at 85-90 kHz depends on the erase head as well as the tuned circuit. The output transformer is short-circuited for this function, and the method of adjustment entails measuring the voltage across the erase head and setting the oscillator core for a maximum reading. Using a valve-voltmeter with low capacitance probe, a reading of around 200 V should be obtained. Using inferior meters will not only affect the reading but also impair the oscillator action. I have never had trouble with these oscillators and suggest that no alteration need be made, except to tickle up the bias to suit whatever tape is employed. Most frequent

fault is ageing of the *ECL86*, and Tandberg can hardly be blamed for that!

The magic-eye is an *EAM86*, which has its own diode, and the circuit may not be immediately familiar. Quite comprehensive filtering of the oscillator voltage is used and the damping has been carefully worked out to give a fairly easily observed indication of average signal, even on this peak-reading device. But there is one stricture: overloading is easy unless you have become used to the design. When the beams of the eye meet, the replayed signal will be to a 4% to 6% distortion level (at 400 Hz). It is wise to keep your level down below the danger mark, to rehearse the programme if possible, and anticipate probable overloads well in advance. Having been caught during a vital choral recording, with an assistant who, more used to the less expensive machines, kept the modulation level high to 'get the best signal-to-noise ratio', I feel that preparation and logging of the programme with noted crescendos, etc., should be routine recording procedure. The results, when a little extra care is taken, are beautifully clean. So, I'm a Tandberg fan: we all have our prejudices!

EXACT SETTING

There are two small points that need mentioning before we pass on to later models. Again, common to all the decks, the method of switching depends on the exact setting of the joystick which has to actuate the microswitch at precisely the right moment. Fig. 2 shows the joystick and microswitch and the three adjusting screws, and (b) gives the settings for the operating points. These are most important. Adjustment can be a bit tricky, with the switch moved both vertically and horizontally and the screws tightened gently as the correct position is gained. It pays to take a little time and trouble over this.

Secondly, the autostop, fitted on the *Series 9* but not the *8*, and relevant also to other models, can be troublesome. Unhandy bending of the wire spring may cause its loosening at the root, and erratic action will ensue. Fig. 3 shows the correct alignment and angle of the spring. The forward dotted line in (b) is the guide, and the spring should be bent at point A so that the operating point is 0.5 mm from this when the spring is moved from the rear to the front position. The guide bracket in which it travels can be bent for free movement. The width of the slot is adjusted by bending at point B. And in (a) the side view is shown, with tape in place. The important factor is the angle at which the vertical part of the spring meets the tape, because, obviously, this must not impose an extra mechanical load. The tape will be seen to ride twisted from the guide if this is incorrect. Finally, do not overlook the possibility of the spring fouling the head covers when these are replaced, and when refitting them, feed the spring gently into a clear position and allow it to ride back into place.

The possibility of suppressor failure has already been mentioned. Having been led a dance once with a leaky suppressor capacitor that circumvented the microswitch action and caused tape spillage, I have something of a phobia about these. They can be disconnected for tests if necessary, but as they are not easy to get at, let me express the pious hope that this fault will never trouble you.



TAPE RECORDIST'S BOOKSHELF

SURVEY OF TAPE RECORDING BOOKS CURRENTLY IN PRINT

THE ALL-IN-ONE TAPE RECORDER BOOK (8th edition) by Joseph M. Lloyd. 212 pages, 150 diagrams. Published by Focal Press Ltd., 31 Fitzroy Square, London W1. Price 15s. 6d.

AUDIO-VISUAL HANDBOOK (2nd edition) by Ralph Cable. 128 pages, line and half-tone illustrations. Published by University of London Press Ltd., St. Pauls House, Warwick Lane, London EC4. Price 9s. 6d. (Reviewed November 1965).

BIRD SONG RECORDING by Frederick Purves. 92 pages, 100 illustrations. Published by Focal Press Ltd., 31 Fitzroy Square, London W1. Price 7s. 6d.

BUILDING AND USING SOUND MIXERS by R. E. Steele. 152 pages, 124 line illustrations and 8 half-tones. Published by Focal Press Ltd., 31 Fitzroy Square, London W1. Price 30s. (Reviewed May 1966).

CIRCUITS FOR AUDIO AND TAPE RECORDING compiled by F. C. Judd. 78 pages, 94 illustrations. Published by Haymarket Press Ltd., 9 Harrow Road, London W2. Price 7s. 6d. (Reviewed June 1966).

THE COLLECTION OF FOLK MUSIC AND OTHER ETHNOMUSICOLOGICAL MATERIAL edited by Maud Karpeles. 44 pages. Published by the International Folk Music Council, Danish Folklore Archives, Birketinget 6, 2300 Copenhagen S, Denmark. Price 15s. (Reviewed August 1959).

COMEDY SCRIPTS FOR TAPE RECORDING by Peter Cagney. 27 pages, 24 line and wash illustrations. Published by 3M Ltd., York House, Queen Square, London WC1. Price 3s. 6d. (Reviewed May 1966).

THE DRAMATAPE GUIDE by H. Woodman. 92 pages, 40 illustrations. Published by Focal Press Ltd., 31 Fitzroy Square, London W1. Price 7s. 6d.

FUN WITH TAPE by Joachim G. Staab. 258 pages, 25 line illustrations. Published by Focal Press Ltd., 31 Fitzroy Square, London W1. Price 21s. (Reviewed February 1968).

THE GRUNDIG BOOK (12th edition) by Frederick Purves. 234 pages, 90 illustrations. Published by Focal Press Ltd., 31 Fitzroy Square, London W1. Price 19s. 6d.

MAGNETIC TAPE RECORDING by H. G. M. Spratt. 368 pages, 203 illustrations. Published by Iliffe Books Ltd., 42 Russell Square, London WC1. Price 63s. (66s. by post). (Reviewed August 1964).

MANUAL OF SOUND RECORDING by John Aldred. 350 pages, illustrated. Published by Fountain Press Ltd., 46 Chancery Lane, London WC2. Price 75s.

MODERN TAPE RECORDING AND HI-FI by Ken Peters. 248 pages, illustrated. Published by Faber and Faber, 24 Russell Square, London WC1. Price 30s. (Reviewed November 1963).

PHILIPS TAPE RECORDING BOOK (3rd edition) by Frederick Purves. 180 pages with line illustrations. Published by Focal Press Ltd., 31 Fitzroy Square, London W1. Price 19s. 6d. (Reviewed September 1968).

PRACTICAL TAPE RECORDING by Percival J. Guy. 82 pages, 45 line illustrations. Published by Norman Price (Publishers) Ltd., 17 Tottenham Court Road, London W1. Price 7s. 6d. (Reviewed November 1966).

SOUND AND VISION by P. E. Sharp. 64 pages, illustrated. Published for the Council of Industrial Design by Macdonald and Co. (Publishers) Ltd., 2 Portman Street, London W1. (Reviewed August 1968).

SOUND: FACTS AND FIGURES compiled by John Borwick. 172 pages, 183 diagrams. Published by Focal Press Ltd., 31 Fitzroy Square, London W1. Price 12s. 6d.

STEREO HANDBOOK by G. W. Schanz. 135 pages, illustrated. Philips Paperback, distributed by Iliffe Books Ltd., 42 Russell Square, London WC1. Price 16s. (Reviewed November 1968).

THE TAPE EDITING GUIDE by Ronald Hack. 64 pages, 28 illustrations. Published by Focal Press Ltd., 31 Fitzroy Square, London W1. Price 7s. 6d.

THE TAPE RECORDER (2nd edition) C. J. Nijssen. 157 pages, 59 line illustrations, 76 half-tones. Published by Iliffe Books Ltd., 42 Russell Square, London WC1. Price 18s. (Reviewed August 1968).

THE TAPE RECORDER IN THE CLASSROOM by John Weston (3rd edition). 132 pages, illustrated. Published by the National Committee for Audio-Visual Education, 33 Queen Anne Street, London W1M 0A1. Price 7s. 6d. (Illustration tape: 52s. 6d.). (Reviewed March 1965).

TAPE RECORDERS by Paul Spring. 207 pages, 144 line illustrations, 27 half-tones. Published by Focal Press Ltd., 31 Fitzroy Square, London W1. Price 42s. (Reviewed February 1968).

TAPE RECORDING SERVICING MANUAL by H. W. Hellyer. 340 pages, 357 line and three tone illustrations. Published by George Newnes Ltd., Tower House, Southampton Street, London WC2. Price 63s. (Reviewed March 1966).

TAPE RECORDER SERVICING MECHANICS by H. Schroder. 122 pages, 62 line illustrations. Published by Iliffe Books Ltd., Dorset House, Stamford Street, London SE1. Price 21s. (Reviewed February 1968).

TAPE RECORDERS—HOW THEY WORK by C. G. Westcott and R. F. Dubbe. 224 pages, illustrated. Published by Foulsham-Sams Technical Books Ltd., Slough, Buckinghamshire. Price 26s. (Reviewed November 1965).

TAPE RECORDING by C. N. G. Matthews. 128 pages illustrated. Museum Press Ltd., 39 Parker Street, London WC2. Price 20s. (Reviewed November 1968).

TAPE RECORDING AND HI-FI by Frederick Oughton. 128 pages, 14 line illustrations, 23 half-tones. Published by Collins Nutshell Books, 144 Cathedral Street, Glasgow C4. Price 6s. (Reviewed August 1964).

TAPE RECORDING AND HI-FI by R. Douglas Brown. 152 pages, 8 line illustrations, 32 half-tones. Published by Arco Publications, 9 Grape Street, London WC2. Price 5s. (Reviewed August 1964).

TAPE RECORDING AND REPRODUCTION by A. A. McWilliams. 287 pages, 180 illustrations. Published by Focal Press Ltd., 32 Fitzroy Square, London W1. Price 42s. (Reviewed January 1965).

TAPE RECORDING FOR THE HOBBYIST by Arthur Zuckerman. 160 pages, illustrated. Published by W. Foulsham & Co. Ltd., Yeovil Road, Slough, Bucks. Price 26s. (Reviewed August 1968).

YOUR BOOK OF TAPE RECORDING by Ken Peters. 87 pages, 33 line and 4 plate illustrations. Published by Faber & Faber, 24 Russell Square, London WC1. Price 12s. 6d. (Reviewed November 1966).

FIG. 1 TANDBERG II RECORD AMPLIFIER BOARD

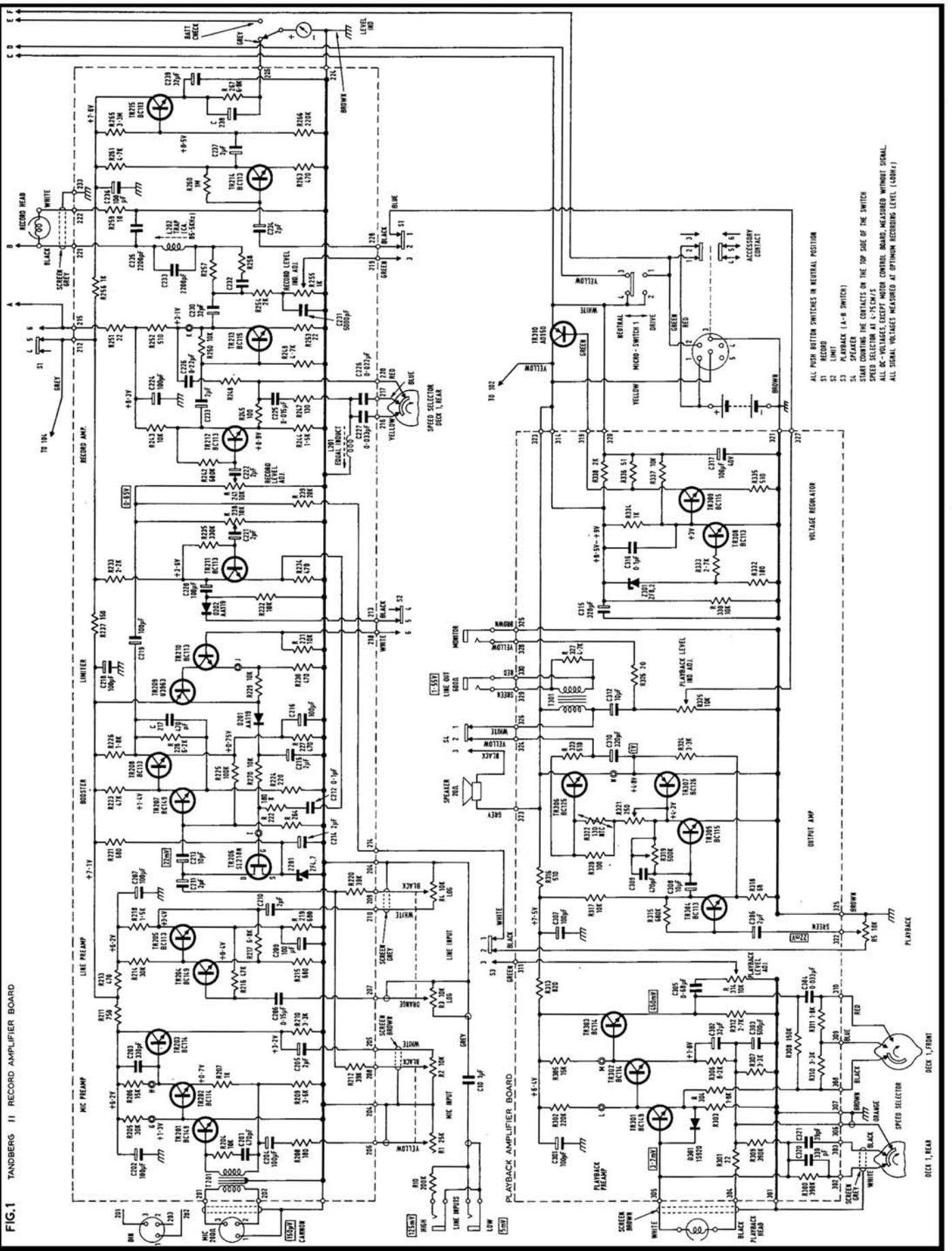

ALL PUSH BUTTON SWITCHES IN NEUTRAL POSITION
 S1 RECORD LIMIT
 S2 PLAYBACK (A-B SWITCH)
 S3 SPEAKER
 S4 SLOW CONTROLS THE CONTACTS ON THE TOP SIDE OF THE SWITCH
 ALL DC-VOLTAGES EXCEPT MOTOR CONTROL BOARD, MEASURED WITHOUT SIGNAL.
 ALL SIGNAL VOLTAGES MEASURED AT OPTIMUM RECORDING LEVEL (100μV)

equipment reviews

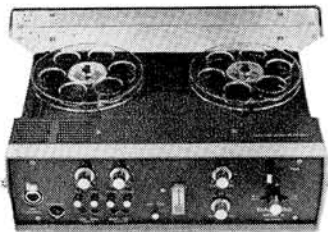

TANDBERG SERIES 11

THE Tandberg Series 11 is an effort to meet the demand for a robust portable recorder with balanced microphone and line facilities, a high overload factor and facilities to mix microphone and local line input signals. Three heads allow input or off-tape monitoring on headset or internal speaker. Speed stability is of a very high order and motor noise is extremely low.

An interesting feature of the line and microphone level controls is that they each consist of ganged potentiometers which act on both the input and output of the line and microphone amplifiers in such a way that even very high level inputs can never overload the amplifiers.

The limiter is a special semiconductor device (*Q206*) which acts as a variable resistor to form an attenuator in conjunction with the level control loading resistors *R212* and *R220*. The limiting action starts at 0 dB on the VU meter and any signal above this level is reduced to peak recording level *without distortion*. I applied a peak recording level signal of 1 kHz to the line input and then instantaneously increased the input by 20 dB (10 : 1); the gain was reduced to peak recording level within one cycle of the 1 kHz waveform, i.e. within one thousandth of a second. When the input signal was switched to normal there was a short re-setting period of about 0.25 second before the recorded signal attained peak recording level. On actual overloaded speech signals, however, there was no audible break in signal level, nor was there any audible overload distortion. The only unnatural effect was that the gain recovered between words so that there was a rather gasping effect as the breath was drawn in for the next word or sentence. The limiter is extremely

MANUFACTURER'S SPECIFICATION (19 cm/s). Battery powered portable tape recorder. **Power Supply:** Ten U2 cells or equivalent. **Consumption:** 2-3 W. **Motor:** DC pulse driven. **Speed tolerance:** $\pm 0.2\%$ relative, $\pm 0.5\%$ absolute. **Spool capacity:** 18 cm (lid open) 13 cm (lid closed). **Frequency response:** 40 Hz—16 kHz ± 2 dB. **Distortion:** below 0.5% (amplifiers), below 3% (tape). **Noise level:** 58 dB below peak recording level at 3% tape distortion. **Wow and flutter:** 0.2% peak (0.14% RMS). **Erase and bias frequency:** 85.5 kHz. **Limiter:** approximately 25 dB over maximum level. **Inputs:** 0.15 mV at

200 ohms, balanced (*microphone*). 5 mV to 10 V at 10 K (*low level line*), 125 mV to 10 V at 200 K (*high level line*). **Outputs:** 600 ohm balanced line (1.55 V 0 dB) and 200 ohm headphone monitor. **Tape speeds:** 19, 9.5 and 4.75 cm/s. **Dimensions:** 33 x 25.4 x 10.2 cm (iwh). **Weight** (including batteries): 13.5 lb. **Price:** £145 19s. (standard), £208 19s. (pilot). **Manufacturer:** Tandbergs Radiofabrikk A-S, P.O. Box 9, Korsvoll, Oslo 8, Norway.

Distributor: Elstone Electronics Ltd., Hereford House, Off Vicar Lane, Leeds 2, Yorkshire.

effective against momentary overload, with normal gain available immediately afterwards for low level recording.

The motor control circuit is similar to that employed in the Revox A77. A phonic wheel on the motor shaft generates an AC signal whose frequency is proportional to tape

speed; this signal is fed to a tuned circuit discriminator which produces a DC voltage proportional to deviation from the required speed. In this system the control voltage alters the pulse width of a 4 kHz signal which powers the DC drive motor for longer or

(continued on page 37)

FIG. 3 TANDBERG SERIES II RECORD/PLAY WOW AND FLUTTER

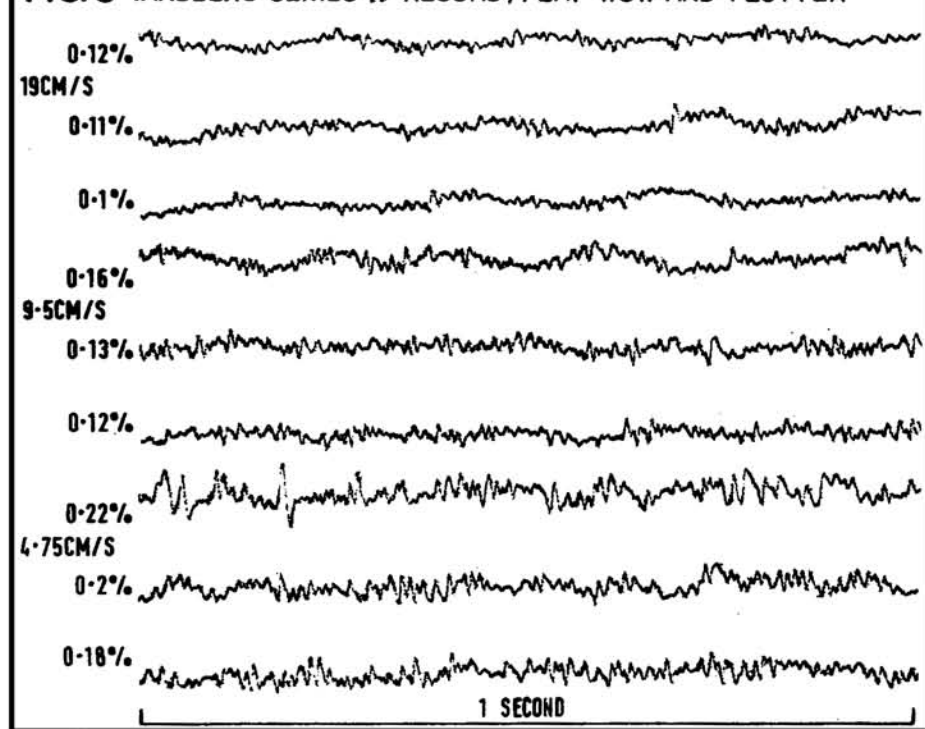
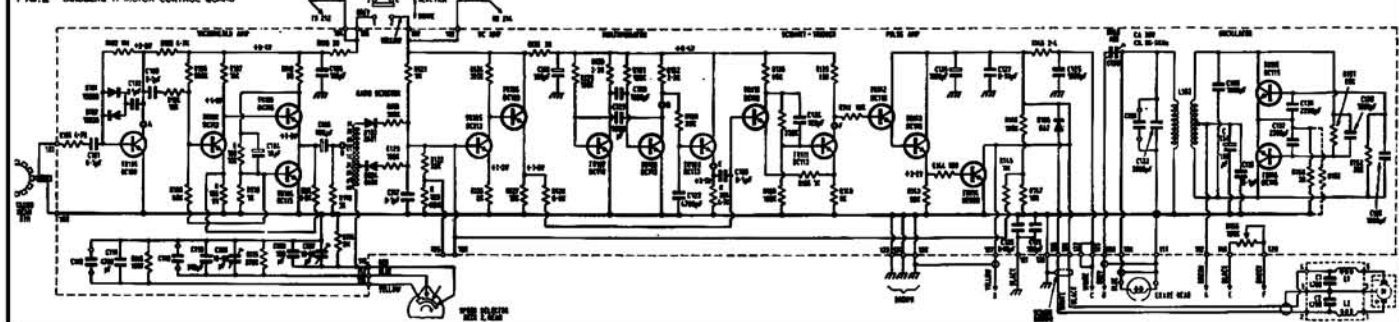

FIG. 2 TANDBERG 11 MOTOR CONTROL BOARD



Have you noticed it too?

With so many shops to choose from, there must be excellent reasons why people prefer to buy more and more from **Francis of Streatham**. Perhaps you would care to find out by calling or writing to us about your requirements in tape and hi-fi equipment too. (S.a.e. with written enquiries please.)

EVERYTHING IN RECORDERS AND HI-FI ON THE BEST OF TERMS

- ★ VERY LARGE STOCKS OF EQUIPMENT AND ACCESSORIES
- ★ NO EXTRA FOR CREDIT UP TO 18 MONTHS
- ★ FREE SERVICE DURING GUARANTEE PERIOD—OWN SERVICE DEPT.

We are TANDBERG specialists and carry full stocks of these famous products.

Also FERROGRAPH, VORTEXION, AKAI, PHILIPS, ETC., ETC.

FOR A FAIR and DEPENDABLE DEAL—BUY IT FROM

SPECIAL OFFER OF WORLD FAMOUS 'SHAMROCK' TAPE
Brand new, top quality polyester.
2400', 7" reel ... 25/-
1800', 7" ... 21/-
1200', 7" or 5½" or 5" ... 15/-
900', 5" ... 12/6
600', 5" ... 10/-
P. and P. 1/6 per reel. Orders over post free. Cash with order please. £3

FRANCIS OF STREATHAM

169-173 STREATHAM HIGH ROAD, LONDON, S.W.16

Between St. Leonard's Church and Streatham Station

Phone: 01-769 0466: 01-769 0192

Please note our only address Free Car Park, Prentis Road nearby
OPEN ALL DAY SATURDAY—EARLY CLOSING WEDNESDAY

We are happy to announce that we can now supply

BRAND NEW BRITISH & GERMAN RECORDING TAPES

P.V.C. POLYESTER & MYLAR

Both manufactured by world reputable British and German firms. Fitted with leaders and stop foils. Not rejects or sub-standard in any way—tapes are splice free and are boxed. Remember: full refund plus postage should goods not meet with your full approval.

Standard Play	Length	English price	German price
3"	150'	2/6	2/-
4"	300'	4/-	3/6
5"	600'	9/-	6/6
5½"	900'	11/6	8/-
7"	1200'	16/-	10/-
Long Play			
3"	220'	3/-	2/6
4"	450'	6/-	5/-
5"	900'	11/6	9/-
5½"	1200'	16/-	10/6
7"	1800'	23/-	14/-
Double Play			
3"	400'	6/-	4/-
4"	600'	8/6	7/-
5"	1200'	21/-	13/-
5½"	1800'	24/-	17/-
7"	2400'	39/-	22/-

EMPTY SPOOLS: 3" 9d. 5" 2/-. 5½" 2/3. 7" 2/6.

N. WALKER Ltd.

28 Linkcroft Ave., Ashford, Middx.

Phone: 53020

YOU CAN HAVE GOOD SOUND EQUIPMENT

if you choose



Grampian Reproducers Ltd. Hanworth Trading Estate, Feltham, Middlesex

FULLY GUARANTEED

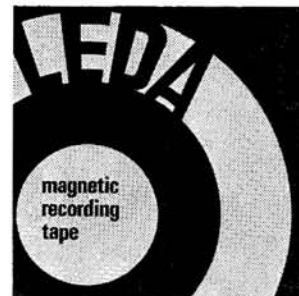

Size Base	Standard		Long	
	P.V.C.	P.V.C.	P.V.C.	P.V.C.
3"	150'	2/6	225'	3/3
4"	300'	4/3	450'	5/6
5"	600'	8/9	900'	10/3
5½"	900'	10/6	1200'	12/6
7"	1200'	12/6	1800'	17/9
Size Base	Double POLYESTER		Triple	
	300'	4/6	600'	9/3
	600'	8/6	900'	13/3
	1200'	15/9	1800'	23/6
	2400'	22/6	3600'	39/9

Factory Fresh. Superb Quality. Leaders, Trailers and Stop Foils on all sizes 5" and above. We supply many local authorities and professional recording studios. May we supply you? P. & P. 2/6 per order. S.A.E. Full Lists.

LEDA TAPES (D), 30 BAKER ST., LONDON, W.1.

Phone: 01-226 7004

Rapid Recording Service

L.P.'s from your own tapes. Master discs and pressings. Recording Studio. Multi-channel facilities for transfer to 8 or 16 mm film tracks. Sound effects library on discs.

Associated Company:

EDUCATIONAL RECORDINGS LIMITED

Do you suffer from INSOMNIA—The modern scourge. Every year hundreds of people kill themselves by taking sleeping pills. Every year hundreds of people ruin their lives by becoming drug addicts. Insomnia is NOT a disease. You can overcome insomnia easily, quickly and safely by acquiring

THE REAL FACTS ABOUT SLEEP.

Send for particulars of this and twenty other tapes on self improvement. Publications:—"Sleep-learning, Its Theory, Application and Technique". "Mental Power through Sleep-suggestion". Distributors of the Cassette battery/mains Sleep-o-matic Unit. Pillow speakers. Time clocks. Brochures from:—

RAPID RECORDING SERVICE, 21 Bishops Close, London E17

UNIVERSITY OF KENT AT CANTERBURY

THE LANGUAGE CENTRE

Applications are invited for the post of SENIOR TECHNICIAN in the LANGUAGE CENTRE. The person appointed will be required to maintain four language laboratories and further audio-visual aids, and to supervise and train two assistant technicians. The salary scale is £987-£1,225 p.a. Further particulars and application forms may be obtained from the Registrar, Beverley Farm, The University, Canterbury, quoting reference T.68/12.

shorter intervals so that the mean speed remains constant at a point where the phonic wheel frequency is equal to that of the discriminator tuned circuit.

The mean tape speeds were within the specified 0.5% at each speed from beginning to end of a 13 cm reel of LP tape.

Short term speed variations are shown in the pen recordings of fig. 3. A cyclical speed variation at about 3.5 Hz is visible on the 19 and 9.5 cm/s traces but, if present, it is obscured by other random speed variations at the lowest speed of 4.75 cm/s. I would hesitate to blame this entirely on mechanical imperfections, as it may possibly be the 'hunting' frequency of the electronic control circuit. Whatever the cause, the RMS combined wobble readings on record/play are well within the specification with maximum read-

miniature monitor output jack feeds a constant voltage signal to a 200-ohm headset, in marked contrast to the average recorder, which feeds a headset with constant current by passing the signal through a high series resistor. I found that a lightweight stethoset headphone provided excellent monitoring on or off the tape at adequate level to estimate background noise, etc., and with excellent sound quality.

We break new ground in this review by basing our signal-to-noise ratio on a DIN 45513 (19S) reference tape, which is recorded at precisely 32 mM/mm across the full width of the tape. This level corresponds to peak recording level and a tape distortion of 3% on average tape. Unweighted system noise, with no tape passing the heads, was 50 dB below reference tape level.

Reference level (32 mM/mm) was recorded at 1 kHz with a third harmonic distortion of only 2% at 19 cm/s. The VU meter at this recording level registered 1 dB below 0 dB.

Full scale meter deflection corresponding to +4 dB, gave 4.2% harmonic distortion at 19 cm/s.

Unweighted tape noise, after erasing reference peak level at 1 kHz, was 49 dB below peak. Weighted signal-to-noise ratio was 54 dB.

Wind or rewind of a 13 cm 900 ft (300 m) reel of LP tape was accomplished in 3 minutes in either direction with the speed falling almost to zero at the end of the reel.

Current drain from a set of new batteries was 150 mA at normal tape transport at 19 cm/s, rising to 300 mA over most of the rewind cycle, and rising still higher to nearly 500 mA as the motor stalled near the end of a reel.

COMMENT

An excellent semi-professional battery recorder. A notable omission is any form of tape position indicator. Perhaps the makers assume that all such measurements would be made on the static studio based tape player, or perhaps they thought the extra load on the poor little motor might prove too much for it. It is obvious from the above consumption figures that wind and rewind should be used sparingly, and that some help should be given to reels that begin to slow down.

The pause or stop key is a great help in getting off to a flying start, but, like another well known battery recorder, it is fatally easy to stop the tape and put the recorder away with the motor still running. This is a thing you only do once, you remember to use the joystick next time!

A. Tutchings.

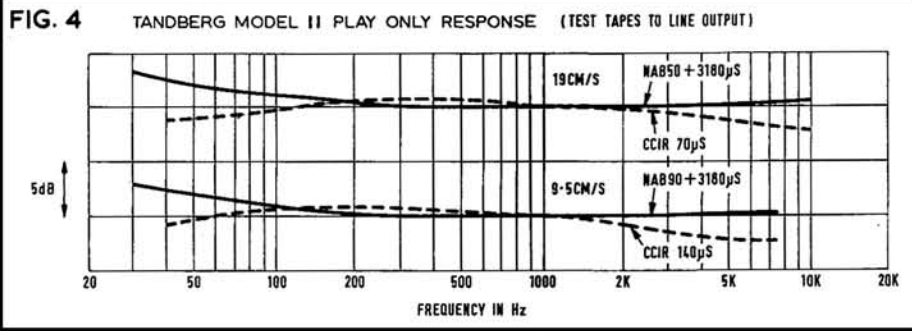

ings of 0.12%, 0.16% and 0.22% at 19, 9.5 and 4.75 cm/s respectively.

The combined wow and flutter from a low wobble test tape was 0.09% at 19 cm/s and wow only was 0.08%. At 9.5 cm/s the readings were exactly the same at 0.09% and 0.08% respectively.

In a portable recorder some compromise must be made in the mass and diameter of the flywheel to avoid speed variation as the recorder is shaken or moved. In the Model 11 the flywheel is quite small and it is used mainly as a speed reduction device to couple the constant speed motor to the capstan. As a result the machine is almost entirely insensitive to handling or sudden change of position. It works equally well on its back, on its side, or even upside down.

Fig. 4 shows the responses obtained when playing CCIR and NAB test tapes. It will be seen that the equalisation is exactly to NAB 50 and 90 μs characteristics.

OVERALL FREQUENCY RESPONSE

Fig. 5 shows the overall record/replay responses from line input to line output at the three speeds. The frequency limits at either end of the frequency scale comfortably exceed the specification figures.

The overall acoustic response of fig. 6 was taken for the sake of completeness without any expectation of a particularly level and extended response. The measured curve shows a reasonable response from 200 Hz to 6 kHz and shows that the tiny internal speaker fulfils its function of avoiding good monitoring facilities of the signal on the tape. The

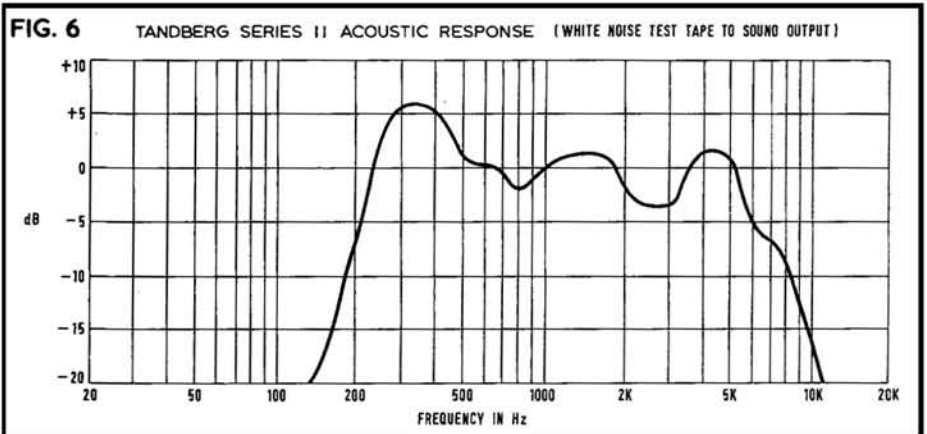
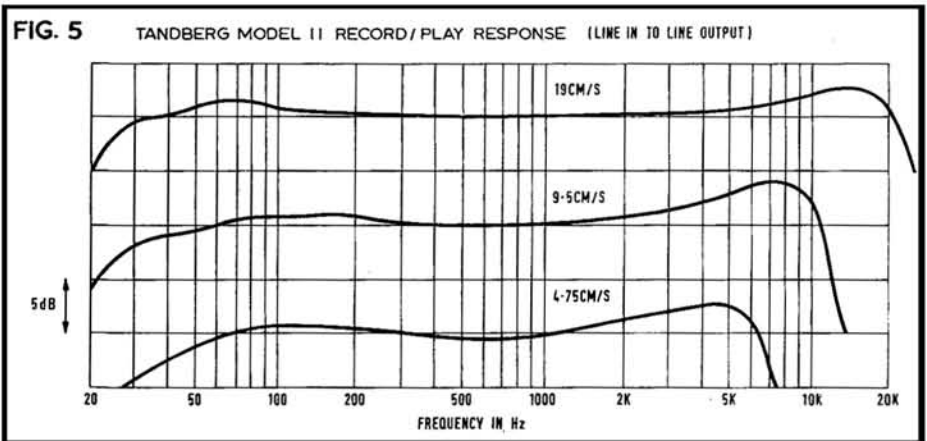

Your Tape Dealer

LONDON AREA

FOR ALL LEADING
AUDIO EQUIPMENT

hifi

Classical Records
by Mail Service

hampstead

HIGH FIDELITY

91a Heath Street,
Hampstead, N.W.3.
Tel. HAMpstead 6377

HAVEN

196-198 SOUTH EALING RD.
Hi-Fi LONDON
W.5
Tel. 01-560 0194

LASKY'S RADIO

Stockists for all the leading makes of Tape Equipment

207 EDGWARE ROAD, W.2. Tel.: PAD 3271
118 EDGWARE ROAD, W.2. Tel.: PAD 9789
33 TOTTENHAM CT. RD., W.1. Tel.: MUS 2605
42 TOTTENHAM CT. RD., W.1. Tel.: LAN 2573
152/3 FLEET STREET, E.C.4. Tel.: FLE 2833

TAPE RECORDER HI-FI CENTRE (SHEEN) LTD

SPECIALISTS IN TAPE RECORDERS, ACCESSORIES,
HI-FI EQUIPMENT

YOUR CENTRE FOR FRIENDLY HELP, SALES AND
SERVICE

3 & 4 STATION PARADE, Open until 8 p.m. on Fridays
SHEEN LANE, SHEEN, PROSPECT 0985
LONDON, S.W.14 Opposite Mortlake Station, S.R.

CHESHIRE

go scandinavian hi-fi . . .

Bang & Olufsen, Tandberg, Arena, Dynatron, Radford,
Sony, Philips, Quad, Leak, Fisher, Sanyo, Pioneer, Akai,
Sansui, Wharfedale, Armstrong, Rogers, Ferrograph,
Trio, Dual, Bryan, Normende, Eddystone, Goodmans,
Braun, etc.

the hi-fi and tape recorder lounge

●EXPERT STAFF ●ADVICE SERVICE ●PART EXCHANGE
●Home Demos ●After Sales Service ●Comparator Demos

GREEN LANE, WILMSLOW, CHES. SK9 1LR
Ring Wilmslow 24766 and ask for Mr. Bird
Closed Weds. except by appointment

FOR ALL YOUR REQUIREMENTS . . .

CHARLESWORTH'S

OF CREWE LTD.

Head Office: 14 Hightown, Crewe. Tel. 3327

Hi-Fi CENTRE: 28 HIGHTOWN, CREWE

Technical Division: 19 Ludford Street, Crewe

Your Tape Dealer

DEVON

THE SOUTH WEST

Tom Molland Ltd.

Invite you to visit their well-equipped
Demonstration Theatre and compare all
the leading makes of Hi-Fi and Tape
Equipment at

110 CORNWALL STREET, PLYMOUTH
Telephone 69285

Immediate delivery to ALL Areas

ESSEX

EPPING — ESSEX
CHEW & OSBORNE LTD.
148 HIGH ST. TEL: 4242

AKAI — AMPEX — ARENA — ARMSTRONG — AUDIO
TECHNICA — B & O — BRYAN — CELESTON
FERROGRAPH — FISHER — GARRARD — GOLDRING
GOODMANS — HACKER — KEF — LEAK — LOWTHER
PHILIPS — QUAD — RADFORD — REVOX — ROGERS
SHURE — SONY — THORENS — TRUVOX
WHARFEDALE — WYNDSOR
Home and Showroom Demonstrations:
After Sales Service — H.P. Facilities
Equipment and Records by post

GLOUCESTERSHIRE

Sound Selection

OF BRISTOL

Tape Recorder and Hi-Fi
Specialists (Demonstration Room)

361-363 GLOUCESTER ROAD,
BRISTOL 7. Tel. 41181

HAMPSHIRE

High Fidelity Specialists

Hamilton Electronics

Hamilton Electronics (Southampton) Ltd.
35 London Road, Southampton. Phone: 28622 3Lines

FORRESTER'S

NATIONAL RADIO SUPPLIES LTD.

70-72 HOLDENHURST ROAD
BOURNEMOUTH HANTS

Largest hi-fi and radio component
store in the south Tel: 25232

HERTFORDSHIRE

WATFORD

High Fidelity Centre

at RADIOLUX Ltd.

36 WOODLANDS PARADE, HIGH ST.

WATFORD (opposite the pond)

WATFORD 29734, 41029

IF IT'S GOOD—WE STOCK IT!

Demonstrations in our Stereo Theatre. Also home
demonstrations with no obligation.

readers' problems

Readers encountering trouble with their tape equipment are invited to write to the editorial office for advice, marking their envelopes 'Readers' Problems—Tape'. Replies will be sent by post and items of general interest may also be published in this column at a later date. This service does not, however, include requests for information about manufacturers' products when this is obviously obtainable from the makers themselves. Queries must be reasonably short and to the point, limited to one subject whenever possible. In no circumstances should such letters be confused with references to matters requiring attention from other departments at this address. We cannot undertake to answer readers' queries by telephone.

UNMATCHED STEREO MICROPHONES

Dear Sir, At present I have a mono tape recorder and use an AKG D24 dynamic microphone. I wish to add a similar microphone, the less expensive AKG D202, which would be used through the mixing facilities of the recorder. Before purchasing the D202, however, I am wondering if it could be used as a stereo pair with the D24 when I obtain a stereo recorder. I have never believed that it is really essential to have completely matched microphones for stereo recordings but would be grateful for your advice.

Yours faithfully, F.W., Newcastle

It depends what you mean by 'completely matched'. Capacitor microphones of different makes and models, for example, may yet work perfectly in stereo because the bandwidth of this type is wide and the response substantially flat—provided the pair chosen are not too dissimilar in polar diagram; two cardioids, say, would be pretty good provided that one adjusted amplifier gain for equal outputs.

However, in the present state of the art, the dynamic (moving coil) types up to the medium-priced D202 you mention are neither flat enough nor of sufficiently extended frequency response to ensure that any two specimens, even of an identical model, will match to 1 dB—the sort of standard to aim at for serious stereo recording. A matched pair to this standard is, however, obtained in the D24 class, as these are a superior version of the well-tried D19 from which the samples sold are selected to fall within a tight-tolerance curve. One pays, of course, for a stronger magnet, superior diaphragm, etc.—plus the selection by individual dead-room measurements; but the result is good enough for the

D24 to have been around most broadcasting and recording studios for some years.

The D202, a relative newcomer to the AKG range, may not match the above at all well, because:

- (1) Its novel, and no doubt excellent, system of separate units for treble and bass, where the D24 is a single full-range diaphragm, must show subtle dissimilarities analogous to those already familiar in listening tests between multiple loudspeakers with crossovers and a really high-class single full-range model.
- (2) There are more tolerances to vary with two units plus crossover values than in the D24.
- (3) The different types will not necessarily be in phase.
- (4) Being physically larger and of unusual shape, a satisfactory mounting for crossed-stereo-pair between D202 and D24 will be rather difficult to achieve.

In addition, the advantage of variable bass-response, achieved in D24 by varying the coupling to the bass air-column behind the diaphragm, will be foregone, as the D202 is not similarly variable.

Good stereo results may be obtainable via loudspeakers of dissimilar types, if only because one can replay the recorded performance any number of times with different settings and layouts until satisfaction is achieved. Live stereo-recording, especially of public performances, is by contrast a single-shot, one-chance-only operation in which differences in microphone-pairs are a variable one can well do without! On a location session one already has troubles enough.

READING A METER

Dear Sir, I have noticed that signals for the recording level meter are taken before the frequency response shaping network in some tape recording amplifiers, and in other designs after. In my Ampex 1163, for instance, HF notes produce a larger deflection of the meter than LF ones of equal amplitude (from an AF signal generator). Does the amount of distortion produced depend on the current fed to the tape head or on the signal impressed on the tape?

Yours faithfully, J.H.D.E., Oxford

Whether the feed to a signal level indicator is taken before or after the frequency response shaping network will depend on the individual circuit and, in particular, the meter damping circuits. The factor at which designers aim is a reasonably fast response time (rise time) with sufficient damping to allow successive transients to retain a level and not cause flicker.

Thus, a sinewave signal at high frequency will have a higher mean level in a given time than that of lower frequency which produces the same peak voltage. A truer test, in the case of your 1163, is a square wave input over selected frequency bands. This is nearer what the meter is expected to indicate during normal use and is one reason for taking off the signal before pre-emphasis is applied.

Distortion depends on the signal impressed on the tape, but as this also depends on the recording voltage (constant current recording being the aim, and the reason for series resistance in the

head feed circuit) your final question does not really apply. When the signal overloads, the peaks exceed the limits decided by the transfer characteristic, and clipping is experienced, distortion resulting.

DISMANTLING A TRUVOX

Dear Sir, I have a Truvox R7 tape recorder and wish to obtain access to the inside. How do I go about this?

Yours faithfully, H.G., Stoke-on-Trent

Better men than we have been caught with the dismantling procedure for the Truvox R7, which looks as if it was poured into its cabinet and left, like a jelly, to set.

However, there is a secret: four screws at the corners of the front grille can be released, the machine turned on to its front and, presto, the whole cabinet lifts off.

As these screws may be domed, they are not always obvious, and to save you any further frustration, we suggest you apply pressure to the cap, insert the blade of a knife beneath the edge and try turning slowly to get a start. Once you get a start, the screw will release fairly evenly.

VOLTAGE TAPPINGS

Dear Sir, I am interested in buying a Tandberg Series 12 tape recorder but note that it requires 220 V at 50 Hz though our power supply here is 240 V. Does this matter?

Yours faithfully, P.A., Cambridge

Voltage tappings are often quite arbitrary. Imported machines often give 'mid-range' voltage figures, and where no specified tappings are provided, a figure of 220 V can be taken to mean from 200-240 V.

This is certainly the case with the Tandberg 12; its regulation circuits permit a wide range of input voltage variation without the need of altering any tapping point.

As a general case, a machine intended for a specific voltage should be run on that voltage, but the stipulation often applies to motor supplies. Some machines will not run happily on voltages 10% low, and motors tend to run hot at the same amount higher. But in these cases, voltage tappings will be given and should be followed. Much more important in this respect is frequency, which drastically alters speed. Fortunately, we are not beset with frequency problems in the UK.

AKAI M8 DISTORTION

Dear Sir, Perhaps you could suggest the remedy for a fault which my Akai M8 tape recorder has developed. This causes intermittent distortion on recording, a few words or a short passage of music being garbled. It is worst at 4.75 cm/s and hardly audible at 19 cm/s. Playback of known tapes is perfect and erasure is normal. I have changed the bias oscillator valve but without success.

Yours faithfully, G. O'K., Cork

(continued overleaf)

Your Tape Dealer

LANCASHIRE

STOCKPORT AUDIO CENTRE
FINEST IN NORTH WEST

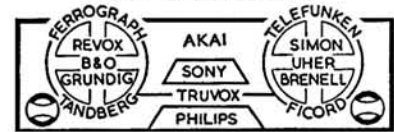

★ ALL MODELS ON COMPARISON DEMONSTRATION
★ EVENING DEMONSTRATIONS BY APPOINTMENT

FAIRBOTHAM & CO. LTD.,
58-62 Lower Hillgate, STO 4872

BOLTON

Specialists in
High Fidelity Sound

H.D. KIRK
Stereolectrics
LIMITED

203 St. George's Road
Phone 23093

BOLTON

J. SMITH & SON

HI-FI EQUIPMENT — STEREOGRAMS
TAPE RECORDERS — 2 SHOWROOMS
B & O., Dynatron, Hacker, Quad, Leak, Radford,
Armstrong, Ferrograph, Revox, Truvox, Uher,
Decca, Garrard, Thorens, Goodmans, KEF, etc.
Comparator Demos Closed all Tuesday
Specialists in 'SOUND' for 36 years

184 THE ROCK, BURY Tel: 1242

ST. HELENS

HAROLD STOTT LTD.

Hi-Fi Consultant

Tape Recorder Specialist. Agents
for all leading makes including Akai,
B & O, Revox, Sony, etc. Advice and
demonstrations given willingly.

18 Westfield Street, St. Helens

NORTHUMBERLAND

SOUND EQUIPMENT SPECIALISTS

Morton
sound Tel. 2-6902
20142
12 OXFORD STREET

NEWCASTLE UPON TYNE 1

NOTTINGHAMSHIRE

Nottingham Tape Recorder Ltd.

BURTON ST. 2 mins. Victoria Station

Specialists in all the best makes of

● TAPE RECORDERS ● AMPLIFIERS ●

● HI-FI DISC EQUIPMENT ●

Telephone: Nottingham 45222

Your Tape Dealer

OXFORDSHIRE

Westwoods

for the

TAPE RECORDER

of your choice

46 George Street

Oxford 47783

SHROPSHIRE

SHREWSBURY'S NEW SOUND CENTRE

Ferroggraph-Leak-Akai-Rogers-Goodman etc.

HEAR THEM IN OUR DEMONSTRATION STUDIO

OPEN ALL DAY
TUESDAY-SATURDAY



Hi-Fi Ltd.

13 WYLE COP.

Tel. 55166

(facing the famous Lion Hotel)

SURREY

FARNHAM

SURREY

- ★ Stockists of all good Hi-Fi apparatus.
- ★ Comparative demonstrations.
- ★ We offer a real after sales service.
- ★ Easiest of terms.
- ★ No parking problems.

Lloyd & Keyworth Ltd.

THE RECORD SHOP

26-27 DOWNING STREET, FARNHAM
SURREY Telephone: Farnham 5534
SURREY AND HAMPSHIRE'S HI-FI SPECIALISTS

CROYDON'S

TAPE RECORDER CENTRE

All leading makes in stock, Hi-Fi equipment, cabinets, etc. Service agents for AKAI Tape Recorders

SPALDING ELECTRICAL LTD.,
352/354 Lower Addiscombe Road,
CROYDON.

ADDISCOMBE 1231/2040

SUSSEX

WORTHING, SUSSEX

Stocking Ferroggraph, Revox, Sony, Tandberg, Truvox, Philips, EMI, Luxor, etc., on fully comparative Demonstration.

BOWERS & WILKINS LTD.

1 Becket Bldgs., Littlehampton Road,
Worthing 5142

WARWICKSHIRE

BIRMINGHAM TAPE RECORDER CENTRE

266 BROAD STREET, BIRMINGHAM 1
(Opposite Bingley Hall)

Most leading makes high fidelity equipment.
Part exchanges welcomed.

Telephone Midland 2680

Your Tape Dealer

WARWICKSHIRE (contd.)

Coventry's 100% tape recorder and hi-fi specialists for service and sales.

Akai — Ampex — Bang & Olufsen —
Ferroggraph — Leak — National —
Radford — Revox — Sony —
Tandberg — Truvox — Wyndor

Coventry Tape Recorder Service

33 King William Street, Coventry
Telephone Coventry 29668

GRIFFIN RADIO LTD

(the high fidelity people)

Fully comprehensive stocks and advisory service for

Monaural and Stereophonic High Fidelity,
Radio, Tape and Disc Equipment

94 BRISTOL STREET

BIRMINGHAM 5 Telephone MID 1359

YORKSHIRE

TAPE RECORDER CENTRE (HALIFAX)

For all the best in Tape Recorders
and Hi-Fi Sales and Service

30 King Cross Street,
Halifax Phone 66832

REVOX
SPECIALISTS

SCOTLAND

GLASGOW

Scotland's Leading Tape Recorder, Video and Hi-Fi Specialists

G. H. STEELE LTD.

Hear true Hi-Fi sound on our 22 speaker comparator system. 14 Hi-Fi combinations ready for demonstration.

SONY VIDEO CENTRE

Agents for: Armstrong, Leak, Fisher, Rogers, Quad, B & O, Goldring, Garrard, Thorens, Connoisseur, Goodmans, Wharfedale, Kef, Celestion, Decca, Truvox, Philips, Sony, Arena, Revox, Tandberg, Brenell, Ferroggraph, Akai, Uher, Grundig.

CREDIT TERMS — PART EXCHANGES
Repairs and Servicing Tel. Douglas 7124

141 St Georges Road, Glasgow C3

Recording Studios

mjb

recording and transcription service

Mono and Stereo records. Latest cutting methods, automatic varigroove, feedback cutter heads, limiters and equalisers, techniques hitherto available only to the professional, facilitating high undistorted cutting levels and extended playing times even from amateur recordings.
Booklet available.

45 HIGH STREET

BURNHAM

Tel. 61303 BERKS

TAPE RECORDERS - AUDIO EQUIP-
MENT - DISC CUTTING STD & LP
FROM TAPE-STUDIO FACILITIES
HIRE SERVICE-SALES-EXCHANGES

MAGNEGRAPH

1 Hanway Place, London, W.1. LAN 2156

READERS' PROBLEMS CONTINUED

You will be well aware that the Akai M8 employs cross-field bias, with a separate head swivelling up to the back of the tape (front as you look at it), during recording.

There are three possibilities of trouble: first, the 100 pF preset capacitor used to set bias amplitude. As erase is in order, we know the waveform is correct up to this component. Check it for an intermittent short-circuit. Secondly, the bias head itself. Check that its face is absolutely clean. Head cleaning operations sometimes miss this one, although erase and signal heads are scrupulously gone over! Thirdly, make sure it is coming up correctly to the tape, that the pivot pin on the angle plate is free, and that the small spring to the right has not jammed.

If the fault occurs regularly enough to be fairly predictable, you could check with a pair of headphones at the signal head, monitoring the signal (ignore absolute quality for this test and concentrate only on the presence of a signal).

STONE SOURCE AND LINE-UP METER

CONTINUED

friends' machines. The whole cost about as much to build as it seemed I would have to pay for a commercial kit for the oscillator alone, calibrating the meter myself and shopping round for the R53 thermistor which varied in price down one London road from 12s. 6d. to 27s. 6d. All the transistors are cheap and easily obtainable, and buying from manufacturers or mail order firms seems to save about 50% compared with certain retail sources of the same items. For me the project has been one of the most useful to date.

PERFORMANCE SUMMARY

Oscillator Range: 14.5 Hz to 2.2 MHz in five ranges centred on 100 Hz, 1 kHz, 10 kHz, 100 kHz, 1 MHz

Output: -4 dB ref. 775 mV RMS, continuously variable

± 0.2 dB, 14.5 Hz-22 kHz } ref 1 kHz
-2 dB at 2 MHz

Output impedance: 300-600 ohms according to setting

Meter sensitivity: -20 dB ref. 775 mV RMS, continuously variable

Frequency response:

+0.1-0.15 dB 14.5 Hz to 22 kHz-3 dB at 200 kHz } ref 1 kHz

Input impedance: 600 ohms or 200 K (approx.)

Range: -3 to +4 dB in 0.5 dB steps; calibrated to 0.1 dB between ± 0.5 dB

Internal error: (i.e. oscillator output measured by internal meter via reference level control): +0.1 - 0.15 dB 14.5 Hz to 22 kHz ref. 1 kHz

I would like to thank Ernest Turner Electrical Instruments Ltd for their help in preparing this article, my father for producing the metalwork and Victor Bridport for taking the photographs.



BY CYRIL GRANGE

ARAPIDLY growing hobby is the study of natural history in general and birds in particular, encouraged by 30 national bodies, a nature trust in every county and numerous city and town societies, all of which welcome government bills to protect the countryside and lead people to enjoy wild nature.

Another tremendous surge of interest is being taken in tape recording, away from the less active pleasure of listening to commercially produced tapes, towards the more challenging one of producing recordings of specific subjects.

Now if we combine these two hobbies, we achieve one of all-absorbing value, and it is this which I hope to tell you about month by

month as certain birds come into song and as special requirements are demanded by the instrument and its operator.

I would assume that you have at present a mains recorder. So well and good, because you will find all sorts of song and 'gabble' round your house and garden. If you have a large garden or a detached house, with shrubs, climbers, and maybe trees, the available vocabulary will be wide.

At the beginning (but I hope you will progress as we go on) you can try your microphone at a house window, possibly for nearby chattering sparrows, for the robin with which you are already friendly, for the skylark (if you are a country dweller) or for the blackbird in the lime tree.

You will probably capture a mixed bag of the most varied noises but, as we proceed, we hope to show much improvement. If the birds are more than 20 ft from the window microphone, then there may well be so much extraneous unwanted sound that a parabolic reflector will have to be used.

If the garden is a large one (and before we can plan special equipment) then it is quite in order to extend the mains lead so that the microphone is within song range (say 5 ft for a wren and 10 ft for a blackbird). It is important however not to use just any scrap lighting flex but triple rubber-insulated and tough rubber sheathed cable so that the equipment will be adequately earthed.

We must have an idea of how bird song pitch compares with the frequency response of the recorder. Take the common mistle thrush: the frequency is estimated to

be from 1.5 kHz to 7 kHz, the wood pigeon 250 Hz to 1.5 kHz, the garden warbler 2.5 kHz to 10 kHz, the starling and robin 3 kHz to 12 kHz and the blackbird 2 kHz to 7 kHz.

Possibly some of us will have professional apparatus with a speed tape of 38 cm/s giving a low noise, low wobble and a relatively wide frequency range. The probable amateur speed will be 19 cm/s. I must emphasise that bird song requires a much wider range of response than is usually recognised and, even with a good machine and suitably matched external speakers, you may well be surprised how difficult realism is to achieve.

The portable battery recorder at 9.5 cm/s will obviously work but results may be rather hard on the ears.

To be able to appreciate where and when to find bird song, we must have a rough idea as to the reasons for singing because they are closely related to the month in which the song occurs. These may be sex attraction, intimidation, safeguarding of territory, call (alarm, social, flight or injury), begging (youngsters) and, I believe, sheer joy.

Birds likely to be offering song in January (which may well vary month by month) are the robin, wren, chaffinch, skylark, blue tit, great tit, hedge-sparrow, blackbird, song thrush and mistle thrush.

The songs during January are not likely to be as loud and joyful as at courtship. They will be more concerned with the preservation of territorial rights (robin), alarm (blackbird), defiance (mistle thrush), nest appropriation (starling), and discipline (blue tit).

GOLDRING-LENCO VV7 PREAMPLIFIER!

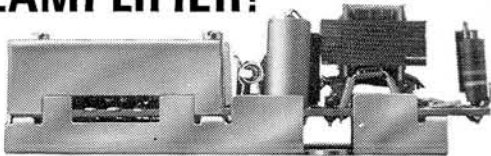

Stereo or mono amplifier too insensitive for today's high quality magnetic cartridges? No magnetic cartridge input? The Goldring-Lenco VV7 Stereo-Equaliser-Preamplifier provides a simple and wholly effective answer. Small enough to mount with a couple of screws under your turntable, it raises the very low output from the finest magnetic cartridges more than enough to ensure full output from any low-gain amplifier—and even from a modest tape-recorder! Correct equalisation is automatic!

Specification

Sensitivity suitable for all magnetic cartridges
 * Gain of approx. 100 times (40dB @ 1 kHz) * Mains powered
 * Equalisation RIAA (BSI 1928) * Signal to noise greater than 60 dB * 2 silicon transistor stages per channel
 * Fully shielded against electrostatic and electromagnetic fields
 * Size 4 3/4" x 2" x 1 1/2" * Weight 6 oz. * Simple to connect.

GOLDRING-LENCO VV7 PREAMPLIFIER £8.10.0.

 Goldring Manufacturing Co. (GREAT BRITAIN) Ltd.,
 486-488 High Rd., Leytonstone, London, E.11. Tel: Leytonstone 8343

OPENING the BIBLE

by Stuart Allen

Principal of Wilson Street Chapel, London E.C.2
 (Non-denominational)

A series of HALF-HOUR TAPE RECORDED ADDRESSES at 1 1/2 ips, 4 track, on 5 inch spools. The first twelve addresses are available for £1 from:—

Mr. B. MARPLE (TR), 20 Rowley Gardens, Littleover, DERBY. DE3 7GF

Money refunded if not satisfactory

WE SPECIALISE IN BRAND NEW

TOP QUALITY BRITISH P.V.C. MYLAR & POLYESTER RECORDING TAPES WITH FITTED LEADERS, Etc., EX 3"

Thanks to bulk purchase we can offer tensilised HI-FI tapes, manufactured by a British firm of world repute. All boxed individually (sealed if required) in polythene. Our tapes are not to be confused with imported sub-standard or used tapes. Full-money refund if not delighted.

This month: "DRY SPLICE" (3/9) given FREE with every order.

Std.		L.P.		D.P.		Boxed				
Length	ea.	Length	ea.	Length	ea.	empty spls				
3"	150' 2/-	5/9	3"	220' 2/6	7/-	3"	400' 4/6	13/-	3"	7d.
4"	300' 4/-	10/-	4"	450' 5/-	14/-	4"	600' 6/9	19/6	4"	1/8
5"	600' 6/-	17/6	5"	900' 8/-	23/6	5"	1200' 12/6	37/-	5"	1/9
5 1/2"	900' 7/-	20/6	5 1/2"	1200' 10/6	30/6	5 1/2"	1800' 17/-	50/-	5 1/2"	1/9
7"	1200' 9/-	25/6	7"	1800' 13/-	38/6	7"	2400' 21/-	61/-	7"	2/-

All orders despatched by return.

Postage and Packing 1/9 per order.

STARMAN TAPES, 421 Staines Road, Bedfont, Middlesex

CLASSIFIED ADVERTISEMENTS

Advertisements for this section must be pre-paid. The rate is 6d. per word (private) minimum 7s. 6d. Box Nos. 1s. 6d. extra. Trade rates 9d. per word, minimum 12s., Box Nos. 2s. extra. Copy and remittance for advertisements in **FEBRUARY 1969** issue must reach these offices by **18th DECEMBER** addressed to: The Advertisement Manager, Tape Recorder, Link House, Dingwall Avenue, Croydon CR9 2TA.

Replies to Box Nos. should be addressed to the Advertisement Manager, Tape Recorder, Link House, Dingwall Avenue, Croydon CR9 2TA, and the Box No. quoted on the outside of the envelope. The district after Box No. indicates its locality.

SITUATIONS VACANT

Hi-Fi and Tape Recorder salesman required by R.E.W. (Earlsfield) Ltd. at their Tooting branch. Good pay and conditions. Apply the Manager, 266 Upper Tooting Road, London S.W.17. Tel. 01-672 9175 or 672 8267.

BBC tv

YOUR HOBBY COULD BE YOUR PROFESSION

BBC Television employs many Film Recordists and Assistant Film Recordists in its Film Operations Department.

For young men between eighteen and twenty-eight, who are interested in imaginative, high quality tape-recording and are dedicated enthusiasts in the art of sound recording, there is a comprehensive training scheme which leads to a challenging and worthwhile career. Conditions of employment are generous and congenial and there are opportunities for travel at home and abroad.

For further details and application form, write to Head of Appointments Department, P.O. Box 1AA, London, W.1 (quoting reference 68.G.960T.R.).

MISCELLANEOUS

Repairs. Our modern service department equipped with the latest test equipment (including a wow and flutter meter and multiplex Stereo Signal Generator) is able to repair Hi-Fi and Tape Recording equipment to manufacturer's standards. Telesonic Ltd., 92 Tottenham Court Road, London, W.1. 01-636-8177.

Skilled tape recorder repairs carried out by expert personnel of many years' experience backed by extensive test equipment: Wow and flutter meter, audio valve voltmeter, audio generator, oscilloscope, etc., with final test performance figures quoted if required—Ferrograph specialists. Tape Recorder Centre, Tel-Lee-Radio, 220 The Broadway, Wimbledon, S.W.19. 01-542-4946.

Early flutter spoils Recording . . . A fact well known to many. Send 6d in stamps for important information on how to deal with this and many other problems connected with wow and flutter. Music Tapes, 36 High Street, Salisbury, Wilts.

FOR SALE—PRIVATE

Ficord 202 Portable Tape Recorder, Leather Case, Mains Unit. As new, £48 o.n.o. Mitchell, 6 Green Street, Smethwick, Warley, Worcs. Tel.: 021-558 1505 evenings.

Vortexion WVBS two track 7½ and 3¾, Gramplan mike, perfect, any test, £55. Commins, "Mafraq", Upper Dean, near Kimbolton, Hunts. Riseley 325.

FOR SALE—TRADE

Always be careful (and money-wise) before buying quality equipment. Send your requirement list to Audio Supply Association for evaluation and quotation. See below . . .

Blackburn has Lancashire's leading Hi-Fidelity/Tape Recorder stockists and Electronic Engineers at Holdings Audio Centre, Mincing Lane/Derwent Street, Blackburn (Tel. 59595).

If quality matters consult first our 70-page photographically illustrated catalogue (5/6) and equipment housing guide (1/6). Members enjoy unbiased advisory service, preferential terms. Membership 7/6. Our associates also manufacture records from your own tapes, or record the Master at our studios (Steinway Grand). Bulk terms for choirs, fund-raising. Please specify requirements. Audio Supply Association, 18 Blenheim Road, London, W.4.

E.M.I. TR52 Professional Stereo Recorder 7½ and 15 i.p.s. Brand new £160. E.M.I. 44C Portable Full track Pilotone Recorder. Brand new £165. Film, Photographic & Sound Services Ltd., 49 Calthorpe Road, Birmingham 15. Tel. 021-454 6482.

TAPE EXCHANGE

Yuletide Greetings to our thousands of Members (past and present) throughout the world. Worldwide Tapetalk, 35 The Gardens, Harrow.

Tapespondents. Free sound magazine. Details free. Far and Wide Recording Club, Eccles, Maidstone, Kent. S.A.E. please.

Mature Opera Enthusiast and acoustic engineer invites correspondence from other collector enthusiasts able to share performances to live opera from British sources for private study. Overseas correspondence not precluded. Box No. 544 (Yorks).

STUDIO FACILITIES

J & B Recordings. Tape to disc—latest high level disc cutting, all speeds. Mastering pressings, studio, mobile. 14 Willows Avenue, Morden, Surrey. MITcham 9952.

Your tapes to disc. 7in. 45—18/-, 10in. L.P.—48/-, 12in. L.P.—55/-. 4-day postal service Masters and Vinylite pressings. Top professional quality. S.A.E. photo leaflet: Deroy Studios, High Bank, Hawk Street, Carnforth, Lancs.

Studio Sound Recording Studios. Recording and disc transcription service. Latest high-level cutting techniques. Mono and stereo records. Exceptional quality obtained from amateur recordings. Members A.P.R.S. 31-36 Hermitage Road, Hitchin, Herts. Telephone Hitchin 4537.

Rapid Recording Service. L.P.s from your own tapes. Master discs and pressings. Demo discs. Mobile recordings. Multi-channel facilities for transfer to 8 and 16 mm film tracks. Sound effects library on discs. Brochure on request from:—Rapid Recording Service, 21 Bishop's Close, London, E.17.

Graham Clark Records. Tape to disc—pressings. Top quality yet lowest prices in country. 7in. 45 from 12/6. Small studio available. S.A.E. leaflet. 23 The Grove, Walton-on-Thames, Surrey. Tel. WT 25627.

RAPID RECORDING SERVICE

**LPs FROM YOUR OWN TAPES
48-HOUR SERVICE**

**MASTER DISCS AND PRESSINGS
RECORDING STUDIO
DEMONSTRATION DISCS**

MOBILE RECORDINGS—ANY DISTANCE

Multi-channel facilities for transfer to 8 or 16mm film tracks. Sound effects library on discs.

Brochure on request from

Rapid Recording Service
21 BISHOPS CLOSE, LONDON, E.17

WANTED

Lee Electronics. The Tape Recorder and Hi-Fi Specialists wish to purchase good quality Tape and Hi-Fi Equipment for cash. 400 Edgware Road, W.2. Phone PAD 5521.

Highest prices offered for good quality Tape Recorders and Hi-Fi. R.E.W., 266 Upper Tooting Road, London, S.W.17.

Good Quality Tape Recorders purchased for cash. Telephone 01-472 2185.

B & O Beocord 2000 P or de luxe half track stereo in good condition. Telephone Ashford (Mddx) 55727.

Wanted second-hand Uher Universal "S" or 5000 Tape Recorder (mono only). Offers, stating condition and price, to Pearlman, 1 Albion Street, Leeds, 1.

Bishopsgate
Institute

CITY

TAPE RECORDER CENTRE

BISHOPSGATE

Liverpool Street Station

**228 BISHOPSGATE
LONDON, E.C.2.**

Telephone: 01-247 2609

Opposite Liverpool Street Station

Hours of Business:
MONDAY to FRIDAY
9 a.m. to 6 p.m.

Closed all day Saturday

**OPEN
SUNDAY**

10 a.m. to 2 p.m.

Part of the NuSound Organisation

At the City Tape Recorder Centre you can see one of the finest selections of tape recorders on display in London. Every leading make and model from Akai to Vortexion.

NOW IN STOCK

The very latest B. & O. 2000 de luxe with 4-track stereo record and replay facilities.

We also have a limited number of B. & O. 2000 2-track table models at our special price £145.0.0.

We are easy to get to being almost opposite Liverpool St. Station (see diagram above) and remember we are the only tape recorder specialists in Gt. Britain open on Sunday!

Do your weekly rush shopping on Saturday with your wife and visit us on Sunday at your leisure!

- **GENEROUS PART EXCHANGES**
- **FREE AFTER SALES SERVICE**
- **UNBEATABLE SPECIAL OFFERS**
- **EXPERT STAFF EXPERT ADVICE**

**WE OPERATE A PERSONAL EXPORT SCHEME—
SAVING UP TO 20% ON LIST PRICE**

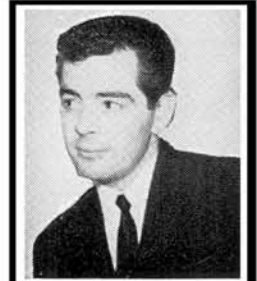

Our manager Bob Hookings is a keen tape recording enthusiast. Bang & Olufsen's are his speciality, having used B. & O. equipment for several years his knowledge of this wonderful range is second to none. He is able to give personal callers his expert advice (please avoid telephoning) not only on B. & O. but on any other recorder suitable to your individual requirements and pocket.

WHEN IN THE CITY—CALL IN AT THE CITY!

THE BANG & OLUFSEN SPECIALISTS



HI-FI in the Home

by John Crabbe, editor of Hi-Fi News and Tape Recorder

This fully illustrated book has been written for the music lover who wants to understand how to achieve the best possible domestic sound quality.

Technicalities are clearly explained and terms defined throughout the text. It deals very satisfyingly with its subject, through musical sounds, components, choosing equipment, installation, care of records, to future developments. There is a comprehensive glossary, bibliography and index.

HI-FI in the Home

has an authority and excellence you will appreciate

40/- from booksellers,

or direct from the publishers (post 2/-)

**BLANDFORD PRESS, 167 High Holborn,
LONDON, W.C.1**

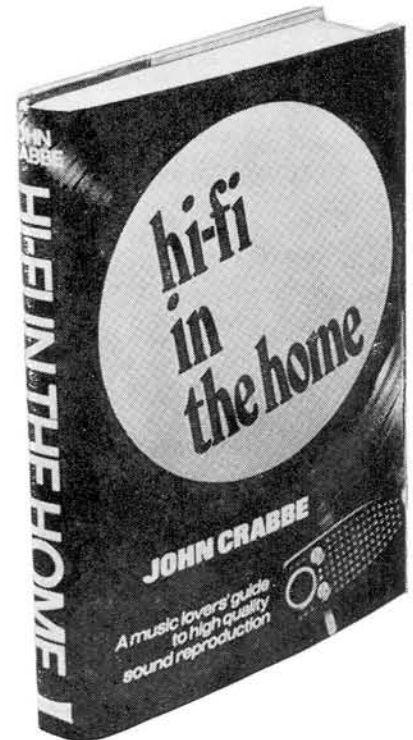

Sanyo puts you in the world class



Introducing the new MR 939 recorder with these outstanding features

- 7 watts per channel
- 4 tracks, 3 speeds
- Sound on sound
- Sound with sound
- Built-in public address system

Tape speeds
7½ ips (19 cm/sec)
3¾ ips (9.5 cm/sec)
1½ ips (4.8 cm/sec)

Wow and flutter
7½ ips: 0.15% R.M.S.
3¾ ips: 0.20% R.M.S.
1½ ips: 0.30% R.M.S.

Recording time
96 min at 7½ ips
(Stereo 1200ft. tape)
192 min at 3¾ ips
(Stereo 1200ft. tape)
384 min at 1½ ips
(Stereo 1200ft. tape)

Signal-to-noise ratio
45 db

Output power
Music power 7W x 2
Undistorted 4W x 2

Frequency response
7½ ips 20-20,000 c/s
(30-15kc ± 3db)
3¾ ips 30-13,000 c/s
1½ ips 30-8,000 c/s

Erase rate
65 db

Crosstalk
50 db (channel-channel)
65 db (track-track)

Output impedance:
Line out: 2 Kohm

Speaker out: 8 ohm
Headphone: 10 Kohm

Input impedance
Microphone: 50 Kohm
Aux: 100 Kohm

Weight
26.3 lbs (16.5 kg)

Accessories
Microphone x 2
Recording tape 7" x 1
Empty reel 7" x 1
Patch cord x 2
Reel stopper x 2
Splicing tape x 1
Microphone stand x 2

Recommended retail price £110.

SANYO

RELIABILITY IS BUILT IN
