

SEPTEMBER 1968 TWO SHILLINGS

tape

recorder

PROFESSIONAL EDITING
TECHNIQUES

BBC RADIO BRIGHTON

UNDERSTANDING CIRCUIT
DIAGRAMS

EAGLE TC450 REVIEW

LABORATORY LANGUAGE
LEARNING

RECORDING FOR DISC

A MINIATURE
ELECTRONIC ORGAN





The missing Link that puts stereo tape into your Hi-Fi system!

This superb tape unit completes *your* system. You already have a power amplifier and a pair of speakers! Now add the Akai 3000D. The Akai 3000D has: ● three heads — erase, record and playback ● frequency response 30 to 22,000 Hz ± 3 db at $7\frac{1}{2}$ ips. ● Signal to noise ratio: better than 50 db. ● first class tape transport. ● two speeds $3\frac{3}{4}$ and $7\frac{1}{2}$ ips. ● Headphone monitoring (or listening) when the unit is used away from your system. Everything you've ever wanted—ever needed in a stereo tape unit.

AKAI
PULLIN
PHOTOGRAPHIC
(A Company within the Rank Organisation)

To: PULLIN PHOTOGRAPHIC DEPT. TR9
11 Aintree Road, Perivale, Middx.

Please send me details of the 3000D.

NAME

ADDRESS

.....



NuSound

BRITAIN'S LARGEST SPECIALISTS



HIGH FIDELITY CENTRES

ILFORD & ESSEX

85/100 ILFORD LANE, PIONEER MARKET, ILFORD, ESSEX
(200 yds. Ilford Station—Half-day Thursday)
Telephone: 01-478 2291

NORTH LONDON

242/4 PENTONVILLE ROAD, LONDON, N.1.
(200 yds. Kings X Station—Half-day Thurs.)
Telephone: 01-837 8200

KENT & S.E. LONDON

36 LEWISHAM HIGH STREET, LONDON, S.E.13.
(Opposite Chiesmans—Half-day Thursday)
Telephone: 01-852 2399



THIS EQUIPMENT AT ALL OUR CENTRES

AKAI

See, hear and compare the complete range of Akai Stereo Tape Recorders. Our experienced staff are able to give expert advice and also demonstrate the many outstanding features of this wonderful range of equipment.

Model 1710W —
Four track, three speed complete stereotape recorder.

A FEW AVAILABLE AT OUR SPECIAL PRICE OF £89.10.0.

(MANUFACTURER'S LIST PRICE £109.17.3.)

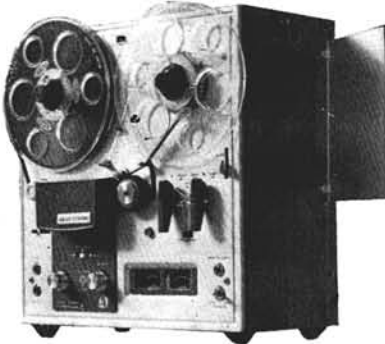

EVERY LEADING MAKE AVAILABLE

- EASIEST HIRE PURCHASE TERMS
- GENEROUS PART EXCHANGES
- FINEST AFTER SALES SERVICING
- EXPERT STAFF AND EXPERT ADVICE

Stockists of: Akai, Ampex, Arena, Armstrong, B. & O., Brenell, Dynatron, E.M.I., Elizabethan, Ferguson, Ferrograph, Garrard, Goldring, Goodmans, Grundig, M.H.V., Hacker, Kef, Leak, Loewe-Opta, National, NuSound, Ortofon, Philips, Quad, Repts, Rogers, Sanyo, Sony, Stereosound, T.R.D., Tandberg, Telefunken, Thorens, Truvox, Uher, Van Der Molen, Vortexion, Wharfedale, Wyndor, etc.

Every make and model of Hi-Fi Unit and Tape Recorder is available for immediate demonstration by our specialist staff who will be delighted to assist you in selecting equipment to suit your individual requirements. Only from NuSound can you benefit from all these invaluable features—the most comprehensive range of equipment on display in the country, expert staff, free technical advice, immediate demonstration of any model and the finest after sales servicing available.

WE OPERATE A PERSONAL EXPORT SCHEME SAVING UP TO 20% ON LIST PRICE



At every NuSound showroom you'll find a wonderfully comprehensive range of equipment backed by over 13 years' experience in this ever growing and highly specialised field—in which the NuSound reputation is "second to none".
Three NuSound Centres specialise in High Fidelity Equipment and Tape Recorders and the other four NuSound Centres are devoted exclusively to Tape Recorders and Accessories.

Visit any NuSound Centre and you'll be certain of 100% Service and Satisfaction.

NuSound

TAPE RECORDER CENTRES

- CITY** 228 BISHOPSGATE, E.C.2. Tel.: 01-247 2609.
(Opp. Liverpool St. Stn.—Closed Sat. Open Sun. 10-2)
- WEST END** 82 HIGH HOLBORN, W.C.1. Tel.: 01-242 7401.
(200 yds. Kingsway—Half-day Saturday)
- E. LONDON** 2 MARYLAND STATION, E.15. Tel.: 01-543 5879.
(Adjacent Maryland Point Stn.—Half-day Thursday)
- N.W. LONDON** 360 KILBURN HIGH RD., N.W.6.
Tel.: 01-624 1656.
(Opp. Kilburn Tube Stn.—Half-day Thursday)

Ferguson make 'more for



Model 3232

LOOK! a Ferguson stereo recorder with track transfer and 2nd channel monitoring.

This sophisticated 3-speed 4-track Stereo Tape Recorder is packed with special features - much more than you could expect for the money. It has 7" reels and accommodates standard pre-recorded tapes. Employing all transistor circuits it is, in effect, two recorders and replay amplifiers independently controllable and integrated to provide stereophonic recording and reproduction. Housed in an attractive teak veneered cabinet with transparent lid.

- Twin all transistor amplifiers • 3 speeds, 7" spools play up to 17 hours on double play tape (mono) • Automatic end of tape stops • Clutched dual concentric controls • Input mixing facilities • Latching pause control • Calibrated meter record indicators • Monitoring while recording on built-in speakers • Track transfer on mono • Second channel monitoring • Comprehensive input and output sockets • Suitable extension loudspeaker available • Supplied complete with two dynamic microphones, reel of tape (1200'), take-up spool and connecting leads.

Model 3232-**£91.13s.**

LOOK! a Ferguson mono tape recorder with 3 speeds and input mixing.

Outstanding value is offered by this 3-speed 4-track mono Tape Recorder. With 3-Watts audio output on speech and music, interlocking controls that prevent accidental 'wiping' of tapes, a metal foil operated automatic stop and a solenoid operated remote pause control. The unit incorporates a new symmetrical motor with low hum field and extensive signal head shielding reduces mains hum to minimum. The cabinet is attractively veneered in teak with a transparent lid.

Model 3216-**£64.19s.**

your money' tape recorders



Model 3238

LOOK! a new Ferguson portable tape recorder.

A 3-speed, 4-track Tape Recorder with 7" spools, presented in black leathercloth with a teak-veneered loudspeaker grille. A removable cover at the rear provides access to input and output sockets, storage space for mains lead and microphone, etc.

- Four tracks, 3 speeds, 7" spools play up to 17 hours on double play tape
- Automatic end of tape stop
- Input mixing controls
- Remote control from microphone
- Latching pause control
- Double track replay
- Monitoring while recording
- Me'er record level indicator
- 4-digit, push-button position indicator
- Graduated dials on rotary controls
- Tape editing index
- Comprehensive input and output sockets
- Powered socket for accessories
- Microphone with remote control switch
- 1200 ft LP tape, take-up spool and connecting lead included.

Model 3238—£58.11s.

A wide range of accessories are available for all Ferguson Tape Recorders.

To: **British Radio Corporation Ltd.**
284 Southbury Road, Enfield, Middlesex

Please send me your free full-colour fact-filled leaflets about Ferguson Tape Recorders.

Name _____

BLOCK CAPITALS PLEASE

Address _____

THORN British Radio Corporation is a member of The Thorn Group

T.21.

Fine! It's a FERGUSON

Ferguson make 'more for your money' tape recorders



LOOK! a superb compact Ferguson Cassette Recorder

This Ferguson Cassette Recorder is the enthusiasts sketch-book and enables you to pick up material for transfer later to the tapes in your library. It is housed in a cabinet moulded from high impact material in black, contrasted with light grey and has a silver coloured metal grille. This machine is battery powered utilising the new instant loading 'Compact Cassette'. It may also be used to reproduce 'Musicassette' pre-recorded tapes monophonically. It has simple piano type keys for tape motion control and a dynamic microphone with remote stop/start control. It is powered by 5 HP 11 type cells and a socket is provided for external power supply. The dimensions of this recorder are: Length $8\frac{7}{8}$ ", width 5", depth $2\frac{1}{8}$ " and it weighs only $3\frac{1}{4}$ lbs.

Model 3236 **£26.14s.**

- Moulded black cabinet with light grey contrast and silver coloured metal grille.
- Ideal for indoor and outdoor use and as a dictating machine.
- Simple piano keys for tape motion control.
- Dynamic microphone with remote stop/start control.
- The instant loading 'Compact Cassette' of tape provided, plays for one hour.
- Meter level and battery condition indicator.
- Will reproduce 'Musicassettes'.
- Operates on five HP 11 batteries or external power supply.
- Comprehensive input/output socket.
- Supplied complete with remote control microphone, cassette of tape, radio connecting lead and muting plug.

Fine! It's a FERGUSON

THORN British Radio Corporation is a Member of The Thorn Group.

Philips announce the stereo recorder you never thought you'd be able to afford!

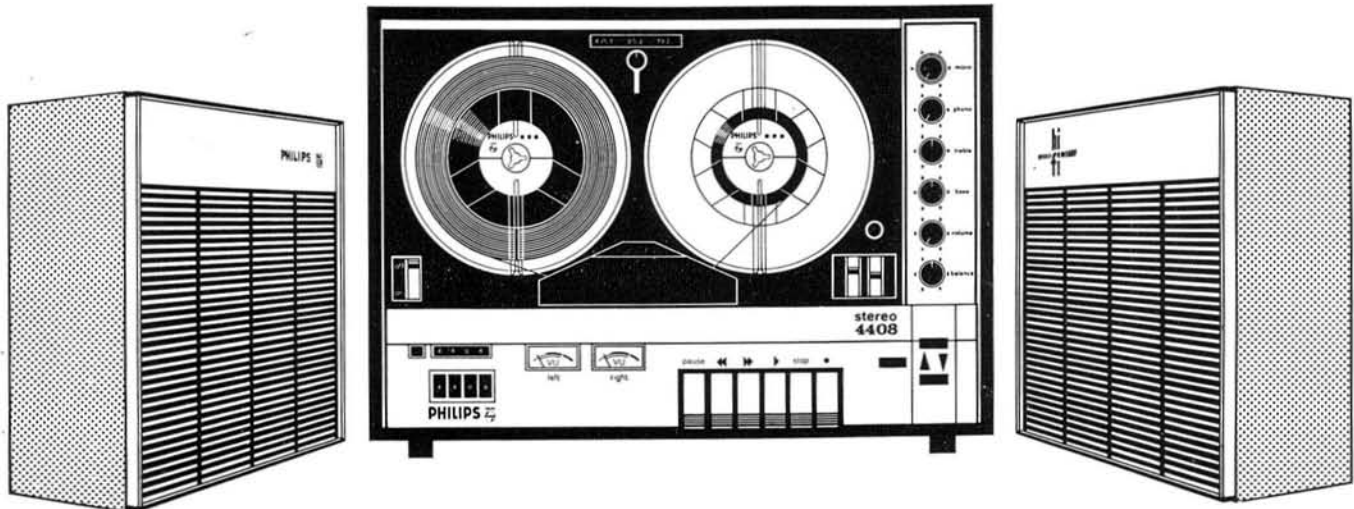

The Philips 4408 stereo model sets a new standard of quality in tape recording. Here is a really sophisticated recorder which delivers superbly realistic 'Living sound'—at a sound price £133.16.8.

And what a machine! Four tracks, three speeds and the full range of input/output controls and sockets. Push-button tape control. Two perfectly matched detachable speakers can be positioned exactly for optimum stereo effect. Six watts output per channel gives impeccable reproduction to Hi Fi standards. Electronic ore-selector gives instant re-find of any item on the

tape. Modulation level control has separate VU meters, dB calibrated for each channel. Illuminated red-green indicators for every recording and playback operation. Multiplay facility lets you build up composite recordings on one track. Even the shape is versatile—you can use the 4408 vertically or horizontally. Get the full-story brochure from us or your Philips dealer.

Free music tape With your 4408 you get a free tape carrying both popular and classical music. Ask your dealer to play it for you: here's what a tape recorder should sound like!

PHILIPS Full Stereo Model 4408

PHILIPS ELECTRICAL LTD. (DEPT. TR1) CENTURY HOUSE, SHAFTESBURY AVENUE, LONDON, W.C.2

IMMEDIATE DELIVERY!

K. J. ENTERPRISES

EVERYTHING AUDIO!

BRITAIN'S PREMIER MAIL-ORDER RECORDING TAPE SPECIALISTS

IMMEDIATE 24 HOUR SERVICE ON ADVERTISED LINES

FULL CASH REFUND GUARANTEED

SEND TODAY AND SAVE!

BRANDED TAPES

20% OFF

**BASF - EMI - GRUNDIG
PHILIPS - SCOTCH - AGFA**

Brand New, Fully Guaranteed and in normal manufacturer's pack.

STANDARD PLAY	LIST PRICE	OUR PRICE	DOUBLE PLAY	LIST PRICE	OUR PRICE
5" 600' }	21/-	16/10	3" 300' Not Scotch	14/-	11/3
5 1/2" 900' } Except Agfa	28/-	22/6	3" 400' Scotch only	16/6	13/2
7" 1200' }	35/-	28/-	4" 600' }	25/-	20/-
LONG PLAY			4 1/2" 900' Agfa, BASF only	30/-	24/-
3" 200' Not Scotch	9/-	7/3	5" 1200' }	42/-	33/8
3" 300' Scotch only	9/6	7/6	*5 1/2" 1800' }	55/6	44/6
4" 450' }	14/6	11/8	*7" 2400' }	77/6	62/-
4 1/2" 600' BASF, Agfa only	21/-	16/10	10" 4600' Agfa only	140/-	112/-
*5 1/2" 900' }	28/-	22/6	TRIPLE PLAY		
*5 1/2" 1200' }	35/-	28/-	3" 450' Not Scotch	22/-	17/8
*7" 1800' }	50/-	40/-	3" 600' Scotch only	24/9	19/6
8 1/2" 2400' BASF, Scotch only	72/6	58/-	4" 900' }	39/-	31/3
10" 3280' Agfa only	85/-	68/-	*4 1/2" 1200' Agfa, BASF only	49/-	39/3
10" 3600' BASF only	95/-	76/-	5" 1800' Not Scotch	66/-	52/10
10 1/2" 4200' Agfa, BASF only	112/-	90/-	5 1/2" 2400' } Agfa, BASF, 7" 3600' only	90/-	72/-
SCOTCH DYNARANGE (L/P)			QUADRUPLE PLAY		
5" 900' }	32/3	25/10	3" 600' }	36/6	29/6
5 1/2" 1200' }	40/6	32/6	3 1/2" 800' } Kodak only	46/-	37/-
7" 1800' }	57/6	46/-	4" 1200' }	64/6	51/6
8 1/2" 2400' }	83/6	66/10			
COMPACT CASSETTES					
C. 60	17/6	14/-			
C. 90	25/-	20/-			
C. 120	33/6	27/-			

Postage and Packing 2/-. ORDERS OVER £3 POST FREE.

FERROGRAPH TAPE—20% OFF!

Brand New. Fully guaranteed and in normal manufacturer's pack.

	LIST PRICE	ONE	THREE	SIX
BN7 1,200' on 7" reel (Dynarange)	50/-	40/-	117/6	230/-
BN8 1,800' on 8 1/2" reel (Dynarange)	71/-	57/-	168/-	330/-
BL7 1,800' on 7" reel (Dynarange)	70/-	56/-	165/-	324/-
BL8 2,400' on 8 1/2" reel (Dynarange)	90/-	72/-	213/-	420/-

Post and Packing 2/-. ORDERS OVER £3 POST FREE.

ILFORD TAPE near HALF PRICE

A bulk purchase of premium grade, top quality POLYESTER MAGNETIC TAPE from one of the world's foremost experts in film coating technology. With FULL LEADER and stop foil, Polythene wrapping, and in original manufacturer's boxes. Available in long-play base only at these BARGAIN PRICES.

	LIST PRICE	ONE	THREE	SIX
900' on 5" reel.	28/-	16/6	48/-	90/-
1,800' on 7" reel.	50/-	32/6	95/-	180/-

Please add 2/- P. & P. ORDERS OVER £3 POST FREE.

SEND FOR LISTS OF OTHER TAPE AND HI-FI BARGAINS

K. J. ENTERPRISES, (Dept. TR), 17 THE BRIDGE, WEALDSTONE, MIDDLESEX (OPPOSITE HARROW & WEALDSTONE STATION) 01-427 0395 (CLOSED P.M. SAT.) REFUND GUARANTEE

SENSATIONAL NEW HALF-PRICE OFFER!

A bulk purchase of top quality Recording Tape manufactured by one of the Country's leading makers. A polyester based tape with super life black coating. Polythene wrapped, boxed, and fully guaranteed. Available while stocks last in one size only.

	NORMAL VALUE	ONE	THREE	SIX
1,800' on 7" reel. Long Play	50/-	26/6	78/-	150/-

POST & PACKING 2/-. ORDERS OVER £3 POST FREE.

AMPEX TAPE

Brand New. Fully Guaranteed, and in normal manufacturer's pack.

'500' SERIES AUDIO TAPE (MYLAR BASE)				
TYPE	DESCRIPTION	LIST PRICE	ONE	THREE
541-9	900' Long Play on 5" reel	28/-	21/-	61/6
541-12	1,150' Long Play on 5 1/2" reel	35/-	28/-	82/6
541-18	1,800' Long Play on 7" reel	50/-	32/6	96/-
551-12	1,200' Double Play on 5" reel	42/-	35/-	103/6
551-16	1,650' Double Play on 5 1/2" reel	56/-	45/-	133/6
551-24	2,400' Double Play on 7" reel	72/6	55/-	163/6

'600' SERIES PROFESSIONAL AUDIO TAPE (MYLAR BASE)				
TYPE	DESCRIPTION	LIST PRICE	ONE	THREE
641-9	900' Long Play on 5" reel	30/6	23/-	66/6
641-18	1,800' Long Play on 7" reel	52/6	39/6	116/-
651-12	1,200' Double Play on 5" reel	46/-	34/6	101/-
651-24	2,400' Double Play on 7" reel	80/-	60/-	177/-

POST & PACKING 2/-. ORDERS OVER £3 POST FREE.

N.B. Other types and sizes available including the inexpensive "White Box" series.

SPECIAL OFFER COMPACT CASSETTES

"MC 90"



Compact Cassettes with 90 mins. playing time. Brand New and packed in normal plastic library box. Available at this exceptional price.

OUR PRICES

"MC 90"
1 for 18/6
3 " 54/-
6 " 105/-
12 " 204/-

Standard pattern to fit Philips, Stella, Elizabethan, Dansette, Sanyo, etc.

Post & Packing 2/-

Orders over £3 Post Free

NOW FROM KJ THE FULL RANGE OF

MUSICASSETTES

AVAILABLE BY RETURN POST.
SEND FOR FREE CATALOGUE

TRIPLE PLAY TAPE — 40% OFF!

A large purchase from two world renowned manufacturers enables us to make this unique half-price offer. Brand new, fully guaranteed, premium grade Polyester Base Tape with FULL LEADER and stopfoil. In original maker's boxes and polythene wrapped at these EXCEPTIONALLY LOW PRICES.

	LIST PRICE	ONE	THREE	SIX
450' on 3" reel Gevasonor	22/-	14/-	40/6	78/-
600' on 3" reel Gevasonor	27/6	17/6	51/-	99/-
900' on 4" reel Gevasonor	39/-	24/6	72/-	140/-
1,800' on 5" reel Gevasonor	66/-	41/6	122/-	238/-
2,400' on 5 1/2" reel Zonal	90/-	55/6	165/-	324/-

Post and Packing 2/-. ORDERS OVER £3 POST FREE.

20% off all Grundig and Philips Equipment

FREE

Our New Illustrated catalogue sent entirely free on request. Britain's most specialized comprehensive range of recording tape and accessories. 20,000 reels always in stock with reductions ranging up to 50%.

MORE FANTASTIC BARGAINS FROM

WE SAVE YOU MONEY!

K.J. ENTERPRISES

SPEAKERS GALORE!

SAVE £6.10.0d. on the SONOTONE SOLENT

The fabulous bookshelf speaker system designed and manufactured by Plessey, one of the country's largest electronics groups. Acoustically designed two-speaker system with crossover network.

ORIGINALLY SOLD FOR £18.0.0d.

NOW OFFERED AT £11-10-0d

CARRIAGE 10/- EXTRA PER UNIT

THIS OFFER REMAINS OPEN ONLY WHILE STOCKS LAST!

WHAT THE REVIEWERS SAID:

"Recommended without reservation for this category of Loudspeaker". David Phillips & Donald Aldous.

"Sonotone 'Solent' deserves to reach a wide public." John Borwick.

"A worthy member of the Hi-Fi family." R. L. West.

Technical Specification:

Cabinet Size 14" x 9" x 8½"
 Woofer 6½", 10,000 Gauss, 1" pole.
 Tweeter 3½" Acoustically loaded
 Frequency response 40-20,000 cps.
 Power Handling 12 watts.
 Impedance 8-15 Ohms.
 Scandinavian style finish.

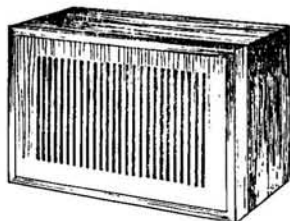

Guaranteed Brand New in Maker's carton

ALSO ANOTHER FANTASTIC PURCHASE

Compact Cassette TAPE RECORDER ONLY 17GNS.

The ELPICO CTR 600 Battery Cassette Tape Recorder

Beautifully styled, pocket-size recorder with "snap-in" cassette loading. Press button operation with separate volume and tone controls. Up to 120 minute playing time on a single cassette. Weighs only 3 lb. 5 oz. Supplied complete with C.60 cassette, remote control microphone, earphone and batteries.

Dimensions 4½" x 8½" x 2½"

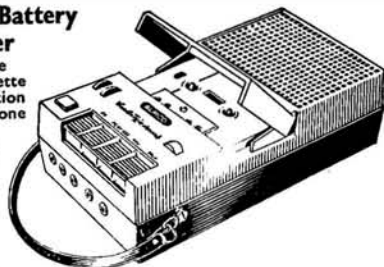

ORIGINAL PRICE 24 gns.

Now offered to you, Brand New and fully guaranteed for the sum of **£17.17.0d.** plus 7/6d. Postage and Packing.

OTHER OUTSTANDING BARGAINS IN "COMPACT CASSETTE" RECORDERS AVAILABLE FROM K. J.

DESCRIPTION	LIST PRICE	OUR PRICE	Post and Packing
Philips 3302 Battery Tape Recorder	25.14.6	20.9.6	7/6
Philips 3303 Battery Tape Recorder	30.9.0	24.7.6	7/6
Philips 3312 Stereo Mains Tape-Recorder	50.8.0	35.0.0	10/-
(with two x GL 559 loudspeakers)	57.15.0	47.0.0	15/-
Grundig C 200 (New Model) Battery Tape-Recorder	38.17.0	31.7.6	7/6
Aiwa TP 1004 Mains/Battery Stereo Tape-Recorder	50.18.6	40.19.0	10/-
Sanyo M.18 Battery Tape-Recorder	24.3.0	20.12.6	7/6

A few only—Philips 3301 at £18.18.0 plus 7/6 Post and Packing.

K. J. ENTERPRISES (Dept. TR)
17 THE BRIDGE, WEALDSTONE, MIDDX.
 Tel: 01-427 0395

sounds great

- '68

harrogate

THE NORTHERN AUDIO FAIR

SEPTEMBER

Friday 20th, Saturday 21st, Sunday 22nd. 11 a.m.-9 p.m.

On show the finest of the world's sound reproduction equipment.

Hear continuous demonstrations of the newest equipment to keep you abreast of all that is latest and best in Pick-ups, Amplifiers, Speakers, Microphones, Stylis, Turntables, Tapes, Tape Recorders . . . plus a huge variety of accessories.

COME OVER THE MOORS FOR THE WEEKEND.

Truly international in character. Some of the apparatus will be on show for the first time ever in the North of England. The Northern Audio Fair will be a fully comprehensive and complete exhibition of the best of Hi-fi equipment.

HOTEL MAJESTIC
 HARROGATE YORKSHIRE

ASK FOR COMPLIMENTARY TICKETS at your nearest AUDIO, RECORD, RADIO or MUSIC Shop, or send stamped addressed envelope to:

AUDIO HOUSE, 42 Manchester Street, London, W.1.

Ferrograph quality Ferrograph reliability Ferrograph fidelity plus a unique combination of 30 features Ferrograph New Generation Series 7



Available in Mono, and in Stereo with and without end amplifiers; with 30 features which market research has proved you, the user, want. Prices from £135 inc. P.T. Features include:

1. All silicon solid-state electronics with FET input stages and wide input overload margins.
2. Vertical or horizontal operation.
3. Unit construction: The 3 individual units i.e. tape deck, power unit and amplifier complex are mounted on a single frame easily removable from cabinet for service or installation in other cabinets or racks.
4. 3 motors (no belts), 3 tape speeds.
5. Variable speed spooling control for easy indexing and editing.
6. Electrical deck operation allowing pre-setting for time-switch starting without need for machine to be previously powered.
7. Provision for instantaneous stop/start by electrical remote control.
8. Single lever-knob deck operation with pause position.
9. Independent press-to-record button for safety and to permit click-free recordings and insertions.
10. 8½" reel capacity.
11. Endless loop cassette facility.
12. Internal loud speakers (2) - 1 each channel on stereo, 2 phased on mono.
13. 4 digit, one-press re-set, gear-driven index counter.
14. 2 inputs per channel with independent mixing (ability to mix 4 inputs into one channel on stereo machine).
15. Signal level meter for each channel operative on playback as well as record.
16. Tape/original switching through to output stages.
17. Re-record facility on stereo models for multi-play, echo effects etc., without external connections.
18. Meters switchable to read 100 kHz bias and erase supply with accessible preset adjustment.
19. Three outputs per channel i.e. (1) line out - level response. (2) line out - after tone controls. (3) power output - 8-15 ohms.
20. Power output 10W per channel.
21. Independent tone controls giving full lift and cut to both bass and treble each channel.
22. Retractable carrying handle permitting carrying by one or two persons.

the tape recorder with
the hearing-is-believing sound



Ideal
for
rack
mounting



Grey
vinyl
case



Elegant
hardwood
case



Listen for yourself

To *know* the Ferrograph New Generation Series 7 you must look at it, listen to it, for yourself. You will find New Generation instruments soon in stock at many of the best tape-recording and Hi-Fi specialists in the country, including the following:

Ferrograph stockists

LONDON AREA

CHISWICK
Masseys Centre of Sound
121/123 High Street, W.4.

HOLBORN
Tape Recorder Centre
82 High Holborn, W.C.1.
Larg's of Holborn Ltd.
76/77 High Holborn, W.C.1.
Imhofs Ltd.
New Oxford Street, W.C.1.

PADDINGTON
Teletape Ltd.
33-59 Edgware Road, W.2.

RICHMOND
F. Cave
27 Hill Street

STREATHAM
Francis of Streatham
169/170 Streatham High Road, S.W.16.

TOOTING
R.E.W. (Earlsfield) Ltd.
266 Upper Tooting Road, S.W.17.

TOTTENHAM COURT ROAD
Teleonic Ltd.
92 Tottenham Court Road, W.1.

BIRMINGHAM
C.H. (High Fidelity) Ltd.
167/169 Bromsgrove Street, 5.
Griffin Radio Ltd.
94 Bristol Street, 5.
C. H. Young Ltd.
170 Corporation Street, 2.

BLACKBURN
Holdings of Blackburn Ltd.
39/41 Mincing Lane

BLACKPOOL
F. W. Benfell Ltd.
17 Cheapside

BOGNOR REGIS
Tansley & Cooke Ltd.
Sandymount Avenue

BRIGHTON
Averys
77 St. James's Street
Lanes Radio
11 Gardiner Street
John King Films Ltd.
East Street

BRISTOL
Sound Selection
361-363 Gloucester Road, 7.
Audio Bristol Ltd.
Park Street Avenue
Bristol & West Recording Services Ltd.
6 Park Row, 1.

CHICHESTER
G. A. Colbourne Ltd.
10 Southgate

CREWE
Charlesworth (Crewe) Ltd.
14 High Town

DERBY
Victor Buckland Ltd.
41/49 London Road

EDINBURGH
J. Nicolson
1 Haddington Place, 7.

GERRARDS CROSS
Edric Films Ltd.
34/36 Oak End Way

GLASGOW
C. H. Steele
141 St. George's Road, C.2.

GOODMAYES
Unique Radio
6 The Facade

GUILDFORD
P.J. Equipment
3 Onslow Street

ILFORD
Ilford Music Shop Ltd.
Pioneer Market, Ilford Lane

BARKING
Davis & Kays
21 London Road

KIRKCALDY
Caithness Brothers
270 High Street

LEEDS
Becketts Film Services Ltd.
The Headrow, 1.
P.W.B. Audio Ltd.
33 Call Lane

LEICESTER
United Film Services
7 Kings Street

LIVERPOOL
Beaver Radio Ltd.
60 Whitechapel

MANCHESTER
Godleys Radio & T.V. Ltd.
8 Shudehill
Lancs Hi-Fi Ltd.
8 Deansgate, 3.
Kendal Milne Ltd.
Deansgate

NEWCASTLE ON TYNE
Turners Ltd.
Pink Lane

NOTTINGHAM
Audio Centre
Pelham Street

OXFORD
Westwoods
45 George Street

PLYMOUTH
A. E. Ford Ltd.
84 Cornwall Street

REDCAR
McKenna & Brown Ltd.
135 High Street

SALFORD
Stephens
348 Great Cheetham Street East, 7.

SHEFFIELD
Sheffield Photo Co. Ltd.
6 Norfolk Row, Fargate

SOUTHAMPTON
University Audio
4 Bargate Street

SOUTHPORT
Wayfarers Radio Ltd.
Burton Arcade

TEDDINGTON
Daytronics Ltd.
119a High Street

TORQUAY
D. & B. Davies Ltd.
Castle Chambers, Union Street

WATFORD
E.M.E. (Watford) Ltd.
188 Queens Road

WORTHING
Bowers & Wilkins Ltd.
1 Beckett Buildings, Littlehampton Road

ABERDEEN
C. Bruce Miller
51 George Street

BANSTEAD
Raylec Ltd.
43 Buff Parade, High Street

BATH
C. Milsom & Son
Northgate

BIRKENHEAD
James McKenzie Ltd.
Grange Road West

BOURNEMOUTH
Tape Recorder Co. (B'mouth) Ltd.
374 Old Christchurch Road

CAMBRIDGE
H. S. W. Speechley & Co.
25 High Street, Linton

CARDIFF
Sound Film Services
27 Charles Street

CHELtenham
University Audio
24 Winchcombe Street

CHESTER
Lloyd & Wylie Ltd.
42 Bridge Street

FERROGRAPH

the tape recorder with the hearing-is-believing sound

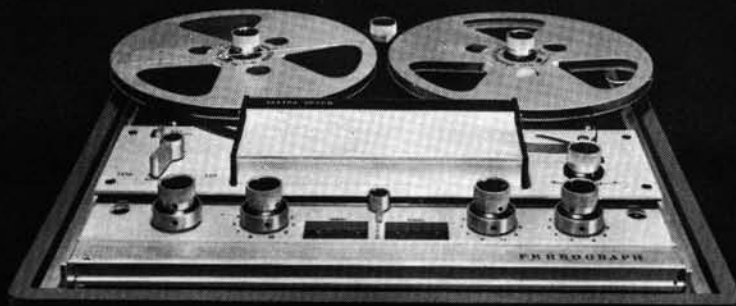

If none of these is near enough to you, in case of difficulty, or for free literature, send us the coupon, or give us a ring on WATerloo 1981.

To The Ferrograph Co Ltd
Ferrograph House
84 Blackfriars Road London SE1
Please send me a free brochure on the
Ferrograph New Generation Series 7

NAME

ADDRESS

.....

.....

T.R.

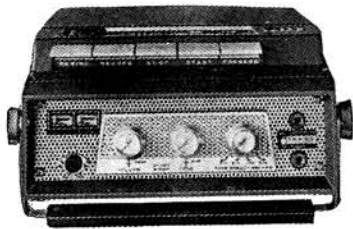

Akai X-IV Stereo Batt./Mains Tape Recorder. List price £169 7 11
Our price 129 gns.

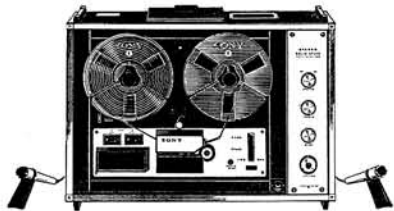

Sony 260 Stereo Tape Recorder
List price £116 5 2
Our price £95.

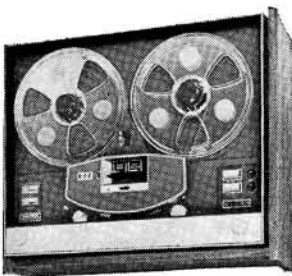

Ampex 753 Stereo Tape Unit
List price £117 16 8
Our price 91 gns.



Akai 1710W Stereo Tape Recorder
List price £109 17 3
Our price £89 10 0

Don't miss this opportunity to choose from the biggest anywhere stock at pre-Budget prices !

Large stocks secured before the budget enable us to offer a wide selection still at pre-Budget prices, but even our big stocks can't last for ever. Make the most of the wide choice, come in and see them for yourself or write for lists now.

H.P. Terms available. Your deposit will be one third of our price, add one-tenth to the balance and divide by 12 for monthly payments.

The equipment shown here represents only a small selection from the wide range of superb machines we have available for immediate delivery.

SEND FOR LISTS NOW!

R.E.W (EARLSFIELD) Ltd

HEADQUARTER SHOWROOMS
AND MAIL ORDER
Dept. TR,

266-8 UPPER TOOTING ROAD,
LONDON, S.W.17
Tel. 01-672 4471/2 and 9175

WEST END SHOWROOMS :
146 CHARING CROSS ROAD,
LONDON, W.1
Tel. 01-836 3365
(opposite Astoria Cinema)

REW

★ **STAR OFFER !**

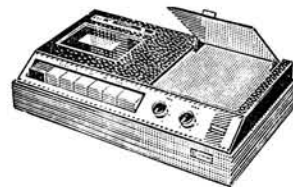

SAVE OVER £13

Magnificent Philips EL 3310 Mains-operated cassette tape recorder. 2-track, high-quality, slim-line model. List price £41 2 10; R.E.W's special price only 26 gns. or on interest free terms £9 2 0 deposit and 12 monthly payments of £1 10 4.

BUY NOW WHILE STOCKS LAST AT THIS PRICE !



Ferrograph 632 Stereo Tape Recorder
List price £163 3 9

Our price 126 gns.
Also model 634 at 132 gns. (list £170 18 0)

PHILIPS TAPE RECORDERS

Available at Pre-Budget Prices!

EL3302 Cassette Portable, current price £31.10.0
OUR PRICE 23 gns.

EL3312 Stereo Cassette, current price £66.19.0
OUR PRICE 55 gns. (includes 2 speakers).

N4304 Mains 2-Track, current price £33.2.10
OUR PRICE 26 gns.

EL3303 de-luxe Cassette tape recorder, current price £37.5.9
OUR PRICE 29 gns.

N4306 Mains 4-Track, current price £56.1.8
OUR PRICE 44 gns.

EL3575 Stereo 4-Track, current price £101.19.4
OUR PRICE 80 gns.

N4408 Stereo Prof., current price £133.5.0
OUR PRICE 105 gns.

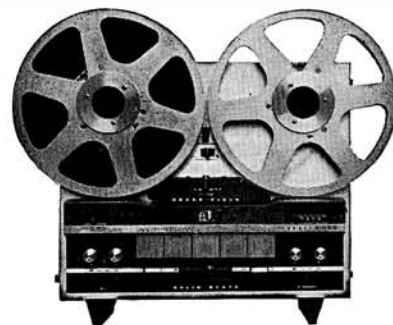

Akai X-300 Stereo Tape Recorder
List price £263 18 3

Our price 195 gns.

INCORPORATING
SOUND AND CINE

EDITOR
JOHN CRABBE

DEPUTY EDITOR
DAVID KIRK

ADVERTISEMENT MANAGER
ROBIN WELLS

Editorial and Advertising Offices:
LINK HOUSE,
DINGWALL AVENUE,
CROYDON, CR9 2TA
Telephone: 01-686 2599

© Link House Publications Ltd., 1968
All rights reserved

COVER PICTURE

A few years ago it was just a truncheon. Now all the best bobbies carry pocket radiotelephones, noise meters and radar equipment. PC Mulvaney of the Coventry City Police is setting a comparatively new trend by employing a *Hartley Tape-Riter* battery dictation recorder for reports that are later transcribed at a typing centre.

SUBSCRIPTION RATES

Annual subscription rates to *Tape Recorder* and its associated journal *Hi-Fi News* are 36s. and 41s. respectively. Overseas subscriptions are 38s. 6d. (U.S.A. \$4.60) for *Tape Recorder* and 42s. 6d. (U.S.A. \$5.10) for *Hi-Fi News*, from Link House Publications Ltd., Dingwall Avenue, Croydon, CR9 2TA.

Tape Recorder is published on the 14th of the preceding month unless that date falls on a Sunday, when it appears on the Saturday.

FIVE YEARS AGO the Philips organisation marketed a 4.75 cm/s cassette system which, they claimed, would eventually revolutionise domestic tape recording and supersede the LP gramophone record. So far it has achieved neither of these aims, Philips themselves working as hard as ever to meet the healthy demand for conventional 6.34 mm recorders.

Though in some respects an engineering landmark, the system is in no way superior to a decent conventional recorder operating at 4.75 cm/s. No technological breakthrough raises the cassette beyond the normal limitations of slow-speed narrow-track operation. The tiny transports are optimised for 4.75 cm/s, of course, and the fragile tape is well protected from mishandling and dust. Yet none of the cassette mechanisms we have tested excelled the wow and flutter performance of a decently made conventional recorder at that speed.

Despite a minor battle with the DCI cassette—lately discarded, to the evident distress of indiscriminate owners—and despite the 33% tax slammed on tape records at the last budget, there are still profitable sales of pre-recorded *Musiccassettes* and mechanisms upon which to play them. The system has been particularly successful in Japan, a market oriented to playing rather than recording.

We never seriously expected the narrow-tape cassette system to supersede 6.34 mm tape, even at the lowest end of the price scale, and our fears of such a change are now diminishing rather than increasing. The most elaborate 4.75 cm/s system our imagination can entertain—opposed-field bias, *Crolyn* tape and a domestic *Dolby* noise reducer—still could not equal the potential of stereo LP gramophone record quality, much less be a viable alternative to conventional recorders—which will also benefit from these new developments.

The best we can hope for is 38 cm/s quality at 19 cm/s. *Dolby* appears to offer this in some respects but how many mechanisms are capable of inaudible wow and flutter below 38 cm/s? We are inclined to say *none*, assuming critical programme material, but in our experience there is one mechanism—perhaps an oddity of mass production—reaching this standard. A remarkably ordinary lightweight recorder was reviewed in the February issue—a Dual *TG27* transistor tape unit. Frequency response was fairly good, signal-to-noise ratio nothing to write home about, but the wow and flutter performance—particularly the wow—was verging on perfection. Ray *Dolby* and Terence Long have argued that wow and flutter below 0.03% cannot be measured with present techniques, since system noise creates false readings. Whatever the theory, we managed to extract 0.025% wow-only from the Dual, the pen-recording being almost a straight line. Further into the reel, the figure reaches 0.03%. This is no miracle, one manufacturer assured us: Dual have simply reduced

the capstan to a panel pin *à la* EMI, pushing any inherent wow up into 10 Hz-plus flutter frequencies. This is partly true—the capstan is a mere 3 mm, supported in an upper bearing to prevent spindle bending. But in the event, Dual have not merely pushed trouble upstairs, for the *overall* wow and flutter figures are also within professional standards throughout an 18 cm reel: 0.075% record/play.

The mechanism under discussion, as we have said, may well be an unusually good sample of its type; we are endeavouring to obtain further samples for comparison. Yet its freedom from long-term speed variations, wow and slip-flutter, may be due largely to the inclusion of tension servos on feed and take-up spools. We frankly cannot be certain of this, but can be dogmatic in one other respect: the servos may be seen in action during fast wind ironing out the slight drive eccentricity and achieving a tight flush reel. All this from a single induction motor and at a pre-budget £57. Lest readers should regard this as advertising, we are obliged to make sad reference to the hum in the accompanying circuitry. The deck designer evidently knew his business, but any electronics man who can descend to hum bucking...

Concluding, 6.34 mm magnetic tape may well be superseded but it will never give way to an inferior recording system. With Akai promising low-speed video on the same inexpensive medium, there may be years in the old dog yet.

FEATURE ARTICLES

- 396 LABORATORY LANGUAGE LEARNING
By Richard Golding
- 398 UNDERSTANDING
CIRCUIT DIAGRAMS
By David Kirk
- 405 TWO SIMPLE ACCESSORIES FOR TAPE
RECORDERS
By G. A. Cloud
- 406 TO ERR IS HUMAN
By Arthur Garratt
- 410 A MINIATURE ELECTRONIC ORGAN
By F. C. Judd
- 415 BBC RADIO BRIGHTON
By Robert Prizeman
- 416 WHAT'S IN A CLUTCH?
By William Henry
- 421 RECORDING FOR DISC
By Peter Bastin

REGULAR ITEMS

- 395 WORLD OF TAPE
- 400 TAPE RECORDER SERVICE
By H. W. Hellyer
- 413 BOOK REVIEWS
- 419 READERS' PROBLEMS
- 423 TANDBERG 64X FIELD TRIAL
By David Kirk
- 427 COLUMN SPEAKER
By Dropout

EQUIPMENT REVIEWS

- 425 EAGLE TC450 STEREO TAPE UNIT
By A. Tutchings

**Ever Ready
High Power
Batteries**



**Ever Ready pack the
Performance!
into battery operated tape recorders**

Ever Ready is the power that performs best in today's cordless record players and tape recorders. Ever Ready High Power Batteries pack in bright sound, crisp reproduction and much, much longer playing time!

Load up with Ever Ready Power – your customers will be expecting it.

The Ever Ready Co (GB) Ltd • Ever Ready House
1255 High Rd • Whetstone • London N20 • 01-445 8877



**Ever Ready
pack the power in**

FURTHER NEWS OF THE AKAI VTR

BRIEF details appeared in this column, last month, of the helical scan video recorder developed by Akai—the first model known to apply a rotating head principle to standard 6.34 mm (audio) tape. The transport mechanism is a distant relation of the X-355 stereo audio recorder, operating at 19 and 9.5 cm/s (4-track stereo audio) and 26 cm/s (audio and video). Video resolution is 200 lines at 40 db signal-to-noise ratio, recording time being some 40 minutes on an 18 cm DP reel. Two ferrite heads are incorporated on the helical drum, a total of four motors being used to drive capstan, drum and spooling turntables. The capstan motor is three-speed, hysteresis synchronous, while the turntable motors are six-pole eddy current outer rotor units. No details have yet been released of the drum motor. Ferrite erase, record and play heads allow the VTR to be used as a normal audio recorder, claimed audio-only frequency response at 9.5 cm/s being 30 Hz-18 kHz ± 3 dB with 1.5% 1 kHz distortion. The Roberts



1000 prototype illustrated is intended for the American market and operates on NTSC standards, video input being 1.4 v p-p, sync negative, 75 ohms. Production for the US market is expected to commence in 1969, the UK market possibly later seeing the Akai X-500 version. Dimensions are 48.5 x 44.5 x 29 cm, weight being 30 kg (66 lb).

TAPE RECORDER STATISTICS

AN increase of 22% in the production of British domestic tape recorders during March 1968, compared with March 1967, is revealed in the latest Ministry of Technology survey. 16,760 domestic recorders were manufactured, professional units being 45% down on last year at 141. Actual UK deliveries during March totalled 50,933 (domestic), 36,455 of which were imported. 1,381 professional recorders were delivered, including 1,208 imported units.

BFOC POSTSCRIPT

THE Leeds address quoted in our July issue for the British Ferragraph Owners Club was incorrect, we are informed. Communications should be made to George West at 34 Oak Street, Shaw, Oldham, Lancs. We regret any confusion caused by this error.

PRESSURE-SENSITIVE SEMICONDUCTOR

A NEW generation of microphones—employing semiconductor elements—may be heralded by the recent development of pressure-sensitive diodes in Japan. Pressure sensitive transistors have already been produced in the USA, but the new Matsushita diode is said to be 100 times more sensitive than any previous component. The large-scale addition of copper and nickel 'contaminants' has been found to create extreme sensitivity to mechanical pressure in a semiconductor, a few grammes force on a finger-tip diode area reducing electrical resistance to one thousandth its unstressed value. In mass production, the diodes are expected to sell at little over £1 and have an enormous number of potential applications. Many patents have already been applied for by Matsushita, in and outside Japan.

DOMESTIC DOLBY MAKES NEW YORK DEBUT

THE first domestic tape recorder to incorporate a Dolby noise reduction circuit was unveiled at the Consumer Electronics Show in June. Manufactured under licence by KLH, the recorder operates at 19 and 9.5 cm/s and is said to achieve 10 db hiss reduction compared with conventional equipment. A simplified version of the professional A301 Dolby system is employed, operating in the critical region above 3 kHz. (The A301 reduces noise in four bands covering the entire audio range.) Provision is made for normal reproduction of existing recordings. The KLH machine will retail in the USA and Canada at about \$500 (£209). Licensing arrangements are currently being made with other manufacturers for production elsewhere in the world.

TAPE RECORDING COMPETITION

AS part of the Thornbury Festival this year, a tape recording competition is being organised. Content and treatment are left entirely to the competitors, programme length being ideally 15 to 20 minutes, though shorter entries will be judged "without penalty". Entries will be judged in two classes dependent on the competitor's age (Junior—below 19 on 1st November 1968, Senior—above 19). Adjudication will be by a panel of three judges, including a representative of the BBC, and will consider originality, content and treatment of the item. Recording quality will be considered merely in relation to the equipment and facilities used.

Entry forms, rules and preliminary advice are obtainable from the Chairman of the Festival Committee—P. J. Holland, 12 Blakes Road, Thornbury, Bristol.

NUSOUND EXTEND THEIR CHAIN

TWO new retail premises have recently been added to the Nusound chain of audio and tape recorder dealers. Largest of the two is situated at the Pioneer Market, Ilford Lane, Ilford, Essex, at showrooms previously belonging to Ilford Music and Photographic. All forms of audio equipment will be on sale at Ilford while the second establishment, in Kilburn High Road, is devoted exclusively to tape recording equipment and associated accessories. Nusound claim now to be the



country's largest audio equipment retail chain, with existing showrooms at High Holborn, Kings Cross, Bishopsgate, Stratford and Lewisham.

UHER RECORDERS STOLEN

UHER recorders valued at £1000 were stolen on Friday 11th July when a Bosch van was raided in Lockets Road, Wealdstone. Four men pulled the driver, Mr. K. Klompfen, into a stolen white Jaguar and later released him at Euston. Police are still searching for the consignment.

ELECTRONICS HOBBIES MANUAL

SIXTEEN shillings and sixpence may seem expensive for a retail catalogue but, running to 994 pages, the *Electronics Hobbies Manual* appears unusually good value. Audio, radio, and general electronic equipment is listed, from assembled units, through kits to individual components. The manual is well illustrated with photographs, sketches and circuit diagrams, and may be purchased at Electronics dealers or direct from Electronics, Edinburgh Way, Harlow, Essex.

NORTHERN AUDIO FAIR

FORTY-FIVE exhibitors are taking part in the 1968 Northern Audio Fair, to be held at the Hotel Majestic, Harrogate, Yorkshire, from Friday 20th to Sunday 22nd September. Akai, BASF, Beyer, Chilton, Dual, Ferragraph, Philips, Reslo, Revox-Studer, Tandberg, Telefunken and Uher are among participants specialising in tape recording systems, general audio-equipment manufacturers including Bowers and Wilkins, Shure, Thorens and Wharfedale. The exhibition is being arranged by Cyril Rex-Hassan, organiser of the annual London Audio Fair. Tickets are obtainable from our editorial office on receipt of a stamped addressed envelope.

NEXT MONTH

A low-cost peak programme meter for constructors will be described by John Fisher in the *October Tape Recorder*, to be published on 14th September. Peter Bastin gives some practical advice on making multi-track music while F. C. Judd adds a divider to the *Miniature Electronic Organ*. The Akai 1710W will be reviewed by Alec Tutchings.

Laboratory Language Learning

THE FIRST OF TWO ARTICLES ON AUDIO VISUAL AND AUDIO LINGUAL TEACHING SYSTEMS BY RICHARD GOLDING

THROUGH a change in attitude towards the need for a second language, and the developments in language laboratories and other aids, new methods of language teaching with more practical objectives are now being introduced into education and industry. We no longer regard a foreign language as just padding for the school curriculum. This Victorian image has disappeared and we have now begun to train our children at the primary stage as linguists able to make personal contact with a foreigner in his own language. Industry will no doubt feel the benefit of this training in 10 or so years time but many people currently engaged in marketing, installing equipment, and general business activities abroad have no knowledge whatever of their customers' language. This is an impossible position to maintain, for export orders no longer come to us automatically; we have to go out and win them, competing against other foreign competitors who speak a second language as a matter of course.

The main language activities that exporters must concern themselves with, if they are to succeed, are personal contact with a foreigner in his own language, effective communication at conferences and formal negotiations, and the translation of documents. There are two ways in which a firm may organise staff language training. It may use the facilities provided by the local education authority at colleges and evening institutes in the neighbourhood or it may employ the services of a language teacher or a firm of language training consultants who can install language laboratory equipment on the premises. One of these is *Inter'lang Ltd., 2 Clements Inn, London W.C.2*, which was established in 1963 to bring modern methods of language teaching to bear upon the mass market of tourists and full-time students. It has now among its clients such organisations as The Institute of Directors, The Beecham Group, and The Molins Machine Company.

Inter'lang has also installed many language laboratories in universities, colleges and further education establishments throughout the country, supplying language courses in French, German, Italian, Spanish, Russian and Danish.

ROTE LEARNING

Language laboratories are mainly concerned with audio-lingual teaching, which means that students are trained to hear and absorb sounds of the target-language (recorded by native speakers), then being drilled into mastering them as near to perfect reproduction as possible. Drilling is a form of rote-learning, it is applied systematically; first comes drilling in sounds, then in basic structure, and then follows practise in handling the language flexibly. In the old classroom type of situation it was never possible to do this effectively. Incorrect reproduction could easily pass unnoticed when the class was speaking in unison and individual attention and correction by the teacher was very limited. (*Why the past tense?—Ed.*)

In the language laboratory it is theoretically possible for students to have a great deal of individual attention. The laboratory is simply a room containing a number of two-channel

tape recorders connected to a master machine on the teacher's console. The students sit in booths, which are sound-proofed to a certain extent, and hear the lessons through headphones from the master track on their own recorder. This is known as the *audio-passive* stage. The next stage—*audio-active*—consists in the students' repetition of words or phrases making up the sound drills. The master material is recorded with time gaps in between the phrases, allowing the individual student to record his own responses on the second track. The master track cannot be erased, but the student can go back and re-record over his own responses if he feels the need. The last stage is the *audio-active-comparative*. The student replays the recording and listens to both tracks at the same time, comparing his response with the original. This method introduces self-criticism and analysis. As the master track has been transferred from the console to the student's deck he may work independently and is not tied down to the pace of the rest of the group.

NOT AWARE

The console is so designed that the teacher can monitor each student individually without the student being aware that he is being overheard. In most systems the teacher can stop the recording to explain where the student is going wrong and how he can rectify defects. This can be done on an individual basis without interrupting any other member of the group, but the teacher can switch into all decks at the same time if he wishes to make a general statement.

The Inter'lang "Languages for Businessmen" courses are intended for use with any adult student of average intelligence. A vocabulary has been carefully selected to be of general value without technical or commercial jargon. The adult atmosphere is induced not only by the choice of adult situations but also by the inclusion of some common commercial expressions which are nevertheless part of everyday speech. The courses have been written by teachers for teachers, based on the experience gained during the last five years in teaching over four thousand businessmen and adult students, and are suitable for use in a language laboratory or with a normal classroom tape recorder. Each language treated in the series is offered at two levels, each of 30-lesson units, the content being based on the current usage of the language.

Each level consists of a Teacher's Manual, Student Manuals and a set of tapes. Tape running time for each unit is from 25-30 minutes, except for the Russian material where units consist of two lessons and two tapes of this length. The total tape running time per level is more than 10 hours. Each lesson comprises an introductory situational dialogue followed by structure drills to provide extensive practice on the structures contained in the dialogue.

Level 1 is designed to provide the learner with a vocabulary of approximately 1,000 words and also to teach him the basic structures of the language, thus allowing him to participate in conversations covering a variety of topics.

Level 2 contains material for consolidation of all aspects of Level 1, and teaches progressively more complex structures leading to near fluency in the language.

The Student Manual contains a text of the dialogues, the text of the drills, omitting the responses of which only the first two are presented in each drill as examples, and a complete vocabulary at the end of the book. The Teacher's Manual contains a general introduction to the course, a lesson by lesson guide consisting of a list of teaching points, an analysis of the drills, a unit vocabulary, suggestions for further amplification of the material, and an index of grammatical points at the end of the book.

These courses may be purchased for use with an existing language laboratory; in some cases they may be hired. Evening Institutes using these courses can be found if you shop around.

One of the latest courses from Inter'lang is their "German for the Technically Minded". The material consists of 12 units. These are linked by a story, to give continuity and to enable the student to identify. Each unit has six sections:

1. Everyday situation dialogue.
2. Drills covering some points in (1).
3. "Dokumentation"—a reading passage, technical on the popular level, with ample vocabulary help.
4. Discussion-dialogue based on (3).
5. Drills grouped round a theme suggested by (4)—such as asking for information and expressing preference, etc.
6. Optional quizzes, poems, etc.

COMFORT AND LUXURY

If you are a businessman in London then you can do the whole thing in the comfort and luxury of the *Linguaphone Language Laboratory*, 26 Oxford Street, London, W.1. Courses in French, German, Italian and Spanish are offered, and each course consists of 60 sessions, each of 50 minutes, in the language laboratory, and of 24 half-hour conference sessions with native speakers and other members taking part. It is possible to arrange a crash course adapted to your own special needs, and really specialised vocabulary sessions can be arranged to meet terminology used in your business or profession. There is a good club for course members where you can obtain food and drinks and this is open from 9 a.m. to 9 p.m. There is a home-study course available on tape and there are ordinary language courses on tape available in 37 languages.

Although language laboratory courses are available for use on a home tape recorder, this application really defeats the object of these specially devised lessons, for they rely on the method by which children learn to speak their own native tongue—mimicry, encouraged by parental explanation. The language laboratory should never be more than an aid to learning with a proper introduction by a teacher who is there at all times to explain relevant points of grammar and phonetics. Struggling on alone with language drills could very well become frustrating and lead to a waste of time and money.

For those who really must study business French at home there is now available from *Harrap Audio Visual Aids*, 182 High Holborn,

London W.C.1 a very good course—"Des machines et des hommes"—in technical and commercial French on discs. This was originally broadcast by French Television and the speakers are all French. The price of the four discs and text book is £11 14s. 2d. (including purchase tax). Each recording deals with a specific industry or commercial organisation as seen through the eyes of a group of engineers and businessmen on a journey through France, visiting firms and studying engineering techniques. On each side of each LP about five situations are covered. For instance, Record 3 Side 2 features (i) an aircraft factory, (ii) a



Rank-Audio Visual language laboratory installation using Truvox mechanisms.

china factory, (iii) a metal-working industry, (iv) how to choose a secretary, and (v) general trade and commerce. Quite a lot of background information is introduced on aspects of France important to any businessman, and the text book carries some useful diagrams, one of which is the layout of a motor car with all the important parts named.

The *Tutor-Tape Company*, 258 Wimbledon Park Road, London S.W.19, are well known for their extensive line of taped courses for the home user and a new course dealing with Commercial German is soon to be available. Some of their existing language courses have language laboratory versions with full drill exercises.

understanding circuit diagrams

A SIMPLE GUIDE TO ELECTRONIC SHORTHAND BY DAVID KIRK

THE title has been very carefully chosen. This article has nothing whatever to do with understanding *circuits* as such but sets out to explain the intricate hieroglyphics which illustrate, for example, *Tape Recorder Service*. It is prompted by several readers who have waved Mr. Hellyer's drawings at us, during the last few months, as proof that this journal really is awfully technical.

Relating circuit diagrams to real combinations of components is really a very simple art. We are, in a sense, learning to 'read' amplifiers, radio receivers and tape recorders, which can be constructed from the information in their diagrams. This is no different to reconstructing a piece of music from dotted staves, except that the soldering iron is easier to play than the piano.

To the uninitiated, a circuit diagram may seem to comprise dozens of different squiggles joined together by mysterious black lines. In fact, while the total number of squiggles may run into hundreds, they may be broken down in most circuits into a dozen or so different types.

Firstly the long black lines. These merely represent the conducting paths connecting the circuit components—*switches, fuses, transistors*, and so on. These paths may be wires, strips of copper on a printed circuit board, or just the chassis; a long line does not necessarily mean along wire—if anything it indicates a frustrated draughtsman.

Commonest of the components is the *resistor*. This is illustrated below (left) as it

indicating the number of noughts at the end of the figures. 390 ohms would similarly become *Orange White Brown*, while 1 ohm would be *Black Brown Black*. 100 ohms, for the record, is *Brown Black Brown*, while 10 ohms is *Brown Black Black*. 1 M (1 million ohms—or 1 Megohm) is *Brown Black Green*.

Two final notes regarding resistors: a fourth colour band refers to the accuracy or *tolerance* of the ohmic value. A cheap resistor (they start at about 1½d.) might have a higher tolerance—and therefore be less accurate—than a more costly low-tolerance resistor. If low-tolerance values are essential in any part of a circuit, the suggested value is given as a percentage on the diagram. Second note: the Greek letter Ω (omega) is often printed in place of the word *ohm*, though not normally in this journal.

After the resistor, the *capacitor* is the most common component in audio and radio equipment. The basic *capacitance* effect was first analysed by Michael Faraday, who took great pains to define a unit of capacitance, called the *Farad*. Unfortunately, a 1 Farad capacitor would be about the size of a football field and practical capacitors are down in the micro-Farad (μF) region. The *micro* does not refer to the inventor's first name but to the *millionth* fraction. Circuit symbol and actual shape are illustrated below, the upper left drawing being simply a specialised form of capacitor known as an *electrolytic*. It performs the same task as a normal capacitor but relies on different chemical effects.

characteristics. Instead they are manufactured specifically for certain purposes (amplifying television signals, amplifying audio, or behaving as electronic pendulums—'oscillating,' for example). A circuit designer selects the transistor best suited to his needs and labels it in the diagram simply by its model number: "An *AC128* would be jolly good here".

Two transistors are illustrated below, the left *p-n-p* version being the most common. *Base*,

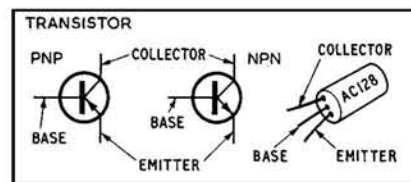

emitter and *collector* are difficult to identify in reality and most manufacturers supply a wiring guide with these components. Various forms of transistor are now in use, though most are similar in appearance, rejoicing in such names as *field-effect (FET)*, *silicon-planar* and *germanium*. These components, incidentally, are particularly sensitive to heat and may easily be damaged when being soldered into a circuit. To prevent undue quantities of heat climbing up the leads into the transistor, a pair of pliers or scissors are used by experienced constructors to keep the lead temperature down.

Valves have much in common with transistors in terms of function, but are now considered rather clumsy and outdated in view of their size and high working temperature. They also require too much electrical energy to be of value in portable battery equipment. Valve connections are made through multi-pin plugs and sockets. While transistors are limited to three connections, valves frequently have up to eight working pins—as distinct from the 'dead' pins used merely to hold the component in its base socket. A simple *triode* valve is illustrated below as it would appear in a

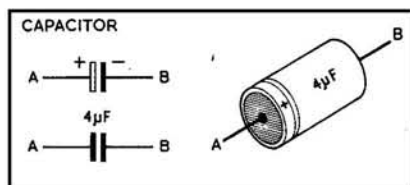
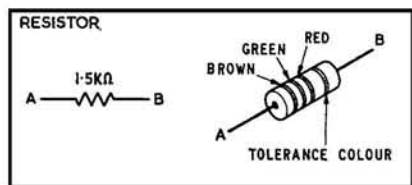

would appear in a circuit diagram and (right) as it might appear in real life. The critical feature of a resistor, obviously, is its *resistance*—a characteristic labelled on it in *ohms*. In order to make life interesting, resistor manufacturers have adopted a *colour code* which is used instead of numerals to indicate resistor values. BB ROY GB is a convenient mnemonic for *Black—0, Brown—1, Red—2, Orange—3, Yellow—4, Green—5, Blue—6, Violet—7, Grey—8, White—9*. (Violet Grey White is such a delightful name that it hardly needs deliberate memorising.)

A resistor value printed on a circuit diagram as 1.5 K, translated to English, is 1,500 ohms. Further translated to the colour code it becomes *Brown Green Red*, the third colour band

The resistor colour code is also sometimes applied to capacitors (in *pico*-Farads—one millionth of a millionth) but, since these components are generally larger than resistors, manufacturers more commonly print the capacitance in numerals. Values vary from several thousand microfarads down to 1 pF, the former often handling high currents in power circuits while the latter deals with the tiny electrical signals fed to a radio from the aerial. These components vary enormously in size and shape but cannot normally be confused with resistors.

Transistors—possibly the most interesting components currently in general use—are not normally referred to in ohms, Farads, or any other value, though they do have analogous

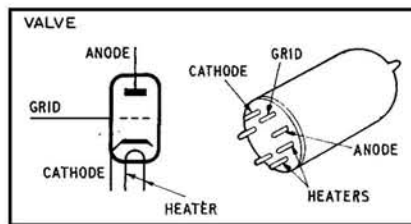

circuit diagram. Relating each connection to its base pin calls for reference to an excellent manual published by Iliffe (9s. 6d.) and entitled *Radio Valve Data*. This also contains valuable

understanding circuit diagrams

A SIMPLE GUIDE TO ELECTRONIC SHORTHAND BY DAVID KIRK

data on transistor connections.

My early dabbling days were spent mainly on constructing simple transistor devices rather than valve circuits. In time I assembled a rather clumsy power pack to convert 250 v AC mains to the 100 v DC and 6.3 v AC required for even the simplest valve experiments: it is very difficult to kill yourself with the torch-battery current used in most transistor devices. Like transistors, valves are referred to in circuit diagrams by their names rather than their electrical characteristics. *Radio Valve Data* tabulates many of these characteristics for the budding designer.

Switches—perhaps we should have started with these. The basic on/off switch is illustrated below (left), shown in its 'off' position. A

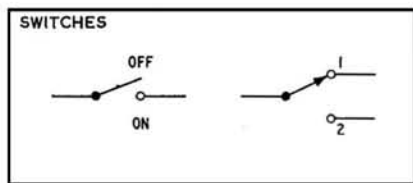

slightly more versatile *two-pole* switch is shown on the right.

Some of the components we have examined are also available in *variable* form—a *variable resistor*, for example, being shown below (left). In practice this is most likely to take the form of a *potentiometer* (centre and right), used to control volume in an amplifier, perhaps, or

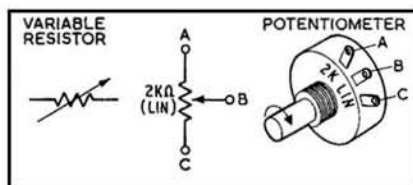

alter tone balance. Such a component would be specified by the total resistance between its A and C ends and possibly also by its internal construction—*carbon* or *wire*. A typical potentiometer might possess a value of 2 k (2,000 ohms), the resistance between slide B and, say, A, falling from 2 k to zero ohms as it is moved from C to A. It is important to note the characteristic or *law* of this component—generally defined as *lin* (linear) or *log* (logarithmic) for reasons which are quite beyond the scope of this article.

Variable capacitors are important in frequency-conscious circuits. A fixed capacitor essentially comprises two sets of metal plates positioned close to each other but separated by a *dielectric*. Two metal tea trays separated

by a thin table cloth form an excellent capacitor, though the electrical value is only a few hundred picofarads. By moving the plates

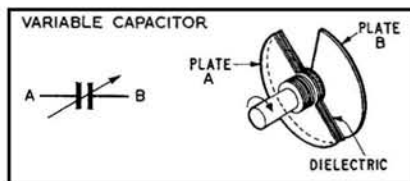

away from each other, it is possible to vary the capacitance over a small range. The tuning control on a radio receiver is generally a

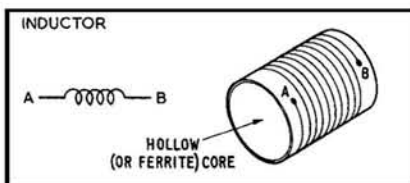

variable capacitor.

The less common *inductor* generally boasts the appearance of a wire coil, wound on a hollow or solid core and defined in Henrys, milli-Henrys or micro-Henrys. It is principally used for tuning circuits (in conjunction with a capacitor) to operate at a single frequency—which returns us to the pendulum analogy.

A *transformer* is best considered as a double inductor—two coils, rather than one, wound on an iron core. To function effectively, the coils must be fairly large in number and the commercial component scarcely resembles a coil at all. Transformers vary in size from less than 2 cm in width to 12 cm. Outside the domestic audio and radio fields, giant transformers are scattered through the country as part of the National Grid electricity supply. Large or small, all these components work on the principle that alternating or fluctuating

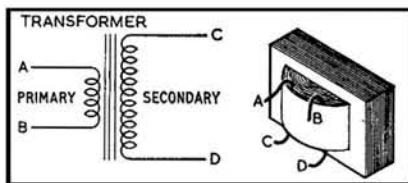

(pendulums once more) electricity inserted at the *primary* cause another current to be *induced* into the *secondary* coil. The process itself is called *electromagnetism*. Transformers are often specified by the ratio of wire turns

between the first and second coils. A 2:1 transformer, typically, might have 300 turns on its primary and 600 on its secondary. A more specific circuit designer will include the model number and brand name against a transformer diagram, and possibly the voltages of various windings.

Not so many years ago, crystal radio kits were still being marketed with crude 'cat's whisker' *diodes* to perform the important task of converting radio signals in an aerial into usable electric currents. In addition to soldering a few components together; the constructor was obliged to fiddle with a short metal wire, touching it against various parts of coarse germanium crystal—much as a feline whisker might be held in contact with a small

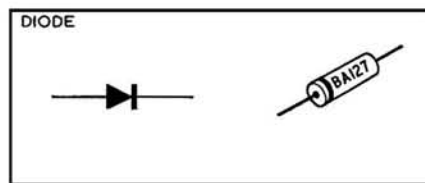

garden stone (don't cut the cat, a true whisker wouldn't really work). Such fiddling is unnecessary today since *germanium diodes* may be purchased quite cheaply with wire and crystal sealed inside a plastic container—similar in size and shape to a resistor. The diode has certain characteristics in common with the transistor and it is no coincidence that the circuit symbol is similar.

For larger currents, we would require stronger and generally larger diodes—referred to by name and make, again, and generally known as *rectifiers*.

There are other forms of electronic component, of course, though they are generally mere variations on those we have considered. *Photo-transistors*, *pressure-transistors*, *thyristors*, *thermistors*, and a few more, have escaped from the limbo of radar and communications. Before they are all in general domestic use, however, the entire electronics industry will probably have moved on to *ic's* (*integrated circuits*). Entire amplifiers will then be scarcely larger than single transistors and, incidentally, will make electronic equipment very much more reliable and less expensive than it is today—at least, we hope so. *ic's* may also reduce Mr. Hellyer's circuit diagrams to simple block arrangements, a single squiggle representing an oscillator, for example, while others indicate a chain of amplifiers, mixing stages, and so on.

Which brings me to the obvious conclusion. If you still cannot grasp the shorthand of electronic circuit diagrams, do not worry. The diagrams may very soon be obsolete.

If a justifiable criticism could be levelled against the Bang & Olufsen 2000, original version, it would be that stereo inputs were not separately controllable. Our own reviewer, writing in the June 1965 issue of *Tape Recorder*,

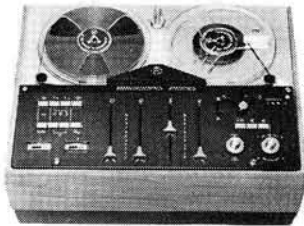

BANG AND OLUFSEN

2000

BY H. W. HELLYER

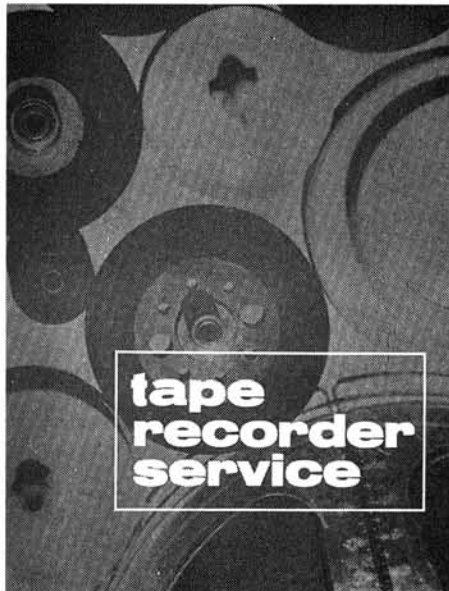

TABLE 1. Resistance readings from transistor connections to chassis, using a 40 K/V meter on the ohms x 1 range, with negative battery polarity to chassis (values in ohms).

Transistor	Collector	Emitter	Base
First driver 2N2613	2.3 K	850	13 K
Second driver AC153	75	65	2.3 K
Complementary AC132	19	21	95
Complementary AC127	90	7.5	75
Upper Output AD139	19	8	21
Lower Output AD139	7.5	0.5	90
1st Power Supply OC75	350	18	650
2nd Power Supply OC75	350	22	2.6 K
Power supply AC128	16	18	350
Power Supply AD149	16	19	18
Zener diode ZF 9.1	Anode 22	Cathode 0	

had remarked that the inputs, especially the radio source, were unduly sensitive. Anything more than 2 mv would overload, and outputs from practically all British tuners were 500 times this level. Mr. Tutchings did not tie the two things, but his findings—"an abnormal sensitivity to mains hum on various signal sources" and a low hiss level, which, for those days, seemed surprising, have proved the efficiency of the design as experience has shown us that correct matching is the secret of obtaining good results. It is the preamplifier circuits that have received the designers' attention and small modifications have completely eradicated even this minor drawback. We have to read the reviews of that date remembering the rarity of transistorised models, and bearing in mind that even our scrupulous Mr. T. could say: "... we seem to have become conditioned to a slight unobtrusive mains hum".

The foregoing criticisms, mild though they were, appear to have been heeded by the B & O designers.

Separate controls have been fitted, each source individually controllable; the excellent slider system has been retained. High and low level inputs for radio and gram are now catered for. It is worth remembering that *H*, for *High*, means that the machine will accept a higher level of signal for full modulation. It is only fair that a machine should be designed to match other items of equipment in the maker's own range, yet we find B & O adding the facility of a 'crystal cartridge' input to the gram preamp. Considering the efficiency of their own very fine magnetic cartridges, this is quite a generous

gesture. When we come to look closely at the circuit, we find the 'crystal' is driven in the 'hard input' mode, and the only change necessary with this kind of *n-p-n* common-collector stage is switching of a large capacitor in series with a 220 k resistor, from the emitter for magnetic cartridge source, with the capacitor omitted and the resistor short-circuited for high impedance input. The nominal ratings are 2 mv at 47 k (*magnetic*) and 40 mv at 4 M (*crystal*).

The radio preamplifier is switchable between 3 mv at 47 k and 100 mv at 100 k inputs and can be rewired, if need be, to accept a high impedance microphone having a sensitivity of 500 mv at 500 k. This is simply a matter of moving a shorting link but, to make things even more versatile, in the *H* mode some 3 db sensitivity can be achieved by changing one of the feedback resistors in each channel from 820 to 560 ohms. Add to this a line source input of 250 mv at 50 k and we have a really versatile mixer input.

Among the several 'improvements' brought in since the *de-Luxe* versions appeared, we find a change in the playback amplifier, which now has 2N2613 transistors for better noise performance, and minor alterations to bring the specifications in line with NAB standards. Record controls have been changed, too, for a type with a more gentle 'curve'.

The output stages cannot be left to speak for themselves, although space makes it impossible to reproduce even a part of the very fine sectionalised switching layout drawings that B & O have produced to make their

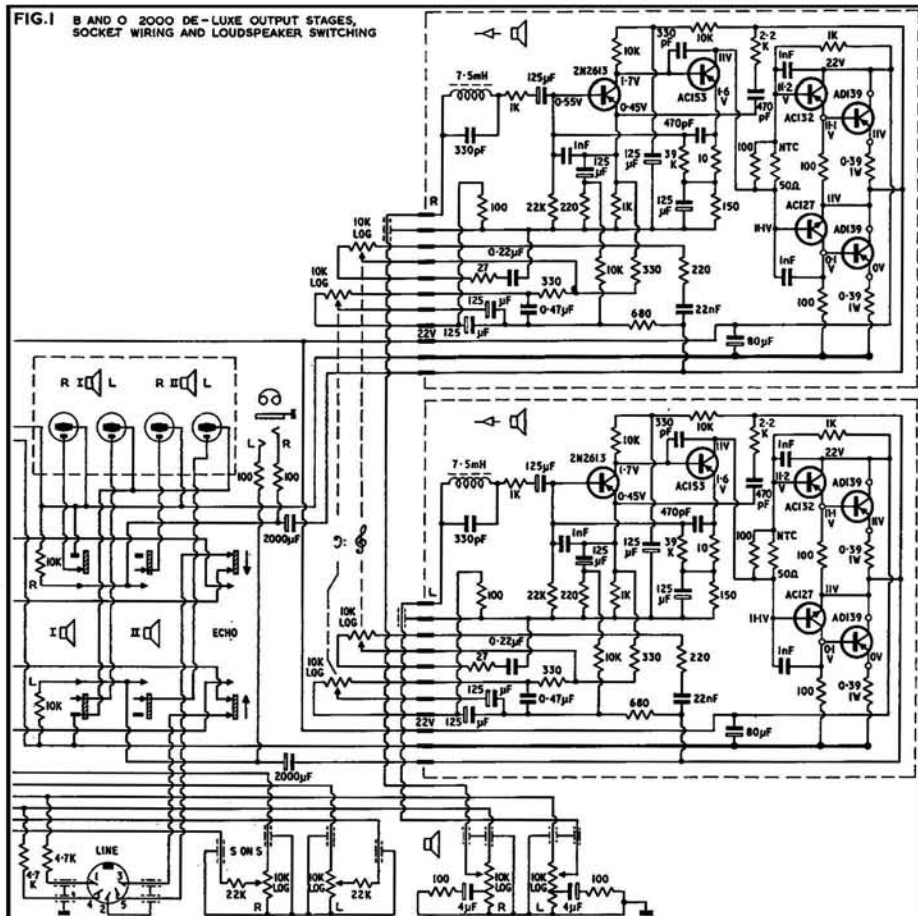



An advanced High Fidelity System for the home. Made by Bang & Olufsen – for those who consider design and quality before price.

Here is a complete music reproduction system which blends the beauty of Danish design with technical excellence and simplicity of use. The Beolab series comprises the Beolab 5000 stereo amplifier, the Beomaster 5000 FM tuner, two specially designed pressure chamber loudspeakers (either Beovox 5000 or 3000), a high frequency sound diffuser (Beovox 2500) and the Beogram 3000 transcription turntable. An individual test certificate is supplied giving the exact

results obtained from both the Beolab 5000 and the Beomaster 5000. *The Beolab System is a world where music attains its purest dimensions.*

Bang & Olufsen also manufacture a range of tape recorders – the semi-professional Beocord 2000 being the natural choice to supplement the Beolab Series.

Bang & Olufsen audio equipment is made for those who consider design and quality first – and remember that your B & O appointed dealer can advise

you of the best way to start a B & O system that will give you pleasure for the years ahead.

Fully descriptive literature is available from your B & O dealer or direct from:

Bang & Olufsen
United Kingdom Division,
Eastbrook Road, Gloucester.
Telephone: OGL2 21591
London Showrooms: 70/71 Welbeck
Street, W.1. Telephone: 01-486 2144

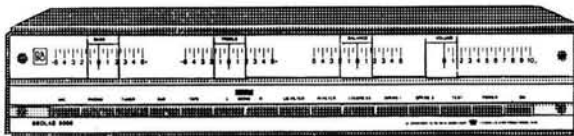

BEOLAB 5000

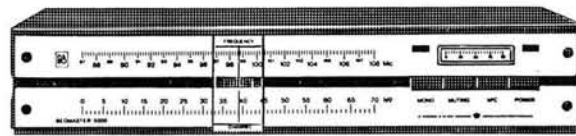

BEOMASTER 5000



BEOGRAM 3000



BEOVOX 2500



BEOVOX 5000

BEOLAB 5000 2 x 60 watts R.M.S. silicon transistor amplifier with very low distortion values. It features calibrated slide rule controls and is extremely versatile due to comprehensive input and output facilities. Elegant free-standing cabinet in teak or rosewood finish. Price £140.0d.0d*.

BEOMASTER 5000. A FM stereo amplifier with outstanding sensitivity and selectivity. Automatic mono / stereo switching. Variable muting and stereo levels. Teak or rosewood finish. Price £103. 5s. 0d*.

BEOGRAM 3000. A transcription turntable unit fitted with the world famous B & O STL/15* tone arm and lowering device and magnetic stereo cartridge. Teak or rosewood finish. Price £82.15. 0d*.

BEOVOX 2500 cube type high-frequency diffuser unit with 6 speakers mounted one to each face for omnidirectional sound distribution. Mounted on steel base or may be suspended. Price £25. 15. 0d*.

BEOVOX 5000. Pressure chamber loudspeaker incorporating a specially designed base unit, two mid range and four high frequency speakers. BEOVOX 3000 speakers are also designed for use with the Beolab System where space is more limited. Prices: £59. 10. 0d* (5000), £49. 10. 0d* (3000).

* Recommended retail prices

FIG. 3

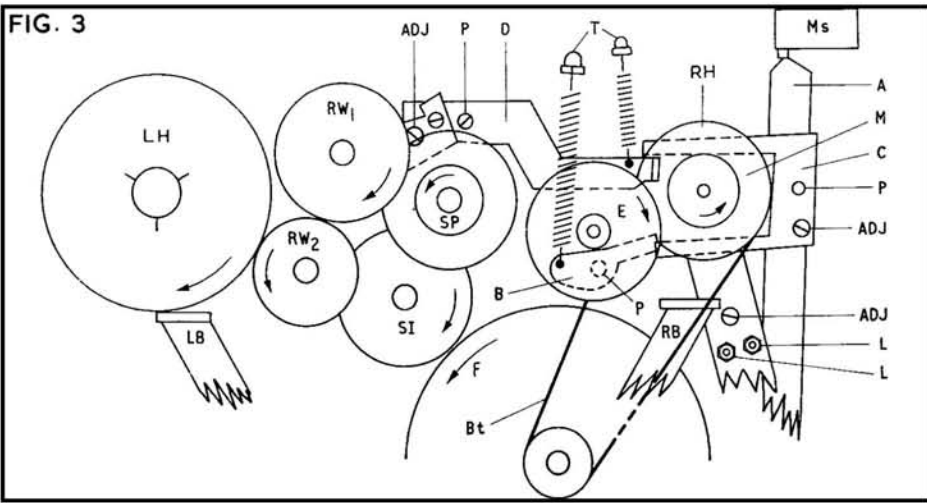

Clutch, brake and drive arrangement of the B & O, not drawn to scale. Key to lettering: LH, left turntable, RW1 and RW2 are rewind pulleys driven from the stepped pulley (motor mounting) SP. Also driven from this pulley are the speed change idler SI, which engages flywheel F, and, for Fast Forward action, the idler E, which engages the righthand spool carrier, RH, shown with top removed and position of plate M evident. Ms is the microswitch actuated by lever A, Bt the take-up belt, P the pivot points, LB and RB the two brake arms. Other identification is given in the text.

precaution of keeping audio power levels down when the speakers are 'in the open', because these are the circumstances when any speaker will be subjected to sudden blasts of sound which does no one any lasting good—apart from this, there is no need to disconnect the speakers, and it is far better to retain the correct output stage loading. Next step in testing, if, as is likely, the power supply has given up, or the protection circuit come into action, is to disconnect the output stages from the DC power supply, check that this is in order, look for obvious short-circuits and attempt to diagnose the trouble from the circuit and by resistance tests. This is one advantage of transistorised circuits; that resistance tests will very often show an operational fault, whereas with valves, it is often necessary for current to flow and the operating conditions must, at least, be simulated.

The table given below is of resistance tests made between the transistor connections and chassis, with no power applied, and using a 40 k/v meter, as stipulated by the makers.

Now, it is obvious that different meters will give slightly different readings—not always in proportion, I hasten to mention, for much depends on the battery voltage of your ohmmeter as well as the o.p.v. of the actual instrument. More important, perhaps, is the requirement that the negative terminal of the battery should be to chassis, not vice versa, as some meters are actually polarised. If you have any doubts about this, check your meter with another before using it for transistor testing.

Let us suppose (a) that you have no access to another meter, and (b) that you cannot see the reason for this precaution anyway! Test your meter by measuring a diode, such as an OA79, or OA81, or even a mains (i.e., high tension) rectifier. Remember the fundamental rule that current will flow only when the anode is positive. Connect your ohm-meter and note any reading. Reverse the connections and again note the reading—in the forward direction, when the anode is positive with respect to cathode, current will flow and the meter will have its battery positive to the anode end.

This is the condition when the ohms reading is 'low'. The cathode end of a diode is generally marked positive or with a red spot, or, in the top-hat type of rectifier, is the outer casing. So much for polarity: as to why we observe it; let us suppose we have a meter whose battery is several volts (on the ohms x 100 range of the Avo 8, for example, a 15 v battery is employed), and we apply the negative voltage probe to the mid-voltage line of the foregoing circuit. This is much like putting an excessive operational voltage exactly where it can do most harm. You will get readings all right, and they will be so misleading as to be valueless. But, more to the point, you may very well cause a transistor designed to operate on low voltage to pass excessive current and destroy itself. One gets no period of grace with transistor testing. No time to say "Whoops! I've touched the wrong point." Before you have voiced your chagrin the damage is done. So watch your probes; observe correct polarity and, for similar reasons, avoid those tentative prods at the circuit when it is operating with power supplies connected.

After which digression I descend from my soapbox and take note of conditions when the power is applied. First and most useful test is for correct mid-voltage. This means that the output pair are passing a reasonably accurate current and that the first of the drivers, the low-voltage one, is not likely to be at fault. This argument applies because a fault at the front end will cause wrong currents to flow, drastically alter the operating conditions of the second transistor and the effect will be magnified, so that by the time we reach the complementary pair, conditions are hopelessly wrong. So, first test mid-voltage. If it is high, this could mean a short-circuited driver transistor, and one must prove whether the output pair are the cause of such a fault or merely the sufferers. To do this, disconnect collector and base circuits of the output pair, switch on and test again. If the voltage is still excessively negative, we can eradicate the output pair for the time being, and concentrate on the drivers. In earlier circuits, where AC128 transistors were used instead of AC153 types, and before the 2N2613 was brought in to replace the AC151, such faults were more common.

Remember, when checking these 'could-be-anywhere' faults, that hum is most likely to originate in the power supply section, having much the same eventual effect with these regulated supplies as a lack of filtering in a
(continued on page 405)

FIG. 3

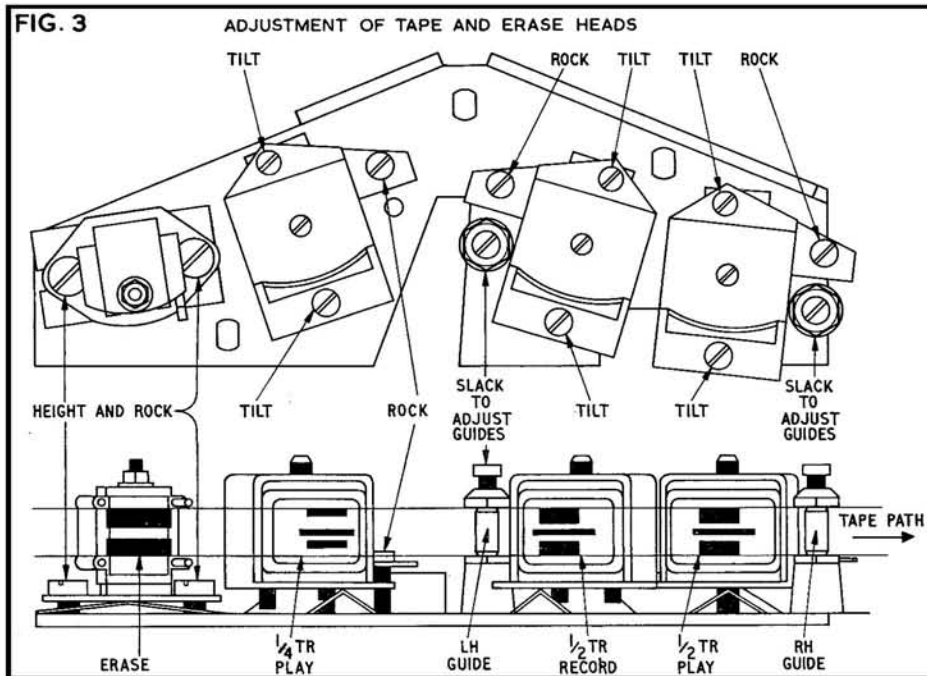

Sanyo puts you in the world class

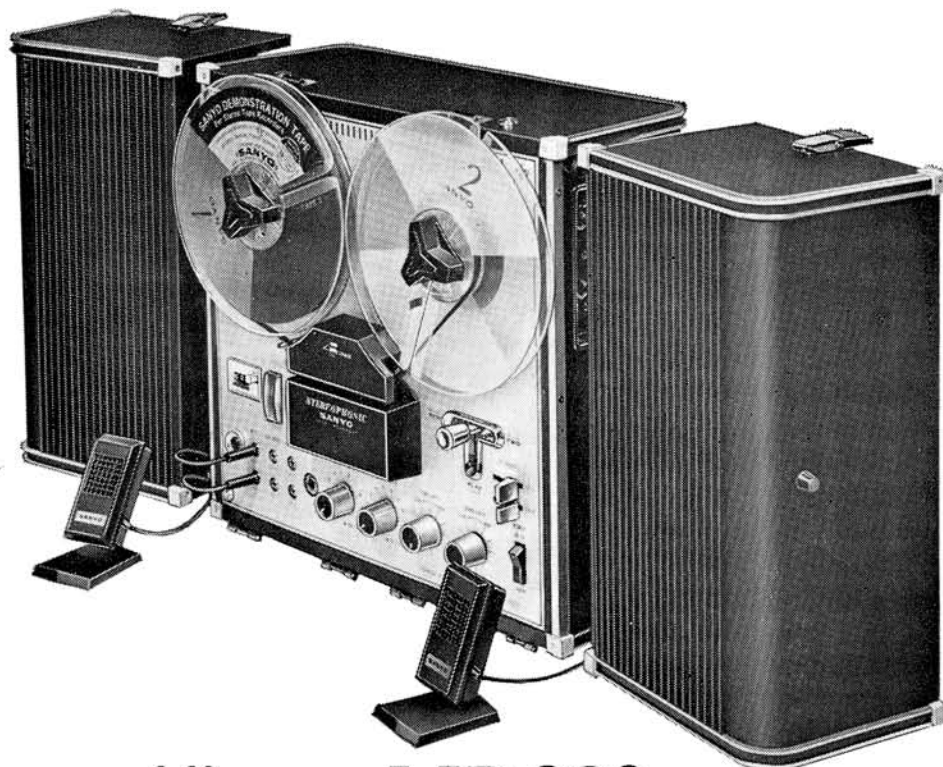

The magnificent MR 929 4 track stereo tape recorder

- sound with sound
- vertical operation
- transistorised circuitry
- detachable speakers

Tape speeds
7½ ips (19 cm/sec)
3¾ ips (9.5 cm/sec)

Recording system
AC bias

Erasing system
AC erase

Reel size
7" dia.

Frequency response
20—19,000 c/s at
7½ ips (19 cm/sec)
(30—15,000 c/s ± 3 db)
30—12,000 c/s at 3¾ ips
(9.5 cm/sec)

Rewind Time
3 min. with 7" (18 cm)

Recording level indicator
VU meter

Power output
Maximum 4w (ea. channel)

Speakers
Two 4" free-edge
permanent speaker boxes.
Voice coil impedance
10K ohms.

Line outputs
1K ohms

Power source
AC 100V, 117V, 125V,
220V, 240V

Dimensions
14½" wide x 12¾" deep
x 11" high (350mm
x 330mm x 280mm)

Weight
28.6 lb. (13 kg)

Accessories
Dynamic microphone x 2,
7" (18 cm) full tape and
empty reel. Patch cord x 2,
Splicing tape, Reel
stopper x 2.

**Recommended selling
price £96**

SANYO

RELIABILITY IS BUILT IN

two simple accessories for tape recorders

G. A. CLOUD DESCRIBES A RAPID SPOOL THREADER AND A DOMESTIC MICROPHONE CABLE STORE

THE first gadget about to be described is very simple to make and is easy and quick to use.

The spool threader will be found suitable for most types of recorders and for those whose spool spindles are either flush or protrude beyond the spool. It is designed mainly for those spools which have a radial slit along one of the spokes of the spool and will be found to be particularly useful for the small 7.5 cm spool or message spool. Fig. 1 is a view from the underside of the rapid spool threader and gives the various dimensions. The wood used should be either hard wood or multiply wood and not less than 1.3 cm thick. The steel pegs are made from an ordinary steel sewing needle of about 1 mm diameter. The longer peg is made by measuring off about 2 cm from the point of the needle, holding it with two pliers, one on each side of the measured position, and sharply snapping the needle between them. The steel peg is hammered into the wood 2.4 cm from the end until 1 cm is left protruding. The shorter steel peg can be made from the remains of the needle (a point is not necessary), being hammered in 1.1 cm from the end until only 2 mm is left protruding. Both pegs should be filed to remove any sharp edges.

The recorder is threaded in the usual manner and the take-up spool arranged so that the radial slit is at the 3 o'clock position, the end of the tape is layed against the centre of the spool (see fig. 2), with the threader slid along so that end A (fig. 1) slides between the

protruding spindle if present, of the take-up spool, while the two steel pegs slide along the radial slit of the spool. The longer steel peg

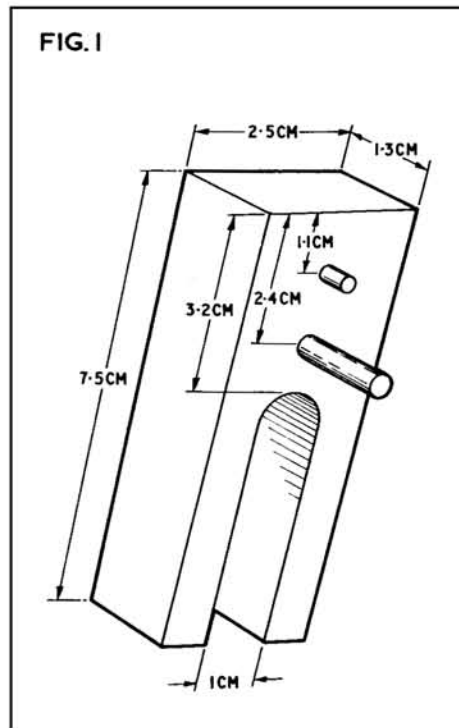

clamps the tape against the spool centre while two turns of the spool are made by using the device as a handle. It is essential while turning the take-up spool also to turn the feed spool in order to keep the tape slack. As the diameter of the steel peg is very small, the threader can easily be removed.

Many domestic tape recorders have inadequate storage space for extras. The writer was faced with the problem of carrying a 20 ft (6 metre) extension lead for the microphone. This can be solved by winding the lead on to an old 18 cm tape spool and carrying it on the tape deck. When winding the lead on to the spool the lead should be doubled so that the two ends are together.

In use, if 10 ft (3 metres) of lead is required, 5 ft (1.5 metres) of both ends are unwound together, leaving the rest on the spool.

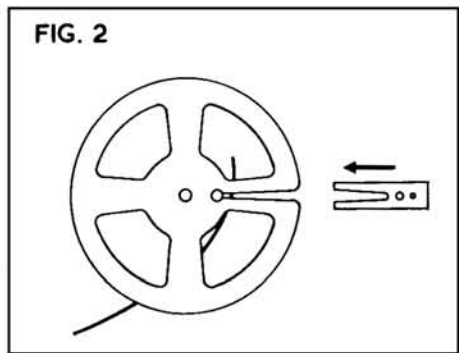

TAPE RECORDER SERVICE CONTINUED

conventional circuit. But it is possible to have such disastrous troubles as completely short-circuited transistors in these regulated supplies and still have a reasonably correct supply voltage under low-signal conditions. So, if hum increases with volume, it can still be the power supply. And the prime culprit is the zener diode, upon which the locking of the reference voltage for the whole circuit depends. Again, resistance tests can tell us a lot, and these are also given in the table.

Motor supply is derived from a winding on the mains transformer, to give 48 v for fast winding, but only 42 v for normal tape drive. A microswitch inserts part of a 25-ohm preset adjuster to achieve this, and there are two points to watch. Although this is a relatively low-voltage motor, it is highly efficient, and is a four-pole synchronous unit, rotating at 1,500 r.p.m. It is important that the voltages between the three motor leads are within 2 v of each other and adjustment of the preset will help reduce motor noise and vibration. But there is always the possibility that the microswitch may have stuck. If the motor receives full voltage all the time, there will be a quite

distinctive noise from it, and there have been cases of premature burnout. (When the opposite condition applies, there is too little voltage for fast winding, and motion is slowed.) As the switch is screwed directly to the chassis, vibration can cause it to work loose and instigate these faults.

Slow rewinding can be caused by mechanical trouble when the right-hand clutch does not clear sufficiently. Felt discs are glued on the turntables, and there have been a number of cases of loose felts due to inferior glue. The upper portion of the turntable, complete, may have to be replaced, and then it is necessary to check clutch and brake adjustment.

Clutches are not quite so straightforward as they appear. Felt discs are used, between the two halves; the spool carrier section being free and the lower section acting as driven portion and brake drum. But under the assembly is a compression spring and right at the bottom of the spindle is a locking ring. The position on the shaft of this locking ring is what initially determines the grip of felt disc on the metal plate, M, that is part of the lower drum assembly. During take-up, the right-hand turntable is belt driven and the amount of coupling between the lower section and the spool carrier is made by a lever which is in the

full lifting position for fast winding, compressing the sections to give a direct drive. The difficulty is to get a smooth take-up of a full, 18 cm, 1,800 ft (730 metre) spool of tape from start to finish, and an even wind. Any mal-adjustment soon shows up as slack winding, or a hesitancy at the end of the fast winding operation. The pulley at the base, which is engaged by the tilting lever, should be adjusted so that, with the machine set to 'Forward', there should be between 1 and 1.5 mm play of the upper turntable, i.e., a slight 'lift'.

Next operation is a bit tricky. There is a pair of lock-nutted screws and a cheese-headed one forward of it, both through the tilting lever to the coupling underplate section. Fig. 3 shows this in better detail than words. These are adjusted, using the lock-nutted ones as a fulcrum, to just not quite allow any drive to the upper turntable with the operating lever at neutral, but brakes disengaged. Sounds awkward, but in practice, with an empty spool as a weight gauge, it is not a long job to get the adjustment right for neutral, then take-up, then fast winding; remembering to check with a full and an empty spool respectively, and in both directions. The cheese-headed screw can be adjusted so that a turntable bearing a weight

(continued on page 409)

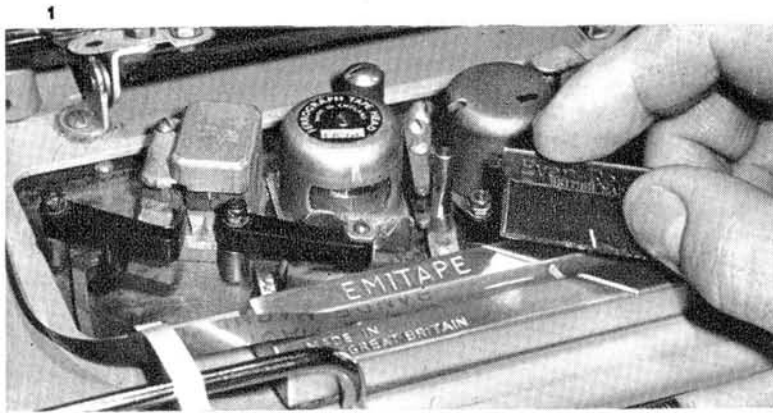

TO ERR IS HUMAN

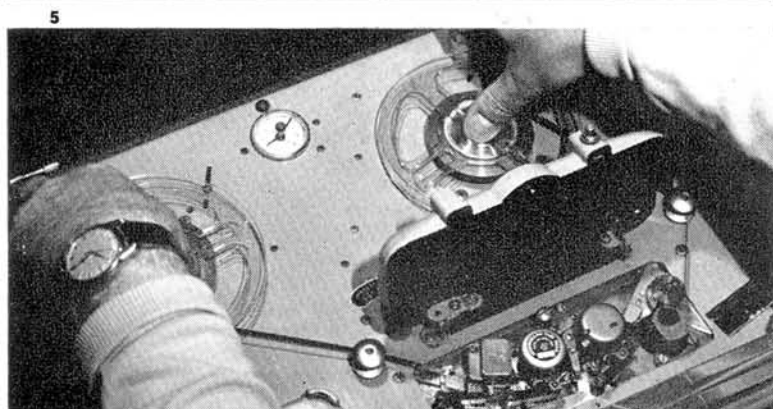
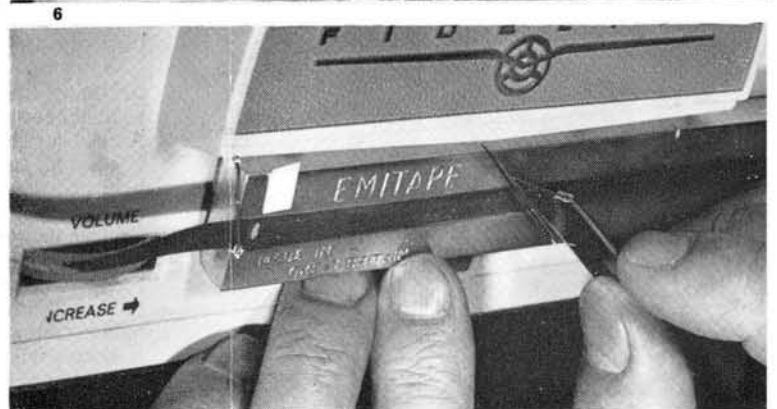
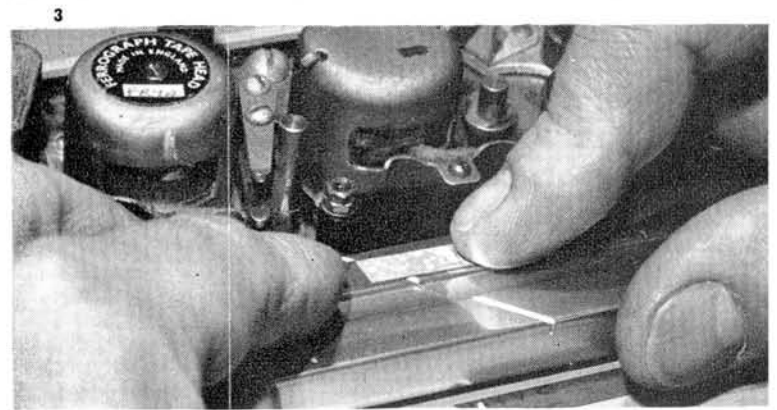

PROFESSIONAL TAPE EDITING TECHNIQUES

BY ARTHUR GARRATT

PHOTOGRAPHS BY R. PERKINS

- 1 Cutting the tape. Note that it is pressed home into the groove and that the mark is opposite the cutting slot.
- 2 Applying the jointing tape.
- 3 Pressing the jointing tape well home outside the groove.
- 4 Holding back the pressure pad and marking the tape. Note the mark on the head shield exactly over the gap to act as a guide to marking.
- 5 Rocking the tape to find the exact place to mark. Note the editing block placed on a convenient position to eliminate unnecessary movement of the tape and note also how the jointing tape is stuck to the deck handle ready to be pulled off and cut.
- 6 Editing on a machine where it is inconvenient to get at the head. The location point is the tape guide above the F in FIDELITY. The block has been marked with a piece of jointing tape.

IF you are going to use a tape recorder properly, you must learn to edit. There is almost no example of tape recording that does not need some cleaning up—with the possible exception of a taped radio programme. Even then it is difficult to get a clean start and finish without using a razor blade.

Now of course if you are using multi-track recording, you cannot edit one track without spoiling the others. If you have two machines, or access to a second machine, you can avoid this by editing the tape and then copying on to another. Then you can keep one tape for recording, edit it, copy to another tape and use the edited tape again for the next recording. You need not worry about the edits, if they are done properly the tape is almost as good as new. (*Some domestic mechanisms object to splices. Never, incidentally, join different brands as the change in characteristic may well prove audible.—Ed.*)

Editing is not only professional, it can be very good fun and is really one of the most creative parts of recording. Anyone who can edit really enjoys taking an interview or talk and turning a series of hesitations and fluffs into an impeccable performance. And, most important, anyone can do it. There is no mystique about it. All you need is the equipment, which costs under a pound, the knowledge of how to do it, and then experience. You need a little dexterity, but not much. I can edit, but I would never be trusted to do a repair job at home!

Let us start with what you need. First of all, a good editing block. This must be husky and well designed so that the groove hugs the tape tightly and the cutting slots are well finished. There are a number of these on the market. Personally I use the EMJ version but others of similar quality exist. This is the most expensive part of the equipment, but for an ordinary amateur it will last a lifetime. Next you need a sharp razor blade, not a double-edged one or you will slice your fingers. Add a wax pencil—a yellow chinagraph works very well or you can squander a couple of shillings on a propelling type (use a wax 'lead', of course). I use a *Scripto*, this has the advantage over an ordinary chinagraph that if the wax breaks at a critical moment you do not have to sharpen it. Finally you need a reel of jointing tape. Get the 7 mm variety (slightly narrower than the recording tape), not the wide stuff which has to be trimmed afterwards. And that is all. I personally never use scissors, although non-magnetic scissors are available. By the way, this question of magnetism. You must take care that the razor blade is not magnetised or you will get clicks and dropouts. What I do is to treat a new blade with my defluxer before use. This may be finicky, but I cannot afford to spoil a valuable tape. If you have a defluxer you may as well do the same, otherwise don't let it worry you.

Editing blocks usually have two cutting slots. One goes straight across, the other at 45°. Unless you are after special effects, always use the 45° slot. Then the edit acts like a quick cross fade and you do not get a sudden change of level and probable click.

If you want to make editing as easy as possible, use a high recording speed (19 cm/s is ideal for speech) and use standard tape. Double and triple play is difficult to cut and handle in the block, it can be edited but it needs much

more dexterity. And use the largest spools you can on the machine. I will explain later about the way you rock a tape back and forth to find the exact spot to cut, and the rocking is much more precise with larger spools.

Before I go into details of finding the exact spot to cut, I will deal with the actual process of cutting and jointing. First the jointing tape. Make sure that this is fresh, if you have had a bit hanging out from the reel for several days it loses its stickiness, and this can be exasperating. There are two schools of thought about the way the jointing tape is organised. Some people start by cutting up a number of pieces, each about 2.5 cm long, and gently attaching them to a convenient bit of metal like a lifting handle on the deck or the edge of the deck itself. Others, including me, pull out a length of jointing tape and stick this on to a convenient place and let the reel dangle in front of the machine. Some jointing tapes are supplied in a neat little container which can be stuck on the side of the machine. Take care not to lose the end of the jointing tape, it has a fiendish habit of sticking itself back on the spool and then it is almost impossible to find the end and prise it loose.

Now to the actual mechanism of jointing tape. I will assume that you have marked the two ends that you want to join with the wax pencil. Put the right-hand bit of tape, the one that is going on to the take-up spool, into the groove in the block and press it home so that it holds (fig. 1). Then cut it carefully with a sliding motion of the blade. Blades only cut properly when there is a sliding motion, this is why circus performers can walk safely up ladders of knives providing they do not slide their feet. Then remove the cut-off end on your left side and slide the cut tape gently about 3 cm to the right. Make sure it is still held tightly in the groove. Now take the other end of the tape, with its mark, and press this home on the block. Once more cut it on the mark. Remove the bit you have cut off and slide the tape to the right until it just butts up against the first tape. Make sure it does just butt. An overlap will give trouble and if there is a gap it will expose the adhesive surface of the jointing tape and this will stick to the tape underneath when the spool is rolled up, causing jumps on playback. Now take your bit of jointing tape, or cut off a bit as the case may be, and press this carefully on to the tape to make the join (fig. 2). This is the only part of editing that can cause trouble. It is essential to lay the jointing tape down exactly parallel to the tape with no overhang. Curiously you will find that the longer the bit of jointing tape, within reason, the easier it is to lay it straight. If it is not straight, do not try and correct it. Peel it off and use another piece of jointing tape.

Now comes a professional trick. After you have smoothed down the piece of jointing tape, remove the join from the groove, put it on to the flat surface of the block and press it firmly home, making sure that there are no air bubbles—you can see these through the jointing tape which should look uniformly white and not as in fig. 3. This trick of pressing the jointing tape down on a flat surface afterwards gives a really permanent joint which will never part providing your jointing tape is good and sticky.

And that's it. After a few tries you should make a perfect joint every time.

So much for the mechanism—now to the skilled part; finding out where to cut the tape. We will start with the simplest possible case. Suppose you have recorded a piece from the radio and you want a clean start and finish. And let us assume that you have a machine which lets you get at the heads so that you can mark the tape where it contacts the head (fig. 4). Run the tape back to the beginning and play it until the first part of the programme comes up—where the mod starts as we say. Stop the machine and rock the tape back and forth using the spools until you have the right spot (fig. 5). Lift the pressure pad—if there is one—and draw a line on the tape at this spot (Photo 4). This is the point you have to cut. Put on a leader; don't be miserly about this, you need at least a couple of feet of it. By the way, the BBC has a system for leaders. It uses white to start and red to end, with any spacers in yellow. Remember it by the lights of a car, white front and red tail. You don't have to copy this coding, but it is a great advantage to have a coding of your own so that you can always be sure just what everything means. Having done this, run the tape to the end and do the same thing again and attach the trailer tape.

Now a word about different machines. I normally use a Ferrograph for editing. On a Ferrograph you can stop the motor and rock the tape with the amplifier still in circuit. If you cannot do this you will have to find a way of lifting the tape off the capstan during editing, either manually or by using the pause control. The Ferrograph is quite easy to edit on, although professional machines are better because they usually have variable speed spooling arranged so that you can listen while you spool; this makes finding the exact spot a bit easier. The latest Ferrograph has this facility, but it is rare on domestic recorders.

If you have a machine where you cannot get at the head, all is not lost. You find a place as near to the head as possible where you can get at the tape at a well defined spot, say a tape guide, and you measure the distance from this spot to the head—*exactly*. One way of doing this is to take a bit of tape with plenty of modulation on it and join it using the slot that goes straight across the block for once, to a bit of leader tape. When you rock this you can easily hear the end of the mod tape. Mark the spot on the tape guide or whatever locating point you use with the wax pencil. Then take the tape out of the machine and put it on the editing block. You know where the mod ends; it is at the joint, and you have the mark of your locating point on the tape. So now you can mark off the distance between the head and the locating mark on your block, measuring from the cutting groove—there are several ways to mark the block, a simple one is to use a bit of jointing tape (fig. 6). Then all you do is mark the tape at the locating point and set your tape mark against the mark on the block, and you can't go wrong.

Now let us think about something a bit more difficult than just attaching a leader and a trailer. Suppose we have an interview that needs cleaning up—and interviews *always* do. First of all the stumble. A speaker says: "I was going down the roo—the road". First of all play the bit several times and listen for any slurring. Probably he really says 'throad' all

(continued on page 409)

to the point of perfection!



◀ **Model RD 505.** Solid state all transistor tape recorder, twin track, two speeds. Superb recording reproduction with outstanding simplicity of control. Entirely portable, will operate anywhere. The act of inserting the mains plug automatically changes over from batteries to its own built-in A.C. power unit. Designed to play or record in any position. Remote control switch on microphone allows full flexibility in use. Dimensions 12" x 10" x 4". Additional features include 3 digit tape counter, fully variable tone control, large internal speaker and automatic level control. Comes complete with dynamic microphone recording lead, earphone, batteries (6 x Ever Ready LPU2 or equivalents). 5" reel of tape and empty spool. **R.R.P. £39.18.0**

RD303E An all transistor solid state tape recorder. Two speeds, twin track. Fully portable with operation from internal batteries or A.C. mains. Automatic or manual recording level control. Remote control switch on microphone for instant start/stop. Uses 3" reels, utmost simplicity of control with brilliant performance—truly a miniature marvel. Dimensions 11½" x 3½" x 7½". Complete with dynamic microphone, recording lead, earphone, batteries (4 x Ever Ready LPU2 or equivalents). 3" reel of tape and empty spool. **R.R.P. £28.17.6**

SHARP



SALES AND SERVICE

16/18 WORSLEY ROAD, SWINTON, MANCHESTER. Tel: SW1 3232 (5 lines)

For further details and leaflet contact:
SHARP SALES & SERVICE, 16/18 WORSLEY ROAD, SWINTON, LANCs.
 Tel: SW1 3232 (5 lines)

Name _____
 Address _____

T.8

in one syllable. This is very difficult to separate, although not impossible. But he may well have a gap between 'down' and 'the'. If so this is where the cut should be made. In a case like this the best place to cut is on the consonant. Pull the tape through slowly and mark the point where he starts to say 'the'. You want to find the exact point where it starts. Mark this on the first "the" and mark the beginning of the second "the". Cut and join and *you will be right*. The timing of the speech is then correct; if you cut inside the gap, you may alter the rhythm and this screams at you. By the way, if he breathes in just before the first "the" use that breath and throw away the other one. In other words use his *first* breath and *second* "the". This sounds perfect, you can't tell one breath from another and it preserves the rhythm. I once edited some tape I recorded on the flight deck of a VC10 and used a breath I took at Cairo to link up with a sentence spoken in Hong Kong!

If you are taking out a whole chunk, for example a complete question and answer, use the same technique. Or, if you like, cut on the *last* consonant in each case, the result will be the same. When you do take out a chunk, you must be careful that the level has not changed appreciably or it will sound wrong. You can sometimes get over this by sticking in a grunt from the interviewer quarried from a bit of the tape lost. Another useful trick is to edit in a pause. This must come from the tape to keep the background the same and is a good reason for always leaving five seconds of atmosphere at either the beginning or end of an interview or talk.

One problem in editing is the odd bit of background noise which changes, like the sound of traffic. You can usually mask this by cutting right up to the consonant because

the speech covers the background for long enough for the ear to forget its level, and you do not notice the break.

One useful trick in an interview is to edit out the question and join up the person being interviewed. You usually have to take out a "well" or some such bridging word. This trick will often improve an interview in which the interviewer had to prompt the speaker.

When there is slurring it can be tricky to find the exact spot to cut. I have a trick here with my Ferrograph, it is one that can be done on other machines too. It is to mark the tape where you think the cut should be and then hold the pinch wheel away from the tape with your thumb, start the motor and drop the pinch wheel back. This gives a virtually instantaneous start and you can check that the mark is in the right place before the cut is made. Incidentally you should not be too timid about cutting; you can always stick a bit back again. I always preserve the last bit of tape I have cut out until I have played the join. Then and only then I drop it into the untidy mess on the floor.

Interviews can sometimes be improved by changing the order of questions. Sometimes a point is brought up late in an interview which fits better earlier on. This is fully justified providing it does not in any way alter the sense or emphasis of the interview. This you must never do; it is unethical, and one *must* preserve the ethics of an interview. This is why you must never put an answer from one question on to another question, it is totally unfair to the man being interviewed.

Suppose you have recorded a piece in a noisy location and you want to go on to another noisy location, how do you match the two so that there is not a sudden and disconcerting change in background level? One way is to use the gain control to fade to zero at the end of the first bit. Then take a level at the new

location in the usual way and mark the position of the gain control with a wax pencil if it is not calibrated. Take the gain back to zero and fade it up to the correct level and start the second piece. Now when you edit you can cut on the fade so that the two background levels are equal at the cut. This, with practice, works extremely well and gives a perfect 'segue' as it is called.

Those are the basic rules of editing. When you know these the rest is practise, practise, practise. You get better at editing all the time and after a year or so you will be able to do edits that at first would be impossible.

Now, what do you edit? There are obvious things. Coughs and splutters should always be removed if possible. Obtrusive 'ers' should come out, but don't just go on a 'de-erring' binge and take them all out. If you do you may alter the personality of the speaker. In fact professional broadcasters often write an odd "er" into a script, it makes it sound more natural. Long pauses should be trimmed—this needs experience to get the pause just right and there are not any rules. It just has to be cut until it sounds right. Sometimes a professional editor may have several goes at a pause until it sounds natural. Clicks and bangs can come out if there is no speech over them. If you take out a clean bang, it is often better to put back some atmosphere in its place to keep that all important rhythm.

Editing music is an art of its own. Simple edits are easy, but to revamp a melody by editing takes musical knowledge and lots of experience. It is very difficult at even 19 cm/s and most music editing is done at 38 or even 76 cm/s.

To sum up, editing is essential, interesting and not half as difficult as you think. It is an art without which you are not a real sound recordist, and it is an art that you can learn and enjoy.

TAPE RECORDER SERVICE CONTINUED

of 160 gm will just begin to rotate, then backed off a little until the rotation stops. This is with the machine switched to 9.5 cm/s and in the rewind mode. With a full 18 cm spool loaded, the turntable should rotate at full speed.

In the fast forward mode, we have an idler engaging with motor pulley and outer section of spool carrier. But instead of being pulled in to this engagement by a spring, after release of a stopper, which is the usual arrangement, we find the assembly shown in fig. 3. The 'reverse c' lever is coupled to the main lever and in fast forward the lower arm of this lever disengages from the sprung lever B, allowing this to press against the bracket of the idler E, which then engages the two turning parts, as before. The only adjustment is the tag to which the spring affording this inward motion is attached, and the vital factor is the clearance of the c lever from the end of the B lever. It is a mistake to adjust the c lever to achieve this at this stage—necessary first to check the rewind adjustment, then return to fast forward for final tests.

On rewind, as the operating lever moves the other way, to the left, the main lever A pivots so that the c lever clears the end of the D arm,

allowing its spring to pivot D, and engage the two idlers RW1, RW2, which transmit the necessary motion to the left-hand turntable. All very straightforward, so far. But the c lever has to be adjusted for exact balance of clearance and for allowance of motor play, the pulley having some eventual movement, and for clearance of the idlers from the stepped pulley to prevent intermittent touching and 'drag'. The adjuster screw on the c lever is the first step, and then, if the clearance in the upward direction is not enough, the adjuster on the angled arm which holds the left-hand main idler. This can be a tricky procedure, and is certainly not to be recommended as a check-test adjustment, but only if it is obviously needed. If there is a 1-2 mm clearance between idlers and stepped pulley when the machine is switched to neutral, then leave well alone.

Brake adjustment, however, may need an occasional touch. Both the brakes should make together, and the time of making should be such that on selection of 'Forward' motion, the right one just clears as the take-up lifter begins to do its job. Problem? Where to find the adjusting screws. Unfortunately, it is necessary to get at these through the front of the mechanism, and this means unshipping the amplifier and control section and swivelling it

forward sufficiently to get a long, thin blade through the aperture in the centre front of the main deck. Once the mechanism is out of its cabinet, the entire amplifier section can be dismantled (as the makers put it), by removal of five screws. These are placed—viewing the amplifier section from the front—(a) between and below the meters, (b) just to the right of the meters, (c) below and between the plug-in board tag mountings, (d) just to the right and below the variable controls, and (e) just above the left-hand of the large electrolytic capacitors.

There are many more small points that could be mentioned; the slack absorbers, with their adjustment both for swinging motion and friction, which are fairly important for flutter elimination, the pressure roller and its individual adjustment, with the additional adjustments for the Mumetal shields and the velvet band by the erase head, plus odd electrical points we have not been able to cover. But space has been beaten us, and we must pass on to fresh fields with a final note that when reassembling, the brass distance pieces below the deck cover should not be forgotten, and the deck cover must be negotiated carefully past the slack absorbers, not forced roughly into place. Anyone tackling the job for the first time will soon see why I have ended thus.

A MINIATURE ELECTRONIC ORGAN

BY F. C. JUDD

PART ONE

THE circuits and constructional details given in this article are for a complete simple single-note electronic organ with a choice of four voices, vibrato and a range of 2.5 octaves from F (174.6 Hz) below Middle c to c at 1046.5 Hz. The dimensions of the case as shown in the diagrams allow only for the circuitry given which includes two transistor and component boards, both being contained in the right-hand compartment on the right (see photos).

In Part 2, next month, additional circuitry will be given for an octave divider and coupler which will allow the entire keyboard to be switched down in pitch by one octave. This is standard practice on commercially made instruments of this nature. A larger circuit board compartment will therefore be necessary as well as additional space for another power supply (for the divider). The compartment on the right could be made larger or a housing assembled beneath the case as will be shown in diagrams and photos. The reader has therefore the choice of constructing the simple basic version as in this article or one with the 'extras' that will be described in Part 2.

I make no claim for originality in the basic idea of a single note keyboard organ. There are of course a number of commercially made instruments of this kind available which, although quite versatile, are rather expensive. The design described in this article has the bare minimum of circuitry to allow for stable operation, clickless keying, fast and slow vibrato and a choice of four voices.

The output signals are in the region of 500 mv at an impedance of approximately 30 κ and will therefore load the line input of a tape recorder or audio amplifier. The output voltage is controllable. The instrument is quite suitable for normal playing in conjunction with a piano or full electronic organ, or can be employed as a tempered scale tone source for multi-track recording and electronic music. The voices are not strictly true organ voices, for it is not possible to produce them with such simple circuits. They do, however, provide contrasting 'flute', 'brass,' 'reed' and mixed flute/brass tones.

The design can be split into two main circuits (fig. 1) comprising master oscillator and vibrato oscillator board and the keying and tone shaping board. The master oscillator is a transistor multivibrator with keyed tuning controls between the negative HT rail and the base of one of the transistors. The vibrato oscillator, assembled on the same board, is a normal transistor phase shift oscillator, the output of which is employed to vary the frequency of the master oscillator. This gives true vibrato and can be pre-adjusted to approximately 10 Hz (fast) or 5 Hz (slow), or

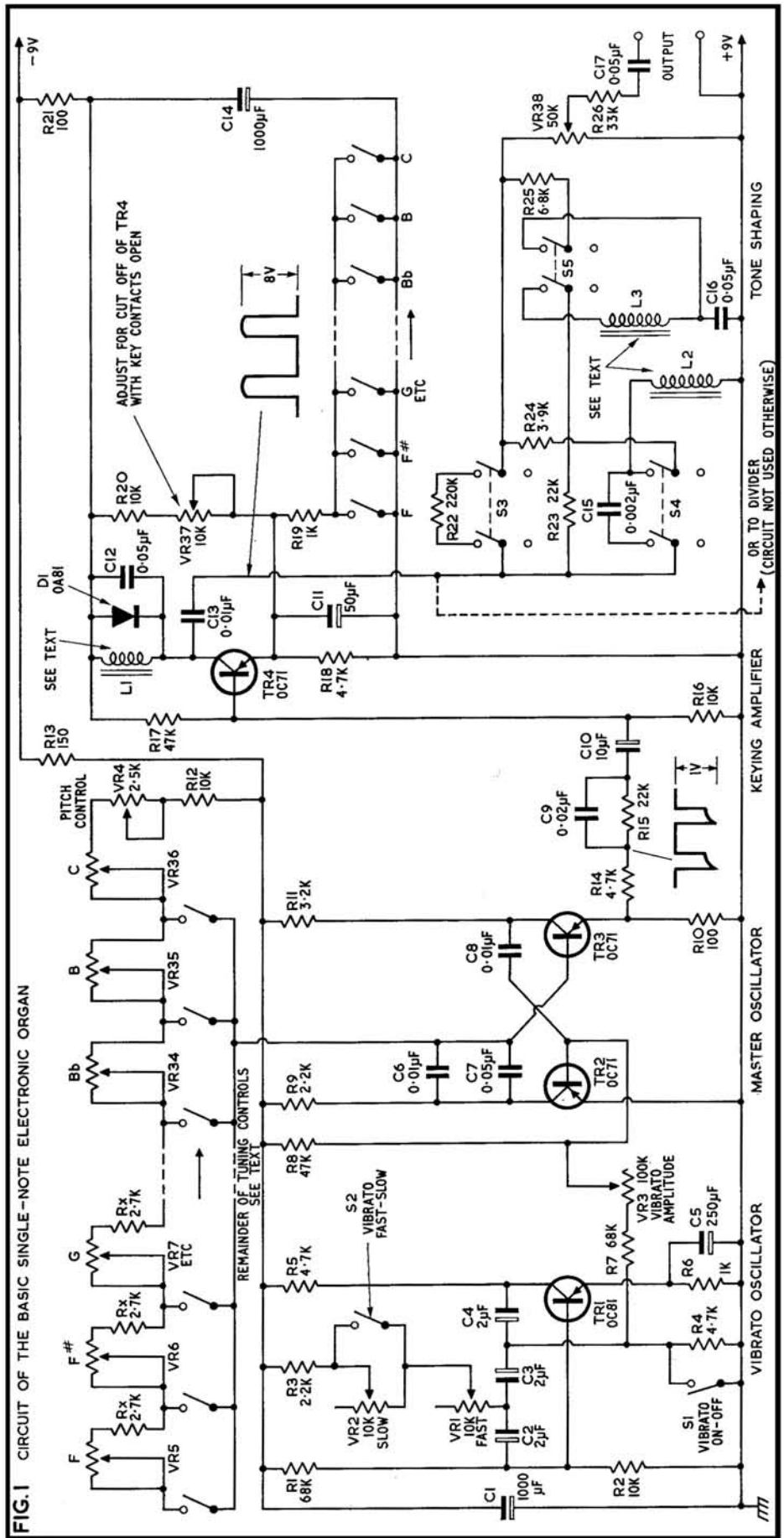

FIG. 1 CIRCUIT OF THE BASIC SINGLE-NOTE ELECTRONIC ORGAN

to suit individual taste. The amplitude can also be pre-set over a small range.

The output from the master oscillator is taken from the emitter of the second stage to a combined keying and tone shaping amplifier. The keyed output from the multivibrator cannot be used directly into an external amplifier because of key clicks. A keying circuit is therefore necessary. In this design the master oscillator tuning components are keyed just before the keying amplifier so that clicks from the oscillator keying are inaudible. The key contacts are conventional gold plated organ types (a minimum of two pairs of contacts per key) adjusted so that the oscillator contact closes before the keying amplifier contact.

The keying amplifier circuit is normally biased to cut-off with the preset control provided. When a key is depressed the transistor conducts and passes the tone already at its base. Tone or voice shaping begins in the collector circuit of the keying amplifier from which a near square wave is obtained. This waveform is switched directly to the output circuit and provides the 'reed' voice. The remainder of the voicing is produced by simple high and low pass filters, the high pass filter providing the 'brass' voice and the low pass circuit the 'flute' voice. When the flute and brass switches are both closed a quite pleasing hybrid voice composed of the two is produced. Any pair can be used also.

The choice of cabinet design can of course be left to the reader. The one shown in fig. 2 was produced to the smallest possible size consistent with the keyboard and housing for the circuits. The 32-note keyboard can be supplied to order by *J. F. Pyne and Co. Ltd., 118 Duncombe Road, Archway, London, N.19* at a cost of approximately £6 10s. The finished keyboard is supplied mounted on a baseboard and the length of the white keys (front to back) will be approximately 16.5 cm. This article and the name of the magazine must be mentioned when ordering to avoid confusion with other keyboard systems.

The first step is to adjust the overall case dimensions to fit the keyboard and accommodate the circuits. The photographs (figs. 3 to 9), including the diagram fig. 5, are intended as a guide to construction generally. The base of the case should be made first and the keyboard fitted as in fig. 3. The front panel frame which will carry the panel for the voice and vibrato switches and the mounting for the tuning controls should next be assembled as in fig. 3. The next stage is the return springs for the keys as in fig. 4. These springs are quite lightly tensioned and can be made from 1 kw electric bowl fire spiral element. Each spring is about 13 mm long and a turn at each is straightened out and looped over small wood-screws, one in each key and the other in the baseboard. Ensure that all the keys can be depressed with a light touch and that they will return to the resting position.

Now comes a slightly more difficult job, the construction of the contact frame. This can be seen quite clearly in fig. 6 and, mounted in position, fig. 8. The special electric organ contact sets can be obtained from *Henry's Radio Limited, 303 Edgware Road, London, W.2*. These each have two pairs of gold-plated make/break contacts, as necessary for the design in fig. 1. Quote "two pair, make/break

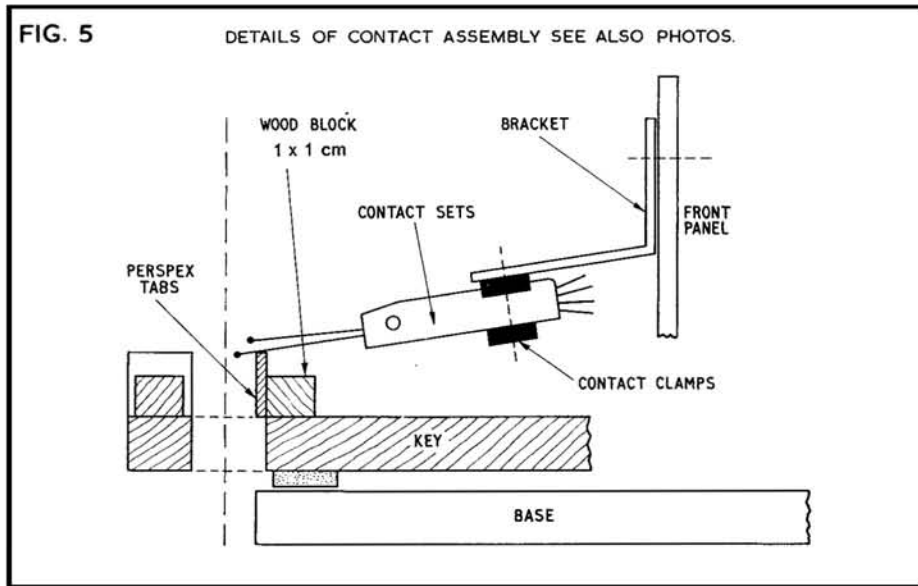
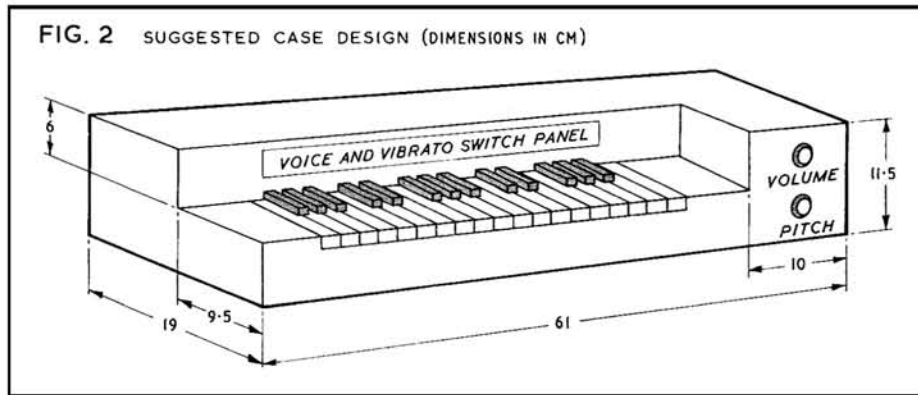

contact sets, transistor types" when ordering. Henry's Radio can also supply the Paxolin mounting rails. A side view of the contact assembly is shown in fig. 5. Note the small blocks at the end of each key. These are faced with a square of Perspex or Paxolin which close the contacts when the key is depressed. Note also that the master oscillator contact must 'make' before the keying amplifier contact. The pairs of contacts must therefore be adjusted accordingly and this should be done carefully without unnecessary bending.

When the contact frame has been assembled as in fig. 7, check that all the keys can still be depressed with a light touch and that they return to rest. The remainder of the case assembly can now be completed as in fig. 8. The tuning controls are next and, in the original, the 32 potentiometers and vibrato speed amplitude controls were mounted as in fig. 9 on 3.2 cm wide Paxolin strip mounted above the keying contact frame and centrally between the front panel and the rear of the case. This allows ample room for wiring the keying contacts, tuning controls and voice switches on the front panel.

A close look at fig. 9 will reveal the two circuit boards in the compartment at the far end. These boards were cut to fit the height and depth dimensions of the compartment and are quite large enough for all the components. They can be cut from standard Paxolin transistor assembly board. The 'pitch' control and

the volume control are mounted on the front panel of the circuit board compartment. The whole of the interior of the finished organ is shown in fig. 9, but as pointed out earlier the reader may have his own ideas as to the case size, shape and layout. The component board layout and physical position of the boards within the case are not critical, neither is the wiring of the contacts, tuning controls and voice switches. No screening or screened wiring were found necessary and no trouble will be experienced with 50 Hz hum if the recommended AC power supply is employed. A 9 v battery could of course be used to power the organ.

Although actual oscilloscope waveforms will be given next month as well as the circuitry for an octave divider, it would be as well to conclude this part with some notes on possible adjustments that may be necessary to some of the component values. These are listed as follows:

- | | |
|-------------------|--|
| (i) c2, c3 and c4 | <i>Vibrato oscillator.</i> May require lower value, about 1 μ E, to produce required 5 to 10 Hz oscillation. |
| (ii) R 12 | <i>Master oscillator.</i> May require adjustment to achieve true pitch for the top c (vr36) from which tuning is begun and continued downwards to F (vr5). |

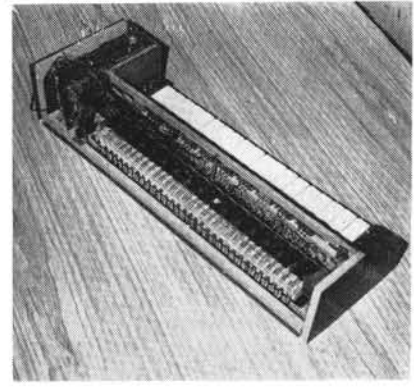
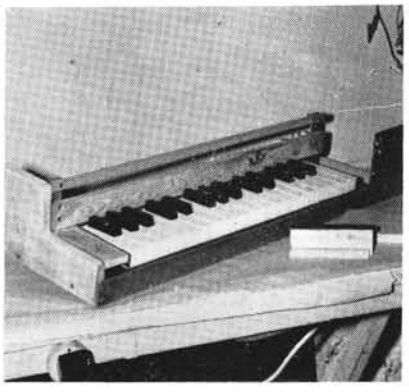
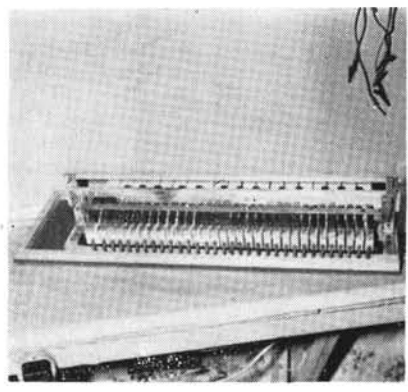
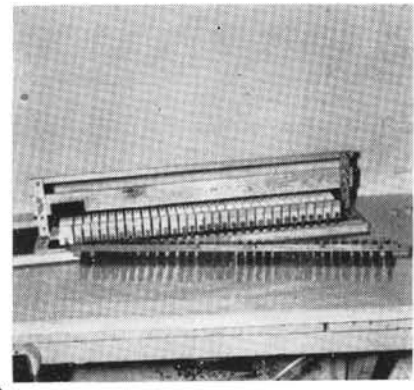
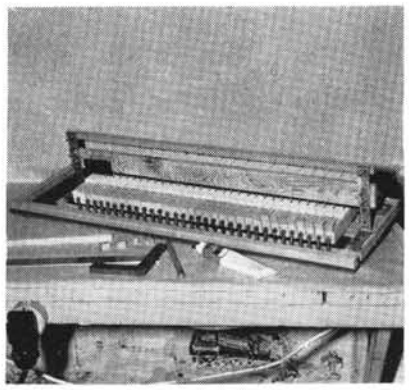
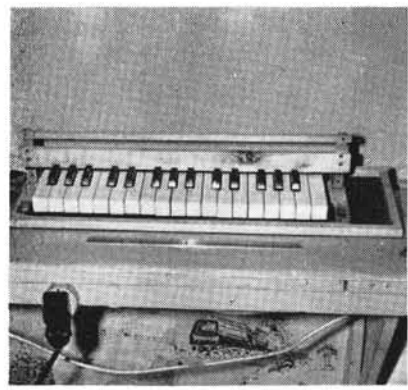

Fig. 3 (top left). Assembly of the keyboard.

Fig. 4 (top centre). Next the key return springs are fitted.

Fig. 6 (top right). The assembly contact frame ready for mounting.

Fig. 7 (lower left) The complete assembly of keyboard and contact frame.

Fig. 8 (lower centre). The casework is completed before the tuning controls and circuit boards are assembled.

Fig. 9 (lower right). The complete assembly. Note mounting method and position of tuning control.

Fig. 10 (left). The completed electronic organ.

Fig. 11 (right). The modified version which includes the frequency divider and its power supply (details to be given in Part Two).

COMPONENTS

Keyboard (32 notes)	J. F. Pyne & Co. Ltd. (see text)
9 V Power Supply	Electroniques PC101
Tuning Controls (32)	
Vr5 to Vr36	Electroniques MP10K Linear
Switches S1, S2, S3, S4, S5	Electroniques SS3271 or SS219
Vibrato speed Vr1 and Vr2	Electroniques MP10K linear
Vibrato amplitude Vr3	Electroniques MP100K linear
Volume control Vr38	Electroniques type E50K Linear
Keying amp pre-set Vr37	Electroniques MP10K linear
L1, L2 and L3	Electroniques P9002 (500 ohms primary)
Component Boards	Electroniques General Purpose Veroboard
Transistors (Mullard)	Tr1-OC81, Tr2-Tr3-Tr4-OC71
Diode, D1 (Mullard)	OA81 or equiv.
Control Knobs calibrated (2)	Electroniques NK2

The values of all other components are given in fig. 1. All resistors are 0.5 W—20% tolerance. Paper capacitors are standard types and can be low voltage working, say 150 V. Electrolytics should all be 12 V working minimum. All the components with the exception of the transistors can be obtained from Electroniques (STC) Ltd., Edinburgh Way, Harlow, Essex. Readers are advised to obtain a copy of the Electroniques components catalogue price 15s. from which component types and numbers can be chosen for ordering.

Author's Note. The circuit of fig. 1 and other constructional details included in this article are the copyright of the author. Publication does not imply that the design may be used for manufacturing as a whole or in kit form. For this purpose permission must be obtained jointly from the author and Link House Publications Limited. The author regrets he cannot provide wiring and layout diagrams or alternative circuitry to suit other components and transistors, or for facilities different from those given in the design.

(iii) RX

In series with vr5, vr6 and vr7 only. Nominally 2.7 k but may require adjustment to achieve pitch of lower E, F and G notes.

(iv) c12

May require adjustment to produce nominal output from Tr4, as shown at an 8 v p-p signal. Will depend on inductance of L.

(v) L1, L2 and L3

These are small transistor output or coupling transformers with a primary winding of approximately 500 ohms DC resistance. Secondary not used and left unconnected.

(vi) R22, R23, R24 and R25

May require adjustment to achieve uniform output signal amplitude.

The recommended power supply unit is the Electroniques PC101 which provides 9 v fully smoothed HT at sufficient current for the oscillator and keying circuits. If the power supply is home constructed, the smoothing capacitor, assuming a full wave bridge rectifier is employed, should not be less than 2000 μ F.

Those who decide to incorporate the frequency divider will require a second power supply with 9 v— and 2 v+ outputs. Details for this will be included in Part 2.

If the power supply is to be included within the case the circuit compartment can be made larger to accommodate it. An earthed metal screen should be placed between the power unit and the component boards. Otherwise the left-hand end of the case could be extended or a small box built underneath.

The keying amplifier preset vr37 must be adjusted so that Tr4 is just cut off—with no collector current and no signals leaking through. This must be checked with the key contacts open.

Before tuning check that all keys operate properly and that the vibrato oscillator is functioning. The vibrato presets should be adjusted so that a light pleasing tremulant effect is produced with most of the potentiometer vr3 in circuit.

For tuning, the vibrato must be switched off and each note tuned in order from the top c. Tuning can be done quite quickly with a piano or another electronic organ by 'zero beating'. Before commencing the tuning set the 'pitch' control to midway position. This will provide a variation in overall pitch of approximately plus or minus a semitone so that the organ can be set to pitch with other instruments slightly off concert pitch. The stability of the tuning is such that after several weeks of intermittent playing and over a wide range of room temperatures no adjustment has been necessary. The instrument was originally tuned against a Lowrey organ at concert pitch.

Part 2 will include photographs of oscilloscope waveforms from this design and will give details of a frequency divider/coupler circuit that can be incorporated with very little circuit alteration. Additional space is obviously required for the divider and its power supply and the writer's version of the 'second' model incorporating these features is shown in fig. 11. The completed organ described in this article is shown in fig. 10.



PHILIPS TAPE RECORDING BOOK (3rd Edition). By Frederick Purves. 180 pages with line illustrations. Price 19s. 6d. Published by Focal Press Ltd., 31 Fitzroy Square, London, W.1.

THIS is the third edition of a paperback that has already established itself, and is well-known to a limited readership. Let us widen those limitations: after all, despite Tony Richardson's contentions in the world of the cinema, this is the critic's duty. Because Frederick Purves's work deserves a wide audience, and because this book, despite its name, should appeal to any newcomer to tape recording and would afford much useful advice to many who fancy themselves adequately experienced.

In other words, this is not merely a work of propaganda. It is, true, tied to the Philips stable, and uses this company's products to demonstrate the author's argument. And why not, when they have hogged such a large percentage of the market? (Grundig account for a good deal of the rest, and it may be of interest that the same author has served Grundig equally well with a similar work published in the *Focal Soundbooks* range.)

Somehow, in 13 close-packed chapters, Mr. Purves has managed to cover the field of tape recording techniques, including a number of trick facilities and the awkward subject of editing, with recording and replaying treated separately where applicable, and the actual machine described in sufficient detail to whet the appetite of the type of chap who is a little afraid of this mysterious device. But, more important, he gives full weight to accessories and methods of inter-connection, with some sound advice (no pun intended) on matching. No space is wasted on the fundamental business of tape recording theory; a short first chapter suffices to lay the ground. The author's approach is severely practical and he hardly puts a comma wrong.

It would take too much space to detail the chapters. A general recommendation must suffice. Perhaps the best summing-up is given in one sentence from Chapter 10. "It doesn't matter what your job is, your tape recorder can usually help you do it better." I go along with that, Mr. P., and would add that for the service engineer and tape recorder salesman, the 'green pages' that occupy the last part of this book prove an invaluable aid, with concise data on the various machines, cross-reference between the makes in the Philips stable, and, just previous, a table of microphone specifications. Well worth its modest price—and not only for Philips owners. **H.W.H.**

TAPE RECORDER CENTRE

GO WHERE YOU KNOW



YOU GET THE
BIGGEST SELECTION
FINEST SERVICE
BEST EASY TERMS

ALL LEADING MAKES AVAILABLE

Akai, Ampex, B & O, Brenell, E.M.I., Elizabethan, Ferguson, Ferrograph, Grundig, Loewe-Opta, National, NuSound, Philips, Repts., Sanyo, Sharp, Sony, T.R.D., Tandberg, Telefunken, Truvox, Uher, Van Der Molen, Vortexion, Wyndson, etc., together with a wonderful range of Tape Accessories.

SEE THIS EQUIPMENT

TELEFUNKEN SPECIALISTS

See, hear and compare the complete range of Telefunken Stereo and Mono Tape recorders. Our experienced staff are able to give expert advice and also demonstrate the many outstanding features of this wonderful range of equipment.

M203—4-track stereo recording, 1 $\frac{1}{2}$ and 3 $\frac{1}{2}$ i.p.s., stereo playback through external amplifier or radio. Price from £88.18.8.

TELEFUNKEN 204E—4-track stereo record/replay. Few available at our special price of 95 gns. (Manufacturers list price £136.12.5)

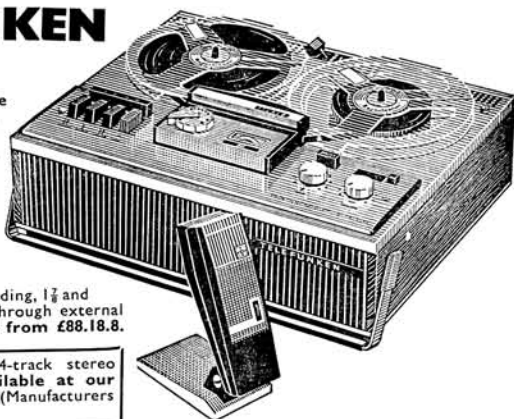

Come to The Tape Recorder Centre, the largest showrooms in Great Britain devoted exclusively to Tape Recorders and Tape Recording Equipment. Whether you are interested in a general purpose tape recorder on a de luxe professional machine, the staff of The Tape Recorder Centre will be pleased to give you the benefit of their many years experience of selling everything in 'Tape'. Every make and model of tape recorder is available for immediate demonstration. Make your choice at The Tape Recorder Centre and be certain of purchasing the machine that is ideally suited to your individual requirements.

Remember—the Tape Recorder Centre Showrooms are the only showrooms in Great Britain specialising exclusively in the sales and service of tape recorders.

- Over 100 Models on Display
- Expert Staff—Expert Advice
- Easiest Hire Purchase Terms
- Generous Part Exchanges
- Free After Sales Servicing

Only one minute from Holborn Tube Station—Half-day Saturday
WE OPERATE A PERSONAL EXPORT SCHEME
SAVING UP TO 20% ON LIST PRICE

***BRITAIN'S
LARGEST TAPE &
HI-FI SPECIALISTS**

THE TAPE RECORDER CENTRE



*PART OF THE *NuSound* ORGANISATION

THE TAPE RECORDER CENTRE LTD. 82 HIGH HOLBORN, LONDON, W.C.1. TELEPHONE: CHAncery 7401/8354

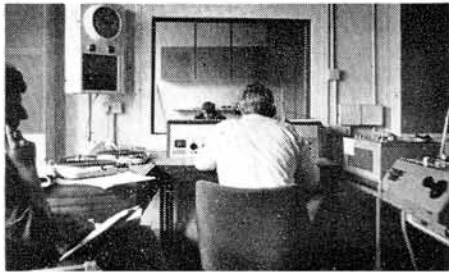

A

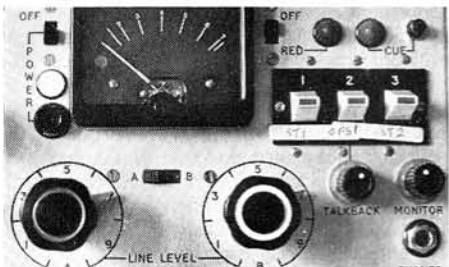

B



C

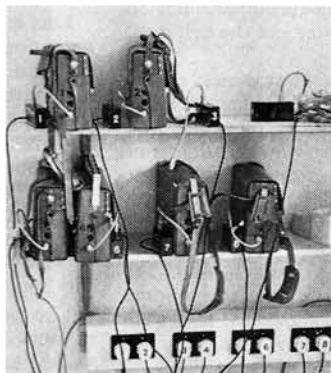

D



E



F

BBC RADIO BRIGHTON

a pictorial visit by Robert Prizeman

A A recording of poems in Studio Two being made on a Revox.

D Six of the eight Uher portables under charge.

E Studio One, viewed from its control cubicle.

B and C Detail of the Peto Scott mixer.

F Thorens turntables in the Studio One control cubicle.

AT 6.15 p.m. on Wednesday 14th February 1968 a new era began—BBC Radio Brighton was on the air.

The new station is designed to increase the community spirit within Brighton, as the growing population is spreading out and losing contact. Now they are united on 88.1 MHz. Radio Brighton can be heard from 6.30 a.m. to 2.00 p.m., averaging about five hours local material a day.

Bob Gunnell, the station manager, has a limited budget with which to maintain the programme output. The key word, therefore, is economy. As an example of how important a consideration this is, edited tape is re-used except on the portables but, as Bob Gunnell explained, they edit as little as possible as it is a waste of both facilities, staff, time and tape. Like all the other local radio stations, Radio Brighton is completely independent of London—except for money. Occasionally, their programmes will be broken into with news bulletins and special programmes broadcast from their 'radio car' which can reach a location within minutes.

Radio Brighton has only two studios housed in an old insurance building close to the Brighton Pavilion. Although the well known BBC atmosphere predominates, Brighton has a special air of its own—casual and unhurried. A staff of 18 work irregular hours to keep the station going. This figure comprises the station

manager, a programme organiser, six presentation assistants, one of whom is an expert on educational matters, one general station assistant, three overworked station assistants who have in fact edited and produced their own programmes, three secretaries, one receptionist and two very essential engineers. As Bob Gunnell said, "the purpose of a local broadcasting station is to serve the community in which it is placed". And so it does, for even while I was there three local writers arrived to read their works. Brighton is lucky in having these and many other free-lance workers available. Radio Brighton really does bring the local people into the homes of Brighton, for on my way to the station I saw a 'passer by' being interviewed—an occurrence very rare in the national programmes.

As far as equipment is concerned, economy is still the most important consideration—in fact Studio Two could well be an advanced amateur set-up. Tape machines employed are five of the Philips professional models, also used in Broadcasting House, one Revox (high speed version of course) and eight Uher portables which are constantly on charge and ready for use at any time. I even came across a Robuk in an upstairs room, but I don't think it was used for broadcasting. Microphone-wise, STC ribbons were employed only in Studio One and for outside broadcasts. The microphones employed generally were the new AKG 202s, which were mounted on the tables

and not suspended. The mixers used were modified versions of a new very versatile Peto Scott mixer, which is available commercially. Gramophone turntables are by Thorens and monitoring is carried out through Goodman's *Maxims* or headphones. The teleprinter is installed in one of the offices for immediate reports from all over the country.

Studio One is quite fascinating, because the control cubicle mixer, turntables and decks are duplicated in the studio for operation by one person. At about 30 seconds to 1 p.m. I watched the announcer casually stroll into this studio, hang up his coat and, with one eye on the clock, fade out some music from a tape which had been playing unattended and announce that they were going over to London for the national news, which they did—immediately. Perhaps this is not so amazing in professional circles, but the casual and skilful operation greatly impressed me.

Similarly in Studio Two, I sat through a 30-minute live programme called *My Kind Of Music*, during which Bob Gunnell interviewed a local personality who selected several pieces of music which was directed in the cubicle by one operator only.

Brighton is only an experimental station, but in my opinion it is already such a success that other local authorities should follow its example with similar set-ups; that is assuming various financial difficulties of which one reads will be overcome.

WHAT'S IN A CLUTCH?

BY WILLIAM HENRY

PART 2 — INDIRECT CLUTCHES

1

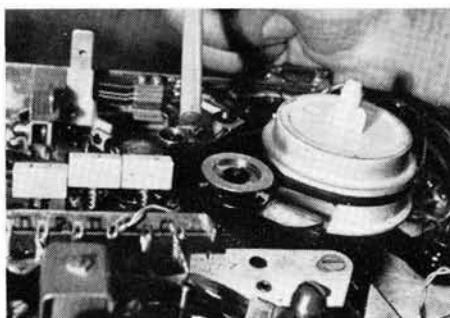

Grundig TK400.

2

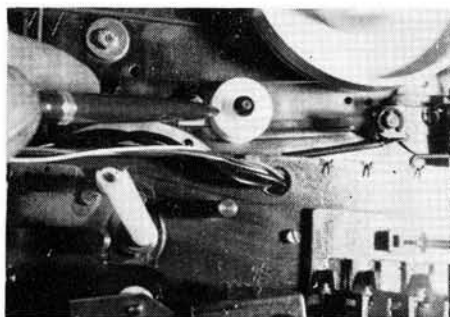

Van der Molen spool carrier.

IT is impossible to talk about clutches without considering belts. We have already seen that belt drive plays an extensive part in domestic tape transport design, and an inspection of some belt-driven clutch assemblies would seem to bear out the argument that complications escalate. It would be interesting to know whether the designer thought first of using one particular drive system and then had to devise clutch methods to suit it, or whether he attacked the problem from the other end. Whatever the answer, we, who repair the blessed things, have to see the design as a whole before we can feel confident about our clutch adjustments.

3

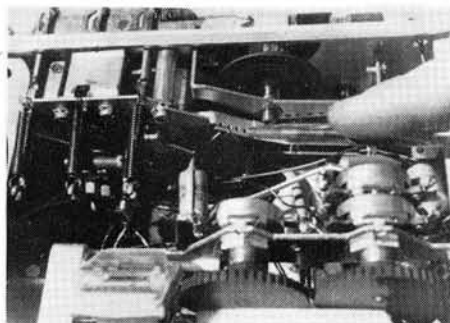

Van der Molen turntable support.

In general, round belts are used where slipping clutches are the take-up technique, and shaped belts where the turntable is a fixed unit (with respect to its axis) and the belt itself provides the necessary slip.

We know already that the thickness of the belt affects the speed of the machine. A small belt has less effect as regards variations and will often be shaped, even when it does not have to slip. A thick belt on a small motor pulley would have to be very accurate, and not subject to ageing changes in diameter if good speed constancy is to be maintained. Shaped belts and larger diameter motor pulleys are more the vogue in present-day machines. Some of the round belt types of the recent past were notoriously subject to permanent deformation with temperature change or disuse.

Worn and hardened belts are a prime fault cause and, as their effect is sometimes more evident on one function than another, difficult to trace. It is often cheaper, and more efficient, to replace all the belts on a doubtful machine before attempting to make any adjustments. The very wide range of belt kits pre-packed by *Tape Recorder Spares Ltd.* (9 Harmsworth Street, London S.E.17) makes this a reasonable proposition. We discussed the jockey pulley and its effect last month. An extension of the idea is the jockey which deliberately alters the tension of a belt for different functions.

Among the several which use this method in conjunction with the slipping clutch are the notable examples of the Grundig TK400 and Van der Molen VR4 and VR7. In both cases, rubberised fabric belts (or, more correctly, bands) are used and the clutch action consists of a light drive during take-up with a more decided action for fast winding as the belt is tensioned by the swivelling of a bracket on which a jockey pulley is mounted. Fig. 1 shows the Grundig method, where there are actually two roller pulleys. The smaller one, indicated by the pointer, is on a pivoted bracket with a tail that sits against a stop in the neutral position and a torsion spring with a long tail to hold the bracket so that it applies a set inward pressure to the drive band. This pressure and the verticality of the pulley are the two factors that matter most. On later versions a pulley with small flanges may be fitted: this is now a standard replacement for TK400 machines that need repair, now that

this model has been withdrawn. This part is known as the compensating roller and an attempt at adjustment will soon show you why. If the belt is pushed down when the machine is switched to play, it should return to the mid-roller position as soon as fast forward is selected. With the roller bracket swivelled by hand so that the roller disengages, in the play function, the drive should slacken off. In fast forward, it should still be sufficient to rotate the turntable.

This rotation is made possible by the inward movement of the other pulley, the one to the front of the turntable, which is mounted on a crescent bracket with a fairly obvious (dangerously obvious) adjustment screw. Another adjusting screw is on a collar which slides along a rod to the right front of our illustration. This collar must be adjusted so that the fast forward belt pulley spring is just not quite tensioned. This is the spring on a Bakelite arm attached to the larger of the two pulleys. Correct adjustment is a very tricky business and unless the machine is in regular use, may well be a wasted labour.

Less exacting, but as important for correct operation, is the slipping belt arrangement of the Van der Molen. Although the Grundig may have seemed straightforward in assembly, there is actually another disc section with felts and brake cord beneath it. The Van der Molen has none of this. There is simply the spool carrier, whose edge can be seen in fig. 2, a fabricised belt in a groove around its periphery and coupling directly to the motor pulley, and a plastic pulley wheel on a swivel arm. This last item is indicated in the illustration.

The position of the pulley determines the amount of slip the belt will have on the motor pulley, and thus is lower for take-up than for fast winding (this is a vertically operated deck). Rods with compression springs, and terminating locknuts, provide the movement, but there are one or two special considerations. A lead weight droops to the right of the pivot arm, and must act as a balance on play, whereas fast winding forces the arm lower and the wheel higher. This seeming compromise can take a lot of delicate adjustment, but the basic rule is to ensure that the pivot arm is horizontal during play, and then to alter tensions by changing the position of the actual spool carrier bearing! This bit of cheating is possible by slackening the hexagonal-headed screw at the top outer corner of the deck.

On the left-hand side and although not strictly a clutch, still relevant to our argument, the spool carrier sits on a sprung section, shown in some detail in our fig. 3. Unless this back tension is correct, no manner of clutch adjustment will affect the compromise between play and forward wind. Similarly, if the motor pulley is fouled, or the belt frayed, adjustment will offer only temporary reprieve. Note please that there are two sizes of belt: a better grip was obtained on later marks by the fitting of a rubber tyre to the right spool carrier, and belt size was lengthened accordingly.

The classic slipping belt drive with take-up tensioning roller is the original Telefunken design. Fig. 4 illustrates this in basic form. Telefunken belts are more heavily constructed than the foregoing drive bands, and are rather expensive. Fortunately, the spring tension can be adjusted within quite wide limits to get the

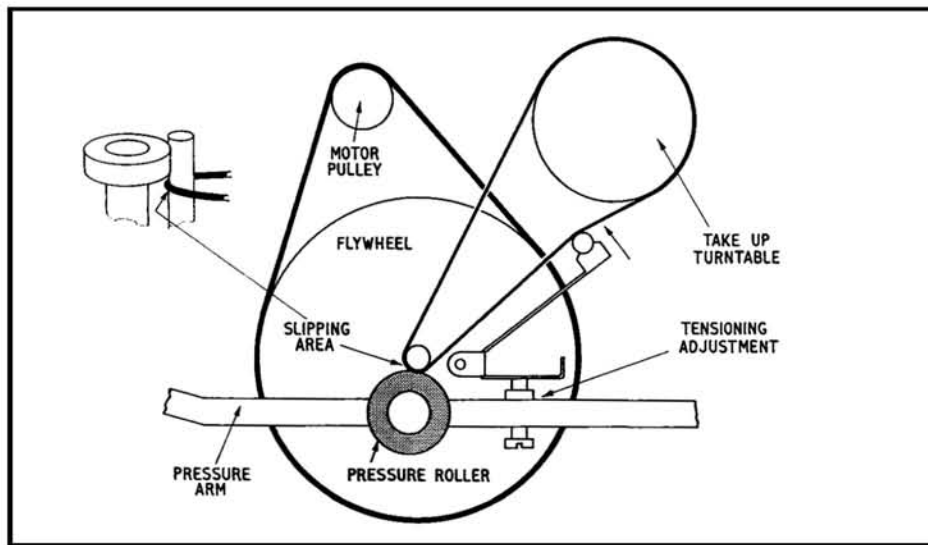

Fig. 4. Telefunken belt drive.

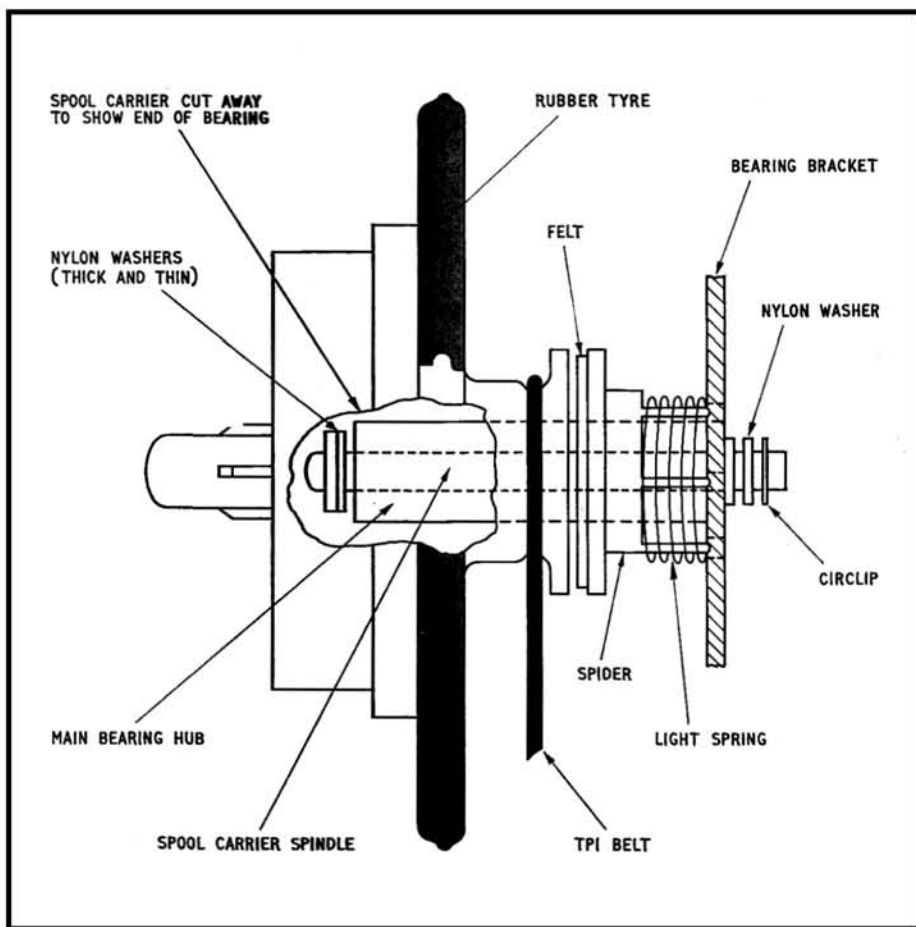

Fig. 5. Van der Molen vertical take-up clutch.

belt grip we require. The idling speed of the turntable, with this kind of design, is arranged to be slightly higher than the maximum spool speed. In this way, slack tape is taken up very quickly and without distress. (Always provided you have the brake tensions right—but that is another story!)

The great enemy of these fabricised belts—as indeed with ordinary rubber belts—is oil that has strayed from an over-eager attempt to improve matters by lubrication. Apart from one or two vital spots, idler bearings, capstan bushes and some pivot points, there is very little need to apply oil or grease to the average

tape recorder mechanism. Oilite bearings have been employed for years, and these do not need re-oiling for very long periods. Adding oil which may well be of the wrong type will result in a kind of emulsion that makes the eventual 'lubrication' more like a backwater mudflat. However, life is never simple, and dust finds its evil way into the works. This makes greased slides and pivots take on an unappetising appearance and cleaning jobs ensue, so re-lubrication may be needed. If so, keep the amount of lubricant to the utmost minimum. One or two spots should suffice for a spindle, the thinnest of smears for a slide. If any grease or oil gets on or near the fabricised belt, you are in trouble. These belts depend on the relative friction of the material between rubber, or fabric and brass, steel or plastic, and tensions are adjusted accordingly. Alterations in the relationships of the friction surfaces will alter the slip, lead to jerky take-up and, if you are not watching, probably ruin a precious tape by winding it round and round the capstan.

A point at which friction can have an adverse effect and be unsuspected, is at the bearing of the turntable spindle. Although the relationship between belt or idler drive and clutch drum may be correct, and all tensions and torques in order, a constant tendency to slip during take-up can be caused by a worn bearing or even a little grit between spindle and the bearing cylinder wall. The exact opposite effect, take-up so hard that the tape is pulled faster than the pinch roller wants to allow it, is a very real danger with the slipping belt types of clutch. Too much friction between belt and slipping surface can cause this. Where particles of rubber from the belt have worked their way between fabric and pulley barrel, then mashed into a tar-like coating with the constant reheating, a good deal of unwanted friction can build up. Take care when cleaning this away not to get any of the diluted mixture on the driving band. Simply wiping the pulley with methylated spirit as it revolves will not do. The band must be temporarily removed and any residual cleaner left to evaporate before the replacement and re-running can be carried out.

Frayed fabric is another danger here. My wife brushes my lapels and makes cryptic remarks about hairs having a clinging habit—she is, of course, talking about the dog's perpetually shedding felt—but it is true that fine threads will insinuate themselves easily into moving systems. Quite often, removal of a bearing ball or cup reveals a nest of fine hairs. Any sign of fraying should lead one first to investigate possible causes such as a pulley slightly out of vertical alignment, and then to think about drive band renewal.

We have already mentioned the Van der Molen *Collaudatore* deck as an example of the slipping belt clutch. Another example of clutch action providing the necessary back tension can be gleaned from this deck. Fig. 5 has already appeared in a servicing article in these pages, but will, with the Editor's permission, bear a repeat. This is the construction of the left-hand spool carrier and subsidiary clutch of the *VR7* deck. The idea is to obtain sufficient back tension to prevent tape 'looping' but to allow a full torque back drive when rewinding

(continued overleaf)

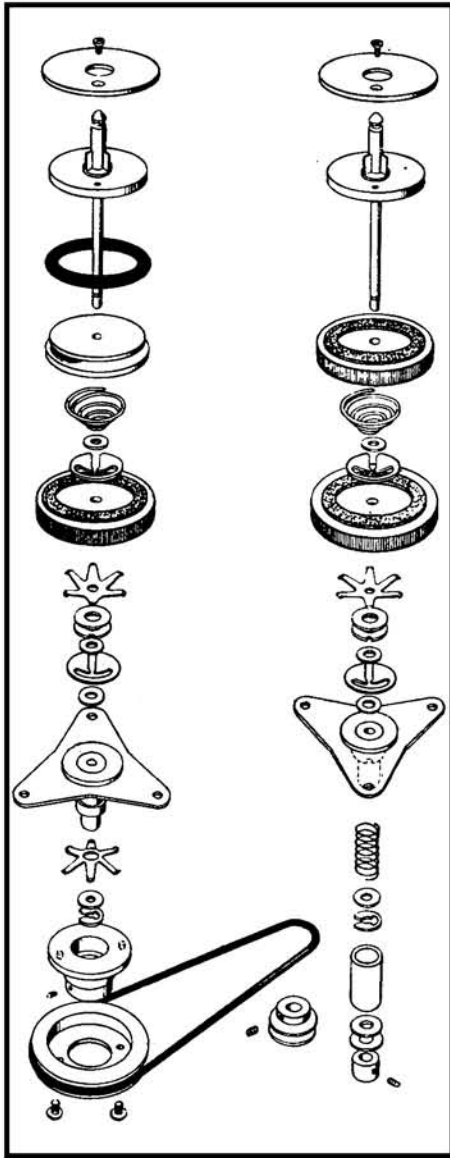

Fig. 6. Exploded view of Akai clutch.

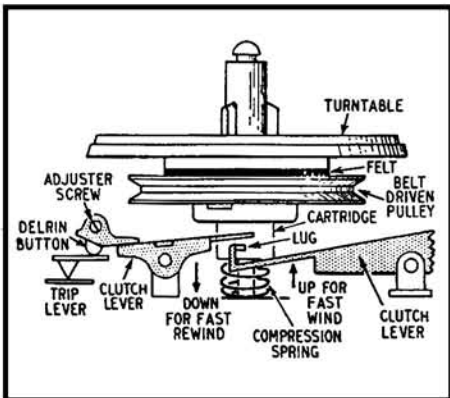

Fig. 7. Tandberg clutch system.

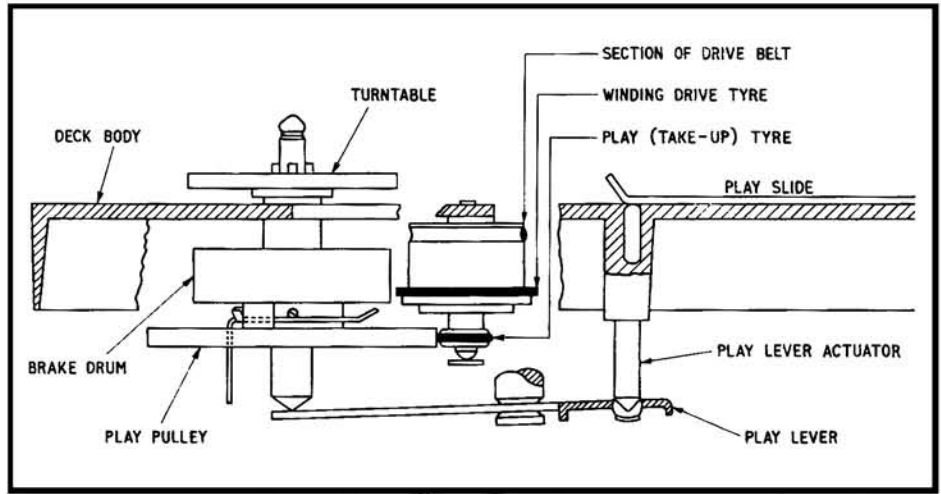

Fig. 8. Ampex 753 arrangement.

without resorting to further levers and decoupling arrangements. The solution is a lightly sprung 'riding' clutch, in this case achieved by a small 'spider' whose feet insert through clearance holes in the deck. Its upper (outer in the vertical operating mode) surface has a layer of felt which is kept in engagement with the carrier by a light spring. Problem is to maintain this light pressure, which must also be no hindrance to the rewind action, where pulley drive again comes into play. Once again, the bearing points, the spindle, plastic washers, and the barrel of the bearing itself, must be kept clean and just adequately lubricated.

The spring bearing, such as employed by Grundig quite extensively, and in various forms by others, is exemplified in perhaps its most awkward form in the Akai clutch system. Fig. 6 shows an exploded view of the spring friction type which they find necessary to enable their machines to operate vertically. As we can see, several discs, plates, springs and felt pads are needed, and the variation in grip is given by alteration of the angle of the legs of the starfish-shaped washers. Note that there are two felted drums on the take-up side. This is partly needed to ensure that when fast winding is selected—it being part of the action to go 'through' play to get to fast forward—there will be a little 'give' in the spool carrier section to prevent snatch and possible tape breakage.

A word of warning is needed here. These decks are intended to operate with a very 'tight' tape tension. A popular testing method with engineers is to switch to a function, with no spools loaded, then twist the opposing spool carrier by hand to see what tension is applied. The results with Akai decks can be alarming, but the whole thing evens out well, and as long as you remember that *all* tape running points must be included when testing, things will be in order. And by *all*, we must include those innocent guide pins and brackets on the top plate, which we removed when we began repairs! On this deck, as on Ferrograph, for example, or Brenell, we find the very effective captive roller. Unfortunately, omission of this from the tape path changes the nature of the tensioning entirely—and this is the clue to

another fault relevant to clutching. Always check that such rotating guides as these, or the tape pins that Telefunken use, are free to spin. Added friction here will upset all our other calculations.

A spring-assisted clutch of a different nature is illustrated in fig. 7. This Tandberg design is an example of a whole class of clutches which rely on very exact adjustment for practically trouble-free operation. In my own experience, more troubles are caused by well-meaning attempts at clearing tape drag, flutter, spillage and similar faults by indiscriminate clutch adjustment than by any actual clutch fault. In our diagram, the clutch is in the play position, with the compression spring being allowed to do its job of pressing the lower cartridge up to transmit torque to the turntable from the belt-driven pulley, via a felt disc, once again. Gravity plays a small part in this assembly, and there will be very little adjustment needed to operate the deck either vertically or horizontally. In fact, Elstone Electronics issue a kit for 'vertical conversion' which simply consists of an end-play limiter for the flywheel capstan spindle. The clutches can look after themselves.

Tandberg make a very fine mechanism, and the adjustment of the clutch levers should only be carried out according to their quite detailed instructions. I understand a servicing article is in preparation on Tandberg machines in general, and details may be omitted here. This drawing, and that of the Akai clutch assembly, appear by courtesy of *Electrical and Electronic Trader*, and I am indebted to the editor for allowing me to use them, and to the manufacturers and distributors for their original preparation. For the photographs, I must shoulder the blame alone, and for figs. 4 and 8.

Which brings us to fig. 8, and Ampex, who have their own ideas about clutch operation. These include rocker lever assemblies and tyred pulleys driven by belts. On some domestic models there has been a little belt trouble, and replacement with an improved type soon overcame that, but in general the only problem is impaired friction either due to excessive lubrication or to an ingress of dirt. In the sectional drawing based on the instructions in their manual for the 753, we see that the clutch pulley simply contacts the tyre on the play wind pulley, and the only true adjustment is alteration of the angle of the tab on the actuator

(continued on page 424)

readers' problems

Readers encountering trouble with their tape equipment are invited to write to the editorial office for advice, marking their envelopes "Readers' Problems—Tape". Replies will be sent by post and items of general interest may also be published in this column at a later date. This service does not, however, include requests for information about manufacturers' products when this is obviously obtainable from the makers themselves. Queries must be reasonably short and to the point, limited to one subject whenever possible. In no circumstances should such letters be confused with references to matters requiring attention from other departments at this address. We cannot undertake to answer readers' queries by telephone.

UNSTABLE TAKE-UP

Dear Sir, The spool holders on my Sony TC200 have an up and down movement of about 7 mm. They are lower than the tape head with the result that the spools wobble and wind unevenly. Any cure you can suggest will be appreciated.

Yours faithfully, P.M., London N.W.3.

About 7 mm vertical play is normal with the spool carriers of the TC200, and there is no adjustment. It is difficult to see how they can be lower than the head, unless someone, at some time, has removed the thrust washers from beneath the lower bearing.

If spools wobble and wind unevenly, it is more likely to be bearing wear. This is not a fault we have suffered with the many Sony models we have handled—but everything has to happen once. The very real possibility is physical damage perhaps through someone's well-meant but misguided attempt at repair by trying to 'straighten' the spindle. This may cause it to sit slightly askew in its deck bearing and nothing you can do will from that moment save the wobble.

We would strongly advise your taking it to a Sony agent for repair.

A VORACIOUS SPECTONE 161

Dear Sir, Can you assist at all with service information on the electronics of the Spectone 161, which has been a faithful servant now for several years? It has in the past six months developed a voracious appetite for EL84's, which it eats at the rate of one every two months, the machine being in use for several hours each day. All measured voltages are within Mullard's handbook tolerances, but

they continue to burn out! This could be one of the 'standard faults' that arise so often, so I'm asking your advice.

Yours faithfully, J.S., Newcastle.

There is no published information on the 161 and, as Spectone has long been out of the tape recorder field (they still manufacture electronic defence equipment) we are not likely to get any direct help from source.

Nevertheless, this seems a straightforward kind of fault. A voracious appetite for output valves indicates one of two things: excess of drive or incorrect load. The first is easily checked. Make sure your inter-valve coupling capacitors are of the best possible quality. No compromise: this is the position where it really matters.

The second factor is not so easily checked, but it is common enough to arouse suspicion. This is simply leakage between windings of the output transformer. Usually, this item is skimmed a bit, except on first-class equipment. And, ironically, it is this item which determines just how good an output stage is to be. So, when replacing, do not look for the original. If you are satisfied with the overall performance of your machine, rebuild the output stage to a better design; follow a circuit that you know, or have had recommended, to be good. For example, in this context, why not try the EL84 in an ultra-linear mode? With the right transformer, costing maybe £2, you can drive an external loudspeaker in a decent enclosure and get remarkably improved results.

TRUVOX PD82 WOW

Dear Sir, I have a Truvox PD82 tape unit, about five years old, and would appreciate your advice.

For about the first few minutes or so of running, reproduction is ruined by wow and flutter. After this it disappears and reproduction is as good as it ever was.

I have made sure everything is clean and free from grease, etc., lubricated the motors, capstan and flywheel bearings (without stripping) and checked the pinch wheel for flats without overcoming the trouble. There is one thing I have noticed—particularly when the pinch wheel has been freshly cleaned the tape does tend to adhere to it, but I have tried the pinch wheel from my R92 recorder and this doesn't overcome the wow.

Do you think, as the instrument is used ten-twelve hours a week, that the record playback head needs renewing? I realize this last query has nothing to do with the wow—the head is beginning to look uneven.

Yours faithfully, E.P.P., Romford.

The fault you describe could well be caused by a faulty motor, which evinces these symptoms during its 'heat-cycle' running up time. You can prove this by switching on the motor alone for ten minutes or so before a replay session, then checking for wow after the customary ten minutes. If it still appears, suspect that rather 'sticky' pressure roller. Check, especially, the roller spindle. These are a good fit, and quite a minute grain of hard matter within the barrel of the pinch roller bearing will cause a fault. But certainly, there should be no tendency for a tape to adhere after cleaning—this prompts me to wonder

what you use to clean it. Have you tried the new Bib kit, which has an excellent cleaning fluid?

If the head appears worn—it is! These heads will operate fairly well to a greater extent of wear than many, but if the wear is sufficient to be visible, they must be pretty bad. Have a look through an optician's or watchmaker's eyeglass, and you may get a shock.

We would mention that the older type of foam pressure block on these machines tended to harden and cause premature head wear through tape pressure, always accentuated by poor tape. Felt or baize covering is necessary.

AKAI M8 SPOOLING

Dear Sir, The drive to the take-up reel on my Akai M8 tape recorder is noisy and uneven. The noise appears intermittently and seems to coincide with a slackening of the drive. I suspect that the trouble is progressive; recently the drive has got so slack that the tape tension does not keep the automatic stop lever up when there is a nearly-full 18 cm reel on the take-up turntable.

I would be very grateful to you for suggestions for overcoming this rather annoying fault. Yours faithfully, T.S., London S.W.15.

The mechanics of this machine were dealt with in a previous servicing article, and it would appear that you have not seen this.

The noise problem is almost invariably caused by the drive idler, whose bearing wears unevenly. It is often advisable to replace idler and bearing bracket. Changing from composition to neoprene bottom washer can help, but is not a complete answer.

The slack drive can be adjusted by altering the star washer positioning in the appropriate spool carrier/clutch assembly. An exploded diagram of the spools and clutches accompanied my original article. If you do not have this by you, we must urge one precaution always make a drawing, or lay out the washers in order relative to the spindle and its cut-outs. This is quite a complicated assembly and a misplaced washer can have some alarming results.



"Wonder what damned surprises we'll have today."

THINKING ABOUT STEREO?

Remember **HEATHKIT!**

for

PORTABLE STEREO TAPE RECORDER Model STR-1

- $\frac{1}{4}$ -track stereo or mono record and playback at $7\frac{1}{2}$, $3\frac{3}{4}$ and $1\frac{1}{2}$ i.p.s.
- 18 transistor circuit
- Moving coil record level indicator
- Built-in audio power amplifiers giving 4 watts r.m.s. per channel.

A COMPLETE STEREO SOUND SYSTEM IN ONE COMPACT UNIT

Ready-to-use Model A/STR-1 £70.6.0 incl. P.T., p.p. 10/6
Kit Model K/STR-1 £58.0.0. incl. P.T., p.p. 10/6

PORTABLE STEREO RECORD PLAYER Model SRP-1

- Fully transistorised
- Automatic playing of any size of record
- Detachable speaker enclosure for best stereo separation.



COMPLETE RELIABILITY AND

VERSATILITY, LUXURY ENTERTAINMENT AT FAMILY PRICES

Ready-to-use Model A/SRP-1 £35.4.0 incl. P.T. p.p. 10/6
Kit Model K/SRP-1 £28.6.0 incl. P.T. p.p. 10/6

for what's **NEW** in **AUDIO**

See **HEATHKIT** at

Northern Audio Fair

Hotel Majestic, Harrogate

September 20 - 22nd, 1968

Rooms 158 - 160

For what's **NEW** in **AUDIO**

Send for the Latest Catalogue

..... it's **FREE!**

To **DAYSTROM LTD.**, Dept. HT.9, Gloucester. Tel. 29451

Please send me FREE CATALOGUE (Yes/No).....

Please send me model(s)

for which I enclose £.....p.p. extra

NAME

(Block Caps.)

ADDRESS.....

Prices and specifications subject to change without notice



TELEFUNKEN

Listen to as many portable recorders as you can. Compare. This is the one that stands out.

From now on, this is the one that all other machines are going to have to try and live up to. Go into any good dealers and ask them what they think about it. Magnetophon 300 is the one you can shake, move or twirl—subject it to any kind of movement—yet it still gives a faultless recording ... compares with very good Hi-Fi machines.

5" spool 2-track. 40-14,000 c/s. $3\frac{3}{4}$ i.p.s. Sockets for radio, microphone, pick-up, headphones, tape recorder, additional loudspeaker, AC power supply/battery charger. Operates on 5 flashlight cells, car battery or rechargeable storage battery.

Recommended retail price £63 3s. 1d. Also 4-track M 301 £69 12s. 0d. At only £76 0s. 2d: M 302 4-track with speeds of $3\frac{3}{4}$ i.p.s. and $1\frac{1}{2}$ i.p.s. Write today for fascinating FREE colour booklet to AEG (Great Britain) Limited 27 Chancery Lane London WC2



RECORDING FOR DISC

By Peter Bastin

THE telephone rang: it's always doing it. A squeaky telephonic voice announced that it belonged to the Director of the Goose Theatre. Dammit, said I, their perishing recorder has gone on the blink again. But it hadn't.

The Voice said that the current show—a musical—was such a success that it had been booked for a West End run. Good, I said. Yes, said the Voice, but look here . . . and it transpired that the Voice wanted an LP record made of the 18 musical numbers in the show. Would I do it? When we'd talked cautiously for a little while about the fee, I agreed and a date was set. 10 a.m. on Friday. Not too early; theatrical people tend to be a little odd before the sun rises at 10 a.m.

On the day, I arrived at the theatre. The secretary was yawning in the office and the caretaker was tentatively feeling the radiators. The stage was in complete darkness and the whole nice new modern theatre smelled of the night before. It was also extremely parky on the stage. I switched some lights on and gave some thought to where the artistes would stand. The stage seemed the best place. The theatre is perfect acoustically and you can hear a whisper at the back of the auditorium. No reverberation—a recordist's dream.

I had taken along my two Ferrographs, one to act as a standby. I had a ribbon microphone to pick up the piano accompaniment and a Beyer M69 on a boom for the singers. I had a cute little cueing device, consisting of a white standby light and a red 'recording' light which was supposed to be powered from the low-power socket at the rear of the Ferrograph. Unfortunately, it transpired that it would only work on the other Ferrograph, still in the car, so I abandoned it in favour of manual semaphore.

I once recorded an orchestra, a choir and an organ (all together) in an abbey and found that the best results were obtained by using one microphone, on the basis that if you stand in front of a heap of musicians, you can hear everything—so long as there are not any of these tricky solos where a close-technique is required. As I hadn't the faintest clue what I was supposed to record, I had to assume that there would be choruses and soloists, in which case the soloists would have to step forward to do their bit.

I got everything hooked up and tested and smoked four pipes. By 10.15 a.m., three weary-looking theatricals appeared and milled round swearing or reading the paper. By 10.30 a.m., the Musical Director had arrived and after

several minutes of confusion and useless conversation, we were nearly ready. The MD was in a devil of a rush because I said that my fee covered the period 10 a.m. to 1 p.m. and anything over that would rate as overtime. "Right," he said, "no test runs—takes every time". This was fine: unknown music, unknown singers, no balance. Oh boy. Anyway, the first number—a chorus thing—was such a mess that they had to do it again. And so we proceeded. Sometimes we had to re-take because unannounced peaks would send the modulation needle over to the other side of the stage. One particular number was most interesting. The song, sung by an extremely talented West End actress, consisted of two matey parts and two operatic parts and after two near-hernias with the Ferrograph, I asked the young lady to take off her Russian boots in the piano bit between the soft and loud passages and hare to the back of the stage, 25 feet away. It worked fine, but she didn't like one ending and the MD asked me to "join up the bits" from the two best takes. I went ice-cold all over. Have you ever tried joining up two bits of operatic music? I did it, heaven help me, I did it, next day in my studio, but did I sweat!

Eventually, we had the 18 in the can and after some lunch we played it back. It was first rate and I offered up a prayer to the little metal Ferrograph gods in Co. Durham. Unfortunately, I wanted to do a nice neat job and send away the master for cutting without having to edit it, but the re-takes, false starts and clicks from switches all over the theatre precluded this. So next day (and all day) I edited the master tape and shuffled everything round into the order they wanted. Three months later the record was released. Probably I expected more than I got but I was certainly surprised at the drop in quality. The master tape was perfect but the disc process most certainly reduced the fidelity. Not enough for the man in the street to notice, but enough for me to notice.

I can say without, I'm sure, risk of contradiction, that the worst people to record are pop groups. I remember doing some audition recordings for one of the major record companies, thereby creating my first antagonism to delinquent music. Mind you, in fairness, the stuff has improved a little but it still sounds to me like a church-hall talent contest. The first pop group I faced up to turned up at the recording session long before I did, having had a good wash as a token of friendship. They turned on their equipment and blazed away. I stopped them halfway through their seventeenth chorus and asked them to turn down their amplifiers which were causing cracks in the walls of the brand new ballroom we were

using as a studio. They obligingly reduced their output from 50 to 40 w: the Ferrograph input gain was at half a notch! After a great deal of reasoning in two-syllable words, I managed to get them to reduce to 20 w, allowing the input gain to be advanced to 1. And away we went. After three hours, we were no nearer a satisfactory take than we were when we started.

I tried the microphones in every possible position; I even tried feeding the guitar and voice mikes direct into the recorder. I even used my microphones but they got drenched in spit, so I took them away. We got their two numbers in the can in due course, largely because the group were getting a little tired of squabbling with each other and wanted to go home.

Another group brought every impossibility with them. The studio we were using was full of reverberation and the only way I succeeded in getting anything on tape was to move the whole boiling out into the fresh air. There, the dead acoustic of a late summer-evening produced a first-class recording. Vocalists can present a thumping great problem. There was the case of the small trumpet and rhythm section combo with a girl singer. The singer had to dominate but the musical figures from trumpet and piano were essential to the recording. We started off in the conventional manner—singer just in front of the musicians. No good: piano too loud, trumpet sounded as if it were in the woods on a Boy Scout rally. Move the singer away, 20 feet away. No good: the outfit sounded 10 miles away, the echo was appalling and the singer's voice was belting round the walls of the room and getting on the tape as reverberation an unpleasant split second after the original. In the end I built up a sort of cubicle affair, put the singer in it, well away from the musicians, and fed both from a series of microphones into the recorder. Turned out all right, but the poor girl singer was shaking like a leaf.

Vocalists are a strange breed. They either want to gobble up the microphone or they stand and stare at it, mesmerized. The beefy baritone or the screaming soprano doesn't give a damn for electronics; they stand immobile and shove it out, *forte* and *pianissimo*, expecting some magical device (or the recordist) to make the necessary adjustments. I always tell vocalists, usually with no effect, to sway back when hitting a high one and move forward during the intimate bits. If they do remember to do this, it is only for the first 45 seconds and then you are on your own, juggling like mad with the gain control. I don't think there is any real answer to this particular problem. If the

(continued on page 429)



LUXOR

brings you the
Swinging Sound
from Sweden



MP613 MALAR

Stereo Tape Recorder—4-track, 3-speed. Frequency response: 7½ i.p.s. 50—19,000 c/s. 3½ i.p.s. 50—12,000 c/s. 1½ i.p.s. 80—6,000 c/s. Output 4 watts mono, 2 x 2 watts stereo. Automatic stop, three position speaker switch. Dual volume control. Four push buttons; recording (special lock prevents erasing) radio, gramophone and microphone. Three position channel selector. High speed rewind. Instant stop. Pause control. Built-in four-channel mixer, multi playback, synchro playback. Combination head, fine laminated Fe-Ni-core, range 50 dB. Max. 7" reel. Available in teak or rosewood with transparent dust cover. Size 15½" x 12½" x 7".

For name and address of nearest stockist phone or write



LUXITONE 84 Bolsover Street, London W.1.
Telephone 01-636 2901 (4 lines)

ONE WAY TO SATISFACTION

Special Pre-Budget Offers

Brand New, Latest Models—

	Deposit £ s. d.	12 Monthly Payments		Cash Price	
		£ s. d.	£ s. d.	£ s. d.	£ s. d.
4-TRACK					
STEREO/MONO					
Philips EL3312...	16 19 10	4 3 4	66 19 10		
Ferguson 3232...	22 18 3	5 14 7	91 13 0		
Sony TC200...	23 15 0	5 18 9	95 0 0		
Sanyo MR929...	24 0 0	6 0 0	96 0 0		
Philips EL3555...	25 19 4	6 5 8	101 19 4		
Aiwa TP1012...	26 0 0	6 8 2	102 18 0		
Akai 1710W...	27 17 3	6 16 8	109 17 3		
Sanyo MR939...	28 0 0	6 16 8	110 0 0		
Sony TC260...	29 5 0	7 5 0	116 5 0		
Tandberg 12/21/41	31 10 0	7 17 6	126 0 0		
Telefunken 204 'E'	34 12 5	8 10 0	136 12 5		
Philips EL4408...	33 16 8	8 6 8	133 16 8		
Sony TC530...	41 10 0	10 6 3	165 5 0		
Beocord 2000K...	39 10 0	9 13 4	155 10 0		
Beocord 2000T...	40 10 0	10 2 6	162 0 0		
Ferrograph 722/4	46 15 0	11 10 5	185 0 0		
Akai M9...	49 3 5	12 3 4	195 3 5		
4-TRACK MONAURAL					
Fidelity Studio	11 5 9	2 16 6	45 3 0		
Grundig TK140	11 14 6	2 18 4	46 14 6		
Philips EL4305...	11 17 9	2 16 8	45 17 9		
Ferguson 3226...	11 10 0	2 16 8	45 10 0		
Telefunken 201	11 18 9	2 19 7	47 13 9		
Ferguson 3228...	11 19 0	3 0 0	47 19 0		
Philips EL4306...	14 1 8	3 10 0	56 1 8		
Ferguson 3230...	14 13 0	3 13 2	58 11 0		
Ferguson 3216...	16 19 0	4 0 0	64 19 0		
REPS M10	18 17 0	4 14 7	75 12 0		
Truvox R54	18 17 3	4 15 0	75 17 3		
Wyndor					
Vanguard	18 18 0	4 14 6	75 12 0		
Tandberg 1526...	20 19 0	5 3 4	82 19 0		
Truvox R204	31 14 2	7 15 0	124 14 2		

Akai X-IV Stereo Portable, 4-Track Mains/Battery, 2 Dynamic microphones, Rechargeable Battery. A.C. Adaptor. 4 speeds, 5" Demonstration Tape. List £169.7.11. Our Price 118 gns. **Akai X-355 Stereo**, 4 Heads, 3 speeds, 3½, 7½ and 15 ips. 50 watts. Auto Repeat-Reverse. Reverbation. List £331.8.6. Our Price 195 gns. **Telefunken 204E Stereo**, 2 x 6 watts. List £136. Our Price 95 gns. **Brenell 5/M/3**, 4 speeds, Mono 2-Track. List £131.16.8. Our price 99 gns. **Tandberg 62X**, 2-Track Stereo Tape Unit. List 138 gns. Our Price 118 gns. **Beocord 1100** 2-track mono. 10 watts. List £98. Our price 69 gns. **Aiwa TP-1004 Cassette Stereo**, 4-Track Battery/Mains, 2 microphones, 2 speakers, 2 watts stereo output. List £62.7.3. Our Price 48½ gns. **Aiwa TP-1014**, 4-track stereo. Mains/Battery, 2 speeds, 2 speakers, 2 microphones. 5" Demonstration tape. List 57 gns. Our Price 45 gns. **Aiwa TP-728 Cassette Portable**. Mains/Battery. AVC or Manual Recording. List £37.18.11. Our Price 24½ gns. **Philips N4306 Cassette**. List £31.10.0. Our Price 24½ gns. **Philips N4306 Automatic De Luxe**. AVC or Manual Record. 4 Tracks, 2 speeds. Mixing. Monitoring and Parallel Tracking. 7" Tape capacity. Teak Cabinet. List £56.1.8. Our Price 44 gns. **Telefunken 301**, 4-Track Battery/Portable. 5" spool capacity. List £69.12.0. Our Price 54 gns. **Telefunken 302**, 4-track Battery Portable. 2 speeds 1½ and 3½ ips. 5" spool capacity. List £70. Our Price 59 gns. **Grundig TK125**. Automatic/Manual. Superimposition, Auto Stop. List 39½ gns. Our Price 35 gns. **Grundig TK120**, Automatic Record. List 37½ gns. Our Price 29 gns.

Carriage, Packing 17/6 extra

INTEREST FREE H.P. TERMS. OPEN SATURDAY 6 p.m. FRIDAY 6.30 p.m. IF UNABLE TO CALL, WRITE FOR BROCHURES. PART EXCHANGES ALSO 18 and 24 MONTHLY TERMS

STEREO TAPE UNITS	Deposit £ s. d.	12 Monthly Payments		Cash Price	
		£ s. d.	£ s. d.	£ s. d.	£ s. d.
Sanyo MR-801...	20 0 0	4 13 4	78 0 0		
Sony TC250A...	20 10 0	4 18 4	79 10 0		
Akai 3000D...	26 11 4	6 11 8	105 11 4		
Sony TC350...	27 5 0	6 16 3	109 0 0		
Beocord 1500...	31 10 0	7 11 8	122 10 0		
Tandberg 62/64X	34 10 0	8 12 6	138 0 0		
Ferrograph					
702/704	40 6 8	10 0 0	160 6 8		
MAINS TWIN TRACK					
Fidelity Playtime	7 18 6	1 16 8	29 18 6		
Ferguson 3224...	8 6 0	2 1 4	33 2 0		
Grundig TK120...	9 17 6	2 9 2	39 7 6		
Philips EL3310...	10 5 10	2 11 5	41 2 10		
Tandberg 1521...	18 19 6	4 10 0	72 19 6		
Truvox R52	18 17 3	4 15 0	75 17 3		
Brenell Mk. V/3					
Std.	26 17 9	6 10 0	104 17 9		
Brenell Mk. V/3					
Mtr.	28 0 2	7 0 0	112 0 2		
Beocord 1100...	24 10 0	6 2 6	98 0 0		
Truvox R202...	31 14 2	7 15 0	124 14 2		
Brenell V/3/M...	32 16 8	8 5 0	131 16 8		
Ferrograph 713	33 18 4	8 9 7	135 13 4		
Ferrograph 713/H	35 16 8	8 16 8	141 16 8		
BATTERY OPERATED TRANSISTORISED					
Philips EL3302...	7 18 0	1 19 4	31 10 0		
Philips EL4304...	8 5 10	2 1 5	33 2 10		
Grundig C200...	12 7 0	3 1 8	49 7 0		
Telefunken 300	16 3 0	7 18 9	63 3 0		
Telefunken 301 4T17	12 0 0	4 6 8	69 12 0		
Telefunken 302 4T19	0 0 0	4 15 0	76 0 0		
Grundig 2200...	24 12 0	6 0 0	96 12 0		
Uher 4000L...	31 16 0	7 18 9	127 1 0		
Uher 4200 Stereo	39 6 0	9 10 0	153 6 0		
Uher 4400 Stereo	39 6 0	9 10 0	153 6 0		

THE RECORDER CO

(DEPT. R) 186-188 WEST END LANE, WEST HAMPSTEAD, LONDON, NW6
Telephone: 01-794 4977

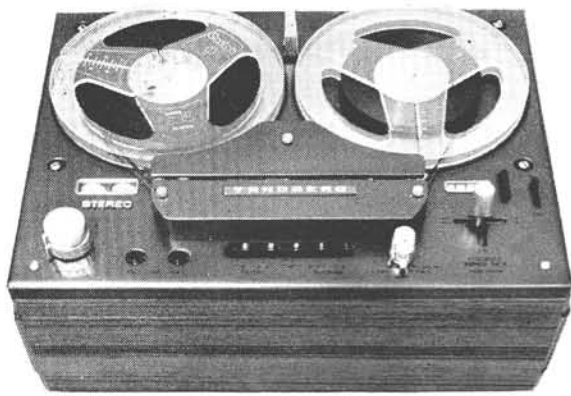

TANDBERG 64X



BY DAVID KIRK

MANUFACTURER'S SPECIFICATION (19 cm/s). Quarter-track transistor stereo tape unit with opposing-field bias. **Wow and flutter:** less than 0.1% RMS. **Frequency response:** 30 Hz-20 kHz ± 2 dB (Scotch TGB 150). **Signal-to-noise ratio:** 62 dB. **Crosstalk rejection:** 60 dB. **Oscillator:** 85.5 kHz. **Dimensions:** 39 x 28.5 x 17 cm. **Weight:** 23 lb. **Price:** £144 18s. including purchase tax. **Manufacturer:** Tandbergs Radiofabrikk A-S, P.O. Box 9, Korsvoll, Oslo 8, Norway. **Distributor:** Elstone Electronics Ltd., Hereford House, Vicar Lane, Leeds 2.

The Tandberg 64X is based on a mechanism first developed in the early fifties. Exterior design changes have been minimal but, to my eyes, the recorder would still hold its own in a Design Centre beauty parade.

But perhaps its most attractive feature would go unnoticed there—the bias head mounted against the pinch wheel bracket.

A Series 6 owner would feel quite at home with the 64X (the 64X being simply a $\frac{1}{2}$ -track derivative). The chromed controls have all been squared off slightly but perform the same functions as before. A four-way joystick selects fast forward wind when pushed to the right,

fast rewind when pushed to the left, playback when pulled to the front of the deck, and 'free' when pushed into a small slot at the rear. The latter position releases the brakes and drive turntable to simplify lacing up. This is particularly useful since, with the selector in its neutral centre position, the turntables are linked by a belt causing the right turntable to rotate in opposition to the left, though not vice versa.

The drive linkage in this mechanism is so ingenious that it warrants closer examination. All functions rely on a single Papst hysteresis synchronous motor. The two turntables (fig. 1) are driven indirectly by a single belt, the unpowered spool being left to rotate freely. An idler is held against the capstan flywheel and stepped motor pulley by a spring, the pulley surfaces being knurled to reduce slip and anodised to prevent metal flaking on to the idler. The soft idler periphery is held away from motor and flywheel when the mechanism is in neutral, fast wind or free positions.

A solenoid pause control is actuated from the centre of the row of black buttons in front of the head covers. This is an important feature as the rather small motor, having a great deal of work to do, takes several seconds to reach a

19 cm/s tape speed. The cheaper mono Tandbergs also have this instant start/pause facility but employ a lockable lever to do the work of the solenoid.

Two buttons to the left of the pause control govern left (Tracks 1 and 4) and right (3 and 2) recording. Unlike the replay selectors on the right, and the pause control itself, the record buttons cannot be locked down until interlocked with the play joystick.

Record gain controls are coaxially mounted on the far left by the magic-eye peak level indicators. Replay level controls, used in conjunction with an external power amplifier, are just left of the joystick. A small three-position switch protrudes beneath the replay control spindle and, in conjunction with the record and play track selectors, permits several permutations of sound on sound, echo, and tape/source comparison. I found myself relying heavily on the instruction book to sort out the switch arrangements required for multi-track recording and echo. A rather more important point—I sometimes find myself with only one hand to spare for switching to record. The Tandberg is rather unusual in leaving a considerable space between record and play interlocks. The play joystick is additionally so stiff that the recorder tends to slide across the table before the play control engages. Watch any Tandberg user and you will see that he places his thumb or palm against the front edge of the recorder to prevent such slipping. This steadying thumb is not available if stretched over to the record buttons.

Two microphone input jacks are mounted on the deck plate, all other sockets being situated at the rear. Two pairs of phono sockets in a recess at the left permit insertion of high level gram or FM stereo signals. The lower pair feed a pilot-tone filter cutting off sharply at about 17 kHz. A third pair of phono sockets provide "cathode follower" (emitter follower?) outputs to the external power amplifier. A further centre channel output is also fitted to simplify dubbing of stereo tapes on to mono recorders. Adjacent to the centre-channel socket are two five-pin DIN sockets, labelled LINE and RADIO, which duplicate the three pairs of phono sockets. An external pause device—a dictation foot switch for example—may be connected through a three-pin valve-base style socket also mounted at the rear.

(continued overleaf)

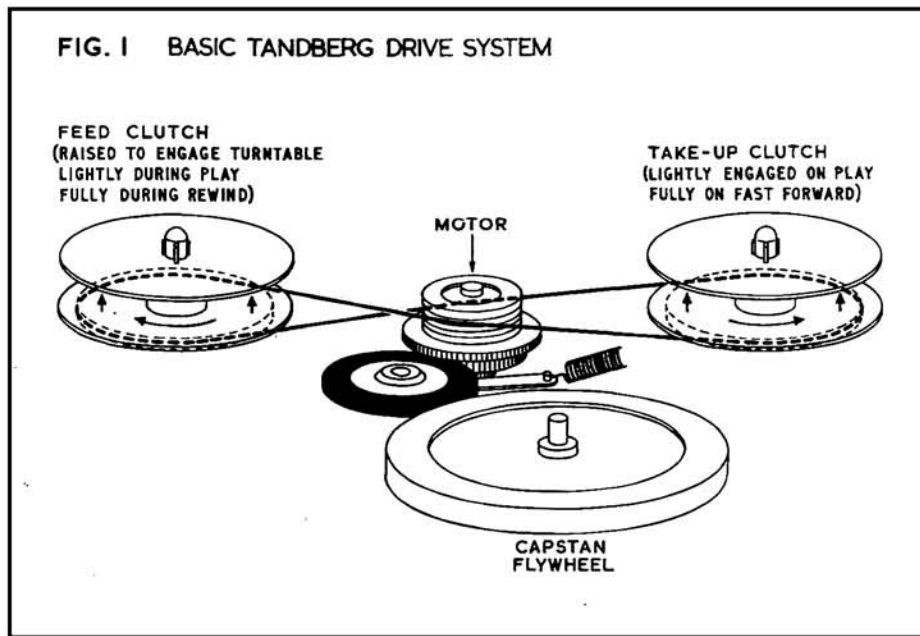

Tandberg have taken the trouble to recommend a specific brand and type of recording tape for the 64X—Scotch TGB150. Since the recorder has a tape/source switch, some interesting hours may be passed comparing the merits of different brands. Frequency response and signal-to-noise ratio depend very much on the tape used for measurement, which is why we feel rather dejected when a manufacturer fails to state the brand on which his published specification is based. TGB150, in common with BASF LH, produces an audible rise in treble which may upset the home-bound music lover but can be of value to the live location recordist. HF sound has a remarkable ability to lose itself in halls and churches—a loss which cannot be attributed entirely to low tape speeds. The newer BASF and Scotch tapes are also comparatively free from dropout—the nightmare of even $\frac{1}{2}$ -track stereo recorders. The 64X does not lend itself to 38 cm/s adaptation.

Strangely, the superficially ordinary Tandberg mechanism has given consistently lower wobble figures, over the years, than any other comparably-priced design. It is well engineered but no better, in this respect, than many other European recorders. The excellent mechanical performance stems from the design itself, which is unusually free from minor flaws. Wow and flutter are consistently low at all feed-reel diameters since the tension is applied by the erase-head pressure pad. The feed turntable itself is only lightly tensioned, to prevent spill, during record and play. Other points: the tape wraps a good 70° round the pinch wheel after leaving contact with the capstan, eliminating one cause of capstan wear and flutter—tape slip. The spool rotation counter is driven from the right-hand turntable, isolated from the tape by the pinch wheel and capstan, in one direction, and by a flexible belt and an idler in the other. It is a common design fault to drive counters from the left turntable, where they exert a measurable effect on overall wow and flutter.

The 64X now has a nylon thrust bearing

Comparing Alec's 64X measurements with those of the conventionally biased 64 (fig. 2, stolen with acknowledgement from his February 1961 and May 1968 reviews), I am impressed by the increased HF response at the lower tape speeds. Signal-to-noise ratio and distortion are comparable so this is not merely a case of sacrificing everything else for an octave of treble.

The 64X is a gentle mechanism which will tolerate the thinnest of tapes. Being a $\frac{1}{2}$ -track recorder, however, LP brands should give slightly greater freedom from dropout than SP. Anything thinner than LP, as always, lays the user open to print-through and physical damage, the latter being audibly as bad as coating dropout. I am not keen on the bent wire autostop sensor, which caused occasional tape creases, and the deep guides in the head channel are rather prone to tangle the tape if it is lifted mid-reel from the recorder. While criticising, and knowing that Arthur Dakin will jump on me if I place a step out of line, I would like to see a more powerful erase oscillator incorporated. Both on the 62 and, to a lesser extent, on the 64X, I have experienced breakthrough of earlier recordings when monitoring new material. The obvious solution, I suppose, is to buy a bulk eraser. With $\frac{1}{2}$ -track stereo equipment, such erasers are usually essential since a central portion of the tape is in most cases left unscanned by erase, record or play heads.

And there it is. A competent design, light enough to be carried by the female of the house, and attractive in any domestic setting. There are better recorders than the 64X but they are all more expensive.

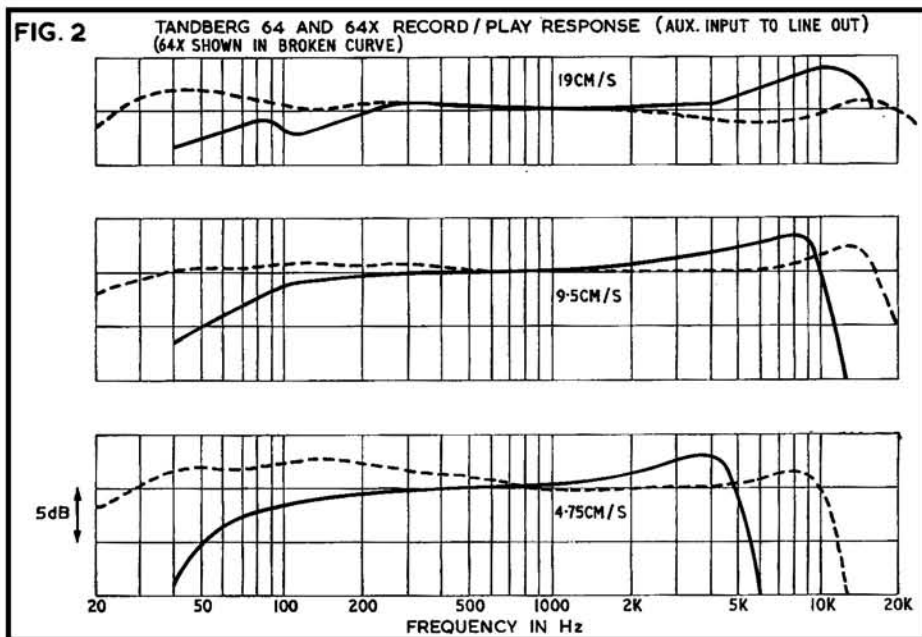

Readers interested in precise figures might care to note the following taken at 15 kHz, 0 dB at 1 kHz being adjusted to suit each tape. BASF LH +7 dB. Philips SP.18 +5 dB. BASF LGS35 +4.5 dB. Zonatape +3.5 dB. Agfa +3 dB. The latter Agfa tape was brand new and measured during its first run. When tested after re-spooling, it rose to +4.5 dB. These 15 kHz figures were all about 3 dB lower on the other channel.

The 64X magic-eyes are a delight to use after the flood of so-called VU-meters to which most manufacturers subject us. Recording a recent performance of Handel's *Messiah*, I had only to set the eyes to touch on the loudest passage of a rehearsed *Amen*; the gain controls were then left untouched throughout the entire performance. Dynamic range was quite adequate for the opposite end of the volume scale—fairly quiet solos—and the resultant tape, in terms of loudness levels at least, was an exact copy of the original.

above the capstan, evidently intended to permit vertical deck operation. I cannot recall seeing this on earlier Tandbergs though the spool turntables have long been grooved to take rubber hub grips.

Single open guitar strings—a severe wow test for professional or domestic recorders—revealed a fairly fast wow, apparently at capstan frequency. Alec Tutchings's 19 cm/s review figures (0.07% wobble, 0.04% wow-only) were later confirmed on a Gaumont Kalee meter, the recorder showing no deterioration after its months of use. A point of incidental interest—slightly higher measurements were obtained when the test tone was played while still recording, from the separate play head, than when measured conventionally. The convention, of course, is to measure wow and flutter on subsequent replay of a test-tone sequence. There seems no logical explanation of this effect, even allowing for cancellation of record and play wobble.

WHAT'S IN A CLUTCH? CONTINUED

lever. But on the yoke arms on which the pulleys are mounted are two adjustment screws for alteration of the clutch disc approach angle, and these are accessible from the rear (or underside) of the deck. Clockwise turning increases torque, and vice versa.

On this deck, and other similar designs—for more than one idea has grown from Ampex original philosophy, here and abroad—tape tension is controlled. Back torque is applied to the brake drums, and the adjustments are two screws on eccentric brackets in the top corners of the deck. As the transport is run in either direction on this and other models, the adjustment for an equal and opposite torque can be quite tricky—but very necessary. Although there is a temptation to adjust the brake actuator levers to get the needed hold-back effect, this should never be done as these are factory set. Brakes are a quite separate subject, and, if space permits at a later date, can receive the sort of scrutiny we have tried to afford clutches in this two-part series.

For the present, we shall have to call a halt, on the warning note that many of these things—brakes, tape tensioning devices, guides, pulleys, etc.—are very closely linked with clutch operation. The moral should always be: tackle the job as a whole, or one repair will lead to another.

equipment reviews



EAGLE TC450

MANUFACTURER'S SPECIFICATION (19 cm/s). Quarter-track stereo tape unit with record and replay preamplifiers. **Frequency response:** 50 Hz-15 kHz ± 3 dB. **Signal-to-noise ratio:** 50 dB. **Wow and flutter:** 0.15% RMS. **Equalisation:** NAB 50 μ S. **Inputs:** 0.2 mV at 1 K (microphone), 1 V (line). **Line output:** 1 V p-p. **Tape speeds:** 19 and 9.5 cm/s. **Dimensions:** 38 x 33 x 16.5 cm. **Distributor:** B. Adler & Sons (Radio) Ltd., Coptic Street, London, W.C.1. **Price:** £69 10s. including £13 3s. purchase tax.

THIS is a relatively low priced stereo unit with full recording facilities and line outputs for feeding external power amplifiers and speakers. It follows the standard pattern of such Japanese recorders in using a single powerful fixed speed motor for fast wind and rewind as well as the two standard tape speeds, which, in this case, are provided by a stepped pulley and idler wheel.

Tape movement is controlled by a single rotary lever which has a central off position, with fast rewind one step anti-clockwise, and playback at the selected speed one step clockwise. A nearby lever changes the slow forward movement of the tape to fast forward wind. Wind and rewind of an 18 cm reel of LP tape took 4 minutes 45 seconds in each direction.

The tape position indicator is driven from the left supply reel turntable and registers eight digits for every 10 turns of the spool carrier.

Long term speed accuracy was within $\pm 2\%$ limits at all parts of an 18 cm reel with maximum deviation occurring near the end of the reel when the tape was being fed from a small diameter hub.

Short term speed fluctuations were mainly at medium and high frequencies although there were small low frequency contributions from capstan, idler wheel and pressure roller. Steady readings were obtained from low wow and flutter test tapes and these are shown in the small panel of fig. 1. It will be seen then that wow is low at 0.06% RMS at 19 cm/s and 0.09% at 9.5 cm/s, and that combined wow and

(continued overleaf)

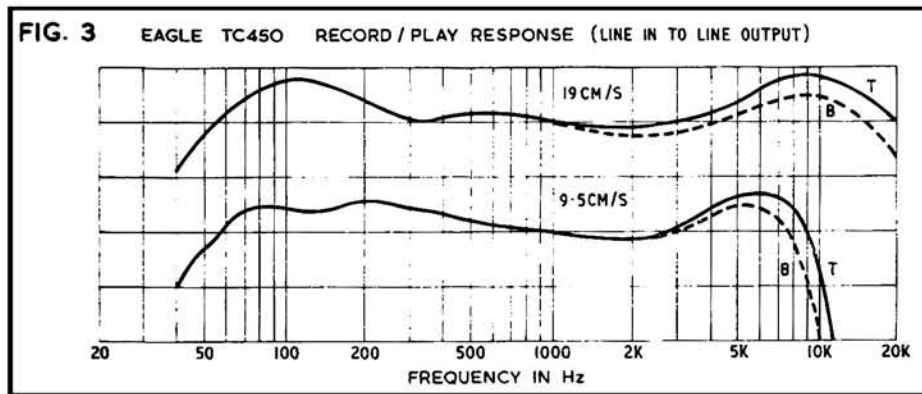
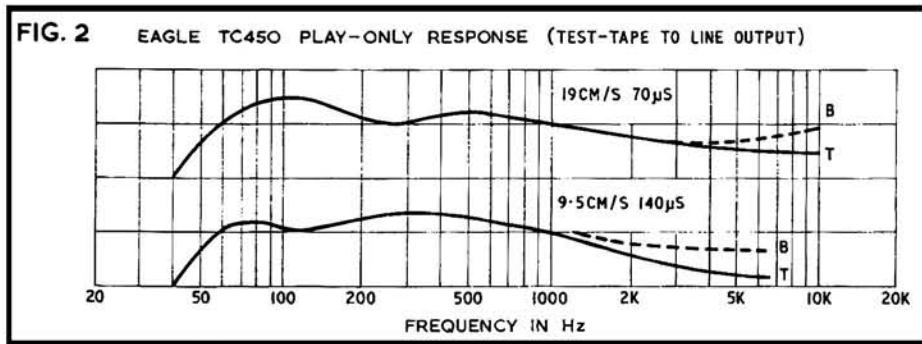
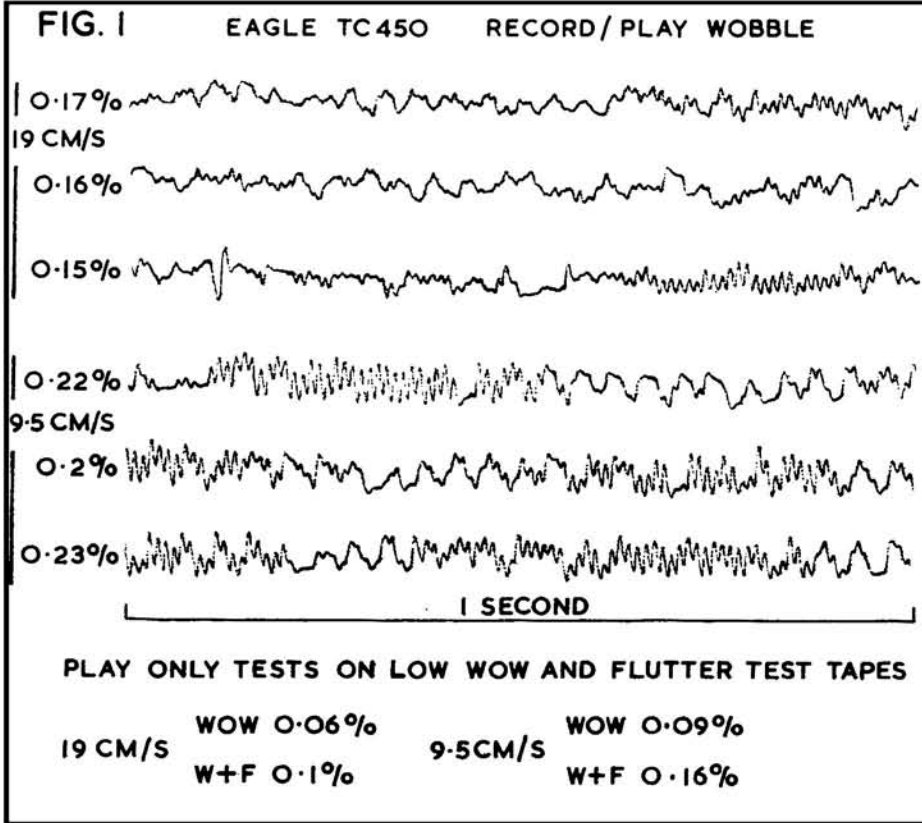

Your Tape Dealer

LONDON AREA

FOR ALL LEADING
AUDIO EQUIPMENT

hifi

Classical Records
by Mail Service

hampstead
HIGH FIDELITY

91a Heath Street,
Hampstead, N.W.3.
Tel. HAMPstead 6377

HAVEN
196-198 SOUTH EALING RD.
HI-FI LONDON
W.5
Tel. 01-560 0194

**LASKY'S
RADIO**

Stockists for all the leading makes of Tape Equipment

207 EDGWARE ROAD, W.2. Tel.: PAD 3271
118 EDGWARE ROAD, W.2. Tel.: PAD 9789
33 TOTTENHAM CT. RD., W.1. Tel.: MUS 2605
42 TOTTENHAM CT. RD., W.1. Tel.: LAN 2573
152/3 FLEET STREET, E.C.4. Tel.: FLE 2833

**TAPE RECORDER HI-FI CENTRE
(SHEEN) LTD**

SPECIALISTS IN TAPE RECORDERS, ACCESSORIES,
HI-FI EQUIPMENT

YOUR CENTRE FOR FRIENDLY HELP, SALES AND
SERVICE

3 & 4 STATION PARADE, Open until 8 p.m. on Fridays
SHEEN LANE, SHEEN, PROSPECT 0985
LONDON, S.W.14 Opposite Mortlake Station, S.R.

CHESHIRE

go scandinavian hi-fi . . .

Bang & Olufsen, Tandberg, Arena, Dynatron, Radford,
Sony, Philips, Quad, Leak, Fisher, Sanyo, Pioneer, Akai,
Sansui, Wharfedale, Armstrong, Rogers, Ferrograph,
Bryan, Normende, Eddystone, etc.

the hi-fi and tape recorder lounge

● EXPERT STAFF ● ADVICE SERVICE ● PART EXCHANGE
● FULL AFTER-SALES SERVICE ● DEMONSTRATIONS DAILY

GREEN LANE, WILMSLOW, CHESHIRE
For personal attention ring Wilmslow 24766
and ask for Mr. Bird

FOR ALL YOUR REQUIREMENTS . . .

CHARLESWORTH'S
OF CREWE LTD.

Head Office: 14 Hightown, Crewe. Tel: 3327

Hi-Fi CENTRE: 28 HIGHTOWN, CREWE

Technical Division: 19 Ludford Street, Crewe

Your Tape Dealer

DEVON

THE SOUTH WEST

Tom Molland Ltd.

Invite you to visit their well-equipped
Demonstration Theatre and compare all
the leading makes of Hi-Fi and Tape
Equipment at

110 CORNWALL STREET, PLYMOUTH
Telephone 69285
Immediate delivery to ALL Areas

ESSEX

EPPING — ESSEX
CHEW & OSBORNE LTD.
148 HIGH ST. TEL: 4242

AKAI—AMPEX—ARENA—ARMSTRONG—AUDIO
TECHNICA — B & O — BRYAN — CELESTION
FERROGRAPH—FISHER—GARRARD—GOLDRING
GOODMANS—HACKER—KEF—LEAK—LOWTHER
PHILIPS—QUAD—RADFORD—REVOX—ROGERS
SHURE—SONY—THORENS—TRUVOX
WHARFEDALE—WYNDSOR

Home and Showroom Demonstrations:
After Sales Service — H.P. Facilities
Equipment and Records by post

GLOUCESTERSHIRE

**Sound
Selection**
OF BRISTOL

Tape Recorder and Hi-Fi
Specialists (Demonstration Room)

361-363 GLOUCESTER ROAD,
BRISTOL 7. Tel. 41181

HAMPSHIRE

**High Fidelity
Specialists**

Hamilton Electronics HE

Hamilton Electronics (Southampton) Ltd.
35 London Road, Southampton. Phone: 28622 3 Lines

FORRESTER'S
**NATIONAL RADIO
SUPPLIES LTD.**

70-72 HOLDENHURST ROAD
BOURNEMOUTH HANTS

Largest hi-fi and radio component
store in the south Tel: 25232

HERTFORDSHIRE

WATFORD

**High Fidelity Centre
at RADIOLUX Ltd.**

36 WOODLANDS PARADE, HIGH ST.

WATFORD (opposite the pond)

WATFORD 29734, 41029

IF IT'S GOOD—WE STOCK IT!

Demonstrations in our Stereo Theatre. Also home
demonstrations with no obligation.

EAGLE TC450 REVIEW CONTINUED

flutter on play only totalled 0.1% at 19 cm/s
and 0.16% at 9.5 cm/s.

Cumulative wow and flutter, however, gave
rather unsteady readings often approaching
nearly twice the amplitude of the play-only
readings as the various frequency components
came in or out of step at any given instant.
The pen recordings of fig. 1 show that the main
offender is a 25 Hz flutter from an eccentric
pulley or shaft of the 1500 r.p.m. drive motor,
with some high frequency tape friction flutter
and a very slight uneven low frequency wow
from various low speed rotating members. The
mean readings were 0.16% at 19 cm/s and
0.22% at 9.5 cm/s.

PLAY ONLY RESPONSE

The play only frequency responses from 70
and 140 μ s standard test tapes are shown in
fig. 2. There was a 2 db difference in the out-
puts of the top and bottom tracks at high
frequencies, but the mean responses were close
to those expected from NAB 50 and 90 μ s play-
back equalisation. System noise with no tape
passing the heads was 40 db below test tape
level.

Record/play tests showed the same differ-
ences in high frequency response, with the
NAB recording pre-emphasis boosting the bass
and treble response to give an overall record/
play characteristic level within 3 db limits from
50 Hz to 20 kHz at 19 cm/s, and 50 to 10 kHz
at 9.5 cm/s.

OVERLOAD TESTS

Overload recording tests at 19 cm/s gave
third harmonic distortion readings of 4%, 3%
and 4% at 500 Hz, 1 kHz and 3 kHz at 12 db
above reference tape level (10mm/mm). Refer-
ence tape level was recorded at -2 db on the
vu-meter, but further tests showed that the
db calibration of the meters was inaccurate
and that rectifier non linearity caused low
readings below -3 db. Despite this, a mean
deflection of -3 db, hitting the red part of the
meter scale only occasionally, gave well recor-
ded tapes with no tendency to overload or
under recording.

Signal-to-noise ratio was measured, by
erasing 500 Hz peak recording level (4%) and
measuring the tape noise, at exactly 50 db
unweighted. Tape hiss, measured through a
250 Hz high pass filter to eliminate hum and
low frequency noise, was -56 db. Bulk erased
tape read -57 db.

COMMENT

Frequency response and signal-to-noise ratio
of this deck are very satisfactory. The measured
wow and flutter readings are slightly high, but
wow is low, and the 25 Hz flutter is only inter-
mittently audible on recordings made on the
same machine. Pre-recorded tapes are free of
'gargle' or obvious wow. The deck is simple
and straightforward to operate and it handles
the tape gently. If you cannot see your way to
affording £120 to £160 for stereo tape facilities,
and you already possess power amplifiers and
speakers, this recorder is at least worth a trial
and may provide a pleasant surprise if all the
mechanical tolerances are in your favour.

A. Tutchings

AN
OCCASIONAL
COMMENTARY
BY DROPOUT

**column
speaker**

ONLY those who have direct dealings with the blind know the value to them of the tape-recorder: it can open up a whole new world, lessening loneliness and offering endless creative occupation. Recently I had the opportunity, through a friend in the trade, to supply a machine to a man who is far from well-off, being a basket-maker. He lives alone; and I will call him Pat Murphy—his name is Pat anyway.

Being an Irishman, he is fond of music, playing the flute, mouth-organ and tin whistle—very well, too. An accident at work in his sighted days destroyed some of the muscles of his right hand and arm; but, nothing daunted, Pat taught himself to play his instruments left-handed. Later, his sight went, and Pat turned to basket-making to supplement his pension. I took the recorder round to him, and spent about an hour showing him how to use it. He grasped it marvellously, never having really 'seen' a recorder before.

Having recorded his own voice, and then some selections on the tin whistle, he was absolutely delighted; and when I dropped in a week later, he was using the thing as though he had had it for years. We shall now put him in touch with a correspondent, and organisations like Tape Programmes for the Blind and the Tape Reading Service for the Blind. He already has a talking book; but of course that is a passive instrument and does not record. I left, humbled but uplifted by his courage and cheerfulness, and thanking God for the invention of the tape-recorder. (*Why not thank the inventors?—Ed.*)

Some time back, I was moaning over the fewness of battery-portables with the speed of 19 cm/s. The opportunity came along to acquire a new Uher 4000L; and it could not be turned down. I only hope I shall be able to pay the rates . . .

What a splendid little machine this is! I used it first when I went to see Pat Murphy: I recorded an interview with him, and then got him to play his mouth-organ and tin-whistle. Back home, I rewound the tape, and played it back through the hi-fi. I had used one of my favourite microphones, the Beyer 119, and the result delighted me: dead silence in the background where so many battery machines show motor-hash and tape-noise; clean, crisp speech, and music without a trace of audible wow. This chap really does go; and if the price be thought high, I can assure any potential purchaser that it is worth every penny of it. In performance, it equals a good mains machine, and outdoes many of those.

It is very simple to use; and has one feature which so far as I know is unique: one can illuminate the meter by pulling out one of the control knobs. Working in a very dark cottage a few days ago, my wife found that a godsend. I wish that the knobs were not so small and crowded; but that is a thing one can tolerate. Wonder of wonders, the case has been designed by somebody who has used one; and one can do everything except changing batteries without taking the machine out.

The other day a tape arrived from a correspondent. I plugged the mains unit into the Uher and played it back, and then proceeded to reply. Trying the tape after I had finished the recording, I found that the Light Programme was yowling away in the background throughout. Of course, picking up a radio programme on a tape-recorder or gramophone is quite common, though a confounding nuisance (I knew a man who lived close to the Crystal Palace and had endless trouble getting rid of TV sound). I got out another tape, and tried recording with a different microphone—substituting a Grampian DP4 for the Beyer 119. Dead silence in the background! That seemed conclusive; and then a thought struck me, and I tried recording with the Beyer mike, but with the mains unit disconnected, powering from the accumulator. Dead silence again! I can only conclude that in some way a combination of the particular mike and the mains unit tunes the Light Programme, though why the Grampian should have so much better taste than the Beyer is beyond me. Can any technical authority explain that one?

Your Tape Dealer

LANCASHIRE
STOCKPORT AUDIO CENTRE
FINEST IN NORTH WEST

★ ALL MODELS ON COMPARISON DEMONSTRATION
★ EVENING DEMONSTRATIONS BY APPOINTMENT

FAIRBOTHAM & CO. LTD.,
58-62 Lower Hillgate, STO 4872

BOLTON Specialists in High Fidelity Sound

H. D. KIRK
Stereolectrics LIMITED

203 St. George's Road
Phone 23093

BOLTON

J. SMITH & SON

HI-FI EQUIPMENT — STEREOGRAMS
TAPE RECORDERS — 2 SHOWROOMS
B. & O. Dynatron, Hacker, Quad, Leak, Radford,
Armstrong, Ferrograph, Revox, Truvox, Uher,
Decca, Garrard, Thorens, Goodmans, KEF, etc.
Comparator Demos — Closed all Tuesday
Specialists in 'SOUND' for 36 years

184 THE ROCK, BURY Tel: 1242

ST. HELENS
HAROLD STOTT LTD.
Hi-Fi Consultant

Tape Recorder Specialist. Agents
for all leading makes including Akai,
B & O, Revox, Sony, etc. Advice and
demonstrations given willingly.

18 Westfield Street, St. Helens

NORTHUMBERLAND
SOUND EQUIPMENT SPECIALISTS

**Morton
sound** Tel. 2-6902
20142

12 OXFORD STREET
NEWCASTLE UPON TYNE 1

NOTTINGHAMSHIRE
Nottingham Tape Recorder Ltd.
BURTON ST. 2 mins. Victoria Station

Specialists in all the best makes of

- TAPE RECORDERS ● AMPLIFIERS ●
- HI-FI DISC EQUIPMENT ●

Telephone: Nottingham 45222

Have you noticed it too?

With so many shops to choose from, there must be excellent reasons why people prefer to buy more and more from **Francis of Streatham**. Perhaps you would care to find out by calling or writing to us about your requirements in tape and hi-fi equipment too. (S.a.e. with written enquiries please.)

EVERYTHING IN RECORDERS AND HI-FI ON THE BEST OF TERMS

- ★ VERY LARGE STOCKS OF EQUIPMENT AND ACCESSORIES
- ★ NO EXTRA FOR CREDIT UP TO 18 MONTHS
- ★ FREE SERVICE DURING GUARANTEE PERIOD—OWN SERVICE DEPT.

We are TANDBERG specialists and carry full stocks of these famous products.

Also FERROGRAPH, VORTEXION, AKAI, PHILIPS, ETC., ETC.

FOR A FAIR and DEPENDABLE DEAL—BUY IT FROM

SPECIAL OFFER OF WORLD FAMOUS 'SHAMROCK' TAPE
Brand new, top quality polyester.
2400', 7" reel ... 25/-
1800', 7" ... 21/-
1200', 7" or 5½" or 5" ... 15/-
900', 5" ... 12/6
600', 5" ... 10/-
P. and P. 1/6 per reel. Orders over £3 post free. Cash with order please.

FRANCIS OF STREATHAM

169-173 STREATHAM HIGH ROAD, LONDON, S.W.16

Between St. Leonard's Church and Streatham Station

Phone: 01-769 0466: 01-769 0192

Please note our only address Free Car Park, Prentis Road nearby
OPEN ALL DAY SATURDAY—EARLY CLOSING WEDNESDAY

We are happy to announce that we can now supply

BRAND NEW BRITISH & GERMAN RECORDING TAPES

P.V.C. POLYESTER & MYLAR
(ALSO PRE-RECORDED FOREIGN LANGUAGES)
RECORDED ON SCOTCH and EMI TAPE

Both manufactured by world reputable British and German firms. Fitted with leaders and stop foils. Not rejects or sub-standard in any way—tapes are splice free and are boxed. Remember: full refund plus postage should goods not meet with your full approval.

Standard Play	Length	English price	German price
3"	150'	2/6	2/-
4"	300'	4/-	3/6
5"	600'	9/-	6/6
5½"	900'	11/6	8/-
7"	1200'	16/-	10/-
Long Play	Length	English price	German price
3"	220'	3/-	2/6
4"	450'	6/-	5/-
5"	900'	11/6	9/-
5½"	1200'	16/-	10/6
7"	1800'	23/-	14/-
Double Play	Length	English price	German price
3"	400'	6/-	4/-
4"	600'	8/6	7/-
5"	1200'	21/-	13/-
5½"	1800'	24/-	17/-
7"	2400'	39/-	22/-

LEARN FOREIGN LANGUAGES the easy way from BRAND NEW PRE-RECORDED TAPES in GERMAN, FRENCH, SPANISH and ITALIAN. 26 step-by-step easy lessons on each tape recorded at 3½ i.p.s. supplied complete with Handbook. Retail 59/6 each. OUR PRICE 19/6 each.

Postage and packing 1/9 per order.

EMPTY SPOOLS: 3" 9d. 5" 2/-, 5½" 2/3. 7" 2/6.

N. WALKER Ltd.

28 Linkcroft Ave., Ashford, Middx.

Phone: 53020

OPENING the BIBLE

by Stuart Allen

Principal of Wilson Street Chapel, London E.C.2

(Non-denominational)

A series of HALF-HOUR TAPE RECORDED ADDRESSES at 1½ ips, 4 track, on 5 inch spools. The first twelve addresses are available for £1 from:—

Mr. B. MARPLE (TR), 20 Rowley Gardens, Littleover, DERBY. DE3 7GF

Money refunded if not satisfactory

WE SPECIALISE IN BRAND NEW

TOP QUALITY BRITISH P.V.C. MYLAR & POLYESTER RECORDING TAPES WITH FITTED LEADERS, Etc., EX 3"

Thanks to bulk purchase we can offer tensilised HI-FI tapes, manufactured by a British firm of world repute. All boxed individually (sealed if required) in polythene. Our tapes are not to be confused with imported sub-standard or used tapes. Full-money refund if not delighted.

This month: "DRY SPLICE" (3/9) given FREE with every order.

Std.	L.P.	D.P.	Boxed empty spls
Length ea. 3 for	Length ea. 3 for	Length ea. 3 for	
3" 150' 2/- 5/9	3" 220' 2/6 7/-	3" 400' 4/6 13/-	3" 7d.
4" 300' 4/- 10/-	4" 450' 5/- 14/-	4" 600' 6/9 19/6	4" 1/8
5" 600' 6/- 17/6	5" 900' 8/- 23/6	5" 1200' 12/6 37/-	5" 1/9
5½" 900' 7/- 20/6	5½" 1200' 10/6 30/6	5½" 1800' 17/- 50/-	5½" 1/9
7" 1200' 9/- 25/6	7" 1800' 13/- 38/6	7" 2400' 21/- 61/-	7" 2/-

All orders despatched by return. Postage and Packing 1/9 per order.

STARMAN TAPES, 421 Staines Road, Bedfont, Middlesex

YOU CAN HAVE GOOD SOUND EQUIPMENT

if you choose



Grampian Reproducers Ltd. Hanworth Trading Estate, Feltham, Middlesex

MORE QUALITY BARGAINS IN

EXCHANGE & MART 8d

EVERY THURSDAY

if you are a RADIO, TV or TAPE enthusiast

singer doesn't bob back and forth, you just have to keep track of him with your controls. It is dangerous to under-modulate and even more dangerous to over-modulate. The best thing is to have a couple of runs-through, setting your controls to peak signals and remembering where the soft bits come so that you can bring the gain up gradually to level the whole thing out. Don't try to do an under-modulated recording then bring it up on a copy. That way, you'll end up with a prime piece of white noise behind the music.

It is interesting to study the type of people you get on these sort of recording sessions. Invariably you will get the untidy-looking twit wandering over to your equipment. He'll stand and stare at it for a while, give you a piercing glare and wander off again. Then there is the I've-got-a-recorder-too type. He owns a mediocre machine which apparently will only record the kids when his uncle isn't in the house; have you ever had this problem; isn't it a devil? The majority of performers ignore the equipment and the recordist and stare at you belligerently if you dare talk to them. Musicians who own their own instruments can barely be in the room with you if they think you are an amateur. Which brings me conveniently to the bit about Musicians' Union and Copyright.

As I mentioned before, I once did a recording of a choir, orchestra, organ and soloists in an abbey. During the pre-recording chaos, an intense-looking chappie came up to me and said, rather pointedly, that he was a member of the Musicians' Union. I expressed enormous interest and he then emphasised that any recording I took was not to be used for any other purpose than the purpose of the recording. This piece of Irish logic referred, of course, more to copyright than the Musicians' Union. It does, however, emphasise the importance of knowing what you are doing. I make it a rule to check with the promoter, if it is a disc recording session, that he has taken all the necessary measures in regard to copyright and professional performers. It is also important to remember that if you take a recording of professional artists at the local Oxo Rooms, even with their permission, you cannot play the recording back *in public*. Personally, I find this all a little childish, but there is, of course, always the danger of someone taking advantage of the fact that he has recorded Shirley Bassey at the local. After all, if there is no control at all, what is to stop him having discs made of his recording and flogging them round the pubs?

Recording for record companies is, to my mind, the most exacting of all types of recording. The master recording must be absolutely perfect, recorded at 38 cm/s if possible. Strong microphone stands and a minimum of heavy cable prevents contraltos from breaking their glissandos. Arm yourself with some paper to make notes on, an ashtray and some coffee, because it may be a long, long session. And one other item: a chair.

Don't do what I once did—I set the religious choir up, did a balance, gave the off sign, switched on—and out of the monitor speaker came Tuesday's Jazz Club at 10 watts.

Your Tape Dealer

OXFORDSHIRE

Westwoods

for the

TAPE RECORDER

of your choice

46 George Street

Oxford 47783

SHROPSHIRE

SHREWSBURY'S NEW SOUND CENTRE

Ferrograph-Leak-Akai-Rogers-Goodman etc.

HEAR THEM IN OUR DEMONSTRATION STUDIO

OPEN ALL DAY
TUESDAY-SATURDAY



Hi-Fi Ltd.

13 WYLE COP.

(facing the famous Lion Hotel)

Tel. 55166

SURREY

FARNHAM

SURREY

- ★ Stockists of all good Hi-Fi apparatus.
- ★ Comparative demonstrations.
- ★ We offer a real after sales service.
- ★ Easiest of terms.
- ★ No parking problems.

Lloyd & Keyworth Ltd.

THE RECORD SHOP

26-27 DOWNING STREET, FARNHAM

SURREY Telephone: Farnham 5534

SURREY AND HAMPSHIRE'S HI-FI SPECIALISTS

CROYDON'S

TAPE RECORDER CENTRE

All leading makes in stock, Hi-Fi equipment, cabinets, etc. Service agents for AKAI Tape Recorders

SPALDING ELECTRICAL LTD.,
352/354 Lower Addiscombe Road,
CROYDON.

Addiscombe 1231/2040

SUSSEX

WORTHING, SUSSEX

Stocking Ferrograph, Revox, Sony, Tandberg, Truvox, Philips, EMI, Luxor, etc., on fully comparative Demonstration.

BOWERS & WILKINS LTD.

1 Becket Bldgs., Littlehampton Road,
Worthing 5142

WARWICKSHIRE

BIRMINGHAM TAPE RECORDER CENTRE

266 BROAD STREET, BIRMINGHAM 1

(Opposite Bingley Hall)

Most leading makes high fidelity equipment.

Part exchanges welcomed.

Telephone Midland 2680

Your Tape Dealer

WARWICKSHIRE (contd.)

Coventry's 100% tape recorder and hi-fi specialists for service and sales.

Akai — Ampex — Bang & Olufsen —
Ferrograph — Leak — National —
Radford — Revox — Sony — Tand-
berg — Truvox — Wyndson.

Coventry Tape Recorder Service

33 King William Street, Coventry
Telephone Coventry 29668

GRIFFIN RADIO LTD

(the high fidelity people)

Fully comprehensive stocks and
advisory service for

Monaural and Stereophonic High Fidelity,
Radio, Tape and Disc Equipment

94 BRISTOL STREET

BIRMINGHAM 5

Telephone MID 1359

YORKSHIRE

TAPE RECORDER CENTRE (HALIFAX)

stock all the best Tape Recorders, Hi-Fi
Equipment, Tape, Pre-Recorded Tapes,
etc.

DEMONSTRATIONS DAILY BY EXPERT
STAFF

30 King Cross Street,
Halifax Phone 66832



SCOTLAND

GLASGOW

Scotland's Leading Tape Recorder, Video and Hi-Fi
Specialists

G. H. STEELE LTD.

Hear true Hi-Fi sound on our 22 speaker comparator
system. 14 Hi-Fi combinations ready for demonstration.

SONY VIDEO CENTRE

Agents for: Armstrong, Leak, Fisher, Rogers, Quad,
B & O, Goldring, Garrard, Thorens, Connoisseur,
Goodmans, Wharfedale, Kef, Celestion, Decca,
Truvox, Philips, Sony, Arena, Revox, Tandberg,
Brenell, Ferrograph, Akai, Uher, Grundig.

CREDIT TERMS — PART EXCHANGES
Repairs and Servicing Tel. Douglas 7124

141 St Georges Road, Glasgow C3

Recording Studios

mjb

recording and
transcription service

Mono and Stereo records: latest cutting methods, auto-
matic varigroove, feedback cutter heads, limiters and
equalisers, techniques hitherto available only to the
professional, facilitating high undistorted cutting levels
and extended playing times even from amateur recordings.
Booklet available.

45 HIGH STREET
BURNHAM

Tel. 61303 BERKS

TAPE RECORDERS - AUDIO EQUIP-
MENT - DISC CUTTING STD & LP
FROM TAPE - STUDIO FACILITIES
HIRE SERVICE-SALES-EXCHANGES

MAGNEGRAPH

1 Hanway Place, London, W.1. LAN 2156

CLASSIFIED ADVERTISEMENTS

Advertisements for this section must be pre-paid. The rate is 6d. per word (private) minimum 7s. 6d. Box Nos. 1s. 6d. extra. Trade rates 9d. per word, minimum 12s., Box Nos. 2s. extra. Copy and remittance for advertisements in **OCTOBER 1968** issue must reach these offices by **20th AUGUST** addressed to: The Advertisement Manager, Tape Recorder, Link House, Dingwall Avenue, Croydon, Surrey.

Replies to Box Nos. should be addressed to the Advertisement Manager, Tape Recorder, Link House, Dingwall Avenue, Croydon, Surrey, and the Box No. is quoted on the outside of the envelope. The district after Box No. indicates its locality.

SITUATIONS VACANT

Hi-Fi and Tape Recorder salesman required by R.E.W. (Earlsfield) Ltd. at their Tooting branch. Good pay and conditions. Apply the Manager, 266 Upper Tooting Road, London S.W.17. Tel. 01-672 9175 or 672 8267.

Magnetic Tapes Ltd. require young men to be trained in the various processes of manufacturing tape recorders for both industrial and commercial use. Varied and interesting work. Genuine interest in the audio field essential. Please write for appointment giving details of any previous experience. Apply to S. E. L. Collings, Magnetic Tapes Ltd. Chilton Works, Garden Road, Richmond, Surrey.

FOR SALE—PRIVATE

Philips EL3556, immaculate condition, plus 12 inch extension loudspeaker in cabinet, microphone, etc., £40. Telephone 01-748 2723.

Microphones—2 Hammond M100 capacitor mics, power supply, extension leads. £30 pair. 2 AKG D19C 60 ohm mics, £12 10s. each. All excellent. C. Sanders, 2 Eynsham Road, Oxford. Cumnor 2459.

FOR SALE—TRADE

Blackburn has Lancashire's leading Hi-Fidelity/Tape Recorder stockists and Electronic Engineers at Holdings Audio Centre, Mincing Lane/Derwent Street, Blackburn (Tel. 59595).

Always be careful (and money-wise) before buying quality equipment. Send your requirement list to Audio Supply Association for evaluation and quotation. See below . . .

If quality matters consult first our 70-page photographically illustrated catalogue (5/6) and equipment housing guide (1/6). Members enjoy unbiased advisory service, preferential terms. Membership 7/6. Our associates also manufacture records from your own tapes, or record the Master at our studios (Steinway Grand). Bulk terms for choirs, fund-raising. Please specify requirements. Audio Supply Association, 18 Blenheim Road, London, W.4.

Dynaco Power Amplifier 120. Almost unused, manufacturer assembled. £60. Tel. Advision Ltd., 01-499 3342.

Diamond Stylis: TC8LP, TC8, Stereo, TC8LP/Stereo, Studio "0", BF40LP Ronette, GC2, GC8, GP65/67, all at 6s. 11d. each; GP91LP at 12s. 6d., post and c. 6d. each. Felstead Electronics (TR), Longley Lane, Gatley, Cheshire.

REVOX IN SCOTLAND

Authorised Representative
It is to your advantage to contact **Hamish Robertson** of THERMAC before investing in this superlative instrument. Tel. 041-LAN. 1529
96 Langside Avenue, Glasgow, S.1

STUDIO FACILITIES

J & B Recordings. Tape to disc—latest high level disc cutting, all speeds. Mastering pressings, studio, mobile. 14 Willows Avenue, Morden, Surrey. MITcham 9952.

Rapid Recording Service. Records made from your own tapes (48-hour service). Master Discs and pressings. Recording Studio—Demo Discs. Mobile Recordings, any distance. Brochure from 21 Bishops Close, E.17.

Your tapes to disc. 7in. 45—18/-. 10in. L.P.—48/-. 12in. L.P.—55/-. 4-day postal service Masters and Vinylite pressings. Top professional quality. S.A.E. photo leaflet: Deroy Studios, High Bank, Hawk Street, Carnforth, Lancs.

MISCELLANEOUS

Repairs. Our modern service department equipped with the latest test equipment (including a wow and flutter meter and multiplex Stereo Signal Generator) is able to repair Hi-Fi and Tape Recording equipment to manufacturer's standards. Telesonic Ltd., 92 Tottenham Court Road, London, W1. 01-636-8177.

Skilled tape recorder repairs carried out by expert personnel of many years' experience backed by extensive test equipment: Wow and flutter meter, audio valve voltmeter, audio generator, oscilloscope, etc., with final test performance figures quoted if required—Ferroglyph specialists. Tape Recorder Centre, Tel-Lee-Radio, 220 The Broadway, Wimbledon, S.W.19. 01-542-4946.

Free with Do It Yourself Gardening Annual 1968—a packet of guaranteed-to-grow Cracker-jack African Marigold seeds. These magnificent plants have superb golden and yellow blooms 3in. to 4in. across. Other top features include: 20 ways to a better garden; Complete guide to lawns; How to cope with pests and diseases; Labelling garden plants; Easy-to-build lily pool; The rose—Queen of flowers; Gardening without soil—beginners guide to hydroponics; What's new in vegetables for 1968; Caring for house plants; 3/- from newagents or 3/11 (pp) from Link House, Dingwall Avenue, Croydon CR9 2TA.

WANTED

Lee Electronics. The Tape Recorder and Hi-Fi Specialists wish to purchase good quality Tape and Hi-Fi Equipment for cash. 400 Edware Road, W.2. Phone PAD 55291.

Highest prices offered for good quality Tape Recorders and Hi-Fi. R.E.W., 266 Upper Tooting Road, London S.W.17.

GOOD QUALITY TAPE RECORDERS PURCHASED FOR CASH. TELEPHONE 01-472 2185.

POST THIS COUPON FOR A REGULAR COPY OF TAPE RECORDER

Subscription Department, TAPE RECORDER, Link House, Dingwall Avenue, Croydon, CR9 2TA.

Please send me a copy of each issue of TAPE RECORDER for months commencing with the issue for which I enclose remittance of £.....s.....d.

Name

Address

..... T.R.

Postal Subscription Rates :

Great Britain : Post paid for 12 months 36/-. 6 months 18/-
Overseas : Post paid for 12 months 38/6, 6 months 19/6

SANYO PORTABLES put you in the world class

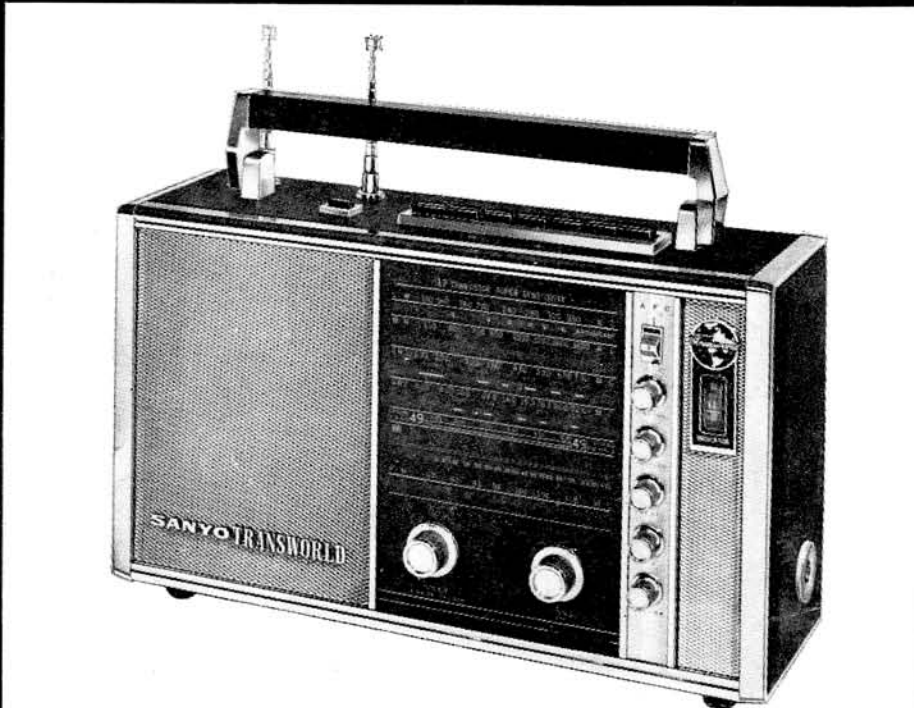

Sanyo 17H-815

A really magnificent radio—it's got everything! Full range, 2 short waves, medium wave, long wave, FM. Fitted sockets for record player, tape recorder and car aerial. Mains or battery powered. 17 transistors, 7 diodes. Speaker 5" x 7" oval. Power output undistorted 2,000 mW, max. 3,000 mW. Batteries 6 x U2. Dial lights. Battery saver switch. Earphone ext. speaker, multiplex sockets. Mains adapter available as extra. Ferrite rod cut out button for car use.

Recommended selling price **£74.11.0.**

Even if you've a roomful of fixed hi-fi in your home, you'll still be impressed with the performance of these special SANYO portable radios and tape recorders. Everything about them is designed to give the highest possible

performance within a reasonable compass of size and price.

For further information write to:

Sales Manager, Marubeni-Iida Co. Ltd,
164 Clapham Park Road, London SW4.

SANYO reliability is built in