

AUGUST 1968 2s 6d

# tape recorder

---

UNDERSTANDING BIAS

---

HOW NOT TO WIN  
A TAPE RECORDING  
COMPETITION

---

WHAT'S IN A CLUTCH?

---

RECORDING FOR  
TELEVISION

---

REVOX A77 FIELD TRIAL

---

REVIEWS: AMPEX 753,  
GRUNDIG TK145  
AND GRAMPIAN 20/3

---





# K. J. ENTERPRISES



BRITAIN'S PREMIER MAIL-ORDER RECORDING TAPE SPECIALISTS

**IMMEDIATE 24 HOUR SERVICE ON ADVERTISED LINES**

FULL CASH REFUND GUARANTEED

SEND TODAY AND SAVE!

## BRANDED TAPES

### 20% OFF

#### BASF - EMI - GRUNDIG PHILIPS - SCOTCH - AGFA

Brand New, Fully Guaranteed and in normal manufacturer's pack.

STANDARD PLAY	LIST PRICE	OUR PRICE	DOUBLE PLAY	LIST PRICE	OUR PRICE
5" 600'	22/2	18/-	3" 300' Not Scotch	14/3	11/6
5 1/2" 900' Except Agfa	29/5	24/-	3" 400' Scotch only	16/7	13/6
7" 1200'	36/7	29/6	4" 600'	26/-	21/-
<b>LONG PLAY</b>			4 1/2" 900' Agfa, BASF only	31/-	25/-
3" 210' Not Scotch	9/3	7/6	5" 1200'	43/2	35/-
3" 300' Scotch only	9/7	7/9	*5 1/2" 1800'	56/11	46/-
4" 450'	14/9	12/-	*7 1/2" 2400'	79/9	63/6
4 1/2" 600' BASF, Agfa only	22/-	18/-	10" 4600' Agfa only	140/9	112/9
*5" 900'	29/2	23/9	<b>TRIPLE PLAY</b>		
*5 1/2" 1200'	36/5	29/6	3" 450' Not Scotch	22/3	18/-
*7" 1800'	51/7	41/9	3" 600' Scotch only	24/10	19/9
8 1/2" 2400' BASF, Scotch only	74/-	59/6	4" 900'	40/-	32/3
10" 3280' Agfa only	85/9	68/9	*4 1/2" 1200' Agfa, BASF only	50/-	40/3
10" 3600' BASF only	96/6	77/6	5" 1800' Not Scotch	67/2	54/-
10 1/2" 4200' Agfa, BASF only	113/6	91/6	5 1/2" 2400' Agfa, BASF only	91/4	73/6
<b>SCOTCH DYNARANGE (L/P)</b>			7 1/2" 3600' only	116/6	93/6
5" 900'	32/8	26/3	<b>QUADRUPLE PLAY</b>		
5 1/2" 1200'	41/-	33/-	3" 600'	37/-	29/6
7" 1800'	58/1	46/6	3 1/2" 800' Kodak only	46/3	37/-
8 1/2" 2400' (Metal Reel)	84/3	67/6	4" 1200'	64/6	51/6
<b>BASF PES.35 L/P Low Noise</b>			<b>COMPACT CASSETTES</b>		
5" 900'	36/10	29/9	C.60	17/6	14/3
5 1/2" 1200'	45/6	35/6	C.90	25/-	20/3
7" 1800'	63/-	50/9	C.120	33/6	27/-
10" 3600'	115/-	91/-			

Post and Packing 2/6

ORDERS OVER £3 POST FREE

### FERROGRAPH TAPE—20% OFF!

Brand New. Fully guaranteed and in normal manufacturer's pack.

	LIST PRICE	ONE	THREE	SIX
BN7 1200' on 7" reel (Dynarange)	50/-	40/-	117/6	230/-
BN8 1800' on 8 1/2" reel (Dynarange)	71/-	57/-	168/-	330/-
BL7 1800' on 7" reel (Dynarange)	70/-	56/-	165/-	324/-
BL8 2400' on 8 1/2" reel (Dynarange)	90/-	72/-	213/-	420/-

Post and Packing 2/6

ORDERS OVER £3 POST FREE

### SPECIAL OFFER COMPACT CASSETTES



Compact Cassettes with 60 and 90 minutes playing time. Brand New and packed in normal plastic library box. Available at this exceptional price.

MC.60	1 for 12/6	3 for 36/-	6 for 69/-	12 for 132/-
MC.90	1 for 18/-	3 for 52/6	6 for 102/-	12 for 198/-

Standard pattern to fit Philips, Stella, Elizabethan, Dansette, Sanyo, etc.

Post and Packing 2/6

Orders over £3 Post Free

### BASF TAPE—30% OFF!

A 'Special Offer' of the world-famous BASF Magnetic Recording Tape. Guaranteed Brand New, Polythene sealed, and supplied in Plain White Boxes.

TYPE	DESCRIPTION	LIST PRICE	ONE	THREE	SIX
LGS.35	900' Long Play on 5" Reel	29/1	19/6	57/-	111/-
LGS.35	1200' Long Play on 5 1/2" Reel	36/4	24/6	71/-	137/-
LGS.35	1800' Long Play on 7" Reel	51/6	35/-	102/-	198/-
LGS.26	1800' Double Play on 5 1/2" Reel	56/4	38/6	112/6	219/-
LGS.26	2400' Double Play on 7" Reel	79/-	55/-	162/-	318/-

Post and Packing 2/6

ORDERS OVER £3 POST FREE

### KODAK TAPE—30% OFF

Brand New, fully guaranteed and in normal manufacturer's pack. Superb quality polyester base tape for top performance. Complete with Full leader and stop Foil.

TYPE	DESCRIPTION	LIST PRICE	ONE	THREE	SIX
P.150/12	1200' Long Play on 5 1/2" reel	35/6	25/6	75/-	144/-
P.150/18	1800' Long Play on 7" reel	55/-	37/6	111/-	216/-
P.200/16	1650' Double Play on 5 1/2" reel	57/9	40/6	120/-	234/-

Post and Packing 2/6

ORDERS OVER £3 POST FREE

### AMPEX TAPE

Brand New. Fully Guaranteed, and in normal manufacturer's pack.

301 SERIES AUDIO TAPE (Mylar Base)					
TYPE	DESCRIPTION	ONE	THREE	SIX	
331-13	600' Standard Play 5" reel	16/6	48/-	93/-	
331-15	1200' Standard Play 7" reel	27/6	81/-	156/-	
341-13	900' Long Play 5" reel	19/6	57/-	111/-	
341-15	1800' Long Play 7" reel	32/6	96/-	186/-	
351-13	1200' Double Play 5" reel	31/6	93/-	180/-	
351-15	2400' Double Play 7" reel	54/-	159/-	312/-	

304 SERIES "LOW NOISE" AUDIO TAPE (Mylar Base)					
TYPE	DESCRIPTION	ONE	THREE	SIX	
344-13	900' Long Play 5" reel	24/6	72/-	140/-	
344-15	1800' Long Play 7" reel	42/6	124/6	243/-	

'600' SERIES PROFESSIONAL AUDIO TAPE (Mylar Base)					
TYPE	DESCRIPTION	ONE	THREE	SIX	
641-9	900' Long Play on 5" reel	23/-	66/6	127/6	
641-18	1800' Long Play on 7" reel	39/6	116/-	226/-	
651-12	1200' Double Play on 5" reel	34/6	101/-	197/-	
651-24	2400' Double Play on 7" reel	60/-	177/-	348/-	

Post and Packing 2/6

ORDERS OVER £3 POST FREE

N.B.—Other types and sizes available including the inexpensive "White Box" series

**NOW FROM K J THE FULL RANGE OF**

## MUSICASSETTES

AVAILABLE BY RETURN POST.  
SEND FOR FREE CATALOGUE

### TRIPLE PLAY TAPE — 40% OFF!

A large purchase from two world-renowned manufacturers enables us to make this unique near half-price offer. Brand new, fully guaranteed, premium grade Polyester Base Tape with FULL LEADER and stopfoil. In original maker's boxes and polythene wrapped at these EXCEPTIONALLY LOW PRICES.

	LIST PRICE	ONE	THREE	SIX
450' on 3" reel Gevasonor	22/-	14/-	40/6	78/-
600' on 3" reel Gevasonor	27/6	17/6	51/-	99/-
900' on 4" reel Gevasonor	39/-	24/6	72/-	140/-
1800' on 5" reel Gevasonor	66/-	41/6	122/-	238/-
2400' on 5 1/2" reel Zonal	90/-	55/6	165/-	324/-

Post and Packing 2/6

ORDERS OVER £3 POST FREE

20% off all Grundig and Philips Equipment

SEND FOR LISTS OF OTHER TAPE AND HI-FI BARGAINS  
**K. J. ENTERPRISES, (Dept. TR), 17 THE BRIDGE, WEALDSTONE, MIDDLESEX (OPPOSITE HARROW & WEALDSTONE STATION)**  
 01-427 0395 (CLOSED P.M. SAT.) REFUND GUARANTEE

# FREE

Our new illustrated catalogue sent entirely free on request. Britain's most specialized comprehensive range of recording tape and accessories. 20,000 reels always in stock with reductions ranging up to 50%.

# MORE FANTASTIC BARGAINS FROM **K.J. ENTERPRISES**

**WE SAVE YOU MONEY!**

## SPEAKERS GALORE!

SAVE £6.10.0d. on the SONOTONE SOLENT

The fabulous bookshelf speaker system designed and manufactured by Plessey, one of the country's largest electronics groups. Acoustically designed two-speaker system with crossover network.

ORIGINALLY SOLD FOR £18.0.0d.

**NOW OFFERED AT £11-10-0d**

CARRIAGE 10/- EXTRA PER UNIT

THIS OFFER REMAINS OPEN ONLY WHILE STOCKS LAST!

### WHAT THE REVIEWERS SAID:

"Recommended without reservation for this category of Loudspeaker." David Phillips & Donald Aldous.

"Sonotone 'Solent' deserves to reach a wide public." John Borwick.

"A worthy member of the Hi-Fi family." R. L. West.

### Technical Specification:

Cabinet Size 14" x 9" x 8½"  
 Woofer 6½", 10,000 Gauss, 1" pole.  
 Tweeter 3½" Acoustically loaded  
 Frequency response 40-20,000 cps.  
 Power Handling 12 watts.  
 Impedance 8-15 Ohms.  
 Scandinavian style finish.

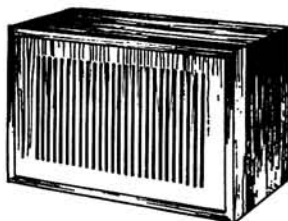

Guaranteed Brand New in Maker's carton

### ALSO ANOTHER FANTASTIC PURCHASE

**Compact Cassette TAPE RECORDER ONLY 21 GNS.**

### The ELPICO CTR 600 Battery Cassette Tape Recorder

Beautifully styled, pocket-size recorder with "snap-in" cassette loading. Press button operation with separate volume and tone controls. Up to 120 minutes playing time on a single cassette. Weighs only 3lb. 5oz. Supplied complete with C.60 cassette, remote control microphone, earphone and batteries.

Dimensions 4½" x 8½" x 2½"

ORIGINAL PRICE 27 gns.

Now offered to you, Brand New and fully guaranteed for the sum of **21 gns.** plus 7/6 Post and Packing.

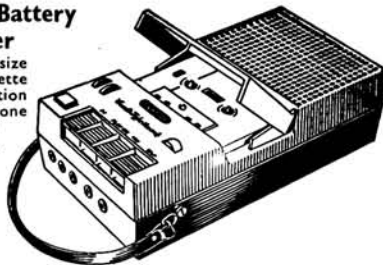

### OTHER OUTSTANDING BARGAINS IN "COMPACT CASSETTE" RECORDERS AVAILABLE FROM K. J.

DESCRIPTION	LIST PRICE	OUR PRICE	Post and Packing
Philips 3302 Battery Tape Recorder ...	31 10 0	26 7 6	7/6
Philips 3303 Battery Tape Recorder ...	37 5 9	31 5 0	7/6
Philips 3312 Stereo Mains Tape Recorder ...	—	42 0 0	10/-
(with two x GL 559 loudspeakers)	66 12 7	55 17 6	15/-
Grundig C 200 (New Model) Battery Tape Recorder ...	49 7 0	41 7 6	7/6
Aiwa TP 1004 Mains/Battery Stereo Tape Recorder ...	62 7 3	51 17 6	10/-
Sanyo M.18 Battery Tape Recorder ...	29 12 10	26 0 0	7/6

**K. J. ENTERPRISES (Dept. TR)**  
**17 THE BRIDGE, WEALDSTONE, MIDDX.**  
 Tel: 01-427 0395



# TELEFUNKEN

Listen to as many portable recorders as you can. Compare. This is the one that stands out.

From now on, this is the one that all other machines are going to have to try and live up to. Go into any good dealers and ask them what they think about it. Magnetophon 300 is the one you can shake, move or twirl—subject it to any kind of movement—yet it still gives a faultless recording... compares with very good Hi-Fi machines. 5" spool 2-track. 40-14,000 c/s. 3½ i.p.s. Sockets for radio, microphone, pick-up, headphones, tape recorder, additional loudspeaker, AC power supply/battery charger. Operates on 5 flashlight cells, car battery or rechargeable storage battery.

Recommended retail price £63 3s. 1d. Also 4-track M 301 £69 12s. 0d. At only £76 0s. 2d: M 302 4-track with speeds of 3½ i.p.s. and 1½ i.p.s. Write today for fascinating FREE colour booklet to AEG (Great Britain) Limited 27 Chancery Lane London WC2.





# NuSound

BRITAIN'S LARGEST SPECIALISTS



## TAPE RECORDER AND HI-FI CENTRES

### EVERY LEADING MAKE AVAILABLE

- EASIEST HIRE PURCHASE TERMS
- GENEROUS PART EXCHANGES
- FINEST AFTER-SALES SERVICING
- EXPERT STAFF AND EXPERT ADVICE

Stockists of: Akai, Ampex, Arena, Armstrong, B. & O., Brenell, Dynatron, EMI, Elizabethan, Ferguson, Ferrograph, Garrard, Goldring, Goodmans, Grundig, H.M.V., Hacker, Kef, Leak, Loewe-Opta, National, NuSound, Ortofon, Philips, Quad, Reps, Rogers, Sanyo, Sony, Stereosound, T.R.D., Tandberg, Telefunken, Thorens, Truvox, Uher, Van Der Molen, Vortexion, Wharfedale, Wyndsor, etc.

Every make and model of Tape Recorder and Hi-Fi Unit is available for immediate demonstration by our specialist staff who will be delighted to assist you in selecting equipment to suit your individual requirements. Only from NuSound can you benefit from all these invaluable features—the most comprehensive range of equipment on display in the country, expert staff, free technical advice, immediate demonstration of any model and the finest after sales servicing available.

WE OPERATE A PERSONAL EXPORT SCHEME  
SAVING UP TO 20% ON LIST PRICE

## NuSound

### TAPE RECORDER CENTRES

- WEST END** 82 HIGH HOLBORN, W.C.1. Tel. 01-242 7401  
(200 yds. Kingsway—Half-day Saturday)
- CITY** 228 BISHOPSGATE, E.C.2. Tel. 01-247 2609  
(Opp. Liverpool St. Stn.—Closed Sat. Open Sun. 10-2)
- E. LONDON** 2 MARYLANDSTATION, E.15. Tel. 01-543 5879  
(Adjacent Maryland Point Stn.—Half-day Thursday)
- N.W. LONDON** 360 KILBURN HIGH RD, N.W.6. Tel. 01-624 1656  
(Opp. Kilburn Tube Stn.—Half-day Thursday)

### TAPE AND HI-FI CENTRES

- N. LONDON** 242/4 PENTONVILLE RD., N.1. Tel. 01-837 8200  
(200 yds. Kings Cross Stn.—Half-day Thursday)
- ILFORD/ESSEX** 85-100 ILFORD LANE, PIONEER MARKET.  
Tel. 01-478 2291 (200 yds. Ilford Stn.—Half-day Thur)
- S.E. & KENT** 36 LEWISHAM HIGH ST, S.E.13. Tel. 01-852 2399  
(Opposite Chiesmans — Half-day Thursday)

### SEE THIS EQUIPMENT



## AKAI SPECIALISTS

See, hear and compare the complete range of Akai Stereo Tape Recorders. Our experienced staff are able to give expert advice and also demonstrate the many outstanding features of this wonderful range of equipment.



**Model 1710W** — Four track, three speed complete stereo tape recorder. A FEW AVAILABLE AT OUR SPECIAL PRICE OF £89.10 (MANUFACTURER'S BEST PRICE £109.17.3).

At every NuSound showroom you'll find a wonderfully comprehensive range of equipment backed by over 13 years' experience in this ever growing and highly specialised field—in which the NuSound reputation is "second to none". Four NuSound Centres are devoted exclusively to Tape Recorders and Accessories and the other three NuSound centres specialise in both High Fidelity Equipment and Tape Recorders.

Visit any NuSound Centre and you'll be certain of 100% Service and Satisfaction.

**BRITAIN'S LARGEST TAPE & HI-FI SPECIALISTS**

---

# tape recorder

---

AUGUST 1968 VOLUME 10 NUMBER 8

INCORPORATING  
SOUND AND CINE

---

## EDITOR

JOHN CRABBE

## DEPUTY EDITOR

DAVID KIRK

## ADVERTISEMENT MANAGER

ROBIN WELLS

---

Editorial and Advertising Offices:  
LINK HOUSE,  
DINGWALL AVENUE,  
CROYDON, CR9 2TA  
Telephone: 01-686 2599

---

© Link House Publications Ltd., 1968  
All rights reserved

---

## COVER PICTURE

The young lady in our picture is not, as might appear, pinned against a vertical wall with the Telefunken M300 held in place by anti-gravity. Actually, she is basking on a wooden jetty, hoping for some August sun, and presumably also hoping for some recordable sounds to come floating by. Happy holidays!

---

## SUBSCRIPTION RATES

Annual subscription rates to *Tape Recorder* and its associated journal *Hi-Fi News* are 36s. and 41s. respectively. Overseas subscriptions are 38s. 6d. (U.S.A. \$4.60) for *Tape Recorder* and 42s. 6d. (U.S.A. \$5.10) for *Hi-Fi News*, from Link House Publications Ltd., Dingwall Avenue, Croydon, CR9 2TA.

*Tape Recorder* is published on the 14th of the preceding month unless that date falls on a Sunday, when it appears on the Saturday.

---

THE PAST 20 years have witnessed considerable improvement in the design of tape amplifiers and heads, and in the production of magnetic tape. Micro-gap manufacturing techniques and the introduction of ferrite core materials have extended both the potential HF response and the useful lifetime of modern heads, while a multitude of minor electronic developments have improved amplifier and oscillator characteristics, to say nothing of the application of low-noise transistors. High coercivity low-dropout tapes are now widely available and even the old bogeys—print-through and tape hiss—are being overcome by electronic means. (A detailed description of the Dolby noise reduction system will be published in this journal shortly.)

In one respect, however, modern knowledge has scarcely advanced since the days of the wartime Telefunken *Magnetophon*. Direct drive, radial head guiding and self-stabilised spool tension can all be traced back to this design, still considered the epitome of a good studio transport.

Kudelski was the first to depart radically from convention, his *Nagra* incorporating an electronically stabilised capstan. Even this system, however, depends upon good engineering to ensure constant tape speed. Yet a constant speed need *not* be the object of the exercise: assuming fluctuation in recording velocity to be inevitable, perfect reproduction can still be approached by varying the replay tape speed to cancel its effect. An experimental Revox modification on these lines is described on page 371. Here, an electronically generated fixed-frequency sinewave is recorded on an effectively conventional transport, parallel to an in-line audio track. On playback, the control tone endeavours to stabilise itself, and thereby the audio track, through the discriminator-controlled capstan motor.

A viable system of this nature requires a very short time-constant if it is to follow the rapid speed variations inherent in the *Magnetophon* family (i.e., all modern audio recorders). *Nagra*, *Revox* and *Leavers-Rich* servo systems all rely on flywheel momentum to damp flutter and wow, the electronic control being merely a long-term speed stabiliser.

The one to three second time-constant is probably due to the flywheel rather than the discriminator. To our knowledge, no company has yet combined a low-inertia drive mechanism with a fast-acting tape-governed servo, though this appears a logical next step forward. It is technically ahead of the open-servo *Nagra* and could prove cheaper than the fine-tolerance engineering demanded for a conventional transport construction.

In the field of instrumentation, tape mechanisms have been evolved with characteristics that put audio standards to shame. There are few red faces, however, as instantaneous stretch-free starting and reversal are rarely required for sound recording. The data boys

are so concerned by speed instability that their 'electronic sprocket' pilot tracks are placed in the middle of multi-channel recordings in order to avoid linear errors between opposite sides of the tape. Pinch-wheel inertia is overcome simply by omitting that component and using a vacuum to suck the tape against the capstans. Needless to say, the unused reverse capstan, at any instant, is switched to *blow*. These techniques, and the host of others evolved for computer systems, deserve close study by the designers of audio tape recorders. We propose to play our little part in this airing with a forthcoming examination of data transport mechanisms. In addition, a leading engineering consultant, specialising in advanced audio recorders, will be describing detailed aspects of tape transport construction.

From the immediate future to the present: our transition from *inches per second* to the *Metric centimetres per second* reference is now complete, after a six-month period in which *i/s* and *cm/s* have been quoted alongside. *Wireless World* made the change in a single month, though tape recording is hardly their prime subject. Apart from queries when first we adopted non-multiples for 15, 7½ and 3¼ *i/s*, we have received no complaints from mystified readers. Since then, as regular readers will know, we have kissed that particular British Standard goodbye.

---

## FEATURE ARTICLES

- 344 RECORDING FOR TELEVISION  
By Peter Bastin
- 347 THE ARRIFLEX ELECTRONIC CAM  
By Richard Golding
- 355 BATTERSEA MESSIAH  
By Peter Sidhome and Paul Reeves
- 357 WHAT'S IN A CLUTCH?  
By William Henry
- 362 UNDERSTANDING BIAS  
By Gerald Chevin
- 367 HOW NOT TO WIN A TAPE RECORDING CONTEST  
By John Shuttleworth

## REGULAR ITEMS

- 343 WORLD OF TAPE
- 349 READERS' PROBLEMS
- 350 TAPE RECORDER SERVICE  
By H. W. Hellyer
- 358 CLOSED CIRCUIT  
By Richard Golding
- 365 BOOK REVIEWS
- 368 REVOX A77 FIELD TRIAL  
By David Kirk

## EQUIPMENT REVIEWS

- 373 GRUNDIG TK145
  - 375 AMPEX 753
  - 377 GRAMPIAN 20/3 MIXER  
By A. Tutchings
-

**Ever Ready  
High Power  
Batteries**



**Ever Ready pack the  
*performance!*  
into battery operated tape recorders**

Ever Ready is the power that performs best in today's cordless record players and tape recorders. Ever Ready High Power Batteries pack in bright sound, crisp reproduction and much, much longer playing time!

Load up with Ever Ready Power – your customers will be expecting it.

The Ever Ready Co (GB) Ltd • Ever Ready House  
1255 High Rd • Whetstone • London N20 • 01-446 1313



**Ever Ready  
pack the power in**

#### PRAGUE AUDIO EXHIBITION

FOURTEEN manufacturers representing various parts of the world met in Prague at the end of May to present their high fidelity devices, reports our Czech correspondent Otto Musil. It is a credit to the recently founded *Czechoslovak Hi-Fi Club*, whose very active members are associated around the magazine *Hudba a zvuk (Music & Sound)* that—for the first time in fact—the Czech public was able to acquaint itself with products previously disregarded by the home industry. Goodmans, SME and Audio & Design attracted the visitors' attention with their exhibits. Most of the models were operating continuously, the tape recorders of Bang & Olufsen, Grundig, Telefunken, Revox and Nordmende being successively used as sources of musical material. Individual reproduction systems, among them some really original amateur designs, were publicly tested. At the same time, the exhibition organizers sought answers to such questions as the potential demand for a high quality tape recorder. Similarly the test sale of an American gramophone record was arranged to probe the commercial result of market current western labels in Czechoslovakia. Under the Czech conditions the *Hi-Fi Expo* exhibition was unusually significant—it will not only influence the plans of the domestic manufacturers but also stimulate foreign trade development, especially now when the new political situation in the country seems to be more than favourable. The first step was made by the amateurs themselves—they decided to build up in Prague a Hi-Fi Hall in which audio equipment of various sorts could be demonstrated permanently.

#### ULTRA-FAST TAPE READER

AN ultra high speed photoelectric punched tape reader has been developed for industrial and instrumentation applications by *Remex Electronics* of California. Used in conjunction with the 26.5 cm. capacity *RS-1000* spooling unit, the *RS-1002* reads at 1,000 characters per second and will rewind or search at 2,000 per second. Up to 2,040 ft. of tape can be accommodated in the spooler (lower section of photograph).

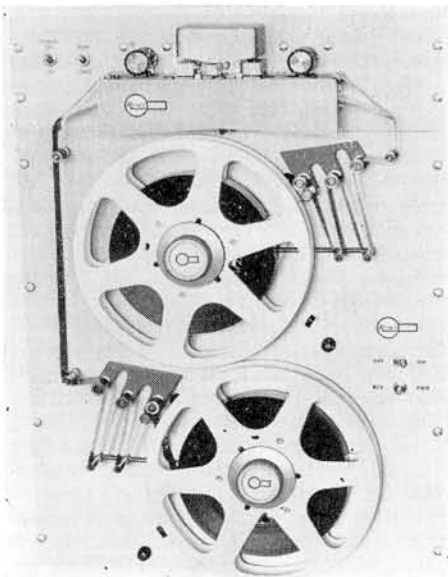

#### RADIO CASSETTE

A RADIO tuner designed to fit the cassette housing of Philips *EL3301* recorders and their equivalents has been developed by Kodama Chemical Industries of Tokyo. The 10 x 6.3 x 1.3 cm receiver is coupled electromagnetically to the recorder's replay amplifier using the record/play tape head as one half of a transformer.

AM and FM units are now being retailed in Japan at the same price—2,000 Yen (approximately £2 7s.). Exporting will commence in August.

#### AKAI HELICAL-SCAN VTR

TWO domestic video tape recorders were exhibited by Akai at the New York *Consumer Electronics Exhibition* in June. The fixed-head *VX-1200*, first described last month, employs cross-field bias to achieve 1 MHz at 114 cm/s, picture quality being described as satisfactory. The second design, unique in two respects, is a helical-scan video recorder using normal 6.34 mm. audio tape at 26 cm/s. A separate set of heads is incorporated to permit stereo audio recording on the same transport.

Also seen at the exhibition was the *X-5* stereo battery recorder, an improved version of the *X-4* employing a brushless electronically stabilised motor. This machine is about to be released on the UK market.

#### NORTH BY SIX

METROSOUND Ltd., agents for Thorens, Ortofon and Sonotone, have moved from their N.1 premises to a new factory at 35-37 *Queensland Road, London N.7*. The new quarters will provide room for expansion of their accessory-manufacturing and servicing facilities.

#### 'TAPE RECORDER' DISTRIBUTION

MANY readers of specialist journals are under the impression that they may enter any newsgagent in the land and buy the publication of their choice. It will be appreciated, however, that the practical difficulties involved in national distribution inevitably leave certain gaps. In cases of difficulty, readers are invited to inform us of their newsgagent's address whom we may then contact directly. A regular order is the simplest way to avoid disappointment.

#### NO TAX ON BIB SPLICER

THE taxation of tape recording accessories, we learn with pleasure and surprise, does not include Bib tape splicers. The provisional post-budget price of the 6.34mm. audio-tape unit has been reduced from £1 3s. 10d. to 19s. 6d. The Customs & Excise Authority have confirmed that the *Model 21* 12.69mm. video-tape splicer is similarly exempt.

#### APRS EXHIBITION

HELD at the Hotel Russell on 25th May, the exhibition of professional recording equipment organised by the *Association of Professional Recording Studios* attracted exhibits from over 20 firms, most of them specialist manufacturers and between them showing most of the products available for high quality recording purposes.

Much of the tape recorder equipment was naturally in the several hundred to several thousand pound category, of particular interest



being the new two-track transistor studio machine by Philips, the *PRO 51*, costing £1800. Weighing 2 cwt. it is certainly intended for fixed installation; this sort of construction seems to be unavoidable if really superlative mechanical performance is vital. Higher in price at £5000, the new Leavers-Rich studio machine was on view, whilst for £7,500 one could buy the *Scotch C 401*, an eight-channel recorder using the isoloop tape transport system. Other studio tape recorders also on show were the *Ampex AG 440*, *EMI BTR4*, *Scully 284-2* and *Studer 37*.

Control and test equipment covering a wide range of applications was also displayed by *Astronic*, *Audio and Design*, *B & K*, *Carston Electronics*, *Elcom*, *Grampian*, and *Lennard Developments*.

A wide variety of professional quality microphones were to be seen on the *AKG*, *Audio Engineering*, *Grampian*, *Neumann* (*Bauch*) and *Shure* stands. Amongst new products was the *AKG D 224*, a miniature version of their *D 202*.

After the exhibition a symposium was introduced by an effective demonstration of the *Dolby* noise reduction system.

#### NEXT MONTH

The September issue will appear on Saturday 13th July. Arthur Garratt returns with an illustrated guide to professional editing — *To Err is Human*. Richard Golding examines the application of tape recording systems in audio-visual and audio-lingual education while Alec Tutchings reviews the low-price *Eagle 7C405*. The *Tandberg 64X* will be field tested by David Kirk.



# RECORDING FOR TELEVISION

BY PETER BASTIN



ONLY once have I appeared on television, which is, no doubt, some contribution towards the stability of the country. Everyone said it was fine, very natural, which only makes me surer than ever that everyone is mad.

The whole thing started when a nice young journalist, very clean and positively shining with after-shave and enthusiasm, came to interview me on the small matter of amateur tape recording. Over coffee, he pried deeply into my reasons for taking up the sport and, to his everlasting credit, didn't give me the sort of look grocers give you when you tell them that you are a recording enthusiast. I played him some of my tapes and he scribbled away like mad. "Cor," I said to myself, "this article is going to be far too long to get on four pages of the paper." A week later a photographer came to see me and we unearthed the coffee pot again. The article duly appeared and very good it was too. I must say that the nice clean young journalist knew how to put words together—and not one spelling mistake. Almost as soon as this red-hot edition hit the streets, a Voice rang me from London. ITV was interested and could the Voice call to see me with a view to being interviewed between the detergents and cat-food? The Voice came up from London in the shape of a well-proportioned, carefree TV man in a sheepskin liberty-bodice and suede shoes. Out came the tapes again (and the coffee pot) and I could hear the subdued whirring of a TV brain. "Right," said Mr. ITV, "we'll send up a camera crew and I'll organise everything."

The camera crew—a director, a continuity girl, a lighting man, a camera man and four tons of equipment—duly arrived and got to work. For three hours they filmed and considered, re-filmed and reconsidered. They filmed everything in my studio; close-ups,

long-shots and closer close-ups; the director lay flat on the floor so that his evil-looking hand could be photographed as a symbol of something or other. There were lights and cables, instruments, bits of equipment and people everywhere and when they eventually left, it felt as if we had been occupied by a vacuum. The idea was now to edit the four reels of film they had shot and when that was done I would have to make a sound-track to go with it for running prior to the interview. In due course, I went up to the studios to look at the film. An interesting point here—most films are shot in negative and projected in negative, reversal being carried out electronically. So this film, 2 minutes 10 seconds of it, was in negative. I sat in a large console thing which ran the film at either of two speeds and timed the whole thing. It was quite an interesting job although a little complex in view of the fact that the film editor had done a rapid-shot sequence—the sort of thing you get at the beginning of *Top of the Pops*. I produced a sound-track of various individual instrument sounds plus a few other weird and factual effects.

I did not see the completed film until the day of transmission—or, to be more accurate—the day of the video recording. The programme is a daily live one, but due to an unforeseen news event, transmission of my item had to be postponed until the next night; they therefore recorded me earlier in the day and shoved me on ice for 24 hours. I arrived at the studios at 2.20 p.m. for 3 p.m. and was shown into a very lush reception suite, completely empty except for some soft lights and sweet music. Smack on 3 p.m. my ITV friend, who was to interview me, two directors, a floor manager and a girl arrived. After some desultory conversation, very little of which related to the Forthcoming Event, we went into the studio. I had been

asked to bring along two Ferrographs, a glockenspiel, a guitar and a trumpet which now rested rather uncomfortably on the bright blue studio floor. The studio was about 50 by 25 ft. completely cluttered, apart from a small area in the middle, with cameras, monitors, caption machines and people. The upper part of the studio was laced with lighting gantries and arcs. Two chairs, a coffee table, two microphones on low stands and some flowers stood ominously in the centre. Three or four people fussed round, laying out my equipment while I hooked up my battery-portable to do a programme on a programme. Unfortunately, the floor manager, an emigrant from Scotland, spotted this wicked business and pointed out that it could nae be done in the studio. So, like a good television star, I put it away.

Right, time to get down to it. The three camera-men stopped playing poker and came to life. They moved their enormous cameras up and down sideways—beautiful, silent action—and peered at the 5 by 4 screens at the back end of them. One broke down. The floor manager shifted our positions and gazed at me with disgust. Actually, he was a very nice chap and became very chatty later on, explaining all about the little transmitter in his top pocket which linked him with the director, out of site in his eyrie aloft. I asked if we were to have a run-through first. "Good heavens no," said Mr. ITV, "we don't believe in that at all: we want spontaneity, that's what we want." He sat there, looking supremely calm, swearing at the camera men and thinking of the next day's programme. He had a light make-up but I, apparently, didn't need it. What I did need was a cup of tea. They ran the film through, which had shrunk from four reels to 130 seconds to 15 seconds. It was quite good. Right, said Mr. ITV, let's go. One camera fastened itself on some un-



intelligible titles all about takes and times and the other two turned viciously on us. The lights became excited, the floor manager said shut up or something like that and we watched the nasty sinister timing hand on the caption board creep round. The film ran and we watched it on all five monitors. Then it was Us. Mr. ITV asked me a series of questions, some of which came out of the blue but, as I had been anticipating them, I managed to fumble a reply. He then muttered something about listening to something I had done—actually a Bastin version of their signature tune—and pressed the start button of the Ferrograph. The tape, of course, was being run in the control room and the switching-on of my machine was mere window-dressing. It looked very good when we replayed the tape. The interview ended abruptly with the famous words "thank you very much" and I hoped that I did not look too surprised or startled.

We returned to the reception suite which now contained two directors, a floor manager, a hostess and several other people. I got my cup of tea and they played the tape through. I was absolutely horrified at the sight of my mouth opening and shutting. It is all very well looking at still photographs for, after a while, you get used to seeing yourself, but to see your face moving is a revolting experience and I am not surprised that the BBC want to put the licence fee up. Sound quality was excellent and I wish that I could get the power they manage to get behind their microphones. The tape ended on a close-up of my face with what I thought to be a ludicrously glassy-eyed blank look. "Good," said Mr. ITV, who was very pleased with that.

One of the directors asked me if I would like to look at the control room and as the teapot was just about empty, I said yes I would. We wound our way between chunks of scenery, boxes and Dalek-like microphone boom units and ascended into the upper regions. The control room had no view whatsoever of any of the three studios. Television directors, unlike radio directors, rely upon electronics to follow the programme in transmission. Each camera has its own monitor set in the control room; in addition, there is a monitor which shows the picture which is leaving the studios and a further monitor showing the picture in actual transmission. If the director selects the picture from Camera 2, this appears on both of the 'final' monitors. In this particular control room, there were two sets of monitors. The director sits at the rear of the people operating the controls in front of the monitors, with his assistant at his side. Behind him, in a glazed-off cubicle, the sound mixer operator. His equipment consisted, in this case, of a built-in

deck—probably *Leavers-Rich*—a *Brenell* and a *Sony* tape recorder. Reverberation was produced on a *Grampian* unit. All controls were of the sliding fader type.

Communication between control-room and studio is via an ultra-short-wave transmitter carried by the floor manager. The idea, presumably, is to channel all directions through one man on the floor of the studio, hence the rightful importance of the floor manager. Everyone in the studio has to wait while the floor manager listens to the squeaky voice from the control room. It is a good system and dispenses with a lot of people standing round shouting at each other. Each camera-operator has a microphone head-set, to receive instructions from the control room, when necessary, and to reply when necessary. When I was there, microphone booms were not used but when they are it is the responsibility of the boom operator to keep his microphone out of camera, not, as I thought, the responsibility of the cameraman.

I had no opportunity to inspect the video equipment, which was a pity. *Ampex* is generally used and very expensive it is too. Video, of course, is not the only mechanical means of transmission. Telecine is extensively used, a combination of cine projection and television recording or transmission. Major films are projected into a box-like arrangement fixed to the lens of a television camera and the sound source is dealt with separately. Most film shots for news and other items are 16 mm., shot at 25 f/s.—roughly equal to a tape speed of 19 cm/s ( $7\frac{1}{2}$  i/s). Film is either single- or double-sprocketed, depending upon whether or not it is to be striped for sound. As I mentioned earlier, film is frequently shot and transmitted in negative, reversal to positive being done electronically. The economy in time and money in such cases is obvious and the quality does not seem to suffer at all.

Television sound has been severely criticised for low quality, but I think it fair to say that the sound which leaves the transmitter is equal to good-quality radio. Unless the equipment is at fault (which is unlikely) transmission at high frequency should not diminish the quality in the least. The trouble is the low standard of fidelity of the average television set. For interest, I have recorded the signature tunes of over a hundred television programmes and in spite of using first-class recording equipment and a direct connection to the set, the quality of sound is atrocious in all cases. Often, and especially with American programmes, the video-recorded sound is bad to begin with; this, coupled with the rotten reproduction within the set, produces extremely bad results. Try closing your eyes and listening only and you

will see (or hear) what I mean. The whole thing is a deception. The major sense used, in watching TV, is vision and the aural sense takes second place. This is known to the TV boys and I am sure that much low-quality sound gets by on this basis. Nevertheless, I think that the television manufacturing industry should pay a little more attention to the amplification stage of their sets. Some attention to proper baffling and enclosing of speaker units would also help as would less intermodulation of sound and vision in the earlier stages.

By now, very possibly, the reader, having become fed up, will say "this article is supposed to be about recording for television". And so it is, but quite frankly, there is such a limited outlet (or inlet) for amateurs in the television field that any article on this subject must be generalised. The only opportunities in television would appear to be personal appearances or the odd job of sound-effects. As I rather specialise in multi-recorded music of a strange and dubious character and even more dubious sound-effects, I may be a little closer to the sacred world of television than some. But not much; television is, naturally enough, a closed shop so far as the amateur is concerned and, quite honestly, television entertainment standards must be kept as high as possible. I do not mean that amateurs are not capable of high standards; they are, but there is no room for the mediocre standard so often associated with amateur enthusiasm. This is perhaps not so unkind as may be at first thought, for everyone will have heard the amateur epic with its poor voices, bad presentation, clicks, blurs and blobs. On the other hand I have heard magnificent work from amateurs, well up to professional standards. Professional standards—that is the key to the whole thing. Radio and television folk are not so much concerned with the status of the recordist or performer so long as his standards reach their level. In this direction, therefore, it is imperative that the finest equipment be used and—much more important—that the material and delivery be first class.

Recording for television is one of those things which happens rarely and when it does you have to be prepared for critical timing, especially if the work is to back a film. Television producers are apt to change their minds rapidly and you may well find that your beautiful tape, when eventually used, has been cut to a tenth of its original length. Avoid excessive top on your recordings and pile on plenty of bass, for television sets do not excel in bass reproduction. And by the way, don't give visiting producers too much to eat and drink otherwise they tend to take root in the armchair.

**New  
from  
Tandberg**

# The Series 15

The new Series 15 combines Tandberg's world renowned qualities of faithful sound reproduction, reliability and compact modern design at a quite remarkably low price. It incorporates many superb features:—

- ★ Programme mixing facilities with separate controls for microphone and line inputs.
- ★ 10 watts output using an external speaker.
- ★ Volume control for monitoring whilst recording at loudspeaker level.

★ Loudspeaker selector-switch providing choice of playback through internal speaker, or external speaker or both simultaneously.

- ★ Three speeds.
- ★ 4 digit illuminated counter with instant reset button.
- ★ Pause control gives instant stop/start.
- ★ Separate Bass and Treble lift and cut controls.
- ★ Signal to noise ratio 55db below maximum recording level.

- ★ Frequency response:—  
7½ ips : 30-20,000 Hz  
(± 2dB40-16,000 Hz)  
3¾ ips : 30-13,000 Hz  
(± 2dB50-10,000 Hz)  
1¾ ips : 30-7,000 Hz  
(± 2dB60-5,000 Hz)

Elstone Electronics Limited,  
Hereford House,  
Vicar Lane, Leeds 2.

# Tandberg

*move up to*

# THE ARRIFLEX ELECTRONIC CAM

Richard Golding describes  
a breakthrough in  
film production techniques

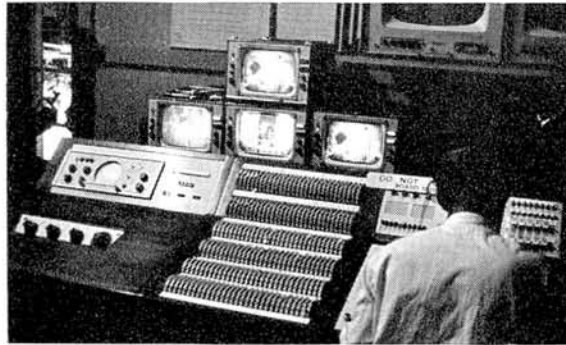

(Left) A bank of television monitors gives the director a precise idea of the view from each film camera. (Below) A group of Arriflex cameras in action.



**U**NDER normal television conditions where the production of a programme may call for a permanent record, possibly for transmission at a later date or even for export, it is necessary to select one of three methods—film, videotape or telerecording. All three have limitations. The conventional method of film making may be a long and expensive operation compared with television production. Videotape has to be played back on the same standards as it was recorded. Telerecording, while greatly improved in recent years, cannot match first generation film in quality and is seriously limited where colour productions are concerned.

The *Arriflex Electronic Cam* system has recently been installed at the Wembley Studios of *Rediffusion Television* and this system offers facilities for complete 35 mm. motion picture production while retaining all the techniques used by television companies during normal television programme production. Special Arriflex film cameras are used, fitted with plumbicon cameras which pick up the image through the optical viewing system and transmit it to television monitors in the control room. This method enables the director to view the actual scene being followed by each of the three cameras on the floor. At all times the director is in complete control of the production, stopping and starting film in the cameras, or interchanging from one camera to another

without interrupting the programme. On a production, three of these cameras are used. The cameraman views the image by means of an electronic viewfinder similar to that used on standard studio television cameras.

The advantages of using this system are that high quality recording on 35 mm. monochrome and colour film is permitted, utilising the artistic and creative possibilities of film techniques, while offering substantial reductions in overall production costs due to the time saved by using multi-camera techniques.

The system works as follows: light from the scene is focused by a zoom lens on to the film in the camera gate. A specially designed reflex shutter in front of the film gate has two reflecting segments. These are mirrored sections which allow a proportion of the available light to be reflected through a suitable system of correcting lenses into the plumbicon camera attached to the side of the film camera. The sections of the shutter are of equal area, one operating during film pull-down and the other during film exposure. The television picture is therefore an exact replica of the scene viewed by the film camera lens and is available to a monitor viewfinder mounted at the back of the camera. The cameraman uses this viewfinder in exactly the same way as in a television camera and has normal control of zoom, focus and framing.

The method of operation follows closely that of a standard television studio production. Pictures from all cameras are permanently available to the director whether the film is running or not. Rehearsal takes place in the usual manner and film is only exposed for the actual take. During rehearsal when film is not being exposed, the amount of film to be used during the subsequent take is indicated by footage counters, one for each camera, displayed on the control desk. Pre-planning ensures that the sequences are arranged for the most economical use of each camera's 1000 ft. magazine of film (10 minutes' running time) and that no camera will run out of film during the take.

The actual take is accomplished by pressing the appropriate button on the vision mixer panel, which starts the film camera and switches its television picture to transmission. Cutting from one camera to another is achieved by pressing the appropriate buttons and, after a delay of one-third of a second to enable the camera motor to attain speed, the vision is automatically switched and the film exposed.

For fast cutting sequences it is possible to keep the cameras running while cutting between them, but this does waste film and is only used for very short periods.

A point that must be made here is that *it is not possible to fade or mix between the film* (continued overleaf)

cameras and the vision mixer therefore is a simple cut only "device". Optical and other effects must be added in the film laboratories.

Programme sound is recorded on sprocketed 17.5 mm. magnetic tape running in sync with the film cameras. To facilitate the later assembly of the processed films, a cue tone, having a different frequency for each camera, e.g. 440 Hz for Camera 1, 1.1 kHz for Camera 2, and 2.7 kHz for Camera 3, is recorded on the sprocketed tape alongside the programme sound. These tones are selected automatically by the vision mixer's cut buttons. During the assembly of the film, the cue tones are played back on a synchroniser to identify the camera and to serve as a guide for cutting.

Sound recording follows the established practice: a number of microphones are connected to the mixing desk of the sound engineer who sees all the action on the set through the monitors in the control room and who can control the microphones set up in various positions. He carries out his mixing in of music and sound-effects in the normal way.

So far it is interesting to note the economy of operation that can be achieved. In comparison with single-camera production, expenditure for equipment and personnel is more than three times higher. On the other

hand, there is a great saving of time and hence the reduction of overall production costs (studio rental, electricity consumption and lamp costs) and actors' pay. In the initial experiments in the Arriflex Studios the production time for one 90 minute film was reduced to 12 days (former average more than 30-50 days) and a long film, with a running time of 2½ hours, was shot in 15 days. Film-stock consumption was about three times the final film length as against roughly 8 or 10 times the final length when using conventional shooting methods. Individual scenes of up to 20 minutes in length were often shot without a break.

For the purposes of the first pilot production made by the Electronic Cam System in England, Rediffusion chose three short sections of a 90 minute drama entitled *The Small Rebellion of Jess Calvert*, which had previously been videotaped in monochrome. These were filmed, in colour, using the original sets and artists. Each of the three sections was filmed as a continuous take, the director controlling the running of the cameras as required. The studio schedule was as follows: camera rehearsal—4½ hours, filming—1½ hours. The completed show copy runs for 15½ minutes and was filmed in approximately 60 minutes on the studio floor.

As one of the features of this system is the simultaneous recording of cue information with sound and picture, enabling rapid and accurate assembly of the rush print in the cutting room, the rush copy could be assembled in four hours. No artistic editing was employed and all the camera cuts are as the director determined at the time of shooting. Gross negative footage including all wastage and short ends was 3000 ft. with a final print footage of 1453 ft., showing a gross shooting ratio of just over 2:1.

Apart from economy, the important part of this system is its role where colour is concerned. At a time when the complexity of interchanging colour programmes recorded electronically is becoming apparent, the Electronic Cam System may prove a vital link in the chain of international and national network programme exchange.

There are manpower problems, however, as with most new systems, involving higher productivity, and these are not likely to be resolved until the changeover at Wembley Studios in July when new agreements on the manning of these camera units may be reached with the union.

The Arriflex System is marketed throughout the United Kingdom by Rank Studio Equipment.

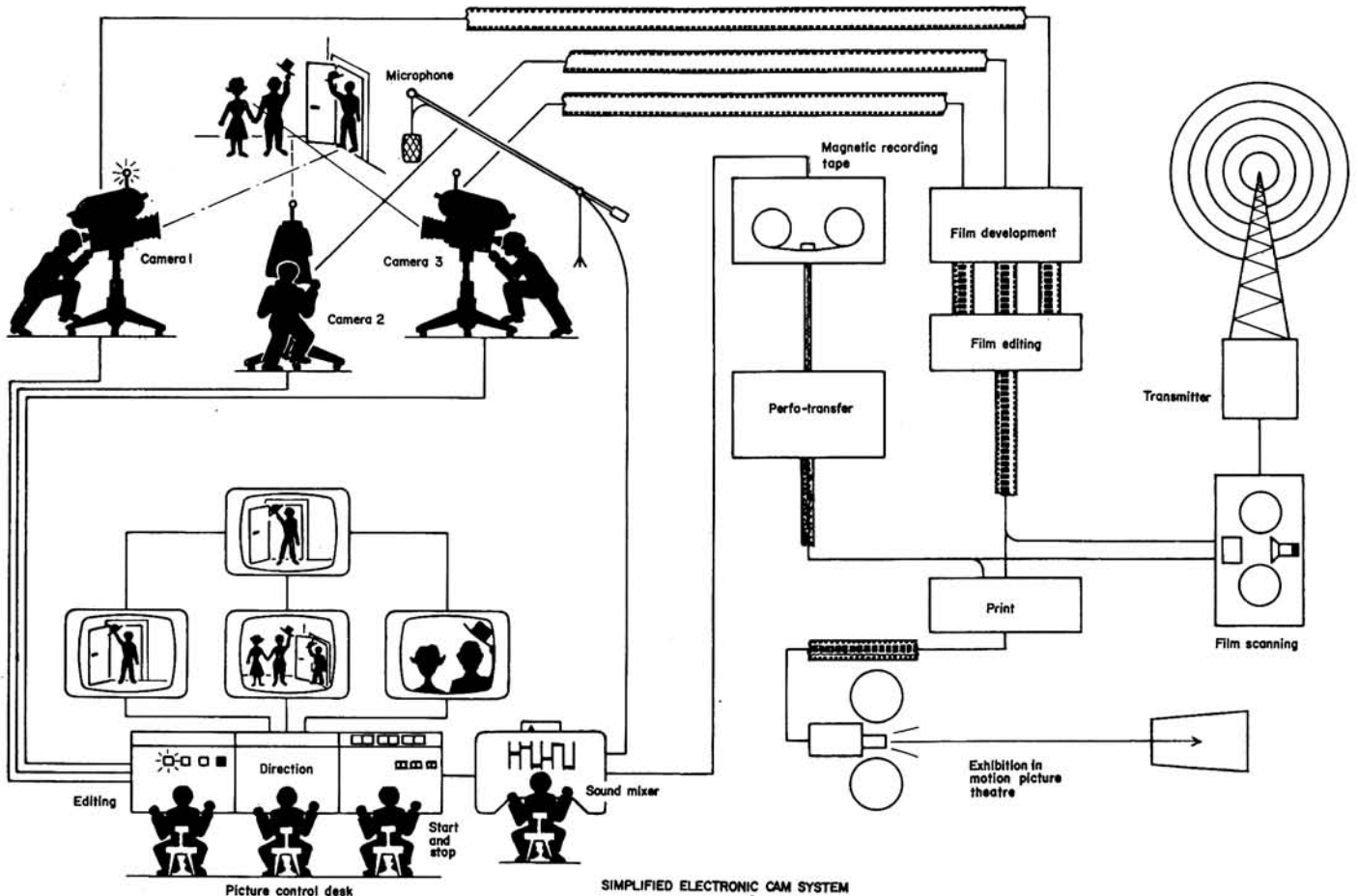

#### SQUEAKING CASSETTES

Dear Sir, I recently purchased a new Philips EL3301 cassette recorder, together with mains supply unit.

During recording and playback there is a continuous high-pitched squeak which appears to come from the cassette itself. This high-pitched note penetrates through felt covering wrapped round the recorder.

My dealer tells me that this is a defect in all Philips Compact Cassettes, and cannot be rectified. Surely this cannot really be the answer, as I find it difficult to believe that anyone would put up with this dreadful toy-like squeak for more than ten minutes.

Yours faithfully, J.C.B., West Worthing.

The squeak you report from this cassette-loading machine is most definitely not common to all these machines, and, to do your dealer some justice, we would suggest you probably misunderstood his statement that the trouble could not be rectified.

The usual cause is the cassette itself, and we presume you have taken the elementary test step of trying another one? If not, please do so. We feel sure you will not wish to be among the users who require only their original spool of tape for the rest of the tape recorder's lifetime, and spare cassettes are a good investment. If the new cassette eliminates the squeak, we advise demanding a replacement.

Actually, the problem is usually caused by wrong seating of the pressure pad spring, which sits in cut-out slots in the cassette, and can be eased into its correct position with a good pair of tweezers. Check that the pressure pad has not hardened. Check also that the cassette pushes the interlock tongue (rear right) fully clear, and does not sit askew as a consequence of the pressure.

If the squeak persists with a new cassette, we suggest you tackle the dealer once more and demand that this be rectified. We do not propose to describe service procedure as this machine is obviously under guarantee and any attempt to rectify the fault on your part would invalidate such a guarantee. But we can quite definitely advise you that this machine does not, should not—and, we trust, eventually will not, squeak.

#### A SLOW-WINDING BRENELL

Dear Sir, I would appreciate your assistance in a matter relating to my Brenell 3 Star. On fast rewind the tape slows and finally stops mid-way along the reel. Fast forward wind is similarly affected though spools almost to the end of the reel. Everything is normal on playback and the motors (unloaded) seem in order. I have changed all belts without success.

Yours faithfully, R.W.H., St. Leonards-on-Sea.

Slow winding on the Brenell 3 Star usually comes back to belt trouble, but as you have changed these, we shall have to look deeper.

Presumably you have checked the head channel and the rotating guides, and made sure that there is no tape trapping? The next point is to check the clutch bracket, and particularly the brake drum where the Tape Position Indicator belt is coupled, making sure that the rocker spring at the side has not fouled.

Normal lubrication should be checked, especially the grease cup at the bottom of the pulley bracket just mentioned. The motor bearings, top and bottom, need wiping over and a single drop of medium (Shell 21) oil applied. Quite often, a slightly worn bearing can cause these faults, even though the motor runs quite happily unloaded.

After all these things, if the fault still persists you must look to power supplies, etc., and then the only thing left is the possibility of a faulty motor. We do not think that spares are available for this model now, so hope you can clear the fault before reaching this stage.

#### GOING INTO SERVICING

Dear Sir, I am interested in becoming a tape recorder servicing and repairman. Can I study tape recorder servicing without studying radio? If so, could you say what books to buy. I would have liked to attend evening classes but am unable to do so because I do shift work. I have no technical knowledge. If it is necessary for me to do radio first please let me know the best way to start.

Yours faithfully, C.S., London E.8.

There is no real short cut to servicing proficiency. One needs a sound theoretical knowledge of the equipment to be handled, a working acquaintanceship with associated equipment, and then plenty of practical experience in diagnosis and fault finding. A good measure of manual dexterity and plain common sense are a great asset. You will appreciate that good service engineers are worth their weight in gold.

In tape recorder servicing, there is the special ability of mechanical operation understanding—it implies not only a knowledge of the mechanics, but a mental quirk which enables one to see through a mode of operation to the eventual action—it can be acquired, but it is often part of the general makeup of the man, and without it, he will never graduate to tape recorders. But first, the basic 'radio' knowledge is needed. If you have no technical knowledge whatsoever, but are of about O level standard, you could try the City and Guilds Course, but before doing so I would urge that you make some arrangements, perhaps offering your services at a pittance, to get some practical experience. The small amount of practical work to be done during the course may be enough to get you through an exam, but is not enough to prepare you for outside work.

We certainly do not recommend studying the subject from books alone. There are only one or two on tape recording, and to understand these, you need the radio groundwork.

The best way to start—go and have a chat with the organiser of evening studies at your local Education Office. Good luck to you.

#### ULTRA DRIVE FAULTS

Dear Sir, I should be pleased to have your comments and advice on a disturbing habit which my 18-month old Ultra 6206 recorder has recently developed. When replaying, the tape (DP or LP Emitape or Scotch respectively) having passed through the sound channel wraps itself round the take-up spool, usually

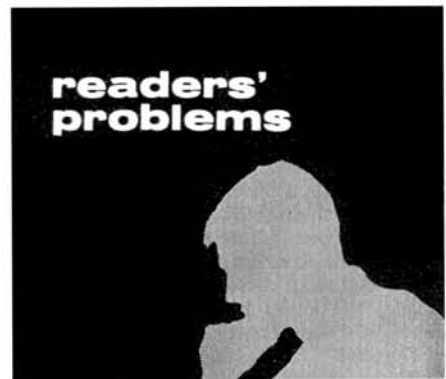

Readers encountering trouble with their tape equipment are invited to write to the editorial office for advice, marking their envelopes "Readers' Problems—Tape". Replies will be sent by post and items of general interest may also be published in this column at a later date. This service does not, however, include requests for information about manufacturers' products when this is obviously obtainable from the makers themselves. Queries must be reasonably short and to the point, limited to one subject whenever possible. In no circumstances should such letters be confused with references to matters requiring attention from other departments at this address. We cannot undertake to answer readers' queries by telephone.

between the bulk of wound-on tape and the top of the reel, and then becomes entangled round the pinch-wheel until the mechanism jams. I have never managed to spot this condition starting, nor to recreate it, e.g. by deliberately wrongly inserting the tape in the sound channel, or by stopping the take-up spool. However, I have noticed that it seems to occur more frequently after using Klenz-tape, but this may well be coincidence. In view of the damage caused to the tape and possible damage to the recorder, I shall be grateful for any suggestions which will help to prevent or cure this condition.

Yours faithfully, M.A.W., Derby.

We would suggest the type of trouble you report may be due to a worn or bent capstan spindle or, as seems more likely, an out-of-line pressure roller. The latter can be caused by a bent spindle, or out-of-line bracket, giving the same effect, even with a true roller. The roller and the capstan must be parallel. If the roller is at an angle to the spindle the tape tends to move toward the point of maximum pressure, which means that if the spindle tends to lean back, the tape gradually moves downward, until it performs the horrifying contortions you describe. Because of guides, etc., the effect may not be noticeable, unless very carefully scrutinised. Watch for a slight belling at the bottom edge of the tape as it passes toward the take-up spool.

Do not overlook the possible fault of poor clutch action, which will retard take-up, cause the tape to spill and wrap wrongly as the spool jerks, then fold back and wrap the roller and capstan. This may have several obvious origins, but we would have thought it would have been observed if you were watching the machine as closely as you say.

**E**XCEPT for the mixer section and the output stages, the 1500 is identical with the 2000 and the following notes can be taken as referring to both, except where explicitly stated otherwise. The deck mechanism follows the common *B & O* practice. Switching is different, because the facilities offered are different, but the sub-circuits are replacement panels that are clipped and wired into place in much the same way and in almost the same positions. With a little patience and a circuit diagram for reference, it is possible to find one's way about these machines fairly easily, despite the initial horror of the 'Clapham Junction' switch connections.

The 1500 is the 'basic' machine, providing a line output for signal feed to an external amplifier or another tape recorder (or to high impedance headphones, if required). The line output voltage is  $0.8 \text{ V} \pm 4 \text{ dB}$ , at a nominal impedance of 47 K. In common with normal DIN standards, the output connections are to pins 1 (left channel) and 4 (right channel) of a five-pin 180° connector socket. This is normal practice, and, in this respect at least, the 1500 is no different from any other semi-professional machine.

But on the input side we find that there is rarely a single application. Although microphone and radio sockets are provided, there is no mixing and, in fact, pins 1 and 4 (stereo) of each of these have linked connections, with pins 3 and 5 of the microphone socket shorted to the common chassis connection of the radio socket and thence back to the screened cable of the flyleads—but not, please note, to the pin 2 chassis connection of the microphone socket. This can be important, unless you feel that the tantalising background hum gives "character" to your recordings! When servicing it is important to reconnect exactly as we find things—no jumping across to convenient anchor points on high quality equipment.

This might almost be interpreted as an 'in-line' tape recorder, although *B & O* have widened its scope by a variation of plug-in pre-amplifier panels. External mixing is the only solution to the full use of this machine, however, and this is where the 2000 scores, with its comprehensive input facilities—and consequently its vastly more complicated switching.

As these plug-in input panels are the same for both machines, it will save space next month if we show their circuitry here, and discuss them briefly.

Whereas **fig. 1** shows the switch wiring and the playback and recording amplifiers (the bias oscillator, you will remember, having been given last month; the power supply, with small variations, is also similar to that already given), **fig. 2** illustrates the three main types of pre amp. These are self-contained printed-circuit boards that slide into the socket position and are held by a forked bracket, swivelling on its retaining screw. They sit vertically, with the machine in its operating condition, and are easily accessible for test with the bottom of the machine removed. In fact, the whole amplifier section, although it is dauntingly compact on first inspection, soon reveals itself as readily available when four screws are removed. The machine can be operated with the amplifier section still wired and swung away for test. If any number of *B & O* tape recorders are to be tested, it pays to make up a multi-connector jumper lead that allows the

removal of the amplifier section on this machine and the two versions of the 2000.

In the foregoing paragraph I spoke of the preamplifiers as if they were in co-incident operation. In fact, in the 1500 they are inserted one at a time; they are alternatives. The radio preamp effects a compromise by being switchable. In the high impedance mode (switched to H), the sensitivity is 150 mV and the impedance 100 K approximately. But when switched to low impedance, the 100 K series resistor is short-circuited for a 2 mV sensitivity at about 47 K. In this mode, by a further alteration, a high impedance microphone can be employed. There are two wired links, plainly marked on the print side of the board by the symbols for radio and microphone. By changing these to the microphone position, the input sensitivity is equal to 0.5 mV and the impedance at 1 kHz over 0.5 M. This is suitable for most crystal microphones with any pretensions to quality, but will not give adequate bass response if cheap microphones are used.

So we get three alternatives with the one radio preamp, but not without a little trouble. By changing the preamp panel for the Microphone version, a really sensitive input can be chosen, at low impedance. 20  $\mu\text{V}$  at 50-200 ohms at the reference frequency of 1 kHz is the rated figure, and this suits the *BM5*, *BM6* and *MD8*. The *BM6* is a mono pressure-gradient microphone with a figure-of-eight polar diagram, a frequency response of 30 Hz-13 kHz  $\pm 2.5 \text{ dB}$  (triple switched trimming for speech and music, with an off position), and an impedance of 180 ohms, which is the accepted studio figure. Altogether, an excellent microphone, so long as you do not try and take it to bits.

By adding the *BM7* unit, the *BM6* is converted to a stereo *BM5*, with uniform phase characteristic. An alternative mono microphone, smaller, and with a spherical response figure, especially at the lower end, is the *MD8*, reputed to be particularly good on speech, when slung round the neck with a Lavalier cord; but the author has to report a gap in his education, never having had occasion to bedeck himself thus with this unit.

Gramophone inputs are catered for by a switched printed circuit board, which matches both the magnetic cartridges, *SP1*, *SP2*, *SP6*, 7 and 8, in the low position, with a sensitivity of 2 mV at 47 K and in the high position, a crystal pickup, with a sensitivity of 40 mV at 4 M. These figures sometimes give a few matching problems, as when high-output crystal cartridges are used, or lower output ceramics; but it should be remembered that the unit is tailored to suit other *B & O* equipment and this it does admirably.

There is yet another input adaptation, and that is when a shorting link board is inserted instead of the preamp, when a line input sensitivity of 15 mV at 20 K can be obtained. And it must be remembered that the microphone socket, in circuit all the time and linked to the radio socket, gives an input sensitivity of 1 mV at 47K. These figures are all stereo, of course, and are those which give meter deflection to the 100% level (0 dB) with record gain control fully advanced.

The bias circuit was published last month, and need not occupy us here. But there is one small point that has raised a query, particu-

larly apt these days when the ugly problems of beat tones are increasing as stereo radio creaks sluggishly into gear. This is the bias filter, whose presence in the line output circuit would be, to coin a phrase, more conspicuous by its absence. The purpose is to prevent any of the HF bias waveform leaking on to the line and possibly interfering with other, external signals. It should be stressed that it can make no difference, because of relative levels and frequencies, to the line signal of the machine itself, so if you suffer from the 'Blow you, Jack' attitude, omission of the filter would not bother you.

In **Fig. 1**, the filter consists of a 7.5 mH inductor tuned by 330 pF in series, with a 4.7 K limiting resistor. The coil is adjustable, and the tuning is for minimum response, measured on a valve voltmeter across the line output, with gain wound up—but only after the oscillator has been adjusted. The tuning is quite definite, and the filtering is a fairly sharp notch.

However, to remain practical: the bias adjustments consist of both coil and capacitor (again a 7.5 mH and 330 pF, but in shunt for resonance, with 10-40 pF trimmer in series). The printed board is mounted above the capstan motor, to the left and forward of the left-hand spool. There is no mistaking it. Unfortunately for some folk, the appearance of a couple of tuned inductors on the main

(continued on page 353)

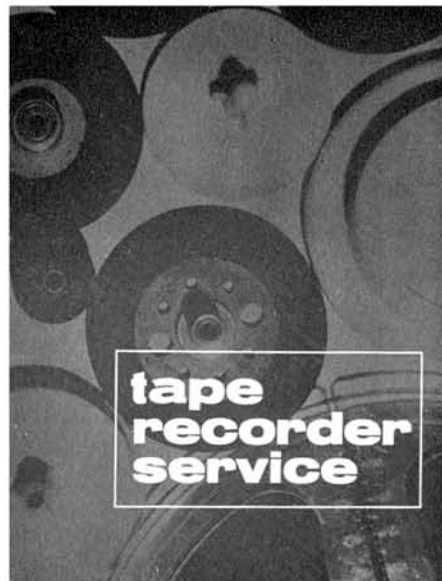

**BANG AND  
OLUFSEN  
1500 AND 2000  
BY H. W. HELLYER**



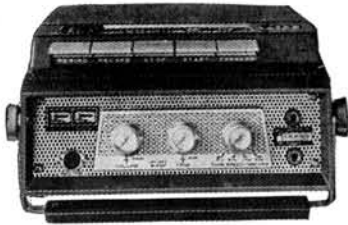

Akai X-IV Stereo Batt./Mains Tape Recorder. List price £169 7 11  
**Our price £138**

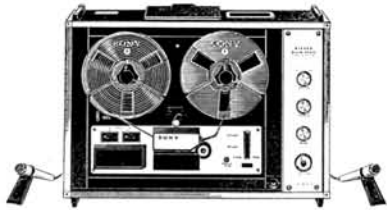

Sony 260 Stereo Tape Recorder  
List price £116 5 2  
**Our price 95 gns.**



Ampex 753 Stereo Tape Unit  
List price £117 16 8  
**Our price 91 gns.**  
Case extra 7 gns.



Akai 1710W Stereo Tape Recorder  
List price £109 17 3  
**Our price £89 10 0**

# R.E.W

for the  
biggest  
anywhere  
stocks at  
pre-Budget  
prices !

Large stocks secured before the budget enable us to offer an enormous selection still at pre-Budget prices, but even our big stocks can't last for ever. Make the most of the wide choice, come in and see them for yourself or write for lists.

H.P. Terms available. Your deposit will be one third of our price, add one-tenth to the balance and divide by 12 for monthly payments.

The equipment shown here represents only a small selection from the wide range of superb machines we have available for immediate delivery.

## SEND FOR LISTS !

### R.E.W (EARLSFIELD) Ltd

HEADQUARTERS, SHOWROOMS  
AND MAIL ORDER :  
Dept. TR

266-8 UPPER TOOTING ROAD,  
LONDON S.W.17  
Tel. 01-672 4471/2 and 9175

WEST END SHOWROOMS :  
146 CHARING CROSS ROAD,  
LONDON W.1  
Tel. 01-836 3365  
(opposite Astoria Cinema)

★ STAR OFFER !

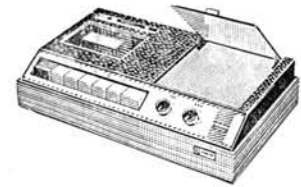

**SAVE OVER £13**

Magnificent Philips EL 3310 Mains-operated cassette tape recorder. 2-track, high-quality, slim-line model. List price £41 2 10; R.E.W's special price only 26 gns. or on interest free terms £9 2 0 deposit and 12 monthly payments of £1 10 4.  
**BUY NOW WHILE STOCKS LAST AT THIS PRICE !**



Ferrograph 632 Stereo Tape Recorder  
List price £163 3 9  
**Our price 126 gns.**



Tandberg Stereo 12  
List price 120 gns.  
**Our price 105 gns.**



Akai X-300 Stereo Tape Recorder  
List price £263 18 3  
**Our price 195 gns.**



panel assembly underneath has been misleading. These are, of course, the filter inductors, this panel being to the left of the preamp mounting, under the chassis.

With a little practice, bias adjustment is easy. The principle is to record two tones, one at the reference frequency of 1 kHz and the other at the upper 3 dB limit of 12 kHz (not the upper response limit, I should stress). These are recorded alternately, but with the signal generator attenuated to an input 20 dB below that which produces a 100% modulation (as indicated on the VU-meter), at the reference frequency. Between 30 and 40 mV should produce full modulation, if all is well, and a 10 times reduction is needed to avoid overloading while adjusting and prevent incorrect tuning to the lower side of the bias 'hump'. Then, the adjustment is made so that the output produced by both of these injected tones is the same, using a vvm across the line output, and adjusting the trimmers for each channel.

After this, it is necessary to adjust the two coils so that the bias to each head winding is the same, and not only on a stereo recording, but also on a mono recording—where, unless some precaution is taken, the difference in the loading could make the oscillator change its energy output. So the method is to insert a series resistor in the earth lead of the record head winding (10 ohms, non-inductive wire-wound resistors, one in each winding). Across these resistors, a valve voltmeter is used, to measure the bias current. Then, with both record buttons pressed, the voltage across one resistor is measured. This should be the same as when only one button is pressed (i.e., stereo compared with mono). If not, the coil should be adjusted, and the test made again, until readings are the same, both on stereo and mono, and on each channel. Bias frequency for these machines is 100 kHz.

The importance of correct bias is too often disregarded—but, to be fair, it is only on a really good machine that the difference in adjustment becomes noticeable. Then, if the adjustment is made for a particular brand of tape, a change of tape will produce recordings of slightly different quality. What has happened is simply that the current that was optimum for tape A is now too much or too little for tape B. If too much, some upper frequency response will be lost; if too little, the higher frequencies will be distorted. Fortunately, on a machine such as the B & O, with a three-head system and off-tape monitoring, adjustment is rendered easy. But it can be tedious when one has to record bands of tone, rewind and replay them to get measurements that can be used for assessment. Nevertheless, for good recording, such extra trouble is well worth while. The better the machine, the more important it is.

And not only bias. The vital necessity for correct tape height and azimuth becomes more urgent as the HF response and the improved channel separation figures of better-class machines is considered. With one of the cheap hum-boxes that usually have some slogan like *High Fidelity Super* plastered across their pseudo-wood covers, the head setting has as much tolerance as a modern playwright. As

(continued overleaf)

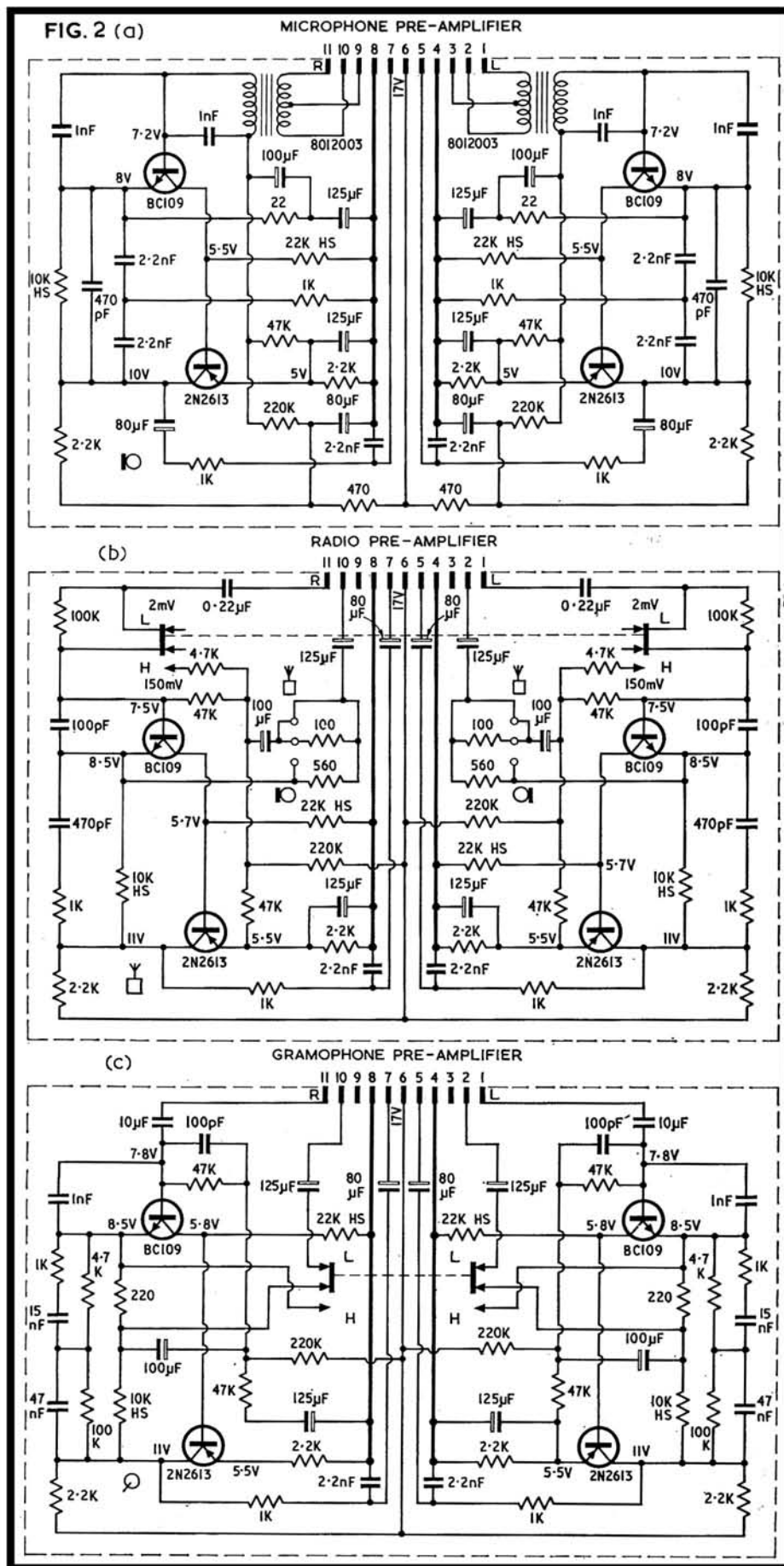

standards improve, so do limits restrict, and more care has to be taken. Fig. 3 shows the head arrangement of the B & O 1500 and 2000 in plan and elevation, to illustrate the head alignment and track disposition, and to enable me to dispose in a few words of the routine adjustments relating to heads. Every picture tells a story though in this case the picture has had to be held over for space reasons I'm sorry to say. It will be included in the next episode; meanwhile here are the details.

Reading from left to right, we have the 1/4-track erase head, 1/4-track playback head, 1/2-track record and playback heads respectively, with the adjustable tape guides at each side of the half-track pair. These guides are easily adjusted by slackening off the top screw, then turning the body (with spanner, not pliers, please!). Correct setting is for level run of tape when it is held against the guide faces, as shown dotted. In the workshop, we use a section of transparent stiff tape with track markings engraved, to speed initial setting up, but if care is taken, a bright light used, and any necessary alterations made so that the track dispositions come as shown in fig. 3, then final adjustment takes little time. The structure of the erase head, with its protruding side pins, acts as a left-hand guide and assists in setting up.

If it is unlikely that the heads have been moved, and if they are not worn, then any adjustment to tilt of the replay heads may be unwise. In the workshop, an alignment bridge

is employed for this adjustment. This is to get the head exactly at right angles to the chassis, or, to be more precise, with the facing elevation coincident with the guide facings. Then, alignment consists principally of rocking the head for maximum response and output, and a white noise tape is best for this job, although B & O recommend a 10 kHz azimuth tape. Having got the 1/4-track play head accurate, the rest can be tracked up on this one. On clean tape you can then record a track and listen to the signal off-tape as you do so, rocking the record head for maximum output, using the side screw for the purpose. Tilt of the record head can be done, and, in fact, there is not much harm in using all three screws here, as the final setting is so easily made and checked. It is good practice to keep that input signal down by 20 dB also when making this test.

After this, the 1/4-track replay head can be adjusted—and here, a little more care is needed. A test tape with track 3 erased is very useful (Mr. Tutchings produces an excellent White Noise Test Tape with track 3 erased, No. 2 in his series. No enthusiast should be without such a basic item). First, one should make absolutely certain that the upper track scans the tape correctly—too high, and a little signal will be lost, drop-outs will be more apparent, the effect of any tape curl more pronounced and the signal-to-noise ratio, already a few dB down, will drop drastically. A good recording is needed, and after height and tilt have been set, the azimuth alignment will pull in the extra few decibels.

Finally, although the erase head has been set for initial height, it is wise to check by

wiping off the recorded 1/4-track signal and actually measuring for residual noise, not just listening casually. Channel separation should also be tested at this stage: on these machines it is better than 45 dB at the reference frequency.

Beware, when testing, of a false top response that turns out on further investigation to be transistor hiss. Oh dear, does that sound cruel! I am not one of those that goes along with the 'transistor sound' school of knockers, but must confess that too many manufacturers have brought out models a teeny bit in advance of transistor technology. Cynics will mutter something about jumping on bandwagons—I shall probably get B & O jumping on me for even daring to whisper such a thing. But we all know it is true, and if we are sensible we shall realise that it does not matter two hoots in this case, when the remedy is so simple. Culprit in the 2000 range was invariably the AC128 in the driver section of the output stages, and replacement with an AC153 is a general recommendation. In the power supply section, an AC153 has also been fitted.

In the preamplifiers, BC109 transistors are being more widely used, whereas some of the earlier units employed UW0029 transistors. If there is any trouble here, replace the semi-conductors in pairs. In some circuits also, you will find the AC151 used instead of an AC126 and sometimes a 2N2613 in place of an AC126 where this is the first stage of a direct-coupled pair. Do not make changes just for the sake of keeping up with the Joneses, but if trouble occurs, it is wise to fall in with the later circuits, for which the illustrations accompanying the 2000 article next month may prove of some use.

# whatever the make . . .

4-TRACK STEREO/ MONO	Deposit £ s. d.	12 Monthly Payments £ s. d.	Cash Price £ s. d.
Philips EL3312 ...	16 19 10	4 3 4	66 19 10
Ferguson 3232 ...	22 18 3	5 14 7	91 13 0
Sony TC200 ...	23 15 0	5 18 9	95 0 0
Sanyo MR929 ...	24 0 0	6 0 0	96 0 0
Philips EL3555 ...	25 19 4	6 5 8	101 19 4
Aiwa TP1012 ...	26 0 0	6 8 2	102 18 0
Akai 1710W ...	27 17 3	6 16 8	109 17 3
Sanyo MR939 ...	28 0 0	6 16 8	110 0 0
Sony TC260 ...	29 5 0	7 5 0	116 5 0
Tandberg 12/21/41 ...	31 10 0	7 17 6	126 0 0
Telefunken 204 'E' ...	34 12 5	8 10 0	136 12 5
Philips EL4408 ...	33 16 8	8 6 8	133 16 8
Sony TC350 ...	41 10 0	10 6 3	165 5 0
Beocord 2000K ...	44 10 0	11 1 8	177 10 0
Beocord 2000T ...	46 15 0	11 8 4	183 15 0
Ferrograph 722/4 ...	46 15 0	11 10 5	185 0 0
Akai M9 ...	49 3 5	12 3 4	195 3 5
Akai X-300 ...	66 18 3	16 8 4	263 18 3
Akai X-355 ...	82 18 6	20 14 2	331 8 6

STEREO TAPE UNITS	Deposit £ s. d.	12 Monthly Payments £ s. d.	Cash Price £ s. d.
Sanyo MR-801 ...	20 0 0	4 13 4	78 0 0
Sony TC250A ...	20 10 0	4 18 4	79 10 0
Akai 3000D ...	26 11 4	6 11 8	105 11 4
Sony TC350 ...	27 5 0	6 16 3	109 0 0
Beocord 1500 ...	33 15 0	8 8 4	134 15 0
Tandberg 62/64X ...	34 10 0	8 12 6	138 0 0
Truvox PD202/204 ...	37 17 4	9 3 4	147 17 4
Ferrograph 702/704 ...	40 6 8	10 0 0	160 6 8
Brenell STB2.5"2" ...	51 10 9	12 11 8	202 10 9

4-TRACK MONAURAL	Deposit £ s. d.	12 Monthly Payments £ s. d.	Cash Price £ s. d.
Fidelity Playtime ...	8 2 9	2 0 9	32 11 0
Fidelity Studio ...	11 5 9	2 16 6	45 3 0
Grundig TK140 ...	11 14 6	2 18 4	46 14 6
Philips EL4305 ...	11 17 9	2 16 8	45 17 9

Check these

**PLUS-POINTS!**

**SANYO  
MR-939  
STEREO**  
(as illustrated)

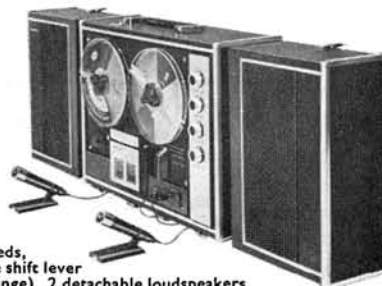

4-track, 3-speeds, selected by one shift lever (no capstan change). 2 detachable loudspeakers. Sound-on-sound. 7 watts per channel music power. Auto shut-off. Upright operation. Compatible with Hi-Fi Stereo Systems. Complete with 2 dynamic microphones. This new model offers everything required by the discriminating enthusiast.

**PRICE £110.0.0.**

Deposit £28 and 12 monthly instalments of £6 16 8

**INTEREST FREE H.P. TERMS. OPEN SATURDAY 6 p.m. FRIDAY 6.30 p.m. IF UNABLE TO CALL WRITE FOR BROCHURES. PART EXCHANGES. ALSO 18 AND 24 MONTHLY TERMS**

4-TRACK MONAURAL	Deposit £ s. d.	12 Monthly Payments £ s. d.	Cash Price £ s. d.
Ferguson 3226 ...	11 10 0	2 16 8	45 10 0
Telefunken 201 ...	11 18 9	2 19 7	47 13 9
Ferguson 3228 ...	11 19 0	3 0 0	47 19 0
Philips EL4306 ...	14 1 8	3 10 0	56 1 8
Ferguson 3230 ...	14 13 0	3 13 2	58 11 0
Ferguson 3216 ...	16 19 0	4 0 0	64 19 0
REPS M10 ...	18 17 0	4 14 7	75 12 0
Truvox R54 ...	18 17 3	4 15 0	75 17 3
Wyndor Vanguard ...	18 18 0	4 14 6	75 12 0
Tandberg 1526 ...	20 19 0	5 3 4	82 19 0
Truvox R204 ...	31 14 2	7 15 0	124 14 2

MAINS TWIN TRACK	Deposit £ s. d.	12 Monthly Payments £ s. d.	Cash Price £ s. d.
Fidelity Playtime ...	7 18 6	1 16 8	29 18 6
Ferguson 3224 ...	8 6 0	2 1 4	33 2 0
Grundig TK120 ...	9 17 6	2 9 2	39 7 0
Philips EL3310 ...	10 5 10	2 11 5	41 2 10
Tandberg 1521 ...	18 19 6	4 10 0	72 19 6
Truvox R52 ...	18 17 3	4 15 0	75 17 3
Beocord 1100 ...	24 10 0	6 2 6	98 0 0
Brenell Mk V/3 Std. ...	26 17 9	6 10 0	104 17 9
Brenell Mk V/3 Mtr. ...	28 0 2	7 0 0	112 0 2
Truvox R202 ...	31 14 2	7 15 0	124 14 2
Brenell V/3/M ...	32 16 8	8 5 0	131 16 8
Ferrograph 713 ...	33 18 4	8 9 7	135 13 4
Ferrograph 713/H ...	35 16 8	8 16 8	141 16 8

BATTERY OPERATED TRANSISTORISED	Deposit £ s. d.	12 Monthly Payments £ s. d.	Cash Price £ s. d.
Philips EL3302 ...	7 18 0	1 19 4	31 10 0
Philips EL4304 ...	8 5 10	2 1 5	33 2 10
Grundig C200 ...	12 7 0	3 1 8	49 7 0
Telefunken 300 ...	16 3 0	7 18 9	63 3 0
Telefunken 301 4T ...	17 12 0	4 6 8	69 12 0
Telefunken 302 4T ...	19 0 0	4 15 0	76 0 0
Grundig 2200 ...	24 12 0	6 0 0	96 12 0
Uher 4000L ...	31 16 0	7 18 9	127 1 0
Uher 4200 Stereo ...	39 6 0	9 10 0	153 6 0
Uher 4400 Stereo ...	39 6 0	9 10 0	153 6 0

# THE RECORDER CO

(DEPT. R) 186-188 WEST END LANE, WEST HAMPSTEAD, LONDON, NW6  
Telephone: 01-794 4977

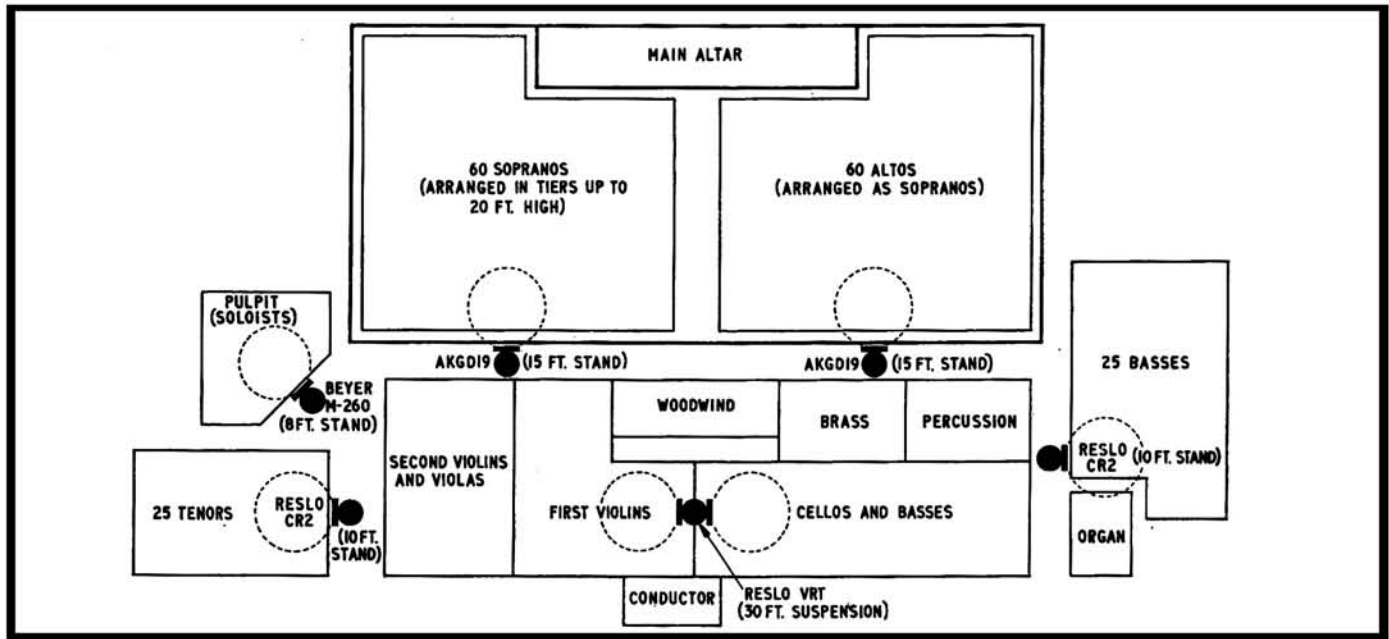

# Battersea Messiah

BY PETER SIDHOME AND PAUL REEVES



THE 4th, 5th and 6th of April this year saw the culmination of seven months' rehearsal in Battersea, South London, when two of its leading grammar schools, the Salesian College for boys and the Notre Dame High School for girls, joined forces to present a mammoth production of Handel's oratorio *Messiah*. Enquiries were made as to the possibility of hiring a professional recording service to tape the performances for eventual private distribution on long-playing records. The fabulous figure quoted prompted the schools to get in touch with the authors, who, as ex-pupils of the Salesian College, had often undertaken small recordings there in the past.

The performances were to take place in the Sacred Heart Church, a magnificent 80 year-old building adjoining the College, but the rehearsals, for three hours every Sunday afternoon, took place in the College hall until a month before the deadline; and as the conductor, Fr. Thomas Carroll, had not yet decided on the positioning of chorus or orchestra in the Church, we were unable to make any worthwhile acoustic tests until then. This posed some problems, as we could not tell how many microphones would be needed, nor what type they would have to be. Having only two in our possession at the time, it was obvious that we should have to hire the rest—and these things have to be arranged several weeks in advance.

At any rate, the first rehearsal in situ demonstrated our first major hurdle; the reverberation time in the Church was some-

thing well over six seconds! This was expected to be less noticeable when the audience was present but, even so, there were some weird effects at the back, near the entrances, due to unusual reflections from pillars and the like. We decided that the sound picked up by the microphones would have to be relayed to the audience over the church's address system, at a level low enough to pass unnoticed by those sitting at the front, but high enough to impart a sense of correct sound-balance to those less fortunate in their seating positions.

To overcome the problem of too much recorded reverberation, we originally planned to use a close-microphone technique for short periods and deploy some 14 microphones—but these plans came to a rapid halt once the prospect of operating a 14-channel mixer, let alone hiring such a monster and its attendant microphones, became clear. We decided instead to use a maximum of six microphones, and to construct a mixer for the purpose. This was a stereo console based on D. P. Robinson's now-famous design which appeared in *Tape Recorder* between June and December 1964. We would like to take this opportunity to thank Mr. Robinson for the tremendous help he has given us with this mixer; we wrote to him time and again with various questions and he has almost invariably replied by return with welcome suggestions.

Having finally settled the number of microphone channels available, the next question was where to put which microphone. Stereo was ruled out, as the cost of manufacturing stereo discs is still prohibitive, so the recording

was made in double-mono on a brand-new two-track Revox 77 (purchased, incidentally, a fortnight before the Budget!). This raised the potential signal-to-noise ratio to some 60dB.

Great patience was required in placing the various microphones, as the conductor was very undecided as to the correct positioning of the various performers. Originally, the main altar was to be stripped of all its trappings and the chorus ranged in tiers on the sanctuary, with the orchestra filling the space normally occupied by the first four rows of pews; but it soon became obvious that no more than 120 of the chorus could be squeezed on the altar, and so the 50 tenors and basses were relegated to the sides of the orchestra, which in turn had to be made more compact. The soloists sang from the ornate pulpit which stands at the side of the altar. In all, we had no less than four 'absolutely final' positionings, each requiring a different microphone arrangement!

Some hair-raising moments were spent in suspending the Reslo VRT orchestra microphone 30 feet up, but all was ready for the 'dress rehearsal' on Tuesday the 2nd. The final arrangement is shown in the diagram. We had some trouble with the massive magnetic field radiated by the electronic organ (which sounded more like an organ than the real thing!), but this was miraculously cured by turning the microphone through 30 degrees or so.

We set up our control room in the sacristy behind the altar (and alienated the parish priest, who took one look at the tangle of cables, the Revox, the mixer, the Vortexion

(continued on page 361)

# SHARP

## to the point of perfection



**Model RD 505.** Solid state all transistor tape recorder, twin track two speeds. Superb recording reproduction with outstanding simplicity of control. Entirely portable, will operate anywhere. The act of inserting the mains plug automatically changes over from batteries to its own built-in A.C. power unit. Designed to play or record in any position. Remote control switch on microphone allows full flexibility in use. Dimensions 12in. x 10in. x 4in. Additional features include 3 digit tape counter, fully variable tone control, large internal speaker and automatic level control. Comes complete with dynamic microphone recording-lead, earphone batteries (6 x EverReady UPU2 or equivalents), 5in. reel of tape and empty spool.

Recommended retail price **£39.18.0**

**5 YEAR  
GUARANTEE**

# SHARP



SALES AND SERVICE

**JULY IS  
SHARP  
MONTH**

Win a Holiday for Two' COMPETITION

Get full details NOW  
from your usual dealer!

For further details and leaflet contact:  
SHARP SALES & SERVICE 1618 WORSLEY ROAD, SWINTON, LANCs.  
Tel: SWinton 3232 (5 lines)

Name \_\_\_\_\_  
Address \_\_\_\_\_  
\_\_\_\_\_

T 11

# WHAT'S IN A CLUTCH?

BY WILLIAM HENRY

1

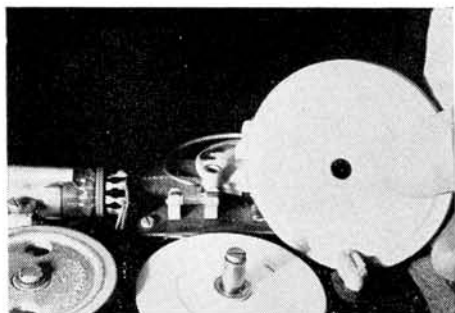

Grundig gravity clutch, showing the upper and lower halves separated. Note machining of spindle and bush in lower half. Felt disc is fixed to underside of upper half. Idler wheel at left gives direct drive for fast winding: for take-up, lower half of clutch assembly is driven by a belt coupled to the flywheel.

2



Philips turntable with individual lifting spindle to separate upper and lower halves. The neoprene washer is clearly seen, and the vulcanite plugs inserted in the lower section. This is the left-hand, supply spool, turntable, but is similar to the take-up except for the shape of the step on the spindle.

3

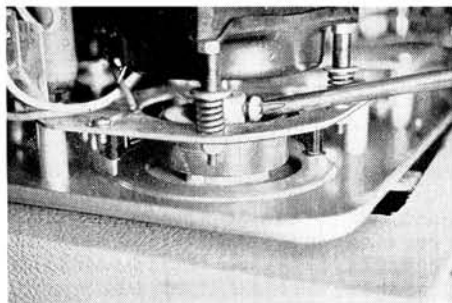

Underside of spool carrier of Magnavox Studio deck, showing screwed clamp which holds turntable to motor spindle. A Phillips screwdriver engages with one of the clamping screws. To the right can be seen the wirewound resistor that limits the supply to the motor.

4

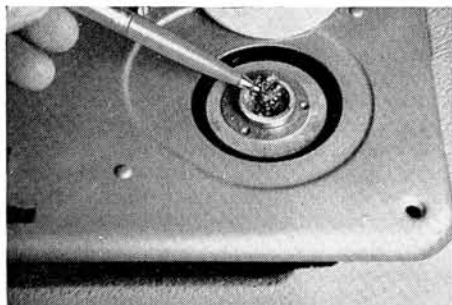

Result of loose drum on the foregoing deck. The motor spindle wears away the softer metal of the turntable. Eventually, the assembly seizes and the motor may be ruined.

THE great majority of mechanical faults on single-motor tape recorders can be traced to clutch troubles. Not a few three-motor machines, although they use drive systems that differ in the clutch arrangement, show similar evidence of incorrect torque after they have been in use for a while.

Clutch adjustment, while it can be a tedious and ticklish business, involving spring balances and measured lengths of tape, if the maker's instructions are to be followed, may nevertheless reduce to a simple matter of common-sense—once an idea of the way the system works has been gained by the owner or repairman. The following notes are an attempt to describe some of the most widely used clutch systems, to discuss their common troubles and suggest a few remedies.

First, a definition. By 'clutch' we mean the method of taking up the slack tape at the right-hand spool while recording or playing. The torque needed for this varies from the low loading of an empty spool to the greater weight of a full one, and so a clutch is a necessity. Its action will be modified by the full torque requirement for fast winding. There are, basically, three types of clutch: the simple gravity clutch, the slipping belt clutch and the spring-loaded slipping clutch.

There are variations within these categories and combinations of them. Each has its peculiar faults and different methods of testing.

To prevent tape spillage and maintain a constant tension, the right-hand spool must try to turn faster than the tape speed will allow. As the tape speed is constant, the angular velocity of the right-hand spool varies. But the pull from the right-hand clutch must not be so fierce as to affect the pinch roller pressure—where there will always tend to be a small amount of tape slipping. Depending on the type of pressure roller, this slipping may allow a constant tape speed if the clutch is wrongly adjusted, if the back tension—also by a clutch or brake arrangement at the left-hand spool is wrong, or if the spool carriers are not at the correct level relative to the tape path through the head channel. The study of pressure rollers is a separate subject which cannot concern us here, but it is worth noting that apparent clutch faults can sometimes be aggravated by erratic pinch pressure. Normally, the test for pinch pressure is that the tape, when pulled by hand, with the roller engaged but the power disconnected, should turn the flywheel smoothly, with no slippage or tendency to snatch.

Assuming the pinch pressure to be in order, the pressure pads, if any, to be locating correctly, not overtight, and any auxiliary back tension braking to be normal, we should then note that the right-hand clutch allows a constant spooling action during playback, from commencement to end of the size of spool the machine is designed to use.

This last point can be important. Testing a machine with oversize or undersize spools can lead to erratic results. Note also that some machines are not comfortable with very thin tape, unless pinch pressure and clutches are re-adjusted to compensate for this. Using triple-play tape on a machine normally adjusted for DP, LP or standard tape can create stretching faults, slippage and wow as the greater weight of the filling spool acts upon some weight-dependent clutches.

Typical examples of simple weight-dependent clutches can be found in the BSR decks and in a number of Grundig machines. The turntable is divided into an upper and lower section, the lower being driven from motor or flywheel either by a belt or an idler wheel. Although the actual method of drive is not in itself important, in practice we find that many clutch faults originate from this drive and before looking for faults in the clutch engagement arrangement, it is wise to ensure that the drive system is in order. In many Philips systems, this is particularly important.

The transfer of torque from lower to upper section of the turntable assembly is generally by a felt ring or disc. Its size will determine the clutch efficiency, and this factor should not be overlooked when replacing felts or turntable sections. Many tape recorders have larger felt discs on the right-hand clutch assembly, although the basic turntable may be outwardly similar. As the amount of tape on the spool increases, the weight compresses the felt and transmits more torque from lower to upper section. Felts should be soft and free from embedded particles of foreign matter to allow for this compression. Treatment with methylated or surgical spirit will soften most felts—but care is needed, for

I AM often asked for details of courses in the use of CCTV equipment, and, since my article in May on the Ravensbourne College of Art Film and Television course, these queries have multiplied. There is not much on offer outside of education, however, except certain film techniques courses running television as a subsidiary or follow-up subject. One of these which strangely is better known abroad than it is here is the London School of Film Technique, 2A Shelton Street, London, W.C.2. It is pretty difficult to get into, I believe, but it has some excellent teaching staff, good equipment and lots of studio space for high set building.

There are a number of technical colleges throughout the country offering full-time film production courses and a few of these run television as well; a call on your LEA would give you full details. Some technical institutes will arrange intensive courses on specialised techniques for organisations able to guarantee a minimum of eight students and it would be worth any interested sales manager's time in making enquiries along these lines. Some colleges of engineering and science offer evening classes for diplomas in photography with extension classes in cinematography and television techniques. Even a diploma in photography could prove useful to gain entry to television proper or even the industrial CCTV unit as advertisements often show.

An item of special interest for those thinking about taking up teaching and who want to specialise in CCTV is the film and television course for student-teachers at Bulmershe College of Education, Reading. It starts in September and its main emphasis will be on film criticism and the history of the cinema, but practical film-making and closed-circuit television will also be covered.

Students on the course will take it as their main subject, backing it up with the usual studies in the theory and practice of education. I am told that applications will be particularly welcomed from anyone with film or TV experience who might consider a change of career.

The syllabus is very interesting. In the first year, an introduction to film-making includes the camera and its controls; still photography with developing and printing; tape recording and film sound tracks; 8 mm. film production. Television drama will also be studied in the first year. In the second and third years the demonstrative and creative potentialities of television will be explored and students may have a choice between making a 16 mm. film or preparing a special study of some aspect of the cinema not covered in the course. During this period also, the work of better known international film directors will be studied in depth, and British Cinema will be studied with special reference to the documentary tradition, the work of its major directors, and the Free Cinema movement.

The CCTV complex should be ready for September with two studio-classrooms and a control room between them with space for camera controls, vision and sound mixers. The television equipment includes two EMI BC920 vidicon cameras with viewfinders for floor use with tripods and skids; one BC900 camera with remote control facilities which will be fitted to an overhead monorail; and an Ampex 7003 videotape recorder. Transmission is to most teaching areas in the college by a VHF system

extended to link with infant and junior schools on the other side of the college campus. In each of these there is a control room overlooking the school hall and two classrooms. Like the college classrooms these are equipped to receive and originate programmes. The distribution system is to be extended to the comprehensive schools which are also on the campus.

A word of warning, however. Entry requirements at colleges of education are fairly high and, although students nowadays specialise in one main subject, they are required to make an extensive study also of other subjects such as Art, English, Maths, History and Geography which make up the normal school curriculum. Do not let this put you off—you will have three years in which to do all this, and it could prove a highly enjoyable experience.

Details of the course, including academic qualifications required, may be obtained from the Registrar, Bulmershe College, Woodlands Avenue, Woodley, Reading, Berkshire. The course tutor is Roger Watkins.

The problem of whether to convert existing rooms into TV studios or to build a new wing especially for the layout is one that is with us all, and really comes before we ever consider specific equipment requirements. Those who find it possible within their budget to build a special installation are rare and extremely lucky; the majority have to convert whatever accommodation they can spare and hope that they reach a happy compromise. The basic considerations for both, however, are the same. These are: enough studio space, sufficient ceiling height, and adequate power supplies. All require the most careful planning.

It is helpful at the start if one knows exactly where one is going. CCTV is forging ahead at such a pace that some systems designed for fairly modest requirements a couple of years ago are now finding their resources overstretched in an effort to keep up with the new requirements thrust upon them.

In the first place, therefore, it is better to have some reserve studio space on which to fall back when needed. If a room is too large it can always be blanked off. I know that Dr. Gibson has done wonders in his limited space at Goldsmiths College with his expositions of the mini and micro studios but it seems to me that at the moment he is just as concerned with experimental work as he is with operation. This is no criticism for we need men like Dr. Gibson to show us the way, but our planning must be concrete and cannot afford to be experimental in the early stages.

Adequate provision must be made for sufficient power supplies for lights and equipment, good ventilation, proper floor covering, and acoustics. The studio is best located on the ground floor for easy access and for the handling of heavy equipment. Quite obviously, it should have wide doors to move equipment and large props in and out without trouble. The ceiling should be at least 14 ft. high for the proper suspension of lighting units. Where high-current light sources are to be installed, a careful survey should be made to determine the total maximum load demand possible under extreme conditions of use and then add a comfortable margin as a safety factor. A generous number of outlets should be supplied all around the wall base, and power circuits

should be kept apart from video and audio circuits in order to minimise the pickup of AC hum and other interference.

The ceiling and walls should be acoustically treated to cut out outside noise and to dampen the studio itself. Acoustic tiles, rock-wool covered with chicken-wire, even egg trays will help to prevent sound reflections and reverberations. The floor should be smooth enough to permit easy camera movement with no picture joggling. If possible, some rolls of stair carpet should be included in the budget. These are very useful for running down gangways or for laying behind tables to deaden the presenters' foot movements. Any spare rolls can be used to cover cables.

Cycloramas are worth thinking about. They can save time and trouble in erecting set walls. The floor-to-ceiling drape can run around three sides of the set if needed, and is very useful to isolate sets side by side in the studio.

These are some of the considerations. Of course, you will need good ventilation, and you will need a separate control room if only to keep the sound engineers from getting in the hair of all the other personnel. This should be sound-proofed in its own right and the viewing aperture should have low-reflective panes of glass separated by an air space for sound insulation.

Ampex have begun deliveries of their VR 5000 and VR 7800 series video tape recorders. The VR 5003 (the international version of the VR 5000) is the smallest and lowest priced VTR Ampex have ever offered. It sells for £795, weighs 63 lb., and has full compatibility with all Ampex video recorders using 25 mm. tape.

The VR 7800 is also helical-scan but is designed as a master recorder in CCTV systems where either a large volume of production is performed or where the highest attainable quality is desired. Its price is £4,650 and its weight is 140 lb. It is equipped with 'Electronic Editing' which permits rather sophisticated productions, using single camera techniques, and the assembly on to one master tape of sequences taken from a number of different tapes. All transients and picture rolls (readers may remember my arguments against mechanical splicing of diagonal helical-scan tracks) are thereby eliminated.

The Electronic Editor is an integral part of the video recorder in both appearance and function. The editor control circuitry is designed into, and is a permanent part of, the recorder's system control. It may be operated in any of five modes, depending on requirements. These modes are: Normal, for standard video operation; Audio only, for insertion of audio or cue material only; Short-in, for periods of less than 20 seconds; Long-in, for periods longer than 20 seconds; Assemble, for inserting material at the end of a recorded section.

In the Normal mode, all channels are placed in record when the record button is depressed. In the Audio only mode, only the selected audio and/or cue channels are placed in record when the record button is depressed. The unselected channels remain in playback. With the Short-in mode, the video erase oscillator is not turned on, but the new video material erases the existing video by a write-over process; also, in this mode, the control track is not erased. In the Long-in mode, the video erase oscillator is



turned on to erase existing material but, as with the *Short-in* mode, the control track is not erased. In the *Assemble* mode, both video and control tracks are erased.

The picture shows the video tape recording of an ear examination using Shibaden equipment. The tripod-mounted *HV14* CCTV camera takes in the whole scene, which is displayed on the 38 x 30 cm. monitor screen bottom left. The second camera, model *HV50*, is hand-held by the nurse to record close-up detail displayed on the upper 25 x 20 cm. monitor. This camera has a separate control unit, on the table to the right of the VTR. Both cameras are controlled by a single operator (not visible), who uses the monitors to select the appropriate picture for recording on the Shibaden *SV700E* VTR to make educational tapes. Quite obviously, this set-up was prepared purely for the photograph and a working system would be altogether different with the recorder well away from the other equipment, but it does show what possibilities exist for this type of recorded examination.

Finally, for those readers in the London area who are looking for some experience in film-making techniques prior to their introduction to CCTV, I append the following list of evening classes available.

Goldsmiths College Evening Dept., New Cross, S.E.14.

London College of Printing, Elephant & Castle, S.E.1.

City Literary Institute, Stukeley Street, W.C.2.

#### ADULT EDUCATION INSTITUTES

**Battersea:** Latchmere Road, Lavender Hill, S.W.11.

**Bethnal Green:** 229 Bethnal Green Road, E.2.  
**Catford:** Holbeach School, Holbeach Road, S.E.6.

**Central London:** 6 Bolt Court, Fleet Street, E.C.4.

**Central Wandsworth:** Riversdale School, 302a Merton Road, S.W.18.

**Chaucer:** Weston Street, Old Kent Road, S.E.1.

**Churchdown:** Malory School, Downham, Bromley, Kent.

**Clapham:** 6 Edgeley Road, S.W.4.

**Highbury Manor:** Starcross School, Risinghill Street, N.1.

**Eltham:** Eltham Green, S.E.9.

**Fulham:** Beaufort House School, Lillie Road, S.W.6.

**Greenwich:** Kidbrooke School, Corelli Road, S.E.3.

**Kensington:** Wornington School, Wornington Road, W.10.

**Camden:** 87 Holmes Road, N.W.5.

**Paddington:** Sarah Siddons School, North Wharf Road, W.2.

**South Lambeth:** Effra School, Barnwell Road, S.W.2.

**Stepney:** Smithy Street, Mile End Road, E.1.  
**Stockwell:** Stockwell Manor School, Stockwell Park Road, S.W.9.

**Streatham:** Hillcroft School, Beechcroft Road, S.W.17.

**Sydenham:** Kingsdale School, Alleyn Park Road, S.E.21.

**Walworth:** Walworth School, Shorncliffe Road, S.E.1.

**Woolwich:** 1a Burrage Road, S.E.18.

## CLOSED CIRCUIT

FURTHER FILM AND TELEVISION COURSES BY RICHARD GOLDING



Ampex VR 7800 video recorder with built-in electronic editor



Smallest and cheapest of the Ampex VTRs the VR5003

# SANYO PORTABLES

put you in the world  
class



### Sanyo MR 400

Modern neatly styled cassette tape recorder. Battery (4UM-2)/mains operation. Double track. AC bias. Tape speed  $1\frac{7}{8}$  ips. Tape recording time 30 mins. 1 track, 60 mins. double track. Rewind and fast forward times 1 minute. Power output 650mW max. Frequency response: 150-7000 Hz.  $2\frac{3}{8}$  x  $3\frac{5}{8}$  PDS speaker, dynamic microphone with remote control switch.

Recommended selling price **£43.14.4.**

Even if you've a roomful of fixed hi-fi in your home, you'll still be impressed with the performance of these special SANYO portable radios and tape recorders. Everything about them is designed to give the highest possible

performance within a reasonable compass of size and price.

For further information write to:

Sales Manager, Marubeni-Iida Co. Ltd,  
164 Clapham Park Road, London SW4.

**SANYO** reliability is built in



these felts are stuck to the underside of the upper turntable in many designs, and the spirit may be a solvent for the adhesive. 'Roughing up' the surface of a felt with the blade of a sharp knife may help if the clutch trouble is not too far advanced. When replacing felts, it is necessary to remember that the material of which the original disc or ring was made should be as nearly simulated as possible—the design depends on the coefficient of friction. Changing this may require readjustments all round. Normal adjustment of a weight-dependent clutch (simple gravity system) is for a similar pull to be obtained with a full spool as with a nearly empty spool, although machines will differ, and some tolerance must be allowed.

For any particular machine, a check on tension can be made with a spring balance and a loop of tape, or a short length of tape with a loop at the end through which the balance is booked. The pull on the spring when the machine is switched to play is noted, and to calculate the moment of a slipping clutch type of mechanism, the pull tangential to the spool is divided by the radius from the hub to the point at which the tangent is drawn. In the workshop, it may be useful to keep records of the slipping moment and direct torque figures for various popular machines, using a given test spool (which need not be anything special as diameter and tape type is not in this case of any significance). Manufacturers do not always quote torque figures. Those that do may stipulate test conditions that are inconvenient to simulate. The workshop notes are a great help, and owners of individual machines may find such notes helpful as reference against an ageing tape recorder.

When testing the torque, etc., always remember that the friction at the spindle and its bearing may have some relevance. Worn bearings and bent spindles, deformed washers and dirt between moving surfaces, lack of lubrication and overheating all have a part to play in affecting correct clutch action—and the cause of the defect may not be instantly apparent. Experience will help reduce the time of investigation. For example, some Grundig machines have a phosphor bronze bush inserted in a plastic turntable section, and time allows the bush to sink slightly. The overall effect is to allow the upper section of turntable to be lowered and to grind against the top of the spindle, increasing the friction and retarding the clutch. Again, Philips lower turntables consist of an alloy spinning, with vulcanised rubber pads inserted for direct clutch grip on fast wind, but a subsidiary disc and spindle through the main bearing on which the upper turntable rests for slipping clutch action. The height of the small spindle is extremely important for the compromise position between take-up and fast winding, and for an even torque between a full and an empty spool. This height is adjustable by packing the disc on its step of the spindle with neoprene washers, and needs some patient adjustment and testing to get just right.

The problem of poor drive is relevant in the Philips case, because on several of the single-

motor machines, especially the EL3541 and EL3542 genre, a single belt winds around the mechanism, engaging both turntable lower sections and the flywheel (the EL3542 type has an idler-driven flywheel), and is tensioned with a jockey pulley on a sprung bracket. Belts that slacken as they age, or, worse, that relax beyond a critical tension as the machine warms up, can give rise to perplexing faults. At the moderate cost of a new belt, if this has not been changed for some time, the prime cause of slipping drive systems can be eliminated, and investigation directed to the more subtle causes of trouble.

Some of these more subtle points have already been touched upon: others would take pages of text to describe. Typical of many designs is the barrelled guide with deep flanges that overhang the tape, and in which particles of tape oxide and dust can get trapped. These effectively reduce the width of the guiding channel and may trap a tape or retard it—and even break it if a clumsy splice passes through. Flattened, instead of rounded guide surfaces, head pin assemblies worn to a 'hard' contour, and head mounting assemblies themselves; these are all possibilities that should be checked when there is some doubt about clutch efficiency, but where the trouble could be an increase in tension rather than a loss of torque.

Even the three-motor machine is not without fault in this respect. In several designs, notably the *Collaro/Magnovox Studio* deck, used by very many manufacturers, the take-up motor is run at reduced power during play. The inclusion of a high wattage resistor in the motor circuit, and switching that combines the coils of both spooling motors is the usual method. But while the take-up motor is under-powered, any increase in back tension can affect take-up. Fast winding will sometimes give the necessary clue, an 18 cm spool tending to slow and sometimes stop as it nears full loading. Check the fastening of the turntables on the motor spindles when this is the trouble. There are different methods, and two particular offenders. First, the single bearing which has hex-headed screws of case-hardened steel threaded in the alloy hub and butting the tempered spindle. These can work loose, may appear to retighten successfully, but will work loose again as the machine warms up, due to the different co-efficients of expansion of the metals. A permanent cure is retapping the hole with a finer thread, slightly larger diameter, and fitting a hardened steel screw.

The second type is that which has a thin inner cylinder in the turntable, with two screws that press this alloy surface against the spindle. After a while, no amount of pressure will effect a good seal, and the only cure is to remove the collar through which the screws are threaded, saw the thin cylinder longitudinally with a junior hacksaw, carefully remove all swarf and reassemble so that inward pressure of the screws makes the now flexible cylinder wall bite hard against the motor spindle.

Spring-loaded clutches, slipping belt designs, those intended for vertical operation, and the compensating clutch and brake systems favoured by *Telefunken* are more involved, and deserve separate treatment in the second part of this article, which will appear next month.

amplifier, and the two Goodmans Maxims, and hurried away muttering "Never again!" over and over to himself) and started to obtain balance as the rehearsal progressed. Then disaster struck. The mixer gave a little squeak and died, the glorious 'fi' becoming less and less 'hi' as the sound faded away. Panic! We took to our screwdrivers and dismantled the console; by this time the rehearsal was over and everyone had gone home. At midnight we too departed, feeling very dispirited indeed.

Most of the next day was spent in trying to get things going again, but with very nearly 200 connections to check we hadn't much hope. (The fault was later traced to a 'dry' joint in the mixing amplifier—a worthwhile lesson to would-be constructors to check every soldered connection as it is made: tedious, no doubt, but time-saving in the end; we had been so keen to get the mixer working in time that we had been a little too slapdash.) So, with all fingers crossed, and a few prayers to the patron saint of recording engineers, we telephoned the manager of the recording firm which had hired us our microphones; and, by a marvellous stroke of luck, he had a three-channel Vortexion mixer available. This was at seven on the Wednesday evening; we commandeered a car to take us to the studios in Chiswick, and by nine were back at Battersea, with our hearts (and our wallets) considerably lighter.

Thursday morning saw us constructing a frightful lash-up, with bits salvaged from our console, to give us, with the Vortexion, a workable six-channel mixer by lunch. The noise had gone up slightly, our signal-to-noise ratio now being 50 dB only, but it all worked!

#### FLUORESCENT HUM

And so that evening brought the first performance. The church was full at least half-an-hour before time, at the last moment someone switched on all the lights in the building, including several fluorescent tubes on the sanctuary: this naturally gave rise to a frightening hum which the mikes picked up with startling clarity, and a good degree of stealth was needed to sidle up to the switches and turn them off in time. The floodlit altar looked much more impressive without the discolouring glare of the neons, as several people later observed.

The Thursday night recording went overboard a couple of times, as we were experimenting with balance, and the 'Hallelujah Chorus' took us by surprise! But on Friday and especially on Saturday all went without a hitch, and the performances could not be faulted. It was simply not possible to believe that the performers were all schoolboys and school-girls! Among the distinguished visitors at one time or another were Cardinal Heenan, Mr. Douglas Jay, and Mr. Braide of the I.L.E.A.; letters of congratulations came from, among others, Mr. Edward Heath and Miss Jennie Lee; and to date we have sold 150 records (or rather, 300 records, as the performances are supplied in a set of two discs) and are having another 50 printed.

The knowledge that all the profits are going to a very deserving cause has made all the work and worry (and the 30 hours' editing that took place afterwards) very worthwhile indeed.

# understanding bias

IN tape recording, the term *AC bias* refers to a high frequency current which is applied to the erase and record heads of a tape machine during the recording process. The frequency is usually at least five times that of the highest frequency to be recorded in order to avoid audible intermodulation with the programme. Most recorders are biased in the 60-100 kHz region. Bias is employed to obtain a linear relationship between the electrical signal fed to the record head and the magnetic impression placed on the tape.

All modern tape is composed of small crystal particles—gamma  $FE_2O_3$ . This substance possesses what is known as *coercive force*—that is, it resists being magnetised or de-magnetised. In practice, the coercive force for professional tape is usually high, at about 320 Oersteds, while that for domestic tape is typically 270 Oersteds.

Fig. 1 depicts a crystal which, when subjected to a magnetic field, moves through an angle  $\theta$ ; when the field is removed it reverts to its original angle. This is known as *reversible action*. Such a crystal is said to have no *remanence* (the residual magnetism in a substance after the magnetising force has been removed). It is obvious that if magnetic tape behaved in this way, signals placed on it would not be retained. Consequently, materials with relatively high remanence are employed, the output signal being proportional to the remanence for a given input level.

Turning from general considerations, let us examine the magnetising process in detail.

Let  $B$  equal flux density in *Gauss* (flux density refers to lines of force per unit area) and  $H$  equal magnetising force in *Oersteds*. For irreversible action,  $B$  increases as  $H$  increases, but as  $B$  is decreased  $H$  should, ideally, remain the same. Fig. 2 shows an ideal tape transfer characteristic; the recorded signal is identical to the applied signal and this state of affairs would be realised if the condition for irreversible action were satisfied by the oxide. In practice this curve is impossible to obtain because if  $H$  is decreased to zero, the tape is still permanently magnetised but the flux density does not return to zero only dropping in value. Thus the flux density is not proportional to the magnetising force. The deviation from linearity is defined by the *permeability*  $\mu = \frac{B}{H}$ . Thus per-

meability may be regarded as the ease with which the material is magnetised or demagnetised—i.e., the opposite of *coercivity*. The core of a tape head, for instance, should be of *high* permeability material so that the residual magnetism in the absence of signal currents in the coil is very low.

Fig. 3 shows a practical tape transfer curve (part of a *hysteresis loop* shown in fig. 4). With a pure sinewave input, a distorted output is obtained but if the signal could be applied to the linear part of the curve, the distortion would be removed (as in fig. 2). The function of the bias signal is to 'push' the signal out on to the straight part of the curve (see fig. 5).

Provided the bias amplitude is correctly specified, the compound signal will always exceed the coercive force of the tape. For example, if a sinewave of 1 V p-p is applied to the record head, only the peaks are likely to be recorded on most tape. Adding an HF bias of say 15 V p-p to 'carry' the AF signal effectively increases the amplitude so that it will exceed the coercivity of the tape and the straight portion of the curve will be used.

If, however, the bias level is set too high, the signal will tend to be erased by the AC field around the head. As they are recorded on the outer layers of the tape, high frequencies are more susceptible to erasure than middle or lower frequencies and so the recorded signal is affected in a frequency selective manner. In an effort to overcome this problem of self-erasure separate bias heads have been used by at least two major manufacturers, with varying degrees of success.

Too low a bias voltage will increase distortion and cause the output signal to drop in level as the signal will not completely occupy the linear part of the curve. Therefore, a point has to be found where the bias is set for least distortion and maximum output with a good HF response for the particular brand of tape the machine is using. Fortunately, for a drop of approximately 3 dB in output, a point of minimum distortion (2-3%) and a reasonable HF response occurs, and this is the *optimum* bias point.

One must be very wary of tape recorder manufacturers who quote ridiculous frequency response characteristics, as the HF response can easily be extended by under-biasing a machine but the distortion is often increased to a point that becomes offensive.

Bias is usually produced by an oscillator incorporated in the electronics of virtually

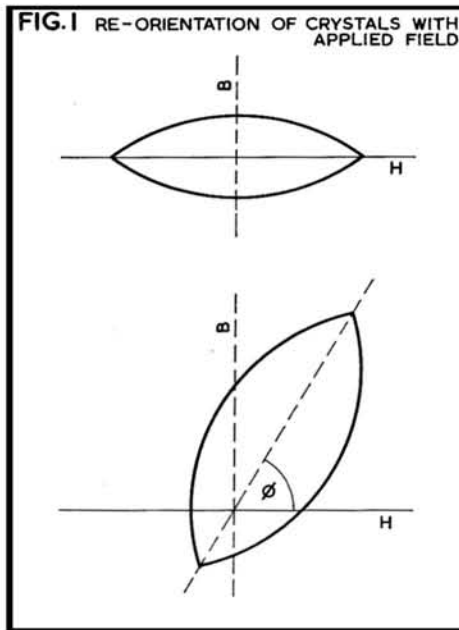

BY GERALD CHEVIN

# understanding bias

every tape recorder, and is energised when the machine is in the record mode. The exceptions are recorders using DC bias or permanent magnet bias which need not be taken seriously, for reasons to be mentioned. Fig. 6 shows the bias oscillator and the AF signal feeding the record head. The bias trap prevents the bias frequency and its second harmonic from feeding back to the output of the recording amplifier, otherwise distortion and unwanted side effects would result. The erase current drives the tape alternately to saturation in both directions (positive and negative) and gradually reduces to zero, leaving little residual noise on the tape (unlike permanent magnets or DC-driven record heads which leave the tape in a magnetised state, causing coating imperfections to become audible).

In order to achieve as many alternations as possible while the tape crosses the erase head gap, the speed or frequency of the erase current needs to be extremely high. A suitable frequency is 60-100 kHz. The record bias is invariably supplied from the same oscillator and thus corresponds in frequency. The erase head is normally of low impedance and requires considerable power, up to 3 W or so, as even heavily over-modulated signals must be erased. The record head impedance is high and requires less power. The oscillator coil is either tapped, as required to match these impedances, or separate windings of different turns ratio are used.

It is essential for a pure sinusoidal wave to be produced by the oscillator; if even harmonic distortion is present in the output, it can lead to high values of intermodulation distortion, by beating with programme material. Non-symmetrical waves (odd harmonics, etc.) will tend to magnetise the record head. To achieve this pure sinewave output, a push-pull circuit, using matched transistors operating in class C, works quite efficiently, though a variety of arrangements have been employed successfully.

Summing up then, AC bias is a high frequency current used to overcome the tape's resistance to magnetisation—or coercivity. Even domestic recorders are usually adjusted in manufacture for a particular tape to ensure the best HF response commensurate with minimum harmonic distortion, maximum output and a good signal-to-noise ratio. It is not difficult to adjust the bias to suit other tapes, provided one has reliable test equipment. Splicing several brands of tape together and comparing the results is worthwhile if one lacks these facilities.

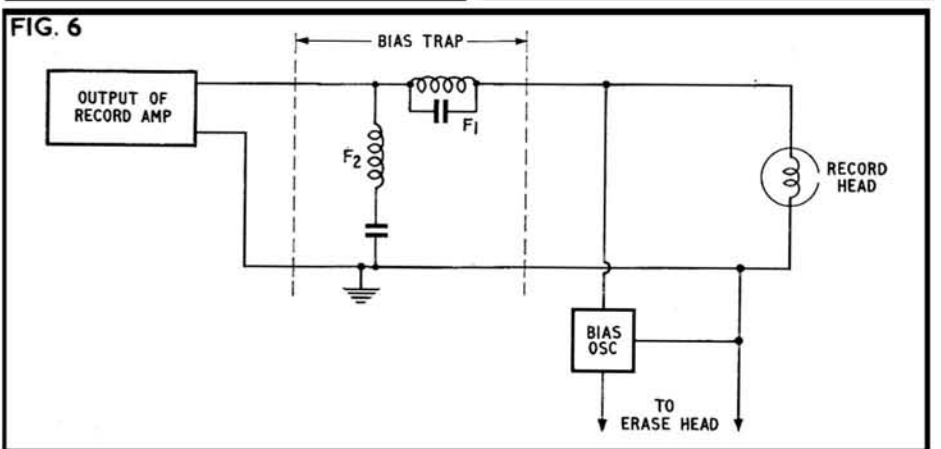
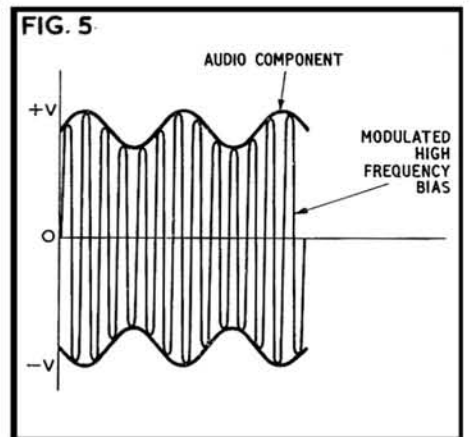
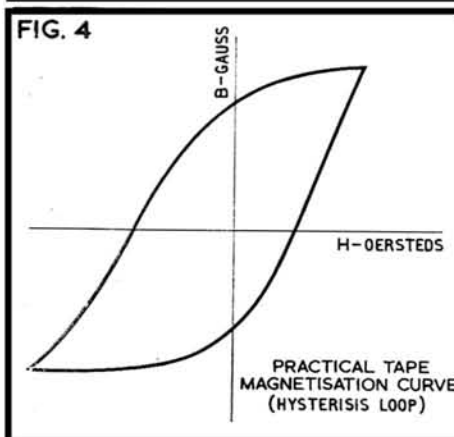
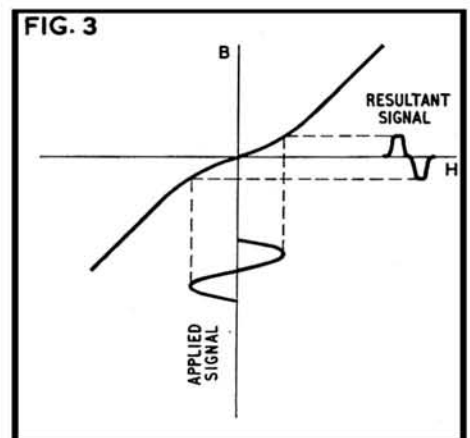
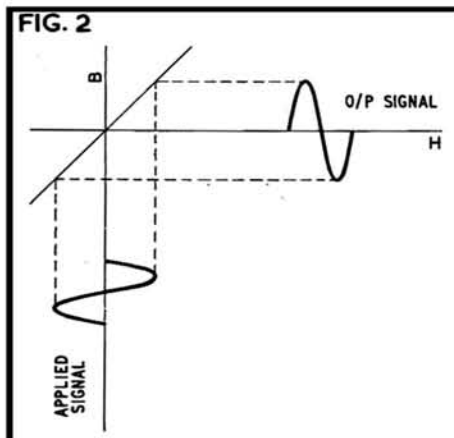

# HEATHKIT offer wonderful value in their Latest Stereo Portable Tape Recorder, STR-1

A COMPLETE SOUND SYSTEM IN ONE UNIT



Kit £58 p.p. 10/6. Ready to use £70-6-0. p.p. 10/6

## FOR THIS SPECIFICATION

- 4-track stereo or mono record and playback at 7½, 3½ and 1½ ips. ● Sound on-sound and sound-with-sound capabilities. ● Stereo record, stereo playback, mono record on either channel. ● 18 transistor circuit for cool, instant and dependable operation. ● Moving coil record level indicator. ● Digital counter with thumb-wheel zero reset. ● Stereo microphone and auxiliary inputs and speaker/headphone outputs . . . front panel mounted for easy access. ● Push-button controls for operational modes. ● Built-in audio power amplifiers giving 4 watts rms per channel. ● Two high efficiency 8" x 5" speakers. ● Operates on 230V AC supply.

**STR-1 SPECIFICATION:** Tape Speeds: 7½, 3½ and 1½ ips. Wow and Flutter: Better than 0.15% rms on 7½ ips; 0.25% rms on 3½ ips; 0.35% rms on 1½ ips. Tape size: ½" wide, Long or Standard play. Reel Size: Standard up to 7". 5½" spools and tapes supplied. Digital Counter: 3 digit counter with zero reset. Heads: 4-track erase record and playback. Microphone: Moving coil hand microphone (mono) supplied. Semi-conductor Complement: 18 transistor, 1 silicon bridge rectifier. Frequency Response: 3dB, 40 c/s to 18 kc/s at 7½ ips; 3dB, 40 c/s to 12 kc/s at 3½ ips; 3dB, 40 c/s to 7½ kc/s at 1½ ips. Signal-to-noise ratio (unweighted): Better than 40dB. Inputs per channel: Microphone 0.35mV. Auxiliary 50mV. Outputs per channel: 4 watt rms into 15 ohms, 1 volt rms (1,000 ohms source). Speakers: Two high efficiency 8" x 5" pm, 15 ohms. Power requirements: 200-250V AC 50 c/s, 60 watts. Cabinet: Materials, 9mm. plywood covered with two-tone Rexine with chrome fittings. Dimensions: 19½" wide x 7½" high x 15½" deep.

DEFERRED TERMS AVAILABLE FOR THIS MODEL.  
LOWEST POSSIBLE INTEREST RATES. SEND FOR DETAILS.

**For what's New in  
Hi-Fi - Radio - Tape  
Send for the Latest Catalogue  
... it's FREE**

To DAYSTROM LTD., Dept. HT8, Gloucester. Tel. Glos. 29451

Please send me FREE CATALOGUE (Yes/No).....

Please send me model(s).....

For which I enclose £..... p.p. extra

NAME (Block capitals).....

ADDRESS.....

Prices and specification may be subject to change without prior notice.

# UP TO 50% OFF!

## BRITAIN'S ONLY TAPE RECORDER MART

specialising in the SALE, EXCHANGE and PURCHASE of every make of high quality Tape Recorder. Brenell, Ferrograph, Ampex, B. & O., etc., we have the lot! Fantastic savings of up to 50% off original list prices for Personal Callers only. Our stocks change daily—call today—we'll over 100 models to choose from—all guaranteed—you pay no tax on secondhand machines.

## TYPICAL BARGAINS

Note: M=Mono, S=Stereo, BP=Battery Portable, 4=4 track, 2=2 track. All with 3 months' written guarantee

GRUNDIG TK20 (M/2) ... ..	OUR PRICE ONLY 22 gns.
PHILIPS EL3549 (M/4) ... ..	OUR PRICE ONLY 29 gns.
AKAI M69 (M/2) ... ..	OUR PRICE ONLY 32 gns.
GRUNDIG TK30 (M/2) ... ..	OUR PRICE ONLY 32 gns.
REPS R10/2 (M/2) ... ..	OUR PRICE ONLY 39 gns.
GRUNDIG TK41 (M/4) ... ..	OUR PRICE ONLY 39 gns.
TELEFUNKEN 300 (BP/M/2) ... ..	OUR PRICE ONLY 39 gns.
WYNDSOR VANGUARD (M/4) ... ..	OUR PRICE ONLY 39 gns.
TELEFUNKEN 85KL (M/2) ... ..	OUR PRICE ONLY 42 gns.
GRUNDIG TK6 (BP/M/2) ... ..	OUR PRICE ONLY 45 gns.
PHILIPS EL3536 (S/4) ... ..	OUR PRICE ONLY 49 gns.
SONY TC464CS (S/4) ... ..	OUR PRICE ONLY 49 gns.
SONY TC200 (S/4) ... ..	OUR PRICE ONLY 55 gns.

NOTE: THESE ARE NOW EVEN BETTER VALUE AS YOU PAY NO TAX ON SECONDHAND RECORDERS

GRUNDIG TK46 (S/4) ... ..	OUR PRICE ONLY 59 gns.
SONY TC250 (S/4) ... ..	OUR PRICE ONLY 59 gns.
FERROGRAPH 4AN (M/2) ... ..	OUR PRICE ONLY 59 gns.
VORTEXION WVA/4 (M/2) ... ..	OUR PRICE ONLY 59 gns.
BRENELL MK5111 (M/2) ... ..	OUR PRICE ONLY 59 gns.
AKAI 1700 (S/4) ... ..	OUR PRICE ONLY 59 gns.
SANYO 929 (S/4) ... ..	OUR PRICE ONLY 59 gns.
PHILIPS EL3534 (S/4) ... ..	OUR PRICE ONLY 59 gns.
AKAI M6 (S/4) ... ..	OUR PRICE ONLY 65 gns.
SONY TC500 (S/4) ... ..	OUR PRICE ONLY 69 gns.
FERROGRAPH 5AN (M/2) ... ..	OUR PRICE ONLY 69 gns.
BRENELL MK5M11 (M/2) ... ..	OUR PRICE ONLY 69 gns.
AKAI M7 (S/4) ... ..	OUR PRICE ONLY 72 gns.
TANDBERG 64 (S/4) ... ..	OUR PRICE ONLY 75 gns.
FERROGRAPH 631 (M/2) ... ..	OUR PRICE ONLY 79 gns.
VORTEXION WVB (M/2) ... ..	OUR PRICE ONLY 79 gns.
VORTEXION WVB/5 (M/2) ... ..	OUR PRICE ONLY 79 gns.
B & O STEREO MASTER (S/2) ... ..	OUR PRICE ONLY 82 gns.
AKAI I710W (S/4) Brand New ... ..	OUR PRICE ONLY 85 gns.
AKAI M8 (S/4) ... ..	OUR PRICE ONLY 85 gns.
SONY 777 (M/4) ... ..	OUR PRICE ONLY 89 gns.
B & O 2000 (S/4) ... ..	OUR PRICE ONLY 105 gns.

PERSONAL CALLERS ONLY

## NEW TAPE RECORDERS

We also stock every make and model of New Tape Recorder plus a complete range of accessories

Part of the NuSound organisation

THE **TAPE  
RECORDER  
MART**

242/4 PENTONVILLE ROAD, LONDON, N.1

(200 YDS. KINGS CROSS)

TERminus 8200

(HALF DAY THURSDAY)

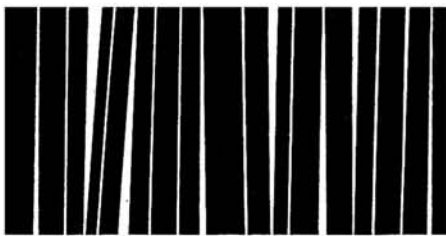

## book reviews

**SOUND AND VISION.** By P. E. Sharp. 64 pages, illustrated. Price 7s. 6d. Published for the Council of Industrial Design by Macdonald & Co. (Publishers) Ltd., 2 Portman Street, London, W.1.

I AM not sure whether I was intrigued or dismayed by the cover of this booklet. It shows a sharp-looking dolly sitting on the floor in a mini-skirt and no shoes, holding a microphone. She is clearly more interested in Sinatra than the earnest young man, also sitting on the floor, who is staring at the immobile reels of a *Series 6 Ferrograph*. It may be, of course, that she is wondering whether the microphone should be plugged in.

The cover to this intriguing-sounding tome is stilted and posed, the colours are dreadful and the title lettering is unworthy of the Design Centre and, indeed, the excellent inside-cover presentation. The booklet is one of a series which ranges from Bathrooms via Boats for Sailing right into Living Rooms—and that should give you a good idea of the booklet's technical scope. The author is an engineer with wide experience in the electronics field and the publishers are public guardians of good taste. Somehow, they never really get together.

There are 22 pages on tuners, pickups, amplifiers, 19 on systems and combinations, five on basic sound theory, two on television, 1.5 on tape-recorders, and quite a lot on hiring, speakers (good), cabinets, record-players, aeriels, etc. By far the most interesting technically is the section on basic sound theory. Not too difficult to understand and illustrated craftily with neat little drawings in the inner margins. The author makes one very sound observation at the beginning when he says "it is astounding how much really bad distortion some people will accept, even highly experienced musicians". On the other hand, when talking of the respective merits of AM and FM radio, I feel that I cannot quite agree with him when he says that AM produces muffled and rushing sounds. Whereas there is no doubt that FM is by far superior in quality, the inference that AM is useless is rather misleading.

The section on amplifiers covers the subject fairly comprehensively, with a nice emphasis on the purpose and use of the mysterious pre-amplifier. In dealing with the type of amplifier for home-listening, Mr. Sharp recommends the use of a 10 W per channel amplifier for drawing-room listening. This, I feel, is a little misleading, especially to the younger hopefuls. 2.5W total output is more than enough in my opinion. However, power in reserve is always useful and I think that this point should have

been made a little more strongly. One recommendation I was pleased to see: the use of a good microphone with any tape-recorder. This, in fact, is about the only valid piece of information worth anything in the microscopic section on recorders. The 1.5 pages deal with speeds, tracking and cassettes. There are photographs of 11 different tape-recorders and a brief summary of price-groups. The author, in dealing with accessories, failed to define the different types of microphone as distinct from their directional capabilities. He also failed to give a clear indication of the problems and advantages of different thicknesses of proprietary tapes.

The booklet contains excellent and easily-understood explanations of the working of various components in the sound and vision field. It is a well-written, well-illustrated book, but clearly aimed at the chap with money to burn and an insatiable desire to be Hi-Fi—a sort of manufacturer's pre-amp. It concentrates on well-designed equipment and the adage that you get what you pay for. As advice to the eager, it is really quite good, but for the tape recordist it says very little indeed. What it does say is common knowledge anyway . . . or should be.

P.L.B.

**PRACTICAL WIRELESS SERVICE MANUAL** (12th Edition). Revised by H. W. Hellyer. 288 pages, illustrated. Price 25s. Published by George Newnes Ltd., Tower House, Southampton Street, Strand, London, W.C.2.

THIS book sets out to be a comprehensive guide to the service engineer and amateur. The emphasis is on test and repair procedure, theory and circuitry; constructional projects have been reduced in number in this edition to allow for the growth that has necessarily taken place in the other sections. While the service engineer will require more detailed treatment of each of the topics considered, it will certainly serve as a quick-reference source for basic theory and tables, laws and conversions. The book gives the complete newcomer to electronics a brief description of how various components and their associated circuits work, and outlines the mechanical principles of various pieces of equipment, illustrating points with ample examples and diagrams. It then deals with the operation and repair of various items of equipment, and with test and alignment procedures in general. H. W. Hellyer's service articles in *Tape Recorder* are familiar to readers, and his attention to practical detail can be seen throughout the book.

Naturally, coming from *Practical Wireless*, the emphasis is on radio; other audio and general servicing are not neglected, however, and the book includes chapters on receivers, valves and other components, servicing mains equipment, detector stages in radios, alignment procedures and testing, FM receivers, radio-grams and audio equipment, tape recorders, semiconductors, cabinet finishing and repairs, instruments, workshop techniques, and a host of facts, figures and formulae. Inevitably there are one or two odd spots, probably the result of a mixture of revising and rewriting the text: the *Garrard Lab 80* seems an unlikely example to choose of a changer fitted to commercial radiograms, and one might question the statement that FM aerial inputs are usually at 300

ohms, in Britain at least. These are minor points, however, and I have only two real criticisms to make.

Just occasionally, an important point is missed in the effort to be general—as in the circuits illustrating magic-eye and meter indicators for tape recorders, where the choice of the right time constants and the need for an adequate dynamic range in the amplifier above the tape's peak recording level are neglected (tape biasing is, however, well covered). Secondly, one would have hoped in this edition to find more examples of transistor circuits, and some of the relatively few transistor circuits which appear are decidedly ancient: one hardly expects to be shown preamp circuits based on OC71s and OC70s, and with the majority of multiplex stereo decoders on the market using transistors it seems odd that an old Mullard valve design should appear when Mullard have published at least two transistorised designs in wide use. However some of the principles are there, and it must be some defence that it is the older designs that are most likely to be in need of service; but with integrated circuitry already appearing in commercial equipment, there is some danger that transistors are going to get missed out altogether! One hopes for fuller treatment in the next edition, and for consideration of transistor power amplifier designs.

Despite these little grumbles, this is a well produced, compact, useful and concisely indexed book, excellent value and highly recommended, particularly to those with a keen interest in radio.

J.H.F.

**THE TAPE RECORDER.** 2nd Edition. By C. J. Nijssen. 157 pages, 59 line illustrations, 76 half-tones. Price 18s. Published by Iliffe Books Ltd., Dorset House, Stamford Street, London, S.E.1.

ONE sees so many books advertised on this subject it is rare to find one which hits that delicate balance between baby-talk and blinding-with-science. This is one of them.

The book is translated from the original Dutch edition of 1963 and is sponsored by Philips. Therefore, it is no surprise to find that all the references are to Philips equipment. No matter, for the references are easily transposed into other machines, other equipment. There are 152 pages of rather nasty thick paper and 59 quite clear illustrations. There are 30 pages of photographs and a whacking great 'tipped-in' (pull-out) illustration in the middle. The book has recognisable affiliations with a Philips book I had years ago, which was also very good. You will probably surmise that I am something of a Philips fan.

The cover-picture, as seems common to most books on tape-recording, looks more like a cookery guide than a technical work, but there may be deep psychological reasons for this approach. The inside, however, is in no way like a cookery guide. It is a very well-written treatise—if I may use the word—on every aspect of recording, ranging from theory to video via acoustics, stereophony, equipment and a dozen other subjects. The book commences, as is only proper, with a chat on the theory of sound, talking about frequency, amplitude, timbre and like terms. The author refers to phons but, to me, does not make it very clear what the difference is between a phon and a

(continued overleaf)

decibel. In my experience, phon is a term used in acoustics and decibel is a term used in electronics. Perhaps it was a mistake to confuse the non-technical reader with these two terms, although it does, of course, make him reach for his dictionary.

The history of tape-recording is very interesting and is covered fairly extensively with some considerable reference to the interesting *Philips-Miller* system. This system chisels out a sound track on a film strip which is replayed by photo-electric scanning. In this particular section, the author refers to "tubes". This, of course, to we Anglo-Saxon purists, is American for valves. He also talks about slide synchronisers and speakers and it is interesting to note that speakers with impedances up to 800 ohms can be obtained. He also categorically condemns non-direct recording from radio sources and goes to some lengths to describe direct channelling of signals from radio or tuner to recorder.

The section on maintenance and fault-finding is fairly standard stuff but well worth reading for all that. Wow and flutter are dealt with (of course) and there is an interesting little bit on drop-out which the author ascribes to interrupted contact between tape and heads, unsupple tapes, faulty coating or dirt generally. On the question of acoustics, reverberation is dealt with in some detail and Mr. Nijssen states that difficulty arises when a delay in excess of 0.05 of a second occurs. He thinks that 0.8 second is satisfactory for speech and 1.5 to 2.5 seconds satisfactory for music, with some increase when recording organs. This is good technical advice but advice which is a little difficult for the amateur without highly-complicated equipment to implement. I find that the best rule is to judge by ear: your ear will soon tell you when reverberation reaches its saturation point. Studio arrangements and effects are covered and the author makes a very valid point when he says that recording in mono is like listening with one ear as opposed to the stereo effect of using both ears. Very good observation. Stereophony is covered in full and there is advice upon the salient facts of choosing a recorder.

There is a section on advice for recording which covers the usual aspects of stupidity and good sense. The author mentions the use of tone-controls when recording but I have never used a machine where these controls work in that context. He talks about hum and I was surprised to note that he did not mention the importance of earthing equipment and the effects of earth loops. This problem is a very great one to almost all recordists and I should have liked to see it covered in much greater detail. A good point is made about the difference in voice-quality when the speaker sits or stands: it is always better when the singer or speaker stands, due, I suppose, to lack of pressure somewhere in the vitals. Mr. Nijssen is apparently an advocate of copy-editing, for which I salute him. He does, however, point out the danger of quality-loss in this respect but I am nevertheless obliged to him for unwittingly supporting my own pet theories on this subject. There is a section upon How to Go About It and some examples of sound

effects. A lot of these are very rusty and old hat but perhaps useful. No mention is made of the unlimited and interesting effects which can be obtained by the use of different speeds and there is only the vaguest reference to tape-loops. These omissions, to my mind, tend to date the book. Techniques such as these have become widely used in the last few years and I should have thought that the original manuscript could have been revised a little to include advice on such techniques.

There is a considerable amount of information on the application of a tape-recorder, education and dictation machines. The section on professional recording is interesting and Mr. Nijssen reiterates the use of high speeds in this respect. He says that 19 cm/s is the minimum speed used professionally. All equipment in professional studios is duplicated, for obvious reasons. Television studios, he says, use perforated tape for synchronised recording with the 16 or 35 mm. vision film, though this does not mean that the original recording is necessarily recorded on perforated tape. But that is another story. Cinema, theatre, copying and automatic recorders are all dealt with briefly and concisely. There are a few lines on electronic music which is described as "fragments of sound edited together to form an artistic sound". Communication recorders, computers and film tracks are dealt with as well as video.

This book is really and truly a case of 152 pages packed with information. They say that you are never too old to learn and I would say that here is a case where that applies in every respect. The novice can learn about how his recorder works and what to do with it: the serious amateur (and the happy one, too) can learn a great number of things which he thought he knew and I suspect that there are more than two or three things in it that the professional does not know. The price of this book is 18s. which works out at about 1½d. a page. And very good value, too. **P.L.B.**

**TAPE RECORDING FOR THE HOBBYIST.**  
By Arthur Zuckerman. 160 pages, illustrated. Price 26s. Published by W. Foulsham & Co. Ltd., Yeovil Road, Slough, Bucks.

I CONFESS I approached this book with some misgivings, as past reading of such hobby-books written for the US market and adapted for the UK market has not entirely convinced me of their value. This book, a revised edition of the book *Magnetic Recording for the Hobbyist* by the same author, contains "a specially written chapter for the English reader" by W. Oliver, a chapter which contains a warning of the higher mains voltages in the UK and a list of British manufacturers of recording and hi-fi equipment. It also contains a caveat on legal points such as copyright that arise later in the book—a caveat that is needed in view of the advice in the opening lines of the book that it is quite legal to copy gramophone records on to tape, and the subsequent advice on how to do so! Perhaps in apology to gramophone record manufacturers thus offended, the author goes on to advise cleaning these records with a *cellulose sponge, detergent and tap water* . . . If one survives this outrage, one is reminded of the American origins of the

book by the hopeful statement that "many FM stations around the country regularly air fine stereo . . .". Would that they did!

Such points apart, the book is mainly an extension of the chatty suggestions to be found in so many recorders' instruction booklets rather than a text book or detailed practical handbook. The information given is mainly sound, if general and elementary, and deals among other things with creative tape recording, sound-and-cine, outdoor recording, etc., with tape manufacture and high speed copying, and with certain points of professional recording in the USA—including a classic photograph illustrating the American taste for ultra-close miking and consequent unnatural sound. The book closes with a brief glimpse of domestic video recording.

This is probably one of the better books written for the USA and adapted for sale here—though at its price I would have liked the Americanisms of language and proliferation of dollar signs to be translated into English. But I cannot really be enthusiastic about it. **J.H.F.**

**CURRENT RESEARCH IN HYPNOPAEDIA.**  
A Symposium edited by F. Rubin. 350 pages, illustrated. Price 80s. Published by Macdonald & Co. (Publishers) Ltd., 2 Portman Street, London, W.1.

THE title and subtitle of this book are both somewhat misleading: it contains not the proceedings of a symposium, but merely a collection of articles on sleep-learning. Some of the work reported is up to 20 years old, and much can only out of politeness be described as research. There is little justification for the reprinting of obscure and equivocal MA theses that have never been published in scientific journals. Many of the serious Russian papers have already been translated and published in the West.

The book makes no extravagant claims but concludes that hypnopaedia during light sleep may be a possibility. Although the Russian experimenters seldom offer electroencephalographic evidence of sleep, the occurrence of sleep-learning can no longer be denied out of hand. However, several points arising from the Russian work should be considered by anyone contemplating the purchase of sleep-learning equipment. First, it is apparently not sufficient merely to play appropriate material during sleep: learning cannot occur without a preliminary "induction" or "conditioning" procedure of a hypnotic nature. Secondly, only selected individuals of a highly suggestible nature may be able to achieve sleep-learning. Further, there are several reports of ill-effects after hypnopaedic sessions: these range from severe headaches to an experimentally demonstrated decline in day-time efficiency, although it is unclear whether they are the consequences of sleep-learning *per se* or merely of the direct disturbance of natural sleep by extraneous noise. Since the actual gains reported are often relatively slight, it seems that even if some fortunate individuals are capable of sleep-learning, the practice may hardly be worthwhile.

Any readers who wish to form their own opinions on the possibility and desirability of hypnopaedia could refer to earlier discussions in *Tape Recorder* (March 1965; February and April, 1967). **J.D.M.**

# how not to win a tape recording contest

BY JOHN SHUTTLEWORTH

WHEN I decided to enter for the *British Amateur Tape Recording Contest* my first move was to make a list of qualities the judges might expect. A little thought produced the following:—

- (1). Interesting material.
- (2). Good performance.
- (3). Good balance.
- (4). High signal-to-noise ratio.
- (5). No plops, clicks or extraneous noise.
- (6). No dropout.
- (7). No distortion.
- (8). No hiss.
- (9). No hum.
- (10). No audible splices.
- (11). Wide flat frequency response.
- (12). The final tape should be pleasant and easy to listen to.

I decided that the first two requirements could be met by finding a group of musicians with an expert director to look after the performance. After all, this is advertised as a tape recording competition and not a programme producing competition. Here I met my first difficulty. As many recordists will know the *Musicians Union* adopt an obstructionist attitude towards recording and their members are not allowed to record unless paid the full union rate. This means that, except for the wealthy, we have to make do with amateur musicians.

It was difficult to find an amateur group of the standard I required, but I eventually contacted one in Woolwich. They only played 'Gospel' music and I thought this might offend some of the judges. But with Union limitations, this was the best I could do, and they certainly were very good and extremely helpful. My next task was to get the recorder ready to satisfy requirements 4, 6, 7, 8, 9 and 11. For this I needed a signal generator, valve millivoltmeter, wobble meter and distortion meter. These items of equipment are all expensive, and to bring them within reach of my pocket I invested in the excellent *Heathkit* range and assembled them myself. Heathkit do not offer a wobble meter, so I had to buy the WHM fluttermeter already assembled.

After several weeks assembling the kits, and the purchase of an expensive test tape I was now ready to check my recorder. First, I thoroughly cleaned all mechanical parts with a soft lintless rag moistened with methylated spirits, and then demagnetised the heads and other metallic parts of the deck.

The test tape was then put on the recorder and the output of the 8 kHz tone measured with the VVM. The head azimuth (i.e. the vertical alignment of the head gap) was adjusted for maximum output on the upper track. This was repeated for the lower track and the head was then adjusted between the two positions found so as to give the optimum position for both tracks together.

The 1 kHz tone was now played on the test tape and the output of the recorder adjusted to give 0.5V. The 10 kHz tone was then played and the replay equaliser adjusted to give the same output, namely 0.5V. A frequency check was then made and the response was found to be within 0.5 dB from 50 Hz to 10 kHz. This was repeated for the lower track.

The replay side of the recorder was now ready to help in checking the record side. A signal generator was fed into the recorder's input and the azimuth of the record head adjusted to given maximum output when the machine was switched to record on a 10 kHz signal. The same procedure was then used as when checking the azimuth of the replay head. Bias was then checked by feeding a 1kHz signal at 0.5V into the input, switching to record and adjusting the bias control for maximum output, and then increasing the bias voltage until the output dropped by 2dB.

The frequency response of the record amplifier was then checked by feeding a 1 kHz signal into the recorder, switching to record and adjusting the record volume until the output level was 0.5V. The frequency was then changed to 10 kHz and the record equaliser adjusted so that the output was again 0.5 V.

A check was then made of the record/replay frequency response and it was found to be within 0.5 dB from 40 Hz—12 kHz then falling off to about 10 dB down at 18 kHz. This was repeated for the lower track.

A wobble check was then made and readings taken at 0.16% RMS. Very careful cleaning and adjustments reduced this to below 0.1% right to the end of the spool and the recorder was then ready for use.

The next task was to find a suitable hall for making the recording. I wanted a 'live' sound with good presence, and this is best obtained in a resonant hall using microphones very close to the performers. In this position the microphones are very critical and any

faults in performance are very obvious. Fortunately the group were extremely competent, and we were able to put the microphones very close indeed. The place finally chosen with a modern chapel with an extremely lively acoustic but with little coloration of its own.

Having set up the recorder and microphones we made a number of trial recordings moving microphones or performers between each trial until we found the exact balance between instruments and between direct and reflected sound.

Bryan Gilbert, the leader of the group, was most helpful during this, giving advice and constructive criticism, and the members of the group were extremely tolerant. We eventually got things as we wanted, noted positions and levels and agreed to meet the following evening for the actual takes.

The recording session went very well. The group were ready and 'warmed up' at the time we were due to start, a most unusual state with amateurs, and the recorder worked perfectly.

After each 'take' we had a playback session and everyone helped with criticisms and suggestions. After several hours of recording we left with four or five good tapes.

The next task was to listen extremely critically to the various takes and select the best. It was found, of course, that the best result could be obtained by using sections from three or four different 'takes' and splicing them together.

Great care was taken with the splicing, so that the splices were completely undetectable, the razor blade being demagnetised before each cut.

When the tape was finished a second recorder was cleaned and set up by the same procedure as the first, and the tape copied so that the one sent to the competition did not contain any splices. Several copies were made and after extensive listening tests the best was sent off. What did the judges think? It was, they said, technically, the best entry, but as it was, after all, only a straight recording of music it could not compare with the multi-track recording that won which obviously took so much more time, effort and skill to produce.

I hope I will be forgiven for feeling a little smug. After all a 'straight recording of music' is what I intended to produce, and my splices must have passed unnoticed.



BY DAVID KIRK

**Fig. 1.** Capstan motor and control circuit board. The tachometer head mounting, though not the head itself, is visible on the right of the rotor.

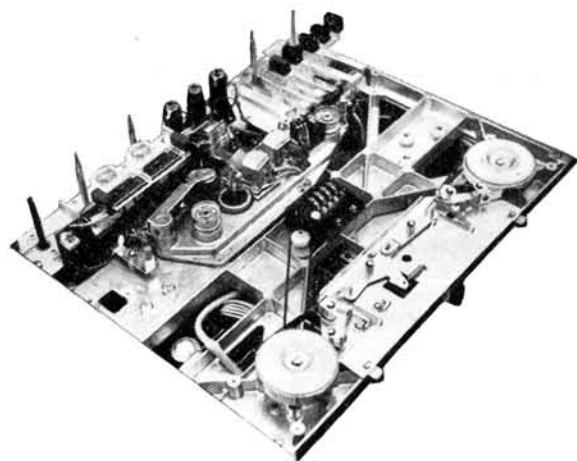
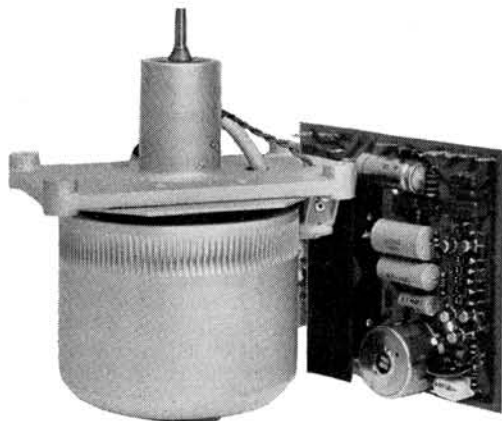

**Fig. 3.** Upper view of mechanism with deck covers removed. Solenoid switch levers can be seen at top corner. Braking is similar to the 736 steel bands acting on cloth. The pinch wheel bracket is mounted away from the head channel to give greater access when editing.

**MANUFACTURER'S SPECIFICATION.** Half-track stereo recorder with self-contained silicon transistor power amplifiers and side-facing speakers. **Tape speeds:** 19 and 9.5 cm/s  $\pm 0.2\%$ . **Wow and flutter (CCIR weighted):** 0.08% at 19 cm/s, 0.1% at 9.5 cm/s maximum. **Spool capacity:** 26.5 cm. (10.5 in.). **Frequency response:** 50 Hz - 15 kHz  $\pm 1.5$  dB, 30 Hz - 20 kHz  $+2 -3$  dB, at 19 cm/s. 50 Hz - 10 kHz  $\pm 1.5$  dB, 30 Hz - 16 kHz  $+2 -3$  dB, at 9.5 cm/s. **Signal-to-noise ratio (CCIF weighted):** 58 dB at 19 cm/s, 56 dB at 9.5 cm/s. **Crosstalk:** 60 dB (mono), 45 dB (stereo) at 1 kHz. **Distortion:** 2% at 19 cm/s, 3% at 9.5 cm/s, full modulation at 1 kHz. **Oscillator:** 120 kHz, push-pull. **Inputs:** 0.15 mV at

50 ohms—6 K or 2 mV at 100 K (microphone—switchable); 2 mV at 33 K (radio); 40 mV at 1 M (auxiliary). **Outputs:** 2.5 V at 600 ohms; 1.2 V at 2.5 K. **Output power:** 8 W per channel continuous at 1% distortion, 4—16 ohms. **Remote control:** electro-mechanical, for all operating functions. **Components:** 54 transistors, 32 diodes, 4 silicon rectifiers, 1 photo resistor (autostop) and four relays. **Power supply:** electronically stabilised to accept 110, 130, 150, 220, 240, 250 V at 50 or 60 Hz. **Weight:** 34 lb. **Manufacturer:** Willi Studer GmbH, CH-8105 Regensdorf, Zurich, Switzerland. **Distributor:** C. E. Hammond & Co. Ltd., 90 High Street, Eton, Windsor, Berkshire. **Price:** On application.

**R**EADERS of the 736HS review and field trial (May 1967) will be aware of the very high regard in which Alec Tutchings and I held the A77's predecessor. The 38 and 19 cm/s HS version could not be faulted on performance, its only real failings being minor operating inconveniences. Capstan wear troubled some professional users of the standard 19 and 9.5 cm/s 736—the penalty for using cine spools on a mechanism designed for larger NAB hubs.

The A77 retains a 27 cm spool capacity and likes cine spools even less than the 736. This field test begins, therefore, with the assumption that nothing smaller than a 7.6 cm hub is employed on the feed turntable.

A 736 owner will be instantly familiar with the A77 controls. The mechanism is entirely relay-operated from a row of buttons on the left of the front panel. These are connected indirectly to the switchpack and are much lighter than before. From left to right, four black buttons govern left-wind, right-wind, play and stop respectively while a fifth red button selects the record mode—interlocked with the play button and the record track selectors. These track selectors are now adjacent to the VU-meters, the appropriate meter being illuminated when actually recording. On the 736, they took the form of two small circular buttons, another pair governing motor speed. The speed control has been combined with the main on/off switch at the right of the panel. At its furthest clockwise or anti-clockwise setting, this switch should cut the capstan motor power when the recorder is used merely as an amplifier. This facility was not provided on the review sample, however. A red mains lamp is positioned above the speed switch.

Two rotary controls beneath the meters govern input gain, each supporting a five-position switch skirt. Moving clockwise, these select *Mic Lo*, *Mic Hi*, *Radio*, *1-2* (*2-1* on the right-hand skirt), and *Aux*. The *1-2* setting allows cross-track dubbing, mixed if desired with a second input. Using *2-1* and reversing the switch settings and input connections, the mixture may be fed back with a third signal to permit an indefinite number of 'multi-track' recordings.

Setting both skirts to *1-2* and *2-1* positions provides facilities for adding echo while cross-tracking.



The two left-hand potentiometers govern playback volume and balance. *Stereo, Channel 1, Channel 2, and Mono* replay may be selected by the switch skirt beneath the volume control—affecting the line and external speaker outputs. The three-position skirt beneath the balance control governs replay equalisation (NAB or IEC) or *Input*.

Revox have at last provided standard jack microphone sockets accompanied, on the front panel, by a ring-tip-and-sleeve stereo headphone socket. Monitor level at this socket is governed by the replay volume and balance controls—rather excessively attenuated but unaffected by fuses in the power amplifier circuits. The left channel blew its fuse on several occasions for no apparent reason, presumably a power amplifier fault.

An original feature which we may expect to see adopted on rival designs is the long hinged head cover. This protects the tape from accidental fouling but leaves the heads reasonably accessible for editing and cleaning. A Mu-metal screen locates against the replay head when playing and chinagraph marks are thus better made at the right-hand guide post. The moulded editing block on the rear head cover, despite appearances, is a perfectly usable tool.

Three controls are concealed beneath the hinged cover, one being an internal speaker cutout, the second a spooling motor switch and the third an inching lever. The latter pulls the tape into close contact with the heads to permit 'rocking' when editing and also allows high-speed gargle monitoring during fast wind—useful if one is in a hurry to find a lost sequence. The motor switch disconnects the power to both spooling turntables (fat *Papst* outer-rotor motors) if one wishes to run a short tape loop. By pressing this and the fast-wind button (to release the brakes) the *A77* becomes an almost perfect editor.

Coaxial spool retainers are still employed in preference to detachable screws or suction devices. A three-bit retainer is also incorporated in the lid of the transportable version supplied for test since the *A77* has no alternative spool-storage facility. This is another idea I can see being copied!

Though superior in styling, the deck cover is manufactured from similar slightly flexible plastic to that which encased the *736*. I am not alone in wishing for a more substantial metal facing though one must make allowances for the comparatively low cost of the recorder.

Before disappearing beneath the deck, I would make a last comment on the top surface: at no time during the months I have used the recorder has the surface become warm. There are no valves, of course, and the three motors all appear to run cold.

Visiting the Revox-Studer factories in September 1966, I was shown a rack-mounted prototype of the *A77* capstan motor. This is a servo-controlled device and, at the time, was connected to a digital-display revolution counter. To prove its self-compensating qualities, I was asked to grip the polished spindle and observe the counter reading. The speed fell for a few seconds and then returned to its original 1600 r.p.m. When I relaxed my fingers, the reading rose for an

(continued on page 371)

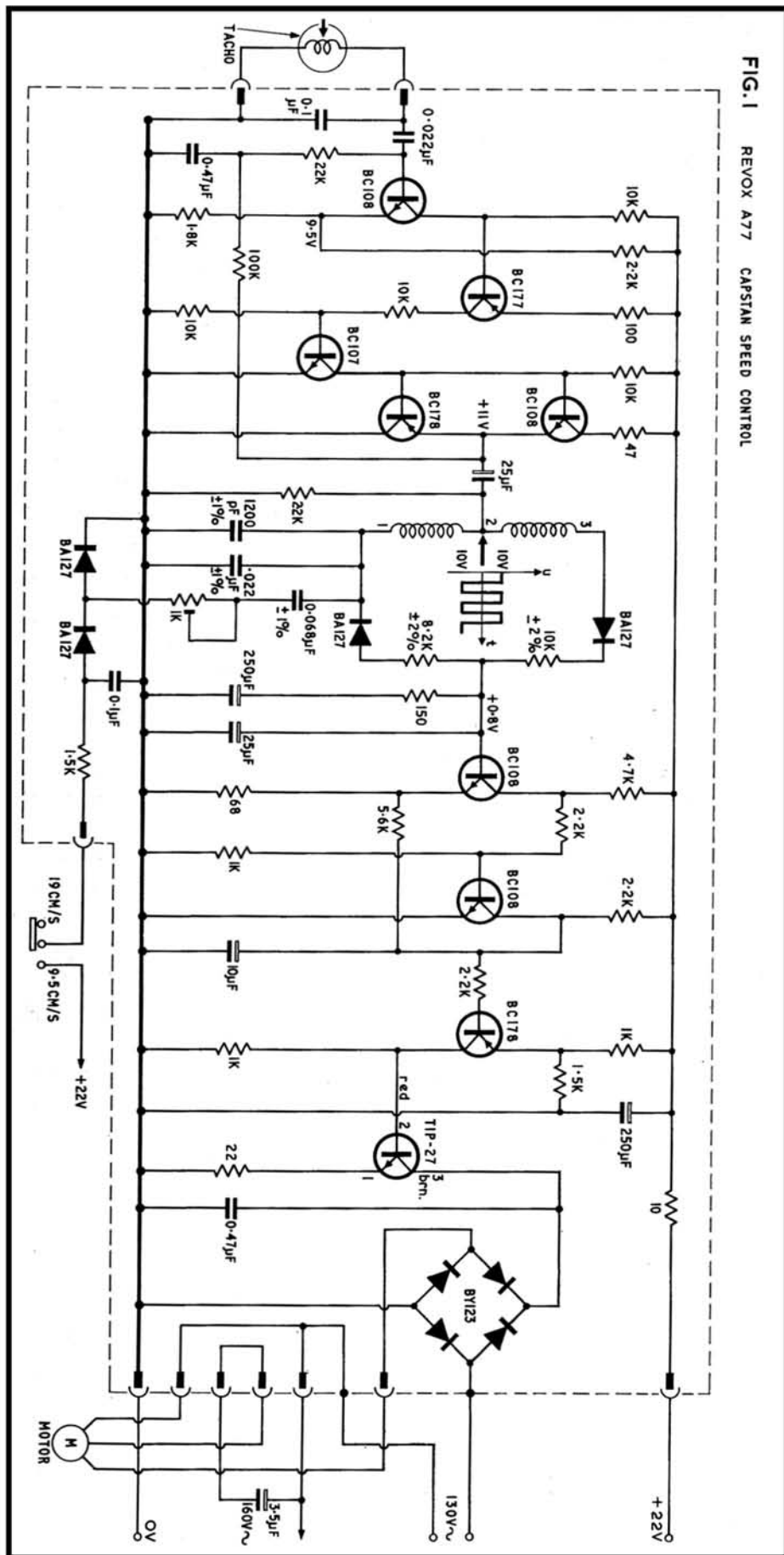

FIG. 1 REVOX A77 CAPSTAN SPEED CONTROL

Bishopsgate  
Institute

# CITY TAPE RECORDER CENTRE

BISHOPSGATE

Liverpool Street Station

**228 BISHOPSGATE  
LONDON, E.C.2.**

Tel. BISHopsgate 2609

Opposite Liverpool Street Station

Hours of Business :

MONDAY to FRIDAY

9 a.m. to 6 p.m.

Closed all day Saturday

**OPEN  
SUNDAY**

10 a.m. to 2 p.m.

Part of the NuSound organisation

At the City Tape Recorder Centre you can see one of the finest selections of tape recorders on display in London. Every leading make and model from Akai to Vortexion.

Many Special Offers of brand new 1968 models showing dramatic savings on the manufacturer's list prices! A wonderful selection of secondhand and shopsoiled models with savings up to 50%.

We are easy to get to being almost opposite Liverpool St. Station (see diagram above) and remember we are the only tape recorder specialists in Gt. Britain open on Sunday!

Do your weekly rush shopping on Saturday with your wife and visit us on Sunday at your leisure!

- **GENEROUS PART EXCHANGES**
- **FREE AFTER SALES SERVICE**
- **UNBEATABLE SPECIAL OFFERS**
- **EXPERT STAFF EXPERT ADVICE**

WE OPERATE A PERSONAL EXPORT SCHEME—  
SAVING UP TO 20% ON LIST PRICE



Our manager Bob Hookings is a keen tape recording enthusiast. Bang & Olufsen's are his speciality, having used B. & O. equipment for several years his knowledge of this wonderful range is second to none. He is able to give personal callers his expert advice (please avoid telephoning) not only on B. & O. but on any other recorder suitable to your individual requirements and pocket.

WHEN IN THE CITY—CALL IN AT THE CITY!

THE BANG & OLUFSEN SPECIALISTS



## SPECIAL BARGAIN OFFER

SONOTONE SOLENT HI-FI  
BOOKCASE SPEAKERS

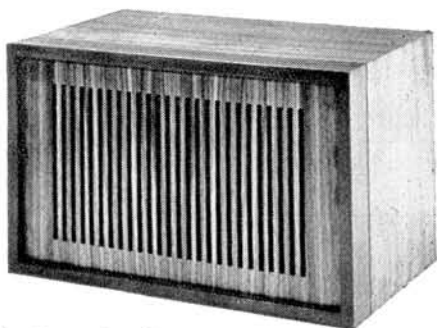

- Scandinavian style cabinet.
- 4 to 8  $\Omega$  impedance. 12 W. input.
- Suitable for valve or transistor amplifiers.
- Can be connected direct to tape recorder.
- Frequency response, 40 c/s to 20 Kc/s.
- Tested by Which magazine.
- Small attractive size, 14 x 9 x 8½ in.
- On permanent demonstration.
- Reviewed by Hi-Fi News, Gramophone and Audio Record Review.
- List Price now £18.10.0.

SPECIAL OFFER £11.10.0 plus p.p. 10/- or 12/6 C.O.D.

**LEE ELECTRONICS**

400 EDGWARE RD., W.2. PADDINGTON 5521

Closed for annual holidays 7th August-6th September inclusive.  
Mail order goods not affected dispatched as usual.

## NEW TAPE RECORDERS

at pre-devaluation and pre-budget prices.

Truvox	...	...	R102	93	9	0
Philips	...	...	EL3301	24	3	0
		(with speakers)	3312A	57	15	0
			3302	24	3	0
AKAI	...	...	910	65	2	0
			1710	89	10	0
			M8	131	5	0
			M9	159	0	0
			X300	194	5	0
		Speakers	SW130	30	0	0
Sharp	...	...	ORD501	34	13	0
				less 15%		
Hitachi Levelmatic	...	...		26	5	0
				less 20%		
Ferrograph	...	...	631	99	15	0
				less 10%		
Grundig	...	...	120	30	19	6
			125	41	9	6
			140	39	18	6
			140E	39	18	6

**BURGESS AT THE CLOCKTOWER, GRAVESEND**

Est. over 37 years  
Telephone Gravesend 2748

instant, fell below its nominal figure, and then returned to 1600. My attention was drawn to a tachometer head mounted just out of contact with a band of teeth indented in the periphery of the external rotor (fig. 1). The head supplies a signal of varying frequency to a control circuit (also visible) which endeavours to correct any variations in motor speed.

The three stages of this circuit are visible in fig. 2, the first being a limiter to compensate for variations in signal from the pick-up head. Such variations may result from changes in grain orientation, which occur during each revolution of the stamped rotor. Variations in frequency are also subject to the 6 dB/octave effect if this is relevant. After limiting, the tachometer signal is passed to a discriminator where changes in frequency are turned into converse voltage changes—as the frequency rises beyond that to which the circuit is tuned, so the voltage falls. The final stage is a DC amplifier which boosts these small correction voltages and imposes them on the main 130 V supply.

Motor and control circuit together are similar in price to the Papst capstan drive incorporated in the 736—in the region of £10. It is theoretically an improvement on the Papst in terms of absolute speed accuracy, being independent both of 50 Hz flutter and mains frequency variations.

The A77 supplied for test possessed a

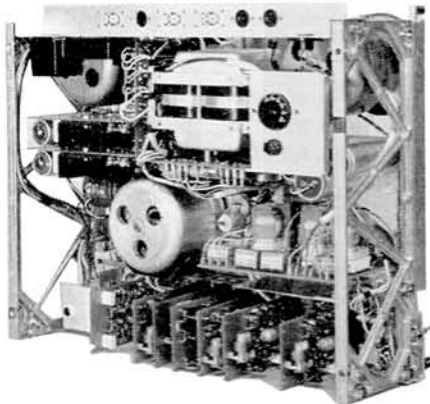

slightly eccentric pinch wheel which caused audible fluctuation of open-string guitar tones and sinewaves with certain thicknesses of tape. Although this measured only 0.06% RMS at its highest, the effect was worse than one might expect since it comprised almost entirely low frequency wow. This pair of trustworthy ears found wobble inaudible on slow orchestral and light popular music.

To see if the control circuit was capable of operating at pinch-wheel rotation frequency (a little over 3 Hz at 19 cm/s), I attempted a

small experiment at imitating the 'electronic sprocket' system employed on most rotating-head video recorders. By recording a sine-wave at the 1.6 kHz tachometer frequency, it was possible to complete the servo loop and use the tape to control its own velocity. The recording, complete with wow, was then played straight into the limiter and discriminator from the line output. Sure enough, the tape drove itself along at 19 cm/s, accelerating to an estimated 80 cm/s when the line output was turned to zero. The recorded wow remained audible at 19 cm/s, however, suggesting that the control circuit, influenced by the rotor momentum, is relatively slow acting. An academic point; the distributor would certainly have replaced the pinch wheel if requested.

Line input and output sockets are mounted in the handle recess and are quite accessible when the recorder is in a vertical position. Three pairs of Phono sockets relate to auxiliary input, line output and duplicated microphone input. A five-pin DIN socket permits two-way dubbing with other stereo recorders, radio input and line output being wired to the pins. Loudspeaker output is from two flat-and-round DIN sockets, two further multi-pin sockets being provided for full remote control and powering of external transistor devices. The internal speakers are cut out when plugs are inserted in the external sockets.

Quality from the side-facing monitors was rather poor, the two units on each channel tending to argue at mid frequencies. An enterprising owner might derive some pleasure from fitting alternative speakers; I would be interested to know the results.

The A77 is rather easier to take apart than the 736. Control knobs pull off, the plated front panel being held by two screws and four grip studs. Similar studs and screws hold the rear deck plate. At this stage, the recorder must be turned upside down and four screws removed from the cabinet base. With the remote control socket links removed, the entire mechanism and circuitry are bared. Guided by the block schematic printed in the cabinet, almost any reasonably knowledgeable owner can remove a suspect printed board

and post it to a Revox service agent. A little care is needed when replacing the cabinet to prevent the speaker leads fouling the capstan motor or protruding through the Phono socket panel. The leads are best Sellotaped to the cabinet as an insurance against further movement when the recorder is carried vertically.

Though some 10 lb lighter than the 736, the A77 is still a respectable heavyweight. Equipment of this type is safer carried on the passenger seat of a car—34 lb in the boot of my Austin Cambridge being quite sufficient to cause instability. Being rather more shallow than the 736, it is fairly comfortable to carry over short distances; hauling the 736HS up a flight of stairs used to be a strenuous adventure.

Running noise is low, confined to a whistle at tachometer frequency. This was acoustic and did not filter through into the audio circuitry. There was none of the annoying rumble generated by certain other recorders, even when the A77 is placed on the 'sounding board' of a wooden audio-equipment cabinet, rumble is inaudible.

One rather noisy component, strangely, was the digit counter! The gears buzz loudly during fast wind and also occasionally jam.

Provided three precautions are taken, the A77 will never snap or badly stretch a tape. Firstly the stop button *must* be pressed before the spool motor cutout switch is switched on after editing—or the slack will snap under the force of the takeup motor. Secondly nothing thinner than DP should be used, at least on small cine spools, as the back tension causes severe stretching—whichever way the tape is threaded round the left-hand guide. I now possess several feet of Kodak Quadruple Play plastic string, originally a tape recording of *The Hound of the Baskervilles*. Thirdly, the fast left-wind button should be pressed to slow a tape being wound to the right (and vice versa) so that the tape is stationary *before* the stop button is pressed. (This is also a worthwhile tip for 736 owners.) The A77 then becomes the gentlest mechanism on the market

The measured noise level (-62 dB on bulk erased tape and -61 dB under normal conditions—June *Equipment Reviews*) was astonishingly low, probably due to the lack of hum in the system. A little tape hiss remains and could probably be removed entirely by increasing the bias current, at the expense of the 4 dB upward slope in frequency response between 4 kHz and 20 kHz (BASF LGS35 LP tape, record/play). Tape noise can be made inaudible on equipment well within a 60 dB signal-to-noise ratio, under domestic 'mid-fi' conditions.

Concluding these rather rambling impressions, I consider the A77 to be an improvement on the 736 though the difference in performance alone would not make me sell the predecessor if I possessed one. Styling and handling are certainly superior, however, the pinch-wheel and power amplifier faults being merely teething troubles. Quality at 19 cm/s is good but gives no cause to abandon 38 cm/s for serious live recording. I am now saving my pennies in the hope that the next few months will see a high-speed version of this superb design.

# Have you noticed it too?

With so many shops to choose from, there must be excellent reasons why people prefer to buy more and more from **Francis of Streatham**. Perhaps you would care to find out by calling or writing to us about your requirements in tape and hi-fi equipment too. (S.a.e. with written enquiries please.)

## EVERYTHING IN RECORDERS AND HI-FI ON THE BEST OF TERMS

- ★ VERY LARGE STOCKS OF EQUIPMENT AND ACCESSORIES
- ★ NO EXTRA FOR CREDIT UP TO 18 MONTHS
- ★ FREE SERVICE DURING GUARANTEE PERIOD—OWN SERVICE DEPT.

We are **TANDBERG** specialists and carry full stocks of these famous products.

Also **FERROGRAPH, VORTEXION, AKAI, PHILIPS, ETC., ETC.**

**FOR A FAIR and DEPENDABLE DEAL—BUY IT FROM**

**SPECIAL OFFER OF WORLD FAMOUS 'SHAMROCK' TAPE**  
Brand new, top quality polyester.  
2400', 7" reel ... 25/-  
1800', 7" ... 21/-  
1200', 7" or 5½" or 5" ... 15/-  
900', 5" ... 12/6  
600', 5" ... 10/-  
P. and P. 1/6 per reel. Orders over £3 post free. Cash with order please.

# FRANCIS OF STREATHAM

169-173 STREATHAM HIGH ROAD, LONDON, S.W.16

Between St. Leonard's Church and Streatham Station

Phone: 01-769 0466: 01-769 0192

Please note our only address Free Car Park, Prentis Road nearby  
**OPEN ALL DAY SATURDAY—EARLY CLOSING WEDNESDAY**

We are happy to announce that we can now supply

## BRAND NEW BRITISH & GERMAN RECORDING TAPES

P.V.C. POLYESTER & MYLAR  
(ALSO PRE-RECORDED FOREIGN LANGUAGES)  
RECORDED ON SCOTCH and EMI TAPE

Both manufactured by world reputable British and German firms. Fitted with leaders and stop foils. Not rejects or sub-standard in any way—tapes are splice free and are boxed. Remember: full refund plus postage should goods not meet with your full approval.

Standard Play	Length	English price	German price
3"	150'	2/6	2/-
4"	300'	4/-	3/6
5"	600'	9/-	6/6
5½"	900'	11/6	8/-
7"	1200'	16/-	10/-
Long Play	Length	English price	German price
3"	220'	3/-	2/6
4"	450'	6/-	5/-
5"	900'	11/6	9/-
5½"	1200'	16/-	10/6
7"	1800'	23/-	14/-
Double Play	Length	English price	German price
3"	400'	6/-	4/-
4"	600'	8/6	7/-
5"	1200'	21/-	13/-
5½"	1800'	24/-	17/-
7"	2400'	39/-	22/-

**LEARN FOREIGN LANGUAGES** the easy way from **BRAND NEW PRE-RECORDED TAPES** in **GERMAN, FRENCH, SPANISH and ITALIAN**. 26 step-by-step easy lessons on each tape recorded at 3½ i.p.s. supplied complete with Handbook. Retail 59/6 each. **OUR PRICE 19/6 each.**  
Postage and packing 1/9 per order.

EMPTY SPOOLS: 3" 9d. 5" 2/-, 5½" 2/3. 7" 2/6.

**N. WALKER Ltd.**

28 Linkscroft Ave., Ashford, Middx.

Phone: 53020

## YOU CAN HAVE GOOD SOUND EQUIPMENT

if you choose



Grampian Reproducers Ltd. Hanworth Trading Estate, Feltham, Middlesex

WE SPECIALISE IN BRAND NEW

### TOP QUALITY BRITISH P.V.C. MYLAR & POLYESTER RECORDING TAPES WITH FITTED LEADERS, Etc., EX 3"

Thanks to bulk purchase we can offer tensilised **HI-FI** tapes, manufactured by a **British** firm of world repute. All boxed individually (sealed if required) in polythene. Our tapes are not to be confused with imported sub-standard or used tapes. Full-money refund if not delighted.

This month: "DRY SPLICE" (3/9) given FREE with every order.

Std.	L.P.	D.P.	Boxed empty sps
Length ea. 3 for	Length ea. 3 for	Length ea. 3 for	
3" 150' 2/- 5/9	3" 220' 2/6 7/-	3" 400' 4/6 13/-	3" 7d.
4" 300' 4/- 10/-	4" 450' 5/- 14/-	4" 600' 6/9 19/6	4" 1/8
5" 600' 6/- 17/6	5" 900' 8/- 23/6	5" 1200' 12/6 37/-	5" 1/9
5½" 900' 7/- 20/6	5½" 1200' 10/6 30/6	5½" 1800' 17/- 50/-	5½" 1/9
7" 1200' 9/- 25/6	7" 1800' 13/- 38/6	7" 2400' 21/- 61/-	7" 2/-

All orders despatched by return. Postage and Packing 1/9 per order.

**STARMAN TAPES, 421 Staines Road, Bedfont, Middlesex**

## OPENING the BIBLE

by Stuart Allen

Principal of Wilson Street Chapel, London E.C.2.

(Non-denominational)

A series of **HALF-HOUR TAPE RECORDED ADDRESSES** at 1½ ips, 4 track, on 5 inch spools. The first twelve addresses are available for £1 from:—

**Mr. B. MARPLE (HFN), 20 Powley Gardens, Littleover, DERBY. DE3 7GF**

Money refunded if not satisfactory

for the best bargains read

THE **EXCHANGE & MART** 8d  
EVERY THURSDAY

Britain's bargain weekly

# equipment reviews

## GRUNDIG TKI45

**MANUFACTURER'S SPECIFICATION.** Auto/manual 4-track tape recorder. **Tape Speed:** 9.5 cm/s. **Frequency Range:** 40 Hz—12 kHz. **Signal-to-noise ratio:** 50 dB. **Spool capacity:** 14.5 cm. **Input:** 2—100 mV at 1.5 M. **Outputs:** 500 mV at 15 K (line) and 2.5 W at 5 ohms (speaker). **Dimensions:** 39 x 29 x 18 cm. **Weight:** 19 lb. **Manufacturer:** Grundig (Great Britain) Ltd., Newlands Park, Sydenham, London S.E.26. **Price:** £53 11s., including purchase tax.

A PARTICULAR feature of this family type recorder is the Grundig *Easy G* Control. This may sound rather like a wild west ranch—but is in fact a very simple tape motion rotary control. From the 'stop' position it is turned one step anti-clockwise for fast rewind: one step clockwise for pause, a further step clockwise for start (normal 9.5 cm/s tape transport), and finally through a momentary stop to the fast forward wind position.

The record control is almost equally ingenious. It is primarily a record push button which is locked down when the main control is in the pause or start position. It is spring loaded in the 'automatic music' position but can be turned against the weak spring to a 'speech' position with a shorter AGC time constant, or clockwise for 'manual' or 'trick' recording. A pair of edge type volume and tone controls complete the main panel, track selector buttons are mounted on the head cover.

The four digit tape position indicator is driven from the right-hand (take-up) spool carrier and clocks up 7 digits for every 10 turns of the reel.

A 900 ft. reel of LP tape was wound or rewound in 3 minutes 20 seconds.

A slight capstan wow at approximately 6 cycles per second was audible on sustained tone and can just be seen on the limited bandwidth wow pen trace at 0.08% rms. Opening the bandwidth to 200 Hz disclosed a heavy high frequency flutter with frequency components well above the pen recorder frequency limit of 100 Hz; cumulative wow and flutter readings ranged from 0.18% to 0.22% as the various components came in and out of step. A steady reading of .2% was obtained from the low wow and flutter test tape with wow at 0.07%. The tape path was cleaned but the high frequency flutter persisted on several samples of tape, and it seems obvious that it is a friction effect, probably due to the pressure pad mounting, although I did not investigate further by removing the top plate and head cover. I should perhaps explain that the ear is not at all sensitive to such very high frequency flutter but it does give a slight roughness to the high frequency sound.

The play only response to line output from a standard 140µS 3½ i/s test tape gives the curve of fig. 2. The 3 dB step in response indicates that the playback equalisation is to the NAB 90 µS characteristic. System

(continued overleaf)

FIG. 1 GRUNDIG TKI45 WOW AND FLUTTER (9.5CM/S)

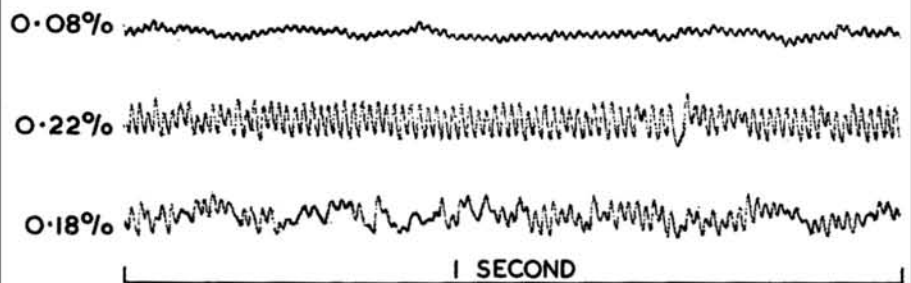

FIG. 2 GRUNDIG TKI45 PLAY-ONLY RESPONSE (TEST TAPE TO LINE OUTPUT)

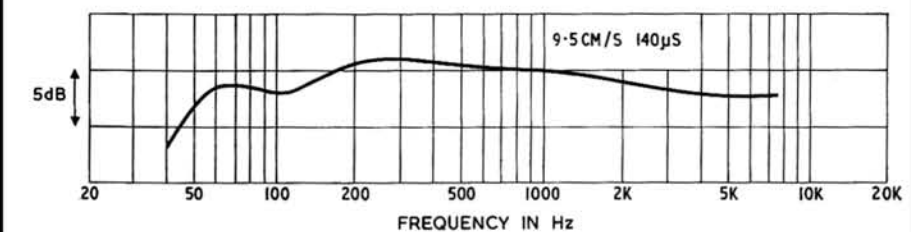

FIG. 3 GRUNDIG TKI45 RECORD/PLAY RESPONSE (LINE IN TO LINE OUTPUT)

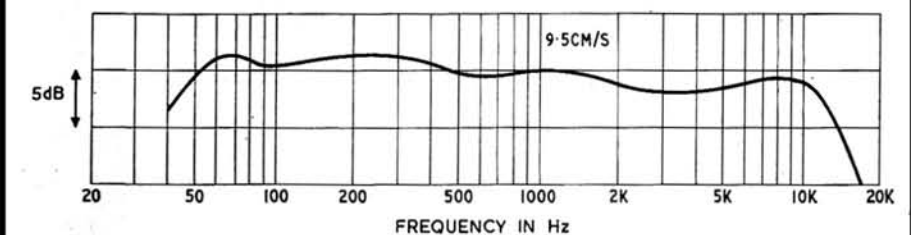

FIG. 4 GRUNDIG TKI45 ACOUSTIC RESPONSE (WHITE NOISE ON SPEAKER AXIS)

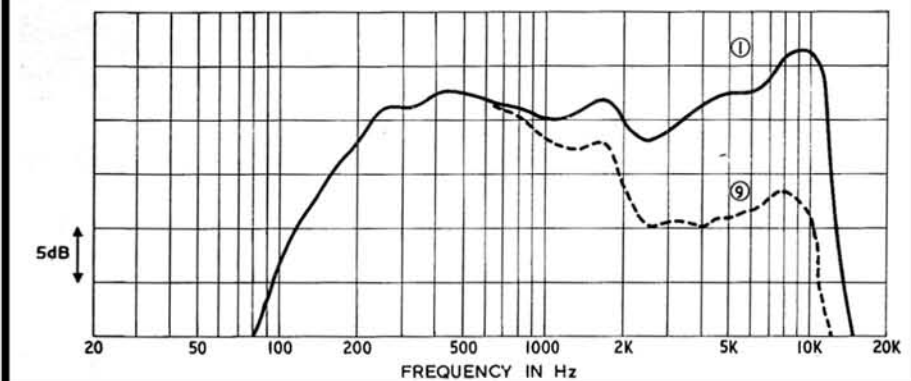
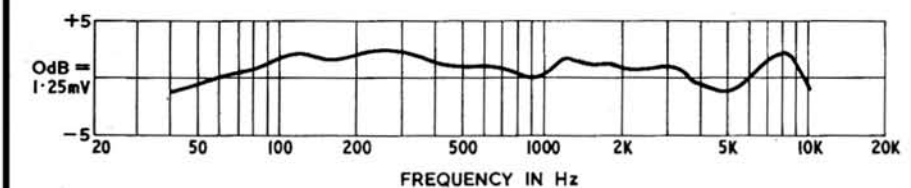

FIG. 5 GRUNDIG GDM 312 MICROPHONE (HIGH-Z)



## Your Tape Dealer

LONDON AREA

FOR ALL LEADING  
AUDIO EQUIPMENT

**hifi**

Classical Records  
by Mail Service

hampstead

**HIGH FIDELITY**

91a Heath Street,  
Hampstead, N.W.3.  
Tel. HAMpstead 6377

**HAVEN**  
196-198 SOUTH EALING RD.  
**HI-FI** LONDON  
W.5  
Tel. 01-560 0194

**LASKY'S  
RADIO**

Stockists for all the leading makes of Tape Equipment

207 EDGWARE ROAD, W.2. Tel.: PAD 3271  
118 EDGWARE ROAD, W.2. Tel.: PAD 9789  
33 TOTTENHAM CT. RD., W.1. Tel.: MUS 2605  
42 TOTTENHAM CT. RD., W.1. Tel.: LAN 2573  
152/3 FLEET STREET, E.C.4. Tel.: FLE 2833

**TAPE RECORDER HI-FI CENTRE  
(SHEEN) LTD**

SPECIALISTS IN TAPE RECORDERS, ACCESSORIES,  
HI-FI EQUIPMENT

YOUR CENTRE FOR FRIENDLY HELP, SALES AND  
SERVICE

3 & 4 STATION PARADE, Open until 8 p.m. on Fridays  
SHEEN LANE, SHEEN, PROSPECT 0985  
LONDON, S.W.14 Opposite Mortlake Station, S.R.

CHESHIRE

go scandinavian hi-fi . . .

Bang & Olufsen, Tandberg, Arena, Dynatron, Radford,  
Sony, Philips, Quad, Leak, Fisher, Sanyo, Pioneer, Akai,  
Sansui, Wharfedale, Armstrong, Rogers, Ferrograph,  
Bryan, Normende, Eddystone, etc.

the hi-fi and tape recorder lounge

● EXPERT STAFF ● ADVICE SERVICE ● PART EXCHANGE  
● FULL AFTER-SALES SERVICE ● DEMONSTRATIONS DAILY

GREEN LANE, WILMSLOW, CHESHIRE  
For personal attention ring Wilmslow 24766  
and ask for Mr. Bird

FOR ALL YOUR REQUIREMENTS . . .

**CHARLESWORTH'S**  
OF CREWE LTD.

Head Office : 14 Hightown, Crewe. Tel: 3327

Hi-Fi CENTRE: 28 HIGHTOWN, CREWE

Technical Division : 19 Ludford Street, Crewe

## Your Tape Dealer

DEVON

THE SOUTH WEST

**Tom Molland Ltd.**

Invite you to visit their well-equipped  
Demonstration Theatre and compare all  
the leading makes of Hi-Fi and Tape  
Equipment at

110 CORNWALL STREET, PLYMOUTH

Telephone 69285

Immediate delivery to ALL Areas

ESSEX

EPPING — ESSEX  
CHEW & OSBORNE LTD.  
148 HIGH ST. TEL: 4242

AKAI—AMPEX—ARENA—ARMSTRONG—AUDIO  
TECHNICA—B & O—BRYAN—CELESTION  
FERROGRAPH—FISHER—GARRARD—GOLDRING  
GOODMANS—HACKER—KEF—LEAK—LOWTHER  
PHILIPS—QUAD—RADFORD—REVOX—ROGERS  
SHURE—SONY—THORENS—TRUVOX  
WHARFEDALE—WYNDSOR  
Home and Showroom Demonstrations:  
After Sales Service—H.P. Facilities  
Equipment and Records by post

GLOUCESTERSHIRE

**Sound  
Selection**  
OF BRISTOL

Tape Recorder and Hi-Fi  
Specialists (Demonstration Room)

361-363 GLOUCESTER ROAD,  
BRISTOL 7. Tel. 41181

**REVOX  
SPECIALIST**

HAMPSHIRE

**High Fidelity  
Specialists**

*Hamilton Electronics* **HE**

Hamilton Electronics (Southampton) Ltd.  
35 London Road, Southampton. Phone: 28622 3Lines

FORRESTER'S

**NATIONAL RADIO  
SUPPLIES LTD.**

70-72 HOLDENHURST ROAD  
BOURNEMOUTH HANTS

Largest hi-fi and radio component  
store in the south Tel: 25232

HERTFORDSHIRE

WATFORD

High Fidelity Centre

at **RADIOLUX Ltd.**

36 WOODLANDS PARADE, HIGH ST.

WATFORD (opposite the pond)

WATFORD 29734, 41029

IF IT'S GOOD—WE STOCK IT!

Demonstrations in our Stereo Theatre. Also home  
demonstrations with no obligation.

GRUNDIG TK145 CONTINUED

noise with no tape passing the heads was  
36 dB below test tape level.

Fig. 3 shows the overall record replay  
response to line output which is within  $\pm 2$ dB  
limits from 45 Hz—12 kHz.

The overload characteristic of the recorder  
was checked on the 'manual' setting at 500  
Hz and third harmonic distortion at 12 dB  
above reference tape level was 3.5%. Tests  
at 1 kHz and 3 kHz gave distortion readings  
of 3% and 3.2% but these are slightly suspect  
as the high frequency flutter made accurate  
readings difficult. Similar distortion readings  
were obtained on 'auto' gain setting with  
input signals 20 dB above normal level.

The time constant, or recovery time, of the  
AGC circuit was measured by applying a  
10 dB one second overload and measuring  
the time it took the circuit to recover to full  
gain. On the 'music' setting the gain was  
within 3 dB of normal after 2.5 minutes, and  
reached full gain after 3.5 minutes. On  
'speech' the time constant was much shorter,  
with recovery time to full gain less than 20  
seconds, and within 3 dB of maximum at  
about 12 seconds.

Unweighted signal-to-noise ratio, after  
erasing peak level 500 Hz signal, was 45 dB  
and machine erased tape hiss, via a 250 Hz  
high pass filter to remove mains hum, was  
51 dB below peak recording level.

The overall acoustic response was measured  
by recording 25 one-third octave bands of  
filtered white noise and measuring the sound  
output at a distance of 1 ft. on the speaker  
axis to give the curves of fig. 4. The dotted  
curve shows the response with the tone control  
advanced fully to a reading of 9. The solid  
line response is that obtained with maximum  
treble with the tone control at 1. Response  
is smooth and well maintained over the range  
200 Hz—12 kHz and this was confirmed by  
listening tests on a wide range of programme  
material.

Speech quality on the microphone supplied  
with the machine was exceptionally smooth  
and sweet, and white noise measurements on  
this microphone produced the excellent  
response of fig. 5. I thought the response  
looked vaguely familiar and a search through  
earlier reviews disclosed curves so similar  
that I suspect they come from a common  
source. I offer no prizes for the solution to  
this riddle!

Grundig are to be congratulated on pro-  
ducing a near perfect specimen of a good  
quality general purpose domestic recorder.

A. Tutchings.





**AMPEX 753  
STEREO  
TAPE UNIT**

**MANUFACTURER'S SPECIFICATION** (19 cm/s). Quarter-track stereo tape unit with record and play preamplifiers. **Wow and flutter:** 0.15% RMS. **Frequency Response:** 40 Hz—15 kHz  $\pm 3$  dB. **Signal-to-noise ratio:** 46 dB (unweighted). **Speed accuracy:**  $\pm 1\%$ . **Inputs:** 35—900 mV at 330 K (line), 1.2—30 mV at 110 K (microphone). **Output:** 2.5 V at 10 K. **Tape Speeds:** 19, 9.5 and 4.75 cm/s. **Dimensions:** 41 x 33 x 19 cm. **Weight:** 27lb. **Manufacturer:** Ampex Corporation, Redwood City, California, USA. **Distributor:** Ampex Great Britain Ltd., Acre Road, Reading, Berkshire. **Price:** £9511s.

**T**HE mechanical design of the 753 is similar to the Ampex machines reviewed in January and February 1966. Space has been saved by mounting the twin VU-meters to the left of the head assembly, and the record keys, microphone jacks and equaliser switch on the right side. A shallow panel below the deck carries two multifunction controls. The left one combines the main on/off switch with coaxial top and bottom channel record level controls, and the right hand skirt operates a six-way function switch giving: *Stereo Tape, Input Monitor, Mono 1, Mono 2, 1 on 2 and 2 on 1*. The upper knob controls echo and track to track transfer.

The three digit tape position indicator is driven from the supply reel and gives a reading of 6 digits for every ten spool revolutions.

An 18 cm reel of LP tape is fast wound or rewound in 2 minutes 55 secs.

**SHORT TERM SPEED**

The short term speed fluctuations are mainly at motor rotation frequency of 25 cycles per second (1500 r.p.m.) indicating a slight unbalance or eccentricity of the motor spindle. The top trace of fig. 1 shows the very slight 25 Hz flutter when the record and play flutters are in step. The lower trace of the 19 cm/s fluttergram shows near cancellation. 200 Hz bandwidth wow and flutter readings are 0.05% and 0.04% respectively.

At 9.5 cm/s the 25 cycle flutter is more obvious and there is evidence of a 2 Hz wow from  
(continued overleaf)

**FIG. 1** AMPEX 753 RECORD / PLAY WOBBLE

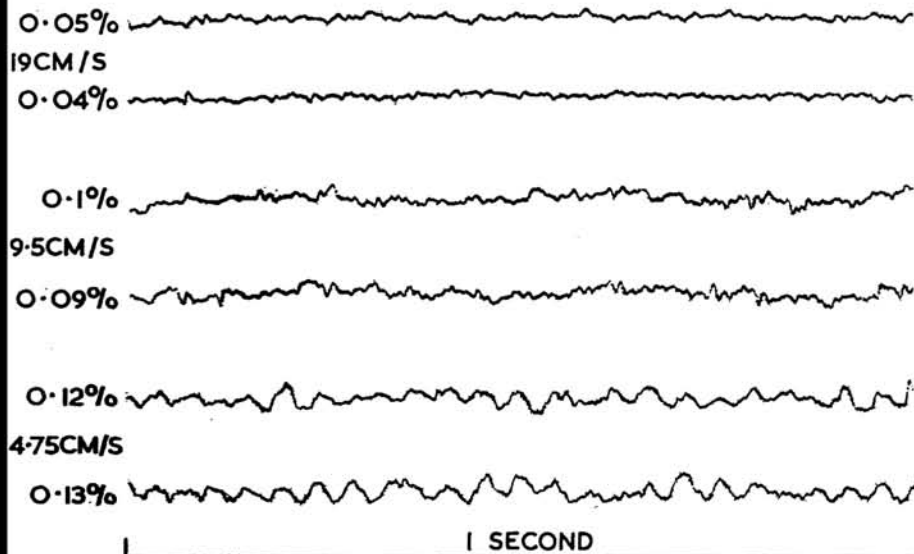

PLAY ONLY TESTS ON LOW WOW AND FLUTTER TEST TAPES

19CM/S	WOW 0.025%	9.5CM/S	WOW 0.06%	4.75CM/S	WOW 0.09%
	W + F 0.5%		W + F 0.08%		W + F 0.12%

**FIG. 2** AMPEX 753 PLAY-ONLY RESPONSE (TEST TAPE TO LINE OUTPUT)

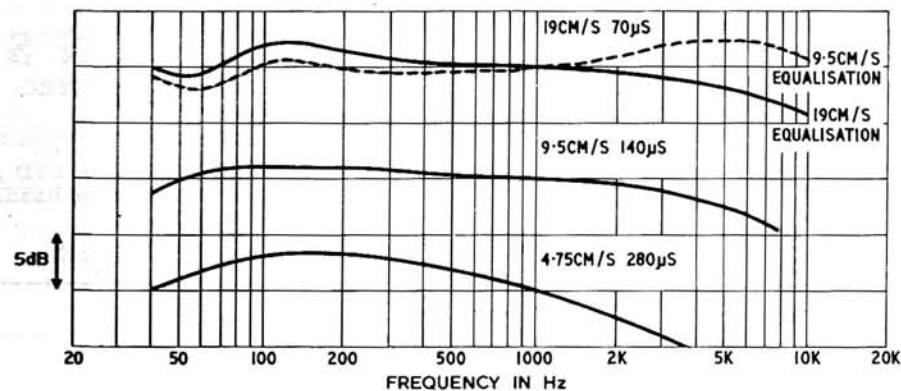

**FIG. 3** AMPEX 753 RECORD / PLAY RESPONSE (LINE IN TO LINE OUTPUT)

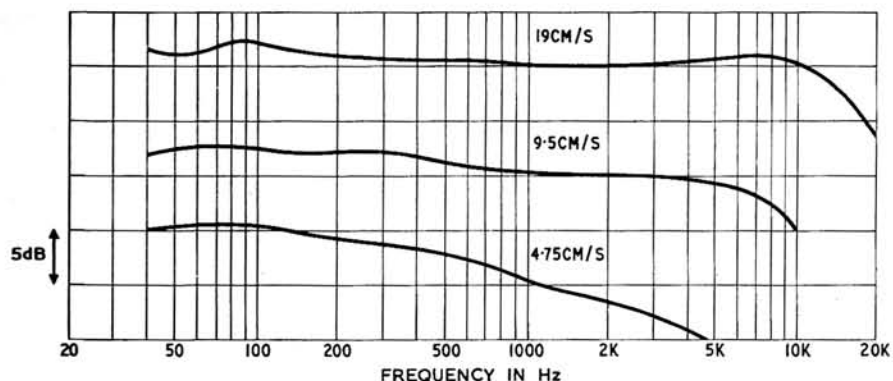

## Your Tape Dealer

LANCASHIRE

STOCKPORT AUDIO CENTRE  
FINEST IN NORTH WEST



★ ALL MODELS ON COMPARISON DEMONSTRATION  
★ EVENING DEMONSTRATIONS BY APPOINTMENT

FAIRBOTHAM & CO. LTD.,  
58-62 Lower Hillgate, STO 4872

## BOLTON

Specialists in  
High Fidelity Sound

H. D. KIRK

**Stereolectrics**  
LIMITED

203 St. George's Road  
Phone 23093

BOLTON

## J. SMITH & SON

HI-FI EQUIPMENT — STEREOGRAMS  
TAPE RECORDERS — 2 SHOWROOMS  
B. & O. Dynatron, Hacker, Quad, Leak, Radford,  
Armstrong, Ferrograph, Revox, Truvox, Uher,  
Decca, Garrard, Thorens, Goodmans, KEF, etc.  
Comparator Demos — Closed all Tuesday  
Specialists in 'SOUND' for 36 years

184 THE ROCK, BURY Tel: 1242

## ST. HELENS

### HAROLD STOTT LTD.

Hi-Fi Consultant

Tape Recorder Specialist. Agents  
for all leading makes including Akai,  
B & O, Revox, Sony, etc. Advice and  
demonstrations given willingly.

18 Westfield Street, St. Helens

## NORTHUMBERLAND

### SOUND EQUIPMENT SPECIALISTS



**Morton  
sound** Tel. 2-6902  
20142

12 OXFORD STREET  
NEWCASTLE UPON TYNE 1

## NOTTINGHAMSHIRE

### Nottingham Tape Recorder Ltd.

BURTON ST. 2 mins. Victoria Station

Specialists in all the best makes of

- TAPE RECORDERS ● AMPLIFIERS ●
- HI-FI DISC EQUIPMENT ●

Telephone: Nottingham 45222

## Your Tape Dealer

OXFORDSHIRE

# Westwoods

for the

## TAPE RECORDER

of your choice

46 George Street

Oxford 47783

## SHROPSHIRE

### SHREWSBURY'S NEW SOUND CENTRE

Ferrograph-Leak-Akai-Rogers-Goodman etc.  
HEAR THEM IN OUR DEMONSTRATION STUDIO

OPEN ALL DAY  
TUESDAY-SATURDAY



**AVON Hi-Fi Ltd.**  
13 WYLE COP.  
Tel. 55166 (facing the famous Lion Hotel)

## SURREY

FARNHAM

SURREY

- ★ Stockists of all good Hi-Fi apparatus.
- ★ Comparative Demonstrations.
- ★ We offer a real after sales service.
- ★ Easiest of terms.
- ★ No parking problems.

### Lloyd & Keyworth Ltd.

THE RECORD SHOP

26-27 DOWNING STREET, FARNHAM  
SURREY Telephone: Farnham 5534  
SURREY AND HAMPSHIRE'S HI-FI SPECIALISTS

## CROYDON'S

TAPE RECORDER CENTRE

All leading makes in stock, Hi-Fi equipment, cabinets, etc. Service agents for AKAI Tape Recorders

**SPALDING ELECTRICAL LTD.,**  
352/354 Lower Addiscombe Road,  
CROYDON.

ADDIscombe 1231/2040

## SUSSEX

WORTHING, SUSSEX

Stocking Ferrograph, Revox, Sony,  
Tandberg, Truvox, Philips, EMI, Luxor,  
etc., on fully comparative Demonstration.

**BOWERS & WILKINS LTD.**

1 Becket Bldgs., Littlehampton Road,  
Worthing 5142

## WARWICKSHIRE

### BIRMINGHAM TAPE RECORDER CENTRE

266 BROAD STREET, BIRMINGHAM 1  
(Opposite Bingley Hall)

Most leading makes high fidelity equipment.  
Part exchanges welcomed.

Telephone Midland 2680

## AMPEX 753 REVIEW CONTINUED

one of the twin capstan pressure rollers, readings are 0.1% and 0.09%.

At 4.75 cm/s the 25 cycle flutter can be heard on a sustained tone or chord together with a one cycle wow from the pressure roller, which happens to coincide with our one second pen trace frequency.

High frequency friction flutter is low at all speeds due to the smooth heads and guides and the absence of pressure pads.

The small panel of fig. 1 shows the play-only wow and flutter at each speed as measured on low wow and flutter test tapes. These readings are close to the mean of the cumulative wow and flutter shown in the pen recordings and are an indication of the speed disturbances to be expected on good quality pre-recorded tapes.

The play only responses from standard test tapes are shown in fig. 2. As the equalisation is not linked to the tape speed switch, it is possible to obtain some measure of tone control at 19 cm/s by switching the equalisation to the low speed position as shown by the dotted line on the 19 cm/s response. The Ampex playback equalisations are close to the NAB 50 and 90  $\mu$ S time constants with a slight roll-off of extreme high frequencies which are equalised by extra pre-emphasis in the recording characteristic.

System noise with no tape passing the heads was 40 dB below test tape level.

Overall record play responses are shown in fig. 3. It will be seen that extra bass and treble lift during recording have extended the 19 and 9.5 cm/s responses to the specified limits of 40 Hz to 15 kHz and 7.5 kHz respectively within  $\pm 3$  dB, but that the 4.75 cm/s record play response is similar to the play only response indicating that no effort has been made to provide proper equalisation at this speed.

## OVERLOAD TESTS

Overload recording tests at 500 Hz, at 12 dB above reference tape level (10mM/mm), showed third harmonic distortion of 2.5% and further tests at 1 kHz and 3 kHz gave distortions of 2.3% and 2.7% respectively. Similar tests at 9.5 cm/s gave readings of 2.5%, 2.5% and 3% at the three test frequencies. These peak recording levels correspond to VU meter readings of +2 dB with test tape or reference tape level at -10 dB on the meters. The tape used for these tests was BASF LGS35 LP.

Peak recording level erased on the machine gave an unweighted signal-to-noise ratio of 50 dB at 19 cm/s and 48 dB at 9.5 cm/s. Tape hiss, measured through a 250 Hz high pass filter to eliminate hum and low frequency noise, was -58 dB and bulk erased tape hiss was just -60 dB.

## COMMENT

Although designed for horizontal or vertical operation, it cannot in fact be used in the horizontal position with any kind of phono plugs in the rear panel as they foul the table or bench before the rubber feet make contact.

The tape motion controls have a slightly rough feel about them, and it seems a pity that rewind could not be a single finger opera-



tion instead of fast forward wind; to rewind one has to pull the rather tiny central lever over to the left before operating the wind control.

Technically the performance at the two higher speeds is above reproach and the combination of separate record and play heads, low distortion and Ampex equalisation seems to give a subjective impression of an even wider dynamic range than that suggested by the excellent test figures. A. Tutchings.

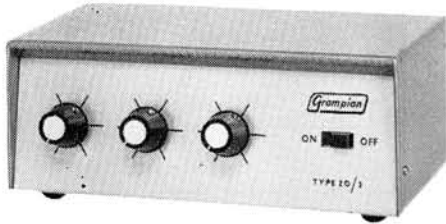

## GRAMPIAN 20/3 MIXER

**MANUFACTURER'S SPECIFICATION.** Three-channel mixer for high impedance microphones. **Input impedance:** 150 K. **Output impedance:** 10 K. **Gain:** 18 dB. **Frequency response:** 20 Hz-20 kHz. **Power Supply:** Internal 1.5 V cell. **Dimensions:** 16.5 x 11 x 6.5 cm. **Price:** £10 10s. **Manufacturer:** Gramplan Reproducers Ltd., Hanworth Trading Estate, Feltham, Middlesex.

THE photograph and the circuit diagram of fig. 1 tell most of the story of the Gramplan 20/3 Mixer. Each microphone is fed through a series 100 K resistor to the slider of a 500 K

screened lead terminated in a standard jack plug.

At full gain, 1 mV to either of the input jacks delivers 8 mV to the output lead. Overload of the output stage occurs at 80 mV for an input of 10 mV. Transistor noise is 0.2 mV at all settings of the input controls. Frequency response is flat over the range 50 Hz-20 kHz, and is only 3 dB down at 15 Hz and 40 kHz.

Most high impedance ribbon microphones have an output of from 1 to 1.5 mV per  $\mu$ B, and this corresponds to normal speech at a distance of 1 ft. from the microphone.

If we follow the convention used for tape recorders of a 4:1 (12 dB) mean-to-peak signal ratio, it will be seen that there is little chance of overload at this input, but the transistor noise is only 32 dB below mean signal or 44 dB below peak. The ear is particularly sensitive to hiss at this level, and it must be compared to better than 50 dB weighted signal-to-noise ratio from a good quality tape recorder. On such a recorder the mixer hiss relative to the signal is appreciably louder than the tape hiss.

If the mean input signal is increased to 2.5 mV, which is the output of most good quality high impedance moving coil microphones, the peaks just reach mixer overload and the S/N ratio is improved by 6-8 dB which brings the mixer noise down to tape level so that it does not obtrude.

### COMMENT

The margin between input transistor hiss and output transistor overload is far too narrow and the only advice I can give prospective users of this mixer is to set the recorder gain so that the mixer hiss can only just be heard under the tape noise (i.e. with all mixer controls off, set recorder gain so that

FIG. 1 GRAMPIAN 20/3 MICROPHONE MIXER

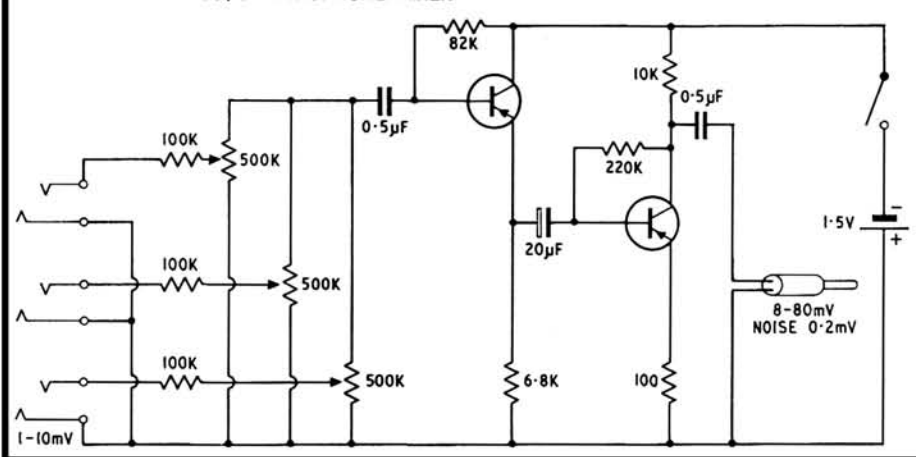

potentiometer so that the signal is earthed when the control is at zero, and most of the microphone signal is fed to the input of the transistor amplifier when the control is at maximum. The input impedance of the emitter follower input stage is about 50 K so that the mixer loss is about 3:1 or 10 dB.

The low impedance output of Tr 1 is fed to a simple earthed emitter amplifier Tr 2 and thence through a coupling capacitor to a

hiss level change is only just noticeable as the on-off switch of the mixer is operated). All changes of microphone level should then be controlled by the mixer knobs.

It should also be emphasised that the mixer overload is very much worse if the output is fed into an impedance lower than about 50 K. Thus the mixer cannot be fed directly into most transistor tape recorders.

A. Tutchings.

## Your Tape Dealer

WARWICKSHIRE (contd.)

Coventry's 100% tape recorder and hi-fi specialists for service and sales.

Akai — Ampex — Bang & Olufsen — Ferrograph — Leak — National — Radford — Revox — Sony — Tandberg — Truvox — Wyndorsor.

**Coventry Tape Recorder Service**  
33 King William Street, Coventry  
Telephone Coventry 29668

Coventry's 100% tape recorder and hi-fi specialists for service and sales.

Akai — Ampex — Bang & Olufsen — Ferrograph — Leak — National — Radford — Revox — Sony — Tandberg — Truvox — Wyndorsor.

**Coventry Tape Recorder Service**  
33 King William Street, Coventry  
Telephone Coventry 29668

YORKSHIRE

## TAPE RECORDER CENTRE (HALIFAX)

stock all the best Tape Recorders, Hi-Fi Equipment, Tape, Pre-Recorded Tapes, etc.

DEMONSTRATIONS DAILY BY EXPERT STAFF

30 King Cross Street,  
Halifax Phone 66832

SCOTLAND

GLASGOW

Scotland's Leading Tape Recorder, Video and Hi-Fi Specialists

G. H. STEELE LTD.

Hear true Hi-Fi sound on our 22 speaker comparator system. 14 Hi-Fi combinations ready for demonstration.

SONY VIDEO CENTRE  
Agents for: Armstrong, Leak, Fisher, Rogers, Quad, B & O, Goldring, Garrard, Thorens, Connoisseur, Goodmans, Wharfedale, Kef, Celestion, Decca, Truvox, Philips, Sony, Arena, Revox, Tandberg, Brenell, Ferrograph, Akai, Uher, Grundig.

CREDIT TERMS — PART EXCHANGES  
Repairs and Servicing Tel. Douglas 7124

141 St Georges Road, Glasgow C3.

## Recording Studios

**mjb** recording and transcription service

Mono and Stereo records' latest cutting methods, automatic varigroove, feedback cutter heads, limiters and equalisers, techniques hitherto available only to the professional, facilitating high undistorted cutting levels and extended playing times even from amateur recordings. Booklet available.

45 HIGH STREET  
BURNHAM  
BERKS

Tel. 1303

TAPE RECORDERS - AUDIO EQUIPMENT - DISC CUTTING STD & LP FROM TAPE - STUDIO FACILITIES HIRE SERVICE-SALES-EXCHANGES

## MAGNEGRAPH

1 Hanway Place, London, W.1. LAN 2156

# CLASSIFIED ADVERTISEMENTS

Advertisements for this section must be pre-paid. The rate is 6d. per word (private), minimum 7s. 6d., Box Nos. 1s. 6d. extra. Trade rates 9d. per word, minimum 12s., Box Nos. 2s. extra. Copy and remittance for advertisements in **SEPTEMBER 1968** issue must reach these offices by **20th JULY** addressed to: The Advertisement Manager, Tape Recorder, Link House, Dingwall Avenue, Croydon, CR9 2TA.

Replies to Box Nos. should be addressed to the Advertisement Manager, Tape Recorder, Link House, Dingwall Avenue, Croydon, CR9 2TA, and the Box No. is quoted on the outside of the envelope. The district after Box No. indicates its locality.

## SITUATIONS VACANT

**Hi-Fi and Tape Recorder salesman** required by R.E.W. (Earlsfield) Ltd. at their Tooting branch. Good pay and conditions. Apply the Manager, 266 Upper Tooting Road, London S.W.17. Tel. 01-672 9175 or 672 8267.

**Magnetic Tapes Ltd.** require young men to be trained in the various processes of manufacturing tape recorders for both industrial and commercial use. Varied and interesting work. Genuine interest in the audio field essential. Please write for appointment giving details of any previous experience. Apply to S. E. L. Collings, Magnetic Tapes Ltd. Chilton Works, Garden Road, Richmond, Surrey.

## FOR SALE—PRIVATE

National solid state tape recorder, auto reverse, 2-speed, mains and battery, complete with 4 tapes, as new, £45 o.n.o. Ring 01-642 3572.

**Akai M8** stereo complete, with Akai SS110 speakers. Price £140. 16 Changi Road, Watton, Thetford, Norfolk.

## FOR SALE—TRADE

**Blackburn** has Lancashire's leading Hi-Fidelity/Tape Recorder stockists and Electronic Engineers at Holdings Audio Centre, Mincing Lane/Derwent Street, Blackburn (Tel. 59595).

**30% off BASF Tape**—L.P. 7in. reel 1,800ft. 36/3; D.P. 7in. reel 2,400ft. 55/9; P. & P. 5/- per order. W.S.L., 104 Norwood High Street, S.E.27.

Turn your tape recorder into a powerful learning machine. Send now for Catalogue of Accessories such as Time Switches, Pillow Speakers, Special Induction Tapes for Learning and Therapy, Endless Tape Cassette Repeaters, Language Courses, G.C.E. Courses, etc. If you do not already have a tape recorder we can supply an all-British 3-speed model for only 28 gns. Credit terms available. Get with it! Take advantage of these new, simpler, faster, educational techniques. Send postcard to:—Institute of Tape Learning (TR), 153 Fellows Road, London N.W.3. 01-722 3314.

Over 20% off Philips, E.M.I., Scotch and B.A.S.F. Tape. Guaranteed top quality, factory fresh, boxed, full leaders. Send for list. Dept. T, Weasel Products, 27 Clifton Gardens, Canterbury.

## STUDIO FACILITIES

**J & B Recordings.** Tape to disc—latest high level disc cutting, all speeds. Mastering pressings, studio, mobile. 14 Willows Avenue, Morden, Surrey. MITcham 9952.

**Rapid Recording Service.** Records made from your own tapes (48-hour service). Master Discs and pressings. Recording Studio—Demo Discs. Mobile Recordings, any distance. Brochure from 21 Bishops Close, E.17.

**Your tapes to disc.** 7in. 45—18/-, 10in. L.P.—48/-, 12in. L.P.—55/-. 4-day postal service Masters and Vinylite pressings. Top professional quality. S.A.E. photo leaflet: Deroystudios, High Bank, Hawk Street, Carnforth, Lancs.

## TAPE EXCHANGE

**Your Recorder** is an electronic, mechanical marvel—use it fully through **WORLDWIDE TAPETALK**, Britain's Foremost Tape-Change, 35 The Gardens, Harrow.

**Italian owner** of extensive tape collection visiting London during autumn wishes to contact collectors using semi-professional equipment and only interested in perfect sound. Interests mainly orchestral (great performers). Box 539 (Milano).

## MISCELLANEOUS

**Repairs.** Our modern service department equipped with the latest test equipment (including a wow and flutter meter and multiplex Stereo Signal Generator) is able to repair Hi-Fi and Tape Recording equipment to manufacturer's standards. Telesonic Ltd., 92 Tottenham Court Road, London, W1. 01-636-8177.

Skilled tape recorder repairs carried out by expert personnel of many years' experience backed by extensive test equipment: Wow and flutter meter, audio valve voltmeter, audio generator, oscilloscope, etc., with final test performance figures quoted if required—Ferrograph specialists. Tape Recorder Centre, Tel-Lee-Radio, 220 The Broadway, Wimbledon, S.W.19. 01-542-4946.

Free with **Do It Yourself Gardening Annual 1968**—a packet of guaranteed-to-grow Cracker-jack African Marigold seeds. These magnificent plants have superb golden and yellow blooms 3in. to 4in. across. Other top features include: 20 ways to a better garden; Complete guide to lawns; How to cope with pests and diseases; Labelling garden plants; Easy-to-build lily pool; The rose—Queen of flowers; Gardening without soil—beginners guide to hydroponics; What's new in vegetables for 1968; Caring for house plants; 3/- from newagents or 3/11 (pp) from Link House, Dingwall Avenue, Croydon CR9 2TA.

## WANTED

**Lee Electronics.** The Tape Recorder and Hi-Fi Specialists wish to purchase good quality Tape and Hi-Fi Equipment for cash. 400 Edgware Road, W.2. Phone PAD 55291.

**Highest prices offered** for good quality Tape Recorders and Hi-Fi. R.E.W., 266 Upper Tooting Road, London S.W.17.

**GOOD QUALITY TAPE RECORDERS PURCHASED FOR CASH.** TELEPHONE 01-472 2185.

## POST THIS COUPON

### FOR A REGULAR COPY OF TAPE RECORDER

Subscription Department, TAPE RECORDER, Link House, Dingwall Avenue, Croydon, CR9 2TA.

Please send me a copy of each issue of TAPE RECORDER for ..... months commencing with the ..... issue for which I enclose remittance of £.....s.....d.

Name .....

Address .....

..... T.R.

Postal Subscription Rates :

Great Britain : Post paid for 12 months 36/-, 6 months 18/-  
Overseas : Post paid for 12 months 38/6, 6 months 19/6

# AMPEX 2163



*exclusive offer*

## THE AMPEX Model 2163 (Series 2100) SOLID STATE STEREO TAPE RECORDER

needs little or no introduction—it is almost certainly the finest semi professional recorder yet produced, even by Ampex whose reputation in the field of high fidelity tape recording is second to none.

We are justifiably proud to make this exclusive offer of the outstanding Model 2163 (post devaluation value more than £300) at almost 30% below the original list price.

**BRIEF TECHNICAL DETAILS:** Stereo/mono 4 track bi-directional recording and replay with automatic reverse ● 3 speeds— $7\frac{1}{2}$ ,  $3\frac{3}{4}$  and  $1\frac{7}{8}$  i.p.s. ● Record/replay frequency response  $7\frac{1}{2}$  i.p.s. 50-18,000 cps,  $3\frac{3}{4}$  i.p.s. 50-14,000 cps ● Mono mixer combines both inputs on one track ● Automatic tape thread ● Exclusive dual capstan drive ● Wow and flutter  $7\frac{1}{2}$  i.p.s. 0.15%,  $3\frac{3}{4}$  i.p.s. 0.2% ● Output power RMS per channel 6 W, total both channels combined 30 W ● 2 VU meters ● Fully transistorised utilising silicon transistors and tantalum capacitors ● Outputs for speakers and headphones ● Automatic tape filters ● 220/250 V. AC mains operated ● Die-cast aluminium construction portable cabinet ● Complete with dust cover and microphone ● **Original List Price £235.0.0.**

**Lasky's Price 162 gns.**

Carriage and insurance in U.K. 25/-.

H.P. Terms £42.10.6 deposit ; 12 monthly payments of £12.0.1 ; Total H.P. Price £186.11.6.

**THIS EXCLUSIVE LASKY'S OFFER IS AVAILABLE BY MAIL ORDER OR FROM OUR HI-FI CENTRES**

## Shop by appointment

In one place at one time—Lasky's Hi-Fi Sound Centres offer you the unique facility of seeing and hearing all the latest equipment by the world's leading manufacturers, together with equipment cabinets and speaker enclosures to suit every taste. Our appointments system allows you to arrange in advance the time and the place and to specify the equipment in which you are interested. Our managers, Mr. M. Rendick at 42 Tottenham Court Road and Mr. B. Whiteside at 118 Edgware Road, head an experienced staff who will give you every assistance in planning a complete system and selecting the equipment most suitable to your requirements. Home demonstrations within reasonable distance of central London can also be arranged.

If you cannot pay us a visit, please write to our senior Hi-Fi planner, Mr. B. Allen, who will be pleased to advise and give our quotation for your choice of equipment. H.P. and Credit Terms are available and we also operate the "Purchase Tax Free" plan for overseas visitors.

42 TOTTENHAM COURT ROAD, LONDON, W.1. Tel: 01-580 2573

118 EDGWARE ROAD, LONDON, W.2. Tel: 01-723 9789

Mail enquiries to Mr. B. Allen, 3-15 Cavell Street, Tower Hamlets, London, E.1.

Open all day Thursday, early closing Saturday.  
Open all day Saturday, early closing Thursday.

# Laskys

*Choice in Sound*

# Sanyo puts you in the world class



## Introducing the new MR 939 recorder with these outstanding features

- 7 watts per channel
- 4 tracks, 3 speeds
- Sound on sound
- Sound with sound
- Built-in public address system

### Tape speeds

7½ ips (19 cm/sec)

3¾ ips (9.5 cm/sec)

1½ ips (4.8 cm/sec)

### Wow and flutter

7½ ips: 0.15% R.M.S.

3¾ ips: 0.20% R.M.S.

1½ ips: 0.30% R.M.S.

### Recording time

96 min at 7½ ips  
(Stereo 1200ft. tape)

192 min at 3¾ ips  
(Stereo 1200ft. tape)

384 min at 1½ ips  
(Stereo 1200ft. tape)

Signal-to-noise ratio  
45 db

### Output power

Music power 7W x 2

Undistorted 4W x 2

### Frequency response

7½ ips 20-20,000 c/s  
(30-15kc ± 3db)

3¾ ips 30-13,000 c/s

1½ ips 30-8,000 c/s

### Erase rate

65 db

### Crosstalk

50 db (channel-channel)

65 db (track-track)

### Output impedance:

Line out: 2 Kohm

Speaker out: 8 ohm

Headphone: 10 Kohm

### Input impedance

Microphone: 50 Kohm

Aux: 100 Kohm

### Weight

26.3 lbs (16.5 kg)

### Accessories

Microphone x 2

Recording tape 7" x 1

Empty reel 7" x 1

Patch cord x 2

Reel stopper x 2

Splicing tape x 1

Microphone stand x 2

Recommended retail price £110.

# SANYO

RELIABILITY IS BUILT IN