

MARCH 1965 TWO SHILLINGS

tape recorder

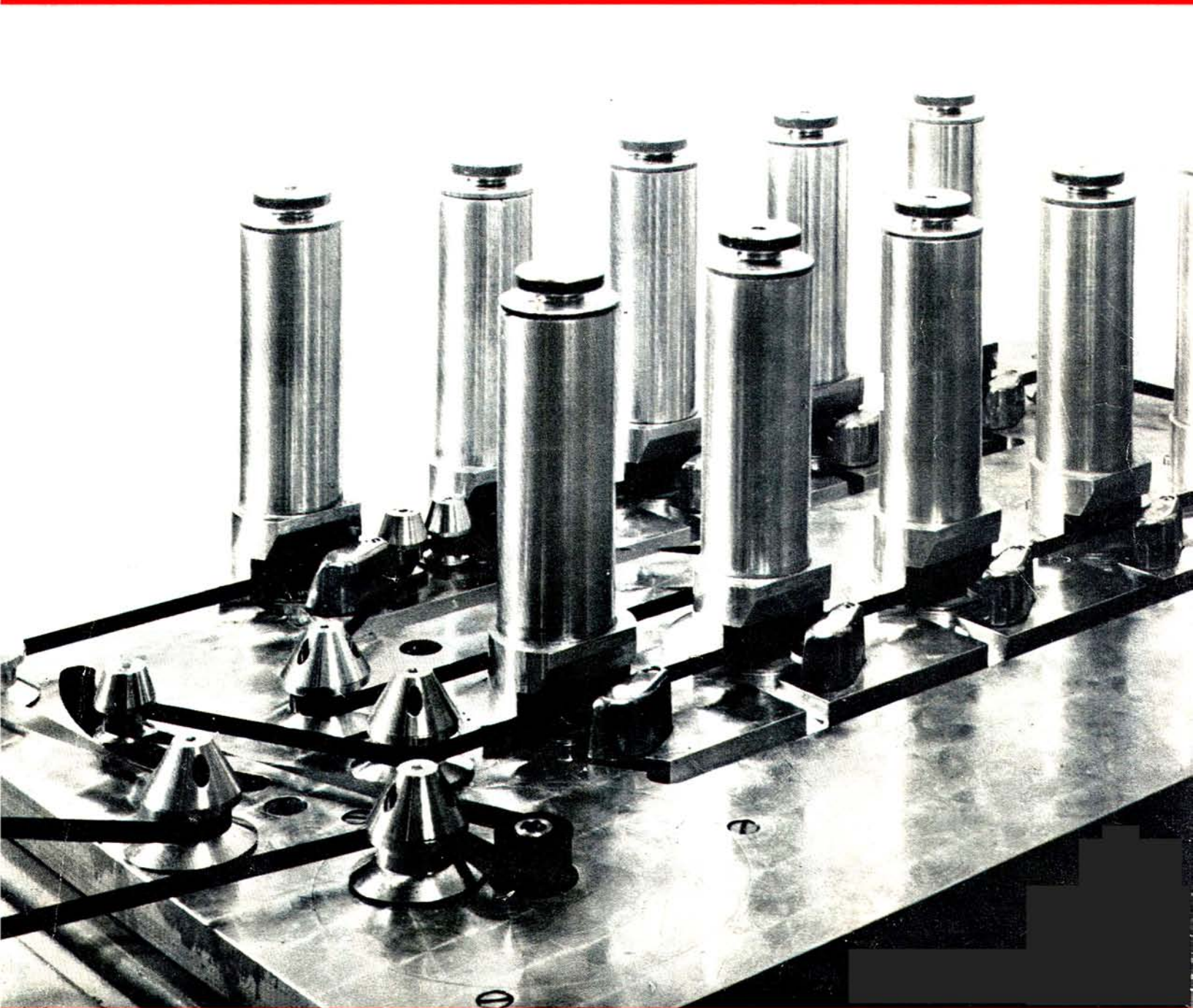

USING TAPE IN YOUTH CLUBS ■ LEARN WHILE YOU SLEEP
SIMPLE WAYS OF IMPROVING RECORDERS ■ TAPE RECORD REVIEWS



**QUALITY PORTABLE RECORDERS NEED
QUALITY BATTERIES—MALLORY**

Mallory batteries last far longer than ordinary batteries. They deliver their power uniformly without fading for lack of rest. And they keep their energy until it's needed—you get *all* you pay for *when* you want it. It's sound sense to insist, always, on Mallory, the quality batteries for your equipment.



Five standard size Mallory Manganese batteries and a range of miniature Mallory Mercury batteries enable you to put lasting, stable power into *your* portable recorder.

MALLORY

for new ideas in batteries

MALLORY BATTERIES LIMITED CRAWLEY SUSSEX Crawley 26041

Here are some of the easy-to-build Heathkit models from our wide range

HI-FI EQUIPMENT CABINETS

A range of over a dozen equipment cabinets is now available to meet the differing needs of enthusiasts. Designed for maximum operating convenience or for where room space is an over-riding consideration, this range includes kits, accurately machined for ease of assembly and "left in the white" for finish to personal taste, ready assembled cabinets or RECORD HOUSING assembled and fully finished cabinets, and has at least one model to meet your requirements. Why not send for full details? Prices from £7 7s. 0d.—£37 16s. 0d.

ALL BRITISH MODELS AVAILABLE ASSEMBLED. PRICES ON REQUEST

Deferred terms on orders over £10.



"Malvern"



MFS

COTSWOLD HI-FI SPEAKER SYSTEM

This is an acoustically designed enclosure 26" x 23" x 14 1/2" housing a 12" bass speaker with 2" speech coil, elliptical middle speaker, together with a pressure unit to cover the full frequency range of 30-20,000 c/s. Delivered complete with speakers, cross-over unit, level control, grille cloth, etc. Ralph West ("Hi-Fi News") says: "The reviewer was very impressed and places this design among the top few and unhesitatingly recommends it to the most critical music lover."

"COTSWOLD" MFS SYSTEM

Similar performance to standard "Cotswold" but designed for the smaller room. Size 36" high x 16 1/2" wide x 14 1/2" deep. Either model £23 4s. 0d. kit.



FM TUNER

A Tape recorder requires a quality tuner

HI-FI FM TUNER, Model FM-4U

Available in two units which for your convenience are sold separately: Tuning unit (FMT-4U—£2 15s. 0d., incl. P.T.), despatched wired and tested, and I.F. amplifier (FMA-4U—£13 3s.). Printed circuit for I.F. amplifier and ratio detector. Built-in power supply: 7 valves. Tuning range 88-108 Mc/s. Total price Kit £15 18s. 0d.

Tape Recording and Replay Hi-Fi Amplifiers Models TA-IM (Mono) and TA-IS (Stereo) For use with most tape decks. Thermometer type recording indicators, press-button speed compensation and input selection. 3-position bias level and printed circuit construction.

TA-IM Kit	£19 18s. 0d.
TA-IM and Collaro "STUDIO"	£31 5s. 6d.
TA-IM and TRUVOX D92/2	£52 18s. 0d.
TA-IM and TRUVOX D93/4	£52 18s. 0d.
TA-IS (illustration Centre) Kit	£25 10s. 0d.
TA-IS and TRUVOX D93/2 . .	£58 10s. 0d.
TA-IS and TRUVOX D93/4 . .	£58 10s. 0d.

A WHOLE RANGE OF PACKAGED DEALS (INCLUDING "CONNOISSEUR CRAFTSMAN" TURN-TABLE and DECCA fess PICK-UP) NOW AVAILABLE TO SAVE YOU FURTHER MONEY.

Get best possible recordings with a tuner



A.M./F.M. TUNER

HI-FI AM/FM TUNER, Model AFM-1

Also available in two units as above: Tuning heart (AFM-TI—£413s. 6d. incl. P.T.) and I.F. amplifier (AFM-AI—£21 16s. 6d.). Printed circuit board: 8 valves; consecutive FM limiting and ratio detector. Tuning range FM: 88-108 Mc/s; AM: 16-50, 200-550, 900-2,000m. Switched wide and narrow AM bandwidth. Built-in power supply. Total price Kit £26 10s.



Save Money and enjoy yourself building these Heathkit models

They are so easy to build even for an absolute beginner. The manual of instruction is fool-proof—just follow the step-by-step.



S-33

MONO CONTROL UNIT Model UMC-1. Designed to operate with the MA-12 or any amplifier requiring 0.25v or less for full output. Suitable for cabinet mounting or free standing. Size 10" x 7" x 4". Kit £8 12s. 6d. Assembled £13 12s. 6d.

DELUXE 6 WATT STEREO AMPLIFIER Model S-33H. A stereo/mono amplifier with the high sensitivity necessary for lightweight ceramic pickups (e.g. Decca Deram). Deluxe version of the S-33. Kit £15 17s. 6d. Assembled £21 7s. 6d.

HI-FI STEREO 6 WATT AMPLIFIER Model S-33. Attractively styled, completely self-contained. Printed circuit makes it easy to build. Only 0.3% distortion at 2 1/2 W/chal. U/I output, ganged controls. Kit £13 7s. 6d. Assembled £18 18s. 0d.

HI-FI MONAURAL AMPLIFIER Model MA-5. An ideal general-purpose reasonably priced mono amplifier, 5 watts output at only 0.5% distortion, has inputs for Gram, Radio. Printed circuit board. Kit £10 19s. 6d. Assembled £15 10s. 0d.

HI-FI SPEAKER SYSTEM Model SSU-1. This kit is easily assembled. It contains speakers and balance control in its direct ducted port reflex cabinet. It is equally suitable for stereo or mono in average room. (Legs 14/6 optional extra.) Kit £10 17s. 6d. Available for vertical or horizontal use.

AUDIO SIGNAL GENERATOR Model AG-9U. Delivers up to 10 volts pure sine-wave (less than 0.1% distortion. 20 c/s to 20 Kc/s). Decade switch-selected frequencies from 10 to 100,000 c/s. Kit £22 10s. 0d. Assembled £30 10s. 0d.

POWER-AMPLIFIER 12-WATT Model MA-12. Single channel, ideal for stereo conversion. Kit £11 18s. 0d. Assembled £15 18s. 0d.

COLLARO "STUDIO" TAPE DECK. Two tracks. "Wow" and "flutter" not greater than 0.15% at 7 1/2" p.s. Long Term Speed Stability better than 0.5%. £17 10s. 0d.

SUGDEN MOTOR UNIT "CONNOISSEUR CRAFTSMAN". Heavy duty motor, operating at 33 1/3 and 45 r.p.m. Very heavy 12" turntable. £17 2s. 11d.



USC-1



TA-IS



TRUVOX D93



STUDIO

HI-FI STEREO 18-WATT AMPLIFIER Model S.99. Within its power rating, this is the finest stereo amplifier available, regardless of price. U/I push-pull output. Printed circuit. Kit £27 19s. 6d. Assembled £37 19s. 6d.

TRANSISTOR INTERCOM. Models XI-1U and XIR-1U. Ideal for office or home. Each Master operates up to five Remotes.

Master Kit £10 19s. 6d. Assembled £16 19s. 6d. Remote Kit £4 7s. 6d. Assembled £5 16s. 0d.

STEREO CONTROL UNIT Model USC-1. A deluxe stereo control unit with variable filter, switched rumble filter, printed circuit boards and many other refinements. Operates direct from tape heads. Kit £19 10s. 0d. Assembled £26 10s.

"OXFORD" PORTABLE RADIO Model UXR-2. Superbly styled hide case, with Golden trim and slide-rule tuning scale; this completely self-contained transistor dual-wave set performs brilliantly everywhere, even in a car. Reproduction is exceptionally good. Printed circuit. Kit £14 18s. 0d.

SHORTWAVE TRANSISTOR PORTABLE Model RSW-1. Four wave-band seven transistor portable with telescopic and ferrite aerials, slow-motion tuning. Covers Medium, Trawler and 6-26 Mc/s in four switched bands. Uses printed circuit board and latest circuit technique. Superbly styled leather case. Kit £19 17s. 6d.

TRUVOX D93/2 AND D93/4 TAPE DECKS. High quality mono-stereo Tape Decks. D93/2 1/2-track for highest fidelity. £36 15s. 0d. D93/4 1/4-track for most economical use of tape. £36 15s. 0d.

GARRARD AUTO/RECORD PLAYER Model AT-6. A 4-speed stereo-mono unit with manual or fully automatic record selection; adjustable counter-balanced arm.

Fitted with Decca Deram ceramic cartridge £14 6s. 1d.

or Ronette 105 mono/stereo cartridge £13 12s. 1d. **GOLDRING Lenco TRANSCRIPTION RECORD PLAYER Model GL-58.** Fitted with the G.60 pick-up arm and Ronette 105 mono-stereo cartridge, it has infinitely variable speed adjustment between 33 1/3 and 80 r.p.m. and four fixed speeds. 3 1/2 lb. turntable to reduce rumble, "wow" and "flutter" £20 1s. 3d.



S-99



USC-1



RSW-1



UXR-2



AT/6

MONEY BACK GUARANTEE

Daystrom Limited unconditionally guarantees that each Heathkit product assembled in accordance with our easy-to-understand instruction manual must meet our published specifications for performance or the purchase price will be cheerfully refunded.

JUST POST THIS COUPON FOR FURTHER INFORMATION

Without obligation please send me

★ **FREE BRITISH HEATHKIT CATALOGUE. . .**

FULL DETAILS OF MODEL(S)

TICK HERE

Kindly write below in BLOCK CAPITALS

NAME

ADDRESS

HT9

DAYSTROM LTD. DEPT. HT9

GLOUCESTER, ENGLAND
A subsidiary of Weston Instruments Group, manufacturers of
THE LARGEST-SELLING ELECTRONIC KITS IN THE WORLD

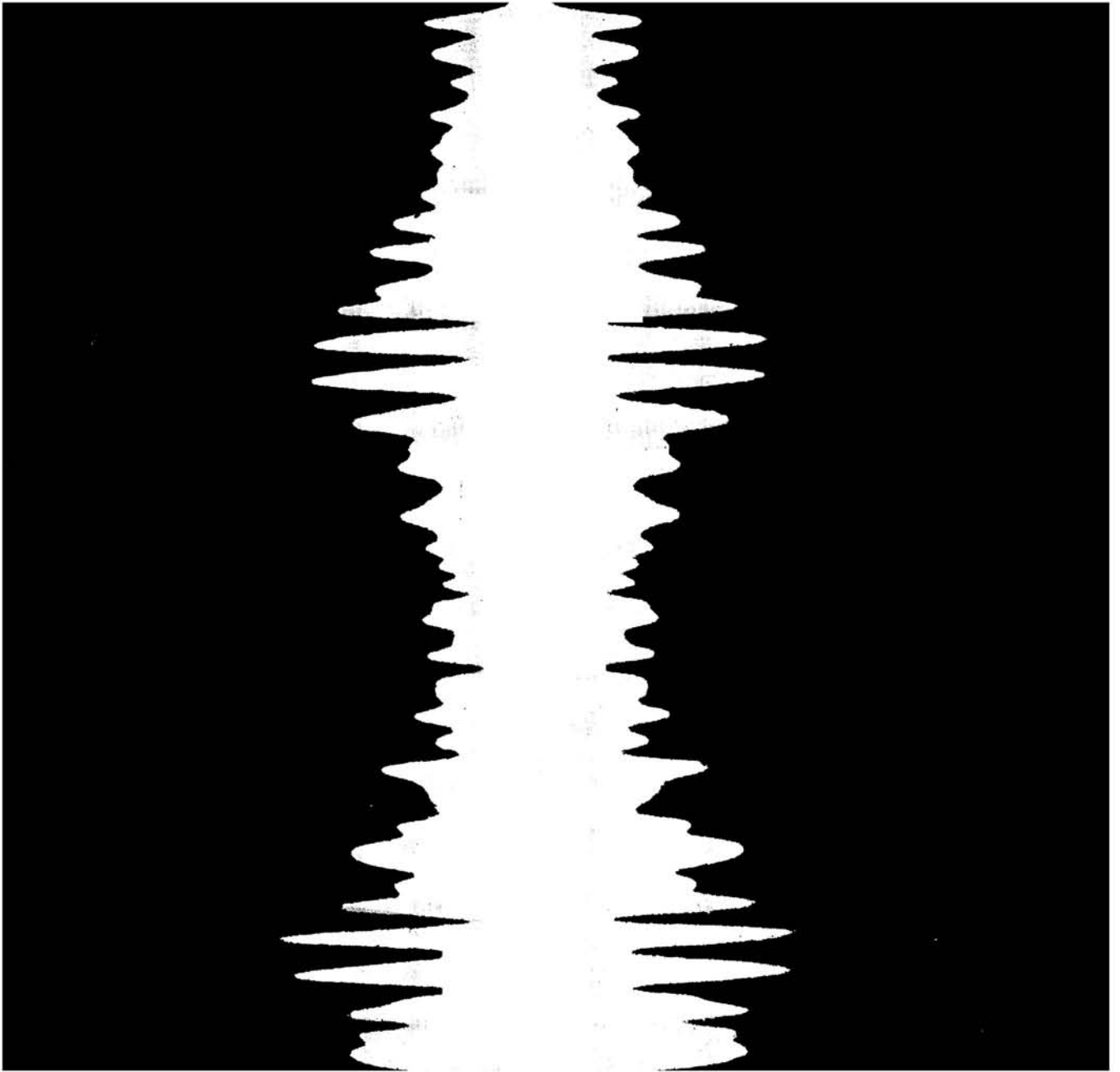

Lawrence of Arabia

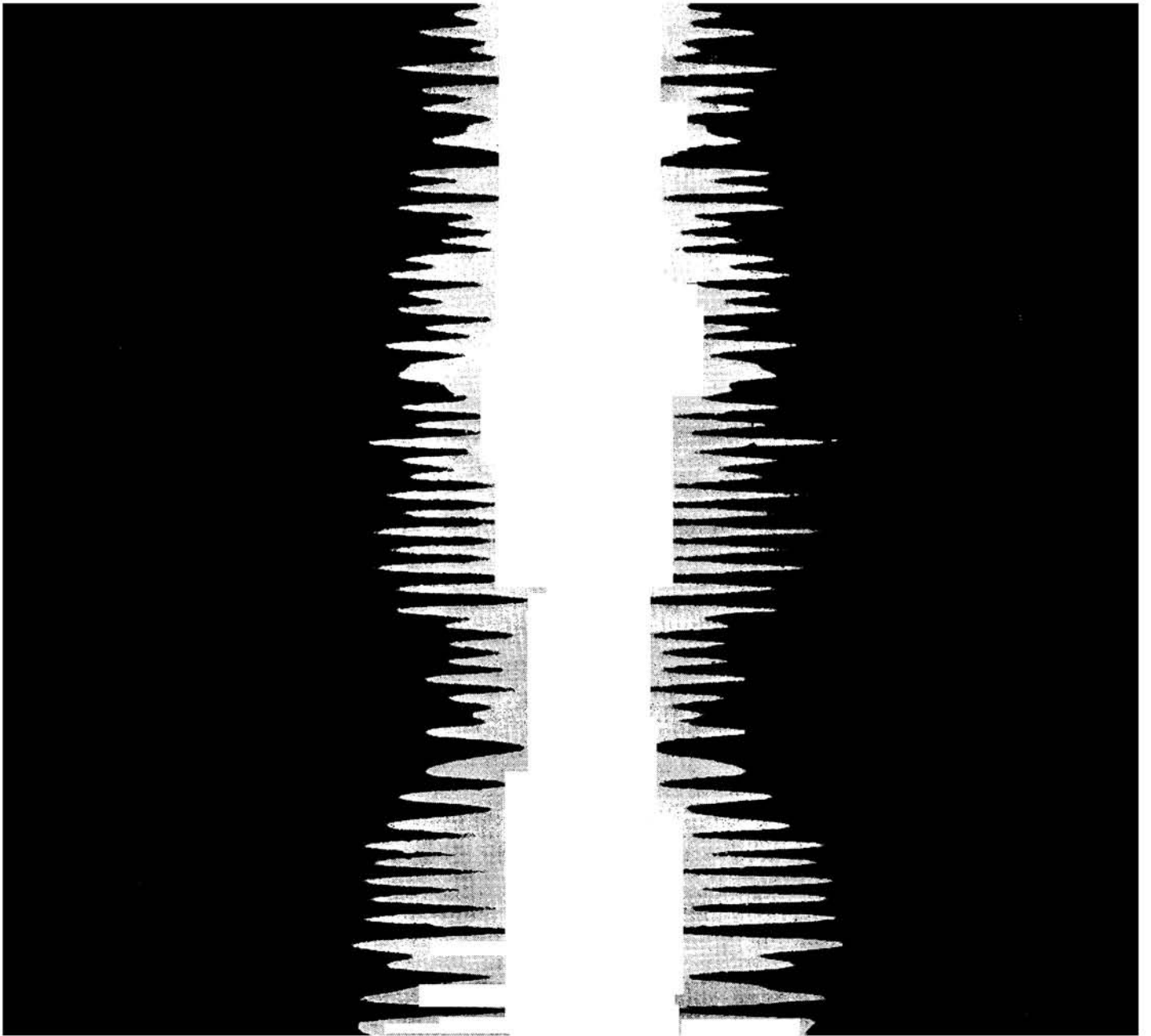

The Yellow Rolls Royce

Who put the sound and fury into 'Lawrence'?
Zonal.

Who taped the purr of 'The Yellow Rolls Royce'?
Zonal.

They both sounded pretty good.

You can get recording tape of the same professional
quality in most hi-fi shops and a good many radio stores.
You ask for Zonatape, and you get results to match.
It's made by Ilford, the photographic people.

ILFORD LIMITED Ilford, Essex



The new symbol
of the Ilford Group

MGM's production of Anatole de Grunwald's 'The Yellow Rolls Royce'. The Sam Spiegel David Lean Production of 'Lawrence of Arabia' A Columbia Picture release.

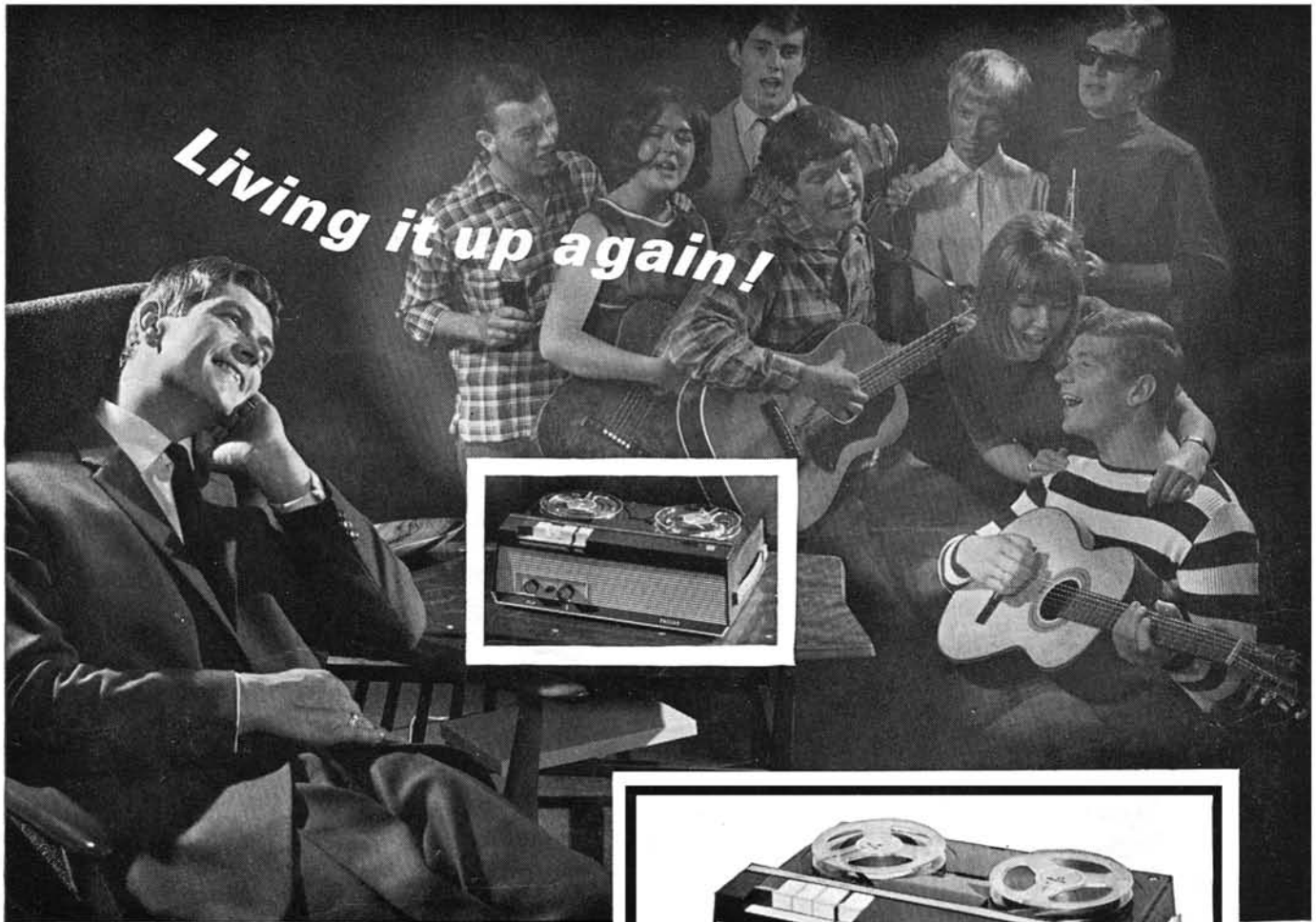

— thanks to
Philips Model EL3552
Tape Recorder 24gns
Automatic and Manual Recording Control



Supplied complete with microphone, tape, empty spool and connecting lead.

The great thing about the party a few weeks ago was the way everyone improvised—making up songs, playing musical instruments, doing impersonations and funny sketches. And thanks to Philips EL3552 Tape Recorder, every happy moment will be remembered as well in years to come as it is today. That's because the EL3552 has Automatic Recording Control. All the host had to do was press the recording switch, and no matter how loud or soft the sound, the EL3552 automatically adjusted itself to give a faithful, undistorted recording of the whole party. See how much fun *you* can have with the EL3552—see it and other Philips Tape Recorders at your local Philips dealer today.

EXPERTS CHOOSE
PHILIPS TAPE

Follow the example of professionals in recording and broadcasting studios all over the world—use Philips Tape, the **only** tape in the U.K. that is made by a tape recorder manufacturer! A product of Philips unrivalled experience and know-how, Philips Tape has all the qualities needed to make your recordings perfect every time.

ANOTHER MEMORABLE PRODUCT FROM



PHILIPS — the friend of the family

tape recorder

INCORPORATING 'SOUND AND CINE'

EDITOR MILES HENSLOW
TECHNICAL EDITOR JOHN CRABBE
NEWS EDITOR DAVID KIRK
ADVERTISEMENT MANAGER ROBIN WELLS
Editorial and Advertising offices
LINK HOUSE, DINGWALL AVENUE, CROYDON, SURREY
Telephone MUNICIPAL 2599 (16 lines)

© Link House Publications Limited, 1965. All rights reserved.

editorial

ONE WONDERS WHETHER Sir Rowland Hill visualised the tremendous impact his service would have on civilisation when he introduced the 'Penny Post' in 1840. After 125 years of development, the postal service has reached Herculean proportions, making possible the transmission of letters to and from any corner of the world.

In the long run, the most important function of the international postal system may be its capacity to destroy political, religious and national prejudices by crossing effortlessly the barbed fences still dividing humanity. The hobbies of tape correspondence and letter-writing between the inhabitants of different lands are therefore to be encouraged; they provide a close friendship between the ordinary folk of this planet. Tape recording hastens the day when written words will be augmented as a matter of course by the sounds of voices. Greater personal contact often brings better understanding, and voices are certainly more personal and human than written characters.

Exchanging tapes from continent to continent may be an excellent thing for the world of the future—but it can be very hard-hitting to the average recordist's pocket. The cost of posting magnetic tape to points a few hundred miles from one's home is very small, thanks to the fast and efficient postal service. But as soon as an exchange takes place between widely separated areas the tape correspondents must choose between facing long delays (three to eight weeks by sea mail) or high costs (from 5s. using first-class airmail).

Much as we revere the GPO for their reliability, we are concerned about a mysterious 'blind spot' which has grown into that organisation. This concern is shared by almost every keen tape correspondent and, without exception, every society founded for the benefit of such enthusiasts. At least one of these societies has forwarded a petition calling for clarification or amendment to the regulation.

According to the *Post Office Guide* (July 1964 edition, page 97), packets containing recordings on disc, tape or wire which include a current or personal message are chargeable at the letter rate of postage and *may not* be posted at second-class airmail rates. On the other hand, tape, disc or wire recordings of other than current or personal messages, such as of music, public speeches and readings from books and magazines, *may* be sent overseas in small packets by second-class airmail. (See pages 99 and 100 of the *Post Office Guide*, as amended by Supplement No. 1—under the headings 'Small Packets', 'Sound Recordings' and 'Inadmissible Articles'.)

The difference between '1st' and '2nd' Class airmail rates is considerable. A 3in. reel of Standard Play tape on a lightweight cine spool normally costs 5s. by the former and 2s. by the latter class when sent airmail to the USA (these rates do not increase significantly over greater distances).

While it is understandable that *written letters* should not be posted at unsealed cheap rates, we find paradoxical the idea that a spool of magnetic tape may be posted at half the normal rate if it contains recorded matter of one kind but only at normal rate if it contains

another type of recording. For all practical purposes there is no physical difference between tape containing a 'current' and 'non-current' recording, but the GPO would have us believe the difference is great enough to warrant an increase in charges of over 100%.

It is difficult to imagine who would take advantage of the 2nd Class rates for non-current material. Only professional studios and broadcasting stations are likely to use the postal service at all extensively for tape-recorded speeches or music, and we cannot believe they would entrust their valuable recordings to an unsealed 2nd class packet.

If the postman is likely to be suspected of wrongful reproduction of other people's tapes, would it not be reasonable to allow the tape correspondent to decide for himself whether he will risk such intrusion? Regular tape correspondents seem unlikely souls to produce tapes of interest to the average postman, who would probably vastly prefer Beethoven's Fifth or selected items from *The Archers*.

Would it be unreasonable to request that the GPO withdraw their inexplicable differentiation between current and non-current recordings? To be fair, we would rather see non-current recordings charged at full rate than the present state of affairs; but the most satisfactory solution would be to include current recordings in the 2nd class airmail system—at the owner's risk. Why should the regular tape correspondent be forced to pay unreasonably high postal charges when the fruits of his activities are a closer understanding between race, nation and religion?

MARCH 1965 . VOLUME 7 . NUMBER 2

- 53 WORLD OF TAPE
- 55 COTSWOLD ROUNDABOUT
By Peter Turner
- 57 FIELD TRIALS OF BATTERY PORTABLES—No. 7
By David Kirk
- 59 A SPOT OF TROUBLE (TAPE PLAY)
By David Haines
- 61 TAPE REVIEWS
- 63 READERS' LETTERS
- 65 SOUND OFF IN THE YOUTH CLUBS
By Harry Nash
- 66 TOWARDS BETTER TAPING—PART 12
By Gordon J. King
- 69 SIMPLE METHODS FOR IMPROVING THE PERFORMANCE OF TAPE RECORDERS
By J. B. Dance
- 71 LEARN WHILE YOU SLEEP
By Frederick Rubin
- 72 TAPE RECORDER SERVICE—No. 39
By H. W. Hellyer
- 74 BOOK REVIEWS
- 75 NEW PRODUCTS
- 77 REVIEW OF CLARKE & SMITH 634
- 79 REVIEW OF GRAMPIAN REVERBERATION UNIT
- 83 READERS' PROBLEMS
- 85 CLASSIFIED ADVERTISEMENTS
- 86 ADVERTISERS' INDEX

COVER PICTURE

The unusual device shown on this month's cover was developed by Telefunken. Magnetophon 24 can be used to test both tape and tape recorders and incorporates a tone generator controlled by punched tape. Detailed examination of segments of the tape width is made possible by these variable-height heads.

SUBSCRIPTION RATES

Annual subscription rates to *Tape Recorder* and its associated magazine *Hi-Fi News* are each 30s. in the U.K. and 32s. 6d. overseas (U.S.A. \$4.50) from Link House Publications Ltd., Dingwall Avenue, Croydon, Surrey. *Tape Recorder* is published on the 14th of the preceding month unless that date falls on a weekend, when it appears on the Friday.

**THERE'S
BIG
NEWS
COMING
FROM**

GRUNDIG

**NEXT
MONTH!**

See the April issue of this magazine, or, if you can't wait, look out for the giant announcements in the National Press on Friday, March 12th.

world of tape

TAPE RECORDERS CAUSE STRIKE IN LAW COURTS

TAPE recording equipment at two London Divorce Courts was officially out of action after a recent strike of shorthand writers. A spokesman for the writers said "We have been driven to this strike action by the lack of consideration and liaison by the authorities, who seem to think we should nurse mechanical recordings in the courts to perfection and then gracefully bow out in such an event without any compensation". The future role of the shorthand writer was being considered by a committee under Mr. Justice Baker.

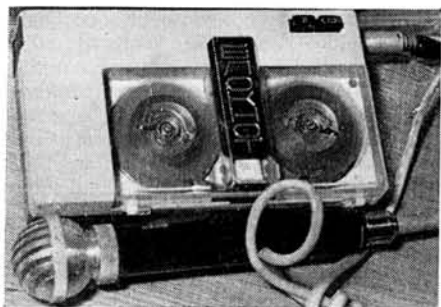

BLOKNOT
MINIATURE
PORTABLE

THE USSR Research Institute of Magnetic Recording, Radio Broadcasting Technology & Television has developed a $\frac{1}{4}$ -track battery portable recorder measuring only $6 \times 3\frac{1}{2} \times 1\frac{1}{2}$ in. *Bloknot* plays for a total of one hour on 120ft. reels of $\frac{1}{4}$ in. tape and weighs $1\frac{1}{2}$ lb. Four miniature storage cells give a running life of between three and four hours.

RETAILERS' DEMONSTRATION STANDARDS CRITICISED

GRUNDIG Director A. F. St. Clair Burton made a praiseworthy attack on the inadequate facilities provided by the average electrical and radio retailer for demonstrating tape recorders. Pointing to the day when video recording equipment will find itself alongside vacuum cleaners and washing machines in the dealers' showrooms, he advocated staff training in the handling of recorders and concentration on a more limited number of products. "Although growing rapidly, the market for tape recorders has only been scratched. I have seen showroom staff", he continued, "who haven't the first idea how to operate a recorder, let alone demonstrate it to a potential purchaser".

BANG & OLUFSEN AND SONY SERVICE

AFTER-sales service, technical literature and spares for B & O and Sony products are now available from: St. Aldate Warehouse, Service Department, Eastbrook Road, Eastern Avenue, Gloucestershire.

SO SOON?

BEGINNING with "You may think this a little premature . . .", the Director of the tape correspondence organisation *Stereo International* has informed his members of a Video Tape Recording section to be formed for purchasers of the *Wesgrove VKR 500*—currently the only domestic television recorder available. It has, perhaps, been overlooked, that the television recorder constitutes a major threat to the popularity of amateur stereo recording. Present-day television screens do not lend themselves to bi-dimensional sound . . . or do they? Director: R. V. Huddleston, 9 College Avenue, Melton Mowbray, Leicestershire.

SONY DOMESTIC VIDEO RECORDER

FURTHER details of a Japanese television recorder have been announced by the Sony Corporation. The *Videocorder 2000*, which should appear on the market next year, operates at a tape speed of $7\frac{1}{2}$ i/s and will cost less than £200. A revolving twin-head unit overcomes the need for high head-to-tape velocity. The manufacturers claim that the recorder has a superior performance to some current

industrial equipment. Fully transistorised circuits simplify the development of a battery version now being undertaken though the first recorders to be sold will be mains powered. Weight and size are similar to present-day domestic sound recorders, namely 33lb. and $14\frac{1}{2} \times 14 \times 8$ in. Maximum recording time is sixty-three minutes per reel. Initial monthly production figures of 2,000 to 3,000 machines are envisaged. An accessory Vidicon camera is also planned, to sell at £88.

HEATHKIT EXHIBITIONS

DEMONSTRATIONS and a display of *Heathkit* electronic kits are being held at the YWCA, 45 Division Street, Sheffield, 1, on February 19th and 20th, from 12.30 pm and 10.30 am respectively, to 9 pm. A similar demonstration will run concurrently with the *Audio Fair* at the Grand Hotel, Southampton Row, London, W.C.1 (close to Hotel Russell) from 11 am to 9 pm, April 22nd to 25th. Admission is free.

NEW DISTRIBUTORS FOR SYNCHRODEK

SYNCHRODEK products, which include tape recorder/cine-projection and 35mm slide synchronisation equipment, are now being distributed in the U.K. by: Fi-Cord International, 40a Dover Street, London, W.1.

TELEVISION RECORDERS FOR HIRE

AUDIO & Visual Rentals Ltd. recently began a hire service of television recording equipment for suggested use by commercial television advertisers and industry. The equipment, which may be used in the company's London studio or on location, is based on an *Ampex VR1550* Video Recorder which uses 2in. tape. Charges range from £20 per hour at the studio to £75 per day at the studio or on location. Tapes may be kept for up to thirty days without charge.

FURTHER PRICE AMENDMENTS

INCREASED costs caused by the recent levy on imported products have resulted in the following price changes: *Uher Universal 5000*—£103 19s. *4000 Report-S*—£108 3s. *784 Royal Stereo*—£156 9s. *Philips EL3300* and *EL3586* are both increased by one guinea to £27 6s.



NEXT MONTH

PUBLISHED on March 13th, the April issue of *Tape Recorder* will see the start of a new series for the newcomer to tape recording by David Kirk and the first of two articles on collecting bird song by A. G. Field. Richard Golding will examine the *Contronics* cine-sound synchronisation system and G. A. Stevens will describe the construction of an integrated microphone pre-amplifier. We apologise for omitting from this issue the Philips EL3548 review, promised in our February issue; this has been unavoidably delayed but should appear in the April number.

**LOOK
AND
LISTEN!**

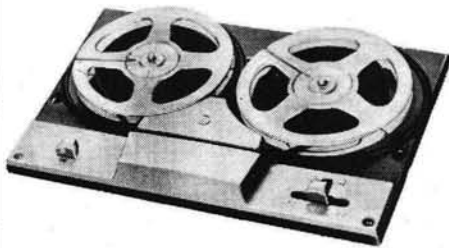

Take a look at the precision-built, quality tested T.D.2. Listen to its superb performance—only BSR could combine good looks with such truly magnificent performance.

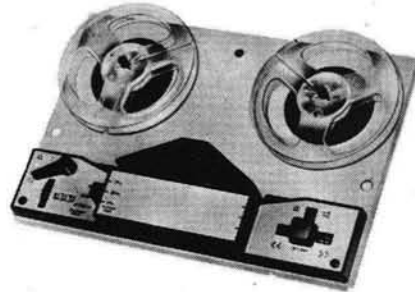

Look, too, at the elegant T.D.10—a tape deck of functional excellence that sounds as good as it looks. Listen to it and you'll know why BSR tape decks are favourites all over the world.

BSR

The world's largest manufacturers of Tape Decks and Record Changers



MONARCH WORKS, OLD HILL, STAFFS

WHEN the Cotswold Tape Recording Society was founded in 1960, one of the first activities to be discussed was a taped programme for hospitals. Apart from knowing that other clubs were doing that sort of thing, we were completely ignorant of the subject; indeed, we had only one real asset—an enthusiast in the person of my joint honorary secretary, Peter Duddridge, who has since done a great deal of free-lance work for the BBC, and is an accepted authority on natural-history recording. He was extremely keen on interviewing and location work generally, and had a taste and a talent for editing. Without him, it may be that there would have been little more than good intentions; but it is fair to say that he has never lacked sturdy backing.

We made enquiries at several hospitals in the district, and found that there were a few in which the internal headphone system could be used to transmit a programme, and that the hospital authorities would be willing to receive it. Thus what we then called "Hospital Roundabout" was born. We decided that a monthly service was as much as we could hope to provide; and this had to be supplied with material, edited to about half an hour, copied and taken by somebody to the hospital, together with the machine for replay, and plugged into the amplifier supplying the inter-com. It is surprising how many snags can arise in so simple a series of operations, but we carried on.

The first problem, of course, was getting the material. At the very start, we had a certain amount of stuff amongst us which could be used; but as that became exhausted, we started sound-hunting with deadly seriousness. That hunt is still on: very much so. We had lightly agreed that "news, views and interviews" would be our subject-matter: we were going to try to bring to people temporarily cut off from their ordinary world some account of what was going on. We



COTSWOLD ROUNDABOUT

would record local happenings; we would talk to interesting visitors to the district; we would get local artistes to give their services for the entertainment of the sick; we would chuck in anything and everything which would be likely to interest and cheer the patients. Nothing sad or depressing; nothing too serious. It all sounded fine; but you try to do it! The amount of time and travel required is much greater than one estimates, even to get the raw material. This has then to be edited and cut down to a short feature—for we rapidly discovered that the sick do not want to concentrate on the same thing for too long. Devote an evening to interviewing a visiting celebrity; then spend another editing your material down ruthlessly, so as to leave the essentials and the punch-lines only, and you find that you are left with three minutes running-time which has cost you as much as six hours to get—and you've got another eight items to find, in time to edit the whole together, with continuity as needed, copy off and distribute against a deadline. In a word: you are editing a periodical, with all the problems entailed.

Gradually we came to find that the hospital is not the best outlet for material of this kind. There are a number of reasons for this: the first is that the programme begins to take shape, to develop something of a life of its own. That means that to get the best out of it one needs to hear it regularly; and patients at a general hospital are usually short-term guests, who will be back home before your next edition gets to them. We had one hospital on our list which caters for long-term patients—TB, orthopaedics and the like—and that made a much better audience for Roundabout, which still goes there.

NO SPARE CHANNEL

Then one has to reckon with the fact that most hospital sound-systems have no spare channel, so that in order to put out Roundabout we had to interrupt the Home or Light. This was inevitably resented by some patients who wanted a favourite programme. Humbly, we can now say that where our programme becomes known and familiar, such an interruption would not be resented, because it belongs to the people for whom we make it and they take part in it; but people to whom it is unknown may rightly object to having it foisted on them. Objections were always few; but they worried us, because we wanted to help, not to annoy.

We began to feel that our audience was rather small when compared

a story of service in sound

BY PETER TURNER

with the efforts the programme cost us; and then the chairman of that day suggested that we might see if we could be of help to the blind and the old. He was himself helping with the servicing of the talking-books supplied to the blind, and knew a great deal about problems faced by the blind. We went into it, and found a great welcome in residential homes for the aged, and in clubs and homes for the blind. It was at that point, I believe, that those of us who were keen on the programme found that we had a new vocation: I know that as soon as my wife and I entered an old folks' home, we became aware of the vast need there is for service—which really means nothing more than friendship—for the old. Thus did magnetic tape lead us to a new world, and we have no regrets.

UNDERSTANDING STAFF

Make no mistake about it: the modern old folks' homes are magnificent. In our experience they are staffed by understanding, skilled and dedicated superintendents and matrons, not a few of whom have become our friends. But they cannot prevent the loneliness which comes to those who have no relatives or friends: to whom Christmas comes without a card or parcel from outside the home because there is nobody to send: to whom the postman never brings anything and for whom the doorbell never rings. These are the ones to whom it means so much if somebody will drop in and have even a brief chat with them—not, for God's sake, in the spirit of the lady-bountiful or even of the welfare-worker, but just as one human being to another. Roundabout does just that.

Distribution problems became different, because homes and clubs are not provided with headphone systems and few have tape-recorders. Further, the programme has to be played during the hours when most people are at work. We found that in a few instances the superintendent of a home had a recorder and would play the programme for us. One has become so keen on it that he not only plays the programme in several different lounges in his own home, but visits other homes too. Then wives can sometimes help, because they are at home during the day; and there are volunteers amongst retired people who are willing to serve in this way. But we try to ensure that members of the

(continued overleaf)

For a REALLY high standard of performance . . .

. . . buy a Brenell tape recorder. Whether you choose the basic MARK 5 Series 2, the more advanced MARK 5 Type M or the STB1, with its many features and facilities, all are capable of giving magnificent results combined with the famous Brenell reliability. Compare these specifications with any other tape recorder on the market :—



Mk. 5 Series 2
4 tape speeds $1\frac{1}{2}$, $3\frac{3}{4}$, $7\frac{1}{2}$ and 15 ips • frequency correction at all speeds • 3 motors (capstan drive - hysteresis synchronous) • low wow and flutter content - .05% at 15 ips, .1% at $7\frac{1}{2}$ ips, .15% at $3\frac{3}{4}$ ips, .25% at $1\frac{1}{2}$ ips • 4 watts power output • monitoring and superimpose facilities • $8\frac{1}{4}$ " dia. reels • Mk 510 for $10\frac{1}{4}$ " dia. N.A.B. reels • fast rewind (1,200ft. in 45 secs) • digital revolution counter.

Mk. 5 Type M
as Mk. 5 Series 2 PLUS:-
Separate record and playback heads and amplifiers • recording level meter • tape monitoring while recording • separate bass and treble controls • superb finish.

STB I
Especially designed for use with external High Fidelity amplifiers • Mono/stereo record/playback facilities with twin recording and twin playback pre-amplifiers • immediate comparison of original and recorded signals • adjustable bias level • playback facilities for $\frac{1}{2}$ and $\frac{1}{4}$ track mono/stereo tapes • sound-on-sound facilities • 2 edgewise meters for recording level, tape output level and bias level.

For full details of these recorders write to the sole manufacturers :—



BRENELL ENGINEERING CO. LTD.
231/5 Liverpool Rd., London, N.1
Telephone: **NORth 8271 (5 lines)**

Please note our new address

COTSWOLD ROUNDABOUT CONTINUED

Society's committee go from time to time, in order to keep in touch; and we like where possible to inaugurate a new service ourselves. The blind often have recorders and manipulate them with great skill.

We changed the name of the programme to *Cotswold Roundabout*, since "Hospital" had become inaccurate and the new name would cover those hospitals—there are several—to which the programme still goes. We began to need more copies; and it became necessary for one of our number—Norman Tustain—to set up a department for the copying and distribution sides. Each tape has a short rota around which it circulates before being returned to base; and we find that people are wonderfully good about this: they play it, and send it on, with comments, with great promptitude, and we have had virtually no circulation troubles due to slackness. Obviously we have to have a fair number of tapes in hand so as to be ready with the next edition before some of the previous month's have come back. Clubs present a different problem from homes, because they only meet on set days. Residents in a home for the old or the blind are always there, and it does not matter much which day one goes. My wife always takes the programme to a home in which she has a particular interest. She rings up during the morning of a convenient day, to find out if it is all right to go. Invariably the answer is a truly joyful: "Oh yes—do come".

When I can go with her, I do. When we get there, most of the residents will be waiting for us, seated as a rule in their usual chairs. As new residents come along, we meet and get to know them; and the cheerful chorus of greeting we get is more than we shall ever need in the way of reward for any efforts we make. We set up the equipment, and the matron brings us tea to drink as we play. Promptly to time, we switch on. And the point is that none of these people need be there unless they wish. Some residents never come: there is no suggestion of a captive audience in any home, yet at the moment of writing we have a monthly audience, all told, of well in excess of 1,200.

AUDIENCE JOINS IN

We quickly found that the way to interest people is to make them join in. We do that in many ways: they like to sing, so we try to include a community-singing session as often as possible; we also include requests where practicable; we have an item of gossip from different homes; and we have a very popular regular series called *This Is Your Home*, which is a feature, contributed by the residents and staff themselves, about the home and those who live there. The one in the current edition includes recordings made when two residents got married to each other, at the ages of seventy-five and seventy-four! One of our homes has an old lady of a hundred-and-four, who is a great character and a fine talker: she has been in the programme several times—once on her hundred-and-fourth birthday. Where the blind are concerned, we get much help and advice from Bill Martin, a blind member of the Society who, with the help of his sighted wife, makes frequent contributions to the programme. Being a skilled musician, he often plays for us as well.

That brings me to another of our discoveries: how willing people are to help, once they know what one is trying to do. In every district, I am sure, there are many talented people, either amateurs or semi-professionals, who have acts which they perform at concerts, smokers and the like. We have made contact with dozens of them, and they have willingly and freely given us their services: musicians, singers, comedians, soloists and ensembles. People have played for us, even composed specially for us. They have lugged things like electronic organs round the County for us, tuned pianos for us, made rooms available for us. They have been quite marvellous, and we could not have managed without them.

But so have the famous. When a celebrity comes to the district, we write to their manager and ask for an interview, saying why. Invariably they agree; and the list of people who have appeared in *Roundabout* reads like Sunday Night at the Palladium. I can recall only a few: Cliff Richard, Cilla Black, Joyce Grenfell, Donald Sinden, Ewen Solon, Rosemary Squires, Joe Henderson, Ken Dodd, Helen Shapiro, Finlay Currie—there have been dozens of them. They talk about themselves, and send greetings to our listeners which are obviously sincere.

(continued on page 82)

READERS who saw Alec Tutchings' review of the Grundig TK6 in the May 1964 issue can have little doubt of this little machine's mechanical and electronic superiority to any other battery portable in its price category. The model submitted for field trial seemed to be just as precisely made and aligned as the one reviewed. Specificational excellence is a fine asset but not the sole consideration, however, when buying a battery recorder. Weight, ease of operation, versatility, portability, appearance—all are important factors in determining the suitability of a machine designed for the specialised task of outdoor recording.

The Grundig TK6 comes complete with moving-coil microphone, patch-cord, 4½in. spool of triple-play tape, and a comprehensive instruction booklet. A light-fawn plastic cover protects the vertical tape-deck and speed-change switch. All other controls are conveniently positioned below the carrying handle. The press-buttons are light but firm in action, governing FAST FORWARD and REWIND, PLAY, RECORD INTERLOCK and PAUSE. The pause control is particularly easy to operate and will lock the tape in the PLAY or RECORD position at almost a feather touch. Pressing a second time returns the pinch wheel and pressure pads to the capstan and head assembly, with complete freedom from acoustic, electric, or electronic 'plops'. The pause control was invaluable for precise setting, with tape stationary, of modulation level on the upwards-facing meter. Indeed, all functions, with the exception of speed changing, could be worked with the hand that held the recorder. Setting to RECORD from an off position was, admittedly, a contortion that welcomed the assistance of another hand—but once the record interlock had been positioned, the pause control overcame this difficulty.

FIELD TRIALS OF BATTERY PORTABLES

NUMBER SEVEN GRUNDIG TK6 BY DAVID KIRK

The model GMD302 microphone supplied, is small, neat and, as it turned out, capable of astonishingly good performance. It fitted into a small side-compartment which also held the mains power cord and input/output DIN sockets. The microphone required positioning through a slot in the detachable storage compartment cover to reach the input socket.

Two other DIN sockets in the storage compartment allow connection of headphones for monitoring whilst recording or replaying (pre-amplifier output), and for an external speaker (power output). To run the recorder from the mains it is merely necessary to insert the Continental-style two-pin plug in an electric-light socket, using the adapter provided. Alternatively, the plug could be replaced by one of the many standard British plugs, though most of these would be too large to fit into the accessory compartment.

Shortly after receiving the TK6, we were approached by the Link House Photographic Department who asked if we could provide recorded sound effects to accompany a film of the 'Do-It-Yourself' Exhibition, organised annually by our publishers at Olympia. This seemed an ideal task for a battery machine, but the TK6 had to prove itself on other material before it could be confidently entrusted with such work.

Transcription of material from disc and tuner indicated a complete absence of audible wow at either speed on mains and battery operation. Recording with half-exhausted batteries and replaying on mains power showed no significant change in pitch and speed. But the most

impressive demonstration of all came when the TK6 replayed a tape it had erased. A slight, very slight, tape hiss and quiet acoustic motor noise was all that showed the machine to be running. Electrical motor noise was non-existent—a rare achievement for a battery machine.

The VU-meter is currently the subject of considerable controversy in recording circles—not to say in this magazine—but one only has to experiment with the one incorporated on this machine to understand why it has such a strong following across the Atlantic. It is large, well damped and not over-sensitive to variations of the input gain level.

The wide dynamic range and low distortion enable reproduction of sounds covering a wide range of volume levels at a given setting of the gain control.

As I entered the hall at Olympia I was convinced that, if suitable recording material could be found, this machine would do credit to the most precise editing and the finest of reproducing equipment. I was, however, rather less confident about my ability to carry this 14lb. weight for more than a few hours. A quick tour of the two floors of demonstration and display stands and my small mental notebook was filled with items that might make suitable effects.

First, however, I decided to reload myself with nourishment to overcome the strains imposed by the twenty-mile journey from home

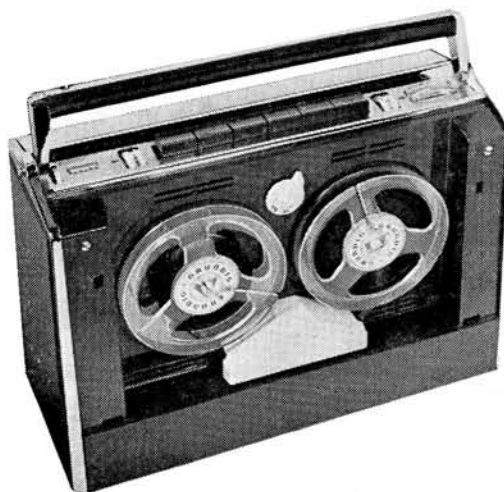

TK6

and the likelihood of going without a lunch. In the absence of a shoulder-strap on the recorder, this meal proved to be a very scanty one indeed, and as I stood before the Buffet trying to spot some food that could be bought and eaten with one hand (the Earth exerting a continuous 14lb. gravitational pull on the other), I resolved that here was the subject for a loud moan: Manufacturers should not make heavy battery recorders without providing an accessory shoulder strap or case.

But I had come, not to eat, but to tape. Returning to the ground floor I placed the recorder down in an undisturbed corner of a stand, extracted the microphone from its compartment and replaced the plastic cover. First on the list of subjects were the sounds of electric drills, cutting machines, cement mixers and other equipment used by do-it-themselves, squealing out above the hum of visitors' voices. These were recorded at varying gain levels and microphone positions. Due to the omni-directional response, the pick-up did not vary widely when the microphone was pointed to the roof and in different directions at ground level; replay on the internal speaker (which deserves classing in a higher category than that of 'portable monitor') showed little difference in quality or volume.

Having captured several sequences of crowd effects, which could be allocated to those parts of the film for which there were no suitable specific sounds, the TK6 was positioned for the capture of 'close-ups' of drills and saws undergoing demonstration at several stands. The recorder, which incidentally looks more like a large portable radio, concealed itself very well, dangling at about knee height, as it and I struggled for a position in the small crowds gathered by each stand.

Unlike tape recorders, the noise made by the motors in electric drills is very similar from brand to brand. As these were by far the noisiest of the machines displayed at the exhibition, scope for recording was less wide than had at first been imagined. Nevertheless, a good

(continued on page 84)

MANUFACTURER'S SPECIFICATION

Tape Speeds: 3½ and 1½ 1/s. **Spool Capacity:** 4½in. **Battery Complement:** Four 1.5V cells. **Battery life:** 15 hours. Can be operated direct from mains. **Frequency Range:** 50 c/s to 7 Kc/s. **Level Indicator:** VU-meter. **Wow and Flutter:** ±0.2%. **Dimensions:** 12½ x 9½ x 5½-in. **Weight:** 13½lb. **Price (including import tax):** £76 13s. **Manufacturer:** Grundig (Great Britain) Ltd., Newlands Park, Sydenham, London, S.E.2.

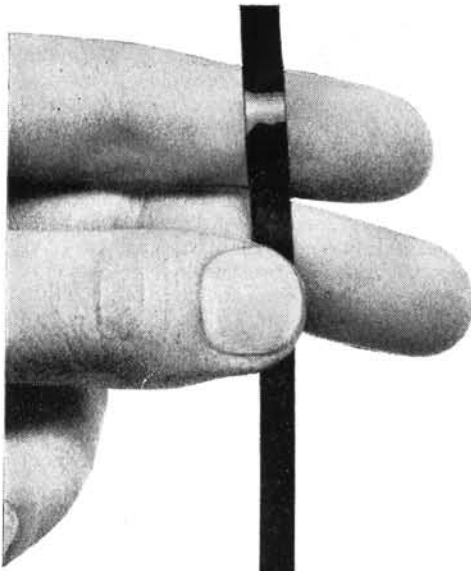

When you give a magnetic tape a new coat that

- is shiny black,
- eliminates oxide rub-off,
- cuts down cleaning,
- increases tape life fifteen times,
- ensures intimate head-to-tape contact,

what do you call it?

"Superlife"

It's shiny black and it is on all polyester tapes throughout the range of Scotch Magnetic Tape.

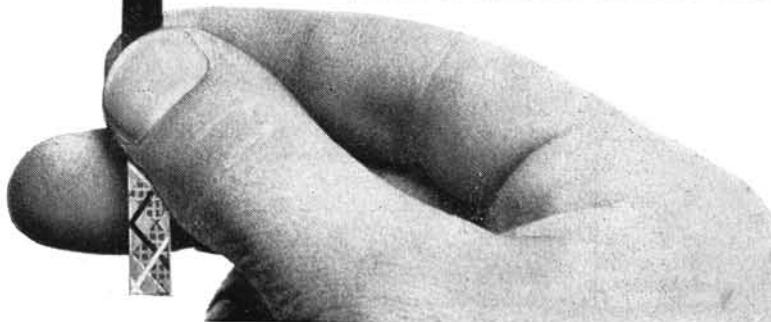
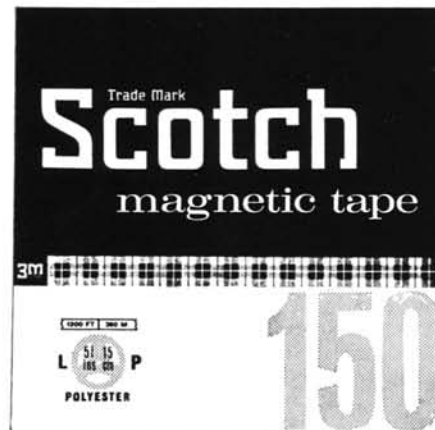

Last month's play depicted a scene that covered several simple changes of location.

This month's play goes a step further.

It depicts a simple *change of scene*—i.e., a break in time. This is achieved by the use of fades and is indicated in the script by a straight line.

To keep things simple, this change of scene does not coincide with a change of location acoustic.

ANNOUNCER: We present a short play entitled *A Spot of Trouble*.
(*Fade-in. Railway-carriage interior. Train proceeding steadily. Corridor-door slides open*)

1st MAN: (*entering*) Excuse me—is this corner seat taken?

2nd MAN: (*hostile*) Yes, it is.

1st MAN: It looks empty to me.

2nd MAN: Then why did you ask?

1st MAN: I was only being polite. (*closing door*) I've been walking up and down the entire train—trying to find a corner seat. (*settling with relief*) Of course, I'd prefer to have a carriage to myself.

2nd MAN: (*drily*) So would I.

2nd MAN: (*doubtfully*) I'm not quite sure that I fancy the idea —

1st MAN: (*severely*) Sir, do you want hordes of passengers invading the carriage?

2nd MAN: Of course not . . .

1st MAN: Very well, then. Help yourself to some winkles . . .

(*Fade out*)

(*Fade in. Train proceeding*)

1st MAN: (*triumphantly*) . . . there you are, you see; as I promised, we've still got the whole carriage to ourselves. Even the ticket-collector didn't come in.

2nd MAN: Do you think it's safe to take our spots off? We don't have to wear them *all* the time, do we?

(*Train begins to slow down*)

1st MAN: Don't take them off just yet. We seem to be stopping at another station.

(*Train comes to standstill. Silence, except for distant birdsong*)

2nd MAN: It's not a station, is it?

1st MAN: I'll look out of the window and see . . . (*lowering window*)

Hmm . . . I don't like the look of this.

2nd MAN: What's the matter? What's going on?

1st MAN: Train robbers!

BY DAVID HAINES

A SPOT OF TROUBLE



1st MAN: But this is the only empty carriage I could find. Empty, that is, except for you. Please accept my apologies for invading your privacy.

2nd MAN: Don't mention it.

1st MAN: (*after a pause*) Excuse me, Sir . . .

2nd MAN: Yes?

1st MAN: I was wondering if we could join forces.

2nd MAN: (*puzzled*) What d'you mean?

1st MAN: (*explaining*) We're coming into Leamington Spa very shortly—and crowds of people will board the train. We don't want them entering our carriage, do we?

2nd MAN: Of course not.

1st MAN: We must take preventive action!

2nd MAN: Such as?

1st MAN: (*slowly*) I have here a bag of winkles.

2nd MAN: Winkles?

1st MAN: I never travel without 'em. A wrinkle is the best friend of the long-distance passenger.

2nd MAN: (*bewildered*) I'm afraid I don't care for winkles.

1st MAN: My dear Sir, we don't have to eat them. The valuable part of the wrinkle, from our point of view, is the head.

2nd MAN: The head?

1st MAN: I refer to this little flat disc. As you see, it covers the opening of the shell—and is very sticky. Normally speaking, one disposes of it if one is eating the wrinkle.

2nd MAN: (*vaguely*) Really?

1st MAN: All we have to do is stick these heads all over our faces.

2nd MAN: I beg your pardon?

1st MAN: We pick the head off each wrinkle—and we stick it firmly on our face.

2nd MAN: Whatever for?

1st MAN: (*patiently*) It stops people from getting in the carriage.

2nd MAN: (*with interest*) Does it really?

1st MAN: The sight of our faces, covered in such spots, will be too ghastly for words. It will ensure an empty carriage from Land's End to John O' Groats.

2nd MAN: Oh, good heavens! In broad daylight?

1st MAN: They're getting very efficient these days. It looks as if we've been shunted down a deserted piece of line . . . and there's a very sinister gang of people on the other side of the field. They're all wearing masks.

2nd MAN: But the masks are white.

1st MAN: Oh, look—one of them's got a megaphone.

FEMALE VOICE: (*through distant megaphone*) Attention!

You two men in the carriage—can you hear me?

2nd MAN: (*calling back*) Are you addressing us?

VOICE: (*continuing*) My name is Dr. Elizabeth Jenkins. I am director-general of the decontamination research-centre of the Ministry of Health. Acting in accordance with information received, we have

(*Continued on page 81*)

TECHNICAL NOTES

Perspective

The two passengers are at close-mike voice-positions. Incorporate slight 'turns' to-and-from the microphone to suggest suitable movement. For example: turning away to lower the carriage-window.

The megaphone-voice should emanate from a distant voice position such as a far corner of the studio. In small rooms, however, the impression of distance is created by reducing gain almost to zero and bringing the megaphone close to the mike-face.

Acoustics

Use a dead room—a room blanketed to exclude reverberation.

Sound-effects

The train: time the dialogue in rehearsal and record a real train for the required duration, either mixing or superimposing it with the studio dialogue. Alternatively the train sequence can be constructed by using the necessary ingredients (*Focal Press Dramatape Guide*, Chapter Ten). Or, use a suitable disc-effect—e.g., *HMV 7FX9*, side 2.

Sliding-door: open and shut a heavy empty drawer. Raise level of train-effect when door is opened, reducing it when door shuts.

Window: push shut a light and squeaky drawer. Raise birdsong-level very slightly.

General effects: rustle of newspaper in early part of the dialogue; and not forgetting chink of 'winkle-shells'.



LOEWE OPTA

Hi-Fi Tape Recorders

FOR PERFECTION IN SOUND

THE NEW OPTACORD 408

THE MOST COMPACT MAINS AND BATTERY RECORDER
Single Speed $3\frac{3}{4}$ i.p.s. Twin Track.
For use on Mains, Batteries and Car Batteries.

39 gns.



OPTACORD 414

Specifications as Optacord 408 plus dig. counter, tone and volume controls.

51 gns.

OPTACORD 414 DIA

As Optacord 414, with built-in Synchronisation for Automatic Slide Projector.

62 gns.

THREE - IN - ONE MAINS - BATTERIES - CAR BATTERIES

71-73 GREAT PORTLAND ST.,
LONDON, W.1.

Tel: MUSEum 2901/5

HIGHGATE ACOUSTICS

Approved Loewe-Opta Stockists

Alexanders, Holburn St., Aberdeen.	Bristol & Cardiff Tape Recorder Centres.	Gilbert Pianos Ltd., 37 Southchurch Road, Southend.	Joplings Ltd., John Street, Sunderland.	Piercy's, 63 Lupus Street, S.W.1.	G. H. Steel, 141 St. Georges Road, Glasgow.
J. J. Allen Ltd., The Quadrant, Bournemouth.	A. Brown & Son, Ltd., 24/28 George Street, Hull.	Grimes Ltd., King Street, Wigan, Lancs.	Kendal Milne & Co., Deansgate, Manchester 3.	Rackhams Ltd., Corporation Street, Birmingham 2.	Tape Recorder Centre, 82 High Holborn, W.C.1.
Arding & Hobbs Ltd., Clapham Junction, S.W.11.	Brown, Muffs, Bradford 1	Guildhall Tape Recorders, 33 Guildhall Street, Folkestone.	John King (Films) Ltd., Film House, East Street, Brighton 1	Recording Machines Ltd., 119 Victoria Street, S.W.1.	Tape Recorder Centre, 30 King Cross Street, Halifax.
Audiocraft, 20 Kettering Road, Northampton.	Camera Thorpe, 6/8 Osmaston Road, Derby.	J. E. Hargreaves Ltd., 1 Railway Road, Blackburn.	R. S. Kitchen Ltd., 22 King Edward Street, Leeds 1.	Tom Reekie Ltd., 10 Bridge Street, Stafford.	J. H. Tate & Co. Ltd., 45 Crowtree Road, Sunderland.
Barkers Ltd., 31 Oxford Road, Worthing.	Campkins Audio, 21 Market Street, Cambridge.	Harveys, High Street, Guildford, Surrey.	Lancashire Hi-Fi Ltd., Tape Centre, 8 Deansgate, Manchester 3.	REW Earlsfield, 266 Upper Tooting Road, S.W.17.	Tele-Sales & Service Ltd., 9 Alexandria Drive, St. Annes, Lancs.
Barretts of Canterbury.	Chelsea Record Centre, 203 Kings Road, S.W.3.	Hamilton Electronics, 35 London Rd., Southampton.	Leech & Haige Ltd., 112 London Road, Oxford.	Ryland Huntley, 15 Old Bond Street, Bath.	Teletape, 33 Edgware Road, W.2.
Battys (Rhyl) Ltd., Rhyl (Tel. 2621).	Chiesmans Ltd., Lewisham, S.E.23.	J. Harris, 231 Baker St., N.W.1.	Massey's, 121/3 High Rd., Chiswick, W.4.	Selfridges Ltd., Oxford Street, W.1.	The Recorder Co., 188 West End Lane, N.W.6.
Wilf Plant, Asfordby, Melton Mowbray, Leics.	City & Essex Tape Recorder Centres, 228 Bishopsgate, E.C.2.	House & Son Ltd., Blake Street, York.	James McKenzie Ltd., Grange Road West, Birkenhead.	Sheen Tape Recorder Centre, 8 Station Parade, Sheen, S.W.14.	Turners Photographic Ltd., 9 The Walk, Ipswich.
Bon Marche, Northgate Street, Gloucester.	Courtney Davies, 12 Station Road, Harpenden.	Howard Tape Recorders, 218 High Street, Bromley, Kent.	Misons, Hi-Fi Specialist, Citadel Row, Carlisle.	Sheffield High Fidelity, 10 West Street, Sheffield 1.	Radio Maintenance (Leicester) Ltd., 111 Queens Road, Leicester.
Leonard Booth, 35 South Street, Eastbourne.	Crosdales (Nelson) Ltd., 41 and 58 Every Street, Nelson, Lancs.	R. H. O. Hills Ltd., Bank Hey Street, Blackpool.	Nicholsons Ltd., High St., Bromley, Kent.	J. Smith & Son, 184 The Rock, Bury, Lancs.	Lloyd & Keyworth, 26 Downing Street, Farnham.
Bourne Radio, 4 Albert Road, Bournemouth.	Dingles, Royal Parade, City Centre, Plymouth.	Imhofs Ltd., New Oxford Street, W.C.2.	Olympic Electronics, 40 Queensway, W.2.	Stanwood Radio Ltd. (All Branches.)	Bristol-Hi-Fi, 28 Upper Maudling Street, Bristol.
LOEWE OPTA	Francis of Streatham, 169 Streatham High Road, S.W.16.	Jones & Higgins, 1-41 Rye Lane, Peckham, S.E.15.	Paish & Co., 130 Union Street, Torquay.	Sport & Radio, 26/29 Aldwich Road, Bognor Regis.	J. W. Mansfield, 18 Liverpool Road, Worthing.

tape reviews

CLASSICS **GEORGE GOODALL**
 JAZZ & FOLK **TONY FARSKY**
 SPOKEN WORD **MAURICE POBBREY**



ELGAR. *Enigma Variations.* Cockaigne Overture. Philharmonia Orchestra conducted by Sir John Barbirolli. **HMV TA-ALP 1998.** 3½ i/s mono. twin track. 35s.

THEME and variations is a form of musical composition that has been popular with composers from the very beginnings of classical music. It is a form that, by its simplicity, is a challenge to a composer's musical skill, and perhaps it is for this reason it has been preserved with little change throughout the years.

One can imagine that Elgar must have enjoyed himself enormously in writing his *Enigma Variations*, and his friends must have been flattered by having themselves immortalised in these musical character sketches. When listening to the performance recorded here one feels that Sir John and the Philharmonia Orchestra get equal enjoyment from playing to us. The recording is well balanced, clean and with a good dynamic range, so this tape should prove a popular issue on the strength of this item on the programme alone.

World Record Club have already given us the *Cockaigne Overture* with George Weldon and the R.P.O. (TT296). The *W.R.C.* tape is rather more vividly recorded, but I feel that the performance given here by Barbirolli is the more poetic. I think also that this tape provides the more attractive Elgar programme. In any event, this is a tape that should give pleasure to many. **G.G.**



SHAKESPEARE. *Scenes and Speeches, Vol. I.* Richard II, Richard III, Henry V, Macbeth, The Merchant of Venice. Narrator: Michael Howley; director: Denis Comper. Dramatised by a team of fifteen actors. **HMV TA-CLP 1738 (Laureate Series).** 3½ i/s mono. twin track. 35s.

DAMON Runyon wrote somewhere "After last night's performance of Hamlet there need be no more doubt as to who wrote the immortal play. Examine the graves of Shakespeare and Bacon and the one that turned over—that's him." Every year, in innumerable classrooms, like damage is done to the whole body of his writings and an anti-Shakespeare prejudice is laid deep enough to last a lifetime. To see a good stage production before classroom study would seem to be the happiest course. Listening to the recorded plays and scenes, the next best. Here on this tape we have a rich motley of favourites.

This first volume has some exciting offerings. The best are from the *Macbeth* scenes with Paul Rogers and Coral Browne, "If it were done . . . 'Twere well it were done quickly". And then a most moving cry from the heart "Out, out brief candle". The elements of despair and frustration contending for mastery as Macbeth's world of conquest crumbles slowly about him.

Not all the scenes reach the same heights but they are spiritedly dealt with. The 'Sceptered Isle' speech from *Richard II*, and Richard's own bitter and self-pitying speech of capitulation to Bolingbroke in Westminster Hall. Paul Rogers again as the crookback king impatient at the frivolous pleasures of England's uneasy piece in 'Now is the

winter of our discontent'. The Prologue and Chorus speeches from *Henry V* delivered by Redvers Kyle call, one feels, for more of the playground-barker quality: quieting the theatre audience, capturing their interest, and thrusting their imaginations into the lofty fields of France. Robert Hardy tackles 'Before Harfleur' speech with great spirit.

Then *The Merchant of Venice* and the two famous pieces "Hath not a Jew eyes" and, of course, 'The quality of mercy is not strain'd'. Anthony Brothers is less than generous to Shylock. However the play is presented, tragedy, romantic comedy, or even melodrama, we must surely grant him resources of intelligence and humour. This it is that gives the threat to Antonio real substance. And Anna Massey as Portia delivers her courtroom plea too much with the foreknowledge of her final trump card. Like justice seen to be done we want to see mercy rejected.

But the tape as a whole is most acceptable and should be an inspiration to students and teachers of the bard. **M.P.**

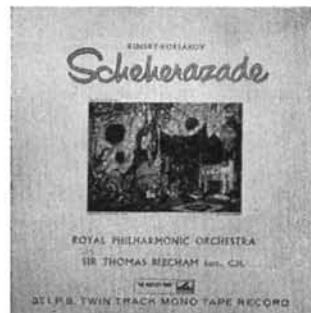

SCHEHERAZADE (Rimsky-Korsakov) *Symphonic Suite, Op. 35.* Steven Staryk (Solo Violin) and Royal Philharmonic Orchestra conducted by Sir Thomas Beecham. **HMV TA-ALP 1564.** 3½ i/s twin-track mono. 29s.

THE coupling of conductor and orchestra here will doubtless give rise to a feeling of nostalgia in many a music lover's breast. If, under its influence, they dash out and buy this tape record, it is a pleasure to be able to say they are unlikely to be disappointed. Colourful music, played with relish and well recorded. What more can anyone want?

The *Scheherazade* symphonic suite is, of course, Rimsky-Korsakov's musical description of tales from the *Arabian Nights*, and with its eastern flavoured rhythms and harmonies he is in his element. Sir Thomas makes it evident that he was also in his. A warmly recommended issue. **G.G.**

THE PATTERN OF POETRY No. 2 (Spoken word tape). Anthology compiled by William Kean Seymour and John Smith. **HMV TA-CLP 1725** (Laureate Series). 3½ i/s twin-track mono. 35s.

THIS volume concludes the seasons as source material—Summer and Autumn—and we have a further score of poems from a rich motley of poets, Andrew Marvell to Laurie Lee. What is less gratifying is that the standard of reading covers almost as great a range.

Alec Clunes is still a great pleasure to listen to. His reading of Nathaniel Tarn's *Ely Cathedral* is marvellously alive and each facet of the descriptive piece is communicated to us with clarity and a real sense of his own delight. Tennyson's short poem *The Throstle* is my other favourite. Read by Kenneth Ratcliffe, the poem's mood—ecstatic and lyrical—could so easily be merely sentimental in less sympathetic hands. Here it emerges with great charm.

I wish I could report as favourably on most of the others. Michael Denison intones the poem *Fern House, Kew* and this indulgence is repeated with the intricate piece by Hopkins *Hurrahing in Harvest*. The sprung rhythm is quite beyond him. Bill Rudderham is too effusive with Marvell's *The Mower to the Glow-Worms* and Dulcie Gray with the same poet's *A Garden* errs slightly on the sentimental side. The metaphysical poets, and Marvell not the least, had a strong ironic and intellectual vein in their writings. Dylan Thomas's narrative poem *Fern Hill*, on the other hand, disgorges words with an exuberance

(continued on page 63)

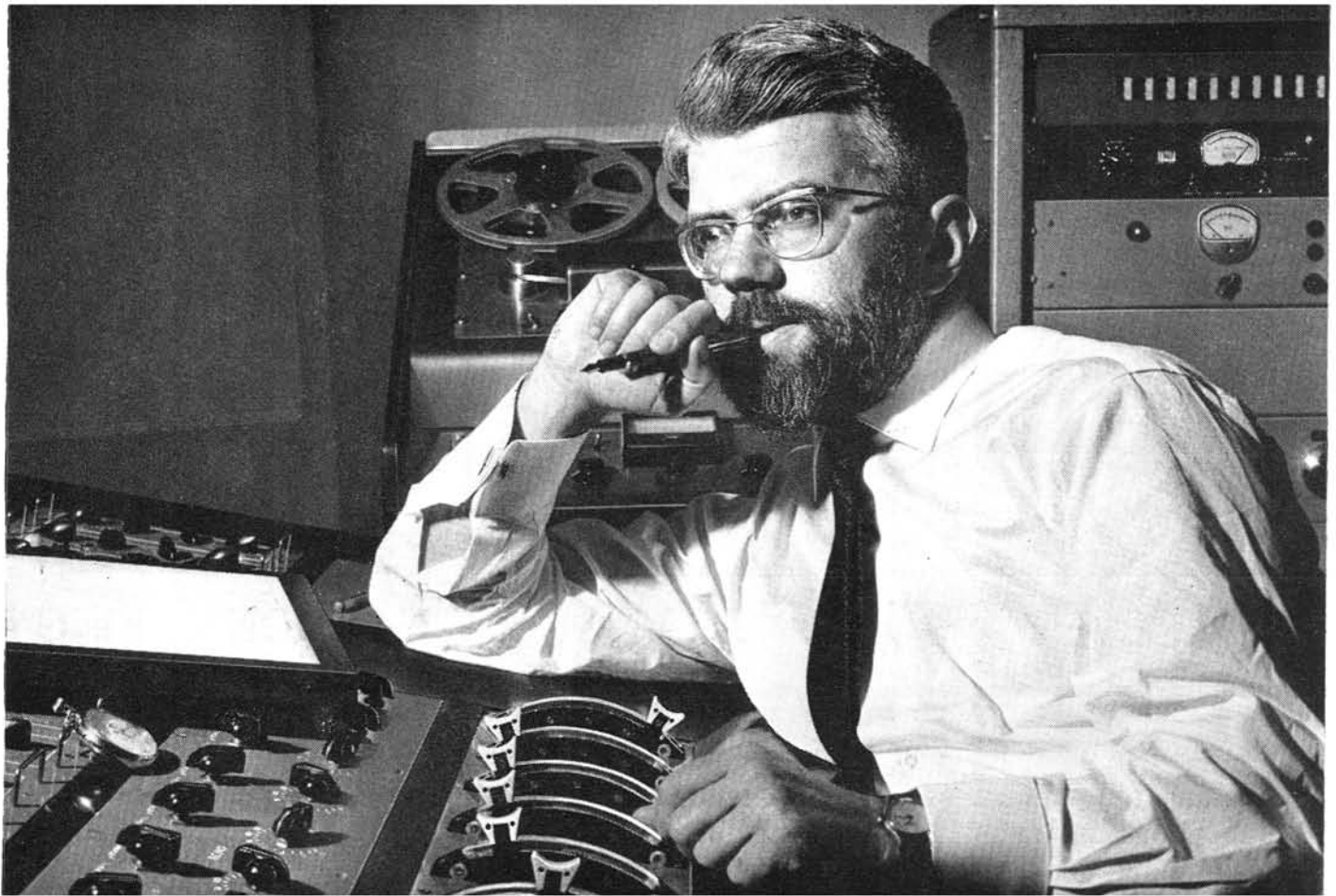

Your equipment may be simpler; but your tape can be the same—if it's Kodak T-100 Tape.

Now you can use *professional* tape, even if you're not in the business

Kodak T-100 Standard Play Tape is a true professional tape. It's used by recording studios all over the world. Now, the *identical* product (not just an amateur version) is available to the enthusiast. Use it for your really important recordings at the higher tape speeds. Its characteristics have been specially planned to deliver the highest possible quality at speeds of 7½ i.p.s. and above.

Unique combination

When you use this superlative professional tape you'll be getting the benefit of a unique combination of features. Generous output level with low distortion. High sensitivity. Better high-frequency response. Higher signal-to-noise ratio.

You may be certain that Kodak T-100 tape will improve the quality of your recordings, whatever tape you are using now.

Unrivalled uniformity

Years at the top of the film business have enabled Kodak to develop the world's most advanced emulsion coating techniques. That's why the coatings on T-100 and other Kodak tapes are accurate to within *millionths* of an inch. Compare the output uniformity of Kodak T-100 tape at 10 Kc/s and see for yourself.

The right base

Kodak have chosen triacetate as the base material for this professional Standard Play tape. And for a very good reason. The superior elastic-

stretch properties of this material mean that, should it break through a recorder fault, it will break cleanly, and can therefore be spliced without signal loss. Only triacetate, with its built-in stretch-resistance offers you this important advantage, together with a high degree of permanence.

Play it soon

Next time you need tape, try a reel of Kodak T-100 Tape (or its long play equivalent, V.150 Tape) and judge for yourself. But when you buy, be prepared for a surprise. The price is no more than you pay for premium quality *amateur* tapes.

© Eastman Kodak Company MCMXXI



Post this coupon today

Please send me full technical data on Kodak T-100 Standard Play Tape

NAME.....

ADDRESS.....

.....

Kodak Ltd., Dept. 70, Kodak House, Kingsway, London W.C.2 **ps**

Kodak T-100 Standard Play Tape

and liberality matched only by Brendan Behan. Lewis Jones treats it far too sombrely.

April Rise by Laurie Lee is a fine poem and even if the full shape of it is not caught by Redvers Kyle he does manage to communicate its exciting intensity. And Rupert Brooke's allegory on faith called *Heaven* is great fun. **M.P.**



SYMPHONIE FANTASTIQUE
(Berlioz). The Philharmonia Orchestra conducted by Otto Klemperer. Columbia TA-33CX 1898. 3½ i/s twin-track mono. 29s.

BERLIOZ's *Symphonie Fantastique* is a truly 'Gothic' work, written in the grand romantic style, with a full-blooded programme of love, death and execution, together with an excursion into the world of demons and witches for good measure. Strange to think

that had it been written but three years earlier, it would have been written in Beethoven's lifetime.

There are perhaps two ways in which music of this type can be performed. The conductor can embellish the romantic element of the work, a sort of tongue-in-cheek approach that may well make the heavier sections more acceptable to modern ears, or he may take the music at its face value and treat the programme more seriously. I feel that Klemperer has taken this last more serious viewpoint in the performance recorded here. There is a sense of foreboding and gloom leading up to the despatching of our hero on the guillotine scaffold that permits of no musicianly 'asides' to evoke melodrama. It is not until the last movement that we are allowed to savour the grotesque and the fantastic. As if to remind us that the preceding events were merely an opium smoker's 'pipe dream' (as indeed they are in the story Berlioz is telling), Klemperer and the orchestra involve themselves with the derision, satire and burlesque of the *Witches Sabbath*, a movement which must have caused some raised eyebrows when first heard, for Berlioz parodies the *Dies irae* melody from a thirteenth century requiem mass as one of its themes.

The actual recording quality is good, and with the review copy at any rate, one could listen to the whole work without having one's attention distracted by tape hiss, or patches of drop-out, or any other serious defect, an experience which seems to be all too rare of late. So if you are waiting for a good version of this work (and the last issue on the *Recotape* label left something to be desired) and if you have no strong preference in style of performance, here is one that can be recommended. **G.G.**

our readers write . . .

. . . about early disgust

From: J. F. Shepherd, 7 Campdale Road, Tufnell Park, London, N.7.

DEAR SIR, When a person decides to purchase his first recorder, just what does he have in mind? To hear himself 'on record'? To write and produce a good play? To tape actual birdsong? Or simply to plug his newly-acquired possession into a radio in order to obtain first class reproductions of the latest "Top Twenty"?

I would venture to suggest that we all know the answer to the latter! The story does not end here, however.

As your magazine has pointed out time after time, a great many 'domestic' recorders are not by any means the wonderful machines their manufacturers would have us suppose. Can there be anything more likely to produce apathy—indeed disgust—in a young person than to sell him a pile of beautifully polished rubbish which has been described as a tape recorder? Quite recently I offered to take one of my own machines to a party. In refusing my offer the young man whose party it was to be explained that he did not like tape recorders: "All they do is make a complete mess, with all their scratching and whistling". I discovered later that he had actually once owned a certain very foreign machine which had sustained him a severe electric shock when he pressed the speed change control. It was an appalling excuse for a recorder which had cost his father over £40. I could go out tomorrow and buy another of the same brand and model from any of five shops which are endeavouring to sell them off for "only £10". I wonder why they are so cheap? **Yours faithfully**

. . . about his ribbon microphone

From: M. H. O. Hoddinott, 19 Dicksons Drive, Chester.

DEAR SIR, The letter from Mr. Birchenall in the January *Tape Recorder* concerning my ribbon microphone design prompts me to write to you with some of the latest developments which constructors may find useful.

The cutting technique described by Mr. Birchenall for the ribbon is most useful but can be further improved if the whole cutting outfit is placed on soft paper such as blotting, rather than directly on the glass sheet. This prevents the rapid blunting of the razor blade that takes place with the original method on the glass and is not only easier but gives a much cleaner cut.

Another idea comes from Mr. P. Gosling of Huddersfield who has managed to find a source for 0.00003in. beaten aluminium foil. This incredibly fragile material is near enough exactly what is wanted and for those wishing to try the foil here is the address of the supplier:

George M. Whiley Ltd., Victoria Road, South Ruislip, Middlesex. The specification is twenty-five sheets of 4in. square aluminium foil 0.00003in. thick, price 8s. 6d.

Mr. Gosling finds it best to cut this foil between sheets of tissue paper and I have found this to be very successful, especially if done on the blotting paper base. The corrugations are also a little tricky and can either be rolled in with a knurled plastic bottle top or simply indented at ½in. intervals using a very blunt razor blade. Make sure to anchor both ends of the ribbon before doing this operation, otherwise it will curl up. Do not attempt to use the comb method which is quite disastrous with this thin foil.

The whole problem of handling the foil presents some difficulty as its tensile strength is infinitesimal and it happily floats away at a breath. If, however, the constructor is prepared to do a little experimenting with the first couple of sheets, a technique can soon be evolved. Needless to say the mounting of the ribbon must also be done with much more care than that required for the 0.0004in. capacitor foil.

When the microphone is fitted with the foil it is essential to fit five silk blast screens inside the gauze covers otherwise the very act of moving the microphone may rip out the ribbon. For the experimenter it is worth trying to fit these screens, that is additional ones, close to the ribbon where they can exert a dynamic damping action on the ribbon at its resonant frequencies. In this way, 'peaky' response in the frequency graph can be smoothed out.

I think that those few hints have brought existing and would-be 'ribbon mike-makers' up to date and it only remains for me to wish them luck in their efforts. **Yours faithfully**

. . . about efficient servicing

From: Harry Leeming, Service Engineer, Holdings of Blackburn Ltd., 39-41 Mincing Lane, Blackburn, Lancs.

DEAR SIR, Regarding Martin York's intriguing article *Some Thoughts on Guarantees*. Whilst I must agree that products of certain manufacturers and their guarantees leave much to be desired, the situation is not as bad as Mr. York would imply. Of course the dealer must be discriminating in his selection of stock, and this is the policy of my employers. We also carefully test all machines as soon as they arrive. Then, in addition to whatever guarantee the manufacturer may give, we ourselves give twelve months free service on all new equipment purchased from us.

This means we have to spend money in equipping and maintaining an efficient Service Department, which might otherwise have been used to give enticing discounts. Perhaps we are on the wrong track—but then we are not trying to compete with supermarkets. A guaranteed after-sales service may not be the quickest way to increase sales, but it is the most satisfactory. **Yours faithfully**



HEAD DE-MAGNETISER

De-magnetises tape heads quickly and simply... Also for pin-point erasing on striped film and tape recordings—removes local unwanted noises without detriment. Has nylon-cushioned twin probes with a concentrated de-magnetising field in the 1/4" gap between the arms. Pistol grip. A.C. mains. Professionally designed for professional recording engineers. £2. 10. 0.



TAPE ERASER

Erases both sides of a 7" tape reel in 30 seconds and positively removes even the very low frequency portions of a recording. Use the WAL Tape Eraser, the only way to ensure an absolutely clean tape—quicker and better. Mains operated. Also erases sound from 16mm. film. 10" aluminium reels. Professionally designed for professional recording engineers. £6. 18. 6.

PRE-AMPLIFIERS

WAL pre-amps are made for every purpose. Fully transistorised, battery-operated, give high gain, completely hum-free. Laboratory built and fully tested. Professionally designed for professional recording engineers. Ask for details of WAL-GAIN Mono, £5. 10. 0. STEREO WAL-GAIN £7. 10. 0. and the superb WAL HI-GAIN with built-in switched equalisation for monitoring, dubbing, etc., etc £7. 16. 0.

Free leaflets available on these professional aids to perfection... please write to:—



ELSTONE ELECTRONICS LTD

EDWARD STREET, TEMPLAR STREET,
LEEDS 2

YOU OWN A GOOD TAPE RECORDER

So insist on obtaining the best sound reproduction from it, and to do this is by getting a Lustraphone Microphone.

A wide range of models both ribbon and dynamic is available.

For full details contact

LUSTRAPHONE LIMITED (Dept. TR 3)

St. George's Works, Regent's Park Road, London, N.W.1.
Telephone: PRImrose 8844/5/6

THE RECORDER CO.

for best machines on advantageous terms

	Deposit	12 Monthly Payments	Cash Price
	£ s. d.	£ s. d.	Gns
4-TRACK STEREO/MONAUERAL			
B. & O. Stereomaster	12 0 0	8 16 0	112
Ferrograph 424	11 12 0	8 13 2	110
Sony TC 500	11 9 0	8 11 8	109
Grundig TK46	10 12 0	7 15 7	99
Philips EL3534	9 16 0	7 4 8	92
Sony TC200	8 6 0	6 4 5	79
2-TRACK STEREO/MONAUERAL			
Sony TC 200	8 6 0	6 4 2	79
Revox Model 736	13 4 0	10 11 8	124
Brenell STB 1	12 0 0	9 0 0	120
Ferrograph 422	11 12 0	8 13 2	110
B. & O. Stereomaster	12 0 0	8 16 0	112
Telefunken 98	10 0 0	7 9 7	95
MAINS 2-TRACK			
Brenell 5 Type "M"	9 5 0	6 18 7	88
Ferrograph 5A/N	8 19 0	6 13 10	85
Telefunken 85	8 15 0	6 10 8	83
Brenell 5/2 (Meter)	7 15 6	5 16 7	74
Brenell 5/2	7 5 0	5 8 8	69
Truvox 92	7 5 0	5 8 8	69
Reps R10 Mk 2	6 4 0	4 12 11	59
Telefunken M55	4 10 6	3 7 9	43
Grundig TK18	4 2 0	3 1 5	39
Grundig TK14	3 13 6	2 15 2	35
Wyndor 707-11	3 9 0	2 5 0	29
Elizabethan Auto 2	2 16 6	2 0 10	26
Ferguson 3206	2 16 6	2 0 10	26
Philips ELB552 Auto	2 14 0	1 17 6	24

Open Saturday 6 p.m.—Friday 6-30 p.m.

H.P. also over 18 and 24 months

If unable to call, write for free brochure, or send deposit now for quick delivery or telephone SWI 4977 for FREE HOME DEMONSTRATION

FREE DELIVERY
PART EXCHANGE

	Deposit	12 Monthly Payments	Cash Price
	£ s. d.	£ s. d.	Gns.
MAINS 4-TRACK			
Grundig TK40	8 19 0	6 3 4	79
Reps R10 Mk 2	7 5 0	5 8 8	69
Truvox R94	7 5 0	5 8 8	69
Philips EL3549	6 12 0	4 17 6	62
Grundig TK23	4 15 0	3 10 10	45
Elizabethan LZ29	4 2 0	3 1 5	39
Philips EL3548	4 2 0	3 1 5	39
Ferguson 3204	3 10 0	2 11 11	33
Elizabethan Auto 4	2 19 0	2 4 1	28
Fidelity Playmaster	2 12 6	1 15 11	23

SPECIAL OFFER! "STANDARD" UNICORDER

Battery or Mains 2-speed Portable
No external mains unit required, completely self-contained. 2 built-in L/speakers. Remote Control. Capstan Drive. Battery/Modulation meter. Up to 2 hours playing time using 3in. Triple play tape. Brand new. Latest model. Guaranteed. Supplied complete with leather carrying case, shoulder strap, microphone, tape, 2 recording leads and earphone. List price 36 gns. Reduced to 24 gns. Limited supplies.

BATTERY

Uher 40005	10 17 0	8 2 2	103
Ficord 202	7 0 0	5 3 10	66
Grundig TK6	6 17 0	5 2 4	65
Butoba MT5	6 4 0	4 12 11	59
Telefunken 300	6 4 0	4 12 11	59
Nat'l Voice Operated	4 17 0	3 12 5	46
Philips EL3586	4 14 0	2 0 10	26



B. & O. STEREO MASTER

112 gns. Deposit £12.0.0 12 payments of £8.16.0

Separate record and replay amplifier. 3 separate mixing controls. 3 speeds—7½, 3½, 1½ i.p.s. Fully transistorised. 8 watt output per channel. Echo multi-play and synchronising facilities. Synchronous motor. Housed in attractive, contemporary Danish designed teak cabinet. Available in 2- or 4-track versions. Also available as a suitcase model. Price £17 gns. Deposit £12.17.0

12 monthly payments £9.3.4

AMPLIFIERS		£ s. d.
Armstrong 222. Stereo.	20w.	27 10 0
Truvox TSA100. Stereo.	20w.	51 9 0
Rogers HG88MK. Stereo.	24w.	40 0 0
Leak Stereo '30'. 20w.		49 10 0
Tripletone Major. 12-15w.		15 18 9

TUNERS		£ s. d.
Armstrong 224 FM		22 10 0
Armstrong 223 AM/FM		28 15 0
Eagle FM...		19 10 0
Quad FM		24 18 9

TUNER/AMPLIFIERS		£ s. d.
Armstrong 227. Stereo		52 15 0
Armstrong 127M. 5w.		26 10 0
Armstrong 127. Stereo		37 10 0

LOUDSPEAKERS		£ s. d.
Leak Sandwich		39 18 0
Wharfedale W3		39 10 0
Wharfedale W2		29 10 0
Goodmans Eleganza 11		27 10 0
Goodmans Maxim		17 10 6
Mini B		11 13 8
Luxor SH/314. 14" Elliptical. Teak or Oak		6 16 6

We will be pleased to demonstrate these fine models or send full details

(DEPT. R) 188 WEST END LANE,
WEST HAMPSTEAD, LONDON, N.W.6
Telephone: SWI 4977

NEVER in my most exaggerated moments of self-acclamation would I pretend to any technical talents. The world in general is a source of constant wonder to me and, so far as I am concerned, tape recording is a hobby that consists of an enormous challenge from start to finish. Anxiety of a terrible nature attends the commencement of every new tape I make and boundless relief floods over me when it is completed.

I was therefore pessimistic when I found that I had been talked into taking my tape recorder along to the youth club. I was particularly alarmed when, on arrival, I found it to be assumed that I knew everything there was to know about tape recording. The idea on that occasion was unimportant enough, merely to record a spontaneous sketch which the members of that particular club particularly enjoyed doing. The club leader would get half-a-dozen boys and girls together, tell each who he or she would be in the sketch, and outline a set of circumstances to which each member was supposed to react in his own individual way.

These sketches were fascinating from the point of view of self-expression, but the role of the tape recorder in these sessions seemed to me to be a superfluous one. But on playing back some of the sketches later it occurred to me that the microphone helped the thing along in that it encouraged the natural exhibitionism of youth, and in doing this probably helped overcome any alien little inhibitions that might still have lurked in the members' minds. Whether this is a good or bad thing from other points of view is an argument which has no place in this article.

WIDER APPLICATION

This first experience of using a tape recorder in youth club work set me wondering about its wider application in this field. It seemed to me that in this age of sound (or as those with a less tolerant attitude would term it, noise) the tape recorder has an important place. It is unfortunately true that teenagers isolate themselves from the rest of the community and sound would appear to be an ideal method of communication; I mean, of course, sound through the medium of the tape recorder.

An idea being worked on at the moment by youth clubs in a large part of East London is a tape magazine. This would be made for the purpose of circulating round the clubs in the area and would consist of recordings of various activities at the clubs, news items, discussions and interviews. I found that there would be no shortage of music: there are numerous amateur groups writing their own numbers. The object of this magazine would be to combat a certain insularity which invariably grows up around a club, and to make members aware that they are part of a larger community.

I have made many enquiries in youth clubs in an effort to assess the extent of the use of tape recording facilities. It is surprising, perhaps, to find in some that there is an amount of antipathy to overcome among members. When I was trying to assess the extent of interest in the proposed magazine I found that a lot of teenagers considered tape recordists guilty of 'intellectualism', the cardinal sin so far as contemporary teenagers are concerned. There seemed to be a general picture of a bearded and corduroyed character, sitting on top of a lonely hill waiting to record the 8.31 to Llandudno—a vision capable of killing at birth any interest in tape recording among the average youth club members. However, this is by no means an impossible obstacle and in several clubs an interest in tape recording has been stimulated.

It seems to me that the function of the tape recorder in youth clubs can be classified under three headings: (1) didactic, (2) recreational and (3) social.

Didactic uses include illustrated lectures on such things as music, travel, etc. Also under this heading may be included illustrated talks about industry which are very useful for young teenagers on the point of entering working life.

Using the tape recorder for recreational activities offers the widest scope. A lot of clubs keep sound libraries of outdoor events together with cine films, etc. Collecting sound effects is very popular and one very interesting activity consists of an initiative competition in which members have to interview local V.I.P's.

However, the tape recorder really comes into its own as a major factor in youth club work in its social application. This classification covers the recording of discussions, conversations and so on and

SOUND OFF IN THE YOUTH CLUBS

BY HARRY NASH

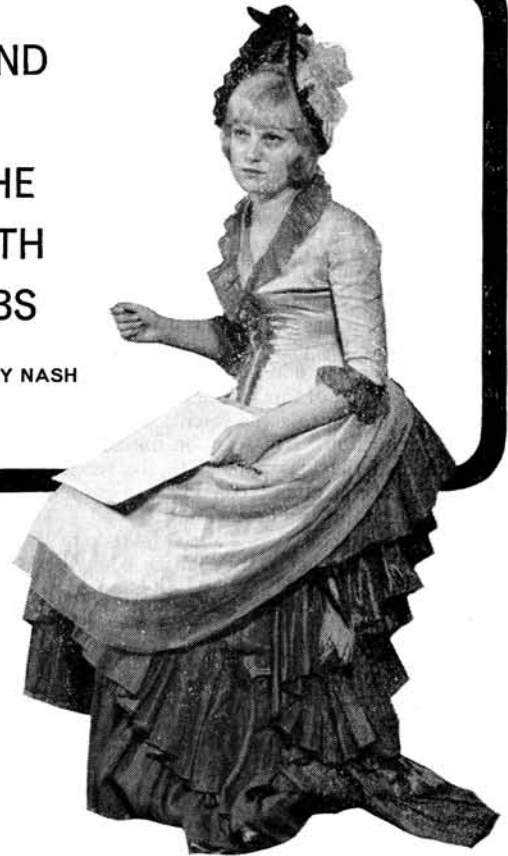

providing a 'live' link with other clubs, not only in England, but abroad.

I was once attached to a club, the members of which were particularly ill-mannered. The leader and his staff of helpers decided to conduct a campaign designed to remedy this state of affairs. My tape recorder and I were enlisted and on the night in question I arrived with my ancient *Elizabethan Escort* (1959 vintage). We decided that the best point of attack was the canteen. The microphone was suspended from the top of the service hatch and hidden behind a tea towel. All we had to do then was to await the arrival of our impolite customers.

I have often been dismayed by the native intuition of teenage London boys which frequently thwarts the best plans of youth leaders. But on this particular evening the quality deserted them. We were treated to some delightfully bad manners and exceedingly coarse remarks.

SPECIAL EVENT

A week later a 'Special Event' was listed on the notice board. When the members, agog with curiosity, were assembled, an edited version of the tape made in the canteen was played. The effect was gratifying and manners improved all round for at least a month afterwards.

Discussions at youth clubs are not, of course, original, and at first consideration the presence of a microphone does nothing to enhance them. But a study of one particular discussion group over a period reveals that the tape recorder performs a valuable function. When participants in a discussion know that they are being recorded they tend to eschew frivolity and adopt a much more responsible attitude. When the tape, or an edited version, is played back, they will note their own weak points as debaters and will try to improve. Thus, their conversational abilities are enhanced as also is the ability to think clearly. And in these days of passive audiences conditioned to look and listen but not to think, that must be a good thing.

As a creative medium the tape recorder is still in process of establishing itself. At present too few youth clubs have tape recording facilities, but where they are available I believe that the tape recorder is making a subtle and beneficial impact on our young people.

TOWARDS BETTER TAPING

BY GORDON J. KING

PART 12. BIAS AND TRACKING PROBLEMS

LAST month it was shown how a fresh signal can be superimposed upon an already recorded track either by arranging for the tape to be held clear of the erase head or by switching off the HF signal supply to the erase head. The HF bias, of course, must continue to be supplied to the record head and care should be taken to ensure that its amplitude does not rise appreciably when the erase head is removed from circuit. It was shown how an artificial load can be switched into circuit to take the place of the erase head to retain a substantially constant bias amplitude.

Over-recording of this nature does tend to impair the quality of the original recording to some extent, and the effect is generally that of treble attenuation. This can be minimised by a reduction in the amplitude of the bias applied to the record head when the over-recording is being attempted. Fig. 4 in last month's article shows one way by which this can be achieved.

While we are considering the amplitude of the HF bias, it will be instructive to see what effects changes in amplitude have on a recording

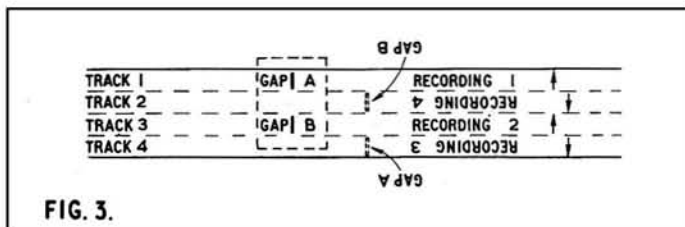
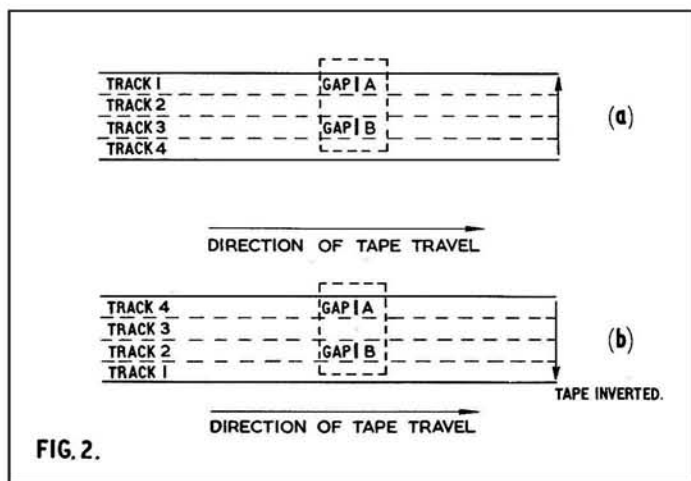
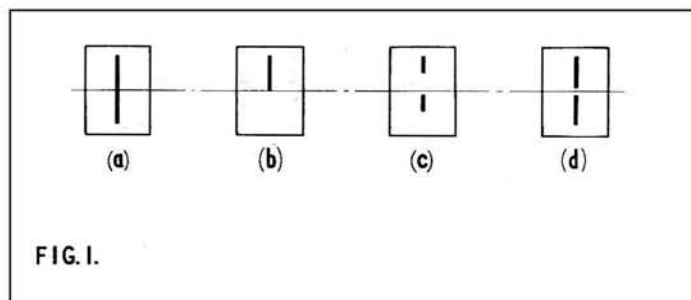

generally and to try and discover whether there is an optimum amplitude. First, let us assume that there is, in fact, an optimum amplitude and that this is established initially by the manufacturer of the recorder. What would happen, then, if we increase the bias amplitude?

A noticeable effect would be a reduction in the depth of the recording for a given level of input signal. The overall distortion would also appear to be reduced, and the general quality of reproduction would seem somewhat more pure in spite of the need to advance the playback volume control more than usual. Adversely, the treble response would be impaired and the recording would seem to lack its usual 'brilliance'. In addition, the signal-to-noise ratio would appear to have worsened. Let us analyse these things.

The signal/noise ratio would be poorer mainly because of the reduced depth of recording brought on by the higher amplitude bias. We know only too well from experience that if we attempt to make a recording with the record level indicator only just moving on signal peaks, the background noise on playback would be abnormally high. The noise takes the form of a 'hiss'. The same applies when the recording depth is reduced by excessive HF bias, even though in this case the recording indicator may be swinging to full scale.

The noise is basically that which is present on the tape to start with. It shows up much more, of course, when the recording depth is low because of the need to turn up the playback volume control to secure the normal level of sound output. Some of the background noise is that produced by the first valve and associated components in the playback channel. That is, the playback head amplifier. For the noise not to show up on a recording its level must be approximately 200 times below that of the signal. This signal/noise ratio would then be 46dB.

As we increase the depth of the recording, so the signal/noise ratio is improved, but then, of course, too great a depth results in a progressive increase in distortion, which is just as bad—if not worse—than a poor signal/noise ratio.

The amplitude of the HF bias is thus set by the maker to provide a satisfactory signal/noise ratio. However, since the treble is also reduced by bias amplitude increase, a compromise amplitude adjustment must be established in relation to the record equalisation, which demands a treble lift. The greater the bias, the greater the treble lift needed for an equalised overall response.

It is interesting to observe that the reduced treble on a tape made with an abnormally high bias amplitude is caused by the HF bias actually tending to demagnetise some of the very short magnets corresponding to the treble that the record head is endeavouring to induce upon the tape!

TOWARDS BETTER TAPING

BY GORDON J. KING

PART 12. BIAS AND TRACKING PROBLEMS

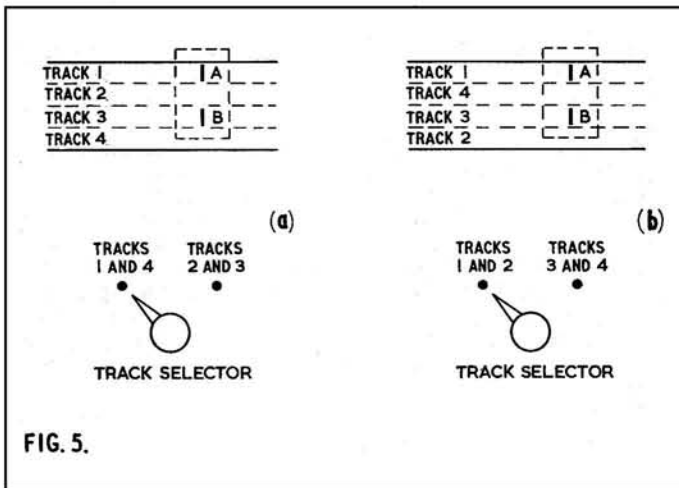
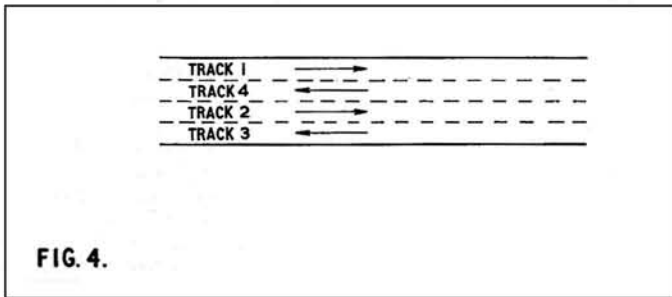

On the face of it, about the best thing that an increase in bias amplitude does is to reduce the distortion. But does it really do this? Tests conducted by the author and other workers in the field have revealed that the apparent reduction in distortion is a function of the reduced depth of recording incited by the heavier bias and not because the tape can particularly record with less distortion when the bias is turned up. We must remember that a tape is biased essentially to linearise the transfer characteristic.

Now, if the level of programme signal applied to the record head is increased to correspond to the increase in bias amplitude, the tape once again becomes fully recorded (i.e., optimum record depth) and the overall distortion is no less than what it was under the original condition with less record signal and less bias. Indeed, the distortion now may be greater owing to the possibility of the record amplifier overloading. Under this condition, of course, the record level indicator would be swinging in advance of its full scale deflection. We would also have found that the signal/noise ratio had resumed its original value. The net result would be a loss of treble. So much, then, for an increase in HF bias. Now let us see what happens when we reduce it.

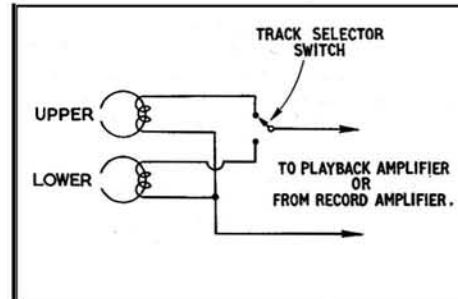

Fig. 6. Typical $\frac{1}{2}$ -track head switching arrangement.

As would be expected for the reasons expounded above, the treble response progressively improves. But let us get this point clear. There is more top, it is true, but if the record channel is equalised to suit the original optimum bias (assuming still that there is such a condition), then a decrease in bias is going to give top emphasis.

The distortion gradually worsens for a given record signal level for the reason that the tape is now running too deeply into modulation. There is the lack of record depth 'control' normally given by the optimum bias amplitude. And when the bias is turned to a low level the signal/noise ratio worsens the same as with too much bias.

Thus we have the full story. Can we truly say that there is an optimum value of bias? Once we have decided upon the amount of distortion that we can tolerate in terms of depth of recording and the record channel equalisation, then we are approaching a condition whereby we can establish the best compromise value of bias. But introduced into the equation is the tape and its parameters, and for each brand of tape, recorded to a certain depth and with a certain applied equalisation, there is an optimum bias amplitude. It is the job of the boffins to work this out and to ensure that the bias on the machines that they design represents a reasonable compromise in terms of all the other things that we have discussed—and the popular brands of tape.

One can spend hours trying to assess subjectively whether an increase or a decrease in bias amplitude improves the performance of a particular recorder. And after the exercise there is often still a big question mark. Obviously, if the bias amplitude is shifted widely from the value set originally by the maker, one can expect some startling effects. But a slight shift either side of the supposed optimum is sometimes worth trying, especially if a new brand of tape is under test.

SOMEWHAT REMOVED

The foregoing discussion may seem somewhat removed from the subject of superimposition, but it is not really when one considers that bias amplitude has a reasonable bearing on just how well an over-recording sounds. In any case, after experimenting with the bias one may need some guide as to how to get back to the original condition!

Before we finish with bias for the time being let us just check up on frequency. From the linearising aspect, the frequency is not too important. Some of the 'popular' types of machine use a frequency within the range of 35 to 80 Kc/s, while professional recorders may go up to 250 Kc/s. It is often said that the frequency should not be less than four times the top audio handled by the machine. If the frequency is below this, passages of heavy recording may exhibit a curious kind of beat interference—a kind of 'ringing' effect.

Usually, however, the frequency is governed by the efficiency of the erase head. Quite a bit of power is needed to give clean erasure, and this often means that the frequency of the oscillator has to be set firstly for optimum power transference into the erase head. On some machines it is necessary to connect a valve voltmeter across a low-value load resistor in series with the erase head and then, with the machine switched to RECORD adjust the core in the oscillator coil or the parallel

(continued overleaf)

UNREPEATABLE OFFER!

● Colossal Price Reduction on World-famous fully transistorized SIEMENS STEREO TAPE RECORDERS

We have purchased a large quantity of these top grade machines and FOR A LIMITED PERIOD ONLY can offer these three models at staggering low prices. Post the coupon NOW to reserve your machine—but hurry! Demand will be enormous!



Model 14 in Teak cabinet suitable for any Hi-Fi system. **ORIGINALLY 89 gns.**

OUR PRICE 49 gns. SAVE 40 gns.

CASH OR INTEREST-FREE TERMS. Min. deposit £6 9s. 0d. 12 monthly payments of £3 15s. 0d.

Model 12. A portable, completely self-contained stereo tape recorder with two built-in speakers. **ORIGINALLY 94 gns.**

OUR PRICE 59 gns—SAVE 35 gns!

CASH OR INTEREST-FREE TERMS. Min. deposit £6 19s. 0d. 12 monthly payments of £4 11s. 8d.

Model 10. A very neat portable with a built-in speaker. **ORIGINALLY 89 gns.**

OUR PRICE 55 gns—SAVE 34 gns!

Min. deposit £6 15s. 0d. 12 monthly payments of £4 5s. 0d.

Brief Technical Specification

Tape speeds	Frequency response	±2dB	Wow and Flutter (RMS)
7½ i.p.s.	45—20,000 c/s	50—18,000 c/s	0.13%
3½ i.p.s.	45—12,000 c/s	50—10,000 c/s	0.16%
1½ i.p.s.	45—8,000 c/s	50—6,000 c/s	0.20%

Any model supplied complete with Dynamic Microphone 4 gns. extra, with spool of tape 1 gn. extra.

Post this Coupon NOW!

I enclose £.....Cash/Deposit for Siemens Model.....

Name.....

Address.....

R.E.W. (Earlsfield) Ltd., Dept. TR, 266 Upper Tooting Road, London, S.W.17 BALham 9174/5

TOWARDS BETTER TAPING CONTINUED

trimmer for maximum voltage. The core of trimmer adjustment, of course, varies the oscillator frequency.

Let us now go over to ¼-track machines. Many tape enthusiasts are currently using ½-track machines and are probably thinking of going over to ¼-track. The following discussion will be of help to such of our fraternity.

A ¼-track machine has a record/playback gap length which is just a little less than a quarter of the width of the tape. Actually, the head has two separate gaps of such dimension complete with two windings, one for each gap.

For the sake of completeness it may be as well at this stage to compare the ¼-track head with the well-known single-track and ½-track heads. The disposition of the gaps on the three kinds of head is shown in fig. 1. At (a) we have the professional single-track head whose gap length embraces almost the whole of the tape width, at (b) the ½-track head and at (c) the ¼-track head. The ½-track head usually only has a single gap and a single winding, but a 'stacked' ½-track head has two gaps and two windings. This is shown at (d). A ¼-track head is thus suitable for stereo, as is a stacked ½-track head.

NUMBERED CONSECUTIVELY

Quarter-track machines feature a switch for changing from one winding to the other on the head. Fig. 2 helps to sort out the four tracks. At (a) the tracks are numbered consecutively from the top of the tape. This means that the winding associated with gap A would be switched into circuit for the first recording on Track 1. To record Track 2 it is necessary to invert the tape and switch to the winding associated with gap B, as shown at (b). Track 3 is recorded by turning the tape back to its starting position still using gap B, as at (a), while Track 4 is recorded by inverting the tape again and switching to gap A, as at (b).

While this method indicates the tracks in order of number from the top to the bottom of the tape, it is not the only method of handling the four tracks. To avoid having to change the spools over four times to arrive back at the starting position (i.e., playback on Track 1) and to avoid having consecutive recordings on opposite sides of the spool, it is possible to rearrange matters so that the first recording is made on Track 1, the second on Track 3, the third on Track 4 and the fourth on Track 2. This may necessitate the fast-rewind motor doing overtime, however.

The idea is shown in Fig. 3. This calls for only two spool changeovers and facilitates indexing. If the tracks are then numbered in order of recording, we get the pattern shown in fig. 4. The arrows show the direction of recording.

Track numbering is sometimes confusing, and it is generally best to consider the tracks in order of number from the top to the bottom of the tape, as shown in fig. 2 (a), irrespective of the order of the recording. The reason for this is because a small number of tape recorder makers number the tracks in order of the recordings when they are made in logical recording sequence, as was described above where four spool changeovers are demanded to arrive back to the starting position; while other makers number the tracks in a straightforward sequence from the top to the bottom of the tape. The numbers chosen are indicated on the track selector switch. This is where confusion can arise.

The point is brought out in fig. 5, where at (a) the tracks are numbered consecutively from the top to the bottom of the tape and at (b) where the numbers are in order of recording. In each case, of course, the actual recording order is the same. That is, gap A is energised for the first and second recordings and gap B for the third and fourth recordings. Should one decide to adopt the recording sequence which is more convenient, as already described, where gap A is energised for the first and third recordings and gap B for the second and fourth recordings, then the track numbering on the selector switch will not apply. It is best if the track selector indications are changed to read "upper gap" and "lower gap", for then one knows exactly which winding and gap are switched into circuit. Fig. 6 reveals how the head windings are generally selected.

Next month we will continue with the discussion on ¼-track recording and look at the advantages and disadvantages.

simple methods for improving the

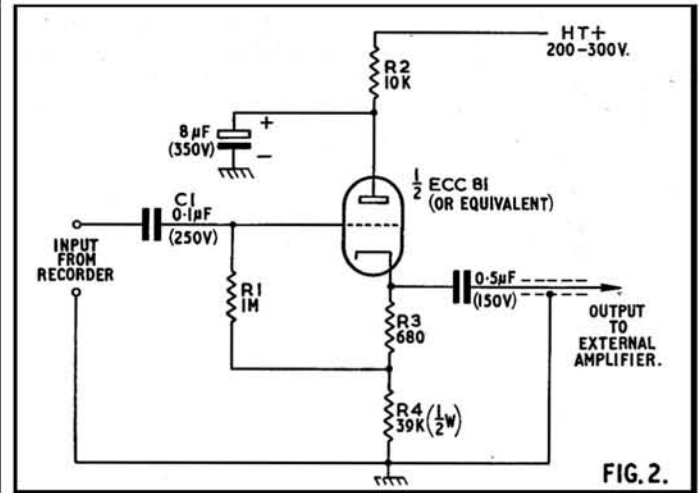
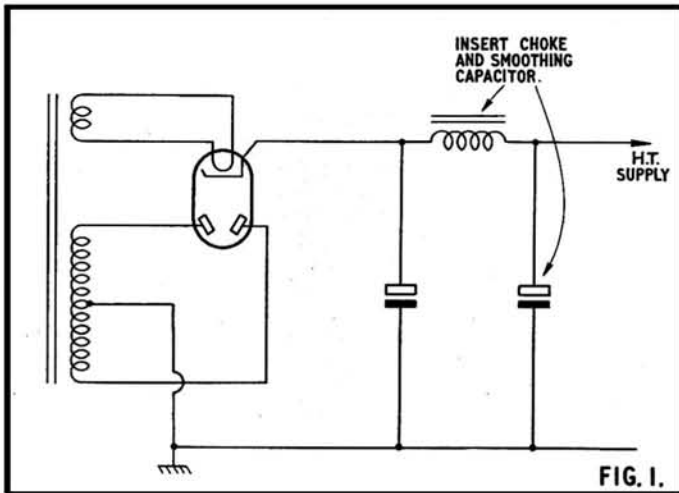

performance of tape recorders

BY J. E. DANCE

THE average person who has purchased a new tape recorder will not wish to carry out very extensive alterations. This article is therefore intended to serve as a guide to those who wish to make relatively easy but effective modifications to their recorder.

One of the main disadvantages of almost all tape recorders marketed for the amateur user is the relatively high hum level. This hum is not apparent when the recorder is used alone with its small internal speaker, but if an output is taken from it and fed into a high quality amplifier connected to a good speaker system, the hum is often quite noticeable.

Any hum resulting from insufficient smoothing of the HT supply is not likely to be noticeable in a reasonably well designed recorder. Nevertheless, if a recorder shows hum on replay, it is well worth while disconnecting the HT supply at the rectifier and placing extra smoothing components in the circuit. A 10 or 20 Henry choke in series with the HT line and a capacitor of about 32µF connected between the circuit side of the choke and earth will reduce the hum level if a major part of the hum is caused by inadequate smoothing (fig. 1). If this is the case, suitable additional smoothing components should be permanently added to the circuit.

In most of the cheap and medium priced recorders the 50 c/s magnetic fields created by the mains transformer and possibly by the motor(s) are the main source of hum pick-up. It has been found that the hum can usually be reduced by a factor of at least ten if suitable magnetic screening is added.

One material which can be used to provide some degree of magnetic screening is tinplate of a fairly heavy gauge. A much better screening material is Mu-metal. This can sometimes be obtained at surplus prices from the old type of radar units which employ cathode-ray tubes, such as the VCR97. It is the metal screening around the CRT which is required. Although Mu-metal should not really be cut, bent or drilled without being re-annealed, the writer has found that, if reasonable care is taken, the thin Mu-metal sheet from this source can be 'worked' without the magnetic properties being badly affected. The Mu-metal from one 6in. CRT is usually enough for screening one recorder.

The optimum location of the screening is best found by trial and error. It will normally be necessary to place a screen between the mains transformer and the low-level amplifier stages. The replay head of most recorders is normally well screened and may not be susceptible to stray hum fields. The writer has found experimentally that a Mu-metal screen placed on the two or three sides of the mains trans-

former nearest to the low-level amplifier stages will reduce the hum level so that it is negligible compared with amplifier and tape noise. It has been found that screening of the motor often has a much smaller effect, presumably because the magnetic field of one field coil more or less cancels that due to the other at a distance of more than 6in. from the motor.

A Mu-metal or tinplate screen should also be tried near the low-level amplifier stages. This may even increase the hum level if the lines of magnetic flux are thereby concentrated near to these stages, but nevertheless it is worth ascertaining experimentally whether a screen in this position effects any improvement. A magnetic screen may also be tried near the re-play head and the switches to which this head is connected.

It will often be possible to fix the screening in place without drilling additional holes in the recorder chassis. The Mu-metal should be handled with care and not be bent any more than is necessary.

If it is found that the hum is appreciably greater at the lowest tape speed, this is likely to be caused by hum pick-up in the coil employed to correct the frequency response. This coil will normally be connected in the second or third amplifier stage. The trouble can be eliminated by shielding the coil with Mu-metal. Some layers of insulating tape can first be wrapped around the inductor and one or two layers of Mu-metal are then wrapped around the outside of the insulating tape. The insulating tape keeps the Mu-metal away from the coil itself. The width of the strip of Mu-metal used should slightly exceed the length of the coil and it is bent to form a cylinder which completely encloses the coil without being so close that the inductance is changed appreciably. Stray magnetic fields will pass through the Mu-metal instead of through the coil. It has been found that the hum pick-up in this frequency-response-correcting coil can be easily reduced to a negligible value by the method described, although it had previously been the main source of hum at a tape speed of 1 7/8 i/s.

An alternative way of eliminating hum pick-up in this coil consists of replacing the coil with a ferroxcube pot core which has been wound so that it has the same inductance as the original. This is admittedly a neater method, but is not so simple to carry out in practice unless one has access to an inductance measuring bridge.

In a badly designed tape recorder the amount of hum pick-up from the heater leads may be appreciable, although the writer has never handled a model in which this form of hum pick-up has been noticeable. It should be possible to eliminate the trouble by carefully re-wiring the

(continued overleaf)

Here's a family of many talents

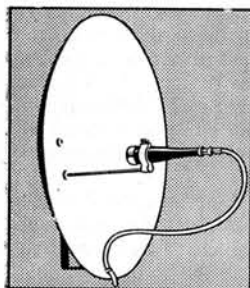
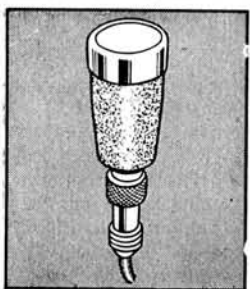
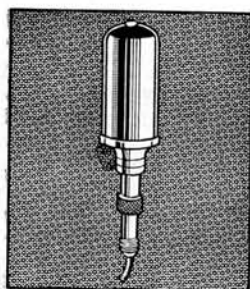
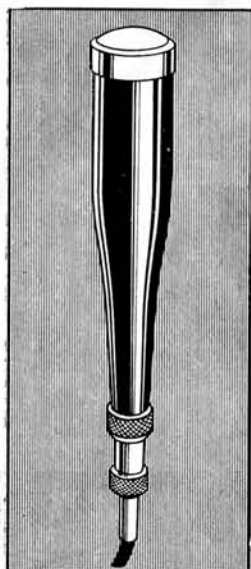

The family resemblance shows in the workmanship, the efficiency, the downright reliability, the integrity that's a feature of every Grampian microphone. There's the DP/4, sensationally successful in the medium price range, now world famous. The Grampian Ribbon Microphone is rightly considered one of the finest of its kind on the market today. The DP/6, too, finds ever-increasing favour—wherever a high grade but amazingly small microphone is required. For further details about them and about the stands, transformers, matching units and the Parabolic Reflector, which are available, ask your Grampian Dealer, or:—



SOUND EQUIPMENT
INTEGRITY THAT YOU HEAR

GRAMPIAN REPRODUCERS LTD.,
HANWORTH TRADING ESTATE, FELTHAM, MIDD. FELTHAM 2657

IMPROVING TAPE RECORDERS CONTINUED

heater circuit. Alternatively, it may even be worth while considering the possibility of feeding the heaters with a direct current derived by rectifying and partly smoothing a low voltage obtained from the mains transformer.

Many people like to place a tape recorder some considerable distance from the high quality amplifier which it feeds. The output provided by most tape recorders for feeding external equipment has a relatively high impedance—typically 200K. Any high frequencies in the tape recorder output will therefore be attenuated to some extent by the effect of the capacitance of the cable used to connect the output of the recorder to the external amplifier. This can be avoided by providing a low impedance output from the recorder in place of, or in addition to, the existing output. One of the easiest ways of doing this involves the addition of a cathode-follower stage; the output impedance of such a stage is a few hundred ohms.

It must be emphasised that the present discussion does not apply to a tape recorder output which is designed to drive an external loudspeaker directly without an external amplifier. Such an output is not normally suitable for high quality sound reproduction, since the power output stages of tape recorders are designed to work the small internal speaker only.

The circuit of a cathode-follower suitable for use as a tape recorder output stage is shown in fig. 2. The 'high fidelity' output should be disconnected from the tape recorder output socket and connected to the input of the fig. 1 circuit. The capacitor C1 prevents the DC potential at the grid of the cathode-follower valve from reaching the other part of the tape recorder circuit. R1 is connected to a tape on the cathode resistors so that the desired bias is obtained for the cathode-follower valve. C3 prevents the steady positive potential at the cathode from reaching the output.

ALMOST ANY VALVE

Almost any valve can be used as a cathode-follower. R3 should be adjusted to provide the correct bias for the particular type of valve employed. The recommended bias voltage and anode current can be found from the valve manufacturer's data. It is not necessary for the anode current to exceed a few milliamps and if necessary R3 may be increased to reduce the anode current. None of the component values are critical.

In the case of the Philips $\frac{1}{2}$ -track recorder type EL3538 and $\frac{1}{4}$ -track recorder type EL3542, a cathode-follower stage may be added without the use of an additional valve. An ECL82 triode-pentode valve is used in these recorders. The pentode section is used as an oscillator during recording and as a power amplifier stage during replay. The triode section of the valve has its anode and grid connected together and is used as a diode to rectify a portion of the audio signal; the rectified signal is used to operate the EM81 indicator tube.

The triode section of the ECL82 valve should be disconnected and an OA202 silicon diode used in its place. The connection to Pins 1 and 9 of the ECL82 is removed. The OA202 is soldered between this connection and earth, the red side of the diode being earthed. This can be done merely by soldering the diode across two points on the tag strip nearest to the ECL82 valve base.

The triode section of the ECL82 (cathode Pin 8, grid Pin 1, anode Pin 9) is now used as a cathode-follower in the circuit of fig. 2, a suitable value for the resistor R3 being 1K. One additional insulated tag must be added to the chassis to support the junction of R1, R3 and R4. R2 and C2 are not required, since the HT potential can be taken from a capacitor already in the recorder.

It has been found in practice that a Philips recorder modified in this way does not suffer from high frequency losses when it is connected to an external amplifier through a very long piece of co-axial cable. A much better high frequency response has thus been obtained.

If valve noise is troublesome in a recorder, check that high stability resistors have been used in the first stage. Any type of hiss may, of course, be reduced by the use of a steep-cut low-pass filter of the type found in most good pre-amplifiers.

By the use of methods such as those described, it has been found possible to improve considerably a number of medium-priced recorders so that they are compatible with fairly high fidelity systems.



learn while you sleep

While arts of Bards heroic
and soul-ennobling thairm-inspiring sage,
I had M'Lauchlan, thairm-inspiring band engage,
Seen there to hear this heavenly band engage,
When thro' his dear strathspeys they bore with Highland rage
Or when they struck old Scotia's melting airs,
The lover's raptur'd joys or bleeding cares,
How would his Highland lug been nobler fired,
How would his matchless hand with finer touch inspired,
How would his matchless hand with finer touch inspired,



SOME CLAIMS AND THEORIES CONCERNING A NEW EDUCATIONAL TECHNIQUE

BY FREDERICK RUBIN

YOU are sleeping . . . sleeping soundly . . . but you will hear and memorise what I say."—The tape recorder drones on and the student—soundly asleep—hears and remembers the facts being fed to him. He is learning while he is asleep.

As its name implies, sleep-learning is the act of acquiring knowledge during sleep. Although the principle is not new, and is generally recognised by psychologists, the application in use today is relatively new and goes as follows: If you speak or whisper into the ear of a sleeping person, the words that you speak are 'heard' and retained by the sleeping person's subconscious mind. When this material is repeated over and over, many people are able to recall it when they wake up.

This is possible, psychologists maintain, because the subconscious mind never sleeps, but is always awake and receptive to spoken words and suggestions. Since it is impractical to whisper into someone's ear, a better method of conveying and repeating the material to the sleeper must be devised—hence tape recording.

But first, let us look back a little—how did it start? People of ancient civilisations, including the Egyptians, Greeks and Romans, used it as memory-training for learning, and applied it to increase their ability to memorise texts and so on. The methods they were using were very interesting, and might be described as an early form of sleep-learning. The priest, who was also the teacher, would whisper in his student's ear while the latter was asleep; but such methods—whilst presumably effective—were denied to the masses, who were considered neither good nor important enough to learn such secrets; so the science of sleep-learning remained a mystery to most people, and is only today being reconsidered.

One of the greatest promises that sleep-learning holds is in the field of education. It may be used for a more efficient and less strenuous type of learning, which will conserve nervous energy and save time in learning the vocabulary of languages, the right accent, memorising lyrics or parts of plays for actors, learning and remembering morse-code, perhaps, or different formulae used in mathematics, physics or chemistry.

To eliminate the disadvantages of the crowded school situation, sleep-learning will facilitate home-study methods for students, and for those who attend evening classes, Polytechnics, etc. It is particularly useful for students who wish to command a large vocabulary, or master special words used in medicine, biology, and other sciences.

Who can learn by the method? Almost everybody, if they are in good health and conscientiously apply themselves to this type of motivated study. People of all ages can practise sleep-learning. Children can use the method as successfully as older people. Many of us would like to gain knowledge we never had time to acquire during our working lifetime. Remember, education is something we take with us to our dying day.

As long as the desire to learn is there, you are likely to succeed by

using sleep-learning. No harmful effects have ever been attributed to the practice of sleep-study—on the contrary, sleep-learning is applied in mental therapy, for personality improvement and breaking bad habits.

The subconscious mind does not register suggestions, thoughts or ideas discriminately. It accepts everything that is communicated to it. The conscious mind, on the other hand, is constantly in a process of selection and rejection, and does so in a relatively objective manner. That is what makes sleep-suggestion and sleep-therapy such an effective instrument for healing, since only constructive suggestions of a beneficial and positive nature are transmitted to the sleeper.

Negative personality traits, such as unreasonable fears, nail-biting, stuttering, and so on, can be treated by sleep-learning when the patient is asleep. It has been used to overcome nervous insomnia, to break the habit of bedwetting, and even to eliminate the desire for dangerous drugs.

If you have a tape-recorder, you can make an excellent device for sleep-learning, but there are specially-designed tape-machines made for this purpose.* In addition you will need a time-switch to turn the recorder on and off at the desired periods of the night, and an under-pillow speaker which can be plugged into your tape-recorder, permitting the learned material, or therapeutic suggestions, to filter softly into your ears from beneath the pillow. Finally, you will need an automatic continuous tape repeating mechanism, commonly referred to as an 'endless tape cartridge'.

Too good to be true? Not at all. Careful study of the evidence of responsible observers indicates that there is great validity in the claims of sleep-learning.

It can and has been a valuable aid to learning with the conscious mind, but it is not an absolute substitute for conventional study. Where it is necessary to learn by rote lists or facts not in themselves meaningful, sleep-learning seems like an absolute blessing. Most of our basic learning is rote material, absolutely necessary before we can go on to analytical thinking. Sleep-learning can aid greatly in time-saving, the ability to retain knowledge, and your ability to memorise.

Many people today own a tape recorder. I hope I have shown that you can use it, not only for your entertainment, but also to increase your knowledge and to learn more quickly and easily. It will be up to the individual practitioner to use the process wisely.

*Editor's Note: Readers are warned that damage can be caused to the drive transmission of many tape recorders not equipped with solenoid remote-control, if left in a PLAY position with power switched off.

FIFTEEN-per-cent import duty or not, a great many foreign tape recorders are being used in this country. And by foreign, I mean Japanese, Italian and Scandinavian, and exclude our old friends *Grundig* and *Philips*, who are by this time practically naturalised.

There is a deplorable tendency to deprecate all things foreign. Call it insularity, if you like; or be more charitable and say it is a natural pride in British workmanship. Well, I shot off my mouth on the subject of British-made equipment a couple of months ago, so I do not need elaborate on the theme, except to re-state my opinion that the best of British is the best. Correspondingly, a fair amount of the foreign equipment that we have received has been of high quality, and the minority of trash has given the rest a bad name.

Hence the choice of the *Sanyo Micropack* as a subject for discussion this month. Not that it pretends to be the best—for 19½ gns one must

positioning is most important for selection of STOP and REWIND.

Braking is not so vital, as the speed of rewind is only little more than an inch per second, and the construction is such (see diagrams) that the tape is fed over rollers attached to the magazine and remains in contact with the head. Nevertheless, the position of the STOP pin is important to maintain correct clearance and prevent the spool rotation being impeded.

RIGHT-ANGLED MOTOR

The motor spindle is at 90° to the mounting plate when in the STOP position, and the cam should be set for this angle by adjusting the spring, which can be done with flat, long-nosed pliers. As the clearance



BY H. W. HELLYER

TAPE RECORDER SERVICE NO.

SANYO MICROPACK M-35

not expect the moon. But it is typical of much other imported equipment, and presents similar service problems.

A secondary reason for the choice is the recent resurgence of the magazine-loaded 'pocket portable'. The system has its advantages, and considerable disadvantages, as followers of David Kirk's *Field Trials* will have noted. This is not a review, so readers will not expect me to steal any of that diligent gentleman's thunder. Our aim is to describe the works.

First, a few words about what it is, and what it does. This machine weighs only two pounds, has an overall size of 6½ × 3½ × 1½ in., and is energised by four pen-light cells (D14 or equivalent, but preferably Nickel-Cadmium Cells to achieve reasonable playing time). A crystal microphone is used, and the internal loudspeaker is a 2½ in. permanent magnet type, receiving 100mW undistorted (or 150mW maximum) of audio power from the four-transistor amplifier. A fifth transistor is used for motor regulation—to which point we shall return later.

The tape is wound on a 2½ in. spool in a flat pack magazine, giving a total length of 260ft. and a total playing time, half-track, there and back, of 34 min. The method of spooling and re-spooling is shown in my diagrams, for which the makers and importers will be glad to hear I accept full responsibility.

DC BIAS

DC bias is used and erase current is also direct. Provision is made for a magnetic earpiece output. A VU-meter is fitted, and tape speed control is an unusual feature provided by direct control of motor regulation via a knob on the top of the camera-like casing, rather similar to the film winder.

Mechanical operation is quite simple. Rotation of a central knob moves a cam, which operates a slider bar for brake release and application, and tilts the motor toward the driven spool. A spring tends to keep the motor in the RECORD or PLAY position, and thus the cam



between the spools is only 2.5 cm. and the motor tilt from PLAY to REWIND is 20°, it can be seen that care is necessary to ensure good, clean driving. Contact pressure of motor spindle to spool at PLAY is 20 gm. If an exact test is to be made, the motor spring can be adjusted.

For a more stringent bench test, the mechanical tensions can be adjusted to give a constant motor current of 40mA ± 5mA, when the motor voltage is constant at 2.4V. This is a condition equivalent to the factory test of a 50 rpm magazine with a torque of 1 gm/cm.

NO CONVENTIONAL BRAKE

Braking was mentioned above, and it will have been noted that this machine has no brake in the conventional sense. Instead, a 'stopper pin' is also coupled to the cam, and should be flat with the plate when in the STOP position, and have a 5.5 mm. clearance when PLAY or REWIND is selected.

The tape transport system is of some interest, as can be seen from fig. 2. Looking at the relevant parts in plan view, the tape is loaded on the full spool A, comes up over the offset roller B, and passes the tape pressure pad (which is really a guide pad), the erase head and the record play head, then down over the front roller C and is wound on to the driven spool D. The heads are mounted on an angled bracket, and it will be noted that the erase head has an insulating piece between the mounting screws and bracket. Omission of this part will cause the motor to cut out, as the casing of the erase head is used as a return path, and is, in fact, returned to the base connection of the regulator transistor in the motor circuit.

The tape width is $\frac{1}{4}$ in. and it is thus suitable for transcribing, although the 0.1 in. gap length may occasion some adjustment of the playback machine. Recording sense is standard, top track, left to right, but the actual mounting of parts is such as to give bottom track right to left. Any cracks about "the other side of the hemisphere" will be rewarded with an Oriental non-smile.

There is not sufficient space to reproduce the circuit in full; and indeed, it is quite conventional and should need no detailed description. The amplifier consists of two 2SB186 transistors in grounded-emitter mode, followed by a pair of 2SB187 transistors in push-pull, feeding an 8-ohm loudspeaker. The push-pull circuit is conventional, with transformer input and output, the centre-tap of the input transformer being biased by a 2.5K and 200-ohm resistor in series, the base feed

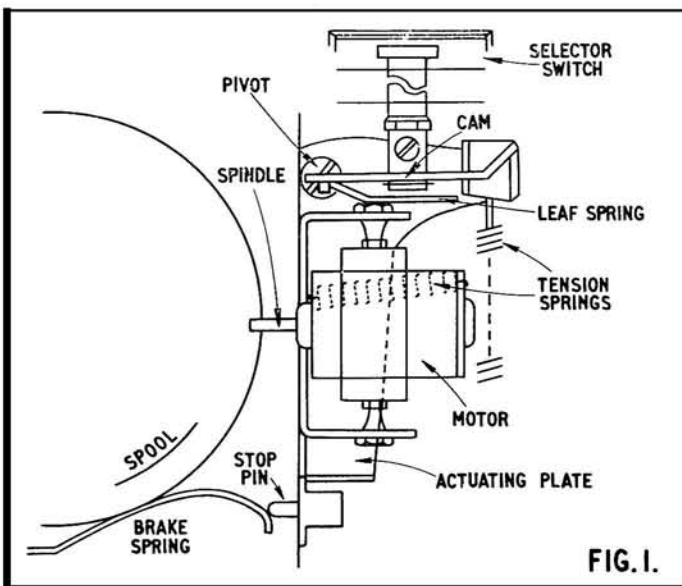

taken from the tapping, and a temperature compensating thermistor fitted across the 200-ohm component. The commoned emitters are taken via a 10-ohm resistor to the 'cut-out' lug of the earphone socket, so that insertion of the earphone removes the emitter load and kills the loudspeaker output. The advantage here is that during recording, the loudspeaker, which is normally in circuit, can either be used as monitor or muted by the insertion of the earphone jack.

The actual earphone output is taken from the primary winding of the input transformer of the push-pull circuit—more correctly, across the collector load of the second transistor. This stage also incorporates the gain control, which operates similarly on both RECORD and PLAYBACK. A tertiary winding of this input transformer supplies a signal voltage, rectified by a 1SA188 diode and applied via a series 100-ohm resistor to the VU-meter.

SECONDARY USE

Metering of the signal is obvious enough, and the secondary use of this meter is to indicate motor voltage. The meter is switched directly across the motor, via a 17K series limiter, during PLAY, the scale being marked appropriately. Fig. 3 shows this method of connection, and also the regulator circuit of the motor. A 2SB272 transistor is employed, shorted by the rewind starter button, and with a 30 μ F capacitor and 300-ohm resistor as charge components. In this way, the charge across the capacitor is maintained reasonably constant by variations in collector current of the transistor for variations of load. The speed control, a 40-ohms resistor, is switched in during RECORD

and PLAY, the motor then being fed from the 3V tapping of the batteries. 6V is applied only during REWIND.

The DC bias is obtained in each case (record and erase heads) by series resistors from the 6V negative line. Bias current when recording should be 250 μ A, and erasing current is 6mA. The resistance of the erase head is approximately 440-ohms.

POSSIBLE FAULT

One fault possibility here, which many users of transistor radios may have met, is a poor contact of the shorting lug of the earphone socket. If the output is distorted, or even non-existent, and insertion

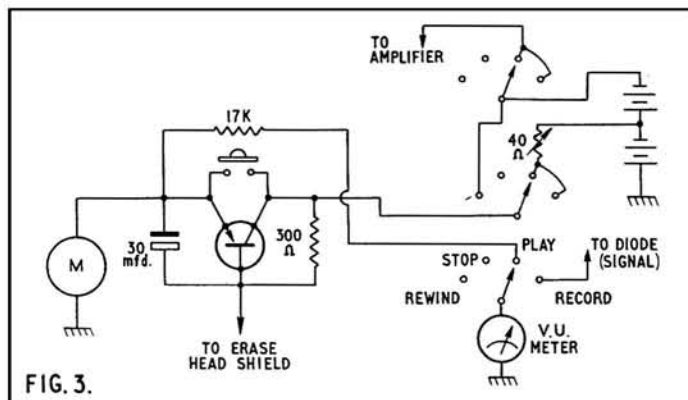
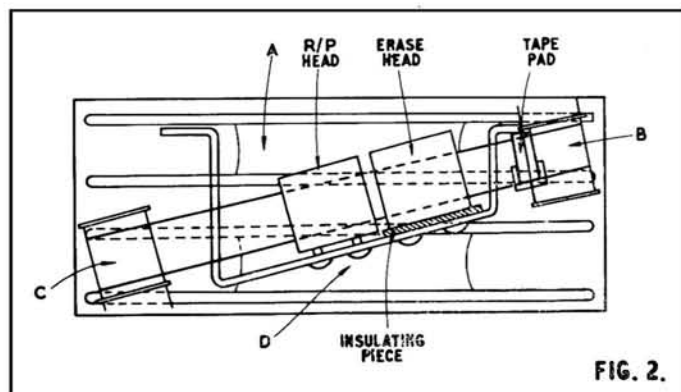

of the earphone gives fair results, do not despair for the output stage: first check on the earphone socket, and temporarily short-circuit the 10-ohm emitter load resistor to chassis to prove the fault. (If in doubt of the appropriate tag, look at the microphone socket and note the blank tag, then the connection from the earphone socket to this resistor is the corresponding one.)

RESIST THE TEMPTATION

First things last: dismantling. The need to mention this became apparent during the writing of these notes, when the re-assembly sequence was fumbled! This is such a compact little machine that one is tempted to take a tin-opener to it in order to disembowel. Resist, and proceed as follows. First, remove magazine, which simply springs into place. Then take off the battery retainer and extract cells. Remove the speed control knob (centre screw) and the selector switch. Again, a central screw—but mind the spring. Then remove the screw which this control conceals (cunning devils), and the two screws at the top rear of casing. A further two screws, at the bottom on each side, allow separation of the casing. Remove the top portion first, and note that the microphone and earphone socket panel slides into place—take care not to break off the leads. Similarly, the meter leads must be treated with care. In case of doubt when re-connecting these, the red is positive and the brown negative.

BRITAIN'S LARGEST SPECIALISTS



As Britain's largest tape recorder specialists, we have on display over 300 models ranging from £15-£250. We are specialists in REVOX, FERROGRAPH, VORTEXION, BRENNELL, AKAI, BANG & OLUFSEN, SONY, TANDBERG and every other leading make of recorder available today.

Our Staff of keen recording enthusiasts offer expert assistance and friendly advice based upon many years experience in selling the finest and best tape recording equipment available.

Our Central London showrooms are easily reached, being close to famous Kings Cross and Liverpool Street Main Line Stations. If you are unable to call send today for our FREE 24 PAGE BROCHURE detailing the tremendous selection of recorders we stock and recommend.

CENTRAL LONDON SHOWROOMS

242/4 PENTONVILLE RD., N.1
Situating only 150 yards from KINGS CROSS Main Line Station, these superb showrooms are the most accessible in LONDON. Simply alight at Kings Cross Station. Ample parking space immediately outside with no restrictions whatsoever. Half-day: Thursday. TERminus 8200.



228 BISHOPSGATE, E.C.2
Almost immediately opposite LIVERPOOL STREET Main Line Station and next door to famous Bishopsgate Institute. Simply alight at Liverpool St. Station. Note: These Showrooms open MON.-SAT. 9 a.m. - 6 p.m. CLOSED ALL DAY SATURDAY. Open Sunday 9.30 a.m. - 2 p.m. BISHopsgate 2609.

ALSO AT

2 MARYLAND POINT STATION (ADJ. STATION), STRATFORD E.15 MAR 5879
205 HIGH STREET NORTH (OPP. EAST HAM STATION) E.6. GRA 6543

Please forward your free brochure to:

NAME
ADDRESS

Send to Head Office: Citex House, 191 Plashet Rd., London, E.13. Dept. T.R.1

CITY & ESSEX TAPE RECORDER CENTRES

book reviews

THE TAPE RECORDER IN THE CLASSROOM. By John Weston, 118 pages, illustrated. Price 5s. Published by the National Committee for Audio-Visual Aids in Education, 33 Queen Anne Street, London W.1.

THIS book is an enlarged edition of a previous one based on a series of articles in the magazine *Visual Education*. It is written for the benefit of school staff who, meeting with a recorder for the first time, wish to know the basic factors of recording and their application in the field of education.

The first 35 pages deal with such topics as "Choosing a Tape Recorder", "Microphones and Tape" and "Care and Maintenance". The author gives practical down-to-earth instruction without assuming a very technical readership. There are several faults, obvious to the average recordist, which might possibly puzzle a beginner. In particular is the error given in a dummy specification which suggests that wow and flutter figures of 0.15% are satisfactory, 0.1% good, and 0.5% very good. To confuse the issue, it is not clear whether these figures apply to particular tape speeds or not.

After covering the elements of recording, the author describes how a recorder and associated equipment can be used to teach languages, instruct backward readers, for speech training and in musical appreciation. This makes interesting reading to the enthusiast and is of great potential use to the teacher.

Towards the end of the book the author returns to the practical side of recording, with tips on editing, using a battery portable, interviewing and so on.

To summarise, apart from a few minor inaccuracies, this book is extremely good value to imaginative teachers and audiophiles interested in learning the many uses of a tape recorder. D.K.

THE TAPE RECORDER by C. G. Nijssen. 142 pages, 57 illustrations and 30 pages of photographs. Price 13s. 6d. Published by Phillips Paperbacks and distributed in the U.K. by Iliffe Books Ltd., Dorset House, Stamford Street, London, S.E.1.

WITH so many books currently appearing on the subject of tape recording, and in particular with re-issues of revised 'standard works' on the subject, it is difficult to see what specific need this translation from the Dutch will fulfil.

The book purports to cater for the rapidly growing number of tape recording enthusiasts. Editorials which have lately appeared in these pages will immediately pose the question: 'What is an enthusiast?' If he is the chap who wants to record the sounds of exhausts in the High Street and edit them into a programme tape, but seldom resorts to anything as highly technical as a soldering iron, no doubt Mr. Nijssen will have a word here and there that can add to the fumes of experience. But it is extremely doubtful that this book has much to offer the chap who can rightfully call himself an enthusiast: much of it is repetition of often-given information. The few pages on more technical subjects appear to have been thrown in as a makeweight. The discussion of pure theory is almost incongruously superficial.

For similar reasons, this book will offer little to the more knowledgeable tape recordist. Indeed, although the original edition in the Dutch is stated to have come out in 1963, this translation adds nothing to the general knowledge of seven or eight years ago. Indeed, although four-track recording is mentioned, triple-play tape considered, and the section on loudspeakers giving a passing glance at Ticonal and Ferroxdure, we find only a brief paragraph acknowledging that transistors are in common use. Also, despite the great publicity given by Philips to four-track facilities of 'Duoplay' and 'Multiplay', only a short paragraph on page 112 gives a hint of the modern machine's scope.

Microphones are very tardily dealt with; a surprising statement that ribbon microphones are seldom found outside a broadcasting studio is almost capped by a following assertion that condenser microphones are 'much used in professional studios' and by implication, only there, despite the fact that they are easily damaged and require a built-in amplifier and also a supply unit (my italics). No mention of the later,

(continued on page 81)

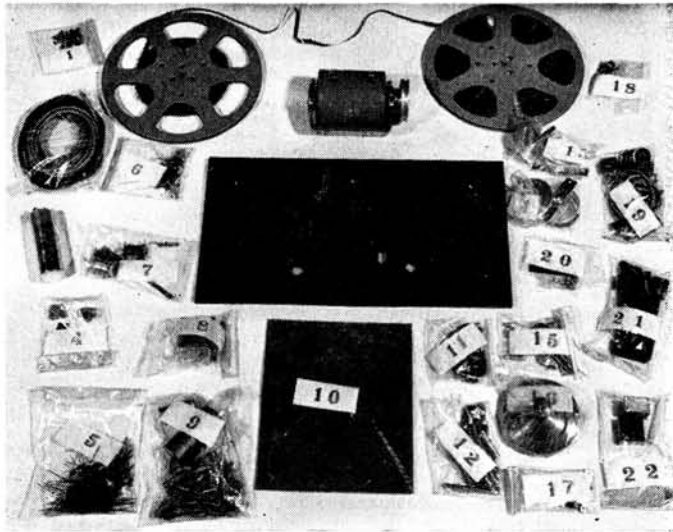

WESGROVE TELEVISION RECORDER

AFTER nearly two years of vague promises, a television recorder of moderate price becomes no longer a subject for the *World of Tape* column but for *New Products*. The *Wesgrove* domestic video recorder outlined in our January issue (page 477) is now on the market in kit form or ready-built. A frequency range of 2 Mc/s is achieved at 90 i/s with a 0.007in. track width, sound being recorded and reproduced through a separate head with a scan of 0.002in. Two video and two audio tracks may be transcribed on to standard $\frac{1}{4}$ in. tape, using permanent magnet erasure. Sound recording is achieved on an FM carrier. Two other speeds, 120 and 150 i/s may be switched for recording 625-line television pictures.

The VKR 500 is designed for use with industrial closed-circuit television systems and recording and reproducing through domestic television receivers. Connection to a receiver entails only minor modifications which can be carried out by a dealer. Alternatively, a television camera may be used, with a microphone, to record one's own programmes.

Magnetic flux density at any point along the recorded track corresponds to the magnitude of the video wave-form at that point. DC bias is fed to the recording heads together with synchronising pulses, which are first passed through a differentiating circuit. The video signal is distorted by a head driver unit which is supplied with the kit in pre-wired and aligned form to ensure constant standard of performance from machine to machine. Also aligned and tested at the factory is the replay pre-

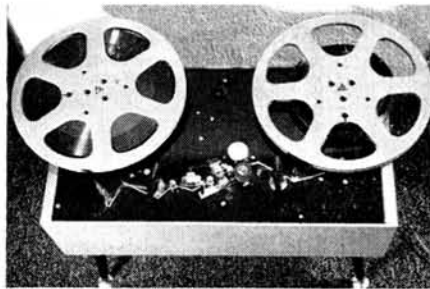

amplifier which feeds an integrator stage with a non-linear input circuit and a series of amplifying and sync' reinsertion stages, after which the signal is fed back into the television receiver or monitor. Layout of the transport mechanism follows conventional systems, the tape leaving the feed spool through a tensioning device, passing over the erase magnet and sound vision heads to the capstan and thence to the take-up spool. The capstan, which is interchangeable to provide different speeds, is belt-driven by a one-tenth horse-power motor. Cost of the VKR 500 is £97 10s. in kit form—£150 as a ready-built

unit. A low-price television camera is planned as an accessory, to sell at under £50. Further information is available from the address below.

Manufacturer: *Wesgrove Electrics Ltd.*, Nash House, New Street, Worcester.

OPTACORD 408 MAINS/BATTERY PORTABLE

HIGHGATE Acoustics are now importing a transistorised tape recorder capable of direct operation from the mains (110/240V, 40 - 60 c/s) and from a 6 or 12V car battery or five $1\frac{1}{2}$ V cells. The *Optacord 408* operates at $3\frac{3}{4}$ i/s with a frequency range from 90 c/s to 10 Kc/s. Wow and flutter are quoted as 0.3% and dynamic range as 46dB. The $\frac{1}{4}$ in. spool capacity gives a playing time of two hours on two tracks, using a 600ft. reel of triple-play tape. Rewind time for this tape length is $2\frac{1}{2}$ minutes.

Facilities for the connection of headphones allow monitoring during recording and replay. Remote control is available as an extra. Independent oscillators provide 55 Kc/s bias and erase current and 100 Kc/s motor control, using a gating transistor and centrifugal switch. The two-tone (grey and silver) cabinet measures $9\frac{1}{2} \times 3\frac{1}{2} \times 8$ in. deep and weighs 4lb. Retail price is £40 19s.

Distributor: *Highgate Acoustics*, 71 Great Portland Street, London, W.1.

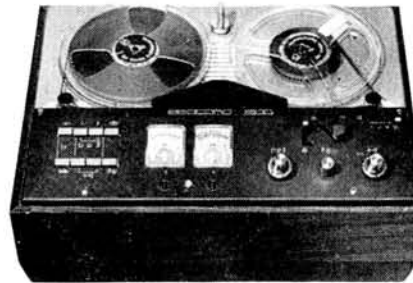

**B. & O.
TAPE
UNIT**

QUARTER-track stereophonic recording, echo, cross-track recording and all the features of the *Bang & Olufsen 2000*, with the exception of mixing and power amplification, are offered by the 1500 tape unit. Twin VU-meters allow independent input gain control on each channel and the price, including import duty, is £93 9s. Distributor: *St. Aldate Warehouse Ltd.*, Electrical and Radio Division, *Innsworth Lane*, Gloucester. (See service note—page 53.)

**MSS
SEND-A-MESSAGE
TAPE**

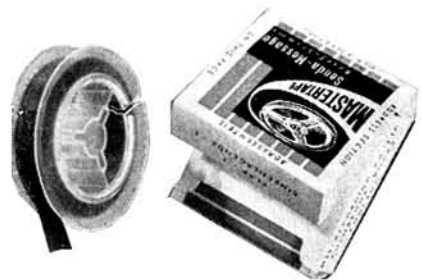

LAATEST innovation from MSS is the *Send-a-Message* tape, offering ten minutes playing time on two tracks at $3\frac{3}{4}$ i/s and selling for 3s. By using Triple Play tape on a $1\frac{1}{4}$ in. diameter polypropylene spool, size and weight have been reduced to less than 0.5oz. including postal pack. This exceptionally light weight lowers the cost of airmail postage to 1s. 3d. (U.S.A.) and 1s. 6d. (Australia). Manufacturer: *MSS Recording Co. Ltd.*, *Poyle Trading Estate*, *Colnbrook*, Slough, Bucks.

"Q"-CORD

R119K 33 Gns NOW 29 Gns } Complete with : dual imp. mike,
200/50. 1200' TP tape, empty 4 1/2" }
203 34 Gns NOW 29 Gns } spool, radio, lead, batteries, cct
and instruction book.

60-10,000 c/s ± 3db. sig/noise 38db. below test level
weight 5lb. 50db. below peak.

3 3/4 I.P.S. NARTB standard, wide tone control, 4 1/4" spools,
over 2 hours recording time, 2-track. Heads by Bogen, AC
bias and erase. Straight through amplifier.

Accessories, headphones, remote control mike, foot control
accumulator, mains adapters, 110V-240V AC.

Delivered anywhere in the U.K. carriage and insurance paid.
6 months FULL GUARANTEE—NO LABOUR COSTS.

NO INCREASE!!! Reduced 15%. Both machines
"NOW" 29gns.!!! Hurry whilst present stocks last!!!

We are passing on to you the benefits from our anticipation
prior to the surcharge!!! Still supplied with all basic
accessories.

Write now for full details to :

C. Braddock Limited

266 Waterloo Road, Blackpool, Lancs.

Telephone : 45049

TAPE RECORDER COVERS



Smart waterproof cover to give complete protection to your tape recorder. Made from rubberised canvas in navy, wine, tan, grey and bottle green with white contrasting pipings, reinforced base, handy zip microphone pocket and name panel.

Philips EL3538	...	63/-
" EL3542	...	63/-
" EL3536	...	70/-
" EL3515	...	57/6
" EL3541/15	...	57/6
" 3541/H	...	72/-
" Starmaker...	...	66/-
Cossor 1602	...	57/6
" 1601	...	63/-
" 1604	...	79/-
" 1605	...	84/-
Stella ST455	...	63/-
" ST454	...	57/6
" ST458	...	79/-
" ST459	...	84/-
Saba	...	63/-
Elizabethan FT.1	...	66/-
" FT.3	...	75/-
" LZ29	...	75/-
Fi-Cord IA	...	52/6
Fidelity Argyle	...	55/-*
Clarion (with strap)	...	52/6
Brenell Mk.5	...	77/-
" 3 star	...	69/-
Truvox R92 and 94	...	99/-
Robuk RK.3	...	67/6
Ferroglyph	...	88/-
Sony 521	...	90/-
Revox	...	84/-
Optacord 414+412	...	63/-

* Without pocket

A. BROWN & SONS LTD.

24-28 GEORGE STREET, HULL. TEL. : 25413, 25412

FRANCIS OF STREATHAM

MAINS OPERATED TAPE RECORDERS

B & O Stereomaster	...	112 gns.
*Brenell Stereo STB I	...	£120
*Brenell Mk. V Model M	...	88 gns.
*Brenell Mk. V Series 2	...	69 gns.
Cossor 4 Tr. 1604 2 sp.	...	39 gns.
Cossor 4 Tr. 1605 4 sp.	...	62 gns.
Cossor 1606 4 Tr.	...	29 gns.
Cossor 1607 Stereo 4 Tr.	...	57 gns.
Elizabethan LZ24	...	34 gns.
Elizabethan Auto	...	26 gns.
Elizabethan LZ29	...	39 gns.
Elizabethan 511 4 Tr. St.	...	65 gns.
*Ferroglyph 422 or 424	...	110 gns.
*Ferroglyph Series 5	...	85 gns.
Fidelity Major	...	35 gns.
Fidelity Playmaster 2 Tr.	...	20 gns.
Fidelity Playmaster 4 Tr.	...	23 gns.
Fidelity 2 Tr.	...	21 gns.
Grundig TK14	...	35 gns.
Grundig TK18 "Magic Ear"	...	39 gns.
Grundig 23A Auto	...	49 gns.
Grundig TK40 4 Tr.	...	75 gns.
Grundig TK41 2 Tr.	...	75 gns.
*Grundig TK46 4 Tr. St.	...	99 gns.
Philips 4 Tr. 3549	...	62 gns.
Philips 4 Tr. Stereo 3534	...	92 gns.
Philips 3548 4 Tr. 2 sp.	...	39 gns.
Philips 2 Tr. Auto 3552	...	24 gns.
*Refectograph "A" 1/2 Tr.	...	105 gns.
*Revox T36	...	£139.19.0
Robuk	...	36 gns.
*Saba Stereo	...	95 gns.
Sony 200	...	72 gns.
Sony 500	...	105 gns.
Stella 458 4 Tr.	...	39 gns.
Stella 459 4 Tr.	...	62 gns.
*Tandberg Series 6	...	110 gns.
*Tandberg Series 7	...	93 gns.
Telefunken 55	...	43 gns.

T'berg Series 8 Mono 2 Tr.	54 gns.
T'berg Series 8 Mono 4 Tr.	59 gns.
*Telefunken 85 de luxe	83 gns.
*Telefunken 96 4 Tr.	69 gns.
*Telefunken 97 4 Tr. Stereo	95 gns.
*Telefunken 98 1/2 Tr. Stereo	95 gns.
*Vortexion WVA	£92.13.0
*Vortexion WVB	£110.3.0
*Vortexion CBL Stereo	£160.0.0
Wyndors Sabre	23 gns.
Wyndors 707 2 Tr.	27 gns.
Wyndors 708 4 Tr.	32 gns.
Truvox R.92 2 Tr.	69 gns.
Truvox R.94 4 Tr.	69 gns.
*Truvox PD.93 or PD.95	59 gns.
*Truvox PD.97 or PD.99	79 gns.

BATTERY PORTABLES

Grundig TK6	...	65 gns.
Cossor 1621	...	26 gns.
Loewe Opta 414	...	51 gns.
Loewe Opta 408	...	39 gns.
Fidelity Playmaster	...	21 gns.
Grundig EN3 Notebook	...	25 gns.
*Butoba	...	59 gns.
*Fi-Cord 202	...	66 gns.
Philips EL3300	...	25 gns.
Philips 3586	...	25 gns.
Stella 471	...	26 gns.
Uher 4000S	...	103 gns.
Telefunken 300	...	59 gns.

*Microphone extra

MAINS POWER PACKS

Philips, Stella or Cossor	...	£5.12.0
Butoba	...	11 gns.
Fi-Cord	...	£7.10.0
Uher 4000, small accum'r	...	18 gns.

Tape Decks by Brenell,
Wright & Wearite

Tape to disc and copy service.

LEADING STOCKISTS OF EQUIPMENT FOR TAPE and HI-FI

... and NO EXTRA FOR CREDIT TERMS

- ★ Minimum Deposit
- ★ No Interest or Service Charges on H.P. up to 18 months
- ★ Free Service during Guarantee Period

● MICROPHONES, MIXERS, ETC.

Grampian Reflector	...	£6.15.0
Grampian Ribbon	...	£11.10.0
Grampian DP/4 Dynamic	...	£8.5.0
Simon "Cadenza" Ribbon	...	£10.10.0
Reslo Pencil Dynamic	...	£11.12.6
Reslo Ribbon	...	£10.12.6
AKG D.119	...	24 gns.
AKG Stereo D.77A	...	£15.10.0
AKG D.19C	...	£17.10.0
TSL Jch. Transistor Mixer	...	£2.17.6
Eagle Mixer	...	£2.19.6
Grundig Mixer Stereo	...	18 gns.
AKG K 50 Headphones	...	£7.10.0
Philips Pre-amp	...	£6.10.0

Also in stock: microphones by
ACOS, FILM INDUSTRIES,
TELEFUNKEN, BEYER, etc.

All WALGAIN PRODUCTS

● TAPES & ACCESSORIES

Standard, Long, Double, Triple Play in
all sizes by all leading makers.

● DELUXERS BY WEARITE, WALGAIN

● Pre-recorded Tapes by Columbia,
H.M.V. and all E.M.I. Labels, Saga,
Tutor-tape, etc.
Bib, Bond and E.M.I. splicers. Matching
transformers. Plugs, sockets, etc.
Prices subject to alteration as announced
by manufacturers.

● STANDS OF ALL TYPES

169-173 STREATHAM HIGH ROAD, LONDON, S.W.16

Between St. Leonard's Church
and Streatham Station

STReatham 0466/0192

Please note this is our only address
OPEN ALL DAY SATURDAY—EARLY CLOSING WEDNESDAY

HI-FI DEPT.

● STEREO AND MONO AMPLIFIERS

Quad Pye Rogers Cadet Mk III
Leak Armstrong Tripletone
Scott Loewe Opta B & O, CSL

● TUNERS

Quad Rogers Pye Leak
Armstrong B & O Tripletone

● LOUDSPEAKERS

Quad Pye Rogers W.B. Kef
Wharfedale Goodmans Tannoy
Lowther Leak Elac Eagle Kelly

B & O, SHB, Tandberg

● MOTORS, PICKUPS

GARRARD incl. Acos
AT6, 401, etc. Thorens

Goldring Tannoy EMI
Connoisseur LencoShure

DECCA incl. Ronette
ffss Mk. III lat-
est Deram, etc. B & O

Philips SME Mk. II
Ortofon ADC BSR

All types of Diamond and Sapphire
stylis, stereo and mono. Microflits,
Garrard, Goldring, and Acos Pressure
Gauges. Disc Preener. Acos Dust
Bug. Cabinets by Record Housing
and G.K.D.

equipment reviews

THIS recorder is primarily designed for educational applications.

The 70V output, for example, may be unfamiliar to readers of this magazine, but it is standard practice in public address work or any system where a large number of speakers are to be fed from a single unit. The speakers used are of about 3K impedance and usually incorporate their own volume controls. The heavy negative feedback maintains a constant voltage irrespective of the speaker load, up to a limit set by the available power output.

A *Wearite* type 5A tape deck is used with specially developed transistor record and play circuits. Separate record and play heads and amplifiers are used so that it is possible to monitor the recorded quality and level, during recording. An 'A - B' switch allows instant comparison between incoming and recorded signals.

The cabinet is finished in light oak, and a large carrying handle is fitted so that the considerable weight may be shared by two people.

The very wide range tone controls allow the best use to be made of recordings with widely differing characteristics, and poor room acoustics can often be overcome by judicious use of these controls.

SPEAK FOR THEMSELVES

The fluttergrams of *fig. 1* illustrate once again the much improved performance of the 5A deck with its smaller diameter capstan and high speed flywheel. There is little that need be said about these traces, as the figures speak for themselves. RMS readings from 0.05% to 0.07% are excellent by any standards.

The playback responses (*fig. 2*) were tested by playing 70 and 100µS test-tapes at 7½ i/s, and 140 and 200µS test-tapes at 3¾ i/s. It will be seen that the most level response at 7½ i/s is given by the old CCIR standard of 100µS, and the most level response at 3¾ i/s with the new CCIR-DIN standard of 140µS.

These responses were taken with the tone controls at zero, and the dotted curves could be brought level by a very slight touch of the bass and treble controls. System noise with no tape running was 35dB below test-tape level.

The record/play responses were equally satisfactory and are shown in *fig. 3*. There is a slight extra fall-off in extreme bass response. These responses were also taken with the tone controls at zero and it was confirmed that the specification figures of ±12dB at 15 Kc/s, and ±14dB at 50 c/s, could be obtained at the extreme settings of the controls.

JUST PERCEPTIBLE

A level 12dB above test-tape level was recorded at the 80% reading of the recording level meter, and 100% level, corresponding to full scale, resulting in only just perceptible waveform distortion of the test 500 c/s signal. This peak signal was erased on the machine and the ratio measured as 49dB. Bulk erased tape was compared to the machine erased tape with no change of meter reading but with a just discernible hiss increase on the tape erased on the recorder.

Music recorded via the auxiliary input jack was beautifully crisp and clean at both speeds, showing that the bias had been properly set for minimum distortion and intermodulation. On the internal speaker,

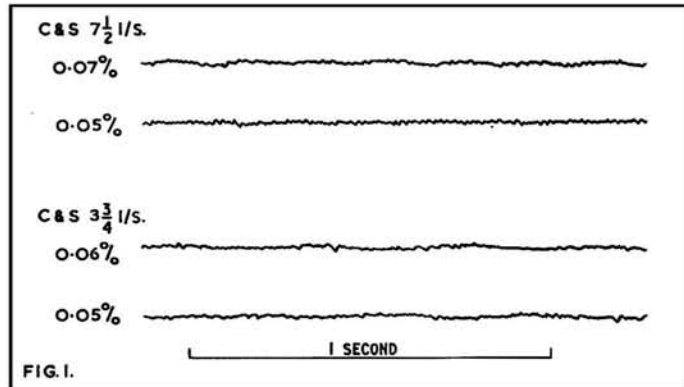

FIG. 1.

CLARKE & SMITH TR 634



MANUFACTURER'S SPECIFICATION: Transistorised 1-track tape recorder. Mains Supply: 200-250V AC. Consumption: 120W. Tape Speeds: 7½ and 3¾ i/s. Spool Capacity: 8½ in. Spooling Time: less than one minute for 1,750ft. Track width: 0.095 in. Wow and flutter: better than 0.16% at 7½ i/s, better than 0.2% at 3¾ i/s. Frequency response: 50 c/s to 15 Kc/s at 7½ i/s ±3dB, 50 c/s to 9 Kc/s at 3¾ i/s. CCIR recording characteristic. Replay characteristic 120 : S. Tape distortion: 3% third harmonic at 1 Kc/s for peak recording level. Signal-to-noise ratio: 50dB unweighted at 7½ i/s. Output power: 10W with 1% distortion at 1 Kc/s. Bass and treble tone controls. Inputs: (a) 1mV at 300K (high impedance microphone). (b) 10mV (low impedance microphone). (c) 60mV at 0.5 Meg. Inputs a or b may be mixed with input c. Outputs: (a) 15 ohms. (b) 70V line. (c) 1V peak at 5K. Internal loudspeaker: 9 x 5 in. Dimensions: 10 x 17½ x 17 in. Weight: 46lb. Price: £108 3s. Manufacturer: Clarke & Smith Manufacturing Co. Ltd., Melbourne Road, Wallington, Surrey.

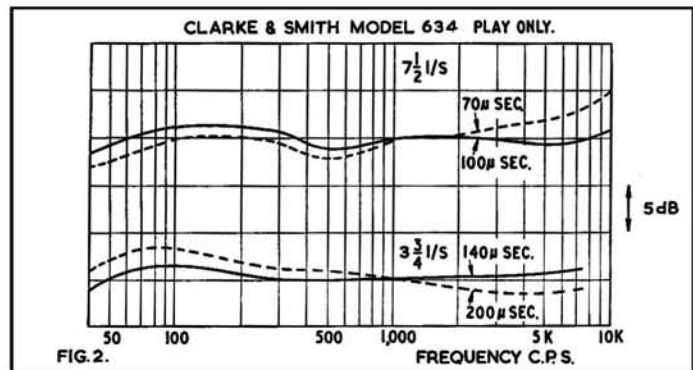

FIG. 2.

it sounded slightly thin with the tone controls at zero, and almost full bass lift was required to give a pleasing balance. A glance ahead to *fig. 5* will show that this is due to the internal speaker-cabinet response. When the music was played into a wide-range external speaker the balance was completely satisfactory with the tone controls centred.

Speech quality inputs, via the alternative microphone sockets provided, were much less satisfactory. Hiss level was extremely high on both high and low impedance inputs, and the bass response was markedly down. This was to be expected on the crystal microphone as the specified input impedance of 300K is not nearly high enough for such a microphone, but there seemed no obvious reason for the bass loss on the low impedance input.

A very low impedance signal source was injected in series with the crystal and moving-coil microphones respectively, and the responses plotted on the 'direct' monitor switch position to give the curves shown in *fig. 4*. The signal source was not earthed and great care was taken to see that no part of the balanced low impedance transformer primary

(continued overleaf)

YOU GET MORE FOR
YOUR MONEY with



MASTERTAPE

... without doubt the lowest cost high grade tape available today! Full range of Standard, Long, Double and Triple Play available at realistic prices.

NATIONALLY DISTRIBUTED BY VIDOR AND AVAILABLE AT YOUR LOCAL RADIO SHOP

Manufactured in England by
M.S.S. Recording Co. Ltd., Colnbrook, Slough, Bucks.

**EXCITING—INEXPENSIVE—EASY TO LEARN
LANGUAGES ON TAPE BY
LANGUATUTOR**

Globetrotters, Business Men, Students and Holidaymakers learn Languages on Tape with Languatutor. Why? Because our experienced Tutors and Nationals teach you to speak the Language of your choice naturally, without effort, and with the correct pronunciation, in the shortest possible time. Languatutor really do make Languages Exciting—Inexpensive—and Easy to Learn.

**FRENCH · GERMAN · ITALIAN
RUSSIAN · SPANISH**

Costs per language—(Twin Track 3½ips) One 5" spool 90/- or Two 4" spools 97/6.

LANGUATUTOR RECORDINGS LTD.

(Dept. TR2), Milton Street, Brixham, S. Devon

Enquiries also invited from the Trade, Schools and Colleges.

for the best
bargains read

**THE
EXCHANGE
& MART** **6d**
EVERY THURSDAY

Britain's bargain weekly

BRAND NEW 100% TESTED RECORDING TAPES

MANUFACTURED BY FAMOUS BRITISH FIRM

Fitted Leaders and Stop fails. All boxed and suitable for 2 or 4 track recorders at any speed.

Our guarantee is in writing with all orders (it has never even been requested)

	Size	Length	P.V.C. Craytherm	P.V.C. Poltray
STANDARD PLAY ...	3"	250'	2/6	2/3
	5"	600'	9/-	8/-
	5½"	900'	11/6	10/-
LONG PLAY ...	7"	1200'	16/-	12/-
	3"	225'	3/-	2/9
	4"	450'	6/-	5/6
DOUBLE PLAY ...	5"	900'	11/6	10/-
	5½"	1200'	16/-	12/-
	7"	1800'	23/-	15/6
EMPTY SPOOLS ...	3"	400'	6/-	5/-
	4"	600'	8/6	8/-
	5"	1200'	21/-	14/6
	5½"	1800'	24/-	19/-
	7"	2400'	39/-	24/-

3" 9d 5" 2/- 5½" 2/3 7" 2/6

Post and Packing 1/- per spool, 4 or more post free.

The above tapes are only available at these prices from:

N. Walker, 28 Linkcroft Ave., Ashford, Middx. Tel: Ashford 53020

CLARKE & SMITH TR634 REVIEW CONTINUED

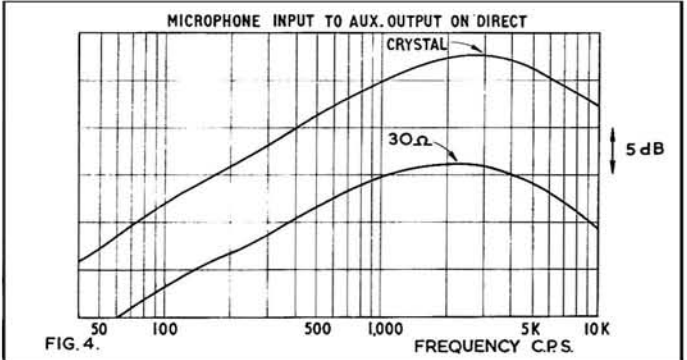
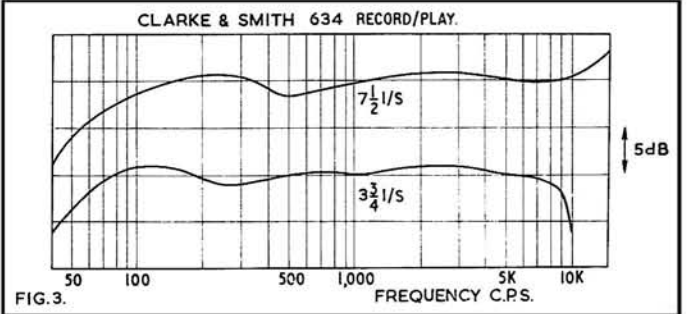

was short circuited by the test set up. Signal/noise ratios on either microphone input were only 30dB due to the high transistor noise.

One third-octave bands of filtered white noise were recorded at 7½ i/s, and the sound output measured on the speaker axis with a calibrated microphone. The resultant response is shown in fig. 5. The bass fall is smooth and of a form which can be easily compensated by the bass tone control. The broad dip in the mid high frequency response can not be dealt with by the tone control and it may lead to slight lack of 'presence' if speech recordings are played in an average class room.

COMMENT

The high noise level on microphone inputs is obviously due to a faulty input transistor. The lack of bass response may also be due to the same faulty transistor, as noise and low input impedance often go together, but I feel that these input circuits need further investigation.

Although the low impedance microphone input is plainly labelled 'balanced' in the specification and instruction book, I could find no reference to the type of input jack plug to be used. Surely it should be of the three contact GPO type?

Apart from the input circuit fault, the recorder is well suited to its purpose, and I can thoroughly recommend it to Education Authorities and teachers for school work. The deck is of proved trustworthiness; the transistor circuits are generally more reliable than valves, and are certainly less fragile, and the cabinet is robust and well designed for school use. A. Tutchings

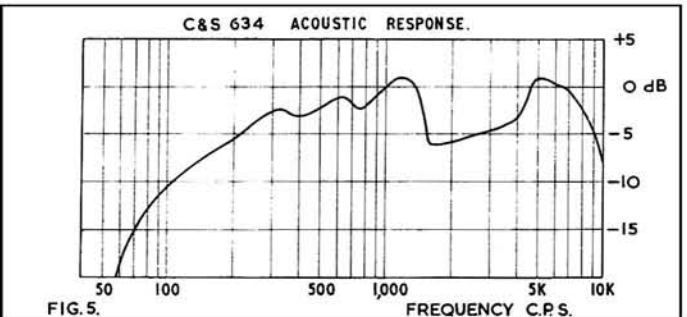

GRAMPIAN REVERBERATION UNIT

USING sophisticated transistor techniques, *Gramplan* have produced in the 636 a simply-operated, self-contained and truly portable "echo-chamber". Musicians, recordists, producers and artists, professional and amateur alike, not forgetting the keen home-concert giver, will welcome this unit, with its attractive styling and multiple applications. For besides its main purpose—reverberation—we have on three simple controls a high-gain microphone amplifier to 600 ohms and an effective mixer, all without power-supply demands or hum problems.

There are two input channels (see Schematic, fig. 1) and after mixing, two signals are derived; one drives the spring delay-lines—the heart of the equipment—via a push-pull class-B amplifier, while a second similar signal by-passes the lines, feeding the output amplifier stage directly to give a 'straight' mixer-amplifier with the reverberation control at zero.

Connecting sockets, all standard GPO Jacks, are grouped in pairs above the appropriate control-knobs with not merely their functions clearly marked, but also levels and impedances. Two microphone-jacks feed a high grade internal transformer (Mu-metal-potted), and ingenious back-contact switching presents the full primary to either plug on insertion, for balanced (pip-ring-sleeve) or unbalanced cable. They are not for simultaneous use, though if all three primary leads are required in 'floating balance', i.e., centre tap not earthed, then a second empty plug inserted in the unbalanced jack does the trick. In this case any screening-braid used must be earthed to chassis, e.g., via the sleeve of the dummy plug, and *not* left joined to the sleeve of the p.r.s. balanced jack-plug, as sleeve is still through to centre-tap, though lifted from earth.

The auxiliary channel also has two input-jacks accepting unbalanced low- or high-level signals, and again they are intended only for alternative use, but here neither jack-plug cuts off the other's signal, so a resourceful stage-manager, fitting a 1 Meg. resistor into his low-

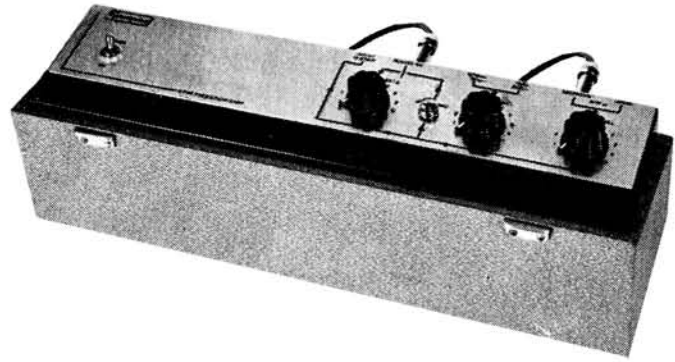

MANUFACTURER'S SPECIFICATION: Transistorised artificial re-verbation generator. **Reverberation method:** mechanical delay lines (two springs). **Transmission delay times:** 29 and 37 mS. **Reverberation time:** 2 seconds total at 300 c/s. **Direct/reverberation ratio:** 1 : 1 maximum. **Frequency response:** Direct signal: 35 c/s - 20 Kc/s \pm 2dB. **Reverberation path:** restricted 100 c/s - 6 Kc/s \pm 3dB. **Input channels:** Low-impedance microphone and auxiliary. **Microphone channel:** Balanced and un-balanced lines via two alternative standard Jack sockets, 25 ohms (200 or 600 ohms to order). **Sensitivity:** 20 μ V on 25 ohms; overload level - 25mV. **Auxiliary channel sensitivity:** 10mV at 50K, overload - 300mV; or 500mV at 1 Meg, overload 15V, unbalanced, via two standard Jack sockets. **Voltage gains (maximum):** Microphone channel: 94dB; auxiliary inputs: 40dB and 6dB. **Interaction between controls:** 1dB. **Noise (reverberation full on), both channels open:** -48dB; auxiliary only: -65dB referred to full output, i.e., 1V at 600 ohms (direct signal only, 300mV output). **Power supply:** Two 9V dry batteries, Mains unit available. 50mA consumption on speech and music. **Dimensions:** 17 $\frac{1}{2}$ x 5 $\frac{1}{2}$ x 6 $\frac{1}{2}$ in. complete with batteries and lid. **Weight:** 12lb. **Finish:** Panel satin silver-black, in wooden carrying case with grey Vynide covering. **Price:** £49. **Manufacturer:** Gramplan Reproducers Ltd., Hanworth Trading Estate, Feltham, Middlesex.

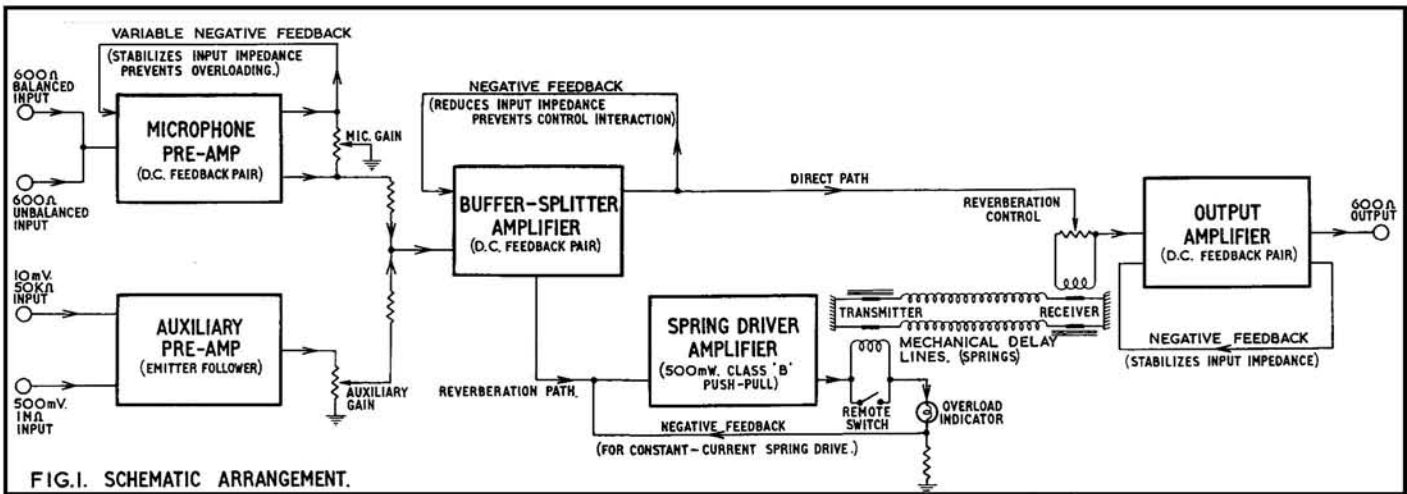

FIG. 1. SCHEMATIC ARRANGEMENT.

level plug, might successfully mix two high-level music sources with local volume-controls and use the auxiliary channel control proper as main fader under voice. This calls for a word in season:

Both direct and reverberation-drive signals are determined by your input levels and settings, and overloading of the first stages and/or the spring-drive will occur if the signals—or the settings—are too high. Risk of first-stage distortion has been minimised in the design by good, stable feed-back arrangements, but if the channel knobs need to be set unduly low before the overload-lamp ceases to glow, a resistive loss, as mentioned above, must be used to reduce inputs to around the levels on the sockets. At the other extreme, the signals must be sufficient for a glow to be in the lamp on sustained peaks, otherwise the springs will be badly under-driven, their full reverberations not realised, and up will come the noise.

It is best to set-up the unit to accommodate incoming levels at knob-positions around 3 - 5, keeping just under the onset of overload glow; the voltage at the output jack then reaches a quarter of a volt without distortion. Advancing the 'reverberate' knob, again to between 3-5, will now add to this direct signal a comfortable amount of clean, full reverberation without 'muddying' speech or music—it is hardly ever

desirable to advance the knob to its full 10. The added sound raises the output level, which can peak to 1V without internal overload; if this level is too high for subsequent amplifiers, recorder, etc., it must be adjusted by use of their appropriate inputs and controls, *not* by varying the Gramplan Unit controls.

The frequency-response of the unit to the direct signal is substantially flat—see curve D (direct) on fig. 2—with a useful slight bass-end loss and treble rise; this gives a little dialogue-filter action, useful for drama and films without being at all objectionable on good music signals. Owing to the differing delays of the two springs, and to multiple reflections, signals at all phase-angles appear when the reverberation is added, and do not admit of direct interpretation in terms of 'flatness' of frequency-response. The curve with reverb on is in fact a series of considerable peaks and troughs (as indeed is the response of an empty room!), and Messrs. Gramplan have kindly provided a graph (fig. 3) plotted with the *Bruel & Kjaer* fast-response auto-recorder which clearly shows this effect.

So with the interests of musicians as well as technicians in mind, the matter of response was approached differently, by plotting the time
(continued overleaf)

Tape Recorder

get tape recorder regularly
 Make sure and order your copy from your newsagent NOW! or use the coupon below and have Tape Recorder sent to your home by post each month

ORDER FORM

TO 'TAPE RECORDER', LINK HOUSE,
 DINGWALL AVENUE, CROYDON, SURREY

Please send me a copy of 'Tape Recorder' every month for **months**

commencing with the **issue**

for which I enclose remittance value

NAME.....

ADDRESS.....

POSTAL RATES

GREAT BRITAIN: POST PAID FOR 12 MONTHS 30/-, 6 MONTHS 15/-

OVERSEAS: POST PAID FOR 12 MONTHS 32/6, 6 MONTHS 16/3

GRAMPIAN REVIEW—CONTINUED

taken by each note of the chromatic scale to die away until just inaudible. In curve R, fig. 2, we have an indication of the 'response' of the spring-unit, following excitation by a half-second note of a constant input at the fundamentals actually met in music. The part within the dotted lines (100 c/s 6 Kc/s) is the range to which the reverberation-path is deliberately limited by the makers, and the corresponding piano-pitch is shown above the graph (though the correspondence is only approximate). Reverberation-control was set to maximum for this test, and the two longest peaks of reverberation, 1 and 2 on middle- and tenor-C are seen to agree closely with two well-marked peaks in the Bruel & Kjaer curve.

The makers emphasise that this unit is not intended to give repetitive, 'flutter-echo' effects as in tape-loop working, featured prominently by pop-music groups, though a 12 c/s flutter did occur on certain impulse-waves by lateral shaking. In common with tape-echo devices, however, the Grampian is provided with a socket for remote muting of the reverberation; closing of the distant switch-contact short-circuits the transmitter-coil, leaving only the direct signal.*

Now there is no provision to mute the direct signal; one chooses between direct alone, or plus varying amounts of reverberation, whereas in special cases, e.g., endings of light-music records (and not

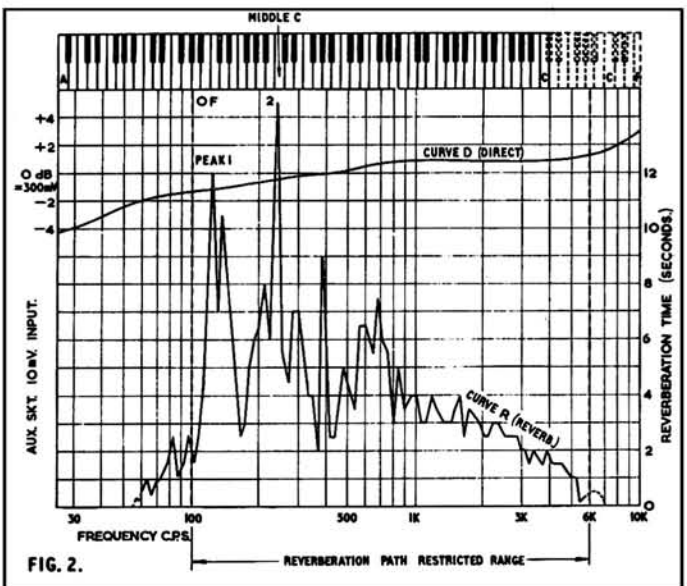

FIG. 2.

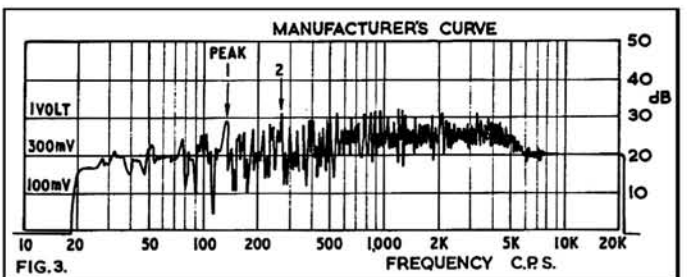

FIG. 3.

Fig. 3. Combined direct and reverb. response curves

forgetting the last movement of Holst's *The Planets*!) one wishes to leave on the reverberation only. The professional recordist will not wish the presence of extraneous direct signal from his "Echo-return" line to upset a previous balance whenever reverberation is added, and the hidden speaker in the living-room (or at an Audio Fair?) to add a 'Cathedral-roll' to choral/organ works at selected moments will soon give itself away with bursts of direct signal each time. I feel sure that customers will ask for the option of silencing it—in fact a suitable control might be better viewed in reverse, i.e., as a means of adding the direct signal—for the groups who are expecting it by analogy from the tape-loop boxes, and for those with simple recording set-ups who do not wish to occupy a mixer-input solely to pass direct signals. With the control one could also reduce the output if forced to work

into a sensitive following input; as it stands the unit has to put out a high level in the interests of adequate spring-drive, and the direct/reverberation ratio is limited to 1 : 1.

These points are emphasised as possible improvements to a unit whose quality of reinforcement is quite up to that of echo-vaults in daily professional use; for comparable reverberation-times I think it equal in sound to the big broadcasting echo-plate used at so many studios (no initials, but many will recognise it—as large as a grand-piano on its side and nearly as heavy). The unit avoids the synthetic quality of all but the very best devices, and is altogether a most attractive instrument.

To end with a carp and a warning: (a) being so nicely boxed, one would prefer chrome coin-slotted screws at the rear for battery replacement, rather than 2 BA hexagonal bolts; (b) the box is remarkably insensitive to tapping, but do not place the whole on foam-rubber over loose floorboards or otherwise shake it about, or that stage-manager will suddenly get an unwanted thunder-effect of clashing springs—the noise is simply disastrous !

B. R. J. Plumtree

* *Gramplan inform us that this facility is available to special order—ED.*

A SPOT OF TROUBLE CONTINUED

isolated your carriage for immediate decontamination.

1st MAN: What's she talking about ?

2nd MAN: I've no idea.

VOICE: (continuing) You are suffering from a deadly and virulent disease which has just entered the country. But have no fear.

First, take off your clothes.

1st MAN: } (in unison) Our clothes ?

2nd MAN: }
VOICE: (continuing) Leave every article of clothing in the carriage. You will then proceed, on foot, across the field to our portable decontamination centre. A team of highly-trained nurses are ready and waiting.

1st MAN: (anxiously) Wait a minute—we can explain—

2nd MAN: (joining in) It's all a misunderstanding—

VOICE: (continuing) Do as you're told. Your carriage will be incinerated very shortly, and it is essential that your clothes are destroyed with it.

2nd MAN: (angrily) This is ridiculous. I am the innocent victim of a practical joke—my face is covered in wrinkles, not spots.

1st MAN: (alarmed) He is right, we're quite harmless. We will sue you for insulting behaviour—

VOICE: (firmly) Do as I say immediately. We know what we are doing, the health of thousands is at stake. An epidemic must be prevented.

1st MAN: }
2nd MAN: } (together, frantically) { This is inexcusable, we refuse. Look, my spots pull off. I demand to see the police . . .
} { Nonsense! We are harmless and innocent. How dare you make such suggestions. I will . . .

(Fade out)

BOOK REVIEWS CONTINUED

improved condenser microphones, or transistorised pre-amplifiers.

The book was searched diligently, and the sparse references to 'mixing boxes' almost overlooked. Again, a short chapter on stereophony barely touches the edge of the subject. It would have been more in keeping with the author's stated terms of reference had more weight been given to mixing techniques, tape recorder circuitry, even in a rudimentary fashion, loudspeaker and additional amplifier advantages and methods of connection, and a review of some of the more frequently used terms in the medium.

This is the price any book must pay for trying to be too comprehensive. The overall effect is that of thinly spread jam on a chunk of stale bread. Only the inquisitive beginner will find his appetite whetted. Readers of this magazine, for example, are not likely to learn a great deal from these twelve chapters, and would gain little from the illustrations except the impression that the term 'tape recorder' was synonymous with Philips. H.W.H.

REPS R10 MkII VERSION

AN IMPROVED MODEL IS NOW AVAILABLE MAINTAINING A HIGH STANDARD OF PERFORMANCE

Exclusive professional type idler wheel for reliability and reduced wow.

D.C heating on pre-amp valves.

Modified Magnavox Studio deck with improved wow/flutter.

Bogen micro-gap two or four track heads fitted.

10 watts nominal R.M.S. Rating.

Calibrated Bass and Treble controls

Mic. Gram/radio inputs, separate controls for mixing.

7½ i.p.s. 40—15,000 C.P.S. ± 1dB 100µS }
3¾ i.p.s. 40—10,000 C.P.S. ± 2dB 200µS } to C.C.I.R.
1⅞ i.p.s. 50— 5,000 C.P.S. ± 3dB 400µS }

5 ECC83. 2 EL84. 1 ECC82. 2 Contact Rectifiers.

Pre-amp Signal/Noise > —55dB at all speeds.



Fully illustrated literature available on request to—

2 Track 59 gns.
4 Track 69 gns.

REPS (TAPE RECORDERS) LTD.

44 Packington Road, Acton,

London, W.3

Phone: Acorn 4141

Hi-Fi News

Britain's best magazine
for the hi-fi enthusiast

REGULAR FEATURES INCLUDE

- ★ Details of new products
- ★ Hi-fi equipment reviews
- ★ Readers' problems answered
- ★ Stereo record reviews



Hi-Fi News

2'-
MONTHLY

Published on the 28th
of the month.
From newsagents and
bookstalls or 2/4 (pp)
from Link House,
Dingwall Avenue,
Croydon, Surrey.



AUDIO FAIR 22nd to 25th April. We are exhibiting under ideal acoustic conditions at the TAVISTOCK HOTEL. Regular recorded concerts to demonstrate not only our tape—free samples available—but other first class equipment, including Woollett speakers and Jobo turntables.

DE VILLIERS (Electronic World) LTD., 16D Strutton Ground, London, S.W.1

STANDARD PLAY (PVC Base)		LONG PLAY (Prestressed Polyester Base)	
3" / 150ft.	4 for 18/-	3" / 225ft.	4 for 22/-
	48/- doz.		60/- doz.
4" / 300ft.	4 for 26/-	4" / 450ft.	2 for 21/-
5" / 600ft.	2 for 26/-	5" / 900ft.	2 for 35/-
5½" / 900ft.	16/-	5½" / 1,200ft.	24/-
7" / 1,200ft.	19/-	7" / 1,800ft.	31/-
DOUBLE PLAY (Prestressed Polyester Base)		TRIPLE PLAY (Prestressed Polyester Base)	
3" / 375ft.	2 for 20/-	3" / 465ft.	2 for 26/6
	108/- doz.		150/- doz.
4" / 600ft.	2 for 30/-	3½" / 650ft.	17/-
5" / 1,200ft.	27/-	4" / 900ft.	23/6
5½" / 1,800ft.	35/-	5" / 1,700ft.	40/-
7" / 2,400ft.	45/-	5½" / 2,300ft.	52/6
		7" / 3,300ft.	80/-

I enclose £ s. d. NAME.....

ADDRESS.....

BLOCK CAPITALS PLEASE CASH WITH ORDER

POST FREE · SEND COUPON NOW—

COTSWOLD ROUNDABOUT CONTINUED

One of those to whom we owe most is Freddy Grisewood. Being a great lover of the Cotswold where he spent his youth, he was very willing to yarn to us for a long time, with his inimitable manner and beloved voice. He has since been a frequent guest in *Roundabout*, and tremendously popular.

Yet it is true that the backbone of the programme is local: local events and local people. Most of our listeners are old; and naturally their minds go back into the past. They love to hear others talking, especially about the past and about the places where they used to live. So we get out and about, finding interesting people and recording them. Some of this work has a genuine scientific and sociological value, for we are recording the voices and the memories of the past before they disappear for ever. But not only things of the past: Dr. Barbara Moore, striding through Gloucester with a panting reporter trying to keep up with her and interview her above the noise of the traffic; the sturdy sons of Stroud throwing five-pound bricks (specially flown in by the U.S. Air Force, Fairford) against the men of Strouds in the States, in Canada and in Australia—not to mention the ladies, throwing rolling-pins in the same good cause; thrilling events at a certain neo-Nazi camp which turned up one summer and was cleared out promptly by Gloucestershire men with long memories; the last trains to run on local routes; the birds of the countryside; the bells of churches and the music of their organs; youth orchestras playing Haydn and choirs singing Bach and Handel; instrumental groups playing Telemann and rock groups singing folk-songs; all sorts of people talking about their lives and their unusual jobs—like a lady gasfitter and the proprietor of a maggot-factory. All is grist—provided it be interesting; and there is a staggering amount of interest about if only you go and look for it.

And that is *Roundabout*. How little did we know, when we first started it, into what it would grow. Very recently the Gloucestershire Community Council and the Red Cross have asked for the programme to go to clubs which they organise; and of course we are delighted. But even more recently comes a development which is quite thrilling, and which we never even dreamed might come about: a lady joined the Society who is a psychiatric social worker, and she, in conversation with our chairman, hit upon the idea of playing the programme to a group of long-standing patients in a mental hospital. Some of these had had little contact with the outside world, and shown little interest in it, for years; and the problem was how to break through to them. It seems that *Roundabout* has done it: these people have suddenly come to life and started talking about their past and themselves. The group leader and the authorities at the hospital are enthusiastic, and asking for more; and of course we have oodles of back-numbers to offer.

A HARD GRIND

For those of us who run it, *Roundabout* has become More a Way of Life than a Programme (if you will pardon the expression). Having reached the point we have, all we know is that we just cannot let it die. My wife takes the programme regularly to two old folks, one of whom is handicapped and now rarely gets out. For various reasons she was prevented from going for a number of weeks. There came a knock on the door, and there was the wife, who had walked several steep miles to say how much they hoped the visits were not ended, and how they had hoped every day that she would come. If any club is thinking of starting such a venture, let me give them solemn warning: you are starting something which will give you much hard work, and which will make you feel sometimes that you were fools when you went into it. Unless you are prepared for the grind, don't do it.

But if you are... well, I don't think that any of us have ever regretted it. You meet so many people whose needs are greater than your own; so many who suffer without complaint—I know one arthritic who roars with laughter though I know that every slight movement is an agony to her and she is never free from pain. There are times when you feel that you are going to chuck it up; and then you feel the touch of an aged hand; a voice says: "Thank you, my dear. I did so enjoy that"—and you know that you'll go on. The recorder you bought for your own fun has spoiled your life in close turns with those of others; and how glad you are.

READERS' PROBLEMS

Readers encountering trouble with their tape equipment are invited to write to the editorial office for advice, marking their envelopes "Readers' Problems—Tape". Replies will be sent by post and items of general interest may also be published in this column at a later date. This service does not, however, include requests for information about manufacturers' products when this is obviously obtainable from the makers themselves. Queries must be reasonably short and to the point, limited to one subject whenever possible. In no circumstances should such letters be confused with references to matters requiring attention from other departments at this address. We cannot undertake to answer readers' queries by telephone.

AN ACCELERATING SOUNDMIRROR

Dear Sir, I own a genuine *George VI Soundmirror* which has had a long rest. Last week when trying it out I found a peculiarity. Apparently it records at normal speed but when switched to **PLAY** it plays normally for a few seconds and gradually accelerates until it appears to be travelling at double speed. Can you suggest a remedy? The rubber pinch wheel has an indentation from being left against the capstan; perhaps it has become too hard.

Also, it appears that the erase head has not been coming to its correct position, having the effect of releasing the selector switch when on **RECORD**. A temporary solution is to hold the switch in the recording position.

Yours faithfully, G.F.L., Durham.

It is a pleasure to meet someone who is still deriving pleasure from one of the old Soundmirrors. As many modern owners assert—they don't make 'em that way any more.

Your problem is entirely one of disuse. The pinch wheel having developed a flat, the tape is now running up the capstan and as it reaches the upper edge of the wheel, the take-up torque causes acceleration. The only remedy really is replacement of the pinch wheel. However, some of the older types were made of genuine rubber and these can be brought back to some semblance of elasticity with a little heat treatment. You can remove it, boil it for a while, and when soft and still hot, remount and run with no tape loaded for a reasonably long period. Repeat this several times over a few days and the pressure of the pinch wheel on the spindle may bring it back to shape.

The erase head trouble entails careful setting and adjustment of the bottom lever. Clean the slide carefully and apply a touch of medium grease (Vaseline will do). You may have to bend the catch plate slightly.

TAPE HEAD WEAR

Dear Sir, Would you please be kind enough to advise me on the following:—

(1) How long would you expect the tape heads in recorders to last with normal intermittent domestic use? I have been told that about 1,000 hours total operating time can be expected before new heads will be needed.

(2) Is there any significant difference in the gap widths of different heads, if so, is this an important factor in the head life?

(3) I have a *Revox F.36* which has worked satisfactorily until a sudden failure revealed head wear after approximately fifteen months (estimated total running time being 250—350 hours). The agent has been helpful and has re-ground the heads but advises that the head life is now uncertain. Head renewal is decidedly expensive and suggests that a change of recorder may prove less expensive in the long run.

(4) Will the tape heads on a $\frac{1}{2}$ -track recorder function longer than on $\frac{1}{4}$ -track machines, or is the choice of tracking systems immaterial in this respect?

(5) Have you any data on the friction between tape heads and tapes of various kinds compared under similar conditions? I have noticed that the working surface of various well-known brands shows wide visual differences in dullness of the oxide coating.

(6) Do you have any data on the tape tension of various machines?

Yours faithfully, W. W. G. Stanmore.

(continued overleaf)

— YOUR TAPE DEALER — London Area

Disc and Tape Reproducing Equipment and Tape Recorders
by Leading Manufacturers
Custom Built Installations

All High Fidelity Requirements and Services Available

Estimates Free

Personal Service

Custom High Fidelity

371 Green Lanes, Palmers Green, N.13 PALmers Green 5228

hifi

FOR ALL LEADING AUDIO EQUIPMENT

call, write, or telephone

hampstead HIGH-FIDELITY

91a Heath Street, Hampstead, London N.W.3 Telephone HAMPstead 6377

LASKY'S RADIO

ALL LEADING MAKES IN STOCK

Cash or Easy Terms

LONDON'S FINEST SERVICE

207 EDGWARE ROAD, W.2

PAD 3271/2

152-153 FLEET STREET, E.C.4. FLE 2833

33 TOTTENHAM COURT ROAD, W.1. MUS 2605

★ PART EXCHANGES WELCOMED ★

- ★ ALL MAKES Hi-Fi and Tape Recorders supplied
- ★ PART EXCHANGES. Terms 12, 18 or 24 months
- ★ SONY Specialists. Full Range Stocked
- ★ GUARANTEED Recorder Repair Service

MAC'S CAMERA SHOPS LIMITED

250-252 KING STREET, HAMMERSMITH, LONDON, W.6
RIV 8581-2 Hours 9-6 Thursday 9-1

SHEEN TAPE RECORDER CENTRE

SPECIALISTS IN TAPE RECORDERS, ACCESSORIES, HI-FI EQUIPMENT
YOUR CENTRE FOR FRIENDLY HELP—SALES AND SERVICE

8 STATION PARADE,
SHEEN LANE, SHEEN,
LONDON, S.W.14

Showrooms Open until 7 p.m.
PROSPECT 0985
(Opposite Mortlake Station S.R.)

WIMBLEDON'S

TAPE RECORDER CENTRE

Agents for: FERROGRAPH, VORTEXION, SIMON,
BRENELL, GRUNDIG, PHILIPS, COSSOR, ETC.

GET IT TAPED THE EXPERT WAY—By letting us install your apparatus

TEL-LEE-RADIO

LIBerty 4946

220 The Broadway, WIMBLEDON, S.W.19

Cheshire

—STOCKPORT—

FAIRBOTHAM & CO. LTD.

47 LOWER HILLGATE STO 4872
FERROGRAPH, REVOX, TANDBERG, BRENELL,
SIMON, TRUVOX, SONY, PHILIPS, MAGNAVOX,
GRUNDIG, TELEFUNKEN

All models on comparison demonstration
Evening demonstrations by appointment

Devon

PLYMOUTH

TOM MOLLAND LTD.

102 CORNWALL STREET

Phone 69282

FERROGRAPH, REVOX, TANDBERG, SIEMENS, AKAI, UHER, SONY,
B & O STEREO MASTER, FI-CORD, AND

The largest selection of Hi-Fi equipment in the West

YOUR TAPE DEALER

Gloucestershire

CHELTENHAM

MODERN RADIO (Cheltenham) LTD.

Service and Hi-Fi Dept. 40/42, St. James Street
Ferrograph, Revox, Telefunken and Truvox always in stock
TELEFUNKEN appointed Service Agent
Phone: Cheltenham 21216/7

Hampshire

BOURNEMOUTH

NATIONAL RADIO SUPPLIES

66 Holdenhurst Road
Bournemouth

Tape, Hi-Fi & components Tel. 25232

HAMILTON ELECTRONICS

HIGH FIDELITY AND
TAPE RECORDER
SPECIALISTS

35 LONDON ROAD

SOUTHAMPTON

TEL. 28622

Lancashire

NOT THE LARGEST SELECTION
NOT THE CHEAPEST SELECTION

JUST THE BEST SELECTION

No High Pressure Sales—Just High Pressure SERVICE After Sales
Manufacturers' Official Agents for:—
REVOX, TANDBERG, TELEFUNKEN, GRUNDIG, B. & OLUFSON, SONY,
"Q"-CORD, etc.

Largest Selection of Pre. Rec. Tapes in the North
SPARES, ACCESSORIES and "EXPERIENCE"

"THE" TAPE RECORDER CENTRE (Blackpool), 266 WATERLOO ROAD
Tel. 45049

H. D. KIRK

Stereolectrics
LIMITED

Specialists in High Fidelity

Phone: 23093

150 HIGHER BRIDGE STREET

BOLTON

**MANCHESTER
LANCASHIRE HI-FI LIMITED**

and now incorporating
The Tape Recorder Specialists
DIXONS ELECTRONIC (Sales and Service)

8 DEANS GATE (NEXT TO GROSVENOR HOTEL)

Leicestershire

LEICESTER

ALL YOUR HI FI REQUIREMENTS

Speakers by: H.M.V. QUAD LEAK ROGERS W.B.
TANNOY MORDAUNT LOWTHER

Tape: WHARFEDALE GOODMAN'S
FERROGRAPH REFLECTOGRAPH GRUNDIG
SIMON BRENELL

Record Department: ALL LABELS-PARASTAT SERVICE
LEICESTER CO-OPERATIVE SOCIETY LIMITED, High Street, Leicester. Tel. 20431

Northamptonshire

PETERBOROUGH, NORTHANTS

Tel: 5643/5644

CAMPKINS RECORD SHOP

RECORD TAPE AND HI-FI EQUIPMENT SPECIALISTS

NEW
ADDRESS

15 LONG CAUSEWAY
(IN CITY CENTRE)

LARGE
STOCKS

READERS' PROBLEMS CONTINUED

Replying to your points in order:

(1) The life of a tape head in a domestic recorder depends, apart from the robustness of the head itself, largely on conditions of use. Tape tension, tape speed, form and tension of any pressure pad (or roller or band), the roughness of the tape surface and the amount of abrasive dust in the atmosphere; all affect head life.

The heads on a high-quality domestic recorder would certainly be expected to last a minimum of 1,000 hours, provided all adjustments are correct, good tape is used, and both the tape and the air are clean. We have experience of heads on test gear of similar quality being changed every twelve months after working eight hours daily—admittedly with no pressure pads.

(2) There is no significant difference in gap-length in the high-quality domestic heads, except that, where separate recording and playback heads are used, the former may have rather longer gaps than the latter: say 0.25—0.5 thou. or more against 0.1—0.15 thou. This does not affect the life in that shorter gaps tend to be associated with thinner pole tips, otherwise efficiency suffers.

(3) If your Revox needed a head re-lapping after only 300-odd hours, there was almost certainly something causing uneven wear: a guide or pressure pin out of alignment, perhaps, or excessive tension.

(4) All other things being equal, $\frac{1}{2}$ -track heads should wear at about the same rate as $\frac{1}{4}$ -track heads.

(5) We know of no published data on wear of various types of heads. However various engineers have observed that 'rough' tape surfaces tend to wear heads at a moderate steady rate while 'smooth' tapes cause a much higher initial rate of wear, but this decreases rapidly to a small steady rate. But note that the visual appearance of the tape surface may be misleading: a rough tape with highly-polished bumps may appear glossier than a smooth one with a fine matt surface.

(6) The specification of a high quality machine should quote the tape tensions for various conditions. If it doesn't—ask! Playing tensions for standard, long-play, and double-play or triple-play should be about 80 gm, 60 gm and 40 gm respectively.

FIELD TRIAL CONTINUED

thirty minutes of sound effects, ranging from the splash of water from a portable swimming pool to the sordid tingle (recorded three times—for luck) of the Buffet cash register, were transferred to tape—very satisfactorily, as subsequent playback showed.

Further recordings made in the ensuing weeks served only to increase my delight in the Grundig TK6. It compared favourably with mains-only recorders approaching a similar price (alas, now over £75 since the import tax has been added), on internal speakers. Connecting the TK6 direct to good-quality amplifiers and speakers produced results that would put many modern 'domestic' recorders to shame.

A few words, now, about batteries. These were as easy to get at as the deck itself, though the catches holding both front and back covers are a little ambiguous in operation. A flexible strap measuring about 6 × 1 in. wide is threaded behind the last two cells to be inserted and a gentle tug on this removes them, giving access to the other three.

The fifteen-hour battery life claimed by the manufacturers is realistic, though it could probably be lengthened by switching the recorder right off when turning the tape transport to STOP. Personally, I would rather have seen the on/off contacts taken from the mechanical function switches rather than the rotary gain control—even though this would have required a longer time for the motor to run up to speed.

One feature not yet mentioned is the three-figure spool rotation counter—not often found on battery recorders. This was no less accurate than those to be found on mains machines, but was smoother in operation than others I have tried.

This, then, is the TK6. Its field trial has probably read more like an advertisement for Grundig—which it is not meant to be. It should be borne in mind that every criticism aimed against it can be placed equally well at the foot of a professional portable: it is heavy, not over-simple to prepare for recording and it consumes batteries quickly. But it also offers high quality recording at 3 $\frac{3}{4}$ i/s (with very good performance at 1 $\frac{7}{8}$ i/s), complete freedom from audible speed fluctuation and inconsistency, monitoring through internal speaker or earphones, and a really high signal-to-noise ratio. It is the perfect portable for the enthusiast requiring a second machine and for the purchaser who wants reliability and versatility in a single recorder.

CLASSIFIED ADVERTISEMENTS

Advertisements for this section must be pre-paid. The rate is 6d. per word (private), minimum 7s. 6d. Box Nos. 1s. 6d. extra; trade rates 9d. per word, minimum 12s. Box Nos. 2s. extra. Copy and remittance for advertisements in **APRIL 1965** issue must reach these offices by **18th FEBRUARY** addressed to: The Advertisement Manager, Tape Recorder, Link House, Dingwall Avenue, Croydon, Surrey.

Replies to Box Nos. should be addressed to the Advertisement Manager, Tape Recorder, Link House, Dingwall Avenue, Croydon, Surrey, and the box no. quoted on the outside of the envelope. The district after box no. indicates its locality.

PERSONAL

Wanted young man interested in tape recorders. Apply Magnegraph Recording Co. Ltd., 1 Hanway Place, W.1.

FOR SALE

LP (5½") 'Tutortape' Advanced French Conversation, 3½" p.s.; Accompanying handbook; 3 gns. new; Price 30/-. Watson, 20 Stockers Avenue, Winchester.

Lyrec TR/16 (stereo) Prof. studio recorder 7½/15/30. Cost originally £900. Accept £300 o.n.o., or exchange TR/50 7½/15 (mono). Box No. 374 (London).

TRADE

A Unique Buy! Recording tape, top brand. 7in. 2400ft. D.P. 25/-, 5½in. 1200ft. 19/6, P. & P. 1/6 per spool. Bargains in all sizes. S.a.e. for list. We repair, buy and sell recorders. E. C. Kingsley & Co. Ltd., 132 Tottenham Court Road, London, W.1. EUSton 6500.

Pre-recorded tapes. Unique complete catalogue listing all makes, mono, stereo, 7½ and 3½ i/s including World Record Club tapes. Call for free copy or send 1s. mailing fee. Dept. T.R.3, Teletape Ltd., 33 Edgware Road, W.2. Phone: PAD 1942.

Speedy and Expert Tape Recorder and Hi-Fi repairs by England's leading Hi-Fi Specialists. Telesonic Ltd., 92 Tottenham Court Road, London, W.1. MUS 8177.

Pre-sleep Study. Learn difficult lessons or parts or improve your mental powers while you sleep! Send now for price list of materials; including the perfect tape machine, time switch, pillow speaker, endless tape cassettes, pre-recorded tape for learning or therapy, language courses, etc. Psychology Tapes Ltd. (TR), 16 Kings College Road, London, N.W.3. PRI 3314.

If quality matters consult Sound News Audio Supply for better terms. 60 page photographically illustrated Hi-Fi catalogue 4s. 6d. Part exchange, servicing. Your precious tapes transferred to unbreakable L.P.s by specialists. Specify requirements. 10 Clifford Street, London, W.1.

New world famous recording tapes Polyester base and fully guaranteed. 5in. 600ft. 7/-, 5½in. 900ft. 9/6, 7in. 1200ft. 12/-, 5in. 900ft. 9/-, 5½in. 1200ft. 12/6, 7in. 1800ft. 13/6, p/p 1/- per spool. Starman Tapes (T.R.), 421 Staines Road, Bedford, Middx.

Lafayette "International" Tape. Polyester: 7in. 2400ft. 22/6; 5½in. 1800ft. 20/-; 5in. 1200ft. 14/-; 7in. 1800ft. 19/-; 7in. 1200ft. 12/-. Acetate: 7in. 1800ft. 14/9; 5in. 900ft. 10/6; 5in. 600ft. 8/-. Refund guarantee. 'Bib' Tape Splicer, 14/11. We also have a full range of Message Tapes and Triple Play Tapes all at lowest ever prices. P. & P. 2/- per order. S.A.E. list. Leda Tapes, 27 Baker Street, W.1.

Continued on page 86

YOUR TAPE DEALER

Oxfordshire

WESTWOOD'S of **OXFORD**
46 GEORGE STREET
PHONE: 47783

Staffordshire

Audio Electronics (Midlands) Ltd.

Specialists in Dictation Mcs., Tape Recorders, Inter Com., Tapes and Accessories

Full After Sales Service on all Equipment
PHILIPS, GRUNDIG, TRUVOX, UHER, ETC.

203 STAFFORD STREET, WALSALL Tel.: 21086

Surrey

FARNHAM, SURREY

The finest selection of Tape Recorders, Hi-Fi Equipment and quality Radiograms in the Provinces is awaiting you at:—

LLOYD & KEYWORTH LTD

26-27 Downing Street, Farnham, Surrey. Telephone: 5534
Comparative Demonstrations, Large stock of Cabinets and Pre-Recorded Tapes.

CROYDON'S TAPE RECORDER CENTRE

All leading makes in stock, Hi-Fi equipment, cabinets, etc.
Service agents for AKAI Tape Recorders

SPALDING ELECTRICAL LTD.,

352/354, Lower Addiscombe Road,
CROYDON

ADDISCOMBE
1231/2040

Sussex

WORTHING, SUSSEX

Stocking Ferrograph, Revox, Sony, Tandberg, Truvox, Philips, EMI, Luxor, etc., on fully comparative Demonstrations

BOWERS & WILKINS LTD.

1 Becket Bldgs., Littlehampton Road, Worthing 5142

NEW PREMISES
NEW PREMISES
NEW PREMISES

132 montague street
CRAY

telephone 2585

CRAY OF WORTHING LTD

Warwickshire

COVENTRY
& DISTRICT
CO-OPERATIVE
SOCIETY LTD.

HIGH FIDELITY SOUND EQUIPMENT TASTEFULLY
DISPLAYED FOR YOUR "BROWSE AROUND" ENJOYMENT

All leading makes: Amplifiers, Control Equipment, Loud-speakers, Cabinets, Tuners, Microphones, Tape Recorders and Ancillary Items in stock or quickly obtainable.

Coventry & District Co-operative Society Ltd., High Fidelity Sound Section, Electrical Dept., First Floor, Central Premises, Corporation Street, Coventry. Tel. Coventry 24031-10 lines

AUDIO & TAPE SALES & SERVICE. HIG. 4182

COLIN G. TURNER M.I.P.R.E.

QUAD. LEAK. ROGERS. TANDBERG. TRUVOX. BRENELL

All makes in stock and on demonstration

39 YORK ROAD, KINGS HEATH, BIRMINGHAM 14

CLASSIFIED ADVERTISEMENTS

TRADE continued

Re-cover your tape recorder leathercloth 50" wide from 7/11 yard. Postage 1/6. Patterns sent. Bonners, Welling, Kent. BEX 5751.

Learn while you sleep. Details of tapes, subjects and equipment from: The Sleep-Learning Association, 14 Belsize Crescent, N.W.3.

Reflectograph 500 recently overhauled to makers' specification. £45. Alpha Sound Services, 50 Stuart Road, Liverpool 22. Phone 051 WATERloo 7862.

"Eroica" Recording Services Ltd. (Regd 1949). Complete Recording Service; studios/mobile/Tape to Disc. Quality recording equipment for all purposes. Ferrograph Sales and Service since 1951. Special offer: Truvox PD 85 Tape Deck Unit (3-speed, quarter track) with level meter and built in pre-amps, simply connect to any good amplifier, as new, bargain £40. "Eroica" House, 34 Ashley Road, Altrincham (Car Park). ALTrincham 6688. Studio Director: Wm. Thurlow Smith, A.R.M.C.M.

WANTED

Lee Electronics. The Tape Recorder and Hi-Fi Specialists wish to purchase good quality Tape and Hi-Fi Equipment for cash. 400 Edgware Road, W.2. Phone: PADdington 5521.

Highest cash prices offered for good quality Tape Recorders and Hi-Fi. See our ad. page 68 this issue. R.E.W., 266 Upper Tooting Road, London, S.W.17.

STUDIO FACILITIES

Discs cut, all speeds, from your tape. Reduced prices. Microgroove 7" 17/6, 10" 37/6, 12" 43/-. Satisfaction guaranteed. West Herts Sound Recording, 9 Tring Road, Northchurch, Berkhamsted, Herts.

John Hassell Recordings. Tape to Disc. Latest high level microgroove cutting system. Competitive prices. Studio and Mobile services. 21 Nassau Road, London, S.W.13. RIVerside 7150.

Rapid Recording Service. 78s and L.Ps. from your own tapes. (48-hour service.) Master Discs and pressings. Recording studio. Mobile recording van. Manufacturers of the Sleep-o-Matic Unit. Foreign language courses available for sleep-learning. Brochures and price lists on request from: Dept. T.R.21, Bishops Close, London, E.17.

Iford Sound Recording Service. Tape to disc—pressings—studio recordings—weddings, school choirs, etc. S.A.E. for list. 445 High Street North, Manor Park, London, E.12. Phone GRA 5107 or evenings CRE 8947.

— TAPE TO DISC SERVICES —

The following are members of the Association of Professional Recording Studios who can be relied on to give satisfaction

MJB RECORDING & TRANSCRIPTION SERVICE

specialise in the production of microgroove records from Professional and Amateur recordings (Acetate copies; Mono and Stereo pressings). Extended playing times achieved by controlled cutting techniques. Studio, Mobile, "Off the Air" and all recording services. Detailed booklet available.

7 HIGH STREET, MAIDENHEAD (Tel: 25630)

TAPE RECORDERS - AUDIO EQUIPMENT - DISC CUTTING STD & LP FROM TAPE - STUDIO FACILITIES - HIRE SERVICE - SALES - EXCHANGES

MAGNEGRAPH

1 Hanway Place, London, W.1.

Tel.: LAN 2156

— YOUR TAPE DEALER —

Wiltshire

SOUTHERN ENGLAND

HI-FI AND RECORD CENTRES

J. F. SUTTON

SALISBURY
18 QUEENS STREET

SOUTHAMPTON
421 SHIRLEY ROAD

Yorkshire

SHEFFIELD HIGH FIDELITY

HI-FI EQUIPMENT AND TAPE RECORDERS

FULL DEMONSTRATION FACILITIES
SPECIALIST REPAIR SERVICE
ALL LEADING MAKES STOCKED

Tel. 20588 10 WEST STREET, SHEFFIELD, 1

TAPE RECORDER CENTRE (HALIFAX)

Stock all the best Tape Recorders; Hi-Fi Equipment; Tape; L-P Records, etc.

DEMONSTRATIONS DAILY BY EXPERT STAFF
2 years FREE SERVICE ON NEW RECORDERS over £35

30 King Cross Street, Halifax. 'phone 66832

Scotland

Edinburgh's TAPE RECORDER specialist

Ferrograph—Grundig—Telefunken—Philips, etc.
W. G. Graham, Assoc. Brit. I.R.E.

Tape to Disc Recording Service
Agent for The Famous Heathkits.

Hi-Fi Corner

1 Haddington Place,
EDINBURGH.
Phone WAV 7901

ADVERTISERS' INDEX

	Page
BASF Chemicals Ltd.	outside back cover
B.S.R. Ltd.	54
Braddock, C., Ltd.	76
Brenell Engineering Co. Ltd.	56
Brown, A., & Sons Ltd.	76
City & Essex Tape Recorder Centres	74
De Villiers (Electronic World) Ltd.	82
Elstone Electronics Ltd.—W.A.L.	64
Francis of Streatham	76
Grampian Producers Ltd.	70
Grundig (G.B.) Ltd.	52
Heathkit (Daystrom Ltd.)	47
Highgate Acoustics.	60
Howard Tape Recorders	inside back cover
Iford Ltd.	48-49
Kodak Ltd.	62
Lustraphone Ltd.	64
Mallory Batteries Ltd.	inside front cover
M.S.S. Recording Co. Ltd.	78
Philips Electrical Ltd.	50
Recorder Co., The	64
Rent-a-Tape Ltd.	78
Reps (Tape Recorders) Ltd.	81
R.E.W. (Earlsfield) Ltd.	68
Scotch Tape	58
Walker, N.	78



TOP QUALITY

TOP QUALITY DOES NOT NECESSARILY MEAN TOP PRICES. We offer you all the best makes in Tape Recorders and Hi-Fi Equipment on the lowest possible terms—ONLY 10% deposit and the balance up to 12 and 18 months with NO INTEREST CHARGES. Why pay more? Why pay interest?

WE SPECIALISE IN MAIL-ORDER, WHICH MEANS YOU CAN ORDER FROM US IN COMPLETE CONFIDENCE, WHEREVER YOU LIVE. DELIVERY IS FREE ANYWHERE IN THE U.K.

Servicing can be an additional expense. We give you 12 months FREE service on all new equipment—if it goes wrong, we make no charge.

If you want to know more about our philanthropic institution, write or phone us now for Free Brochures and Free Details of all our Terms. (If we don't convince you that we offer the best terms in Gt. Britain, you can always go elsewhere.)

Please indicate interests:

TAPE RECORDERS

Mono under £50

Mono over £50

Stereo Battery

HI-FI

Amplifiers and Tuners

Speakers and Enclosures

Turntables and Arms

Portable Radios & R/Players

HOWARD

TAPE RECORDERS · HI-FI

218 HIGH ST. BROMLEY. KENT. RA.V. 4000



ON **BASF** LETTER TAPES SPECIALLY PACKED FOR MAILING



BASF LETTER-TAPE enables you to talk to relatives and friends anywhere in the world. **BASF** insistence on highest quality production makes the Letter-Tape extra sensitive to capture every shade of expression. Delight your friends far away—let them *hear* your news on the 150 feet long-play tape specially made for mailing. The lightweight **BASF** Letter-Tape comes complete with mailing carton and reply labels, and costs only 5/6d.



—SYMBOL OF
AUTHENTIC SOUND



BASF CHEMICALS LIMITED, 5a GILLESPIE ROAD, LONDON, N.5. TEL: CANonbury 2011