

SEPTEMBER 1964

TWO SHILLINGS

tape recorder



INSURING TAPE RECORDERS AKAI 345 REVIEW
RIVAL TO TELCAN A TAPE PLAY FOR AMATEUR PRODUCTION

**Another
BRILLIANT RECORDING
on**

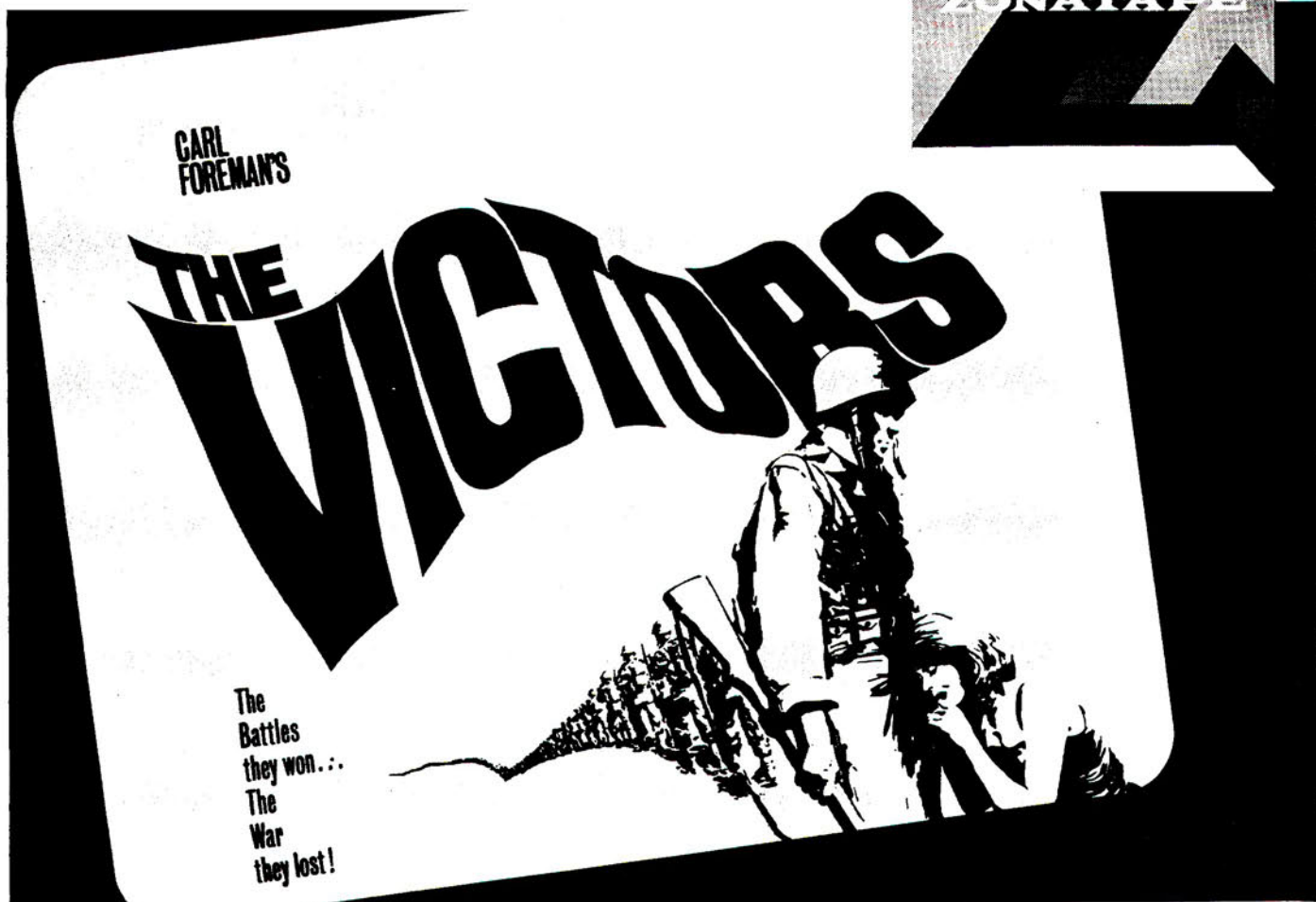

The same quality magnetic coating used for the magnificent sound recording of "THE VICTORS" is available to you... offers you a fidelity in recording limited only by the capability of your tape recorder. Choose from 4 types: Diacetate or PVC Standard Play, Polyester Extra Play and—just released—Polyester Double Play. Wound on distinctive coloured spools, clear, red, green and blue for easier identification. Supplied in attractive, durable book-type containers. Stocked by all the best hi-fi and radio shops.

New—a comprehensive range of Zonatape accessories, including coloured printed leader and timing tapes... multi-purpose coloured leaders... and metallic stop and sensing foil.

**BRIEF SPECIFICATION OF ZONATAPE
TYPE 700 POLYESTER EXTRA PLAY**

Intrinsic Coercivity Hci.	310 Oersted (high)
Retentivity Br.	1200 Gauss
Bias	6.3 milliamps
Peak signal to basic noise ratio	— 71 dB
Reel to reel variations	± 1 dB at 1000 cycles
Ultimate tensile stress	8 lb.

ZONATAPE

CLEARLY THE BEST FOR RECORDING SOUND



ZONAL FILM (MAGNETIC COATINGS) LTD

ZONAL HOUSE, WESTFIELDS ROAD, ACTON, W.3. ACORN 6841

FREE!

COLOUR BROCHURE

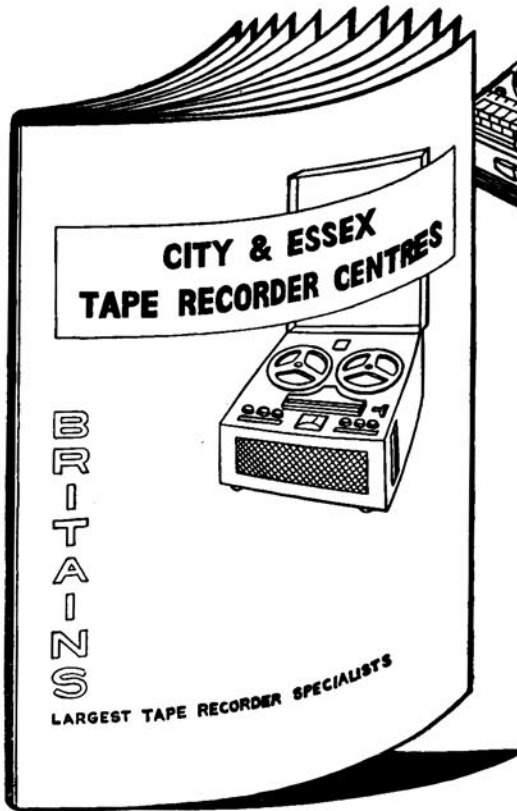

This wonderful new, attractively illustrated FREE brochure brings you full details of the tremendous range of tape recorders and many unique features that we as BRITAIN'S LARGEST TAPE RECORDER SPECIALISTS offer you.

Full details of recorders we particularly recommend giving prices, specifications, etc., and a comprehensive list of all models available today are contained in the brochure, together with our unique FREE TRAVEL VOUCHER entitling you as a customer to full refund of your travelling expenses to and from any of our showrooms.

Hurry and send for your FREE copy today.

5 STAR FEATURES

- ★ FREE TRAVEL TO AND FROM OUR SHOWROOMS
- ★ FREE DEMONSTRATIONS IN YOUR HOME
- ★ OVER 300 MODELS FROM 15-243 GNS.
- ★ FREE ONE YEAR SERVICING
- ★ FREE TECHNICAL ADVICE

NOTE—BISHOPSGATE SHOWROOMS OPEN MON.-FRI. 9a.m.-6p.m. SUNDAY 9.30a.m.-2p.m. CLOSED ALL DAY SATURDAY. OTHER SHOWROOMS OPEN MON.-SATURDAY 9a.m.-6p.m. THURSDAY TO 1p.m.

POST THIS COUPON NOW!

CITY & ESSEX TAPE RECORDER CENTRES

228 BISHOPSGATE, E.C.2 (opposite Liverpool St. Station) BIS 2609
 2 MARYLAND STATION, STRATFORD, E.15 (adj. Maryland Station) MAR 5879
 205 HIGH STREET NORTH E.6 (opposite East Ham Station) GRA 6543
 232 EAST INDIA DOCK RD., POPLAR, E.14 (adj. Blackwall Tunnel) EAS 5978

Please send me your FREE BROCHURE

Name.....

Address.....

CITY & ESSEX TAPE RECORDER CENTRES

HEAD OFFICE: CITEX HOUSE, 191 PLASHET RD., LONDON, E.13



GO
FOR ANY
SOUND
KEEP IT
SAFE
ON



PHILIPS TAPE

GREEN
for standard
RED
for longplay
BLUE
for doubleplay
GREY
for tripleplay

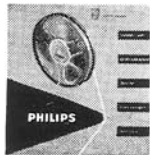

Capture a sound on Philips Tape and it's yours for ever—yours to play back and enjoy whenever you like. Available in all current reel sizes of standard, longplay, doubleplay and tripleplay, Philips Tape gives you all these advantages: great sensitivity, wide frequency range, low noise level, high resistance to stretching or breakage, powerful adhesion of the magnetic coating. And of course, they're colour-packed for easy identification. Whatever tape recorder you own, get the best out of it—with Philips Tape.

FINE PRODUCTS FROM PHILIPS—THE FRIEND OF THE FAMILY

PHILIPS ELECTRICAL LTD., ELECTRO-ACOUSTICS DIVISION, CENTURY HOUSE, SHAFTESBURY AVENUE, LONDON WC2 (TA4314)



Do it yourself Exhibition

Come to this fascinating Exhibition and learn how best to tackle those 101 do-it-yourself jobs around the home.

See demonstrations of the latest do-it-yourself techniques and equipment and discuss your problems with the experts in the Do it yourself magazine Instruction Centre. See the colourful displays of modern and traditional handicrafts in the Overseas section.

Olympia

11-26 September

National Hall

10 am.—930 pm daily (except Sundays)

Closes 7 pm September 26th

Admission 3/- Children 1/6

12th INTERNATIONAL HANDICRAFTS & DO IT YOURSELF EXHIBITION SPONSORED BY DO IT YOURSELF MAGAZINE

WORLD RECORD CLUB OFFERS YOU THE CHOICE OF ANY 3 PRE-RECORDED TAPES



58 The fabulous dynamic Duke Ellington himself in eight great numbers including Stomping at the Savoy, In the Mood and Honeysuckle Rose.



1 Tchaikovsky Swan Lake, John Hollingsworth conducts the Sinfonia of London in a great performance of this well-loved ballet music. Also in stereo.



59 The silken voice of Nat King Cole in 'Walkin', Because You're Mine, You'll Never Grow Old, Baby Won't You Say You Love Me and 8 more.



30 Ian Carmichael, Joyce Blair, star cast and orchestra. As Long As He Needs Me, Consider Yourself, all the hit numbers from Lionel Bart's great show. Also in stereo.



49 Beethoven Fidelio Overture, Brahms St. Anthony variations, Mendelssohn Hebrides Overture, Wagner Siegfried Idyll. Superb interpretations. Also in stereo.



50 David Hughes, Barbara Leigh, Andy Cole and chorus sing Indian Love Call, Rose Marie, and all the other tunes from Friml's well-loved musical. Also in stereo.



61 The world's 3 greatest sonatas — Beethoven's Moonlight, Pathetique and, Appassionata—superbly played by famous TV pianist Joseph Cooper.

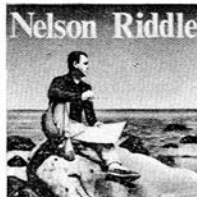

71 The smooth sound of the Nelson Riddle Orchestra in Touch of Your Lips, Body and Soul, The Tender Touch, As you Desire Me—11 favourites in all.



44 Leopold Ludwig and LSO combine brilliantly in an exciting 'double': two of the world's greatest symphonies receive vivid new interpretations. Also in stereo.



68 Cuban Carnival, Yesterdays, Blues in My Heart, and eight more great numbers played by George Shearing with vocals by Dakota Staton.



48 Deep in My Heart, Drinking Song, Serenade—all the old favourites fresher than ever with Marion Grimaldi, Linden Singers and Orchestra. Also in stereo.



53 Bizet's thrilling music magnificently performed by Sinfonia of London under Muir Mathieson. Also in stereo.



77 In the Mood, Bugle-Call Rag, Chattanooga Choo-choo, Serenade in Blue—9 original tracks by the immortal Glenn Miller and his band.



14 Tchaikovsky Symphony No. 5, Sir Malcolm Sargent and LSO combine to give this famous symphony a dramatic and colourful rendering. Also in stereo.



35 Ol' Man River, Bill, Make Believe, many more well-loved numbers from this famous musical memorably sung and played by full star cast. Also in stereo.



11 Dvorak Symphony No. 5—From The New World. Leopold Ludwig conducts the London Symphony Orchestra in a dramatic and moving performance. Also in stereo.



72 The magnificent Platters bring you Sixteen Tons, My Dream, Mystery of You, You'll Never, Never Know, One in a Million—10 superb numbers.



69 The exquisite playing of the Virtuoso Ensemble matches the beauty of Schubert's celebrated Trout Quintet, which contains some of his most famous melodies.



40 Bruna Rizzoli and Giuseppe Savio with the chorus of the Teatro Nuovo di Milano and orchestra conducted by Napoleone Annovazzi.



52 Gracie Fields sings her favourite songs for you, including In My Little Bottom Drawer, Sally, Song of the Mountain and ten others.



31 Rimsky-Korsakov: Scheherazade, Sir Eugene Goossens conducts the LSO in a breathtaking performance of this rich and exotic masterpiece. Also in stereo.



45 Crazy Rhythm, Bijou, I cover the Waterfront, Northwest Passage, Blowin' a Storm, etc. The master clarinetist plays 12 numbers in great style. Also in stereo.



2 Grieg Piano Concerto. Alexander Jenner in an electrifying performance with the Bavarian State Radio Orchestra conducted by Odd Gruner-Hegge.

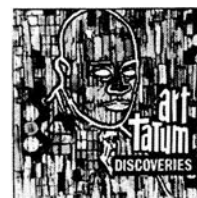

76 Unforgettable Art Tatum in person plays Tenderly, Body and Soul, Without a Song, Begin the Beguine—12 superb numbers from the greatest-ever jazz pianist.



74 Superb Sarah Vaughan in ten great numbers. If I Loved You, Saturday, It's Delovely, You'll find me There, etc. Every one a hit.



38 Hervey Alan, Ian Wallace, Marion Grimaldi and chorus sing the immortal favourites: Cobler's Song, Robbers' Chorus, Chu Chin Chow, etc. Also in stereo.



34 Stardust, How High the Moon, Nearness of You, 'Round Midnight, King David—eight numbers by the vibraphone genius, Lionel Hampton. Also in stereo.



54 Tchaikovsky's last and greatest symphony, is here given a splendidly moving rendering by the Sinfonia of London conducted by Muir Mathieson. Also in stereo.



65 Our Love is Here to Stay, The Nearness of You, Guilty, and nine more great hits, all with America's top vocal group, the fabulous Four Freshmen.



81 Some of Chopin's loveliest melodies magnificently played by world-famous pianist Fou Ts'ong—The Four Ballades, Nocturne in F Sharp Major, etc.

FOR ONLY 30/-

THE GREATEST BREAKTHROUGH SINCE TAPE RECORDING!

Here is the greatest World Record Club introductory offer ever made . . . a unique offer never before matched by any record club or company anywhere in the world!

EVERY ONE OF WORLD RECORD CLUB'S UNRIVALLED RELEASES AS 12" LPs IS NOW AVAILABLE ON 3 3/4 ips TAPE!

Now you have the opportunity to play any WRC release on your tape recorder. Each of these 'tape records' runs at 3 3/4 ips, mono, on 5" spools and can be played on either 2 or 4 track recorders. New electronic techniques of tape-to-tape transfer give these 3 3/4 ips WRC pre-recorded tapes a standard of reproduction unattainable previously at less than 7 1/2 ips.

WORLD RECORD CLUB 7-POINT PLAN MEANS BETTER LISTENING FOR YOU!

1. AN UNPARALLELED INTRODUCTORY OFFER.

Choose now, any three of the superb 3 3/4 ips pre-recorded tapes shown here, for only 10/- each and number them on the attached coupon. (If you wish, of course, you can choose 12" LPs instead. Introductory discs and tapes are both the same price.) Please send no money until after you have received, played and approved them. We want you to prove to yourself, before paying, that our tapes are equal to the world's best.

2. THE OPPORTUNITY TO BUILD A UNIQUE TAPE COLLECTION.

The WRC plan offers you an exciting and varied annual repertoire of more than 70 selected tape releases, covering classics, jazz, shows, ballet music, light music and 'pops'. Every one is a superlatively recorded 3 3/4 ips mono tape (or 12" LP—mono and stereo). Tapes are offered to you at the

privilege club price of 29/- (plus a small charge for post and packing)—much less than you would pay elsewhere for recordings of anything like this quality. Your only obligation, as a Club member, is to agree to buy four more tapes (or 12" LPs) during your year of membership. Beyond this, there is no subscription or membership fee.

3. A PLANNED PROGRAMME.

Every World Record Club release is hand-picked by an independent panel of Britain's top musical authorities. The Countess of Harewood, Lord Montagu of Beaulieu, Sir Arthur Bliss, Richard Attenborough, Cyril Ornadel, Ray Ellington, Leon Goossens, Malcolm Arnold, Steve Race, John Hollingsworth, Antony Hopkins—and, as special adviser on tape, Miles Henslow.

4. NEW CLUB MAGAZINE.

The new club magazine contains 48 pages, many in colour. Packed with fascinating features, information, competitions and special offers, it comes free to all WRC members.

5. SPECIAL CONCERT PRICE CONCESSIONS.

Many concert halls and theatres throughout the country (including the Royal Festival Hall) allow special concession rates to club members for many performances.

6. FREE BONUS TAPES.

The more you buy, the more you save! After fulfilling the minimum membership obligations, you earn another tape of your own choice free for every extra three you buy!

7. EXCLUSIVE EXTRA RELEASES.

In addition to the regular monthly selections, the club offers members exclusive extra tapes at the standard Club price.

World Record Club is unique—the first and greatest Record and Tape Club in Britain, with the largest show catalogue (on tape and mono/stereo disc) in the world. No other method of tape—or record-buying offers you so many additional benefits, so much freedom and variety of choice, with no 'high-pressure' selling. And, of course, there are no subscriptions or membership fees of any kind.

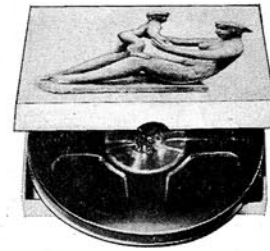

... AND IF YOU OWN A STEREO TAPE RECORDER hear the fantastic reproduction of

STEREO 21

THE NEWEST, TRUEST SOUND ON TAPE TODAY!

Revolutionary new STEREO 21 pre-recorded tapes (7 1/2 ips twin-track) are issued exclusively by World Record Club. But they are offered without membership commitments of any kind. The first list of all new STEREO 21 releases is now available. It features 30 superb stereophonic tapes ranging from Beethoven's Eroica with Josef Krips conducting the LSO, to a lavish full-cast production of Oklahoma.

As always, WRC prices present unparalleled value—all STEREO 21 releases cost either 50/- or 60/- depending on playing time (up to 50 minutes). STEREO 21 tapes are now obtainable through leading retailers or direct by post from World Record Club. Send for full catalogue now—STEREO 21 must be heard to be believed!

7-DAY FREE TRIAL OFFER—POST TODAY!

STEREO 21 FREE BROCHURE

To: THE WORLD RECORD CLUB Ltd. (Dept. TRR4)
Box 11 PARKBRIDGE HOUSE, RICHMOND, SURREY.

SEND NO MONEY NOW

3 3/4 ips pre-recorded tapes	12" LPs
------------------------------------	---------

Tick what you want

Please send me, without obligation, on 7-day free trial, the three selections indicated. (Your 3 selections must be either all tape or all disc.) If satisfied, I will pay you 30/- plus 3/- postage, packing and insurance. Only at that stage may you enrol me as a full member of World Record Club, entitled to all the benefits described. My only obligation as a member would be to agree to purchase 4 more top quality 3 3/4 ips tapes over the next year at the special club price of 29/- each (or 12" LPs at 26/6) plus a small charge for post and packing. If I am not completely satisfied with my 3 selections, I will return them to you within 7 days, in good condition, and owe you nothing.

Signed.....
this offer applies in Gt. Britain and N. Ireland only.

MY 3-SELECTION 'PACKAGE' COMPRISES

Choice No. 1 Choice No. 2 Choice No. 3



(place tape/disc key numbers only in the circles)

Tick here if stereo 12" LPs are required where available

Mr/Mrs/Miss.....
(BLOCK CAPITALS PLEASE)

ADDRESS.....

To: THE WORLD RECORD CLUB Ltd. (Dept. TRR4)
Box 11 PARKBRIDGE HOUSE, RICHMOND, SURREY.

Please send me your free colour brochure, showing the full range of your new STEREO 21 releases.

NAME.....
(BLOCK CAPITALS PLEASE)

ADDRESS.....

* Elizabethan, Fidelity, Wyndor and other famous makers fit MASTERTAPE!

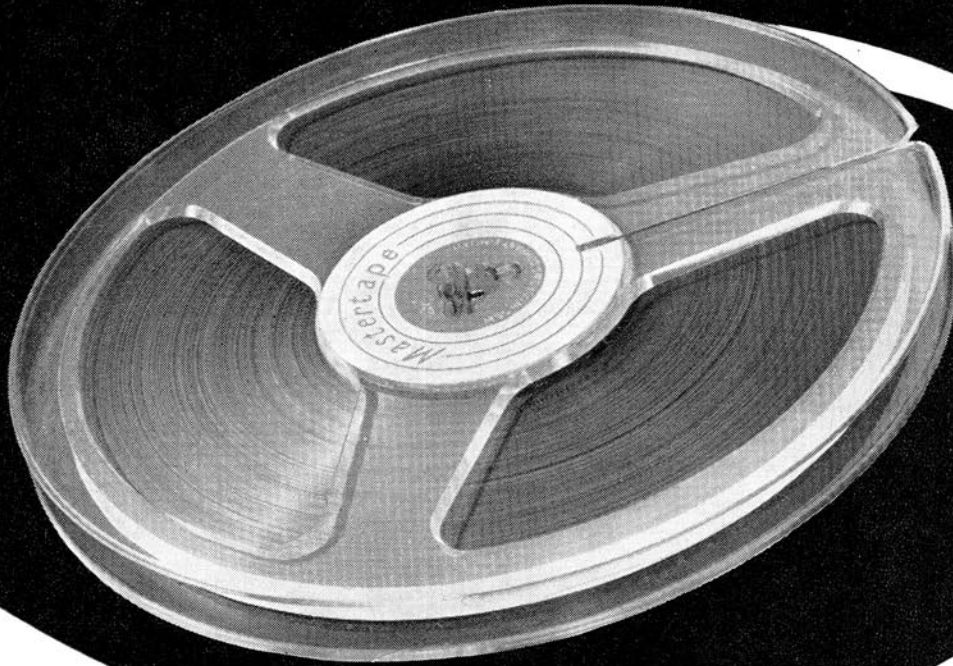

MASTERTAPE

Nationally distributed by Vidor and
available now at your local radio shop.

... there is a Mastertape to suit your requirements. Just compare these prices for the most popular sizes: 5½" 900 ft. Standard Play (P.V.C.) 20/-; 5½" 1200 ft. Long Play (P.V.C.) 25/-; 7" 2400 ft. Double Play (Polyester) 55/- and our 10 minute Mini-Voice Letter at 2/8d. — the best quality and value in high grade recording tape!

* Always have a spare reel for that unexpected recording session!

Manufactured in England by
M.S.S. RECORDING CO. LTD. Colnbrook, Slough, Bucks.
Tel: Colnbrook 2431 (8 lines)

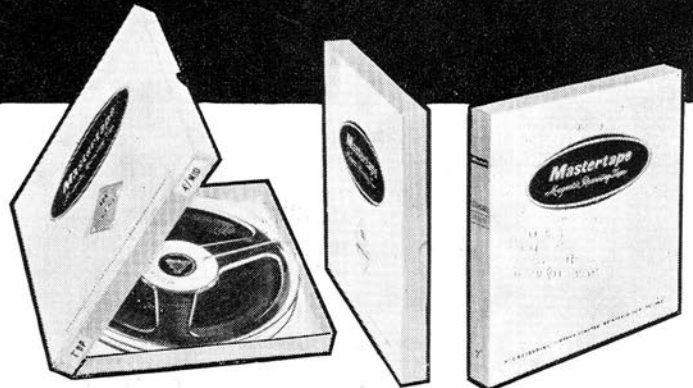

Here are some of the easy-to-build Heathkit models from our wide range

HI-FI EQUIPMENT CABINETS

A range of over a dozen equipment cabinets is now available to meet the differing needs of enthusiasts. Designed for maximum operating convenience or for where room space is an over-riding consideration, this range includes kits, accurately machined for ease of assembly and "left in the white" for finish to personal taste, ready assembled cabinets or RECORD HOUSING assembled and fully finished cabinets, and has at least one model to meet your requirements. Why not send for full details? Prices from £7 7s. 0d.—£37 16s. 0d.

ALL BRITISH MODELS AVAILABLE ASSEMBLED. PRICES ON REQUEST

Deferred terms on orders over £10.



"Malvern"



MFS

COTSWOLD HI-FI SPEAKER SYSTEM

This is an acoustically designed enclosure 26" x 23" x 14 1/2" housing a 12" bass speaker with 2" speech coil, elliptical middle speaker, together with a pressure unit to cover the full frequency range of 30-20,000 c/s. Delivered complete with speakers, cross-over unit, level control, grille cloth, etc. Ralph West ("Hi-Fi News") says: "The reviewer was very impressed and places this design among the top few and unhesitatingly recommends it to the most critical music lover."

"COTSWOLD" MFS SYSTEM

Similar performance to standard "Cotswold" but designed for the smaller room. Size 36" high x 16 1/2" wide x 14 1/2" deep. Either model £23 4s. 0d. kit.



FM TUNER

A Tape recorder requires a quality tuner

HI-FI FM TUNER, Model FM-4U

Available in two units which for your convenience are sold separately: Tuning unit (FMT-4U—£2 15s. 0d., incl. P.T.), despatched wired and tested, and I.F. amplifier (FMA-4U—£13 3s.). Printed circuit for I.F. amplifier and ratio detector. Built-in power supply: 7 valves. Tuning range 88-108 Mc/s. Total price Kit £15 18s. 0d.

Tape Recording and Replay Hi-Fi Amplifiers Models TA-IM (Mono) and TA-IS (Stereo) For use with most tape decks. Thermometer type recording indicators, press-button speed compensation and input selection. 3-position bias level and printed circuit construction.

TA-IM Kit	£19 18s. 0d.
TA-IM and Collaro "STUDIO"	£31 5s. 6d.
TA-IM and TRUVOX D92/2	£52 18s. 0d.
TA-IM and TRUVOX D93/4	£52 18s. 0d.
TA-IS (illustration Centre) Kit	£25 10s. 0d.
TA-IS and TRUVOX D93/2	£58 10s. 0d.
TA-IS and TRUVOX D93/4	£58 10s. 0d.

A WHOLE RANGE OF PACKAGED DEALS (INCLUDING "CONNOISSEUR CRAFTSMAN" TURN-TABLE and DECCA fess PICK-UP) NOW AVAILABLE TO SAVE YOU FURTHER MONEY.

Get best possible recordings with a tuner



A.M./F.M. TUNER

HI-FI AM/FM TUNER, Model AFM-1

Also available in two units as above: Tuning heart (AFM-TI—£413s. 6d. incl. P.T.) and I.F. amplifier (AFM-AI—£21 16s. 6d.). Printed circuit board: 8 valves: consecutive FM limiting and ratio detector. Tuning range FM: 88-108 Mc/s; AM: 16-50, 200-550, 900-2,000m. Switched wide and narrow AM bandwidth. Built-in power supply. Total price Kit £26 10s.



Save Money and enjoy yourself building these Heathkit models

They are so easy to build even for an absolute beginner. The manual of instruction is fool-proof—just follow the step-by-step.



S-33

MONO CONTROL UNIT Model UMC-1. Designed to operate with the MA-12 or any amplifier requiring 0.25v or less for full output. Suitable for cabinet mounting or free standing. Size 10" x 7" x 4". Kit £8 12s. 6d. Assembled £13 12s. 6d.

DELUXE 6 WATT STEREO AMPLIFIER Model S-33H. A stereo/mono amplifier with the high sensitivity necessary for lightweight ceramic pickups (e.g. Decca Deram). Deluxe version of the S-33. Kit £15 17s. 6d. Assembled £21 7s. 6d.

HI-FI STEREO 6 WATT AMPLIFIER Model S-33. Attractively styled, completely self-contained. Printed circuit makes it easy to build. Only 0.3% distortion at 2 1/2 W/chal. U/I output, ganged controls. Kit £13 7s. 6d. Assembled £18 18s. 0d.

HI-FI MONAURAL AMPLIFIER Model MA-5. An ideal general-purpose reasonably priced mono amplifier, 5 watts output at only 0.5% distortion, has inputs for Gram, Radio. Printed circuit board. Kit £10 19s. 6d. Assembled £15 10s. 0d.

HI-FI SPEAKER SYSTEM Model SSU-1. This kit is easily assembled. It contains speakers and balance control in its direct ducted port reflex cabinet. It is equally suitable for stereo or mono in average room. (Legs 14/6 optional extra.) Kit £10 17s. 6d. Available for vertical or horizontal use.

AUDIO SIGNAL GENERATOR Model AG-9U. Delivers up to 10 volts pure sine-wave (less than 0.1% distortion. 20 c/s to 20 Kc/s). Decade switch-selected frequencies from 10 to 100,000 c/s. Kit £22 10s. 0d. Assembled £30 10s. 0d.

POWER-AMPLIFIER 12-WATT Model MA-12. Single channel, ideal for stereo conversion. Kit £11 18s. 0d. Assembled £15 18s. 0d.

COLLARO "STUDIO" TAPE DECK. Two tracks. "Wow" and "flutter" not greater than 0.15% at 7 1/2" p.s. Long Term Speed Stability better than 0.5%. £17 10s. 0d.

SUGDEN MOTOR UNIT "CONNOISSEUR CRAFTSMAN". Heavy duty motor, operating at 33 1/3 and 45 r.p.m. Very heavy 12" turntable. £17 2s. 11d.



USC-1



TA-IS

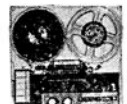

TRUVOX D93



STUDIO

HI-FI STEREO 18-WATT AMPLIFIER Model S.99. Within its power rating, this is the finest stereo amplifier available, regardless of price. U/L push-pull output. Printed circuit. Kit £27 19s. 6d. Assembled £37 19s. 6d.

TRANSISTOR INTERCOM. Models XI-1U and XIR-1U. Ideal for office or home. Each Master operates up to five Remotes. Master Kit £10 19s. 6d. Assembled £16 19s. 6d. Remote Kit £4 7s. 6d. Assembled £5 16s. 0d.

STEREO CONTROL UNIT Model USC-1. A deluxe stereo control unit with variable filter, switched rumble filter, printed circuit boards and many other refinements. Operates direct from tape heads. Kit £19 10s. 0d. Assembled £26 10s.

"OXFORD" PORTABLE RADIO Model UXR-2. Superbly styled hide case, with Golden trim and slide-rule tuning scale; this completely self-contained transistor dual-wave set performs brilliantly everywhere, even in a car. Reproduction is exceptionally good. Printed circuit. Kit £14 18s. 0d.

SHORTWAVE TRANSISTOR PORTABLE Model RSW-1. Four wave-band seven transistor portable with telescopic and ferrite aerials, slow-motion tuning. Covers Medium, Trawler and 6-26 Mc/s in four switched bands. Uses printed circuit board and latest circuit technique. Superbly styled leather case. Kit £19 17s. 6d.

TRUVOX D93/2 AND D93/4 TAPE DECKS. High quality mono-stereo Tape Decks. D93/2 1/2-track for highest fidelity. £36 15s. 0d. D93/4 1/4-track for most economical use of tape. £36 15s. 0d.

GARRARD AUTO/RECORD PLAYER Model AT-6. A 4-speed stereo-mono unit with manual or fully automatic record selection; adjustable counter-balanced arm. Fitted with Decca Deram ceramic cartridge £14 6s. 1d.

or Ronette 105 mono/stereo cartridge £13 12s. 1d.

GOLDRING Lenco TRANSCRIPTION RECORD PLAYER Model GL-58. Fitted with the G.60 pick-up arm and Ronette 105 mono-stereo cartridge, it has infinitely variable speed adjustment between 3 1/2 and 80 r.p.m. and four fixed speeds. 3 1/2lb. turntable to reduce rumble, "wow" and "flutter" £20 1s. 3d.



S-99



RSW-1



UXR-2



AT/6

MONEY BACK GUARANTEE

Daystrom Limited unconditionally guarantees that each Heathkit product assembled in accordance with our easy-to-understand instruction manual must meet our published specifications for performance or the purchase price will be cheerfully refunded.

JUST POST THIS COUPON FOR FURTHER INFORMATION

Without obligation please send me

★ **FREE BRITISH HEATHKIT CATALOGUE. . .**

FULL DETAILS OF MODEL(S)

TICK HERE

Kindly write below in BLOCK CAPITALS

NAME

ADDRESS

HT9

DAYSTROM LTD. DEPT. HT9
GLOUCESTER, ENGLAND
 A subsidiary of Weston Instruments Group, manufacturers of
THE LARGEST-SELLING ELECTRONIC KITS IN THE WORLD

COSSOR BREAKS THE PRICE BARRIER!



NEW!

FULL STEREO TAPE RECORDER CR 1607 yet it's only **57** GNS

This magnificent tape-recorder—with the reassuring name of Cosson—is completely self-contained. The 4-track recording system will play for approximately 8½ hours, (stereo 4½ hours) using 5½" LP tape at 1½"/second.

It's so simple to use—with its multipurpose control. 'Warm-up' time is eliminated because of the all-transistor amplifier—you get instant reproduction!

The 'multiplay' facility enables you to copy a recording from one track to another—whilst simultaneously adding a new recording!

NEW ADDITION TO THE COSSOR RANGE—THE CR 1606!

This attractively styled, two-tone beige coloured model is ideal for the beginner. Weighs only 13 lbs. 4-track single speed operation. At 3½"/sec. recording/playback time is 6 hours, 20 minutes approx. with 5½" reel DP tape. Yet costs only 29 gns.

See your Cosson dealer at once for full demonstration and detailed leaflet giving full technical specifications.



* LOOK AT ALL THESE SUPERB ADVANTAGES

- Stereophonic & Monophonic recording/playback employs 4-track technique.
- Mains operated, all-transistor amplifier—no 'warm-up' time—wood cabinet.
- Suitable for use as a P.A. amplifier with microphone, record player or radio inputs.
- Multiplay—a recording on one track may be copied onto another whilst adding a new recording.
- Two built-in loudspeakers—one for each channel.
- Recording level can be adjusted with tape stationary.
- Output sockets for playback via external amplifier or loudspeakers.
- Two speeds—1½" and 3½"/sec.
- Four digit programme indicator, with zero reset.
- Supplied complete with stereophonic moving coil microphone, 5½" reel LP tape, empty spool and radio connecting leads.

COSSOR

RADIO & TELEVISION LTD

233 TOTTENHAM COURT RD., LONDON W.1

tape recorder

INCORPORATING 'SOUND AND CINE'

EDITOR **MILES HENSLOW**

TECHNICAL EDITOR **JOHN CRABBE**

ADVERTISEMENT MANAGER **ROBIN WELLS**

Editorial and Advertising offices

LINK HOUSE, DINGWALL AVENUE, CROYDON, SURREY

Telephone MUNICIPAL 2599 (12 lines)

© Link House Publications Limited, 1964. All rights reserved.

editorial

VIDEO RECORDING for the amateur. Despite the difficulties in getting *Telcan* into production, the announcement of two important developments in the television field allows us to return to this most interesting subject with more hopes, suggestions and prophecies, together with a few facts.

When *Telcan* first made its appearance on BBC Television News just over a year ago, it seemed to be far ahead of its time. Two young engineers had beaten the established manufacturers at their own game, and the way was cleared for home television recording within that year. In fact time has shown that *Telcan* played the role of a sharp goad, greatly accelerating efforts by the large concerns (mainly established audio manufacturers) to perfect a similar device. But *Telcan* was, and is, only the crude forerunner (the *Blattner-Stille* of video, perhaps) of sophisticated machines which will eventually satisfy the domestic market. Running at 12 feet-per-second, the same can be said of the *Fairchild*, a polished American machine, suspiciously similar to the British invention. We must look to the helical-scan rotating head system—perfected by *Ampex*, copied by *Precision*, brought down in price recently by *Philips*, and currently (we presume) being prepared for mass production in Japan—as being a practical means of achieving quality at low cost.

There is nothing inherently expensive about rotating-head video recording techniques; their high price can be attributed to expensive development costs and a limited market. When mass-production takes over, as it certainly will, prices will plunge just as they did in the audio field.

Consider, now, the usefulness and versatility of a personal TV camera, recorder and monitor receiver. At 12 feet-per-second, programme-editing would be extremely difficult; with the helical-head it would be near-impossible—without expensive splicing equipment. The video version of today's audio tape splicing block might well cost as much as the recorder itself.

But good audio recordings are not difficult to obtain without complex splicing—surely the same will be true with video? Unfortunately it most certainly will not, if *creative* recording is planned. And here is the main drawback of the video recorder. Taping television broadcasts should not be difficult—doubtless the same copyright situation will arise as exists now with recordings of radio broadcasts; instant Richard Dimpleby will delight the many individuals who are happy just to sit and absorb: the passive listener, the passive viewer—both will be catered for as adequately in the future as now. But the creative recordist will meet an art-form which may prove impossibly difficult to perfect. Imagine the average tape-play of the type churned out in bulk by contemporary clubs. As long as the characters *sound* the part, the performance can be given a more or less professional finish. But in front of a television camera the amateur will be subject to much more idiosyncratic nervousness than was the "mike shy" recordist. To perform in an amateur TV production he will need the memory and skill of a professional actor. There will be no script to hand—unless one can be concealed "off camera". The subject of the

play will be severely restricted unless unlimited funds allow for costumes, scenery effects and artificial beards—the full resources of a professional film studio, in fact.

It might be said that these criticisms could be levelled at amateur cine photography. While this hobby has not "caught on" as widely as still photography, cine film is much more robust and permanent than a 12 feet-per-second tape recording which, even with today's long-life tapes, will be worn out after 200 hours' use. Furthermore, film can be edited with a precision that makes audio tape editing seem "hit-and-miss". The cost of film, much too high considering the popularity of the hobby, limits individual sequences in an amateur film production to a few seconds. The problem of script memorisation therefore solves itself.

At present stages of development, the TV camera needs to be extensively panned as, unlike its cine equivalent, switching off the recorder at the end of a shot results in a delay of several seconds while the picture synchronisation is readjusted to the following sequence. This picture jumping may be difficult to eliminate on playback of the completed recording.

In common with the cine photographer, the video recordist will probably want to spend much of his filming time out of doors. The average 8mm. camera and its associated equipment are just as easily carried as the average battery audio recorder. The outdoor video recordist is, however, liable to be chained to a motor vehicle for power and mobility. But with cables of up to 200ft. permissible between camera and recorder, this may not be a great deterrent to some, in view of the relative ease of "playback" via the domestic TV receiver.

Such is the gloomy picture painted for the future of domestic television tape recording. It is up to the creative (and, at the moment, rich) individual to think around these problems and do what he can—when the time comes—to prevent video recording sinking into the role of a visual juke-box.

SEPTEMBER 1964 . VOLUME 6 . NUMBER 8

- 309 WORLD OF TAPE
- 311 A RIVAL TO TELCAN
By John Berridge
- 312 MAKING THE COMMERCIAL—A PLAY
By Roy Russell
- 317 FIELD TRIALS OF BATTERY PORTABLES—No. 3
By David Kirk
- 318 A TRANSISTORISED TAPE AMPLIFIER—PART 2
By S. Welldon
- 321 A STUDIO QUALITY MIXER—PART 4
By D. P. Robinson
- 325 TOWARDS BETTER TAPING—PART 6
By Gordon J. King
- 329 MAGNETIC MEMORY
By P. D. Turner
- 329 PROTECTING YOUR TAPE RECORDER
By John Gaselee
- 331 REVIEW OF AKAI 345
- 333 TAPE RECORDER SERVICE—No. 33
By H. W. Hellyer
- 336 OUR READERS WRITE
- 337 CLASSIFIED ADVERTISEMENTS
- 338 ADVERTISERS' INDEX

COVER NOTE

Closely resembling a radiogram, the *Fairchild* domestic video recorder forms this month's cover picture. Details of this new machine are given by John Berridge, in his article on page 311.

SUBSCRIPTION RATES

Annual subscription rates to *Tape Recorder* and its associated magazine *Hi-Fi News* are each 30/- in the U.K. and 32s. 6d. overseas (U.S.A. \$4.50) from Link House Publications Ltd., Dingwall Avenue, Croydon, Surrey. These include free copies of the indexes.

THE TAPE RECORDING EVENT OF 1964

**PHILIPS GIVE YOU
THE MAGNIFICENT NEW
TAPE RECORDER WITH
AUTOMATIC AND MANUAL
RECORDING CONTROL
(MODEL EL3552)**

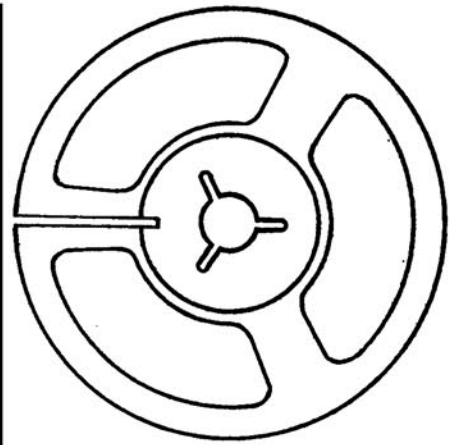
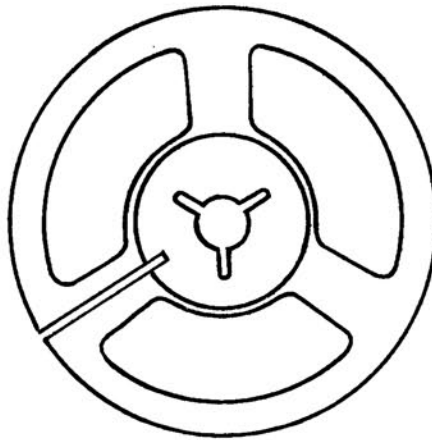

This is the tape-recorder for 1964. A real jet-age job in style and sound. The Model EL3552 has Philips world-famous quality and reliability with a big *plus*—Automatic Recording Control! Whatever the volume, every sound is faithfully reproduced without distortion. Sound goes in undistorted and comes out undistorted. Automatic Recording Control takes complete charge if you want it to. When you prefer manual setting, just press a button and take over.

- Twin track recording and playback at 3 $\frac{3}{4}$ i.p.s.
- Push-buttons give instant selection of record, playback, fast wind, fast re-wind, tape pause and stop. Record button has safety interlock.

- Variable controls for on/off, volume and tone.
- Magic Ribbon recording level indicator functions for both Automatic and Manual operation.
- Socket for connection to Hi-Fi amplifier, second tape recorder or radio.
- Gives over 3 hours playing time with 5 $\frac{3}{4}$ " reel of DP tape.
- Supplied complete with moving-coil microphone, 5" reel of LP tape, 5" empty spool and screened connecting lead.

ALL THIS FOR ONLY 24 GNS

To get the best from your Philips Model EL3552 use the tape that is made for it—Philips Tape. Best for every tape-recorder in colour coded packs for easy identification.

GREEN standard-play
RED long-play
BLUE double-play
GREY triple-play

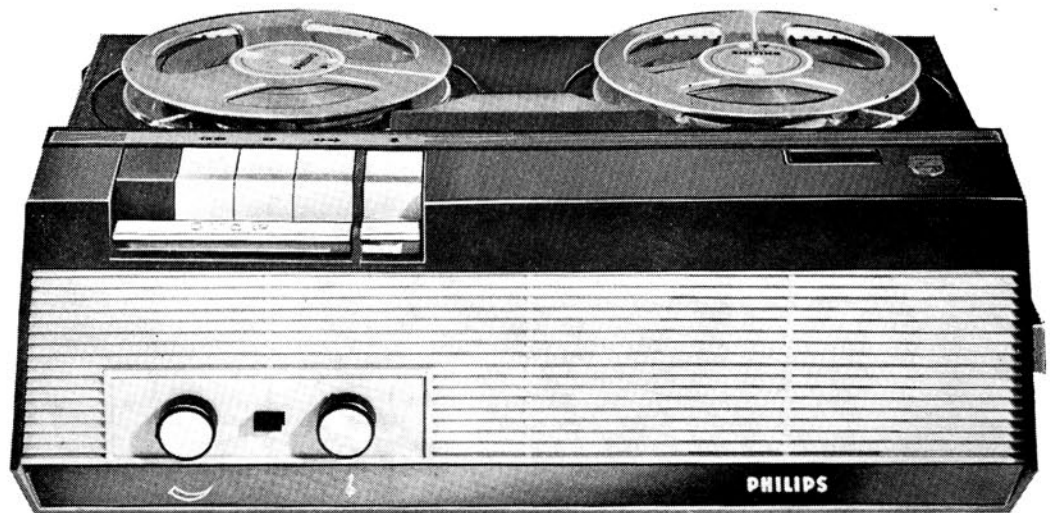

PHILIPS — the friend of the family

world of tape

BUDGET STEREO ON TAPE

WE apologise for the omission of a *New Products* column this month, but pressure of space, together with the postal strike, made it necessary to hold this over until next month. One machine, however, recently announced by *Cossor*, is worthy of mention in any column. At £59 17s. it is the least expensive complete stereo recorder ever to be offered on the British market.

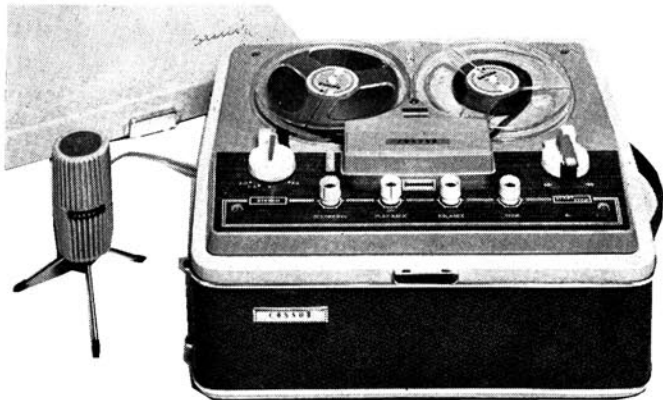

Full facilities for $\frac{1}{4}$ -track recording and replay, as well as MULTIPLAY and inter-track recording, are offered by the CR1607 (shown with microphone), with speeds of $3\frac{1}{2}$ and $1\frac{1}{4}$ i/s. Peak-to-peak wow and flutter figures of 0.6% are claimed, with a frequency response from 80 c/s to 15Kc/s at the faster speed and 80c/s to 10Kc/s at $1\frac{1}{4}$ i/s.

Output power is 1.5W per channel to two internal speakers located at either side of the cabinet. Dual outputs are provided for external

speakers and amplifiers, and straight-through amplification enables replay from, for example, a gramophone pick-up, without necessarily recording. A headphone monitoring socket permits stereo replay of tapes into earphones, and allows recordings to be overheard as they are made. Maximum

spool size is $5\frac{1}{2}$ in. giving a playing time, using LP tape on $\frac{1}{4}$ -track mono, of $8\frac{1}{2}$ hours. Other features include automatic stop, four digit position indicator, fully transistorised electronics and lockable PAUSE button.

A moving-coil stereo microphone is included in the price, and a range of accessories are available at extra cost.

A monophonic version of the CR 1607, using a similar deck layout, is the CR 1606 (also illustrated). Only one speed is provided ($3\frac{1}{2}$ i/s) and the price is £30 9s.

Manufacturer : Cossor Radio & Television Ltd., 233 Tottenham Court Road, London, W.1.

NEXT MONTH

THE October issue of *Tape Recorder*, to be published on October 2nd, will include a review of the Reslo VRT/L ribbon microphone and the conclusion of Stewart Welldon's tape amplifier series. The pro's and cons of spools, magazines, cartridges and cassettes, will be discussed by Kenneth Glenwood, while Part 5 of the Studio Mixer will detail the construction of a versatile peak-programme meter. Tape reviews, omitted this month due to pressure on space, will return as usual.

'OXTAPES'

AN enterprising scheme for the collection of funds for *Oxfam* has been started by the *Greenhorn Sound Recording Studio*. Using a variety of domestic mains and battery recorders, a tape is being produced, with recordings covering many topics of interest. This is to be hired out to anyone requesting a copy, in exchange for a 5s. contribution to the famine-relief fund. The organisers hope to bring out a regular "magazine on tape" with a frequency of four to six months.

Support, either of a financial kind or recorded contributions, would be greatly appreciated. Subjects as wide as a world trip in music to a talk on Lancashire dialects have so far been received. Readers are invited to contact the organisers : *Greenhorn Sound Recording Studio*, 69 Nursery Road, High Brooms, Tunbridge Wells, Kent.

BINDERS—PRICE REDUCTION

REFERRING to the note published last month, concerning *Tape Recorder* and *Hi-Fi News* binders, those have now been reduced in price, from 15s. to 12s. 6d. each, post paid. With housing space for twelve issues plus index, they are obtainable from : *Modern Bookbinders Ltd.*, Walpole Street, Blackburn, Lancs.

MAGNETIC RECORDING CONFERENCE

THE 1964 conference on magnetic recording began on July 6th, at the Institution of Electrical Engineers. Among the subjects covered in the broad programme were automatic stop and sequence control systems, the *Synchropulse* magnetic tape interlock, and the editing of audio tapes without cutting.

Video was well to the fore, with papers describing servo-systems and frequency modulation in video tape recorders, and the description of a "compact slant-track recorder for television signals".

PRACTICAL NOISE CONTROL

FROM September 16th to 18th inclusively, a short course covering all aspects of noise control is to be held at the Institute of Sound and Vibration Research. The course fee is £4 4s. and application forms can be obtained, together with further information, from : *Dr. T. Priede, Course Organising Secretary, Institute of Sound and Vibration Research, The University, Southampton.*

PHILIPS VIDEO RECORDER

WITH the announcement of a new video recorder, *Philips Electrical* have broken the high price category of helical-scan equipment, with a machine selling at less than £1,000.

The recorder was shown for the first time by *Peto Scott* at the International Conference on Magnetic Recording early in July. The combined record/playback head is made of *Ferroxcube*, giving an extremely long working life, and is easily replaced by extracting it from the rotating assembly.



Coupled to its pre-amplifier by a rotating transformer, the head scans 1 in. tape moving at $7\frac{1}{2}$ i/s, at approximately 23 yards per second. Maximum playing time, using 1,800ft. of LP tape, is 45 minutes.

Designed to CCIR television standards, the recorder is intended for use in education and industry and will be available in several different versions, together with relevant accessories.

Manufacturer : *Philips Electrical Ltd.*, Century House, Shaftesbury Avenue, London, W.C.2.

Agfa tape is specially made to take all the knocks and wear of constant playing. The magnetic emulsion is *bonded* to the polyester base – for good. Heads stay clean and free from iron oxide deposits. That's why you'll get the most consistently perfect reproduction you've ever heard. Agfa tape is *really* special (yet it's the same price as ordinary tape).

One thing Sir Lancelot can't resist is *Magneton Illustrated* – our colour magazine, all about recording – and you don't have to enter the lists to get a copy – they're free. Write to Agfa Ltd. 27 Regent Street, London, S.W.1. (REGent 8581). *Agfa PE Recording Tapes, Long-play, Double-play, Triple-play* are available in shatter-proof plastic cassettes (5", 5½" and 7" spools).

Agfa tape is extra tough



Products of Agfa-Gevaert AG

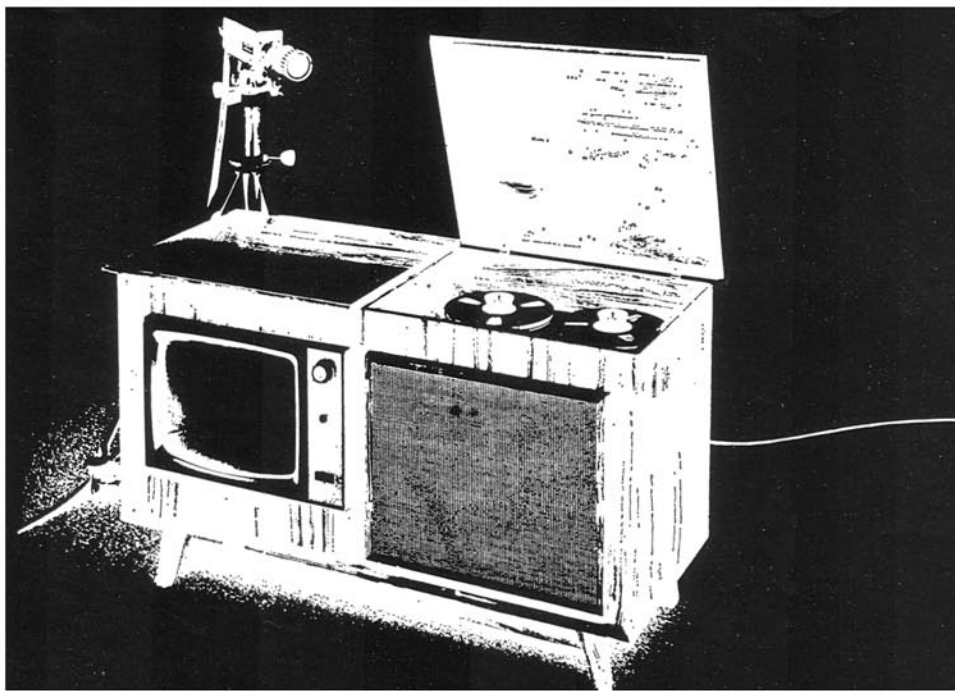

a

rival

to

Telcan

BY JOHN BERRIDGE

THERE is no denying that interest in the possibilities of a TV tape recorder, at a price within reach of the average enthusiast, is tremendous. The way in which the publicity and public relations surrounding *Telcan* was mishandled in no way detracts from its undoubted achievement. In remarkably short order, another contestant entered the arena, this one a prototype machine known as the V-5000 developed by *Winston Research Corporation of Los Angeles*, a subsidiary of the large *Fairchild Camera and Instrument Corporation*. A recent showing on the East Coast has aroused considerable interest, and a great deal of public comment in various segments of the American technical press.

The prototype model shown here, in a simple but attractive walnut console, consists of a conventional black and white television receiver modified slightly to permit video, audio and sync signals to be extracted from the receiver, fed into the recorder and then back into the receiver again. Alternatively, a composite video signal can be taken from a small vidicon camera of the industrial close-circuit type.

The recorder itself makes use of much the same design philosophy as *Telcan*. A tape speed of 120 i/s allows stationary heads to be used, and in fact one playback and two record heads are used. As in standard professional audio recorders, the record head has a relatively wide gap, the playback head extremely narrow. The gap of the latter is only .000039 in. (less than one micron). Each head scans a 50-mil track, and the heads themselves are moveable to allow four separate tracks to be scanned, in much the same fashion as 4-track audio tape.

The tape itself, because of the high frequencies used, is instrumentation tape, but in standard $\frac{1}{4}$ in. width; also, because of the high tape velocity, it consists of 9,000ft. on a $\frac{1}{2}$ -mil base, wound on standard 10 $\frac{1}{2}$ in. NAB hubs and flanges. This still allows only 15 minutes of actual recording time in one pass. Therefore, a photocell sensing circuit, which functions through a slit cut in the tape near each end, actuates an automatic reversing mechanism. Four complete passes are made without pause, the record and playback heads being re-positioned each time, to lay down four separate tracks and provide a full hour of material on one reel of tape. Various press reports have implied that the recording is thus continuous, yet it seems naively obvious that tape moving at ten feet per second cannot be reversed instantaneously. Similarly a run-up-to-speed time is needed, and the Fairchild data actually shows an acceleration time of 4 seconds and a reversal time of 8 seconds. In truth, these handling times are quite respectable, but in the usual 59 minute 25 second programme there would be three 8-second breaks at 15-minute intervals, during which programme material would be lost. Sensibly, the signal is 'squelched' during any change-of-mode operation.

The method of tape modulation has not been revealed, though some related factors have. "Signal enhancement based on information theory" is reportedly the technique, and the available literature states specifically that both video and audio signals are multiplexed to allow both to be recorded on the one track (a difference with

Telcan, which uses separate tracks). Couple this with other factors, such as Winston Research's heavy involvement in instrumentation and telemetry recorders (magnetic, that is), and it seems likely that some sort of frequency or phase modulation might be employed, perhaps linked with some type of information-processing circuitry.

Using top-quality studio standards as a criterion, both video and audio bandwidths are somewhat restricted. Audio is quoted as 50 c/s. to 6 Kc/s. + 3 dB, which speaks for itself, video being 1 Kc/s to 2 Mc/s. The latter is not flat but "emphasised" for best picture quality. There is a gradual roll-off above that. The restricted high-end response results in a certain loss of definition, with some picture slurring, reportedly not objectionable. Comparison photos made from the Fairchild recorder of live and recorded picture quality seems to indicate that the American machine produces somewhat better playback quality than does *Telcan*, a matter much open to interpretation. Despite its limitations, the V-5000 produces creditable results for a prototype.

The high-tape speed raises two inherent problems. The first is head wear, but the use of micro-polished tape will decrease this considerably, and a head life of 1500 hours appears perfectly feasible. A conventional erase head is out of the question since the tape is moving too fast for such a head to achieve more than fractional erasure. Thus, all tape must be bulk-erased before use.

Aside from the high speeds, the transport mechanism is quite conventional, utilising the three-motor arrangement (probably for convenience, as far as the prototype is concerned), and Fairchild have stated that there would be no problems involved in using a single motor in an eventual production model. Since this machine makes no attempt to use the sync signal itself to obtain sync stability, but relies entirely on accurate tape speed, it can be made to accept any processed signal. Thus, dubbing from one machine to another would be a simple matter of inter-connecting audio, video and sync feeds. The vidicon camera is a fairly common closed-circuit type, using the standard American 525-line interlaced scanning system. Many such cameras feed a conventional TV receiver on RF signal, but this one probably doesn't since it would be much cheaper and simpler to feed a processed signal direct.

Neither Winston, nor its parent Fairchild, are planning production of a version of the V-5000, and the probable course of action is that one of the established receiver manufacturers would produce under license. Fairchild and others seem to think that a receiver/recorder/camera combination in console form could be retailed for about \$500. Along with this, a 9000ft. reel of tape would sell for about \$28 and replacement heads would cost about \$15 apiece. These figures can be appreciated by realising that a good semi-professional audio recorder costs around \$550 and a 7in. reel of tape around \$4. As a further comparison, a full hour of "magnetic home movies" would cost the \$28 for the tape, re-useable many times. In 8 mm. cine, the same one hour would cost \$108, including processing—and a one-shot effort at that.

THIS tape-play may be freely performed and recorded for amateur use without payment of royalty. All professional rights remain vested in the author.

The characters do not call for high drama technique; they should be played naturally, with conviction and at a good pace. The sound effects play two important parts: they set the background and assist the action and are within the compass of any club or group of people. The whole recording may be made at one live session with the effects created by the actual origins of the sounds.

CHARACTERS

Mrs. G (The 'lady' of the house, indoctrinated by commercials, and determined to get the best out of the products they advertise.)

Producer (Roger) (The man who tries to keep things on the move, and smooth over difficulties. He becomes exasperated but tries very hard to control himself.)

Miss Ojoy (Shirl) (A girl who relies more on her looks than her personality.)

PRODUCER: Did you get that? It's essential, dear. Got it?
MISS OJOY: Yeh, but I can't pull her about whilst we're on camera, can I? It's got to look real, you said.

PRODUCER: Oh yes. Let's watch it, that's all.

MISS OJOY: Bit chilly for tights this morning. My legs are blue.

CAMERAMAN: Not to worry. Won't show on the telly.

PRODUCER: You took the costume with the job, dear. Good job for you we work on the sunny side of the street.

MISS OJOY: Sun? In England? You're joking.

SOUND: (*reporting*) Sound O.K., Roger.

PRODUCER: Thanks Gilbert. Shirl. Try number thirteen, for luck.

CAMERAMAN: Isn't that pushing it, Roger?

PRODUCER: All right. Try fifteen. I'm easy.

(*Feet on gravel path*)

PRODUCER: Ring and knock, we're behind schedule already.

(*Ring and knock*)

MISS OJOY: No sign of life.

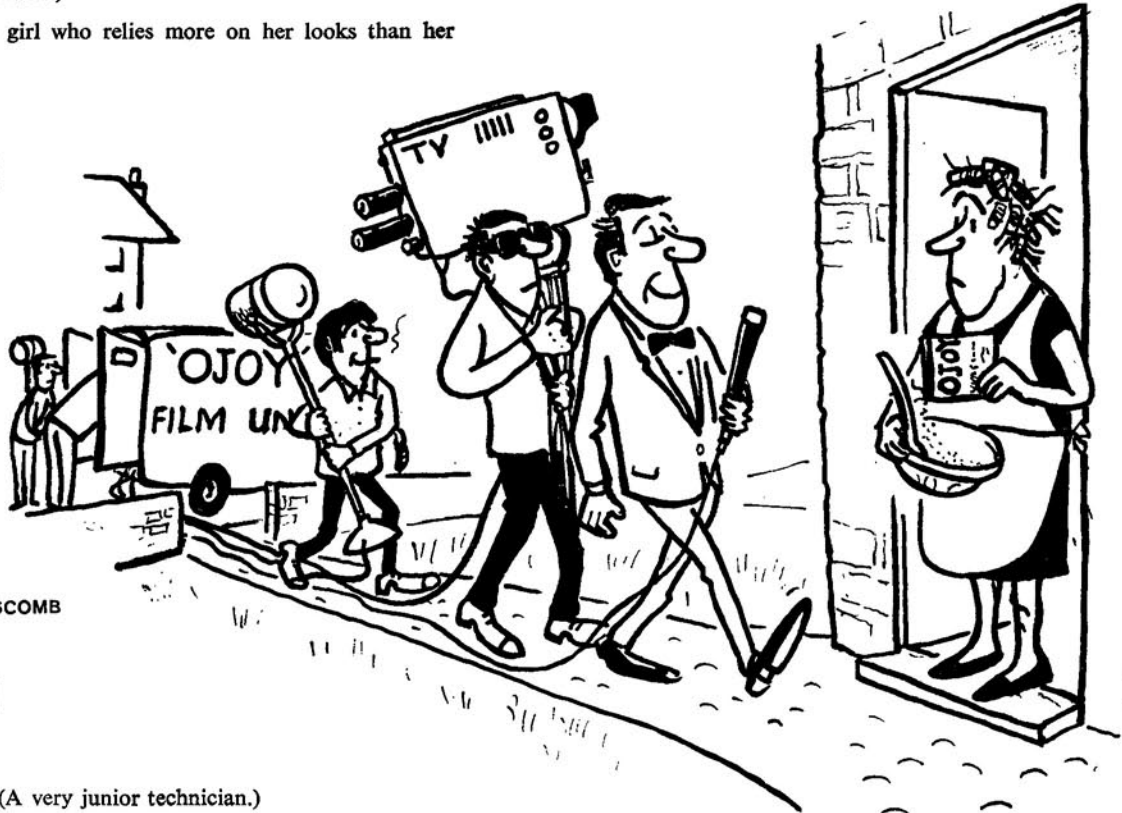

CARTOON BY ANSCOMB

Cameraman (George) (A very junior technician.)

Sound Engineer (Gilbert) (An even more junior technician.)

Mrs. G. is something of a 'character', but not consciously humorous. She may be played in a dialect, and this should be overstressed with an unsuccessful attempt at 'speaking posh' which comes out in certain words (depending on the dialect used).

The other parts are straightforward and suitable for performance by people of widely different ages and personality.

(*Fade out opening music. Sound of a car pulling up. General background sounds of local street. Equipment being unloaded efficiently and without fuss. Small crowd gathers in background if required.*)

PRODUCER: (*quiet authority*) Right, everybody. Set-up. Camera on roof. Mike just over front doors of these two. Let's hope we get something decent out of one of them.

CAMERAMAN: Roger, could Shirley see the housewife holds the product up more in this one, please? When we print the last take I doubt if we'll see the name on the packet. And that kills it.

PRODUCER: Thanks, George, yes. Shirl.

MISS OJOY: Yeh.

PRODUCER: O.K. Give it ten seconds.

(*Door opens*)

MRS. G.: She's out, number thirteen. Gone to—Oh! You're Miss Ojoy, aren't you? Recognise you anywhere. Yes, Ojoy for joyful whiteness; that's what I say.

PRODUCER: And that's what the packet says madam.

MRS. G.: You needn't tell me that, young man.

PRODUCER: So you use Ojoy, madam?

MRS. G.: Use it! I swear at it—by it. Woollens, cottons, nylons, capons—sorry I've got one in the oven.

PRODUCER: One what, madam?

MRS. G.: A capon—for his dinner. That's how it got in: I don't really wash capons with Ojoy. That would be silly, wouldn't it?

PRODUCER: Quite. What about coloureds, madam?

MRS. G.: Yes, I've seen them buying Ojoy too.

PRODUCER: No; do you wash coloureds with Ojoy?

MRS. G.: Oh, I see. 'Course. Coloureds, whites, smalls, very smalls.

MISS OJOY: Your whole weekly wash in fact?

MRS. G.: Yes, well, I can't mention *everything* can I? I mean, it wouldn't be proper, you know.

PRODUCER: But you do use Ojoy?

MRS. G. : Oh yes. For everything. Washing up. Clean the carpet. Wash down the walls. Once over the floors. Peel off the wallpaper. Wouldn't surprise me if it didn't shift that there 'B.O.' Although I've no need for it as you can probably tell.

PRODUCER : And would you give permission for us to film you.

MRS. G. : On the films? Me?

PRODUCER : No. For television.

MRS. G. : Well, that's better, isn't it? The neighbours wouldn't have to turn out, would they? To see me.

PRODUCER : (*quick aside to cameraman*) She's a natural, if we can only get it on film.

CAMERAMAN : (*quick aside*) Unnatural if you ask me.

MISS OJOY : And what washing machine have you, Mrs.....?

MRS. G. : Well, you put water in first, then the clothes and it goes round and round like—

PRODUCER : No. She means what make?

MRS. G. : Make? Oh, silly me. The make.

MISS OJOY : Yes, the name. Like the advertisements.

MRS. G. : Oh, it's a very famous name. You know the one. Advertised in the paper it is. You can't miss it. You'd know it if I mentioned it.

MRS. G. : Hundred pounds. Ooh, lovely.

MISS OJOY : To qualify to make this film you have to have a giant size packet in the house.

MRS. G. : You're right, you have. I read it in the local paper. Quite right, young lady.

PRODUCER : But have *you* a packet, madam?

MRS. G. : Have I? Now you just stay there. Don't go. You promise?

PRODUCER : We won't.

SOUND : We've got a right one here.

PRODUCER : Don't know. Could come out well. She's different.

CAMERAMAN : Now you really are joking.

PRODUCER : Don't forget she's a *genuine* user. Could be just the new impact gimmick we badly need. The straightforward stuff's getting played out. Shirl.

MISS OJOY : Yes, Roger.

PRODUCER : Whatever happens, keep to the set questions. We'll edit the gaffs out in the cutting room. Look out.

MRS. G. : What did I tell you? There's the giant size that I got the Alfred Munnings painting free with. This is the one the toasting fork came with. And that's the tenpenny size with eightpence off

MAKING THE COMMERCIAL



A TAPE PLAY FOR AMATEUR PRODUCTION BY ROY RUSSELL

PRODUCER : What name is it, madam?

MRS. G. : It's a Di-reck.

PRODUCER : Di -Reck? I haven't heard of that make. Can you describe it?

MRS. G. : Course. It came in the paper.

PRODUCER : I'm not asking how it was *wrapped*, madam.

MRS. G. : Silly you, you're not with it, are you? The paper; the *morning* paper. I wrote away for it, and the man from the paper came and I signed the entrance and he told me I got four days to decide whether I go on the Never-Never trail or take the money back.

PRODUCER : I see. You mean the Hire Purchase Law.

MRS. G. : Is it? Yes well, it's a Di-reck then isn't it? Full page, you see it in all the papers. "Buy Di-reck from the factory." That's what I did.

PRODUCER : Well, perhaps we'll leave out the name. We won't mention it.

MRS. G. : Oh, I don't mind advertising Ojoy. It's really good. So why shouldn't I mention it.

PRODUCER : Exactly. And when the films come out, there's a prize of one hundred pounds to the housewife who's given the most natural answers to Miss Ojoy here.

— no sorry, it's the giant Alfred Munnings I got the eightpence off. Very good of him I thought; must cost him quite a bit. 'Course, they're only reproductions.

PRODUCER : (*going along with her*) You couldn't expect them to be originals.

MRS. G. : No. How many packets would I have to buy at once for one of *them*. Couple o' dozen at least.

PRODUCER : At least. Now, to work. This is what we do, Mrs. . . . We start the camera. Miss Ojoy knocks on your door and—

MRS. G. : It will go all over, won't it, on the telly? Cos I've relatives don't get the same programmes we do, you know.

PRODUCER : They'll see it, Mrs.—(*aside*) If it's ever finished— It'll be fully networked. Now, Miss Ojoy—

MRS. G. : Yes, I read in the paper she'd be round our way this week and to look out for the Ojoy van. I cut it out, and put it behind the clock and I bought the lot of course, but I never dreamt you'd come down our street. Now do you want me with the detergent packet or the Ojoy soap that kisses the back of me hand or the bath soap that has lather on its lather, or the Ojoy bendrounder for the toilet seat?

SOUND : She's got the lot.

(continued on page 315)

33 GNS BUYS FINGER-TIP CONTROL- AND 15 LUXURY FEATURES!



- 4 tracks—12 hours playing ■ 2 speeds— $1\frac{7}{8}$ and $3\frac{3}{4}$ ■ Superimpose button ■ Auto-stop ■ Programme indicator ■ Pause control ■ Microphone and lead included
- Straight through amplifier ■ External speaker socket ■ Finger-tip piano key control ■ Tape inching either way at a touch ■ High quality amplifier, 3 watts output ■ Two-tone finish ■ Free reel of BASF tape ■ Free BASF booklet of tape recording hints.

ULTRA

Features the most



TO : ULTRA RADIO & TELEVISION LTD.
TELEVISION HOUSE, EASTCOTE, RUISLIP, MIDDLESEX
Please send me free colour leaflet on the Ultra tape recorder

Name.....

Address.....

.....



MAKING THE COMMERCIAL

CONTINUED

PRODUCER : Well, that's wonderful Mrs..... But this is to advertise the washing powder only. Could we stick to that, please?

MRS. G. : Right. I'll take the others in and clean up a bit.

PRODUCER : Clean up? How d'you mean?

MRS. G. : Put something a bit more—you know, glamorous on. I'm not on the films every day, am I?

PRODUCER : No, you're fine : absolutely right. Wouldn't have you any other way. Honestly.

MRS. G. : Well, thanks very much. Glad you like it. This is just as I got up this morning, you know. Nothing special.

PRODUCER : Really? Now. Listen carefully. You go in and close the door. Then Miss Ojoy knocks and asks you the questions. And you just say whatever you like about Ojoy. All you said when we first met, remember?

MRS. G. : Just like Hollywood. See you in a minute.

(Sound of door closing)

PRODUCER : Well, here we go. For better or worse. O.K. Shirl. Knock her up.

MISS OJOY : O.K.

PRODUCTION : Action.

(Knocks on door. Door opens)

MRS. G. : Are you ready, then?

PRODUCER : Cut! Yes, we're ready. Just answer for the questions, please. Close the door and wait for the knock.

(Door closes)

PRODUCER : Action!

(Knock on door, door opens)

MRS. G. : Shouldn't I have special make-up?

PRODUCER : Cut!

MRS. G. : Like Elizabeth Taylor and Sir Richard Burton. And they're a bit better looking than me, you must admit.

PRODUCER : No dear. It's a special camera. You're gorgeous.

MRS. G. : Oh! You're only flattering me to to get the best out of me.

PRODUCER : *(near exhaustion)* Close the door.

(Door closes)

PRODUCER : Action!

(Knock on door. Door opens)

MRS. G. : Yes?

MISS OJOY : Good morning, madam. We're doing a survey on washing powders. Which make do you use?

MRS. G. : Well, I told you just now I use Ojoy, you know I do. You saw all the packets here—

PRODUCER : *(still controlling exasperation)* Cut! No, dear; pretend you've never seen us before. We're doing it now for the camera's benefit.

MRS. G. : Oh! You should have told me that. I'll get it this time.

(Door closes)

PRODUCER : Action!

(Knock on door. Door opens)

MISS OJOY : Good morning, Madam. We're doing a survey of washing powders. Which make do you use?

MRS. G. : Oh! Yes. My goodness me. I always use Ojoy. "Ojoy for the Joyful Whiteness". That's the message on the packet. *(To producer)* I thought I'd show the packet to the camera here—

PRODUCER : Cut! No, madam! Talk to Shirl—er—Miss Ojoy. You don't know the camera's there.

MRS. G. : But I thought you wanted a commercial. I could make up one of those jingle things if you want it. You know, like "Oh boy for Ojoy", I'm very quick at anything like—

PRODUCER : No! Forget the commercial! Forget the camera! It isn't working. Just answer the questions. Please.

MRS. G. : Oh! Like an actress in real life. Only realer.

PRODUCER : Yes! From the survey question, Shirl. We'll bodge the door opening from what we've got. Action!

MISS OJOY : We're doing a survey of washing powders. Which make do you use?

MRS. G. : Oh, Ojoy. Always. And I can prove it because by a funny coincidence I happen to have a packet with me. As you happen to be accidentally passing and stopped to ask my opinion—

PRODUCER : Cut! No madam! *Don't* show the packet so obviously.

MRS. G. : But they always show the packet. On the cereals and the ciggies. They all show them. Some of them dance about like this, and then open themselves. Haven't you seen them?

PRODUCER : But we'll shoot you... shoot you showing the packet at the end. That's the pay off.

MRS. G. : Oh yes, a hundred pounds. Hope I win.

PRODUCER : Everything depends on whether we use the material.

Now, no packet. From Question Two, Shirl. Action!

MISS OJOY : Why do you use Ojoy in preference to other washing powders?

MRS. G. : Well, it's kinder to the hands. Oh, silly me, that's the soap isn't it? The powder plays up something chronic with mine. Look at 'em.

PRODUCER : Cut! No, never mind George, keep rolling all the time. We'll chop it in ribbons afterwards. The powder, madam, the powder!

MRS. G. : Silly me. I'm getting confused. Er... Well, I mean to say, it's easily the most smashing for woollens and silks and nylons and—better not make the same mistake and say capons, had I? what comes next, yes and coloureds and whites. *(To Producer)* I'm getting the hang of it now.

PRODUCER : Yes! Smashing. Just answer the questions truthfully. *(To Miss Ojoy)* Go on, Shirl.

MISS OJOY : And what made you change to Ojoy in the first place?

MRS. G. : Well, to tell the truth, it was the savings stamps really. You see, I used White-O for years, but they don't stock White-O at the supermarket where I get my stamps and I'm saving stamps for a set of Peter Scott pigeons—I love him on the BBC, don't you?

PRODUCER : Cut! This is impossible. I can't go on. I can't make this film. It will ruin my reputation.

MRS. G. : Is the camera still going?

PRODUCER : *(in despair)* Of course not. You've ruined it.

MRS. G. : Ruined it. I never touched it. Let me tell you, I've never seen so much fuss made over a little bit of chatting-up in all my life. I could have done my whole week's wash whilst you've bin flapping around here.

PRODUCER : *(renewed enthusiasm)* Go on, George. Take it. Roll 'em. And you could do the whole weekly wash, madam, with Ojoy, in the time it has taken us to make this short film at your front door?

MRS. G. : Certainly, I could. Easy as kiss your hand. You mean with Ojoy? Not on your life. I can't be bothered with lather all over the kitchen and it's stacked with free gifts anyway. No. I've cut it all out. White-O, Ojoy, the lot. Now I take the whole flipping wash to the Launderette and use their soap powder in plain packets. Sure as my name's Mrs. Gray. If you're going to waste my time like this get all this stuff off my flowers. *(Confusion of equipment being taken up : feet on gravel path, car doors, engine starting.)* I've had enough of this nonsense. If you can't do a simple job and keep the place neat and tidy, I've no time for you. As for you, young lady, you deserve a right spanking for being in public dressed like that. Disgusting. Yes, be quick about it. And you can tell them from me—

(Car roars away)

MRS. G. : *(to herself)* Good riddance, too. I knew it was a racket. Those women on the telly are all actresses. I can tell. You can't get real people doing all that clever answering. I've proved that for myself. Once and for all. Ojoy? I should say so.

(Fade in concluding music)



EVER READY HIGH POWER MEANS 4 TIMES MORE RECORDING PER BATTERY

This is the Ever Ready HP2 battery, one of the revolutionary new range of High Power batteries. At current drains of 300 mA in tape-recorders the HP2 has a working life over 4 times as long as that of the standard U2. HP batteries are extending the life and so the use of many types of battery-powered equipment from toys to photo-flash in the same way. Get full details from The Ever Ready Co (GB) Ltd., Hercules Place, Holloway, London N7. Telephone: ARChway 3030



for longer life!

FIELD TRIALS

OF BATTERY PORTABLES

EXCLUDING its detachable playback amplifier and speaker, the Sharp TRC-1004 makes the EL3300, described last month, seem of gigantic proportions. Standard $\frac{1}{2}$ in. tape is used, wound on non-standard metal spools. The very small size of the recorder is achieved by the ingenious expedient of mounting the spools co-axially one above the other. This type of stacking is not new, however, and readers may recall the *Countess* mains-recorder which, during the brief period it was on sale, made use of the same principle.

In fact, vertical mounting of this type is mechanically much simpler to achieve than one might imagine. The lower spool is supported by a tightly-fitting metal hub, with a diameter of about half an inch. Through the axis of this hub passes a narrow spindle which widens to form an independent hub for the top spool. The motor power can

spool, then the latter is placed on the top hub of the recorder, where it is held by a combination of precision engineering, low gravity and good luck. The spool-holder is clipped into a slot on the front of the deck. The appropriate bush is selected (two are available for the two hub sizes used), placed on the spindle, and used to support the feed spool (this is clarified, I hope, by the photograph).

Having acquainted myself with the machine, it seemed the right time to try some actual recording. The weight was surprisingly large, considering the size of the unit, but caused no discomfort even after long periods of carrying. Recording outdoors was quite straightforward, with the Vu-meter oscillating sedately within the black band that signified correct modulation level. Re-playing these sounds later in quiet surroundings was not impressive. Much of the recording was lost in a background of loud hiss and electrical interference apparently caused by the motor. Turning up the volume only worsened the quality, as the tiny speaker (3 x $\frac{1}{2}$ in.) and amplifier produced a very high level of distortion. Returning to the earpiece, the comparative qualities suggested that a separate replay amplifier and speaker might produce more pleasant results. This was indeed the case. Speech reproduced fairly well when taken from the pre-amp output but, contrary to normal results, music was reproduced even more satisfactorily than speech, although wow was quite audible. What remained



then be applied to either spool, while the one not being driven directly is allowed to free-wheel under power from the tape.

Although it takes some time to acquire the technique of threading the recorder, the controls are very simple to use and can be operated with fore-finger and thumb of a single hand. Mechanical functions are governed by one lever, positioned close to the rim-operated volume control. The latter is used on both record and replay. A black, spring-loaded record interlock is positioned near the Vu-meter.

While the mechanics of the recorder are ingenious, the design of the carrying-case is positively fantastic. Manufactured from thin black leather, its conglomeration of studs, fasteners and clasps allows the user to do any of the following: carry the complete recorder with playback unit attached, in one case, with or without the accessory case; carry the recorder and amplifier on one strap but in separate cases; or carry the recorder alone, again with or without accessories.

The thick leather shoulder-strap threads round these various cases to provide extra support. Gaps in the metal lid and case make the uppermost spool visible during operation.

Moving now to the accessories, we find a microphone—a moving-coil type with built-in table stand—earpiece, splicing tape, recording lead and jack adapter. The earpiece was powered by the pre-amp alone, without aid from the playback unit, and was of reasonable quality. It was, however, much too large to hold itself in my ear, but could be comfortably held in place by hand.

All these accessories fitted into the gadget-bag mentioned previously, but another example of Japanese originality took the form of a standard spool holder. As the spools used on this machine cannot be interchanged with those on standard recorders, this little device allows the interchange of tapes from standard to non-standard spools. If it is wished to wind the tape from a normal 3in. spool on to a Sharp

NUMBER THREE SHARP TRC-1004 BY DAVID KIRK

of the background noise was lost in all but quiet musical passages, whereas it was distinctly audible between sentences on speech. The use of DC bias for recording and erase doubtless contributes much to the poor signal-to-noise ratio. Permanent-magnet-erase could hardly have produced more interference.

Another annoying fault, possibly limited to the model sent for trial, lay in the playback switch. The mechanical lever, if pushed fully home (as it normally was, being spring-loaded) cut out the playback amplifier. Consequently it was necessary to provide a little pressure against the force of the spring to hear recordings through the monitor speaker. It is worth pointing out that this did not happen when the pre-amp output was used for replay, neither did it occur when the machine was inserted in its leather case, as the overlapping sides of the case provided the required force against the spring.

The TRC-1004 is, therefore, a reasonably good machine, barring the rather noisy erase and motor system and its one mechanical fault. Technically, it is a brilliant new approach to miniaturisation and an outlet for many original ideas in recorder construction.

MANUFACTURER'S SPECIFICATION

Speed: $1\frac{1}{2}$ i/s. **Wow and Flutter:** 0.8% RMS. **Frequency Response:** 200 c/s to 3 Kc/s ± 3 dB. **Battery Life:** 4 hours minimum. **Consumption:** 115mA. **Recording Time:** 30 minutes per track on two tracks. Combined Vu-meter and battery life indicator. **Spool Capacity:** Non standard. $3\frac{1}{2}$ in. diameter. **Price:** £37 6s. **Distributor:** Wholesale Supplies (Swinton) Ltd., 16-18 Worsley Road, Swinton, Manchester.

BEFORE proceeding with a description of the playback circuit functions, there are a few small points on recording left over from last month. The oscillator circuit was designed for an erase head having an impedance of 250-300 ohms at 60 Kc/s. It is emphasized that it should be used only with heads having similar characteristics, such as those normally found on the Brenell, BSR and Magnavox decks. The substitution of such heads by other types may necessitate a change in transformer design and in the value of the tuning capacitor. Because of the considerable carrier storage effects in the transistors, the final values of the various components were obtained empirically, and it is not advisable to change them without careful consideration of the thermal stability of the circuit and the peak currents involved. Remember, transistors are among the fastest-acting fuses ever invented!

The recording level is indicated on a 0-50 or 0-100 μ A miniature moving-coil meter used in a normal bridge detector circuit, the limiting resistor R.25 being chosen to give the desired deflection. The value shown gives above 80% deflection on a 50 μ A movement for 60 μ A of recording current. When recording normal speech and music, allowance should be made for the inertia of the meter movement, otherwise overloading will occur. The recording signal can be monitored by connecting headphones to the emitter circuit of Tr.5, the loading on the stage being negligible.

To complete the circuit details for the diagram printed on page 267 last month, a table giving technical information and commercial types for the transformers and inductor is given with this article (Table 1). A small error appeared on the circuit: the lower contact on Sa.10 should have been joined to the line immediately beneath (right-hand junction of R.32/C.22).

EQUALISATION CIRCUITRY

Now to the recording functions. Assuming that the tape has been recorded to a constant level of surface induction over the required frequency band, then the open-circuit playback voltage rises with frequency at the rate of 6dB/octave until various losses become significant. The short-circuit current, however, is substantially constant with frequency over a large portion of the band, and this is the easier and more logical arrangement when used with a transistor amplifier. A disadvantage is that the bass equalising networks are more dependent upon the head characteristics than when a voltage-driven front-end is used, but the networks can be quite simple and are readily adjusted.

It is usual to add a small amount of treble-boost on playback to overcome losses due to the head structure and spacing between the tape surface and the head. These losses are, of course, dependent upon the type of head and magnetic tape used, and also on the tape transport system, so that once again it is advantageous to use simple networks for equalising.

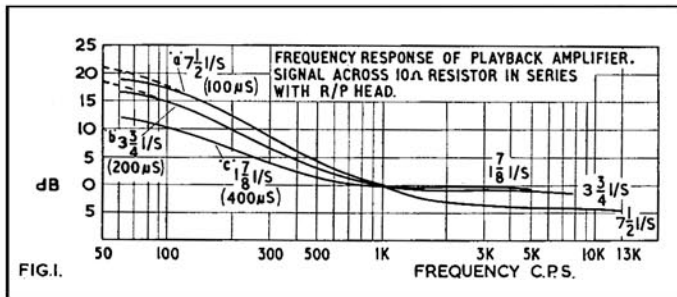

Referring to the complete circuit (page 267, August), on playback the first two stages form a low-impedance current-operated amplifier. For a tape speed of 3 $\frac{1}{2}$ i/s the frequency response falls with increasing frequency in conformity with the impedance of a series combination of a capacitance and a resistance having a time constant of 200 μ s, this slope being mainly determined by R.4, R.5 and C.3. The low-frequency roll-off due to the relatively high DC resistance of this particular head is compensated for by the RC network R.34/C.27 (the value of C.27 is 1 μ F).

The network R.16/C.12 provides equalising for the treble losses mentioned above.

A driver transformed with a turns ratio of 2:1+1 is switched into the collector of Tr.4, Tr.5 being omitted on playback. The need for a primary inductance of at least 4H together with a low DC secondary resistance enforces the use of a fairly large transformer. The transistor

used in this stage must be capable of handling a peak collector voltage of about 20V.

Transistors Tr.6 and Tr.7 are switched into a Class-B push-pull amplifier, the output transformer having a split primary winding to provide local negative feedback. The turns ratio reflects a load of 44 ohms to each transistor from a 3 ohm loudspeaker, the peak power in which is about 1.2W.

About 6dB of overall negative feedback is applied from the loudspeaker to the base of the driver transistor, and this must be correctly phased to prevent oscillation. The total harmonic distortion at 1W output is typically less than 3% at 400 c/s.

If Tr.4 is left connected as in the recording amplifier by operating the auxiliary output switch, about 1V RMS is available to drive an external amplifier (from a source-impedance of 680 ohms), the total distortion being less than 0.5% at this level. The frequency response of the playback amplifier is given in fig. 1 (curve 'b').

The maximum operating temperature for the audio output stage is limited by the increase in quiescent current with temperature. The

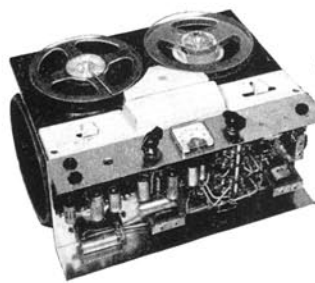

A TRANSISTOR TAPE AMPLIFIER

BY S. WELLDON

maximum ambient temperature with each output transistor attached to either a three inch square fin or a metal chassis (via a mica insulating shim) is 60°C (140°F), which is adequate for normal domestic use. However, where the equipment is totally enclosed in a small cabinet and operated for long periods of time, the motor(s) may cause overheating. In such cases it is advisable to use a thermistor in the base biasing network to control the quiescent current. A suitable arrangement consists of a 50 ohms (at 20°C) thermistor in parallel with a 680 ohm resistor, connected in place of R.30.

Cross-over distortion becomes evident below 10°C (50°F) ambient, but this can also be overcome by the inclusion of a thermistor as described above.

A summary of the performance of the amplifier, using typical transistors, is given in Table 2.

Typical arrangements of the complete amplifier are shown in the photographs reproduced last month and here, in the latter case, coupled to a BSR deck. The layout can be varied considerably provided that a few simple precautions are observed.

The input and output stages should be kept reasonably clear of each other, as with any high-gain amplifier. The input socket for the R/P head should be mounted near the appropriate contacts on the change-over switch, a screened lead (microphone cable) being taken from the switch to the first stage.

A suitable arrangement for the change-over switch is as follows: 1st wafer (nearest knob), Sa.1, Sa.2, Sa.3; 2nd wafer, Sa.4, Sa.5, Sa.6; 3rd wafer, Sa.7, Sa.8, Sa.11; 4th wafer, Sa.9, Sa.10, Sa.12. This keeps the erase oscillator clear of the amplifier as well as allowing some of the components to be strapped across the switch.

In view of the high peak currents circulating in the output stages, good earth connections, separate from those of the first stages, should be used.

The output transistors are electrically insulated from the chassis by mica shims and nylon screws. Care should be taken that the fixing holes for these are clean and free from burrs. This warning also applies to the mounting of the power transistor in the power pack.

For initial testing, whether from batteries (e.g., lantern or bell cells)

or from a power pack (having a low output impedance), the DC conditions should be measured with a high-resistance test-meter. A 1A fuse should be included in the negative supply lead, and the erase oscillator rendered temporarily inoperative by disconnecting its supply lead. Static tests can then be carried out on the main amplifier without connecting the amplifier to the tape deck.

Table 3 gives the average static conditions with the amplifier switched to play back and with volume control set for minimum output. Voltages are with respect to chassis, the collector current being calculated with sufficient accuracy by dividing the voltage across the emitter load by the resistance of the load. The quiescent current in the audio output stage can be checked by inserting a milliammeter in the negative supply line to the common point between the two halves of T.4 primary (collector) winding.

If R.33 has been left unconnected, it should be momentarily attached, with the loudspeaker connected. Increased gain or oscillation indicates incorrect phasing, and one pair of leads to either T.2 (primary) or T.4 (secondary) should be reversed.

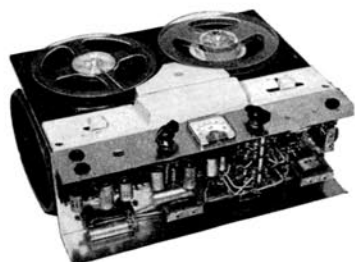

A TRANSISTOR TAPE AMPLIFIER

BY S. WELLDON

PERFORMANCE AND TESTING PART TWO

The frequency response of the amplifier on *playback* can be measured with the R/P head plugged in to the appropriate socket, a low-value resistor (5-10 ohms) being placed in series with the 'earthy' side of the head. A signal generator can then be connected across this resistor, the audio output being monitored either across a 30hm resistor used in place of the loudspeaker, or at the auxiliary output socket (see fig. 1).

For testing static conditions on *record*, the test-meter should be used as previously described. Table 4 gives the average conditions.

The response of the amplifier on record can be measured with the R/P head connected, and a signal injected at J.2, the output voltage being monitored at Tr.5 emitter. Care should be taken that the output level at 1 Kc/s is sufficiently low so that the high-frequency boost does not overload the output stage.

With the negative supply lead connected to the erase and bias oscillator the amplifier should be switched to record *only* when the erase and R/P heads are connected. The windings on both heads (as supplied) are floating with respect to earth, so that either lead in each case can be taken to the earthy side of the coaxial plug. In the case of the R/P head, the screening braid is also earthed at the amplifier. Remember also to connect a wire from the chassis to the metal-work of the tape deck.

OSCILLATOR MEASUREMENTS

Before operating the oscillator, check that the windings on T.3 are correctly orientated, since errors here could cause damage to the power transistors. Of the secondary winding of T.3, the start of the low-impedance part is taken to earth, the tape to the erase head, and the finish of the overwind to C.23. A test-meter in series with the negative supply lead can be used to measure the DC input current to Tr.6/Tr.7, which should be about 270-290 mA when oscillating correctly.

The erase voltage, which should be about 24V RMS, can be measured by a valve-voltmeter connected to the erase socket by short lengths of unscreened wire. The HF bias current can be checked by measuring the voltage across the R/P head or, more accurately, by measuring the voltage developed across a 10 or 20 ohm resistor in series with the earthy side of the R/P head. For the latter measurement the screening

braid of the cable from the head should be left connected to earth, and not taken to the 'live' end of the resistor.

The third and final part, next month, will provide details of a power supply for mains operation and circuit modifications giving switched correction for the three standard tape speeds.

TABLE 1 TRANSFORMER AND INDUCTOR DETAILS

	Turns ratio	Primary inductance	Primary DC resistance (ohms)	Secondary DC resistance (ohms)
L1	—	370mH	60	—
T1	1 : 8	200mH at 50c/s with 8mA DC	50	700
T2	2 : 1 + 1 bifilar secondary	4H at 50c/s with 7mA DC	150	20+20
T3	1 + 1 : 3	34μH	—	—
T4	3.8 + 3.8 : 1 bifilar primary	700mH	4	0.2

	Belclere	Colne Electric	Parmeko
L1	TF2549	06039	P3004
T1	TF2550	06040	P3005
T2	TF2551	06041	P3006
T3	TF2547	06042	P3007
T4	TF2552	06043	P3008
(T3 for Truvox deck)	TF2545	06044	P3009

TABLE 2 AMPLIFIER PERFORMANCE WITH TYPICAL TRANSISTORS

Record	
Current drain of recording amplifier only ..	20 mA
Current drain including erase circuit ..	320 mA
Input resistance at 400 c/s ..	250 ohms
Input voltage for 60 μA of recording current ..	20 μV
Total noise output, with volume control at maximum, referred to peak recording level	45 dB
Signal-to-noise-ratio, with 100 μV input, and volume control adjusted to give 60 μA of recording current ..	55 dB
Total harmonic distortion at 60 μA level ..	less than 0.2%
Erase voltage ..	24 V RMS
Bias voltage ..	60 V RMS
Bias current ..	270 μA
Playback	
Quiescent current drain ..	25 mA
Current drain at 1W output ..	170 mA
Input resistance at 1 Kc/s ..	50 ohms
Input voltage for 1W out at 1 Kc/s ..	50μV
Total noise output, with volume control at maximum, relative to 1W output ..	50 dB
Signal-to-noise ratio, with volume control adjusted to give 1W from tape recorded at 60 μA level ..	55 dB
Total harmonic distortion at 1W output ..	less than 3%
Total harmonic distortion at 1V at auxiliary output socket ..	less than 0.5%

TABLE 3 AVERAGE STATIC CONDITIONS ON PLAYBACK

Transistor	Emitter Voltage (V)	Collector Voltage (V)	Collector Current (mA)
Tr1	0	-0.6	-0.45
Tr2	-0.3	-3.5	-0.7
Tr3	-1.5	-7.5	-4.0
Tr4	-1.0	-11.0	-7.0
Tr6	—	-12.0	-2.5
Tr7	—	-12.0	-2.5

(5mA total)

TABLE 4 AVERAGE STATIC CONDITIONS ON RECORD

Transistor	Emitter Voltage (V)	Collector Voltage (V)	Collector Current (mA)
Tr1	0	-0.6	-0.45
Tr2	-0.3	-3.5	-0.7
Tr3	-1.5	-7.5	-4.0
Tr4	-1.0	-6.2	-7.0
Tr5	-6.0	-11.0	-8.0

HITACHI

TAPE RECORDERS

HAVE A NAME FOR BEAUTIFUL SOUND



Hitachi tape recorders are called BELSONA, which means 'beautiful sound'. It's a name they well deserve, for true sound fidelity, fullness of tone and volume. And because Hitachi are one of Japan's leading electronics manufacturers, technical features and quality of finish are unsurpassed.

BELSONA TRA 500 29 gns

Superb compact mains operated model, suitcase style. Has unique 'Automatic Recording Level Control'. 2 recording speeds, double track, Hi-Fi sound reproduction. Up to 3 hrs recording with Hitachi 5" I.p. tape. Attachment for direct recording from radio, stereo or T.V. Operates on convenient 'one-band' control system. All accessories.



BELSONA TRQ 399 35 gns

Transistorized luxury portable, which incorporates many 'standard model' features. It has 2 recording speeds, double track, 3 inch recording tape, fast 4 minute winding and rewinding, dimensions approximately 9" x 3½" x 6". Complete with case and many accessories.

Also available BELSONA TRA 722 2-speed mains operated 42 guineas.

For full details please consult your dealer and in case of difficulty contact:

Lee Products (G.B.) Ltd.,
10/18 Clifton Street, London E.C.2. Telephone: B1Shopsgate 6711
(Distributors for U.K.)



Hitachi, Ltd.

Tokyo Japan

A STUDIO QUALITY MIXER PART FOUR

BY D. P. ROBINSON
MIXING & MONITORING

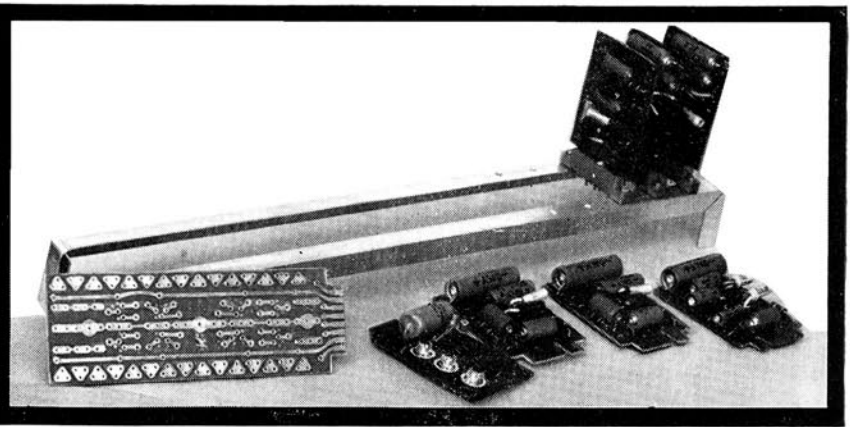

BY the time an input has reached the mixing stages it has passed through one of the plug-in amplifiers and so is of about the same amplitude as any other input signal; also, should it be necessary, it is frequency corrected—as for example from a magnetic or crystal pickup. Fig. 1 shows the circuit of the mixing amplifier, of which two will be needed for complete stereo operation. The input impedance at the base of Tr1 is low, so that each input is isolated from the others by the series 4.7K mixing resistors. Each mixer will accept up to eight inputs; these are the programme feeds and the oscillator feed, the latter being connected to both channels. For stereo, the two mixers are paralleled with C10 which commons the two signals but retains separate main gain controls for both channels.

The first two transistors in the circuit are connected in a similar manner to those in the amplifiers already described, with both AC and DC feedback; Tr3 is an isolating stage before the main gain control. From this control the signal passes two ways, the first to another isolating emitter-follower which eventually feeds the monitor amplifier. This is to ensure that any switch clicks which might be made in changing the monitor switching from input to output will not appear on the output signal which is recorded. The second path is to the front panel pre-set control which is used to balance the channels for stereo use and to adjust the level out to suit the recorder in use. The signal level at this point is still low, and a further stage of gain is required.

There are often occasions when it is required to feed more than one recorder, and to prevent accidents on location it is always better that the various outlets should be isolated; nothing is more annoying than to ruin an important recording because one of the ancillary pieces of equipment has a faulty plug which has shorted the whole signal. The

output stage, fig. 2, provides a maximum gain of about ten times at a very low output impedance from the emitter of the second transistor. Three outputs are shown, each with a series resistor which essentially sets the output impedance. The mixer can, therefore, be correctly matched into other equipment which may have a 600 ohm input. If one of these outputs is accidentally shorted, the level at either of the others changes by about 1 dB only, which would not be noticed in practice with speech or music.

The circuitry is very similar to that used in the preceding amplifiers, and so will not be described in detail. To obtain the maximum output, which can be 4V RMS if required, it is important to have the DC conditions accurately set-up. For this the emitter of Tr2 should be at about 8V, and R3 can be adjusted if necessary. Increasing R3 will reduce the DC at the output, and vice-versa. With normal tolerances on components, the voltage will be between 7V and 9V, and only if the highest possible level out is required will it be necessary to make this adjustment.

Fig. 3 shows the method of construction used inside the mixer. In the initial stages miniature tagstrip was used, and while being electrically satisfactory this made servicing very difficult. An investigation was made into the possibilities of using plug-in boards for the inside, and fig. 3 shows the results. The Radiospares organisation markets a skeleton printed card, which has two supply lines and a series of isolated connection points, so that almost any circuit can be built up. The completed card plugs directly into a special eight-way socket which incorporates a plastic key, that can be moved to correspond with a slot cut in the board, so that only the correct board will plug into

(continued on page 323)

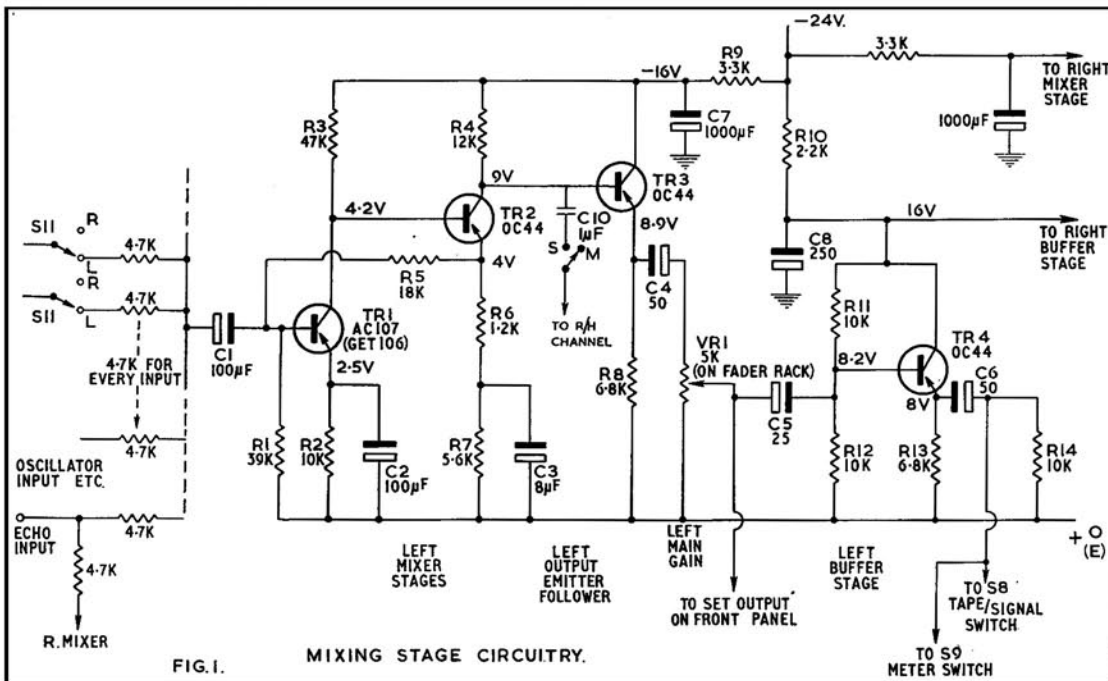

FIG. 1. MIXING STAGE CIRCUITRY.

Fig. 3: (above) shows the plug-in amplifiers and aluminium-angle mounting rack. Ease of service is afforded by this method of construction.

Fig. 1: (left) shows the mixing amplifier circuitry. Two of these will be required for stereo.



Try it yourself . . .

THERE IS NOTHING LIKE D 12

Because the D 12 dynamic directional microphone with cardioid characteristic has no tendency for developing feedback when loudspeakers are located near the microphone. And, if you want more brilliancy, fuller bass, crystal clear transparency and higher volume, ask for the D 12.

Excellent sensitivity and magnetic shielding. Frequency response 40-15,000 cps, 18 db front back ratio. Price: £34.0.0.



POLITECHNA (LONDON) LTD.
3 PERCY STREET
LONDON, W.1

Telephone: LANGham 6236 Telex: 23894 Cables: Polindust London

Amalgamated Wireless (Australasia) Ltd., Sydney, Wellington—Connoisseur Records Ltd., Dublin—McCurdy Radio Industries Ltd., Toronto—International Aeradio (East Africa) Ltd., Nairobi—David Pollock (Pty.) Ltd., Johannesburg—A. Rajab & A. Silsilah, P.O. Box 203, Jeddah—Soundrite Ltd., Singapore, Penang, Kuala Lumpur—The China Engineers Ltd., Hongkong.

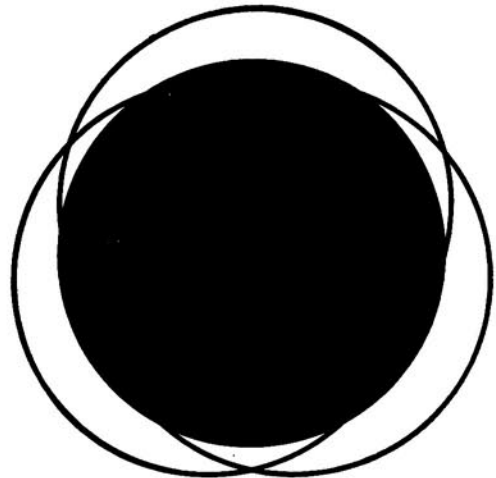

How round is Round ?

Precision engineering to a microscopic degree is entailed in the manufacture of Tandberg Capstan and Flywheel assemblies. Only by adherence to the most exacting manufacturing processes is it possible to turn out tape recorders, with "Wow and Flutter" figures that measure up to Tandberg requirements*, every time, repeat "Every Time"!

A very good example is the "Roundness" or perhaps surprisingly the "Unroundness" of the Capstan. As you probably know, by centreless grinding the Capstan is ground to a very precise dimension, but unfortunately, there is always a tendency in this procedure, to get an uneven number of "corners". These corners cause an uneven transport of the tape due to the varied radius of the Capstan.

In addition, an even more dangerous WOW component is caused by the movement of the Capstan's centre, due to unroundness. The latter component will be more serious the greater number of corners there are. The unroundness, defined by the difference between the inscribed circle and the circumscribed circle, should be less than 0.001 m.m. when there are 3 corners, and about 0.5/1000 m.m. with 5 corners. Only one European Capstan Manufacturer has so far been able to meet Tandberg's specification.

Mr. A. Tutchings reviewing Tandberg Series 6 in The Tape Recorder:— "At 7½ i/s the flutter remained below 0.1% RMS for very long periods, only very occasionally did it rise to 0.11% where friction effects happened to build up to a maximum. At 3½ i/s the readings averaged 0.12% RMS with very little change in reading from beginning to end of reel".

*Wow and Flutter 0.15% R.M.S. 7½ i.p.s.
0.2% R.M.S. 3½ i.p.s.
0.3% R.M.S. 1½ i.p.s.

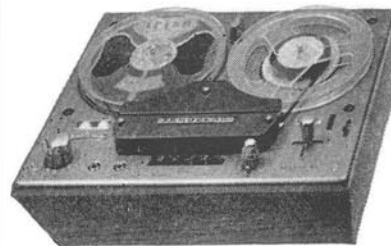

Write for details of
Tandberg Series 6 & 7
Tape Recorders and
28 page booklet of
Technical Reviews.

Tandberg

ELSTONE ELECTRONICS LIMITED
Edward St., Templar St., Leeds 2. Tel: Leeds 35111 (7 lines)

A STUDIO QUALITY MIXER CONTINUED

the appropriate socket. The plugs are mounted on lin. centres on aluminium angle which is then fastened inside the mixer, making a very neat, easily serviceable arrangement.

At this stage it is convenient to discuss the testing of the circuits. It is probably easier for the constructor if each unit is tested as it is made, using batteries, or the power supplier shown in Part 2, to give the 24V needed. In this way any mistakes in the wiring are quickly found, which is better than being faced with a rather complicated piece of electronic detection work at the end of the complete construction. It is most important to see that the polarity of the supply is correct, since reverse connection will damage the transistors—and unlike valves there is nothing to hint at trouble: no smoke, no explosions, just an

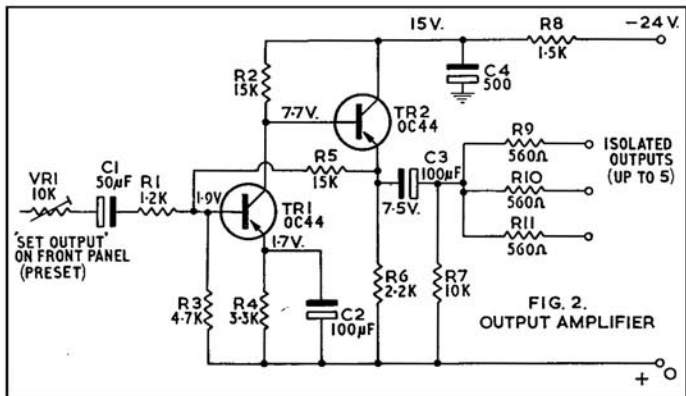

expensive silence! The voltages on the circuit diagrams can be checked against the values actually obtained. For this, any instrument will be satisfactory since the circuits are low impedance and will not be unduly loaded.

There are two exceptions to this, the first is the base of the first transistor in the High Level amplifier, and the other is the base of the measuring transistor in the peak-programme meter circuit, which will be discussed later. The voltages at these points should only be measured with a valve-voltmeter or similar device with an input impedance of at least 5 megohms. If other instruments are used, the shunt effect will lead to incorrect and misleading results—see *Hi-Fi News*, March 1964 (*Test Instruments for the Enthusiast*). The voltages read at other points in any of the circuits should agree with the values given to within 15% at the outside, and will probably be much nearer since the actual transistor parameters are not significant in establishing the operating conditions. This is mainly achieved by the feedback resistors. A quick check can be made around each transistor to ensure it is operating correctly. Starting from the emitter, in the case of a p-n-p germanium transistor (OC44 say) the base should be about 0.1 - 0.3V more negative, and the collector at least a volt more negative. A silicon transistor (OC202) will have 0.4 - 0.6V between emitter and base, and n-p-n types are more positive on the electrodes with reference to the emitter.

If possible, the AC performance of the stages should then be checked, using a signal generator as the source. The response should be flat—defined here as +0 dB to -1 dB from 20 c/s to 20 Kc/s for all units, with the exception of the line amplifier which, at full gain, is -3 dB at 50 c/s. With the preset control turned down by 6 dB this unit, also, is flat to the above limits. This is a fairly tight specification to meet, but is not too difficult using the types of transistors quoted in the text—in fact the high frequency response extends well above 20 Kc/s. The following figures should be obtained for the complete system, with the gain controls all set at maximum, and 0dB=0.775V, at the output terminals.

High level, input for full output = -20 dB; max input level = +6 dB.

Line Amp, input for full output = -62 dB; max input level = +2dB, or -42 dB in -20 position; max = +22 dB.

Mic Amp, input for full output = -90 dB in 600 ohm; max = -25 dB, or -103 dB in 30 ohm; max = -38 dB.

Required input for 55 dB signal/noise: **Mic**, 30 ohm = -82 dB, 600 ohm = -69 dB; **Line** 30 ohm = -52dB, 600 ohm = -39 dB.

The overall noise factor can be derived from these figures: with a gain of 90 dB on the microphone input, from a 600 ohm source, the Johnson noise at the output will be -127.0+90, or -37.0 dB. The input of -69 dB will be amplified to +21, and since this gives 55dB signal-to-noise ratio, the noise must be -34 dB or 3 dB worse than the theoretical limit. The noise figure is thus 3 dB, and so compares extremely favourably with anything on the market at the present time.

As well as the main chain, a subsidiary path provides full monitoring facilities. In both listening and metering the monitoring amplifier can be switched to either the signal to be recorded, or alternatively, the playback signal; in most professional recorders there is usually an extra head connected permanently to a playback amplifier so that by switching between the output of this and the incoming signal, it is possible to make a direct comparison, so that the quality of the tape can be assessed as it is made rather than waiting to the end and rewinding only to find that a mistake made when switching means that the whole has to be redone.

Provision is made in the mixer to accept the playback signal so that the comparison switch can be mounted on the front panel, where it is labelled INPUT-PLAYBACK. There is also a volume control so that the two signals can be adjusted to be of exactly the same amplitude, since it is extremely difficult to judge small differences between two signals if they are not at the same level. In this way, using the two Control keys the recorder may be situated in a remote position and forgotten during a recording and more time spent on important work such as balancing and timing cues.

For driving the monitoring loudspeakers external amplifiers are used, and these can be either valve- or transistor-driven as wished. There are many designs for both types on the market, and the actual type chosen will depend on the exact use envisaged; but it should be remembered that for use in a permanent installation this same amplifier drives the studio loudspeakers, when it may be that a large room is used which will need considerably more power than a small recording studio. The input sensitivity of these amplifiers, for full output, may vary from volts to millivolts, so it was thought necessary to include an amplifier stage which is used—in addition—to amplify the signal from the tape recorder playback. The same unit as the recording output stage (fig. 2) is used, with the exception that the 10K variable potentiometer in series with the input is omitted and the input passes in from the slider of a potentiometer on the front panel, marked MONITOR. Also, the 560 ohm resistors at the output are omitted, since there is only one output for each channel. If the monitor amplifiers are 600 ohm transformer-input types, then a 560 ohm resistor should be included in series with each output lead for correct matching.

The output from the tape recorder may be either high or low impedance, although almost certainly the latter in the higher priced machines. But to make the mixer completely universal the input impedance should be high. Fig. 4 shows the simple emitter-follower used, following the two volume controls. One is used to adjust the playback level to equal the amplitude of the record signal, while the other is used to set the playback level to the studio only, when the performers are listening to their recorded efforts. The use of two controls means that once each is set, there is no further need to alter them. Next month we shall continue this discussion of the monitoring facilities and give details of a peak programme meter.

Footnote: Fortiphone transformers, including the MSC 1829 mentioned last month, are now handled by: Parmeko Ltd. (Barking Division), Thames Road, Barking, Essex (Telephone: RIPpleway 1092).

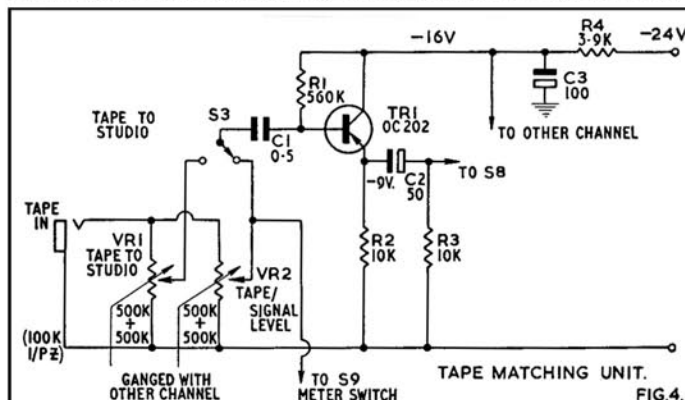

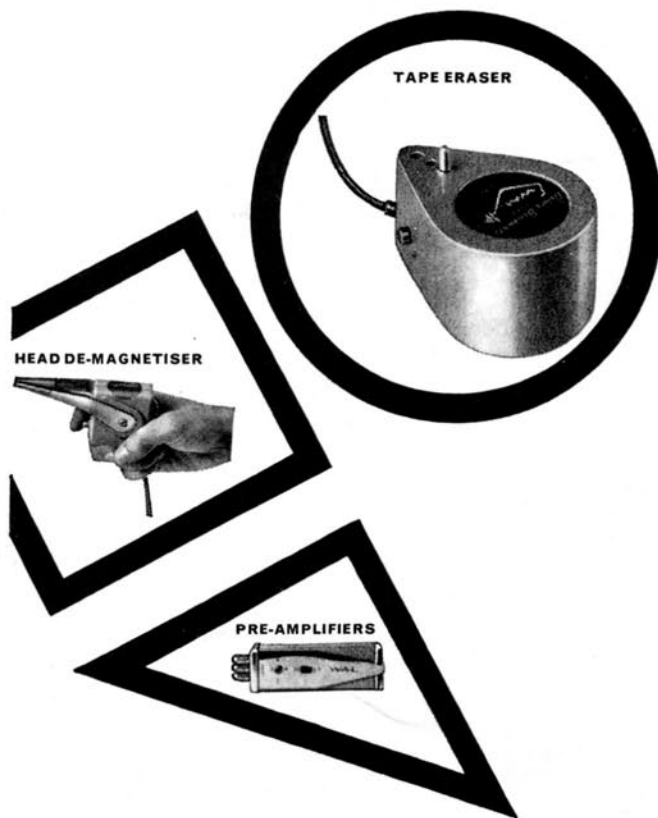

Three basic essentials for the recording enthusiast

Tape Eraser

Erases both sides of a 7" tape reel in 30 seconds and positively removes even the very low frequency portions of a recording. Use the WAL Tape Eraser, the only way to ensure an *absolutely* clean tape—quicker

and better. Mains operated. Also erases sound from 16 mm. film, 10" aluminium reels. Professionally designed for recording engineers. £6.18.6.

Head De-magnetiser

De-magnetises tape heads quickly and simply. Also for pin-point erasing on striped film and tape recordings—removes local unwanted noises without detriment. Has nylon-cushioned

twin probes with a concentrated demagnetising field in the 1/8" gap between the arms. Pistol grip. A.C. mains. Professionally designed for professional recording engineers. £2.10.0.

Pre-amplifiers

WAL pre-amps are made for every purpose. Fully transistorised, battery-operated, give high gain, completely hum-free. Laboratory built and fully tested. Professionally designed for professional recording eng-

ineers. Ask for details of WAL-GAIN Mono £5.10.0. STEREO WAL-GAIN £7.10.0. and the superb WAL HI-GAIN with built-in switched equalisation for monitoring, dubbing etc. etc. £7.16.0.



Free leaflets available on these professional aids to perfection... please write:

ELSTONE ELECTRONICS Ltd
Edward Street, Templar Street, Leeds 2.

FRANCIS OF STREATHAM

IN STOCK NOW—THE NEW B&O STEREO MASTER

A superlative instrument—105 gns. £120
*Brenell Stereo STB 1 ... 88 gns.
*Brenell Mk. V Model M ... 69 gns.
*Brenell Mk. V Series 2 ... 28 gns.
Cossor 1603 ... 39 gns.
Cossor 4 Tr. 1604 2 sp. ... 62 gns.
Cossor 4 Tr. 1605 4 sp. ... 23 gns.
Elizabethan 'Popular' ... 38 gns.
Elizabethan LZ29 ... 110 gns.
*Ferrograph 422 or 424 ... 85 gns.
*Ferrograph Series 5 ... 35 gns.
Fidelity Major ... 20 gns.
Fidelity Playmaster 2 Tr. ... 23 gns.
Fidelity Playmaster 4 Tr. ... 65 gns.
Grundig TK6 ... 35 gns.
Grundig TK14 ... 39 gns.
Grundig TK18 'Magic Ear' ... 45 gns.
Grundig TK23 4 Tr. ... 75 gns.
Grundig TK40 4 Tr. ... 75 gns.
Grundig TK41 2 Tr. ... 99 gns.
*Grundig TK46 4 Tr. St. ... 36 gns.
Philips 3541 4 Tr. ... 42 gns.
Philips 4 Tr. 3541/H ... 62 gns.
Philips 4 Tr. 3549 ... 92 gns.
Philips 4 Tr. Stereo 3534 ... 27 gns.
Philips Starmaker 4 Tr. ... 105 gns.
*Refectograph 'A' 4 Tr. ... 36 gns.
Robuk ... 93 gns.
*Simon SP5 ... 79 gns.
Sony 200 ... 106 gns.
Sony 500 ... 39 gns.
Stella 458 4 Tr. ... 62 gns.
Stella 459 4 Tr. ... 29 gns.
Stella 456 ... 110 gns.
*Tandberg Series 6 ... 93 gns.
*Tandberg Series 7 ... 83 gns.
*Telefunken 85 de luxe ... 69 gns.
*Telefunken 96 4 Tr. ... 95 gns.
*Telefunken 97 4 Tr. Stereo

*Telefunken 98 4 Tr. St. ... 95 gns.
*Vortexion WVA ... £93.13.0
*Vortexion WVB ... £110.3.0
*Vortexion CBL Stereo ... £160.0.0
Wyndsoor Trident ... 33 gns.

TRUVOX

R.92 2 Tr. Recorder ... 69 gns.
R.94 4 Tr. Recorder ... 69 gns.
*PD.93 (2 Tr.) or PD.95 (4 Tr.) ... 59 gns.
*PD.97 (2 Tr.) or PD.99 (4 Tr.) Stereo ... 79 gns.

BATTERY PORTABLES

Cossor 1621 ... 26 gns.
Philips 3586 ... 25 gns.
Loewe Opta 414 ... 47 gns.
(Mains/Battery/Car)
*Butoba ... 66 gns.
*Fi-Cord 202 ... 66 gns.
Stella 471 ... 26 gns.
Stuzzi Memo-Cord ... 25 gns.
Uher 4005 ... 93 gns.
Sanyo ... 36 gns.
* Microphone extra

MAINS POWER PACKS

Philips, Stella or Cossor ... £5.12.0
Grundig ... 8 gns.
Butoba ... 11 gns.
Fi-cord ... £7.10.0
Uher 4000 ... £16.10.0

Tape Decks by Brenell, Wright & Weaire.

Tape to disc and copy service.

LEADING STOCKISTS OF EQUIPMENT FOR

TAPE and HI-FI

... and NO EXTRA FOR CREDIT TERMS

- ★ Minimum Deposit
- ★ No Interest or Service Charges on H.P. up to 18 months
- ★ Free Service during Guarantee Period

● MICROPHONES, MIXERS, ETC.

Grampian Reflector ... £6.15.0
Grampian Ribbon ... £11.10.0
Grampian DP/4 Dynamic ... £8.0.0
Lustraphone VR/64 ... £7.17.6
Lustraphone LFV/59 ... £8.18.6
Simon 'Cadenza' Ribbon ... £10.10.0
Reslo Ribbon ... £10.2.0
AKG Stereo D.77A ... £15.10.0
AKG D.19C ... £17.10.0
TSL 3 Channel Mixer ... £2.7.6
Grundig Mixer Stereo ... 18 gns.
AKG K 50 Headphones ... £7.10.0
Philips Pre-amp ... £6.10.0

Also in stock microphones by ACOS, FILM INDUSTRIES, TELEFUNKEN, etc.

ALL WALGAIN PRODUCTS

● TAPES & ACCESSORIES

Standard, Long, Double, Triple Play in all sizes by all leading makers.

● DEFLEXERS BY WEARITE, WALGAIN

● Pre-recorded Tapes by Columbia, H.M.V., and all E.M.I. Labels, Saga, Tutor-tape, etc.
Bib, Bond and E.M.I. splicers. Matching transformers. Plugs, sockets, etc.
Prices subject to alteration as announced by manufacturers.

● STANDS OF ALL TYPES

HI-FI DEPT.

● STEREO AND MONO AMPLIFIERS—

Quad HMV Pye Rogers
Leak Armstrong Tripletone
Scott B & O Chapman Eagle

● TUNERS

Quad Rogers Pye H.M.V.
Leak Armstrong Chapman
B & O Tripletone

● LOUDSPEAKERS

Quad Pye Rogers W.B. Kef
Wharfedale Goodmans Tannoy
Lowther Mordaunt Leak
Lockwood Elac Eagle Kelly

● MOTORS, PICKUPS

Garrard Tannoy EMI
Goldring Lenco Shure
Connoisseur Decca Stereo
Decca Deram Pickering
Philips Ronette
Ortofon B & O
Acos SME Mk. II
Thorens ADC BSR

All types of Diamond and Sapphire styli, stereo and mono. Microlifts, Garrard, Goldring and Acos Pressure Gauges. Disc Preener. Acos Dust Bug. Cabinets by Record Housing and G.K.D.

169-173 STREATHAM HIGH ROAD, LONDON, S.W.16

Between St. Leonard's Church and Streatham Station

STReatham 0466/0192

Please note this is our only address

REFERRING back to the end of last month's article, where we discussed impedance matching between microphones and tape recorders, it must be emphasised that to avoid instability and hum problems, screened cable (e.g., screened microphone cable) should be employed at the interconnections. It is always best to locate the transformer as near as possible to the tape recorder input and then run a low impedance line to the microphone. In that way there is less possibility of hum pick-up, since low impedance circuits are less susceptible to hum pick-up than high impedance circuits. It may also help to connect the transformer case (best made of mu-metal) and the cable screens to an external earthing point.

There is less possibility of hum troubles when a transistorised amplifier is employed, but it should be noted that the resulting high overall gain between the microphone and the output circuits of the tape recorder could promote instability if the earthing is not attended to properly.

TOWARDS BETTER TAPING

Fig. 2: (below)
Reslo GE Transistor
Coupler



Fig. 3 (left)
Gramplan DP4 moving-coil
microphone

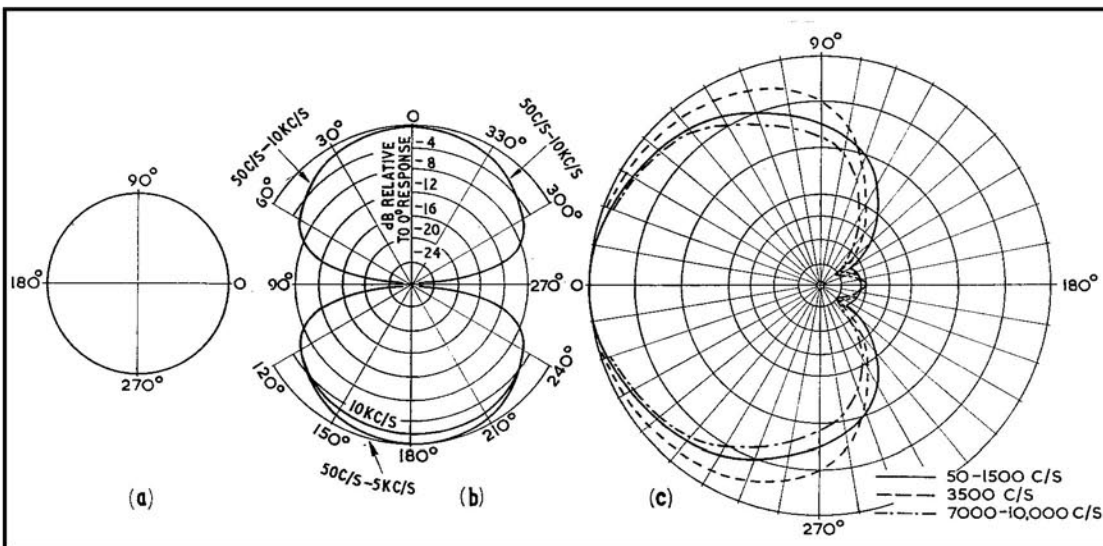

PART 6 microphone directional properties

BY GORDON KING

Fig. 1: (left) shows the polar response of an omnidirectional (a) bi-directional (b) and cardioid (c) microphone. Note that response varies slightly with frequency.

Some tape recorders, of course, have microphone inputs at low impedance (and sometimes high impedance as well). Matching to a conventional low impedance microphone then fails to cause any problems. Nevertheless, there may still be a need for a pre-amplifier if a microphone with a sensitivity below that suitable for the microphone input channel of the tape recorder is adopted. Such an amplifier may be necessary if a very low level ribbon microphone is employed in place of the moving-coil microphone furnished with the recorder. Incidentally, ribbon microphones are of very low inherent impedance (due to the 'single conductor' arrangement of the ribbon) but the impedance is usually stepped up to the required value by an inbuilt transformer.

Condenser microphones cannot easily be used direct with a tape recorder designed for ordinary high or low impedance microphones. A condenser microphone demands a polarising voltage (as we saw in Part 4) and this is usually supplied by an ancillary unit which connects close to the microphone and which delivers an output voltage at low or medium impedance. In addition to sensitivity, frequency response and impedance (all dealt with in past articles of this series), microphones possess another important characteristic—that of *directivity*. Directivity refers to the sensitivity or the pick-up pattern of the microphone at angles round it.

For example, a microphone with the label 'non-directional' or—more professional—*omnidirectional* has no favoured direction of acceptance and thus responds equally to sounds arriving from all directions.

A microphone said to have a *figure-of-eight* characteristic favours mostly sounds arriving from the front and back and least sounds arriving from the sides, top and bottom. Since the response of this type of microphone occurs in two major directions, it may also be termed *bi-directional*.

Another pick-up pattern is the *cardioid*—meaning heart-shaped.

Microphones with this characteristic have the ability of rejecting sounds arriving from the back. Since the maximum response is thus from the front of the microphone, the term *unidirectional* is also used to identify microphones with a cardioid response.

There are, then, three primary pick-up patterns: (i) omnidirectional, (ii) bi-directional, and (iii) unidirectional. In practice, there are degrees of these responses and admixtures of the three. Indeed, it is possible on certain microphones to adjust the response either electrically or by acoustic damping to suit a specific requirement.

The three pick-up patterns are illustrated respectively in fig. 1 at (a), (b) and (c). The actual response is a little dependent upon frequency, as (b) and (c) show.

In the omnidirectional category fall practically all the lower-priced crystal microphones, the condenser and most of the moving-coil types. The basic ribbon microphone is bi-directional, but it can sometimes be adjusted to provide a unidirectional response.

The unidirectional (cardioid) response is available from a few dynamic type microphones, though such a polar response shape is also produced by the combination of a ribbon element with a moving-coil unit. A microphone of this kind is the 4033-A by S.T.C., and the response at fig. 1(c) is from that microphone. Since two elements are employed, the 4033-A can be switched to cardioid, ribbon or moving-coil, giving heart-shaped, figure-of-eight and omnidirectional responses respectively.

Microphones employing a diaphragm, as distinct from a ribbon, such as the moving-coil (dynamic), condenser and crystal, are said to be *pressure operated*. That is, they respond to the pressure component of the sound radiation. The rear of the diaphragm is cut-off from the pressure wave by the case or housing of the microphone. It thus remains at normal atmospheric pressure at the rear, the movement of the diaphragm, therefore, being evoked by pressure variations at the

(continued on page 327)

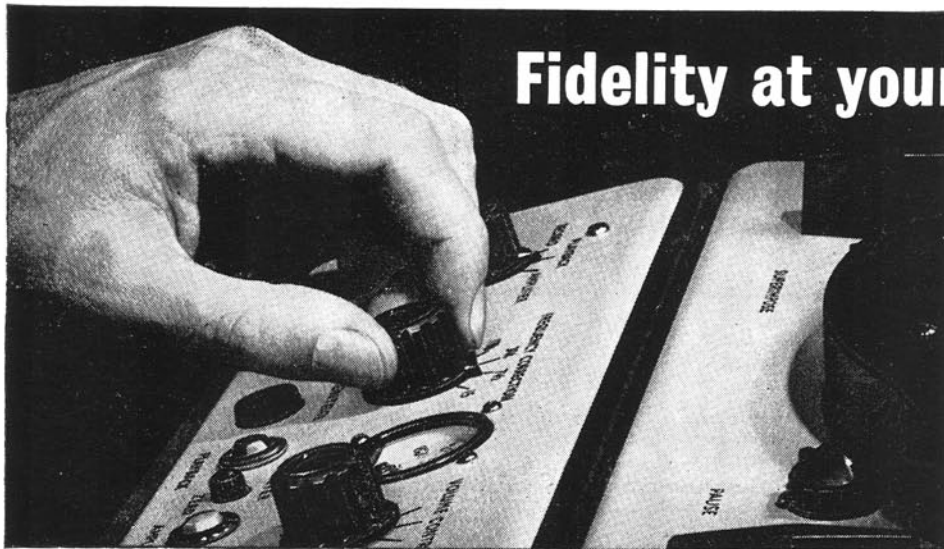

Fidelity at your fingertips.....

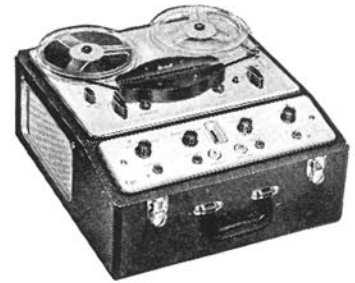

The immediate, unerring response to the controls of a Brenell tape recorder only goes to emphasise the precision engineering and clever electronics which are built into each machine.

.....with a BRENELL tape recorder

Record and playback performances are as impeccable as the following specification conveys :-

MARK 5 Series 2. 4 speeds $1\frac{1}{2}$, $3\frac{3}{4}$, $7\frac{1}{2}$ and 15 ips . frequency correction at all speeds . 3 independent motors . exceptionally low "wow and

flutter" content . double gapped ferrite erase head to minimise erase noise . narrow gapped record/playback head for extended frequency response . pause control . superimpose control . recording level indicator (meter available) . up to $8\frac{1}{2}$ " dia. reels . fast rewind . digital rev. counter.



GD814

For full details of the complete range of mono and stereo models write to the sole manufacturer :-

**PLEASE NOTE
OUR
NEW ADDRESS**

BRENELL ENGINEERING CO. LTD.
231/5 Liverpool Road, London, N.1.
Telephone: NORth 8271 (5 lines)

SUMMER SALE !

OF UNSOLD STOCK

			Our Sale Price			Our Sale Price
ELIZABETHAN	Popular 200	Save £6	£18 3 0	STELLA	459	Save £11 £54 2 0
ELIZABETHAN	Popular 400	Save £6	£20 5 0	GRUNDIG	TK/41	Save £13 £63 15 0
STUZZI	Memocord	Save £12	£22 13 0	GRUNDIG	TK/40	Save £12 £70 19 0
Q-CORD	203	Save £12	£23 14 0	SONY	200	Save £21 £61 19 0
WYNDSOR	Trident 2-T	Save £9	£25 13 0	UHER	4000/S	Save £15 £82 13 0
WYNDSOR	Trident 4-T	Save £7	£29 15 0	SONY	801	Save £29 £64 9 0
BUTOBA	MT/7	Save £8	£31 18 0	SANYO	S-61/TMR and mains unit	Save £10 £33 1 0
PHILIPS	EL.3541	Save £6	£31 16 0	SONY	500	Save £15 £99 9 0
GRUNDIG	TK/14	Save £6	£30 15 0	FERROGRAPH	424	Save £16 £99 10 0
ELIZABETHAN	LZ/29	Save £6	£33 18 0	SONY	600	Save £38 £105 17 0
COSSOR	1604	Save £7	£33 19 0	VORTEXION	CBL	Save £30 £130 0 0
COSSOR	1605	Save £10	£55 2 0	SONY	777A	Save £40 £126 19 0

All complete with Manufacturer's Guarantee Cards, etc.

H.P. terms possible.

Write for Lists.

Please indicate interests
TAPE RECORDERS
Mono under £50
Mono over £50
Stereo

HI-FI
Amplifiers and Tuners
Speakers and enclosures
Turntables and Arms
Portable Radios and Grams

HOWARD

TAPE RECORDERS . HI-FI

218 HIGH ST. BROMLEY. KENT. RAV. 4000

TOWARDS BETTER TAPING CONTINUED

front in accordance with the pattern of the sound radiations.

With a ribbon microphone, however, both sides of the ribbon are coupled to the sound field, which means that its movement is caused by differences in sound pressure *between* the two sides. Such a microphone is sometimes called a *pressure gradient* type, and since the pressure gradient of a sound wave is proportional to the 'particle velocity' of the sound, the term *velocity operated* may be used to describe ribbon microphones. This is rather a loose term, since pure velocity operation is impossible due to the inefficiency of coupling between a conventional ribbon and the velocity component of the sound wave.

The tape enthusiast will now begin to realise that microphones have far more to them than may have first been thought, but because the microphone is to a tape recorder as is the lens to a camera, we make no excuse for using three articles to investigate this most important component. The whole success of 'live' tape recordings depends upon the choice of microphone and upon the way it is used, and before one can choose and use, at least a fundamental knowledge is required of the characteristics and principles of operation of the device concerned.

THE TRANSISTOR COUPLER

Last month's article revealed that sensitivity and impedance are two major electrical factors that must be wholly satisfied before a microphone different from that for which the tape recorder was designed can be used successfully. We saw that both matching and boosting can be accomplished by a small, plug-in transistor amplifier.

This can be commercially purchased or made at home, and a useful device in this respect is shown in fig. 2. This is the *Reslosound Type GE Transistor Coupler*, designed for use in place of an input transformer to couple a low impedance microphone, for instance, into a high impedance circuit.

This unit was mentioned briefly last month, and in view of the fact that such a device does allow a tape recordist to use a low-level, low impedance microphone instead of, say, the high impedance crystal microphone supplied with his recorder, one or two more words about it would not be amiss at this juncture.

We have already seen that the less expensive microphone often supplied with the 'popular' type of tape recorder invariably has a high sensitivity but a restricted frequency range. This allows the designer of the tape recorder to obtain full drive with two stages of voltage amplification after the microphone. Better quality microphones have a smaller output voltage and a better frequency response and need three stages of amplification. Moreover, the microphone supplied with the machine is often of high impedance while the better type of microphone is low impedance.

Thus, a transistorised coupling device kills two birds with one stone. It gives the extra stage of amplification and it satisfies the matching requirement. The *Reslosound* unit matches impedances from 20 to 600 ohms into a high impedance microphone input channel designed for use with a crystal microphone. It also gives a 100-to-1 signal boost, and when used with a ribbon microphone gives an output to the recorder of a level equal to or greater than that obtained direct from a crystal microphone. The unit operates from a 9V battery contained within the case.

Most low-impedance microphones are designed for a balanced output. That is, two wires carry the signal to the tape recorder but neither is earthed. Instead, a screening braid is often used on the cable, and this is earthed to avoid hum troubles on extended lines.

Low impedance lines can be extended to 100ft. or more without too much fear of hum, and for shorter runs ordinary twisted flex has been known to work satisfactorily, but generally speaking it is often best to use proper screened microphone cable.

High impedance lines cannot be extended as low impedance ones, and the limit is about 25ft. if hum and frequency response troubles are to be avoided. Low capacitance coaxial type cable (such as television downlead) makes a successful line for high impedance microphone circuits, but care should be taken to avoid moving long lengths of line while recording, for the change in line capacitance due to this action can sometimes give rise to a high background noise.

When a matching device and/or booster is used, this should always be placed as close as possible to the high impedance circuit to keep the

high impedance cable as short as possible, the required line extension then being made at low impedance.

There are many enthusiasts whose claim is that for the best all-round work there is nothing to beat a good ribbon microphone. Such microphones undoubtedly head the list for good quality within a reasonable price range, though there may be an extra cost if a booster/matcher is needed. The ribbon is excellent for recording music, provided its bi-directional response is considered.

Some such units are available with removable damping pads to modify the inherent bi-directional response, providing more of a cardioid effect. The ribbon—or indeed any directional microphone—exhibits an apparent rise in sensitivity when the sound source is close to it. Speaking close to a ribbon, for example, tends to cause an unnatural rise in bass response but, again, correction is sometimes available in the form of pads to satisfy any speaking distance. Normally, however, speaking at less than about 2ft. from a ribbon should be avoided.

The bi-directional characteristic of the ribbon can be used to advantage when it is required to suppress sounds arriving at right-angles, or thereabouts, to the required sounds. The idea would be to orientate the microphone to provide the best required—to unwanted sound radio.

The ribbon could also be a good choice for use in a highly reverberant room, for its figure-of-eight response pattern effectively reduces the reverberation pick-up by a factor of about 3-to-1 relative to an omnidirectional microphone.

Conversely, in a room which is acoustically dead, an omnidirectional microphone may be a better choice, since this would respond to reflected sounds arriving from all directions and tend to give a bit more 'life' to the recording.

A cardioid response is useful when it is required to eliminate all sounds arriving from the rear. A classic application of such a microphone is on a stage, where it is required to suppress unwanted noises emanating from the orchestra pit and the audience. The cardioid, due to its directivity, is also less responsive to reflected sounds by a factor of about 3-to-1.

For interviews, the slender type hand microphone is becoming popular (see fig. 3). Such microphones are essentially omnidirectional and employ a moving-coil insert. Some models can also be used as stand microphones by means of swivel holders.

MICROPHONE ACCESSORIES

Special attachments and microphones are available for a diversity of applications, it being, of course, well outside the scope of this article to detail them all. The now well-known *Gramplan Parabolic Reflector* is again worthy of note by tape recordists. This is a reflector which focuses sound waves rather like a reflector in a car headlamp focuses light rays. The microphone is positioned at the point of focus of the reflector by a clamp, and the assembly is then orientated to the line of the distant sound-source. Many splendid bird song recordings have been produced by this method of focusing sound.

Eventually, the tape enthusiast, after having mastered the art of microphone techniques, will wish to try his hand at the simultaneous use of more than one microphone. Electrically, there is no reason why two or more microphones could not be connected in parallel (or series) through suitable matching pads to the common microphone input socket of the recorder.

There are two major disadvantages to this method. One is that the price for correct matching is that the signal from each unit is attenuated by a ratio related to the number of microphones so connected; the second is that it is not possible to adjust easily the sensitivity of each microphone channel to provide the required acoustic effects.

The solution to these problems lies in the use of a microphone mixer. This is a piece of equipment which channels each microphone signal separately, ensures the correct match, restores the sensitivity, and permits individual control of each microphone circuit.

Some mixers are arranged to accept low and high impedance inputs, so that in addition to microphone signals, radio or pickup signals can also be mixed. Each channel usually has its own gain control, and the common output may be at either high or low impedance (or switchable according to the requirements).

Now that transistors are becoming popular from the audio aspect, they are beginning to replace valves in mixers. Transistors relieve the hum problems associated with mains power supplies in low-level stages, and owing to the low power consumption of transistors a small battery will give many months of service in an audio mixer.

REPS R10 MkII VERSION

AN IMPROVED MODEL IS NOW AVAILABLE MAINTAINING A HIGH STANDARD OF PERFORMANCE

Exclusive professional type idler wheel for reliability and reduced wow.

D.C heating on pre-amp valves.

Modified Magnavox Studio deck with improved wow/flutter.

Bogen micro-gap two or four track heads fitted.

10 watts nominal R.M.S. Rating.

Calibrated Bass and Treble controls

Mic. Gram/radio inputs, separate controls for mixing.

7½ i.p.s. 40—15,000 C.P.S. ± 1dB 100µS	} to C.C.I.R.
3¾ i.p.s. 40—10,000 C.P.S. ± 2dB 200µS	
1¾ i.p.s. 50— 5,000 C.P.S. ± 3dB 400µS	

5 ECC83. 2 EL84. 1 ECC82. 2 Contact Rectifiers.

Pre-amp Signal/Noise > —55dB at all speeds.



Fully illustrated literature available on request to—

2 Track 59 gns.
4 Track 69 gns.

REPS (TAPE RECORDERS) LTD.

118 Park Road North, South Acton,
London, W.3 Phone: Acorn 4141

TAPE RECORDER COVERS



Smart waterproof cover to give complete protection to your tape recorder. Made from rubberised canvas in navy, wine, tan, grey and bottle green with white contrasting pipings, reinforced base, handy zip microphone pocket and name panel.

Grundig TK.1	49/6	Philips EL3538	63/-
" TK.5	55/-	" EL3542	63/-
" TK.6	67/6	" EL3536	70/-
" TK.8	63/-	" EL3515	57/6
" TK.14 & 23 & 18	59/6	" EL3541/15	57/6
" TK.20	52/6	" 3541H	72/-
" TK.24	55/-	" Starmaker	66/-
" TK.25	55/-	Cossor 1602	57/6
" TK.30	60/-	" 1601	63/-
" TK.35	63/-	" 1604	79/-
" TK.40 & 41	66/-	" 1605	84/-
" TK.46	82/-	Stella ST455	63/-
" TK.55	63/*	" ST454	57/6
" TK.60	75/*	" ST458	79/-
" TK.830/3D	63/-	" ST459	84/-
" Cub	35/*	Saba	63/-
Telefunken 85	65/-	Elizabethan FT.1	66/-
" 75/15 & 76K	55/-	" FT.3	75/-
" 95	69/6	" LZ29	75/-
Philips 8108	57/6	Fi-Cord 1A	52/6
" 8109	63/-	Fidelity Argyle	55/*
" 3534	87/-	Clarion (with strap)	52/6
" 3459	79/6	Brenell Mk.5	77/-
		" 3 star	69/-
		Truvox R92 and 94	99/-
		Robuk RK.3	67/6
		Ferroglyph	88/-
		Sony 521	90/-
		Revox	84/-
		Optacord 414 + 412	63/-

*Without pocket.
A. BROWN & SONS LTD.
24-28 GEORGE STREET, HULL. TEL. : 25413, 25412



SAVBIT ALLOY
saves wear on
soldering iron bits

The world-famous copper loaded alloy containing 5 cores of non-corrosive flux, that saves the soldering iron bit. Ersin Multicore Solder is also available in high tin quality alloys. 60/40 in 22 s.w.g. for printed circuits, transistors, etc.

BIB RECORDING TAPE SPLICER

Gives a professional touch—A handy precision tool allows quick and accurate editing—no wastage or post-editing clicks. Can be mounted direct on the tape deck. It uses all your odd lengths of tape.

18/6 each



THE HANDY DISPENSER

Easy to find in the tool box—simple to use. Virtually a third hand for tricky soldering jobs. 14 feet 5-core 18 s.w.g. ERSIN MULTICORE SAVBIT alloy in a continuous coil used direct from free-standing dispenser. **2/6 each**

BIB WIRE STRIPPER AND CUTTER

Strips insulation without nicking wire, cuts wire cleanly, adjustable to most thicknesses. Splits extruded plastic twin flex. **3/6 each**



MULTICORE SOLDERS LTD.

MULTICORE WORKS · HEMEL HEMPSTEAD · HERTS. (BOXMOOR 3636)

MAGNETIC MEMORY

BY P. D. TURNER

PRESERVING PRECIOUS MOMENTS

ONE day in the summer of 1962 I had occasion to call upon a clergyman whose church is in the very midst of the Forest of Dean, with the trees growing right up to the lych-gate. My wife was with me, and while I went to see the vicar, she took our dog for a walk in the forest. When we had had our talk, the vicar accompanied me back to the car. We saw my wife sitting on a fallen tree-trunk, deep in conversation with an old man. By her side was a battery recorder, and her microphone was in her hand. We waited until the interview was over.

The old man, it seemed, had lived most of his life in the Forest, but had been born in the Cotswolds and had been to school in Stroud. Though he had left there when only a lad, and had not returned, he talked about the place with a freshness of memory which was a joy to hear—speaking in a voice in which the accent of the southern Cotswolds mingled with that of the Dean. Such voices, alas, are becoming rare. He talked with a complete absence of self-consciousness, and seemed oddly uninterested in hearing the sound of his own voice played back to him. We asked how old he was: "Aighty-fower, if I do see Feb'ry," he replied.

After we got back home, we looked round the town for some postcards, and were able to send him one which showed his old school and the part of the town in which he had lived. In appearance, it has not changed much since he left it. In reply, we received a card with a view of the Forest, written in a firm, clear hand. But before the end of 1962, the vicar rang me to say that the old man had died: he had not "seen Feb'ry". We shall not see him again; but all we have to do is to play that tape, and we are carried back to the Forest glades

upon that golden day. One precious memory is stored for us for ever.

How many moments might have been kept, had we known the secret then!—had, indeed, the secret been known at all, in earlier years. Moments pass from the memory and may only be recalled by some faint echo—like the taste of the *madeleine* which provoked Proust's great novel. This, surely, is the great charm of the recorder, with its magnetic memory: it resides on tapes which one may almost never play—and then, suddenly, the magic switch destroys time, and a bell tolls across the years.

One does not always succeed with tape, any more than one does with a camera. There may be more failures than successes. Perfect art is rare; but fortunately this does not matter, for it is the unexpected thing which evokes memory—sometimes the very thing which marred the recording. I have one tape on which I was recording the dawn chorus at half past four one May morning. Somehow, a bird flicked a pebble against an iron bucket near the microphone, producing a clang which makes the listener jump; but that clang brings back to me that heavenly dawn more vividly than the birds. How I cursed the car that brought back a courting-couple one night when the nightingales returned to my village after an absence of years! Yet, when I play the tape, the sound of the car, braking roughly on the gravelly lane, somehow focuses memory in a way which the clear notes, ringing over the Golden Valley, cannot do.

Therefore there is no need to despair if a recording lacks some of the perfection we rightly try to achieve: on another level it may be the better for it. There are many fascinations about recording, and each has his own taste; but for me the deepest purpose of recording is to secure a haphazard, often unintentional, garnering of those little things which provoke memory.

If only I had started recording sooner! There used to be a group of elderly men who foregathered in the local at midday. The landlady set her elbows firmly on the counter when not using them to draw beer, and joined in the conversation. I thought I spoke the language, but much of the talk was beyond me. Now every member of the midday school is dead, and the sound of those voices irretrievably lost. I try not to make the same mistake any more.

For some reason, sound seems a more potent storer of memories than vision—or at least it is so with me. So how grateful I am for the day I helped a friend to hump a Series 1 Ferrograph into a hall to record a lecture: it began my interest in the magnetic memory, and though I did not know it at the time, that moment changed the whole of my life. I use recorders for many things, and enjoy them all; but the greatest benefit is the one I did not foresee.

PROTECTING YOUR TAPE RECORDER

BY JOHN GASELEE
SOME NOTES ON
INSURANCE

IT is quite easy not to give a thought to the question of insuring one's tape recorder until it is too late—when it has met with an accident, or has been stolen. Now, therefore, is the time to make sure that adequate insurance protection is in force so that, in the event of loss or damage, although one may be put to considerable inconvenience, at least there should be no direct financial loss.

There are a number of different ways in which a tape recorder may be insured. On the whole, however, it is probably safe to say that the greatest risk is from accidental damage. Thus it is wise to choose the widest cover available.

In the first place, there is the straightforward "householder's" policy to be considered. If all the contents of the house are insured under such a policy, this will include a tape recorder, tapes, and all additional items of equipment. Whereas this may seem to be satisfactory enough, the point to remember is that the cover under such a policy is very limited. Admittedly, fire, burglary, theft, storm damage, etc., is covered, but no claim will be paid for *accidental* damage. Incidentally, although the policy is primarily intended to apply to

anything when it is in the house, there is *some* cover when it is outside the house—although this often applies when it happens to be in *another* house.

Of course it may very well be possible to extend this form of "comprehensive" policy so that any accidental and external damage which may be caused to the tape recorder while it is in the house will be covered by the policy. This is unlikely to cost more than a few shillings a year, and may be well worth-while. On the other hand, this extension of cover might apply only while the tape recorder was in the house.

Generally speaking, it is probably more satisfactory to arrange a special policy for the tape recorder and all its accessories on "all risks" conditions. Incidentally, there is a reason for the inverted commas. Such a policy does *not* cover every single risk of loss or damage; there are a few exceptions.

A number of companies specialise in issuing this type of policy. Broadly, the actual cover provided by the different policies on the market is likely to be much the same, although there may be some variations in the rates of premium charged. For this reason, rather than approach the first insurance company which comes to mind, there is much to be said for making the necessary arrangements through the intermediary of a firm of insurance brokers. For a firm of brokers should know which company has the best policy for one's own particular needs. No charge is made for this service, as the brokers receive their remuneration by way of commission from the insurance company.

Unfortunately, it is not yet possible to effect a policy which is all-embracing, in that it covers full maintenance such as cleaning, overhaul, and the replacement of valves. Furthermore, it is usual for a

(continued overleaf)



Quality Magnetic Recording Tapes

TO SUIT EVERY BUDGET...

- ♣ for professional studio use
- ♣ for homes, schools, churches

UNCONDITIONALLY GUARANTEED

Irish makes a quality tape for every purpose for both the amateur and professional. Irish is the only premium-quality tape at a standard price. The exclusive Irish Ferro-Sheen process prevents shedding of abrasive oxide . . . assures reduced head and tape wear, superior sound quality. Every Irish tape is 100% unconditionally guaranteed!

FREE—"Signature Tape" binding with every 5", 5¼" and 7" reel. "Signature Tape" makes identification of tapes easy . . . makes a handsome binding which can be stored on shelves or bookcases . . . gives added protection to recordings . . . gives tape box extra strength.

Recording Tape Series #190

- Standard 1½ mil acetate
- Long Playing 1 mil acetate
- 1 mil Mylar*
- Double Play tensilized ½ mil Mylar*



Professional Tapes Series #200

- Standard 1½ mil acetate, 1½ mil Mylar*
- Long Playing 1 mil acetate
- 1 mil Mylar*
- Double Play tensilized ½ mil Mylar*



*Dupont Registered Name

Shamrock Recording Tape

EXPERIMENTAL, AMATEUR AND HOBBY TAPES



Here's the low-cost economy tape for all non-critical uses. Available in 5" x 7" reels with plastic or Mylar film backing in 1 mil, .5 mil, and 1.5 mil thickness.

Available in Shamrock box shown, or in a plain white box for your own imprint.

UNITED STEREO TAPES Division of Ampex

A complete line of four-track pre-recorded tapes. Write for complete catalog.

Write for complete Catalog Specifications and Prices.

MORHAN
EXPORTING CORPORATION
458 Broadway, New York 13, N. Y.

PROTECTING YOUR TAPE RECORDER CONTINUED

policy to exclude what is known as electrical and mechanical breakdown. It is not always easy to determine just what is meant by this. For instance, if there is a normal breakdown of any kind while the tape recorder is running, this would *not* be covered by an "all risks" policy. But, if any adjustment should be needed if it had received a sharp blow, or been dropped heavily on to a table, it is quite likely that a claim might be paid—although the views of different companies tend to vary on such points.

Incidentally, with many "all risks" policies (such as those which cover jewellery, or one's personal effects), the insurance cover may apply "whilst anywhere in the United Kingdom, including whilst in transit". Whereas some policies on tape recorders may be as wide as this, others tend to be rather more restricted, due mainly to the risk of theft. For instance, a policy may provide cover only while the recorder is in a club, hotel, or other premises—including one's own home—or actually in transit. Here, of course, the interpretation of "in transit" is vague. If one has a recorder in a car, and stops for a meal, one might have difficulty in arguing that, if the recorder was stolen from the car, it was in transit at the time. Admittedly it was in the process of being moved from one place to another, but it would not have actually been in transit when it was stolen. This, therefore, is a point to be clarified with the insurers if one has a policy on these lines.

If the tape recorder is likely to be used out of doors, it is pointless to have a policy which does not give full cover all the time. It is easy to take the view that an accident is unlikely to happen under these circumstances, but it is surprising how often an accident does occur just at the moment when something is not covered by insurance. For a small additional premium, the insurance company may agree to extend the policy so that one has the full cover which is needed.

As mentioned, there is a fairly wide variation in the basic rates of premium. About the lowest likely premium is 10s. per £100 of value; on the other hand, some insurers may charge 25s. or so. If less than £100 is to be insured, it is quite possible that there may be no reduction at all in the premium, or that it will by no means be proportional. The reason for this is that the fixed expenses of simply issuing a policy make it quite uneconomic for insurers to issue policies for very small values.

This brings one to the question of the correct insurance value. In the first place, it is unlikely that insurers would agree to a brand new replacement if a comparatively old model (which has seen a number of years of service) is a total loss. Secondly, simply insuring for a specific sum does not necessarily mean that it will be paid in the event of loss, for insurers look upon it as representing no more than their *maximum* liability. In fact, a claim will be based on a fair value for the equipment at the time of loss, and this is what can lead to differences of opinion and subsequent arguments.

HOW MUCH IS IT WORTH ?

As mentioned, it is unlikely that one will be paid for a brand new replacement. Nor will one be paid the money which the recorder would have fetched in the second-hand market had one decided to sell it. What one *should* receive is the money enabling one to buy a similar recorder, i.e., a similar model of the same value.

So as to avoid any difficulty when it comes to the settlement of a claim, it *may* be possible to arrange for the insurers to "agree" the value when the insurance is effected. In this case it is likely that a professional valuation will be needed, and the insurers may ask for a fresh one each year as the value of the equipment drops. If one has an "agreed value", it means that the value in the policy will be paid without question should the recorder be a total loss during the currency of the policy.

It is advisable to give as full a description of the recorder as possible together with its serial number. Any other major items of equipment should be mentioned separately, together with their own values. All other accessories can be included under a general heading of "unspecified items of equipment". This means that there will be no need to alter the policy each time a small item is acquired.

Make sure, however, that the sum insured is adequate to cover everything on risk at the moment, and also any acquisitions which may be made during the year.

equipment reviews



★
AKAI
345
AUTOMATIC
★

Manufacturer's Specification : Semi-professional automatic stereo tape recorder. Frequency range: 60 c/s—10 Kc/s at $3\frac{3}{4}$ i/s, 60 c/s—15 Kc/s at $7\frac{1}{2}$ i/s. Signal/noise ratio: 50dB at $7\frac{1}{2}$ i/s, 45dB at $3\frac{3}{4}$ i/s. Wow and flutter: less than 0.06% rms at $7\frac{1}{2}$ i/s, less than 0.1% rms at a $3\frac{3}{4}$ i/s. Equalisation: correct equalisation of tapes recorded to NARTB characteristic. Tone controls: bass and treble continuously variable. Channel separation: better than 80dB at 1 Kc/s. Distortion: within 3% at 1 Kc/s (total harmonic). Motor: hysteresis synchronous two-speed motor, 3,000—1,500 rpm at 50 c/s; capacitor start, dynamically balanced. Tape speeds: $7\frac{1}{2}$ i/s and $3\frac{3}{4}$ i/s (15 i/s with accessory capstan and pinch wheel). Reel sizes: up to 7 in. (NAB $10\frac{1}{2}$ in. with outrigger adaptor type 345-10). Power output: 6W per channel. Fast wind: less than 60 seconds for 1,200ft. Power requirements: 100VA. Weight: 65 lbs. Price: £208 19s. Remote control: £6 10s. 0d. Distributor: Pullin Optical Co. Ltd., Ellis House, Aintree Road, Perivale, Greenford, Middlesex.

This is a truly magnificent instrument; magnificent in appearance, performance and weight. I have just carried it 20 ft. and the sweat is dripping into my typewriter! It is fully professional in facilities and styling, with such accessories as complete remote control and NAB $10\frac{1}{2}$ in. reel adaptors. The only compromise towards domestic use is the fitting of $\frac{1}{4}$ -track heads; a professional machine would have $\frac{1}{2}$ -track heads for stereo and a full-track head for mono, but these refinements would be required for the recording of master tapes or for broadcast use, and fitting such heads would limit the types of pre-recorded tapes which could be played on this machine. As it is, $\frac{1}{4}$ or $\frac{1}{2}$ -track mono or stereo can be played at will. For two-track playback the head is moved downwards so that the $\frac{1}{4}$ -track heads scan the centre portions of the $\frac{1}{2}$ -track recordings.

The word 'Automatic' in the title of this recorder highlights another

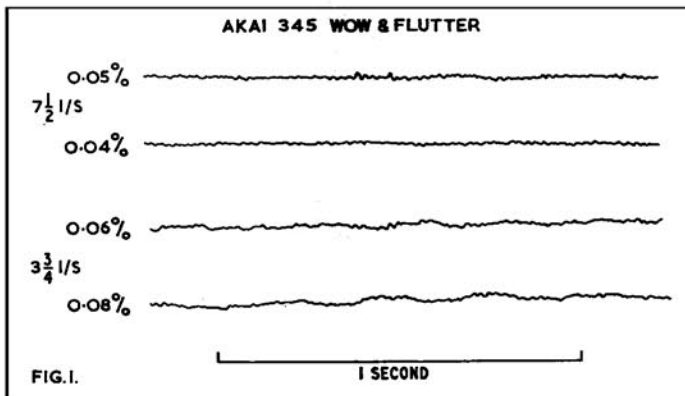

FIG. 1.

exclusive and very useful facility: the large timing dial at the rear of the machine, between the two tape reels, can be pre-set so that when two index points coincide the tape motion is reversed, either at normal speed to give 'reverse', where the other track is played, or at high speed to give 'repeat'. The cycle is repeated each time the dial returns to zero until cancelled by a third pre-set function button.

All push-button controls are light to the touch as they only operate electrical contacts and are not required to perform any mechanical function. A safety button is provided on both direct and remote controls which must be pressed at the same time as the 'play' button to go into the recording mode.

Stereo loudspeakers are fitted to the sides of the case with moveable metal reflectors which can be set to angle the sound forward when the machine is standing upright in the normal operating position.

Fig. 1 shows the 'fluttergrams' or pen recordings of short-term deviations from a constant speed. At $7\frac{1}{2}$ i/s the meter reading was rock steady, with the integrated RMS reading between 0.04% and

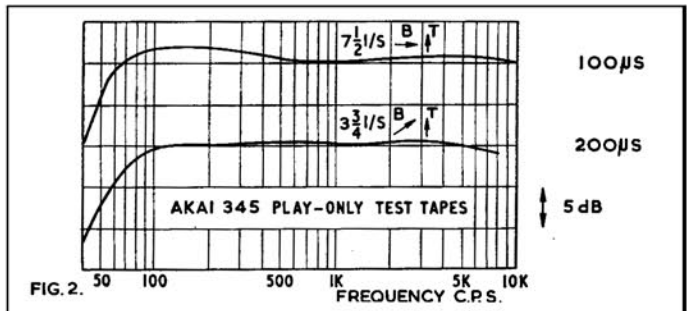

FIG. 2.

0.05%. At $3\frac{3}{4}$ i/s a slight trace of capstan flutter at 3 c/s showed up at brief intervals when the recorded and replay flutters happen to coincide. The RMS readings were 0.06% minimum and 0.08% maximum. The tape driven flywheel to the left of the heads effectively isolates the scanning point from any slight variations in supply reel loading. This flywheel also comes into its own when the tape motion is reversed and the capstan is feeding the tape to the heads at a constant speed. As no pressure pads are used, any variation of tape tension would be absolutely fatal when operating in this condition, but wow and flutter readings were identical to those taken in the normal forward mode.

100 and 200 μ S test tapes were played and the output measured at the low level output jacks. Bass and treble tone controls were set to the most level responses from test tapes and the position of the pointers on these controls are shown above each response curve. Fig. 2 shows that the responses can be made level over the range 60 c/s to 10 Kc/s and 80 c/s to 8 Kc/s at $7\frac{1}{2}$ i/s and $3\frac{3}{4}$ i/s respectively.

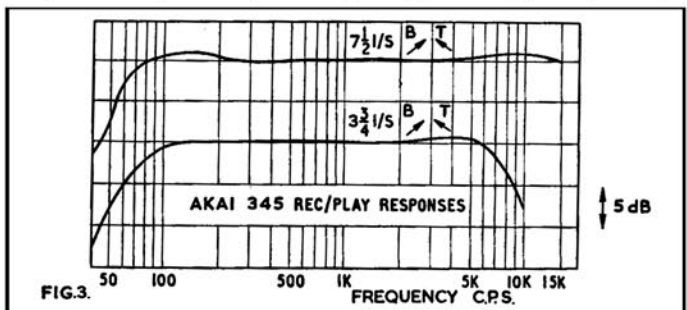

FIG. 3.

Hum and noise was 40dB below test-tape level at $7\frac{1}{2}$ i/s and 35dB below test tape level at $3\frac{3}{4}$ i/s. Later recording tests showed that a level 12dB above test tape level could be recorded without distortion at either speed, so that the effective signal noise ratio is 52dB at the higher speed and 47dB at the lower speed.

The overall record/replay responses of fig. 3 show that the treble tone control has to be turned back a bit for a level response. This indicates a higher level recording at high frequencies than on my

(continued overleaf)

● **You're Guaranteed a Better Deal**

When you **PART EXCHANGE**
Your **TAPE RECORDER**
with **R.E.W**

A friendly welcome awaits you at our bright showroom extension. Here you will find a lavish array of equipment at every price level . . . make your choice for immediate delivery or if you cannot visit us, the fast and friendly R.E.W. Mail Order Service makes it easy for you to enjoy the professional results only possible with an advanced Tape Recorder. Get in touch with us now. We have thousands of satisfied customers and a reputation for generous part exchange, reliability and specialist service.

MACHINE OF THE MONTH



SONY T.C. 500

Full stereo facilities with independent recording and playback amplifiers, providing professional mixing facilities. Manual cueing, digital tape counter, instant stop, automatic tape lifter. Instantaneous selection of $7\frac{1}{2}/3\frac{3}{8}$ ips. Response—30-18000 cps at $7\frac{1}{2}$ ips. Harmonic—distortion—less than 2% a 3 db below rated output. Detachable speakers for stereo separation.

106 gns including microphones and accessories.

TERMS: £11.6.0 deposit and 12 monthly payments of £8.6.8.

CASH FOR YOUR TAPE-RECORDER OR HI-FI. Highest cash offers for good equipment . . . get in touch today!

OPTIONAL INSURANCE at nominal rates against unemployment, sickness or accident during term of H.P. agreement. Premium 6d. in the £—gives cover over two years.

Bargain Basement?

We have an unrivalled stock of new and used machines at unbeatable bargain prices—30%-60% reductions on original prices! Make a point of asking for our Special Bargain List.



300 MACHINES ON DISPLAY!

Call, see, hear and choose the Tape Recorder you've always wanted from one of the biggest ranges anywhere. Just about every model—for off-the-shelf delivery.

An unrivalled stock of leading makes of new and used machines at unbeatable bargain prices—30%-60% reductions on original prices! Make a point of asking for our Special Bargain List.

You're guaranteed maximum satisfaction with the R.E.W.

"PLUS FIVE" SERVICE

- Generous part exchange allowances.
- No interest terms—lowest deposits.
- Off-the-shelf delivery from the biggest range under one roof.
- Free servicing and free delivery.
- Optional personal insurance.

INTEREST FREE TERMS

Take your pick from our wide range and have any machine you want for 10% deposit, balance twelve months and no interest charged. (18-24 months H.P. terms also available.)

Home demonstrations in the London area gladly arranged. By return enquiry service. Agents for all makes.

R.E.W

(Earlsfield) Ltd.
Mail Order Department
266/268 (TR) Upper Tooting
Road, London, S.W.17.
Telephone: BALham 9174-5

AKAI REVIEW CONTINUED

recording test-tapes and confirms that is to NARTB standards at both speeds. Tests were made on both tracks, but responses and levels were so similar that it was unnecessary to plot them separately.

A level 12dB above test tape level was recorded at a VU meter reading of plus 3dB, at the top of the red sector of the meter scale, and the level could be increased by a further 2-3dB before waveform distortion was evident. CRO examination of normal programme recordings showed that the full dynamic range of the recorder and tape were used when the meter kicked around mid-scale most of the time, with peaks into the red occasionally.

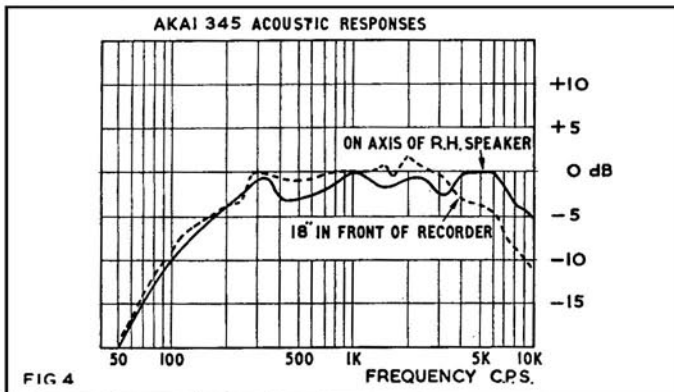

A white noise test-tape containing 25 bands of filtered white noise was played at $7\frac{1}{2}$ i/s with the tone controls set as in fig. 2 and the sound level measured at a distance of 1 ft. on the axis of the RH loudspeaker to give the solid curve of fig. 4. Next the microphone was moved to a point about 18 in. distant from the front of the recorder and the response measured again to give the dotted curve of fig. 4. The responses are smooth and free of peaks so that the playback tone controls may be used to raise the bass and treble slightly to give a nicely balanced response over the range 100 c/s to 10 K/c/s.

This is the *Rolls-Royce* of domestic and semi-professional recorders for those who can afford the best 'regardless', or for a firm or organisation who can make full use of its very versatile playback facilities.

Its performance is faultless in almost every respect; my only complaint concerns the reel fitting which consists of a non-fluted spindle and a single rubber covered peg which is designed to fit American type reels. Unfortunately it will not accept any Continental reel or any of the small diameter reels, and it is a bit of a chore to rewind a tape on to a suitable reel before being able to play it. Nevertheless, if one can afford this kind of machine the price of a few dozen suitable reels would be a small item.—A. Tutchings.

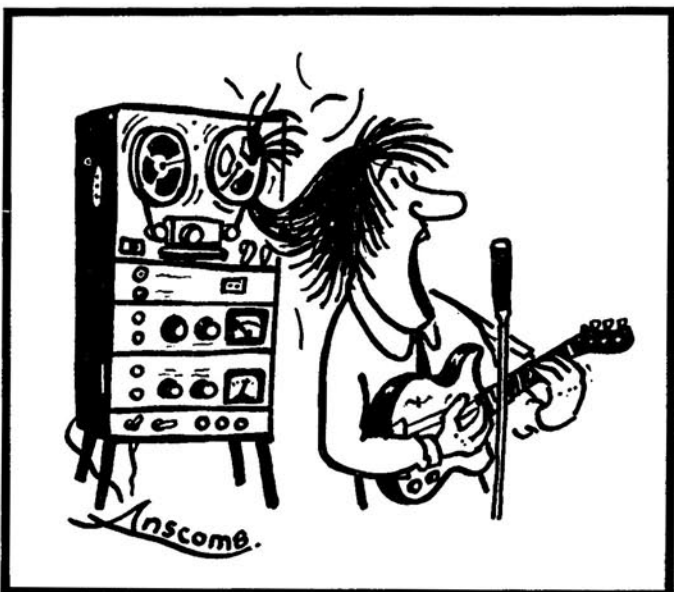

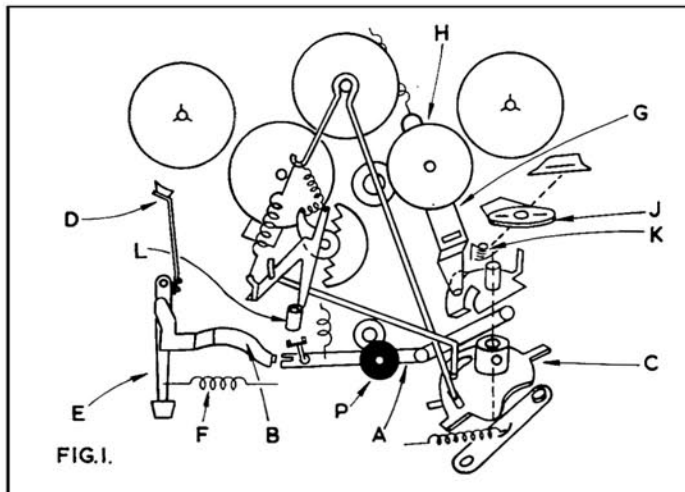

taking care with the smaller, top one. Remove the screw at the 1,600 Kc/s side of the dial, then unsolder four of the six wires; the yellow, green and orange PVC wires and the screened cable. One does not have to be careful with a ferrite rod when dismantling, for this machine does not use one, relying on the mains aerial system, or an external aerial; a correctly balanced aerial input such as a high 15-20ft. horizontal wire will improve the sensitivity.

But, to get back to my brief. The tape recorder mechanism is very similar to the model 101. However, the diagram reproduced on page 227 of the July 1964 issue was rather skeletal—my fault I hasten to interject! Fig. 1 of this month's article therefore attempts to give a few more details, particularly of the selector cam and the speed-change system.

There are many mechanical similarities also with the 362B and the 464, which will be referred to as we progress. In fact, this machine is typical of the Sony technique, except for the single belt that drives the tape position indicator. The "belt versus idler" controversy is not part of my brief, but it is impossible to resist teasing Rafe Seabrook by saying that the Sony system is a good argument for idler wheel drive. From the servicing point of view, it gives less trouble than many

TAPE RECORDER SERVICE

BY H. W. HELLYER

NUMBER 33

CONTINUING THE
SONY RANGE

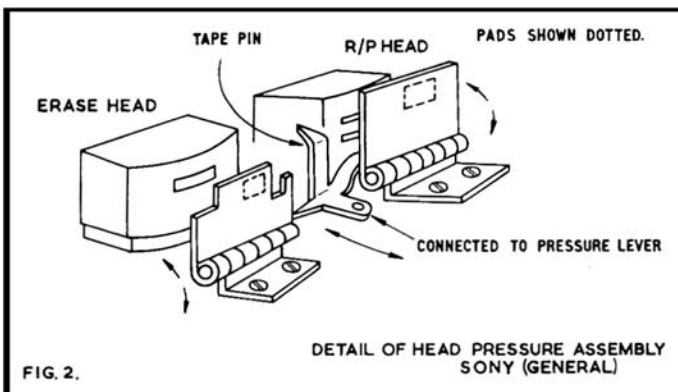

MODEL 362 is a two-speed ($7\frac{1}{2}$, $3\frac{3}{4}$ i/s) $\frac{1}{4}$ -track machine, taking spools of up to 7in. diameter with a radio tuner incorporated. In appearance it is somewhat similar to the general run of models previously discussed, except for the distinguishing feature of the tape position indicator (digital type), between and to the rear of the spools. It is, in fact, slightly larger and heavier than preceding models, being $17\frac{1}{2} \times 8 \times 15$ in., weight 31 lb., but the circuit is neither complicated, nor the mechanism more elaborate.

Five valves are used in the main tape recorder and a three-transistor radio tuner is fitted. The valve line-up is somewhat similar to the 262, except that a 6CA4 mains rectifier is used, but the radio tuner is quite a bit simpler than the type we met with the 103, having, in fact, a conventional "radio" circuit, with aerial feeding directly to the 2T73 frequency changer. This is quite adequate for normal purposes, but whether the medium-wave coverage on AM is sufficiently good for quality recording is quite another matter. The sensitivity is pretty well as the average transistor radio, 10 μ V with the internal aerial, and the selectivity is better than 20dB at 10 Kc/s off tune. But with stations bumping in after dark on the lower wavelengths of this band, and the terrible interference, it is questionable whether the purist would be satisfied. This is not the fault of the makers, let me hasten to say, before the pens reach the inkpots. They have done their best with a clever automatic gain control circuit and a split load output that prevents the annoyance of the reduction of level when switching to record from the radio that besets the average "hookup". This is a problem that one or two readers have mentioned, solved by what might be called a constant-impedance circuit.

While on the subject of the radio section, it may be worth mentioning the dismantling procedure. Looking at the radio section with the printed board to the left, component side upwards, it will be noted that there are two screws holding the edge of the board itself, and five others. Ignore the lower right screw, but remove the other four,

comparable but belt-driven machines.

In fig. 1, the cam is shown "exploded" and the operation of the function selector is as follows. When the cam is turned clockwise one position, the arm A is allowed to be drawn in by spring pressure so that the pinch roller P engages the capstan and the pressure pad bracket moves inwards. The cam has a single screw fixing, and the position of this should be checked to ensure free travel of the arm A.

The same action of arm A engages the pivoted lever B and releases brake D from the left hand spool. The pause lever E acts against spring F to re-apply it. Check spring F for jerky initial action when switching to PLAY. Note also that the arm B, which is stepped, can cause erratic braking if loose at the pivot.

Continuing this primary action, the upper section of cam C moves lever G to engage the idler H with the right-hand lower section of the spool carrier and upper section of the motor pulley. The end spring assists this action, and is, again, an obvious point to check for jerky take-up. Quite important also is the riding level of lever G, and the set in it, to prevent the lower edge of the idler periphery rubbing on the larger step of the motor pulley. This fault is not so obvious, because the "ironing-out effect" of the simple felt clutch pads can obscure the directness of the mechanical interference. The fault is more obvious with a lightly loaded spool, as the clutches are dependent on the weight upon the spool carrier.

This same action is accentuated when the machine is switched to FAST FORWARD. The movement of this separate external control turns the wheel J, depresses the torsion spring K on the boss of the upper section of the cam and forces lever G in and down, contacting the larger section of the motor pulley directly, to give fast forward winding. The trouble sometimes met is vibration of a nearly empty spool, due to the clutch action taking over, and the answer is to make sure the upper cam section is turning fully into position when the part J moves.

(continued on page 335)

'Q' - C O R D U A L I T Y O M P A C T B J E C T I V E E L I A B L E D U A L T R A C K

60-10,000c/s \pm 3db. sig./noise 50 below peak
 Heads by BOGEN
 Push Pull Osc. AC erase.
 10 x 10 x 4. 3 1/2 I.P.S. 5 lbs.
 Constant speed 4 1/2 inch spools. 2 hrs. play. Operate in any position.
 Buhler motor. No pr. pad on record head. Finest components. West German Ideal for dubbing.
 Inputs for mike, radio outputs for amp. & spkr.
 Powered from Mains/Battery/Car Battery/6v or 12v/Also for 203 6v. accumulator.

"Complete with dynamic mike, spool, radio lead, cct. diagram, batteries etc."

203 - 34 Gns. R119K - 33 Gns.
 Write for full details
C. Braddock Limited
 266 Waterloo Road, Blackpool
 Telephone: 45049



FREE OFFERS

NEW SUPER QUALITY TAPE IMPROVED at no increase of price.

SUPERIOR callendered oxide to make "dropouts" even rarer than before. SUPERIOR new Triple Play, stronger and more stretch-free than most DP; all reel sizes 3" to 7". LEADER TAPE trailer and stopfool on 4" to 7" spools, all grades. ALL REELS factory-sealed in polythene.

AT LEAST 40% CHEAPER.
 than any other tape of comparable quality.

1 FREE SAMPLE LENGTH OF TAPE ON A 7" REEL

2 BUY ANY TAPE FROM OUR RANGE, AND GET A TAKE-UP SPOOL OF THE SAME SIZE - FREE

DE VILLIERS (Electronic World) LTD., 16D Stratton Ground, London, S.W.1

STANDARD PLAY (PVC Base)		LONG PLAY (Prestressed Polyester Base)	
3" / 150ft.	4 for 18/-	3" / 225ft.	4 for 22/-
	48/- doz.		60/- doz.
4" / 300ft.	4 for 26/-	4" / 450ft.	2 for 21/-
5" / 600ft.	2 for 26/-	5" / 900ft.	2 for 35/-
5 1/2" / 900ft.	16/-	5 1/2" / 1,200ft.	24/-
7" / 1,200ft.	19/-	7" / 1,800ft.	31/-

DOUBLE PLAY (Prestressed Polyester Base)		TRIPLE PLAY (Prestressed Polyester Base)	
3" / 375ft.	2 for 20/-	3" / 465ft.	2 for 26/6
	108/- doz.		150/- doz.
4" / 600ft.	2 for 30/-	3 1/2" / 650ft.	17/-
5" / 1,200ft.	27/-	4" / 900ft.	23/6
5 1/2" / 1,800ft.	35/-	5" / 1,700ft.	40/-
7" / 2,400ft.	45/-	5 1/2" / 2,300ft.	52/6
		7" / 3,300ft.	80/-

Please send Free Offer 1 Please send Free Offer 2

I enclose £ s. d. NAME

ADDRESS

BLOCK CAPITALS PLEASE CASH WITH ORDER

POST FREE - SEND COUPON NOW -

COMPLETE "SLEEPOMATIC" UNIT FOR ONLY £20

Comprising transistorised tape machine, auto time-switch, microphone, batteries, and under pillow speaker.

INTERESTING FREE BOOKLET and details of our range of tapes, discs and equipment gladly sent on receipt of postcard.

(We are the pioneers of Automated Sleep-learning in Gt. Britain)

EDUCATIONAL RECORDINGS LIMITED
 (Dept. TR) 21 Bishops Close, Church Lane, London, E.17

Exceptionally wide frequency response—virtually level from 40 c/s to 15 Kc/s—combined with excellent transient response, makes this the ideal instrument for the studio and wherever a high standard of fidelity is essential. Two models are available, each in three impedance sensitivities.

Model G.R. 1, having a semi-cardioid response, gives approximately 10 db suppression to high frequencies at the rear face. It is ideal for overcoming problems of feed-back between microphone and speakers.

Model G.R. 2, having a bi-directional "figure of eight" sensitivity pattern, discriminates against unwanted side noise both in the vertical and horizontal planes.

Supplied in attractive, padded instrument case, complete with 18 ft. screened lead, swivel holder and connector **£11.10.0.**

A full range of accessories are available. Please send for illustrated leaflet.

Enquire too for details of the famous Gramplan DP4 range of Moving Coil Microphones



the Gramplan Ribbon Microphone



GRAMPLAN REPRODUCERS LTD
 Hanworth Trading Estate, Felcham, Middlesex.
 Felcham 2657

BRAND NEW 100% TESTED RECORDING TAPES

MANUFACTURED BY FAMOUS BRITISH FIRM
 Fitted Leaders and Stop fails. All boxed and suitable for 2 or 4 track recorders at any speed.

Our guarantee is in writing with all orders (it has never ever been requested)

	Size	Length	P.V.C.	Polytray
STANDARD PLAY ...	3"	250'	2/6	2/3
	5"	600'	9/-	8/-
	5 1/2"	900'	11/6	10/-
	7"	1200'	16/-	12/-
LONG PLAY ...	3"	225'	3/-	2/9
	4"	450'	6/-	5/6
	5"	900'	11/6	10/-
	5 1/2"	1200'	16/-	12/-
DOUBLE PLAY ...	7"	1800'	23/-	15/6
	3"	400'	6/-	5/-
	4"	600'	8/6	8/-
	5"	1200'	21/-	14/6
EMPTY SPOOLS ...	5 1/2"	1800'	24/-	19/-
	7"	2400'	39/-	24/-
	3" 9d	5" 2/-	5 1/2" 2/3	7" 2/6

Post and Packing 1/- per spool, 4 or more post free.
 The above tapes are only available at these prices from:
N. Walker, 29 Linkscroft Ave., Ashford, Middx. Tel: Ashford 53020

TAPE RECORDER SERVICE CONTINUED

Watch out for the brake arm (BS in fig. 1 of July, 1964) which is actuated by a rod that runs just beneath the step of G. Fouling at the latter point can give some queer effects. Clearance of the brake arm, as with the 101, is more than half a millimetre from the cam with the machine at STOP.

The speed change assembly is drawn in an "oblique" projection in fig. 1. Apologies are due for this method of lumping so many different methods of presentation in a single sketch, but it is quite explanatory when viewed against the machine, whereas a series of jottings, besides earning the displeasure of the Art Department at Link House, would require a good deal of extra explanation. The action again depends on the spring, pivoted arm, and the drive is from the motor pulley via the drive pulley shown cut away to the flywheel. The fork arm is pivoted at L and actuates the curved riser on which the idler bracket rides. Note the small spring joining the tip of the fork arm and the riser.

The engagement of the idler is ensured by the motion of the transverse rod in the slot of the main cam and the hole of the fork arm. This looks a very loose arrangement, but works surprisingly well. It should be noted, however, that the action is, so to speak, in reverse, the rod pushing off the pivoted arm, and again, spring pressure makes the final movement and should be checked when wow is evident. Erratic spring tension is, in fact, as likely as the more often suspected deformed idler. Again, as with the take-up idler, the position of the idler relative to the motor pulley should be checked. Before making drastic alterations to brackets, see that the motor pulley itself has not settled downwards, and place it correctly, making sure the set screw is tight.

Azimuth adjustment on this machine is quite simple, with a two-screw fixing of the head mounting. The right-hand screw is used for final adjustment. Correct procedure on this, as on other machines in the Sony range, is to connect a loading resistor of about 8 ohms to the external loudspeaker jack, with a valve-voltmeter in parallel, and to replay a 7 Kc/s test tape at $7\frac{1}{2}$ i/s. But as many of us are not immediately able to lay our hands on an appropriate test tape, much less a valve-voltmeter, we can resort to the empirical method of adjusting while listening to a known good passage.

The tape shifter system used on many of the Sony machines follows the style of fig. 2. Hinged plates with torsion springs are mounted on the head-plate. The pressure pads are fixed to the hinged section, which is kept in position with the torsion of the spring when the machine is in the PLAY (OR FORWARD, on some machines) position. Neutralising the controls brings the pressure roller bar or lever back and the tape pin or shifter connected near the outer end of the pressure lever holds off the hinged plates. This gives plenty of clearance when in neutral, but the only adjustment of pressure is the mounting of the plates. The mounting hole of the pressure pin may be slotted, but this is only to allow adjustment for clearance when in the PLAY position, not any form of pressure adjustment. Variations on this style include a single pad plate, with a differently shaped tape shifter.

Model 362B is similar in many respects, from the servicing point of view. The adjustments are the same, and the mechanism follows the design of fig. 1. But this is a more comprehensive machine, and has several points worth noting.

The three-speed selection is a combination of the mechanical system outlined above, and electrical switching. For $7\frac{1}{2}$ i/s, the larger, lower part of the motor pulley is engaged; for $3\frac{3}{4}$ i/s, the smaller, upper part of the pulley, and the same for $1\frac{7}{8}$ i/s, except that the motor windings are switched to bring about the reduced revolutions. This is a double-pole type.

One question that is sometimes asked is the suitability of Continental or other foreign-made tape recorders for this country. There are very few, nowadays, that do not have the facility of frequency change to suit the local mains supply. Voltage change is comprehensive on most machines; but it should be remembered that frequency change requires not only the setting of the motor circuit, as will be described, but nearly always demands that the capstan and perhaps the pinch roller should be altered to suit the slight difference in speed.

On the 362B, the frequency change switch will be found just to the right of the take-up spool. This simply adds $0.7\mu\text{F}$ to the $1.8\mu\text{F}$ split-phase capacitor when 50 c/s is selected. Using the machine with the wrong frequency setting not only gives an incorrect tape speed, but

(continued overleaf)

YOUR TAPE DEALER

London

Disc and Tape Reproducing Equipment and Tape Recorders
by Leading Manufacturers

Custom Built Installations

All High Fidelity Requirements and Services Available

Estimates Free

Personal Service

Custom High Fidelity

371 Green Lanes, Palmers Green, N.13 PALmers Green 5228

hifi

FOR ALL LEADING AUDIO EQUIPMENT

call, write, or telephone

hampstead HIGH-FIDELITY

91a Heath Street, Hampstead, London N.W.3 Telephone HAMPstead 6377

LASKY'S RADIO

ALL LEADING MAKES IN STOCK

Cash or Easy Terms

LONDON'S FINEST SERVICE

207 EDGWARE ROAD, W.2

PAD 3271/2

152-153 FLEET STREET, E.C.4. FLE 2833

33 TOTTENHAM COURT ROAD, W.1. MUS 2605

★ PART EXCHANGES WELCOMED ★

- ★ ALL MAKES Hi-Fi and Tape Recorders supplied
- ★ PART EXCHANGES. Terms 12, 18 or 24 months
- ★ SONY Specialists. Full Range Stocked
- ★ GUARANTEED Recorder Repair Service

MAC'S CAMERA SHOPS LIMITED

250-252 KING STREET, HAMMERSMITH, LONDON, W.6
RIV 8581-2 Hours 9-6 Thursday 9-1

SHEEN TAPE RECORDER CENTRE

SPECIALISTS IN TAPE RECORDERS, ACCESSORIES, HI-FI EQUIPMENT
YOUR CENTRE FOR FRIENDLY HELP—SALES AND SERVICE

8 STATION PARADE
SHEEN LANE, SHEEN,
LONDON, S.W.14

Showrooms Open until 7 p.m.
PROSPECT 0985
(Opposite Mortlake Station S.R.)

WIMBLEDON'S TAPE RECORDER CENTRE

Agents for: FERROGRAPH, VORTEXION, SIMON,
BRENELL, GRUNDIG, PHILIPS, COSSOR, ETC.

GET IT TAPED THE EXPERT WAY—By letting us install your apparatus

TEL-LEE-RADIO

LI Berty 4946

220 The Broadway, WIMBLEDON, S.W.19

Cheshire

STOCKPORT

FAIRBOTHAM & CO. LTD.

47 LOWER HILLGATE STO 4872
FERROGRAPH, REVOX, TANDBERG, BRENELL,
SIMON, TRUVOX, SONY, PHILIPS, MAGNAVOX,
GRUNDIG, TELEFUNKEN

All models on comparison demonstration
Evening demonstrations by appointment

Devon

PLYMOUTH

TOM MOLLAND LTD.

102 CORNWALL STREET

Phone 69282

FERROGRAPH, REVOX, TANDBERG, SIEMENS, AKAI, UHER, SONY,
B & O STEREO MASTER, FI-CORD, AND

The largest selection of Hi-Fi equipment in the West

— YOUR TAPE DEALER —

Gloucestershire

CHELTENHAM

MODERN RADIO (Cheltenham) LTD.

Service and Hi-Fi Dept. 40/42, St. James Street
Ferrograph, Revox, Telefunken and Truvox always in stock
 TELEFUNKEN appointed Service Agent
 Phone : Cheltenham 21216/7

Hampshire

BOURNEMOUTH

NATIONAL RADIO SUPPLIES

66 Holdenhurst Road
 Bournemouth

Tape, Hi-Fi & components

Tel. 25232

HAMILTON ELECTRONICS

**HIGH FIDELITY AND
 TAPE RECORDER
 SPECIALISTS**

35 LONDON ROAD

TEL. 28622

SOUTHAMPTON

Lancashire

H. D. KIRK

Stereolectrics
LIMITED

Specialists in High Fidelity
 150 HIGHER BRIDGE STREET

Phone: 23093

BOLTON

**MANCHESTER
 LANCASHIRE HI-FI LIMITED**

and now incorporating
 The Tape Recorder Specialists
 DIXONS ELECTRONIC (Sales and Service)
 8 DEANS GATE (NEXT TO GROSVENOR HOTEL)

Leicestershire

LEICESTER

ALL YOUR HI FI REQUIREMENTS

Speakers by : H.M.V. QUAD LEAK ROGERS
 TANNAY MORDAUNT LOWTHER W.B.

Tape : FERROGRAPH GOODMANS
 SIMON BRENELL REFLECTOGRAPH GRUNDIG

Record Department : ALL LABELS-PARASTAT SERVICE
 LEICESTER CO-OPERATIVE SOCIETY LIMITED, High Street, Leicester. Tel. 20431

Northamptonshire

PETERBOROUGH, NORTHANTS

Tel : 5643/5644

CAMPKINS RECORD SHOP

RECORD TAPE AND HI-FI EQUIPMENT SPECIALISTS

NEW ADDRESS **15 LONG CAUSEWAY**
 (IN CITY CENTRE)

LARGE STOCKS

Oxon

WESTWOOD'S of **OXFORD**
 46 GEORGE STREET
 PHONE: 47783

TAPE RECORDER SERVICE CONTINUED

prevents the motor from performing at maximum efficiency. It should not be used for attempted speed alteration.

The 362B uses a transistorised pre-amplifier stage ; a 2SD64 is used as input and 2SD65 as second stage amplifier, driving the main valve amplifier, which consists of 6BM8 triode-pentode, a separate 6AR5 oscillator (at 48 Kc/s), a 6ME5 record level indicator, with a 6CA4 mains rectifier.

Other points worth noting are the push-push on-off switch, which can give trouble if the rocker mechanism fouls up ; the monitor switch, which cuts out the internal speaker, switching the amplifier to the earphone jack, when the switch is ON—a tricky one that usually catches someone at least once, as the Grundig loudspeaker pull-on muting switches did—and a 5-pin DIN socket for auxiliary RECORD/PLAYBACK, using external amplifiers. On earlier models, a playback speaker switch was fitted near this socket, for muting the internal loudspeaker. This was later replaced with the line-out jack. The input selector switches, to the right of the sloping control panel are also the push-push type, using the conventional slide tag switch, with angled vertical arms and a latch-plate. The important thing to note if the switches do not lock or release correctly is that the whole assembly mounts on a sub-plate, and the positioning of this relative to the main deck should be checked before the switch levers are monkeyed with.

our readers write . . .

. . . about extension speakers

From : H. Leeming, Holdings of Blackburn Ltd., 39-41 Mincing Lane, Blackburn, Lancs.

DEAR SIR, May I be allowed to make a point which your contributor Mr. King omitted to mention in his article on using extension speakers (June issue).

A designer of speakers for use with hi-fi equipment does not worry unduly about their sensitivity as he can usually take it for granted that they will be used with an amplifier of at least 8W output. This is far from being the case with the average recorder, however, whose power output is seldom above 2W (whatever the makers may claim) and several top quality hi-fi speakers are definitely unsuitable for use with domestic tape recorders, as they just won't make enough noise.

If a speaker is being purchased for use with a tape recorder it is advisable to hear the results when it is fed from a low power amplifier. There are in fact several speakers that are suitable for use with top quality equipment, the *Lowther Acousta* being a particularly good example.

Yours faithfully,

. . . about half ounce tapes and an 8mm film

From : J. W. Barrow, Managing Director, MSS Recording Co. Ltd., Poyle Trading Estate, Colnbrook, Slough, Bucks.

DEAR SIR, Mr. Finlayson's interesting article on *Half-Ounce Tapes* in your April issue reflects the growing demand for lightweight tapes for correspondence purposes. Although we cannot offer a half-ounce tape at the moment, your readers may like to know that this company does market a *Mini-Voice Letter* weighing just under one ounce which can be sent anywhere for 3s. or less according to the appropriate postal rates. In this form it includes the strong covering envelope and a spare envelope which can be enclosed for the return message, both envelopes being supplied free. The retail carton adds another half-ounce, but this can be discarded without risking damage to the tape. The *Mini-Voice Letter* costs 2s. 8d. and plays for five minutes on each track at 3 $\frac{3}{4}$ i/s.

I have also noted your appreciative comments in the May issues of *Tape Recorder* and *Hi-Fi News* about our film *Journey into Tape*, which some of your readers may have seen at the recent Audio Fair. This film can now be borrowed free of charge by tape clubs and other interested organisations on application. It gives a factual description of the processes and machinery involved in making *Mastertape* and illustrates some of the lesser-known techniques in close detail. The film lasts about ten minutes and needs an 8mm. magnetic sound projector.

Yours faithfully,

CLASSIFIED ADVERTISEMENTS

Advertisements for this section must be pre-paid. The rate is 6d. per word (private), minimum 7s. 6d. Box Nos. 1s. 6d. extra; trade rates 9d. per word, minimum 12s. Box Nos. 2s. extra. Copy and remittance for advertisements in **OCTOBER 1964** issue must reach these offices by **5TH SEPTEMBER** addressed to: The Advertisement Manager, Tape Recorder, Link House, Dingwall Avenue, Croydon, Surrey.

Replies to Box Nos. should be addressed to the Advertisement Manager, Tape Recorder, Link House, Dingwall Avenue, Croydon, Surrey, and the box no. quoted on the outside of the envelope. The district after box no. indicates its locality.

FOR SALE

Stereo tape recorder (Sony 521) as, with stereo headphones (E-102). Also LP tapes, £75, complete. **Demonstration**: MARYland 2324.

Klemt Echolette for sale, ideal for group or singer, about to turn professional. Price £55 or near offer. Phone MARYland 2324.

Ferrograph 808—1960 model—£60 o.n.o. Ferrograph 424A—1962 model—£80 o.n.o. Both as new. Private sale. Box No. 371 (Middx.).

Revox E36 2-track stereo. £65, one owner, excellent condition. Hinds, Little Wethers, Sandy Lane, Northwood, Middx.

TRADE

Pre-recorded tapes. Unique complete catalogue listing all makes, mono, stereo, 7½ and 3¾ i/s including World Record Club tapes. Call for free copy or send 1s. mailing fee. Dept. T.R.3, Teletape Ltd., 33 Edgware Road, W.2. Phone: PAD 1942.

A Unique Buy! Recording tape, top brand, 5½in. 1200ft. 19s. 6d.. 7in. 2400ft. D.P. 28s. 6d. P. and P. 1s. 6d. per spool. Bargains in all sizes. S.A.E. for list. E. C. Kingsley & Co., 132 Tottenham Court Road, London, W.1. Phone: EUSton 6500.

Speedy and Expert Tape Recorder and Hi-Fi repairs by England's leading Hi-Fi Specialists. Telesonic Ltd., 92 Tottenham Court Road, London, W.1. MUS 8177.

If quality matters consult Sound News Audio Supply for better terms. 60 page photographically illustrated Hi-Fi catalogue 4s. 6d. Part exchange, servicing. Your precious tapes transferred to unbreakable L-Ps by specialists. Specify requirements. 10 Clifford Street, London, W.1.

Something Slipping? . . . try Vita-Drive, an excellent rubber drive cleaner that definitely prevents slipping of Pinch Wheels, Intermediate Drives and Belts used in Tape Recorders and Record Changers. Used by Service Organizations throughout the world. Ask your Dealer for it or write us. A product of Friend's Mfg. Co., 614 Arch Street, Philadelphia, PA., U.S.A. 19106.

Sound Effects—Castle 45 r.p.m. discs, 8s. each or on tape 18s. 6d. each including postage and packing. Titles include: mixed effects, trains, animals, military parades, electronic music, bells and sirens, haunted house, etc. Send 3d. stamp for lists. Recorded Tuition Limited, 174 Maybank Road, South Woodford, London, E.18.

Learn while you sleep. Details of tapes, subjects and equipment from The Sleep-Learning Association, 14 Belsize Crescent, N.W.3.

continued on page 338



VENNER
14 DAY
CLOCKWORK
TIME SWITCHES

29/6 P & P 2/6

KINGSWOOD SUPPLIES (T.R.18), 4 Sale Place, London, W.2. PAD 8189

AUTOMATIC CONTROL over radio and/or tape recorder. Will switch ON/OFF or OFF/ON once every 24 hours at any manually pre-set time. Minimum time lapse 30 minutes. It has a current rating of 1 amp sufficient to carry radio and/or tape recorder. Complete with key and mounting bracket. Used but in perfect condition. Fully guaranteed. Also 5 amp model available 35/- pp 2/6

YOUR TAPE DEALER

Staffordshire

Audio Electronics (Midlands) Ltd.

Specialists in Dictation Mcs., Tape Recorders, Inter Com., Tapes and Accessories

Full After Sales Service on all Equipment

PHILIPS, GRUNDIG, TRUVOX, UHER, ETC.

203 STAFFORD STREET, WALSALL

Tel.: 21086

Surrey

FARNHAM, SURREY

The finest selection of Tape Recorders, Hi-Fi Equipment and quality Radiograms in the Provinces is awaiting you at:—

LLOYD & KEYWORTH LTD

26-27 Downing Street, Farnham, Surrey. Telephone: 5534

Comparative Demonstrations, Large stock of Cabinets and Pre-Recorded Tapes.

CROYDON'S TAPE RECORDER CENTRE

All leading makes in stock, Hi-Fi equipment, cabinets, etc. Service agents for AKAI Tape Recorders

SPALDING ELECTRICAL LTD.,

352/354, Lower Addiscombe Road, CROYDON

ADDIscombe 1231/2040

Sussex

WORTHING, SUSSEX

Stocking Ferrograph, Revox, Sony, Tandberg, Truvox, Philips, EMI, Luxor, etc., on fully comparative Demonstrations

BOWERS & WILKINS LTD.

1 Becket Bldgs., Littlehampton Road, Worthing 5142

NEW PREMISES
NEW PREMISES
NEW PREMISES 132 montague street
telephone 25855

CRAY

CRAY OF WORTHING LTD

Warwickshire

COVENTRY & DISTRICT CO-OPERATIVE SOCIETY LTD.

HIGH FIDELITY SOUND EQUIPMENT TASTEFULLY DISPLAYED FOR YOUR "BROWSE AROUND" ENJOYMENT

All leading makes: Amplifiers, Control Equipment, Loud-speakers, Cabinets, Tuners, Microphones, Tape Recorders and Ancillary items in stock or quickly obtainable.

Coventry & District Co-operative Society Ltd., High Fidelity Sound Section, Electrical Dept., First Floor, Central Premises, Corporation Street, Coventry. Tel. Coventry 24031-10 lines

BIRMINGHAM

Tel. HIG 4182/CAS 3546

COLIN G. TURNER, M.I.P.R.E.

SALES AND SERVICE

Comparison demonstrations daily. Truvox, Brenell, Sony, Grundig, Cossor, Luxor, Tandberg, etc. Also Hi-fi by Quad, Leak, Trio, HMV, Rogers, ADC, KEF, Braun and others.

39 YORK ROAD · KINGS HEATH · BIRMINGHAM

Mail Order

Export

Personal

Wiltshire

SOUTHERN ENGLAND

HI-FI AND RECORD CENTRES

J. F. SUTTON

SALISBURY
18 QUEENS STREET

SOUTHAMPTON
421 SHIRLEY ROAD

CLASSIFIED ADVERTISEMENTS

TRADE—continued

Pre-Sleep Study. Learn difficult lessons or parts or improve your mental powers while you sleep! Send now for price list of materials: including the perfect tape machine, time switch, pillow speaker, endless tape cassettes, pre-recorded tapes for learning or therapy, language courses, etc. Psychology Tapes Ltd., (TR) 16 Kings College Road, London, N.W.3. (PRI 3314).

Lafayette Tape Cheaper! Polyester Base 7" 2,400ft. 22/6; 5 3/4" 1,800ft. 19/6; 5" 1,200ft. 13/6; 7" 1,800ft. 18/6; 5" 900ft. 10/6; 7" 1,200ft. 11/6; 7" 1,800ft. (Acetate) 14/6 p. & p. 1/6. Refund guarantee, s.a.e. list. Leda Tapes, 12 Montague Road, London, E.11.

WANTED

Lee Electronics. The Tape Recorder and Hi-Fi Specialists wish to purchase good quality Tape and Hi-Fi Equipment for cash. 400 Edgware Road, W.2. Phone: PADdington 5521.

Highest cash prices offered for good quality Tape Recorders and Hi-Fi. See our ad. page 332 this issue. R.E.W., 266 Upper Tooting Road, London, S.W.17.

Wanted, for cash, unused recording tapes and pre-recorded tapes, good quality only, any quantity, large or small, shop stocks, etc. "The Record Exchange", 46 South Clerk Street, Edinburgh. We also buy record players, transistor radios, tape recorders.

TAPE EXCHANGES

Tapesponding is fun. The Australian Tape Recordists Association puts you in contact with enthusiasts all over the world. For details write: Hon. Sec. P.O. Box 67, Eastwood, N.S.W., Australia.

Join the World Round Robin Club. For details write J. Page, 45 Elgin Avenue, Belmont, Harrow, Middlesex.

STUDIO FACILITIES

Tape to Disc service, editing, and dubbing, all speeds. Studio available for musical groups. Outside recordings our speciality. Ilford Sound Recording Service, 63 Aintree Crescent, Barkingside, Ilford, Essex. Phone: CRE 8947 and GRA 5107. S.A.E. for list.

Rapid Recording Service, 78s and L.Ps. from your own tapes. (48-hour service.) Master Discs and pressings. Recording studio. Mobile recording van. Manufacturers of the Sleep-o-Matic Unit. Foreign language courses available for sleep-learning. Brochures and price lists on request from: Dept. T.R.21, Bishops Close, London, E.17.

Tape to Disc Recordings. Finest professional quality, 10in. L.P. 42s. (32 min.), 12in. L.P. 48s. (45 min.), 7in. E.P. 21s. 48-hour Postal Service. S.A.E. for leaflet to: Deroy Sound Service, 52 Hest Bank Lane, Hest Bank, Lancaster.

— TAPE TO DISC SERVICES —

The following are members of the Association of Professional Recording Studios who can be relied on to give satisfaction

MJB RECORDING & TRANSCRIPTION SERVICE

specialise in the production of microgroove records from Professional and Amateur recordings (Acetate copies; Mono and Stereo pressings). Extended playing times achieved by controlled cutting techniques. Studio, Mobile, "Off the Air" and all recording services. Detailed booklet available.

7 HIGH STREET, MAIDENHEAD (Tel: 25630)

TAPE RECORDERS - AUDIO EQUIPMENT - DISC CUTTING STD & LP FROM TAPE - STUDIO FACILITIES - HIRE SERVICE - SALES - EXCHANGES

MAGNEGRAPH

1 Hanway Place, London, W.1.

Tel.: LAN 2156

— YOUR TAPE DEALER —

Yorkshire

SHEFFIELD HIGH FIDELITY

HI-FI EQUIPMENT AND TAPE RECORDERS

FULL DEMONSTRATION FACILITIES
SPECIALIST REPAIR SERVICE
ALL LEADING MAKES STOCKED

Tel. 20588 10 WEST STREET, SHEFFIELD, 1

TAPE RECORDER CENTRE (HALIFAX)

Stock all the best Tape Recorders; Hi-Fi Equipment; Tape; L-P Records, etc.

DEMONSTRATIONS DAILY BY EXPERT STAFF
2 years FREE SERVICE ON NEW RECORDERS over £35

30 King Cross Street, Halifax. 'phone 66832

Scotland

Edinburgh's TAPE RECORDER specialist

Hi-Fi Corner

Ferrograph—Grundig—Telefunken—Philips, etc.
W. G. Graham, Assoc. Brit. I.R.E.

1 Haddington Place,
EDINBURGH.

Tape to Disc Recording Service

Phone WAV 7901

Agent for The Famous Heathkits.

ADVERTISERS' INDEX

	Page
A.K.G.	322
Agfa Ltd.	310
Braddock, C., Ltd.	334
B.A.S.F. Chemicals Ltd.	340
Brenell Engineering Co. Ltd.	326
Brown, A., & Sons Ltd.	328
City & Essex Tape Recorder Centres	299
Cossor Radio & T.V. Ltd.	306
De Villiers (Electronic World) Ltd.	334
Do it yourself Exhibition	301
Educational Recordings Ltd.	334
Ever Ready (G.B.) Ltd.	316
Francis of Streatham	324
Grampian Reproducers Ltd.	334
Heathkit (Daystrom Ltd.)	305
Highgate Acoustics	339
Hitachi Ltd.	320
Howard Tape Recorders	326
Kingswood Supplies	337
Morhan Exporting Corporation	330
Multicore Solders Ltd.	328
M.S.S. Recording Co. Ltd.	304
Philips Electrical Ltd.	300, 308
Reps (Tape Recorders) Ltd.	328
R. E. W. (Earlsfield) Ltd.	332
Tandberg (Elstone Electronics Ltd.)	322
The World Record Club Ltd.	302, 303
W.A.L. (Elstone Electronics Ltd.)	324
Walker, N.	334
Ultra Radio & T.V. Ltd.	314
Zonal Film (Magnetic Coatings) Ltd.	298



LOEWE OPTA

Hi-Fi Tape Recorders

FOR PERFECTION IN SOUND

OPTACORD 414

With the first-ever high frequency motor ensuring long life and constant speeds. Unsurpassed for a portable tape recorder. Single speed $3\frac{3}{4}$ ips. Twin Track. For use on mains, batteries and car batteries.

47 GNS.

OPTACORD 414 DIA

As the OPTACORD 414, with built-in Synchronisation with Automatic Slide Projector.

57 GNS.

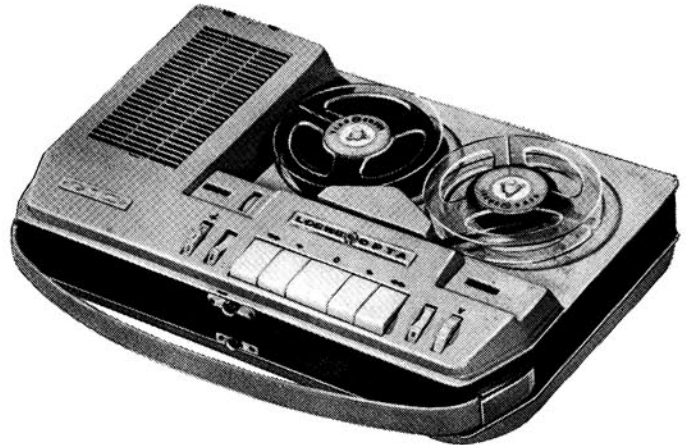

**THREE-IN-ONE
MAINS — BATTERIES — CAR BATTERIES**

HIGHGATE ACOUSTICS

Telephone: MUSEum 2901/5

71/73 GT. PORTLAND STREET, LONDON, W.1

Approved Loewe-Opta Stockists

Alexanders, Holburn St., Aberdeen.	Bristol & Cardiff Tape Recorder Centres.	Gilbert Pianos Ltd., 37 Southchurch Road, South-end.	Joplings Ltd., John Street, Sunderland.	Piercy's, 63 Lupus Street, S.W.1.	G. H. Steel, 141 St. Georges Road, Glasgow.
J. J. Allen Ltd., The Quadrant, Bournemouth.	A. Brown & Son Ltd., 24/28 George Street, Hull.	Grimes Ltd., King Street, Wigan, Lancs.	Kendal Milne & Co., Deansgate, Manchester 3.	Rackhams Ltd., Corporation Street, Birmingham 2.	Tape Recorder Centre, 82 High Holborn, W.C.1.
Arding & Hobbs Ltd., Clapham Junction, S.W.11.	Brown, Muff's BRADFORD 1	Guildhall Tape Recorders, 33 Guildhall Street, Folkestone.	John King (Films) Ltd., Film House, East Street, Brighton 1.	Recording Machines Ltd., 119 Victoria Street, S.W.1.	Tape Recorder Centre, 30 King Cross Street, Halifax.
Audiocraft, 20 Kettering Road, Northampton.	Camera Thorpe, 6/8 Osmaston Road, Derby.	J. E. Hargreaves Ltd., 1 Railway Road, Blackburn.	R. S. Kitchen Ltd., 22 King Edward Street, Leeds 1.	Tom Reekie Ltd., 10 Bridge Street, Stafford.	J. H. Tate & Co. Ltd., 45 Crowtree Road, Sunderland.
Barkers Ltd., 31 Oxford Road, Worthing.	Campkins Audio, 21 Market Street, Cambridge.	Harveys, High Street, Guildford, Surrey.	Lancashire Hi-Fi Ltd., Tape Centre, 8 Deansgate, Manchester 3.	REW Earlsfield, 266 Upper Tooting Road, S.W.17.	Tele-Sales & Service Ltd., 9 Alexandria Drive, St. Annes, Lancs.
Barretts of Canterbury.	Chelsea Record Centre, 203 Kings Road, S.W.3.	Hamilton Electronics, 35 London Rd., Southampton.	Leech & Haig Ltd., 112 London Road, Oxford.	Ryland Huntley, 15 Old Bond Street, Bath.	Teletape, 33 Edgware Road, W.2.
Battys (Rhyl) Ltd., Rhyl (Tel. 2621).	Chiesmans Ltd., Lewisham, S.E.23.	J. Harris, 231 Baker St., N.W.1.	Massey's, 121/3 High Rd., Chiswick, W.4.	Selfridges Ltd., Oxford Street, W.1.	The Recorder Co., 188 West End Lane, N.W.6.
Wilf Plant, Asfordby, Melton Mowbray, Leics.	City & Essex Tape Recorder Centres, 228 Bishopsgate, E.C.2.	House & Son Ltd., Blake Street, York.	James McKenzie Ltd., Grange Road West, Birkenhead.	Sheen Tape Recorder Centre, 8 Station Parade, Sheen, S.W.14.	Turners Photographic Ltd., 9 The Walk, Ipswich.
Bon Marche, Northgate Street, Gloucester.	Courtney Davies, 12 Station Road, Harpenden.	Howard Tape Recorders, 218 High Street, Bromley, Kent.	Misons, Hi-Fi Specialist, Citadel Row, Carlisle.	Sheffield High Fidelity, 10 West Street, Sheffield 1.	Radio Maintenance (Leicester) Ltd., 111 Queens Road, Leicester.
Leonard Booth, 35 South Street, Eastbourne.	Croasdales (Nelson) Ltd., 41 and 58 Every Street, Nelson, Lancs.	R. H. O. Hills Ltd., Bank Hey Street, Blackpool.	Nicholsons Ltd., High St., Bromley, Kent.	J. Smith & Son, 184 The Rock, Bury, Lancs.	Lloyd & Keyworth, 26 Downing Street, Farnham.
Bourne Radio, 4 Albert Road, Bournemouth.	Dingles, Royal Parade, City Centre, Plymouth.	Imhofs Ltd., New Oxford Street, W.C.2.	Olympic Electronics, 40 Queensway, W.2.	Stanwood Radio Ltd. (All Branches).	Bristol-Hi-Fi, 28 Upper Maudling Street, Bristol.
	Francis of Streatham, 169 Streatham High Road, S.W.16.	Jones & Higgins, 1-41 Rye Lane, Peckham, S.E.15.	Paish & Co., 130 Union Street, Torquay.	Sport & Radio, 26/29 Aldwich Road, Bognor Regis.	J. W. Mansfield, 18 Liverpool Road, Worthing.

LOEWE OPTA



**PROTECT
STORE
TABULATE
YOUR
TAPES...**

**BUY THEM IN
BASF
LIBRARY BOXES,
AND USE THE
FREE
LIBRARY INDEX**

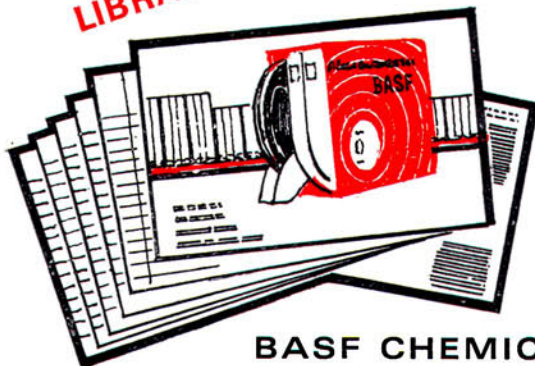

Buy your tapes in BASF Library Boxes. Made from hard wearing Polystyrol they hold the tapes in swivel open cassettes—keep them in perfect playing condition free from dust or damage. And you can use them for an easily worked reference library—just ask your dealer for the *Free* BASF Library Index.

BASF Single Tape Library Boxes for LONG PLAY tapes now cost:

5" 31/-, 5½" 38/6, 7" 55/-.

Also Three Tape Library Boxes containing:

Three 5" L.P. Tapes—84/-.
Three 5½" L.P. Tapes—105/-.
Three 7" L.P. Tapes—150/-.

New DOUBLE PLAY tape Library Boxes:

Single Tape 5" 45/-, 5½" 58/6, 7" 82/6.
Three Tapes 5" 126/-, 5½" 165/-,
7" 232/6.

SYMBOL OF AUTHENTIC SOUND—

BASF CHEMICALS LTD.

5a Gillespie Road, London, N.5. Telephone: CANonbury 2011

