

# the TAPE RECORDER

PRICE 1/6

JULY 1962  
Vol. 4 No. 6

INCORPORATING "SOUND AND CINE"



## IN THIS NUMBER

- Sound and Cine
- Equipment Reviewed
- Tape Recorder Service
- Details of New Products
- Making a Tape Calculator
- Tape Recorder Workbench
- An Auto Stop for the Collaro Deck
- The Calibration and Use of Test Tapes
- Our Readers Write
- News and Pictures from the Clubs

# 4 REASONS THAT MAKE THE **Garrard** TAPE SYSTEM SO SIMPLE



3

## 1 SIMPLE TO OPERATE

Anyone can operate the Garrard system. Controls have been simplified. There are three positions only—PLAY—RECORD—WIND.

## 2 MAGAZINE LOADING

No tape threading. No spilling. No anchoring of tape. Just place the magazine on the deck and it is ready to operate.

## 3 EASY STORAGE

The Magazine is the same size as an average book. It fits neatly on a bookshelf using the Library Storage Unit.

## 4 GARRARD TAPE POSITION INDICATOR

Gives precise and accurate indication of recordings on the tape.

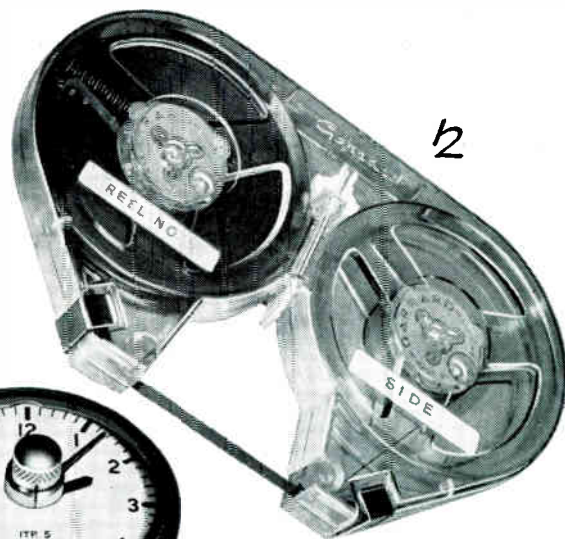

2



4

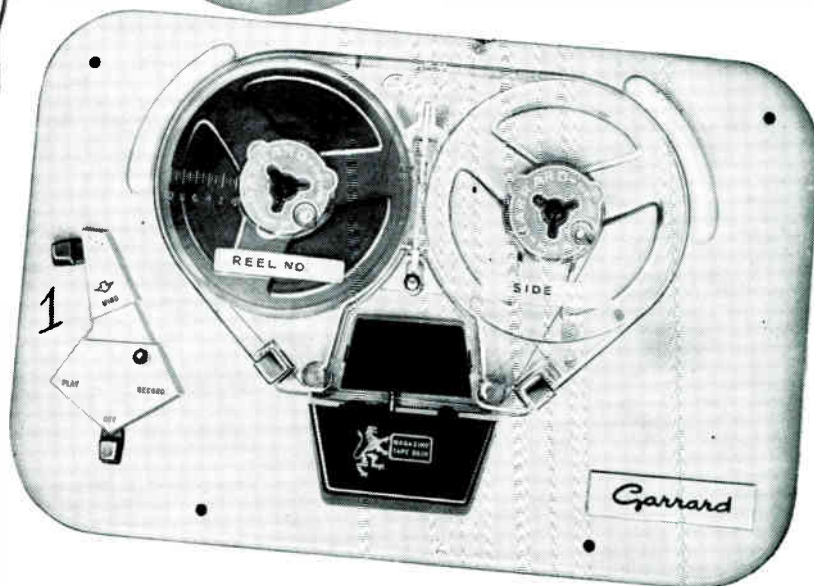

## CONTINUOUS-EASY TAPE RECORDING & PLAYBACK WITH THE GARRARD MAGAZINE METHOD

### MAGAZINE TAPE DECK ACCESSORIES

	£	s.	d.
Magazine containing 650 ft. Double Play Tape in container ...	1	13	4
Magazine only with one empty spool ... .. .		8	0
Reel of 650 ft. Double Play Tape ... .. .	1	4	0
Garrard Spool only ... .. .		3	3
Library Storage Magazine Container ... .. .		3	6
Tape Position Indicator ... .. .	1	19	6

**THE GARRARD ENGINEERING & MANUFACTURING CO. LTD.**

SWINDON WILTSHIRE



# 2 YEARS FREE SERVICING!!

REPS RIO

**C & ETRC + REPS =  
100% SATISFACTION**



REPS are the manufacturers of one of the finest hand built tape recorders in this country and they, like ourselves, are so confident of their outstanding REPS RIO that they issue a TWO YEARS FREE replacement component guarantee with every one sold. We are so confident that all the recorders we stock are the finest in their class that we issue a unique TWO YEARS FREE SERVICING GUARANTEE with every new recorder over £35. Therefore if you buy from C & ETRC you get two whole years absolutely free servicing coupled with two years free components. Why purchase elsewhere when you obtain these wonderful guarantees FREE! Call into any of our showrooms and see the fabulous Reps RIO together with the finest range of recorders on display in this country.

**SPECIFICATIONS**  
Frequency response 40—16000 c.p.s.  
Three speeds 1½, 3½, 7½ i.p.s.  
PRICE: 2-track 59 gns. 4-track 69 gns.

- ★ OVER 250 NEW & LOW-PRICED S/HAND RECORDERS ON DISPLAY ★
- ★ GENEROUS PART EXCHANGES ★ CASH & HP TERMS OVER 9-24 MTHS ★
- ★ HOME DEMONSTRATIONS ★ FREE DELIVERY ★ FREE PAMPHLETS etc ★

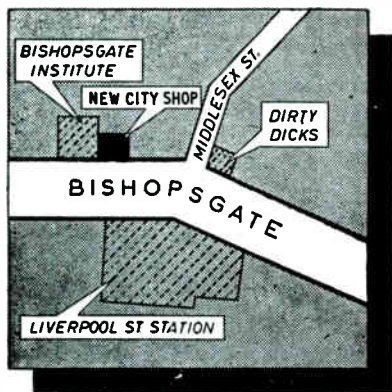

## SHOWROOMS

**CITY** 228 BISHOPSGATE, E.C.2 (Opposite Liverpool Street Station) BIS 2609  
Open Mon.-Fri. 9 a.m.-6 p.m. Closed Sat. Open Sun. 9 a.m.-2.30 p.m.

**STRATFORD** 2 MARYLAND STATION, E.15 (adj. Maryland Station)  
(E. Ham and Stratford open all day Saturday) MAR 5879

**EAST HAM** 205 HIGH ST. NTH., E.6 (opp. E. Ham Station) GRA 6543

# CITY & ESSEX TAPE RECORDER CENTRES

# THE SOUND OF **SONY**... A WONDERFUL SOUND



## The **SONY** 521 Stereophonic Tape Recorder

Here is brilliant engineering in sound. The Sony 521. Here is perfection in dimensional recording and reproduction. The Sony 521. Here are the many extras usually reserved for professional instruments—built-in amplifiers and speaker units, two and four track play-and-record features and trouble-free synchronous motor drive. The Sony 521. Here are sensitive level meters and split-second stop lever, assuring true fidelity, precise cueing and editing. The Sony 521.

- \*  $7\frac{1}{2}$  +  $3\frac{3}{4}$  tape speeds
- \* tape index indicator
- \* instant stereo/mono switch
- \* tone control
- \* automatic cut-off
- \* additional line outlet
- \* headphone monitor jack
- \* professional mixing

**124 gns.** including 2 dynamic microphones and all accessories

# SONY<sup>®</sup>

RESEARCH MAKES THE DIFFERENCE

Detailed specifications on the range of Sony tape recorders are available from the

Sole U.K. Distributors: **TELLUX LIMITED** 44 BRUNEL ROAD, ACTON, W.3. Tel: SHE 0331  
*A member of the K.G. (Holdings) Group of Companies*



# BIGGER THAN EVER

The image shows the cover of the 1962 **Hi-Fi YEAR BOOK** and a schematic diagram of a transistor amplifier circuit. The book cover features the title "Hi-Fi YEAR BOOK" at the top, with "1962" written below it. A central slogan reads "QUAD for the closest approach to the original sound". Below this, there are five circular icons representing different audio components: a speaker, a tuner, a microphone, a recorder, and a pickup. At the bottom of the cover, a list of contents includes "PICKUPS · MOTORS · TUNERS · SPEAKERS · AMPLIFIERS · MICROPHONES · RECORDERS". A price tag of "10/6" is visible in the bottom right corner of the book cover. The circuit diagram to the right shows a transistor in a common emitter configuration. It includes a base resistor, a base capacitor labeled "C1", an emitter resistor labeled "R5" connected to ground, and a collector load resistor. The output is taken from the collector through a coupling capacitor, labeled "OUTPUT". The circuit is powered by a "+9V" source.

## JUST PUBLISHED—COMPLETELY REWRITTEN

The 7th edition of this world renowned annual publication has been enlarged and now contains 272 pages and includes articles by leading authorities. The disc Stereo Picture and Microphones by Stanley Kelly; New Developments in Transister Amplifiers by George Tillet; Radio Tuners by Arthur Wayne; The Dynamic Decibel and Time on Tape by Graham Balmain. Loudspeakers for 1962-3 by Ralph West. Technical specifications are given of over 1000 items of Hi-Fi and Tape Equipment, and over 500 of these are photographically illustrated.

Available from your local bookseller, newsagent or direct from the publishers.

**MILES HENSLOW PUBLICATIONS LTD. 99 MORTIMER ST., LONDON, W.1**

**hifi**  
BOOKS

# CALL OFF THE SEARCH!

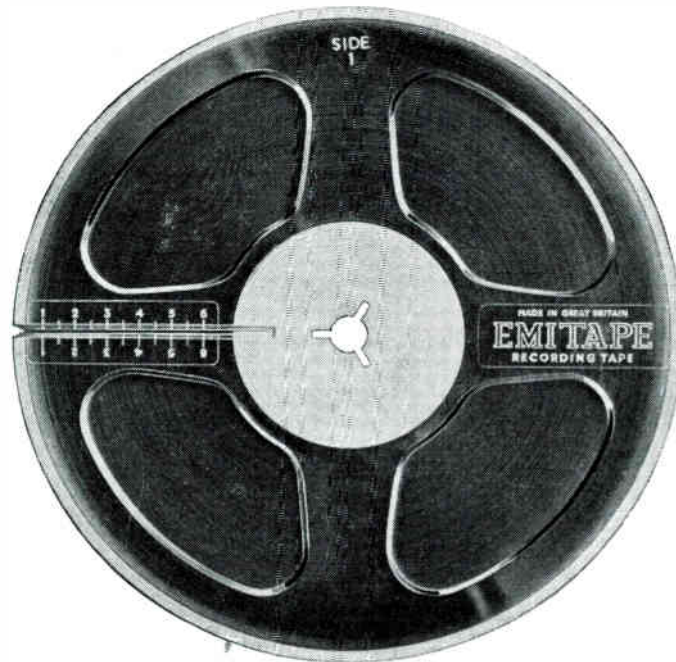

## Double-play Emitape 100 is now easy to get

Emitape 100 *was* hard to get. So many people wanted it. And this is the reason for the big demand. Emitape 100 gives twice the normal playing time, superb frequency response, minimum head wear—in fact, the best results for low-speed operation. The same research that produced Emitape for Video Recording (the most difficult tape of all to manufacture) also produced Emitape 100. Which means that Emitape 100

doesn't just make big claims. It keeps them.

Today, new production techniques are turning it out in even larger quantities. So although it's still wanted (more and more), the search can be called off. Emitape 100's everywhere—*now*.

**Emitape**

E.M.I. TAPE LIMITED · HAYES · MIDDLESEX · HAYES 3838

ET49



# the TAPE RECORDER

Editor ----- MILES HENSLOW  
 Advertising Editor ----- Julian Berrisford  
 News Editor ----- Alan Lovell  
 Editorial Offices --- 99 Mortimer Street, London, W.1  
 Telephone ----- MUSEum 3967 to 3969



## EDITORIAL



MEMBER OF THE  
 AUDIT BUREAU  
 OF CIRCULATIONS

STILL more Tape Records! Six new labels from the EMI catalogue are on the way—all for tape recorders and players which incorporate the  $3\frac{1}{2}$  i/s speed, and all on 5 in. reels, mono twin-track. This is the news that reached us a few days before this number of *The Tape Recorder* went to press and—once more—it is big news in the world of tape. It was in this column, just 11 months ago, that we announced the news of *World Record Club's* large-scale plans for mono tapes at  $3\frac{1}{2}$  i/s. And, almost simultaneously with this announcement, *Saga* stepped up production, bringing out some really first-class releases in the light music field. Only a few months later *W.R.C.* pulled another welcome rabbit from the hat, in the form of stereo tapes at  $7\frac{1}{2}$  i/s on seven-inch spools.

In the light of all this interest in tape records, we should not forget that it was EMI who pioneered the movement, in September 1954—eight years ago—with the first British mono tapes, and that they also followed this up a year later with the first stereo tapes (October 1955). This latter was a particularly brave venture, for at that time there were not more than a few dozen stereo tape recorders in amateur hands, and it is only today—seven years later—that these very fine tape catalogues are beginning to enjoy the public support that they deserve.

EMI announce the first of their regular monthly  $3\frac{1}{2}$  i/s releases to begin on the anniversary—in September of this year; but a special release, described as “a prelude”, will be made on June 18th—which means that the new tapes should be available by the time this magazine is on sale. The tapes, will be marketed by *EMI Records Limited*, and will be on *HMV*, *Columbia*, *Capitol*, *Parlaphone*, *MGM* and *Liberty* labels. All will be sold at 35s. per tape, except those on the *Capitol* label, which will be priced at 35s. and 38s. The artists included in the first release will be The Temperance Seven, Frank Sinatra, Shirley Bassey, Adam Faith, Cliff Richard, and Mr. Acker Bilk. There will also be film sound track music from *Gigi*, *The King and I*, and *The Young Ones*, and show music from *The Sound of Music* and *The Black and White Minstrels*. In all there will be 18 tapes in this curtain-raising release, which should have a wide appeal to the hundreds of thousands of tape recorder users with a preference for light music.

Dealers who have specialised in the tape field inform us that the demand for tape records is now beginning to reach an important size, and that it has been increasing steadily for over a year. There is no doubt that this new EMI venture will create a great stimulus, and that within a few years the combined tape catalogues will hold a choice of material for all users and all tastes of music. Furthermore, with stereo surely establishing itself, it is not unreasonable to assume that this choice will be

## CONTENTS

	Page
How Others Use Tape ... ..	237
Here and There and Everywhere ... ..	238
News and Pictures from the Clubs ... ..	240
Building Round the Harting Deck	
Part 1—Ways and Means	
By A. G. Watling ... ..	243
The Campaign for Good Service ... ..	245
Sound and Cine	
Recording Musicians	
By R. Golding ... ..	246
Tape Recorder Workbench	
No. 36 A Relay Circuit for slide changing	
By A. Bartlett Still ... ..	249
Tape Recorder Service	
No. 7 Walter Tape Recorders	
By H. W. Hellyer ... ..	250
An Auto-Stop for the “Studio” Deck	
By C. G. Webb ... ..	253
A Tape Calculator	
By H. J. Allsopp and E. G. Cobb ... ..	255
Our Readers Write ... ..	257
The Calibration and Use of Test Tapes (Part 5)	
By A. Tutchings ... ..	259
Details of New Products ... ..	261
Equipment Reviewed ... ..	262
Classified Advertisements ... ..	268
Advertisers' Index ... ..	270

extended to enlarge, or at least double up the range in some categories.

With things as they are—with the greater portion of the tape recorder market represented by lower priced “domestic” instruments—and with the smaller remainder represented by good quality stereo and semi-professional mono machines—it seems to be a wise policy on the part of tape manufacturers to concentrate their energy on the present classification. By this we mean stereo at  $7\frac{1}{2}$  i/s, and light music (mono recorded) at  $3\frac{1}{2}$  i/s. The tape user who has the equipment to give him first-class quality will not be interested in the  $3\frac{1}{2}$  i/s speed: similarly, the user who looks for good, average quality entertainment from portable and semi-portable machines will not be interested in large spools and extra expense. These two standards seem to have been established on grounds of common sense and popular demand. We hope that they will settle down this way on a firm, uncomplicated basis.

## COVER PICTURE

THIS month's front cover photograph shows a Telefunken tape recorder being used for speech training in Germany. The operator is seen controlling the recorder and monitoring.



## JULY NUMBER



Contents include:  
 A New High-Fidelity  
 amplifier

Making your own cabinets  
 Equipment Reviewed



NOW ON SALE

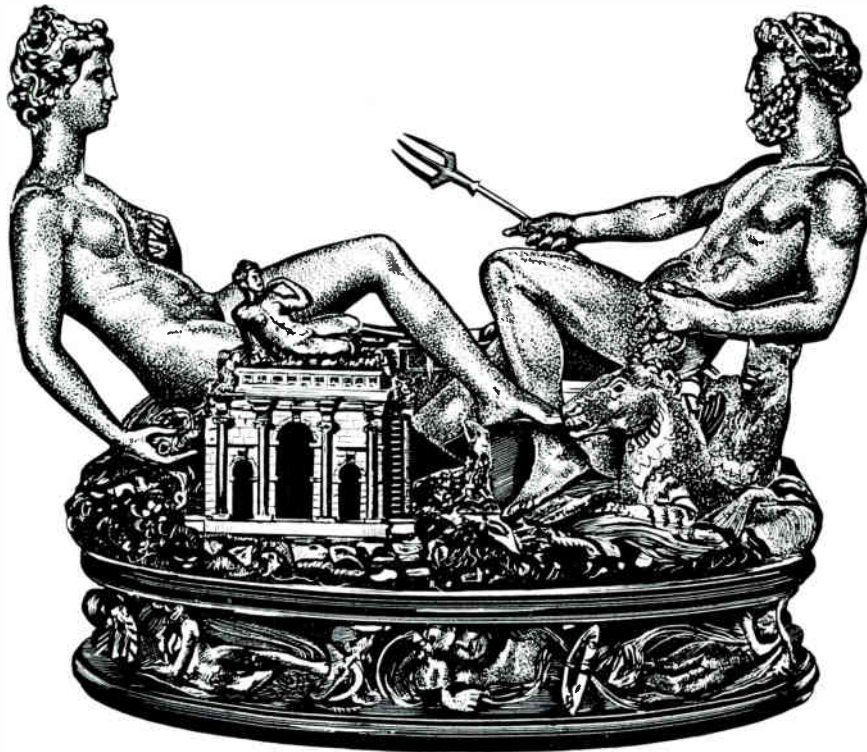

*as perfect as human skill can achieve*

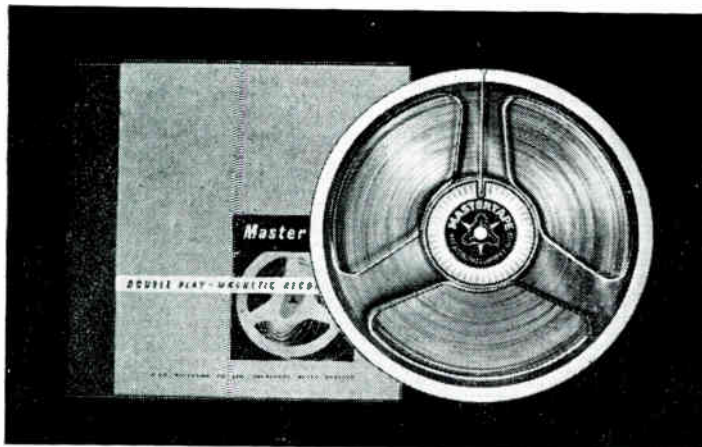

The almost incredible skill of his art was nearly equalled by the passion, intrigue and self assertion of Benvenuto Cellini's private life. It is certain that his genius created some of the finest gold and silver work of 16th Century Florence the world has ever seen. It has rarely been equalled and will almost certainly never be excelled.

The superb quality of Mastertape will delight the most discriminating lover of high-fidelity sound recording. For quality of reproduction, strength and brilliance, Mastertape is an appropriate complement to any tape recorder and is specially approved by Grundig (Gt. Britain) Ltd. for use on their machines.

Obtainable from your local dealer or, in case of difficulty write to the address below for your nearest stockist.

**British Mastertape Makes Sound Sense**

# ***Mastertape***

MSS RECORDING COMPANY LIMITED  
COLNBROOK, BUCKS. Tel.: Colnbrook 2431

*Send for free full colour brochure of useful hints and list of tape prices.*

A MEMBER OF THE **BICC** GROUP OF COMPANIES



# HOW OTHERS USE TAPE



MONO and stereo recordings of the same performance can be made simultaneously on a special type 17-channel audio mixing control console manufactured by E.M.I. Electronics Ltd., for Levy's Sound Studios of New Bond Street, London.

This latest development in mixing equipment includes console, rack-mounted units and special features designed by E.M.I. to meet Levy's particular requirements. It is being used for making the highest quality master recordings on magnetic tape for the production of gramophone records, commercials and feature programmes.

## Tape Service for the Blind

FOR a number of years, the tape recorder has been looked upon as a piece of luxury equipment, only to be seriously indulged by the hi-fi enthusiast with plenty of spare cash to spend on his hobby. It has also found its way into many houses in the guise of a temporarily essential instrument which will keep "junior" off the streets. After the first batch of rock and roll discs has been transferred to tape, and the resultant non-stop performance has driven mother up the wall, and father to the local, the novelty suddenly wears off, and a few guineas' worth of electronics ends up collecting dust.

Few people have given much serious thought to the wonderful possibilities inherent in the tape recorder insofar as the blind are concerned and, strangely enough, we hear few instances of the national and provincial organisations, concerned in the welfare of the blind, using this exceptional medium on a large scale. It remains for organisations, such as "Tape Programmes for the Blind", to do what it can to emphasise not only the desirability of the blind being in possession of a tape recorder, but the absolute necessity of it.

Particularly in the case of blind children does the writer of this article feel that the tape recorder must be given a more important place than it at present enjoys. Why should it be necessary in this modern age for children to go through the tedious process of learning braille as the only acceptable means of keeping in touch? It is not suggested that braille becomes obsolete, as there will obviously always be a place for it, but the spoken word is so much more natural, and the possibilities inherent in tape are so much more fascinating, that the recorder has become an "open sesame" to many blind people.

Modern machines are becoming much simpler to operate, and never let it be said as an argument against their use that blind people cannot cope—I have watched a blind man operate a tape recorder with greater dexterity than many a sighted person. I have also found that, with a carefully guided demonstration, most of the blind are soon happily operating their machines, and turning out some really worthwhile material. To get

children used to a tape recorder, therefore, will be to open the way to easier communication. (The exchanging of tapes is becoming more popular every day.) It will improve their diction, make them more self-confident, help them to learn by means of the educational tapes available such things as languages, and a host of other subjects. It will give them a new and exciting hobby—the opportunities of making live recordings are too numerous to mention, but here are but a few: bird song; animal sounds; thunder storms; traffic noises; railway engines and trains generally; fun fairs.

Think of a small 3-inch reel of tape containing the youthful description of his surroundings, coupled with appropriate sounds, being despatched to a counterpart in some other country, and the joy and interest of receiving the tape back, and listening to a similar description of, say Vancouver or New York or Rio de Janeiro. All this is possible, and is going on all the time with sighted enthusiasts, who find it much more interesting than writing a letter. How much more thrilling and fascinating for someone who finds it *impossible* to write one. Yes, there are braille letters, but how many sighted persons can read braille?

It is a well-known fact that some European countries are already wide awake to this necessity, and do, in fact, provide every blind person with some form of tape recorder, thus helping them to retain a sense of self-sufficiency in the community.

The R.N.I.B., we believe, are now turning to the provision of a play back tape machine for the purpose of listening to the "Talking Book", which is now being recorded on tape as well as, or instead of, on discs. However, the blind person cannot use this machine for recording purposes! Only for listening, and then only to the special tapes prepared for the equipment. The machine is either purchased or rented by the blind person.

"Tape Programmes for the Blind" is *very* concerned with this whole question, and as well as providing library tapes to the owners of tape recorders, the organisation is anxious to increase its funds in order to be able to provide machines, either on loan, or as a gift to a blind person, who can put this equipment to good use. It has, in fact, already begun to do this. Perhaps you, who are reading this article, may feel inclined to support this venture and, if so, the organisers will be very pleased indeed to hear from you.

M. Chambers

## Teletape Tape Library

TELETAPE have announced the formation of a Tape Record Library which will provide a hire service in respect of all pre-recorded tapes available in Great Britain. Every tape contained in the Teletape Catalogue, plus all mono and stereo World Record Club tapes, will be available to members. A rapid postal delivery will be operated.

An annual subscription will be payable upon joining the library and will amount to the retail price of the total number of tapes a member will require to loan at any one time.

Upon completing the membership form and paying the appropriate subscription, a member will be enrolled and issued with a membership number. The first selections which will be despatched by return.

Should a member decide that he wishes to purchase a tape he has hired, he may return the library copy with his remittance, less the transfer fee paid, and he will receive a factory-fresh copy post free together with another library copy of a different choice without transfer charge.

Further details from Teletape of Marble Arch, 33 Edgware Road, London, W.2.

## New Club

M. SUTTON, 5, Sandringham Avenue, Helsby, Warrington, Lancs., is interested in starting a tape recording club in the East Cheshire area. Anyone interested should contact Mr. Sutton at the above address.

# HERE AND THERE AND

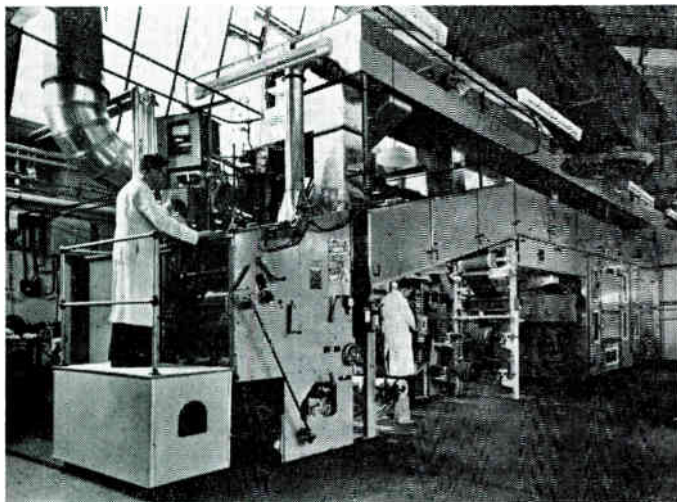

The recently installed tape spreading machine at the re-equipped Colnbrook, Slough, factory of the M.S.S. Recording Co. Ltd., a member of the British Insulated Callender's Cables Ltd. Group. Believed to be the fastest of its kind in Europe, the spreader has a maximum speed of 200 feet per minute and produces magnetic oxide-coated recording tape for audio-frequency recording in the professional entertainment, commercial and domestic fields, as well as for scientific and industrial applications.

## A.P.R.S. Assist Private Recording Studios

THE Association of Professional Recording Studios Ltd., is the representative organisation of the private recording industry in Great Britain. Membership is confined to bona fide professional recording studios and a few manufacturers of recording and ancillary equipment.

There are new businesses with limited experience and others involved in recording, not qualified to become members, who feel the need for some connection with the association. This need has recently been recognised by instituting associateship. Anyone having an interest in or concerned with recording may now apply to join as an associate. Enquiries should be made to the General Secretary, 34a Arterberry Road, London, S.W.20.

## Large Orders for Elizabethan

FOLLOWING the recent visit to the United States of Elizabethan's Mr. Lubin and Mr. Thomas, orders in excess of \$500,000—with possibly even larger orders to come—were secured at the Chicago World Fair.

Equally pleasing to Elizabethan is the fact that this company's products are able to compete favourably with the products of both the largest and the longest established manufacturers of tape recorders throughout the world.

## E.M.I. Records Announce Music on Tape

REGULAR monthly releases of music on  $3\frac{1}{2}$  i/s tape are to be made by E.M.I. Records Limited from next September. As a prelude to the regular releases, E.M.I. are making a special issue—on June 15th—of 18 tapes under the H.M.V., Capitol, Columbia, Parlophone, M.G.M., and Liberty trademarks.

Artists featured in this initial issue include Shirley Bassey, Mr. Acker Bilk, Johnny Burnette, Adam Faith, Ella Fitzgerald, Connie Francis, Peggy Lee, Cliff Richard and The Shadows, Helen Shapiro, Frank Sinatra, The Temperance Seven and Bobby Vee.

There is film soundtrack from "The King and I," "Gigi" and "The

Young Ones," and music, too, from such popular shows as "The Sound of Music" and "The Black and White Minstrels." Said a spokesman of E.M.I. Records: "The repertoire has been very carefully selected from proved best-sellers on disc, and the original master tapes have been used to ensure that the reproduction from these tapes is of the highest possible standard. The tapes are not intended in any way to replace records. But there are now over one million tape recorders in this country, and with these releases we are providing an additional service in meeting the undoubted demand for music on tape."

Each tape costs 35s., with the exception of those issued under the Capitol trademark which are priced at both 35s. and 38s. The new releases are twin-track mono tapes at  $3\frac{1}{2}$  i/s, and each tape is contained on a five-inch spool in a strong cardboard pack illustrated with a miniature reproduction of the original L.P. cover.

E.M.I. pioneered music on tape in the U.K., issuing its first mono tapes at  $7\frac{1}{2}$  i/s, in September 1954. E.M.I.  $7\frac{1}{2}$  i/s stereo tapes were first issued in October 1955. Both types are still available, but this is E.M.I.'s first entry into the  $3\frac{1}{2}$  i/s market.

## Wyndor Colour Film

IN continuance of their regular policy Wyndor Recording Company have again included the cinema in their launching programme for a new model. Twentieth Century Publicity Films have produced for them a wide-screen colour film which has begun a year's run in cinemas to announce the Wyndor "International".

A new innovation is that this film is also being shown at News Theatres at London main line terminals as well as at the News Theatre in Piccadilly Circus, London. By this means a travelling audience is informed as well as regular local cinema-goers.

## Leicester Co-op. Audio Festival

MR. WILLMAN and his colleagues of the Leicester Co-operative Society Ltd., deserve congratulations on their recent Audio Festival and Fair held at the Leicester Co-operative Hall.

To gather together some 30 manufacturers so soon after the London Audio Festival indicates a well thought out plan and initiative on the part of those concerned. Most of the manufacturers were represented either by display or display units and a good number were personally represented at part or all of the show.

The evening demonstrations were well attended and over 100 people were able to sit in comfort and listen to various pieces

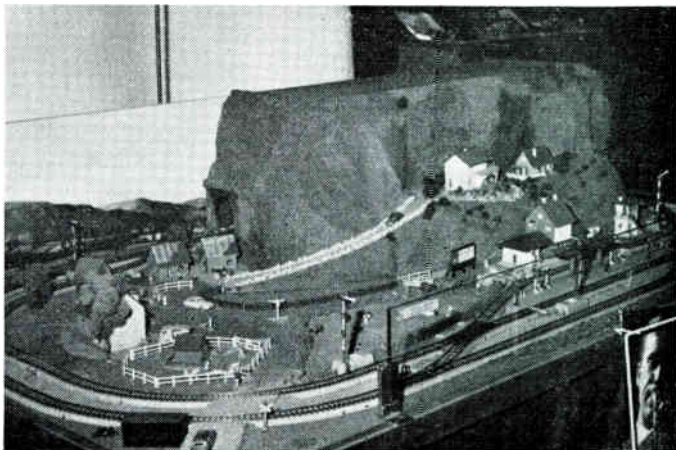

A model railway operated by impulses recorded on magnetic tape was featured by BASF Ltd. at the Leicester Audio Festival.



# EVERYWHERE

of equipment. The demonstrations included the Tandberg stereo recorder by Mr. Dakin of A. C. Farnell Ltd., Lowther speakers and amplifiers by Mr. Donald Chave, Tannoy speakers, amplifiers and stereo cartridges by Mr. J. Bunt of Tannoy Ltd., and EMI (Emisonic) Equipment by Mr. Nicholls of Clarke and Smith Ltd. The new full range Woollett speaker was also given an airing by Mr. Woollett on the last two days.

The show which lasted for four days attracted over 4,000 tape and Hi-Fi enthusiasts.

## Recording Enthusiasts Required

**D**ERBY Hospital Tape Service require technical enthusiasts willing to assist in church service recording. The equipment used is Ampex 970 stereo recorders, Tandberg Series 6 and ribbon microphones. Anyone interested in this work should contact T. Allen, 45 Cadgwith Drive, Darley Abbey, Derby.

## BBC Order Philips Recorders

**A**FTER extensive field trials the BBC has placed an order for Philips professional tape recorders, model EL3566.

Several machines were initially requested for trial purposes. After five months' intensive operations BBC engineers expressed their satisfaction with the machine and have placed an order for a total of 90 machines. Four of the early machines are at present being used in the current affairs and news studio used for the sound programmes, "Radio Newsreel" and "Ten o'Clock".

The machine is a two-speed (15 and  $7\frac{1}{2}$  i/s) recorder available in polished wood carrying case or suitable for rack mounting. The machines used in the current affairs studio are mounted into a specially constructed table with the amplifier units end on behind the tape deck, giving a compact working area for the studio engineer. The present machines are full-track monaural operation but twin-track stereo models will be available later this year. The deck design incorporates three motors and the



amplifier unit has a VU meter for recording/playback levels. The fast wind speed is variable by means of a 6-position control. European, NAB or Cine spools can be accommodated.

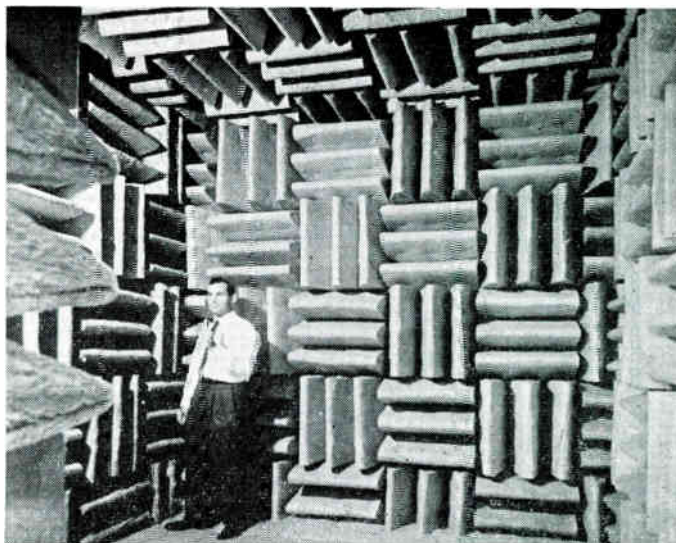

*The latest in sound-proof chambers for testing precision microphones recently installed by Shure Brothers Incorporated in the new extension to their factory in Evanston, Illinois. Lined throughout with sound-absorbing spun-glass wedges the room is carried independently on a cushion of air to isolate it from any structural vibrations in the building itself.*

## New Recording Studio in Scotland

**S**COTTISH singers and musicians will be able to carry out recording sessions with the latest E.M.I. equipment at the new Waverley Record studios of George Jeffrey, Ltd., in Edinburgh next summer.

This company—the only major recording organisation in Scotland—has placed a contract worth £5,600 with E.M.I. Electronics, Ltd., for a ten-channel mono/stereophonic mixing console and a TR90 stereophonic tape recorder.

The mixing console will be used for making both monophonic and stereophonic master tapes from which records can be cut on a disc cutting lathe.

Recording will be by means of the E.M.I. Stereosonic sum and difference technique or by the spaced microphone method, and the console will be able to control the mixing of inputs from up to eight microphones. The latest E.M.I. transistor-operated amplifiers and ancillary units will be incorporated.

George Jeffrey, Ltd., has previously taken delivery of three other E.M.I. tape recorders—a TR52 which is both stereo and transportable, a TR51 mono and transportable, and an RE321 which will be used whenever it is necessary for recordings to be made outside the studio. This latter type of tape recorder is used extensively for on-the-spot sound and television news reporting by the BBC and other broadcasting organisations.

★  
NEW  
B.S.R.  
BATTERY  
TAPE  
DECK  
★



**W**E recently had the opportunity of seeing a prototype of a new battery tape deck manufactured by B.S.R., who claim to be the largest manufacturers of tape decks in the world. This deck no doubt will be used in future battery portable machines from many British tape recorder producers. The deck itself uses two speeds,  $3\frac{3}{4}$  and  $1\frac{1}{2}$  i/s, and will take a 4 in. spool. The deck can be supplied with a mains operated motor, if required.

# NEWS AND PICTURES FROM



Four members of the Northampton Tape and Cine Club examine some early models of the phonograph. This club claims to have the largest membership in the country.

**DURING** one month the Cornwall Tape Club have recorded a stage play for converting to a radio play, a concert for Hospital recording by Probus Male Voice Choir, a Pop Talent Contest at the City Hall, judged by Alan Freeman. Tape of the winning group—the Staggerlees of Redruth—was used in the I.T.V. news item.

Next came the audition tape for the Staggerlees to send to Philips and the same day a visit to Trewithen House and gardens and recording of the outdoor service there. These tapes have now been edited and fed into local Hospitals and Old People's Homes by Mrs. Whittaker.

During May, recording of Truro Towns Women's Guild Choir is booked, an outing to Goonhilly Downs G.P.O. Satellite radio station, a Civil Defence Regional Exercise and a start on a Sound Dictionary of Cornish Birds.

Also during this month microphone practice is being arranged for all members using their tape recorders, club microphones and boom and the services of a singer, violinist and pianist in a School Hall. Further details from J. Burgess, Old Church Cottage, Mount Hawke, Truro.

**DURING** the coming months the Stoke Newington Amateur Tape Recording Club members will be having demonstrations of the Grundig Stereo T.K.60 and the Elizabethan Major 2-track recorder.

Many hours are spent weekly providing programmes to local hospitals and the blind association and new members are urgently required to assist in this work. Any interested readers should contact E. Horne, 53 Londesborough Road, London, N.16.

**ON** May 2nd at the Watford meeting, Mrs. Brammer gave a lecture on speech training to members of the West Herts Tape Recording Society. She gave examples of good and bad speech and played recordings to illustrate.

Only a few members turned up for Sound Hunt on Sunday, May 6th, but a very enjoyable afternoon was spent capturing the sounds as listed once again by John Grainger. A drive around Watford provided the location for train sounds, footsteps in

tunnels and telephone conversations, all of which were heard during tea at John and Jean Grainger's home. George Richardson produced the better recording on his TK1, whilst the Minivox team produced the more humorous.

Further information can be obtained from P. Holloway, 29 Fishery Road, Hemel Hempstead.

**SINCE** the formation of the Middleton Tape Recording Club, earlier this year, membership has risen from the three founder members to the present total of twenty-seven.

Recent club activities include a trip to the Audio Fair by three members who returned with nearly all the leaflets and brochures that were available. They also obtained some exceptional sounds by using a Philips battery portable. A sample programme was prepared and replayed at the Oldham Blind Social Centre. This consisted of an edited version of the carnival parade and a play recorded and acted by the Hounslow Tape Recording Club, which was loaned to them for the occasion by their hon. member from London, Mr. G. Wells.

Club meetings are weekly on Thursday evenings at 7 p.m. and held at Tonge School, Oldham Road, Middleton. Details can be obtained from G. West, 187 Oldham Road, Middleton, Lancs.

**THE** first issue of a magazine by World Wide Tape Talk, is now available, but up to the present time, no name has been given to it by the Secretary. Members of the club are invited to send in any suggestions and it is hoped in the next issue to announce the winner. During the last 8 months, membership has risen to 300 and more are joining daily. Full details of this organisation can be obtained by contacting, C. Towers, 35 The Gardens, Harrow, Middlesex.

**MEMBERS** of the Howard Wall and Bethnal Green Tape Recording Society recently visited the Universal Programmes Corporation at Great Portland Street, W.1. There, under the able guidance of Mr. Allen Stagg, they were introduced to the marvels of professional magnetic recording, including the making of microgroove master L.P. discs, both mono and stereo, with the latest equipment. Visits were made to their recording studios, and mixing and dubbing rooms.

On May 18th, the club held a demonstration night at Bethnal Green Town Hall where members of the public were invited. To an attendance of about 100, the chairman, L. Burchell, welcomed the guests and outlined the work and policy of the society after which a stereo demonstration was given by L. Hastings with his Ferrograph Model 422. The visitors were then invited to inspect the machines and equipment and club members answered questions.

Further details available from R. J. Gentle, 24 Hyde Road, London, N.1.

**CARLISLE'S** new Tape Recording Club, formed in November, is to help the city's school teachers at their job. The 20-strong club will give lectures to Carlisle school teachers about the techniques of tape recording.

Secretary Mr. J. E. Francis said recently: "Carlisle's musical director, Mr. Wells asked us to do this because the teachers are a little 'frightened' of tape recorders." Most of the city's schools are supplied with tape machines but the trouble is that the teachers don't know much about them and are afraid something dreadful may happen half way through a lesson.

The club meets every Friday for 1½ hours, the youngest member is 18, the oldest is a sprightly 64. Details available from J. Bateman, 47 Waldegrave Road, Longsowerby, Carlisle.



# THE CLUBS

**M**EEETINGS during May included an "At Home" evening when members of the Cambridge Amateur Tape Recording Society played hosts to 12 members of the Northampton Tape and Cine Club. After a late start, Richard Hillman gave a talk entitled "Portable Tape Recorders—at Work and Play". This was followed by "Town and Gown" when Len Brown spoke about the different gowns used in the Colleges at Cambridge and other universities.

During the second half of the programme, the visitors showed a very interesting Tape/Slide Show and J. Arthur Smith's amusing production "All in a Day's Work". This was the first "At Home" in which the club have participated, and the secretary would be pleased to hear from other clubs interested in exchange visits. Further details from *M. Renshaw, 6 St. Vincent's Close, Girton, Cambridge.*

**O**N Friday evening—6th April, three members of the "Sound-Hunters" (Peter Wainright, Stephen Gaunt and Michael Storey) visited the Clevethorpe old-folks home in Wakefield to entertain them through the medium of the tape recorder. A pre-recorded programme was played of selected old-time records, voices of the past and Wakefield sounds, followed by an impromptu interview of some of the old folks present. It is hoped that this get-together for the old people at Clevethorpe will become a regular event.

The home is run for ladies only and they proved to be a very entertaining group themselves. Much enjoyment for all was had in the play-back of recitations given by the ladies. They also recorded their requests for various recordings by such people as Gracie Fields, Turner Layton and Ken Dodd and even the voices of Sir Winston Churchill and Baden Powell. The "Sound-hunters" will return in three weeks armed with a request programme.

Further information can be obtained from *M. A. Storey, 331 Horbury Road, Wakefield, Yorks.*

**D**ESPITE the high price of tape recorders in New Zealand (almost 100 per cent. increase on UK prices) considerable success has been achieved in promoting this wonderful hobby. Membership increased during the year from 140 to over 270 members here in New Zealand and overseas.

Six branches of the New Zealand Tape Recording Club have been established in the main centres of New Zealand, and meetings are held on a monthly basis.

Some highlights of the past year were: 1, The first Tape Recording Club Conference held in Levin, with delegates attending from all parts of New Zealand. 2, The first commercially-produced "Directory and Manual". 3, The production of a regular national newsletter—"The Tape-Echo", in addition members continue to produce a sound magazine on tape called "Tape Digest". Other services available to members are: 1, Technical Advisory Service. 2, Library service with a very comprehensive range of recordings and books available. 3, Friendship Section—who not only welcome new members, but give valuable instruction on producing tapes for exchange. The club also has a special Overseas Section to look after the requirements of their overseas members.

The New Zealand club would be pleased to hear from other tape recording organisations overseas. Details should be sent to the Secretary, *Ken Tuxford, P.O. Box 7060, Auckland W1, New Zealand.*

**I**T was the turn of the younger generation to show their paces at a recent meeting of the Whitstable and District Tape Recording Club and schoolboy members Michael Glover (14) and Peter Robinson (12) kept their elders well entertained with their presentation of the third episode of the members' participation



*Here's a tape from one of your friends—with a P.S. A picture cartoon by Dentler.*

thriller serial. Varied accents, sound effects, and touches of typical schoolboy humour all found their way on to the tape.

After several good laughs, the action of the play found its way to the tricky point when it was time to leave it to the next member to continue. Thus it falls to the lot of one of the lady members, Mrs. Reeves, to take it from there.

Further details can be obtained from *T. Robinson, 17a St. Annes Road, Whitstable.*

**T**HE Rugby Amateur Tape Recording Society held its annual Convention Night on Thursday May 24th, in the large upstairs lounge of the Red Lion Hotel, Rugby. This was with the kind consent of Mr. and Mrs. S. Haskins who also provided an excellent buffet at the request of the committee for this "special" event.

Mr. J. O. Bannister (President) opened the meeting with a speech that pointed out the importance of tape recording in the world today, and of how tape recorded reports were used between the world and the latest American in Outer Space; and what a valuable means of communication it was. He hoped that next year it would be possible to have a One-day Convention in the form of an audio fair for the benefit of everyone.

Secretary, M. Brown followed with a report of the year's work by the club members and told of the recordings that had been made in the town amongst which one was that of the presentation to Dr. Charles Reginald Hoskyn of the Honorary Freedom of the Borough. Pleasure was expressed at the presence of their blind member, Mr. Jack Willis, after his serious illness and hopes for his continued steady progress. Mr. A. Lovett gave out the club announcements after which Mr. T. Davis showed a short film made at a previous meeting. This was the second showing for some members but gave an excellent opportunity to those that had missed it first time.

Each club attending had been requested to name a spokesman to give a short account of his or her club's activities. Mr. Foster, secretary of Northampton Tape and Cine Club was first to tell of the activities of his club; followed by Mr. N. Littlewood—chairman for Nottingham Co-operative Amateur Tape Recording Society; Mr. Warden spoke for Coventry Tape Recording Club; Mr. Joy for Warwick and Leamington Spa Amateur Tape Recording Society; Mr. Longmore for Coventry Audio and Cine Club; Mr. Davison for Birmingham Tape Recording and Audio Club and Mr. Gilbert for South Birmingham Tape Club. Representatives from the Press also attended. Telegrams were received from York and Cambridge Clubs regretting that they were unable to attend.

The evening passed all too quickly. Mr. G. Dawson and Mr. T. Davis were in charge of the buffet; Mr. J. Campden recorded the activities on the club's machine, whilst Mr. W. Tilcock used his machine for synch. with Mr. Davis' projector. Details of future activities can be obtained from *M. Brown, 219 Clifton Road, Rugby.*

# IT'S NOT THE ONLY HOBBY YOU KNOW—OR DO YOU?



Any 8mm. enthusiast will tell you, tape recording is highly complimentary to cinematography. Don't say we said so, but 8mm. cine can also be usefully employed to supplement tape recording. Sound and sight are rarely separable and regular reference to 8mm. Magazine and the Tape Recorder will keep you up to date in both fields.

Don't take our word for it and rush to spend anything from twelve to two hundred pounds on a camera. Take 8mm. Magazine home this month and see for yourself.

Make sure of your copy by ordering now

## 8mm. MAGAZINE

JULY ISSUE ON SALE  
FRIDAY, JUNE 29th

**G. M. SMITH  
PUBLISHING CO. LTD.**

MICRON HOUSE,  
GORRINGE PARK AVENUE,  
MITCHAM, SURREY



# BUILDING ROUND THE HARTING DECK

## (I) WAYS & MEANS

by  
A. G. WATLING

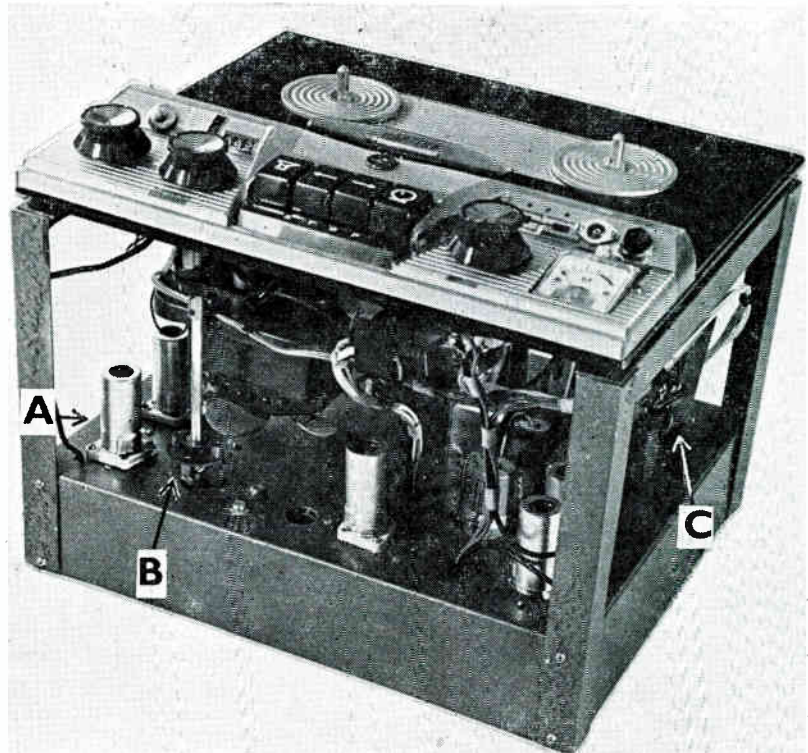

Fig. 2. The finished Recorder. The unit chassis construction is to fit an existing cabinet. A—playback; B—speed and equalisation switch; C—mains transformer.

THE Harting tap3-deck has been available fairly recently on the "surplus" market and, as a reputable deck with a reliable mechanism, it deserves consideration for a "do-it-yourself" recorder. To assist any of you who have considered it but have held back for lack of detailed information, I propose to explain the way I tackled the job, the facilities I obtained and the circuits which I adapted to work to the deck. The circuits are not, please note, necessarily the best way out of everybody's problems. They are not transistorised either—though there is no reason why the experimenter should not do this in the playback and record amplifier circuits. The main objective was to provide high-quality playback to feed an existing main amplifier system, and an equalised recording channel with two mixable inputs. Room was left to build in a 3-watt power amplifier at a later date if the equipment was to become self-contained.

### The Deck

Since the deck design influences the layout of the electronics, let us first consider the facilities it offers. There is a single motor, driving the capstan and flywheel through idler wheels which engage either for  $7\frac{1}{2}$  i/s or  $3\frac{1}{2}$  i/s. (The knob which controls these has an "off" position.) The final engagement of the selected idler is controlled by the "playback" or "record" push-buttons. The take-up and

rewind spools are driven by a double belt system—the first (main) belt is always running to drive an intermediate pulley and this is coupled to the required spool or spools by mechanical linkages from the four "function" push-buttons. These push-buttons are all purely mechanical with no electrical contacts at all. So very early in the design you will have to consider what switching you will require and how to link it with the deck.

There are three control knobs on the front of the deck (see fig. 1). From the left, a dual concentric control which can be used for a playback volume/tone potentiometer combination. Next the speed-change knob—its "off" position can be linked to a mains switch for the motor. Then the push-buttons, followed by another dual concentric control which can be "record" gain for two separate inputs (a mixer control). At the end is a plastic cover for a microphone compartment, which I have replaced by a Japanese meter. This, believe it or not, is a push fit in the space, and leaves room for a neon pilot to indicate when Oscillator H.T. (and therefore erase head) is on.

The "record" push-button is mechanically locked by a little trigger to discourage mistakes, and has a cast socket under it to enable it to operate a sliding plunger. This can usefully be a No. 10 knitting needle, the head of which will operate two Bulgin micro-switches (see circuit details) and they can be mounted on a home-made bracket under the front of the deck. You will find occasional tapped holes under the deck which are very useful for this sort of thing!

The heads are on a little platform, which can be adjusted for azimuth, and the pressure-pads are on a common sprung mounting operated by the playback or record buttons. (On my sample they were set too low, for no apparent reason, and had to be "bodged".)

Before doing any work, turn the deck upside down and take a good look at the way the belts run. In particular, examine the main drive belt from the motor to the back idler pulley and make sure there are no cracks in it. If there are, a five-shilling renewal from T.S.L. is well worth it, because changing the belt without removing the motor is impossible, and you will not bless the operation when the deck is wired-in. The correct replacement belt is essential, as its thickness is part of the rewind drive and also a factor in the total mechanical noise from the deck. The Harting deck has been criticised as noisy, but with the belts in good condition, the motor fixing grommets properly centred and the deck mechanically isolated from its supports, it is only just audible.

The deck can, of course, be conventionally mounted in a case with a multi-wire cable to the chassis. In this instance it was designed

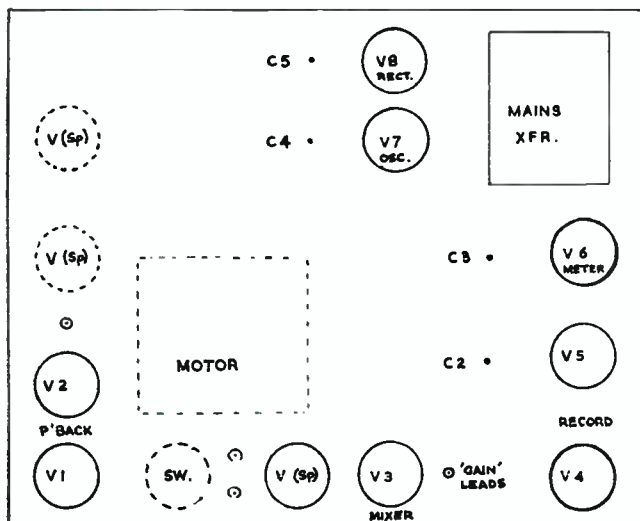

# U.S.A's 3rd LARGEST SELLER NOW ARRIVES IN BRITAIN!

## AKAI Terecorders

*for those who expect the earth in a world of sound*



### MODEL 69 'DE-LUXE'

**Wide Frequency Range:** Equipped with a record/play head which consists of specially treated core-materials being imported from West Germany.  
**Output Power:** 6 watt, can drive larger size extension speaker up to 12 in. Self contained speaker is 6½ in. in diameter.  
**7 in. Reel Capacity:** Accepts 3 in. and 5 in. reels as well.  
**Level meter:** with pilot lamp for easier determination of correct volume control setting when recording.  
**Index (Revolution) Counter.**  
**Instant Stop Control:** Spot editing and momentary stops are easily accomplished by use of the instant Stop Lever.  
**Monitoring and better reproduction:** Monitoring of your recording may be accomplished by plugging a crystal earphone into the recorder's Output Jack. Superb reproduction can be obtained by operating a large Hi-Fi speaker direct from the Output Jack. Also your existing power-amplifier that does not have a pre-amplifier of its own may be driven from the same Jack.  
**Head Output and three position Power Switch:** If desired, the tape transport mechanism (tape deck) of the recorder can be operated independently of the built-in amplifier and speaker. The Head Output Jack and the three-position Power Switch are provided to make this special function possible.  
 Retails at 79 GNS.

### HI-FI WIDE RANGE STEREO SPEAKER SYSTEM MODEL SS-50

Matched with the Model M-6 in styling and size, complete with connecting cables.  
**Speakers:** Two 8-inch mechanical 2-way (with built-in coaxial tweeter) speakers in a dividable carrying case.  
 Retails at 30 GNS.

### MODEL M6

Records and plays back either 4-track stereophonically or 4-track monophonically and also plays back 2-track prerecorded stereo tapes. Hysteresis Synchronous Motor always ensures constant tape speed. Designed for vertical or horizontal operation. Two inline and accurate VU-Meters reads recording and playback levels.  
 A precision index Counter. Recording/play head consists of specially treated core-materials which are being imported from West Germany. Maximum output power of the built-in amplifier is 6 watt on each channel (total 12 watt) which can drive up to 12 in. extension speaker system. Dual Head and Preamp Outlets are provided for connection direct to any other pre-amplifiers or stereophonic amplifier.  
**Instant Stop Lever.** All operating controls are interlocked.  
**Automatic stop device.**  
 The pinch wheel is always automatically released from capstan which protects it against a "spot" on the soft rubber surface causing uneven running.  
 Retails at 130 GNS.



Akai's new modern factory in Japan where the finest equipment is produced under the most up-to-date conditions.

Akai® is the most important contribution that has been made to first-class tape recording equipment for years. In a comparatively short time, they have established themselves in a leading position in the American Tape Recording Field.  
 Now they have come to Britain and one has only to examine them to see why they are going to prove serious competition to those European manufacturers, who have led the field for so long. You find this hard to believe? Then see the Akai Terecorders for yourself, contact your usual dealer or the sole importers.

\* Due to trade agreements Akai are sold under the name of Roberts in the U.S.A.

For descriptive literature and full information of the Akai Terecorders contact your usual dealer or **NORTHGATE (CAMERAS) LIMITED**, 119/125 Wardour Street, London, W.1  
 Tel.: GERrard 7030, 7038, 7939



as a complete drop-in unit for a friend's cabinet, and the chassis became an integral part of the recorder. This has the advantage that switches can all be on the chassis and lined up with shafts from the deck. This was only necessary in the equalisation circuits (to provide a direct relationship between speed and equalisation), but the principle is a useful one and eases interconnection problems.

The chassis is the same size as the deck (14½ × 12 in.) and is 3 in. deep. Strengthened by turned-over flanges and riveted corners, it supports the deck on two end arches made from ½ in. aluminium angle. Rubber grommets are set in the top angles and 2BA bolts pass through these to fasten the deck. At the rear there are two

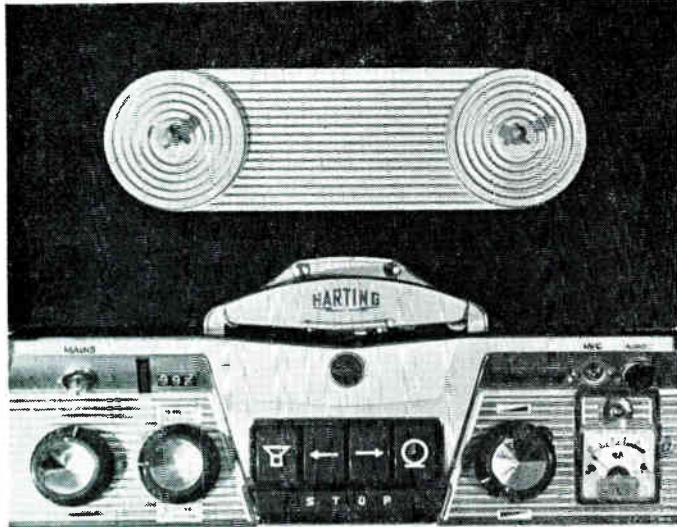

Fig. 1. Plan view of the modified Harting deck used by the author. The meter, input jacks and pilot lamps are additional items.

convenient tapped holes in the deck. At the front the bolts must pass downwards from under the plastic cover and have locknuts below the angle pieces.

From the pictures it will be seen that the motor and fan limit the shallowness of the recorder and also the amplifier layout of valve cans and capacitors. A recommended layout is shown in fig. 3.

#### Factors affecting Layout

- (1) The lead from the playback head must be as short as possible. This influences the position of the input end to the playback amplifier.
- (2) Power supply must be away from the head, and the mains transformer position adjustable for minimum hum pickup.
- (3) Microphone input and its valve must be near the input socket and able to be shielded from hum fields.
- (4) The equalisers (playback and record) should be lined up with the speed change assembly, so that the switch can be used to mount the equalising components. These in turn should be reasonably close to the valve circuits they serve.
- (5) The leads carrying "erase" and "bias" supplies must be carefully screened and routed away from high impedance grid or anode circuits. This is more important than usual for the bias supply because the record head is high impedance and a considerable oscillator output voltage is necessary to obtain the correct bias current. (This voltage can be picked up in the oddest places and can easily overload audio stages without anything being heard to account for wild voltmeter readings. When in doubt, remove the oscillator valve!)
- (6) Accessibility for maintenance. (7) Spacing for ventilation.

The last two are by no means least important. In considering the maintenance accessibility one must remember the need for test points—places where H.T. can be easily measured and sections of the circuit isolated for easy fault finding. Here is where the amateur builder can set his own standards, and equal professional equipment at little extra cost. Performance and facilities are one thing—the steady maintenance of them year after year is quite another. Ventilation affects all current carrying components to some extent and whatever safety factors you build in to the equipment will be altered when it has been running a couple of hours.

## THE CAMPAIGN FOR GOOD SERVICE

★ The campaign for Good Service, inaugurated by *The Tape Recorder* several months ago, has received favourable comment from various sections of the electronics industry. Our readers will be glad to know that the insistence on higher standards of engineering is bearing fruit. Responsible traders welcome it. In the following article, Andrew M. Green, F.I.S.M., M.I.O.M., puts a further point of view. He pays tribute to *The Tape Recorder* and stresses that Good Service is the foundation of modern electronics.

Mr. Green is the founder-member of the Institute of Service Management.

ALTHOUGH tape recorders started their life as industrial items of equipment, they have become as well known to the public as T.V. sets and record players. Mechanically and electrically, they are often more delicate and precise. It is for this reason that sincere congratulations are offered to *The Tape Recorder* for not merely taking an "armchair interest" but an active and constructive step to improve After Sales Service.

The Consumer Advisory Council of the British Standards Institution recently declared that servicemen in general cannot be trusted—and then to prove their statement, detailed instances where test cases had been carried out, resulting in four failures of six on a television service repair.

Group Captain Fennessy, C.B.E., managing director of Decca Radar, in a recent article stated, however, that to ensure success in servicing both at home and abroad. "After Sales Service starts in the Lab." Whichever way you look at it, the art and craftsmanship of efficient servicing is becoming more and more a subject in which the general public and industry are interested.

The Radio and Television Retailers' Association and the Radio Trades Examining Board are making efforts to improve their standards, but without the support of the retailing dealer and/or the manufacturers these attempts will be entirely wasted.

In January 1961 a new institute was formed—the Institute of Service Management. Note the stress on *management*, for it is the Service Manager who is responsible for the policy that can "kill or cure" the market for future sales. After all, efficient service means more sales. This institute, with a membership now nearing the 100 mark, is already arranging examinations with the City and Guilds Institute to create a standard of proficiency of service managers, and hopes in the not so distant future to organise training courses to assist or train the service engineer. Work on tape recording equipment will form an important part of this training. At present, the subject is almost totally neglected, except for one or two enterprising manufacturers who run courses on their own models for a selected few agents.

The present members of the Institute of Service Management consist of senior executives from practically every trade, retail and manufacturing. They have enjoyed numerous evening lectures appertaining to service problems. In March, this year, Caspar Brook (Director of the Consumer Association—publishers of *Which?*) stated at a London meeting of the I.S.M. that in his opinion retailers should be responsible for the efficient repairing and servicing of all the products they stock. This pushes the ball back to the retailer, but obviously dealers will have to rely on a "liberal policy of goodwill by the manufacturer" when guarantees are involved which, anyway, should cover "an unconditional period of between 6-12 months". This policy obviously calls for a very close liaison and understanding between both groups. Here again, the I.S.M. can help by bringing representatives of both sides together to enable mutual troubles to be ironed out. The owner of the equipment is the ultimate beneficiary.

H.R.H. the Duke of Edinburgh expressed interest and good wishes to the I.S.M. recently, but let us see more dealers and manufacturers not only becoming interested in improving their After Sales Service but taking active steps, like the present campaign in *The Tape Recorder* to implement these. Tape recording enthusiasts set themselves a high standard—the quality of articles in these pages bears ample proof—and they expect those high standards to be emulated by the engineers who may be called upon to service their precious equipment, and by the firms that manufacture it.

# Sound and Cine

## RECORDING MUSICIANS

by R. GOLDING

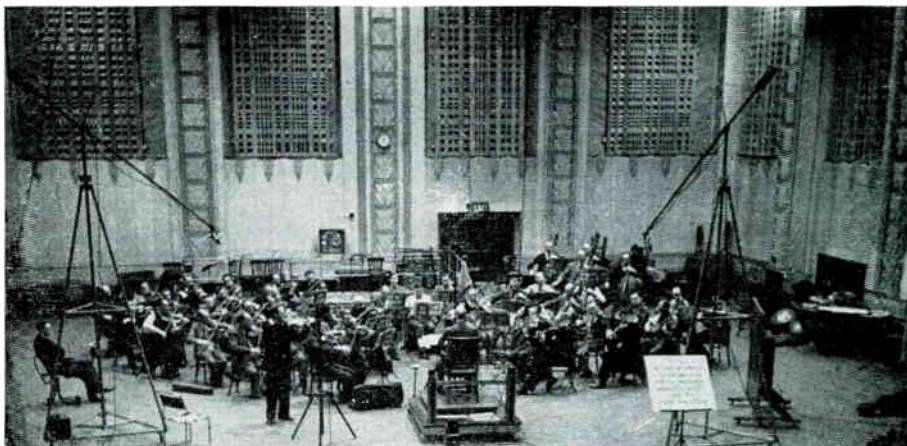

FOR an annual fee of one guinea members of the Institute of Amateur Cinematographers (U.K. and International office, 8 West Street, Epsom, Surrey, telephone: Epsom 2066) may now re-record certain non-copyright orchestral and choral music from the catalogues of most main gramophone companies, *provided that this is for private use*. For a public performance a licence must be obtained in addition, from Phonographic Performances Ltd., 356 Oxford Street, London, W.1. Dubbing fees for items not covered by this I.A.C. concession may be arranged through the Sound Film Music Division of the Mechanical Protection Society Ltd., 380 Streatham High Road, London, S.W.16.

The small trouble that one goes to in clearing music rights is worth it if the film acquires more balance through this last minute addition of a track; and if one is prepared to make a compromise by accepting what is available through the I.A.C. the costs need not be high. There are many among us, however, who maintain that no work with talent and originality in its scriptwriting, and with idealists as cast and crew, can be *complete* unless the track has been specially chosen or composed as an integral part of the whole film.

This makes sense to me to a certain extent for I should like to see this quality which is evident in the works of Antonioni and Resnais, where these directors are closely identified with all stages of the film, extended to our own live-action world a little more. Looking back at the hundreds of good amateur films I have seen in the past few years, only those animated cartoons of Stuart Wynn Jones and Derek Purslow have had this *completeness*. These are special cases, however, with the sound side relying on a hand-drawn or *Musique Concrète* sound track. The whole film is then the product of one man's mind and effort.

Where the production is in the least ambitious, and where a team is concerned, there are many difficulties to overcome in this respect, not the least being the time element. In a well run group or cine club this lack of time may be overcome by intelligent use of the officials, some of whom, incidentally, may be delighted to have something to do that has a direct connection with film making—namely, production management.

### Amateur Musicians

The production manager (and this is an essential post in any involved film) has many outlets in his search for an original sound track, for there are a great number of good amateur music societies and orchestras and many, many eager amateur composers to be had merely for the advertising. This is a fact that does not seem to be generally appreciated by the cinematographer, but it is very true. Just as for the amateur actor, to the keen amateur musician, the film means the permanent record of his many months spent rehearsing; and if the job is well done, there is the chance that his efforts may be appreciated by many more thousands than could have attended his one live concert.

One advertisement in a journal (such as the bi-monthly *Music in Education* or the monthly *Music and Musicians*) or even a direct approach to the Principal of the local evening institute, could bring immediate and satisfying results. In the London area

alone there are dozens of first-rate music groups with their own classrooms that may be used free of charge (if the production manager has the right approach) and adapted for a recording session. Where these classrooms are entirely unsuitable the school assembly hall itself may prove the answer during, say, a Saturday or Sunday when there is no other activity going on elsewhere in the school, and when the traffic outside is relatively quiet.

One London film group recently invited me along to a recording session in the main music room of a London College where the production manager and the recordist had amassed an impressive collection of borrowed equipment, and where the enthusiasm of the recording crew was matched only by the interest of the musicians in what was going to take place. The occasion was the recording of some nine minutes of music and choir sections, intended for mixing with an already recorded commentary track—the final composite recording to last about fifteen minutes. The conductor was familiar with the film theme, the composer had timed all her sequences to the split second, rehearsals had gone according to this timing, and the director was happy with a wild recording rather than a post-synched session with some form of interlock, preferring to adapt the cutting copy to the sound master print in the final editing stage.

### The Recording Session

The dimensions of the room were about 80 ft. long by 35 ft. wide by 15 ft. high and while the conductor expressed a desire for a higher ceiling, the director and recordist were quite satisfied with the quality obtained during rehearsals. These rehearsals with full recording equipment had enabled the recordist to carry out some damping operations, and had afforded him the opportunity to try out all his microphone positions.

### The Set-up

The diagram shows: (1) The far wall damped lightly with thin cotton curtaining along its entire length and about six inches away from the wall itself. (2) A stage with thick heavy curtains with an air space 25 ft. long by 12 ft. wide by 10 ft. high under the proscenium arch. During the choral sequences these curtains were kept closed both for balance and as a safeguard against accidental noise coming from the workshops back stage. (3) The rear wall of flat painted, white brick, containing two doors which opened on to a long narrow corridor. This wall was left uncovered according to the theory that damping areas in the immediate vicinity of the orchestra have a harmful effect on instruments such as the violin. (4) The end wall with three windows overlooking a quiet back street. These windows were blanketed, but not sufficiently to prevent one or two of the takes being ruined by slight, far-off car noise. (5) A raised and permanent bank of seats with padded backs and seats. On these were stacked various surplus chairs presenting a myriad of minor sound reflecting surfaces. (6) The choir, who were needed for only a few sequences, were situated so that the longer reverberation time from wall 3 would give their voices more dressing. (7) An *E.M.I. TR50* tape recorder running at 15 i/s. (8) A Lustraphone mixer with two *Simon*



Cadenza ribbon microphones plus the output stage of the *Vortexion* mixer was connected to the TR50. (9) A *Vortexion* mixer with one *Simon Cadenza* and two *Reslo* ribbon microphones.

All five microphones were on floor stands, and the two from the *Lustraphone* mixer were subject to change in position according to the sequence requirement. For instance, when the choir were not singing their microphone was moved down to a position between the viola and the cello section, and the woodwind microphone was moved to the left or right, to take away or to give prominence to the horns. The three *Vortexion* mixer microphones were moved slightly in or out according to the recordist's instructions.

The recording apparatus was in the most convenient place that could be found, as it was impossible to set up the equip-

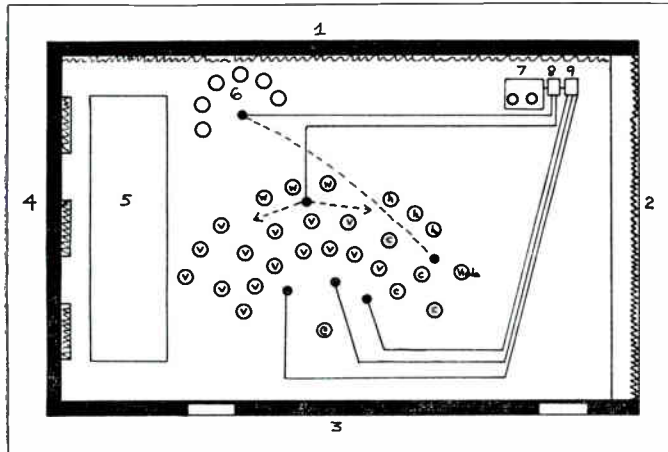

ment outside the room: but this allowed close contact between recordist and conductor and permitted the composer and director (armed with stopwatch) close control over all the proceedings.

The nine-minute track contained eleven sequences, some of which were under forty seconds, but as everyone wanted perfection and nothing less, and because some sequences needed as many as eight takes before they were right, the session lasted over three hours. Some very satisfactory takes resulted and, although the conductor, a successful recordist in his own right, would have preferred a higher room for a more mellow tone, and the use of his own single moving coil microphone positioned high and central in front of the orchestra, rather than these five ribbons, he was well pleased with the result.

Quite obviously, the methods used here would not apply in every case and for any sized room, but this session does give an indication of what a well-organised team can achieve. The most important part of the whole exercise is the facility for the recordist to be present at rehearsals with his equipment.

#### If You Think You're Busy . . . !

Herman Wuyts has just finished his first six months as a full-time T.V. film producer in Belgium (regular readers will remember my accounts of some of his fantastic amateur films—"Saga to a Red Rose," "Aether," "The Magic Ring," "Juke Box," etc., prior to his turning professional) and has recently spent a few days over here recuperating.

"The T.V. strip, 'The Little Man' (a live-action satirical series on everyday life in Belgium) is a nightmare with me," he says. "From last December until now I have made about 300 separate films of three minutes each one, editing and sound track included. You've no idea how popular the programme is. Everyone in Belgium knows the 'Little Man,' and the children adore him. There is even a fan club! I didn't realise it when the first pilot films were shot, but this programme has turned out to be my big chance in life. You should really see us in action—we never had so much fun. The only trouble is that sometimes the fun has to go on and on through the nights."

In between finding subjects and filming them for this series, Herman has found time to make a full length documentary for Schools'

Television and, having founded an independent company of his own, is also working on a 35-mm. Eastman-colour sound film on jazz. He plans to be his own distributor in Belgium at least.

#### Free Return Air Trip to South Africa

The East London Cine Club of South Africa is promoting its second International Amateur Film Festival from January 7-14th, 1963. The competition is open to all 8-mm. and 16-mm. workers living anywhere in the world. Films which have won an award in a previous competition may be entered and the entries may be B. & W. or colour and with or without sound. All amateur films are eligible.

The first prize will be a free return air trip by Sabena Airlines to South Africa. The winner will also have the opportunity to visit the world-famous Kruger National Park, and to film wild life in its natural state. Other prizes include the latest model Canon Zoom camera and all competitors will receive a genuine handmade African curio. Competitors will also receive a copy of the marking sheets as well as a tape recording of the senior judges' comments on their film.

There are four sections in each gauge: Fiction, Documentary, Travel and Unclassified, and for the purposes of the Festival the 8-mm. and 16-mm. films will be judged separately. Springbok trophies will be awarded to the winners of each section and the second and third in each section will be awarded silver and bronze plaques. The film judged best of the Festival, whether 8 mm. or 16 mm., will be awarded the free trip plus the valuable Sabena trophy which will be won outright.

All films will be returned airfreight at the expense of the Festival. There is no entry fee, all films will be insured against loss or damage while in Africa, and there should be no delay in the returning of films to the owners afterwards.

To help the organisers prepare the special souvenir brochure, competitors are asked to send as much information as possible about the making of the film together with photographs.

Further information and entry forms from: *The Secretary, Festival Committee, P.O. Box 399, East London, South Africa.*

It does sound from the above that this is to be an extremely well-organised competition and one worth patronising. If you were considering entering a film, I would advise an early air letter to the secretary as entry forms and films must be at the Festival by November 24th, 1962, and I know from experience how the time can slip by when preparing for a competition, especially if the film is not quite complete.

#### Pioneer Documentary Drama Film

Peter Davis, the live secretary-producer of Pioneer Films, tells me that he is now hard at it on the new production featuring drama activities in London Schools. The visuals are to be handled by Omega Film Unit of Eastcote with the Pioneer group in charge of all recording. Most of the sound will be lip-synchronised, using the Pioneer blimp and a variable speed *Reflectograph*—using one track for master dialogue and the other track for a variation of the synchropulse method. Apart from this and other filmic activities, Peter has been developing a conversion to mag/opt of some 16 mm opt projectors and claims perfect sound results and now intends to turn this conversion out in quantity.

#### A Group to Watch—The Other Eye

A friend tells me, quite confidentially, that a small group of young people who are tired of merely lamenting the "drift towards unthinking passivity in art and entertainment" have decided to do something about it. They are setting up a project to be called "The Other Eye", where everyone will have the chance to participate in every form of art. They will be using the theatre at Estonian House, Notting Hill Gate, W.11, to produce plays, modern dance, art exhibitions. And there they will show films, one of which they have already made—"The Rocking Horse"—a 16 mm film with optical track. Further sound films are planned.

The group will plough all profits back into a fund which will "enable young people to devote more time to the practice of their art". Further details from: *The Other Eye, 3 Chalcot Square, London, N.W.1.*



# SEE **ALL** MAKES

Hear all makes. At the Tape Recorder Centre showroom you can see, hear and compare them *all*, on the spot. The country's leading specialists in tape recording are there to give you unbiased help in choosing from the country's largest stocks of equipment. At The Tape Recorder Centre there is the model best suited to your needs (and your pocket). And everything else for tape recording, office dictation and hi-fi, plus excellent HP terms. See all makes, hear all makes, at

**THE**  
**TAPE**  
**RECORDER**  
**CENTRE**



**Philips**  
**Elizabethan**  
**Grundig**  
**Ferrograph**  
**Stella**  
**Vortexion**  
**Brenell**  
**Ampex**  
**Tandberg**  
**etc**

82 High Holborn, London WC1. Tel: CHA 7401







# NOW TOP STARS AND SHOWS ON E.M.I. <sup>3 3/4</sup> I.P.S. TWIN TRACK TAPE RECORDS



DETAILS OF FIRST 18 RELEASES AVAILABLE FROM YOUR USUAL RECORD DEALER  
E.M.I. <sup>3 3/4</sup> I.P.S. TWIN-TRACK TAPE RECORDS CAN BE PLAYED ON MOST HALF OR QUARTER TRACK TAPE REPRODUCERS!

Also included in first release are:—

- MR. ACKER BILK
- JOHNNY BURNETTE • ADAM FAITH
- ELLA FITZGERALD • CONNIE FRANCIS
- PEGGY LEE • HELEN SHAPIRO • JIMMY SHAND
- THE TEMPERANCE SEVEN • BOBBY VEE
- GIGI • THE SOUND OF MUSIC

E.M.I. RECORDS LTD., E.M.I. HOUSE, 20, MANCHESTER SQUARE, LONDON, W.1.



THE GREATEST RECORDING ORGANISATION IN THE WORLD

## ... tape recorder workbench

### No. 36. RELAY CIRCUIT FOR SLIDE CHANGING

by A. Bartlett Still

A COUPLE of months ago a reader in Carshalton wrote to the Editor and asked for help with a relay circuit. The letter was passed to me, and it struck me that there may be other readers with a similar problem; so I thought I would make this particular circuit the subject of one of my monthly articles. Incidentally, I would say to those readers who are kind enough to write to me that, spare time being what it is, I cannot always reply immediately, but you will get a reply.

Our friend in Surrey has a stereo tape deck and amplifier which he wishes to use in addition to the normal manner, with his automatic slide projector. A mono commentary could be recorded on one track, leaving the other free to accept a signal that can be used for changing the slides. Ideally one would record a short "burst" of, say, 1 Kc/s, whenever the slide is to be changed. On replay this signal can be fed into a relay unit, resulting in a switching contact changeover.

This month's circuit is of just such a relay unit that I have developed, designed to be as simple as possible. In order to avoid any modification to the main amplifier to obtain a heater supply, or the possibly dangerous H.T. voltage that valves would need, transistors are used. The circuit will operate from a battery supply of 9 to 12 volts, with a maximum drain of 25 mA. Because of a desire to keep the number of transistors used to a minimum, and to keep the circuit as simple as possible, one slight drawback has to be admitted. The relay will be found to be normally energised, application of a signal causing it to de-operate. In practice this means that, particularly if the



with a signal of about 500 mV r.m.s. or better. Because of the low impedance of transistor circuits, the source impedance of the signal line should not be too high. If it is, then an emitter follower stage should be used at the input to give an impedance transfer, unless sufficient signal is available to withstand the degree of shunting that will be imposed. One way of ensuring a low source impedance is to use the loudspeaker feed, a dummy load can replace the speaker itself if silent operation is required.

#### Amplification may be Necessary

One final point—I mentioned that a signal of 500 mV is needed. Some tape amplifiers give rather less than that, and so some amplification is needed. This would be a single transistor stage A.C. amplifier (i.e. on the signal side of the coupling condenser) such as my colleague Mr. A. Tutchings has described in the past. Note that the positive (earthy) line of such a stage would go to earth, and *not* to the positive battery connection shown, since the relay unit works with both a negative and a positive rail with respect to earth.

#### Looking Back Over Three Years

This article being No. 36 in the series, it is some three years since I started, and I have just been reading the opening words of No. 1: "We are living in an age of "Do-it-yourself", an age when all manner of people are tackling all manner of unfamiliar jobs, large and small, and very often with success. Economy is doubtless the original motive, but the unique satisfaction that is derived is worth far more than the monetary saving, although this can be considerable at times. For tape recorder owners the field of maintenance and modification can be wide and ambitious. It will be the aim of this series to stimulate this ambition by giving the informed guidance that should always be sought. We are not going to advise on major re-builds, we want to help you to get the best out of your machine, and keep it that way. We will be looking for your letters, not only suggesting subjects on which you would like hints and advice, but also giving details of your own ideas that have proved successful and that you would like to pass on".

I wonder if I have kept my promise, I feel I have, so how about you letting me know of your bright idea.?

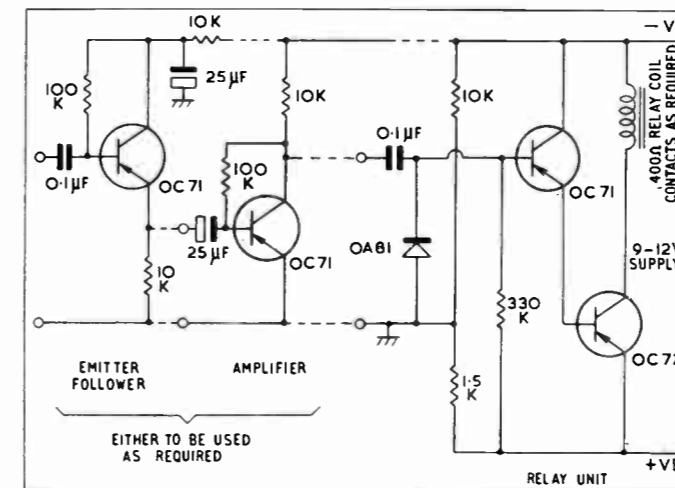

operating coil of the slide projector is not continuously rated, care must be taken to switch on the supply to the slide changer only when the relay unit supply is already on. Perhaps better still, a suitable switch could be arranged to do both together, remembering that the two circuits must be carefully isolated, particularly if the projector apparatus is mains operated.

#### Operating Details

The unit whose circuit I show is not at all frequency selective, though the response is not really flat. The sensitivity tends to fall off by a few dB above about 5 Kc/s, while below about 200 c/s the relay tends to chatter. The best operation occurs between about 800 c/s and 3 Kc/s. It should be found that an oscillator is not necessary for recording the operating signal, a whistle in the microphone or even the word *change*, ought to be sufficient.

Full operation of the relay (and the one I used was a P.O. 600 type, having a coil resistance of 400 ohms) should be obtained

PLEASE MENTION "THE TAPE RECORDER" WHEN REPLYING TO ADVERTISEMENTS.



# AN AUTO-STOP FOR THE "STUDIO" DECK

by C. G. WEBB

THE Collaro Studio deck is not fitted with any automatic means of stopping the tape transport at the end of the reel, or as a result of a tape break. The writer had several reels of tape ripped to shreds (because he allows his children to use the recorder) and so he decided something must be done before all his 7 in. reels became shortened to the contents of 3 in. reels. The basic arrangement of the modification which was developed was described in an earlier copy of *The Tape Recorder*.

The parts are cut from 22 gauge brass strip, referring to the drawing (which is actual size) the method of marking out the shape of the limb, which actuates the switch is shown together with centres for drilling and positions of folds. Only non-ferrous metals should be used.

Part A should be cut out with snips, or the kitchen scissors will cut it quite easily (provided, of course, that the wife is out).

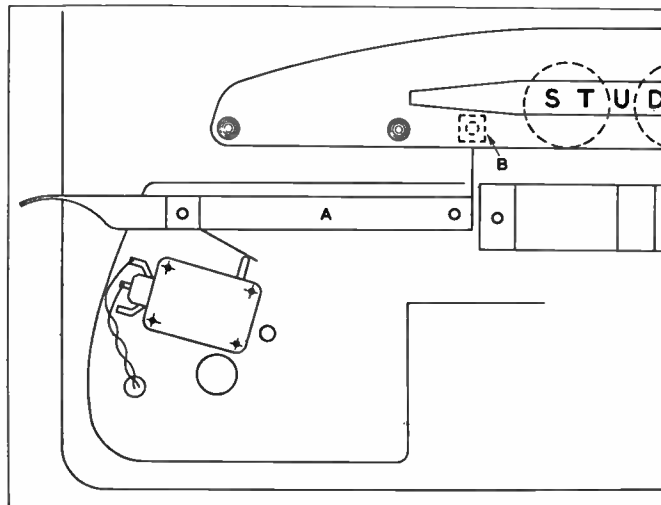

Several types of micro switches were tried, the Bulgin S.530 was found easy to accommodate and very sensitive, so the drilling template has been marked out for this switch. The switch is wired to cut out the two spool motors, leaving the capstan motor running. Cutting out all three motors would have left the pinch wheel in contact with the stationary capstan spindle, with disastrous effects to the pinch wheel.

Reference to the drawing of the connecting block on the underside of the deck, and to the colours of the wires indicated, will make it clear how this was achieved. A word of warning here will not be out of place. There are many moving parts under the deck, so make absolutely sure that the flex from the switch to the block is securely fixed where it cannot possibly get mixed up with the works.

After mounting the parts on to the deck and wiring the switch, the switch should be adjusted by bending the tongue which contacts the pip of the switch, slightly one way or the other, so that the switch just makes with the tape, holding the tip of part A out of the slot in part B. Run the tape through two or three times to make sure the operation of the switch is consistent.

The 4 B.A. bolt used as the pivot is fitted through the deck, with the head on the underside, secured on top by a nut filed down to approximately half its thickness. This nut also serves as a bearing for the arm. Finally, a washer and nut keeps the arm in place.

The plastic cover now requires two small cut-outs before refitting. The limitation of the stop mechanism is that it only

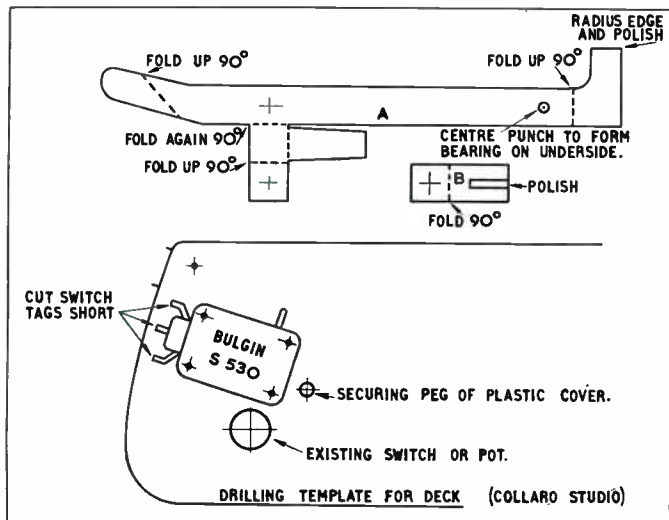

All the burrs should be removed with a fine file, and the position of the two holes carefully marked and drilled. For this a 4 B.A. bolt was used, for which a 9/64th in. drill is required: other sizes which may be to hand may be used with a corresponding drill size.

The folds as indicated on the drawing should now be made. Some care is needed here as the two drilled holes must line up. The centre-punched spot at the end of the limb, should be gently punched until a pimple is formed on the underside. This acts as a bearing point for the end of the limb and will move smoothly through its travel across the deck.

The tip of the limb, as indicated on the drawing, must be nicely radiused and polished, as it will be in contact with the back of the moving tape and must not snag any splices or scrape and so damage the tape. The other end, after folding, should be bent round to form an easy hold for a finger, whilst loading the deck with a reel of tape. The remaining tongue on the limb should be bent to somewhere around 30 degrees, to contact the pip of the micro-switch.

Part B is cut from one of the offcuts, slotted, drilled and then folded. If the piece of brass is sandwiched between two odd pieces of plywood, held in a vice, by cutting the wood and the brass together, the slot should not cause any difficulty. Carefully remove all traces of burr, corners and edges and then polish, because the coated face of the tape will be running over this.

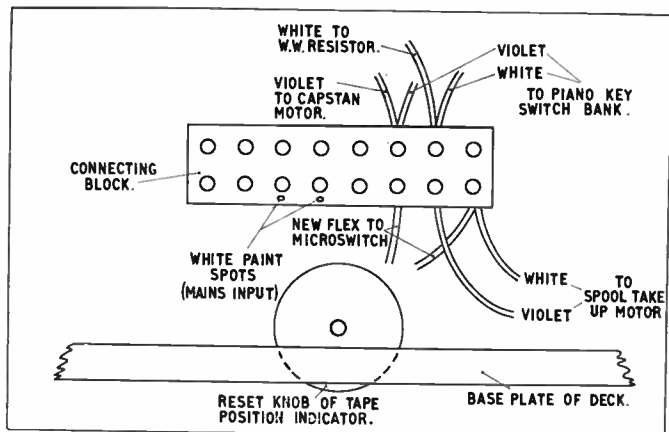

performs satisfactorily with the tape moving from left to right, recording or playing back; but not on fast wind or rewind. However, one does not normally leave a machine unattended during fast winding or rewinding, so perhaps that is not an over important shortcoming.

# FOR ONLY £8

YOU CAN BUY A PROFESSIONAL  
RIBBON MICROPHONE  
COMPLETE WITH  
DESK STAND

The M8A is a new ribbon microphone from Film Industries; it employs the highly successful ribbon assembly that is used by recording and broadcasting studios throughout the world. By improved manufacturing methods we are now able to make these available at a price within the reach of all serious enthusiasts.



PRICE **£8**

All impedances and complete with desk stand and 12ft. screened cable.

Get the best from your recorder—

**BUY A FILM INDUSTRIES MICROPHONE,**

send for full details:

**FILM INDUSTRIES LTD.**  
90 BELSIZE LANE, N.W.3

Tel: HAM 9632

# BINDERS

for  
THE TAPE RECORDER

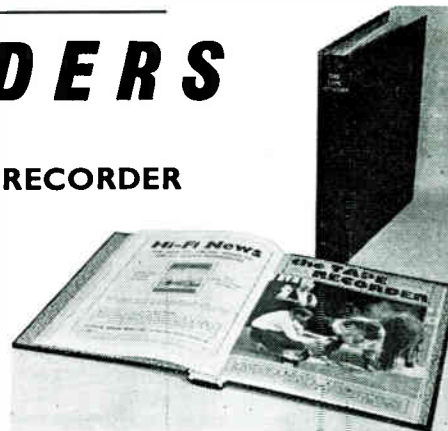

Semi-permanent Binders for  
Volume 4 now available.

From the first number keep your copies clean and ready for easy reference. Semi-permanent binders are available for volume 4. Each case will take twelve copies plus index and will open flat at any page. They are covered in black buckram and gold blocked on spine with name and volume number. Also available, volume 3.

Price 15s. post free.

**MILES HENSLOW PUBLICATIONS LTD**  
99 MORTIMER STREET, LONDON W.1

# FRANCIS OF STREATHAM

## ● TAPE RECORDERS AT 169/171

Brenell Mk. V Model M ...	88 gns.
*Brenell Mk. V ...	64 gns.
Brenell 3 star ...	58 gns.
Brenell 3 star stereo ...	89 gns.
Cosor 4 Tr. 1602 ...	37 gns.
Cosor 4 Tr. 1601 ...	59 gns.
Elizabethan 'Popular' ...	24 gns.
Elizabethan TT3 ...	39 gns.
*Ferroglyph 422 or 424 ...	110 gns.
*Ferroglyph 4AN ...	81 gns.
*Ferroglyph 4AN/S ...	88 gns.
Fidelity Argyll Major ...	20 gns.
Fidelity Minor ...	22 gns.
Grundig TK14 ...	35 gns.
Grundig TK 24 ...	55 gns.
Grundig TK40 4 Tr ...	75 gns.
*Grundig TK60 Stereo ...	128 gns.
*Harting HM8 Stereo ...	86 gns.
Optacord 403 ...	43 gns.
Optacord 412 ...	45 gns.
(Mains/Battery/Car)	
Philips 4 Tr. 3541 ...	34 gns.
Philips 4 Tr. 3542 ...	59 gns.
Philips 4 Tr. Stereo 3536 ...	92 gns.
*Reflectograph 'A' 1/2 Tr. ...	105 gns.
*Reflectograph 'B' 1/2 Tr. ...	115 gns.
Reflectograph 'D' Deck ...	75 gns.
Robuk ...	36 gns.
*Simon SP5 ...	93 gns.
*Simon Stereo 462 4 Tr. ...	75 gns.
Sony 1 and 1/2 Track ...	124 gns.
Stellaphone 4 Tr. ...	37 gns.
Stellaphone 4 Tr. ...	59 gns.
Stuzzi 4 Tr. ...	28 gns.
Stuzzi Tri-Corder ...	63 gns.
*Tandberg Series VI Stereo 1/2 or 1/4 Track ...	110 gns.
*Tandberg Mono, 3B ...	76 gns.

*Telefunken 85 KL ...	79 gns.
*Telefunken 95 ...	59 gns.
*Telefunken 96 4 Tr. ...	69 gns.
*Telefunken 97 Stereo ...	95 gns.
Truvox Series 80/2 Tr. ...	55 gns.
Truvox Series 80/4 Tr. ...	59 gns.
Truvox R7 ...	82 gns.
Veritone 16 ...	91 gns.
Uher Universal ...	83 gns.
*Vortexion WVA ...	£93.13.0
*Vortexion WVB ...	£110.3.0
*Vortexion C Stereo ...	£148.10.0
Windsor Heron ...	25 gns.
Windsor Victor ...	45 gns.

NEW 4-TRACK MODELS BY PHILIPS,  
COSSOR, STELLAPHON AS ADVERTISED.

**BATTERY PORTABLES**

Philips Portable ...	24 gns.
Optacord 412 ...	45 gns.
(Mains/Battery/Car)	
Butoba ...	66 gns.
Grundig TKI ...	29 gns.
Clarion ...	19 gns.
Clarion Twin Set ...	8 gns.
Clarion Phonotrix ...	39 gns.
Minivox C ...	23 gns.
Fi-Cord 202 ...	66 gns.
Stella ...	25 gns.
Stuzzi Memo-Cord ...	25 gns.

\*Microphone extra  
**FACTORY-FRESH BATTERIES**  
ALWAYS IN STOCK

### WE SPECIALISE IN

- Tape to disc service
- Tape copy service
- RECORDER HIRE SERVICE

## LEADING STOCKISTS OF EQUIPMENT FOR TAPE and HI-FI

... and NO EXTRA FOR CREDIT TERMS

- ★ Minimum Deposit
- ★ No Interest or Service Charges on H.P. up to 18 months
- ★ Free Service during Guarantee Period

Prices subject to alteration as announced by manufacturers.

### ● MICROPHONES AND MIXERS

Grampian DP/4 Dynamic	£8. 0.0
Lustraphone LD/66 ...	£4. 2.6
Lustraphone VR/64	
Ribbon ...	£7.17.6
Lustraphone LFV/59	
Dynamic ...	£8.18.6
Simon 'Cadenza' Ribbon	£10.10.0
Reslo Ribbon or Dynamic	£9.12.6
Reslo Cardioid ...	£9. 2.6
AKG Stereo	
Dynamic D.88 ...	£19.19.0
TSL 3 Channel Mixer ...	£2. 2.0
Grundig Mixer ...	£16.16.0

Also in stock microphones by  
ACOS, FILM INDUSTRIES,  
TELEFUNKEN  
ALL WALGAIN PRODUCTS

### ● TAPES & ACCESSORIES

Standard, 'Double Play' and Long Play in all sizes by all leading makers.  
● Pre-recorded Tapes by Columbia, H.M.V., Saga, etc.

Bib, Bond and Romagna splicers. Matching transformers. Plugs, sockets, etc.

AT OUR HI-FI DEPT. AT  
181 Streatham High Road

- STEREO AND MONO AMPLIFIERS by
  - Quad Walgain Rogers
  - Leak Dulci Armstrong
- TUNERS by
  - Quad Rogers
  - Leak Dulci Armstrong
- LOUDSPEAKERS by
  - Quad G.E.C.
  - W.B. Wharfedale
  - Goodmans Tannoy
  - Audistatic Mordaunt Leak
- MOTORS, PICKUPS, by
  - Garrard Tannoy
  - Goldring Lenco Shure
  - Connoisseur Decca Stereo
  - Philips Ronette
  - All-Balance. B&O
  - Ortofon SME

All types of Diamond and Sapphire styli, stereo and mono. Microlifts, Garrard SPG3. Acos Dust Bug.

**CABINETS**  
Record Housing  
Leak 'Southdown'

Please note our only addresses as below

**169-171 STREATHAM HIGH ROAD, LONDON, S.W.16**

Between St. Leonard's Church  
and Streatham Station

STReatham 0466/0192

Hi-Fi Dept. 181 STREATHAM HIGH ROAD, S.W.16



# A TAPE CALCULATOR

by H. J. ALLSOPP and E. G. COBB

DURING many months of serious tape recording, several occasions have arisen when an item has had to be erased from an intermediate position on the tape and replaced with something else. This has meant timing the unwanted section with a stop-watch and finding something of the same duration as a replacement. An obviously time consuming business.

To avoid this time wasting, a simple calculator has been made which will, with two settings, indicate the duration of playing time of a length of tape to within a few seconds.

## Preliminary Check

Before proceeding further, it was thought advisable to check the performance of the digital type counter. A tape was set up so that the junction of the aluminium foil trip and the tape itself was just touching the hub of the take-up spool. The digital counter was set at zero and the tape played through in the normal manner. The tape was then fast-rewound until just before zero was reached on the counter and the machine was stopped. The tape was then rewound by hand until the trip-foil/tape junction was in the position described above. The counter reading was found to be 998, i.e. two revolutions more on rewind. This represented a 0.2% error which was considered negligible. No adjustments were therefore necessary to the counting mechanism.

The next step was to check the tape tension on play and fast rewind. A tape was set up and played through, reversed and played through again to ensure that the original reel was wound under "play" conditions. It was then replayed through timing every 100 revs from zero with a stop-watch. The reel was then fast rewound and timed as before. Fig. 1 shows the graph so obtained. It can be seen that the maximum difference was 11 seconds. This was considered to be within the limits to be ex-

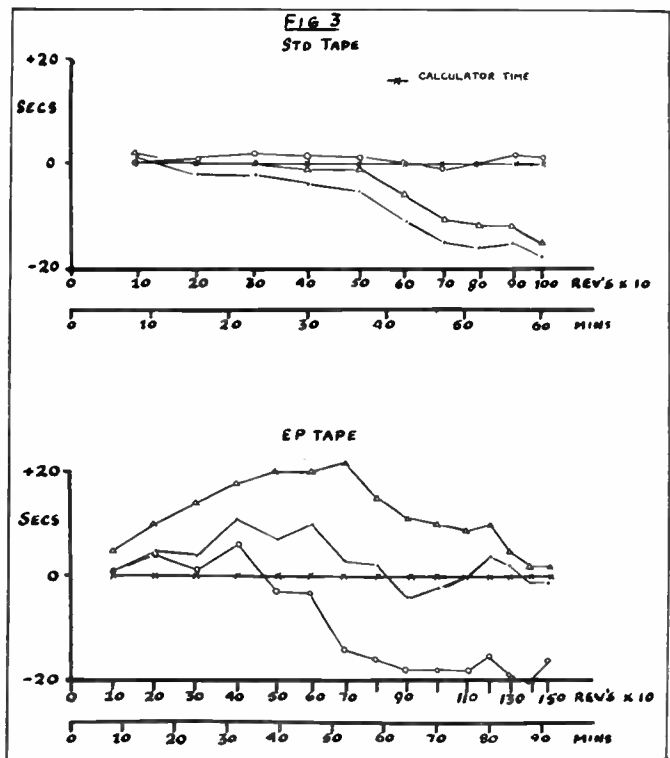
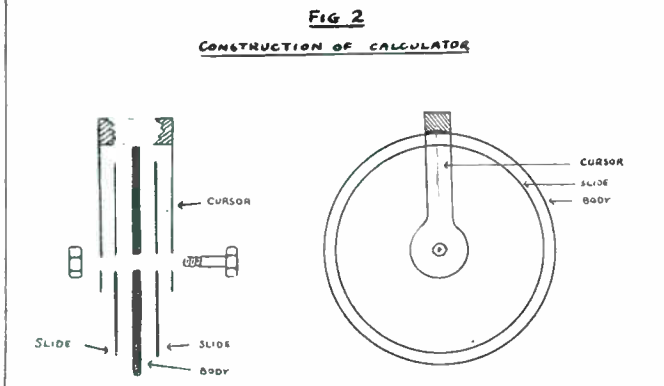
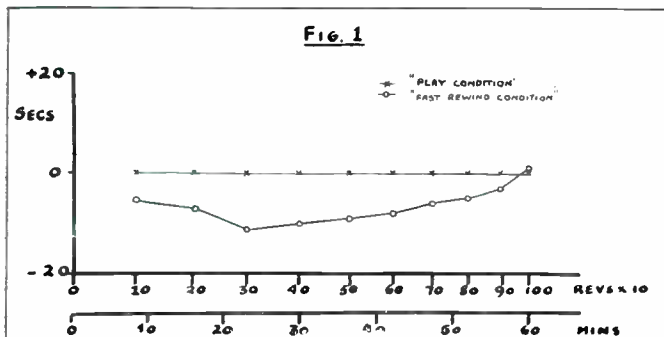

pected from the finished calculator. No adjustments were therefore made to the tension mechanism of the recorder.

The final point to be checked was that the time taken to play through at  $7\frac{1}{2}$  i/s was half that taken at  $3\frac{1}{2}$  i/s. This was done and the overall error was 2.4 secs. Thus there was no need to calibrate twice for these speeds.

Having established that the deck itself was operating within reasonable limits, a take-up spool was selected having the same diameter hub as the play spool and the 7-inch Std and EP tapes were set up as described and timed with a stop-watch at every 25-unit counts on the digital counter. This was repeated to ensure accuracy.

## The Calculator

This is shown diagrammatically in fig. 2 and consists of an 8-inch diameter body sandwiched between two 7-inch diameter transparent discs. On the outer sides of these 7-inch discs are mounted two  $\frac{1}{4}$ -inch-wide strips of rigid transparent plastic engraved radially with a cursor line. These strips are joined together outside the 8-inch disc and pivoted through the common centres.

An 8-inch disc of high grade cardboard was carefully cut out. Two circles 7 inches and  $5\frac{1}{2}$  inches in diameter were inscribed lightly in pencil. Suitable circles to facilitate subdivision were also described on either side of these original ones.

The 7-inch diameter circle was divided into 64 equal divisions representing minutes of running time for a 7-inch reel of standard tape at  $3\frac{1}{2}$  i/s. The  $5\frac{1}{2}$ -inch circle was divided into 32 divisions again representing minutes of running time but at  $7\frac{1}{2}$  i/s. Each of these divisions was then subdivided into 4 to give 15-second intervals. This was easily accomplished using dividers and "pacing out" therewith.

The reverse side of this same disc was divided in a similar way, but into 96 and 48 minutes respectively representing the running time of E.P. tape at the different speeds. (continued overleaf)



FOR AUDIO IN BIRMINGHAM

IN DOUBT?

Choose by Comparison

IN TROUBLE?

Try our Service

SALES OR SERVICE ON ALL QUALITY RECORDERS  
14 YEARS SPECIALIST KNOWLEDGE AT YOUR DISPOSAL

416 MOSELEY ROAD, BIRMINGHAM 12

Telephone Calthorpe 2554

BRAND NEW FAULT FREE 100% TESTED  
TOP QUALITY RECORDING TAPE

(As supplied to the Far East Broadcasting Corp.)

WHY PAY MORE?

Polyester Long Play.  
Super Quality

Size	Length	Price
3"	220'	3s. 0d.
5"	900'	11s. 6d.
5½"	1200'	16s. 0d.
7"	1800'	23s. 0d.

P.V.C. Standard

Size	Length	Price	
		Domestic	Super
3"	160'	2s. 3d.	2s. 6d.
5"	600'	8s. 6d.	9s. 0d.
5½"	900'	10s. 9d.	11s. 6d.
7"	1200'	15s. 3d.	16s. 0d.

REFUND GUARANTEE (Never requested)

N. WALKER, 28 Linkscroft Avenue, Ashford, Middlesex

you'll be glad  
you recorded it on  
**gevasonor**  
magnetic tape

**GEVAERT**

Ask your dealer  
for free descriptive leaflet

GEVAERT LIMITED · ERENTFORD · MIDDX.

ILFORD SOUND RECORDING SERVICE

445 HIGH STREET NORTH,  
MANOR PARK, LONDON, E.12



**WEDDINGS RECORDED**  
**TAPE TO DISC**  
**TAPE TO TAPE**

STUDIO:—GRA 5107

OFFICE:—GRE 8947

A TAPE CALCULATOR—continued

The slides were made from 7-inch diameter discs of celluloid because it was thought more accurate for the counter scales to appear adjacent to both time scales.

It was engraved as follows: a 7-inch diameter disc of paper was cut out and placed in position on the appropriate side of the body, marked with time scales, and the two held firmly together.

The 25-unit digital counter intervals were carefully marked off against their appropriate times on to this paper disc. The intervals between each 25 units were considered linear, and each of these were subdivided into units of 5 using dividers as before.

The celluloid disc was then placed on top of the paper disc, clamped firmly, and inscribed using the paper scale as a guide. This was repeated for the other types of tape. To make these inscribed lines more legible they were filled with coloured wax.

Two pieces of celluloid were marked with a cursor line as shown, and fixed together with a spacer to make a sliding fit around the body of the calculator.

All components were drilled so as to have a common centre, and after the body had been inscribed suitably, to designate speed, type of tape etc., they are fixed together with a nut and bolt, the nut being adjusted to give a sliding fit.

In order to calculate the duration of an item at a position between two readings of the counter, say "A" and "B". Counter reading "A" is set at zero on the time scale and duration is read off the time scale opposite counter reading "B".

Similarly the duration of the length remaining at the end of a tape may be determined simply by setting the counter reading registered at the end of the last recording and reading the time opposite the last graduation on the counter scale.

Fig. 3 gives the actual times as recorded by a stop-watch of three standard and three extended-play 7-inch reels of tape.

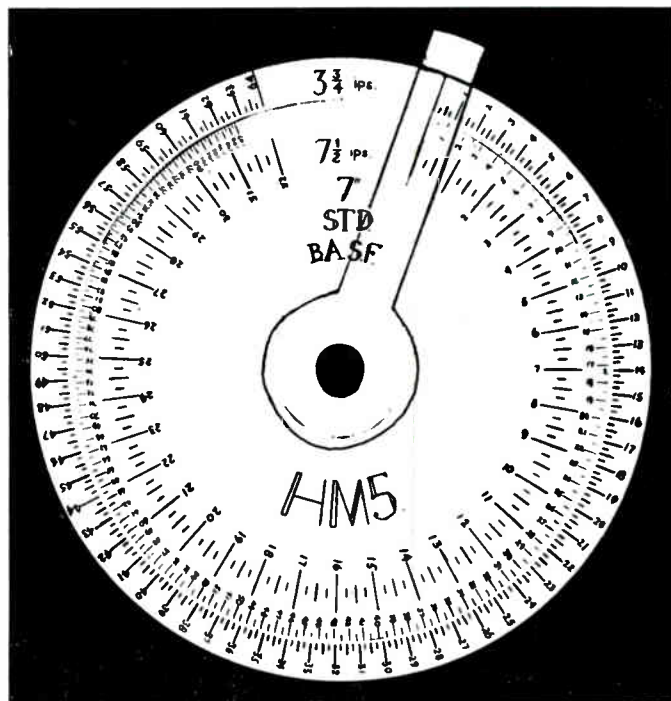

These are compared with the times predicted by the calculator. It will be seen that the maximum overall error is 26 seconds and as this particular reel was partly in "play" and partly in "fast rewind" condition this is not considered excessive. Usually in practice errors greater than 15 seconds are seldom encountered.

A calculator has been made which will, with two settings, indicate the duration of a length of tape at any position within that tape, whether a 7-inch E.P. or Std. at 3½ or 7½ i/s.

For such accuracy it has been necessary to standardise on one particular brand of tape. This is because the hub diameters vary between manufacturers, as does the thickness of the tape. Both will influence the overall revolutions of the tape reel, and consequently the reading times. Fig. 4 shows the finished article.



# our readers write . . . . .

## . . . about the Tandberg

**From:** N. G. Robinson, Arlynden, 2 Brookwood Avenue, Sale, Cheshire.

*Dear Sir:*—As a satisfied user of a Tandberg Series 6 Two Track Stereo Recorder I was most interested in the review of this instrument by Mr. A. Tutchings in the April issue.

May I comment on the subject of his last paragraph—"One little vice"?

I too was non-plussed and "ham-handed" as a newcomer to this model when trying to fit a tape; due of course to the revolutions of the reels in opposite directions. I discovered the remedy by accident—which is to fit the tape before switching on the current when it will be found that both L.H. and R.H. reels will revolve freely and are in fact "idlers". It makes all the difference between easy loading and a difficult and often trying operation.

I hope this information is of use to other Tandberg users.—

*Yours truly,*

\* \* \*

## . . . about warped spools

**From:**—K. Tuxford, 3 Russell Street, Ponsonby, Auckland W.I., New Zealand.

*Dear Sir:*—For some time I have been hoping that you would publish an article on how to "revive" buckled or warped spools. This appears to be one aspect in tape equipment that has been seriously overlooked. Oh yes, I am aware that certain books on tape recording advise you to throw them out, when they warp or buckle, this might be quite an economic idea, where spare empty tape spools can be obtained at a reasonable cost.

Here in New Zealand, we have to pay the following prices for empty tape spools—3 in., 5s. 6d. each; 5 in., 8s. each; 7 in., 9s. 6d. each!!! So you will appreciate why we consider a warped spool an expensive item to replace. Investigations have shown the following reasons for warping: 1, High temperature and humidity (very common in N.Z.). 2, Excessive heat from tape decks. 3, Bad stacking after use.

As I have already mentioned spools and their standard seem to have been well overlooked in the past, perhaps this letter may stimulate some of your readers into submitting a solution.

Finally, I am sure that most tape enthusiasts who participate in tape exchange have had the unfortunate experience to receive a tape with the spool broken in transit—probably a good argument for the use of high impact plastics!—*Yours faithfully,*

## . . . about recorders at sea

**From:**—Vincent J. Horsford, Monkseaton, Northgate, Northwood, Middlesex.

*Dear Sir:*—I wonder if any of your readers happen to be keen tape recording enthusiasts like myself, but also at sea. Though I do not regularly read your magazine or others in the same field, I have never noticed any correspondence from sea-going persons or articles which deal with the use of tape or disc equipment on board.

Over the past three years as a purser in the Merchant Navy, I have found it much more pleasant to have some source of entertainment (musical, that is) in one's cabin, and thus have gradually realised the advantage of a tape recorder which is not affected by rough weather or other causes of agitation to a turntable.

Not being a truly "gen kid" in the field of electronics, etc., I started off in a small way with a "Gramdeck" fitted to my record player. This I found to be a surprisingly good little addition and congratulate the designer for its simplicity and ease of use. From that I went to the 59 gns. 4-track Philips after selling out my previously large record collection and player plus Gramdeck. One thing for which I was glad, was that my record player had been fitted with an additional variable speed control and all tapes I made on the Gramdeck were set to run at standard  $3\frac{3}{4}$  in. so I had a small start to a future tape collection.

As time passed by and my Philips was most certainly well used, and appreciated, I too began to appreciate the possibilities of tapes, and the thought of hi fi or stereo soon overwhelmed me and I once again sold my equipment to buy the Philips stereo recorder. Now, over the past year my tape collection has grown to thirty 7 in. L.P. spools, covering practically every type of music and includes several edited special broadcasts of such things as the space launches, etc.

However, during the earlier part of this year I had the opportunity to listen to the performance of some truly professional tape equipment, and this persuaded me to venture deeper into the hi fi field by the purchase of a Tandberg Model 6 stereo deck and a Rogers HG88 Mk. 2 amplifier. These latter I have now had in use here at home for three weeks, and am truly astounded by the performance and capabilities, though my speakers (10 in.—5 ohm) are of no special make and of foreign origin purchased in Aden. The record turntable used too is of foreign origin, a DUAL 300A stereo (I believe a Telefunken product).

Now, no doubt the hi fi and stereo specialists who are lucky enough to be in a permanent abode, may look down their noses and disagree with me when I state that despite the fact that our smallish cabins on board are not quite suitable for high-class listening, I myself find that such a thing is possible. The biggest difficulty, however, is that of the portability of equipment, and next comes the problem of working on ships' mains which are generally 220 D.C., though in my own company certain ships use 220 A.C. but 60 cycles.

Because I am very keen now to improve the standard of all tapes I record from any source, and also the standard of my equipment apart from tape deck and amplifier, I would be extremely pleased to hear from other persons at sea, or persons ashore, who are interested in furthering the improvement and standards possible when using equipment under the conditions as found aboard a ship.

*Yours faithfully,*

## . . . about the Tri-column

**From:**—P. D. Turner, Cave Cottage, Oakridge Lynch, Stroud, Glos.

*Dear Sir:*—In the May issue of *The Tape Recorder* you published a report of a meeting of the Cotswold Tape Recording Society at which one of our members—Ray Tingley—demonstrated to us a "Tricolumn" speaker which he had made. Under the report—and all other similar reports from different clubs—you added, as is your custom, a note that further details could be had from the secretary—meaning, of course, further details about the Society, not the speaker. We have, nevertheless, been inundated with letters from all over the country, asking about the speaker. We have done our best to reply: but some enquirers did not even enclose a stamp! Surely this is an obvious courtesy when writing to an amateur body? *Yours faithfully,*

**Editor.** Copies of the "Tricolumn" reprint can now be obtained from the editorial office, price 2s. post free.

## EXPERIMENTAL RECORDING

for beginners

by A. Tutchings

This is the second book in our "Hi-Fi Books" series and presents in convenient form the series of articles by A. Tutchings on "Twenty Practical Experiments in Magnetic Recording" and full instructions on "Building a fully portable recorder". This uses a clockwork motor and has been acclaimed from all parts of the world for its ingenious design and high quality recording. Limited print order.

### NOW AVAILABLE

Obtainable only from the publishers, price 5/9 inc. p. & p.  
HI-FI BOOKS, 99 MORTIMER STREET, LONDON, W.1



1



2



**PHILIPS**

T A P E R E C O R D E R S

at the

# CHELSEA RECORD CENTRE

and all records and equipment

203 KINGS ROAD LONDON SW3 FLA 2596



3

1 The brilliant new battery-operated mobile recorder **24 GNS**

2 The professional recorder at YOUR price **59 GNS**

3 The Family Tape Recorder! Four Tracks! Super-imposing facilities **34 GNS**

## TAPE RECORDER COVERS



Smart, waterproof cover to give complete protection to your tape recorder. Made from rubberised canvas in navy, wine, tan, grey and bottle green with white contrasting pipings, reinforced base, handy zip microphone pocket and name panel.

Philips EL3536	...	70/-
" EL3515	...	57/6
" EL3541/15	...	57/6
" Starmaker	...	66/-
Cosmor 1601	...	57/6
Stella ST455	...	63/-
" ST454	...	57/6
Saja MK.5	...	57/6
Stuzzi Tricorder	...	58/-
Saba	...	63/-
Wyndor Viscount	...	55/*
" Victor	...	60/*
Elizabethan Princess	...	60/-
" Avon	...	60/-
" Escort	...	57/6*
" Major	...	63/-
" FT.1	...	66/-
" FT.3	...	75/-
Fi-Gord	...	52/6
Korting (4 track stereo)	...	63/-
Harting Stereo	...	66/-
Fidelity Argyle	...	55/*
Simon SP4	...	63/*
Clarion (with strap)	...	52/6
Brenell Mk.5	...	77/-
" 3 star	...	69/-
Minivox C	...	61/-
Robuk RK.3	...	67/6
Ferroglyph	...	80/-
Sony 521	...	90/-
Grundig TK.1	...	49/6
" TK.5	...	55/-
" TK.8	...	63/-
" TK.14 & 23	...	59/6
" T.K.20	...	52/6
" TK.24	...	55/-
" TK.25	...	55/-
" TK.30	...	60/-
" TK.35	...	63/-
" TK.40	...	†
" TK.50	...	60/-
" TK.55	...	63/*
" TK.60	...	75/*
" TK.830/3D	...	63/-
" Cub	...	35/*
Telefunken 85	...	60/-
" 85	...	65/-
" 75/15	...	55/-
" 76K	...	55/-
" 95	...	69/6
Philips 8108	...	57/6
" 8109	...	63/-
" EL3538	...	63/-
" EL3542	...	63/-

**A. BROWN & SONS LTD.**  
24-28, GEORGE STREET, HULL Tel: 25413, 25412

## MAKE YOUR TAPE RECORDER REALLY PORTABLE

WITH A **Valradio** CONVERTER

A Valradio converter enables you to operate your tape recorder from car, boat or caravan battery, or any other source of low voltage or D.C. supply, making it possible for you to record outdoor events, or dictation, or to provide entertainment when you go on holiday or picnics, etc.

Prices range from £6.10.0., many models available

Write for fully descriptive folder to

**Valradio**

**VALRADIO LTD.**  
Dept., TR/C.,  
Browells Lane,  
Feltham, Middlesex  
Tel. Feltham 4242

Valradio and Stereosonoscope are the registered trade marks of Valradio Ltd.

To Valradio Ltd., Dept. TR/C., Browells Lane, Feltham, Middlesex

Please send me fully descriptive folder of converters suitable for tape recorders

NAME \_\_\_\_\_

ADDRESS \_\_\_\_\_

## Ferroglyph

(Appointed Dealer)

### Special Announcement

Many visitors to our London Showrooms remark that our stock of high quality tape recorders and audio equipment surprises them—many express the wish that they had visited us **FIRST**.

For really personal service and attention, for first-class equipment and after sales service executed in our own service departments, we maintain,

**IT PAYS TO DEAL WITH A SPECIALIST.**



Geoffrey V. Smith

### accessories for your **Ferroglyph** The Nusound "Numix"



The "NUMIX" is a convenient mixer which enables a Ferroglyph user to mix and fade at will two programmes, from microphone and radio/radiogram. Alternatively, speaker output sockets from power amplifiers can be used. Any combination of two programmes is possible with the Nusound "NUMIX" device.

Price: £47.6. Radio Lead complete 7/6.

Write for leaflet on "NUMIX 1", "NUMIX 2", and "MONITOR" UNITS

## NUSOUND RECORDING CO.

35 CRAVEN STREET, W.C.2.

TELEPHONE TRA 2080



# THE CALIBRATION AND USE OF TEST TAPES

PART 5 ————— By A. TUTCHINGS

**I**N this, the last of the present series on test tapes, I want to show how white noise test tapes may be used subjectively, using no test gear whatsoever. The ear has a very short memory, and to aid in the estimation of changes of sound level, a constant reference signal is required. This reference source should have a spectral response which is as "white" as possible, i.e., it should contain a wide range of frequencies of roughly equal levels.

Peter Walker of Acoustical Mfg. Co., once described how a £1 note could be used as a source of white noise by rubbing it between the fingers—but such a piece of test equipment is rather expensive for my purpose and I looked around for something simpler. A one-inch diameter disc of plastic foam, about half an inch in thickness, proved to be the answer. If this is held, at the edges, by the forefinger and thumb, and the rear surface scratched gently by the nail of the second finger, the radiated sound from the front face of the disc is almost exactly what we require.

When held about six inches from the ear the sound level is very roughly 10dB below 1 dyne per cm.<sup>2</sup>, or a little more than 60dB above hearing threshold. When it is moved closer to or further away from the ear, the sound level varies according to the inverse square law. In other words bringing it closer, to within three inches of the ear, will increase the sound level four times or 12dB; taking it away, to twelve inches, will reduce the sound level by 12dB.

## Matching Levels

The next step in the operation is a little difficult to describe as it is so purely subjective. If any one of the noise bands from a white noise test tape is played into a loudspeaker and the ear is placed on the axis of the speaker at a distance of about 3 ft., it will be found that the noise from our "scratcher" can be matched fairly accurately with the sound from the speaker by moving it to and fro between the speaker and the ear. If it is too near, the sound from the speaker will be masked by the "scratcher"; if too far away, the speaker noise will predominate and the noise from our reference source will be lost. After a little practice it will be found that a fairly critical distance can be found where the two sounds match in level, even though the frequency content is noticeably different.

The procedure, therefore, is to set the speaker level so that a mid-frequency noise band is matched with the reference source about 6 inches from the ear.

## Low Frequency Cut-off

At very high frequencies it will almost certainly be found that the sound output from the speaker is very low, and the reference source will have to be moved at least a foot away to avoid masking the low sound level from the test unit. This indicates that the sound output is at least 12dB below the mid-frequency band. At some band in the mid-upper frequency range it may be found that the "scratcher" has to be moved in close to the ear to mask the sound output from the loudspeaker; this indicates the presence of a peak in the response of the speaker or tape recorder. As the noise bands from the tape drop in frequency, a point will be found where the reference source will have to be moved further away to give a sound balance; this marks the low frequency cut-off of the system. Thus, peaks and dips in the speaker sound level of more than about 6dBs can be pinpointed as can the high and low frequency cut-off limits of the recorder-speaker combination.

It is difficult to estimate ear to reference source spacing to better than about 2 inches without some external aid, and I have found that a point light source, placed behind the operator, so that a sharp shadow is cast on a wall in front of him, allows the spacing to be measured fairly accurately without turning the head and so losing the position.

All this may sound a bit "Heath Robinson", but it does give a lot more information than a simple unaided listening test. I have found that the one octave white noise test tape is best suited to this subjective

method of test as only seven noise bands are used, and the test can be carried out fairly quickly to avoid ear fatigue and uncertainty in the "readings."

Tape recordings of full range white noise are also useful in setting up a stereo sound system. If the speakers are out of phase, for example, the noise will be heard on each side of the room with a quite obvious "hole in the middle". When the speakers are properly phased the noise will appear to come from a point midway between the speakers. If a one octave white noise tape is used, the stereo image should remain stationary between the speakers on each one of the noise bands. Any wander of the stereo image indicates unequal responses in the two speakers, or local reflection near one of the speakers.

## Test Tape for Four-Track Heads

To conclude, I would like to describe a test tape where the operative track is blank, and where the adjustment objective is dead silence! This, of course, is a special factory test tape for the vertical alignment of four-track recorder heads. The tape is recorded at full level across the width of the tape except for track 3 which is blank and has been carefully erased over a width of 45 thou' so that when the normal 43 thou' playback head is properly positioned the output is zero. Full range white noise is recorded on the rest of the tape surface so that by switching to track 1 the head may be aligned for azimuth, and then, by switching to track 3 the vertical placement may be checked. By turning the tape over, tracks 1 and 3 may be compared for output and frequency balance. Note that all tests are done "by ear" so that adjustment time and test gear are reduced to the minimum.

## Conclusion

I hope these articles have made it clear that the prime requirement of a test tape is that it be recorded to certain well-defined characteristics, even though that characteristic, in the white noise tape, be absolute randomness! Level, frequency, azimuth, and track position must be held to fine limits so that any recorder may be set up to a uniform standard so that recordings made on different machines, no matter how geographically separated they may be, may be interchanged, to give identical replay characteristics.

The white noise test tape makes a bid to extend the standardisation to acoustic responses, but, in the present state of the art, these responses, like wow and flutter figures, should be treated with some reserve as we have a lot to learn about the interpretation and analysis of such information.

## BUYING OR SELLING

For quick results advertise in the Classified Columns—  
See Page 268

## BUILD A HIGH QUALITY LOUDSPEAKER FOR UNDER £5

using the Elec 8N/148 drive unit.

Full building instructions are available in reprint form for  
R. N. Baldock's remarkable Tricolumn loudspeaker.

In February 1962 Ralph West wrote: "They were even subjected to A-B tests against other speakers of considerably greater cost. Quite unfair really, but the results were most surprising . . . To round off, this is in no way a mere gimmick, but a serious loudspeaker design of very reasonable performance."

Can be built by any average handyman, easily in an evening.  
Send 2s. 6d. for complete instructions.

Hi-Fi BOOKS, 99 MORTIMER ST., LONDON, W.1

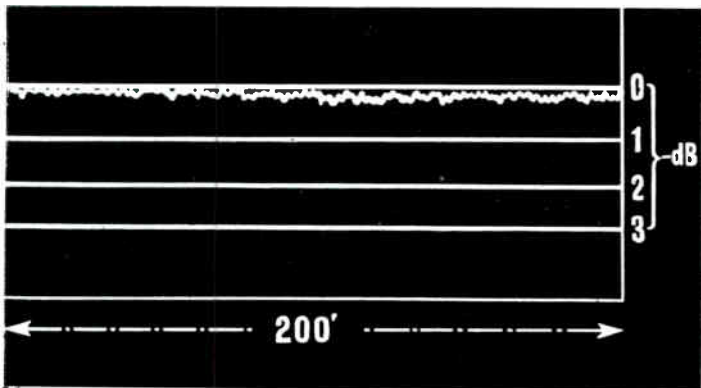

**This is an outline . . .**

of the penrecording made by  
**F. C. Judd, A. Inst. E., Technical Editor**  
 "Amateur Tape Recording"

On *Doubleplay Polyester*  
**'ELECTRONIC WORLD' TAPE**

Mr. Judd's other test findings include:-  
 Maximum drop-out, on any grade, less than 1.5 dB. Uniformity of output; Double Play Polyester  $\pm 0.25$  dB; Long Play Polyester better than  $\pm 0.5$  dB; Standard Play Acetate  $\pm 0.5$  dB. Noise level measurement recording and erase tests: Satisfactory in every way, even on a domestic tape recorder.

**DE VILLIERS (Electronic World) LTD.**

16d Strutton Ground, London, S.W.1

**STANDARD PLAY (Acetate base)**

3in. spool 175ft. 4 spools for 18/-  
 or 48/- dozen

4in. spool 300ft. 4 spools for 25/-

5in. spool 600ft. 2 spools for 25/-

5½in. spool 850ft. 15/- per spool

7in. spool 1,200ft. 17/6 per spool

**LONG PLAY (Polyester Base)**

3in. spool 225ft. 4 spools for 22/-  
 or 60/- dozen

4in. spool 450ft. 2 spools for 20/-

5in. spool 900ft. 2 spools for 33/-

5½in. spool 1,200ft. 22/6 per spool

7in. spool 1,800ft. 29/- per spool

**DOUBLE PLAY (Special polyester base)**

3in. spool 375ft. 4 for 36/-  
 or 100/- per dozen

4in. spool 600ft. 2 for 27/6

5in. spool 1,150ft. 25/- per spool

5½in. spool 1,750ft. 33/- per spool

7in. spool 2,400ft. 42/6 per spool

I enclose remittance for £      s.      d.

Name.....

Address.....

**BLOCK LETTERS PLEASE**      Mail only, cash with order

**Now... you  
 can order  
 direct from  
 Hi-Fi News**

**AUDIO  
 Read**



**the original  
 magazine a-  
 bout high fi-  
 delity every  
 month. Use  
 convenient  
 order form.**

**Hi-Fi News**

**99 Mortimer Street**

**London, W.1., England**

I enclose 35/ for a 1 year subscription to AUDIO which is to be mailed post-free from the U. S. (Please print or type name and address)

Name.....

Address.....



# TAPE, RECORDERS & ACCESSORIES

## FIRST DETAILS OF NEW PRODUCTS

● We remind our readers that notices of equipment listed and illustrated in this monthly feature are in no sense reviews. When figures, specifications and diagrams are published, these data are extractions from manufacturers' lists. When samples of this equipment are submitted for test, they are passed to our technical contributors, whose reports are published in a separate section.

★

### FERGUSON MODEL 3200 TWO-TRACK RECORDER

★



THE Ferguson model 3200 is a completely new tape recorder using the FTD.3 tape deck designed and built in the Ferguson factories. Priced at 26 guineas, model 3200 is a twin track single speed ( $3\frac{1}{2}$  i/s) instrument with piano-key tape controls and a 7 in. x  $3\frac{1}{2}$  in. elliptical loudspeaker. An additional feature is the provision of a "pause" key to permit temporary interruption of recording or playback.

The latest type electronic recording level indicator is employed and the volume and tone controls are provided with graduated scales to facilitate resetting. Reel diameter is  $5\frac{1}{4}$  in.—using double play tape on both tracks gives three hours playing time. Rewind time is  $2\frac{1}{2}$  minutes in either direction. Audio output is 3 watts. Input sockets are provided for microphone, radio, or pickup, and provision is made for fully compensated high-fidelity playback via external equipment if desired.

An interesting feature is that the amplifier and tape-deck are constructed as one unit, which facilitates possible servicing. The cabinet is made of preformed wood covered with P.V.C. material by a new process which avoids cuts and joins on corners. The Model 3200 is supplied complete with crystal microphone, 850 ft. reel of standard tape, take-up spool and connecting leads. Manufacturers: Ferguson Radio Corporation Ltd., Thorn House, Upper St. Martin's Lane, London, W.C.2.

★

### UHER "4000 REPORT" BATTERY RECORDER

★



UHER, well known for the production of mains operated tape recorders, have produced a two-track, four-speed portable recorder weighing only 6 lb. Known as the "Uher 4000 report" it is capable of taking spools up to 5 in. in diameter and is powered by four 1.5 v. cells or a rechargeable battery available as an extra. Operating speeds are  $7\frac{1}{2}$ ,  $3\frac{3}{4}$ ,  $1\frac{7}{8}$  and  $\frac{3}{8}$  i/s, giving a claimed frequency response of 50–22 Kc/s at the highest speed and 50 to 5 Kc/s at the slowest. Power output is rated at 1 watt, through an internal loudspeaker.

Facilities available include push-button controls; fast forward and rewind; recording level and battery life meter; low impedance microphone input; tone controls and separate recording and playback volume controls. A mains unit is available if required together with a foot-operated remote control. The size of the "4000" is 11 x 8 x 3 ins. Price: £97 13s.

The distributors are: Bosch Ltd., Domestic Appliance Division, 205 Great Portland Street, London, W.1.

TWO new recorders have been produced by Elizabethan (Tape Recorders) Ltd., both available in two- or four-track versions. The first of these is the Model LZ 30 which has three speeds:  $7\frac{1}{2}$ ,  $3\frac{3}{4}$  and  $1\frac{7}{8}$  i/s. The frequency response claimed is 50 to 14,000 c/s at  $7\frac{1}{2}$  i/s; 50 to 10,000 c/s at  $3\frac{3}{4}$  i/s and 50 to 6,000 c/s at  $1\frac{7}{8}$  i/s. Wow and Flutter figures quoted: 0.15% at  $7\frac{1}{2}$  i/s. The output from the machine is rated at 5 watts. Facilities available include mixing, separate tone control, 7 x 4 in. speaker, tape position indicator, recording level

★

### ELIZABETHAN MODEL LZ 29 RECORDER

★



indicator, two inputs and two outputs. The machine is supplied complete with crystal microphone, tape, spare spool and radio connecting lead. The price is £33 12s. (two track), £36 15s. (four track).

The second machine is the LZ 29 which is fitted with three 4-pole induction motors. The frequency response quoted is the same as for the previous model. This machine is priced at £36 15s. (two track) and £39 18s. (four track). Full details of both machines can be obtained from the manufacturers, Elizabethan (Tape Recorders) Ltd., Bridge Close, Oldchurch Road, Romford Essex.

### New Triple Play Tape from BASF

THE first to be commercially available in this country, BASF's remarkable new Triple Play Tape has been specially developed for portable and similar small-spool tape recorders. At  $1\frac{7}{8}$  i/s the new tape provides 45 minutes recording or playback time on a 3 in. spool—treble that of standard tape. Available on 3 in., 4 in. and  $4\frac{1}{2}$  in. spools holding 450, 900 and 1,200 feet respectively. Further details available from BASF Chemicals Ltd., 5a Gillespie Road, London, N.5.

### SUBSCRIPTION RATES

The subscription rate to *The Tape Recorder* is 21/- per annum (U.S.A. \$3.00) from The Tape Recorder, 99 Mortimer Street, London, W.1. Subscription + Index, 24/- (U.S.A. \$3.25).

# EQUIPMENT REVIEWED



★  
GRUNDIG  
TK40  
RECORDER  
★

**Manufacturer's Specification:** Mains voltage: 50 cycles A.C. only, 110, 200, 220, 240 volts. Power consumption: 70 Watts (approx.). Max. spool size: 7 in. (lid removed), 5½ in. (under lid). Tape speeds: 7½ i/s, 3¾ i/s and 1⅞ i/s. Running time per 1,800 ft. Grundig double play tape type TDP: 3 hrs. at 7½ i/s, 6 hrs. at 3¾ i/s and 12 hrs. at 1⅞ i/s. Fast wind: forward 3 mins. 35 secs., rewind 2 mins. 36 secs. Wow and flutter: ±0.1% at 7½ i/s, ±0.12% at 3¾ i/s and ±0.2% at 1⅞ i/s. Frequency response: 60–18,000 c/s at 7½ i/s, 60–15,000 c/s at 3¾ i/s and 60–9,000 c/s at 1⅞ i/s. Plus or minus 3 dB. Full level recording, output from high impedance socket: 1,150 mV at 7½ and 3¾ i/s and 750 mV at 1⅞ i/s. Distortion factor max: 5% at 7½ i/s, 6% at 3¾ i/s and 6.5% at 1⅞ i/s. Input sensitivities: Microphone input 2 mV. Radio/diode input 6 mV. Output power: 2.5 Watts. Loudspeaker: 4 in. × 6 in. with ceramic magnet. Hum and noise level from high impedance output: 8 mV. From low impedance output 27 mV. Weight: 27 lbs. 8 oz. Dimensions: 16½ in. × 15 in. × 7⅞ in. Type of microphone supplied: GDM18 high performance moving coil microphone. Price (including microphone): £78 15s. 0d. Manufacturers: Grundig (Great Britain) Ltd., Newlands Park, Sydenham, London, S.E.26.

THERE are so many original features in this new Grundig recorder that it is difficult to know where to begin. I think the gadget that appeals to me most is the push-button reset of the tape position indicator—a finger tip touch and the counter is set to zero—it is so easy that it becomes second nature to do it automatically at the start of each reel, so that the indicator is really used, and is not, as is so often the case, neglected because one is too lazy or forgetful to turn it back to zero each time.

A twin button at the other end of the keyboard releases a built-in tape cleaner which brushes dust and dirt from both surfaces of the tape and so prevents drop outs which tend to be more obvious on a four-track machine such as this.

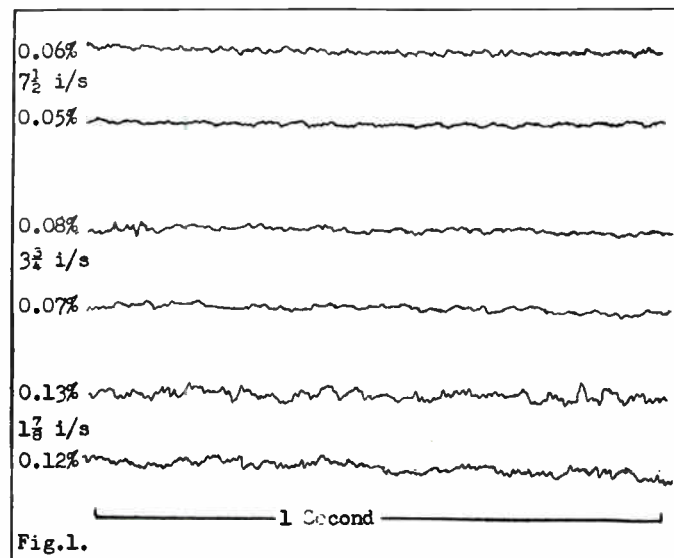

Fast forward and backward spooling of the tape is controlled by a slide lever which can also be used as an inching control for exact positioning of the tape or for editing. The piano key controls are light to the touch and yet positive in action. All tape motion controls are grouped to the left and the track selection keys are on the right. A fabric band holds the tape against the heads instead of the normal pressure pads and, as will be seen later, tape flutter caused by friction effects is low.

A new and useful innovation is to bring out the head connections to a pair of sockets so that external heads may be used for recording or replay on, for instance, a cine projector. But the application is much wider than this; other track configurations may be tried, and dubbing or copying from another deck becomes very simple.

The output from the top track is available from a socket at the rear of the machine and Grundig supply a monitor amplifier type MA2 and earphones type SE3 to synchronise a recording on the lower track with a previously recorded track. The two tracks may be played together by depressing both track keys.

### Speed Wow and Flutter

The use of a *Papst* external rotor motor ensures exact and constant speed and the machine tested was within plus or minus 0.5% of the

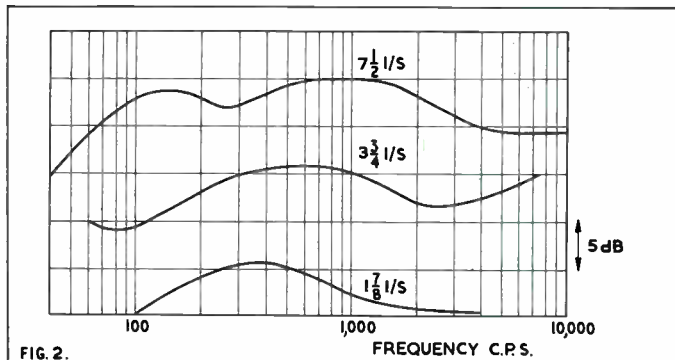

nominal speed on each of the tape speeds. Fluttergrams for the three speeds are shown in fig. 1 and it will be seen that tape motion is extremely smooth.

A word or two of explanation of the specification figures is in order at this point. The figures given are Peak deviations from the mean speed, this is indicated by the ± sign. If the wow or flutter waveform is sinusoidal, the Peak figure may be converted to *r.m.s.* by multiplying by 0.707. The specification figures thus become: 0.07%, 0.085% and 0.14% for tape speeds of 7½, 3¾ and 1⅞ i/s respectively, and reference to the *r.m.s.* readings against the fluttergram pen traces show that the measured figures are well within the specification. Friction effects are low giving little high frequency flutter, wow is completely negligible at all speeds; and only at the lowest speed of 1⅞ i/s is there the slightest trace of 25 c/s flutter from the motor shaft.

### Replay Only Response

Fig. 2 shows the playback responses from standard test tapes recorded to C.C.I.R. 100, 200 and 400 microsecond characteristics for speeds of 7½, 3¾ and 1⅞ i/s. The output was measured at the low level high impedance outlet which is used to feed an external amplifier. All responses show a tendency towards a 5 dB fall in high note response which indicates that the playback equalisation is matched to about 50, 100 and 200 microsecond recording characteristics. The bass response is also allowed to fall due to head contour effects. This means that C.C.I.R. tapes will need a touch of top and bass lift if replayed through a wide range amplifier and speaker. On the internal speaker the tone control provided has sufficient range to ensure good musical balance within the limitations of the small speaker and cabinet.

The responses of fig. 3 show that the overall record-replay response is excellent at all speeds and that bass lift applied during recording has



levelled out the low note response and that the fiercer recording pre-emphasis gives adequate high note response. On peak recording tests the magic eye record level indicator closed at 8 dB above test tape level and some waveform distortion was evident if the recording was pushed

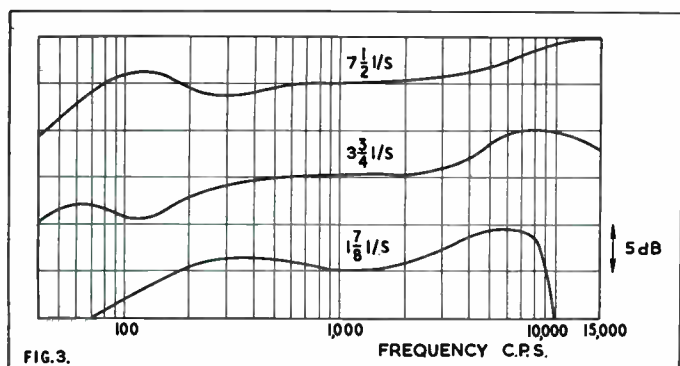

beyond this point. This indicates that the tape is slightly under biased to give the widest possible frequency response at the lower tape speeds.

#### Signal Noise Ratio

Despite the above-mentioned under biasing, the signal noise ratio is excellent, and measures 45 dB below magic eye peak when measured at line output, and 48 dB below indicator peak when measured across the L.S. outlet. Hum and noise are present in about equal proportions. Recorded noise is within 1 dB of bulk erased tape noise which proves that the bias and erase waveforms are free of even harmonic distortion.

#### Acoustic Response

As the recording characteristic used was different to that of my pre-recorded white noise test tape, a series of one-third octave noise bands were recorded on the machine and replayed into the internal speaker so that the overall electro acoustic response could be measured. The calibrated test microphone was placed one foot from the front

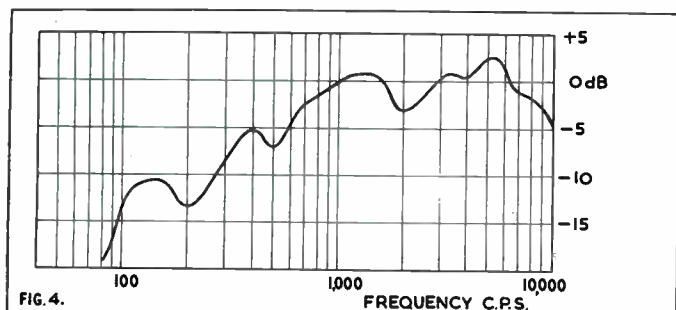

of the cabinet, on the speaker axis, and the outputs plotted to give the curve of fig. 4. The response is smooth and free of peaks but, as is usual with small speaker enclosures of this type, there was some loss of bass response.

#### Microphone Response

The microphone supplied with the TK40 is the Grundig GDM 18 which is a moving coil microphone with a high impedance output. This was also tested in the December review of the TK14 recorder. The present review gives me a chance to test a second sample and the response of fig. 5 shows a similar characteristic to the earlier one. The bass cut below 200 c/s prevents boom on voice recordings but may show up as a lack of "body" in recordings of wide range music or sound effects. High note response is smooth and clean and completely uncoloured.

**Comment:** My only criticism of this recorder concerns the very inadequate output stage provided. It is a "raw" pentode with no negative feedback to reduce third harmonic distortion or to take care of changes of speaker impedance. The result is that the quality on a wide range speaker, plugged into the low impedance output, is quite terrible. I agree that it is worth feeding a wide range speaker from a Hi-Fi amplifier which, in turn, is fed from the line output of the TK40

—but surely in a machine of this class a few more shillings should have been spent on the output stage so that it could feed a good speaker directly? Apart from this, I give this machine full marks. Its tape

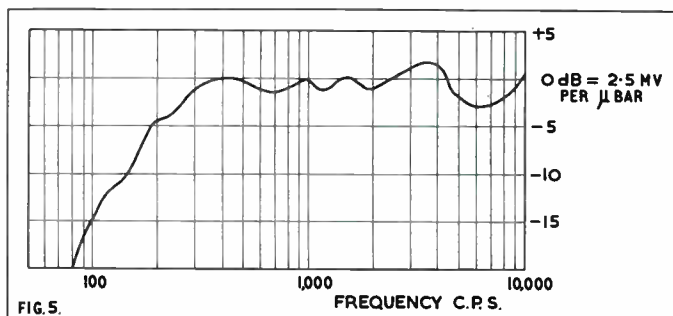

handling is quite superb and operation is beautifully simple. Every possible facility has been provided for the advanced enthusiast but the well laid-out controls and instruction book enable the verist tyro to make good recordings right away.

A. Tutchings

### ★ PHILIPS STARMAKER FOUR-TRACK RECORDER ★



**Manufacturer's Specification:** Tape speed:  $3\frac{3}{4}$  i/s. Frequency response: 80–10,000 c/s. Suitable for L.P. and D.P. tapes on 3, 4 or 5 in. spools. Four-track monaural. Maximum playing time 4 times 1 hr. (5 in. L.P. tape). Output: 1.5 Watts. Built-in 7 in. speaker. Fast winding in both directions. Mains supply: A.C. only 110, 127, 220 and 240 volts 50 cycles. Power consumption: 60 Watts. Signal to noise ratio: better than 40 dB. Wow and flutter (peak to peak): less than 1%. Transistor AC107 and valves ECC83, EL95, DM71 plus metal rectifier. Four input channels. Mic. 3,000 ohms, 0.2 millivolts. Radio (diode) 50K, 3 millivolts. Gram 2.2 megs, 130 millivolts. Gram (flat plug) 2.2 megs, 130 millivolts. Two output channels: External loudspeaker, 3–7 ohms 1.5 Watts. Radio (diode) amplifier 30K, 1 volt. Weight: 13 lbs. Size: 14 in. × 9½ in. × 4½ in. Price: £28 7s. 0d. Philips Electrical Ltd., Century House, Shaftesbury Avenue, London, W.C.2.

THIS recorder is the big brother to the Philips EL3585 and the Stella ST470 transistor portable recorders recently reviewed. The same upright styling is used to economise in table space and to provide a large flat baffle area for the internal loudspeaker. The control system also is identical and takes a lot of beating for utter simplicity and foolproof operation. The meter indicator of the portable has been replaced by an "exclamation mark" magic eye record level indicator in the larger mains model; it is sited between the record and track change buttons on the top panel of the recorder.

A transistor is used for the first stage pre-amplifier to ensure low hum and noise, but the rest of the circuit uses valves. The large

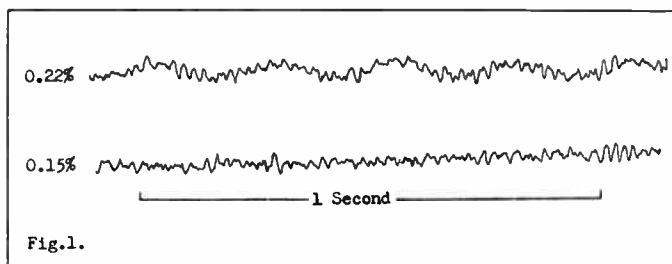

For highest  
quality equipment



at lowest  
possible prices

**HI-FI FM TUNER, Model FM-4U**

Available in two units which for your convenience are sold separately: Tuning unit (FMT-4U—£3 2s. incl. P.T.), despatched wired and tested, and I.F. amplifier (FMA-4U—£11 11s.). Printed circuit for I.F. amplifier and ratio detector. Built-in power supply; 7 valves. Tuning range 88-108 Mc/s. (Illustrated bottom right). Total price **£14.13.0**

**HI-FI AM/FM TUNER, Model AFM-1**

Also available in two units as above: Tuning heart (AFM-TI—£5 5s. 6d. incl. P.T.) and I.F. amplifier (AFM-AI—£19 8s.). Printed circuit board; 8 valves; consecutive FM limiting and ratio detector. Tuning range FM: 88-108 Mc/s; AM: 16-50, 200-550, 900-2,000m. Switched wide and narrow AM bandwidth. Built-in power supply. Total price **£24.13.6**

**TO ALL MUSIC LOVERS AND  
HI-FI ENTHUSIASTS**

*Our wide range does not permit adequate coverage of all models. A FREE CATALOGUE and full specifications of any particular model will be gladly sent on request without obligation on your part. ASSEMBLED MODELS NOW AVAILABLE. PRICES ON REQUEST.*

*All prices include free delivery in U.K. Deferred terms available on orders over £10.*

**Tape Recording and Replay Hi-Fi Amplifiers  
Models TA-IM (Mono) and TA-IS (Stereo)**

For use with most tape decks. Thermometer type recording indicators, press-button speed compensation and input selection, 3-position bias level and printed circuit construction.

TA-IM ... ..	£18. 2.6
TA-IM and Collaro "STUDIO" ...	£30.10.0
TA-IM and Truvox D83 ...	£47.2.6
TA-IM and TRUVOX D84 ...	£45.5.0
TA-IS (illustration Centre) ...	£23. 6.0
TA-IS and Collaro "STUDIO" ...	£35.14.0
TA-IS and TRUVOX D83 ...	£52.6.0
TA-IS and TRUVOX D84 ...	£50.9.6

A WHOLE RANGE OF PACKAGED DEALS (INCLUDING "CONNOISSEUR CRAFTSMAN" TURNTABLE and DECCA floss PICK-UP) NOW AVAILABLE TO SAVE YOU FURTHER MONEY.

**HI-FI EQUIPMENT CABINETS**

A range of equipment cabinets is now available to meet the differing needs of enthusiasts. All are accurately machined for ease of assembly and left "in the white" for finish to personal taste. Designed for maximum operating convenience or for where room space is an overriding consideration, this range has at least one model to meet your requirements. Why not send for full details?



**THE "MALVERN"**

**£11.12.6 to £18.10.0**

**"COTSWOLD" HI-FI FREE SUSPENSION  
SPEAKER SYSTEM**

This is an acoustically designed enclosure 26 in. x 23 in. x 14½ in. housing a 12 in. bass speaker with 2 in. speech coil, elliptical middle speaker together with a pressure unit to cover the full frequency range of 30-20,000 c/s. Capable of doing justice to the finest programme source, its polar distribution makes it ideal for really Hi-Fi Stereo. Delivered complete with speakers, cross-over unit, level control. Tygan grille cloth, etc. All parts pre-cut and drilled for ease of assembly and left "in the white" veneered for finish to personal taste. Can be easily assembled in an evening and you then have a system fully comparable with any in the £40-£75 class. Assembled weight 61 lb. **£21 19s. 0d.**



**COTSWOLD**

**Here are some other easy-to-build Heathkit Models for you:**

**HI-FI SPEAKER SYSTEM Model SSU-1.** This kit is easily assembled. It contains twin speakers and balance control in its direct ducted port reflex cabinet. It is equally suitable for stereo or mono in average room. (Legs £1 1s. 0d.) Less legs. **£10 14s. 0d.**

**HEATHKIT ELECTRONIC WORKSHOP KIT, Model EW-1.** This new kit will help your boy to understand electronics, by making at least 20 exciting experiments, including Transistor Radios, Intercom Sets, Burglar Alarm, Electric Eye, etc. **£7 18s. 0d.**

**HI-FI STEREO 6-WATT AMPLIFIER Model S-33.** Attractively styled, completely self-contained. Printed circuit makes it easy to build. Only 0.3% distortion at 2½ W/chal. U/I output, ganged controls. **£12 8s. 6d.**

**AUDIO SIGNAL GENERATOR Model AG-9U.** Delivers up to 10 volts pure sine-wave (less than 0.1% distortion, 20 c/s to 20 kc/s). Decade switch-selected frequencies from 10 to 100,000 c/s. Internal 600 Ohm N/I load, or external. **£19 19. 6d.**

**POWER AMPLIFIER 12-WATT Model MA.12.** Single channel, ideal for stereo conversion. **£10 19s. 6d.**

**LOW INPUT HI-FI STEREO PRE-AMPLIFIER Model USP-1.** An input of 2-20 mV will produce an output adjustable from 20 mV to 2 volts. This enables low-input p.u.'s, etc., to load fully subsequent amplifiers of medium sensitivity. Negligible distortion. **£6 17s. 6d.**

**COLLARO "STUDIO" TAPE DECK.** Two tracks. "Wow" and "flutter" not greater than 0.15% at 7½ p.s. Long Term Speed Stability better than 0.5%. **£17 10s. 0d.**

**SUGDEN MOTOR UNIT "CONNOISSEUR CRAFTSMAN".** Heavy duty motor, operating at 33½ and 45 r.p.m. Very heavy 12" turntable. **£18 3s. 6d.**

**COMPLETE MATCHED STEREO OUTFIT, including RP-1U Record Player (until supplies are exhausted), S-33 Stereo Amplifier and SSU-1 Twin Speaker Systems. Pedestal Speaker legs £2 2s. optional extra. £44 9s. 0d.**

**HI-FI STEREO 18-WATT AMPLIFIER Model S-99.** within its power rating, this is the finest stereo amplifier available, regardless of price. U/L push-pull output. Printed circuit construction. **£26 19s. 0d.**

**TRANSISTOR INTERCOM, Models XI-1U and XI-1U.** Ideal for office or home. Each Master operates up to five Remotes. 9v battery operated. XI-1U **£10 15s. 6d.** XI-1U **£4 3s. 0d.**

**STEREO CONTROL UNIT Model USC-1.** A deluxe stereo control unit with variable filter, switched rumble filter, printed circuit boards and many other refinements. Operates direct from tape heads. **£18 18s. 6d.**

**TRANSISTOR PORTABLE RADIO Model UXR-1.** Superbly styled hide case, with golden relief and crystal easy-to-tune dial; this completely self-contained 6-transistor dual-wave set performs brilliantly everywhere, even in a car. Reproduction is exceptionally good. Printed circuit. **£14 3s. 0d.**

**SHORTWAVE TRANSISTOR PORTABLE Model RSW-1** Four wave-band seven transistor portable with telescopic and ferrite aerials, slow-motion tuning. Covers Medium, Trawler, and 6-26 Mc/s in four switched bands. Uses printed circuit board and latest circuit technique. Superbly styled leather case. **£21 6s. 0d.**

**TRUVOX D83 AND D84 TAPE DECKS.** High quality mono/stereo Tape Decks. D83 2-track for highest-fidelity. **£31 10s. 0d.** D84 (identical presentation) 4-track for most economical use of tape. **£29 8s. 0d.**

**"MOHICAN" GENERAL COVERAGE RECEIVER Model GC-1U.** Fully transistorised. Four piezo-electric transmitters. To overcome the problems of alignment, etc., the R.F. "front end" is supplied as a pre-assembled and pre-aligned unit. **£38 15s. 0d.**

**GOLDRING-LENCO TRANSCRIPTION RECORD PLAYER Model G.L.58.** Fitted with the G.60 pick-up arm, it has infinitely variable speed adjustment between 33½ and 80 r.p.m. and four fixed speeds. 3½ lb. turntable to reduce rumble, "wow" and "flutter". **£19 12s. 6d.**

**SOME OTHER HEATHKIT MODELS AVAILABLE**

World's largest-selling VALVE VOLTMETER ... ..	Model V-7A	£13.0.0
G/P OSCILLOSCOPE (5 in. Flat-face screen) ... ..	Model O-12U	£36.10.0
"HAM" TRANSMITTER ... ..	Model DX-40U	£32.10.0
VARIABLE FREQUENCY OSCILLATOR ... ..	Model VF-1U	£11.2.0
TRANSISTOR RADIO for the youngsters ... ..	Model UJR-1	£2.13.6
RESISTANCE/CAPACITANCE BRIDGE ... ..	Model C-3U	£8.6.6
AUDIO VALVE MILLIVOLTMETER ... ..	Model AV-3U	£13.18.6
AUDIO WATTMETER ... ..	Model AW-1U	£14.14.0

**DAYSTROM LTD. DEPT. HT7  
GLOUCESTER, ENGLAND**

A member of the Daystrom Group, manufacturers of  
**THE LARGEST-SELLING ELECTRONIC KITS IN THE WORLD**



**SSU-1**



**S-33**



**AG-9U**



**MA-12**



**USP-1**



**USC-1**



**TA-IS**



**TRUVOX D83**



**STUDIO**



**S-99**



**UXR-1**



**RSW-1**



**GL-58**



**F.M. TUNER**

JUST POST THIS COUPON FOR FURTHER INFORMATION

Without obligation please send me

★ **FREE BRITISH HEATHKIT CATALOGUE ...**  TICK HERE

**FULL DETAILS OF MODEL(S) ...**

Kindly write below in BLOCK CAPITALS

NAME .....

ADDRESS .....

HT7



## EQUIPMENT REVIEWED—(continued)

6½ in. speaker, which is adequately baffled by the flat shallow cabinet, gives a forward completely uncoloured tone quality which is a welcome change to the boxed-in sound of so many table model recorders. In fact I would go so far as to say that this is about the only recorder with a built-in loudspeaker to which I have been able to listen for long periods without fatigue and without looking around for a wide range

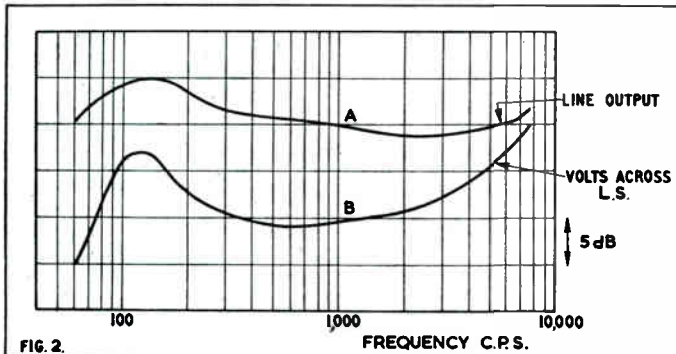

FIG. 2.

extension speaker. This does not mean that the sound output from this little machine is equivalent to that of a super hi-fi system, but it is pleasant to listen to and free of obvious faults.

### Wow and flutter

This manufacturer's specification gives still another variation on the theme of how to define short-term speed variations. This time it is "Less than 1% peak to peak". To convert to our usual *r.m.s.* figure we must multiply by  $\sqrt{2/2}$  or 0.35 to give the most pessimistic reading, where the wow or flutter waveform is sinusoidal; if the waveform is peaky, then the Root Mean Square reading may be lower. Thus we hope for something less than 0.35% *r.m.s.* and the fluttergrams of fig. 1 show our hopes to be justified. The worst reading obtained was

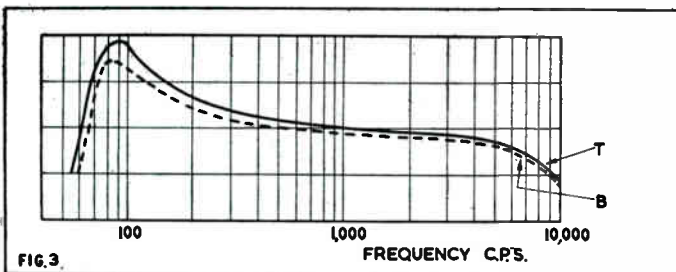

FIG. 3.

0.22%, when the five cycle capstan wow was in phase on record and playback, and was down to 0.15% when they were out of phase and cancelling. The flutter was pretty random with a slight 50 c/s flutter coming up occasionally from the 3,000 r.p.m. motor.

The slight capstan wow could be heard on a sustained pure tone, but it was not audible on any of the musical programmes recorded on this machine.

### Play Only Response

Fig. 2A shows the playback responses from a 200 microsecond test tape at the line output, and fig. 2B that across the Ext.L.S. sockets with the internal loudspeaker working. The lower curve reflects the impedance curve of the loudspeaker and shows that a nearly constant current is maintained through the voice coil by the use of an uncorrected pentode output stage. Thus a wide range speaker should be fed through an external hi-fi amplifier from the line output of the recorder.

### Record Replay Response

The overall record replay responses on the two tracks are shown in fig. 3. The bass rise improves the quality on the internal speaker, but it can make the reproduction a trifle heavy when the line output is fed to a hi-fi system. The uniformity of the two tracks is excellent and they were both exactly on azimuth.

A recording 15 dB above test tape level could be made without distortion and this indicates that the bias has been properly chosen

(Continued on page 267)

## — TAPE TO DISC SERVICES —

The following are members of the Association of Professional Recording Studios who can be relied on to give satisfaction

### MJB RECORDING & TRANSCRIPTION SERVICE

specialise in the production of microgroove records from Professional and Amateur recording; (Acetate copies; Processing Masters and Pressings at 16½, 33½ & 45 r.p.m.) Extended playing times achieved by controlled cutting. Editing, Label printing, Mobile and "Off the Air" Services.  
7 HIGH STREET, MAIDENHEAD (Tel: 230)

TAPE RECORDERS · AUDIO EQUIPMENT · DISC CUTTING STD & LP FROM TAPE · STUDIO FACILITIES · HIRE SERVICE · SALES · EXCHANGES

### MAGNEGRAPH

1 Hanway Place, London, W.1

Tel: LAN 2156

### RAPID RECORDING SERVICE

78s & LPs from your own tapes

Master Discs and pressings

Recording Studio equipped with Bechstein Grand Mobile Recording Van—"Off the Air" Service

Practising studios with or without accompanist  
21 Bishops Close Church Lane, E.17 COP 3889

## — YOUR TAPE DEALER —

Specialists in Hi-Fi Equipment and Tape Recorders

### CHELSEA RECORD CENTRE

203 KINGS ROAD, S.W.3 FLA 2596

Open till 8 p.m. (except Thursdays)

Disc and Tape Reproducing Equipment and Tape Recorders by Leading Manufacturers

CUSTOM BUILT INSTALLATIONS

All High Fidelity Requirements and Services Available

Estimates Free

Personal Service

### Custom High Fidelity

371 Green Lanes, Palmers Green, London, N.13

Tel. PALmers Green 5228

# hifi

FOR ALL LEADING AUDIO EQUIPMENT

call, write, or telephone

hampstead HIGH-FIDELITY

91a Heath Street, Hampstead, London N.W.3 Telephone HAMpstead 6377

# LASKY'S RADIO

ALL LEADING MAKES IN STOCK

Cash or Easy Terms

LONDON'S FINEST SERVICE

207 EDGWARE ROAD, W.2

PAD 3271/2

33 TOTTENHAM COURT ROAD, W.1 MUS 2605

# FREE H.P!

**YOU PAY CASH  
PRICE ONLY—NO  
INTEREST CHARGES**



**WE HAVE THE BIGGEST SALES IN THE COUNTRY! WHY?  
BECAUSE WE GUARANTEE YOU THE BEST TERMS.**

*Including:*

DEPOSITS FROM ONLY 10% ★ UP TO 2 YEARS TO PAY ★ BIG FREE TAPE OFFERS TO CUSTOMERS ★ 12 MONTHS FREE SERVICING—NO LABOUR CHARGES ★ FREE DELIVERY ANYWHERE IN U.K. ★ NO PURCHASE TAX ★ COMMISSION PAID ON SALES YOU MAKE FOR US ★ 15% INTEREST PAID ON YOUR DEPOSIT ★ FULL INSURANCE COVER ON ALL H.P. SALES ★ *and lots more besides.*

As THE APPOINTED MAIN AGENTS for ALL the best makes, our Mail Order Department specialises in orders by post with thousands of sales throughout the whole of England, Scotland, Wales & N. Ireland—order from us wherever you live—You get cheaper terms, faster delivery, better service from us.

Nearly 500 machines in stock—dozens of different mains, battery & stereo models on permanent demonstration in our showrooms.

**Open to 8 p.m. FRIDAYS & 6 p.m. SATURDAYS.**

*If you want proof of how you can actually save money by buying from us, write, phone or call in NOW for free brochures and full details of our terms:*

# HOWARD TAPE RECORDERS

218 HIGH STREET, BROMLEY, KENT. RAVensbourne 4477 & 4000



## EQUIPMENT REVIEWED—continued

for clean quality rather than for a very extended frequency response. Nevertheless the extremely narrow gap heads show a good response up to at least 10 Kc/s with practically no top lift in the playback amplifier.

### Signal Noise Ratio

Noise and hum were -32 dB below test tape level on both tracks. If allowance is made for the 12 dB margin between test tape level and tape overload, we get a figure of 44 dB which is excellent for a four-track machine in this price range.

### Acoustic Response

The overall acoustic response was measured by feeding one-third octave bands of white noise into the radio input socket and measuring

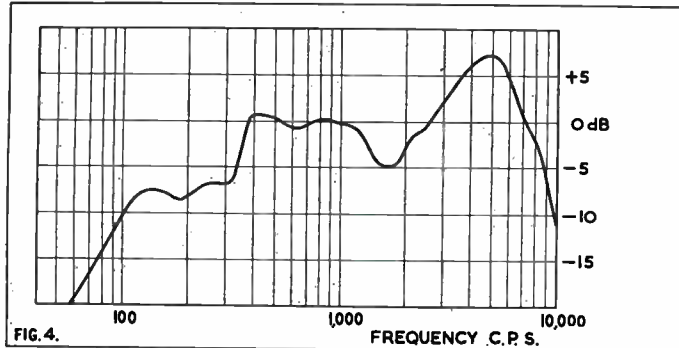

the sound output during replay of the recorded tape. The response of fig. 4 shows that a useful acoustic output is maintained down to 100 c/s with a slightly tilted response up to about 6 Kc/s.

### Microphone Response

The microphone response was measured, fig. 5, and found to be quite satisfactory for good voice recording.

The output impedance is low to suit the transistor input stage.

**Comment:** I demonstrated this recorder to a number of other tape enthusiasts and, without exception the comment was: "Doesn't it

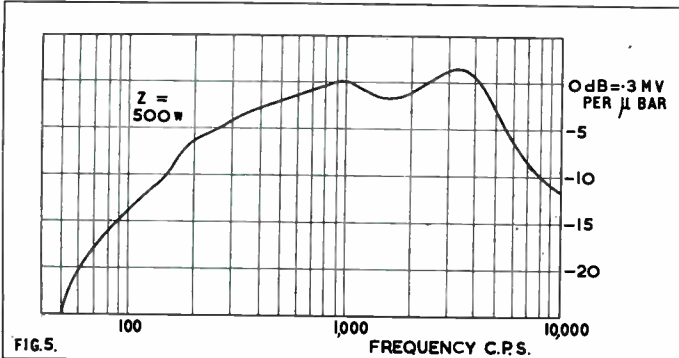

sound clean." I think this is a refreshing change from: "Listen to the high note response"—some of which was never heard in the studio!

Perhaps, with the aid of this recorder, we might bury the frequency response boggy and concentrate on clean sound for a change—I sincerely hope so!

A. Tutchings

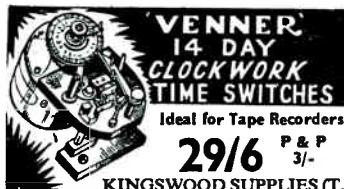

**AUTOMATIC CONTROL** over radio and/or tape recorder. Will switch ON/OFF or OFF/ON once every 24 hours at any manually pre-set time. Minimum time lapse 30 minutes. It has a current rating of 1 amp sufficient to carry radio and/or tape recorder. Complete with key and mounting bracket. Used but in perfect condition. Fully guaranteed.

KINGSWOOD SUPPLIES (T.R.2), 4 Sale Place, London, W.2. PAD 8189

## YOUR TAPE DEALER

LEONARD G. FRANCIS PRESENTS . . .

### SHEEN TAPE RECORDER CENTRE LTD.

SPECIALISTS IN TAPE RECORDERS AND ACCESSORIES, ETC.,  
YOUR CENTRE FOR FRIENDLY HELP—SALES AND SERVICE

8 STATION PARADE,  
SHEEN LANE, SHEEN,  
LONDON, S.W.14

Showrooms Open until 7 p.m.  
PROSPECT 0985  
(Next to Mortlake Station S.R.)

## Country and Provincial

BOURNEMOUTH

### NATIONAL RADIO SUPPLIES

66 Holdenhurst Road,  
Bournemouth

Tape, Hi-Fi & components

Tel. 25232

H. D. KIRK

*Stereolectrics*  
LIMITED

Specialists in High Fidelity  
150 HIGHER BRIDGE STREET

Phone: 23093

BOLTON

R.E.S. (COVENTRY) LTD.

### SPECIALISTS IN HIGH FIDELITY and all makes of Tape Recorders

All leading makes of High Fidelity Equipment stocked and demonstrated under ideal conditions. ★ *The Best Selection—Terms and After Sales Service in the MIDLANDS.*

R.E.S. (Coventry) Ltd. 128 Far Gosford St. Coventry 28781/2

COVENTRY

### RECORD & HI-FI CENTRE

19 SMITHFORD WAY, COVENTRY - Phone 21561

TAPE RECORDER & HIGH FIDELITY SPECIALISTS  
PART EXCHANGES TERMS

EXETER—DEVON

**FILDEWS**

99 FORE STREET

EXETER

PHONE: 74161/2

We cover the whole of Devon—Dorset—Cornwall and West Somerset with Tandberg—Brenell—Phillips—Grundig, Tape Recorders etc. Main Ferrograph distributors for area.

FARNHAM, SURREY

- ★ Stockists of all the leading makes of High-Fidelity Equipment
- ★ Comparative Demonstrations
- ★ Cabinet Manufacturers and Designers
- ★ Personal service and satisfaction guaranteed
- ★ Specialists in custom-built Hi-Fi Equipment

**LLOYD & KEYWORTH LTD, The Record Shop**

26/7 Downing Street, Farnham, Surrey. Telephone: Farnham 5534  
SURREY AND HAMPSHIRE'S HI-FI DEALERS

### TAPE RECORDER CENTRE (HALIFAX)

Stock all the best Tape Recorders; Hi-Fi Equipment;  
Tape; L-P Records, etc.

DEMONSTRATIONS DAILY BY EXPERT STAFF  
2 years FREE SERVICE ON NEW RECORDERS over £35

30 King Cross Street, Halifax.

'phone 66832

CLASSIFIED ADVERTISEMENTS — (continued)

For Sale

**American recording tape** 1,800 ft. LP. 7 in. Boxed. 24s. 6d. Lots of 4 90s. Money back guarantee. Trade enquiries invited.—Zodiac Ltd., 19 Gerrard Street, W.1.

**Make the most of your recorder.** List of tape libraries send for s.a.c.—D. O. French, 136 Tollington Park, N.4.

**American Pre-Recorded Tapes supplied.** Send 3s. 6d. for current catalogue, all makes.—Imported Records, 42 Broadway, London, S.W.1.

**Minivox C battery** 2 speeds, with Mains Unit. Cost 30 gns. One year old, 19 gns. Bargain. Box No. (London) 294.

**Stern's Mullard Type "C"** tape pre-amplifier with power pack suitable for Wearite-Collaro-Truvox. Perfect order hardly used, £10. Box No. (London) 295.

**Lee Electronics offer** famous manufacturer's zipped waterproof canvas Tape Recorder Covers, complete with microphone compartment at half retail prices. Send for comprehensive lists: 400 Edgware Road. Tel.: PADDington 5521.

**Butoba MT 5.** Few months old, complete with Mains Unit, mic., leads, covers and batteries, offered at  $\frac{2}{3}$  list price. Ten tapes included free. Also **50 Pre-recorded Tapes**, unused and in manufacturer's boxes, mainly classical, at 7½ i/s. Original cost 35s. to 50s. each. For quick sale, 21s. each or 5 for £5. Offers invited for the 50. Hardinge, "Pin-jarra" Pinewood Grove, New Haw, Weybridge, Surrey.

**Your choice of tape equipment**, or pre-recorded tapes offered in exchange for items connected with pre-1929 motoring books, magazines, photographs, accessories, even complete cars. J. Berry, 88 Westfields Avenue, London, S.W.13.

**Annual Bargain Sale of Tape Recorders.** Telefunken Model 85, list price over £80. One only, slightly shop soiled, but otherwise unused, reduced to £45. One Fi-Cord Portable Recorder, reduced from 59 gns. to 32 gns. H.M.V. Voicemaster Recorder, brand new, but slightly shop soiled, reduced to £52. Also other Tape Recorder bargains at—Lancs Hi-Fi Ltd., 8 Deansgate, Manchester. (For readers living in Yorkshire, we can bring these over to our depot at—16 Ivegate, Bradford, 1.)

**"Tape Recorder"**, clean; 1959 Sept., Nov., Dec.; all 1961-1962. 2s. each. S.A.E. please. D. Northcott, 12 York Street, Penzance, Cornwall.

**Vols. 1, 2, 3, "Tape Recorder"**. In Binders and Index. Vol. 4 "Hi-Fi News" Binder and Index. all good condition, 36s. each includes p.p. Mr. R. Waddington, 72 Thomson Avenue, Balby, Doncaster.

**Unusual American L.P.s and Pre-recorded Tapes.** Ben Charles, 480 Muswell Hill, Broadway, London, N.10.

**Tape Recorders.** Save from 30 per cent. to 60 per cent. on the original price. Large stock of secondhand, new, shop soiled machines. All guaranteed. Obtainable on our No Interest Terms. Best part exchange allowances on your existing equipment. Call, write, 'phone today for free list. Quotation and details. Our mail order covers the whole country. R. E. W. Earlsfield Ltd., 266 Upper Tooting Road, London, S.W.17. Balham 7710.

**All issues "Tape Recorder"** except Vol. 1 no. 12. Good condition. Offers: Macdougall, 185 Crofthill Road, Glasgow, S.4.

**Fi-Cord 1A**, mic., battery charger, tapes, as new, £40. Palmer, 4 Cotswold Crescent, Chelmsford, Essex.

**Vortexion WVA**, Grampian mic., £70. Fi-Cord 1a, Grampian, £45. Both immaculate condition. Williams, CUN 9608 evenings.

Tape to Disc

**Tape/Disc/Tape transfer, editing, duplicating.** If quality and durability matter (especially with L.P.s from your precious tapes) consult Britain's oldest transfer studio. Recording equipment supplied with home maintenance guarantee. Generous part-exchange. 48-page photographically illustrated Hi-Fi catalogue 2s. 6d. 1,800 branded tapes 30s. Sound News, 10 Clifford Street, London, W.1.

**Tape to Disc service, editing, and dubbing**, all speeds. Studio available for musical groups. Outside recordings our speciality. Ilford Sound Recording Service, 63, Aintree Crescent, Barkingside, Ilford, Essex. Telephone: CRE 8947 and GRA 5107.

**Tape to disc recording service.** All speeds. 50 minute L.P.s. Photographic sleeves with all recordings.—E.R.S., 162 Shirland Road, London, W.9.

Miscellaneous

**Large Mobile Service Force** in England and Wales operated as an insurance policy by major electronic group has surplus effort to undertake additional contract maintenance commitments. Replies in confidence to—Box 836, Granthams Advertising, Reading.

**Immediate capacity available for Coil Winding.** Assembly and Wiring of Electronic Equipment, Prototypes.—Olson Electronic Limited, 54 Myddelton Street, London, E.C.1. TER 8081.

DO YOU SPLICE TAPE?



HOW TO SPLICE TAPE

★ If you use tape, sooner or later you will need to know how to splice tape—how to repair simple or complicated breaks—how to edit your material—how to cut out words or syllables, etc. All this is described in this well-illustrated booklet, in which stage-by-stage photos and text provide the complete answer to professional tape splicing.

Price 2/6 . . . Postage paid

THE TAPE RECORDER

99 Mortimer Street, London, W.1

ADVERTISERS' INDEX

	Page
Audio	260
B.A.S.F. Chemicals Ltd.	272
A. Brown & Sons Ltd.	258
Chelsea Record Centre	258
City & Essex Tape Recorder Centres	231
Elstone Electronics Ltd.	271
E.M.I. Records Ltd.	252
E.M.I. Tape Ltd.	234
Film Industries Ltd.	254
Francis of Streatham	254
Garrard Engineering and Manufacturing Co. Ltd.	230
Gevaert Ltd.	256
Heathkit	264
Hi-Fi Year Book	233
Hi-Fi Books	257
Howard Tape Recorders	266
Ilford Sound Recording Service	256
Kingswood Supplies	267
M.S.S. Recording Co.	236
Northgate (Cameras) Ltd.	244
Nusound Recording Co.	258
R. E. W. Earlsfield Ltd.	269
The Recorder Co.	271
Reeves Sound Service	256
Tape Recorder Centre Ltd.	248
Tellux Ltd.	232
Valradio Ltd.	258
D. Villiers	260
N. Walker	256
Wellington Acoustic Lab. Ltd.	268
Bmm. Magazine	242



## EQUIPMENT REVIEWED—continued

for clean quality rather than for a very extended frequency response. Nevertheless the extremely narrow gap heads show a good response up to at least 10 Kc/s with practically no top lift in the playback amplifier.

### Signal Noise Ratio

Noise and hum were -32 dB below test tape level on both tracks. If allowance is made for the 12 dB margin between test tape level and tape overload, we get a figure of 44 dB which is excellent for a four-track machine in this price range.

### Acoustic Response

The overall acoustic response was measured by feeding one-third octave bands of white noise into the radio input socket and measuring

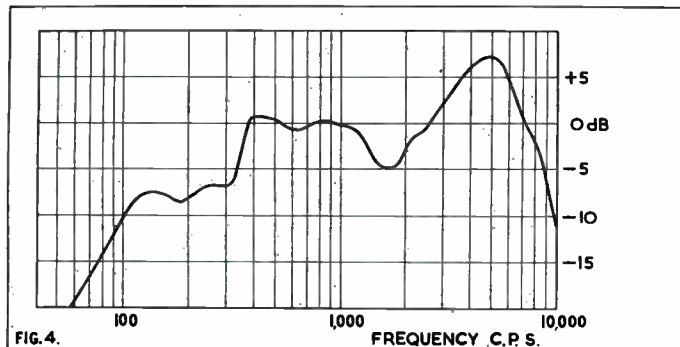

the sound output during replay of the recorded tape. The response of fig. 4 shows that a useful acoustic output is maintained down to 100 c/s with a slightly tilted response up to about 6 Kc/s.

### Microphone Response

The microphone response was measured, fig. 5, and found to be quite satisfactory for good voice recording.

The output impedance is low to suit the transistor input stage.

**Comment:** I demonstrated this recorder to a number of other tape enthusiasts and, without exception the comment was: "Doesn't it

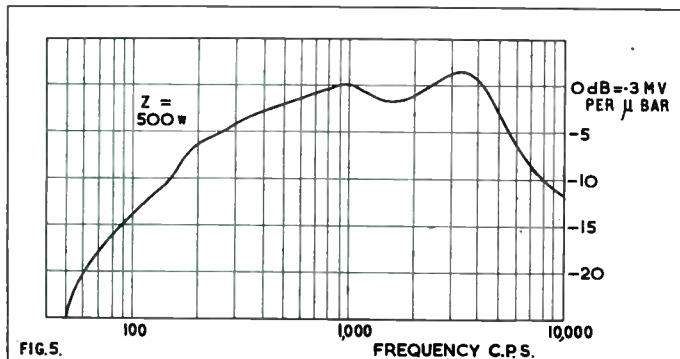

sound clean." I think this is a refreshing change from: "Listen to the high note response"—some of which was never heard in the studio!

Perhaps, with the aid of this recorder, we might bury the frequency response boggy and concentrate on clean sound for a change—I sincerely hope so!

A. Tutchings



AUTOMATIC CONTROL over radio and/or tape recorder. Will switch ON/OFF or OFF/ON once every 24 hours at any manually pre-set time. Minimum time lapse 30 minutes. It has a current rating of 1 amp sufficient to carry radio and/or tape recorder. Complete with key and mounting bracket. Used but in perfect condition. Fully guaranteed.

## YOUR TAPE DEALER

LEONARD G. FRANCIS PRESENTS . . .

### SHEEN TAPE RECORDER CENTRE LTD.

SPECIALISTS IN TAPE RECORDERS AND ACCESSORIES, ETC.,  
YOUR CENTRE FOR FRIENDLY HELP—SALES AND SERVICE

8 STATION PARADE,  
SHEEN LANE, SHEEN,  
LONDON, S.W.14

Showrooms Open until 7 p.m.  
PROSPECT 0985  
(Next to Mortlake Station S.R.)

## Country and Provincial

BOURNEMOUTH

### NATIONAL RADIO SUPPLIES

66 Holdenhurst Road,  
Bournemouth

Tape, Hi-Fi & components

Tel. 25232

H. D. KIRK

*Stereoelectrics*  
LIMITED

Specialists in High Fidelity  
150 HIGHER BRIDGE STREET

Phone: 23093

BOLTON

R.E.S. (COVENTRY) LTD.

### SPECIALISTS IN HIGH FIDELITY and all makes of Tape Recorders

All leading makes of High Fidelity Equipment stocked and demonstrated under ideal conditions. ★ *The Best Selection—Terms and After Sales Service in the MIDLANDS.*  
R.E.S. (Coventry) Ltd. 128 Far Gosford St. Coventry 28781/2

COVENTRY

### RECORD & HI-FI CENTRE

19 SMITHFORD WAY, COVENTRY - Phone 21561

TAPE RECORDER & HIGH FIDELITY SPECIALISTS  
PART EXCHANGES TERMS

EXETER—DEVON

**FILDEWS**

99 FORE STREET

EXETER

PHONE: 74161/2

We cover the whole of Devon—Dorset—Cornwall and West Somerset with Tandberg—Brenell—Phillips—Grundig, Tape Recorders etc. Main Ferrograph distributors for area.

FARNHAM, SURREY

- ★ Stockists of all the leading makes of High-Fidelity Equipment
- ★ Comparative Demonstrations
- ★ Cabinet Manufacturers and Designers
- ★ Personal service and satisfaction guaranteed
- ★ Specialists in custom-built Hi-Fi Equipment

**LLOYD & KEYWORTH LTD, The Record Shop**

26/7 Downing Street, Farnham, Surrey. Telephone: Farnham 5534  
SURREY AND HAMPSHIRE'S HI-FI DEALERS

### TAPE RECORDER CENTRE (HALIFAX)

Stock all the best Tape Recorders; Hi-Fi Equipment;  
Tape; L-P Records, etc.

DEMONSTRATIONS DAILY BY EXPERT STAFF  
2 years FREE SERVICE ON NEW RECORDERS over £35

30 King Cross Street, Halifax.

phone 66832

## — YOUR TAPE DEALER —

### LEICESTER

#### ALL YOUR HI FI REQUIREMENTS

Speakers by: H.M.V. QUAD LEAK ROGERS  
TANNOY MORDAUNT LOWTHER W.B.  
WHARFEDALE GOODMANS.  
Tape: FERROGRAPH REFLECTOGRAPH GRUNDIG  
SIMON BRENNELL.  
Record Department: ALL LABELS-PARASTAT SERVICE.  
LEICESTER CO-OPERATIVE SOCIETY LIMITED, High Street, Leicester. Tel: 20431

### MANCHESTER

See the sound SPECIALISTS for your New Tape Recorder  
Stockists of FERROGRAPH, PHILIPS, BRENNELL,  
GRUNDIG and other well-known makes  
LANCASHIRE HI-FI LTD.  
Home Music Centre — 8 DEANS GATE  
(near Grosvenor Hotel) MANCHESTER

## TAPE RECORDERS and HI-FI

The Largest Electrical store in the North



158, NEW BRIDGE STREET,  
NEWCASTLE UPON TYNE 1  
Telephone: 29866

## WESTWOOD'S of OXFORD

46 GEORGE STREET  
PHONE: 47783

PETERBOROUGH, NORTHANTS

Tel: 5545

### CAMPKINS RECORD SHOP

RECORD TAPE AND HI-FI EQUIPMENT SPECIALISTS

NEW ADDRESS

15 LONG CAUSEWAY  
(IN CITY CENTRE)

LARGE STOCKS

## HAMILTON ELECTRONICS

HIGH FIDELITY TAPE RECORDERS 35 LONDON ROAD

TEL. 28622

SOUTHAMPTON

SOUTHAMPTON—SALISBURY

- ★ All the best makes of Tape Recorders
- ★ Hi-Fi Systems and Records
- ★ Expert knowledge and advice

The West of England High Fidelity Specialists

J. F. SUTTON 421 SHIRLEY ROAD, SOUTHAMPTON  
15-18 QUEEN STREET, SALISBURY

WORTHING, SUSSEX

We stock Hi-Fi Equipment by Leak, Quad, Goodsell, RCA, Acos, Garrard, Collaro, Tannoy, Wharfedale and Goodman and give fully comparative Demonstrations

**BOWER & WILKINS LTD.**

1 Becket Bldgs., Littlehampton Road Worthington 5142

## CLASSIFIED ADVERTISEMENTS

Advertisements for this section must be pre-paid and accompanied by a postal order, money order, or cheque. The rate is 6d. per word with a minimum charge of 7/6d. Box numbers may be used for an extra charge of 1/6d. The trade rate is 9d. per word, plus 2s. for a box number, conditions on application. Send replies to box numbers, c/o "The Tape Recorder", 99 Mortimer Street, London, W.1.

No responsibility will be accepted by the editor, the publishers, or the printers of The Tape Recorder for the quality of any goods offered, bought, or exchanged through the medium of these columns, or for any failure in payment, etc., though the greatest care will be taken to ensure that only bona fide advertisements are accepted.

All advertisements for the August issue must arrive not later than July 3rd.

For Sale

#### SPECIAL OFFER

4 copies only for fully-bound editions of "The Tape Recorder" Volume 2, February 1960 to January 1961 individually hand-stitched and covered in black buckram, gold-blocked on spine. Perfect condition originally 46s. now offered at 35s. Post free 99, Mortimer Street, London, W.1.

At Electrical and Radio Supplies, 29 New Street, St. Neots, Huntingdon, your Tape Recorder and Hi-Fi repairs receive the personal attention of the proprietor, D. G. Frost, Assoc. Brit. I.R.E. Telephone: St. Neots 236.

Ferrograph 422 and 4 A/N always in stock ready for immediate delivery and demonstration. City & Essex Tape Recorder Centres. See page 231.

Pre-recorded tapes. Unique complete catalogue listing all makes, mono, stereo. 7½ and 3½ i/s including World Record Club tapes. Call for free copy or send 1s. mailing fee. Dept. T.R.3 Teletape Ltd., 33 Edgware Road, W.2 PAD 1942.

Recording Tape. Save up to 30%. Send for list. Also 50 second-hand Recorders in stock. E. C. Kingsley & Co., 132 Tottenham Court Road, London, W.1. EUS 6500.

Ask your dealer for American Ferrodynamics "Brand Five" recording tapes. The best tape value!

Find that review you want—get a copy of the index to volumes 1, 2 & 3 Tape Recorder. Price 2s. each posted.

Use up those odd lengths of tape, splice them together professionally after reading "How to Splice Tape", price 2s. 6d. posted, from The Tape Recorder, 99 Mortimer Street, London, W.1.

Repairs and modernising of Tape and Gram equipment. New heads, Amplifiers, etc., fitted by Experts. Prompt service. Specialised Hi-Fi equipment built to order for private or Studio use.—Harding Electronics, 120a Mora Road, London, N.W.2. GLA 1770.

"Brand Five" American Tape. Standard Play 5 in. (600 feet) 16s., Long Play 5 in. (900 feet) 18s. 6d.; 5½ in. (1,200 feet) 23s. 6d.; 7 in. (1,800 feet) 35s. Sent by return. Post Free!—Watts Radio, 54 Church Street, Weybridge, Surrey.

All makes of tape recorders repaired or modified. Miniflux heads supplied. "Audiomaster" equipment serviced. Audio installations built to your specification by John C. Latham, Deimos Ltd., 8 Corwell Lane, Hillingdon, Middx.

American Recording Tape, new boxed, long-play tape, 1,800 ft. on 7 in. 27s.; lots of 4, 100s.; 900 ft. on 5 in., 16s.; lots of 4, 60s. Satisfaction guaranteed and post free. Empty reels available. J. L. Darvell, 31 Hamilton Crescent, London, N.13.

THE WAL D-MAG, head demagnetiser, long nylon covered probes. £2.10.0

WAL GAIN transistorised pre-amplifiers. Mono £5, Stereo £7.10.0 and Hi-Gain (latter CCIR equalised). £7.16.0

THE WAL BULK ERASER. £7.18.6

Available from all leading dealers. (Wholesale include T.D. & B., London, and A. C. Farnell, Leeds).

WELLINGTON ACOUSTIC LABORATORIES LTD.  
Farnham, Surrey (6461)

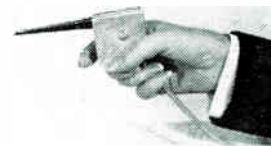



# hi fi

## FOR BEGINNERS

by John Borwick

PRICE  
**7/6**  
(plus 9d. postage)

★ THIS IS THE FIRST TITLE IN THE HI-FI BOOK SERIES, AND WE RECOMMEND IT THOROUGHLY TO EVERY ENTHUSIAST. READERS WHOSE PARTICULAR INTERESTS LIE WITH TAPE WILL FIND THAT CHAPTER 7 ALONE WILL MAKE THE BOOK WORTHWHILE. "HI-FI FOR BEGINNERS" IS THE IDEAL BOOK FOR EVERYONE WHO HAS JUST STARTED, OR IS ABOUT TO START THIS HOBBY.

**MILES HENSLOW PUBLICATIONS LTD. 99 MORTIMER STREET, LONDON, W.1**

### BRITAIN'S LARGEST TAPE RECORDER AND HI-FI PART EXCHANGE SPECIALISTS

If you have outgrown your present tape recorder or hi-fi equipment and would like to own a more advanced machine, as used by professional and serious tape recorder enthusiasts. Contact us today !!!

### MAIL ORDER EXPERTS

#### AND APPOINTED AGENTS FOR

Ferrograph 4AN	... 81 gns.
Veritone 1	... 89 gns.
Ferrograph 422/4	... 110 gns.
Reflectograph 'A'	... 105 gns.
Tandberg 6 Stereo	... 110 gns.
Vortexion WVA	... £93.13.0
Brenell Mk. 5 'M'	... 88 gns.
Simon SP.5	... 93 gns.
Brenell Mk. 5	... 64 gns.
Truvox R7	... 82 gns.
Philips Stereo	... 92 gns.
Sony 521 Stereo	... 124 gns.
Reps R10	... 59 gns.
Ampex Stereo 971	... 225 gns.
Revox Stereo	... 110 gns.

ALL ABOVE RECORDERS AVAILABLE FROM STOCK

#### WE HAVE THOUSANDS OF SATISFIED CUSTOMERS THROUGHOUT THE BRITISH ISLES

#### TRANSISTOR-BATTERY

Grundig TK1	... 29 gns.
Optacord 412	... 45 gns.
Butoba MT5	... 69 gns.
Fi-Cord A1	... 59 gns.
Philips EL3585	... 24 gns.
Stuzzi Magnette	... 59 gns.

Tuners
Amplifiers
Microphones
Speakers
Pick-Ups, etc.
Transcription Motors

Large stocks of new and used tape recorders at bargain prices. Ask for list. 30% to 60% reductions on original price.

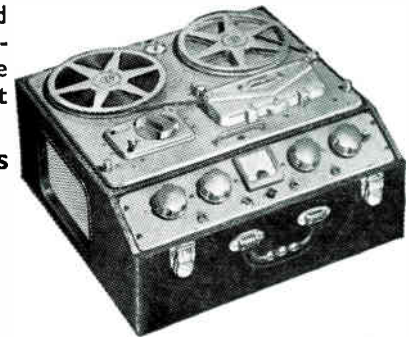

Ferrograph 4AN

ALL GOODS AVAILABLE ON OUR FAMOUS

### NO INTEREST TERMS

20% deposit, balance 12 months. 18 to 24 months terms available

FREE SERVICING—FREE DELIVERY—300 MACHINES ON DISPLAY—OUR MAIL ORDER DEPARTMENT WILL DEAL WITH YOUR ENQUIRY BY RETURN. WRITE—PHONE—CALL FOR A QUOTATION ON YOUR MACHINE. A LARGE SELECTION OF USED TAPE RECORDERS.



Tape recorders

## REW

EARLSFIELD LTD., 226 UPPER TOOTING ROAD, LONDON, S.W.17  
Telephone: BALHAM 7710

100 yards from Tooting Broadway underground station: opposite Tooting Market

CLASSIFIED ADVERTISEMENTS — (continued)

For Sale

**American recording tape** 1,800 ft. L.P. 7 in. Boxed. 24s. 6d. Lots of 4 90s. Money back guarantee. Trade enquiries invited.—Zodiac Ltd., 19 Gerrard Street, W.1.

Make the most of your recorder. List of tape libraries send for s.a.c.—D. O. French, 136 Tollington Park, N.4.

**American Pre-Recorded Tapes** supplied. Send 3s. 6d. for current catalogue, all makes.—Imported Records, 42 Broadway, London, S.W.1.

**Minivox C** battery 2 speeds, with Mains Unit. Cost 30 gns. One year old, 19 gns. Bargain. Box No. (London) 294.

**Stern's Mullard Type "C"** tape pre-amplifier with power pack suitable for Wearite-Collaro-Truvox. Perfect order hardly used, £10. Box No. (London) 295.

**Lee Electronics** offer famous manufacturer's zipped waterproof canvas Tape Recorder Covers, complete with microphone compartment at half retail prices. Send for comprehensive lists: 400 Edgware Road. Tel.: PADDington 5521.

**Butoba MT 5.** Few months old, complete with Mains Unit, mic., leads, covers and batteries, offered at ½ list price. Ten tapes included free. Also **50 Pre-recorded Tapes**, unused and in manufacturer's boxes, mainly classical, at 7½ i/s. Original cost 35s. to 50s. each. For quick sale, 21s. each or 5 for £5. Offers invited for the 50. Hardinge, "Pinjarra" Pinewood Grove, New Haw, Weybridge, Surrey.

Your choice of tape equipment, or pre-recorded tapes offered in exchange for items connected with pre-1929 motoring books, magazines, photographs, accessories, even complete cars. J. Berry, 88 Westfields Avenue, London, S.W.13.

**Annual Bargain Sale of Tape Recorders.** Telefunken Model 85, list price over £80. One only, slightly shop soiled, but otherwise unused, reduced to £45. One Fi-Cord Portable Recorder, reduced from 59 gns. to 32 gns. H.M.V. Voicemaster Recorder, brand new, but slightly shop soiled, reduced to £52. Also other Tape Recorder bargains at—Lancs Hi-Fi Ltd., 8 Deansgate, Manchester. (For readers living in Yorkshire, we can bring these over to our depot at—16 Ivegate, Bradford, I.)

"Tape Recorder", clean: 1959 Sept., Nov., Dec.; all 1961-1962. 2s. each, S.A.E. please. D. Northcott, 12 York Street, Penzance, Cornwall.

Vols. 1, 2, 3, "Tape Recorder". In Binders and Index. Vol. 4 "Hi-Fi News" Binder and Index, all good condition, 36s. each includes p.p. Mr. R. Waddington, 72 Thomson Avenue, Balby, Doncaster.

**Unusual American L.P.s and Pre-recorded Tapes.** Ben Charles, 480 Muswell Hill, Broadway, London, N.10.

**Tape Recorders.** Save from 30 per cent. to 60 per cent. on the original price. Large stock of secondhand, new, shop soiled machines. All guaranteed. Obtainable on our No Interest Terms. Best part exchange allowances on your existing equipment. Call, write, 'phone today for free list. Quotation and details. Our mail order covers the whole country. R. E. W. Earlsfield Ltd., 266 Upper Tooting Road, London, S.W.17. Balham 7710.

All issues "Tape Recorder" except Vol. 1 no. 12. Good condition. Offers: Macdougall, 185 Crofthill Road, Glasgow, S.4.

**Fi-Cord 1A**, mic., battery charger, tapes, as new, £40. Palmer, 4 Cotswold Crescent, Chelmsford, Essex.

**Vortexion WVA**, Grampian mic., £70. Fi-Cord 1a, Grampian, £45. Both immaculate condition. Williams, CUN 9608 evenings.

Tape to Disc

**Tape/Disc/Tape** transfer, editing, duplicating. If quality and durability matter (especially with L.P.s from your precious tapes) consult Britain's oldest transfer studio. Recording equipment supplied with home maintenance guarantee. Generous part-exchange. 48-page photographically illustrated Hi-Fi catalogue 2s. 6d. 1,800 branded tapes 30s. Sound News, 10 Clifford Street, London, W.1.

**Tape to Disc service**, editing, and dubbing, all speeds. Studio available for musical groups. Outside recordings our speciality. Ilford Sound Recording Service, 63, Aintree Crescent, Barkingside, Ilford, Essex. Telephone: CRE 8947 and GRA 5107.

**Tape to disc recording service.** All speeds. 50 minute L.P.s. Photographic sleeves with all recordings.—E.R.S., 162 Shirland Road, London, W.9.

Miscellaneous

**Large Mobile Service Force** in England and Wales operated as an insurance policy by major electronic group has surplus effort to undertake additional contract maintenance commitments. Replies in confidence to—Box 836, Granthams Advertising, Reading.

**Immediate capacity available for Coil Winding.** Assembly and Wiring of Electronic Equipment, Prototypes.—Olson Electronic Limited, 54 Myddelton Street, London, E.C.1. TER 8081.

DO YOU SPLICE TAPE?



HOW TO SPLICE TAPE

★ If you use tape, sooner or later you will need to know how to splice tape—how to repair simple or complicated breaks—how to edit your material—how to cut out words or syllables, etc. All this is described in this well-illustrated booklet, in which stage-by-stage photos and text provide the complete answer to professional tape splicing.

Price 2/6 . . . Postage paid

THE TAPE RECORDER

99 Mortimer Street, London, W.1

ADVERTISERS' INDEX

	Page
Audio	260
B.A.S.F. Chemicals Ltd.	272
A. Brown & Sons Ltd.	258
Chelsea Record Centre	258
City & Essex Tape Recorder Centres	231
Elstone Electronics Ltd.	271
E.M.I. Records Ltd.	252
E.M.I. Tape Ltd.	234
Film Industries Ltd.	254
Francis of Streatham	254
Garrard Engineering and Manufacturing Co. Ltd.	230
Gevaert Ltd.	256
Heathkit	264
Hi-Fi Year Book	233
Hi-Fi Books	257
Howard Tape Recorders	266
Ilford Sound Recording Service	256
Kingswood Supplies	267
M.S.S. Recording Co.	236
Northgate (Cameras) Ltd.	244
Nusound Recording Co.	258
R. E. W. Earlsfield Ltd.	269
The Recorder Co.	271
Reeves Sound Service	256
Tape Recorder Centre Ltd.	248
Tellux Ltd.	232
Valradio Ltd.	258
D. Villiers	260
N. Walker	256
Wellington Acoustic Lab. Ltd.	268
Bmm. Magazine	242



# Tandberg

## SERIES 6

### 4 TRACK

and now also by  
special request

### 2 TRACK

EACH MODEL **110** gns

**Tandberg**<sup>GB</sup>



## Stereo Tape Deck

### 3 speeds - 3 heads

### 4 amplifiers

The Tandberg Series 6 is a "no compromise" instrument capable of delivering consistently fine "professional" quality when used with comparable amplifier and speaker systems. Booklet of 4-track technical reviews on request.

ELSTONE ELECTRONICS LTD · EDWARD STREET · TEMPLAR STREET · LEEDS 2 · Tel: Leeds 3-5111 (7 lines)

# irish

## Ferro-sheen process MAGNETIC RECORDING TAPE

A. C. FARNELL LTD · HERFORD HOUSE · VICAR LANE · LEEDS 2  
Tel. LEEDS 3-5111

### 18 Months to Pay

	Deposit		18 Monthly Payments		Cash
	£	s. d.	£	s. d.	
<b>MAINS 2-TRACK</b>					
Truvox R82 ...	5	15 6	2	17 9	55
Brenell 3 Star ...	6	2 0	3	0 11	58
Reps. R.10 ...	6	4 0	3	2 0	59
Brenell Mk. 5 ...	7	2 0	3	6 10	64
Telefunken 85KL ...	8	6 0	4	3 0	79
Ferrograph 4A/N ...	9	0 0	4	4 6	81
Brenell 5 Type "M" ...	9	5 0	4	12 5	88
Veritone 16 ...	9	13 0	4	15 6	91
Simon SP/5 ...	9	16 0	4	17 8	93
Reflectograph "A" ...	11	5 0	5	10 0	105

#### 4-TRACK MONAURAL

Grundig TK23 ...	4	15 0	2	7 3	45
Brenell 3 Star ...	6	2 0	3	0 11	58
Philips EL3542 ...	6	4 0	3	2 0	59
Cossor CR.1601 ...	6	4 0	3	2 0	59
Truvox R.84 ...	6	4 0	3	2 0	59
Elizabethan Major ...	7	3 0	3	7 11	65
Reps. R.10 ...	7	5 0	3	12 6	69
Grundig T.K.40 ...	8	0 0	3	18 8	75

#### 4-TRACK STEREO/MONAURAL

Philips EL3536 ...	9	16 0	4	16 6	92
Telefunken 97 ...	10	0 0	4	19 9	95
Akai M.6 ...	13	13 0	6	16 6	130

Open all day Saturday—  
Friday 6.30 p.m.

### THE RECORDER CO.

features the highly successful

#### OPTACORD

#### 412

CASH  
45 GNS.

or  
£4.15.0 deposit  
and 12 monthly  
payments of  
£3.10.10



THE tape recorder that can be used indoors on mains and outdoors on batteries without adaptors. Professional grade Hi-Fi reproduction plays back voice and music clearly and naturally. Only 45 gns. OPTACORD 412 embodies latest and many expensive features such as push-button control, fast wind and rewind, tape position indicator instantaneous stop, tone control, etc. We shall be pleased to demonstrate—or send fuller details.

- ★ INTEREST FREE terms
- ★ FREE INSURANCE COVERING YOUR PAYMENTS IN THE EVENT OF SICKNESS OR UNEMPLOYMENT
- ★ FREE DELIVERY ★ PART EXCHANGES

### 12 Months to Pay

	Deposit		12 Monthly Payments		Cash
	£	s. d.	£	s. d.	
<b>MAINS TWIN-TRACK</b>					
Argyll Minor ...	2	6 3	1	14 8	22
Grundig TK14 ...	3	13 6	2	15 2	35
Elizabethan TT3 ...	4	2 0	3	1 5	39
Reps. R.10 ...	6	3 11	4	13 0	59
Telefunken 95 ...	6	3 11	4	13 0	59

#### 4-TRACK

Stuzzi ...	2	16 6	2	0 10	26
Philips "Star Maker" ...	2	16 9	2	2 7	27
Argyll 4-T ...	3	4 0	2	6 4	29½
Elizabethan FT1 ...	3	11 5	2	13 7	34
Philips EL3541 ...	3	11 5	2	13 7	34
Stella ST454 ...	3	17 9	2	18 4	37
Sound ...	4	15 0	3	10 10	45
Elizabethan FT3 ...	4	15 0	3	10 10	45
Grundig TK23 ...	4	15 0	3	10 10	45

#### BATTERY

Clarion Mk. 1 ...	2	0 0	1	9 11	19
Philips EL3585 ...	2	10 5	1	17 10	24
Stella ST470 ...	2	15 0	1	19 2	25
Clarion Mk. 2 ...	2	16 9	2	2 7	27
Grundig TK.1 ...	3	1 0	2	5 8	29
Optacord Battery/ Mains	4	15 0	3	10 10	45
Ficord IA ...	6	4 0	4	12 11	59
Stuzzi Magnette ...	6	4 0	4	12 11	59
Butoba MT5 ...	7	0 0	5	3 10	66

If unable to call, write for free brochure or send deposit now for quick delivery.

# THE RECORDER CO.

(Dept. R) 188, WEST END LANE, WEST HAMPSTEAD, LONDON, N.W.6.

Telephone: SW1 4977

# NOW!

## NEW BASF

## TRIPLE PLAY TAPE

### GIVES YOUR PORTABLE BIG-MACHINE CAPACITY

Yes, this new BASF tape, specially developed for portable and other small-spool recorders, gives you 45 minutes continuous recording or playback at  $1\frac{7}{8}$  i.p.s. — treble the playing time of Standard tape. Triple Play is thinner than other BASF tapes but has all BASF dependable qualities . . . dimensional and magnetic stability, full frequency response, negligible print through, super-smooth surface. BASF Triple Play tape is available from your dealer on 3", 4" and 4½" spools holding 450, 900 and 1200 feet respectively.

# 45 minutes playing time on a 3" spool



## BASF TRIPLE PLAY TAPE

*makes the most of your portable*

**BASF** CHEMICALS LIMITED 5a Gillespie Rd. London N5