

# the TAPE RECORDER

PRICE 1/6

DECEMBER 1961  
Vol. 3 No. 11

INCORPORATING "SOUND AND CINE"



## IN THIS NUMBER

- A New Add-on Sound-for-Cine Unit
- Readers' Letters
- Faults your recorder may have
- Equipment Reviewed
- Other recording Systems
- Details of New Products
- Tape Recorder Workbench
- How others use tape
- Sound and Ciné
- News and Pictures from the Clubs

## A PROGRAMME

Make the most of your tape recorder and your tape recordings. Whatever the type of programme you most enjoy you'll immediately recognise the consistent, uniform quality that you get from AUDIOTAPE . . .



## WORTH RECORDING

the extra crispness at the top and the extra depth of bass – without the loss of the essential middle tones that often prove so elusive. AUDIOTAPE has only one standard of quality – the finest obtainable –



## IS WORTH THE

backed by more than ten years' experience in magnetic tape manufacture and more than two decades of practical experience in the art of sound recording. You cannot buy a better tape than AUDIOTAPE – it speaks for itself.



## BEST OF TAPES

Available in 5 different types with a base material and reel footage to suit every requirement. All 5" and 7" reels of AUDIOTAPE are supplied on the exclusive C-Slot Reel – the fastest threading tape reel ever developed.



## AND THE BEST OF TAPES IS

# audiotape

TRADE MARK

*... on the sensational C-SLOT REEL!*

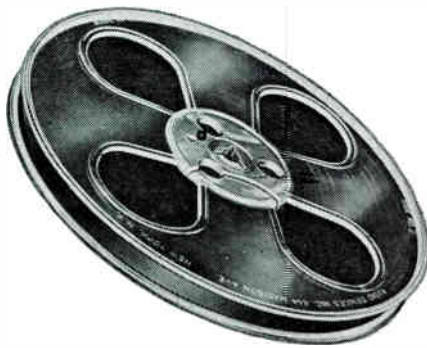

Manufactured by

**AUDIO DEVICES Inc., New York, N.Y.**

Concessionaires to the United Kingdom

**LEE PRODUCTS (G.B.) LIMITED**

"Elpico House", Longford Street, London, N.W.1.

Telephone: B1Shopsgate 6711 (all lines) Telegrams: Leprod, London



# 2 YEARS FREE SERVICING!!



## *Free Gifts, Free Tapes, Commission and Discounts !!!*

If that's what you want when you buy a tape recorder then you most certainly will not come to us to purchase one. We cannot and will not give you these things for our reputation as Britain's leading tape recorder specialist company is not built on sales gimmicks but on SERVICE. What we do give you is two whole years of worry-free, trouble-free and above all cost-free servicing. Every new tape recorder over £35 carries our unique and exclusive two years absolutely FREE SERVICING GUARANTEE, that many thousands of more than satisfied customers have found to be the best obtainable anywhere. Make your choice when buying that new tape recorder. Gimmicks or superlative free servicing by a company specializing in nothing but recorders and servicing.

### SPECIALISTS IN

FERROGRAPH, VORTEXION, BRENELL, REFLECTOGRAPH, GRUNDIG, REPS, ETC.

- ★ OVER 250 NEW & LOW-PRICED S/HAND RECORDERS ON DISPLAY ★
- ★ GENEROUS PART EXCHANGES ★ CASH & HP TERMS OVER 9-24 MTHS ★
- ★ HOME DEMONSTRATIONS ★ FREE DELIVERY ★ FREE PAMPHLETS etc ★

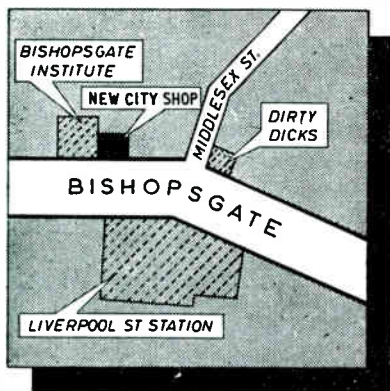

◀ **CITY SHOWROOMS** 228 BISHOPSGATE, E.C.2 BIS 2609  
Open Mon.-Fri. 9 a.m.-6 p.m. Closed Sat. Open Sun. 9 a.m.-2.30 p.m.

**STRATFORD** 2 MARYLAND STATION, E.15 (adj. Maryland Station)  
(E. Ham and Stratford open all day Saturday) MAR 5879

**EAST HAM** 205 HIGH ST. NTH., E.6 (opp. E. Ham Station) GRA 6543

# CITY & ESSEX TAPE RECORDER CENTRES

For highest quality equipment



at lowest possible prices

**HI-FI FM TUNER Model FM-4U**

This model is available in two units which, for your convenience, are sold separately. They comprise a Tuning Unit (model FMT-4U) at £3.5.0. incl. P.T. and an I.F. amplifier unit (model FMA-4U) at £11.11.0. The Tuning Unit is despatched wired and tested. Provision is made for stereophonic F.M. radio transmissions. Printed circuit for I.F. amplifiers and ratio detector. Built-in power supply, 7 valves, many refinements. Range 88-108 Mc/s. (Illustration bottom right.)

**Total Cost ... .. £14.16.0**

**TO ALL MUSIC LOVERS AND HI-FI ENTHUSIASTS**

*Our wide range does not permit adequate coverage of all models. A FREE CATALOGUE and full specifications of any particular model will be gladly sent on request, without obligation on your part. WIRED AND TESTED MODELS NOW AVAILABLE. PRICES ON REQUEST.*

*All prices include free delivery in U.K. Deferred terms available on orders over £10.*

**TAPE-RECORDING AND REPLAY HI-FI AMPLIFIER.**

**Mono. model TA-IM, Stereo model TA-IS**

For use with most tape decks. Thermometer type recording indicators, press-button speed compensation and input selection, 3-position bias level and printed circuit construction.

TA-IM	£18. 2.6
TA-IM and Collaro "STUDIO"	£30.10.0
TA-IM and TRUVOX Mk. 6	£46.17.6
TA-IS (illustration Centre)	£23. 6.0
TA-IS and Collaro "STUDIO"	£35.14.0
TA-IS and TRUVOX Mk. 6	£52. 1.0

**A WHOLE RANGE OF PACKAGED DEALS (INCLUDING "CONNOISSEUR" TURNTABLES and DECCA ffs PICK-UP) NOW AVAILABLE TO SAVE YOU FURTHER MONEY.**

**HI-FI EQUIPMENT CABINETS**

A range of equipment cabinets is now available to meet the differing needs of enthusiasts. All are accurately machined for ease of assembly and left "in the white" for finish to personal taste. Designed for maximum operating convenience or for where room space is an overriding consideration, this range has at least one model to meet your requirements. Why not send for full details?

**£11.5.6 to £17.18.6**



**THE "MALVERN"**

**"COTSWOLD" HI-FI FREE SUSPENSION SPEAKER SYSTEM**

This is an acoustically designed enclosure 26 in. x 23 in. x 14 1/2 in. housing a 12 in. bass speaker with 2 in. speech coil, elliptical middle speaker, together with a pressure unit to cover the full frequency range of 30-20,000 c/s. Capable of doing justice to the finest programme source, its polar distribution makes it ideal for really Hi-Fi Stereo. Delivered complete with speakers, cross-over unit, level control, Tygan grille cloth, etc. All parts pre-cut and drilled for ease of assembly and left "in the white" veneered for finish to personal taste. Can be easily assembled in an evening and you then have a system fully comparable with any in the £40-£75 class. Assembled Weight 61 lbs. ... .. £21.19.0



**COTSWOLD**

**Here are some other interesting Heathkit Models for you:**

**HI-FI SPEAKER SYSTEM Model SSU-1.** This kit is easily assembled. It contains twin speakers and balance control in its ducted port reflex cabinet. It is equally suitable for stereo or mono in average room. (Legs £1 1s. 0d.) Less legs £10 17s. 6d.

**HEATHKIT ELECTRONIC WORKSHOPS KIT, Model EW-1.** This new kit will help your boy to understand electronics, by making at least 20 exciting experiments, including Transistor Radios, Intercom Sets, Burglar Alarm, Electric Eye, etc. ... .. £7 18s. 0d.

**HI-FI STEREO 6-WATT AMPLIFIER Model S-33.** Attractively styled, completely self-contained. Printed circuit makes it easy to build. Only 0.3% distortion at 2 1/2 W/chal. U/I output, ganged controls. ... .. £12 8s. 6d.

**AUDIO SIGNAL GENERATOR Model AG-9U.** Delivers up to 10 volts pure sine-wave (less than 0.1% distortion. 20 c/s to 20 kc/s). Decade switch-selected frequencies from 10 to 100,000 c/s. Internal 600 Ohm N/I load, or external. £19 19s. 6d.

**POWER AMPLIFIER 12-WATT Model MA-12.** Single channel, ideal for stereo conversion. £10 19s. 6d.

**LOW INPUT HI-FI STEREO PRE-AMPLIFIER Model USP-1.** An input of 2-20 mV will produce an output adjustable from 20 mV to 2 volts. This enables low-input p.u.'s etc., to load fully subsequent amplifiers of medium sensitivity. Negligible distortion. £6 17s. 6d.

**COLLARO "STUDIO" TAPE DECK.** Two tracks. "Wow" and "flutter" not greater than 0.15% at 7 1/2" p.s. Long Term Speed Stability better than 0.5%. ... .. £17 10s. 0d.

**SUGDEN MOTOR UNIT "CONNOISSEUR"**. Heavy duty motor operating at 33 1/3 and 45 r.p.m. Very heavy 12" turntable. £17 15s. 5d.

**COMPLETE MATCHED STEREO OUTFIT.** Including RP-1U Record Player (until supplies are exhausted), S-33 Stereo Amplifier and SSU-1 Twin Speaker Systems. Pedestal Speaker legs £2 2s. optional extra. £44 9s. 4d.

**HI-FI STEREO 16-WATT AMPLIFIER Model S-88.** Within its power rating, this is the finest stereo amplifier available, regardless of price. U/L push-pull output. 0.1% distn. at 6 w/chal. ... .. £26 12s. 6d.

**STEREO CONTROL UNIT Model USC-1.** A de luxe stereo control unit with variable filter, switched rumble filter, printed circuit boards and many other refinements. Operates direct from tape heads. £18 18s. 6d.

**TRANSISTOR PORTABLE RADIO Model UXR-1.** Superbly styled, hide case, with golden relief and crystal easy-to-tune dial, this completely self-contained 6-transistor dual-wave set performs brilliantly everywhere, even in a car. Reproduction is exceptionally good. Printed circuit. ... .. £14 18s. 6d.

**SHORTWAVE TRANSISTOR PORTABLE Model RSW-1.** Four wave-band seven transistor portable with telescopic and ferrite aerials, slow-motion tuning. Covers Medium, Trawler, and 6-26 Mc/s in four switched bands. Uses printed circuit board and latest circuit technique. Superbly styled leather case. £22 10s. 0d.

**TRUVOX TD-1 Mk. 6 TAPF DECK.** High quality mono/stereo Tape Deck. 3 B.T.H. shaded pole motors with silent drive. "Wow" and "flutter" limited to less than 0.2%. Complete operation by push-button controls. £29 15s. 0d.

**"MOHICAN" GENERAL COVERAGE RECFIVER Model GC-1U.** Fully transistorised. 4 piezo-electric transistors. To overcome the problems of alignment etc. the R.F. "front end" is supplied as a pre-assembled and prealigned unit. £38 15s. 0d.

**GOLDRING-LENCO TRANSCRIPTION RECORD PLAYER Model G.L.58.** Fitted with the G.60 pick-up arm, it has infinitely variable speed adjustment between 33 1/3 and 80 r.p.m. and four fixed speeds. 3 1/2 lb. turntable to reduce rumble, "wow" and "flutter". £20 12s. 2d.

**OTHER HEATHKIT MODELS AVAILABLE**

World's largest-selling VALVE VOLTMETER	...	Model V-7A	£13.0.0
G/P OSCILLOSCOPE (5 in. Flat-face screen)	...	Model O-12U	£36.10.0
"HAM" TRANSMITTER	...	Model DX-40U	£32.10.0
VARIABLE FREQUENCY OSCILLATOR	...	Model VF-1U	£11.2.0
TRANSISTOR RADIO for the youngsters	...	Model UJR-1	£2.16.6
RESISTANCE/CAPACITANCE BRIDGE	...	Model C-3U	£8.6.6
AUDIO VALVE MILLIVOLTMETER	...	Model AV-3U	£13.18.6
AUDIO WATTMETER	...	Model AW-1U	£14.14.0

**DAYSTROM LTD., DEPT. HT.12, GLOUCESTER, ENGLAND**

A member of the Daystrom Group, manufacturers of **THE LARGEST-SELLING ELECTRONIC KITS IN THE WORLD**



**SSU-1**



**S-33**



**AG-9U**



**MA-12**



**USP-1**



**USC-1**



**TA-IS**



**TRUVOX Mk 6**



**STUDIO**



**S-88**



**UXR-1**



**RSW-1**



**FM-4 TUNER**

JUST POST THIS COUPON FOR FURTHER INFORMATION

Without obligation please send me

★ **FREE BRITISH HEATHKIT CATALOGUE . . .**

FULL DETAILS OF MODEL(S).....

Kindly write below in BLOCK CAPITALS

NAME .....

ADDRESS .....

TICK HERE

HT12

# A WyndSOR Christmas means a happier New Year

Make really good music this Christmas, whether you play an instrument or not. And there's years of enjoyment to follow with a 'Heron' tape recorder and a 'Heron Companion' record player. They can be purchased together or separately. You can play tapes or records, make recordings from one to the other, or from the radio, or with the stylish microphone. And the total cost is less than ever before possible, because the 'Heron Companion' is designed purely to play through the 'Heron' or your radio. So you save duplicating the expense of amplifier and loud-speaker. What's more you can take them everywhere you go.



## good to get together with

The 'Heron' tape recorder sounds so attractive that it is worthy of extra use in a not-so-obvious role. It has a remarkable amplifier and 7" x 4" speaker for easy-on-the-ear listening. Even when you walk out with your 'Heron' and 'Heron Companion' they're light to carry—and they match in colour and style—like fashionable luggage.



*the featherlight Heron and Heron Companion in portable harmony*

### SPECIFICATION

**HERON** 3½ i.p.s. ● output 3 watts ● 1½ hours playtime ● mic and gram/radio inputs ● monitoring through microphone ● 10,000 lines gauss speaker ● extension speaker and Hz outputs ● magic-eye record indicator ● pocket for microphone and leads.  
25 gns. with microphone, 850 ft. of tape, spools and spare plug.

**HERON COMPANION** High Crystal lightweight pick-up ● reversible sapphires ● Continental plug connections ● 4 speeds: 78, 45, 33½ and 16 r.p.m.  
Price £8 2s. 4d. inc. P.T.

# WYNDSOR RECORDING CO. LIMITED

WyndSOR Works, 2 Bellevue Road, Friern Barnet, London, N.11 Telephone: Enterprise 2226/7 Cables: Wyndreco, London



## WE'VE GOT WHAT IT TAPES AT THE TAPE RECORDER CENTRE

Every model, every make. Hundreds to choose from to put before you the most comprehensive selection of Tape Recorders and Hi-Fi equipments in Europe. Expert, honest advice to make sure you get exactly what you want.

### Tape Recorders

Grundig  
Elizabethan  
Ferrograph  
Vortexion  
Brenell  
Reflectograph  
Simon  
Harting  
Telefunken  
Philips  
Spectone  
Sony

### H.M.V.

Veritone  
Stuzzi-Magnette  
Fi-cord  
Truvox  
Kurland  
Reps  
Wyndson  
Audiograph  
Minivox  
Korting  
Stella-Cossor

### Hi-Fi Equipment Microphones

Speakers, etc.  
Leak  
Quad  
Rogers  
Armstrong  
Jason  
Dulci  
Pamphonic  
Stentorian  
Avantic  
S.M.E.

### Collaro Goodsell

Elpico  
Decca  
Philips  
Wright & Weaire  
G.E.C.  
Goodmans  
C.Q.  
Wharfedale  
Elac  
B.J.  
Garrard

### Connoisseur Goldring

T.S.L.  
Acos  
Lustraphone  
Cadenza  
Reslo  
Record Housing  
Linear  
Tannoy  
Ortofon  
Auriol

*All Accessories, Tapes, etc. by return of post.  
All makes in stock.*

### Lowther Film Industries Audiomaster

Tape  
Emitape  
Scotch Boy  
BASF  
Grundig  
Telefunken  
Irish  
Philips  
Agfa

# THE TAPE RECORDER CENTRE

CHOOSE IN PERSON— CHOOSE BY POST

Central London: 82 High Holborn, W.C.1 CHAncery 7481

North London: 75 Grand Parade, Green Lanes, Harringay, N.4 FITzroy 2316/7/8

*Only at these two Showrooms will you find the complete Tape Recorder Centre range!*

# There are two kinds of people who'll want this new



## TK 24 4 TRACK MODEL

... Two quite different kinds of people will want the new TK 24 — the inexperienced and the experienced. The inexperienced because they don't know any better and the experienced because they don't know any better either: because there isn't any better than this brilliant new four track Grundig model. The new TK 24 makes no compromises. It doesn't ask you to choose whether you want high fidelity or long play — it gives you both! All the time! Six hours record/playback.

It doesn't ask you to scrap all your existing conventional twin track 3½ i.p.s. tapes — it lets you play them back as well (and how good they sound!).

It doesn't expect you to have to make complicated arrangements to produce special trick effects — *it allows two tracks to be recorded separately and then played back together.* (Normally, of course, you would play them back separately to get the doubled playing time that four track gives you).

In fact it's the most accommodating tape recorder ever made — even by Grundig!

No matter how much you know — or don't know — about Tape Recorders, go to your nearest Grundig Approved Dealer and have him demonstrate the TK 24.

See and hear Grundig quality for yourself; the simplicity, the compactness, the styling, the really first rate performance of a new model that will stay 'new' for years.

PRICE **55** guineas (including Microphone)

GET THE MOST OUT OF LIFE

GET THE **GRUNDIG TK24**

**GRUNDIG (Great Britain) LTD.**

Advertising & Showrooms : 39/41 New Oxford Street, London, W.C.1.  
Trade enquiries to : Newlands Park, Sydenham, London, S.E.26.  
(Electronics Division, Gas Purification & Chemical Company Limited)

Please send me the free fully illustrated leaflet of the new TK24 four track model tape recorder and the wonderful 20 page book TOP STARS and GRUNDIG.

Name

Address

Nearest Town

GS.YR.235/6

# today's best on NOW BEST ON WORLD RECORD CLUB OFFERS

# ANY 3



29. Me and My Shadow, Among My Souvenirs, Near to Me . . . 11 great Garland songs. Disc/Tape: mono only

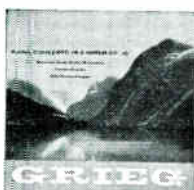

28. Grieg Piano Concerto. Odd Gruner-Igge dynamically conducts the Bavarian State Radio Orchestra. Alexander Jenner piano. Disc/Tape: mono only



30. Ian Carmichael, Joyce Blair, star cast/orchestra. As Long as He Needs Me, Consider Yourself, plus 11 hit numbers from Bart's great show. Disc: mono/stereo. Tape: mono only



31. Rimsky-Korsakov: Scheherazade. Sir Eugene Goossens and LSO in a breathtaking performance. Disc: mono/stereo. Tape: mono only



38. Hervey Alan, Ian Wallace, Marion Girmabli and chorus sing the immortal Cobbler's Song, Robbers' Chorus Chu Chin Chow, etc. Disc: mono/stereo. Tape: mono only

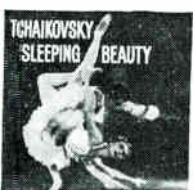

39. Sparkling playing by Sinfonia di London, brilliantly conducted by John Hollingsworth. Disc: mono/stereo. Tape: mono only



40. Star casting highlights from Puccini's great operas, including famous One Fine Day. Disc/Tape: mono only



NAT KING COLE



46. Tchaikovsky Symphony No. 4. Sir Malcolm Sargent and LSO in dramatic rendering of this colourful symphony. Disc: mono/stereo. Tape: mono only

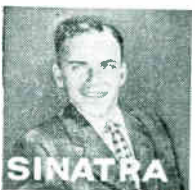

36. Look Over Your Shoulder, My Lean Baby, White Christmas, Don't Worry About Me, 12 songs by the one-and-only Sinatra. Disc/Tape: mono only



30. Answer Me, Nature Boy, Ruby and the Pearl, 8 more songs in the unique Nat King Cole manner. Disc/Tape: mono only

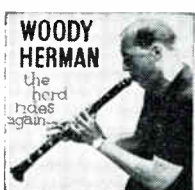

45. Crazy Rhythm, Bijou, I Cover the Waterfront, etc. The great clarinetist plays 12 numbers. Disc: mono/stereo. Tape: mono only



22. 12th St. Rag, Isle of Capri, Smile, Blue Moon, 12 characterists, numbers from the Duke. Disc/Tape: mono only



46. Elizabeth Lerner, Andy Cole, Peter Knight singers. Exciting 'double' featuring highlights from two famous shows. Disc: mono/stereo. Tape: mono only



47. Brahms Violin Concerto. Superb playing by Endre Wolf and Sinfonia di London under the baton of Anthony Collins. Disc: mono/stereo. Tape: mono only

## THE BIGGEST BREAK-THROUGH SINCE TAPE RECORDING!

Not only is this the greatest World Record Club introductory offer yet made . . . it is a unique offer never before matched by any record club or company anywhere in the world!

### Any 3 for 30/- . . . Tape or Disc!

Choose now any 3 titles from the varied selections shown above. Next, decide whether you prefer them as high-fidelity 3 1/2 ips pre-recorded tapes, or as high-fidelity 12" LPs. Either way the price is the same. Just 3 for 30/- tape or disc. That's only 10/- each!

### Unconditional Guarantee

When you receive your 3 titles you have 7 days in which to listen to your selections and decide whether or not you want to keep them. If you don't, just send them back and you owe us nothing. This guarantee is absolutely unconditional!

### Joining World Record Club

We know however that you'll not only be surprised but amazed. A host of new technical developments have gone into the production of these tapes. They provide, at 3 1/2 ips, a range and response that was never previously attainable at

this slow speed. The LPs too, are the equal in quality of the world's best. We believe you will be anxious to keep them (if you do, you'll be saving up to £6 on shop prices for the tapes, or up to £4.10s. on the LPs). This decision will make you a full member of World Record Club, entitled to share all the many extra unique facilities that make the Club the only one of its kind in the world.

Your only undertaking is to agree to buy four more tape records (or 12" LPs) over the year from the exciting and adventurous selection of at least 60 titles that will be offered to you. Each of these future Club releases will cost you only 29/- plus postage. Tape or 12" LP—both cost the same. Again, far, far below any comparable shop prices for an original full length star recording. This is only possible because of the Club system of direct-by-mail distribution.

### The more you buy the more you save!

If you buy more than your agreed 4 (and most members do) you can choose yet another title absolutely free for every 3 extra selections!

### Your benefits as a club member

- \* FREE monthly magazine, packed with illustrated feature articles!
- \* FREE bonus tapes and 12" LPs!
- \* EXCLUSIVE extra releases!
- \* SPECIAL concert and theatre price concessions!
- \* EXPERT GUIDANCE: WRC recordings are planned by an eminent advisory panel including the Countess of Harewood, Lord Montagu of Beaulieu, Sir Arthur Bliss, Richard Attenborough, Cyril Ornadel, Ray Ellington, Leon

Goossens, Malcolm Arnold, Steve Race, John Hollingsworth and Antony Hopkins. As special technical adviser on tape, WRC are privileged to have the services of Miles Henslow, editor of this magazine and distinguished authority on electronics.

### Your Guarantee of Quality

WRC guarantees that every tape or record you choose (introductory offer, regular selection or bonus) will be of absolute top quality—the equal in every way of the very best recordings available anywhere in the world today. You may return any tape or record with which you are not entirely satisfied.

### Future titles include:

- Gilbert and Sullivan: Mikado, Gondoliers, Pirates of Penzance.
- Enigma Variations, Boult/LPO
- Nat King Cole, Lionel Hampton, Dean Martin, Duke Ellington.
- Beethoven: Symphonies 1, 4, 6 & 9. Josef Krips/LSO
- La Traviata—star cast and orchestra.
- Moussorgsky: Night on a Bare Mountain etc., Sargent/LSO
- Porgy and Bess, Carousel, Desert Song, and many other great shows.

### Waste no time!

Select the 3 titles you would like. Fill in and post the coupon today. Remember to indicate whether you require tape or disc. Send no money now. This is an opportunity you cannot afford to miss!



# record... TAPE TOO! YOU THE CHOICE OF



32. Star cast and orchestra stage all the famous songs: Getting to Know You, Hello Young Lovers, etc.  
Disc: mono/stereo. Tape: mono only



33. Beethoven 5th, plus Elgner, Josef Krips and LSO in a taut interpretation matching the power of the music.  
Disc: mono/stereo. Tape: mono only



34. Stardust, How High the Moon, Nearness of You, Round Midnight... 8 numbers by the vibraphone genius, Lionel Hampton  
Disc: mono/stereo. Tape: mono only



35. Ol' Man River, Bill, Make Believe, many more memorably sung and played by full star cast.  
Disc: mono/stereo. Tape: mono only



36. Beale St. Blues, After You've Gone. 12 hits by one of the world's greatest trombonists. Disc/Tape: mono only



37. Thrilling playing: Revolutionary Study, Polonaises A and A flat, Fantasy-Troisquatre, 12 favourites in all.  
Disc/Tape: mono only

## FOR 30' TAPE OR DISC!

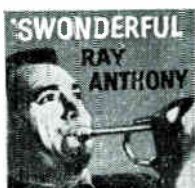

41. Night and Day, King Porter Storm, Pannas from Heaven, plus 9 more scintillating tunes. Disc/Tape: mono only

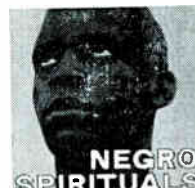

42. George Browne, Isabelle Lucas and chorus sing Jericho, Swing Low, 12 well-loved songs.  
Disc: mono/stereo. Tape: mono only



43. Andy Cole, Barbara Leigh, 'White Sammes' singers: High Society, Three Coins, Harry Lime, Gipsy, 11 top film hits.  
Disc: mono/stereo. Tape: mono only

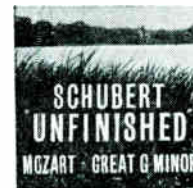

44. Leopold Ludwig and LSO in an exciting 'double': two of the world's greatest symphonies.  
Disc: mono/stereo. Tape: mono only

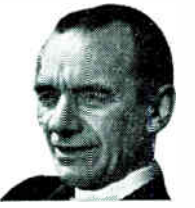

SIR MALCOLM SARGENT



25. Ian Wallace, Joyce Blair and chorus. Some Enchanted Evening and all the unforgettable songs from this great musical.  
Disc: mono/stereo. Tape: mono only



48. Marion Gramaldi, Linden Singers and Orchestra. Deep in My Heart, Serenade—all the old favourites.  
Disc: mono/stereo. Tape: mono only

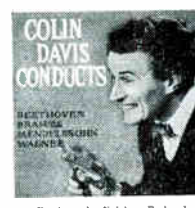

49. Beethoven's Fuleto, Brahms' St. Anthony Vars, Mendelssohn's Hebrides, Wagner's Siegfried Idyll. All under Britan's greatest young conductor.  
Disc: mono/stereo. Tape: mono only

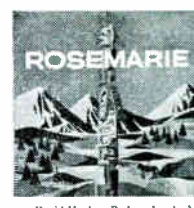

68. David Hughes, Barbara Leigh, Andr Cole and chorus sing Indian Love Call, Rose Marie, many many more.  
Disc: mono/stereo. Tape: mono only



51. They Can't Take That Away From Me, Baby Doll, It Only Happens When I Dance With You, 12 favourite songs from the great Fred Astaire.  
Disc/Tape: mono only

### FACTS ABOUT WRC TAPE RECORDS

By the use of new electronic techniques, World Record Club is able to offer, at 3 3/4 ips, tapes of a standard previously unattainable at less than 7 1/2 ips.

All are recorded on the same high-class Emitape as that used for professional recordings, with extended frequency response. The tapes are twin-track and can be played on either 2 or 4-track recorders. The spool size is 5'.

At this stage all WRC 3 3/4 ips tapes are *mono* only. However for stereo enthusiasts we have something special too:

### STEREO TAPE RECORDS (7 1/2 ips TWIN-TRACK)

An exciting catalogue of 7 1/2 ips pre-recorded tapes *in stereo* only has just been prepared. These are *not* exclusive to club members and may be ordered direct by anyone individually and without membership commitments. Stereo tapes are on 7" spools and run at 7 1/2 ips only. The reproduction quality of this series is fantastic and *must be heard to be believed*. Stereo tapes cost from 50/- to 60/- depending on playing time, plus 3/- postage, packing and insurance. A list of titles will be sent on receipt of a postcard to the Club, marked STEREO. *Do not use the coupon for this stereo list unless you are also joining WRC.*

## SEND NO MONEY NOW

TO WORLD RECORD CLUB (DEPT. TRR2)  
BOX 11, PARKBRIDGE HOUSE,  
THE LITTLE GREEN, RICHMOND, SURREY

I wish to join World Record Club as a

Tape member (3 3/4 ips pre-recorded tapes)	Disc member (12" LPs)
---	--------------------------

(Please tick which you want to be. Members must select all disc or all tape—unfortunately it is not possible to mix.)

Please send me the three titles of my choice as indicated. If I keep them beyond 7 days you may enrol me as a member of World Record Club and I will pay you 30/- plus 3/- postage/packing/insurance. As a member I agree to choose a minimum of 4 releases at 29/- each (plus postage) from your annual programme of at least 60 exclusive selections. After 1 year I may cancel my membership with no further obligations if I so choose.

All records/tapes supplied to me are covered by your 7 day unconditional guarantee.

Signed .....

*This offer applies in Gt. Britain & N. Ireland only.*

### SPECIAL NOTE FOR TAPE MEMBERS ONLY

Because of the Club outlay involved in setting up its new tape division, we ask tape members only to agree to pay £1 deposit AFTER approving their first 3 choices. (Send no money now) This deposit will be deducted from the price of your 4th selection

Place record/tape numbers only in boxes

1st Choice No.

2nd Choice No.

3rd Choice No.

Tick here if stereo 12" LPs required where available

Tick here if 7 1/2 stereo tape leaflet also required

Mr/Mrs/Miss .....

(Block capitals please)

Address .....

## the truest sound

For sound reproduction as it should be—as close as possible to the original—make Shure microphones your unvarying choice. They are the finest for every purpose, years ahead of others in the technical excellence of their design and performance, the most comprehensive range obtainable anywhere.

**Model 545 'Unidyne III'** for public address, tape recording, communications and similar applications requiring compactness with maximum operating efficiency.

**Model 420 'Commando'** can be used indoors or outdoors, for all general-purpose applications. Quality performance at moderate cost.

**Model 540S 'Sonodyne II'** This versatile new microphone features *variable frequency response*, allowing the user to tailor the microphone to the application.

**Model 55SW 'Unidyne'** The most widely used microphone in the world, specified by leading sound engineers and requested by celebrities.

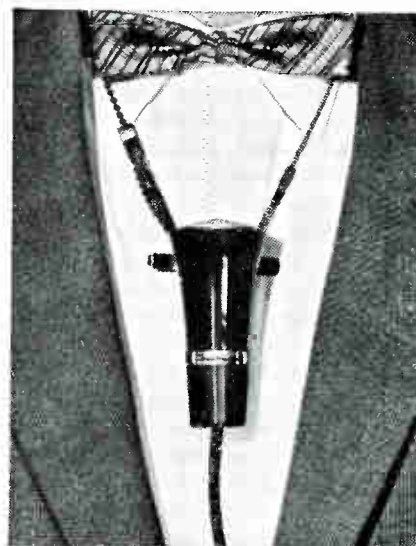

Model 420 'Commando'

The new Shure microphone catalogue is available on application to the address below

**SHURE ELECTRONICS LIMITED**  
84 Blackfriars Road · London SE1  
Telephone: WATerloo 6361

**SHURE**

Setting the world's standard in sound



Model 55SW  
'Unidyne'

Model 545  
'Unidyne III'

Model 540S  
'Sonodyne II'

# the TAPE RECORDER

Editor - - - - - MILES HENSLOW  
 Advertising Editor - - - - - Julian Berrisford  
 News Editor - - - - - Alan Lovell  
 Editorial Offices - - - 99 Mortimer Street, London, W.1  
 Telephone - - - - - MUSEum 3967 to 3969



★  
EDITORIAL

MEMBER OF THE  
AUDIT BUREAU  
OF CIRCULATIONS

SERVICE facilities for tape recorders is an important subject. Had we not been aware of it before, we should certainly have been in no doubt after the publication of our November number. Dealers who wrote to us were unanimous in their views that some form of recognition should be given to those who know their job and who have the facilities for doing it thoroughly, but an even more interesting note was struck by some of them, who (while commending the idea as a whole) implored us either to ensure that it was properly handled, or to leave it well alone. With that line of thought we are indeed in complete sympathy; for we most certainly do not intend to set ourselves up as layers down of rules, but rather to assist interested parties to benefit from any organisation which their own good work and wishes must make possible.

After-sales service is an essential, where almost any type of machine or electrical instrument is involved, and it is unfortunate that the tape recorder side of the electronics industry did not pay more attention to this fact in past years. Only a fool, or a very well equipped and competent mechanic, would buy a motor car without first assuring himself that bits and pieces were reasonably well distributed throughout the country's repair depots. The same applies to TV and radio sets, and the manufacturers know this and prepare the ground. But with tape recorders it seems that both makers and purchasers are to blame for much of the trouble they have suffered.

Unlike a motor car, however, the entrails of a tape recorder that cause most of the trouble are electronic; and in order to ensure that any make of recorder shall not lose its good name through bad service facilities, the basic precautionary essentials are (a) the co-operation of retail outlets throughout the country, where properly trained mechanics are employed and (b) the provision of proper circuitry and maintenance literature, plus an intelligent parts list, so that these mechanics know what to expect. In this, with a few notable exceptions, the manufacturers have failed lamentably. In some cases, it seems, they have been content to sell their products anywhere and everywhere, through any outlet that would display them; and "service" meant either "send it back to us", or the pot luck that the innocent purchaser had to take.

Initially, to assist both readers and dealers, we invite dealers to write to us, stating specifically (1) what makes of tape recorders they currently undertake to service in their own service premises, (2) whether they carry reasonable spares stocks, (3) details of their regular service personnel. And, also initially, while this reference list is being compiled, we will reciprocate by recommending readers in these areas to deal with them. This we are in fact already doing, experimentally, for readers and dealers who have written to us, but it is important at this stage

CONTENTS

	Page
News—Pictures—Ideas	513
News from the World of Tape	514
News and Pictures from the Clubs	516
Common Tape Faults	
By F. K. Rawson	519
Readers' Problems	523
Tape Recorder Workbench	
(No. 29) Tape Recorder Adjustments	
By A. Bartlett Still	525
An Add-On Cine/Sound Unit (Part 1)	
By A. Tutchings	526
Sound and Cine	
By Richard Golding	529
How Readers are using Stereo	531
Other Recording Systems	
By Graham Balmain	533
Our Readers Write	537
Details of New Products	539
Equipment Reviewed	541
Classified Advertisements	548
Advertisers' Index	550

that readers do *not* write to us, asking for service addresses. We have neither the staff to handle the correspondence, nor have we more than a handful of suitable dealer addresses.

Eventually, we hope to compile a useful, nation-wide list of dealers, and to revise and publish this for the benefit of all tape recorder owners and would-be buyers. Further, we look forward to the time when all such dealers will themselves find it beneficial to publish and display the monogram which will be a guarantee to their customers of good, after-sales service. But this end cannot be achieved in few days, or even weeks, if it is to be organised on really sound lines. But, in order to speed the day, we do earnestly seek the co-operation of both dealers, and readers who have first hand knowledge of dealers with reliable and efficient service facilities.

NEXT MONTH

FOR the do-it-yourself enthusiast interested in cine, Mr. A. Tutchings continues his article on an Add-on unit for a cine projector. Two of the latest tape recorders to appear on the market will be reviewed; they are the Tandberg Model 3B and the Brenell Mark 5M. As usual all the regular features will be included, *Tape Recorder Workbench*, *Sound and Cine*, *Here and There and Everywhere* and *Detail of New Products*, to mention but a few. As we still hear from readers unable to obtain copies a few days after the magazine appears on the bookstalls, may we suggest that you place an early order with your newsagent or tape recorder dealer.

COVER PICTURE

THE news story on page 514 of this number gives the background of our cover photograph. When one listens to a broadcast, inevitably the mind conjures up a picture of vast concert halls, of dozens of officials working to lights, clocks and banks of controls. In actual fact, as a result of the tremendous electronic strides made in recent years, the broadcast can eventually emerge from two or three streamlined boxes and two spools of tape. Such in essence is the B.F.N. station in Berlin, equipped by Telefunken, who kindly sent us the photo.

SUBSCRIPTION RATES

The subscription rate to *The Tape Recorder* is 21/- per annum (U.S.A. \$3.00) from The Tape Recorder, 99 Mortimer Street, London, W.1. Subscription + Index, 24/- (U.S.A. \$3.25).

# This Christmas...

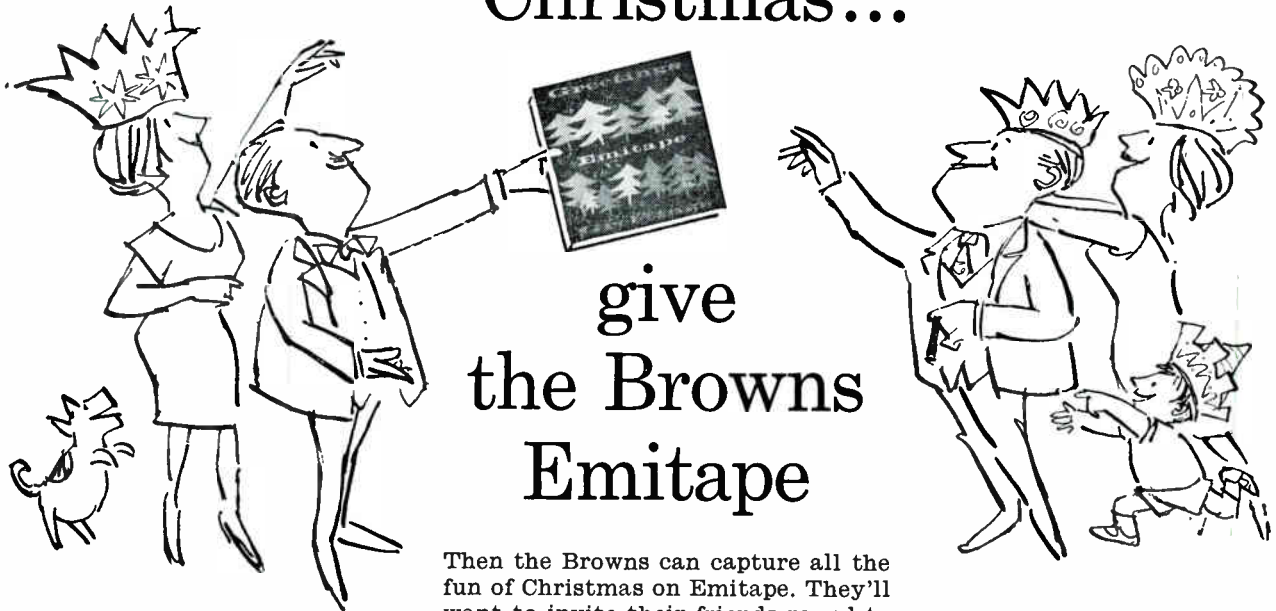

give  
the Browns  
Emitape

Then the Browns can capture all the fun of Christmas on Emitape. They'll want to invite their friends round to listen to this, so you must give them another reel of Emitape to record their friends' reactions to the Brown Christmas (know anyone called White?).

Cheerfully wrapped for Christmas, Emitape comes in four reel sizes. Fits any stocking, looks good on the best trees.



## And, for the Greens, the new Emiguides

When it comes to getting the quality right, Mr. Green is well named. His Achilles' heel is well covered by one of the Emiguides—John Borwick's six instructional tapes. The other five Emiguides give you the right of way through the rest of the tape-recording maze. They're available as a set or separately to all sound-wise Santas for 8/6 each.



**Emitape**



EMITAPE DIVISION  
E.M.I. SALES AND SERVICE LTD  
HAYES, MIDDLESEX

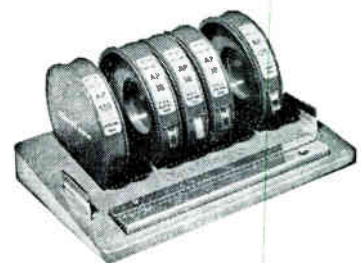

## And a present under £2 for Mr. Black

If Mr. Black asks you for three reels of leader tape, a reel of jointing tape, a reel of metallic stop foil, an Emitape jointing block and a pair of cutters, that's just his delicate and oblique way of asking for the Emitape Accessory Kit. 37/6.

# News - Pictures - Ideas!

## Tape in Libraries

THE most significant development in tape recording in the past five years has been the gradual absorption of the new recording techniques into the ordinary activities of every-day life, including the community services. It is no compliment to some of them that they have been so slow to realise the advantages they could gain from these new short-cuts in communication and the time-saving processes which tape recording can offer. The modern recorder still has a lot of red tape to cut and plenty of new fields to conquer. But all around the ramparts of prejudice and tradition are going down!

One service which could make great use of tape recording, both for its own convenience and the public good, is the public library. This important service, which has the widest possible community impact, has been curiously tardy in adopting tape-recording facilities. These are already long overdue in the research section of library reference departments, which are being used more and more extensively by writers, teachers and students, as well as by those who take an active part in national and local affairs.

## Laborious Copying

You don't have to go to the Reading Room at the British Museum or to one of the specialised reference libraries to realise the amount of time spent in research work by all kinds of people. The amount of note-taking and copying that goes on is immense. Many visitors take away reams of matter, representing the work of several hours. The most noticeable fact is that nine out of ten do their copying laboriously in longhand. A few use shorthand; some who can type and who have long "slabs" to copy are lucky sometimes to get the permission of an understanding librarian to take a portable typewriter and the work they wish to copy into a quiet room—if one is available.

Surely the time has come when tape-recording facilities should be made available in every reference library of any size. In libraries where much of this work is done regularly such facilities are absolutely necessary. They could be provided in several ways, according to the demands of the users. The basic provision should be a small room or cubicle, with table and plug points, to enable anyone engaged in research to take in a tape recorder for the purpose of quickly recording extracts and collating notes. Where the potential demand justifies it, a tape recorder could be made available at a small fee on stated hire periods. There could be a separate hire fee for the tape, repayable on its return. Many users would probably prefer to use their own tape.

## Further Suggestions

Such a service would enable serious research workers to do their actual "copying" in a tenth of the time occupied by the outdated manuscript method. They would probably save so much time—and incidentally a great deal of eye-strain, too—that they would be able to look up many more references during a single visit to the library and could cover a great deal more ground. This faster turnover would help to relieve the growing congestion in many reference libraries.

Library extensions which are now being carried out in various places, including some London suburbs, might well include a facility which is in line with technical progress, and which would be a definite improvement in the library service itself.

An adaptation of the same idea could be used to replace, or as an alternative to, some of the photostat services used to supply photo-copies of letterpress material required for reference for literary research purposes. There are, in fact, several other ways in which tape recordings could ease the task of those who now spend long periods finding, sifting and copying lengthy extracts from newspaper files, books and other sources. It is quite possible that in the future some of the micro-film services now used by the more advanced libraries—and which many others are anxious to adopt—may be replaced by visual record-



The meeting between Malcolm Mitchell, who appears on television with his group, and Sonia Dean, an authoress of popular light novels, was to discuss a proposed scheme of recording Miss Dean's novels, with the possibility of Malcolm Mitchell providing the introductory music, on a composite tape.

ing in sound, on tape. It is obvious, in any case, that it cannot be long before there opens up in the library services an almost illimitable field of development in tape-recording, including music on tape as an inevitable adjunct to the music section of every large library.

An acceptable and useful service for general readers—and one which would ensure that full use was made of the recording equipment provided—would be regular "Books of the Month" talks by staff librarians, available to listeners on demand in a replay cubicle. These talks could cover both fiction and general literature, with additional talks on poetry, drama and other subjects, brought up-to-date at less frequent intervals. This kind of service is capable of endless expansion and many young librarians would welcome opportunities to "broadcast" in this way. These tapes would also be welcomed by schools. C. F. Carr



★  
**ROBOPHONE  
TELEPHONE  
ANSWERING  
MACHINE**  
★

A NEW telephone answering machine—the first British production to employ printed circuits and transistors in its construction—has been announced by Robophone Ltd. of Tottenham Court Road, London.

Called the Robophone, this new machine will answer the telephone, record messages, give callers information and act also as an all-purpose dictating machine. The instrument has been accepted by the General Post Office for use in conjunction with its telephone equipment. It is manufactured in London and is being made available on a contract hire basis—just like a telephone—for periods of 3, 5 or 7 years duration at rates from 27 shillings per week. Installation and maintenance is free.

# NEWS FROM THE WORLD

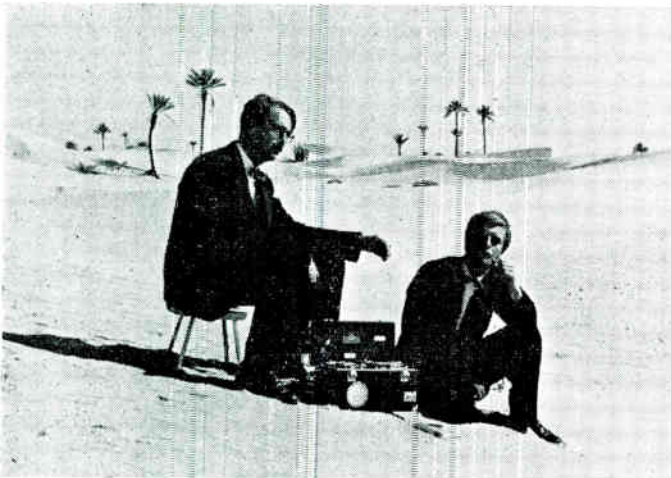

Peter Judge (left) and Simon Allison, members of the Cambridge University Libyan Expedition, listen to a recording of Arab musicians—made on an E.M.I. portable tape recorder—while waiting for dinner in the desert 30 miles north of Sebha. Ten undergraduates made up the party which studied two little-known oases, at Sebha and Gadhames, 600 miles from the coast. They astonished Arabs by "taking something of Cambridge life to the desert" by dressing for dinner.

## Novel One-Man Broadcasting Studio in West Berlin

ACCORDING to hearsay, Napoleon was able to write a letter to Josephine and discuss battle tactics with his field marshals at the same time. Now, a century and a half later, a man is living in West Berlin who, similar to the Corsican, is able to do several things simultaneously although without employing his talents for amorous and warlike purposes: the Berlin representative of the British Forces Network.

Mr. Andersen is an executive in a British administration office in West Berlin, but after office hours the likeable Briton exchanges his office desk for the control desk of the British Forces Network, Berlin studio. At the control desk the serious gentleman does something quite unexpected: he splits himself into several personalities—a sound engineer, producer, announcer, interviewer and disc jockey.

In the Spandau suburb of Berlin the Telefunken G.m.b.H. has furnished the British Forces Network with a novel, modern broadcasting studio, that permits in practice one-man operation without being a temporary matter. In the near future it will be taken into operation. All units installed in the control room, once the sound engineer's domain, are duplicated in the announcer's booth with the exception of the two tape recorders which can be operated remotely from the booth. In addition two record players are installed in announcer's booth.

After he has calibrated all the measuring units himself, Mr. Andersen is thus able to play records, control volumes, regulate the audio quality, operate tape recorders, cross-fade and carry out trick effects and speak at the same time, inducing a shy person being interviewed to talk, and crack jokes, while sitting in the booth.

Announcing, controlling, changing the records, operating the tape recorders, etc., mean that Mr. Andersen must very often do two things at once. If, for example, he starts talking during the last few bars of a dance number to announce the next record, he must simultaneously press the control upwards and keep an eye on the scale indicating the volume. Twenty-two such knobs and controls are arranged in front of him, and it is essential that he selects the correct one.

This one-man design meets half-way the easy-going, natural character of the B.F.N. broadcasts, which so often appear

improvized and are so refreshing for just this reason. One of the most popular B.F.N. disc jockeys is Bill Crozier—a man who announces on request programmes and is reputed to be able to humorously pass over illegible addresses. But in spite of its carefree ways the B.F.N. is quite a serious station and, as Mr. Andersen says, "Everything that comes from Berlin must be all right".

\* \* \*

## World Tour as Prize for Radio Series

A MINIATURE world-tour of famous capitals as a Cabaret act. That is the first prize in the new series of 'Make-a-Tape'—the nation-wide radio talent competition. Whichever act wins this outstandingly successful Radio Luxembourg show will be flown to Paris for three days by Aer-Lingus, on to Rome for another three days and finally over to New York for a week. In each of these capitals the winners will appear as a Cabaret in a top night club.

'Make-a-Tape'—which has broken all records as a radio show—is a competition for the best two-and-a-half minute tape recording. Currys—who sponsor the show—expected between forty and fifty tapes a week when they started the first series last year. Soon they began to get over three hundred. In the first two series over five thousand tapes were received. From old-age pensioners in Wales (who appeared in the first final) to sixty-five-strong school choirs, the variety and high standard of talent surprised everybody. Now the third series of 'Make-a-Tape' has begun. Compered by Macdonald Hobbey, the show has the full support of Philips and E.M.I., and will be heard by millions of radio listeners every Sunday at 10.30 p.m. on Radio Luxembourg throughout the winter.

\* \* \*

## New Offices for Ampex Great Britain Limited

ON 2nd October, Ampex Great Britain Limited, who are responsible for the sales of Ampex equipment in Great Britain, moved to new premises at 72 Berkeley Avenue, Reading, telephone Reading 55341, Telex 84146. Hitherto, the Company had shared premises at Reading with its sister manufacturing company, Ampex Electronics Limited. This new move makes available additional space for Ampex Electronics Limited both for manufacturing and development, made necessary by the continuing expansion of both Ampex companies at Reading. The new premises of Ampex Great Britain Limited are near to those of Ampex Electronics Limited, so that the same close liaison between the manufacturing and sales organisations will continue.



DECEMBER  
NUMBER

★

Contents include:  
A Crystal Controlled  
[FM Tuner  
Horn Loaded Loudspeakers  
Readers' Letters

★

NOW ON SALE

# OF TAPE

## Audio Festival Announcement

AT the 1962 International Audio Festival at the Hotel Russell, London, from April 26 to 29, the opening day (Thursday) from 11 a.m. to 4 p.m. will be a trade preview. The public will be excluded until after 4 p.m.

This was decided at the first meeting of the exhibitors' committee held at the Hotel Russell last week, when R. Merrick (British Ferroglyph) was elected chairman of the 1962 Festival. The exhibitors' committee consists of P. Walker, of Acoustical Manufacturing Co. Ltd.; A. Farquharson, of Armstrong Wireless & Television Co. Ltd.; Mrs. E. Hawkins, of Goodmans Industries Ltd.; F. Hawkins, of H. J. Leak & Co. Ltd.; J. Rogers, of Rogers Developments (Electronics) Ltd.; T. B. Livingstone, of Tannoy Products Ltd.; L. Young, of Vitavox Ltd.; Gilbert Briggs, of Wha-fedale Wireless Works Ltd.; J. Maurice, of Lustraphone Ltd.; and D. Chave, of Lowther Manufacturing Co. Ltd.

A progressive new step decided upon was that certain selected wholesalers be asked to participate as exhibitors. These selected wholesalers, who have been enthusiastic supporters of the audio industry for many years, would not be expected to give demonstrations or to show goods, but would be allowed to hire furnished lounges at a nominal rate so they could entertain their trade customers.

A new attraction to enhance the Festival aspect of the exhibition is that Gilbert Briggs will be giving a live demonstration of recordings. Mr. Briggs, one of the famous names in the audio industry, has already given concerts at the Carnegie Hall, New York, and the Royal Festival Hall, London, which aroused world wide interest.

Already nearly 60 firms have applied for space at the Audio Festival and there is a notable increase in the number of tape recorder and tape manufacturers who will be participating.



Bob Danvers-Walker, the well-known Radio and T.V. announcer, has just returned to England from his latest B.B.C. assignment—a trip to Nice on a Lambretta scooter, recording a "Holiday Hour" programme for broadcast next February. Bob used the Fi-Cord 1A—which has accompanied him on many daring and unusual assignments in the past.

### Demonstration Week at Nusound

NUSOUND Recording Co. will be holding a Ferroglyph Week from the 2nd to the 9th December at their showrooms at 35 Craven Street, Trafalgar Square, London, W.C.2, from 10 a.m. to 7 p.m. All models will be demonstrated including the latest 420 series. No tickets are required.

### Stroiling Minstrelles

THIEVES who entered the factory of Simon Equipment Ltd., on the night of 2nd October, made off in a Simon van with among sundry items, a van load of 54 Minstrelle and 6 Cymbal tape recorders. The Simon van was later found emptied and abandoned after it had been reported for causing an obstruction. Simon Equipment Ltd. have a record of the serial numbers of the missing recorders. Any information regarding the theft should be sent direct to the above company.

### Stereo Tapes

DURING the month of January World Record Club will be issuing 28 stereo tapes, the first releases of a new series. These tapes will be recorded on 7½ i.p.s. tape and will cost between £2 10s. and £3 according to playing time, which is up to 48 min. The repertoire will range from jazz to classical music including Shows and Operettas. The artists include Sir Arthur Bliss, Colin Davis, Leon Goossens, Josef Krips, Leopold Stokowski, Ian Carmichael and Lionel Hampton.

### Sound and Cine Demonstration

CLEMENT WAIN LTD. held an evening of Sound and Cine at the Castle Hotel, Newcastle, on Monday, October 16th, when Mr. A. Dakin, representing A. C. Farnell of Leeds, the Tandberg Record Importers, gave a complete demonstration of the Model 3 and the Stereo Model 6 to an audience of 200.

### Six Lectures on Sound Recording

A SERIES of six lectures entitled "The Technique of Sound Recording" is being given by *Hi-Fi News* contributor Peter Ford at the British Institute of Recorded Sound, 38 Russell Square, London, W.C.1. The first two lectures were given earlier this month and the third (Nov. 24th) will deal with Electrical Disc Recording 1919-61, (Dec. 1st) The Evolution of Magnetic Recording, (Dec. 8th) Sound Recording and the Cinema and (Dec. 15th) Stereophonic Sound. Tickets are available, priced 2s. 6d., from the address given above.

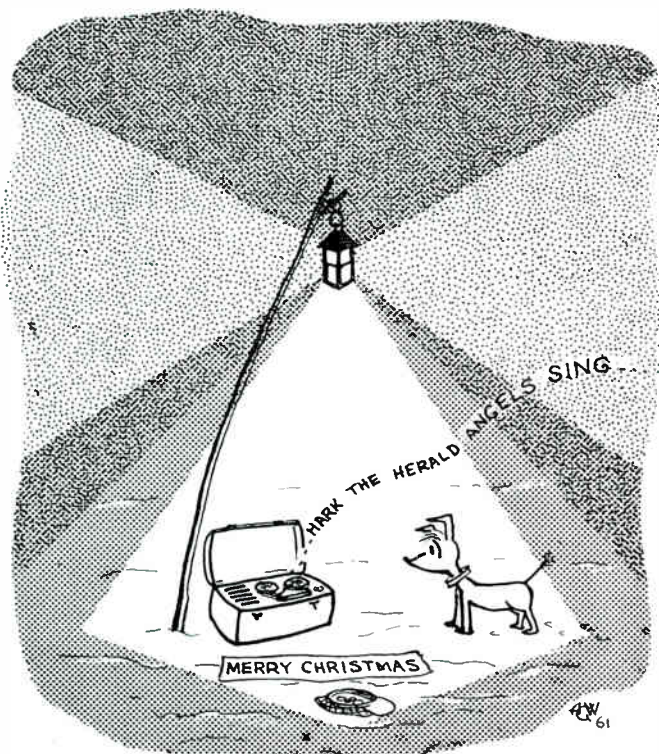

The waits that couldn't . . .

# NEWS AND PICTURES FROM



Some members of the North London Tape and Hi-Fi Club gather round the table for a demonstration of the Butoba battery portable recorder.

OUTSIDE recordings have been the order of the day at the North London Tape and Hi-Fi Club recently.

The Enfield show, held in September, provided a wonderful opportunity for members to show their skill at interviewing and using portable tape recorders. Although, unfortunately, the club had no stall of its own, this did not prevent them from compiling a half-hour programme about the show, including interviews with other club secretaries, recordings of live music by local bands and general effects.

The programme has since been used as part of a recorded newstape, issued weekly to blind and handicapped people in the district by the Enfield branch of Toc H.

Excerpts from the Enfield Show tape will be used in a magazine programme, which is intended to be circulated to other clubs throughout the country, and perhaps abroad.

Hymns—a dozen of them—sung by a local church choir especially for the occasion, were recently recorded by members of the club for playback at Enfield's War Memorial Hospital, where some patients are unable to attend a normal service. Congregational Church minister, the Rev. S. J. Gadsden, will conduct the service, while the selection of the hymns, as the minister wants them, will be done by club members.

A demonstration of headphone stereo was recently given at the club by Mr. G. N. Tughan, of Teletape, Edgware Road, Marble Arch, who, representing Denham and Morley Ltd., gave a detailed talk on the Butoba portable machine. Accompanied by Mr. Thomas, manager of the servicing department of Teletape, Mr. Tughan also played some pre-recorded tapes and the very advanced Sony recorder was demonstrated.

Competition number five, the production of an original two-minute advertisement, was won by Ray Maslin, of Borehamwood, who has gained second place in the two previous competitions. He submitted an advert for a wonderful, never-to-be-forgotten holiday of the future—on Luna, Mars or Venus.

Further details of club activities can be obtained from R. Collinson, 30 Ridler Road, Forty Hill, Enfield, Middlesex.

FOLLOWING a meeting of five tape recording enthusiasts, and a letter in the local paper, September saw the formation of the **Hastings & District Tape Recording Club**. Twelve recordists were present at the first meeting, which was held at the Secretary's home, and Mr. H. Tompson was elected Chairman, Mr. J. G. Ashman Treasurer and Mr. J. F. M. Aitchison, Secretary.

The first few meetings were made up mainly of introductions, and listening to recordings made by other members. Organ Music recorded in a local church was played by J. Tompson and T. Jackson. An amusing experiment in Music Concrete was

produced by I. Hills. A tape of congratulation and good wishes was heard by the club, sent by the first Honorary member, Cecil Coslow of Preston, Lancs., a long standing contact of the founder member, T. Stevens. At the third meeting on October 3rd the club welcomed its first Lady Member, Miss Rosemary Parminter.

Further details can be obtained from J. F. M. Aitchison, 62 Vicarage Road, Hastings, Sussex.

A B.B.C. recording unit visited Crawley recently to make a short feature programme of life in the New Town, entitled "Postmark U.K.". The secretary of the **Crawley and Sussex Tape Recording Club** was invited to give a short interview on the aims of the club, and what has been recorded over the last few months. The programme is to be transmitted in the General Overseas Services later in the month.

Further information is available for readers interested in joining, from R. C. Watson, 32 Southgate Drive, Crawley.

THE **West Wales Tape Recording Club** was again fortunate to have a second visit from Mr. G. R. Pontzen, of Messrs. Lustraphone Ltd., to give a demonstration and talk on their famous range of microphones. The club have by this time become quite regular users of these microphones and were delighted to see that this firm has again added to its already large variety of microphone equipment. Mr. Pontzen, who was on holiday in Wales, was good enough to give up one evening to come to Aberystwyth to give this demonstration.

The club has also started a monthly competition between club members, where the overall winner will receive a prize after being judged by local dignitaries. They have also started another year of Hospital broadcasting and several of the members have given hours of valuable time in going to places of interest and recording items and concerts for the service.

Further details can be obtained from G. Jenkins, 5 Glyndwr Road, Aberystwyth.

RECENTLY the **Leeds & District Tape Recording Club** visited the Leeds Central Fire Station and spent a very interesting two hours being shown around, and also recording interviews. They were also lucky enough to record a live turnout of two fire engines, complete with bells, when the electric motor in a butcher's refrigerator caught fire. Some of the firemen were found to be recording enthusiasts too.

At a later meeting Mr. Markinson, a committee member and the club's Public Relations Officer, brought along an unbelievable amount of "do it yourself" aids for tape recording. He showed a remote control boom microphone stand worked by electric motors used for stage work, also timing devices for switching recorders on and off at pre-set times, a vibration proof microphone stand and assorted gimmick effects.

During the month of October the club visited the B.B.C. studios in Leeds and were shown round by Mr. Enoch, who explained the workings of the studios and all the equipment.

New members are welcome to attend any meeting and details can be obtained from R. Crossley, 96 Stainbeck Road, Meanwood, Leeds, 7.

DURING the month of September, the United Kingdom has been the meeting place for many **World Tape Pals**. A group of members met N. and C. Driscoll, of Dallas, and spent a very enjoyable time together. Another meeting, proving that the world is a very small place, occurred in Petticoat Lane, when the U.K. secretary and his wife, roaming around with a portable recorder met two Israeli members—Dr. A. Rimon and his wife. The visitors recorded their impression of the market, both from the tourist angle and from the practical housewife's point of view.

Anyone interested in joining **World Tape Pals** should contact R. and J. James, 45 Boundary Road, Colliers Wood, London, S.W.19.



# THE CLUBS

**T**HE secretary of the **Friern Barnet and District Tape Recording Club** has now received a cup from Mr. J. Neal, and it has been decided to award this for another type of competition, and not for the "Five-minute Tape" to be judged at Christmas. Mr. J. Fulton's cup will be awarded for the best tape.

A very successful visit was made to Temple Mills Marshalling Yard. Members were made welcome by Mr. J. Briggs, the Assistant Yard Master, who piloted the club to the "Hump" and the control tower, where operators explained their duties and responsibilities. The club then had the unique experience of travelling in a guard's van from Temple Mills to Hither Green.

The club car rally was won by Mr. C. Green's crew. All the instructions were given on tape, and all the answers had to be recorded. Portables came into their own. It is said that the shortest way to Southgate from Friern Barnet is via Wood Green and Leicester Square! A further rally is planned for the New Year.

The club meetings are held fortnightly. Further information can be obtained from *A. Andrews, 13 Hartland Road, Friern Barnet, London, N.11.*

**T**HE **Glasgow Tape Recording Club** have completed another successful year despite several changes of secretary and the loss of several particularly active members. The annual general meeting held during October was a busy evening despite an early start and a half-hour extension of time. Members are continuing to meet at the Christian Institute, Glasgow, alternating between Tuesday and Thursday fortnightly. All meetings commence at 7.30 p.m. Enquiries from those interested will receive a postcard giving details of the next meeting. Secretary *Mr. Dryden, 43 Daisy Street, Glasgow 52.*

**M**EMBERS of the **Bromley Tape Recording Club** visited the **Dartford Club** recently and a very full programme was organised for the evening. Demonstrations were given by members of the Dartford Club and included tape editing, audio mixing, ribbon microphones and the parabolic reflector. The reflector was made by L. Coates, who took two weeks producing the required shape. A general discussion followed and the meeting was closed by the chairman, Mr. G. A. Pulham. Further details of club activities can be obtained on request from *E. H. Foreman, 117 Westgate Road, Dartford, Kent.*

**T**HE **Walsall and District Tape Recording Club** now has for its President Jack Jackson, the well-known radio artist. To start off his association with the club he sent a very amusing tape for members to listen to. This was much appreciated as it was realised that Jack Jackson is a very busy man.

One of the members gave a colour slide show complete with taped commentary at the last meeting and has promised to give a further show at a later date.

The club is now anxious to increase membership, which at the moment stands at 24. Anyone interested is asked to contact the Secretary who will be pleased to supply details. *Mrs. J. Walford, 41 Mill Road, Pelsall, Walsall.*

**T**HE latest meeting of the **Cotswold Tape Recording Society** was devoted to a lecture by Colin Woods on tape mechanisms. This was illustrated by blackboard drawings of the commonest systems, which were discussed from the point of view of their main advantages and drawbacks. Colin Woods has made a number of decks himself, to his own designs, and some of these ideas were shown. All had the merit of extreme simplicity which avoided some of the major snags of more complicated mechanisms.

As the chairman, Clifford Benn, remarked, when thanking Colin for his talk, members now have a far better understanding of the delicate and exacting requirements of a satisfactory tape-



*Mr. R. Crossley, secretary of the Leeds and District Tape Recording Club, seen recording in the club's studio.*

transport system, coupled with an increased admiration for the way in which these requirements are met even in mass-produced decks. Further details of club activities can be obtained from *P. D. Turner, Cave Cottage, Oakridge Lynch, Stroud, Glos.*

**T**HE meeting of the **Rugby Amateur Tape Recording Society** held on October 19th was well attended as Mr. J. F. Parrington of B.A.S.F. Chemicals was giving a talk and demonstration. The film "The Magic Tape" was shown together with slides and members found the programme both interesting and educational. A sample of mailing boxes issued by B.A.S.F. was given to the secretary for distribution to members after the meeting, and some booklets were presented for the club library. The president, Mr. J. Bannister, organised a quiz which was found by some members to be rather difficult, nevertheless, Mr. D. Middleton obtained the highest marks and received a prize.

The Christmas Draw is now ready and it is hoped that the proceeds will exceed the total of last year. The result will be announced on December 21st, 1961. Further details of club activities can be obtained from *Mr. M. Brown, 219 Clifton Road, Rugby.*

**A**T the Annual Dinner of the **West Middlesex Tape Recording Club** it was announced that Mr. Angus McKenzie had accepted the invitation to become president of the club for the coming year. Mr. McKenzie quickly pointed out that he will not be content to remain the head of a piece of notepaper, but would like to help and assist members as much as possible. It was also announced during the evening that new premises had been found and that in the future it may be possible to hold weekly meetings. Other founder members who attended the dinner were Mr. and Mrs. P. Copinger, now residents of Kilmarnock, and Mr. F. Westcott, once chairman of the Federation of British Tape Recording Clubs. The meeting ended with members looking forward to another exciting and interesting year. New members are welcome, details of meeting places can be obtained from *Mr. H. Saunders, 20 Nightingale Road, Hampton, Middlesex.*

**M**R. R. Finch is anxious to form a tape recording club in Halesowen, Worcestershire. Any reader interested should contact *Mrs. D. Hollyoak, 20 Honeyborne Road, Sutton Coldfield, Warwickshire.*



wishes you a magnetic Xmas and a tape-recorded New Year

For the first time on tape . . .

# HANDEL "MESSIAH"

*The Complete Score*

HEATHER HARPER, soprano ★ HELEN WATTS, contralto ★ DUNCAN ROBERTSON, tenor  
ROGER STALMAN, bass ★ CHRISTOPHER WOOD, harpsichord ★ RALPH DOWNES, organ

LONDON PHILHARMONIC CHOIR  
LONDON PHILHARMONIC ORCHESTRA

FREDERIC JACKSON, Conductor

MONO . . . 3½ i.p.s. STG 8051-3 97/6 set 3 tapes



STG 8063

### Chris Barber Band and the Lonnie Donegan Group

'Tiger Rag'; 'Ice Cream'; 'Saratoga Swing'; 'Precious Lord Lead me on'; 'Tight like that'; 'Down by the Riverside' and 'Leaving Blues'; 'Over in the New Burying Ground'.

STG 8068

### Muggsy Spanier Dixieland Band & Dixieland Battle

'Bugle Call Rag'; 'That's a Plenty'; 'Royal Garden Blues'; 'Margie'; etc.

### Pete Fountain Dixieland All Stars (a) & Pete Daily Band (b)

(a) 'Farewell Blues'; 'At the Jazz Band Ball'; etc.

(b) 'Swanee River'; 'A Closer Walk'; etc.

★ SAGA TAPE RECORDS USE  
**SCOTCH** TAPE EXCLUSIVELY

STG 8070

### Ken Colyer Jazzmen

'Wabash Blues'; 'Shine'; 'Bucket Got a Hole In It'; 'Isle of Capri'; etc.

### STG 8045 Silk Satin and Strings Caesar Giovannini Orchestra

An 'easy listening' album by a brilliant orchestra—symphonic in size:—'Jealousy'; 'Sleepy Lagoon'; 'Holiday for Strings'; 'From This Moment On'; 'Laura'; and seven others.

STG 8054

### Caesar Plays

Caesar Giovannini, pianoforte

'Begin the Beguine'; 'All the things you are'; 'Vienna'; 'City of my Dreams'; 'Malaguena'; 'Somewhere over the Rainbow'; etc.

STG 8056

### You Make Me Feel So Young

Nancy Wright (Vocalist) with Caesar Giovannini Sextet.

Best Hi-Fi Demonstration tape available

STG 8047

### Re-Percussion

'Crocodile Crawl'; 'Cymbalation'; 'Pentatonic Clock'; 'Moonlight Reflection'; 'That's a Plenty'; 'Cloud Nine'; etc.

Dick Schory Ensemble

Over 100 percussion instruments create a fresh new sound for superb 'stereo listening'.

STG 8069

### An Evening with Big Bill Broonzy

'Hey Bub Blues'; 'This Train'; 'I'm Going Down the Road'; etc.

STG 8046

### Lucky Thompson Quintet

Thompson—tenor sax; Jimmy Hamilton—clarinet; Billy Taylor—piano; Oscar Pettiford—bass; Osie Johnson—drums. 'Tune for Tex'; 'Kamman's A' Coming'; 'Where or When!'; 'Mr. E—Z'; 'Ever so Easy'.



STG 8048 T for Trombone

### Jack Teagarden Band

Teagarden—trombone and vocals. Featuring Ruby Braff, trumpet. 'Lover'; 'After You've Gone!'; 'Stars fell on Alabama'; etc.

★ ALL PACKAGED IN ATTRACTIVE  
FULL-COLOUR PICTORIAL BOXES



the *liveliest* name in *tape records*

127 KENSAL ROAD, LONDON W.10

518

# COMMON TAPE FAULTS

By F. K. RAWSON

The Author has arranged to make the tape height adjuster and a suitable suspension of colloidal graphite available if there is sufficient interest. Enquiries should be addressed to him, c/o The Tape Recorder. **Warning.** Suspensions of Colloidal Graphite in solvents may damage plastics and should therefore be avoided.

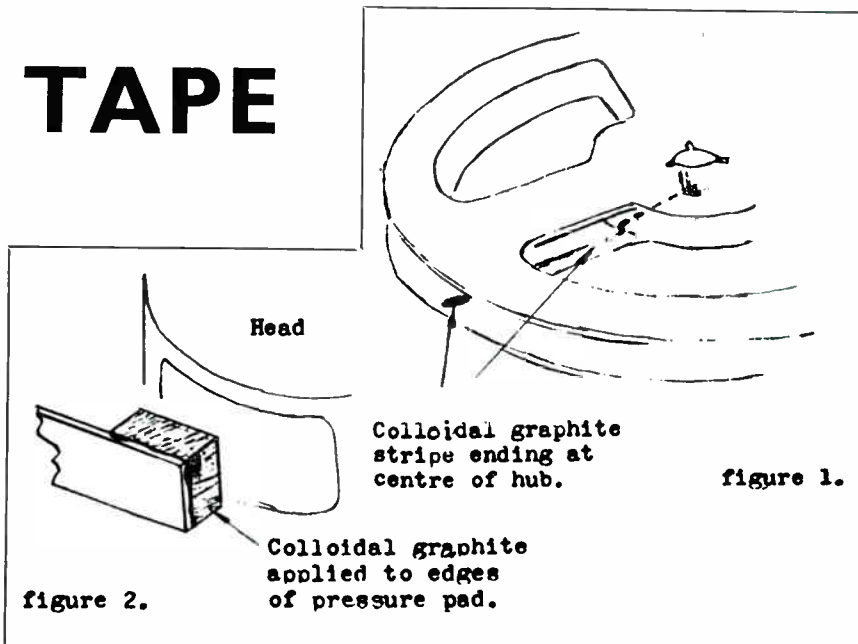

**D**URING the course of building, testing and listening to a number of tape recorders, a series of "off beat" troubles, which I have given the name "side effects," have inflicted themselves upon the equipment. As these side effects have no doubt troubled others it seemed worthwhile documenting them, with at least a few suggestions as to how they can be alleviated.

## Static

On most tape recorders static electricity on the tape or mechanism at some time or other causes considerable interference to the signal being recorded, and in some cases during playback of recorded tapes. The static is generated in several ways, typically (a), as the tape separates from the feed reel (b), as the tape enters the take-up reel and (c) anywhere where the tape undergoes friction, such as under the pressure pads.

Additionally, in some mechanisms having belt drives or large masses of plastic in their construction, whole sections of the machine itself may become charged. The effect is similar to that which occurs on combing hair—the crackle and attraction to the comb are familiar to everyone.

## Form of Interference

The interference is caused by the low energy sparks which discharge the static to earth, particularly as the tape passes over guide rollers, etc., or as it passes on to the reel. In some cases the

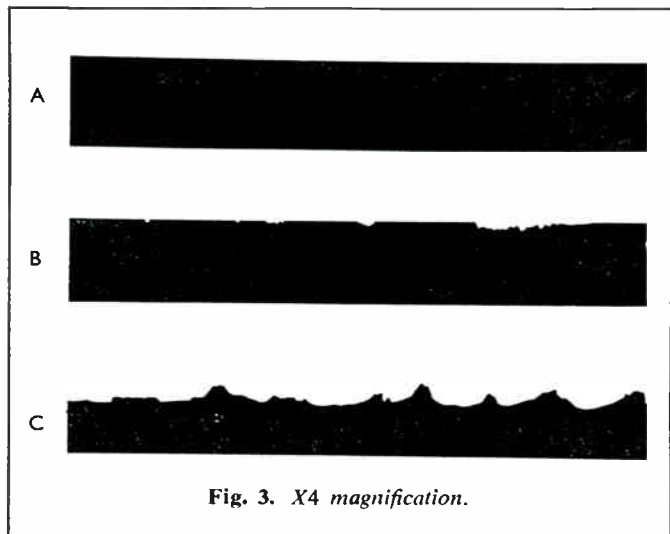

Fig. 3. X4 magnification.

period between discharges can be several seconds, as the static charge gradually builds up to the level to cause flashover to earth. The interference is usually in the form of clicks which may be very troublesome when recording from the radio. Static generated at the pressure pads due to friction may cause continuous low level hiss on the programme material.

The degree of static produced can vary a great deal with the level of air humidity. At some periods it will be non-existent; at others it can be a real source of annoyance. The static level will be at its highest when the air is at its driest—this is usually during frosty weather. Modern tapes are far less troublesome than the earlier acetate based types, some of which produce copious amounts of static.

## Overcoming Static

Fortunately, most static troubles can be overcome by providing conducting paths to earth at strategic points, by means of colloidal graphite in water applied by brush. For instance, a thin conducting stripe applied down one spoke of plastic tape reels from the outer edge of the rim to the centre spigot hole (fig. 1) will alleviate the build up of voltage as the tape passes from reel to reel. Some little ingenuity is required to achieve continuity through the reel hub, but gaps in the moulding can usually be found through which the brush can be inserted.

An easier alternative method consists of treating the reel with an anti-static *Perspex* polish, manufactured by Imperial Chemical Industries Ltd. Although this polish is specifically for *Perspex* it has been found to work well on polystyrene tape reels without visibly causing any harm. This same method can be used to treat plastic decks and cover plates, etc. Unfortunately, the use of polishes does not appear to produce a very long-lasting solution.

Pressure pad static can be cured by painting the edges of the pressure pads with graphite, making sure that it makes contact with the earthed metal pad carrier. Care must be taken to ensure that the graphite does not flow on to the pressure faces of the pads (fig. 2).

## Applying Colloidal Graphite

The colloidal graphite should be applied in a very thin film by means of an ordinary artist's paint brush—size 0 has been found quite suitable. It goes almost without saying that the colloidal graphite must be allowed to dry before using the machine, otherwise the tape may be damaged. The smudging of the graphite which takes place with usage does not greatly detract from its conducting properties.

Strange as it may seem, static build up can also take place on metal reels. One particular make of reel was found to be insulated from the deck hub by its well applied layer of paint.

# Introducing the new *Ferrograph* 420

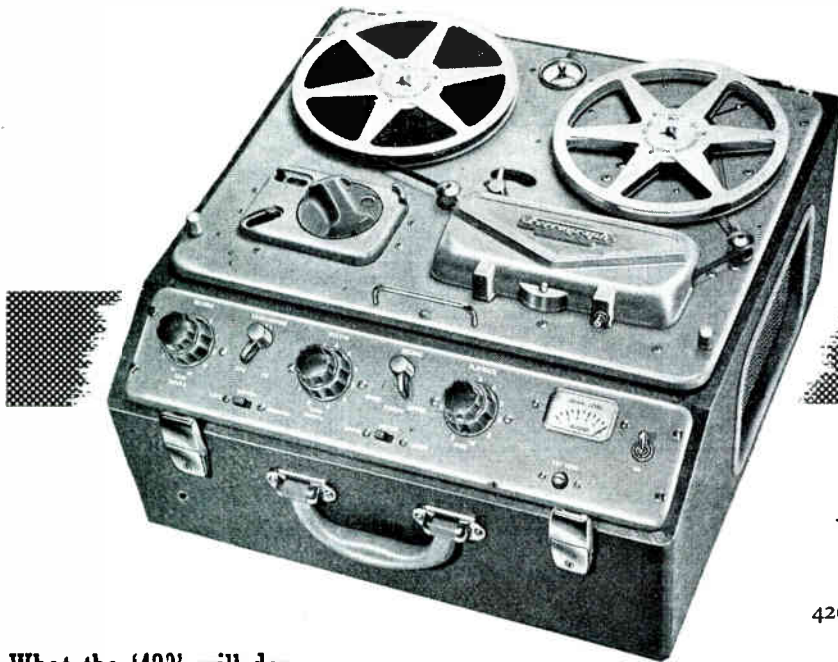

With facilities for mono/stereo recording and play back and incorporating four separate amplifiers for maximum versatility.

## What the '420' will do:

- 1 Mono records and plays back with continuous monitoring on either channel.
- 2 Stereo records and plays back with continuous monitoring on both channels.
- 3 Permits the introduction of echo effects.
- 4 Plays back on one channel whilst recording on the other.
- 5 Re-records from one track to the other.
- 6 Whilst re-recording, permits additional material to be superimposed.
- 7 Permits instant comparison of recorded signal with input signal.
- 8 Plays back four-track pre-recorded material (Model 424 only.)

With the introduction of the Ferrograph Series 420, Tape Recording enters an exciting new phase. Here for the first time is an instrument so versatile that it is difficult to conceive a need that cannot be satisfied. Its wide range of facilities is the direct result of a close study of user requirements based upon the evidence provided by a comprehensive survey in which several thousand Ferrograph users took part. The advanced standard of performance achieved by the Series 420—stemming from intensive research into all aspects of head, amplifier and tape transport design—once again demonstrates Ferrograph's mastery of the art of tape recording.

*The Incomparable* **Ferrograph**

**SERIES 420**

Model 422U	200/250v 50 c.p.s.	Model 422E	110v 50 c.p.s.
Model 424A	117v 60 c.p.s.	Model 424U	200/250v 50 c.p.s.
	Model 424E	110v 50 c.p.s.	

**110 gns.**

**BRITISH FERROGRAPH RECORDER CO. LTD.**

84 BLACKFRIARS ROAD, LONDON, S.E.1

Telephone: WATerloo 1981

520

## COMMON TAPE FAULTS—(continued)

The cure was to remove the paint from the inside of the hub hole with a small rolled-up piece of emery paper.

In order to forestall a flood of correspondence reaching the Editor's desk, it must be stated that some manufacturers already take precautions to minimise static build up—on the other hand, many do not.

### Tape Scrape

Times without number the tape recorder and its companion bent and distorted reels must have been cursed as they scrape, scrape, round and round like some horrible cracked gramophone record during the quiet passage of some delectable piece of music. Apart from the annoyance caused by the scraping reel, damage is being done all the time to the tape, and the tapes most likely to suffer are the older, often valued, ones which have a less well keyed oxide layer than modern tapes. That the edge oxide is removed is clearly shown in shadow-graphs of fig. 3.

Fig. 3a shows a tape which has been stored and used on a good true running reel. The tape edge is still in very good condition. Fig. 3b and 3c show the degrees of damage which can be caused by tape scrape on warped reels. All the tapes, which are of the same type, are approximately the same age (10 years) and have had similar usage.

Any tape edge damage obviously degrades the quality of the recorded signal, and in the case of large area flaking it can momentarily reduce the signal to an insignificant level. In the case of slight edge damage, the audible effect is an increase in random noise with a generally "roughened" recording.

The scraping reel's dark deeds are not yet at an end. Each time the tape scrapes the reel, the tape is slightly slowed down and consequently wow is introduced during recording and playback.

The scrape can be due to a number of factors. The reel itself is the most usual culprit, it may have distorted flanges, be under-size (or over-size) for the machine, or may have an inaccurately moulded boss. The spigot boss on the machine can also be damaged or wrongly adjusted.

The simplest way of stopping tape scrape, apart from throwing away faulty reels (an expensive pastime) and correcting obvious defects in the recorder itself, is to fit a pair of simple tape height adjusters of the type shown in fig. 4. The adjusters are fitted to the deck either by drilling the deck and using fixing screws or, alternatively, they can be cemented to the deck with an epoxy resin glue of the *Ara'dite* type. In any case it is advisable to affix the adjuster temporarily to the deck with a little rubber gum, in order to check the operation in the proposed position before final fixing.

The adjuster illustrated is suitable for the *Collaro Studio* deck and some others, but clearances should be checked on any other decks before making the guides.

### Magnetised Deck

Another odd effect which has caused a considerable amount of trouble is deck magnetisation. During a period of experimental work on a new recorder, difficulty was experienced with non-linearity distortion which occurred during the recording process. Checks on the recording amplifier revealed no clues, and bias level tests over a wide range produced no improvement. The frequency response of the head system was approximately correct although the dynamic range was somewhat restricted.

On playing back a deck erased tape, the hiss level was higher than normally expected, and considerable rumble of a random nature was in evidence. The heads were demagnetised with a 'de-fluxer' as it seemed likely that a magnetised head could be causing the trouble. Only a very slight improvement could be detected. The bias/erase oscillator was then checked for the possibility of mechanical vibration moving a loose tuning slug for this had been known to produce audible results on another occasion; but this time the slug was quite tight in its thread.

One further explanation seemed possible, and this was that the whole of the deck plate was magnetised, and was thereby inducing a standing field in the heads, with which the normal

de-fluxer could not cope. The rumble could then be produced by variation in the magnetic field caused by eddy currents in the moving parts of the deck, and particularly in the flywheel.

A fairly large mains transformer (80 watts) having E and I laminations was stripped down, and the E laminations were replaced all in the same direction to form a King-size in de-magnetisers. The field from this arrangement was applied all over the deck, finally being removed well away before switching off. The windings were, of course, energised from a 240 volt 50 cycle normal mains supply.

The result of de-magnetising the deck was a quiet tape background almost at virgin tape level, the disappearance of non-linearity distortion and an expansion of the dynamic recording range to its normal level.

The magnetism has been found to build up again gradually in the deck plate, and so the process must be repeated at intervals. It is thought that the field build up is caused by magnetic transients when switching off the deck motors. Possible ways of effecting a permanent cure are the replacement of all ferrous links, distance pieces, etc., between the motors and the deck, and by the use of mumetal shields at suitable points.

If anyone contemplates carrying out a deck de-magnetisation it is recommended that the deck is covered with a soft cloth before starting operations, otherwise the sharp vibrating edges of the laminations will quickly remove the paint. It goes almost without saying that all the connections of the transformer coil should be taped up effectively and that the core should be earthed.

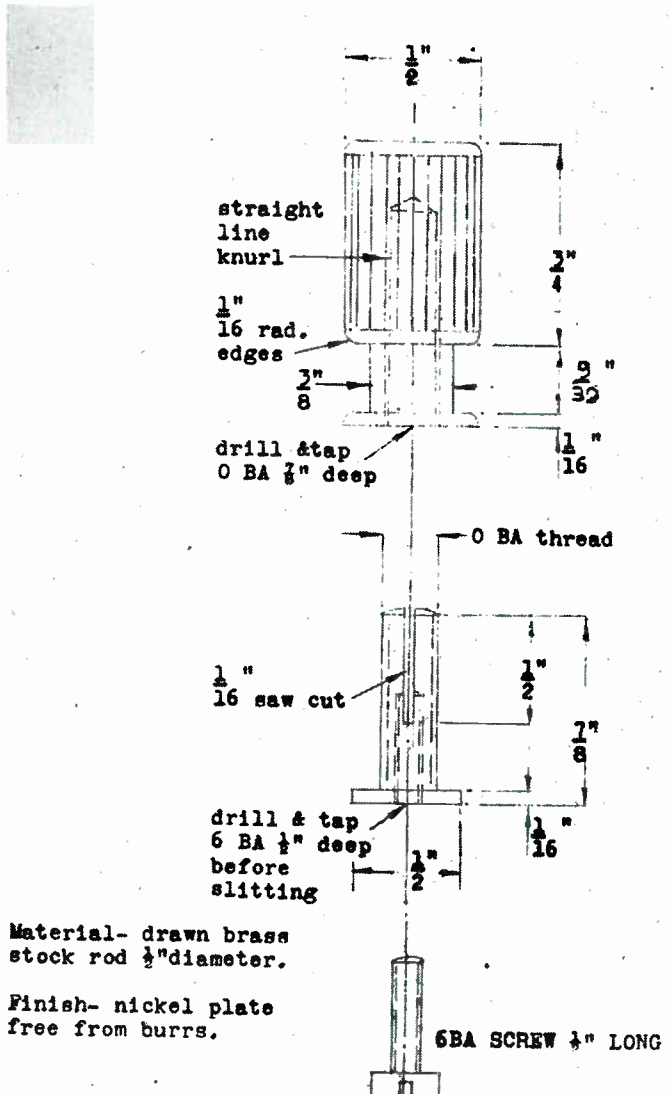
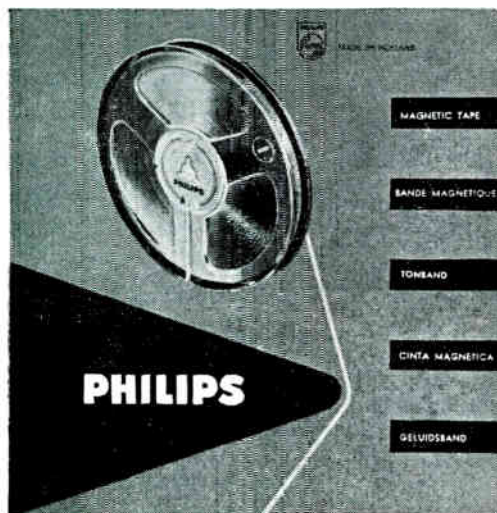
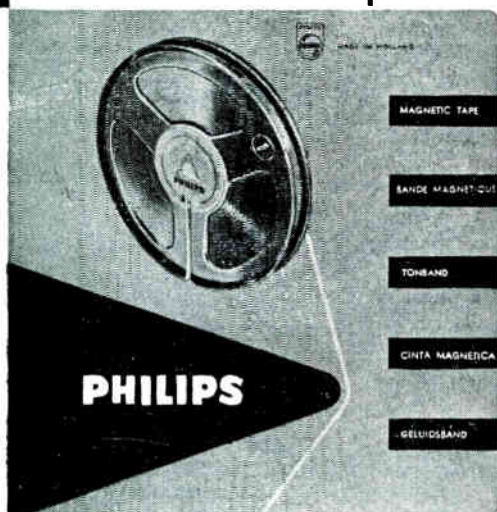

figure 4



**GREEN**

For standard tapes



**RED**

For longplay tapes

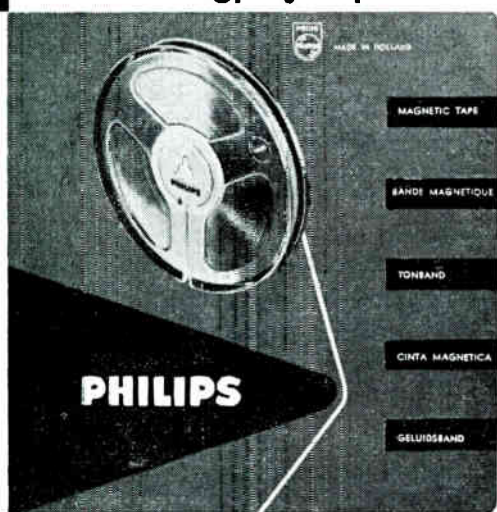

**BLUE**

For doubleplay tapes

# Fast, easy tape selection -with Philips **COLOUR** coded packs

From now on, all Philips tape packs in the 3", 4", 5", 5½" and 7" reel sizes will be colour coded; green for standard tapes; red for long-play tapes; blue for double-play tapes. This entirely new packaging system ensures quick, easy identification of every size and type of tape. It eliminates the possibility of error when you change reels, makes selection easier when you're buying new supplies, helps you maintain your tape library with complete efficiency. And remember, Philips tapes are the best you can buy. They give you really *lifelike* sound—improve the performance of every tape recorder. Buy your Philips tapes in the new colourful packs today!



# PHILIPS

-the friend of the family

PHILIPS ELECTRICAL LTD · CENTURY HOUSE · SHAFTESBURY AVE · LONDON WC2  
(PR3760)

# Readers' Problems

## Connecting Speakers in Parallel

Dear Sir:—I wish to use two 15-ohm Axiette speakers for mono connected to the one 15-ohm outlet on a Ferrograph 4A recorder. I understand that simply to connect the speakers to one plug and then plug in to the 15-ohm outlet is somehow detrimental and also changes the impedances.

I am completely ignorant of technical matters and apologise in advance for troubling you with what may be a triviality.

Yours faithfully, J. E. N., Wirral.

It will be perfectly permissible to connect your two Axiettes in parallel for use with your Ferrograph 4A. Theoretically this does indeed upset the matching slightly, but not enough to worry about. It will restrict very slightly the maximum power output, but you are not likely to need it anyway.

You will need to connect the speakers in phase. Place them very close together, face to face, then if they are out of phase you will hear very little sound at all; if they are in phase you will hear plenty. Mark the leads then for future reference.

## Linking Equipment

Dear Sir:—Since reading your magazine I find myself with the "bug" and would now like to start something in a small way.

I know absolutely nothing about radio, other than the obvious, and cannot afford costly material, being an amateur photographer and a D.I.Y. fan, but I am keen.

I have a Cossor radiogram, Decca television and a TK 24 Grundig tape recorder and I wish to link the radio, gramophone and television (sound) to the tape recorder, through one switch panel, and from this same panel, to take sound to one or all of eight speakers, one in each of the corners of my lounge, one in kitchen, dining room and bathroom (to keep me company in my darkroom), all on one floor.

I have made an effort to find out how to start, but after one or two enquiries, I have been "put off" by one or two "doleful Joe's" who talk of very expensive equipment or very complicated circuits. Can you possibly assist me?

Yours faithfully, T. P. E., Fulham.

I do hope that by the time you reach the end of this letter you will not think that I am also a "doleful Joe", but I do think you are being a little ambitious in the set-up you propose for your tape recorder, radio, etc.

Let us consider this question of loudspeakers first of all, and for the moment please exclude the T.V. set from all my remarks, I shall deal with that separately at the end. Both radio and tape recorder will probably have a loudspeaker output impedance of 3 ohms and have about  $4\frac{1}{2}$  watts of power available. Normal listening level from a loudspeaker represents a mean power of between  $\frac{1}{2}$  to 1 watt giving a "safety factor" of about 6 to 1 to ensure that the high level transients are not unduly distorted. If you attempt to split this power between a large number of loudspeakers it may mean that you are running into distortion at the mean listening level—a horrible state of affairs. To make matters worse the power output of  $4\frac{1}{2}$  watts depends upon a loudspeaker impedance of 3 ohms, but if you connect two 3-ohm loudspeakers at the same time the load impedance is only  $1\frac{1}{2}$  ohms, and three loudspeakers would present a load of 1 ohm. These two conditions would mean that progressively less power was available for the same distortion level. By a suitable arrangement, known as series/parallel one can connect a number of loudspeakers and maintain the correct impedance in which case dummy loads are inserted when any speaker is disconnected to keep overall impedance correct. However, this will not help your first problem, obtaining enough power to feed the loudspeaker system as if they were all switched on.

The input side of your tape recorder represents an easier problem, a signal should be taken, via screened lead, to a selector switch which will connect them one at a time to the tape recorder. For this purpose all the signals should be similar in terms of

amplitude, but this is fairly easy to arrange by means of potential divider networks in all lines except the lowest level, which will almost certainly be the microphone.

Now I must come back to the question of the television set. It has been pointed out several times in both "Hi-Fi News" and "The Tape Recorder" that a direct connection to a television set can be dangerous, even lethal. This is because a T.V. set is an A.C./D.C. device, connected directly to one side of the mains. Provided a suitable isolating transformer is fitted by a competent electrician then connection can be made as to other equipment.

## Tape Hiss

Dear Sir:—I am using a Wearite 4A deck in conjunction with the Mullard Type "C" Tape Pre-amplifier/erase unit, which I made from a kit supplied by Stern Radio Ltd. This kit I modified by adding a Ferrograph Head Lift transformer. The rest of the chain is a G.E.C. 912-Plus amplifier and valve pre-amplifier, feeding into the G.E.C. Periphonic with presence Unit.

All is well—apart from tape hiss which is a little too prominent. Virgin tape has a lower hiss level than recorded tape and on replay the hiss does not increase, so I assume the head is not magnetised. If I record zero signal at the same time holding the tape away from the record head, then on playback, the hiss is reasonably low level, so I assume the erase head is working satisfactory.

I have tried substituting a new valve for the first valve in the record circuit with no noticeable improvement. Could you please suggest any lines of attack that might help me to reduce the hiss level?

Yours faithfully, G. H., Wrexham.

I suspect that the main cause of the tape hiss about which you complain is the bias oscillator. If the wave form contains any amount of second harmonic distortion it will be asymmetrical and result in a DC component in the recording bias applied to the tape. Any such DC component shows up tape surface irregularities as a hiss which can be well produced by your amplifier and speaker set-up. The remedy will probably be to use a better quality bias oscillator coil or, better still, use a push-pull oscillator. I think you will find that Mullard's publication in respect of the tape amplifier will be helpful in this direction.

## Ribbon Microphones

Dear Sir:—I purchased an Elizabethan Escort tape recorder almost two years ago and recently obtained a Geloso Ribbon microphone (low impedance) and transformer, so that longer cables may be used. The recordings are a great improvement over the crystal microphone, but there is too much hum present.

I have tried shielding the transformer and earthing it to (a) the deck (b) earth, but without success. Please can you suggest a solution?

Yours faithfully, F. W., Bolton.

There are one or two possibilities as to why you are experiencing hum with your new microphone. The lead between the microphone and the transformer will probably not need to be screened, but, if it is screened this must be securely earthed to the tape recorder. The lead between the transformer and the recorder should be kept short, within twelve inches, and be screened with a really close braid. Turning now to the question of the transformer itself, this should have an unbalanced output. The manufacturer can confirm this for you. It is unlikely that screening the transformer would be as important as shielding it magnetically.

(Continued on page 528)

## RAPID RECORDING SERVICE

78s & LPs from your own tapes

Master Discs and pressings

Recording Studio equipped with Bechstein Grand

Mobile Recording Van — "Off the Air" Service

Practising studios with or without accompanist

21 Bishops Cleeve Church Lane, E.17 COP 3889

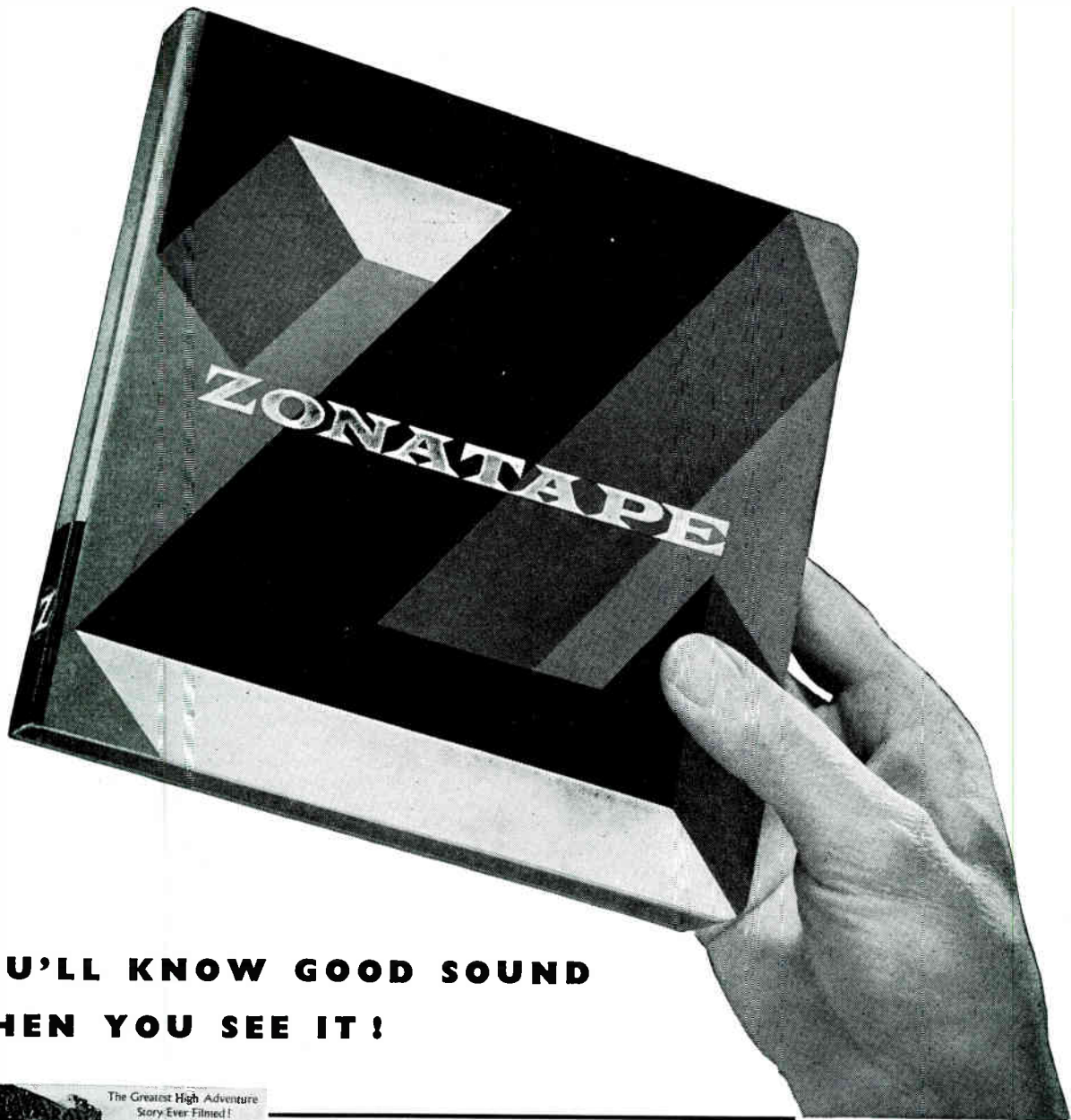

**YOU'LL KNOW GOOD SOUND  
WHEN YOU SEE IT!**



If you've seen "Ben Hur" or "The Guns of Navarone" you'll know what we mean. Both these outstanding films were recorded on Zonastripe—a fact worth remembering when you are buying tape and want to buy the best. Zonatapes are supplied in handsome case bound library containers and are obtainable from most high class radio, music and photographic shops.

*Write for leaflet "The Basis of Every Good Magnetic Recording" and the name of your nearest Zonatape stockist.*

ZONAL FILM (MAGNETIC COATINGS) LTD., THE TOWER, HAMMERSMITH BROADWAY, LONDON, W.6 · TEL: RIVERSIDE 8741



# ... tape recorder workbench

## No. 29. TAPE RECORDER ADJUSTMENTS

by A. Bartlett Still

A COUPLE of months or so ago a reader sent me a suggestion he had received (I believe from America) for demagnetising tape heads, and sought my comments. Briefly, the procedure was as follows: Plug in to the mains and switch on. After allowing time for the valves to warm up, with no input and the record level control turned down, switch to "Record". A few seconds later—pull the mains plug out. This whole procedure may be repeated two or three times.

The idea behind all this is to use the H.F. bias supply to do the demagnetising, and advantage is taken of the reservoir capacity in the power unit section to cause this to die away slowly, after the power is removed. Will it work? Here I think the answer is that it will work to a limited extent—but that is all. The gradual removal of an A.C. field is correct demagnetising procedure, but the field must be strong enough initially to magnetise the head to a greater extent than it was originally—this is hardly likely to apply with the normal level of bias.

However, it is worth trying, but if you are unlucky enough to have heads magnetised to the extent that you had noticed the consequent increase of background hiss, then the procedure may have to be repeated half a dozen or more times before improvement is found. It depends to a great deal on the amount of metal in the head construction. Some machines, by the way, have a capacitor built in to do this automatically every time it is switched from "Record" to another function. With these, no advantage would be gained.

### Two Separate Processes

I would like to turn now to the subject of tape recorder adjustment. This can only be dealt with very superficially, the amount of test gear available will vary with the minority of my readers, the vast majority will have the same quantity—nil! I am thinking of those who have built their own machine, from their own or a published design, using a commercially-built deck. Even with a minimum of test gear, the end results will be so much better if the problem is tackled in the right way.

My illustration shows, in block diagram form, the component parts of every complete tape recorder. A lot of machines use one head for the purpose of both recording and replaying. This

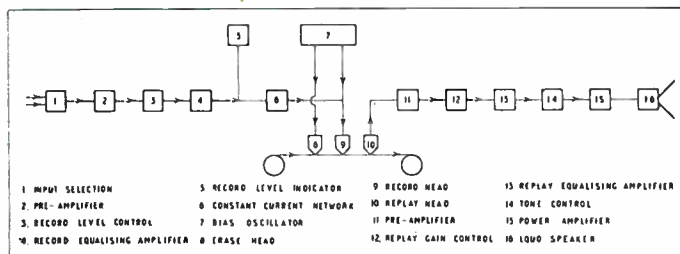

A Block Diagram of the Complete Tape Recording Process

does not alter the fact that the two processes are entirely separate, and that the head will be separately connected in each instance. Again, one amplifier only is used, but it is—or should be—arranged to perform two different functions.

A particular block on my diagram may consist of several valves on a professional machine, and a couple of resistors only in a 30 gn. model; but the fact remains that it will be there; and if we can isolate it and understand its function, things are made much simpler. Considering the more popular size of machine, let us examine each constituent and find out what it does and what it is likely to consist of.

Input selection (1) is more or less self-explanatory. This may be an arrangement of jack sockets, with suitable load resistors, and switch contacts operated by the jacks or a selector switch

to ensure that only one is connected at a time. An alternative arrangement is a simple resistive mixer such as I described recently.

The Pre-amplifier (2) will be the first amplifier stage, probably an EF86 valve. It is a linear stage to boost the input signal to a level suitable for correction. In order to set the signal level, the Record Level Control (3) is used. This is invariably a potentiometer type gain control and simplicity itself. The Record Equalising Amplifier (4) is one of the items that can make or mar the whole performance. One or two valve stages are used to give the treble boost necessary to overcome losses inherent in the recording process.

### Replay Chain

The output of this stage is fed to the Record Level Indicator (5) and also to the Constant Current Network (6). The former is usually a magic eye, a form of valve voltmeter, while the latter is a passive network designed to cause the head to present a constant load independent of frequency. It also serves the secondary purpose of keeping the A.C. bias out of (4) & (5). The Bias Oscillator (7) feeds both the Erase Head (8) and the Record Head (9). The level of bias fed to (9) is normally critical, affecting the frequency response required from (4). Good performance depends on a correct setting of both.

The replay chain, which must be considered separately, often uses common components with the record chain, with or without modification. The Replay Head (10) may in fact be (9). The Pre-amplifier (11) can be identical to (2) because block (3) can double for block (12). The Replay Equalising Amplifier (13) may well use the same valves as (4), but the conditions are changed. It now has to impart bass boost to make good the losses in the replay process, and it should be set correctly to a standard.

The three remaining items, Tone Control (14), Power Amplifier (15) and Loudspeaker (16), can, of course, vary widely from a single EL84 and six-inch speaker to a *Leak* or *Quad* with a *Lockwood* enclosure. The purpose is the same—to produce power from a voltage signal, and to reproduce it with such tone correction as may be necessary to suit the listening conditions.

### Next Month

The foregoing may perhaps sound rather elaborate as a description of a simple tape recorder, but I fancy it will make things easier when (next month) I try to outline a systematic checking procedure. In the meantime I would like to thank those many readers who have taken the trouble to write to me during the past year, and extend to you all my best wishes for the Christmas Season.

## Accessories For Your **Ferrograph** The Nusound "Numix"

The "NUMIX" is a convenient mixer which enables a Ferrograph user to mix and fade at will two programmes, from microphone and radio/radiogram. Alternatively, speaker output sockets from power amplifiers can be used. Any combination of two programmes is possible with the Nusound "NUMIX" device.  
Price: £47.6. Radio Lead complete 7/6.



Write for leaflet on "NUMIX" and  
"MONITOR"

**NUSOUND RECORDING CO.**

35 CRAVEN STREET, W.C.2. Telephone: TRA 2080

By A. Tutchings

# AN ADD-ON CINE SOUND UNIT

A NEW DO-IT-YOURSELF FEATURE FOR OUR CINE ENTHUSIASTS TO BUILD

SOME time ago I tested, for review purposes, four of the latest sound stripe 8 mm projectors at prices ranging from £149 10s. to £180. Although these projectors represent a formidable technical achievement the sound quality would be considered pretty poor by a tape enthusiast. At 16 fps, the usual speed for amateur

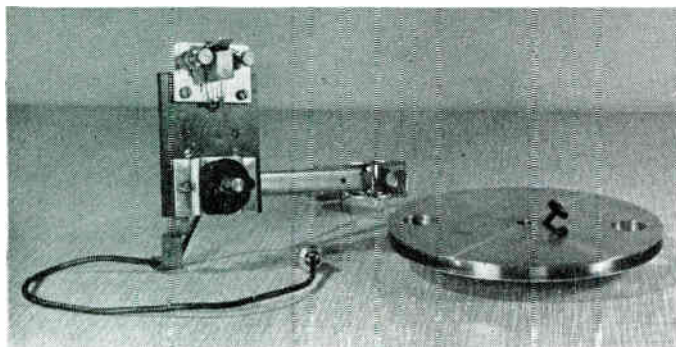

*The hardware: The flywheel cum tape spool (right) measures 5½ in. in diameter, weighs 1 lb. and carries a ¼ in. by ½ in. slot on its outer rim to hold the tape. The head unit (left) is made up from standard "Portab'e Recorder" kit items. The magnetic head, head plate with tape guides and pressure pad, together with the supply reel spindle and bracket, are mounted on a platform with a means of clamping to the supply reel arm of the projector.*

● Our contributor and reviewer, Alec Tutchings, is one of the most thorough do-it-yourself thinker-outers that it has so far been our pleasure to meet. As most readers probably know, the *Gramdeck* was his creation; and it was undoubtedly a continuation of his experiences and experiments with this unit which resulted in the make-it-yourself, spring-driven tape recorder which was recently described for constructors in this magazine. In turn, as a direct result of these do-it-yourself features, Alec Tutchings has found himself in the kit business. It began, as he says, as a form of self-defence! It was easier to buy small stocks of difficult bits, and to make the special bits himself, than it was to write scores of letters to readers who were stuck. But very soon the idea developed into an interesting sideline and he formed a small company to cope with it; and through this company, too, he now markets test tapes for the tape recorder industry—"White Noise", test tones, azimuth adjustment etc.

It was about a year ago that he dropped the hint that he was working on a do-it-yourself device for adding sound to 8mm films; and we immediately extracted his promise that we should have the first details for publication in *The Tape Recorder*, and so here they are.

Many of our readers who are also cine enthusiasts will want to have a go at this latest Tutchings idea—particularly those who have already built the portable recorder. But we earnestly beg them not to write to us for information or for bits and pieces.

The author is the only source of advice and information. Write to him c/o *The Tape Recorder*. This also applies to enquiries about bits and pieces that are not available from local dealers.

film, the response was limited to 3-4 Kc/s and the signal noise ratio to about 30 dB. The background noise was made more obvious by "drop outs" of a magnitude quite unknown in tape work; one did not have to listen for them, they hit you straight between the ears! Splices were also unpleasantly audible, but it was quickly realised that the picture diverted attention from most of the shortcomings of the track. It was also very obvious that sound contributed so much to the film that a cheap and simple way of adding sound to an 8 mm film would have an instant appeal to the amateur film maker who wanted to experiment with its potentialities before investing in a lot of very expensive equipment.

## Commentary Synchronisation Possible

You may say that such a means already exists in the tape synchroniser fitted to many projectors, where the tape recorder controls the speed of the projector so that commentary synchronisation is possible. Quite so, but is there a simpler and more direct way of achieving the same end? I think there is, and those of you who have followed my earlier articles\* will not be surprised to see that I have used one of my "wind up pull through" devices, using the projector as the prime mover to transport tape and film together. The tape moves three times faster than the film to take advantage of the better sound quality so obtained, and to ease the problem of smoothing out wow and flutter from the sprocket drive of the film.

The photographs and captions tell most of the story. When the projector is switched on the film is projected in the normal way. As the film is pulled from the supply reel the flywheel turns and winds up the tape in the rim slot. The mass and inertia of the flywheel filters out short-term speed irregularities due to the meshing of the sprockets and the film perforations. It will be seen that the only critical mounting parameter is the fore and aft placement of the head plate so that the tape moves smoothly from the R.H. tape guide to the flywheel slot.

## Suitable for Speech and Sound Effects

And now what about results—how good is it—and what are the limitations of such a simple system? I may be biased—but I think the performance is excellent! Synth is maintained

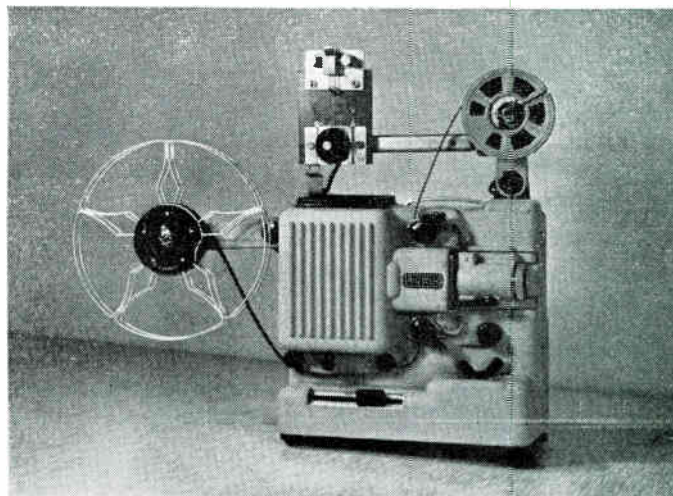

*Stage 1. Setting up. The head unit is clamped to the supply reel arm and the film threaded in the usual way.*

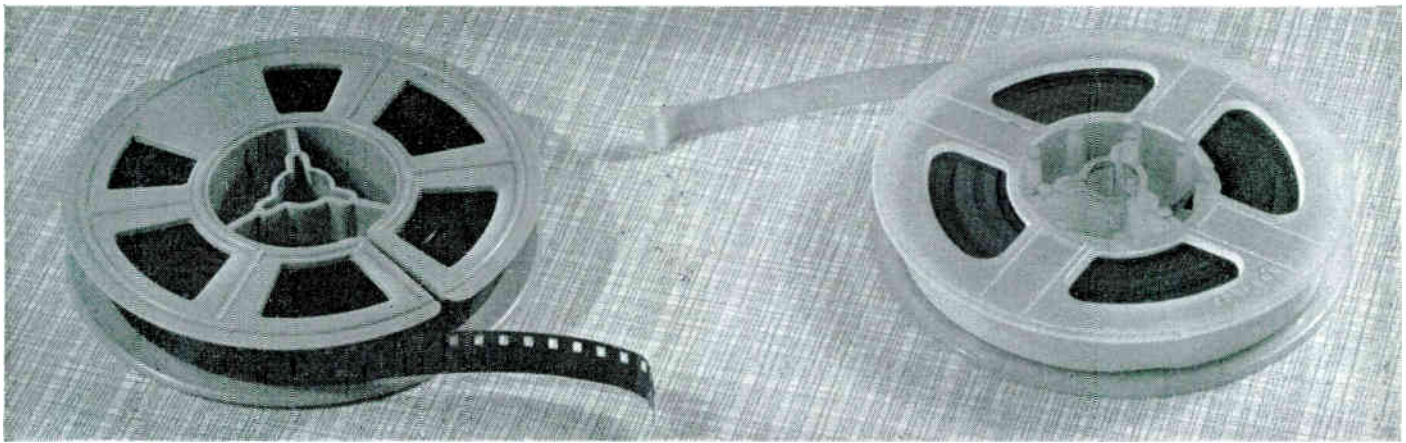

The film (left) is a normal camera loading, slit and spliced at the processing plant to give a standard 50 ft. 3 in. reel with a showing time of 4 minutes. The tape (right) is also contained on a matching 3 in. spool, but due to the thinner base, 150 ft. of standard play tape can be accommodated. The end of the tape leader is rolled and bound with splicing tape for anchorage purposes.

to better than plus or minus one second over the four-minute run; quite good enough for simple commentary and broad background effects (see later note).

Wow and flutter are again acceptable for speech and sound effects. Sound quality is excellent with Portable Recorder transistor electronics, as indeed it should be with a mean tape speed of  $7\frac{1}{2}$  i/s.

#### Varying Tape Speed

And here is the real titbit: sound recorded on the spring driven portable recorder can be replayed on the projector with no change of pitch. It must be admitted that this is part design and part luck as the actual tape speed varies from beginning to end of the reel, but it just so happens that the two to one change in speed due to the changing diameter of the take up reel on the portable recorder is almost exactly matched by the falling diameter of the film supply reel combined with the much smaller build up of the flywheel effective diameter.

#### Superimposing

The implication of this is quite startling. It is possible to record background effects on the portable recorder at the same time that the picture is being shot by the camera. This does not mean that

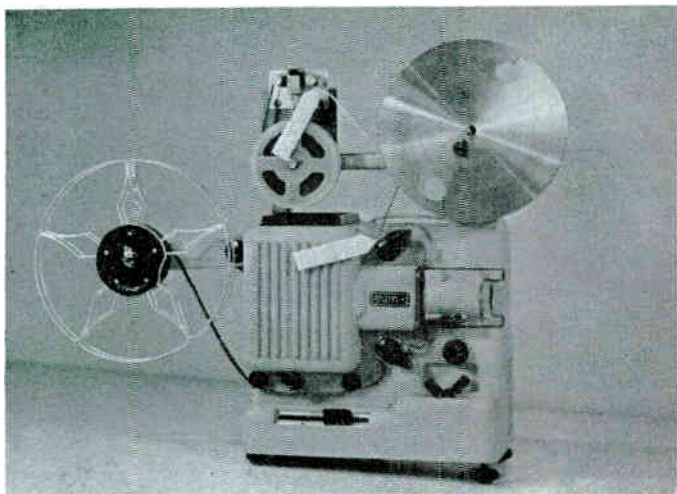

Stage 3. The prepared tape end is anchored in one of the slots of the flywheel with the white leader within one inch of the sound head. The junction of the black leader with the film is on the top sprocket of the projector. See arrows.

lip-synch is possible, but broad background noises like children playing, beach noises, train noises, etc. can be collected at the

\*Now available in reprint booklet form "Experimental Recording for Beginners". 5s. 9d. P. & P.

time of shooting; it may be necessary to do a little tape editing to bring in the noises at the right place, but such an effects track does add to the interest of the picture very considerably and simple superimposition of the commentary over this track is quite satisfactory.

#### Hand Rewind

And the debit side? No music—the speed constancy of the average silent projector is not good enough and slow changes of pitch can make the music sound rather sea-sick. Projection time limited to 4 minutes, and there is a bit of a palaver on rewind if the projector is used for this purpose. With a separate manual rewinder there is no problem and it is all over in less than a minute. But—let us be fair about all this and not try and push this device too far. It is not meant to replace £200 worth of equipment—if it were, my fortune would be made! It is simply a means of experimenting with sound and film for the dedicated "do it yourself" who gets a kick out of extract-

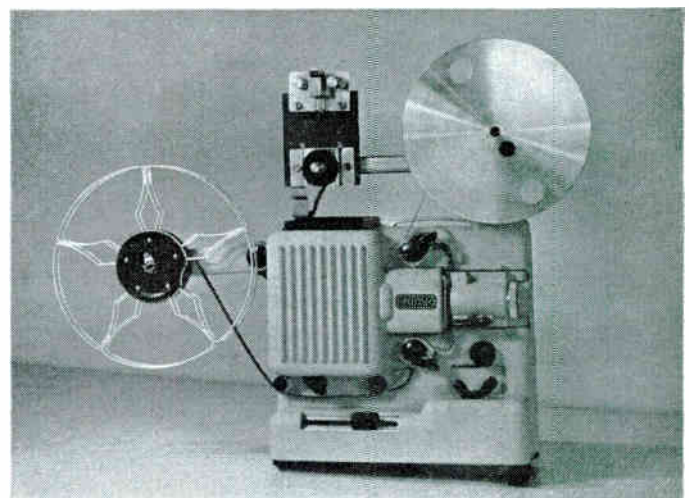

Stage 2. The flywheel disc is secured to the supply reel spindle by the angled screw which grips even the shortest spindle projection and fits all projectors so far tested.

ing satisfying results from simple and cheap home made equipment, and as such, I present it to you.

Next month I shall describe a three transistor record-replay amplifier contained in a small 6 x 5 in. loudspeaker box which will allow good quality speech recording on the projector unit described above. It will also provide low level speaker playback on the same unit which will be perfectly adequate for family listening in a small room, but it can be used as a preamplifier to feed a radio set or power amplifier where a larger audience has to be catered for.

A. Tutchings.

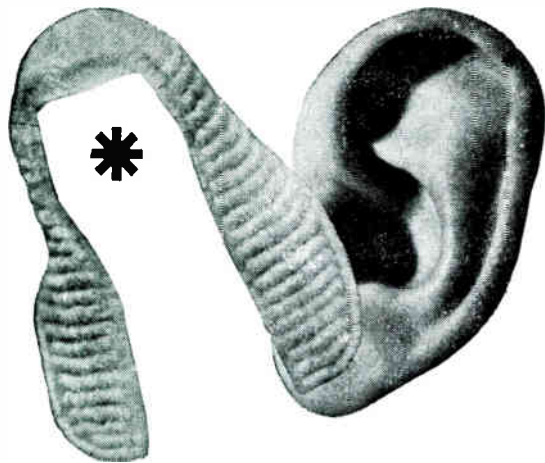

\* let your EARS be the JUDGE of the

# Tandberg

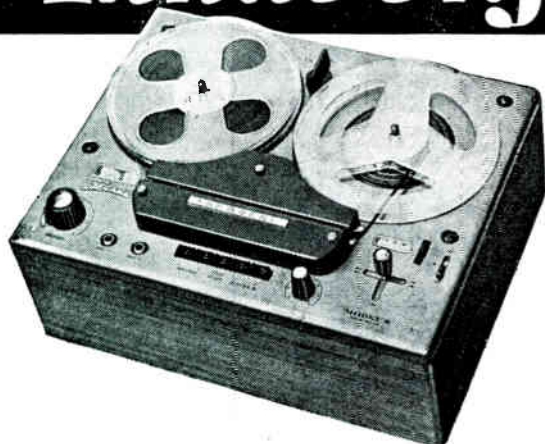

## SERIES 6

### STEREO TAPE DECK

Records 4 tracks. Plays back 2 and 4 track stereo and monaural tapes. 3 speeds, 4 tracks, 3 heads, 4 amplifiers.

12 page booklet of 5 reviews from Technical Press free on request.

**RETAIL PRICE 110 gns**

Monaural 2 track model 3B now available **76 gns**

(Complete with carrying case)

FROM SPECIALIST TAPE RECORDER & HI-FI DEALERS

**Tandberg** GB ELSTONE ELECTRONICS LIMITED,

Edward St., Templar St., Leeds 2.

Telephone: Leeds 3-5111 (7 lines)

#### READERS PROBLEMS — (continued)

Dear Sir:—I own a Spectone 161 tape recorder which uses the Collaro Mk IV tape deck. After making various recordings of music at all speeds and at the correct level as stated in the makers' handbook, I find that when erasing the recording there is still a faint trace of the original recording left on both tracks.

I have cleaned the head, checked the pressure pads, but still it persists. The bias and erase frequency stated by makers is approximately 60Kc/s. The machine is only 4 weeks old, but I have had another machine for over two years without any trouble of this kind, and I would like to trace the fault myself. Can you please assist me?

In a recent booklet issued by Scotch Brand Tapes it states that their brand of tape has an exclusive silicone lubricant which reduces head wear. Does this mean that the cheaper tapes which are now on the market cause heads to wear quicker than the better tapes?

Finally do you recommend Klensatape for keeping heads free from oxide?

Yours faithfully, **B.E.C.J., Derby.**

The major problem contained in your letter is undoubtedly the incomplete erasure you are experiencing with your new tape recorder. In general there are two possible causes of this and it will first be necessary for you to determine which applies in this instance. If the tracking of the erase head, with respect to the record/playback head is incorrect then a thin track of the original recording will be heard at a loudness governed by the ratio of the normal track width and the width of this secondary, unwanted track. If this is the cause on your machine, one would expect to find differing results depending upon which track direction you are using, since the Collaro deck uses different record and erase heads for each direction. It is unlikely that they would both be incorrectly set by the same amount.

On the other hand incomplete erasure may be due to insufficient power being fed to the erase head and in such a case quite obviously the results would be the same in either direction of the tape. Should you decide that the trouble is due to incorrect tracking then I think you will find that the sound channel can be suitably adjusted once you have determined, by visual inspection, the correction necessary. In the latter instance though, I would suggest that you seek the manufacturer's advice, since I believe it to be unwise to alter a designed circuit without knowing all the details.

As far as your other two queries are concerned, I can say that I use "Klensatape" myself and have found it to be a most satisfactory form of routine cleaning, providing care is taken to clean the sound channel more thoroughly when it seems to need it. It is difficult to comment on the cheaper tapes that can be obtained on the "surplus" market, they vary so widely. Some are inferior stock being sold off, while some are in fact of quite good quality. In general, though, it is best to find a brand of tape you like and use it always, this will give you the most consistent quality of recording.

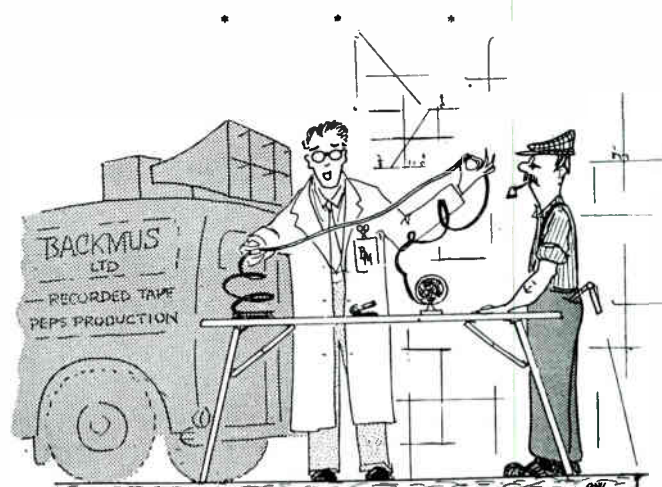

"Now then . . . is that a long enough tea-break . . . ?"

# Sound and Cine

WITH BOLEX AND FI-CORD  
IN KYLLINI

by R. GOLDING



THE passengers on the Greek ship entering the Gulf of Corinth were distracted from watching the dolphins play in the wake of the ship by a special announcement from the public address system. "Would the passenger in cabin 3a" it said laconically, "please go at once to hees cabin".

There, 3a found a huge suspicious looking Customs Officer holding a passport and pointing down at an equally huge cabin trunk. "Open eet, Meester Morris!"

The trunk, when opened, did not reveal the expected wires and detonators but one H16 *Bolex*, one *Fi-Cord* with *Grampian* and *Res'lo* microphones and four sets of batteries and two chargers, one tripod, six reflector floods, four *Malham* telescopic floorstands with two extra clip-on units, one series-parallel junction-box, 2,000 feet of colour filmstock and one *Leica* 'still' camera. The fact was that Leslie Morris was off on another filming holiday and this equipment was, in his opinion, the bare minimum he could possibly take to make a fifteen-minute documentary on the Under 30's Travel Club holiday centre at Kyllini. The officer was satisfied with this explanation but insisted on entering all details in the passport.

### The rough shooting script

The film was to be shot from a fairly loose script, worked out from a long study of the club leaflets and photographs, and the story line was to take in the multi-racial slant—and



The guide being recorded as she described the wonders of Ancient Greece.

the fact that forty French girls would be on holiday there at the same time. The budget allowed plenty of scope in choice of picture and a cutting ratio of 4:1, which meant that 2,000 ft. of filmstock could be edited to a 15-minute optical sound film.

The plans for shooting and which more or less worked out according to script were: 200 ft. on the journey from London to Patras via Ancona and Corfu and arrival at the Kyllini village, which is situated in the shadow of a medieval fortress ("Which is only visible if you climb the flagpole" says Leslie.) 500 ft. for the days spent on the kilometre long beach with its volley ball, beach tennis, gaily coloured sun umbrellas and facilities for canoeing and skin diving.

A further 500 ft. were allocated for the camp activities, which included horse-riding across the sand dunes and open country, various sports arranged during the daytime, the bar which sold cheap wines and Ouzo at 7d. a glass, and which was transformed into a miniature night club the moment dinner was over, the cane-roofed restaurant overlooking the sea and with a breathtaking view of the earthquake islands of Zante and the small stone villas and pretty bungalows that comprise the camp sleeping accommodation.

A final 800 ft. were for the excursions to Olympia, Bassae, Castro, Delphi, Rhodes, Mycenae, Corinth, Athens and Cape Sounion.

### Lighting system plays tricks

After he had been there two weeks, Leslie was joined by Keith Raven who brought another *Bo'ex* and another *Fi-Cord* to help record the later excursions. In the camp everything went more or less to plan, except that the lighting system played tricks with them at times; for instance, one night when filming a jive session in the bar they found that it was only possible to run three lamps from the power circuit (the electric razor socket, incidentally, at times took five). When this happened again and again they decided that the power circuit must have a five amp cut out and the camp director was forced to ask the power station for another four amps.

One of the many interesting and unexpected cameos at the camp was the nightly event of a Greek fisherman using a long rod with a ny'on line at the end of which was baited a live female tunny. When the line was thrown out the female fish attracted half-a-dozen males who swam close after her as she was drawn in. The fisherman then found it quite simple to catch them in a small net.

### The Fi-Cord

Apart from its normal holiday value of providing music for the beach, the *Fi-Cord* gave remarkably good results when recording natural background sound and the popular Bouzouki music and was used to great extent on the tours.

The coast road from Athens to Cape Sounion, which overlooks the famous Gulf of Egina, proved fruitful in the recording of local colour and music. At one open air cafe, a Greek husband and wife on a short holiday from America, where they had lived for many years, were being given the traditional welcome by their relations. During the celebration, the wife was urged to sing an old Bouzouki lament on how she was so pleased to meet all her old friends again, and how she would

# HOW DO YOU IMPROVE ON MAGNIFICENCE?

There are a few things you can't improve, not significantly. The odd refinement here and there, the minor blemish eradicated, is all that's worthwhile for several years. Eventually, there'll be a design or manufacturing development of real consequence. Then, and only then, does a major change take place.

The people who have bought the Brenell Mark 5 deck or our tape recorders, know that they have bought also that kind of design and craftsmanship integrity. There's a special satisfaction in owning a machine which, year after year, cannot be outdated in facility or performance . . . one with styling natural to its purpose and unaffected by passing fashion.

Such excellence does not come cheaply, but neither is it as expensive as comparably efficient equipment. Understandably, a Brenell dealer is not to be found in every High Street, but it would be well worthwhile to go out of your way for a demonstration of our claims. We would be pleased to send you your nearest dealer's address and any literature or particular information you may require.

**MARK 5 DECK**  
28 Gns

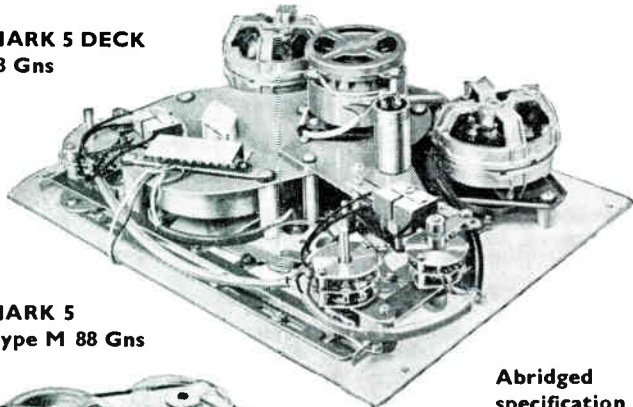

**MARK 5**  
Type M 88 Gns



### Abridged specification

3 INDEPENDENT MOTORS (Capstan motor-hysteresis synchronous)  
4 RECORDING AND PLAYBACK SPEEDS  $1\frac{1}{8}$ ,  $3\frac{1}{2}$ ,  $7\frac{1}{2}$  and 15 i.p.s. FAST REWIND (1,200 ft. rewind in either direction in 45 secs.)  
ACCEPTS  $8\frac{1}{2}$  in. reels. INTERLOCKED CONTROLS.  
PAUSE CONTROL . DIGITAL REV. COUNTER . PROVISION FOR EXTRA HEADS (Mono or Stereo).

### 'WOW AND FLUTTER'

Below 0.05% at 15 i.p.s.    Below 0.15% at  $3\frac{1}{2}$  i.p.s.  
Below 0.1% at  $7\frac{1}{2}$  i.p.s.    Below 0.25% at  $1\frac{1}{8}$  i.p.s.

Tape Recorder range includes—

Mark 5: 64 gns., Mark 5 Stereo: £99.12.0, 3 Star: 58 gns.,  
3 Star Stereo: 89 gns.

# Brenell

Sole manufacturers

GD 908

**BRENELL ENGINEERING CO. LTD, 1a DOUGHTY STREET LONDON, W.C.1. CHANCERY 5809 and HOLBORN 7358**

## SOUND AND CINE — (continued)

miss it all when she was in America once again. Leslie and Keith, busy with the Fi-Cords, taped it all but were made to promise to send copies immediately they returned home.

The dancing made fascinating filming, with its Circassian Circle where the leading man weaves an intricate pattern for his circle to follow while waving a handkerchief of encouragement. Once or twice, however, the search for the true Bouzouki led to failure, but this was more through the local amplifying systems than anything else, especially in one cafe where every instrument seemed to have its own amplifier and speaker, making balance impossible.

One of the many amusing incidents on the tours took place in the stadium at Olympia, where Leslie was arrested for using a tripod. He was marched away to the police station where he spent an uncomfortable half hour before the English-speaking director of the local museum came in to soothe the police.

### Recording the guide

One of the most satisfying uses of the Fi-Cord was in the on-the-spot recording of the various guides and their commentaries. "In fact," Leslie says, "you could almost make a complete script up from the tape afterwards, but in any case we will find it useful for making up the final track."

The final track, which is being made up at this moment, consists of guitar solos, Bouzouki, natural background and crowd sounds and a commentary. Six prints of the film will be available to interested organisations after Christmas. Personally I can't wait to see what happened with the forty French girls!

### The Vancouver International Amateur Film Festival

The Festival committee has been successful in arranging for Guy Glover, executive producer of the National Film Board of Canada, to be one of the panel of judges to make the awards in the contest next February. Other qualified judges will be announced later. Entry forms are available from the Grasshopper Group (address below) to be forwarded to intending entrants who request them. *All films must be in 16 mm gauge only.* The date for receipt of entry forms is January 1st, 1962. The date for receipt of films is January 15th, 1962. One dollar is requested towards the cost of return mail postage, no other expense will be required from the entrant for the return of the film by surface mail. (International Postal Coupons for one dollar may be obtained from any Post Office.)

In sending films to this competition, the contestant does not have to concern himself with the Canadian Customs, as all arrangements have been made for the free entry of films, and they will be cleared at Vancouver upon arrival. It would, however, be well for each contestant, before sending his film to Vancouver, to enquire from his own Customs Department, whether he has to make out any forms to ensure his film re-entering his own country without difficulty, when returned to him at the end of the Festival.

The Major Award is a genuine Eskimo carved statuette. In addition to this will be a prize of a 16 mm Autoload 200-S Camera valued at \$225 presented by *Bell and Howell, Canada Ltd.*, silver plaque awards, Diplomas, and Certificates of Public Showing.

### Hong Kong Package Films

I have just received a catalogue covering 118 different subjects ranging from glimpses of Japanese life, Aboriginal dances in Formosa, the Suez Canal, Spanish bullfighting, and Indian villages in New Mexico, to scenes of everyday life in England. These films, in 8 mm and 16 mm colour, are produced by Corrascope Films of Hong Kong, and are intended, mainly for splicing into amateur films.

Apart from making up lost footage, most of the films in the catalogue appear to have some considerable merit of their own as space fillers in a home movie show. For catalogue and prices write to: D. Surtees, 28 Manchester Street, London, W.1, who is the English agent for Corrascope.

# HOW READERS ARE USING STEREO —

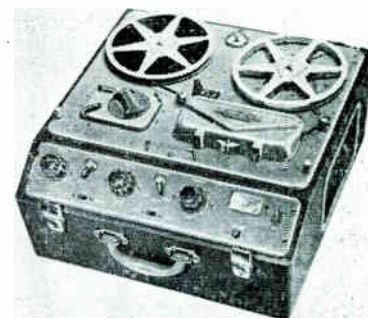

WITH the advent of stereo disc players in this country in 1958, it was a good guess that domestic stereo tape recorders would soon appear. The first domestic tape recorders (mono) were on sale in 1948/49, but no form of stereo from tape was available for home use until 1955/56, when E.M.I. introduced the "3025" stereo player and, simultaneously, released their first Columbia and H.M.V. Stereosonic tapes.

The Stereosonic equipment was for replay only. It was in no way portable, for it consisted of two large console cabinets.

## High Cost

About four years passed before the first domestic stereo recorders appeared. These included the *Reflectograph*, the *Brenell*, and the *Tandberg*, and they were capable of recording and replaying stereo; several other recorders also appeared on the market, providing stereo playback facilities. Since then manufacturers have produced machines with two track stereo, four track stereo, stacked and staggered heads, with and without internal amplifiers. Others supplied add-on units which converted a mono recorder into a stereo playback machine. Accessories, too, had to be doubled, two microphones had to be purchased, two loudspeakers and sometimes two amplifiers. This generally put the price of stereo far above the reach of most amateurs, resulting in poor sales of this type of equipment. To add to the problems, stereo pre-recorded tapes once cost approximately twice the price of the disc, and for most stereo enthusiasts the music they required was not on tape.

During the last two years there has been an increase of stereo

tape recorders in this country and abroad. The battle of stacked versus staggered heads has resulted in a victory for the former; but the problem of the number of tracks is still very much in the news.

With this thought in mind, the editorial in the March issue of *The Tape Recorder* invited readers to write in to this office giving details of the stereo recorders in use by them, stating (1) Type of recorder owned (2) Type of microphones used (3) Type of stereo recordings made (4) Stereo record and playback or playback only (5) No. of pre-recorded tapes owned (6) Whether stereo was contemplated (7) Two or four track (8) Stereo machine used for? (9) Other equipment used in conjunction with recorders.

## Summing Up

The resulting number of letters from stereo enthusiasts showed us that stereo on tape was far more popular than we had thought. So much so that the majority of the replies did not fall into any simple classification so, for the time being, we have selected 20 in our first survey. It can be seen that the problem of two or four track recording is very real and that the quicker it is sorted out, the better it will be for the tape recording industry.

We plan to run further surveys at a later date. Readers wishing to co-operate with us in this matter should send details for the survey on a separate piece of paper, and not as part of any covering letter. We would again like to emphasize that names and addresses will not be published or made available to any other source without the permission of each writer, should the occasion ever arise.

Recorders	Microphones	Stereo Recordings	Stereo & Mono Record Stereo & Mono Play	No. of Pre-Recorded	No Stereo but Contemplated	2 or 4 Track	Stereo used for	Other Equipment
Tandberg Series 6	Reslo R.B.T.	Microphone & Records	Playback only	—	—	4	Preparing to give a Drama Production on Stage using no Actors	Quad Tuners & Amplifiers
Grundig T.K.60	Grundig GDM 15	Microphone & Records	Both	8	—	2	Would like 4 track machine	
Ferrograph 4 A/N	Reslo R.B.L.	—	Playback only	—	—	2	Amateur Dramatics	
Tandberg Series 5	Acos 39-1	Microphone & Radio Discs	Both	3	Yes	4	Private use	
Bradmatic 5B		Microphone & Radio Discs	Both	—	—	2	Private use	Shirley Laboratories TWA 1515
Phillips EL 3536	Phillips	Microphone & Radio	Both	—	—	4	Private use	
Tandberg Series 5	Reslo & Gramplan DP 4	Radio	Playback only	—	—	2	Private use	Chapman Tuner, Leak Varislope Jason, Ficord & Telefunken
Brenell Mark 5	Reslo	Microphone only	Both	—	—	2	Private use	
Phillips EL 3536	Phillips	Disc & Microphone	Both	6	—	4	Tape exchanging in stereo	
Brenell Mk 5 & Collaro	Reslo and Acos	Disc & Microphone	Both	6	—	2	Tape exchanging in stereo	
Phillips EL 3542 & EL 3527	Phillips	—	—	—	Yes	4	Collecting sound effects	
Reflectograph Model B	Reslo & Trix G 7822	—	—	2	Yes	4	Private use	Leak Varislope, Dulci Tuner, Wharfedale Speakers, Garrard Turntable
Tandberg Stereo 3	Simon Cadenza	Microphone only	Both	8	Yes	2 and 4	Private use	Shirley Laboratories TWA 1515
Ferrograph 88	Reslo CRL	Microphone only	Both	60	—	2	Teaching Music	
Reflectograph 570	Acos	—	—	—	Yes	2	Cine Work	
Brenell 3 Star	Reslo	—	Playback only	11	Yes	2 and 4	Private use	
Reflectograph 570	Lustraphone, Gramplan, Simon	Microphone & Radio	Both	1	—	2 and 4	Church Recordings	
Home Constructed	Reslo, Phillips, Lustraphone	Microphone & Radio	Both	20	—	2 and 4	Tape Club Work	Audiomaster Amplifier, Lowther Acosta, Dektron Mixers
Reflectograph 570, E.M.I., Truvox								

# DON'T CUT THE TOP OFF

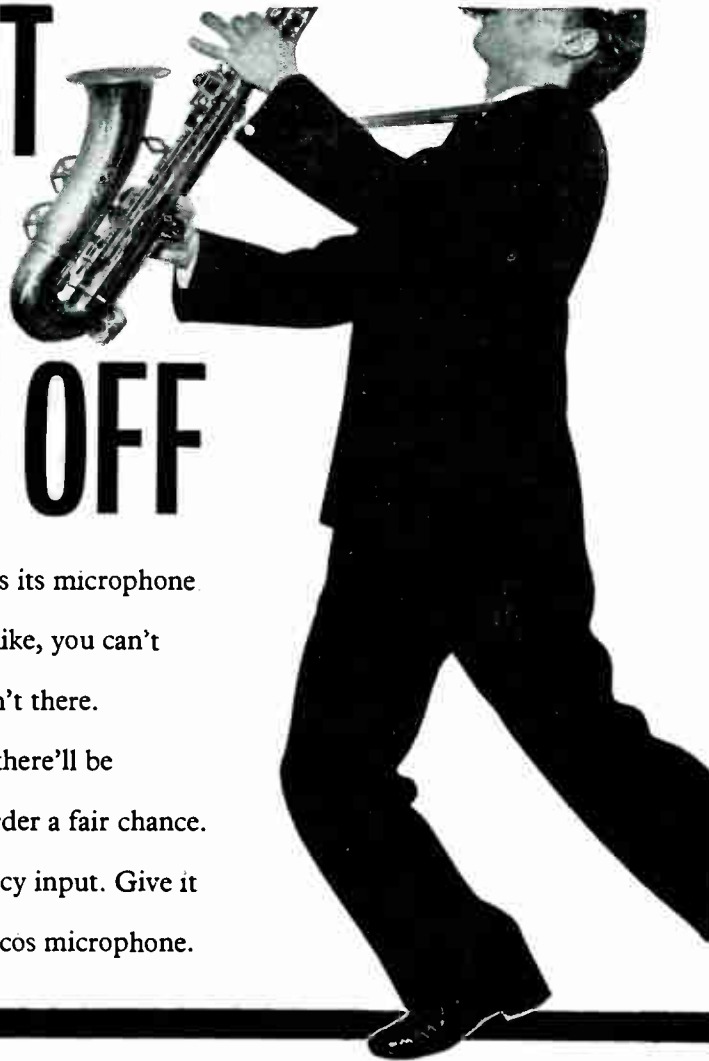

A tape recorder is only as good as its microphone  
If you cut a top note off in the mike, you can't  
blame the recorder if the note isn't there.  
If there's distortion at the start, there'll be  
a din in the end. Give your recorder a fair chance.  
Give it a balanced, wide-frequency input. Give it  
a good microphone. Give it an Acos microphone.

## USE AN ACOS MICROPHONE



### MIC 39

A crystal hand microphone of exceptionally attractive appearance. Extended frequency response; noise-free cable and die-cast liner to minimise hum and ensure excellent signal-to-noise ratio. Available with table-stands and floor stand adaptor. U.K. Retail price 3 gns. Other Acos microphones include the famous fold-away MIC 40 (35/-) the MIC 28 Lapel Microphone (50/-) and a superb new stereo microphone (£6.6.0)

*Acos microphones are standard equipment with most British high-quality tape recorders.*

**acos**

ARE <sup>also</sup> DOING THINGS IN STYLE

COSMOCORD LTD WALTHAM CROSS HERTS TEL: WALTHAM CROSS 27331



# OTHER RECORDING SYSTEMS

RECORDING on tape, in the widest sense of that term, includes many ingenious and practical systems which are beyond the normal scope of this magazine. The Teficord, a German mechanical embossing method, is one example; the Philips-Miller system, a mechanical method which produces a variable-area optical track, is another. The latest, and probably the most promising and versatile idea, is "thermoplastic" recording, in which a pattern of electrostatic charges representing the input signal is used to deform a momentarily melted transparent plastic layer according to its instantaneous strength and distribution. Playback is by optical methods, depending on the refraction of light by the deformed coating, and can be used either to project recorded pictures directly on to a screen or to convert other recorded data into a suitable electrical form. Recordings are erased by re-heating the coating.

Even optical film recording can be included in a list of systems using media in tape form. And if this sounds like stretching the point too far, remember that there is a large and important section of industry and business where "tape" means paper with holes punched in it. That, too, is recording.

However, there is enough material in even the restricted field of magnetic tape recording for several books. Our conventional a.c.-biased system is only one of a number of methods of storing information in "analogue" form (that is, where the tape modulation is continuously proportional to the input signal), let alone the various methods of "digital" recording (where information is stored as saturating pulses arranged according to a pre-determined code). I want here to pick out a few techniques from other fields which could be used in sound recording, as well as an undeveloped audio idea which deserves more attention.

## Carrier-Erase

Among the "direct-recording" systems—those which apply the electrical input as it stands directly to the tape, without transforming it in any way—you are probably familiar with the d.c.-biasing method used on many dictating machines. Its main disadvantages are the difficulty of keeping the tape correctly biased in the face of different tape-coating thicknesses, dirt on the heads and so on, and the signal/noise ratio due to the d.c. bias, which is rarely better than 30dB in practical conditions.

The latter at least could be improved by turning to account the ease with which a short-wavelength (high-frequency) signal can be erased by a direct field. In "carrier-erase" recording, the tape is first saturated continuously with a single h.f. tone signal, which is subsequently part-erased by a standing d.c. in the recorded head. The audio-frequency recording current is superimposed on the d.c., adding to it and subtracting from it

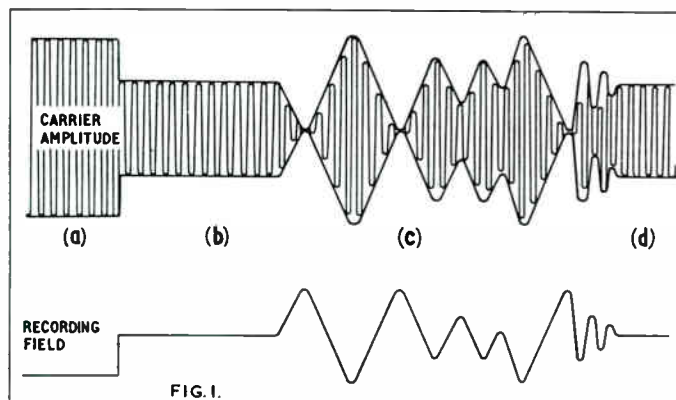

Fig. 1. Idealised representation of Carrier-Erase Recording. (a) Tape saturated with carrier signal. (b) Steady bias field applied. (c) Bias + audio signal applied. (d) End of recording.

according to the polarity and strength at any instant and thus modulating the carrier signal on the tape. This operation is illustrated in fig. 1.

The frequency and wavelength of the carrier are of some importance; the first because it determines the upper a.f. limit, the second because it affects the shape of the recording characteristic—or rather, the erasing characteristic—and thus helps to determine the dynamic range of the system. Fig. 2 shows erasing

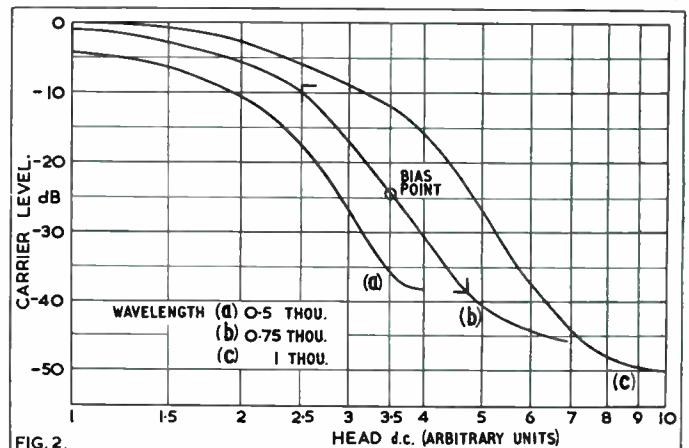

Fig. 2. Transfer characteristics of Carrier-Erase Recording. Carrier level vs head d.c., wavelength as parameter. (0.75 thou' is equivalent to 10 Kc/s at  $7\frac{1}{2}$  i/s, for example.)

characteristics for carriers of three recorded wavelengths. Curve *b* appears most suitable for linear recording, but the final choice will, as usual, be the result of a compromise between dynamic range, frequency range and tape speed. The d.c. "bias" erases the carrier to about the point indicated and the superimposed a.f. swings within the range shown.

The first obvious advantage of carrier-erase recording is the lower d.c. "bias" required compared to the normal d.c.-biased system. This means lower noise, of course; a dynamic range of over 40dB is possible at  $7\frac{1}{2}$  i/s with suitable playback arrangements. The second advantage is that little or no recording amplification is required. The system was first devised for data-recording in missiles and aircraft, where space and power is strictly limited, and used currents derived directly from thermocouples, strain-gauges and so on to erase the pre-recorded carrier. For "intelligible-speech-only" applications, a suitable combination of microphone and head would suffice, with bias supplied by a battery or even by a permanent magnet.

The disadvantage lies in the necessity for an efficient demodulator in the playback chain if anything approaching high quality is required. However, complicated playback equipment was no problem in the original application, and would be unimportant in portable reporting and dictating machines, for instance; it would be left in the office. If immediate playback were needed, perfectly intelligible reproduction (though with limited frequency response and obtrusive noise) needs only a simple detector or even a low-pass filter.

## Frequency-Modulation

Carrier-erase recording is only one step removed from amplitude-modulated carrier recording, which is itself analogous to a.m. broadcasting. Indeed, the only detectable difference between the two (apart from the higher noise from the former) is that their recorded signals are in exact anti-phase. A.M.-carrier recording for audio is pointless, since it is prone to exactly the same drop out and noise troubles as direct-recording systems and needs more complicated electronics. However,

# Alive to every sound



Like the ears of this wary fox, the Gramplan DP4 microphone is sensitive to an extremely wide range of sounds. With its uniform frequency response from 50 to 15,000 c/s, the reliable, medium-priced DP4 will greatly improve the standard of your recordings.

## Gramplan DP4

—also for broadcasting, public address and call systems.

Low impedance microphone, complete with connector and 18 ft. screened lead . . . . . **£8. 0. 0.**  
Medium and high impedance models . . . **£9. 0. 0.**

A complete range of stands, swivel holders, reflectors and other accessories is available.

**GRAMPIAN—sounds like the real thing!**

Write or phone for illustrated leaflets:



**GRAMPIAN REPRODUCERS LTD**  
Hanworth Trading Estate, Feltham, Middlesex. Feltham 2657

## FRANCIS OF STREATHAM

### ● TAPE RECORDERS AT 169/171

*FERROGRAPH 422	110 gns.
FERROGRAPH 424	110 gns.
Brenell Mk. V Model M	88 gns.
*Brenell Mk. V	64 gns.
Brenell 3 star	58 gns.
Brenell 2 star stereo	89 gns.
Cossor 4 Tr.	37 gns.
Cossor 4 Tr.	59 gns.
Elizabethan FT.1 4 Tr.	34 gns.
Elizabethan FT.3 4 Tr.	45 gns.
Elizabethan 'Popular' De Luxe	24 gns.
Elizabethan TT3	39 gns.
*Elizabethan Major	65 gns.
*Ferrograph 4AN	81 gns.
*Ferrograph 4AN/S	88 gns.
Fidelity Argyll Major	28 gns.
Fidelity Minor	22 gns.
Grundig TK14	35 gns.
Grundig TK 24	55 gns.
*Grundig TK60 Stereo	128 gns.
*Harting HM8 Stereo	86 gns.
Korting MT 157 4 Tr.	85 gns.
Magnafon Zodiac	39 gns.
Philips 4 Tr. 3541	34 gns.
Philips 4 Tr. 3542	59 gns.
Philips 4 Tr. Stereo 3536	92 gns.
*Reflectograph 'A' 1 Tr.	105 gns.
*Reflectograph 'B' 1 Tr.	115 gns.
Robuk	36 gns.
*Simon SP5	93 gns.
Sony	124 gns.
Stellaphone 4 Tr.	37 gns.
Stellaphone 4 Tr.	59 gns.

Stuzzi 4 Tr. Junior	26 gns.
Stuzzi Tri-Corder	63 gns.
Telefunken 76 4 Tr.	60 gns.
*Telefunken 85 KL	79 gns.
Truvox Series 80/2 Tr.	55 gns.
Truvox Series 80 4 Tr.	59 gns.
Truvox R7	82 gns.
Uher Universal	79 gns.
*Uher 4 Tr. Stereo	126 gns.
*Vortexion WVA	£93.13.0
*Vortexion WVB	£110.3.0
*Vortexion C Stereo	£148.10.0
Wyndor Heron	25 gns.
Wyndor Victor	45 gns.

### BATTERY PORTABLES

Philips Portable	24 gns.
Butoba	69 gns.
Grundig TKI	29 gns.
Clarion	19 gns.
Clarion Twin Set	8 gns.
Clarion Phonotrix	39 gns.
Minivox C	23 gns.
Fi-Cord	59 gns.
Fi-Cord 101	53 gns.
Stuzzi 'Magnet'	59 gns.
Stuzzi Memo-Cord	25 gns.

FACTORY-FRESH BATTERIES ALWAYS IN STOCK

\*Microphone extra

### WE SPECIALISE IN

- Tape to disc service
- Tape copy service
- RECORDER HIRE SERVICE

## LEADING STOCKISTS OF EQUIPMENT FOR TAPE, DISC and RADIO . . . and NO EXTRA FOR CREDIT TERMS

- ★ Minimum Deposit
- ★ No Interest or Service Charges on H.P. up to 18 months
- ★ Free Service during Guarantee Period

Prices subject to alteration as announced by manufacturers.

### ● MICROPHONES AND MIXERS

Gramplan DP/4 Dynamic	£8. 0. 0
Lustraphone LD/66	£4. 2. 6
Lustraphone VR 64	£7. 17. 6
Ribbon	£7. 17. 6
Lustraphone LFFV/59	£8. 18. 6
Dynamic	£10. 10. 0
Simon 'Cadenza' Ribbon	£9. 12. 6
Reslo Ribbon or Dynamic	£10. 12. 6
Reslo Cardioid	£19. 19. 0
AKG Stereo	£2. 2. 0
Dynamic D.88	£16. 16. 0
TSL 3 Channel Mixer	£2. 2. 0
Grundig Mixer	£16. 16. 0

Also in stock microphones by ACOS, FILM INDUSTRIES, TSL, G.B.C., TELEFUNKEN

### ● TAPES & ACCESSORIES

Standard, Double Play and Long Play in all sizes by all leading makers.  
● Pre-recorded Tapes by Columbia, H.M.V., Saga, etc.  
Bib, Bond and Romagna splicers. Matching transformers Plugs, sockets, etc.

AT OUR HI-FI DEPT. AT 181 Streatham High Road

- STEREO AND MONO AMPLIFIERS by Quad Walgain Rogers Leak Dulci Armstrong Telefunken, etc.
- TUNERS by Quad H.M.V. Rogers Leak Dulci Armstrong
- LOUDSPEAKERS by Quad G.E.C. W.B. Wharfedale Goodmans Tannoy Audistic Mordaunt
- MOTORS, PICKUPS, by Garrard Tannoy Lenco Shure Connoisseur Decca(ffss)Stereo Philips Ronette Thorens. All-Balance. Goldring Ortofon SME

All types of Diamond and Sapphire styli, stereo and mono. Microlifts, Garrard SPG3. Acos Dust Bug.

CABINETS Record Housing Leak 'Southdown'

Please note our only addresses as below

**169-171 STREATHAM HIGH ROAD, LONDON, S.W.16**

Between St. Leonard's Church and Streatham Station

STreatham 0466/0192

Hi-Fi Dept. 181 STREATHAM HIGH ROAD, S.W.16

## OTHER RECORDING SYSTEMS — (continued)

frequency-modulated carrier recording has the same advantages over direct-recording as f.m. radio has over a.m., and for this reason is widely used in analogue data systems, especially where very low frequencies must be recorded.

There is no space here to describe a f.m. system in detail. Briefly, a carrier signal which saturates the tape is varied in frequency around a "no-modulation" centre value according to the amplitude of the input, its frequency being represented by the rate of change of carrier frequency. The playback signal is amplified and limited before it is demodulated, so that a large frequency-deviation is possible and tape dropouts, frequency-response losses, etc. are only effective outside certain limits. Fed thus with an input of constant amplitude, the frequency-dis-

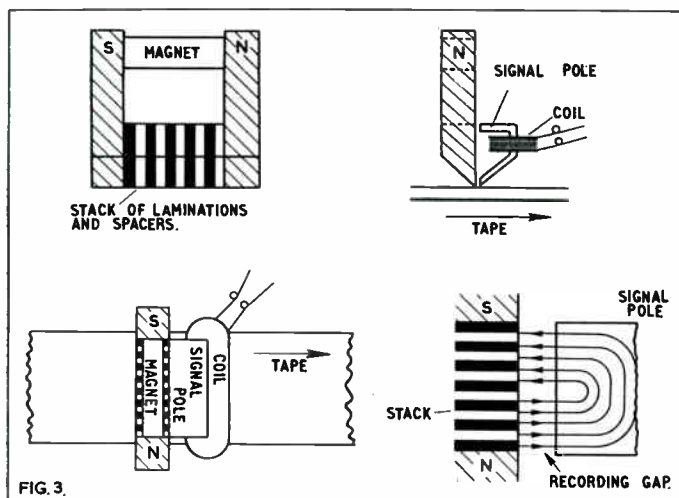

criminating demodulator reconverts frequency into amplitude and change-of-frequency into frequency, removes the carrier components and re-presents the original input.

The virtues of the system lie, paradoxical'y, in the topsy-turvy transformations which ordinary system defects undergo. Tape noise effectively disappears; crosstalk, hum and other external interference arising before the discriminator gives unintelligible background noise; "wow" is converted into amplitude variations; "flutter" into modulation noise. Waveform distortion can only arise from dropouts or sensitivity variations in the tape beyond the capabilities of the limiter, or from incremental phase distortion.

The f.m. system thus shifts the main burden of quality from the tape—which is least able to bear it—to other parts of the equipment which are, in the present state of development, well able to do so. It will be evident that the mechanism must be excellent, the carrier oscillator must be extremely stable in frequency, and phase shifts must be carefully controlled.

Reported figures for a f.m. carrier audio system are impressive:

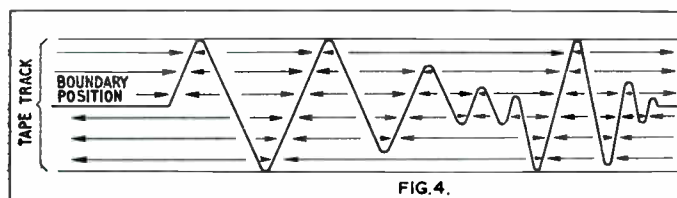

Fig. 4. Magnetisation pattern on tape track in Boundary-Displacement Recording. The current waveform in the head is represented exactly by the boundary waveform, so is not shown separately. Arrows show direction of tape saturation.

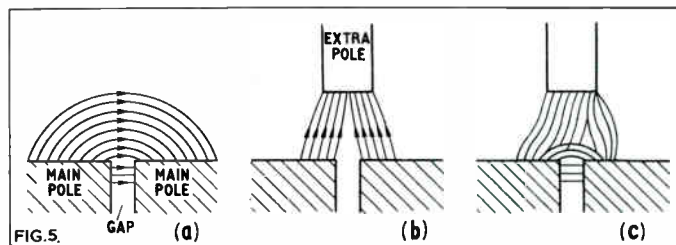

Fig. 5. Flux pattern in a Cross-Field Head. (a) Diffuse field due to main poles. (b) Cross field between main and extra poles. (c) Resultant concentrated field.

at a tape speed of 15 i/s, background noise approached 80dB below maximum output, modulation noise about -60dB; amplitude variations within 0.2dB; harmonic distortion less than 0.3%; for an a.f. range up to 15 Kc/s. The mechanism used was said to have wow and flutter below 0.03% peak. Subjectively, reproduction was found to be much "cleaner" than from conventional tape recording (because of the lower modulation noise), and slightly cleaner than the best direct disc reproduction (because of the lower distortion).

Attempts at this are definitely for development laboratories and rich geniuses only, I fear, if any real improvement on direct recording is wanted.

### Boundary-Displacement

Returning to direct recording, a system called "boundary-displacement" which was widely publicised about ten years ago, bears roughly the same relation to a.c.-biased recording as variable-area optical recording does to variable-density. The whole tape track is first saturated in one direction by a permanent magnet; this serves also for erasure. The recording head then saturates one-half of the track in the opposite direction so that, in the absence of modulation, the playback head senses a fairly high background noise but still no organised signal magnetisation.

Modulation is achieved by displacing the boundary between the two sections of the track according to the instantaneous value of the input signal. This can be done either by moving the recording head across the track (e.g. a very small permanent magnet with fine, closely-spaced poles), or—more suitable for audio work—by using a special head whose sharply-defined field boundary, normally biased to the track centre, moves as the exciting current changes. Either way, the playback head senses net flux changes similar to those produced by other direct-recording methods. A suitable recording head structure is illustrated in fig. 3, and a diagram of typical recorded magnetisation patterns in fig. 4.

### Advantages of the System

Some important advantages arise from this recording method. Firstly, signal linearity depends only on the geometrical accuracy of the boundary position, not on the magnetisation characteristic of the tape itself, since the tape is never magnetised other than to saturation in one direction or the other (except in a small transition region at the boundary). Overloading occurs very sharply when the boundary reaches the track edge, of course.

Secondly, the output at full modulation is high—12dB or more above that from an a.c.-biased recording—because of the large magnetisation swing. This makes dynamic ranges of over 50dB possible at 7½ i/s, despite the high saturation background noise.

Thirdly, the system is much less affected by imperfect or irregular head/tape contact than other direct-recording systems are. Indeed, it was developed originally to reduce this effect in analogue data recording on drums with heads spaced away from their coated peripheries; no drum is ever perfectly regular, and this method was found to reduce the consequent output variations to about one-fifth of those encountered with other systems. It also needed no a.c. bias, which is always a problem in non-contact recording because of both the amount required and the consequent wastage of h.f. registration. *Continued overleaf*

## Hi-Fi Books

Make

# IDEAL PRESENTS

★ A Hi-Fi book or subscription to one of our magazines makes an ideal present for anyone interested in Tape or Hi-Fi.

### 1961 Hi-Fi Year Book

Now in its 6th year of publication this annual is regarded the world over as the indispensable guide to British High Fidelity products. Over 800 items of equipment are listed, 500 of which are illustrated. A special section is included on cine sound equipment.

. . . . 10/6 (p & p 1/3)

### Hi-Fi for Beginners

This book is thoroughly recommended to every enthusiast; it has been acclaimed from all sides as being the ideal book for everyone who has just started or is about to start this hobby. Those whose particular interest lies in tape will find that Chapter 7 alone will make this book worthwhile.

. . . . 7/6 (p & p 9d.)

### Experimental Recording

This book presents in convenient form the series of articles by A. Tutchings on "Twenty Practical Experiments in Magnetic Recording" and full instructions on "Building a Fully Portable Recorder" using a clockwork motor and transistor amplifier.

. . . . 5/- (p & p 9d.)

### How to Splice Tape

If you use tape, sooner or later you will need to know how to splice tape, how to repair simple or complicated breaks, how to edit material, how to cut out words or syllables, etc. All this is described in this well-illustrated booklet.

. . . . 2/- (p & p 6d.)

★ ★ ★

### Bound Volumes

We have available copies of Volume 2 of *Tape Recorder*. These are covered in black buckram, are hand-stitched and gold blocked on spine. The price is 46s., special presentation volumes bound in red leather are also available, details on request.

### Binders

Keep your copies clean and ready for easy reference. These semi-permanent binders are available for all volumes of *Tape Recorder*. Each case will take twelve copies plus index and will open flat at any page. They are covered in maroon buckram and are gold blocked on spine. Price 15s. post free.

### Subscriptions

A subscription to *The Tape Recorder* is an ideal present as it lasts for a whole year and yet costs only 21s. (with index 24s.). *Hi-Fi News* costs 27s. 6d. or 30s. with index. A really unusual present would be a year's subscription to our American contemporary *Audio*, this can be arranged through us. Price 35s.

**MILES HENSLOW PUBLICATIONS LTD.**  
99 MORTIMER STREET · LONDON · W.1

## OTHER RECORDING SYSTEMS—(continued)

### Cross-Field Heads

These last two features—reduction of contact effects and absence of h.f. losses during recording—could be well used in audio recording at the present time. Attempts at the latter have in fact been made, modifying conventional heads in order to curtail the trailing fringe of the bias field which tends to erase recorded high-frequency signals. With conventional heads, this results in the familiar observation that the optimum bias for h.f. signals is considerably less than for the middle and lower frequencies on which it is usually set.

Since h.f. signals are concentrated in the surface of the tape coating whereas lower frequencies permeate it, a possible way to overcome this defect is to record on the tape normally from the coated side but to bias it from the back with a separate head. The central parts of the coating would then be biased correctly for the lower frequencies as before, but the surface would be in a region of lower bias field rather than higher. However, the arrangement is cumbersome and difficult to adjust.

### The Third Pole

Development of this idea resulted in the unconventional "cross-field" head, which has a third pole opposite the normal recording gap. This pole is energised by a coil in series with the normal coils, the cross-field between it and the main poles combining with the normal gap-finging field to produce a resultant recording field with a sharp boundary at its trailing edge (fig. 5). Given proper adjustment of gaps and coils, the optimum bias for h.f. signals can be made practically equal to that for low frequencies, instead of the 1:2 ratio normally encountered. The consequent increase of h.f. registration—say 10 Kc/s at  $7\frac{1}{2}$  i/s—can be 6dB or more.

The cross-field head has other incidental advantages, including more uniform magnetisation through the coating at low frequencies, a smaller effective flux density in the main pole structure, and reduced head/tape contact effects (though not so much so as in boundary-displacement recording).

### To Follow—Unconventional Playback Heads

It is interesting to note that moving the third pole to one side of the recording gap can localise the cross-field to an extent which makes erasure possible, though with some loss of h.f. registration. Taken to a limit, with the third pole back on the coated side of the tape and the coils connected differently, this results in the combination erase/record/playback head which is still popular in some quarters. It is sad that the latter, having lost the original advantages of its parent, should be the only surviving relative of a useful, promising and practical idea.

This article has dealt mainly with magnetic recording systems. I hope later to describe some unconventional playback heads, further examples of "how the other half lives". The next article in this series will be concerned with decibels and similar units.

## ANNOUNCEMENT

### 1962 EDITION HI-FI YEAR BOOK

Tape Recorder Dealers who keep stocks of equipment and/or where facilities for demonstrations exist, and wish to be included in the Directory of Tape Specialists, are invited to send their name and address to the Editor

This entry is free of charge

**THE TAPE RECORDER**  
99 Mortimer Street, London, W.1.

# our readers write . . . . .

## . . . about tape clubs and drama groups

From: Eric Yardley, 7 Luther Road, Teddington.

Dear Sir:—For those keen on tape recording and also having an interest in theatre, there are many ways in which they can assist in amateur drama clubs.

The most obvious way, of course, is in the sound effects department; how many productions are ruined by ineffective noises off. Only this week I saw a presentation by a professional repertory company, and the whole effect of the play was marred by the sounds off which were meant to be a car crash and later a firework display. It needs considerable skill to simulate the real effect, and a true technician will not be satisfied until the sound is true to life, with the correct degree of distance imposed. It is just as important, of course, for these noises to arrive spot on time, to synchronise with action on stage, which again is not always easy.

Another way sound men can help, is by recording actors' voices and playing them back so that faults can be corrected. This is particularly important in dialect plays.

Drama clubs are always anxious to hear from technicians willing to assist in this way, and any such person who would like to join the Teddington Theatre Club would be welcomed. Full details on request.

Yours truly.

\* \* \*

## . . . about 'Inside the Outside'

From: T. Bolton, 35 Transmere Road, Petts Wood, Kent.

Dear Sir:—With reference to A. G. Watling's article in the October issue of *The Tape Recorder*. I read this with great interest until I came to the section on 'operating controls'.

Not so long ago I purchased a new machine. My first thought when looking at it was, "How will I ever know what all these knobs and buttons are for?" But after reading the very well worded instruction booklet, supplied with the machine, it all became apparent. I could now (not that I have any desire to do so) operate it blindfolded and so could the other members of my family.

Just one last point, as a tape recorder is not the sort of thing you would lend to any Tom, Dick or Harry, why worry if you cannot tell what each knob is for by just looking!

Yours faithfully.

\* \* \*

## . . . about the Countess

From: J. M. Lynch, Holmeswood, 30 Nant Fawr Crescent, Cyncoed, Cardiff.

Dear Sir:—Mr. Aldridge spoils his case by overstatement and generalisation. My experience of the Countess and presumably that of the reviewers in *The Tape Recorder* and other magazines do not bear out his charges of overheating and high hum level. Despite its small size the thing is built like a battleship; its components, including transformers, are generous; its replay head monitors from tape, using half an ECC83 and an EL84; the monitoring output, via an external speaker, is quite sufficient to detect any overmodulation, which is its sole purpose. Whether or not it is still being produced, the fact remains that the Countess is excellent value for 30 guineas and much better than other British recorders similarly priced. The Miniflux heads alone are sufficient guarantee of that. I have had experience of an original Timbra. The specification in its instruction book is less exuberant than that which you published in December 1959 and its sound quality at  $3\frac{1}{2}$  i/s does not compare with that of the Countess at the same speed. I must not, of course, generalise about all Timbras from this one.

Mr. Aldridge's main charge of unnecessary and indeed uncalled for mystery is, however, entirely justified. The Countess is made in the United Kingdom; it is not the same as the Timbra, which is Dutch; it has never so far as I know been advertised as on sale at its allegedly original price of 89 guineas; it cannot superimpose in the normally accepted sense of that term. On ensuing

concerning its origin I was told by the distributors that it was the result of a "frustrated order".

Surely readers of your journal are entitled to know: (a) the maker of the goods they are invited therein to buy, and (b) why the recorder is being sold at a third of its stated list price. We look to Radio Clearance Limited for answers. Incidentally, you say you were assured spares were available. The Countess uses a non-standard jack plug unobtainable elsewhere. I asked to be allowed to buy spares but was permitted one only. It would be enlightening to know the availability of the less accessible parts of the recorder.

Yours faithfully.

\* \* \*

## . . . about writers' cramp

From: S. Bahrman, 42 Cloudesley Mansions, Cloudesley Place, London, N.1.

Dear Sir:—Since you published my letter (on cheap tape) in the September issue, my mail has grown huge and although I fo bear to trouble you, it is still flowing in.

Please take pity on a man with writer's cramp—it is even getting so bad that shortly I will be unable to turn the controls on my recorder! To avoid such a dreadful state of affairs will you please allow me to inform your readers that I have at last found a tape which is highly acceptable by my recorder and my pocket.

Yours faithfully.

\* \* \*

## . . . about the Gramdeck pause control

From: B. Churchill, 291 Whippendell Road, Watford, Herts.

Dear Sir:—I read with interest Mr. D. A. Cloud's article on the Gramdeck pause control. (September 1961). Whilst I have no doubt that his apparatus works efficiently, even for different spool sizes, I find that on my own Gramdeck, the friction between the tape and the capstan is still sufficient to pull the tape through when the pressure roller is moved away from the capstan. When the take-up spool is stopped as well I find that the tape immediately folds double and winds itself round the capstan.

Gramdeck owners might be interested to hear of my own method for producing an instant stop/start. At the desired time, the thumb and index finger of the left hand should squeeze the pressure pad tightly on to the record/replay head, thus gripping the tape. The index finger of the right hand simultaneously disengages the pressure roller from the capstan. To avoid tape spill, the thumb of the right hand is used to stop the supply spool and the fingers of the left hand controls the take-up spool. The turntable is, of course, left rotating and starting is effected by pressing the pressure roller release button and releasing the pressure on the head at the same time.

Using this method I have recorded test tone and the only evidence of the pause on playback is a faint click.

Yours faithfully.

\* \* \*

During the past few months, a considerable number of readers' letters have reached this office with names and addresses either incomplete or indecipherable. In such cases we are unable to answer the points and queries raised. One of these letters recently received was from a Mr. F. P., Gobridge, Stoke-on-Trent. If this reader will forward his full name and address, a reply will be forwarded to him. (Editor).

TAPE RECORDERS · AUDIO EQUIPMENT · DISC CUTTING STD & LP FROM TAPE · STUDIO FACILITIES · HIRE SERVICE · SALES · EXCHANGES

**MAGNEGRAPH**

1 Hanway Place, London, W.1

Tel: LAN 2156

# Now FAITHFUL MUSIC REPRODUCTION

from tape recorders  
even at hall recitals

## USING THE WHARFEDALE LS/6B NEW LINE SOURCE SPEAKERS

The value of line source speakers for ensuring intelligibility in unfavourable acoustic conditions is now widely appreciated, but hitherto the benefits of clear speech reproduction have only been obtainable at the expense of reduced bass due to the restricted cabinet size of most designs. In consequence, most line source speakers are unable to reproduce music faithfully. The new Wharfedale model LS/6B overcomes the problem by providing a short column—LS/6—middle and high frequencies with a separate bass enclosure—W2/B. A pair of LS/6B's give excellent stereo reproduction.

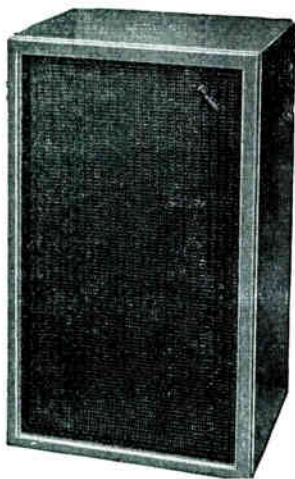

**SPECIFICATION—LS/6.**  
Treble Line Source Assembly. Size: 36" x 7½" x 5". Weight 28 lb. Fitted with 6 special high flux 5" units. W2/B BASS CABINET: Size: 23½" x 14" x 12". Weight 37 lb. Fitted

with WLS/12 unit, 400 c/s separator and treble V.C. Max. input: 20 watts R.M.S. Impedance: 15 ohms. Transformers available for other impedance. Finish: Light oak with woven plastic grille. Price:

LS/6B Complete	£58 0 0	LS/6	£27 10 0
W2/B	£23 10 0	400/CR3/2 Crossover	£10 0 0



**IDLE BRADFORD  
Yorkshire**

Tel: Idle 1235/6  
Grams: Wharfedel,  
Idle, Bradford

## The Northampton TAPE & CINE CLUB

President:  
COUN. J. TOMPKINS  
Chairman:  
Mr. H. FINIMORE

Secretary:  
Mr. J. HARRISON  
36 Spring Gardens  
Northampton

Treasurer:  
Mr. A. FOSTER  
Asst. Sec.:  
Mr. C. W. EATON

27<sup>th</sup> Sep 1961

Dear Sir,  
I am writing to acknowledge the receipt  
of two tapes 7" Dia 1800 ft Electronic World Brand

These tapes have been carefully tested on several different machines including professional equipment, in all cases with equally satisfactory results.

The tests show that your Electronic World Tape is better than every brand of British or European tape that is generally available and is equal in quality with one brand of American professional tape at a very much higher price. There are to all intents and purposes no drop outs or other common faults, there is also a genuine consistency of response of approx.  $\pm \frac{1}{2}$  dB on the playback of a 1,000 c.p.s. signal previously recorded at a fixed level throughout the whole tape.

Most other tapes we have tested have failed badly on this particular test.

Yours faithfully,  
H. M. Finimore, *Chairman, N.T.C.C.*

Unsolicited  
testimonial.  
Facsimile available  
on request.

# Convinced NOW!

## TRIED TESTED AND PROVED

Need we say more to prove the reliability  
of our tapes

7" 1200' Acetate	17/6 each	POST
7" 1800' Polyester	29/- each	FREE
7" 2400' Polyester	42/6 each	

**GUARANTEE.** If you are not completely satisfied, we undertake to refund the full price plus the cost of your return postage.

## POST COUPON NOW!

**D. VILLIERS**

**16/20 STRUTTON GROUND, LONDON S.W.1**

QTY PRICE

"Electronic World" 7" 1200' Acetate @ 17/6  .....

"Electronic World" 7" 1800' Polyester @ 29/-  .....

"Electronic World" 7" 2400' Polyester @ 42/6  .....

Please forward details of full range of tapes available.

Name .....

Address .....

(BLOCK LETTERS PLEASE)

Mail only: Cash with order.

# TAPE, RECORDERS & ACCESSORIES

## FIRST DETAILS OF NEW PRODUCTS

● We remind our readers that notices of equipment listed and illustrated in this monthly feature are in no sense reviews. When figures, specifications and diagrams are published, these data are extractions from manufacturers' lists. When samples of this equipment are submitted for test, they are passed to our technical contributors, whose reports are published in a separate section.

### TRUVOX SERIES 80 TAPE DECKS



TRUVOX announce four items in the new "Series 80" range of tape decks, tape units and complete recorders: PD82. A two-track tape unit comprising a Series 80 tape deck, finished in two tone beige with matching cabinet, fitted with pre-amplifier and push pull erase and bias oscillator self-powered and ready to connect to any high fidelity amplifier. Price £42. PD84. A four-track tape unit as above but with track selector (1-4 and 2-3) which also has a stereo replay position. Price £46. D82. Tape deck only, twin track. Price £26 5s. The D84 tape deck only, four-track with track selector/stereo switch. Price £29 8s.

Features include 7 in. reels, three motors, fast wind and rewind, instant mechanical brakes, push button interlock which returns the record switch to play back when stop, wind or rewind buttons are pressed. Separate drive wheels for each speed automatically disengaged when machine is switched off. Speeds can be selected whether deck is running or stationary. Pause control, tape position indicator, wow and flutter better than .15 per cent. at  $7\frac{1}{2}$  i/s, better than .2 per cent. at  $3\frac{1}{2}$  i/s. Frequency response claimed at  $7\frac{1}{2}$  i/s. 40-20,000 c/s.  $\pm 3$ dB, at  $3\frac{1}{2}$  i/s. 40-12,000 c/s.  $\pm 3$ dB. Manufacturers: Truvox Ltd., Neasden Lane, London, N.W.10.

### Mains Unit for Philips Portable

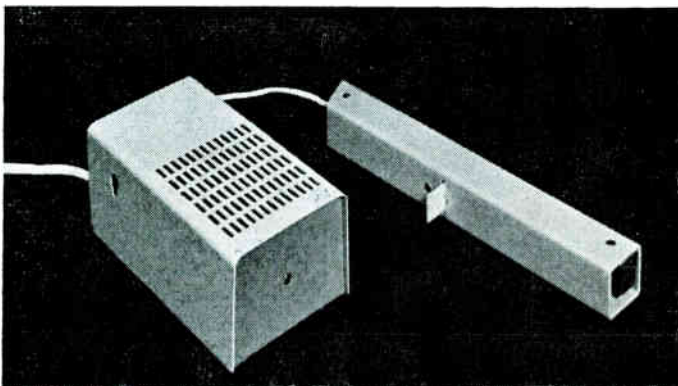

PHILIPS Electrical Ltd., have now introduced a mains supply unit designed for their new battery tape recorder.

The two-unit device consists of a plastic tube which fits into the battery compartment of the recorder and a metal encased transformer and rectifier. The metal encased unit measures 6 in. x  $3\frac{1}{2}$  in. x 3 in. and the full unit weighs only 2 lb. 10 oz. It is to sell at £5.

The recorder can be powered from the mains by this device which operates on 110, 127, 200-250v A.C. (50 c/s). Manufacturers: Philips Electrical Ltd., Century House, Shaftesbury Avenue, London, W.C.2.

### Pre-amplifiers for Stereo Playback

INCREASED versatility for two Philips tape recorders is provided by the addition of a new supplementary piece of equipment. The Philips pre-amplifier, type EL 3774/00 has been designed for the monophonic EL 3541 and EL 3542 tape recorders, enabling among other facilities, playback of pre-recorded two- and four-track stereophonic tapes.

For stereo playback, or simultaneous playback of two separate mono tracks the pre-amplifier is plugged into the stereo outlet already provided on the recorder and connected to the pickup sockets on a radio, or an amplifier with a loudspeaker system. This will form the right hand reproducing channel whilst the tape recorder forms the left.

On some of the earlier versions of these two tape recorders slight modifications may be needed in order that the low DC operating voltage for the pre-amplifier can be applied. The pre-amplifier costs £6 10s. and if modification is needed it can be carried out at small cost by the local dealer. Manufacturers: Philips Electrical Ltd., Century House, Shaftesbury Avenue, London, W.C.2.

### M.S.S. TAPE-RACK

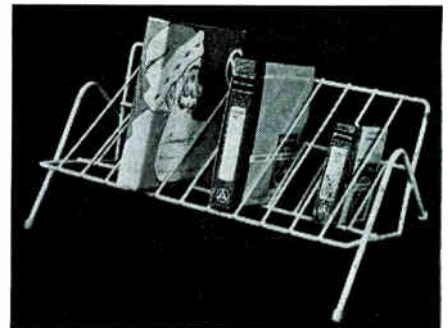

THE M.S.S. Recording Company Ltd. have produced a practical, good looking and inexpensive means of storing magnetic recording tapes of various sizes. The Tape-Rack contains up to twelve tapes of any of the usual sizes between 3 in. and  $8\frac{1}{4}$  in., each box resting securely in its own compartment, with the title panel clearly visible. The unit is made from strong, welded steel, finished in abrasion-proof plastic, with rubber feet to protect furniture, and weighs only a few ounces. Selling price is 18s. 6d. The Tape-Rack is supplied boxed, post free from M.S.S. Recording Co. Ltd., Colnbrook, Bucks.

ILFORD SOUND RECORDING SERVICE  
445 HIGH STREET NORTH,  
MANOR PARK, LONDON, E.12



**WEDDINGS RECORDED**  
**TAPE TO DISC**  
**TAPE TO TAPE**

STUDIO:—GRA 5107

OFFICE:—CRE 8947

# NUSOUND

RECORDING COMPANY  
ANNOUNCE A

## *Ferrograph*

### SPECIAL WEEK

2nd. to 9th. DECEMBER — 10 a.m. to 7 p.m.  
SATURDAY TO SATURDAY

ON DISPLAY WILL BE FERROGRAPH MODELS 422 — 424 — 4A/N — 4A/H — TAPE DECKS, LINKED TO WIDE-RANGE SPEAKERS AND AMPLIFIERS. SPECIAL 4-TRACK DEMONSTRATION TAPES, MIXERS, MICROPHONES, AND COMPLETE RANGE OF ACCESSORIES

**IT PAYS TO DEAL WITH A SPECIALIST**

**NUSOUND RECORDING COMPANY**  
35 CRAVEN STREET, TRAFALGAR SQUARE,  
LONDON, W.C.2. TELEPHONE TRA 2080

## PSYCHO-DISCS & TAPES

Educational Recordings Ltd. announce the release of a unique L/P record:-

### the AGER TALKING HYPNO-DISC

Side 1: Complete instruction on self-hypnosis  
Side 2: A revolving hypnotic device together with the voice of a Hypnotist.

Price 3 gns. Post free.  
(overseas postage extra)

We also supply L/P records and magnetic tapes on Psychology, health, sleep-learning, and many other interesting subjects.

Brochure gladly sent free under plain cover on request.

Write NOW to:  
**EDUCATIONAL RECORDINGS LTD.,**  
Dept. 13B, 27, York Road., Ilford, Essex.

## MAKE YOUR TAPE RECORDER REALLY PORTABLE

WITH A **Valradio** CONVERTER

A Valradio converter enables you to operate your tape recorder from car, boat or caravan battery, or any other source of low voltage or D.C. supply, making it possible for you to record outdoor events, or dictation, or to provide entertainment when you go on holiday or picnics, etc.

Prices range from £6.10.0., many models available

Write for fully descriptive folder to

**Valradio**

**VALRADIO LTD.**  
Dept., TR/C.,  
Browells Lane,  
Feltham, Middlesex  
Tel. Feltham 4242

To Valradio Ltd., Dept. TR/C., Browells Lane, Feltham, Middlesex.  
Please send me fully descriptive folder for converters suitable for Tape Recorders.

NAME \_\_\_\_\_  
ADDRESS \_\_\_\_\_

## TAPE ENTHUSIASTS—DON'T MISS THIS OUTSTANDING **Bib** FREE OFFER

Simply tear off the flap from any Bib Recording Tape Splicer carton and post it, together with a stamped addressed envelope to the address below. By return, we will send you a 2/6d packet of Bib Tape Reel labels and a Data Card *free of charge!* This offer closes Dec. 31st. 1961—post that flap now!

### Bib Recording Tape Splicer

Lets you edit tapes accurately—with no tape wastage or post-editing clicks. Chromium plated—can be mounted direct on to tape deck (18/6d).

SEND US  
THIS  
FLAP

FROM ANY **Bib**  
TAPE SPLICER  
CARTON...



**Bib tape Reel Labels**  
Self-adhesive—suitable for  
typing or writing.  
24 in packet. 2/6d.



**Bib Tape Data Card**  
Provides a fund of useful  
information on  
playing times.  
2/-.

... for  
**FREE**  
2/6<sup>d</sup> packet  
of  
**TAPE REEL  
LABELS  
AND A  
DATA CARD**

Write to:  
**MULTICORE SOLDERS LIMITED, Maylands Avenue, Hemel Hempstead, Herts.**

TA 6149



# EQUIPMENT REVIEWED

★  
GRUNDIG  
TK 14  
RECORDER  
★

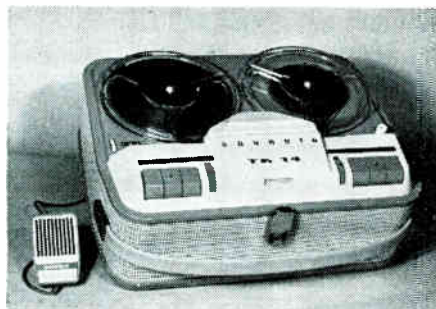

● **Manufacturers' Specification:** Mains voltage: A.C. only, 200-220, 220-240 volts 50 c/s. Current consumption: 55 watts max. Valves: ECC83, ECL86, EM84 plus two metal rectifiers. Recording level indicator: Magic eye. Tape speed:  $3\frac{1}{2}$  i/s. Frequency response: 40-12,000 c/s +3 -5dB. Recording sense: Top track, left to right, International standard. Max. spool size:  $5\frac{1}{2}$  in. Running time per tape (using 1,200 ft. L.P. type TLP2): 1 hour each track. Signal to noise ratio: Better than 50dB. Wow and flutter: Less than  $\pm 0.2\%$ . Fast rewind time: Approx.  $2\frac{1}{2}$  mins. for full spool TLP2. Selector keys and buttons for: Fast rewind, fast forward, wind, start, stop, temp stop, Micro. Radio recording. Controls for: Recording level/volume, tone/mains switch. Internal speaker switch. Inputs: Microphone, 2mv, .5 meg. Radio/gram, 80 mv, 1 meg. Outputs: 500 mv, 15K. and speech coil imp 5 ohms. Output power: 2.5 watts. Loudspeaker: Multi octave elliptical,  $5\frac{1}{2} \times 4\frac{1}{2}$  in. with ceramic magnet. Dimensions:  $14\frac{1}{2} \times 11\frac{1}{2} \times 6\frac{1}{2}$  in. Weight: Approx. 20 lb. Microphone: GDM18 high performance moving coil microphone. Price: £36 15s. inc. microphone. Manufacturers Grundig (Great Britain) Ltd., 39-41 New Oxford Street, London, W.C.1.

THIS is the cheapest recorder to come from the Grundig stable and it is an interesting exercise to see where economies have been made to get down to the low price and still to maintain the above specification. The cabinet is almost all plastic, with a grey fabric finish which matches earlier Grundig machines very closely and has the advantage of being harder wearing and more easily cleaned than most materials. A single two-pole induction motor drives the recorder and the mechanical noise is higher than on earlier machines using Papst type synchronous motors, also the speed constancy is not so good as on the dearer units. The design of the deck is brand new, and the piano key controls are light and positive in action and a joy to use.

Setting for "Record" is a two-handed, or perhaps, I should say a two-fingered operation, where a recording button must be pressed at the same time as the start key. On stopping, after a recording session, the circuit is automatically reset to "play" so that there is no chance of accidental erasure. The new style instruction book takes advantage of the simple controls to describe by picture and numbers, and words of one syllable, how to set up the machine for each function, so that even a child could operate it by going carefully through each sequence.

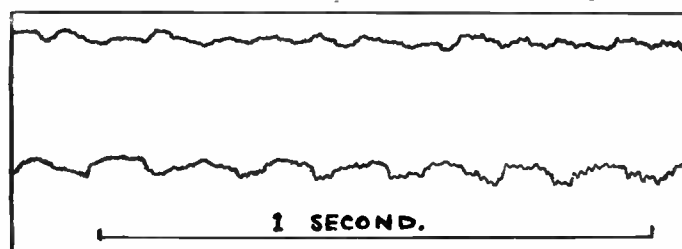

Fig. 1. Fluttergram readings (top) .12% (bottom) .22%

Speed and wow and flutter: I have added "speed" to the heading of this paragraph because, although wow and flutter are

used to define short term variations in speed, it is unusual to find a recorder running more than a few per cent. outside the nominal speed, and when it does happen it invites comment and further investigation. This recorder, when tested on a pre-recorded tape, was obviously running fast, and measurements with a timing loop of known length gave a figure of 10% above the nominal speed of  $3\frac{1}{2}$  i/s. Obviously, the motor loading was rather light with only a loop, so further tests with a constant frequency test tape and full reels dropped the figure to 8%, falling to 6% near the end of the reel.

The dress cover was removed (see instructions if you want to do this, because there is a trick in it) and it was found that the flywheel was driven from the motor by a plastic belt with a D shaped cross section. Close inspection showed that the belt had become twisted, so that the flat was resting across the V of the pulley so that the effective pulley ratio was *not* that calculated by the designer. The belt was replaced so that the

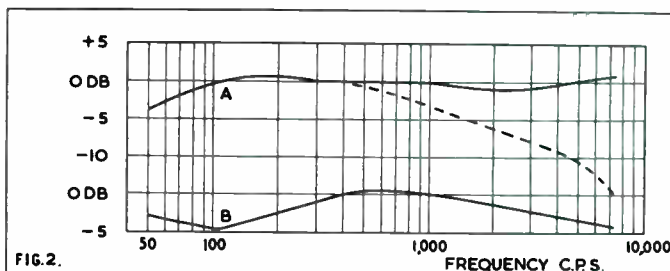

FIG. 2.

### Play response only

rounded section seated properly in the grooves and the speed was now much more constant, showing less variation from beginning to end of the reel, but still nearly 5% fast.

However, 5% is just about tolerable, in fact all old films shown on T.V. are projected at 25 fps to suit television standards, although they are of course recorded at 24 fps, a speed increase of 4%. Let it be noted that this speed increase will only show up when tapes recorded at exactly  $3\frac{1}{2}$  i/s are played, and that

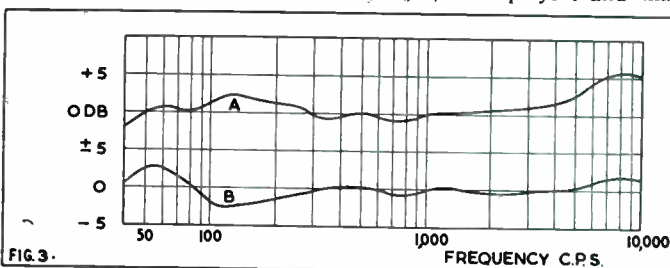

FIG. 3.

### Record/replay response

material recorded on this machine will be on pitch when replayed on the same recorder, but many sound slightly low pitched and slow when played on another instrument.

The specification states wow or flutter as  $\pm 0.2\%$ , i.e. Peak values rather than R.M.S. To convert we multiply by .707 (Assuming sinusoidal wow or flutter) which gives approx. 0.15 R.M.S. The fluttergram of Fig 1 shows that flutter is very low and that wow, at capstan rotation frequency of about 7 c/s, can give total readings varying from .12% to .22% R.M.S. depending on whether the recorded wow is in or out of phase with the replay wow. Although audible on a pure tone, the short term speed variations were not noticeable on music, and, for a machine in this price class may be considered satisfactory.

### Test Tape Measurements

**Playback response:** The playback only response was measured using a 200 microsecond test tape. Fig. 2A shows the voltage across the internal loudspeaker with the tone control fully up,

# GIVE YOUR RECORDER A PRESENT

This Christmas buy your tape recorder a present, and what better choice than a Film Industries microphone. By giving your recorder the chance to work at its full potential you will be delighted at the improvement to your recordings.

## M8 RIBBON MICROPHONE

The M8 is a ribbon microphone of exceptional merit with a frequency response of 35-13,000 c/s  $\pm$  3 dB and is available in all impedances up to 57 K ohms. 12 ft. of screened cable is fitted, other lengths can be supplied on request. In *The Tape Recorder* A. Tutchings wrote of the M8... "this microphone shows evidence of careful design, and the workmanship, technical performance and styling are excellent. It can be thoroughly recommended for studio or semi-professional use, or for home use where the associated equipment can do justice to its very wide range response".

Price £8. 15. 0.

## M7 MOVING COIL MICROPHONE

This popular moving coil microphone has a frequency response of 35-9,000 c/s  $\pm$  3 dB. The source impedance is 20 ohms.

Price £6. 5. 0.

ALSO AVAILABLE: TABLE AND FLOOR STANDS;  
IN-LINE MATCHING TRANSFORMERS.

Write for details:

Tel: HAMPSTEAD 9632

FILM INDUSTRIES LTD. · 90 BELSIZE LANE · LONDON N.W.3



# Lee Electronics

TAPE RECORDER · HI-FI AUDIO SPECIALISTS

400 EDGWARE ROAD PADDINGTON  
LONDON W.2. PADDINGTON 5521

Appointed Agents for the London, W.2 Area

## SONY 521



The beauty of precision...

### Sony STEREOPHONIC TAPE RECORDER MODEL 521

- ★  $7\frac{1}{2}$  +  $3\frac{3}{4}$  tape speed selector
- ★ tape-index indicator
- ★ instant stereo-mono switch
- ★ flat or bass tone control
- ★ automatic cut-off
- ★ additional line outlet
- ★ headphone monitor jack
- ★ instantaneous 2-source recording (mixing) 124 guineas including 2 microphones and all accessories.

YOU ARE CORDIALLY INVITED TO CALL AND HEAR THIS SUPERB INSTRUMENT AT OUR EDGWARE ROAD SHOWROOMS. HOME DEMONSTRATIONS CAN ALSO BE ARRANGED BY APPOINTMENT

## EQUIPMENT REVIEWED—(continued)

solid curve; and with the tone control fully down, dotted curve. Fig. 2B shows the output from the test tape at the low level output socket where the tone control is not operative.

**Record replay responses:** The A and B curves of Fig. 3 show the overall record-replay responses at the L.S. and low level sockets respectively. These curves, in combination with those of fig. 2, seem to show that a recording characteristic of about 150 microseconds has been adopted in conformity with the very latest B.S.I. and Continental deliberations not yet firmly established but showing a trend away from the hitherto recommended C.C.I.R. 200 microsecond response for this speed. Overload recording tests prove that a signal 12dB above test tape level can be increased to plus 14dB before waveform distortion becomes evident. The magic eye beams just close at 11dB above test tape level.

**Signal noise ratio:** This seemed to be the most optimistic part of the technical specification, but the claims are fully met, with unweighted noise and hum 52dB below peak recording level if tape overload and output stage overload are made to almost coincide by proper setting of the gain control. At lower settings of the gain control steady low level hum from the later stages of the amplifier obtrude to give readings nearer 40dB, but objec-

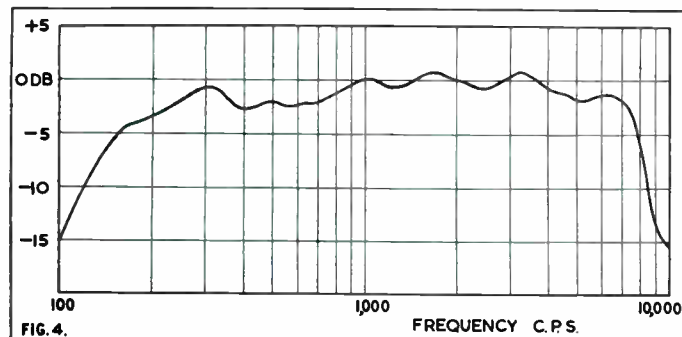

Acoustic Response

tive tests on a wide range extension speaker show really excellent signal to noise ratio. This is in part due to proper biasing of the tape, so that full peak level is recorded without distortion, and very careful shielding of the head together with excellent amplifier design and layout. Even the motor is individually screened by a heavy electromagnetic shield which is open at each end for adequate air cooling.

**Power output:** Electrical overload occurred at a power output of just over 2 watts. Maximum undistorted acoustic power output

★  
GRUNDIG  
GDM 18  
MOVING COIL  
MICROPHONE  
★



was 105 phons at a distance of 12 inches from the speaker fret; this is about average for the combined output stage and loudspeaker efficiency in small table model recorders.

**Acoustic response:** The overall response, including speaker and cabinet, was measured in the usual way by feeding one-third octave bands of filtered white noise into the recorder and measuring the output from the speaker during replay with a calibrated microphone. The response is plotted in Fig. 4 and is seen to be remarkably level over the range 150 c/s to 7,500 c/s.

**Microphone response:** The microphone provided is a good quality moving coil instrument, and the response, measured by the white noise technique, is indicated in Fig. 5. There is some fall

in response below 200 c/s but the complete lack of the usual diaphragm peak at 3 or 4 Kc/s gives very smooth speech quality without the hardness common to some of the cheaper crystal microphones. If, against all expert recommendation, music is

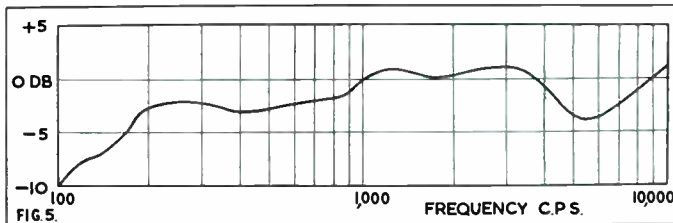

Grundig GDM 18 Microphone Response

recorded via the microphone from the loudspeaker of a radio set or radiogram, it will be found that results with this microphone are quite surprisingly good.

**Comment:** I give full marks for frequency response, both electrical and acoustic, for really excellent signal to noise ratio, and for simple operation and general styling. I reserve two little black marks for mechanical noise and for the slightly high speed. But, for a relatively cheap recorder, I would put it near the top of its class.

A. Tutchings.

### Manufacturer's Comment

The two pole motor used in the construction of the T.K. 14 Recorders must not be excessively loaded in a radial direction since this would adversely affect the speed of the machine. For this reason a drive belt having a triangular cross section has been used which makes contact with the motor pulley over a large area, thereby affording a sufficiently large co-efficient of friction. This arrangement makes fairly high demands, however, on the accuracy of the positioning of the motor pulley in relation to the groove in the flywheel. If the motor pulley is moved in an up or downward direction (the motor pulley is held by a torsion spring on the motor shaft), then the belt will ride on the flanges of the groove, the speed will alter, the drive belt may twist and may even come off the pulley.

This matter has received our closest attention and we are now able to offer round section drive belts, the hardness of which is of a definite figure so as to provide good friction without the need for a very critical alignment of the motor pulley. In all cases where difficulties are encountered as outlined in the review, a round section drive belt is forwarded by us to the Dealer or user concerned. We are also investigating a general changeover from the drive belt having a triangular cross section to one having a round cross section.

Whilst it must be agreed that a two pole motor will always produce more mechanical noise than an outer rotating cage motor, we are making every endeavour to ensure that no machine having a noise level in excess of 47 phons will leave our factory. By comparison, the noise level of the T.K. 20, fitted with a heavy duty outer rotating cage motor has a noise level of 45 phons.

With regard to the comment under "Playback response" we should like to say that it is true that our more recent equalisation networks are approaching N.A.R.T.B. specifications. We feel that the C.C.I.R. specifications do no longer enable the designers of such networks to ensure that the signal to noise ratio of a machine equalised to C.C.I.R. recommendations are as good as they could be. The T.K. 14 makes use of an equalisation which is very close to the N.A.R.T.B. recommendations whilst tapes recorded to C.C.I.R. still do not sound unpleasant.

One additional comment concerns the description of the cabinet which, is stated to be "almost all plastic". This is perhaps, somewhat misleading since the main part of the cabinet is of 19 gauge steel (1 mm), covered with a scrim and a 25 thou plastic band. The main chassis of the T.K. 14 is composed of two U shaped 19 gauge steel strips, one forming the rear half, the other forming the front half of the main body of the machine. The T.K. 14 is therefore extremely solid in this respect although the bottom and the lid are of plastic. This, however, is no ordinary plastic, but of a shatterproof variety and breakages should not occur even if the machine is inadvertently dropped against some hard object.

**FAMOUS BRAND AMERICAN TAPES**  
**FIRST GRADE QUALITY. FITTED WITH LEADER**  
**TAPE AND STOP FOIL.**

**BRAND NEW AND GUARANTEED**

5 in. Std. Play, 600 ft. ....	13/-
5 in. Long Play, 900 ft. ....	16/6
5 in. Double Play, 1,200 ft. ....	32/-
5 1/2 in. Long Play, 1,200 ft. ....	19/6
5 1/2 in. Double Play, 1,800 ft. ....	37/-
7 in. Std. Play, 1,200 ft. ....	21/-
7 in. Long Play, 1,800 ft. ....	28/6
7 in. Double Play, 2,400 ft. ....	47/-

**SYNCHROTAPE BRAND TAPES**

3 in. Long Play, 225 ft. ....	4/9
5 in. Std. Play, 600 ft. ....	12/-
5 in. Long Play, 900 ft. ....	16/-
5 1/2 in. Std. Play, 850 ft. ....	15/6
5 1/2 in. Long Play, 1,200 ft. ....	18/6
7 in. Std. Play, 1,200 ft. ....	19/-
7 in. Long Play, 1,800 ft. ....	27/-

**BRAND NEW AND GUARANTEED**

PLEASE ADD POSTAGE SEND FOR FULL LISTS

**G. W. SMITH & Co. (RADIO) Ltd.**

**3-34 LISLE STREET**  
**LONDON, W.C.2**

Telephone: GERRard 8204/9155

HOURS OF BUSINESS — 9 a.m. - 6 p.m. THURSDAY 9 a.m. - 1 p.m.  
 OPEN ALL DAY SATURDAY

**TAPE RECORDER**  
**COVERS**



Smart, waterproof cover to give complete protection to your tape recorder. Made from rubberised canvas in navy, wine, tan, grey and bottle green with white contrasting pipings, reinforced base, handy zip microphone pocket and name panel.

Philips EL3515 ...	57/6
.. EL3541/15 ...	57/6
Cossor 1602 ...	57/6
.. 1601 ...	63/-
Stella ST455 ...	63/-
.. ST454 ...	57/6
Saja MK 5 ...	57/6
Stuzzi Tricorder ...	58/-
Saba ...	63/-
Wyndson Viscount ...	55/-*
.. Victor ...	60/-*
Elizabethan Princess ...	60/-
.. Avon ...	60/-
.. Escort ...	57/6*
.. Major ...	63/-
.. FT.1 ...	66/-
.. FT.3 ...	†
Fi-Cord ...	52/6
Korting (4 track stereo) ...	63/-
Harting Stereo ...	66/-
Fidelity Argyle ...	55/-*
Walter 101 ...	55/-
Simon SP4 ...	63/-*
Clarion (complete with strap) ...	52/6
Brenell Mk.5 ...	77/-
.. 3 star ...	69/-
Minivox ...	61/-
Robuk RK.3 ...	67/6

**A. BROWN & SONS LTD.**  
 24-28, GEORGE STREET, HULL Tel: 25413, 25412

**FREE**

**ROBUK**  
**TAPE RECORDER**  
**FUN BOOK**



**36**  
**GNS**

**Robuk RK3 THREE-SPEED TAPE RECORDER**

The most exciting tape recorder value ever offered at 36 gns., the Robuk RK3 has 7" spools—8 hrs. playing time plus 3 speeds. Separate input and gain controls for gram. and mic., separate on/off switch, tone and volume controls, and many more unique items. Send for Robuk's FREE FUN BOOK which lists fascinating games and hobbies, and tells you all about the Fabulous RK3!

**SEE THE ROBUK RK3 ON TV ADVERTISING MAGAZINES THROUGHOUT THE COUNTRY**

To: ROBUK ELECTRICAL INDUSTRIES LTD.  
 559-561 Holloway Road, London, N.19

Please send the Robuk Fun Book and full details of the RK3.

Name .....

Address .....

TR3



**Now... you can order**  
**direct from Hi-Fi News**

**AUDIO**



**Read the original magazine about high fidelity every month. Use convenient order form.**

**Hi-Fi News**  
**99 Mortimer Street**  
**London, W.1., England**

I enclose 35/- for a 1 year subscription to AUDIO which is to be mailed post-free from the U. S. (Please print or type name and address)

Name .....

Address .....

## EQUIPMENT REVIEWED—(continued)

### Gevasonor Tape

MANY years ago I sat on a committee whose job it was to write a specification of the ideal recording tape. To-day, nearly a decade later, I still find it extremely difficult to put anything on paper which really ties down the performance of a given tape. In the June issue of this magazine when reviewing Zonatape I fell back on the old standby of using the "Brand X" comparison technique where certain easily measured characteristics of the review tape were compared with those of two British made tapes and one typical Continental tape. The characteristics measured were: Optimum bias, defined as the bias which results in maximum output at 1Kc/s when the input signal is maintained constant; input signal with optimum bias to place a standard level on the tape, this level is 10 gauss, or 10 lines per sq. cm., at 1Kc/s at a tape speed of  $7\frac{1}{2}$  i/s; and finally overload, defined as the number of dB's above standard recording level where the 3rd harmonic distortion reaches 5 per cent. These measurements have been adopted because they should form part of the setting up procedure for all domestic recorders, and are included in my testing sequence when reviewing such units.

### Extended and Double Play Tapes

Two Gevasonor tapes were submitted for review: an extended play tape, and a double play tape. Both use a tensilized polyester base, approx. 1 thou. thick for the E.P., and .5 thou. for the D.P. As is usual with the thinner tapes the oxide thickness is also slightly less than the equivalent standard play tape. The softer limper base also reduces the so called spacing loss, as the oxide can make more intimate contact with the recording head pole pieces. The tables show that there is an

Tape	Signal	Bias	Overload	
A	3.0	3.5	+15dB	} These tapes were tested for June Zonatape review.
B	3.7	3.5	+14dB	
C	4.5	4.0	+14dB	
Z	4.1	3.5	+13dB	
G.E.P.	4.25	4.0	+12dB	
G.D.P.	4.0	3.7	+12dB	Gevasonor Double Play.

Freq.	DB			
	A	B	C	Z
10.0 Kc/s	-3.0	-2.4	-0.4	-1.3
7.5 ..	-0.25	0	+1.0	+1.1
5.0 ..	0	+0.8	+1.0	+1.2
3.0 ..	-0.4	+0.6	+0.4	+0.7
2.0 ..	-0.4	0	0	+0.2
1.0 ..	0	0	0	0
500 c/s	+0.6	0	+0.4	+0.3
250 ..	+0.6	0	+0.5	+0.3
120 ..	0	-0.7	0	-0.2
60 ..	-2.0	-2.0	-1.7	-1.7
40 ..	-4.0	-4.0	-3.8	-4.0

appreciable improvement in high note response under our standard test conditions. I hasten to add that this improvement is not exclusive to these review tapes but is common to all thin tapes. Naturally we have to pay something for this improvement, and the price is a small reduction of overload level as the volume of oxide per unit length is less and it cannot store quite so much magnetic energy. The higher bias and signal level for the review samples also shows that the coercivity or magnetic stiffness of the oxide is higher, and this is in line with the other Continental tape tested (C). Thus the high note improvement is due to three reasons: thinner oxide, higher coercivity oxide, reduction of spacing loss due to thinner and limper base. These tapes can therefore be recommended for use with recorders which are known to be adequately biased, and

## THE IDEAL GIFTS



## FOR ALL TAPE ENTHUSIASTS

### THE METRO-SOUND RANGE OF TAPE RECORDER ACCESSORIES

- KLENZATAPE**—for cleaning Tape Recorder Heads Complete kit, 12/6d. Fluid Refills, 3/11d.
- METRO-SPLICER**—for both Recording Tape and 8 mm. Cine-Film—Complete with Film Emulsion Scraper and spare Cutting Unit, 15/-. Spare Scrapers, 1/-. Spare Cutting Units 2/6d.
- The Original METRO-TABS**—for making positive identification of Recordings AT A GLANCE—3/11d. complete with Index.
- Tape Deck Cleaning Brush**—made from specially shaped feather-soft non-scratch Nylon, 2/6d. each.

*The above items now complete with many spares in the*

**METRO-SOUND TAPE ACCESSORIES SET** lavishly mounted and luxuriously packaged for only £2 2s. 0d. (Normal Total Retail Value £2 4s. 9d.).

*Sole Manufacturers:*

**The METRO-SOUND Mfg. Co. Ltd.**  
19a Buckingham Road, London, N.1. (CLIssold 8506/7)

## Listen and Learn

with

## TEACH-U-TAPES

on SHORTHAND SPEED TRAINING,  
SPEAKING IN PUBLIC, TAPE  
RECORDING, INSOMNIA,  
SALESMANSHIP,  
SELF-UNDERSTANDING.

**35/- each**

(3 $\frac{1}{2}$  i/s Twin-track)

*Just complete the slip below and send to:-*

**KLP FILM SERVICES LTD.**  
3 Queens Crescent, Richmond, Surrey  
(Mail orders only)

Please send me full details of 'Teach-U-Tapes.'

Name.....  
(BLOCK CAPITALS PLEASE)

Address.....

(Ref. TR12)

# FREE H.P!

**YOU PAY CASH  
PRICE ONLY—NO  
INTEREST CHARGES**



**WE HAVE THE BIGGEST SALES IN THE COUNTRY! WHY?  
BECAUSE WE GUARANTEE YOU THE BEST TERMS.**

*They include:*

DEPOSITS FROM ONLY 10% ★ 2 YEARS TO PAY ★ SPECIAL FREE OFFERS ★  
12 MONTHS FREE SERVICING NO LABOUR CHARGES ★ FREE DELIVERY ANY-  
WHERE IN UK. ★ NO PURCHASE TAX ★ CHEAP SECOND-HAND MACHINES  
★ COMMISSION PAID ON SALES YOU MAKE FOR US ★ 10% INTEREST PAID  
ON YOUR DEPOSIT ★ SPECIAL CUSTOMER DISCOUNTS ★ *and lots more besides.*

As Main Agents for ALL the best makes, our Mail Order Department specialises in orders by post with thousands of sales throughout the whole of England, Scotland, Wales & N. Ireland—order from us wherever you live—You get cheaper terms, faster delivery, better service from us.

Nearly 500 machines in stock—dozens of different mains, battery & stereo models—both new & second-hand—on permanent demonstration in our showrooms.

If you want proof of how you can actually save money by buying from us, write, phone or call in NOW for free brochures and full details of our terms:

**OPEN TO  
8 PM FRIDAY NIGHT**

**HOWARD  
TAPE RECORDERS**

—cut off here and post this coupon to us NOW—

PLEASE RUSH ME FREE BROCHURES AND FULL DETAILS OF YOUR TERMS:

Name .....

Address .....

ER/D

NAME BELOW ANY MODELS YOU ARE PARTICULARLY INTERESTED IN:

218 HIGH STREET, BROMLEY, KENT. RAVensbourne 4477 & 4000

where an improvement in extreme top response is desired particularly at low tape speeds where the recorded wavelengths are very short.

In order not to complicate the tables I have not so far mentioned another variable which is quite well known to tape manufacturers and testing laboratories but which makes the precise definition of frequency response even more difficult; this is the "directional effect" where the frequency response

	Forward		Backward	
	G.E.P.	G.D.P.	G.E.P.	G.D.P.
10.0 Kc/s	-0.8	+1.2	+0.2	+2.6
7.5 "	+1.7	+3.0	+2.6	+4.4
5.0 "	+2.0	+3.0	+2.6	+3.8
3.0 "	+1.2	+1.5	+1.2	+2.0
2.0 "	+0.4	+0.5	+0.5	+0.5
1.0 "	0	0	0	0
500 c/s	0	0	0	0
250 "	+0.2	+0.2	+0.2	+0.2
120 "	-0.4	-0.4	-0.4	-0.4
60 "	-2.0	-2.0	-2.0	-2.0
40 "	-4.4	-4.4	-4.4	-4.4

depends on the direction of the tape over the heads. The figures in the main table are for track 1, i.e. the tape is being unwound from the spool on which it is supplied; the test figures shown in the lower table are for track 2 where the tape is being wound in the other direction on to its own reel! This occurs on tapes using acicular or long needle-shaped particles which are oriented along the length of the tape to improve the magnetic characteristics, but where the particles do not lie parallel to the oxide surface but are tilted slightly so that one end is slightly nearer the surface than the other. I believe the same effect can also take place when crystal rather than shape anisotropy (favoured direction of magnetisation) is used. All this underlines the fact that tape is not as simple as it looks, and no two reels of tape are identical in every respect, not even samples from the same production run! So pity the poor reviewer who is expected to say "this is a good tape" or "this is a bad tape". The answer is very often "it all depends" on your recorder, what you want to use it for, which characteristic of the tape is most important for your particular application, etc. Nevertheless, I have used tapes on a variety of recorders and programme material, listening very carefully for faults which are not amenable to objective measurement, such as "drop outs", under signal noise, and intermodulation, and all I can say is that "they sound jolly good" and perhaps, after all, that is all that really matters.

#### A. Tutchings

**Manufacturer's Comment.** We would like to point out that the outstanding high frequency response of the Gevasonor tapes is not only due to the three reasons given. It is also due to the highly polished oxide surface which also reduces head wear.

The review of the Reslo PRL Microphone published in the November issue was sent to the manufacturers for comment. This was received too late, and is printed below.

#### Manufacturer's Comment

We are endeavouring to achieve an average production performance of  $\pm 2$  dB over the range 70 c/s to 12 Kc/s, i.e. similar to the RB Series microphones.

The unit reviewed last month was a pre-production sample and it would seem from the test results to be somewhat below the standard we are aiming at. Greatly-improved facilities will be available at our works very soon now, enabling us to maintain a very high standard of performance with greatly-increased production.

If a true bi-directional performance is required the foam damping pads fitted can be readily removed. The red Reslo label is fitted on the ribbon side of the microphone and for all normal recording or sound reinforcement use, where the sound source will be at least 12 in. away from the microphone, this side should be regarded as the front. For intimate style singing or crooning, with the mouth only an inch or so from the case, the plain side should be regarded as the "front" and the red label side as the rear.

## — YOUR TAPE DEALER —

Specialists in Hi-Fi Equipment and Tape Recorders

### CHELSEA RECORD CENTRE

203 KINGS ROAD, S.W.3 FLA 2596

Open till 8 p.m. (except Thursdays)

Disc and Tape Reproducing Equipment and Tape Recorders  
by Leading Manufacturers

CUSTOM BUILT INSTALLATIONS

All High Fidelity Requirements and Services Available

Estimates Free

Personal Service

### Custom High Fidelity

371 Green Lanes, Palmers Green, London, N.13

Tel. PALmers Green 5228



ALL LEADING MAKES IN STOCK

Cash or Easy Terms

LONDON'S FINEST SERVICE

207 EDGWARE ROAD, W.2

PAD 3271/2

42 TOTTENHAM COURT ROAD, W.1 MUS 2605

LEONARD G. FRANCIS PRESENTS . . .

### SHEEN TAPE RECORDER CENTRE LTD.

SPECIALISTS IN TAPE RECORDERS AND ACCESSORIES, ETC.,

YOUR CENTRE FOR FRIENDLY HELP—SALES AND SERVICE

8 STATION PARADE,  
SHEEN LANE, SHEEN,  
LONDON, S.W.14

Showrooms Open until 7 p.m.

PROSPECT 0985

(Next to Mortlake Station S.R.)

## — Country and Provincial —

BOURNEMOUTH

### NATIONAL RADIO SUPPLIES

66 Holdenhurst Road,

Bournemouth

Tape, Hi-Fi & components

Tel. 25232

H. D. KIRK

*Stereolectrics*  
LIMITED

Specialists in High Fidelity  
150 HIGHER BRIDGE STREET

Phone: 23093

BOLTON

### CANTERBURY

FERROGRAPH—REFLECTOGRAPH  
FI-CORD — SIMON — PHILIPS ETC.  
TAPES ALWAYS IN STOCK ACCESSORIES

GOULDENS, 36, High Street.

Telephone: 4034

R.E.S. (COVENTRY) LTD.

### SPECIALISTS IN HIGH FIDELITY and all makes of Tape Recorders

All leading makes of High Fidelity Equipment stocked and demonstrated under ideal conditions. ★ *The Best Selection—Terms and After Sales Service in the MIDLANDS.*

R.E.S. (Coventry) Ltd. 128 Far Gosford St.

Coventry 28781/2

## — YOUR TAPE DEALER —

### CROYDON, SURREY

Stockists of Grundig and all makes of tape recorders, tapes and accessories. Specialists in tape synchronised with cine projectors

**CROYDON CINE EXCHANGE LTD.**  
48 SOUTH END, CROYDON  
Telephone: Croydon 0236

### EXETER—DEVON

**FILDEWS** • 99 FORE STREET  
EXETER  
PHONE: 74161/2

We cover the whole of Devon—Dorset—Cornwall and West Somerset with Tandberg—Brenell—Phillips—Grundig, Tape Recorders etc. Main Ferrograph distributors for area.

### FARNHAM, SURREY

- ★ Stockists of all the leading makes of High-Fidelity Equipment
- ★ Comparative Demonstrations
- ★ Cabinet Manufacturers and Designers
- ★ Personal service and satisfaction guaranteed
- ★ Specialists in custom-built Hi-Fi Equipment

**LLOYD & KEYWORTH LTD, The Record Shop**  
26/7 Downing Street, Farnham, Surrey. Telephone: Farnham 5534  
SURREY AND HAMPSHIRE'S HI-FI DEALERS

## Tape Recorder Centre (Halifax)

Yorkshire's Leading Tape Recorder Specialists

Comparative Demonstrations Daily • Official Telefunken Service Agents  
Hi-Fi Stockists

**SOUND INSTALLATIONS**

30 King Cross Street, Halifax Phone: Halifax 66832

### LEICESTER

#### ALL YOUR HI FI REQUIREMENTS

Speakers by:	H.M.V.	QUAD	LEAK	ROGERS	
	TANNOY	MORDAUNT	LOWTHER	W.B.	
	WHARFEDALE	GOODMANS.			
Tape:	FERROGRAPH	REFLECTOGRAPH	GRUNDIG		
	SIMON	BRENELL.			

Record Department: ALL LABELS-PARASTAT SERVICE.

LEICESTER CO-OPERATIVE SOCIETY LIMITED, High Street, Leicester. Tel: 20431

### MANCHESTER

See the sound SPECIALISTS for your New Tape Recorder.

Stockists of **FERROGRAPH, PHILIPS, BRENELL, GRUNDIG** and other well-known makes

**LANCASHIRE HI-FI LTD.**

Home Music Centre — 8 DEANS GATE  
(near Grosvenor Hotel) **MANCHESTER**

**WESTWOOD'S** of **OXFORD**  
46 GEORGE STREET  
PHONE: 47783

### PETERBOROUGH, NORTHANTS

Tel: 5545

## CAMPKINS RECORD SHOP

RECORD TAPE AND HI-FI EQUIPMENT SPECIALISTS

NEW ADDRESS

**15 LONG CAUSEWAY**  
(IN CITY CENTRE)

LARGE STOCKS

## CLASSIFIED ADVERTISEMENTS

Advertisements for this section must be pre-paid and accompanied by a postal order, money order, or cheque. The rate is 6d. per word with a minimum charge of 7/6d. Box numbers may be used for an extra charge of 1/6d. The trade rate is 9d. per word, plus 2s. for a box number, conditions on application. Send replies to box numbers c/o "The Tape Recorder", 99 Mortimer Street, London, W.1.

All advertisements for the January issue must arrive not later than November 28th.

### For Sale

**Pre-recorded tapes.** Unique complete catalogue listing all makes, mono, stereo, 7½ and 3½ i/s including World Record Club tapes. Call for free copy or send 1s. mailing fee. Dept T.R.3 Teletape Ltd., 33 Edgware Road, W.2. PAD 1942.

**Accessories for your Ferrograph recorder.** The "Numix" and "Monitor" units, write for lists, tel' or call.—Nusound Recording Co., 35 Craven Street, Trafalgar Square, W.C.2. Tel.: TRA 2080.

**Tape/Disc/Tape transfer, editing, duplicating.** If quality and durability matter (especially with LP's from your precious tapes) consult Britain's oldest transfer service. (LP's from 16s.). Limited quantity 1,800 ft. American branded LP tapes 35s. Sound News, 10, Clifford Street, London, W.1.

**Recording Tape.** Save up to 30%. Send for list. Also 50 second-hand Recorders in stock. E. C. Kingsley & Co., 132 Tottenham Court Road, London, W.1. EUS 6500.

Now ready **Bound edition of Volume 2 Tape Recorder.** Handsomely bound in black huckram, hand stitched. Price 46s. each post free from The Tape Recorder, 99, Mortimer Street, London, W.1.

**Ask your dealer for American Ferrodynamics "Brand Five" recording tapes.** The best tape value!

**Hi-Fi for you:** Amplifiers, recorders, mixers, etc. Built to your own requirements. Fully guaranteed. Estimates free.—Harmel Electric, 81 Ram Gorse, Harlow, Essex. Tel.: Harlow 25589.

**Tape splicing is easy and accurate with Easysplice Tape Splicer 5s.** patented, guaranteed. Over 6,000 sold.—Easysplice, 30 Lawrence Road, Ealing.

**Recording Tape.** See my advertisement on page 538. Nobody has yet asked for his money back.—Villiers.

**Repairs and modernising of Tape and Gram equipment.** New heads. Amplifiers etc. fitted by Experts. Prompt service. Specialised Hi-Fi equipment built to order for private or Studio use.—Harding Electronics, 120a Mora Road, London, N.W.2. GLA 1770.

**Ferrograph 2/AN converted to 3/AN.** Excellent condition, regularly maintained, case slightly marked £53. No offers. Box (London) 286.

**"Brand Five" American Tape.** Standard Play 5 in. (600 feet) 16s., Long Play 5 in. (900 feet) 18s. 6d.; 5½ in. (1,200 feet) 23s. 6d.; 7 in. (1,800 feet) 35s. Sent by return. Post Free!—Watts Radio, 54 Church Street, Weybridge, Surrey.

**Exciting news from NRS!** Revolutionary new "Symphony" Automatic Tape Recorder makes its debut this month! Unique in the whole world, opens up new vistas of enjoyment from tape recording. Stuzzi Radio tuner adds radio to above for only £5 9s. 6d. Details from Northern Radio Services (Dept. T.R.) 16 King's College Road, London, N.W.3. Tel.: PRIMROSE 3314.

**Secondhand recorders—**Grundig Cub £12 10s. Ferrograph 2A/H, £39 10s. Vortexion WVB. £50. Grundig TK5, £19 10s. TK20, £25. TK25, £27 10s. TK820, £37 10s. Brenell Mk. 3, £20. Stuzzi, £27 10s. E.M.I. L2b, £30. Philips Minor, £15. E.M.I. Disc cutter, £25. Many others of all types. Magnagraph, 1 Hanway Place, London, W.1. LAN 2156.

**Last few pre-recorded tapes for sale at 33½ to 60% below cost price.** All new and unused, mainly in manufacturers' boxes. One Telefunken KL 85 recorder, few months old and in perfect condition, £50 or v.n.o. original cost 83gns. M. M. McKay, Pinjarra, Pinewood Grove, Weybridge, Surrey.

**Ferrograph 88 stereo 7½/15 in. series 4 deck.** Mint condition. 10 reels tape, spare set valves, test tape, £65. TR 90 case £2. K. Attwood, 29a Mount Nod Road, Streatham, S.W.16.



# Two Years Guarantee

NOT MASS PRODUCED BUT VIRTUALLY HAND-MADE FOR RELIABILITY AND CONSISTENTLY HIGH STANDARD OF PERFORMANCE

**R10 SPECIFICATION: 2 or 4 track version. 10 watts push/pull output.**

Record Replay Responses—

7½ ips. 40–16,000 C.P.S. } ± 3 dBs.  
 3 ips. 40–10,000 C.P.S. } At optimum  
 1½ ips. 50– 6,000 C.P.S. } bias setting.

Signal/Noise ratio—

half track 50 dBs at 3¾ ips.  
 quarter track 45 dBs at 3¾ ips.

Modified Collaro Studio Deck. Microphone and Radio/Gram inputs each with separate gain controls for mixing. Separate bass and treble controls. ± 12 dBs at 50 cycles and 12 k/cs. Adjustable monitor volume control independent of record level. Peak signal lever meter 2¼ in. square. Bogen heads. Record safety device. 600 ohms Cathode follower output. Two per cent total harmonic distortion on peaks. 200/250 volts 50 cycles or 100/120 volts 60 cycles. Valve line up: 3 EF86, 2 ECC83, 1 ECC82, 2 ECL86. Metal rectifier, contact cooled.

Prices: 2 Track 7" spools ... .. 59 gns.  
 4 Track 7" spools ... .. 69 gns.



Fully illustrated literature available on request to—

**REPS (TAPE RECORDERS) LTD.**  
 118 Park Road North, South Acton,  
 London, W.3 Phone: Acorn 4141

## SOUTH LONDON TAPE RECORDING AND HI-FI CENTRE

RENOWNED

### PART EXCHANGE SPECIALISTS

and appointed agents for:

FERROGRAPH 4AN ... ..	81 gns.	SONY STEREO 521 ... ..	124 gns.
FERROGRAPH 422U ... ..	110 gns.	TANDBERG Series ... ..	110 gns.
FERROGRAPH 808 ... ..	105 gns.	BRENELL MK 5 ... ..	64 gns.
REFLECTOGRAPH "A" ... ..	105 gns.	PHILIPS STEREO ... ..	92 gns.
VORTEXION WVA ... ..	£93.13.0	TRUVOX R7 ... ..	82 gns.
BRENELL MK 5 "M" ... ..	89 gns.	SIMON SP5 ... ..	93 gns.
		REPS R10 ... ..	59 gns.

If you have outgrown your present tape recorder or hi-fi equipment and would like to own a more advanced machine, as used by professionals and serious tape recorder enthusiasts, contact us today for a free quotation.

We have thousands of satisfied customers throughout the British Isles. We also hold a large stock shop-soiled and second-hand machines at bargain prices. Ask for list.

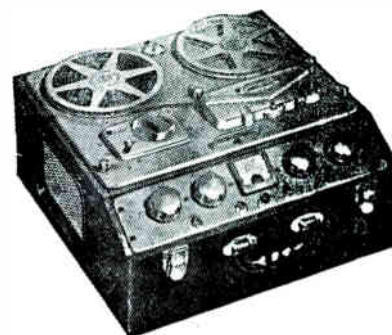

FERROGRAPH 4AN, 81 gns.

Also in Stock:—

TRANSISTOR-BATTERY  
 Grundig TK1 ... 29 gns.  
 Minivox B ... 23 gns.  
 Butoba MT5 ... 69 gns.  
 Philips EL3585 ... 24 gns.  
 Stuzzi ... 59 gns.

Tuners  
 Amplifiers  
 Microphones  
 Transcription Units  
 Speakers  
 Pick-ups

### THE BEST NO INTEREST TERMS

20% DEPOSIT  
 BALANCE  
 12 MONTHS

18-24 MONTHS  
 TERMS  
 AVAILABLE

FREE SERVICING—FREE DELIVERY—FREE TAPE OFFERS—200 MACHINES ON DISPLAY—OUR MAIL ORDER DEPARTMENT WILL DEAL WITH YOUR ENQUIRY BY RETURN. WRITE—PHONE—CALL FOR A QUOTATION ON YOUR MACHINE. A LARGE SELECTION OF USED TAPE RECORDERS. TELEPHONE: BALHAM 7710

**REW**

EARLSFIELD LTD. 266 UPPER TOOTING ROAD, LONDON, S.W.17  
 100 yards from Tooting Broadway underground station: Opposite Tooting Market

For Sale—(continued)

**American recording tape** new, boxed, long play tape, 1800 ft. on 7 in. 27s., lots of 4 £5, 900 ft. on 5 in. 16s., lots of 4 £3. Satisfaction guaranteed and post free. Empty reels available. J. L. Darvell, 31 Hamilton Crescent, London, N.13.

**Lowther Acousta Twin** stereo speaker enclosure, superb instrument. As new condition £90 o.n.o. Mather, Pine Hill House, Easebourne, Near Midhurst, Sussex. Tel.: Fernhurst 328.

**Amplex Model 2560 Stereo System.** Consists of model 960 recorder and a pair of 2010 amplifier/speakers, also together with its 2 dynamic microphones and monitoring head set. 7 months old. Cost new £401 4s. 6d., asking only £275. All the above are as new. Write A. S. Mackenzie-Low, Millfield, Old Town, Bexhill-on-Sea, Sussex. Phone Bexhill 3922.

**Recording Tape** 1200 ft. PVC 15s. 600 ft. 9s. R/Guarantee. P/P 1s. per spool. N. Walker, 28 Linkcroft Avenue, Ashford, Middx.

**Reflectograph model 570** stereo, exceptional condition, offers over £100; also Ferguson stereo radiogram model 602 RG, offers over £50. ALB 2380 Mr. Andrews.

**Ferrograph 3A/H.** Excellent condition, with Bib splicer and carrying case. £70. Lewis, 14 Kyveilog Street, Cardiff.

**Stuzzi Magnette** two speed portable also Telefunken KL 75, with microphones. Overhauled makers perfect. £25 each. Box No. (Birmingham) 287.

**"Eroica" Recording studios** (Established 1949). This studio has advanced in step with all the major developments in Sound Recording in the past twelve years and our experience is at your service. We supply reliable mains and battery tape recorders for all purposes: microphones, tuners, speakers, tape, etc. See and hear our Stereo Recordings on the Ferrograph 422. New issue of Fairground Organs on L.P. due shortly: hear our latest brass recordings in the new Paxton release (Liszt, Brahms, Smetana etc.) Studio (Steinway piano, Electronic organ). Mobile recording and tape/disc service giving the very best from your tapes, including music editing. By dealing with a working studio which currently serves the needs of medical and physical research, radio astronomy, industry, music and speech training, broadcasting and TV, you will benefit by the latest and best ideas in sound recording. Eroica Studios, Peel Street, Eccles Manchester, ECCles 1624. Studio Director: Thurlow Smith A.R.M.C.M.

Miscellaneous

**Reeves Sound Service.** The Midlands foremost service specialists, repairs and overhauls to all makes of tape and audio equipment. Retain the value of your instruments by placing your repairs in our hands, we are service agents to Government Departments and leading Manufacturers. Over 14 years of audio specialising guarantees satisfaction at reasonable cost. Trade service enquiries welcome.—416 Moseley Road, Birmingham, 12. Telephone Calthorpe 2554.

**All makes of tape recorders repaired or modified.** Miniflux heads supplied. Audio installations built to your specification by John C. Latham, Deimos Ltd., 8 Corwell Lane, Hillingdon, Middx.

**L. Bishop Ltd., Tape Recorder Services,** 1708 Bristol Road South, Rednal, Birmingham. Telephone Rubery 709. Grundig Specialists.

Tape to Disc

**Tapes? Transfer? Consult Sound News** for better rates. See above.

**Tape to Disc service,** editing, and dubbing, all speeds. Studio available for musical groups. Outside recordings our speciality. Ilford Sound Recording Service, 63, Aintree Crescent, Barkingside, Ilford, Esscx. Telephone: CRE 8947.

**Quality Service,** quantity discount, printed labels/covers. Audio equipment supplied: callers welcome. MJB Transcription Service, 7, High Street, Maidenhead. Tel.: 230.

**Tape to disc. Adanac Recordings,** send a personal Christmas message this year. Records from 12s. 6d.—E. H. Jackson, 36 Bannatyne Street, Lanark, Scotland.

**Tape to disc recording service.** All speeds. Photographic sleeves with all recordings. Details from E.R.S., 162 Shirland Road. London. W.9.

Personal

**S.O.S.** Anyone in contact with Mr. Frank Barrett, Quebec, Canada, please contact Mr. P. Stewart, 22 Coronation Grove, Swaffham, Norfolk.

**Free Gift** to every 100th member of "Worldwide Tapetalk". S.A.E. for particulars, 35 The Gardens, Harrow.

— YOUR TAPE DEALER —

**HAMILTON ELECTRONICS**  
HIGH FIDELITY  
TAPE RECORDERS 35 LONDON ROAD  
SOUTHAMPTON  
TEL. 28622

SOUTHAMPTON—SALISBURY

- ★ All the best makes of Tape Recorders
- ★ Hi-Fi Systems and Records
- ★ Expert knowledge and advice

The West of England High Fidelity Specialists

**J. F. SUTTON** 421 SHIRLEY ROAD, SOUTHAMPTON  
15-18 QUEEN STREET, SALISBURY

WORTHING, SUSSEX

We stock Hi-Fi Equipment by Leak, Quad, Goodsell, RCA, Acos, Garrard, Collaro, Tannoy, Wharfedale and Goodman and give fully comparative Demonstrations

**BOWER & WILKINS LTD.**  
1 Becket Bldgs., Littlehampton Road Worthing 5142

ADVERTISERS' INDEX

	Page
B.A.S.F. Chemicals Ltd. ....	552
Brenell Engineering Co. Ltd. ....	530
British Ferrograph Recorder Co. Ltd. ....	520
A. Brown & Sons Ltd. ....	544
City & Essex Tape Recorder Centres ....	503
Cosmocord Ltd. ....	532
Educational Recordings Ltd. ....	540
E.M.I. Ltd.—Sales & Service Ltd. ....	512
Elstone Electronics Ltd. ....	528-551
Film Industries Ltd. ....	542
Francis of Streatham ....	534
Gramplan Reproducers Ltd. ....	534
Grundig (G.B.) Ltd. ....	507
Heathkit ....	504
Howard Tape Recorders ....	546
Ilford Sound Recording Studios ....	539
K.L.P. Film Services Ltd. ....	545
Lee Products (G.B.) Ltd. ....	502
Lee Electronics ....	542
Magnagraph ....	537
Metro-Sound Manufacturing Co. Ltd. ....	545
Multicore Solders Ltd. ....	540
Nusound Recording Co. ....	525-540
Philips Electrical Ltd. ....	522
R. E. W. Earlsfield Ltd. ....	549
Rapid Recording Service ....	523
The Recorder Co. ....	551
Reps Tape Recorders Ltd. ....	549
Robuk Electrical Industries Ltd. ....	544
Saga Sound ....	518
Shure Electronics Ltd. ....	510
G. W. Smith & Co. (Radio) Ltd. ....	544
Tape Recorder Centre Ltd. ....	506
Valradio Ltd. ....	540
D. Villiers ....	538
Wharfedale Wireless Works Ltd. ....	538
World Record Club ....	508-509
Wyndson Recorder Co. ....	505
Zonal (Magnetic Coatings) Ltd....	524

PLEASE MENTION "THE TAPE RECORDER" WHEN REPLYING TO ADVERTISERS

# THE NEW Tandberg TAPE RECORDER model 3B

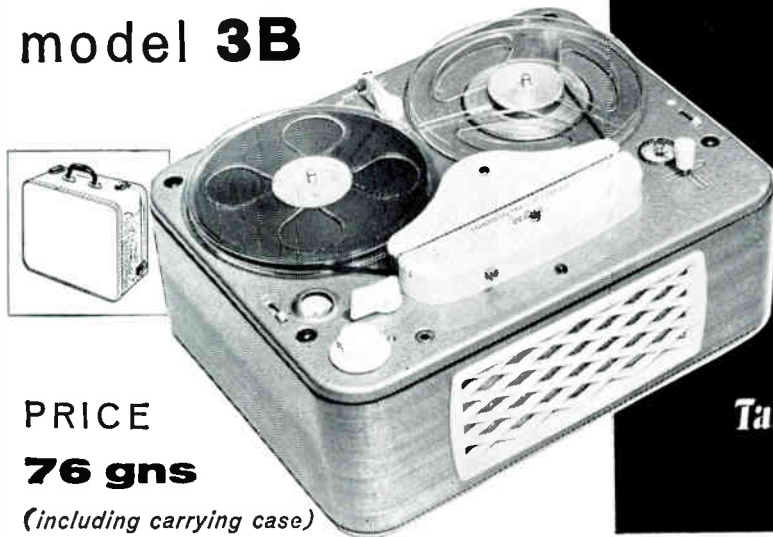

**PRICE**  
**76 gns**  
(including carrying case)

*the name that fulfils the promise  
of the most superb recording  
now offers you an outstanding  
2 track monaural portable*

2 tracks 7" reels  
3 speeds  $7\frac{1}{2}$  -  $3\frac{3}{4}$  -  $1\frac{7}{8}$   
3 watts output  
5" x 7" speaker  
Instant stop - Bass lift

*Also available :*

Model 6 Stereo Tape Deck.  
4 tracks - 3 speeds - 3 heads.  
Booklet of reviews on request.

**Price 110 gns.**

**Tandberg GB** ELSTONE ELECTRONICS LIMITED,  
Edward St., Templar St., Leeds 2.  
Telephone: Leeds 3-5111 (7 lines)

## 9 Months to Pay

	Deposit £ s. d.	9 Monthly Payments £ s. d.	Cash Gns.
<b>MAINS TWIN-TRACK</b>			
Argyll Minor ...	2 6 3	2 6 3	22
Wyndson Heron ...	2 15 0	2 12 3	25
Grundig TK14 ...	3 13 6	3 13 6	35
Elizabethan TT3 ...	4 2 0	4 1 11	39
Victor ...	4 2 0	4 1 11	39
Allegro ...	4 8 6	4 8 2	42
Spectone "161" ...	5 2 11	5 2 11	49
Telefunken 95 ...	6 3 11	6 3 11	59

<b>4-TRACK</b>			
Stuzzi ...	2 16 6	2 14 6	26
Argyll 4-T ...	3 4 0	3 4 0	29½
Elizabethan FT1 ...	3 11 5	3 11 5	34
Philips EL3541 ...	3 11 5	3 11 5	34
Stella ST 454 ...	3 17 9	3 17 9	37
Sound ...	4 15 0	4 14 6	45
Elizabethan FT3 ...	4 15 0	4 14 6	45

<b>BATTERY</b>			
Clarion Mk. 1 ...	1 19 11	1 19 11	19
Minivox "C" ...	2 8 4	2 8 4	23
Philips EL3585 ...	2 10 5	2 10 5	24
Clarion Mk. 2 ...	2 16 9	2 16 9	27
Grundig TK1 ...	3 1 0	3 0 11	29
Ficord IA ...	6 3 11	6 3 11	59
Stuzzi Magnette ...	6 3 11	6 3 11	59
Butaba MT5 ...	6 18 8	6 18 8	66

## It all depends on YOU

**THE** best recorder for **YOU** may not suit Smith, Brown or Jones, but **WE** can offer you a range of nearly 50 different types and the benefit of seven years experience to help you choose.

Having tested them all, there are very few questions about tape recorders that we cannot answer—including how to pay in the easy way, without interest charges.



★ **FREE INSURANCE COVERING YOUR PAYMENTS  
IN THE EVENT OF SICKNESS OR UNEMPLOYMENT**

★ **FREE DELIVERY**      ★ **PART EXCHANGES**

## 18 Months to Pay

	Deposit £ s. d.	18 Monthly Payments £ s. d.	Cash Gns.
<b>MAINS 2-TRACK</b>			
Telefunken 75/15 ...	9 18 0	2 5 6	47
Brenell 3 Star ...	12 4 0	2 14 0	58
Brenell Mk. 5 ...	14 4 0	2 18 11	64
Elizabethan Major ...	14 5 0	3 0 0	65
Grundig TK35 ...	15 15 0	3 10 0	75
Truvox R7 ...	15 15 0	3 10 0	75
Telefunken 85KL ...	17 19 0	3 12 3	79
Ferrograph 4A/N ...	18 1 0	3 14 6	81
Brenell 5 Type "M" ...	18 10 0	4 2 2	88
Simon SP/4 ...	20 0 0	4 8 8	95
Reflectograph "A" ...	22 5 0	4 17 6	105

<b>4-TRACK MONAURAL</b>			
Wyndson Victor ...	10 9 0	2 5 7	49
Grundig TK24 ...	11 11 0	2 11 4	55
Telefunken 76 ...	12 7 0	2 12 10	57
Brenell 3 Star ...	12 4 0	2 14 2	58
Philips EL3542 ...	12 8 0	2 15 1	59
Stella ST455 ...	12 8 0	2 15 1	59
Truvox R84 ...	12 8 0	2 15 1	59

<b>4-TRACK STEREO/MONAURAL</b>			
Korting MT 157 ...	17 17 0	3 19 4	85
Telefunken 77K ...	17 17 0	3 19 4	85
Harting H.M.8 ...	18 6 0	4 0 0	86
Philips EL3536 ...	19 12 0	4 5 7	92

Open all day Saturday—  
Friday 6.30 p.m.

# THE RECORDER CO.

If unable to call, write for free brochure or send deposit now for quick delivery.

(Dept. R) 188, WEST END LANE, WEST HAMPSTEAD, LONDON, N.W.6.

Telephone: SWI 4977



# MIRROR FINISH FOR ALL BASF TAPES

Authentic Sound takes on an even finer note. The new specially treated, mirror-smooth magnetic coating is now available on **all** BASF tapes. Of particular value for four-track recording, it ensures the closest contact between tape and recording head... gives improved reproduction of higher frequencies and greater purity of tone. The popular advantages of BASF tape — mechanical strength, magnetic stability, resistance to print-through — remain unchanged. They help to preserve the sound that only BASF tapes are made to take and give!



## **BASF** Magnetic Recording Tape for Authentic Sound

Standard · Long Play · Double Play

**BASF** CHEMICALS LIMITED 5a Gillespie Road London N5

Published by Miles Henslow Publications, 99 Mortimer Street, London, W.1.  
Printed by STAPLES PRINTERS LIMITED (Incorporating F. Howard Doulton Ltd.) Warton Road, Stratford, London, E.15