

the TAPE RECORDER

PRICE 1/6

APRIL 1961
Vol. 3 No. 3

INCORPORATING "SOUND AND CINE"



IN THIS NUMBER

- International Audio Festival and Fair Details
- Tape Recorder Gear Changing
- Building a Clockwork-Driven Portable Recorder
- Putting the West End on Tape
- Sound and Ciné—Scenarios
- Leak-Proof Batteries for Portables
- Reviewing Tape Recorders
- Field Trial of the TKI
- Tape Recorder Workbench
- Here and There and Everywhere—News and Pictures

. . . and this is why we don't believe in "gimmicks"

FOR more than twelve years — longer, probably, than any other firm in the industry — we have been making Tape Recorders. But never have we aspired to produce the greatest number nor to cater for all sections of the market.

Ferrographs, in fact, are **not** mass-produced. Each is built with painstaking skill in a series of complicated operations that can only be carried out by experienced technicians dedicated to the pursuit of quality.

Long ago we foresaw that a time would come when many would expect the Tape Recorder to compete with — perhaps even to oust — the gramophone as a home entertainer. We have never shared this viewpoint. Because **Recording** has always been our business we have consistently and whole-heartedly directed our energies towards the attainment of the highest standards of fidelity in tape **recording** — realising full well that magnetic tape stands supreme as a recording medium.

The unrivalled reputation enjoyed throughout the world today by the Ferrograph is the direct result of this wise and logical policy.

We have no intention of introducing features into the Ferrograph for the purpose of competing with the gramophone. We believe that such developments as ultra-slow tape speeds, very narrow tracks and suchlike are 'gimmicks' that could, at the present state of the art, lead to a general lowering of performance standards in tape recording. We at Ferrograph refuse to make any such compromise with quality as would be inevitable.

Those who choose the Ferrograph do so because their quest is for High Fidelity — not longer playing time. We aim to give it to them without sacrificing any of the proved features that Ferrograph engineers have developed over the years — without recourse to extreme pre-emphasis, hum-bucking, short-life narrow gap heads or similar artifices.

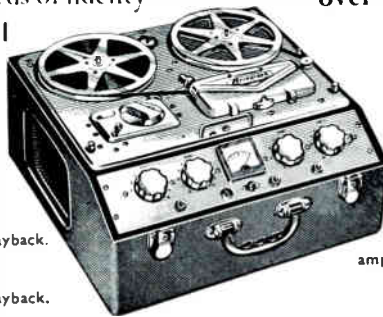

Series 4A

4A/N Two Speeds $3\frac{3}{4}/7\frac{1}{2}$ i.p.s. Monaural Recording/Playback.

81 Gns.

4A/H Two Speeds $7\frac{1}{2}/15$ i.p.s. Monaural Recording/Playback.

86 Gns.

Stereo 808

Two Speeds $3\frac{3}{4}/7\frac{1}{2}$ i.p.s. For use with external Hi Fi amplifiers and Loud Speakers. The all-purpose machine for Monaural and Stereo Recording/Playback.

105 Gns.

Three Independent Motors · Synchronous Capstan Motor · Recording Level Meter · Brief Stop · Interchangeable Plug-in-Heads
Switched Speed Change with Compensated Correction Network · Separate Tone Controls · High Fidelity $2\frac{1}{2}$ Watts Output Stage
Uses $8\frac{1}{2}$ " Tape Spools · Gear-Driven Turns Counter · Automatic Switch Cuts Motors at End of Spool · Endless Loop Cassette (Optional Extra)

The Incomparable **Ferrograph**

BRITISH FERROGRAPH RECORDER CO. LTD.

(A subsidiary of the Ferrograph Company Ltd.)

88 HORSEFERRY ROAD, WESTMINSTER, S.W.1 · Tel: SULLivan 5426/7/8

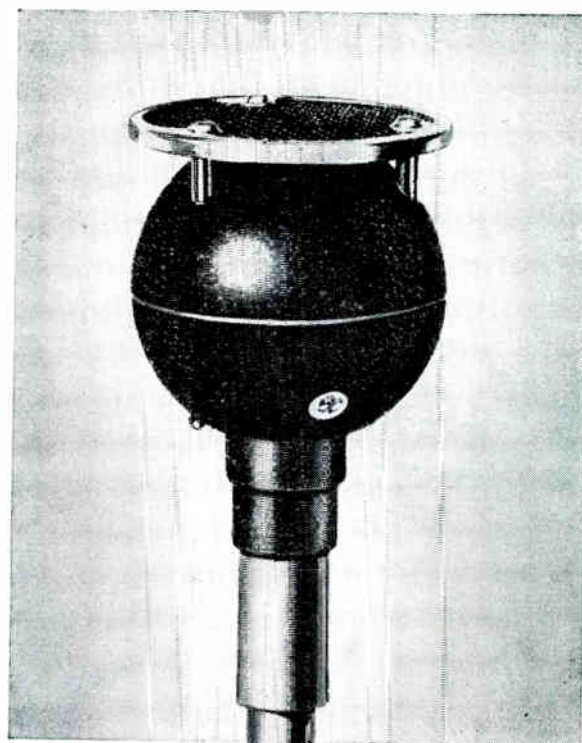
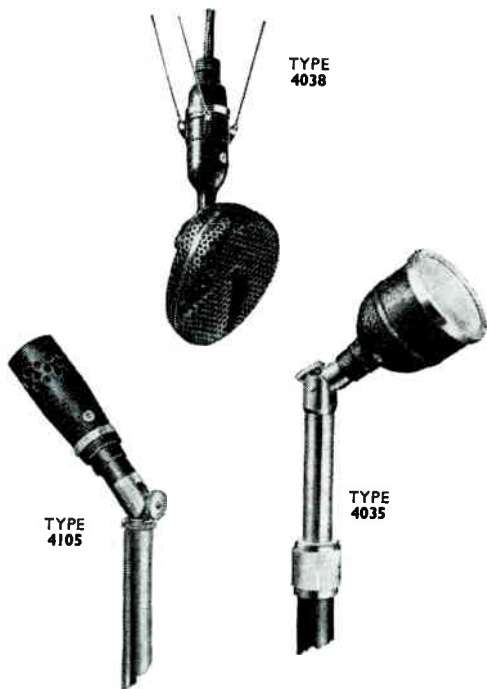

SOUND SENSE . . .

Obviously the quality of reproduction obtainable from your recording equipment depends basically on the input received from the microphone. Hence the wisdom of using a microphone of the highest sensitivity and response. The fact that STC microphones are used by the B.B.C. is sufficient recommendation.

There is an STC microphone suitable for every purpose.

Type	Response in cycles	Suitability	Price*
4021 Moving Coil	30-15,000	Speech or Music	£21
4035 Moving Coil	40-10,000	General purpose and out-of-doors	£18.10.0
4037 Moving Coil	30-15,000	Speech or Music	£20
4038 Ribbon	30-15,000	Music	£38.10.0
4105 Cardioid (Moving Coil)	60-10,000	General purpose	£20

*All microphones have an impedance of 30 ohms.
Full range of stands, accessories and cables available*

** Subject to alteration without notice.*

STC MICROPHONES contribute to high-quality reproduction

Standard Telephones and Cables Limited

Registered Office: Connaught House, Aldwych, London, W.C.2
PUBLIC ADDRESS DEPARTMENT

HIDE PLACE WORKS · ESTERBROOKE STREET · LONDON · S.W.1



BIG NEWS FROM ELIZABETHAN!



ANNOUNCING THE NEW POPULAR DE LUXE

Sensational new addition to the Elizabethan range. Splendid styling matches a first-class performance. And all complete at a real budget price!

- ★ 3½ i.p.s., B.S.R. deck with safety record interlock
- ★ Frequency response 60-8,000 c/s.
- ★ Column type magic eye record level indicator.
- ★ Handsome two-tone styling with storage compartment for mike and accessories.
- ★ Volume and tone controls.
- ★ New Circuit: 12AX7, ECL82 and 6EM5 with a 7 in. x 4 in. high flux speaker, giving 2½ watts output.
- ★ Provision for external loudspeaker.
- ★ Inputs for mike, radio/gram and telephone adaptor.

Complete with mike 1½ in. reel of tape, spare speed and radio/gram lead. **24 gns.**
Standard Popular also available at **19½ gns.** complete.



MAJOR NOW 4-TRACK

The superlative Major can now be obtained as either a twin-track or 4-track instrument. Both versions offer a standard of performance only found previously in higher grade professional equipment.

- ★ Phenomenal frequency response: 50-20,000 c/s (7½ i.p.s.); 50-14,000 c/s (3½ i.p.s.); 50-7,000 c/s (1½ i.p.s.), all ±3dB.
- ★ 6 watt push-pull output.
- ★ Meter recording level indicator.
- ★ 10 in. x 6 in. high-flux elliptical speaker, 4 in. tweeter.
- ★ Built-in superimposition and mixing.
- ★ Separate bass and treble controls.

Complete with 7 in. reel of tape. Mike optional extra. **65 gns.**



FT1 NEW PRICE!

Now greater-than-ever four-track value. A beautifully designed two-tone instrument with many extras.

- ★ 4-track (over 6 hours' recording time at 3½ i.p.s.).
- ★ Simple press-button track selection.
- ★ Frequency response 50-12,000 c/s.
- ★ Independent bass and treble controls.
- ★ Stereo play back facilities (with add-on unit).

Complete with mike, tape, etc. **34 gns.**



FT3 NEW PRICE!

At its new price the FT3 represents unique value. No other model on the market offers so many facilities for so little.

- ★ 4-track (over 17 hours' recording time at 1½ i.p.s.).
- ★ Simple press-button track selection.
- ★ Frequency response 50-16,000 c/s at 7½ i.p.s.
- ★ Separate bass and treble controls.
- ★ Independent input controls for full mixing.
- ★ Complete stereo record/layback facilities (with add-on unit).

Complete with high-gain mike, 7 in. reel of tape, etc. **NOW 45 gns.**

SOMETHING SPLENDID FOR EVERYONE

This year there's an Elizabethan to suit *everyone*. Whatever his requirements. Whatever his budget.

All this is possible because Elizabethan specialise in making fine tape recorders. There are so many new developments today—in electronics, in styling, in manufacturing methods—that only a specialist manufacturer like Elizabethan can offer these developments at such a remarkably low price.

Remember, too, that Elizabethan machines are made in Britain. So you're spending no money on import duty or shipping costs.

When you buy Elizabethan you're buying *value*: intelligent design, experienced electronics, handsome styling. All this, coupled with real rugged reliability to stand up to the life that an enthusiast's recorder leads.

Everyone's going **ELIZABETHAN**

World radio History

to: Elizabethan (Tape Recorders) Ltd., Romford, Essex.

Please send me full details of the Elizabethan range.

NAME

ADDRESS

.....TR1

if
you think
that all brands of
recording tape are alike...

wait
till you
visit

Stand 9
Audio Festival
Russell Hotel



Irish Brand Magnetic Recording Tape



If you are thinking of purchasing Hi-Fi (Radio, Tape or Record) Equipment, you cannot afford to miss getting your **FREE** copy

of the
BRITISH HEATHKIT CATALOGUE
An absolute beginner can build this equipment and **SAVE MONEY!**



WHO . . . ME?

- Q Me? Build a radio or a Hi-Fi set? You're crazy!
- A No we're not . . . You or anybody else can assemble a Heathkit model without knowing anything about electronics.
- Q I'd certainly like to . . . but I know absolutely nothing about electronics . . . I wouldn't know where to start!
- A That's easy . . . the instruction book will tell you exactly where to start. It even shows you . . . with large, clear pictures.
- Q How would I know where all of those parts go?
- A You only do one simple step at a time. The instruction book tells you exactly what part to use, where it goes and exactly how to install it. You simply go down the checklist of 'things to do'. Detailed illustrations make it even easier.
- Q But wouldn't I have to solder?
- A Yes, but there's nothing mysterious about a simple solder connection.
- Q But I've never had a soldering iron in my hand!
- A Again, the instruction book tells you . . . and shows you . . . exactly how use a soldering iron. It's really very simple.
- Q I don't know . . . I've seen the inside of a radio before. It looks awfully complicated.
- A You're right . . . but remember . . . with a Heathkit model you do only one simple step at a time.

YES, YOU!

- Q You'll be surprised how easy it is.
- Q Well, it sounds pretty good . . . but what happens if it doesn't work when I've finished?
- A Your Heathkit model is guaranteed to work when completed. If it doesn't you can get advice directly from the Service Dept. and, if necessary, return it to the factory. It will be thoroughly checked and put in perfect working condition. Any defective parts will be replaced free of charge (if the kit has been returned within the warranty period).
- Q And what if something goes wrong after the warranty period?
- A Your kit will be serviced in the same manner. You will, however, be charged a reasonable fee to cover cost.
- Q You really stand behind these kits don't you?
- A We most certainly do! We know the value of having a satisfied customer . . . we have thousands of them.
- Q And you really think I can put one of these kits together?
- A Certainly, and enjoy doing it!
- Q You know . . . I think you've got something there.

(✓) Connect a 22 KΩ resistor (red-red-orange) from socket C1 (NS) to ground lug C9 (NS). See Figure 8.

(✓) Connect a .005 μfd disc capacitor from socket C4 (NS) to IF transformer Q4 (NS).

() Bend socket lug C5 and IF transformer lug Q3 toward each other until they make contact and overlap slightly. Solder the connection securely. (1).

() Install a .005 μfd capacitor from socket (NS) to ground lug C9 (NS). Dress the capacitor close to chassis, under the capacitor previously installed.

It's easy!
JUST FOLLOW THE MANUAL.

Read the step . . . perform the operation . . . and check it off—it's just that simple. These plainly-worded, easy-to-follow, steps are combined with pictorial diagrams to take you through every phase of assembly. Let our experience be your teacher!

DELIVERY FREE U.K.
DEFERRED TERMS AVAILABLE.

You'll get plenty of these detailed pictorial diagrams in your Heathkit construction manual to show where each and every wire and part is to be placed. Everything you do is spelt out in pictures so you can't go wrong. That's what makes it such fun!

Without obligation, please send me

★ **FREE BRITISH HEATHKIT CATALOGUE** FULL DETAILS OF MODEL(S)

Kindly write below in **BLOCK CAPITALS**

NAME

ADDRESS

HT-4

TICK HERE

DAYSTROM LTD.

DEPT. HT-4, GLOUCESTER

A member of the Daystrom Group, manufacturers of

THE LARGEST-SELLING ELECTRONIC KITS IN THE WORLD

HERE'S

MARK 5 DECK · 28 GNS.

where you get performance!

A tape recorder is only as good as its deck. This is where precision in manufacture and assembly are vital for professional standards of recording and reproduction. In the Brenell Mark 5 deck there's a rare combination of advanced technology and an almost-forgotten kind of craftsmanship.

The Mark 5 deck has a remarkable, new main motor of a type widely regarded as the most efficient to be used in tape recording. The **HYSTERESIS SYNCHRONOUS MOTOR**, with a balanced outer rotor and a heavy, statically and dynamically balanced flywheel. It brings 'wow and flutter' down to below .1% at 7½ i.p.s.

This and the other components providing the specification shown below, are assembled with fanatical care. Brenell Mark 5 production is an individual task which is repeatedly checked and tested. Nothing less than mechanical and electrical perfection will do.

At 28 gns., you'd be missing a great deal to pay less and there's no need to pay more.

Abridged Specification:

3 INDEPENDENT MOTORS

4 RECORDING SPEEDS

FAST REWIND

in either direction. 1,200 ft.

reel rewound in 45 seconds.

WOW AND FLUTTER

Below .05% at 15 i.p.s.

Below .1% at 7½ i.p.s.

Below .15% at 3½ i.p.s.

Below .25% at 1½ i.p.s.

FREQUENCY RANGE

15 i.p.s.: 50/16,000 c/s ± 3dB

7½ i.p.s.: 60/12,000 c/s ± 3dB

3½ i.p.s.: 60/7,000 c/s ± 3dB

1½ i.p.s.: 60/4,000 c/s ± 3dB

SELECTIVE FREQUENCY CORRECTION

at 15, 7½ and 3½ i.p.s.

ACCEPTS R1 REELS

PAUSE CONTROL

DIGITAL REV. COUNTER

PROVISION FOR EXTRA HEADS



3 STAR



MARK 5

Tape Recorders:

3 STAR · 58 GNS. ★ MARK 5 · 64 GNS. ★ 3 STAR R/P STEREO · 89 GNS. ★ MK. 5 R/P STEREO · £99.12.0

*½ track available with 3 star models

Brenell

Full details and the address of your nearest stockist from the Sole Manufacturers:

BRENELL ENGINEERING CO. LTD.

1a DOUGHTY STREET · LONDON · WC1 · CHANCERY 5809 & HOLBORN 7358



WE'VE GOT EVERYTHING— AND NO INTEREST CHARGES ON H.P.

in Tape Recording and Hi-Fi Equipment. No Interest charges on orders over £30. Personal demonstrations in the Showroom, new 1961 edition of **FREE 88-page Catalogue**. All Makes:

Tape Recorders

Grundig
Elizabethan
Ferrograph
Vortexion
Walter
Brenell
Reflectograph
Simon
Harting
Telefunken
Phillips
Spectone

H.M.V.

Veritone
Stuzzi-Magnette
Fi-cord
Truvox
Kurland
Reps
Wyndson
Regentone
Perth-Saja
Elektron
Minivox
Korting

Hi-Fi Equipment Microphones Speakers, etc.

Leak
Quad
Rogers
Armstrong
Jason
Dulci
Pamphonic
Stentorian
Avantic
S.M.E.

Collaro

Goodsell
Elpico
Decca
Phillips
Wright & Weaire
G.E.C.
Goodmans
C.Q.
Wharfedale
Elac
B.J.
Garrard

Connoisseur

Goldring
T.S.L.
Acos
Lustraphone
Cadenza
Reslo
Record Housing
Linear
Tannoy
Ortofon
Auriol

*All Accessories, Tapes, etc. by return of post.
All makes in stock.*

Lowther

Film Industries
Audiomaster
Tape
Emitape
Scotch Boy
BASF
Grundig
Telefunken
Irish
Phillips
Agfa

THE

CHOOSE IN PERSON— CHOOSE BY POST

For free Catalogue, send this coupon to
The Tape Recorder Centre Ltd., Dept. R
75 Grand Parade, Green Lanes, Harringay,
London, N.4.
Telephone STAmford Hill 1146



Name

Address

BLOCK LETTERS PLEASE

TAPE RECORDER CENTRE

SHOWROOMS: Central London 82 High Holborn, W.C.1. CHA 7401 North London 75 Grand Parade, Green Lanes, Harringay, N.4. STA 1146, 2097

VERSATILITY ADAPTABILITY PORTABILITY

**twin channel
stereophonic
tape recorder**



EMI

**MODEL
TR52/2**

For recordings outside the studio, for critical assessment of performance in halls and theatres, for use in scientific and industrial research when two recordings are required simultaneously, the transportable TR 52 offers the recording engineer a wide range of facilities.

Built to the highest electrical and mechanical standards and with all units easily removable for quick servicing the TR 52 embodies EMI's unique experience over many years in the development and production of sound equipment.

Extensively used by Armed Forces,
Government and Industrial Research
Establishments, Recording,
TV and Film Studios.

*Price **£245** complete
Decks only available as a separate unit.
Complete with stereo head block **£75***

EMI ELECTRONICS LTD
Recording and Relay Division
HAYES · MIDDLESEX · ENGLAND · Tel: HAYES 3888 Ext: 2672

DON'T CROSS THE CHANNELS

Stereo tape recording has come to stay. If you want first-rate stereo sound in the end, you must have a first-rate stereo microphone from the start. This microphone must have the same balanced, wide-frequency response as a mono mike, and in addition achieve separation of all sound into two separate channels. Acos microphones have long been amongst the best in the world; Acos are the leading pioneers in stereo. No wonder, therefore, that the new ACOStereo microphone is strictly in the champion class for performance, separation, good looks and good value.



MIC 44

The new ACOStereo MIC 44 is a fully stereophonic microphone, operating on the coincident phase principle. It contains two inserts with figure-eight characteristics, at 90° to each other, giving overall clover-leaf response with first-rate channel separation. Output -68 dB ref 1V/dyne/cm²; frequency response 50-8,000 c/s; separation better than 12 dB at 1 kc/s. UK retail price £6.6.0.

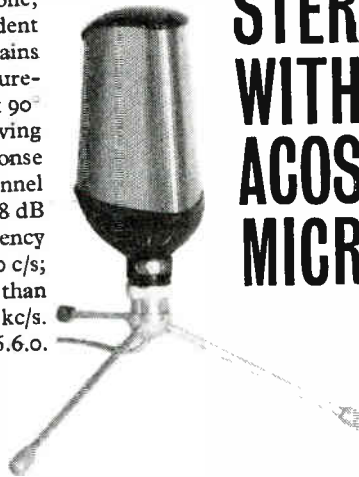

GET SET FOR STEREO WITH AN ACOSTEREO MICROPHONE

also
acos ARE DOING THINGS IN STYLE

See you at the Audio Fair, Demonstration Room 211, Stand 20

COSMOCORD LTD WALTHAM CROSS HERTS • TEL: WALTHAM CROSS 27331 (London subscribers please dial WS27331)

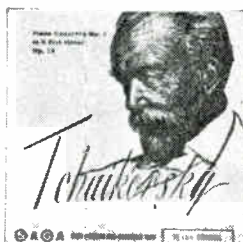
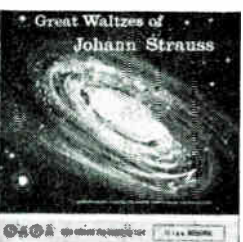
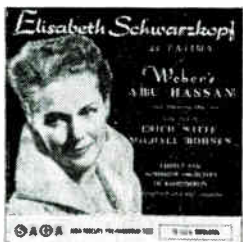

At last    
 has expanded
 its previous limited
 production of its famous
 pre-recorded tapes

FOR TWO YEARS our limited production facilities obliged us to concentrate our efforts on filling export orders. A limited supply indeed of SAGA tape records were able to reach the home market. AT LAST, our new equipment has enabled us to expand both our catalogue and our supply and you may now order SAGA tape records from your nearest retailer. Use the coupon below to obtain our new expanded catalogue only if you have difficulty in obtaining copies from your local retailer.

SAGA PRE-RECORDED TAPES are *the most accepted* line of tape-records in the Commonwealth. They are issued at both 3¾ i.p.s. and 7½ i.p.s; both in mono and stereo. All SAGA pre-recorded tapes are packaged in pictorial boxes. They are unconditionally guaranteed. Our copying techniques are unexcelled, and, of course, we use SCOTCH brand tape exclusively.

Ask for     by name

SAGA SOUND
 127 KENSAL ROAD
 LONDON W.10

SAGA SOUND,
 127 KENSAL ROAD, LONDON W.10

Please send me FREE, without obligation, a copy of your new SAGA tape catalogue.

NAME

ADDRESS.....

..... S.T.2



microphones

Did you know that dynamic microphones can be used in cold and hot, in dry and humid atmosphere, in wind and rain, by inexperienced people and children. Dynamic microphones are insensitive against shock and careless handling. These are the reasons why most tape recorder manufacturers, broadcast reporters, film units and others prefer to specify dynamic microphones.

AKG leads the world in the research and development of dynamic and condenser microphones. AKG owns hundreds of patents. Among these are many basic patents covering new principles of obtaining cardioid patterns, extended frequency range, low distortion and new designs.

C 60

Miniature Condenser Studio Microphone for T.V., film and stage. Uses either the well proved CK 28 cardioid or the CK 26 omni-directional capsule. Weight only 2.1 ounces. Pictured with W 60 wind-screen.

New

K 50

Dynamic headphones for stereo and mono. 30 . . . 20,000 cps, 127 phon output per system. Requires only 0.156 milliwatts (=0.25 volts) per system for average listening level. No tight coupling to ear necessary. Used for true sound monitoring.

C 28

The Condenser Studio Microphone with cardioid and omnidirectional characteristics, with extension tubes to make the microphone inconspicuous. 30 . . . 18,000 cps (cardioid) 30 . . . 30,000 cps (omni), 20 db front-back ratio, 1.3 millivolts per microbar at 200 ohms, impedance 50/200 ohms.

D 19 B

The golden Cardioid Microphone for highest fidelity requirements, with bass attenuation switch. Discrimination 15 db, impedance 60, 200 ohms or high, frequency range 40 . . . 16,000 cps. Most popular semi-professional microphone on the continent.

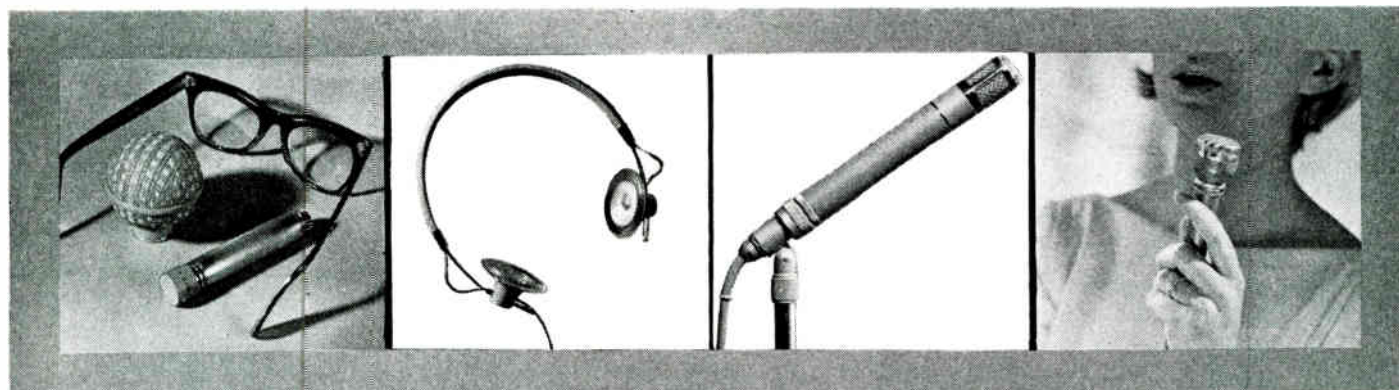

All enquiries to :

POLITECHNA
LONDON W.1
TELEPHONE: LANGHAM 6236

(LONDON) LIMITED
3, PERCY STREET
CABLES: POLINDUST LONDON

See us at the
AUDIO FAIR
Booth 4,
Room 220

There are two kinds of people who'll want this new



TK 24 4 TRACK MODEL

... Two quite different kinds of people will want the new TK 24 — the inexperienced and the experienced. The inexperienced because they don't know any better and the experienced because they don't know any better either: because there isn't any better than this brilliant new four track Grundig model. The new TK 24 makes no compromises. It doesn't ask you to choose whether you want high fidelity or long play — it gives you both! All the time! Six hours record/playback.

It doesn't ask you to scrap all your existing conventional twin track $3\frac{1}{2}$ i.p.s. tapes — it lets you play them back as well (and how good they sound!).

It doesn't expect you to have to make complicated arrangements to produce special trick effects — *it allows two tracks to be recorded separately and then played back together.* (Normally, of course, you would play them back separately to get the doubled playing time that four track gives you).

In fact it's the most accommodating tape recorder ever made — even by Grundig!

No matter how much you know — or don't know — about Tape Recorders, go to your nearest Grundig Approved Dealer and have him demonstrate the TK 24.

See and hear Grundig quality for yourself; the simplicity, the compactness, the styling, the really first rate performance of a new model that will stay 'new' for years.

PRICE **55** guineas (Including Microphone)

GET THE MOST OUT OF LIFE

GET THE **GRUNDIG** **TK24**

GRUNDIG (Great Britain) LTD.

Advertising & Showrooms: 39/41 New Oxford Street, London, W.C.1.
Trade enquiries to: Newlands Park, Sydenham, London, S.E.26.
(Electronics Division, Gas Purification & Chemical Company Limited)

Please send me the free fully illustrated leaflet of the new TK24 four track model tape recorder and the wonderful 20 page book TOP STARS and GRUNDIG.

Name.....

Address.....

Nearest Town.....

G.S. TR. 275

Two Years Guarantee

NOT MASS PRODUCED BUT VIRTUALLY HAND-MADE FOR RELIABILITY AND CONSISTENTLY HIGH STANDARD OF PERFORMANCE.

MODEL R30/R40

1. $1\frac{7}{8}$ ips can be fitted for an extra 3 gns.
2. Superimposing fitted as standard.
3. Mixing facilities.
4. Provision is made for the addition of a STEREO HEAD.



TECHNICAL SPECIFICATION

The R.40.

$1\frac{7}{8}$ ips 70—4,500 \pm 3db.

$3\frac{3}{4}$ ips 60—9,000 \pm 3db.

$7\frac{1}{2}$ ips 50—15,000 \pm 3db.

15 ips 40—20,000 \pm 3db.

(signal noise ratio at $7\frac{1}{2}$ ips—47db.)

Separate record amplifier.

Push-pull bias erase oscillator for low tape hiss.

Separate bass and treble controls \pm 15 db at 14 kc/s—15db at 40 c/s.

Supplied complete with Acos 39/1 microphone, Radio Record lead and 1,200' P.V.C. Tape.

MODELS

R10 59 GNS.—2 track

69 GNS.—4 track

R20 62 GNS. with magic eye record indicator

R30 66 GNS. with meter record level indicator

R40 70 GNS. as R30 but with push/pull sound output

R10 SPECIFICATION:

2 or 4 track version. 10 watts push/pull output. (2 EL84 valves)

$7\frac{1}{8}$ ips 30—18,000 cycles \pm 3 dBs } at optimum
 $3\frac{3}{4}$ ips 40—12,000 cycles \pm 3 dBs } bias setting
 $1\frac{7}{8}$ ips 50— 6,000 cycles \pm 3 dBs }

Collaro Studio Deck. Microphone and Radio/Gram inputs each with separate gain controls for mixing. Separate bass and treble controls.

\pm 12 dBs at 50 cycles and 12 k/cs. Adjustable monitor volume control independent of record level. Peak signal level meter $2\frac{1}{4}$ in. square. Bogen heads. Record safety device. 600 ohms Cathode follower output. Two per cent total harmonic distortion on peaks. 200/250 volts 50 cycles or 100/120 volts 60 cycles. Valve line up: 1 EF86. 2 ECF80. 2 ECC83. 1 ECC82. 2 EL84. Metal rectifier, contact cooled.

Please send me without obligation full details of your range of Tape Recorders. I am particularly interested in Model R.....

Mr

Fully illustrated literature available on request to—

REPS (TAPE RECORDERS) LTD.

118 Park Road North, South Acton, London, W.3.

Phone: Acorn 4141

the TAPE RECORDER

Editor MILES HENSLOW
 Technical Editor John Borwick
 Assistant Editor Julian Berrisford
 Editorial Offices - - - 99 Mortimer Street, London, W.1
 Telephone MUSEum 3967 to 3969



★

MEMBER OF THE
 AUDIT BUREAU
 OF CIRCULATIONS

EDITORIAL

THIS number should reach most of our home readers just before the holiday—so we wish them a Happy Easter! To our many overseas readers this must be a back-dated wish, but we hope they enjoyed it. The same applies, in their case, to our Audio Show pages, but in this case we intend to see that they receive a very full report, plus pictures, in the May number.

There will be several new and interesting tape recorders on show for the first time at the forthcoming show. About some of them we are still as much in the dark as our readers, because manufacturers like to keep everyone guessing until the last minute! This has even applied to our directory sections in the 1961 Year Book, now at Press—so we cannot say much about them that is worth saying at this stage. One thing is of importance however, and that is the term “quality” which we know will apply to several of them. The past year (and that is to say the year's gap between shows) has seen a number of new models—and even new makes appear on the horizon and disappear. The Trade has suffered as a result. Many customers have also suffered. So have some of the firms who produced them. And one of the major reasons for this state of affairs is “quality”, or lack of it.

What was a fair boom in tape recorders became, in many cases, a sad fizzle. People will *not* spend good money on inferior workmanship, and there has been far too much of it in evidence. We have heard cases of dealers refusing to handle some models because of silly faults that could so easily have been rectified before the machines left the factories. News travels fast, and bad news travels even faster. The result is that the good makes, the good names, and the reliable firms have scored: the manufacturers who tried to do too much too quickly have felt the repercussions.

In this magazine we are interested in quality before quantity, and we shall never lose an opportunity for handing out full praise to good products. We only wish that more manufacturers would get together and draw up some plans for a system that has proved of such tremendous value in the Japanese camera trade. In this case, the rules, as laid down, are so strict that it is virtually impossible for an instrument to leave the country with inherent faults. The results have already paid magnificent dividends. Japan was once looked upon as a “copyist” nation: today her products have earned the respect and admiration of the whole world.

We hope that the foregoing remarks will not be misinterpreted, and that we shall not be taken to task for implying that British products are no good! Far from that, we emphasise that the best of our Tape Recorder and Hi-Fi products are without equal, anywhere. What we are trying to punch home is the fact that we would like to see many more manufacturers

APRIL - - - - - 1961

VOL. 3 - - - - - No. 3

CONTENTS

News, Pictures and Ideas	121
The Audio Show, Guide and details	122
News from the Clubs	124
Gear Changing—on your recorder, By John Borwick	127
Build This Really Portable Recorder Part 5—Transistor Power Amplifiers By A. Tutchings	129
Field Trials of Portables The New Grundig TK1	132
How we put the West End on Tape (2) By David Kinglake	135
Owners of Portables, be warned! Advice on leak-proof batteries	137
Readers' Problems	139
Sound and Ciné Choosing a Subject By Richard Golding	141
Tape Recorder Workbench (21) Achieving Optimum Bias By A. Bartlett Still	145
Equipment Reviewed	147
Our Readers Write	153
Classified Advertisements	156
Advertisers' Index	158

up in the top bracket for quality. And what we are warning our readers about is the *Penny-wise: Pound foolish* belief that any audio product can be good value if it is obviously built-down to a ridiculously low price. Far better to pay a bit more and buy something that is obviously good. The alternative is to have to buy again at a later date, and to end up with something that could have been twice as good, given the money that was originally thrown away.

The Audio Show is a wonderful opportunity for looking over a really wide range of interesting products—and, as we said earlier, there will be some really worthwhile things to be seen and heard. We wish you an interesting experience—and good hunting!

COVER PICTURE

HERE is a seasonal picture—and *not* one which was just taken for the excuse, either! A Grampian microphone to be tried out under field conditions, a long-promised date for a recording of young chicks, and an opportunity for visiting old friends at the new premises of Poultry Services Ltd., in the neighbourhood of Welwyn Garden City—all these things combined provide the makings of our Easter cover. We have *never* before seen so many chicks. Thousands of them. They are packed as “day-olds” in the boxes you see. There are (or should be, please check) about 200 on the cover. Footnote, the tape was excellent—full track on E.M.I. model L2.

NEXT MONTH

THE final instalment of A. Tutchings' constructional series, *Build This Really Portable Recorder* will appear in our May issue. Reviews include the *Stuzzi Tricorder*, the *Mixing Ade* and the new *Zonal* tape. A full report of the Audio Show. Sound and Ciné. Many pages of news and pictures. “Teaching Tape” is continued by I. W. Jarman. All the usual features will, of course, be there—Workbench, Readers' Problems, Post-bag, etc. Out April 28th. Don't forget to place a firm order with your agent!

SUBSCRIPTION RATES

The subscription rate to *The Tape Recorder* is 21/- per annum (U.S.A. \$3.00) from The Tape Recorder, 99 Mortimer Street, London, W.1. Subscription + Index, 24/- (U.S.A. \$3.25).

skirling scotsmen



insist on

TRADE MARK

SCOTCH

BRAND
recording tape

WORLD'S LARGEST SALES OF MAGNETIC TAPE



News - Pictures - Ideas!



Schools, Have You Tried This?

WHILE experimenting with the Tandberg's "Sound-on-Sound" facility, I decided to play a few impromptu tricks with it. The first of these was to feed the radio output into Channel 1, and to connect the microphone to Channel 2. By fading down the monitoring, room speaker, so as to avoid feedback through the mike, and suitably positioning the mike, I added my own running commentary to the programme by using the "Sound-on-Sound" switching position. The results, as intended, were amusing; but they were turned to far better account, for a pianist heard them and immediately decided that this was an excellent aid to tuition and practice.

Owners of stereo recorders, other than the Tandberg (on which this "Sound-on-Sound" is apparently unique) may have already experimented on these lines, using one channel for the basic programme, and the second for the accompaniment. We shall be glad to have comments, if so. By using different settings of volume on the two channels during replay, either the accompaniment or the basic programme can be emphasised. **M.K.**

* * *

Introducing Indicord

MANY tape enthusiasts have said—and many hundreds more must have thought—how interesting it would be to be able to see what was actually recorded on tape. In the laboratories this has been possible for some time, and electronic engineers have found it a godsend to be able to work with a visible trace, when trying to splice recorded "Videotape", rather than depend upon sounds, measurements or meter readings. Now it is possible for everyone to use this facility, as the result of a new product, "Indicord" which has just appeared on the market.



Indicord is a liquid which contains minute particles of ferro-magnetic material. A loop of recorded tape can either be dipped into it, or it may be spread along the tape by means of the eye-dropper type of applicator that is supplied with the bottle as a cap. It works on the same principle as the old school-room experiment of sprinkling iron filings on to a paper over a magnet. Just as the filings take up the pattern of the lines of force emanating from the magnet, so do the ferromagnetic particles of "Indicord" show up the magnetically-recorded pattern of the tape.

Even without a magnifier it is quite easy to see the difference between, say a 100 and a 200 c/s note. Indeed, as a simple experiment, and working from a known tape speed, one could name the recorded "tone" by measurement. Used with a microscope, "Indicord" should prove most useful for the schoolroom. Engineers whose work is with tape recorders should find it an extremely valuable tool, for it can obviously show up gap effects, poor contact between tape and heads, etc. Many readers will find it sufficiently fascinating to buy a bottle for the fun of it! And it is certainly good value for that purpose alone for the 5s. 6d. that it costs.

Will dealers and readers please note the name and address of the manufacturer, thus saving our correspondence department much work: **H. P. Freedman, 271-273 Archway Road, London, N.6.**

Dear Sir:—For the past year I've been a regular reader of your magazine, and have found it very interesting. Enclosed is a photograph of a Broadcasting Studio on RAF Gan. The studio, as you can see, was built by airmen spending an overseas tour there. In the studio we used two Telefunken 85R tape recorders, which were used for pre-recording programmes. They were used for about four hours everyday for seven days a week, and with the exception of minor defects have given excellent performance over ten months, and to my knowledge are still giving good performance.

The output from the tape recorder is amplified and fed into a transmitter, which covers almost all the Island. The photo was taken whilst I was recording a programme. I hope this will be of interest to you. *Yours faithfully, D.J. Heris.*

Audio Fair Photographs

OUR cartoonist and two of our writers have been briefed to prepare a full report of the Audio Fair for us which will be published in our May number on sale on April 28th. Our roving camera man will be in attendance throughout the show and readers who are interested in any pictures should contact him for anything special that they would like to have photographed. Prints of photographs taken from day to day will be prominently displayed and will be on sale on the Ground Floor. Further details of this service can be obtained from our Photographic Office, **Colour Printers Ltd., 29 George Street, London, W.1.,** from which address any prints may be ordered.



"Sounds of nature, he says! Tropicalised Equipment, he says!"

EXHIBITORS' GUIDE

LIST OF EXHIBITORS

Name	Booth No.	Dem No.
Acoustical Manufacturing Co. Ltd.	47	215
A.K.G.	4	220
Ampex (Gt. Britain) Ltd.	17	313
Armstrong Wireless & Television Co. Ltd.	57	202
Associated British Tape Recording Clubs Ltd.	41	
Audio Fidelity (England) Ltd.	40	256
Aveley Electric Ltd.	63	354
Badische Anilin & Soda Fabrik A.G.	2	222
Brenell Engineering Co. Ltd.	34	254
British Ferrograph Ltd.	36	234
Butoba	52	321
Chapman (Ultrasonics) Ltd.	19	355
Chitnis Electronic A.G.	50	117
Clarke & Smith Ltd.	58	
Challen Instrument Co.	37	261
Collel Ltd.	55	213
Cosmocord Ltd.	20	211
Decca Record Co. Ltd.	29	236
EMI Records Ltd.	32	120
EMI Sales & Services Ltd.	30	113
Fi-Cord (Distribution) Ltd.	43	348
Garrard Engineering & Manufacturing Co. Ltd.	65	302
Gevaert Photo-Producten N.V.	23	255
The Gramophone Co. Ltd.	31	121
Grampian Reproducers Ltd.	21	152
Grundig (Gt. Britain) Ltd.	15	147
Goodmans Industries Ltd.	56	315
Miles Henslow Publications Ltd.	67	—
Hillife Electrical Publications Ltd.	5	—
H. J. Leak & Co. Ltd.	22	304
Long Playing Records Library Ltd.		
Lowther Manufacturing Co. Ltd.	69	237
Lustraphone Ltd.	39	114
Minnesota Mining & Manufacturing Co. Ltd.	45	352
M.S.S. Recording Co. Ltd.	68	204
Mullard Ltd.	10	111
Multimusic Ltd.	16	336
Magnavox Ltd.	42	361
Orr Industries Inc.	9	212
Pamphonic Reproducers Ltd.	7	247
Philharmonic Records Ltd.	8	217
Philips Electrical Ltd.	6	317
Pye	49	342
Radford Electronics Ltd.	59	218
Record Housing	46	248
Robuk Electrical Industries Ltd.	38	122
Rogers Developments Ltd.	1	347
Rola Celestion Ltd.	60	334
Shure Bros. Inc.	53	252
Simon Sound Equipment Ltd.	48	118
Standard Telephones & Cables Ltd.	35	—
A. R. Sugden & Co. Ltd.	64	221
Tannoy Products Ltd.	24	145
Tape Recorders (Electronics) Ltd.	25	115
Telefunken G.m.b.H.	14	322
Teppaz S.A.	62	242
Veritone Ltd.	11	159
Vitavox Ltd.	54	161
Vortexion Ltd.	51	149
Walter Instruments Ltd.	44	359
Wellington Acoustic Laboratories Ltd.	61	—
Wharfedale Wireless Works Ltd.	3	337
Whiteley Electrical Radio Co. Ltd.	71	311
Zonal Films (Magnetic Coatings) Ltd.	33	214

The 1961 International Audio Festival

THE organisers of the 1961 International Audio Festival and Fair, to be held at the Hotel Russell, Russell Square, London, W.C.1, on April 6th-9th inclusive . . .

Sight and Sound . . . have advised us that the Ground Floor is taken up with the Display Stands of over 70 Exhibitors—this is the *visual* part of the Festival, where the design of the many various products can conveniently be inspected and information obtained. In addition, each manufacturer will have his own Demonstration Room on an upper floor of the hotel, in which frequent demonstrations of the equipment in actual use can be heard in conditions approximating the dimensions of a normal living room. Thus the Festival covers both *Sight and Sound*.

This Year—an Audio Theatre

In addition, there will be an Audio Theatre, seating 200, in which half-hourly Talks and Special Demonstrations will take place. This is an innovation which will undoubtedly prove very popular. The 1961 Audio Festival is truly International. In addition to the many British exhibitors, there is representation from firms in France, Eire, the United States, Germany, Austria, Belgium and Japan, thus giving visitors an unrivalled opportunity to compare the audio products of many countries all under the same roof.

Emphasis on Quality . . . only firms manufacturing products of the highest quality are allowed to exhibit at the Audio Festival . . . all would-be entries are "vetted" by a Festival Committee in advance to ensure that only the highest standards of quality in design, workmanship and efficiency are exhibited.



★
One of the new Audiograph tape recorders to be demonstrated by Chitnis Electronics on Stand No. 50.

★

The 1961 Festival will also include special demonstrations of historic recordings, as well as of the latest high fidelity and stereophonic records, plus the finest and latest examples of tape recording and gramophone equipment.

Hi-Fi News Reviewer at the Keyboard!

Mr. A. Wayne, the famous concert pianist and broadcasting star, will be giving live and recorded demonstrations in the Cosmocord Studios. Mr. Wayne is equally well known in the electronic field as the designer of the Shirley Laboratories TWA 1515/D amplifier, recently described in *Hi-Fi News*.

A "shot in the arm" will be the theme of the demonstration by Audio Fidelity Records Ltd., and Dr. Ridley will be in attendance, complete with white coat, stethoscope and hyperdermic syringe.

A Wealth of New Hi-Fi Apparatus

Hi-fi enthusiasts will have the opportunity of seeing new equipment manufactured by many companies throughout the country. Lowther Manufacturing Company will be demonstrating their usual range of equipment, plus a new simplified push-pull transformerless 5 watt transistor amplifier, and Messrs. Goodmans will show for the first time the Axiom 110 and 112 loudspeakers. Philharmonic Records Ltd., will be playing their stereo discs, which are recorded in 3-track stereo, and then converted to

AND AUDIO FESTIVAL NEWS

2-track on the disc. This is claimed to add more depth to the recording than the normal process. Also to ensure that no faults are contained in the finished product, the discs are transparent, which allows the purchaser to examine for air bubbles, etc. A new stereo integrated amplifier has been produced by Rogers Development using the new Mullard ECL86 valve. New features include provision for compatible stereo pickups, simplified speaker matching and click suppressors on the on/off switch, styling remains the same as the Mark I.

Audio Show: Important!

With the co-operation of the organisers of the Festival, we have arranged a special "at-the-door" issue of tickets for readers who have forgotten, lost, or failed to receive them on time. Those who find themselves at the door without tickets should ask for the *Tape Recorder* representative. He will be carrying a supply of tickets and will issue them to applicants on the spot. *Editor.*

Tape recording enthusiasts will be able to see the new Ferrograph five series and, although the outward appearance remains the same, a modification has been made to the capstan drive assembly, doubling the speed of the capstan motor and reducing the capstan diameter accordingly. This results in greatly reduced wow and flutter figures.

New 4-Track Models

Also on show will be the 808/4 Recorder capable of reproducing pre-recorded tapes of the 4-track variety. Although we have very little information, we have been told to expect a new tape recorder from Wyndor Recording Company, and a new tape recorder from the Gramophone Co. Ltd., which will allow the operator to have a record player and tape recorder in a single cabinet. Gevaert Ltd., will be taking part in the Audio Fair for the first time this year, and will be exhibiting their Gevasonar range of magnetic tape. In the demonstration room Mr. L. A. Guest will present a programme under the title "High Fidelity in Sound and Colour" on Gevasonar magnetic tape, accompanied by colour slides on Gevacolor film.

Outside Exhibitions

As has been the case in all preceding years a number of firms will be demonstrating in adjoining buildings and further afield. Daystrom Ltd., manufacturers of the Heathkit range of products, will be in the Bedford Room of the Grand Hotel, Southampton Row, and a full range of equipment will be on



★
Latest Addition to the A.K.G. Range of Microphones is the Miniature C60. This will be on view at Stand No. 4.
 ★

view in the basement. Lockwood and Co. (Woodworkers), Ltd., under the supervision of Mr. Stanley Timms, will be holding a four-day show at the International Broadcasting Company, 35 Portland Place, London, W.1. A full range of Lockwood speaker enclosures will be demonstrated and tickets can be obtained from the **Hi-Fi Stand**.

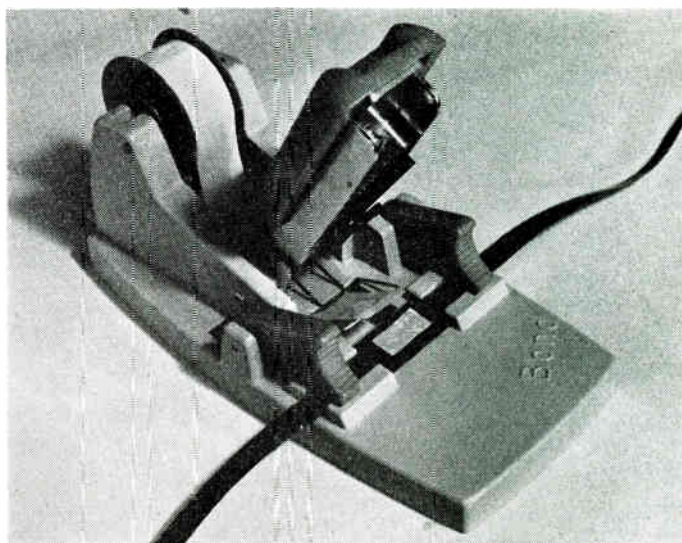

On show for the first time at this year's Audio Fair will be the *Bond Splicer* (see photograph above). The whole operation of splicing tape is simplified with the use of this splicer. The cutting blades are mounted in the cutting head and a spool of splicing tape fits neatly into place at the rear of the splicer. Spring loaded arms firmly hold tape and the finished splice is "waisted" to prevent fouling of the tape guides. The *Bond Splicer* is distributed throughout the U.K. by **Ciné Accessories Ltd. 15 Bond Street, Brighton**. First tests suggest that this device is a really outstanding product.

Visit the IBC Too

During the run of the Audio Festival there will be another very interesting exhibition at the IBC Headquarters, 35 Portland Place, London, W.1. Here Mr. Stanley Timms of Lockwood will be showing the complete range of his fine cabinet work for loudspeakers and consoles, and visitors will receive a warm welcome. It is more than probable, at the same time, that they will be able to see at close quarters the new stereo "Lyrec" tape and disc cutting installation which is used for making many of the popular records in the catalogues each month. This is a strong tip for a good "extra" for visitors to London.

Times to note are: 6.30—9.30 p.m. Thursday and Friday.
 9.30 a.m.—9.30 p.m. Saturday and Sunday.



APRIL NUMBER

★

Contents include:

- A New Speaker Idea for Constructors—The Tricolumn
- Improving Magnetic Tape
- Understanding Hi-Fi
- Hearing Aids

★

NOW ON SALE

NEWS AND PICTURES FROM



THE above photograph is of some of the members, and their machines, of the **Howard Wall and Bethnal Green Tape Recording Club**, which was founded in October, 1960, by some of the employees of the firm of Howard Wall, Ltd. Its members to date total 24, and the most successful activities up to the present time have been a recording of the choir of nurses of the Mildmay Hospital and the Youth Charter Service at the Shoreditch Tabernacle. A very high standard of recording has been achieved by the Club members by their enthusiasm as sound recordists, and their technical knowledge in sound reproduction. As a Club, keen on tape exchanging classical music and plays, they hope to carry out some experiments in *Musique Concrète* in the near future. Further details from *Mr. H. A. Schaller, Shoreditch Tabernacle, Huxley Road, London, E.2.*

A TRADE Demonstration was the subject of the meeting on February 15th to members of the **South-West London Tape Recording Society**. This was given by Mr. Witmond and Mr. Hartley of Simon Equipment Limited, who brought along several of the machines they manufacture. The demonstration commenced with a talk about the Simon SP4 Tape Recorder and its facilities. This was followed by a demonstration of the Simon "Minstrelle" 4-track stereo machine. The meeting was then opened for questions, and several interesting points were discussed. The whole evening was most interesting and informative. Details of the Exhibition for March 18th are now fixed. This Exhibition which will show the work of the Institute, will be open on this day from 3 p.m. to 9 p.m. at Mayfield School. The Tape Recording Society is arranging a studio and control room in which demonstrations of drama, music, etc., will be given. A display room is also planned to show other Club activities, including stereo recording, tape exchanging, etc. Visitors will be given the chance to record their voices, and members will be on hand to answer any queries on any aspect of tape recording.

THOUGH described by Sir Miles Thomas as "a most humane and praiseworthy idea", an Ilford journalist's project of a sound news magazine for the blind was considered a poor commercial proposition by three judges in the *Daily Mail* Get Ahead Contest on Thursday. Mr. Walter Gillings, 48 year old ex-editor, who produces "What Goes On Here" on tape as a voluntary service to Ilford Blind Welfare Association, appeared on B.B.C. television in the second heat of the competition, which offers over £7,500 in prize money. Gaining 26 points, he will receive £26. Two other contestants who appeared in the heat, a 66 year old New Malden inventor, with an idea for fixing carpets, and a Manchester man of 59, who has marketed an umbrella with interchangeable covers, were awarded 56 and

38 points, respectively. Mr. Gillings was questioned by Mrs. John Profumo, Sir Miles Thomas and Mr. William Hardcastle about his plans for *Blind Bulletin*, after a film had shown him and his son, Fleet Street sub-editor Ronald Gillings (26), making their tape recording of local news and presenting it at Fellowship House, Ilford, where blind people were seen listening to "What Goes On Here". He told the panel he needed the prize money to buy the equipment to make copies of the recording for distribution to his subscribers. He also needed transport to facilitate a presentation service which would be available to Blind Clubs in and around London. The judges, in summing up, stated that the idea of assisting the blind in this way was excellent, but it was doubtful whether Mr. Gillings could compete with the full coverage of news supplied by the B.B.C. After the programme Mr. Gillings was heard to say "I don't suggest that it will make a million, but, given sufficient capital to make a good start and develop it fully, I'm sure I could make a commercial success of it".

LAST month two of the members of the **Brighton Tape Recording Club**, Messrs. E. Giles and R. Vivian, supplied sound effects for a local junior Dramatic Society Production of "Sinbad the Sailor", and at the same time made a stereophonic recording using the Grundig 830-30, Philips 3536 Stereo Recorder and a Grundig 830.3D for sound. Also, a third member, Mr. J. Payne, went out during the interval with a G.B.C. Clarion Portable and interviewed members of the audience. This was eventually dubbed on to the finished tape and produced hilarious results when played back to the actors. Members have now been asked by the Senior Dramatic Group to produce various sound effects for a serious play that they are producing this month, so this enables them to start another section of the Club. To obtain outside sound effects another of our recent members has planned and built his own tape recorder. This he showed us at Club meetings in various stages of building. Now it is finished and works satisfactorily. The Club is also writing and producing a play on tape, giving us all an exercise in dubbing, editing, mike placing and sound effects. Many interesting programmes are planned, and information can be obtained from *Mr. E. Giles, 83, Ditching Road, Brighton, 7, Sussex.*

ON January 3rd two members presented for display their home built equipment to members of the **Ilford and District Tape Recording Society**. Mr. J. Hunter put on show a four-channel microphone mixer with three high and one low gain inputs. Mr. F. Faulkner brought with him a Mullard Type "C" Pre-amp, a stereo kit modified for meter level indication and with the added convenience of erase fade facilities. Mr. Whitmore's demonstration of Simon recorders, on the 17th, was well attended and members were quick to recognise the versatility of the well-known S.P.4. At the other end of the financial scale there was the new "Cymbal" recorder which sells at 24 gns. The general view was that this was the perfect machine for buyers in this price range, offering real reliability and it's "Garrard" magazine deck. Further details of the club may be obtained from *Mr. D. Bolton, 13, Gloucester Road, Manor Park, London, E.12.*

THE meeting of the **Rugby Amateur Tape Recording Society** held on February 9th, was spent listening to a tape received by the society's American member, Mr. H. Woerner, from the Universal Tape Network of America. As well as containing some enjoyable American music, the tape contained details of the Network's activities, membership and future plans. At a later meeting Mr. G. Dawson and Mrs. V. Tilcock visited Dewar

THE CLUBS

Fifteen men, two ladies and an owl, make up the membership of the Northampton Tape and Cine Club. The array of equipment includes two Grundigs, two Ferrographs, a Brenell and a Sound Tape Recorder, of course, this does not include the other part of the club with their cine equipment. Altogether it appears that this club certainly know what to do on club evenings, and with an owl as a member, they must have some really late night sessions.



Lodge (Ladies Section) to play back a tape they had compiled with the assistance of Mr. T. Davis. This was much appreciated by the audience and it is hoped to produce a regular programme in the near future. Further details from Mrs. V. Tilcock, 53, Fleet Crescent, Rugby.

* * *

MEMBERS of the Friern Barnet and District Tape Recording Club, who have been presenting programmes to local hospitals, welcomed Mr. A. Lovell to a Club Night meeting recently. Mr. Lovell presented a most interesting talk with tape recordings on the Hospital Broadcasting Service. It was noted particularly that the quality of the recording made set a very high standard, and the range of programmes has enabled the Club to take full advantage of this service, and tapes are now regularly received and played to local hospitals. As a result of this meeting, members were pleased to have the opportunity of visiting the Poplar Civic Theatre, and witnessing the recording of a hospital tape. The Club thoroughly enjoyed the visit, and were able to see the hard work which goes on behind the scenes. At a later meeting members saw a slide demonstration of Princess Margaret's wedding, and it is intended to record a commentary to be kept in the Club Library. During the showing, unknown to members, the comments were being recorded, but it is doubtful whether these will make a suitable commentary. The Club has been considering items of interest for the Friern Barnet show, and they hope to demonstrate tape recorders, cine equipment and record interviews. During the last month a visit to the Grafton Radio Society for a lecture and demonstration by F. C. Judd, and preparing a tape for the National Contest has given Club members food for thought over the coming months. Further details of Club activities can be obtained from the Secretary, Mr. A. S. Andrews, 13, Hartland Road, Friern Barnet, London, N.11.

* * *

MEMBERS of the West Middlesex Tape Recording Club were pleased to receive a visit from Mr. Ken Blake of the London Group at the Southall meeting on February 23rd. His tape entitled "North Sea Saga" was extremely enjoyable, backed up with eighty 35mm colour slides. Mr. Phipps told members that he had only taken up photography seven months before he undertook the trip, and members were very impressed with his artistic achievements. His talk on tape really brought home to the Club the hard work that the fishermen of England have to put in to bring fish to this country, but they have a worthy spokesman in Mr. Phipps, who has been approached by several

members of the fishing industry to release some of his slides for advertisement purposes. Later in the evening Mr. Phil Mead, manager of one of the Musicraft shops, and one of the earliest members, brought along the new Grundig TK1 battery recorder. Members were impressed by this little machine, and had the privilege of testing it for themselves. The quality on playback, through its own speaker, was good, but when played back through a Vortexion it was clear that a high proportion of the available frequencies were all on the tape. Also being used for the first time was a Heathkit speaker bought by the Club, in conjunction with Mr. John King. This is the first item of "real" equipment purchased by the Club, and members formed the opinion that they had made a good investment. Details of all the Club's programmes can be obtained from Mr. H. E. Saunders, 20, Nightingale Road, Hampton, Middlesex.

* * *

TO increase their membership the Brixton Tape Recording Club have had a number of colourful posters printed, which are to be seen on display at local libraries, the Town Hall and newsagents shops. Results so far regarding new members have been promising. The Club has been approached by Mr. Charles Standen, Organiser of the Tape Reading Service for the Blind, with a view to putting on tape complete monthly magazines, also a regular reading of "Which". Members readily accepted and arrangements are already under way. The Secretary has announced that many interesting evenings have been arranged, including demonstrations by H.M.V., Truvox and Stuzzi, on March 28th, April 11th and 25th, respectively. Mr. J. Kelly, 11, Anner Road, London, S.W.11, will supply any further details, if required.

* * *

The Cotswold Tape Recording Society made a practical start with its service for hospitals and similar institutions, when Mr. Peter Duddridge presented a tape with the title "Just Yours" at Sunnyside Home for Old People, Cheltenham. This consisted of messages recorded in the homes of relatives of those living in the Home, each followed by a tune selected by the relatives. The programme was greatly appreciated. Mr. Yeats, chairman, has also been visiting hospitals in Cheltenham with a battery recorder, and has been given special privileges with regard to visiting outside normal visiting hours. He takes messages to and from patients and their relatives. A variety programme by local artistes is due for recording shortly, and these will be presented to several local hospitals over their internal communication system. Details of future club meetings can be obtained from Mr. P. D. Turner, Cave Cottage, Oakridge Lynch, Stroud, Glos.

THE MAGNAFON ZODIAC

A NEW LOOK TAPE RECORDER FOR THE FAMILY

For Father — Electronic Equipment at its Best

For Mother — Tape Recorder that Blends with the Furniture and so simple to operate that the children can be left in safety without harm or damage occurring.

The Zodiac is Designed for the Family who want a Reliable Tape Recorder Incorporating all the Latest Equipment

MIXING ● TRICK CONTROL ● LARGE SPEAKER ● PAUSE CONTROL ● 3 SPEEDS ● TONE AND BASS CONTROLS MONITOR FACILITIES ● 7" SPOOLS ● HI-FI OUTPUT SOCKET

COMPLETE 39 gns. or 4 TRACK 45 gns. (legs 2 gns. optional)

GO TO YOUR NEAREST DEALER NOW AND SEE THE ZODIAC

MANUFACTURERS—MAGNAFON COMPANY OF LONDON

DISTRIBUTORS—R. MARKING & CO. LTD., 197 STREATHAM ROAD, MITCHAM, SURREY Tel: MITCHAM 4044/5



NEW... for High Fidelity Stereo and Monitoring ...
from

S.G. Brown

The "Super K" Headphones are the newest product of S. G. Brown Ltd., and are designed especially for High Fidelity Stereo requirements. They are attractive in appearance, extremely comfortable to wear and incorporate plastic head band and earpieces.

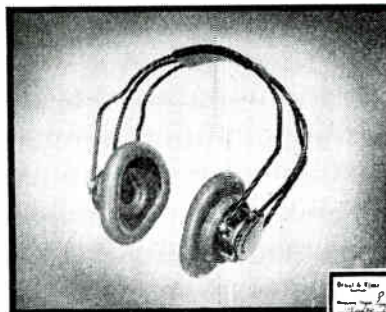

SUPER K Headphones

Span Nine Octaves!

The Frequency Response Curves right were produced under the following conditions.

BEAT FREQUENCY OSCILLATOR Type 1014 producing a signal of 2.5V. (modulated to 32 c/s with a swing of 30 c/s) to SUPER K EARPIECE, close coupled to ARTIFICIAL EAR Type 4109 with 6 cc. coupler, measured signal being amplified by MICROPHONE AMPLIFIER Type 2603 and recorded on a Type 2304 LEVEL RECORDER.

Recorded Medium shows Response flat ± 1 dB 20 c/s—6,000 c/s; 6 dB reduction to 8,000 c/s; 6 dB reduction to 12,000 c/s with continued reduction to 20,000 c/s. Nine octaves pianoforte coverage from 24 c/s to 7,800 c/s.

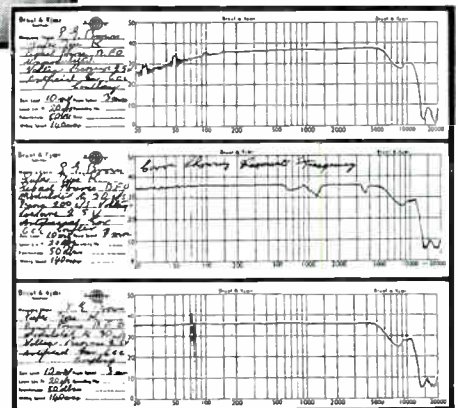

Write for full information to:

S.G. Brown

LTD. SHAKESPEARE STREET

WATFORD

HERTS

Telephone: Watford 27241

By John Borwick

GEAR CHANGING— on your recorder

THE advantages of fast and slow tape recording speeds are, in a word, *quality* for the former, and *economy* for the latter. Basically, therefore, we will use the higher speeds— $7\frac{1}{2}$ and 15 i/s—where quality is of prime importance, and the slower speeds— $3\frac{3}{4}$ and $1\frac{7}{8}$ i/s—when tape economy matters more.

But before outlining some of the tricks you can play by changing tape speeds, I would like to examine these relative advantages in a little more detail, since there is quite a bit more to them than we can put “in a word”. Taking the slow speeds first, our desire for economy is not prompted only by meanness. When sending tapes through the post, for example, we legitimately want to get the recorded material—family messages, instructions, business memoranda, etc.—on as small a reel as possible, and $7\frac{1}{2}$ i/s would then be wasteful. In the same way, when recording a play or other programme running over the hour or half hour spool duration, we may decide that the slight loss in quality at a slower speed is amply compensated by the avoidance of that enforced “interval” while we turn over the spools. Again, when making lots of outdoor recordings, there is a limit to the number of tapes we can conveniently carry, etc.

Quality

The arguments for using higher tape speeds may also be expanded from the single word “quality”. It is true that, within limits, fidelity reproduction of the full frequency range just cannot be obtained unless we use $7\frac{1}{2}$ or 15 i/s. But on top of this, the business of editing or building programmes with tapes is a good lot easier and more accurate at the higher speeds. Splicing tapes in such a way that the timing of the pauses, music entries and sound effects is artistically exact calls for split second cutting and joining, and this degree of accuracy is just not possible at $3\frac{3}{4}$ i/s or less.

Clearly, then, some situations call for high tape speeds and others for low—which presumably accounts for the emergence of the many multi-speed tape recorders now on the market. But, like everything else, this lack of standardisation has introduced not a few headaches. Overcoming these calls for what I term “gear changing”, and you’ll see what I mean from the following concrete examples, each of which is capable of variation to suit your own particular problem.

Changing Up . . .

Some months ago, I was taking part in a “Questions and Answers” session in the BBC series “Sound,” and a listener had submitted a tape-recorded question. He included some music recordings he had made for us to comment on, and the main part of his tape was recorded at $7\frac{1}{2}$ i/s. However, at one point it occurred to him that the BBC might not have $7\frac{1}{2}$ i/s tape equipment, so he interpolated one musical item for us to replay at 15 i/s—although he had no 15 i/s machine himself! He managed this by running his $7\frac{1}{2}$ i/s music tape at $3\frac{3}{4}$ i/s and re-recording this on to the $7\frac{1}{2}$ i/s tape he sent us. (I think he possessed two $7\frac{1}{2}$, $3\frac{3}{4}$ i/s Ferrograph recorders.) Therefore, when we ran this at 15 i/s, the music was restored to the correct pitch and tempo.

Ingenious, but another quite unexpected factor was introduced by this piece of gear-changing. We discovered that this 15 i/s recording actually sounded *better* than the other music at $7\frac{1}{2}$ i/s. After a great deal of discussion we decided that the quality improvement got through running the BBC machine at 15 i/s instead of $7\frac{1}{2}$ i/s had more than compensated for the loss in high frequencies—anyway equalised in the listener’s Ferrograph—when

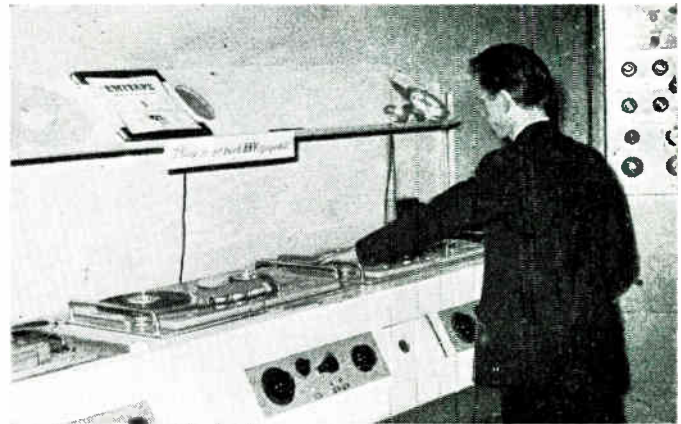

running at $3\frac{3}{4}$ i/s. In any case, we realised, running a tape originally recorded at $7\frac{1}{2}$ i/s at half speed would mean that all frequencies present were halved, and so the replay head would introduce less HF loss than usual.

. . . and Changing Down

Now let’s take an example in which we want to change *down* rather than up. Say the chap we’ve just been discussing had wished to correspond by tape with someone whose machine ran at the single speed of $1\frac{7}{8}$ i/s. To get round this one, he would record everything on to one of his machines at $3\frac{3}{4}$ i/s then replay this at $7\frac{1}{2}$ i/s, re-recording on to the second machine at $3\frac{3}{4}$ i/s. The resultant $3\frac{3}{4}$ i/s tape would be at double speed, and therefore come out right, when his friend replayed at $1\frac{7}{8}$ i/s. There is a real danger that some deterioration in quality will occur this time—during the $7\frac{1}{2}$ i/s playback. Assuming that the recordings included sounds over a frequency range of 50-10,000 c/s, the $7\frac{1}{2}$ i/s version would double up to 100-20,000 c/s. Inevitably, therefore, some of the high frequencies would be lost on replay. At the bottom end of the frequency scale too we are likely to be in trouble, since any mains hum—at 50 c/s plus harmonics—is raised an octave and so enters the range at which our ears are more sensitive.

Two more sources of noise, which we can normally ignore, have to be considered when we start gear changing, namely tape hiss and bias. Due once again to the shifting up or down the scale of octaves, a level of tape hiss which goes unnoticed on the original recording will sometimes become quite a nuisance when played or re-recorded at different speeds. The High Frequency bias which is mixed with the programme signal during recording, is of course supersonic—usually 40,000 c/s or higher—and therefore inaudible, but changing down a couple of gears will sometimes reproduce the bias as a continuous whistle, whose audibility will depend on the goodness of your ears and (tape) heads.

Gimmicky Gear Changing

So much for the sensible or necessary cases of changing tape speeds, but we might just finish with a few remarks on the various tricks you can get up to. Most owners of multi-speed recorders will have tried the effect of playing back their voice

(Continued overleaf)

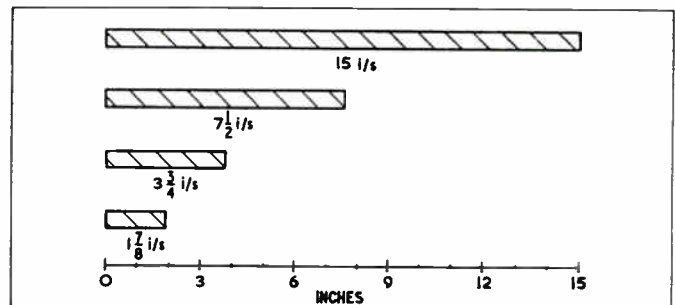

The four standard speeds—and the tape used by them.

Chitnis AUDIOGRAPH

STEREO AND MONO TAPE RECORDERS

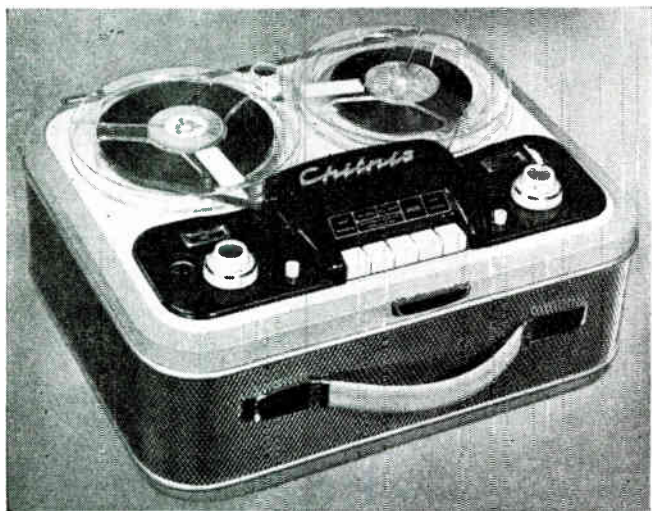

SEE THEM ALL AT THE
AUDIO FESTIVAL
BOOTH 50
DEMONSTRATION ROOM 117 OFFICE 116

If you cannot visit us at the Audio Festival, your local Audiograph stockist will gladly show you the latest range. In case of difficulties, we will gladly send you name and address of nearest stockist.

KM 22	Two-track, two speed (3 $\frac{1}{2}$ & 1 $\frac{1}{2}$ ips) mono with reel of tape.	48 gns.
KM 33	Two speed, four-track mono with reel of tape.	54 gns.
KMS 66	4-TRACK STEREO with second speaker in lid paired inputs (micro/radio/PU) and outputs (5 & 15 ohm and low level throughout. Pause, s/impose, etc. With reel of tape.	66 gns.
9/S4K	Illustrated above. Similar spec. to KMS/33 but with simple monitoring speaker only.	56 gns.
AF42	Popular two speed (3 $\frac{1}{2}$ /7 $\frac{1}{2}$), four-track recorder with microphone and tape.	39 gns.

Chitnis omni-directional and cardioid dynamic microphones (mono and stereo) available for above.

You get more for your money when you buy a

**Chitnis
AUDIOGRAPH**
QUALITY TAPE RECORDER

Distributed to leading stockists through wholesale houses

For latest leaflets, please write to

CHITNIS ELECTRONICS LTD. 66 BOLSOVER ST.,
LONDON, W.1
Euston 4264-5-6

RECORDER GEAR CHANGING—(continued)

at the wrong speed, and while the effect is quite amusing, that's about all you can say about it. However, an interesting variation is to pitch your voice down and speak slowly before changing speeds upwards, or vice versa, and you can create an entirely new voice for yourself and your family, which will keep friends guessing at a party, etc.

Pitch your voice up!

It is a variation of this idea, of course, which is used for the famous "Chipmunks" records. If you have two tape recorders, or one which gives continuous monitoring of one track while you record on another, you can get the same effect, by proceeding as follows: first record the accompaniment, plus any "grown up" dialogue, at your higher tape speed, then wind back to the beginning and change to the next lower speed. Now, start the playback and interpolate your "wee folk" voices, singing or speaking at your usual pitch, but at half speed. When the mixed recording is played back at the accompaniment's original speed, you will be *amazed* . . . and no doubt full of admiration for Mr. David Seville whose voice is used for *all* the characters on the Chipmunks' discs.

Try the Gimmicks at full speed!

It is sometimes suggested that amateur musicians can imitate virtuosos by recording themselves playing the piano, guitar, etc., an octave lower and at half speed—taking two minutes over Chopin's "Minute Waltz", for example. But the trick is given away on fast replay, by the fact that the instrument never sounds truly lifelike. The explanation is that all musical instruments have a different combination of overtones from note to note, so that Middle C has a different sound from the C an octave below played back at double speed. Provided you know what you are doing, however, there's no doubt that a two-speed tape recorder can more than double your enjoyment.

ORTOFON

The ultimate in pick-up head and arm design

Standard ORTOFON Cartridges Type C together with SMG 212 or RM 309 arms are used regularly by leading gramophone record companies for quality control on master discs as well as by leading European broadcasting authorities. These pick-ups are characterised by robust construction, and exceptional performance.

● NEW ORTOFON STEREO HEAD TYPE SPU

Gives true stereophonic reproduction without compromise, cross-talk or distortion. Fits standard SMG 212 arm with its calibrated counterbalance to give controlled needle pressure.

48 HOUR SERVICE
As the only authorised Ortofon Service Agents in U.K. TSL give 48 hour repair and stylus replacement service.

- OUTPUT 0.5V r.m.s. at 10 cm/sec peak velocity.
- IMPEDANCE 2.0 ohms.
- STYLUS TIP RADIUS 17 microns (0.00068 in.).
- STYLUS PRESSURE 1-4 grms.
- X-TALK - 20dB to 8 Kc/s - 15dB to 16 Kc/s.
- COMPLIANCE - 10 - 5cm/dyne.

From leading stockists. Literature from the sole trade distributors:

TECHNICAL SUPPLIERS LTD. HUDSON HOUSE
63 GOLDHAWK RD.
LONDON, W.12

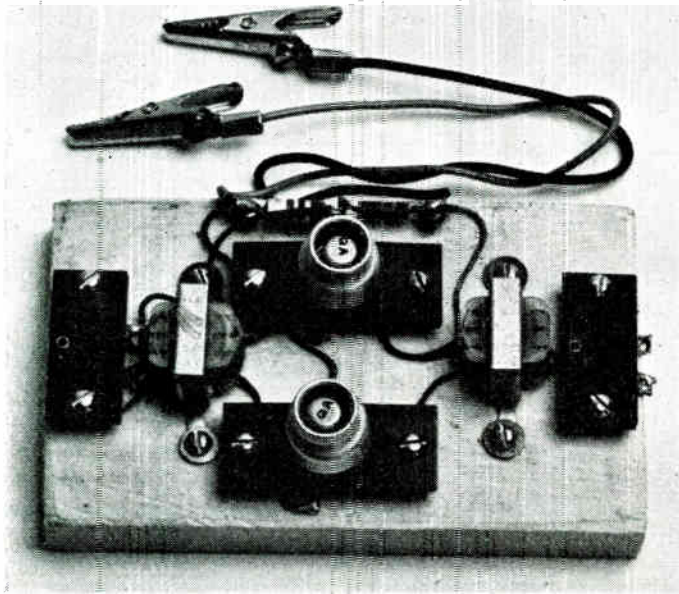

BUILD THIS REALLY PORTABLE RECORDER

PART 5 — TRANSISTOR POWER AMPLIFIER

THE output jack of the portable recorder described so far provides low level headphone monitoring, or checking of a recorded tape in the field. There are many occasions where loudspeaker playback would be useful. The design of the output stage depends on the purpose of the loudspeaker; if it is to be used at low level, by the operator only, to check the content of a recording, or to make sure that the recording is on the tape, with no great pretensions about quality or power output, then a simple power transistor and miniature loudspeaker may be added to the present outfit with little increase in weight or cost.

Fig. 1a shows the simplest possible circuit, using a 2 in. diameter speaker with an impedance of 700 ohms which is

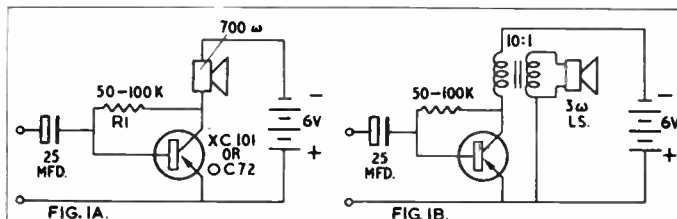

connected directly into the collector circuit of the Class A output stage. The speaker is sold by T.S.L. Ltd. Type CMS250. The transistor is an Edison Swan XC101 or Mullard OC72 with an H.T. voltage of 6 volts and R1 selected so that the collector current is 20 ma. Alternatively a more normal 3 ohm speaker may be matched to the transistor by a suitable 10 : 1 transformer. (Fig. 1b). If a 1 in. \times $\frac{1}{2}$ in. \times $\frac{1}{8}$ in. stack, similar to that used for the microphone transformer, is to be used, the core material should be Radio metal with 1,000 turns of 30 S.W.G. wire on the primary, and 100 turns of 20 S.W.G. as the secondary.

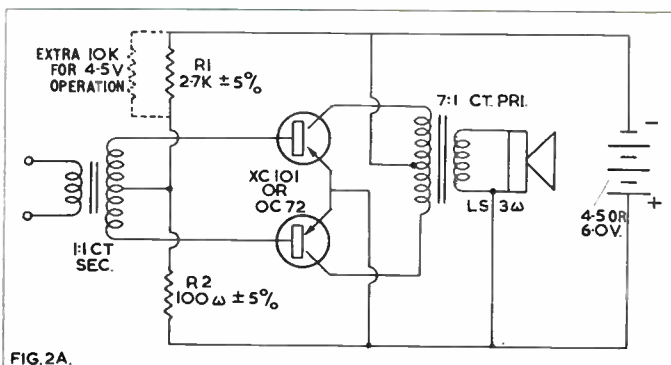

If an old Stalloy core speaker output transformer can be found in the junk box it may be stripped down and wound with the same number of turns. The E and I laminations should not be interleaved in this case but stacked with all the E's and I's together so that each leg of the core has a small air gap. A single layer of paper, about the thickness of this page, may be used to define the gap.

If several people are to listen to the playback, then a larger speaker together with a push-pull output stage must be used. The speaker should be as large and efficient as possible with a coil impedance of 3 ohms. A 5 in. \times 10 in. elliptical unit with a reasonably heavy magnet should be satisfactory, and should be housed, together with the power amplifier and battery, in a case or box which provides adequate baffle area and bass response. Fig. 2 and photograph, show the circuit and layout of a simple push-pull transformer coupled output stage which will deliver 330 milliwatts to the speaker for an input voltage of 1 volt, or a power input of about 2 milliwatts, into the primary of T.1.

The transformers used in my prototype are Radiospares T/T.1. Driver, and T/T.2. Output. The transistors are Edison Swan XC101's mounted in my kit 3 pin plugs and sockets, but Mullard OC72's can also be used. For those who would like to try and make their own transformers the following information is given as a guide: T.1. Primary 2,000 turns. Secondary 2,000 turns, centre tapped. Radio metal interleaved core or Stalloy gapped core as described above. T.2. Primary 750 turns, centre tapped 30 S.W.G. enamelled wire. Secondary 100 turns 20 S.W.G. As the primary DC currents cancel the laminations may be interleaved even with the Stalloy core.

The resistors R1 and R2 set the base potential of the transistors so that the total collector current is 10 ma. this operates the push-pull transistors in Class AB rather than the usual Class B where each transistor is biased almost to cut off. In Class B each transistor only draws current on one half cycle, and "cross over" distortion is very evident on a reasonably wide range loudspeaker. This can be reduced by negative feedback, but an extra stage is needed to make good the loss of gain. We are not concerned

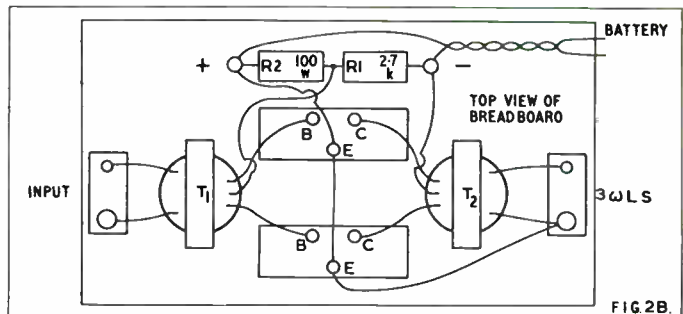

The **Tandberg Series 6** is a 'no-compromise' instrument capable of delivering consistently fine 'professional' quality when used with comparable amplifier and speaker systems

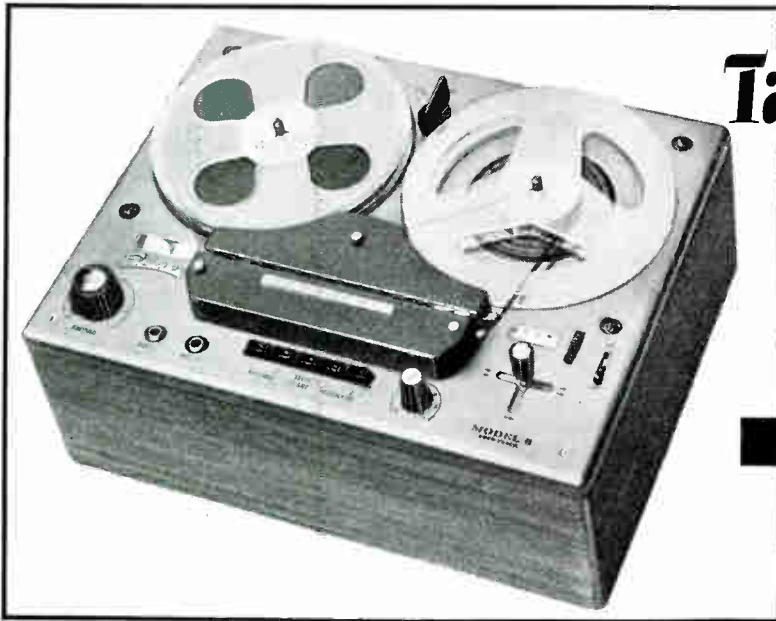

Tandberg STEREO TAPE DECK

3 Speeds 4 Tracks 3 Heads

Features include

*Free-Standing or Build-in Teak Cabinet
Flawless Technical Specification
High and low level mixer inputs & cathode follower outputs
Two Recording and Two Playback Amplifiers
"On and Off the tape" monitoring
Sound-on-Sound Simultaneous record and playback*

RETAIL PRICE 110 gns

FROM SPECIALIST TAPE RECORDER & HI-FI DEALERS

Tandberg GB ELSTONE ELECTRONICS LTD
EDWARD STREET · TEMPLAR STREET · LEEDS 2
TELEPHONE: LEEDS 3-5111 (7 lines)

Capture all the charm

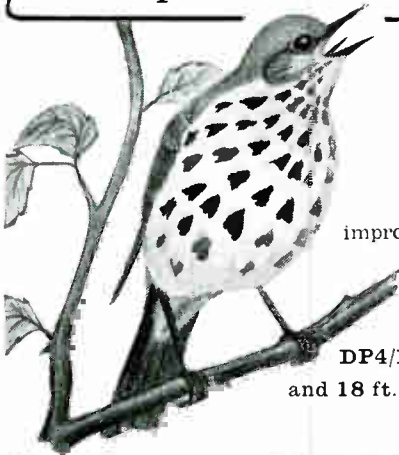

with a **Grampian DP4**

If you want better results from your recording equipment, this reliable, sensitive microphone is for you. It will give improved performance out of all proportion to its modest price.

With a uniform frequency range of 50 c/s - 15,000 c/s, the Grampian DP4 satisfies the most exacting recordist.

Ideal too for broadcasting, public address, call systems, etc.

DP4/L (low impedance) microphone complete with connector and 18 ft. screened lead - £7.11.0 Medium and high impedance models - £8.11.0.

A complete range of stands, swivel holders and other accessories is available.

A must for the outdoor recordist . . .

the Grampian DP4 Parabolic Reflector

The reflector is designed to concentrate sound from a distant source to a focal point - the Microphone head. Thus ensuring maximum amplification and realism with a minimum of interference from unwanted side noises. Price £5.15.0.

Write or telephone for illustrated literature.

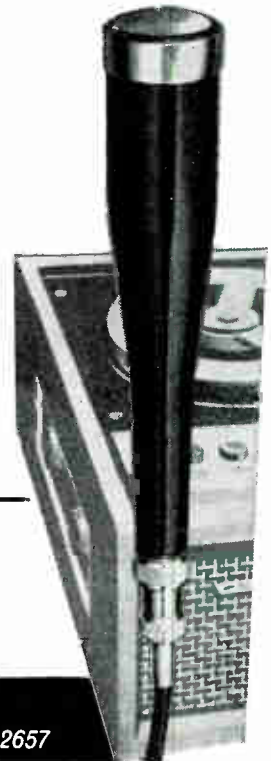

GRAMPIAN REPRODUCERS LIMITED

Hanworth Trading Estate, Feltham, Middlesex. FELtham 2657



FIELD TRIALS OF PORTABLES

THE NEW GRUNDIG TKI

★ These Field Trials began in November 1959, and have included all the battery portable recorders currently available—usually as soon as they made their first appearance—except for the expensive professional machines. For the benefit of new readers, we repeat that our Field Trials are by no means technical reviews. You will not find frequency range graphs, wow and flutter measurements, and the rest. We feel these to be less helpful in the present case since the popular transistor recorders do not claim the high fidelity statistics of their heavier *semi-portable* mains-operated relations.

Instead we have tried to answer such questions as “Can I really take it anywhere?”; “Can anyone learn to operate it easily?”, and “Are its tapes interchangeable with other machines?”. Some technical points will need mentioning, of course, but these will normally take second place to descriptions of the success or otherwise of actual recordings made under typical conditions.

HAVING heard that Grundig were planning to bring out a new transistorised portable tape recorder to cost a little more than their popular Cub machine, we had been looking out for the TK1 for some time, and welcomed the opportunity of putting it through its paces. Before we go any further, let us say that it out-performs the Grundig Cub in practically every respect. As soon as we had unpacked the TK1, opened up the sealed plastic bags containing the Ray-O-Vac leak-proof batteries, and fitted them inside the machine, we set out on our travels. The precincts of *The Tape Recorder* office (100 yards from Broadcasting House) have been featured before in these Field Trials, and as this month's photographs show, my colleague and I once again made this part of town our “field” of operations.

The first few recordings were made with the volume control set at a series of graduated readings, and we played this back as a check that the recording level shown by the recommended magic eye indications corresponded to the best volume for our purpose. There is no shoulder strap with the TK1, but it was found that the machine would perform perfectly satisfactorily resting on edge, on its back, or carried by the handle. A useful feature which has been suggested a number of times in these reports is some means of keeping the spools safely on the spindles when the machine is turned up to any angle, and the TK1 has solved this very neatly. A collar on the top of the spindle has three equi-distant shoulders, and when the spool is in position, this collar can be given a slight turn so that it holds the spools even when the machine is held upside down. As always happens on these occasions, our recording efforts—particularly the one of tyre squeals at a zebra crossing—made us a centre of attraction, and we were badgered several times to let people hear our recordings. This we did—even to a pair of traffic wardens—and can report that the built-in loudspeaker gives ample playback volume and surprising fidelity in view of its necessarily limited size. The tone control is by way of being an extra on a machine of this kind, and it was found that judicious use of this helped to give pleasant playback quality both in the middle of a busy street and back in the confines of the editorial office.

The appearance of the TK1 produced universal admiration, and it would appear to be the last word in the trend which has made portable tape recorders look more and more like ladies' handbags. The weight of the machine is appreciably more than



that of the Cub—8 lbs as against 5½ lbs—but this is a small price to pay for the improvement in loudspeaker reproduction, and compares favourably, after all, with the weight of many a handbag!

The lid has to be removed to get at the controls—which is something of a nuisance for on the spot recordings—and a recess has been included to house the microphone in transit. The controls are quickly mastered, comprising as they do two main knobs only. The left-hand control is the *function selector switch* with four positions as follows: rewind, off, playback, and record.

Anti-erasure safety lock

Beside this control is a white push button, and this must be depressed before the selector switch can be turned to the record position. This is intended as a safety measure to prevent accidental erasure, and although it is found on many mains operated recorders, it is less common on transistor models. Provision is not made for fast winding in a forward direction, but a moment's thought confirms that the rewind facility is the one which is most often required, and on 3 in. spools—maximum playing time 15 minutes per track on double play tape—it is a simple matter to reverse the spools and rewind if this is found to be necessary. Associated with the selector switch and placed centrally in front of the tape heads slot is a *stop bar*. This has the effect (once the selector switch has been moved to the playback or record position) of allowing the motor to turn but holding the capstan off the tape. Thus it is seen to be the equivalent of a pause control, but a useful extra is the fact that on depressing this stop button and sliding it forward, it will remain locked until such time as recording or playback is required, i.e. it behaves as a quick start device.

The second control knob has in fact two controls mounted on the same shaft, the outside control acts as *tone control* during playback only and *monitor loudness control* during recording. For recordings through the microphone, it will usually be best to turn this monitoring control fully anti-clockwise, so as to silence the built-in loudspeaker. During playback, it was found that advancing this control too far clockwise produced a hissing sound, and the best quality seemed normally to occur at positions up to half of the traverse. The inner control is the *recording gain and*

playback volume control and relies on a small red dot to identify its setting. The magic eye level indicator is situated at the top of the deck between the spools, and was found to give reliable readings. Two sockets on the right-hand side of the machine allow for programme inputs, connection to an external amplifier or loudspeaker, and the possible operation from an external 6-volt source such as a car battery.

Mike and Speaker Details

The standard microphone supplied with the machine is a dynamic type, extremely light and fixed to a 7-foot co-axial cable. There are two extra recording leads supplied, one of which incorporates a resistance designed to reduce the level of high sensitivity sources, such as the external loudspeaker sockets of a radio or gramophone, etc. An unusual feature of these leads is that one of them carries an extra pin to mute the TK1's internal loudspeaker, whereas the other one does not. This allows some choice in the matter of monitoring, since certain situations will make it necessary to monitor on the loudspeaker belonging to the source, whereas in other circumstances, e.g., when recording from a gramophone pickup direct, the TK1's loudspeaker must be operative. After collecting a variety of sound effects using the microphone, a number of trial recordings were made from the radio, and from the telephone—Grundig include a telephone adaptor in their list of accessories—and in all cases very good recordings were obtained without any difficulty or the need for specialised knowledge.

Other Kinds of Playback

The really acid test, on which many transistor machines show up badly, is to play back their tapes on a superior semi-professional recorder. This was done and found to give excellent results. The usual trouble, namely noise from the transistor recorder's motor, was completely absent. The effect was also tried of playing tapes from a number of other machines on the TK1, listening through hi-fi apparatus, and the standard of inter-changeability was found to be all that one could wish. The leak-proof batteries as supplied give a working life of approximately 20 hours, but it must be said that this figure depends very much on how the machine is used. In particular, it assumes that the batteries will be “rested” for anything up to 24 hours between spells of usage. The present field trial involved family recordings over a period of a week in addition to the original street session, and a second set of batteries became necessary due to the popularity of the machine, and the fact that many of the recordings were played back several times over.

The Cub Compared

The above notes have been written without reference to the earlier Field Trial of the Grundig Cub, but it may be useful to give the main differences between these two Grundig machines. First, the TK1 has 7 transistors against the Cub's 5, and has in addition a magic eye level indicator. The frequency response of the TK1 is much better than that of the Cub (80 to 8,000 c/s as against 150 to 5,000 c/s) and the power output has been increased 2½ times. The TK1's loudspeaker is also larger than that of the Cub, but by far the most important point of difference relates to the actual running speed of the tapes. As many readers will know, the Cub drives the tape by the pull



of the take-up spool, so that the actual speed at which the tape passes the recording head is continually increased as more tape accumulates on the take-up spool. Whereas this is serious only when tapes are to be exchanged with standard machines, there is no doubt that many users would feel it a considerable limitation. The TK1 reverts to the standard practice, and a drive capstan is employed giving a fixed speed of 3½ i/s (indeed a centrifugal switch ensures constant speed even for varying conditions of tape loading and battery freshness).

Summing up therefore, we can say that the Grundig TK1 makes a first rate collector of sounds for the enthusiast who also possesses a heavy mains machine, and it may also be recommended to anyone who has neither the financial or space resources for a mains job. Incidentally, we learn that a mains conversion unit is to be available for the TK1 (one already exists for the Cub) so that mains operation is possible.

John Borwick

Technical Specification

Battery complement: 4 × 1.5 v Monocells, Leak-proof Ray-O-Vac Industrial Type 3LP; 2 × 1.5 v Monocells, Pay-O-Vav Type 1 LP. **Battery Life:** 20 hours approx. One motor, consumption 200 mA approx. **Transistors:** OC74, 3 × TF65, 2 × OC72, OC602 special. **Level indicator:** DM71 magic eye. **Tape speed:** 3½ i/s. **Frequency Response:** 80-8,000 c/s ± 3 dB. **Signal to Noise Ratio:** 40 dB. **Recording Sense:** International twin track. **Output Power:** 250 mW. **Loudspeaker:** 5 ohms, 4-in. **Maximum Spool size:** 3 in. **Playing time:** 2 × 15 mins., using Double Play tape. **Fast Wind Back.** Straight-through amplifier facility, with monitor level control. **Tone control.** Printed circuit amplifier. **HF Bias:** 40 Kc/s. **Dimensions:** 11½ × 7 × 4½ in. **Weight:** 8 lbs. with batteries. **Price:** £30 9s. including GMIL dynamic microphone, reel of tape, 2 connecting leads—for high and low level inputs, and set of batteries.

Manufactured by Grundig (Great Britain) Ltd., Newlands Park, Sydenham, London, S.E.26.

This is the tape YOU need

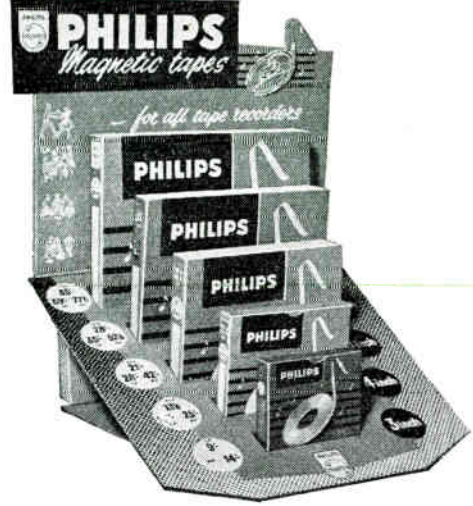

No matter what you want to record . . . no matter which tape recorder you use . . . for results that do complete justice to the original sounds, use Philips Tapes. Why are they so outstanding? Just look at these advantages:

- Great sensitivity and wide frequency range.
- Low noise level and unvarying high quality.
- Strong pvc base—resistant to stretch or snapping.
- Powerful adhesion of magnetic coating.

Available in 3", 4", 5", 5½" and 7" reel sizes: the last three sizes are packed in durable books designed for convenient storage and quick reference. Philips Tapes are made in three types: standard, long-play, and double-play.

Look for PHILIPS TAPES

in the new handy dispenser

We look forward to seeing you on STAND No. 6 at the International Audio Festival at the Hotel Russell, April 6-9

PHILIPS TAPES ARE A PRODUCT OF
PHILIPS—the friend of the family

PHILIPS ELECTRICAL LTD · CENTURY HOUSE
 SHAFTESBURY AVENUE · LONDON · WC2
 (PR3600A)



THE BUTOBA MT5

the battery operated machine
 with mains operated performance

ONLY THE BUTOBA HAS ALL THESE FEATURES

69 GNS. Incl. 5" tape, connecting lead and moving coil microphone.

Experts are unanimous in acclaiming the Butoba as the finest machine of its kind on sale today.

- 5 in. tape, giving up to 4 hours playing time.
- High fidelity frequency range.
- 7 in. x 5 in. speaker and 1 1/5 watts output.
- Adjustable treble control on recording and play back.
- Mixing.
- Monitoring of both radio or mike recordings.
- High quality steel deck, life lasting ball bearings and dynamically balanced 5 in. flywheel all give lowest wow level and flutter.
- High sensitivity level.
- Extremely low noise level. No more than on expensive mains machines.
- Light in weight—12 lbs. complete with batteries. Economic battery life—up to 100 hours.
- Mains converter for home use.
- Prompt service facilities.

Advance details of the Butoba and accessories, including carrying case available on request from:

DENHAM & MORLEY LTD.,
 DENMORE HOUSE, 173-175 CLEVELAND STREET, W.1. TEL: EUSTON 3656-7

SEE IT ON STAND 52
 HEAR IT
 IN DEMONSTRATION ROOM 321

HOME-BUILT RECORDER—(continued)

with extreme battery economy, and the slightly higher quiescent current is a small price to pay for the higher gain and lower distortion of the Class AB stage.

With 6 volts H.T. an output of 1 volt across the 3 ohm speaker (330 milliwatts) is obtained for an input voltage of 1 volt RMS. With an H.T. of 4.5 volts the standing current falls to 5 ma and slight "cross over" distortion may be evident. R1 should be shunted with an extra 10K resistor so that the total collector current is again raised to 10 ma. With the lower H.T. voltage the maximum undistorted output is about 150 milliwatts, and the peak input voltage required is .5 volt R.M.S.

The portable recorder output jack will only deliver .5 volt R.M.S. into the primary of T.1. without distortion, so there is little point in using 6 volts H.T. on the power amplifier as the distortion is set by the driver stage. If, however, R4 in the portable recorder amplifier is shunted with another 10K resistor so that the total collector load is 5K then more drive power is available, and the driver stage and the power output stage overload together at a power output of about 250 to 300 milliwatts. The change in R4 does not affect the recording capabilities of the recorder amplifier.

With an efficient loudspeaker 300 milliwatts gives adequate volume, and this output will just be reached with peak recorded tape so that no gain control need be fitted. If peak acoustic output is required from the slightly under recorded tapes obtained on the portable recorder, an extra driver stage may be added as

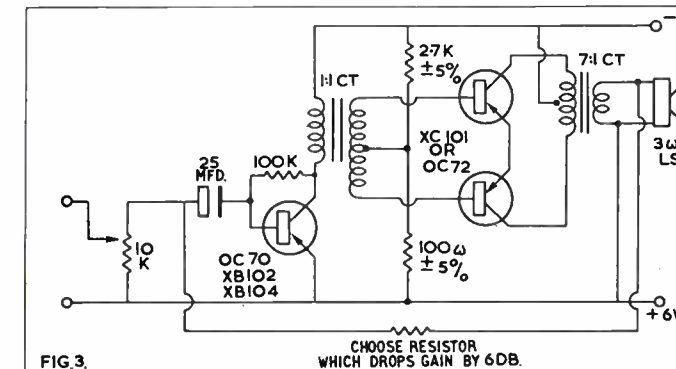

shown in Fig. 3. A little negative feedback is applied to reduce distortion to the lowest possible level at medium power outputs.

I personally favour the middle choice, with the fixed gain and the tape and amplifier overload coincident. A quick check on a given recording will soon show whether the tape is recorded at the correct level. With the 6 to 10 dB margin below tape overload mentioned in Part 1, amplifier and tape overload will be a very rare occurrence and under recording will be made obvious by poor playback volume. With the higher gain power amplifier and gain control the fact that the tape is under recorded may not be discovered until the tape is critically reviewed under more favourable conditions at home where tape noise may now be audible.

When the push-pull output stage has been assembled it should first be fed from the Ext. L.S. terminals of a good quality radio or tape recorder with the internal speaker switched off so so that the quality of the transistor output may be judged on its own loudspeaker with little possibility of driver stage distortion. If R2 is shunted with 100 ohms or less "cross over" distortion will be very evident even at low volume as a kind of "buzzy" quality. If this distortion persists with the specified resistance values then R2 may be increased, or R1 decreased by not more than 10 per cent. until the distortion disappears. This method may be used when no milliammeter is available to set the total collector current to 10 ma. At peak output the current will rise to 50 - 60 ma. If pure tone is being used for testing do not maintain overload for more than a few seconds as the transistors may exceed their rated dissipation. It will be found that after sustained overload the quiescent no signal current will be high for a short time until the transistors cool down. It is possible to permanently damage the output transistors by vigorous overload for long periods.

A. Tutchings

Two (nearly) Blackeyes!

THEY all know me at the tape-recorder shop. I'm the girl who bought a brand new TK.20—and blew it up the same day. They were very kind; telling me that there had been one other isolated instance in the history of sound when another poor soul had done the same thing. Nevertheless, I hang my head in shame with the memory of the day I plunged all my savings into tape.

Having chosen the model—because I liked the look of it—the young man in the shop went to endless trouble to explain the works to me. Unfortunately I was too excited to listen; my mind was busily planning how I could improve my piano playing, and exploring the possibilities of a new world of endless music. I handed over my entire bank balance, and received the instruction book, on a concert platform somewhere in the clouds, and walked out with my prize. At home—the explosion shattered my dreams as I happily plugged the machine into the mains—via the extension speaker sockets.

Blast Number Two

That was the first time. After settling the bill: 1 output transformer and labour charges £2 1s. 6d. I had only just time for a quick giggle into the microphone, when the second blast rocked the foundations of my home. Whilst waiting for the prodigal to return from the workshop, I had studied the book of instructions with avid concentration. Recognising the inadequacy of recording from gramophone discs by method A, I took my record player to a radio shop for adaption to method B; according to the mechanic this was impossible, so settled for method C. After three weeks, the record player was returned to me with a long trail of flex protruding from some obscure origin under the turntable.

At last—with the return of the Grundig—I was all set to record Brahms Violin Concerto from a borrowed disc. This was it! My pipe dream was about to materialise. Following the directions: "Connect the record player with a screened lead to the correct input on the recorder" I began the operation with a methodical attention to detail that would have done credit to the most fastidious scientist. The blast which followed, naturally came as a severe shock to my nervous system. With a wild shriek, I pulled the offending connection from my precious tape recorder, (fortunately without touching the metal plug on the end), and retired to the other side of the room.

Half an hour lapsed before I could recover my composure sufficiently to approach the scene again; then closing my eyes tightly, I switched the thing on at arms length. The roof did not fall in, the room remained silent and stationary—and bliss! The magic eye winked at me.

Splendid Isolation

Later I learned that the radio technician—sadly lacking initiative when fitting the screened lead—had failed to notice that the player was an AC/DC machine. He had not taken the necessary safety precautions of providing an isolating transformer. Had I grasped the metal plug in my haste instead of the flex, my fate would have been sealed at the receiving end of 230 volts.

Technically speaking I am still a "square"; but by learning the hard way, I now have an excellent recording of Brahms Violin Concerto. Miss V.J.

TAPE RECORDERS · AUDIO EQUIPMENT · DISC CUTTING STD & LP FROM TAPE · STUDIO FACILITIES · HIRE SERVICE · SALES · EXCHANGES

MAGNEGRAPH

1 Hanway Place, London, W.1

Tel: LAN 2156

HOW WE PUT THE WEST END ON TAPE (2)

IN my first article on this feature tape, I described a couple of failures and a couple of moderate successes in our Saturday evening jaunt. This second half, I regret, contains even more failures and less successes. In one way it is a pity, but from this abundance of failures we learnt quite a lot.

Our first job was to summarise the material we had, which was precious little. Luckily we had a few bits and pieces of London recordings in "stock", taken on previous outings, which we added. These were some traffic noises, with Big Ben in the background; a London pub with piano; an open air market; a band in the park; soldiers marching with a band, and some other odds and ends. But our theme finally came from the remarks made by the old chap in Regent Street, who talked about the difficulty of keeping alive in London at times. Also a casual sentence from the "carnation man" who said "I can always make a living".

From here it was not such a difficult step to a theme illustrating and contrasting several different ways of life. People who lived easily—or people whose life was difficult. Such a theme is very wide, and hence we had to limit it to subjects on which we had material.

The final tape

The tape started with Big Ben, and we mixed into this the title "Living and Partly Living—A study of life and ways of living in London". The commentary throughout was done alternately by Harry and myself, and we tried to give ourselves the subjects and dialogue best suited to our voices. This helps, in a small way, to a more acceptable finished result.

After we faded Big Ben, Harry introduced the first subject, which was "Living by Selling". This we followed by a poem, "The Caledonian Market", by William Plomer. This poem, and the second one introduced at the end of the feature, provided some contrast in the illustrating material. If it seems a strange procedure to speak poetry in the middle of a feature tape, consider whether it is absolutely necessary to use only recorded material. The idea is to illustrate, by appropriate means, a set theme, and if a poem, or piece of prose, a dramatic excerpt, or some such will perform this function, I see no reason why it shouldn't be used. All available material, surely, is grist to the mill. Often a poem will add to a recording, will improve it. Let me suggest you try mixing together a recording of a train, and a reading of "The Express", by Stephen Spender. I feel such a combination would provide an interesting, imaginative, and unusual sound picture. There is a great deal of lyrical poetry made for such combinations—and a lot of good prose as well.

However, in our case, we followed the poem with an actual market recording, using only enough of each to give the listener time to appreciate the picture, but not time to get bored. It is a great temptation to use a long length of a certain recording, just because it provides a mass of personal associations. The listener, however, not having those associations, will soon get bored with too much.

From our "selling", we changed to a completely different type of life, the military. We had a recording of marching



Some interviewees are more "forth-coming" than others.

soldiers and a band in the Mall, with some taxi-horns making themselves obvious at times. These taxis provided us, *en passant*, with another way of life.

The military music led us to music in the park, with a little connecting dialogue, which itself led us to a section on entertainment. We had no recordings of plays in London theatres, so this section was mainly concerned with the Pub piano-player, and the rock 'n' roll coffee-bar guitarist. The dialogue was as light as possible. "Entertainment; Relaxation; While some 'live it up', others work, in pub and coffee-bar". This was quite sufficient, as the recordings were then self-explanatory.

A contrast

After this lighter section, we turned to a more serious side of life, using the recording made in Regent Street. To introduce this, I again used the title, plus the previous line of the play from which it comes, T. S. Eliot's "Murder in the Cathedral". The lines are: "And meanwhile we have gone on living; living and partly living".

It was our opinion that this old chap was, by comparison, only "partly living". He told us of the difficulties of getting along, and why he found it necessary to sell matches and bootlaces as he did. Although the actual conversation was quite long, we had to cut out a great deal, in order to stick to the point.

We passed from him to those people who attempt to tell us how to live, and used a recording taken at Speakers' Corner, and the chap with the placard already mentioned.

The next piece of dialogue, "One can, of course, find the inevitable optimist", introduced our friend of the carnations, telling us how he could always make a living. This was followed, with some script of living and dying, by our recording of the ambulance.

The ending

By this time we were practically at the end of our material, and so we concluded with the first four verses of a fifteenth century poem "In Honour of the City of London", by William Dunbar. These verses are very apt, and end in a rather, to me, exciting way: "O town of towns! Patron and not compare, London thou art the flower of cities all!"

We then faded in Big Ben again, and a closing announcement. The subject is, obviously, far more extensive than this small consideration, and would take years of research to cover completely, but this documentary of ours shows a few of the problems of living in London, and a few aspects of the people who live there. The total length was fifteen minutes—a fifteen minutes which contained a great deal of material by comparison.

I hope that these two articles have been of interest, have given you a few ideas, and provided an insight into our way of producing documentary.

UNUSUAL SINGLE SPEAKER SYSTEM

An inexpensive column speaker constructed from a concrete pipe and fitted with a good 8" or 10" unit has attracted much interest and admiration because of its clean, open sound.



A CONCRETE COLUMN

Complete kits of wooden fixtures are available including absorbent wadding and diffusing cone.

Price £3-15-0 for 8" model

Recommended 8" unit—8/145

£6-19-11 including purchase tax

Price £4-18-0 for 10" model

Recommended 10" units—W.10 FSB £12-9-10

Golden/FSB £8-6-7 10" Bronze FSB £5-5-11

Prices include purchase tax.

Suitable concrete pipes can be purchased from builders' merchants at about 12/6d and 17/6d



IDLE BRADFORD YORKS

Grams: "Wharfedel" Idle Bradford

Phone: Idle 1235/6

Reslo

for the highest quality
sound reproduction

RIBBON

TYPE CR

15 dB average
front to back
discrimina-
tion.



RIBBON
MICROPHONE

You will be
very welcome
on stand No. 19
& room No. 355 at
INTERNATIONAL
AUDIO FAIR

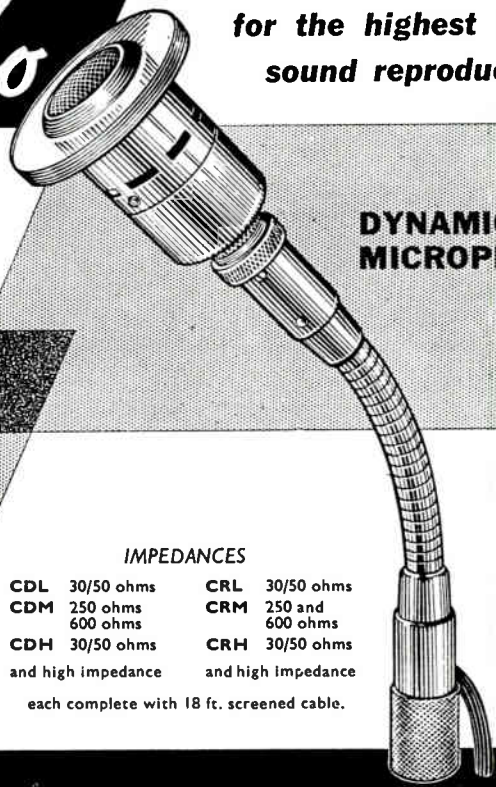

DYNAMIC
MICROPHONE

IMPEDANCES

CDL 30/50 ohms	CRL 30/50 ohms
CDM 250 ohms 600 ohms	CRM 250 and 600 ohms
CDH 30/50 ohms and high impedance	CRH 30/50 ohms and high impedance

each complete with 18 ft. screened cable.

DYNAMIC
TYPE CD

Baffle-fitted to
increase
sensitivity by
3 dB over the
whole speech
frequency range.

RESLOSOUND LIMITED
sales division



24 UPPER BROOK STREET · MAYFAIR · LONDON · W1
telephone HYDE PARK 2291/2/3 · cable DERRITRON · LONDON

owners of portables—be warned!

ABOUT a year ago I bought a small, battery-driven portable recorder. It cost me between £25 and £35, and it soon became a most popular "toy" in the home—apart from doing the various useful jobs for which I purchased it. In fact it became so popular that the inevitable happened. A relative begged me to lend it to her for a week and, caught in a weak moment, I succumbed. The week became a month. I then went away on my annual holiday, and the month became two. She then went away for her holiday, and eventually I got my "baby" back, together with a charming and disarming smile and a profuse apology, nearly five months after we had kissed it goodbye.

I knew something was wrong the moment I gripped it to take off the back an hour or so later. It was sticky. The cover came off reluctantly, as though ashamed to show me the worst. And it was the worst. Two of the cells fell out when touched, together with their brass clips. The remainder were sitting in a glutinous, slimy puddle. The contacts in the recorder were covered with a thick blue-green coating of corrosion. The first of these fell away when pressed; the second hung on by an eighth of an inch of remaining metal. That, however, was only the beginning. The puddle had leaked through into the electronics weeks earlier. A screwdriver revealed the same scene of havoc within. The recorder was finished. Being a keen constructor, I salvaged the transistors, the tape head and the motor and deck mechanism. The remainder went straight into the dustbin.

If you own a small, battery-driven, transistorised tape recorder, and if you have not used it for a week or so, please put this magazine down right away and inspect it. Look at its dry cells and make sure that they are labelled "Leak Proof". If they are not, throw them away at once and replace them. Most (probably all) manufacturers specify leak-proof cells: unfortunately many users do not realise the importance of that warning. I hope that my sad experience will underline its urgency.

To couple this warning with a more interesting topic, however, I am adding details of a completely new cell which I have just discovered, and which other readers will probably like to hear about. It is made in the U.S.A., but I understand that it is now available on the English market. It is known as the "Ray-O-Vac Industrial Leak-Proof Battery". It is claimed to have an exceptionally long life, compared with many other batteries, and I believe that Grundig have adopted it for their new T.K.1 which is just about to appear on sale.

We endorse the above writer's warning about leak-proof batteries for portables; and although these cells are usually specified very clearly by manufacturers, this is not the first

THERE ARE SEVERAL TYPES OF LEAK-PROOF CELLS ON THE MARKET—USE NOTHING ELSE

story we have heard about damage resulting from the careless use of other types. The "Ray-O-Vac" cell is already well-known in this country, but the model mentioned is indeed new, and we can confirm that Grundig have specified it (and are supplying it) for the new T.K.1. So, we understand, are E.M.I. for their professional portable, the L2 (now renamed the RE321 in its new version). This latest "Ray-O-Vac" cell should not be confused with previous cells by that name, and is known as the 3LP. Its full title is "Industrial Leak Proof".

We requested details from the makers, which they supplied to us, together with a report of a test carried out by a Grundig engineer. As will be seen, these figures confirm a very considerable increase of working life, compared with a standard cell which was also tested. In fact the new cell not only appears to be able to take a much harder punishment, but provides nearly twice the service in spite of it. Printed below (left) are the tables of the tests, and below is a cut-away drawing which shows the method of construction and the essential components of a leak-proof dry cell.

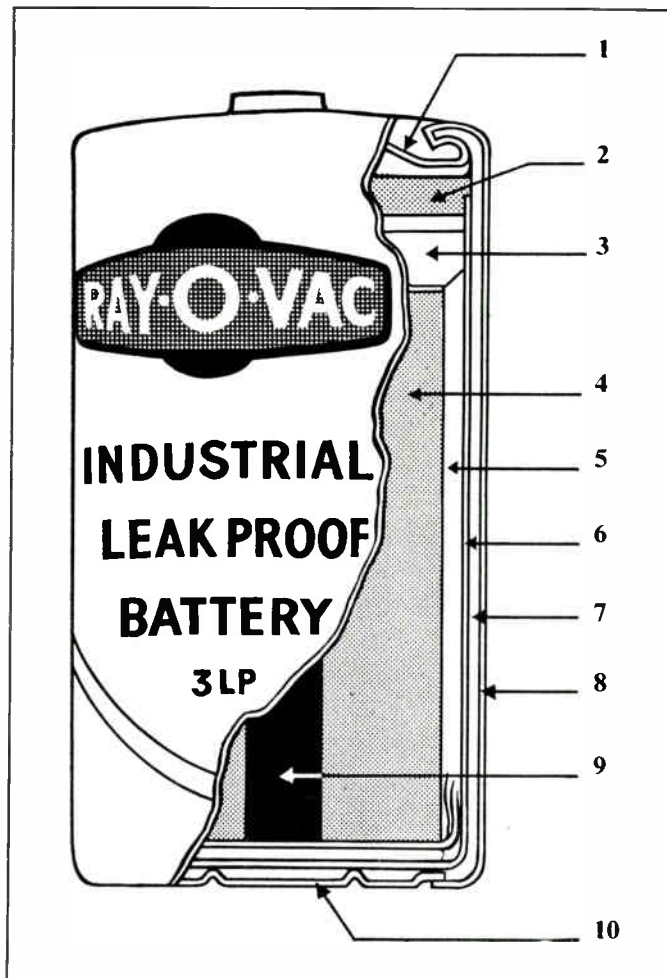

1. Steel top cap. 2. Plastic seal. 3. Air space. 4. Manganese dioxide. 5. Electrolyte. 6. Zinc. 7. Bitumen tube insulator. 8. Steel jacket. 9. Carbon rod. 10. Steel bottom plate.

TEST RESULTS

Ray-O-Vac 3LP

11 hours continuous down to 1.1 volts per cell.
 24 hours rest
 2 hours continuous down to 1.1 volts per cell.
 24 hours rest
 1½ hours continuous down to 1.1 volts per cell.
 14½ hours service.

Standard Cell (another manufacturer)

4 hours continuous down to 1.1 volts per cell.
 24 hours rest
 2½ hours continuous down to 1.1 volts per cell.
 24 hours rest
 1 hour continuous down to 1.1 volts per cell.
 7½ hours service.

9 Months to Pay

	Deposit £ s. d.	9 Monthly Payments £ s. d.	Cash Gns.
MAINS TWIN-TRACK			
Argyll Minor ...	2 6 3	2 6 3	22
Geloso G.256 ...	2 16 6	2 15 7	26
Robuk RK3 ...	3 15 0	3 15 8	36
Minstrelle ...	4 2 0	4 1 11	39
Spectone 171 ...	4 2 0	4 1 11	39
Allegro ...	4 8 6	4 8 2	42
Grundig TK20 ...	4 8 6	4 8 2	42
Victor ...	4 15 0	4 14 6	45
Spectone "161" ...	5 2 11	5 2 11	49
4-TRACK			
Stuzzi ...	2 16 6	2 14 6	26
Argyll 4-T ...	3 5 1	3 5 1	31
Elizabethan FT1 ...	3 11 5	3 11 5	34
Phillips EL3541 ...	3 11 5	3 11 5	34
Stella ST 454 ...	3 17 9	3 17 9	37
Sound ...	4 15 0	4 14 6	45
Elizabethan FT3 ...	4 15 0	4 14 6	45
BATTERY			
Clarion ...	2 15 0	2 12 3	25
Grundig TK1 ...	3 1 0	3 0 11	29
Trav-ler ...	3 1 0	3 0 11	29
Clarion Mk. 2 ...	3 9 4	3 9 4	33
Minivox "C" ...	4 6 1	4 6 1	41
Walter (Battery/ Mains) ...	5 15 6	15 6	55
Ficord IA ...	6 3 11	6 3 11	59
Stuzzi Magnette ...	6 3 11	6 3 11	59

Open all day Saturday—
Friday 6.30 p.m.

THE RECORDER CO.

(Dept. R) 188, WEST END LANE, WEST HAMPSTEAD, LONDON, N.W.6.

Telephone: SW1 4977

Have You tried them ALL? —We have!

Having tested and assessed the characteristics of every type of tape recorder sold in Britain over the past 7 years we are in an unrivalled position to assist you to the best possible marriage of what you want with what you want to pay.



★ FREE INSURANCE COVERING YOUR PAYMENTS
IN THE EVENT OF SICKNESS OR UNEMPLOYMENT

★ FREE DELIVERY

★ PART EXCHANGES

18 Months to Pay

	Deposit £ s. d.	18 Monthly payments £ s. d.	Cash Gns.
MAINS 2-TRACK			
Telefunken 75/15... 9 18 0	2 5 6	47	
Truvox R6 ... 11 15 0	2 11 2	55	
Brenell 3 Star ... 12 4 0	2 14 0	58	
Grundig TK25 ... 13 2 0	2 17 10	62	
Brenell Mk. 5 ... 14 4 0	2 18 11	64	
Elizabethan Major 14 5 0	3 0 0	65	
Grundig TK30 ... 14 5 0	3 0 0	65	
Grundig TK35 ... 15 15 0	3 10 0	75	
Truvox R7 ... 15 15 0	3 10 0	75	
Telefunken 85KL ... 17 19 0	3 12 3	79	
Ferroglyph 4A/N... 18 1 0	3 14 6	81	
Simon 5P/4 ... 20 0 0	4 8 8	95	
Reflectograph "A" 22 5 0	4 17 6	105	
4-TRACK MONAURAL			
Wyndor Victor ... 10 9 0	2 5 7	49	
Grundig TK24 ... 11 11 0	2 11 4	55	
Telefunken 76 ... 12 7 0	2 12 10	57	
Phillips EL3542 ... 12 8 0	2 15 1	59	
Stella ST455 ... 12 8 0	2 15 1	59	
4-TRACK STEREO/MONAURAL			
Korting ... 14 8 0	3 3 4	68	
Telefunken 77K ... 17 17 0	3 19 4	85	
Harting H.M.8 ... 18 6 0	4 0 0	86	
Phillips EL356 ... 19 12 0	4 5 7	92	

If unable to call, write for free brochures or send deposit now for quick delivery.

FRANCIS OF STREATHAM

● TAPE RECORDERS AT 169/171

Korting MT 157 4 Tr., 2 speed, full stereo with monitor head and amp.	85 gns.	*Simon SP4 ...	95 gns.
*Brenell Mk. V ...	64 gns.	Spectone 161 ...	49 gns.
Brenell 3 Star 2 or 4 Tr. ...	58 gns.	Stellaphon 4 Tr. ...	37 gns.
Brenell 3 Star Stereo ...	89 gns.	Stellaphon 4 Tr. ...	59 gns.
Coscor 4 Tr. ...	37 gns.	Stuzzi 4 Tr. ...	27 gns.
Coscor 4 Tr. ...	59 gns.	Stuzzi Tri-Corder ...	63 gns.
Elizabethan FT.1 4 Tr. ...	39 gns.	*Telefunken 85KL ...	79 gns.
Elizabethan FT.2 4 Tr. ...	55 gns.	Telefunken 76 4 Tr. ...	60 gns.
Elizabethan 'Popular' ...	19½ gns.	Uher Universal ...	79 gns.
*Elizabethan Major ...	65 gns.	*Uher 4 Tr. Stereo ...	103 gns.
*Ferroglyph 4AN ...	81 gns.	*Vortexion WVA ...	£93.13.0
*Ferroglyph 4AN/S ...	88 gns.	*Vortexion WVB ...	£110.3.0
*Ferroglyph 808 ...	105 gns.	Wyndor Victor ...	45 gns.
Ferroglyph Stereo-Ad ...	30 gns.	BATTERY PORTABLES	
Fidelity Argyll ...	29 gns.	Butoba ...	69 gns.
Fidelity Minor ...	22 gns.	Documentor ...	43 gns.
Grundig TK20 ...	42 gns.	Grundig 'Cub' ...	26 gns.
Grundig TK24 ...	55 gns.	Clarion ...	25 gns.
*Grundig TK30 ...	65 gns.	Clarion Twin Set ...	8 gns.
*Grundig TK35 ...	75 gns.	Minivox ...	37 gns.
*Grundig TK60 Stereo ...	128 gns.	Minivox 2 speed ...	41 gns.
*Harting HM8 Stereo ...	86 gns.	Fi-Cord 101 ...	53 gns.
H.M.V. ...	£50	Stuzzi 'Magnette' ...	59 gns.
Magnafon ...	39 gns.	Steelman ...	55 gns.
Marconiphone No. 1 ...	39 gns.	Trav-Ler ...	29 gns.
Marconiphone No. 2 ...	42 gns.	Walter Metropolitan ...	55 gns.
Phillips 4 Tr. 3541 ...	34 gns.	* Microphone extra	
Phillips 4 Tr. 3542 ...	59 gns.	Batteries for all transistor requirements	
Phillips 4 Tr. Stereo 3536 ...	92 gns.		
*Reflectograph 'A' ½ Tr. ...	105 gns.		
*Reflectograph 'B' ½ Tr. ...	115 gns.		
Reflectograph Playback Deck 'D' ...	55 gns.		
Robuk ...	36 gns.		
Saba 4 Tr. Stereo ...	65 gns.		
*Saba ...	79 gns.		

WE SPECIALISE IN

- Tape to disc service
- Tape copy service
- RECORDER HIRE SERVICE

LEADING STOCKISTS OF EQUIPMENT FOR TAPE, DISC and RADIO ... and NO EXTRA FOR CREDIT TERMS

- ★ Minimum Deposit
- ★ No Interest or Service Charges on H.P. up to 18 months
- ★ Free Service during Guarantee Period

Prices subject to alteration as announced by manufacturers.

● MICROPHONES AND MIXERS

Grampian DP/4 Dynamic	£8.11.0
Lustraphone VR/65.NS	£15.15.0
Stereo Ribbon ...	£4.2.6
Lustraphone LD/66	£7.17.6
Lustraphone VR/64	£8.18.6
Ribbon ...	£10.10.0
Lustraphone LFFV/59	£3.13.6
Dynamic ...	£8.15.0
Simon 'Cadenza'	£19.19.0
Ribbon ...	£2.2.0
Simon Cadenza Crystal ...	£16.16.0
Reslo Ribbon or Dynamic ...	
AKG Stereo	
Dynamic D.88 ...	
TSL 3 Channel Mixer ...	
Grundig Mixer ...	

Also in stock:
ACOS, FILM INDUSTRIES, TSL,
G.B.C. MICROPHONES. STANDS.

● TAPES & ACCESSORIES

Standard, Double Play and Long Play in all sizes by all leading makers.
● Pre-Recorded Tapes by Columbia, H.M.V., Bi-Tape, etc.
Bib and Romagna splicers. Matching transformers. Plugs, sockets, etc., etc.

In stock at our HI-FI Dept. at 181, Streatham High Road

● STEREO AND MONO AMPLIFIERS by
Quad Pye Rogers
Leak Dulci Armstrong
Jason H.M.V. Elpico etc.

● TUNERS by
Quad H.M.V. Rogers
Leak Pye Armstrong
Jason Dulci

● LOUDSPEAKERS by
Quad G.E.C.
W.B. Wharfedale
Goodmans Kelly (ribbon)
Audiostatic Mordaunt

● MOTORS, PICKUPS, by
Garrard Tannoy
Lenco Shure
Connoisseur Decca (fms)
Phillips Ronette

Goldring Ortofon SME
All types of Diamond and sapphire styli, stereo and mono. Microlifts, Garrard SPG3, Acos Dust Bug.
CABINETS
Record Housing
Leak 'Southdown'
W.B. Enclosures

Please note our only addresses as below

169-171 STREATHAM HIGH ROAD, LONDON, S.W.16

Between St. Leonard's Church
and Streatham Station

STReatham 0466/0192

Hi-Fi Dept. 181 STREATHAM HIGH ROAD, S.W.16

Readers' Problems

Track Conversion

Dear Sir:—I wish to convert my $\frac{1}{2}$ -track recorder to 4-track in the near future, but have a large number of recordings in $\frac{1}{2}$ -track that I wish to keep. In the interests of tape economy, is it possible to erase half of the present $\frac{1}{2}$ -track recordings therefore converting them to $\frac{1}{4}$ -track? I would appreciate any comments you may care to make. Yours faithfully, R.L.C., London, N.1.

It is perfectly in order to erase half of your existing $\frac{1}{2}$ -track recordings by the simple expedient of setting your new $\frac{1}{2}$ -track machine into the record condition. If you are unlucky there is just a chance that cross-talk may occur, i.e. you may hear a faint trace of the original track when replaying the new $\frac{1}{2}$ -track recording. This will be due to the fact that the $\frac{1}{4}$ -track erase head does not leave a sufficient "land" between the new and old tracks. No cross-talk should be audible when replaying the original $\frac{1}{2}$ -track recording through the $\frac{1}{4}$ -track head.

Continuous Tapes

Dear Sir: Could you please send me details of any tape playing instruments which will play tapes continuously without the need for changing? There is mention of such a thing in the January edition of your magazine. Yours faithfully, M.W.D., Fife.

There are a number of machines and accessories designed to play tapes continuously. Naturally, these are most frequently used for business or domestic background music applications. First of all, there is the continuous playing cassette which may be fitted to a wide variety of tape decks. This will usually give only a limited playing time, but is useful for repeated announcements, music, etc. Examples are, Guy's Calculating Machines' Brittape, the Ferrograph and the Philips units.

In the second category we have the self-contained background music reproducers which give continuous repetitions of programme material lasting up to a couple of hours or more. These have been described in the news pages of this magazine, and include the Moodmaster, Muzak and Reditune systems.

Dear Sir:—For just over two years I have possessed a Grundig TK20 recorder. In the not too distant future I intend to part exchange this machine for a new model. Will I be able to play the tapes, I've already made, on my new machine (whatever make it is) when I get it? Yours faithfully, D.K., East Dulwich.

The recordings you have made on your Grundig TK.20 machine are standard $\frac{1}{2}$ -track, playing in the conventional left to right direction. This means that you will be able to play these tapes perfectly satisfactorily on any new $\frac{1}{2}$ -track machine which you require. Also, you may like to know that it will be possible to replay the tapes on a 4-track machine (using only track 1 or track 2 for example) though at a slight loss in volume.

Dear Sir:—A question about tape which I have not seen discussed. How long does a spool of recorded tape store without ill effects to the recording? Less than a year? I ask this because I recorded several complete opera performances last year when they were broadcast from Covent Garden, and these were a great success. *The Trojans* was one. It was played back two or three times before being put away, but recently I got it out to listen to again and it sounded terrible. The solo voices were fair enough, but the orchestra and chorus passages had become "hollow" and blurred. Why is this?

Ours is a Grundig Console Tape Recorder (Type 700 C) and we use Scotch Brand Magnetic Tape—150 Polyester Extra Play. The Grundig instructions book say, (Section 10) "... a piece of recorded tape or a whole spool can be stored indefinitely with no ill effects to the recording, ..." but can it? I should be very obliged if you or any of your readers can advise me in this matter, as there seems little use in recording particular things if they are not going to last. Your faithfully, G.D., Bristol.

Under ideal conditions, recordings on magnetic tape may be

stored for very long periods—certainly 10 years—without appreciable deterioration. In your particular case, the hollowness of which you complain is almost certainly due to "print through". This, as you probably know, is due to the layers of tape magnetising each other as they remain in such close proximity on the spool. The effect is of faint echoes which are most noticeable on loud recorded passages, and while most modern tapes are relatively free from print through, it is accelerated if the tapes are stored in too high a temperature or in the vicinity of stray magnetic fields. The moral is, when you wish to retain recordings for long periods, you should not record at too high a level, store the tapes carefully, and run them through occasionally, using the fast wind if you are not listening to the music.

Line Impedance Microphones

Dear Sir:—First, I must congratulate you on two excellent journals. They provide, what is for me, the perfect balance between the out and out technical stuff and the patient explanation for the dumb layman (Me, although I'm learning), and those touches of humour.

Please could you tell me the advantages of line (medium) impedance microphones? Do they work off high and low impedance inputs without transformers, or is it just for transistor circuits? Yours faithfully, R.D., Bristol.

The nominal impedance of line impedance microphones is 600 ohms. This value originally had the advantage that very long lines and cables, such as are employed in broadcasting and professional recording circles, have been evolved to match this impedance. As a result, most professional microphone amplifier equipment has an input impedance of 600 ohms. More recently the increase in the use of transistor recorders has made medium impedance microphones more popular than ever, since no matching transformer is then required in the recorder itself.



ASK FOR

"BRAND FIVE"

RECORDING TAPE

made by FERRODYNAMICS Corporation U.S.A.

THE BEST TAPE VALUE !

NOW AVAILABLE FROM LEADING DEALERS EVERYWHERE

More and more tape recorder enthusiasts are changing to "Brand Five" tape—for quality of Recording and Reproduction it is really first-class and the price will suit your pocket. Next time you buy tape insist on genuine "Brand Five"—you'll not be disappointed.

Wholesale Enquiries to Official Distributors:

V. L. DEWITT LTD.

24/26 Hampstead Road, London, N.W.1.
Telephone: Euston 3533

Enquiries from Tape Recorder Manufacturers and Foreign Importers to:

ELECTRO-TECHNO-DYNAMICS LTD.

101 Leadenhall Street, London, E.C.3.
Telephone: AVE 6982

High Grade Acetate Base			
SA5.	5"	600'	1.5m. 16/-
LA5.	5"	900'	1.0m. 18/6
LA6.	5 1/2"	1,200'	1.0m. 23/6
SA7.	7"	1,200'	1.5m. 25/-
LA7.	7"	1,800'	1.0m. 35/-
Extra Quality Mylar Dupont			
DM3.	3"	300'	0.5m. 13/-
DM5.	5"	1,200'	0.5m. 37/6
SM7.	7"	1,200'	1.5m. 40/-
LM7.	7"	1,800'	1.0m. 44/-
DM7.	7"	2,400'	0.5m. 60/-
DT7.	7"	2,400'	0.5m. (Tensitized) 70/-

Other sizes and types available



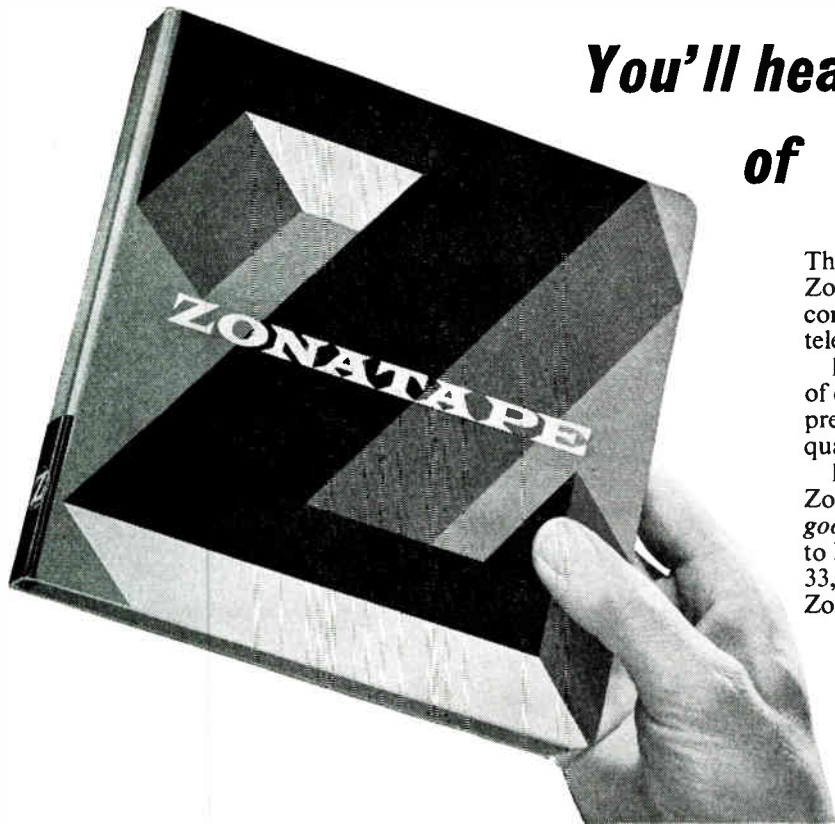

You'll hear nothing but good of **ZONATAPE**

This is hardly surprising if we tell you that Zonal Magnetic Coatings are those most commonly used in film, broadcasting and television studios.

It is against this professional background of experience and exacting standards that we present Zonatape as the new standard in $\frac{1}{4}$ " quality tape for home recorders.

If you would like to hear more about Zonatape send for leaflet 'The basis of every good magnetic recording'. If you would like to hear Zonatape visit the Audio Fair (Stand 33, Demonstration Room 214) or ask your Zonatape dealer.



Zonal Film (Magnetic Coatings) Ltd. The Tower, Hammersmith Broadway, London W.6. RIVerside 8741

HIGH QUALITY TAPE RECORDER SPECIALISTS! BEST PART EXCHANGE

OFFICIALLY APPOINTED AGENTS FOR:

- ★ FERROGRAPH
- ★ AMPEX
- ★ SIMON
- ★ REFLECTOGRAPH
- ★ REPS
- ★ GRUNDIG
- ★ VORTEXION
- ★ BRENELL
- ★ WYNSOR

ALLOWANCE ON YOUR PRESENT TAPE RECORDER—HI-FI EQUIPMENT, etc.

MONO RECORDERS

Brenell 3 Star ...	58 gns.
Brenell Mk 5 ...	64 gns.
Wyndor Victor ...	45 gns.
Telefunken 75 KL-15 ...	47 gns.
Telefunken 85 KL ...	79 gns.
Telefunken 4-Track ...	57 gns.
Grundig TK 20 ...	42 gns.
Grundig TK 24 ...	55 gns.
Veritone Venus ...	66 gns.
Philips EL 3541 ...	34 gns.
Philips EL 3542 ...	59 gns.
Simon Minstrelle ...	39 gns.
Simon SP4 ...	95 gns.
Sound Studio ...	42 gns.
Sound Studio 4-Track ...	45 gns.
Saba Hi-Fi ...	79 gns.
Reflectograph "A" ...	105 gns.
Chitnis 4-Track ...	54 gns.

Vortexion WVA ...	89 gns.
Ferrograph 4 AN ...	81 gns.
Ferrograph 4 SN ...	88 gns.
Wyndor 4-Track ...	49 gns.
Robuk RK3 ...	36 gns.
Reps R10 ...	59 gns.
Reps R10 4-Track ...	69 gns.
Reps R30 ...	66 gns.
Reps R40 ...	70 gns.
Elpico TR500 ...	28 gns.
Truvox R6 ...	55 gns.
Truvox R7 ...	82 gns.

STEREO	
Korting ...	68 gns.
Philips EL3536 ...	92 gns.
Harting HM8 ...	76 gns.
Chitnis Stereo ...	56 gns.

Brenell 3 Star ...	92 gns.
Ferrograph 808 ...	105 gns.

TRANSISTOR—BATTERY

Grundig Cub ...	26 gns.
Clarion ...	25 gns.
Fi-Cord ...	59 gns.
Butoba ...	69 gns.
Minivox ...	37 gns.
Steelman ...	55 gns.
Stuzzi Magnette ...	59 gns.

MICROPHONES

Reslo
Lustraphone
Cadenza
Grampian
A.K.G.
Grundig, Etc.

TAPES

B.A.S.F.
Audiotape
Irish Tape
E.M.I.
Ferrograph
Grundig

PRE-RECORDED TAPES
ACCESSORIES
TUNERS
AMPLIFIERS
SPEAKERS
PICK-UPS
MOTORS
CONVERTERS

THE BEST TERMS **NO INTEREST**

20% Deposit | 18—24 Months
Balance 12 months | Terms Available

FREE SERVICING—FREE DELIVERY—FREE TAPE OFFERS—150 MACHINES ON DISPLAY—OUR MAIL ORDER DEPARTMENT WILL DEAL WITH YOUR ENQUIRY BY RETURN. WRITE—PHONE—CALL FOR A QUOTATION ON YOUR MACHINE. A LARGE SELECTION OF USED TAPE RECORDERS.

TELEPHONE: BALHAM 7710

REW EARLSFIELD LTD. 266 UPPER TOOTING ROAD, LONDON, S.W.17
100 yards from Tooting Broadway underground station: Opposite Tooting Market

SOUND and CINE

Choosing a Subject

by Richard Golding

I HAVE been asked by many readers to expand on my earlier definition of lip synch. Lip synch is simply this: when a character is talking on the screen one should see his lip movements matched perfectly to the spoken words on the soundtrack. If he shuts a door, one must hear it slam at precisely the right moment. If a dog barks, the bark on the soundtrack must be perfectly timed to the visual jaw movement. When our Greek dancer in "Never on Sundays" throws a glass to the ground, one must hear the smash of broken glass the instant it strikes the floor, and so on.

Too much sound

Most soundtracks, however, suffer from an overload of sound effects, for most of us forget that the ear is as selective as the eye, and that it is unnecessary to include everything. The point here, I feel, is that, in the case of the eye we turn our attention away from an object by looking at something else, but, in the case of the ear all the sounds within an audible range are striking our ear all the time; the ones we want to absorb being controlled by a mental process of selection which allows one sound through and stops others. The ticking of a clock, through this process, on occasions may be more disturbing than the roar of an express train.

This can simplify matters for the Cine man and his lip synch track, especially when his equipment determines that his sound must be added at post-synching sessions. Most Scenarios, and this is the second subject in our normal Competition class, can get by, if lip synch is desired, by the addition of a dialogue track and one essential effects track.

Narration plus background

Pure narrations, plus naturalistic sounds which are presented as a natural part of the scene and which might be heard by anyone standing in the same position as the camera, are very popular and present a way out with most Scenario film makers today, and Terry Nunn's "The Story of Elias Creem" is a successful example. Elias Creem is a mild, ineffectual character, dressed in a wing collar and a shabby suit, beginning to go bald, but with one ambition in life—to be famous. He dreams of ways to achieve fame—as a conductor of a large orchestra—a mountaineer—a tachiste painter—a dictator, cheered by the crowds. One day his television blows up and gives him the Idea. If he can make a big enough bang then everyone will hear of him.

He makes one bang after another, and each one is greater and noisier than the one before. The final bang, of course, is a little premature and he ends up as a name on a gravestone that no-one has ever heard of. The narration for this film was recorded first in its entirety, followed by the effects track. Each sound effect was preceded by a spoken comment for identification—"wind"—followed by a gentle blowing across the microphone or—"explosion"—a burst paper bag and a dropped saucepan lid. The tape, recorded at 7½ i/s, was then sent away for transfer to optical track. All the key words and narration were located on to a separate trackreader, and then edited to the picture.



A Section of the "Elias Creem" Script

Shot	Camera	Dialogue and effects
4.	M.S. Gravestone	Narrator: He didn't want to end up as a name on a gravestone no-one had ever heard of . . .
5.	M.S. Gravestone. but more elaborate.	Narrator: He wanted to end up as a name on a gravestone that everyone had heard of.
6.	C.U. Elias in garden staring into camera.	Elias: I want to be famous.
7.	C.U. Elias indoors. far-away look in eyes.	Narrator: He used to dream of ways of achieving his ambition . . .
8.	C.U. Elias as conductor.	Music (stormy).
9.	M.S. Elias as mountaineer planting Union Jack.	Wind whistling.
10.	C.U. Interior. Elias as top-hatted dancer.	1930'ish tune.
11.	C.U. Garden. Elias as Hitler.	"Sieg Heils" (preferably).
12.	L.S. Suburban road. Elias turns down garden path.	Narrator: The trouble was that he just didn't seem able to get started. Every evening when he got home from work all he ever did was watch the Telly.

In the finished film there are four lines of lip-synched dialogue but in his new film "The Maestro" which has the same sort of "Frustration" theme running through it, Terry is relying on only a mixture of naturalistic and non-naturalistic sound to carry the track through. The film takes place around the Albert Memorial

**IT'S SO MUCH MORE FUN
TO ADD SOUND WITH THE**



... because its so much easier!

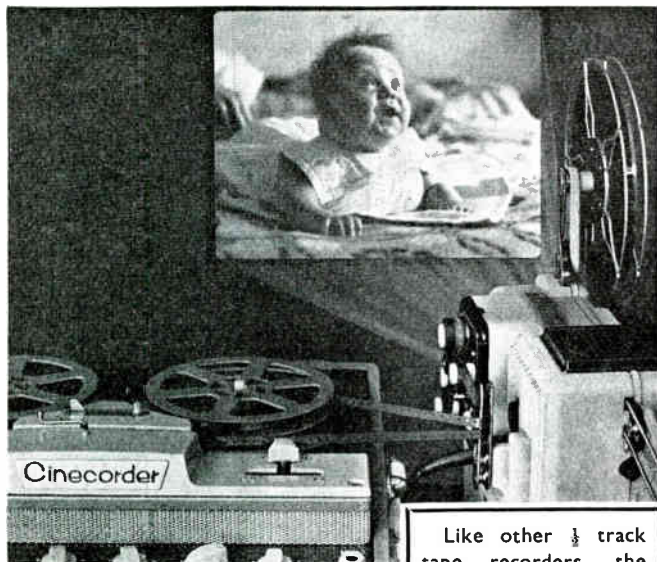

**The Cinecorder
gives you:**

- ★ Separate Loudspeaker in lid to stand by screen.
- ★ Special Tape Timer for accurate film analysis and soundtrack cueing.
- ★ Unique "Shiftrack" feature for superimposing commentary over background music or effects.
- ★ A host of unique features.
- ★ Comprehensive instruction book.

For full particulars write to

KGM electronics Ltd

Bardolph Road, Richmond, Surrey.

Like other $\frac{1}{2}$ track tape recorders, the Cinecorder will record and playback to international track standards on plain or perforated tape.

But only the Cinecorder has the special facilities that make it so much simpler to record sound tracks for films.

For 100% projection sync. you can still use perforated "Cinetape" on your present tape recorder—it's available separately. So are tape sprocket units for the Eumig Imperial and Bolex M8R projectors, and a range of other accessories.

RIC 7171 (5 lines)

LANE'S SERVE THE SOUTH

THE LARGEST HI-FI & RECORDER STOCKISTS
SERVING SUSSEX & THE SOUTH COAST

TAPE RECORDERS · AMPLIFIERS
TUNERS · LOUDSPEAKERS, ETC.
LEADING MAKES ALWAYS IN STOCK
At the advertised prices
Enquiries welcomed without obligation
Write, Phone or Call

- FREE DELIVERY WITHIN 25 MILES
- EQUIPMENT BY LEADING MAKERS
- COMPONENTS, BOOKS, ETC.
- DEPENDABLE SERVICE
- SHOWROOM WITH DEM CONTROL PANEL

**BRIGHTON'S ALL-THE-YEAR-ROUND
AUDIO FAIR**

LANE'S (RADIO)
LTD.
Half-day Wednesday

11 GARDNER ST., BRIGHTON
(Between North St. & North Rd.)
Phone: BRIGHTON 20773

People in Search of Perfection Choose

FILM INDUSTRIES

Type M8

RIBBON MICROPHONE

In the November issue A. Tutchings wrote of the M8

"... this microphone shows evidence of careful design, and the workmanship, technical performance, and styling are excellent. It can be thoroughly recommended for studio or semi-professional use, or for home use where the associated equipment can do justice to its very wide range response."

PRICE

£8.15.0

ALL IMPEDANCES UP TO HIGH

ALSO AVAILABLE:

DESK, TABLE, FLOOR STANDS
IN-LINE MATCHING TRANSFORMER
M7 MOVING COIL MICROPHONE

Write for leaflet C.1.

90 BELSIZE LANE, N.W.3



HAM 9632

and features a young conductor who cannot find an orchestra to accept him. The treatment is slightly surrealistic, and the sound effects include: crowd noises, running feet, walking feet, feet climbing and descending steps, a tolling bell, a lion roaring, bird noises, a train, a station announcer, an orchestra tuning up and then playing, audience applause, and weeping.

Terry Nunn puts a great deal of time and effort into his films, but admits that a scenario should be made to be seen once only and therefore its impact must be immediate.

A recent short and very funny film which had this immediate impact on me is "*Misunderstanding*". Made in Yugoslavia, it shows how the mistaken delivery of a millstone to a modern art museum created a new fashion in sculpture. The exploitation of the anecdote, especially when one can satirise modern society, is well worth attempting, but the story line must be a strong one.

The shaggy dog story is not far removed, and in "*Ebb*" Paul Hansard tells the tale of the Cabinet Minister who has been dismissed. In this B & W 8mm. short the degradation is shown by the Minister's transfer from saloon car to bubble car, from bubble car to scooter. Finally reduced to walking, he throws himself in the river near Chelsea Bridge, but swims down river in time (and Big Ben shows exactly the same time it did as when the film opened) to be reinstated in the Cabinet. Camerawork, direction and particularly the cutting are excellent. The track, too, is an amusing invention, with its recurring motif of a melancholy-whistled tune to a guitar.

At the other end of the scale is the Epic type of Scenario of the sort "*It Happened Here*" now in its fourth year of production. This film, directed by Kevin Brownlow, aspires to an indictment of the behaviour of crowds and is an attempt at securing absolute realism and authenticity. It studies the attitude of the individual within the crowd and seeks to show what might have happened had Britain been defeated and overrun in the Second World War. Its realistic battle scenes are staggering and produce an intensification of the audience's "willing suspension of disbelief" by the photographic actuality and authenticity of the backgrounds.

The Magic Ring

In the costumed epic field, our old friend Herman Wuyts of Belgium (*Raga to a Red Rose*) comes up now with his charming "*The Magic Ring*", a legend with an oriental setting. The story line is simple—A mysterious princess enslaves a young girl by means of a magic ring. The girl is freed by a young male servant of the court and the two flee, but just as they are on the point of escape the youth is shot down from behind by an emissary of the princess.

The visuals are remarkable; against a sunset sky, the watchman blows his horn, the princess sits impassive and malevolent in her dark torchlit state-room; the young girl, blindfolded, paces incessantly to and fro in a giant cage; a black-robed knight, mounted on a black charger, gallops through a wood in beautifully photographed contre-jour shots. The track is music with one or two effects such as a huge gong being struck and the watchman blowing his horn.

"*The Magic Ring*" is a splendid film to watch, and only suffers through the director's inability to present human relationships to advantage. Roger Begue, of Paris, on the other hand, knows exactly how to handle his actors and with "*La Cage*" has succeeded in producing just the right atmosphere for a romantic drama setting. A young invalid girl dreams of the time when she had the full use of her legs, and in particular she recalls the young man with whom she had a very tender friendship. One of the sole pleasures that she has is a bird in a cage, but too often she compares it with her own personal situation. The young man comes to visit her one day, bringing with him his new girl friend. At the end of the visit he realises that his feelings are



still strong for the young invalid girl and returns later to see her alone. The old gardener then brings another bird to share the cage. Most scenes are back lighted from the huge windows of the house, but boosted by blue filters over floodlights. The track contains no commentary but consists of carefully chosen music to subtly underline the film's sensitive atmosphere.

The most difficult of all Scenarios for the amateur is the Human Drama where the expression of emotion must play a great part in the film. The reason for the lack of success in this type of film is obvious, but in the recent Italian "*Sortileges*" we have a director expert in creating and sustaining a mood. The young girl of the film, who is a delightful and most charming sensitive actress, on a walk through some woods witnesses a couple making abandoned love together and through this she experiences a violent emotional shock. In panic she runs from them quite some way before she comes across a strange country house she has never seen before. Half in wonder she enters the house for refuge while she can compose herself. The atmosphere of the house is *fin de siècle* and almost Cocteau, and everywhere she goes in the house a huge black dog follows her. There are several short shock sequences followed by the arrival of a handsome young man who apparently lives in the house. The tempo, from then on, is fierce and frightening until finally she is able to escape from the house and woods to try to regain her peace of mind in her own outside world. Symbolism plays a great part in this film and if it were not for the strong and credible story line the film could well qualify for our third and final class of Genre which I hope to develop in the next article.

"The Magic Lantern"

For those of you interested in new techniques I recommend "*The Magic Lantern*" (Saville Theatre). As you know, it is live acting and film combined, but the perfection of the multiple and moving images is fantastic. Agreed it is music hall rather than cinema but it is rich in ideas, and opens innumerable possibilities. It brings to mind the possibilities of Dynamic Frame that have really never been fully exploited. With this method of masking, the screen can take on all forms and dimensions at will, allowing a maximum of freedom and is quite within the normal amateur's range.

Finally some technical news of interest from America. An optical track on 8mm. film has now been successfully recorded and demonstrated by Dr. John Maurer. The optical track is 25 thousandths of an inch wide, and runs at 24 frames per second. The track will just fit into the area between the perforations and the outer edge of the film, and the listening results are clear and satisfactory. It seems that 8mm. is catching up fast with its big brothers. All that is needed now is a good 8mm. projector with an optical sound reproducing head, and this is bound to come.

2 NEW and EXCITING Innovations

THE BOND RECORDING TAPE SPLICER

—professional splices in seconds!

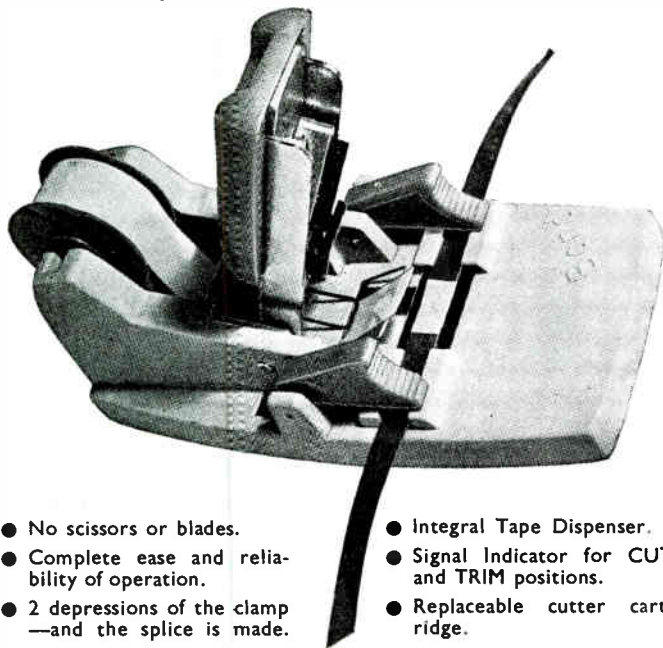

- No scissors or blades.
- Complete ease and reliability of operation.
- 2 depressions of the clamp—and the splice is made.
- Integral Tape Dispenser.
- Signal Indicator for CUT and TRIM positions.
- Replaceable cutter cartridge.

Tape Editing with the BOND is a new found pleasure

32/6

complete with 150" × ½" jointing tape

THE SENSATIONAL TR.100 TRANSICORDER

—the miniature 4 lb. all transistor tape recorder with BIG recorder features—in precision made MINIATURE form

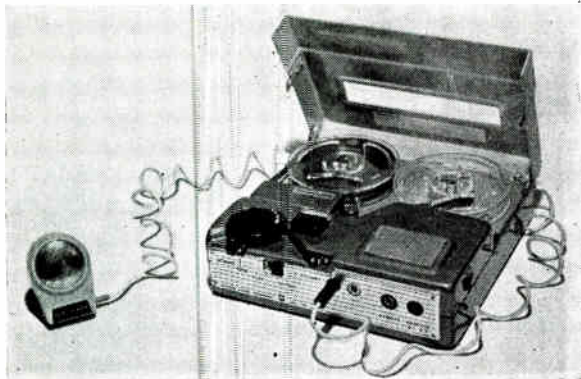

- Tape speeds 3¾ and 1½ i.p.s.
- Reel size 3" spool.
- All usual office style accessories.
- 6 transistors (inc. 2 power transistors) plus 2 diodes.
- Volume level and battery life meter.
- Single lever operation and power rewind.

Precision, Versatility, beauty of style and portability

39 gns.

(inc. case, mic., tape and reel)

Sole Distributors:

CINE ACCESSORIES (BRIGHTON) LTD.
15, BOND STREET, BRIGHTON, SUSSEX

Allegro Contessa

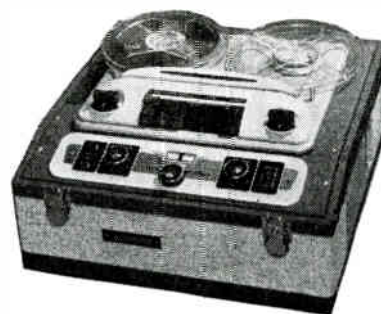

So much
better

42 gns.

★ Tastefully Designed Cabinet ★ 3-Speed Collaro Deck
★ Fitted with 2 Track Quality-Bradmatic Heads ★ 2.4 Watts Output
★ Well Laid Out 5 Valve Conventionally Wired Chassis ★ Straight Through Amplifier ★ Bass and Treble Controls
★ Inputs for Radio, P.U. & Mic. ★ Outputs for External Amplifier & L.S. ★ Complete with Acos. Mic. 45 and 7" Spool of Tape.

Also available in Kit Form. £33.

Including Post & Packing. Obtainable only from Manufacturers.

For further details and brochures write to

ALLEGRO SOUND EQUIPMENT LTD.

7-8 AVERY ROW, MAYFAIR, LONDON MAY 9910

Ferrograph

(Appointed Dealer)



Geoffrey V. Smith

Ampex and Ferrograph Tape Recorders—see and hear these fine instruments at Nusound's London Showrooms, where we display a representative range of high quality Recorders and Audio equipment. You are cordially invited to visit us. **IT PAYS TO DEAL WITH A SPECIALIST.**



AMPEX Model 970

NUSOUND RECORDING COMPANY

35 CRAVEN STREET, TRAFALGAR SQUARE,
LONDON, W.C.2. TELEPHONE TRA 2080

... tape recorder workbench

Practical suggestions for the tape handyman

by A. Bartlett Still

No. 21 - ACHIEVING "OPTIMUM" BIAS

TWO months ago I explained the circuitry necessary for the measurement of the all important bias current fed to the record head of a tape recorder. As is now often the case, I am pleased to say, this was as a result of readers' enquiries, but I would now like to take the subject a little further for the benefit of those readers who may not realise the potentialities of bias current adjustments. There is, of course, little point in measuring bias current unless the current can, in fact, be altered, and an alteration is likely to lead to some improvement.

Varying Bias Current

On the rather better models of tape recorder, designed to a stricter specification, there will be some means of altering the bias current to a greater or lesser degree built in. This will be a pre-set control, and it will normally be adjusted during testing to give optimum results with the tape that the makers have chosen to recommend. With the cheaper models, fixed value components are often used, calculated to a "design centre"

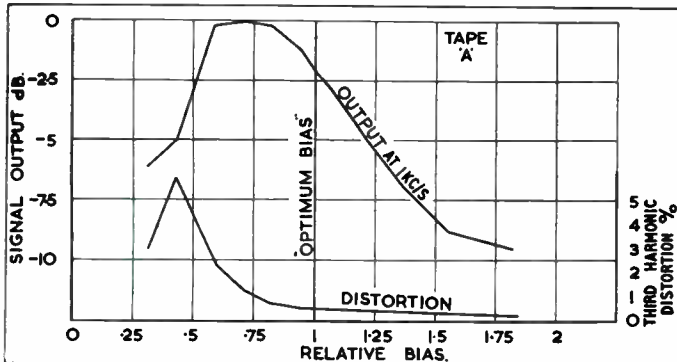

Fig. 1. Displays "optimum bias". The lower curve shows the third harmonic distortion factor, and the upper curve shows the output, as bias is altered.

rating, about which there must necessarily be variation. In this latter case the ability to make intelligent adjustment may well mean that the bias level can be corrected.

Normally the bias voltage available from the oscillator is higher than is necessary, the voltage being dropped to the correct level by resistance, or a capacitor presenting the corresponding impedance. This component will make a direct connection between the record head and the oscillator circuit so it should be fairly easy to find and change into a small preset variable, associated with a fixed value. The idea is to take the existing value and allow it to be changed by about $\pm 25\%$. This is likely to allow a bias change of no more than $\pm 10\%$, but this should be more than enough.

Tape Bias

Should you find that your machine is already fitted with some means of bias adjustment, it is logical to suppose that the level has been set, and with the aid of better instruments than you are likely to have available. It will, however, have been set to be correct for the tape recommended by the maker, and it is surprising how many owners change their brand of tape. Different brands of tape do have varying bias requirements, and a machine having a superlative performance with one tape may be outside "spec" on another. On such a machine, alteration of bias setting or tape would, in my opinion, be ill advised. However, the owner of a machine on which there is reason to suppose that the bias has not been set to the optimum level may well feel justified in making an alter-

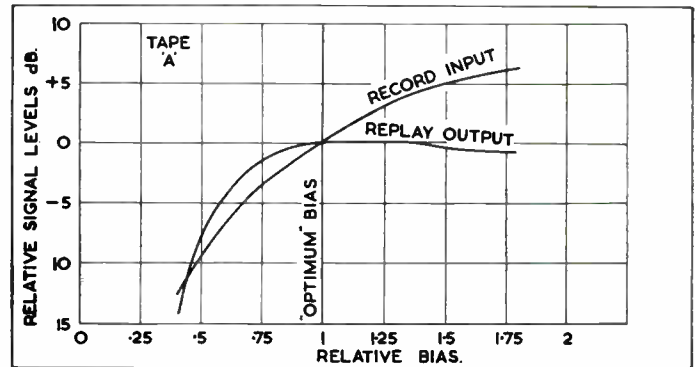

Fig. 2. Shows how change of bias also changes tape sensitivity.

ation in view of the useful effect on performance that can accrue.

The first important thing to realise is that it is not possible to give an arbitrary bias condition for a given tape except in theoretical magnetic terms. In practical terms of bias current, it must always be related to the record head in use. But it will be understood that, provided the same head is always considered, the requirements of various tape can be spoken of in terms of current. For the purpose of illustrations here, all the current figures have been transposed so that optimum bias is taken to be unity.

"Optimum" bias is largely a conventional term, although
(Continued overleaf)

MAKE YOUR TAPE RECORDER REALLY PORTABLE

WITH A **Valradio** CONVERTER

A Valradio converter enables you to operate your tape recorder from car, boat or caravan battery, or any other source of low voltage or D.C. supply, making it possible for you to record outdoor events, or dictation, or to provide entertainment when you go on holiday or picnics, etc.

Prices range from £6.10.0., many models available.

Write for fully descriptive folder to



Valradio

VALRADIO LTD.
Dept., TR/C.,
Browells Lane,
Feltham, Middlesex.
Tel. Feltham 4242



To Valradio Ltd., Dept. TR/C., Browells Lane, Feltham, Middlesex.
Please send me fully descriptive folder for converters suitable for Tape Recorders.

NAME _____
ADDRESS _____

bi Tapes

NEW

QUALITY
PRE-RECORDINGS

BACKGROUND &
MOOD MUSIC

TRAD JAZZ

MODERN JAZZ

LATIN AMERICAN

PIANO POPS &
LIGHT

ORCHESTRAL

12/6 to 52/6

3" AND 5" REELS

Special
Sound Effects

JOURNEY BY TRAIN—DAY AT
THE ZOO—EVERYDAY SOUNDS
JOURNEY INTO SPACE

FOUR 3" REELS IN ONE PACK
48/6

CUT HERE

Bi-Tapes Ltd., 78a Upper Berkely Street, London, W.1

Please send me free catalogue giving full details of pre-recorded tapes.

* I enclose remittance of 48/6 for special pack of sound effect tapes.

* Delete if not applicable.

NAME

ADDRESS

TAPE RECORDER WORKBENCH—(continued)

it represents a level that is often used on the better tape recorders. Reference to fig. 1 will show how it is derived. An input signal is fed, at 1 kc/s, to the record amplifier at an amplitude that is sufficiently low to avoid any risk of saturation of the tape. If the bias current is steadily increased, the replay output will follow the upper curve, while the lower displays the third harmonic distortion factor. The bias current ordinate

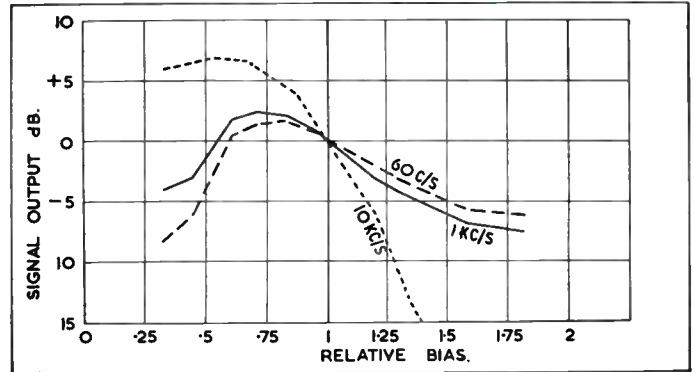

Fig. 3. Shows the erasure effect of the H.F. bias. Three "spot" frequencies, recorded at the same input level, indicate a more marked effect on higher frequencies than on low.

values have been chosen so that unity represents optimum bias, the point at which the replay output has fallen by 2 dB from the maximum. It may be said to represent the point at which the distortion curve flattens out.

An alteration of bias will also affect tape sensitivity, the ratio between record and replay signal amplitudes, all other factors remaining constant. This effect is shown in fig. 2, wherein the replay level is the one at which 5% third harmonic distortion is reached, the input being adjusted accordingly. Zero dB represents these two levels at unity bias, the relative levels at greater or less bias giving an indication of tape sensitivity. It will immediately be seen that an increase of bias beyond optimum does not produce any greater replay level, but requires a greater input signal.

Affected Frequency Response

Variations of tape sensitivity and distortion conditions over the range being considered would not, perhaps, be immediately noticeable during normal use of the machine. What does become apparent, and often causes complaint, is the affect on frequency response that can result from quite a small change in bias conditions, the sort of change that occurs when the recording is made on a different brand of tape. Note the word "brand" here, normally different types of tape of the same manufacture have similar bias requirements. In fig. 3 I have plotted the replay signal, with constant record input, of three spot frequencies. The erasing effect of the HF bias can be readily seen to have a more marked result as the signal frequency is increased.

Although my treatment of this somewhat complex subject has, of necessity, been rather brief, I hope that readers will have begun to understand how important the recording bias is to performance. Any reader who would like to pursue the subject, and who has access to back numbers of *Hi-Fi News* is commended to an article on the subject in the December 1959 edition. This takes the matter further in showing the effect of incorrect bias on the performance of various sample tapes.

WAL GAIN TRANSISTORISED PRE-AMPLIFIERS. Many applications, extra gain for Mics, Tape Heads, P-U's, etc., etc. Supplied complete with phono plugs, battery, screened lead, etc. Mono £5, Stereo £7.10.0d.
WAL BULK TAPE ERASER. Erases both tracks, 7" reel of tape in 30 secs. £7.18.6d.
WALTRAK TRANSISTORISED AUDIO OSCILLATOR, 1,000 cps, supplied complete with probe, battery, etc. Excellent accessory for service, testing, etc. £6.10.0d.

Also two new interesting accessories will be shown on our Stand 61 at the London Audio Fair.



WELLINGTON ACOUSTIC LABORATORIES LTD., FARNHAM, SURREY. Pham 6461.

EQUIPMENT REVIEWED

★
WALTERS
METROPOLITAN
RECORDER
★



Manufacturer's Specification

Mains voltage: A.C. only 200/250: 100/125 volt. 50 cycles. **Batteries:** 3 Ever-Ready P.P.9. **Transistors:** 7 Mullard Type. **Reel size:** 5½ in. maximum. **Tape speed:** 3¼ i/s. **Recording and playback times:** (a) 850 ft. standard tape—45 minutes per track. (b) 1,200 ft. long play tape—1 hour per track. (c) 1,700 ft. double play tape—1 hour 30 minutes per track. **Frequency response:** Overall 50 to 9,000 c/s. Straight through amplifier only 40 to 15,000 c/s. **Record-Playback head:** Fully screened, combined Record-Play head, medium impedance micro-gap type. **Record-Playback amplifier:** 7-stage built-in amplifier with separate bias oscillator and record level indicator. Push-Pull output stage with negative feedback. Also separate feedback equalisation. **Speaker:** 7 in. by 4 in. Elliptical high flux permanent magnet. **Output:** 2 watts plus. **Signal to noise ratio:** Better than 40 dB. **Microphone:** High fidelity crystal microphone. **Controls:** (a) Combined on-off switch and volume control. (b) Five position "control lever" for Neutral, Record, Play, Fast forward, Fast reverse. (c) Safety lever to prevent accidental erasing. (d) Instant Stop-Start control. (e) Tone control—Recording monitor control. (f) Record level control. (g) Superimpose button. **Mixing facilities.** **Recording level indicator:** Magic eye. **Overall dimensions:** 14 in. by 13¼ in. by 5¼ in. **Weight:** 17½ lbs., less batteries. **Price:** £57 15s.

Manufactured by Walter Instruments Ltd., Garth Road, Morden, Surrey.

Subjective Tests

ALL recorders submitted for review are tested under domestic conditions before being subjected to more detailed tests in the laboratory. Sometimes the listening tests confirm the laboratory measurements, and sometimes they contradict them, or let us say, the ear is more tolerant than the meter! With one exception this proved to be the case with the instrument under review. To put things in proper perspective I therefore propose to describe my "home" tests first.

No batteries were supplied with the review model, so my first test was to switch to mains and plug in. The tape contained a pre-recorded sequence which demonstrated the machine's possibilities as a portable recorder: children playing on the beach, a football match, interviewing, dictation, etc., and the quality and signal/noise ratio was most impressive. The tape also contained a selection of dance music which was reproduced very well. On plugging in the microphone for my first recording tests, however, the story was very different; the voice quality was thin and very high pitched with a high note peak which caused violent overloading on sibilants (film recordists call it

"sibilant splash"). The volume indicator, of the exclamation mark type, was worse than useless; it indicated the presence of modulation, but that was about all; in any case the gain had to be full on for speech about 6 inches from the microphone.

Radio recording was much better, but the volume indicator was of little use, and one tended to make a test recording and note the volume control setting for future tests. B.B.C. speech quality was good, and comparable to the demonstration recording. Music was also pleasant, but there was a slight roughness which sounded like an inaudible mains hum which was chopping the music slightly—let me emphasise that the "burble" was not very obtrusive and could be disregarded on casual listening.

Next a new trouble showed up in the form of a "tone" of about 300 c/s behind every recording—it was now audible also on the pre-recorded tape, and sometimes, but not always, on unrecorded blank tape. This was eventually tracked down to oscillation of the pressure pad, which consisted of a thin piece of felt mounted on a block of foam rubber. When the felt got slightly sticky it was dragged along with the tape for a fraction of an inch and then pulled back by the spongy mounting several hundred times a second. Cleaning the pad with carbon tetrachloride cured the trouble for short periods, but it kept recurring and a prolonged session of bending the pressure pad spring was required to cure it long enough to complete the other tests.

Wow and Flutter

Fig. 1 shows how deceptive listening tests can be when compared with actual measurements—or vice versa—the just perceptible "burble" turns out to be nearly 1 per cent. R.M.S. flutter. The flutter frequency is 50 c/s, and the speed of the capstan drive motor is 3,000 rpm or 50 revs per second, so that the prime source of the trouble is very evident. It is, however, extremely unlikely that the capstan flywheel could speed up and

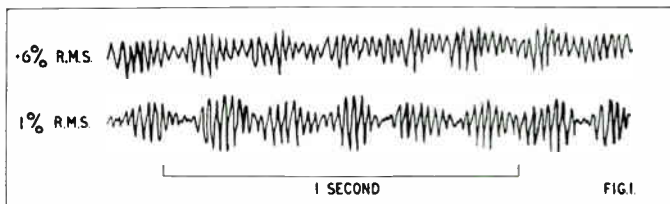

slow down 50 times per second by plus and minus 3 per cent., the amount needed to give a 1 per cent. R.M.S. reading. The motor spindle bears on a tyre on the top surface of the flywheel so that any out of balance or vibration of the motor is thus transmitted through 90° to the capstan as a sideways vibration, and this, added to the relatively smooth drive of the flywheel, will "twitch" the tape through with a superimposed flutter of 50 c/s. The flutter on a pre-recorded tape will be approximately half that shown on my fluttergram, which indicates the combined record and play flutter. It will be seen that a very slight eccentricity of the capstan modulates the flutter at the capstan rotation frequency of 5 to 6 c/s.

Playback Response

A 200 micro-second C.C.I.R. test tape was used to measure the playback only response of the unit. Single frequency readings below 1Kc/s were unstable and variable, and previous experience indicated that this was probably due to fairly violent fluctuations in the low frequency response, which did not repeat exactly on each run. A gliding tone tape was therefore used to plot the detailed response shown in fig. 2. The spot frequencies of the normal test tape are also indicated by crosses. The large oscillation in low note response are caused by interference

TAPE RECORDER COVERS



Smart, waterproof cover to give complete protection to your tape recorder. Made from rubberised canvas in navy, wine, tan, grey and bottle green with white contrasting pipings, reinforced base, handy zip microphone pocket and name panel.

Grundig TK.5 55/-	Cossor 1602 57/6
" TK.8 63/-	" 1601 63/-
" TK.20 52/6	Stella ST455 63/-
" TK.24 56/-	" ST454 57/6
" TK.25 55/-	Saja MK.5 57/6
" TK.30 60/-	Stuzzi Tricorder 58/-
" TK.35 63/-	Saba 63/-
" TK.50 60/-	Wyndor Viscount 55/-
" TK.55 63/-	" Victor 60/-
" TK.60 75/-	Elizabethan Princess 60/-
" TK.830/3D 63/-	" Avon 60/-
" Cub 35/-	" Escort 57/6
Telefunken 85 60/-	" Major 63/-
" 85 65/-	" FT.1 66/-
" 75/15 55/-	" FT.3 66/-
" 76K 55/-	Fi-Cord 52/6
" 77K 57/6	Korting (4 track stereo) 63/-
Philips 8108 57/6	Harting Stereo 66/-
" 8109 63/-	Fidelity Argyle 55/-
" EL3538 63/-	Walter 101 55/-
" EL3542 63/-	Simon SP4 63/-
" EL3536 70/-	Clarion (complete with strap) 52/6
" EL3515 57/6	Brenell Mk.5 77/-
" EL3541/15 57/6	" 3 star 69/-
	Minivox †

† Without pocket
 † Price to be announced.

A. BROWN & SONS LTD.
 24-28, GEORGE STREET, HULL Tel: 25413, 25412

THE METRO-SOUND RANGE OF TAPE RECORDER ACCESSORIES



- KLENZATAPE**—for cleaning Tape Recorder Heads Complete kit, 12/6d. Fluid Refills, 3/11d.
- METRO-SPLICER**—for both Recording Tape and 8 mm. Cine-Film—Complete with Film Emulsion Scraper and spare Cutting Unit, 15/-.
- Spare Scrapers, 1/- Spare Cutting Units 2/6d.
- The Original METRO-TABS**—for making positive identification of Recordings AT A GLANCE—3/11d. complete with Index.
- Tape Deck Cleaning Brush**—made from specially shaped feather-soft non-scratch Nylon, 2/6d. each.

The above items now complete with many spares in the

METRO-SOUND TAPE ACCESSORIES SET lavishly mounted and luxuriously packaged for only £2 2s. 0d. (Normal Total Retail Value £2 4s. 9d.).

Sole Manufacturers:

The METRO-SOUND Mfg. Co. Ltd.
 19a Buckingham Road, London, N.1. (CLIssold 8506/7)

ESSEX TAPE RECORDER CENTRES



* LONDONS LARGEST TAPE RECORDING SPECIALISTS

NO INTEREST?

- * FREE CATALOGUES, PAMPHLETS ETC.
- * FREE DELIVERY ANYWHERE
- * FREE AFTER SALE SERVICING
- * FREE TECHNICAL INFORMATION
- * FREE HOME DEMONSTRATIONS

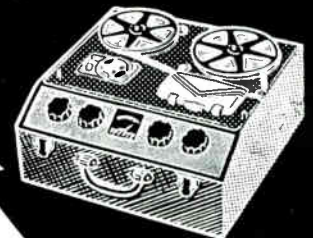

ALL THESE RECORDERS ARE IN STOCK . . . AND MORE TOO . . .

Alba	Harting	Elizabethan
Amplion	HMV	Ferrograph
Brenell	Korting	Gainsborough
Butoba	Philips	Peto-Scott
Casian	Reps	Reflectograph
Clarion	Sagatone	Regentone
Cossor	Simon	Telefunken
Crown	Sound	Veritone
Elpico	Spectone	Vortexion
Fi-Cord	Stella	Walter
Fidelity	Truvox	Wyndor
Grundig	Uher	

* CALL AT OUR LONDON SHOWROOMS WHERE YOU MAY SEE HEAR & COMPARE ANY OF THE RECORDERS FROM OUR TREMENDOUS RANGE OF OVER 250 MODELS.

ADDRESSES

2, MARYLAND POINT STATION, STRATFORD, LONDON, E.15. (HEAD OFFICE)
 TELEPHONE: MARYLAND 5879

205, HIGH ST. NORTH, EAST HAM LONDON, E.6. (OPP. EAST HAM STN.)
 TELEPHONE: GRANGEWOOD 6543

between the main head gap and a secondary gap caused by sharp changes in the profile of the head at the points where the tape runs on and off the pole pieces. The main dip at 130 c/s occurs when the pole face length coincides with one complete wavelength at this frequency.

Signal to Noise Ratio

Hum, and tape noise due to the permanent magnet erase system, were together 20dB below test tape level. With no tape the hum was 25dB below test tape level. Switching over to battery operation eliminated the mains hum, leaving only transistor and motor noise at 42dB below test tape level—but erased and biased tape noise was still only 23 to 24dB below test tape level. The low frequency "grumble" caused by the P.M. erase was, of course, exaggerated by the peaky low note response of the head, and the same tape played on a studio reproducer, with a level response down to 40 c/s, measured the erase noise as 30dB below test tape level. Later recording tests showed that

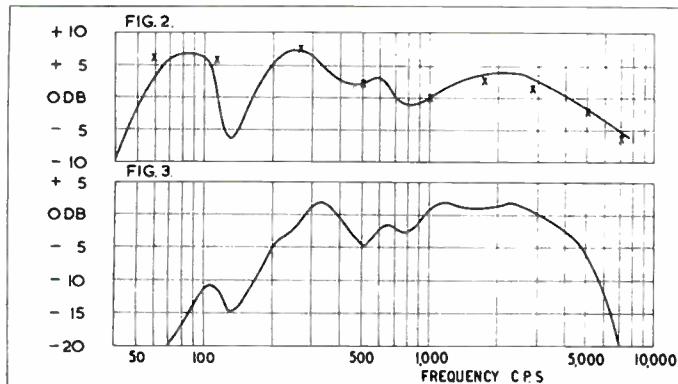

a signal 12dB above test tape level could be recorded with negligible distortion. This means that tapes recorded on this machine show a signal/noise ratio of better than 40dB on wide range playback equipment, and 36 to 37dB when played on the portable recorder.

Record/Play Response

The record/play response was almost identical with the replay response shown in fig. 2. This indicates that the recording pre-emphasis and bias are correct; this is confirmed by the overload test mentioned above, which showed a clean recorded waveform at a level 12dB above test tape level, and by the clean undistorted quality which is characteristic of a properly biased tape, and which overrides any minor imperfections in frequency response.

Acoustic Response

A white noise test tape was next played, and the sound output measured 1 ft. from the speaker fret. The response is shown in fig. 3; the high note response is maintained to 5Kc/s on the speaker axis, and this nicely balances the low note cut off at 200 c/s due to the small cabinet and speaker combination. The head peak at 100 c/s helps to maintain some semblance of bass response down to this frequency.

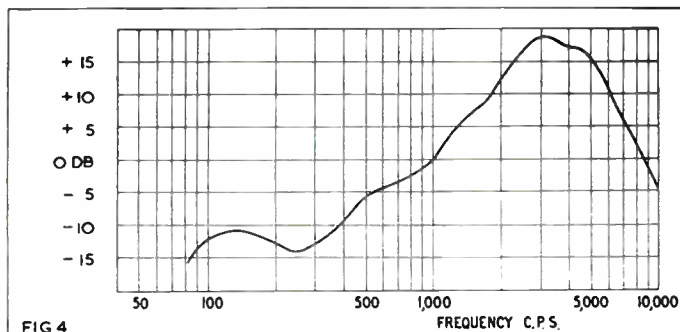

EQUIPMENT REVIEW—(continued)

Peak Output

The maximum undistorted acoustic output at 1 ft. from the loudspeaker was 107 phons. This is slightly above average compared with a number of mains-operated recorders with built-in loudspeakers whose outputs range from 98 phons to 108 phons. The maximum undistorted electrical power output was 2 watts, corresponding to 2.5 volts across a 3 ohm load.

Microphone Response

The microphone is a crystal unit fitted with an internal transformer to match the input impedance of the transistor amplifier. Fig. 4 shows the response, and indicates why it sounded so bad; the response varies plus and minus 15dBs from 1 Kc/s over the range 100 c/s to 5,000 c/s. I happened to have quite a selection of medium impedance microphones available, and they all sounded much better than the one provided with the recorder.

Comment

Although I have had to criticise certain features of this recorder, I have to admit that it sounds much better than it measures—except the microphone which sounds much as the response would lead you to expect. The power output is high and it creates a healthy noise—more than enough for most indoor uses—and enough for many outdoor applications. The sound quality is clean and crisp.

I note that, although three P.P.9. type batteries are fitted, only one powers the capstan motor, the other two are connected in parallel to feed the transistor amplifier or rewind motor. Such batteries are only rated for 5 to 50 mA drain, and I feel that the 100 to 120 mA drain of the continuously running capstan motor is rather high for one such battery.

One very minor final criticism—the take-up reel drive is a gravity type slipping clutch which only operates when the machine is horizontal—a very weak spring would allow operation when the machine is carried vertically.

A. Tutchings

(continued on page 151)

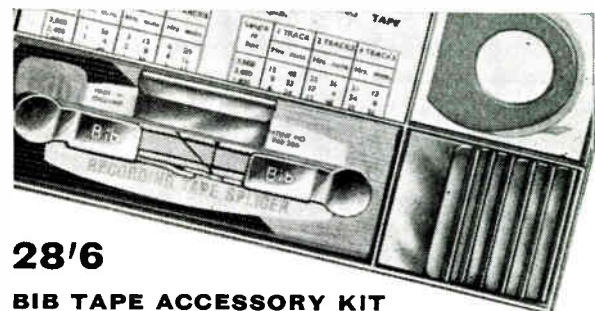

28/6

BIB TAPE ACCESSORY KIT

COMPLETE IN A STURDY BOX CONTAINS:

- **Bib Tape Splicer** chromium plated on flock sprayed base, complete with cutter. May be mounted direct on tape deck. (Available separately 18/6.)
- **Bib Tape Data Card.** Provides playing times for standard, L.P. and D.P. tapes for 12 sizes of reels for 1, 2 and 4 tracks. Capacity of 6 sizes of reels for 3 types of tape. Performing times for 48 classical works.
- **Reel of Splicing tape on dispenser.**
- **6 Spare razor cutters.** • **24 Bib Tape Reel Labels.**

BIB TAPE REEL LABELS
Self adhesive suitable for typing or writing.
Packet of 24: 2/6d.

BIB TAPE REEL LABEL MULTICORE SOLDERS LTD.	TITLE	REEL NO.
	COMPOSER	SPEED
	ARTIST	DATE
		DP — LP — SP

Available from your usual dealer; if in difficulty, send remittance to:

MULTICORE SOLDERS LTD.
MAYLANDS AVENUE, HEMEL HEMPSTEAD, HERTS.

TA 5135



MICROPHONES FOR ALL ASPECTS OF RECORDING

- ★ DYNAMIC
- ★ RIBBON
- ★ *British throughout*

LUSTRAPHONE LIMITED manufacture a wide range of microphones designed to cover all branches of sound reproduction. Many are eminently suitable for recording purposes both indoors and out. Shown here are two typical examples of the way in which LUSTRAPHONE cater for specialised recording requirements. The full range of LUSTRAPHONE MICROPHONES is to be seen at the Audio-Festival. If you cannot visit us please send for descriptive literature.



"LAVALIER" DYNAMIC
Comprises model LFV/H59 "PEN-CIL" microphone mounted on special neck harness to afford the user complete freedom of movement. In low, line or high impedance. £8 18 6

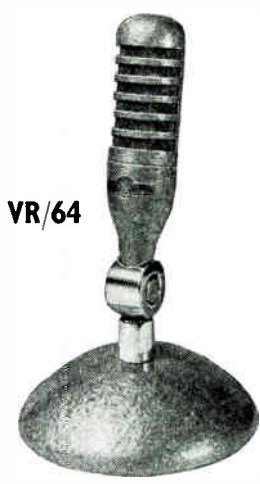

VR/64

RIBBON VELOCITY MICROPHONE

Substantially flat response to 14,000 c/s. With base and cable. For low, line or high impedance. £7 17 6

Also available transistorised 4-channel microphone mixer, stands, etc.

AT THE AUDIO-FESTIVAL
BOOTH 39 DEM. ROOM **114**

LUSTRAPHONE LTD. ST. GEORGE'S WORKS
REGENTS PARK RD., LONDON, N.W.1
Phone: PRImrose 8844

WORLD-WIDE PERSONAL SERVICE

STOCKS INCLUDE NEW EQUIPMENT AVAILABLE FROM 1961 AUDIO FESTIVAL

PLEASE NOTE—Prices quoted subject to alteration in accordance to those advertised by manufacturers at time of receipt of order.

★ RECORDERS			
Vortexlon W.V.A. ...	£93 13 0		£268
Vortexlon W.V.B. ...	£110 3 0		£315
Brenell Mk. V ...	64 gns.		£192
Brenell 3 Star Stereo ...	89 gns.		£267
Clarion Transistor ...	25 gns.		£75
Cossor 1601 4 Tr. ...	37 gns.		£111
Cossor 1602 4 Tr. 3 spd. ...	59 gns.		£127
Simon Minstrelle ...	39 gns.		£117
Ferroglyph 4AN ...	81 gns.		£243
Ferroglyph 4AH ...	86 gns.		£258
Ferroglyph 808 Stereo ...	105 gns.		£315
Grundig TK55 Stereo ...	92 gns.		£276
Grundig TK20 with Mic. ...	42 gns.		£126
Grundig TK24 ...	55 gns.		£165
Grundig TK30 ...	65 gns.		£195
Philips 4 Track EL 3542 ...	59 gns.		£117
Philips 4 Track Stereo EL 3536 ...	92 gns.		£276
Philips 4 Track ...	34 gns.		£102
Reflectograph "A" 1/2 Tr. ...	105 gns.		£315
Reflectograph "B" 4 Tr. ...	115 gns.		£345
Scuzzi Magnette ...	59 gns.		£177
Scuzzi Tri-corder ...	63 gns.		£189
★ DECKS			
Wearite 4A mono ...	£36 10 0		£105
Wearite 4B ...	£41 10 0		£119
Brenell Mk. V ...	28 gns.		£84
Brenell Stereo Deck ...	£33 16 0		£101
Brenell Pre-Amp. and Amp. ...	£24 0 0		£69
★ MICROPHONES AND MIXERS			
Bang & Olufsen Ribbon ...	£16 0 0		£46
Lustraphone LD/66Z ...	£4 12 6		£13

Lustraphone LFV/59 Dynamic	8 1/2 gns.	£25.50
Lustraphone VR/64 Ribbon	£7 17 6	£23
Lustraphone VR/65 N.S. Stereo Ribbon	15 gns.	£45
Reslo Ribbon RBL/T or CRR	£8 15 0	£25
Gramplan Moving Coil	£7 11 0	£22
Simon "Cadenza"	10 gns.	£30

TAPES

SCOTCH BOY, IRISH, BASF, GRUNDIG, AGFA, MSS, FERROTape—ALL SIZES IN STANDARD, LONG PLAY AND DOUBLE PLAY.

Components and accessories by leading manufacturers.

★ SPEAKER SYSTEMS			
Quad Electrostatic ...	£52 0 0		£149
Wharfedale 5FB/3 ...	£39 10 0		£113
Wharfedale Coaxial 12 ...	£25 0 0		£72
Wharfedale Golden 10 ...	£8 14 11		£20
Tannoy 12in. Monitor ...	£30 15 0		
Tannoy 15in. Monitor ...	£37 10 0		
WB. 1016 ...	£7 12 3		£16
Goodmans AL.120 ...	£29 10 0		£84
Goodmans AL.100 ...	£23 10 0		£67
Goodmans Triaxiom ...	£25 0 0		£72
Goodmans 300 ...	£11 5 9		£32
Goodmans 400 ...	£16 1 0		£41
Mordaunt "Arundel" ...	£39 10 0		£113
Kelly Ribbon Mk. II ...	£10 10 0		£30

★ MOTORS AND PICK-UPS			
ORTOFON ARMS, MONO AND STEREO HEADS.			
Decca Stereo P.U. 3 Complete	£21 0 0		£45
Lenco GL60 Trans. Unit	£27 12 6		£60
Lenco GL58/R. Stereo P.U.	£24 5 7		£53

Garrard 301 ...	£22 7 3		£49
Garrard 4HF/Stereo P.U.	£19 4 8		£45
Connoisseur Motor Type "B"	£27 16 1		£59
Connoisseur, 2 sp. Motor	£16 13 1		£36
Goldring 700 ...	£9 14 9		£21

★ AMPLIFIERS & TUNERS			
Quad 22-Control Unit	£25 0 0		£72
Quad II Amplifier	£22 10 0		£65
Leak Stereo 20 Amp.	£30 9 0		£87
Leak Point One Pre-Amp.	£21 0 0		£60
Rogers Junior Stereo	£28 10 0		£82
Rogers Master Stereo Unit	£35 0 0		£100
Quad FM Tuner	£28 17 6		£60
Chapman AM/FM	£29 8 0		£60

Enquiries for all items by firms mentioned in this advertisement invited.

BINSON "ECHOREC" UNITS
BINSON STANDARD ECHOREC pre-amplifier enables echoes to be imposed on signals between microphone (or other source) and amplifier or recorder. 3 channels available, and timing of echoes is controllable. Details on request. PROFESSIONAL AND TRADE DISCOUNTS. 140 gns. £420
Binson "Baby Echorec", similar to above, but for single-channel working. 80 gns. \$240

- FULL OFFICIAL RATES OF EXCHANGE FOR PAYMENT IN ANY CURRENCY.
- MANY ITEMS FOR 110 VOLTS A.C.
- TRANSISTOR RADIOS.
- ACCESSORIES.
- LARGE AND UP-TO-DATE STOCKS:
- PROMPT REPLIES TO ENQUIRIES;

Carriage charged at cost.

NOW AT LARGER PREMISES

MODERN ELECTRICS (RETAIL) LTD.

120 SHAFTESBURY AVENUE LONDON W.1

(3 mins. from Piccadilly Circus and opposite Columbia Cinema)

Tel: TEM 7587 & COV 1703 Cables: MODCHAREX LONDON

*

SPECTO ROYAL
8 mm
PROJECTOR
and
TAPE
SYNCHRONISING
UNIT

*

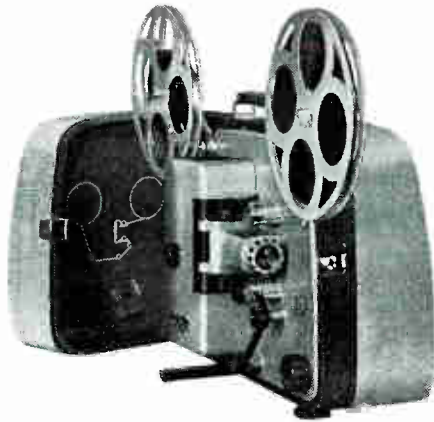

THE Specto-Royal 8 mm projector is very neatly designed with a two-tone laminated case. It is easy to carry and the plastic handle will lie flat on top of the case when not being used. The side-cover is easy to remove by means of the two Cheney clips and contains a 9 ft. mains lead. There are two spool arms with 400 ft. capacity which fold out from the chassis, each with its own rubber driving belt. Weight—12 lbs.

Film Threading

Film threading is speedy owing to the guide posts on either side of the 16 toothed sprockets being in a fixed position with no pressure guide to click open. There are four guide pins, two above and two below the gate, to take the film, and the whole lens unit swings out, in the conventional manner, quickly and easily. There is plenty of room to make gate cleaning simple.

The machine is suitable for use with AC mains of 110-240 volts. Settings are placed at the back of the machine, under the lamp-housing cover which has to be removed for voltage changing. The settings, however, are clearly shown and to alter them takes only a second, the operative setting always being visible through a slot in the housing cover. Separate switches are allowed for motor and lamp, the motor switch acting as a variable speed control.

Illumination

The 21.5V/150W Truffector lamp incorporates its own optical system and is so designed that the lamp can only be replaced in one way, ensuring that the filament is correctly positioned. It incorporates a silvered concave reflector mirror built into the lamp envelope which directs an image of intense brightness through the projection aperture. The lens on this particular machine was a f/1.5 Vario-Quinon 15-25mm zoom. The shorter focal length of 15mm gave a 4ft. by 3 ft. picture at a throw of approximately 13 ft. The screen image was sharp and there was no appreciable fall off at the edges that one is given to expect with a variable lens. The zooming action did not appear to upset the picture.

Mechanics

The three-bladed shutter is belt driven from the motor shaft. The double claw engages the perforations with a smooth pull-down motion even with a damaged sprocket hole. The cooling system seems adequate with the fan placed under the motor and inside the main alloy body. There is an adjustable foot. A well-designed framing control is built into the side of the lens unit. The power rewind is easily effected by reversing belt positions on the spool arms. Rewind time—200 ft. in a few seconds.

The Specto Synchronising Unit Type 209

The synchronising unit is small and compact, measuring approximately 5×3×3 in., and is nicely finished. It is designed for use with any tape recorder having a tape speed of 3½ i/s and which allows a loop of tape to be drawn through the unit. It has a heavy and adjustable stand to suit the height of the tape recorder deck and is threaded conventionally from left to right. The tape passes, from the tape recorder, around a compensating pulley on the synchroniser that finds its position

EQUIPMENT REVIEWED—(continued)

according to the tape speed. The position of this pulley directly controls the projector motor circuit through a flexible drive from the synchroniser to the projector drive. The synchroniser is geared in a ratio to pull 3½ inches of tape through its mechanism during the time that 16 frames pass through the projector gate.

Summary

I was quite impressed by the performance of these two machines running coupled, and found that adding a commentary and simple sound effects to some supplied packaged films was both very easy and amusing to do. The tape maintained accuracy within a few frames all the way through. I liked the variable projector lens and the projector speed control which gave slow running down to about 12 frames a second and fast running up to about 22 frames a second which means that movement can be produced more or less naturally on silent package films running at 24 fps. I think that both these machines are good buys at the price.

Prices: Specto-Royal with Vario-Quinon lens, £33; Synchronising unit type 209, £14 19s. 6d. Manufactured by Specto Ltd., Vale Road, Windsor, Berks. **Richard Golding**

*

THE VENNER
"AUTOPOINT"
PORTABLE
TIME SWITCH

*

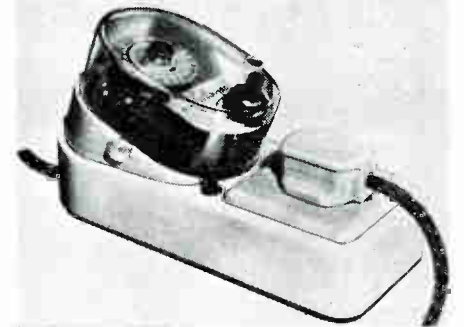

FOLLOWING our recent "New Products" announcement of this device, we received a specimen for test and review. It is a handsomely made gadget, as might be expected, for Venner have been specialists in the time-switch business for many, many years. At first thought, many potential users may hesitate to fork out £5 17s. 6d. for a switch to work the tape recorder—but it is a safe bet that, once unpacked in the home, the hi-fit set, the recorder and the radio will only come off second best in the list of jobs for it to do! Rated to handle 13 amps, the "Autopoint" is more than capable of switching on your 3 Kilowatt heater in the early morning, an hour or a half before the alarm drags you out of bed. It will also turn it off again after you have slammed the door in your rush for the train, and have the room nicely warmed for you to come home to in the evening. Provided only that the various household electrical appliances to be used with it are fitted with similar 3-pin plugs, it is a matter of seconds only to change its duties from heater to electric blanket, or to radio and recorder.

The "Autopoint" is supplied with a yard and a half of 3-core cable, and when this is fitted with an appropriate 3-pin 15-amp plug, and plugged into the mains, installation is complete. An "on/off" switch is located immediately below the clock dial, and a small red pilot lamp glows when it is on. A fused 3-pin plug at the front of the unit can then be used to connect any appliance to it (or group of appliances with a total load not exceeding the plug rating). The unit is all-electric, including the clock which starts when it is switched on. The clock face is marked out in two 12-hour sections, subdivided to show quarter-hour intervals. Two pairs of *On* and *Off* hands are fitted, so that the "Autopoint" can be used for two separate "on/off" switchings during the twenty-four hour period. If only one switching operation is required, the two "on" hands are swung together, likewise the two "off" hands.

When the switching times have been selected and set, the complete clock face is turned anti-clockwise until the "Time" pointer shows the time by your watch or clock. The unit is then started, and will continue to obey its pre-set instructions

Mastertape in new BOOK Style CONTAINERS

Made for your tape library

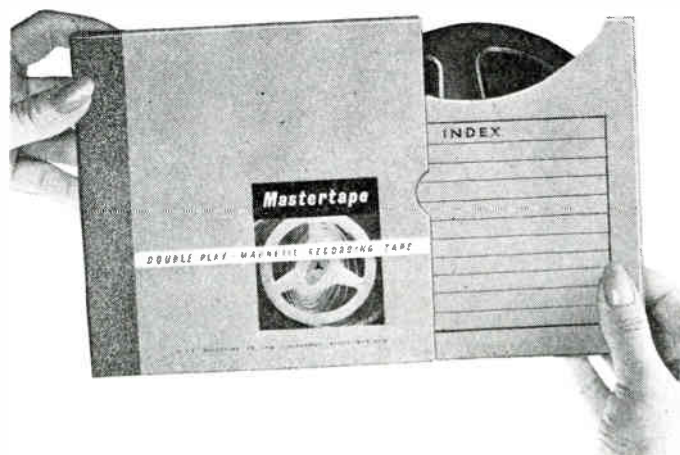

Completely dustproof · Long Lasting
Distinctive colour for each grade
Standard tape Crimson · Long Play
Lemon · Double Play Blue · Special
identification panel and internal pro-
gramme list · Now standard packs
for every spool of MSS Mastertape.

mss Mastertape
IS NOW AVAILABLE IN
4 GRADES
AND
7 SPOOL
SIZES

GET IT TAPED ON

mss Mastertape

M.S.S. Recording Company Limited. Colnbrook,
Buckinghamshire Telephone: Colnbrook 2431

A MEMBER OF THE
BICC
GROUP OF COMPANIES

See us at the Audio Fair, Booth 68, Demonstration Room 204
Office 240

EQUIPMENT REVIEWED—(continued)

until you alter them, day in and night out. It is only necessary to remember to re-set the clock to the correct time of day if you switch the unit off, or move it from room to room—because it is an electric movement!

In use it was found that the period between “on” and “off” can be very accurately set, and it can be adjusted down to a 30-minute session. This is quite short enough for almost any radio feature that one normally wants to record. Another very useful feature of the “Autopoint” is that its two “on/off” operations can be set quite close together on the clock. For example, you can record a programme which starts at 10.15 a.m., and switch off at 10.45 a.m., and then switch on again at 11.30 a.m. for another 30-minute session. At the other extreme, should such a facility be required, one can set the clock to switch on at, say, 12.45 noon, and to remain on for 22 hours.

Since the primary point of this review is to describe the unit's usefulness for home recording during one's absence from home, it is of greater interest to note that a long period of “Off” can be arranged to follow the selected period of “On”. In practical terms, for example, one can set the dial to switch on the radio and recorder for a session in the morning, and provided that one does not work more than a 22-hour day it will remain off until one returns home!

We have written a great deal, both in *Hi-Fi News* and *Tape Recorder*, about avoiding “flats” on pinch rollers through leaving tape recorders switched on (mechanically) when not in use. These observations are not overlooked when recommending a time-switch device; but one does not normally record programmes daily during one's absence, and provided that the procedure is not overdone it is unlikely that any harm will result. In any case, even if very considerable use is made of the facility, a new rubber tyre for the pinch roller can be reckoned in pence, and the tremendous advantages of being able to record items that would otherwise be missed must outweigh this small item many times. “Autopoint” is thoroughly recommended and is really excellent value for money.

E. D.

which?

So many recorders — so very easy to make a mistake. Our recommendations are worth having, for we know recorders.

personal service

We do not employ salesmen this is a personal business



And Mr. Dickinson is available to give advice and full demonstrations

free terms

Interest free terms, free delivery, expert tuition on all machines.

service

We undertake service on all recorders. Rapid service—Reasonable charges.
Brenell, Korting, Cossor, Elizabethan, Grundig, Philips, Spectone, Stella, Telefunken, Uher, Wyndors, Butoba, Clarion, Minivox, Stuzzi, Fi-Cord, etc.

DICKINSONS OF PALL MALL LTD.

11 Royal Opera Arcade, Pall Mall, S.W.1 TRA 2881

Behind Her Majesty's Theatre in the Haymarket
(One minute from Piccadilly Circus or Trafalgar Square)

our readers write

. . . about a neat automatic stop

From:—J. J. Staff, "Deodar", Lower Road, Hockley, Essex.

Dear Sir:—I read with interest the article in your fine magazine on "Automatic Stops" by A. Bartlett Still in the February issue, and I am wondering if some of your readers may be interested in the following perhaps less complicated arrangement, which I have had good success with.

The circuit is more or less self-explanatory, the reason for using a transformer was (a bell transformer is ideal) to make the period of operation indefinite, but if mains hum is experienced, and it is not practical to place same outside of recorder case, a suitable battery may be used, but this must be replaced frequently, to maintain the usefulness of the unit. The battery would be connected across points A-B and the top half of the circuit ignored.

The value of R2 will depend on the operating voltage of the relay. The relay must have contacts capable of carrying 240 volts at, at least 80 watts. The operation of unit is as follows. When S1 is turned on current will flow through to the relay, but, owing to R2, it is not sufficient to operate relay, but as soon as the tin foil on the tape shorts out S2, the relay will operate and R2 is of correct value to allow enough current to flow in order to cause relay to hold on, even if S2 is open circuited again, and will continue to be so until S1 is opened. The value of R2 may appear rather critical but a little trial and error will soon give desired effect.

If wired correctly this unit can be made to turn off the entire mains supply to the recorder, which is very useful if it is likely to be unattended for a considerable period. *Yours faithfully.*

. . . about the Collaro modification

From:—A. Coakley, 121 Shaw Heath, Stockport, Cheshire.

Dear Sir:—In F. K. Rawson's article on the modification of the "Studio" Collaro tape deck, he says that the deck is rendered serviceable when the record/playback switch is left in the record position. I possess an Elizabethan Major recorder and it is impossible to have a tape erased by fast winding, when the record/playback switch is left in the record position. It is by no means a fault of the recorder because it says in the instruction book that this is correct. *Yours faithfully.*

Mr. F. K. Rawson writes:

"My article described the provision of a "record" interlock for use with the "Studio Deck", not for use with the Elizabethan Major recorder. The Elizabethan Major is fitted with a considerably modified "Studio" deck having non-standard heads and extra mechanical fittings which provide an interlock preventing fast wind with the record/playback switch set to the record position.

The interlock which I have described prevents the record/playback switch being left in the record position at any time other than when it is deliberately set to this position. It automatically re-sets to playback each time the deck is turned to the off position. It is thus impossible to spoil a tape by attempting to playback with the record/playback switch set to the record position."

. . . about hum

From:—C. R. Owens, 260 Edge Lane Drive, Liverpool, 14.

Dear Sir:—I have recently completed a tape recorder utilising the Collaro Mk. 4 Transcriber, Armstrong PABO-3 Tape Pre-amp and Dulci DPA10 amplifier and pre-amp. Results are very good except for a persistent mains hum pickup which is louder than one would normally expect. From tests carried out, I am certain that the fault lies in my wiring of the heads to the tape pre-amp via the switch banks.

The circuit in use at the moment is of my own design and allows the use of both record and replay buttons, i.e. the erase

circuit is completed only when the record button is pressed. I have already obtained the recommended wiring diagram from Collaro Ltd., but in this only the replay buttons are utilised for both record and replay, and this seems to increase the risk of accidental erasure. I would be grateful if you or any of your readers could supply any hints to reduce the hum, or suggest a circuit with low pickup of mains hum, which also embodies the use of both record and replay buttons. In such a widely used tape deck, I am confident that someone must have encountered this difficulty and found some means to overcome it.

Yours faithfully.

. . . about sound and cine

From: K. M. Garrett, 24 Lothian Road, Middlesbrough, Yorks. (Secretary of the Erimus Research Group, Cine Section)

Dear Sir: It was with great interest that we read in your December issue, the suggestion that Tape Societies should take up cine!

Being a group of amateur cinematographers devoted "to the pursuit of amateur film making in all its aspects" it was only natural that we, and most other amateur cine organisations too, quickly realise that in tape recording we had found, at least in part, the answer to our "sound" problems.

Quite a large percentage of our membership consists of "tape and cine" enthusiasts, and the group itself owns a machine, which when not in use on group projects, is available on (free) loan to members. This machine, in addition to its use for recording commentaries to group films, is also frequently used for correspondence with members who have now left the area, but who still wish to keep in touch with us.

The Tape Recorder is one of the periodicals which circulate amongst members and all copies back to No. 1 are available for reference in the group library. It has been a source of much information to us, over the past two years, and has, on several occasions, provided the answer to problems that have beset us.

It is interesting to note that the idea of tape societies embracing cine and vice versa, has its parallel in the history of cinematography. Some eighty years ago, Frieze-Green invented his cine apparatus and then sought a means of adding sound. At the same time, but on the other side of the Atlantic, Edison was endeavouring to add vision to his recorded sound. Although an approach was made by Frieze-Green in 1887 when he sent Edison copies of the drawings for his apparatus, these two famous men never got together to achieve their twin objective. Let us hope that here the parallel ceases and that cine and tape enthusiasts will get together to what we are quite sure, will be to their mutual advantage. *Yours faithfully.*

. . . about the "Add-on" deck

From: J. Hone, 10 Aldbourne Road, London, W.12

Dear Sir: I have been inundated with letters from readers since you printed the article describing my "Add-on" deck. I have replied to all the people who have written to me, but would like to clear up one or two queries which readers have asked about in their letters. Although most of the letters I received were about adapting the "Add-on" deck to different makes of recorders, and all the writers were eager to make one, a lot of the letters asked many questions which I could only have answered properly if the unit were professionally made and foolproof.

It must be remembered that not only was the deck made primarily for use with the Ferrograph, but that it cost only about 45s. to make, and is the basis of an idea which, no doubt, can be developed and made to finer limits. One query concerned the use of odd thickness tapes (i.e. LP tape on the recorder and standard tape on the "Add-on" deck or vice versa). I have found no difficulty here at the moment, and the

hifi

FOR BEGINNERS

by John Borwick

**ORDER YOUR
COPY TODAY!**

★

PRICE 7/6

(Plus 9d. postage)

Due to the heavy demand for this book, it has been decided to substantially increase the print order, and the publishers therefore regret that there will be a slight delay in the despatching of some copies already ordered. Readers are advised to order now so as to be sure of getting a copy of this indispensable book.

★ THIS IS THE FIRST TITLE IN THE LONG-AWAITED SERIES OF HI-FI BOOKS, AND WE RECOMMEND IT THOROUGHLY TO EVERY ENTHUSIAST. READERS WHOSE PARTICULAR INTERESTS LIE WITH TAPE WILL FIND THAT CHAPTER 7 ALONE WILL MAKE THE BOOK WORTHWHILE. OTHER CHAPTERS DEAL WITH LOUDSPEAKERS : AMPLIFIERS : PICKUPS : TURNTABLES : RADIO TUNERS : STEREO : INSTALLING HI-FI. A FINAL CHAPTER OF "QUESTIONS AND ANSWERS" WILL EXPLAIN MANY PROBLEMS. "HI-FI FOR BEGINNERS" IS THE IDEAL BOOK FOR EVERYONE WHO HAS JUST STARTED, OR IS ABOUT TO START THIS HOBBY.

MILES HENSLOW PUBLICATIONS LTD. 99 MORTIMER ST., LONDON, W.1

hifi
BOOKS

READERS' LETTERS—(continued)

only thing that is likely to happen is that the tape will wind on either of the take-up reels *rather loosely*. When making a copy of an 1,800 ft. LP tape, usually accommodated on a 7 in. reel, I use 8½ in. reels, and when it does wind on loosely the large reels keep the tape in place.

Another point brought up was how to copy an item from the *middle* of a recorded tape when the clean tape would be at the beginning of the reel. It was said that the speeds of each reel would be different, owing to one reel being half empty. I also find no difficulty here; presuming that you want to copy an item off the middle of a tape, you load the tape on to the "Add-on" deck spindle in the usual way, having first run the tape through your recorder on to a normal take-up reel until you have come to the desired spot. The half filled take-up reel is now placed on top of the recorder's take-up reel as before, but since it is only one item which you want to copy, you can use a small reel of tape (I use flexible plastic 3 in. cine reels) containing just enough tape to receive the recorded material. Once again, the tape will only wind on loosely with no ill effects.

It must be remembered that before you start a copying session, you must make preparations and once you have worked out a routine I am sure that good quality copies can be made. By the time you read this, Mr. A. Tutchings will probably have had a letter printed showing a slight modification to the "deck." I think that both my idea and his modification have good points, but I feel that by having the gap of the external head scanning the lower track of the tape some sound effects and permanent material will have to be rewound every time you want to make a copy, if you use Mr. Tutchings' method.

When ordering a head from Mr. Tutchings, also purchase the head plate and guides and obtain the insulated washers to raise up the head. This will make the gap scan the top track in the usual way.

Yours faithfully,

... about tape prices

From:—Wilmex (Distributors) Ltd., St. Stephen's House, Westminster, London, S.W.1.

Dear Sir:—Whilst we are of course only able to answer Mr. Parkinson's comments from the point of view of Irish Brand Tape and not on behalf of the whole industry, Mr. Parkinson might be interested to learn that ever since American dollars were liberalised in 1959 Irish Tape has been available in this country. It is by no means necessary to pay 35s. for a reel of Standard Play Tape 1,200 ft. or 50s. for 1,800 ft. However, like all things in this world the cost of a product very much dictates its quality. For instance, one can purchase an Irish Brown Band 195 Standard Play tape at the price of 27s. 6d. for 1,200 ft., and indeed it is quite likely that very little difference in quality would be apparent from our normal 35s. tape. Alternatively, the Long Play tape is available and costs 39s. 6d.

We feel that some warning should be given against the public purchasing extremely cheap tape which is obviously of sub-standard quality. As Mr. Parkinson and many of your other readers may already know, magnetic tape is manufactured in a width of 18 in. or more and this is subsequently cut to ¼ in. widths. In this process the side lengths of the original film strip are usually slightly less than a ¼ in., and it is possible that at the extremities the oxide coating will not be as perfect as for the remainder of the strip. This tape then becomes sub-standard and eventually in certain cases finds its way on to the market at considerably lower prices than normal proprietary makes. It is also possible that any reel of sub-standard tape can contain a high proportion of splices whereas normal proprietary tape is splice free. As long as the public realises these facts when purchasing sub-standard tape no harm is done, but we feel it is quite likely that there are many users of tape recorders who may be misled.

Finally, we should like to draw attention to the fact that technical reviews of magnetic tapes are available. The I-ish Company also freely offers to all interested parties complete technical data sheets of their products.

Yours faithfully,

— YOUR TAPE DEALER —

Specialists in Hi-Fi Equipment and Tape Recorders

CHELSEA RECORD CENTRE

203 KINGS ROAD, S.W.3 FLA 2596

Open till 8 p.m. (except Thursdays)

Disc and Tape Reproducing Equipment and Tape Recorders

by Leading Manufacturers

CUSTOM BUILT INSTALLATIONS

All High Fidelity Requirements and Services Available

Estimates Free

Personal Service

Custom High Fidelity

371 Green Lanes, Palmers Green, London, N.13

Tel. PALmers Green 522A

LONDON AREA, W.1

- Stockists of leading makes of Tape Recorders
- Comparative demonstrations at any time

H. C. HARRIDGE

8 MOOR STREET W.1

Telephone: GERRard 7108



ALL LEADING MAKES IN STOCK
Cash or Easy Terms

LONDON'S FINEST SERVICE

207 EDGWARE ROAD, W.2

PAD 3271/2

42 TOTTENHAM COURT ROAD, W.1 MUS 2605

LEONARD G. FRANCIS PRESENTS . . .

SHEEN TAPE RECORDER CENTRE LTD.

SPECIALISTS IN TAPE RECORDERS AND ACCESSORIES, ETC.,
YOUR CENTRE FOR FRIENDLY HELP—SALES AND SERVICE

8 STATION PARADE,
SHEEN LANE, SHEEN,
LONDON, S.W.14

Showrooms Open until 7 p.m.
PROSPECT 0985
(Next to Mortlake Station S.R.)

H. D. KIRK

Stereolectrics

LIMITED

Specialists in High Fidelity
150 HIGHER BRIDGE STREET

Phone: 23093

BOLTON

BIRMINGHAM

TAPE RECORDERS on "NO-INTEREST" Terms!

NO EXTRA CHARGES FOR EXTENDED CREDIT. You pay the Retail Price only. Grundig, British Ferroglyph, Philips, Vortexion, Telefunken, etc. Comparative daily demonstrations of all Leading Makes of Stereo Hi-Fi Equipment and Recorders

JEWKES & CO. LTD.

The Midlands Hi-Fi and Tape Recorder Specialists
285 BROAD STREET, BIRMINGHAM 1. MID 4829/20

R.E.S. (COVENTRY) LTD.

**SPECIALISTS IN HIGH FIDELITY
and all makes of Tape Recorders**

All leading makes of High Fidelity Equipment stocked and demonstrated under ideal conditions. ★ *The Best Selection—Terms and After Sales Service in the MIDLANDS.*

R.E.S. (Coventry) Ltd. 128 Far Gosford St.

Coventry 28781/2

— YOUR TAPE DEALER —

ACOUSTIC PRODUCTS

Hi-Fi Stereo Tape Recorders
Specialised Loudspeaker enclosures and
Equipment Cabinets Designed to order
Write or ask for Mr. Pendreich
54 ELM ROW, EDINBURGH, 7. Tel.: WAV 6338

FARNHAM, SURREY

- ★ Stockists of all the leading makes of High-Fidelity Equipment
- ★ Comparative Demonstrations
- ★ Cabinet Manufacturers and Designers
- ★ Personal service and satisfaction guaranteed

LLOYD & KEYWORTH LTD, The Record Shop
26/7 Downing Street, Farnham, Surrey. Telephone: Farnham 5534
SURREY AND HAMPSHIRE'S HI-FI SPECIALISTS

Tape Recorder Centre (Halifax)

Yorkshire's Leading Tape Recorder Specialists
Comparative Demonstrations Daily ● Official Telefunken Service Agents
Hi-Fi Stockists
SOUND INSTALLATIONS
17 Rawson Street, Halifax Phone: Halifax 66832

LEEDS

**HEADROW HOUSE &
144 BRIGGATE LEEDS, I.**

VALLANCES

Branches at Otley, Harrogate,
Mansfield, and Scunthorpe

**A WIDE SELECTION OF THE FINEST
RECORDERS AND ACCESSORIES**

LEICESTER

ALL YOUR HI-FI REQUIREMENTS

H.M.V. · DULCI · QUAD · LEAK · CHAPMAN · ROGERS · AUDIOMASTER
Speakers by TANNAY · LOWTHER · W.B. · H.M.V. · WHARFEDALE
Tape Recorders FERROGRAPH · REFLECTOGRAPH · GRUNDIG · SIMON
BRENELL · RECORD DEPT · ALL LABELS · PARASTAT SERVICE
LEICESTER CO-OPERATIVE SOCIETY LTD.
HIGH STREET Telephone: 20431

LIVERPOOL'S TAPE SPECIALISTS.

*Offer unique sales and
service facilities throughout the
Northwest.*

Stockists of FERROGRAPH
REFLECTOGRAPH, GRUNDIG,
etc., etc.
FREE H.P. up to 12 MONTHS

COGHLAN & ROBINSON LTD. 18 HACKINS HEY, (off Dale
St.,) L'POOL 2. CEN: 5245

MANCHESTER

The Tape Specialists



**FERROGRAPH · BRENELL
PHILIPS · TELEFUNKEN**
and all other good makes

8 DEANS GATE · MANCHESTER

Next to Grosvenor Hotel

PALMERS of MIDDLESBROUGH DARLINGTON

JASON · LEAK · ROGERS · PAMPHONIC · W.B.
WHARFEDALE · R.C.A. · GOODMANS · GRUNDIG
Call or send for lists:—
3 East Street, Darlington or 106 Newport Road, Middlesbrough

CLASSIFIED ADVERTISEMENTS

Advertisements for this section **must be pre-paid**, and accompanied by a postal order, money order, or cheque. They must be clearly written or typed, and must be in the form of a separate sheet of paper if included with a letter dealing with other subjects.

The rate is 6d. per word, with a minimum charge of 7s. 6d. Box Numbers may be used for an extra charge of 1s. 6d. The trade rate is 9d. per word, plus 2s. for a box number, conditions on application. Send replies to Box Numbers c/o "The Tape Recorder", 99 Mortimer Street, London, W.1.

All advertisements for the May issue must arrive not later than **April 4th.**

For Sale

A binder will keep your copies of The Tape Recorder clean and ready for easy reference, price 15s. posted from 99 Mortimer Street, London, W.1.

Recording Tape. Best quality P.V.C. on 5½ in. reels. 850 ft. at 19s. 6d., and 1,800 ft. Double Play at 37s. 6d. P. & P. 1s. Fenham Radio Company, 80a, Sandyford Road, Newcastle upon Tyne, 1.

Pre-Recorded Tapes. Unique 40 page catalogue listing all makes, mono stereo, 7½ and 3¼ i.p.s. Send 2s. 6d., refundable on first tape record purchased. Dept. TR4, Teletape Ltd., 33, Edgware Road, London, W.2.

Tape/Disc/Tape transfer, editing, duplicating. If quality and durability matter (especially with LP's from your precious tapes) consult Britain's oldest transfer service. (LP's from 16s.). Limited quantity 1,800 ft. American branded LP tapes 35s. Sound News, 10, Clifford Street, London, W.1.

Use up those odd lengths of tape, splice them together professionally after reading "How to Splice Tape" price 2s. 6d. posted from The Tape Recorder, 99, Mortimer Street, London, W.1.

Find that review you want—get a copy of the index to volume one Tape Recorder. Price 2s. posted.

Recording Tape. Save up to 30%. Send for list. Also 50 secondhand Recorders in stock. E. C. Kingsley & Co., 132, Tottenham Court Road, London, W.1. EUS 6500.

Pre-Recorded Tapes. We supply every pre-recording made. Send for our lists. Fenham Radio Company, 80a, Sandyford Road, Newcastle upon Tyne, 1.

Easysplice tape splicer—patented and guaranteed. Makes tape splicing simple, easy and accurate. 5s., P. & P. 6d. Easysplice, 30 Lawrence Road, Ealing.

"Eroica" Recording Services (Established 1949). Tape Recorders for the home, industrial and professional use. (Up to sixteen channels). Whether you record "Merry Madrigals" or track moon rockets, we can equip you. Ferrograph, Tricorder, Magnette (Battery) etc., from stock. Special offer Ferrograph "808" stereo demonstration model, as new £95 (List 110). Experienced recordists advise on your problems. Studio (Steinway Piano), mobile unit. Tape/disc (music editing). Hear our current recordings of "British All Star" and "Black Dyke" Bands on Paxton label. Open all day Saturdays. Five minutes from Motorway M.62. "Eroica" Studios, Peel Street, Eccles, Manchester. ECCles 1624. Director: Thurlow Smith A.R.M.C.M.

Tandberg 2-track stereo, £50 o.n.o. also Philips 4-track EL3542 almost new £40 o.n.o. Inspection London. Box No. (London) 265.

Loewe-Opta tape recorder, 2 speeds, tone control, 5½ in. spools, trick button, portable, brand new, including mic. and four tapes £75 o.n.o. R1Verside 4980, or Box No. (London) 266.

Miniphon pocket recorder, complete batteries, recording spools 1½ hours, mic. transformer for mains operation, stethoscope and single ear-phones. £25 for quick sale. Box No. (Derby) 267.

Stuzzi battery tape recorder "Magnette" two speeds microphone and all accessories as new. £47. A. S. Mackenzie-Low, Bexhill 3922.

Grundig Stenerette dictating machine. Mic. Foot control, Stethaphones. Tape cassette. Beautiful condition. £25. Box No. (Derby) 268.

The New Reflectograph model B in special carrying case. Absolute ultimate in Hi-Fi 4 track recording. Bought (£118) for medical research now abandoned. Accept 100 gns. Also scarcely used Pye Hi-Fi pre-amp and main amp. Cost £45 offered £22. Dr. M, The Grove, Lincoln.

All in perfect condition Grundig TK35 £55 Grundig 4 channel mixer £9 10s. 2 Grundig dynamic microphones £4 10s. each. 2 Grundig condenser microphones £3 each. Other accessories. 2 Wharfedale W.3 loudspeakers finished in walnut only two months old £29 10s. each. A. S. Mackenzie-Low. Phone: Bexhill-on-Sea 3922.

FREE H.P.!

**YOU PAY THE
CASH PRICE
ONLY—OVER
24 MONTHS!**



**WE HAVE THE BIGGEST SALES IN THE COUNTRY! WHY?
BECAUSE WE GUARANTEE YOU THE BEST TERMS.**

They include:

**DEPOSITS FROM 10% ★ 2 YEARS TO PAY ★ SPECIAL FREE OFFERS ★ FREE
SERVICING FOR 12 MONTHS ★ FREE DELIVERY ANYWHERE IN U.K. ★ NO
PURCHASE TAX ★ PART-EXCHANGES & CHEAP SECOND-HAND MACHINES ★
COMMISSION PAID ON SALES YOU MAKE FOR US ★ 10% INTEREST PAID ON
YOUR DEPOSIT ★ SPECIAL CUSTOMER DISCOUNTS ★ and lots more besides.**

As Main Agents for ALL the best makes, our Mail Order Department specialises in orders by post with thousands of sales throughout the whole of England, Scotland, Wales, & N. Ireland—order from us wherever you live—you get better terms and better service from us.

We have 400 machines in stock—£20,000 worth of 80 different new and second-hand models on permanent demonstration in our showrooms.

If you want to know why it will pay you to buy from us, and how you can save money, write phone or call NOW for full details of all our terms, and free brochures on all the best makes:

HOWARD
TAPE RECORDERS
218 HIGH ST. BROMLEY, KENT. RA.V. 4477

CUT OFF HERE

Please rush me full details of your Terms and Tape Recorder brochures:

Name..... Address.....

Name below any models you are particularly interested in :

ER/APR

YOUR TAPE DEALER

WESTWOOD'S of **OXFORD**
46 GEORGE STREET
PHONE: 47783

PETERBOROUGH, NORTHANTS Tel: 2759
Hi-Fi Equipment and Record Specialists
Tape Recorders - - Record Players
Comparative demonstrations of all leading makes of Audio equipment
CAMPKIN'S RECORD SHOP
12 PARK ROAD
also at KP Camera Shop, Kings Parade, Cambridge

HAMILTON ELECTRONICS
HIGH FIDELITY TAPE RECORDERS 35 LONDON ROAD
TEL. 28622 **SOUTHAMPTON**

SOUTHAMPTON—SALISBURY
★ All the best makes of Tape Recorders
★ Hi-Fi Systems and Records
★ Expert knowledge and advice
The West of England High Fidelity Specialists
J. F. SUTTON 421 SHIRLEY ROAD, SOUTHAMPTON
15-18 QUEEN STREET, SALISBURY

WORTHING, SUSSEX
We stock Hi-Fi Equipment by Leak, Quad, Goodsell, RCA, Acos, Garrard, Collaro, Tannoy, Wharfedale and Goodman and give fully comparative Demonstrations
BOWER & WILKINS LTD.
1 Becket Bldgs., Littlehampton Road Worthing 5142

RAPID RECORDING SERVICE
78s & LPs from your own tapes
Master Discs and pressings

Recording Studio equipped with Bechstein Grand Mobile Recording Van — "Off the Air" Service
Practising studios with or without accompanist
21 Bishops Close Church Lane, E.17 COP 3889

SPOT ARTISTES and TITLES
ON TAPE— ACCURATELY— QUICKLY



A three figure tape revolution counter with reset wheel that attaches quickly without disturbing the tape.

"It carries out to the letter what it is designed to do."
THE TAPE RECORDER

PRICE
CALL-BOY 42/6
EMITAPE 7" SCOTCH 7" & 5 1/2" ONLY
TAPE POSITION INDICATOR

Trade enquiries invited
COLTON & CO. (Lapidaries) LTD., The Crescent, Wimbledon, London, S.W.19

CLASSIFIED ADVERTISEMENTS—(continued)

For Sale (continued)

Recording tape, best quality PVC 30 per cent. below list price. Suit every speed and all 2 and 4 track recorders. 5 in. 900 ft. at 19s. 6d.; 5 1/2 in. 900 ft. at 19s. 6d.; 5 1/2 in. 1,800 ft. at 37s. 6d.; 7 in. 1,200 ft. at 25s.; 7 in. 1,800 ft. at 37s. 6d. P & P 1s. All guaranteed perfect. Fenham Radio, 80a, Sandyford Road, Newcastle 1.

Wanted

TK20 or similar good Grundig wanted. F. Riddle, 113, Church Road, Northolt, Middx. Viking 4734.

The Tape Recorder Vol. 1, Nos. 1, 3, 5, 6, 11 and 12 or complete Vol. Walker, 15 Prestwood Drive, Thundersley, Essex.

Collector seeks tapes of rarely heard operas, also recitals, if any, by De Los Angeles and Tebaldi. Box No. (Essex) 269.

The Tape Recorder Vol. 2, Nos. 1, 2 and 4. Offers to Scoffin, Lantern House, Chesham.

Miscellaneous

Tape Recorder need repairing? Let London's largest tape recorder specialists do it for you, expertly and economically. Essex Tape Recorder Centres, 2, Maryland Station, Stratford, E.15. MAR 5879.

All makes of tape recorders repaired or modified. Miniflux heads supplied. Audio installations built to your specification by John C. Latham, Deimos Ltd., 8 Corwell Lane, Hillingdon, Middx.

Tape Recorder and Hi-Fi repairs. Official Walter Service Centre, Swift Teleservice, Quarry Bank Mill, Styal, Ches. Tel.: Wilmslow 6213.

Tape to Disc

Tape to Disc—Comprehensive 78-45-33 1/2 service available from Rendezvous Records, 19, Blackfriars Street, Manchester 3.

Tapes? Transfer? Consult Sound News for better rates. See above.

Tape to Disc service, editing, and dubbing, all speeds. Studio available for musical groups. Outside recordings our speciality. Ilford Sound Recording Service, 63, Aintree Crescent, Barkingside, Ilford, Essex. Telephone: CRE 8947.

Tape to Tape or Disc Microgroove Master Discs and Pressings from 12s. Stamped addressed envelope for details to OMEGA Recording Co., 112, Sunny Bank Road, Potters Bar, Middx. POB 6428.

ADVERTISERS' INDEX

	Page
A.K.G. m.b.H.	116
Allegro Sound Equipment Ltd.	144
B.A.S.F.	160
Bi-Tapes Ltd.	146
Brand Five Tapes	139
Brenell Engineering Ltd.	111
British Ferragraph Recorder Co. Ltd.	106
A. Brown & Sons Ltd.	148
S.G. Brown Ltd.	126
Chitnis Electronics Ltd.	128
Cine Accessories Ltd.	144
Colton & Co. (Lapidaries) Ltd.	158
Cosmocord Ltd.	114
Denham & Morley Ltd.	134
Dickinsons of Pall Mall	152
Essex Tape Recorder Centre Ltd.	148
Elizabethan (Tape Recorders) Ltd.	108
E.M.I. Electronics Ltd.	113
Elstone Electronics Ltd.	130
Film Industries Ltd.	142
Francis of Streatham	138
Grampian Reproducers Ltd.	130
Grundig (G.B.) Ltd.	117
Heathkit	110
Howard Photographic	157
K.G.M. Electronics Ltd.	142
Lanes Radios Ltd.	142
Lustraphone Ltd.	150
M.S.S. Recording Co. Ltd.	152
Magnograph	131
Modern Electrics Ltd.	150
R. Marking & Co. Ltd.	126
Metro-Sound Manufacturing Co. Ltd.	148
Multicore Solders Ltd.	149
Nusound Recording Co.	144
Phillips Electrical Ltd.	134
R.E.W. Earlsfield Ltd.	140
Rapid Recording Service Recorder Co.	158
Reps Tape Recorders Ltd.	138
Reslosound Ltd.	118
Saga Sound	136
Scotch Brand Tape	115
Standard Telephones & Cables Ltd.	120
Tape Recorder Centre	107
Tape Recorder (Electronics) Ltd.	112
T.S.L. Ltd.	159
Valradio Ltd.	128
Wellington Acoustic Laboratories Ltd.	145
Wharfedale Wireless Works Ltd.	146
Wilmex (Distributors) Ltd.	136
Zonal Film (Magnetic Coatings) Ltd.	109
	140

Hear for yourself on Stand 25

International Audio Fair, Hotel Russell

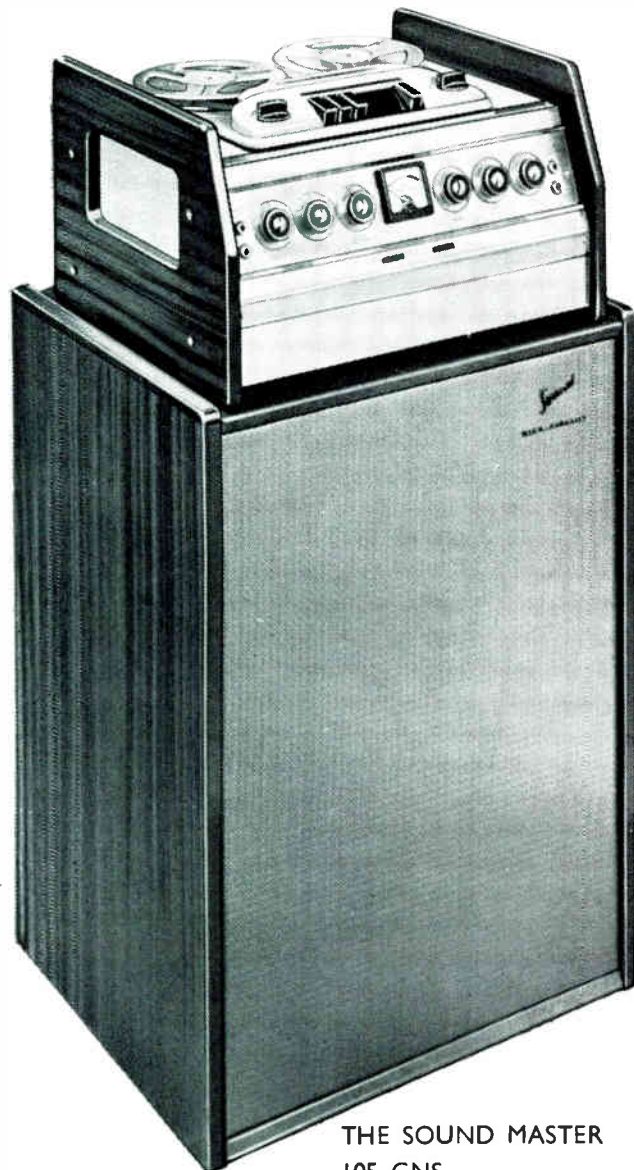

THE SOUND MASTER
105 GNS.

The new Sound Tape Recorders

10 years' tape recorder manufacturing experience —that is your surety of the quality of a Sound Tape Recorder. Each tape recorder has a host of fine features, supplied completely ready to use. Twin track and four track models available.

All this experience lies behind the the new Sound Master, a precision instrument engineered to professional standards of performance and reliability. It is a four track, three speed machine with separate recording and replay amplifiers. There are full facilities for mixing, monitoring and multiple superimposition, and 10 watts output through the acoustically-designed reflex loudspeaker system. A unique feature is the facility to record and playback simultaneously. The Master is, in fact, a complete magnetic recording system offering studio quality performance.

Sound Tape Recorders are available in a range of models to suit every pocket.

See for yourself on Stand 25

(Demonstration Room 115)

SOUND

TAPE RECORDERS (ELECTRONICS) LTD.

784-788 High Road, Tottenham, London, N.17.

Telephone: TOTtenham 0811

159

7/4/6

only

Authentic Sound

will
pass
this
test

Every day on the farm BASF tape is passing the most critical of all tests for authenticity. As part of an intensive rearing programme, piglets are removed from the sow soon after birth, fed on special foods and given that 'at home' feeling by tape recordings of their mother's grunts. To convince a piglet the recording has to sound authentic. There are three reasons why BASF tape provides the sound that never fails to do so.

The first is its Luvitherm base which permanently holds the magnetic oxide in the tightest bond. The second is the oxide itself, made by a special BASF process to ensure magnetic stability no matter how long the tape is stored. The third is —'know-how'. BASF is the original magnetic recording tape. Today a vast reserve of more than 25 years experience and continued development keeps it ahead for authenticity. Whatever your recorder you can always be sure of registering its complete range of frequencies on BASF tape . . . always reproducing them . . . always obtaining Authentic Sound whatever and wherever you record.



insist on
the tape with
the Luvitherm base



Magnetic Recording Tape

Standard · Long Play
Double Play · Editing Sound

BASF CHEMICALS LIMITED 5a GILLESPIE ROAD LONDON N5

Don't miss seeing BASF at the Audio Fair, Hotel Russell,
April 6th - 9th — Stand 2, Demonstration Room 222

Published by Miles Henslow Publications, 99 Mortimer Street, London, W.1.
Printed by STAPLES LTD., (Incorporating F. Howard Doulton Ltd.) Warton Road, Stratford, London. E.15.

(h) xosj