

T. & R. Bulletin

Incorporating

The Journal of the Inc. Radio Society of Great Britain

(BRITISH EMPIRE RADIO UNION)



Vol. 5. No. 3. September, 1929 (Copyright)

Price 1/6

TRANSMITTING CONDENSERS? THE NEW "G.R."

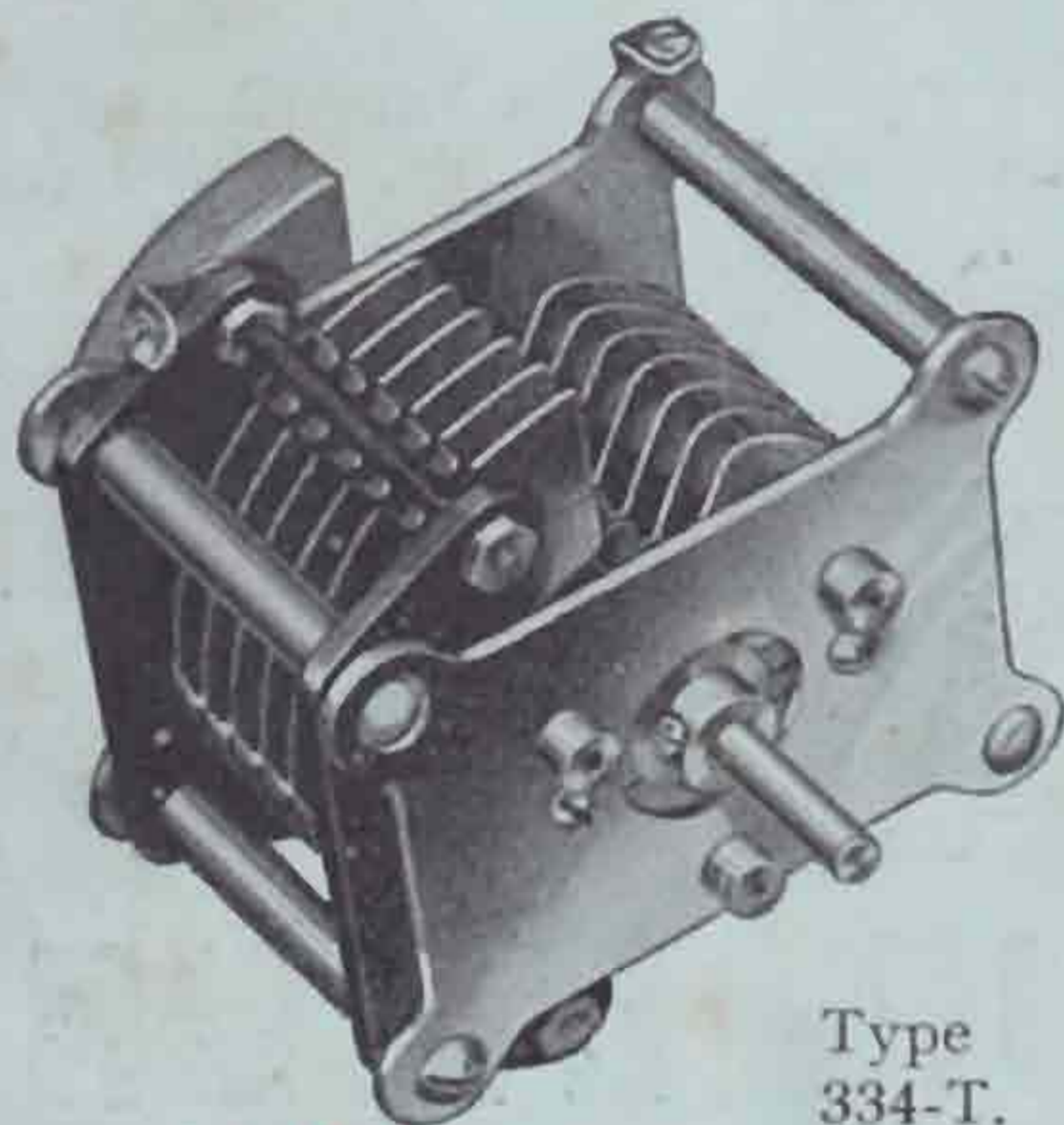

Type
334-T.

2,000 VOLT TYPE 334 CONDENSERS

Breakdown Potential somewhat over 2,000 V. DC; Double-spaced taper plates; Usual GR Soldered Rotor and Stator Assemblies; Selected Dielectric of minimum dimensions in weak, almost unvarying field; Almost nil temperature co-efficient; good for 5-metre waveband upwards; Perfectly counterweighted; noiseless bearings, self-compensating for wear; LOW PRICES; PROMPT DELIVERIES.

Type 334 R ... Max Cap. '00025 mF. List Price 32/6
Type 334 T ... Max Cap. '00010 mF. List Price 20/-
Type 334 V ... Max Cap. '00005 mF. List Price 18/6

AS USED BY EVERY CIVILISED GOVERNMENT; GR CONDENSERS ARE USED BY THE G.P.O., B.B.C., N.P.L., Etc.; THERE MUST BE A REASON FOR THIS! OVER 40 OTHER TYPES, RANGING IN PRICE FROM 5/6 to £26 10 0. ALL DESCRIBED AND ILLUSTRATED IN OUR FREE 188-PAGE CATALOGUE.

AND
THIS IS
OUR NEW



750 WATT "Q.M.B." POWER SWITCH

LIST PRICE ONLY 2/6 POST FREE.

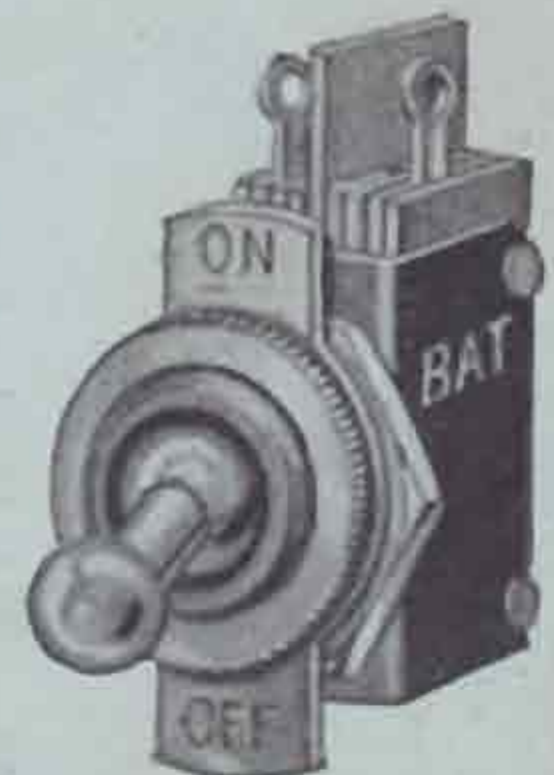

As our Registered Trade Mark says, "BEST AFTER TEST." The switch is very small, yet easily breaks 3 Amps. at 250 Volts! Use them in all low-powered Transmitting Circuits and keep the Undertaker away! For H.F., L.F., H.T., L.T. and Transmitting Circuits. For AC. and DC. Mains Supply Units; For Gramophone Motors, etc. Send for free pamphlet; request at the same time our famous "CLAROSTAT" Booklet (all about DC. and AC. Mains Units, including L.T. Units, with Scale Drawings).

DON'T FORGET TO SEE US, AS USUAL, AT THE MANCHESTER RADIO EXHIBITION. AMONGST OTHER INTERESTING NEW APPARATUS WE SHALL HAVE A COMPLETE RANGE OF MOVING COIL SPEAKERS OF STARTLING PERFORMANCE YET PRICED MOST ATTRACTIVELY. REMEMBER OUR STAND IS NO. 95.

CLAUDE LYONS LTD., LIVERPOOL.

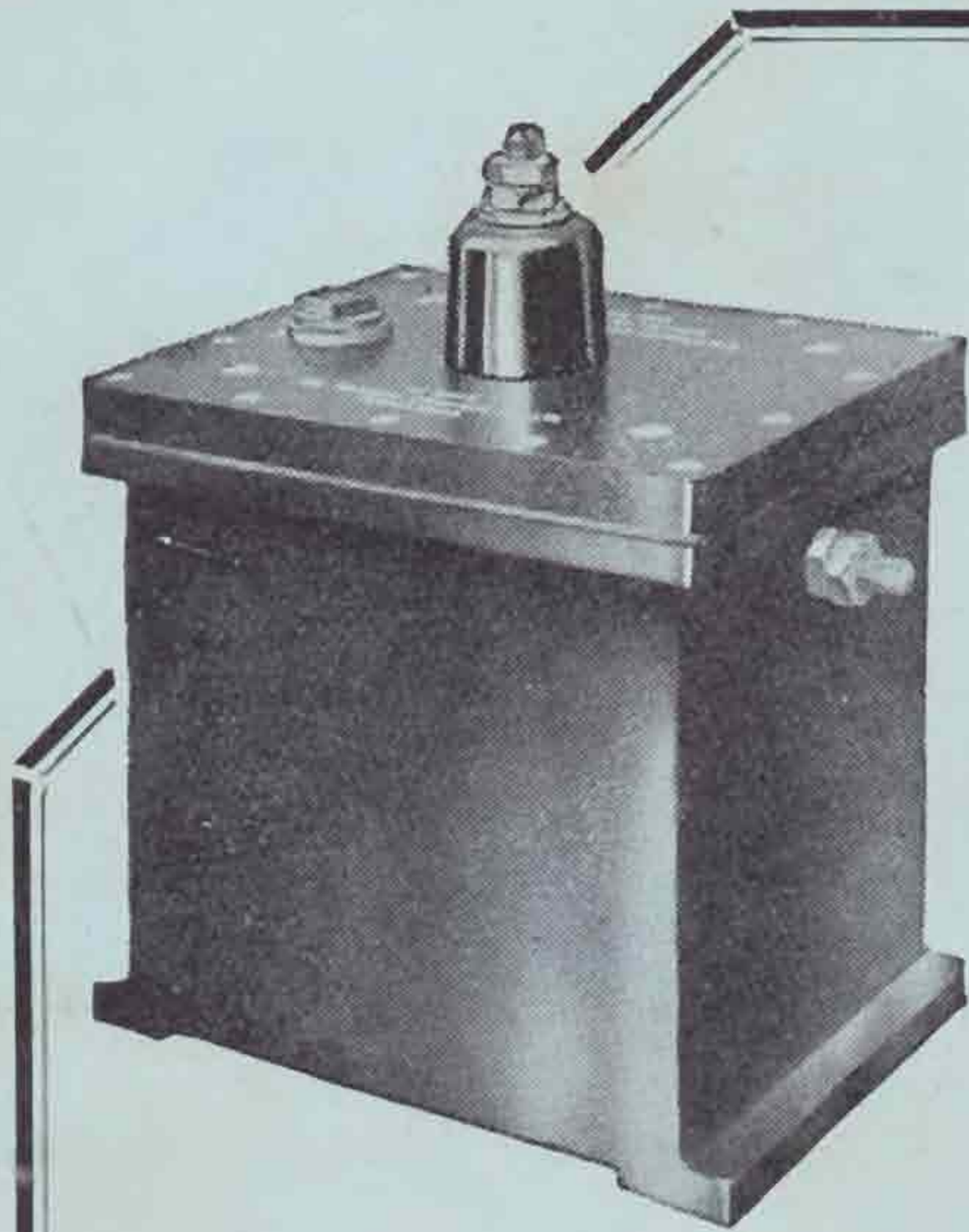

T.C.C.

TRANSMITTING CONDENSERS

The Condenser illustrated has a capacity of .0002 and is required to pass 5 amps. at 50 metres and work at 10,000 volts D.C.

Condensers for all purposes, including Power Factor Improvements, Wireless Reception, Smoothing, Telegraphy.

"T.C.C." Transmitting Condensers have been working at Post Office and Broadcasting Stations for years and have given satisfaction. We invite your enquiries giving details as to capacity and voltage, etc.

TELEGRAPH CONDENSER CO., LTD., Wales Farm Road,
North Acton, London, W.3.

CA 454

FERRANTI

H.T. SUPPLY UNIT

(Incorporating the Westinghouse Metal Rectifier).

No better H.T. Supply Unit is available at any price. The Output, up to 100 milliamps at 200 volts, is adequate for the best Receivers, and there is

NO MAINS HUM AND NO "MOTOR BOATING"

The Ferranti H.T. Supply Unit type BEM1 provides a high standard of SAFETY and complies with the wiring rules of the Institution of Electrical Engineers.

AN H.T. SUPPLY UNIT OF THIS QUALITY IS ESSENTIAL FOR MOVING COIL SPEAKERS.

For the constructor, charts are available relating to a number of H.T. Supply Units and will be sent gladly on receipt of details of your requirements.

**SIMPLE TO BUILD, SAFE TO USE,
RELIABLE IN OPERATION.**

FERRANTI LTD. HOLLINWOOD LANCASHIRE



PRICE
£13 10 0

ALWAYS MENTION THE R.S.G.B. WHEN PURCHASING.

TRAR

BULLETIN.

The only British Wireless Journal Published by Amateur Radio Experimenters

*All correspondence and matter for publication to be addressed to the Hon. Secretary, 53, Victoria St., London, S.W. 1.
Tel.: Victoria 4412.*

Officers and Council for year 1929.

President : GERALD MARCUSE, Esq. (G2NM).

Acting Vice-President : H. BEVAN SWIFT, Esq. (G2TI).

Honorary Treasurer : E. DAWSON OSTERMEYER, Esq. (G5AR).

Honorary Secretary : G. F. GREGORY, Esq. (G5PZ).

Honorary Editor : G. W. THOMAS, Esq. (G5YK).

COUNCIL :

K. ALFORD, Esq. (G2DX), D. P. BAKER, Esq.

(2OQ), J. CLARRICOATS, Esq. (G6CL) A. HAMBLING,

Esq. (G2MK), CAPTAIN K. HARTRIDGE (G5CB),

A. HINDERLICH, Esq. (G2QY), E. MEGAW, Esq.

(GI6MU), J. W. MATHEWS, Esq. (G6LL), R. L.

ROYLE, Esq. (G2WJ), A. WATTS, Esq. (G6UN)

SEPTEMBER, 1929.

Vol. 5. No. 3.

EDITORIAL.

The Society and the Amateur.

It has been our policy to throw open the correspondence columns of the BULLETIN to letters relating to any phase of the radio art, or similar allied subjects; moreover, in the event of correspondence dealing with both sides of a debatable point being received in this office and intended for publication, we have not, at any time, been guilty of selecting those letters which hold public opinion to our point of view. The editorial columns of a journal form the mouthpiece through which official policies and ideas are made known. If a journal with a fixed editorial policy so arranges and edits its correspondence columns to bear out its own policy and throw criticism of it into the shade, then we can only say that when such a policy, or collection of fallacious ideas, is dropped, the better it will be for the journal's readers.

One of our contemporaries has recently expressed its own ideas, and the ideas of a few of its readers, regarding the policy and attitude of the Radio Society of Great Britain to the British transmitter. It can be truthfully said that the policy of the Society is to provide assistance to British amateurs in every possible way, and generally to look after the interests of its members both nationally and internationally. That it adheres to this policy is not questioned by the vast majority of satisfied active members; to those members who regret the change from the old Wireless Society of London to the Society in its present form, a change from a society dealing with wireless in its infancy to the premier Radio Transmitting Society in Europe, we say that the interests of the majority must receive greater attention than those of a minority. When we claim to be the foremost society in Europe, we make no idle boast; when we claim, as we do, to represent the British transmitting amateur in dealings with the authorities, and also to serve him in a host of other ways, we are confident we can justify such a claim. The Radio Society of Great Britain is willing to assist every member from the man with the 250-watt station and a laboratory holding all the apparatus he requires, to his brother amateur of limited means with the 2-watt transmitter. Our QSL Section is but one of the many sidelines of activity. As a section of a National Society it enjoys a unique reputation, inasmuch as solitary amateurs in remote parts of the world, or in countries where there may be less than half a dozen transmitters, make use of our service for the interchange of cards.

Let any transmitter who doubts the sincerity of purpose of those connected with the destinies of this Society visit our stand at Olympia. Let him put forward his claims that the Society does not adhere to the policy outlined above, or that such a policy is not that which is expected of a National Radio Transmitters' Society. Finally, let him join the Society and read the BULLETIN; let him take part in the social functions and other organised gatherings; and last, but by no means least, let him attend the Fourth Annual Convention at the end of September, and there meet his fellow transmitters, those who nursed no fancy grievance, but instead, supported that which exists to support them and showed an example to the rest of the world of a unified National Society formed to carry out a definite policy.

* * * * *

Convention, 1929.

The opening of the R.M.A. Exhibition is but a week ahead, which means that Convention is almost here. During the ten days that the Exhibition is in progress, and especially during the two days at the end of the first week, amateurs from the British Isles will be meeting their fellow members—confirming friendships in the flesh that had previously existed in the aether. We want every single member who visits the capital to enjoy himself, and London members will not knowingly allow a visitor to do otherwise. Besides doing our best to entertain you, we are going to ask you to do some honest work. Nobody likes business meetings, but they are a very necessary evil in the existence of every company or society—and the more up-to-date and go-ahead such an institution is, the more necessary is it that its business meetings shall have the outspoken considerations and feelings of the greatest possible proportion of its members. Convention during the autumn cannot embrace the Annual General Meeting of the Society, but the business transacted on the Saturday afternoon will have as great a bearing on the future conduct of the Society as any that may be transacted at the Annual General Meeting. The result of the district Representative Elections are to be found in this issue, and we sincerely hope that all Districts will be represented at Convention. Besides the representatives who hold office on Committee, there are seven other seats to be filled in accordance with regulations passed at last Convention. It is unnecessary to cite the duties of these representative members here; it will suffice if we say that some of the most important honorary duties in the Society, especially those which come under the critical eyes of the average transmitter, are shouldered by the representative members. Now is your time to say what you will of the past year's work, and to elect those members to carry on the duties for the next twelve months. In the past, the provincial member has, unfortunately, had very little to say in the election of such members, as, owing to the time of year at which such elections took place, the London member had the ballot box almost entirely to himself. We hope, however, that the change will act as a stimulant and that the work of the Society in the year to come will not fall short of the hopes and desires of our members, wherever in the wide world they may be situated. Come, therefore, all who are able, and meet each other during the few days in the autumn when the British stations are conspicuous by their absence from the ether.

SEE YOU AT THE RADIO EXHIBITION—STAND 285.

Convention Notes.

The Convention dinner will be held at Pinoli's on Saturday, September 28. Tickets are 5s. each and can be obtained direct from Mr. Clarricoats (G6CL), who is organising the social arrangements. It is essential that all those who wish to attend should send a card *to-day* as accommodation has to be reserved. Last year over 140 members were present; we expect to beat this figure but it must be remembered that we cannot accommodate more than 160, so please send that card *NOW*.

The Delegates' meeting at 10 a.m., Saturday morning will, we are certain, evoke considerable discussion. In order therefore to proceed speedily with the meeting, we urge all Delegates to attend prepared with the salient features of their business previously prepared.

Motions to be presented at the Business meeting in the afternoon should be duly proposed and seconded and handed to the President prior to the meeting.

We are particularly anxious that our provincial members shall enter into the business discussions.

Applications from several provincial members for accommodation have been received at H.Q. Unfortunately there seems to be a dearth of offers from the London men this year. We ask therefore that as many Londoners as possible advise Mr. Clarricoats (G6CL) immediately as to what accommodation they can offer.

Stand photographs are still wanted. These should be sent to H.Q. immediately. If required back after exhibition a note to that effect should accompany the photographs.

For the convenience of provincial members arriving in London who wish to get into touch with H.Q. staff the following list of telephone numbers may be of use:—

Mr. G. Marcuse, Royal 3482 (G2NM).
 Mr. E. D. Ostermeyer, Buckhurst 1942 (G5AR).
 Mr. Bevan Swift, Pollards 1639 (G2TI).
 Mr. J. Clarricoats, Finchley 3512 (G6CL).
 Mr. G. W. Thomas, Mountview 7818 (G5YK).
 Mr. J. W. Mathews, Clissold 9380 (G6LL).
 Mr. A. Watts, Tudor 3970 (G6UN).

R.S.B.G. Short-Wave Four.

Before commencing the description of this screen-grid H.F. receiver, it is felt that it would be as well to enumerate a few of the advantages of possessing a really efficient short-wave receiver, one that can be relied upon to produce consistently good results from day to day.

It is possible, with such a receiver, to receive 2XAD and other American stations at good loud-speaker strength, even when it is daylight the whole way across the Atlantic Ocean. Similarly, the other short-wave stations of the world can be received at varying strengths, depending upon the atmospheric conditions prevailing, and the time of day at which reception is carried out. The transmitter will at once see that to possess a receiver whose detector circuit tuning is not affected by changes of aerial capacity, together with the amplification obtainable with this receiver, is going to render DX work very much easier.

receiver is used. Furthermore, it is a simple matter to take the base and front panel, carrying all the components and screens, out of the cabinet. The aluminium cabinet is 24" long by 10" wide, by 7" high, and is made with a wooden base. The metal base previously referred to is bolted to the front panel, so that when all is in position, there is a clearance of $\frac{3}{8}$ " between the two bases. Wooden runners are screwed to the wooden base to give some additional support to the metal base. The space between the two bases is used to carry certain connections not at H.F. potential; this is dealt with again later.

Ample screening has been provided between the H.F. and detector circuits, in order that the tuning of the aerial or grid circuit of the H.F. valve may have a negligible effect on the tuning of the detector circuit, which, as will be seen from the diagram, is somewhat unconventional. The use of this circuit

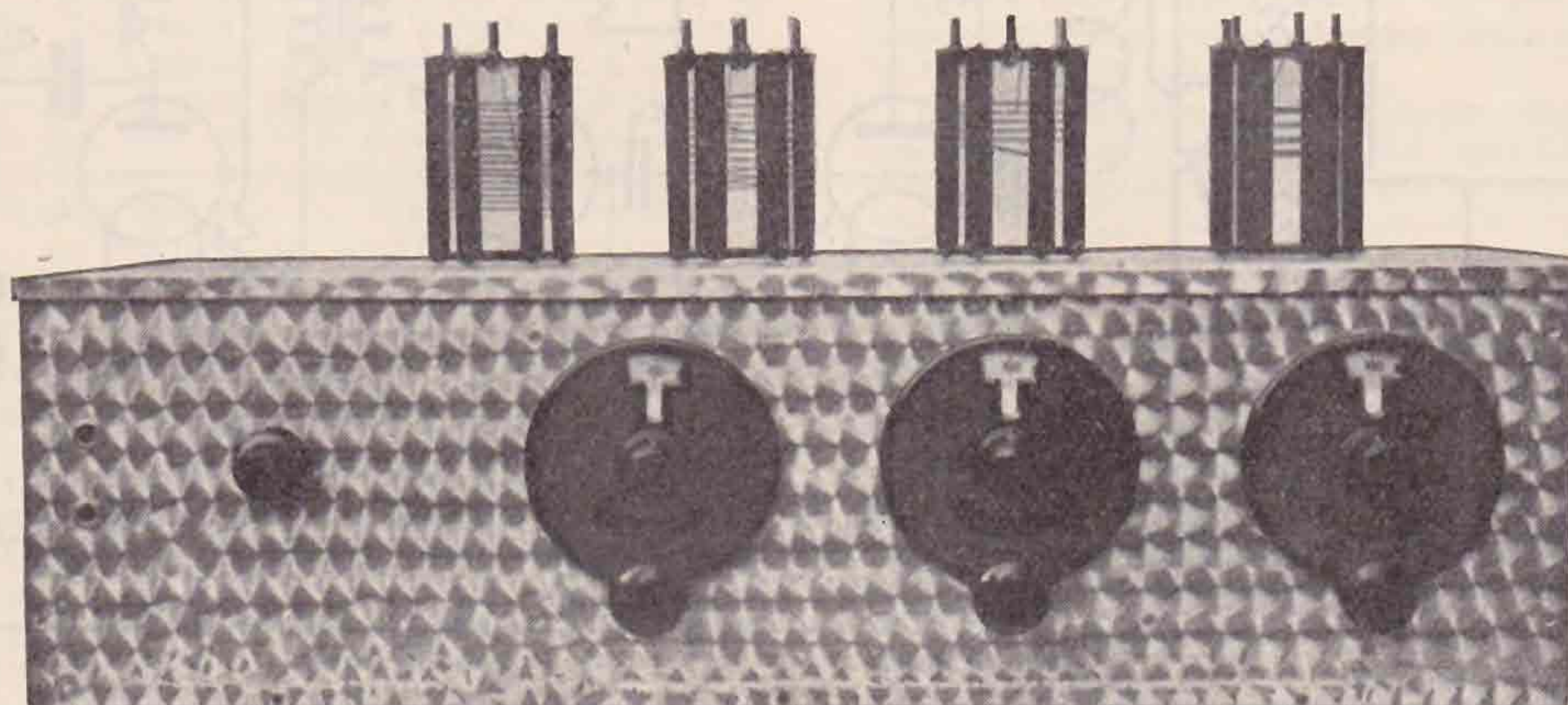

One or two points of design may be emphasised, such as the use of a complete machine-finished aluminium container, manufactured by Messrs. Paroussi, including a metal base in place of the more usual wooden one. Components at H.F. potential, such as some fixed condensers, coils, valve-holders, etc., are mounted off the base on $\frac{3}{8}$ " ebonite pillars. These are tapped 4 B.A. at either end, and are screwed on to both the component and the base; by this means the maximum possible insulation is provided, as no direct metallic contact exists between the component and the base.

The container is divided into three compartments for housing the H.F., detector, and L.F. circuits respectively. The screens are bolted on to the base, front panel, and back of the cabinet. The metal base is bolted on to the front panel, but there is $\frac{1}{4}$ " clearance all round the base, *i.e.*, between the base and the two sides and back of the cabinet. This has been done in order to prevent any doubtful contacts between the base and any other parts of the cabinet, which would, of course, create noises in the phones at the high frequencies at which the

has been found to minimise the numerous disadvantages of the more usual type of circuit; this will be dealt with in more detail later.

It will also be noticed that fixed condensers are placed between certain points to maintain stability.

It is proposed to give the details of the construction, commencing with the H.F. portion.

The aerial is connected to a Clix plug and socket, mounted on the side of the cabinet, on a small piece of ebonite, and then fed through a 75 mmfd. Claude Lyons variable condenser, which is contained inside the cabinet, and can be pre-set with each change of coil. It is mounted 3" above the base on two ebonite pillars of $\frac{3}{8}$ " rod. The aerial coil, L_2 , is one of the well-known B. & J. type, and is tuned by a .0001 mfd. Polar Volcon condenser, with phosphor-bronze ball bearings. This is C_2 in the diagram. The lay-out of this compartment can readily be seen from the photograph. The 1 mfd. T.C.C. condenser, C_5 in the diagram, mounted against the screen in the photograph, is connected across the $1\frac{1}{2}$ -volt grid bias battery, in order to earth one end of the coil.

The H.F. valve is a Marconi S.625, and is mounted in a standard holder on two ebonite pillars, and passing through the screen into the detector compartment. It is advisable, however, to remove the centre contact in the H.F. side of the holder, and connect the grid pin of the valve to the coil L_1 by means of an ordinary valve leg attached to a small piece of flex. This is done because it would seem that for use at these high frequencies, the capacity between the grid clip and the two filament clips on the holder is somewhat high. The portion of metal screen provided with the holder is bolted to the main screen with 4 B.A. bolts.

condenser, C_3 , stripped to two moving and three fixed vanes. This is quite a simple matter, and should most certainly be done, as the tuning, even with the capacity reduced as described, is very sharp.

The reaction condenser, C_4 , is also a Polar .0001 mfd. The two H.F. chokes, Ch_1 and Ch_2 , are mounted as shown in the photograph; Ch_1 on the screen to the H.F. compartment, and Ch_2 on the base near the screen to the L.F. compartment. Ch_1 is a Polar standard choke, and Ch_2 is a Polar short-wave type. It was found impossible to use short-wave chokes at both points, owing to the

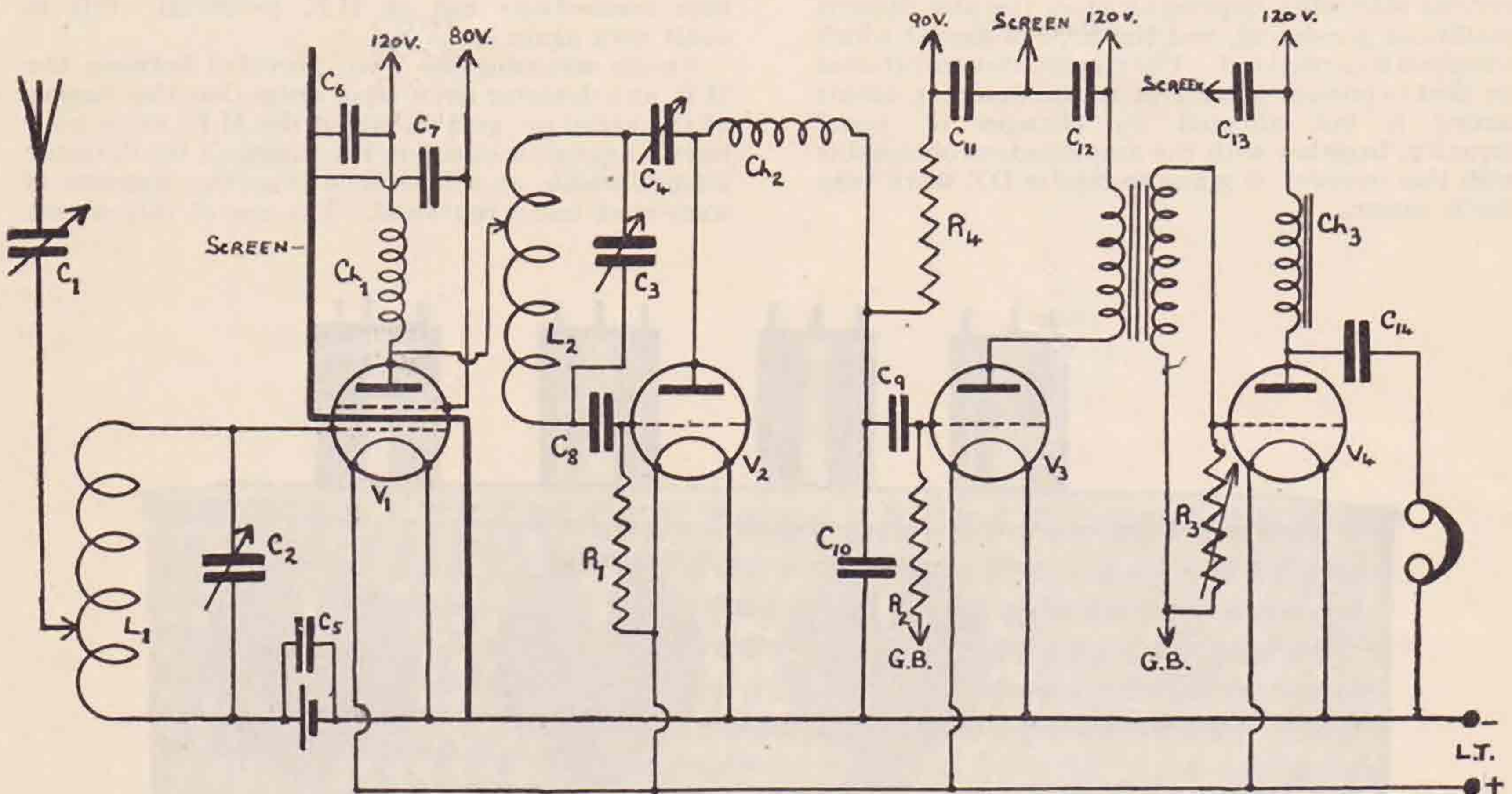

C_1 —Claude Lyons 75 mmfd., midget variable condenser.
 C_2, C_3, C_4 —Polar .0001 mfd., "Volcon" variable condensers.
 $C_5, C_6, C_7, C_{11}, C_{12}, C_{13}$ —T.C.C. 1 mfd. condensers.
 C_8 —T.C.C. .0003 mfd. condenser.
 C_9 —T.C.C. .01 mfd. condenser.
 C_{10} —Mullard .001 mfd. condenser.
 C_{14} —T.C.C. 2 mfd. condenser.
 L_1, L_2 —B. and J. coils, size dependent on wave-band to be covered.
 Ch_1 —Polar Standard H.F. choke.
 Ch_2 —Polar short-wave H.F. choke.
 Ch_3 —Pye 32 Henries L.F. choke.
 R_1 —Pye 5 megohm grid leak.

R_2 —Mullard 1 megohm grid leak.
 R_3 —Claude Lyons "Clarostat," volume control type.
 V_1 —Marconi valve S.625.
 V_2 —" " DE5B.
 V_3 —Mullard " P.M.5X.
 V_4 —" " P.M.6.
 Transformer—Ferranti A.F.3.
 Strip of sockets and plugs for L.T. and H.T. connections, and support for mounting C_3 and C_4 , are manufactured by Messrs. B. & J. Wireless Co.
 Miscellaneous—6 B.A. and 4 B.A. screws and nuts.
 2 Telephone jacks.
 3 Indigraph dials.

The detector compartment calls for some care in wiring and assembling.

The circuit, as will be seen from the diagram is the Ultraudion, and seems to be undoubtedly the best for this purpose.

The lay-out can be seen in the photograph, and should not need much explanation. The two 1 mfd. T.C.C. condensers, C_6 and C_7 , are connected, one from the screen to the screen grid, the other from the low potential end of the H.F. choke, Ch_1 , to the screen, and act as H.F. by-pass condensers, in addition to being across the H.T. battery.

The coil, L_2 , also is one of B. & J. type, and is described later. This is tuned by a .0001 mfd. Polar

uncontrollable oscillation set up between the chokes, both being tuned to the same frequency.

All components in this compartment, with the exception of the by-pass condensers C_6, C_7 and C_9 , are mounted on distance bushes as previously described. C_9 is a T.C.C. .001 mfd., and is connected between screen and the low-potential end of Ch_2 , to avoid any H.F. currents getting into the grid circuit of the L.F. amplifier. The lead to the grid of the first L.F. valve is taken from this condenser, through the base, and *underneath* the screen, thus obviating the necessity for drilling the screen. The grid leak is a Pye 5 megohm, and is used because wires are provided for directly soldering into

the circuit, thus doing away with the necessity for a holder. The grid-condenser, C_8 , is a T.C.C. .0003 mfd. All wires that do not carry H.F. are passed through holes in the metal base, and taken to their required points. Glazite is used for this purpose, and when it is carrying the H.T. voltage, it is advisable to slip a small piece of sistoflex over it, at the point where it passes through the hole. All negative L.T. connections are taken through the base, and then to the nearest screw-head, and soldered to a tag attached there.

The two variable condensers, C_3 and C_4 are mounted on a small strip of ebonite attached to the front panel by means of four 2" pieces of $\frac{3}{8}$ " ebonite rod. The condensers are, therefore, mounted nearer the coil and clear of the front panel, thus shortening the leads; also as they are at high potential to the screen, it is desirable to keep them as far away as possible. Two short pieces of ebonite rod are used as extension handles, and pass through a $\frac{3}{8}$ " hole in the panel. A small piece of 2 B.A. rod is screwed into the end, and the slow motion dial attached in the usual manner. Indigraph dials are used, and are well suited for this purpose. Whiteline valve-holders are used for the detector, and two L.F. valves, the detector valveholder being mounted on two $\frac{1}{2}$ " bushes.

It will be found necessary to vary the H.T. tapping to the detector valve, as the frequency increases, the maximum being about 120 volts. For this purpose a separate H.T. lead is provided. The screen-grid has another, and the anode of the H.F. valve and the two L.F. valves have a common lead. Screen-grid voltage is about 70-80 volts, and the maximum voltage on the amplifiers is 120 volts. The detector valve is a Marconi D.E.5.B.

With regard to the coils. These are wound on B. & J. formers, which consist of six ebonite rods attached to the circumference of two ebonite rings by means of ebonite screws. Four pins are mounted in one end to provide connections. These formers are exceptionally fine for the purpose, and work very efficiently.

The diameter of the former is $2\frac{1}{2}$ " and slots are cut for the wire at distances dependent on the wave-range of the coil.

For a range of 23,000 K.C. to 15,000 K.C. (13-20 metres) an aerial coil of four turns spaced $\frac{1}{4}$ " with the tap connected $1\frac{1}{2}$ turns from the earth end. The detector coil consists of five turns spaced 3-16", with the tap $1\frac{1}{2}$ turns up from the plate end. This coil can also be used as the aerial coil for the next frequency band, which is 15,000 K.C. to 10,000 K.C. (20-30 metres). The detector coil for this range consists of ten turns spaced 3-16" with the tap at $3\frac{1}{2}$ turns. The next range is from 10,000 K.C. to 6,000 K.C. (30-50 metres). The previous coil is used as the aerial coil, while for the detector circuit a coil consisting of sixteen turns spaced $\frac{1}{8}$ " is used. The tap in this case is $5\frac{1}{2}$ turns up.

It will thus be seen that all the coils are interchangeable, the aerial coil being the next smallest to the detector coil.

The coils described will, of course, cover the two amateur bands round 7,000 K.C. and 15,000 K.C., while the smallest aerial coil will be found to cover the 28,000 K.C. band when used in the detector circuit.

The L.F. compartment contains the strip of sockets for connecting the H.T. and L.T. This consists of five Clix sockets mounted on an ebonite strip, and supported by two copper brackets, attached to the base by means of 6 B.A. bolts. A strip of ebonite containing five plugs, suitably spaced to fit the sockets, forms the connection to the batteries. Three of the sockets are for the three H.T. and tappings, and the remaining two are used as negative H.T. and L.T. combined, and positive L.T.

As will be seen from the circuit diagram, a stage of R.C. coupling is used immediately after the detector, and is followed by a stage of transformer coupling. The R.C. unit consists of a Mullard 150,000 ohm resistance and holder, and a grid leak of 1 megohm with a grid condenser of 01.mfd., mounted in a standard Mullard holder. The trans-

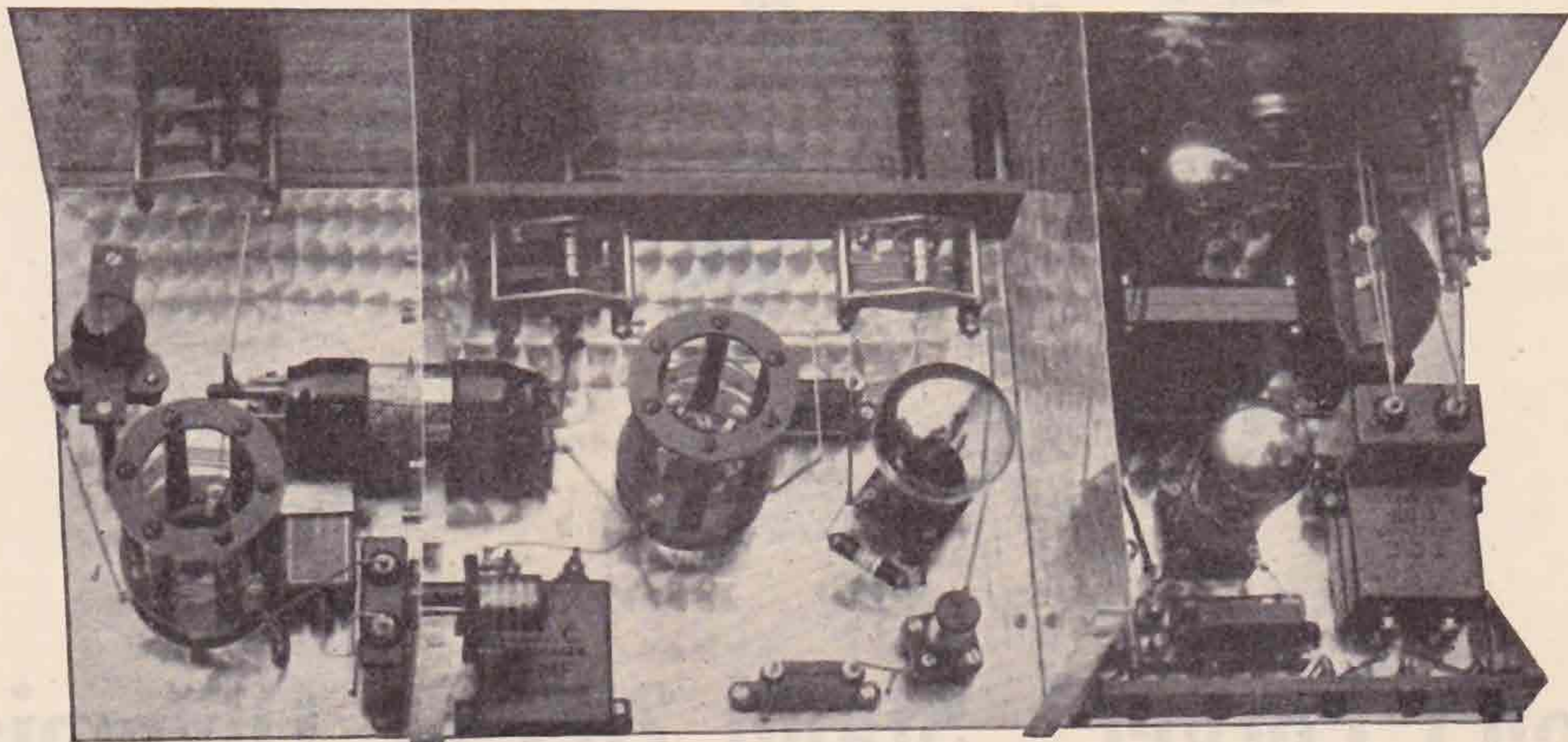

former is a Ferranti A.F.3, and has a Clarostat volume control connected across its secondary. The telephones are connected to jacks, joined in parallel through a choke-condenser circuit. The choke is a Pye standard 32 henries, and the condenser is a 2 mfd. T.C.C.; in this way, only one connection need be made to the telephone jacks, the other being made through the panel.

In spite of the fact that this receiver has three controls, the operation has been found to be very simple. On account of the use of a well-shielded S.G. stage, irregularities of the reaction control, due to aerial "dead spots," are non-existent. The reaction control is very smooth, provided the H.T. to the detector valve is adjusted properly, and can be left alone when searching over small ranges of wavelength. Actually, an increase in reaction is required at both ends of the tuning condenser scale on each coil; this may be said to be due to the increase in the losses of the circuit due to the higher frequency used at one end of the scale, and to an increase in the ratio of capacity to inductance of the circuit at the other end. In the centre of the scale, the increase in one case, and the decrease in the other would appear to balance each other out.

As has been mentioned earlier, the detector circuit chosen helps considerably to minimise the effects on both strength of oscillation and frequency of this circuit, when the frequency of the grid circuit of the H.F. valve is varied. When the tappings on both coils and the setting of the aerial coupling condenser have been properly adjusted, the frequency of the detector circuit is pulled but a few hundred cycles when the frequency of the H.F. valve grid circuit passes across the frequency of the former circuit. Further, the strength of oscillation of the detector

is almost independent of the frequency of the H.F. valve grid circuit, though a slight pull of the oscillation is noticed on the higher frequency limits of the set.

A word concerning the tappings on the coils will not be out of place. For maximum strength, the tap from the S.G. valve on to the detector circuit could well be direct on to the plate turn. This position, however, gives too tight a coupling, and the tuning is not then independent of the H.F. valve grid circuit tuning. On reducing the tapping until it is about one-third of the way along towards the grid end, a negligible reduction of strength is noticed, and is more than compensated for by increased ease of control; a further movement towards the grid end results in a marked drop in signal strength. The tapping of the aerial on the grid coil of the H.F. valve is kept well down towards the earthed end of the coil; better results have been obtained by keeping this tapping well down, and using a larger coupling capacity than by the use of a higher tapping and a smaller coupling capacity.

The optimum setting of the coupling condenser depends to a certain extent on the length of aerial in use. On the higher frequency band only a little capacity is required, whereas on, say, 7,000 K.C., the condenser can be full in, or even short-circuited.

In conclusion, it is felt that any trouble incurred in the making of this receiver will be amply compensated by the performance and results obtained. It is not claimed that it is the simplest receiver that could be made in the circumstances, but it is one that can be relied upon to give satisfactory results over a wide range of frequencies, which would make it one that could be appreciated by every amateur, be he a transmitter or not.

RATHER WEEK

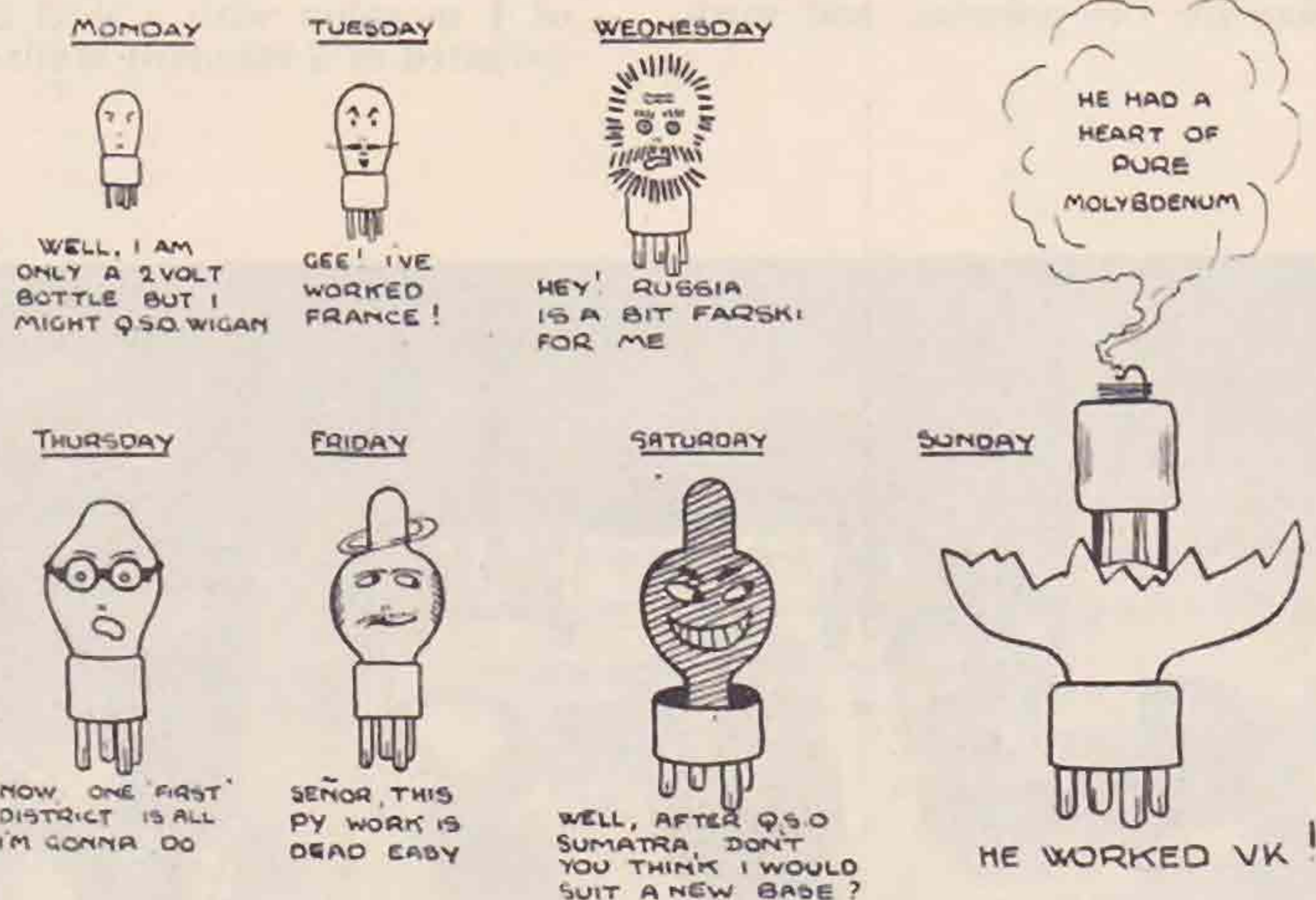

Don't Forget! Stand 285 at Olympia!

SOME POINTS ON BROADCAST RECEIVER DESIGN

By D. N. CORFIELD, D.L.C. (Hons.) (G5CD).

The purpose of this article is not to deal with any specific type of receiver, but merely to consider the most important points to be observed in the design of receivers.

By "broadcast receivers" one must not exclude those for use on the short wave-lengths, or to be up-to-date high-frequencies, as there is an appreciable amount of broadcast entertainment to be received nowadays on short wave-lengths, and the same principles apply, although the details may differ.

In order to consider design, we must divide the receiver into six parts, viz. :—

- (1) Aerial system and associated tuning.
- (2) High-frequency amplifier.
- (3) Detector.
- (4) Low-frequency amplifier.
- (5) Loud-speaker.
- (6) Power supply.

It is proposed to commence with part (1), which actually must be considered in conjunction with parts (2) and (3).

Aerial System.

The old maxim "The better the aerial the better the results" is still very true even in the days of stages of S.G. H.F. valves, for the better the aerial the less valves required, and the less mush and distortion introduced, apart from saving in cost and simpler control. There is nothing for the average type of receiver to beat the standard inverted L P.M.G. type aerial, and a good earth. Avoid, if possible, multi-wire aerials, unless the total length available is less than about 60 ft. Extra wires do not pull their weight; the increased power picked up is offset by the increased capacity and consequent lack of selectivity. Use aerial wire of ample cross-section, not less than 7/029", and several small insulators in series are better than one large one.

In cases where efficiency on short wave-lengths is aimed for, the length of the aerial may with advantage be somewhat less; it will improve the signal strength to mush ratio.

Next for consideration comes part (2), and for simplicity it is easier to consider parts (1) and (2) together.

High-Frequency Amplifier.

In a receiver where the minimum of distortion is required, and a reasonably good unscreened aerial can be erected, it is preferable from a quality point of view to dispense with H.F. amplification altogether, unless the set is to be used for station chasing and not musical entertainment.

Given a good aerial in most districts, a considerable number of Continental stations can be received after dark, and of suitable quality for moving coil speaker reproduction, and this same applies to the short waves, conditions being suitable. Without the use of H.F. amplification some may argue that this cannot be done in daylight, but after all, how many people have the time or even desire to listen to broadcast transmissions from abroad during daylight; in the summer most people like to get out while it is light, and in the winter it is dark, so everything is satisfactory.

If it is thought that the aerial system may not give sufficient volume from a distant station, then one H.F. valve may be used, but more than one is not advised unless conditions are exceptional.

Whatever the wave-length, it is preferable to use either loose coupling between the aerial and grid coil or aperiodic coupling; or at least wind the aerial portion of the coil over the grid portion and not tap on the same winding. Of course, actually the latter method comes under the title of aperiodic coupling. Pure loose-coupled aperiodic coupling is really only satisfactory for the short waves, where it may consist of several turns of wire direct between aerial and earth about 1 or 2 inches from the grid coil. When loose coupling is employed for the longer waves it must be tuned, preferably in such a way that the L.C. ratio is high; in other words, use a small variable condenser, say about .0003 mfd. at the most. Do not bother to use Litz wire for this coil; the aerial losses are so large that any saving in loss in the coil will be negligible compared with the total. In the case of the grid coil Litz wire is preferable, and as regards L/C ratio the same applies, and the condenser may be increased to .0005 mfd. maximum, so that about the same wave-length range can be covered per pair of coils.

The advantages of loose coupling are: Good selectivity without the cutting off of side bands and consequent distortion of the upper register. Of course, selectivity can be obtained by the use of finely tuned H.F. stages, but side band distortion is bad, particularly with those of the high magnification type using S.G. valves. The aerial tuning may be used as a volume control without introducing distortion. It permits a much finer adjustment of reaction in sets using no H.F. valve, without backlash. Lastly, the calibration of the grid circuit tuning is almost constant whatever the aerial; in other words, the grid circuit condenser may be calibrated as a rough wavemeter without any serious error if the aerial is changed or modified at any time.

The disadvantages are: Extra tuning control and slight reduction in power available. But if the coils are designed correctly it is surprising how small this reduction may be compared with direct coupling, and in cases where an anode bend detector is used with loose-coupled grid and aerial circuit often an increase and not decrease may be obtained, due to the lower damping of the circuit.

Where it is necessary to use H.F. amplification, due to unsuitable aerial conditions, or greater range of set, it is better not to concentrate on trying to get too much gain per stage, but rather to use more than one stage, and never use more than one S.G. valve, otherwise neutralising may be very difficult and screening will need to be very elaborate, apart from the serious side band distortion incurred.

For one H.F. stage an ordinary H.F. valve neutralised in the conventional manner is the best; for a higher gain use a S.G. valve, and for two stages an ordinary valve and a S.G. is about the best combination. The latter combination is the most suitable for portable sets. If quality of reproduc-

tion is essential, do not attempt anything in the nature of a super-heterodyne or a set with a frame aerial of the portable type, where limitation in space prevent the use of most suitable circuits and components.

The best method of coupling H.F. valves or H.F. valve to detector is by an H.F. transformer having three windings—primary, secondary and neutralising, and, if required, reaction. Tune the primary winding and do not use a large step up in the ratio, not more than 2:1, for all-round purposes; 1:1 is the most suitable, but the ratio may be fixed by considerations of the H.F. valve working impedance. Some form of screening is advisable for only one valve and a metal panel is almost essential. Do not place any coils close to the metal panel or screen, particularly if they are of large diameter; the least distance advisable is the diameter of the coil. All variable condensers should be earthed on one side. The circuit can almost always be adapted to make this possible, even for a reaction condenser. In cases where anode bend detection is used and no H.F. valve, the condenser, if earthed in the usual way, would short circuit the grid bias, but this is overcome by earthing the condenser, and not taking the earth potential end of the coil to the condenser, but to the grid bias battery and shunting the battery with a condenser of about .01 mfd. or larger. In the case of reaction a modified Hartley circuit may be used, where the feed back current passes through the reaction winding first from the plate of the valve, the condenser being between the low potential end of the winding and earth.

Detector Arrangements.

In considerations of (3) we have four alternative means of rectifying, viz.: (a) Crystal; (b) leaky grid; (c) anode bend; (d) diode.

(a) A crystal may be used following H.F. valves with some success, but the adage "Clear as a crystal set" is not strictly true, because a crystal followed by a L.F. amplifier is not satisfactory from a quality point of view, as it is almost an impossibility to match the crystal impedance with a transformer primary winding, for the very good reason that each sensitive spot on the crystal has a different effective resistance. A crystal's insensitiveness compared with a valve need not be commented upon.

(b) *Leaky grid*.—Probably in the average set the most useful form of rectification. It is the most sensitive to weak signals, which is of great importance in sets of the frame aerial and portable types and generally for short wave sets. Where sensitivity and fair quality is required on the long waves, values of grid condenser from .0002 mfd. to .0005 mfd. are satisfactory, and grid leaks from 0.5 megohm to 2 megohms. For the short waves a lower capacity and higher resistance is advised, say .0001 condenser and 5 megohm leak.

If R.C. coupling is to be used after the detector, do not use too high an anode resistance, not as high as if anode bend was used, say, about $\frac{1}{2}$ or $\frac{1}{4}$ the value used for anode bend, and use a valve of moderately low impedance and a positive bias on the grid leak. With a transformer after the valve use one with a high primary impedance and an inductance not less than 50 henries if good quality is desired.

(c) *Anode Bend*.—For real quality it is the best type one can use, if carefully adjusted; that is to say, H.T. and grid bias. The results as regards sensitivity are not far behind "grid leak," due to the lower damping of the detector on the circuit and consequent better selectivity and higher resonant peak of the grid coil or H.F. transformer secondary.

A valve of fairly high gain and impedance should be used, an R.C. type, and biased from 1.0 to 4.5 volts, depending on the H.T. voltage. It is not advisable to use any transformer after an anode bend detector, but always R.C. coupling. The best values of components for average use are: Anode resistance, 250,000 ohms; condenser, .01 to .015 mfd.; and grid leak, 1 to 3 megohms—that is, with a valve of about 30–40,000 ohms impedance and M. of 30–40.

(d) *Diode*.—This type of detector depends for its working on using the valve as a pure rectifier in the same way as one uses a valve for rectifying A.C. power for H.T. It is very inefficient, being very little better than a crystal, but is capable of producing very fine quality, though it is generally unsuitable for ordinary use. Of course, reaction cannot be used with it, which makes it useless for distant reception unless a considerable amount of H.F. amplification is used before it, with consequent side band distortion. This nullifies its improvement in quality over an anode bend detector, consequently its only real application is for reception from a powerful local station.

All types of detection must be followed with a shunting condenser across the input to L.F. amplifier. This should not be too large a condenser, else the high notes will suffer, or too small, or the detector will be inefficient and reaction difficult; a suitable value is between .0002 and .0005 mfd., depending on the L.F. amplifier input impedance; that is to say, use about .00025 mfd. for R.C. amplifiers, with anode resistances as mentioned in paragraph 3c, and with transformers use a higher value; if the transformer impedance happens to be very low, as in a cheap transformer, say, about 10–20 henries, up to .001 mfd. may be an advantage.

The Low-Frequency Amplifier.

(4) L.F. amplifier can be divided into three parts: (a) Initial stage, including plate circuit of detector valve; (b) intermediate stage or stages; and (c) output stage.

(a) The initial stage should be designed carefully, as no extra care in subsequent stages will cure distortion introduced there. Wherever possible it should be of R.C. type, transformers being only used if gain is a principal consideration, as in a portable set. The values given in the paragraph 3c are suitable. The valve should be of medium impedance and fairly high gain, say, about 20–30,000 ohms, and a M. of 20–30. (b) The intermediate stage, of course, includes this valve, and suitable anode resistance is about four times the impedance of the valve—that is to say, 80–100,000 ohms. It is essential not to skimp the H.T. on this valve; keep it as high as possible, and at least 120–150 volts, preferably more, as the valve will only actually receive a quarter of the H.T. volts available. The above presumes the intermediate stage is to be R.C. coupled to the output stage. If a transformer

is to be used a somewhat lower impedance valve may be used with advantage, say, about 10,000 ohms, followed by a transformer of about 4:1 ratio and inductance about 25—50 henries. A transformer will give a somewhat greater gain, but not so much more as is popularly imagined, and the R.C. will give a much better over all response, particularly in the bass register.

(c) The output stage requires careful consideration in order to avoid distortion and overloading. Dealing first with the grid circuit, it may follow either R.C. coupling or transformer. If the former, a grid condenser may be about 0.1 mfd. or higher, up to 1 mfd. is quite satisfactory following a valve of the class mentioned in (b). The grid leak may be from .25 megohm to 100,000 ohms, depending on the size of the grid condenser. In the latter case, of course, the usual connections are used, except in the case of where the output stage consists of more than one valve in parallel. Then both in the R.C. or transformer case it is advisable to connect a resistance of about 1,000 ohms, or more if required, in series to the grid of each valve to prevent the valves oscillating at high frequency, usually above audible limit, between themselves. This is often shown by one valve running much hotter than the other or failing long before the other or others.

So far push-pull has not been dealt with, but this is in effect the same as two valves in parallel, and gives precisely the same output level for the same input level, and not more output, as is commonly supposed. The only advantage of push-pull is the fact that a smaller or less expensive output transformer can be used, as the magnetic circuit need only be large enough to accommodate the alternating current pulse, the D.C. component being balanced out if the valves are matched. This advantage is set off by the fact that the input transformer is more expensive, but generally cost for cost, push-pull will give better results. Where the quality is not required to be almost perfect, single output, or parallel valves, is the simplest and cheapest, in that an ordinary output transformer or choke output can be used. Push-pull only scores from the cheaper output transformer point of view in cases where large valves are used in the output stage, say, 15-watt valves at least.

As regards Pentode-type valve, their chief application is in cases where economy in costs and current consumption are essential. It is not a suitable type for a large output or for sets where quality is essential. They will give a wonderful stage gain in the same way as a S.G. H.F. valve, and will produce results for one stage equal in volume to two ordinary stages. The quality of reproduction is not as good as for ordinary power valves, mainly due to the fact that its output impedance is exceedingly high, necessitating a high inductance choke or output transformer. Now a high inductance output transformer is difficult to build, in order not to saturate due to the anode current, and have a low self-capacity winding, which would otherwise cause high-note loss. Possibly the best method of utilising their output is to use a high resistance moving coil type loud-speaker, one whose coil is designed for a Pentode.

Loud-Speakers.

(5) Loud-speakers are of three main types—

horn, cone (balanced armature or reed), and moving coil.

The horn types are not advised, unless one has space to house a horn of length at least 15 ft. These horns can be obtained of exponential type, *i.e.*, curve of horn is logarithmic in shape, folded into a shape that is not unreasonable in size. The results with a horn of over 15 ft. long can be very fine; those with length about 20 ft. are at least equal to a moving coil type. The movement for driving the diaphragm should be preferably of the balanced armature type.

Cone type are generally very good. Avoid any with a small movement, or those using a modified earpiece. If the reed-type drive has a fairly large movement, the results may be quite good and the output fairly large without distortion or rattle. The best type is the balanced armature movement, which will give large volume without distortion. Most cone-type loud-speakers require a step-down output transformer, or an output choke tapped to give step-down, as their resistance is about 800 ohms and impedance at middle speech frequency about 5,000 ohms.

Moving Coil Type.—This type gives by far the finest results, and a colossal volume without distortion. It is preferable to use a fairly strong field, say, at least 10 watts in the winding. The permanent magnet type are quite satisfactory in cases where economy in current is essential, but work best if a small magnetising winding is used, as well to assist the magnets, say, about 3 watts.

Generally speaking, the low-resistance moving coil type is the best, as it may be used at any distance from the amplifier if the transformer is in the amplifier, and it is more robust. The high-resistance type suffer in some cases from burn-out or mechanical discharge in the windings after a while. With a high-resistance type always use a choke output circuit or transformer, otherwise if the coil happens to rub on the pot it may become alive at H.T. volts, with unpleasant results if the pot is touched.

With all types of loud-speaker either an output transformer or choke output is advisable. The results are better, and the windings of the speaker are likely to last longer.

Power Supply.

(6) (a) For L.T. the general thing is an accumulator, but A.C. filament heating is quite satisfactory with indirectly-heated valves or those specially designed, but it is not advised for ordinary valves unless they are large power valves consuming at least 1 ampere or more. Generally speaking, D.C. mains are not a success for filament heating, unless, again, valves with heavy current consumption are used, and in any case smoothing chokes must be provided and suitable condensers of the electrolytic type. Rectified A.C. by means of a "metal" rectifier is not as good as using suitable valves on raw A.C.

(b) H.T. is best of all supplied from H.T. accumulators, but mains eliminators may be used with entire success if well designed. In choosing an eliminator do not use one too small in capacity, neither get one on the large size in output, as they are notorious for their bad regulation, *i.e.*, voltage not constant with load. This causes distortion if the smoothing condensers are not adequate in

(Continued on page 62.)

Contact Bureau Notes.

By H. J. POWDITCH (G5VL).

Our leading 56 M.C. station (that opening should cover all members of Group 7A and do away with personalities) has been fixing a copper ball on his aerial and is annoyed. Two small boys are said to have hailed him, asking if "he wouldn't mind about fixing up the other two now and come down, as mother was waiting to bring the mangle in."

To get to business, "Mr. Blank" has promised an Irish shillelagh of guaranteed pedigree and useful for quelling QRM of all sorts. The QRP people seem to be in greatest need of an instrument such as this and we are making it a challenge affair, all C.B. groups on QRP work being eligible to enter for the competition. The deadly weapon will be held by the winning group up to December 31 of each year, but may not be used to incapacitate possible challengers. The award will be made to the group showing proof of best six QSO's (real ones, not reports) with six different countries, covering the greatest total mileage with guaranteed input maximum of 3 watts. For this year the period from 24.00 G.M.T. on August 31 to 24.00 G.M.T. on December 31 will be taken for the first award. C.B. manager's decision will be final on all points. In addition, I suggest supplying to the winning G.C. a rubber stamp suitable for use on the group's cards: "Champion QRP Group of Great Britain, 1929," or something to that effect if the members want it.

Just a word here addressed to all stations. Give the low power men a chance to get over. I hope there will be good competition between them for the Blank trophy (no, Mr. Editor, that is the *nom de guerre* of the donor) and appeal to other stations to make things as easy as possible. Our friends of the A-B persuasion have been telling us how this may be done.

We can do with more QRP groups to make the competition keener, and in case you are all thinking that 3 watts is a hopelessly low input, G2VV, the G.C. of Group 8B, has just got R4, T8, in a QSO with VK. Input exactly 5 watts!

28 M.C. is still very quiet—the prophets who forecast this falling off during the summer have scored a bull. I had a series of cables from W6XAQ, asking us to listen for his signals on 10.6 ms. over several days. This station is at Paloalto, California, and in the spring was using several kilowatts. As none of our 28 M.C. stations were able to pick up his signals on the present tests it looks rather hopeless for the amateurs. Perhaps by the time this gets printed the tide will have turned. I hope to arrange a series of 24 hour transmission tests later in the year and give good notice to listeners in other countries.

In passing, G5VL hopes to be in London for Convention, though it is not quite certain at the time of writing. So if anyone has a brick or two to throw there will probably be an opportunity then.

There is some little trouble now and then in persuading stations to write informally when they join up with a C.B. group. It only means a post-card and gives me definitely the information of

QRA and the group they wish to work with. Please, if you have not done so, get it over now. QRA again is:—Porth, St. Columb Minor, Cornwall.

Group reports are given below.

28 M.C. GROUPS.

Group 1B.—G.C. G5SY now has BRS250 in his group. The latter has been on receiver a lot and logs local signals but no DX. G5LU has a CC set going but has some trouble in getting crystal to work unless this is previously heated. It then gives a "blue glow" with 2 watts. Anyone else noticed this? G5SY finds a P.M. 1 HF. good as detector and now seems satisfied with his gear. W3ANP has been visiting him after calling on G6LL and G5VL. No DX has been heard. G6LL is returning to the group work. G5ML and BRS136 do not report.

Group 1C.—G.C. G6VP has kept a successful sked with G6WN for four Sundays out of five. On the Sunday that G6WN did not receive the signals, BRS250, who is located a further 15 miles away in the same direction, found them OK. As both of these stations have received the signals on other occasions it seems that a curious local skip effect is involved. G5YK has not heard anyone, but has perfected a S.G. receiver "as easy to control and as fast to search as his 14 M.C. receiver." And the R.F. stage does amplify! We would like to hear more about this. G6WN's operators are given all praise by G.C. for perseverance—and, naturally, results as shown by their CC signals. Good local reports from a maximum distance for the season have been coming along. On receiver, EAM, G6HP, and the sked with G6VP. G6UJ has a nil report but is rebuilding. He asks for dope on very short aerials to be used with a movable reflector. (Write to BRS255.—G5VL.) G6VP has pulled in CT IAA's harmonic (verified) R3/R6 every Sunday. He thinks this is a remarkable feat at present. Other commercials' harmonics have also been heard. Busy clearing up his note with success.

Group 1D.—All except G.C. E1 7C are away, but hope to get going during the present month.

Group 1E.—G.C. G2OD has nothing to report. He was on for part of W6XAQ tests but, like the rest of us, heard nothing. G5UB and BRS72 also send nil reports.

Group 1F.—G.C. 2CX is tuning up with local stations now that he is settled down in new QRA. G5WK is on holiday. G6HP has been on during Sunday mornings and most afternoons. He was called on July 23 at 11.35 G.M.T. by a rather weak station, d.c. with some chirp. Will this station please drop a card to G6HP? G6WN gets his signals each week. BRS25 logged only G6WN on 14th. PA. OCX is preparing for his move to Java, and is taking some high-power gear out with him. Skeds are being arranged with the group when PK. ICX starts work.

Group 4A.—G.C. 2AUH forecast of "best times" is given below:—

SEPTEMBER 20—OCTOBER 20.

	7 M.C.	14 M.C.
Australasia ...	20.40 (abt) Very Scarce.	21.00-22.00 05.00-07.00
N. America ...	21.00-07.00	18.00-02.00 West Coast abt 02.00 dec
S. America ...	22.00 abt. Vy scarce.	18.00-02.00
S. Africa ...	FQ at 20.30	17.30-20.00
North Africa ...	Any time	?
Asia ...	19.45-AU	16.00-21.00

Group 5A.—(3550 KC. Fading) G.C. G6FY has been laid up, but promises further reports when data is collected.

Group 7A.—(56 M.C. work). The report of G.C. G2DT's untimely end is, I understand, "greatly exaggerated." The new pole missed him each time it fell. Likewise, a yarn current in the district to the effect that G2DT was getting in stock to open a "Radio Stores" proves unfounded. The carriers were delivering the parts for his new transmitter, that's all. A curious theory was set out in the letter of a W station: That the frequency of these signals changes after leaving transmitter. He advocated a receiver with a tuning range of 7 cm., with the nominal frequency more or less in centre, as covering the variation experienced. The tuning range would thus be about .8 M.C.

Group Centre G2DT is pleased to announce the following skeds:—

EFFECTIVE SEPTEMBER AND OCTOBER.
56 mc.

G6TW.

Nightly, except week-ends ...	2000 to 2015 G.M.T.
Saturdays ...	1300 to 1330 G.M.T.
Sundays ...	1000 to 1030 G.M.T. 1300 to 1330 G.M.T. 1730 to 1800 G.M.T.

G6DH.

Sundays ...	1000 to 1015 G.M.T. 1315 to 1330 G.M.T. 1700 to 1715 G.M.T.
-------------	---

(Above times of G6DH to be advanced one hour upon cessation of B.S.T.)

G6HX.

Saturdays ...	1500 to 1530 G.M.T.
Sundays ...	0900 to 0915 G.M.T. 1100 to 1130 G.M.T. 1400 to 1415 G.M.T.
Nightly ...	2110 to 2120 G.M.T. Xmttg 2100 to 2110 G.M.T. } Rx. 2120 to 2130 G.M.T. }
Occasionally ...	0745 to 0800 G.M.T.

G6LK. QRL making special Var. Condensers and hopes soon to be active.

2AAM. QRT until October owing business QRM.

G2DT completed alterations to Rx and has forwarded above skeds. to S.A.R.R.L. and A.R.R.L. and hopes for the best.

BRS98 joins the Group and is most welcome; thought he was on 5 m. until QRH-meter was calibrated when he found he was on 3m. Hi!

Group 8A.—(QRP) G5RV has been looking after the group whilst G.C. G2ZN was laid up. His first note is that EVERY STATION REPORTS. F.B.—G5VL.) Erratic conditions have been

generally noticeable. G2ZN has got back to his key. G5RV asks me to give his theory of "Ear inertia" as opposed to the "Aether inertia" of G2ZN noted in last month's notes.

The point they are arguing over is why a QRP signal may be received as loudly as one from a higher-powered station. G5RV says: "Supposing station A, input 20 watts, works station B, input 1 watt. Distance between the stations and general conditions are, of course, identical. They find they are both R5 intensity. Now, theoretically, assuming that each station has average efficiency, B's 1 watt will impress a certain voltage on the grid of A's detector valve and this voltage will pass through the L.F. stage to 'phones. The same process will happen to A's signals as heard in B's 'phones. As A's power is 20 times that of B, it is safe to assume that—if B supplies a voltage of X volts to the grid of the detector—A will supply 20X volts, approximately. There is not much doubt that the actual strength of A's signals is 20 times that of B. The human ear, however, does not respond to various intensities of sound in their correct proportions and thus A's signals will appear the same as (or very little louder than) B's. The real advantage of QRO is that it is more reliable than QRP." (I have given the above in full, but personally I don't agree that reception conditions at both ends are often identical. Also, the voltage effect of a 20-watt signal as compared with 1 watt on receiving aerial is not (I think) X20 at any distance. The human ear is generally accepted as only registering sound variation of about 20 per cent. But here G5RV is dealing with comparisons of sound values and not variations. I hope he will point out my errors.) G2ZN has a doubtful QSO with FM8KIK. His points for QRP are:—Steady PDC. Efficient radiator (he finds "End-on Hertz" good.) Call the other man, not give endless "tests." (Another candidate for A-B, obviously.) 2AUT is working on skip with G2ZN and G5AZ. BRS245 QRT till September. G5AZ with 2 watts on 7 mc. has EU 9BA (near Liberia) with R4, a R9 from a D and FM, O.K., SM and CT to his credit. On 14 mc. he worked HAF3XY. G5RV, with one solitary watt, on 7 mcs., has QSO with OH (R5). OZ (R4). D4QV at Hanover (R7). On QRO, viz., 2 watts, SM (R6), UO (R6) and HAF (R3). On 4 watts from old QRA, W3BNU reported his CC signals. A series of tests for end of August will take the form of each station in group calling various countries at prearranged times.

Group 8B (QRP). This is a new group of low power enthusiasts under G.C. G2VV. Stations and details are as follows:—G6SO has CC on 2½ watts. G5JF has worked nine countries on fone with 4 to 5 watts. G2RT has 5 watts on 7 mc. and hopes to get going on 14 mc. G5CM has a FB note and 5 watts. G2OA is working a LS.5 in Hartley on 14 mc., sked. with G5MQ, G6RW and WIASU. G2VV is on 7 and 14 mc., but BCL.QRM limits his times.

Group 9A (Weather Investigation).—G.C. G5UQ has his transmission schedule in full working order and offers of reports are reaching him. Please keep the schedule of transmissions given in August notes handy and push it across to any hams likely to listen for the tests. The A.R.R.L. have already given out full details through their O.B. stations.

(Continued on page 62.)

Low Power at G6CL.

By J. CLARRICOATS (G6CL).

After a period of three years' work on low power it is considered that a few remarks regarding this type of transmission may prove of interest to some of our BRS and AA members who may be hesitating before deciding to apply for a full licence on the score that transmitting is an expensive business.

During the summer of 1926 the first transmitter was put into operation, working exclusively on the old 45-metre band. In those days the circuit used was a tuned grid arrangement, and the high-tension supply of 180 volts was derived from small-type "Ever-ready" batteries.

With this combination the log book shows that in seven months a total of 469 stations in 18 European countries were worked. The input during this period varied from 5 to 0.2 watts, and, judging by the details given by the other stations, the signals were apparently satisfactory. The first aerial used was a half-wave aerial, 72 ft. long, almost vertical, and badly screened, but this was later changed to a two-wire system with a 70-ft. span and a 30-ft. lead-in. The aerial in both cases was connected directly on to the plate coil. Experiments were conducted on aeriels varying from 30 up to 100 ft. horizontal span, and as far as could be judged European stations could be worked with ease on any length of wire. Indoor aeriels of different shapes and lengths were tried, and numerous contacts up to 500 miles were effected, proving to my personal satisfaction that, providing the transmitter is oscillating well, signals will be radiated from any odd length of aerial.

The first DX was worked in January, 1927, when Nijni, Novgorod (UIUA) and Lynn, Mass., U.S.A. (NU1BKE) were reached. The input then was 4.5 watts. In those days Russian stations were not so plentiful as in 1929!!!

The year 1927 passed with little new work accomplished, except that in the latter months numerous contacts were made with our old friend Hogg in Iceland. Six new countries were worked, and a total of 750 stations communicated with. Most of the work was done on the two-wire aerial and a 1-watt input.

The following year saw the beginning of DX at G6CL. The extraordinary period between March and April, when American stations were received every morning between 05.00 and 08.00 G.M.T. at great strength, was taken advantage of, and during the few weeks between March 4 and March 29 no less than 25 American-Canadian stations were worked. The input during this time was between 5 and 7 watts, derived from a small 300-volt accumulator battery. The valve used was a Telefunken R.E. 504, and later an R.E. 134. These valves are excellent for low-power work, and when run at 20 to 25 m.a. give a very clean-cut note free from chirp.

The first work on the old 23-metre band was begun in May, 1928, and it is of interest to recall that within five minutes of G2AX assuring me that my signals were going out, I was in touch with NU1ASY in Essex, Conn., U.S.A., where I was reported R4. Several other eastern seaboard Americans were worked during the summer, the input being 6 watts maximum.

It should be noted that the same aerial was used for both 45 and 23, an arrangement which is still in use. No aerial tuning devices were used, and, as has been previously mentioned, the aerial was connected directly to the plate coil.

With the exception of French Morocco and Roumania, no new countries were added during 1928, but a total of 504 contacts was made.

One interesting point noted in my log is worthy of mention. During the evening of August 4 (just after moving QRA) I decided to try and effect a contact with whatever was available. The transmitter was accordingly hooked up to a piece of bell wire 40 ft. long and run to a clothes prop in the garden, the height being less than 6 ft. GW15C replied to my first call, and reported me R4 with an input of 0.5 watt. Several new aerial systems have been tried since that date, but the final decision was made recently when a 70-ft. single wire, 20 ft. high, was erected.

A quarter-wave aerial and quarter-wave counterpoise for 45 metres was found to give good results, but the counterpoise did not find favour in other quarters of the "Ciel" establishment.

The year 1929 has so far been more successful than anticipated. The 14 M.C. band has been used almost exclusively, and already all continents have been worked. During April Australia was "captured," and on the 22nd a remarkable contact with Yokohama was made with an input of 4.8 watts. The input at the Japanese end was even less, being 3.8 watts! My signals were reported R6.

Two further VK stations were worked in May, and on the 3rd of that month PY1AW gave me the final continent for W.A.C. Egypt and Tunis have also been worked, besides many North Americans.

For the past nine months a tuned plate-tuned grid circuit has been in use, and a Cleartron CT 25X valve used as the oscillator. The plate supply has been derived from Pertrix batteries. Since January, 1929, nearly 300 stations have been worked, and of these over 150 have been situated more than 1,000 miles from London.

For European work it is now definitely established that signals are louder when using 3 watts than 7 watts on the 14 M.C. band.

Summarising this record, it can be safely stated that for European working 3 watts is sufficient, and for DX an input of 7 to 10 watts need not be exceeded. From past experience any single wire aerial, and almost any length, will suffice up to 500 miles, but for DX a fairly high aerial working at half or full wave seems most efficient.

It is considered advisable to work with the aerial as near the plate end of the coil as possible, but higher input should not be preferred to a clear, chirpless note.

One final word, the receiver used is fundamentally the same as the first ever used, and a two-valve Reinartz employing Weeco valves three years' old. The only change since 1926 has been the substitution of valve base coils for those of more orthodox design.

If this short article serves but to show that their is much still to be done with low power, satisfaction will have been obtained.

Station Description (ZS4M and ZS4E)

By ZS4M (C. H. HILL).

[We have much pleasure in presenting a description of the station jointly owned and operated by C. H. Hill (ZS4M, ex FOB3V) and F. E. Frost (ZS4E, ex FOA9A).—EDITOR].

The transmitting and receiving gear, together with the power plant, are housed in a single room specially built for this purpose, due regard having been given to the necessary facilities for aerial leads in, power supply, and the housing of the various high and low tension accumulators and charging and rectifying apparatus. The initial power for supplying the plates and filaments of the three transmitters, as well as for charging the many high and low tension accumulators supplying the several receiving units is derived from the town supply of 210 volts 50 cycle A.C., and the shack has been specially wired so as to facilitate the tapping of the mains at different points.

The several aerials employed for reception and transmission are slung from a single wire drawn taut between two steel masts approximately 85 feet high and having a separation of 120 feet. Although one aerial only is used for reception on the different wave-bands, each of the three transmitters has its own separate aerial (details of these will be given later), and these have been arranged with a view to reducing to the greatest possible extent the coupling between them. Furthermore, each aerial is a separate entity, in that it can be lowered or raised at will, and that each has its own earthing arrangement. There is no question that certain losses do occur due to the other adjacent aerials, the steel masts and the stays (these last mentioned are well broken up with insulators), but it is felt that this is not very serious, and the excellent results obtained would seem to bear this out.

The above will suffice for a general description of the station as a whole, and now will follow a very brief description of the different transmitting and receiving units.

The 7 M.C. Band : Transmitter Call Sign ZS4E (ex FOA9A).

The tube, in this case a Mullard VO-500, is built into a conventional series feed Ultraudion circuit. (It may be mentioned here that many different types of circuit have been tested, and, although with careful adjustment, no particular circuit would appear to have any advantage as regards input and output and the ratio of the one to the other, yet for ease of adjustment and steadiness of wave the Ultraudion is preferred, and this circuit, therefore, has been adopted throughout.) The input varies somewhat with the mains voltage, but an average figure is round about 750 watts. The plate supply for the tube is obtained from a 3000-0-3000 transformer and rectification is effected by means of two Osram 500-watt valves. The pulsating output from these two tubes is shunted by a two microfarad high voltage condenser, and this is the only smoothing apparatus employed. (This also applies to the other transmitters.) Notwithstanding the absence of elaborate smoothing gear, reports of T8 and T9 are received on this wave. This fact taken in conjunction with the somewhat rough note which is obtained on the 20 band is indicative of the very considerable effect which the tuning of the transmitter and general adjustment has on the note. The somewhat rougher note is preferred for DX

working. The filament supply for this tube is unrectified A.C., obtained from the town supply, and stepped down to the required voltage.

The transmitting aerial consists of a single vertical wire (7-22) of a length equivalent to half the working wave-length and fed at a current node. The feeder line is of the twin wire type, slightly less in length than one-fourth of the working wave. The two wires are separated approximately 8 ins., and the feed is series-tuned. A Weston Thermo Couple (0.5 amps.) instrument is inserted in each line immediately after each of the two balancing condensers (these read slightly over 3 amps. on normal power), and by this means the correct adjustment of the aerial and feeder line for correct disposition of the current loops and nodes is obtained. Experiment has shown that where care is taken to maintain a current loop in the centre of the aerial coil (thus balancing the feeder correctly) the best results are obtained when the aerial is equal to exactly the fundamental length of the wave. Another point which may be of interest is that the feeder line is no more than about three feet above the ground, and this has been found by experiment to give the most satisfactory results.

The receiver employs the usual modified Reinartz circuit with the addition of a stage of screened grid high frequency amplification. By means of a system of plugs and jacks, the maximum of four valves, or the minimum of two, may be used. This receiver has its own high and low tension supply and charging apparatus.

The 14 M.C. Band—Transmitter Call Sign ZS4M (ex FOB3V).

The tube in this case is a Mullard VO-250, built in the usual type series feed Ultraudion circuit. The rated input of 250 watts to the tube is never exceeded, and the normal working input is approximately 200 watts, varying, however, slightly above and below this figure, with fluctuations on the mains supply. The plate supply for this tube is obtained from the same source as that of ZS4E, and the same filter arrangement (such as it is) is employed. A system of switching is used in order to divert the high tension supply to this tube, and suitable resistances are employed to adjust the input. The filament supply is unrectified A.C., and a separate transformer is in circuit to obtain the required voltage and current. Each of the three transmitters has its own key, and relays are used to isolate the operator from the power supply, and further to improve the efficiency of the transmitters as a whole. By means of switches, any one of the three keys may be employed for any one of the transmitters at the will of the operator or operators. In all the power leads to the transmitters, as well as to the leads running to the several transmitting relays, high frequency chokes are inserted to isolate the transmitter energy as much as possible. The transmitting coils in this transmitter as well as in ZS4E, are constructed of heavy copper tubing, and are self-supporting. The diameter of each coil is 6 ins., and the turns are spaced approximately one and one-half diameters, or, at any rate, sufficient to

eliminate any choking effect on the tube. Smooth control of the filaments of all transmitting and rectifying tubes is obtained by means of a variable tapped resistance, though switches enable any one of the transmitters to be cut out of circuit as desired. In addition to this arrangement, each of the transmitters has a separate variable filament resistance, and by this means any variation in the mains supply may be counteracted.

The transmitting aerial is in most respects similar to that used with ZS4E except that in this case (1) the respective lengths of the aerial and feeder line are adjusted to the operating wave-length; (2) the aerial is operated on its first harmonic; (3) the aerial is not vertical, but is slung at an angle of 45° with the ground; and (4) no angle is made by the aerial with the feeder line at the point of connection; that is to say, the feeder is also at an angle of 45° with the earth, and thus in a straight line with the aerial and in the same plane. This is mentioned apropos of nothing except in description of the actual aerial employed here on the 20 metre band.

The tuning arrangements here are similar to those employed in the case of ZS4E, except that Weston ammeters (0—3) are used instead of the larger instruments on the longer wave. The aerial current fluctuates in the neighbourhood of $1\frac{1}{2}$ amps., and varies, of course, with the mains supply.

The receiver is very similar to that used with ZS4E, a stage of high frequency amplification being used, followed by a detector and two stages of A.F. amplification. As in the case of the receiver at ZS4E, the number of valves in circuit may be varied at will. This receiver has its own separate plate and filament supply, and provision has been made

by means of switches for charging these. As mentioned in the general description of the station in an earlier part of this article, only one receiving aerial is used throughout, and it may be mentioned, in passing, that the aerial (also vertical) bears a more or less definite ratio to the length of the waves received, and experiments indicate that such is conducive to maximum signal strength. This may not always be so, but it would seem to be a reasonable hypothesis, and experiments have so far most certainly borne this out.

The 28 M.C. Band : Transmitter Call sign FOA9A.

Very little can be said in regard to this, as no definite work has actually been done on this wave. Briefly, however, the tube is a Philips Z3 in a modified series feed Ultraudion circuit. The normal input is in the region of 100 watts, and the plate supply is obtained from the same source as that of ZS4E and ZS4M by means of switches and suitable resistances. The filament supply is A.C. derived from a separate transformer. The transmitting aerial is designed for operation on the first harmonic, and such is merely clipped on to the aerial coil, no earth or counterpoise being used. Very little experimental work has been done on this transmitter as yet, and no contacts have been made.

The receiver is a modified Schnell O-V-2, and, like the two receivers previously mentioned, has its own individual plate and filament supply, and the necessary rectifier and charger for keeping these in condition.

The whole of this work, including the plan of the building, was conceived, designed and executed by ZS4E, the writer (ZS4M) being, however, a useful adjunct for the carrying and putting away of tools.

Some Points on Broadcast Receiver Design

(Continued from page 57).

size, and also causes back coupling among the valves and motor boating.

Do not use an eliminator at all unless the set is provided with de-coupling resistances in the H.T. lead to each valve except the last. These resistances may be about 20,000 ohms, and condensers down to earth from them of from 2—4 mfd., the larger the better. If available, choke coils are better than resistances, as they do not drop so much H.T. voltage across them; for the HF. and detector stages old inter-valve transformers make good H.T. chokes. De-coupling resistances are of advantage also for accumulators, and are almost essential for dry battery operation.

The ideal arrangement is an accumulator battery for the H.F. and detector stages, and an eliminator for the L.F. and power stages. A suitable arrangement would be 80 volts in accumulators and 200 volts or upwards from the eliminator. In designing an eliminator use condensers made to stand twice the H.T. voltage, as the voltage on no load is 1.4 times the nominal. Never adjust the output voltage of an eliminator by dimming the filament of the valve; use a tapped transformer or a potential divider. If you dim the valve the emission will be lost permanently.

Contact Bureau Notes—(Cont. from page 59).

Group 10A (1770 kc. work).—G.C. G60T tells us that owing to its formation in the midst of the holiday season and the fact that some members were not aware it had been officially formed in time to report, the group has only a comparatively few reports this month. G5UM is working on a quick change-over transmitter from C.O. to T.P.T.G. and also the relation between aerial current and signal strength at a distance and finds that a minimum of 0.2 amps. is necessary for over 30 miles. He finds that he can cover London on less than this however. G5RX does not send in a full report but is working to prevent interference to BCL's on the wave-length; they object to his transmitting after midnight! It seems very unreasonable—but suggests to the G.C. an additional line of work for the group. BRS164 has been busy but finds few stations and too much QRN. His best conditions for reception seem to be with barometer about 29.5" and during rain.

That finishes up the Group reports which have reached me but it may be of interest to mention that C.B. has now 200 members on its books. Will any of these members who find that they possibly have to wait a few days for a reply to a letter or something of the sort please bear the above figure in mind? But—we can always find room and time for one more member.

How to Supply Your Short-Wave Receiver with Power from the A.C. Mains.

By ROLF WIGAND D4AFA (DE0065).

We do not hesitate to build an A.C. power supply for our transmitter (be it 5 watts or 5 kilowatts), but surely few have thought of making their short-wave receiver a mains supplied one. I had never heard of an amateur who had successfully supplied his short-wave receiver with both L.T. and H.T. from the A.C. mains, a thing which is generally regarded as impossible.

My receiver is a 1929 type with a screened grid valve, and I have often been troubled by a steady falling off of the H.T. which not only upset the calibration of the receiver but caused bad howl, rattling and other unwelcome noises. The filament battery was not at fault and was kept well charged by a trickle charger. I first decided to replace the H.T. dry battery with an eliminator, and obtained some chokes, condensers, resistances, a transformer and a rectifier of the highly evacuated

Experiments were conducted with a view to cutting out the slight hum noticed, but no amount of filter would eliminate it completely. As a result of these experiments I decided to build my power supply accordingly to the diagram shown in Fig. 1. The transformer T has a split primary; both halves may be used in parallel for 110 volt mains or in series for 220 volt mains. Three secondary windings supply the H.T. (600 volts centre-tapped) and the L.T. (2.5 volts centre-tapped) for the telefunken full-wave rectifier and finally 4 volts for indirectly-heated cathode valves. The 300 volt windings are shunted by C_1 and C_2 to cut out radio frequency that may occasionally be generated by the rectifier valve. The filter consists of a double choke, Ch, and three condensers, C_3 , C_4 and C_5 . All these parts are contained in a small iron box which is kept about 4 ft.

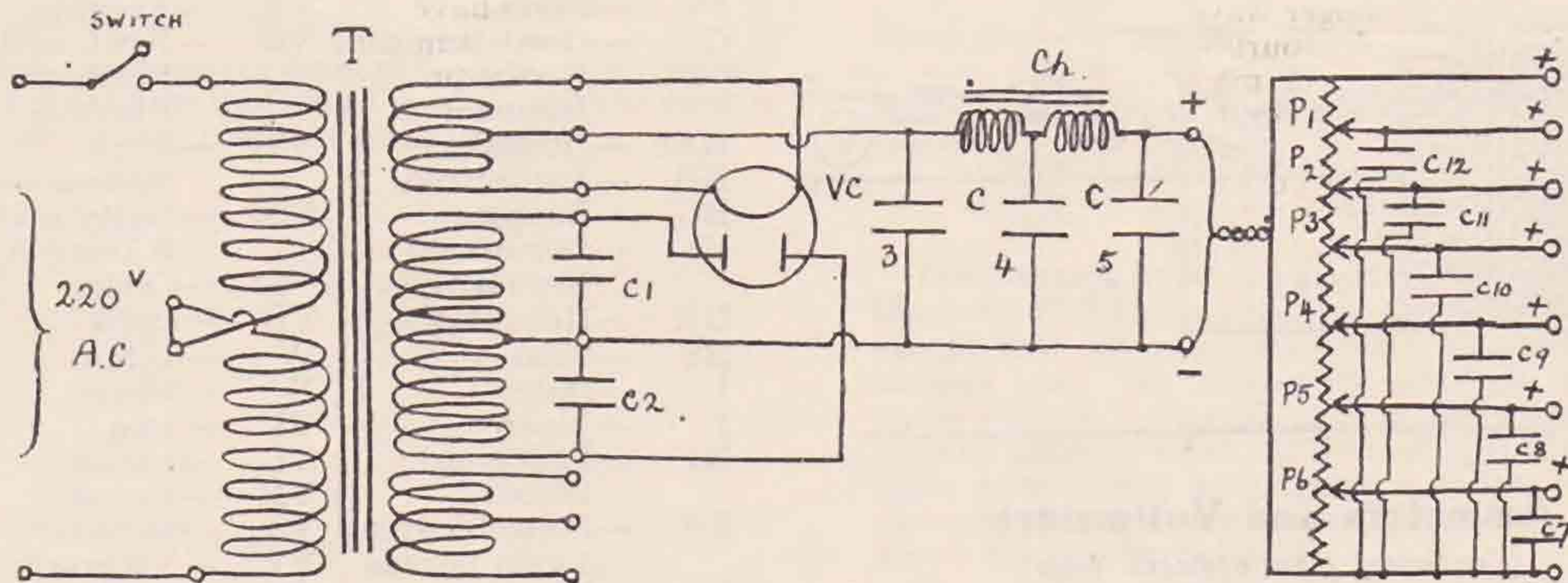

Fig 1

Wigand

C_1 and C_2	— .1 mfd.	Ch	—double choke (40 Henries at 40 mas.); 17 Henries at 15 mas.;
C_3	— 8 mfd.	V	—full wave rectifier, RGN 1503
C_4 and C_5	— 4 mfd.	P_1 to P_6	—5,000 ohms.
C_6	— 6 mfd.	P_5	—3,000 "
C_7 to C_{12}	— 2 mfd.	P_4	—2,000 "
C_{13}	— 4 mfd.		

T—transformer with 48 volt secondary, centre tapped.
 Cell—Full wave Tantalum—Lead rectifier.
 C—Dry electrolytic condenser, 2,500 mfd., 10 volts.
 Ch_1 and Ch_2 —Large air-gap chokes; 2 Henries at .4 amps.; 1 Henry at 1.5 amps.; 7 ohms.
 R—About 20 ohms.
 V—Voltmeter.

Note: Never switch on the mains unless there is a load between + and - terminals.

type (Telefunken). I built a power supply with a three stage filter, and the whole arrangement, though very hay-wire, worked surprisingly well. Only a slight hum could be heard in the headphones, but not of the type usually obtained from badly filtered R.A.C. It did not spoil the tone of any note, and if a crystal-controlled station was received it sounded perfect T9. Phone, also, was received well and the reaction control was silent. You know that badly filtered R.A.C. on the plate on an oscillating detector valve in a B.C. receiver will result in terrific rattling at the point where the receiver goes into oscillation. Fortunately, nothing of this sort occurred and I was pleased with my success.

away from the receiver. From the terminals marked + and - two flexible leads bring the well-filtered R.A.C. to the potential divider, which consists of six wire-wound potentiometers (P_1 to P_6), the sliders of each being connected to a terminal and well bridged to common negative by a condenser of two mfd. It is possible, therefore, to obtain any H.T. for the receiver from zero up to about 400 volts. The values used are given below Fig. 1.

Having solved the problem of replacing the H.T. battery with a mains unit, I tackled the subject of the L.T. supply, for I was anxious to prove that a short-wave receiver wholly fed from A.C. mains was not an impossibility. So I connected together

my full-wave tantalum rectifier, two 1 Henry chokes (for 1.5 amps., with air gaps), an electrolytic condenser and a voltmeter. I then plugged in the L.T. leads of the receiver, switched on and expected to find a hum enough to drown everything. Nothing like that occurred. Again the slight hum noticed earlier and again the pleasure that all notes, music, speech and any modulation came through well. The diagram of the L.T. substitute is shown in Fig. 2. Of course, during the tests with this apparatus I always kept in mind that a new H.T. battery and a well charged accumulator truly give pure D.C., and so I was constantly switching over from batteries to substitutes to see if harm was done to the character of any received signal.

After these encouraging results I also tried to use valves with indirectly heated cathodes using raw A.C. on the filaments. This gave much trouble in a normally built receiver, but I think will work well if a specially constructed receiver is used. I am building one and will report on the results (be they positive or negative) at a later date.

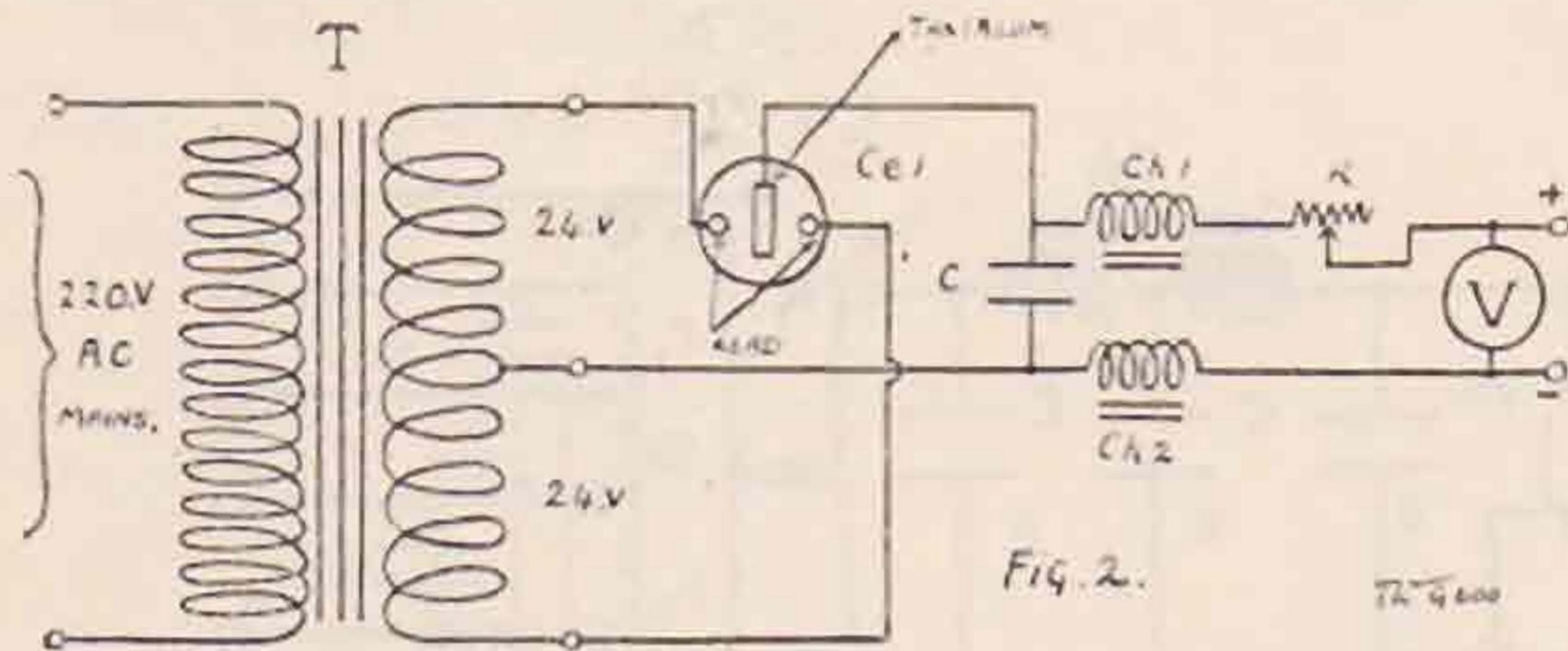

Ammeters and Voltmeters

(Continued from opposite page).

CB is a fibre which continues to the axis D of the pointer DF, and thence to the spring E. A slight movement of the spring E causes the pointer to revolve.

When the current passes through ACB, AC is heated and expands. The expansion naturally causes relaxation, so that E contracts and pulls the fibre. DF thus moving in an arc.

Thus the arc traversed by the pointer DF is proportional to the current passing.

The pointer is made to move over a scale of amperes, which may be measured by the method explained previously.

This type of ammeter may also be used as a voltmeter by the series resistance method.

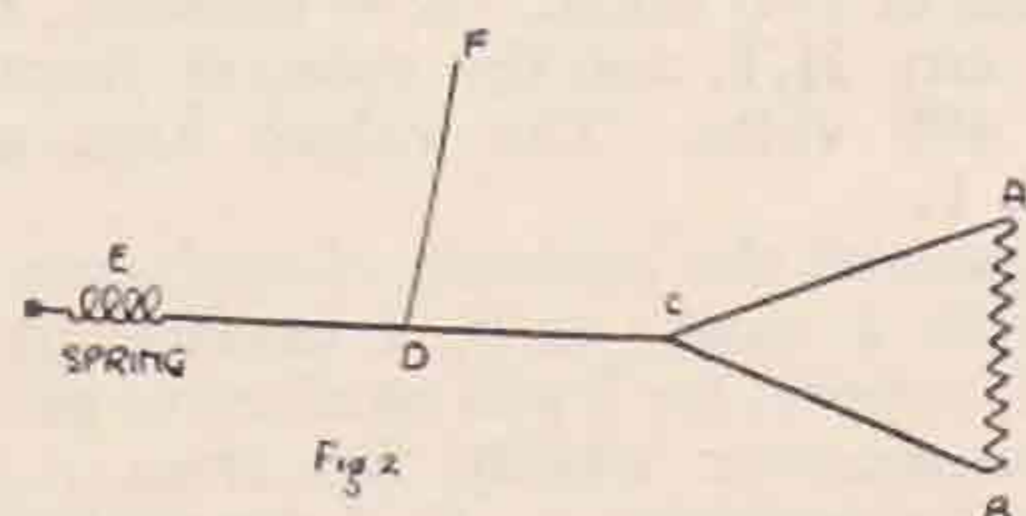

International Amateur Prefixes, 1929.

AU	—Siberia and Turkestan	OK	—Czecho-Slovakia
CE	—Chile	ON	—Belgium
CM	—Cuba	OZ	—Denmark and Faroe Islands
CN	—Morocco	PA	—Holland
CP	—Bolivia	PK	—Dutch East Indies
CT	—Portugal, Madeira & Azores	PY	—Brazil
CV	—Rumania	RV	—Persia
CX	—Uruguay	RX	—Panama Canal Zone
D	—Germany	RY	—Lithuania
EAR	—Spain	SM	—Sweden
EI	—Irish Free State	SP	—Poland
EL	—Liberia	SU	—Egypt
ES	—Estonia	TF	—Iceland
EU	—Russia	TG	—Guatemala
F	—France	TI	—Costa Rica
FA	—Abyssinia	UL	—Luxemburg
FI	—French Indo-China	UN	—Jugo-Slavia
FM	—Algeria and Tunis	UO	—Austria
FQ	—Cameroons	VE	—Canada
FV	—Sahara	VK	—Australia
G	—Great Britain	VO	—Newfoundland
GI	—Northern Ireland	VQ	—Northern Rhodesia
HAF	—Hungary	VS1	—Straits Settlements
HB	—Switzerland	VS3	—Malay States & Hong Kong
HC	—Ecuador	VS7	—Ceylon
HI	—Dominican Republic	VU	—India
HR	—Honduras	W	—U.S.A.
HS	—Siam	X	—Mexico
I	—Italy	YI	—Iraq
J	—Japan	YL	—Latvia
K1	—Phillipine Islands	YM	—Danzig
K4	—Porto Rico and Virgin Islands	YS	—Salvador
K6	—Hawaii	YV	—Venezuela
K7	—Alaska	ZL	—New Zealand
LA	—Norway	ZP	—Paraguay
LU	—Argentine	ZS	—South Africa
OA	—Peru	ZT	
OH	—Finland	ZU	

District Representatives.

The following is the list of District Representatives for the year ending September, 1930.

No nominations have been received for the Districts 2 and 8, but we hope that these positions will be filled by the time these notes are in print.

- No. 1.—I. D. J. BEATTIE (G6BJ).
- 3.—J. NODEN (G6TW).
- 4.—A. C. SIMONS (G5BD).
- 5.—D. P. BAKER (G2OQ).
- 6.—R. C. HORSNELL (G2ABK).
- 7.—H. C. PAGE (G6PA).
- 9.—G. COURTENAY-PRICE (2OP).
- 10.—J. CLARRICOATS (G6CL).
- 11.—L. H. THOMAS (G6QB).
- 12.—T. A. ST. JOHNSTON (6UT).
- 13.—H. V. WILKINS (G6WN).
- 14.—J. WYLLIE (G5YG).
- 15.—H. ANDREWS (G5AS).
- 16.—C. MORTON (G15MO).



(Registered

Trade Mark.)

THIS IS OUR TRADE SYMBOL

"Best after Test"

~ AND NOTHING COULD MORE FULLY DESCRIBE
THE QUALITY of our COMPONENTS & APPARATUS ~

SINCE THE LAST OLYMPIA SHOW WE HAVE MADE EXTENSIVE ALTERATIONS
AND ADDITIONS TO OUR PREMISES. WE ARE NOW FULLY
EQUIPPED AND ORGANISED ADEQUATELY TO COPE
WITH THE REQUIREMENTS OF OUR VERY
NUMEROUS AND EVER-INCREASING
CLIENTELE.

HERE IS ONE OF
OUR NEW PREMISES
COMPRISING SHOWROOMS
EXECUTIVE OFFICES &
LARGE WAREHOUSES
AT THE REAR.



TURN OVER
AND READ MORE
ABOUT US. DO NOT
FAIL TO WRITE FOR
OUR LARGE 188-pp.
CATALOGUE.

Telephone :
4641 Central.

CLAUDE LYONS LTD
76 OLDHALL ST.
LIVERPOOL

Grams :
"MINMETKEM," L'pool.

COME AND SEE US AT THE -

-MANCHESTER RADIO EXHIBITION.

ELIMINATORS & MAINS



COMPONENTS & KITS.

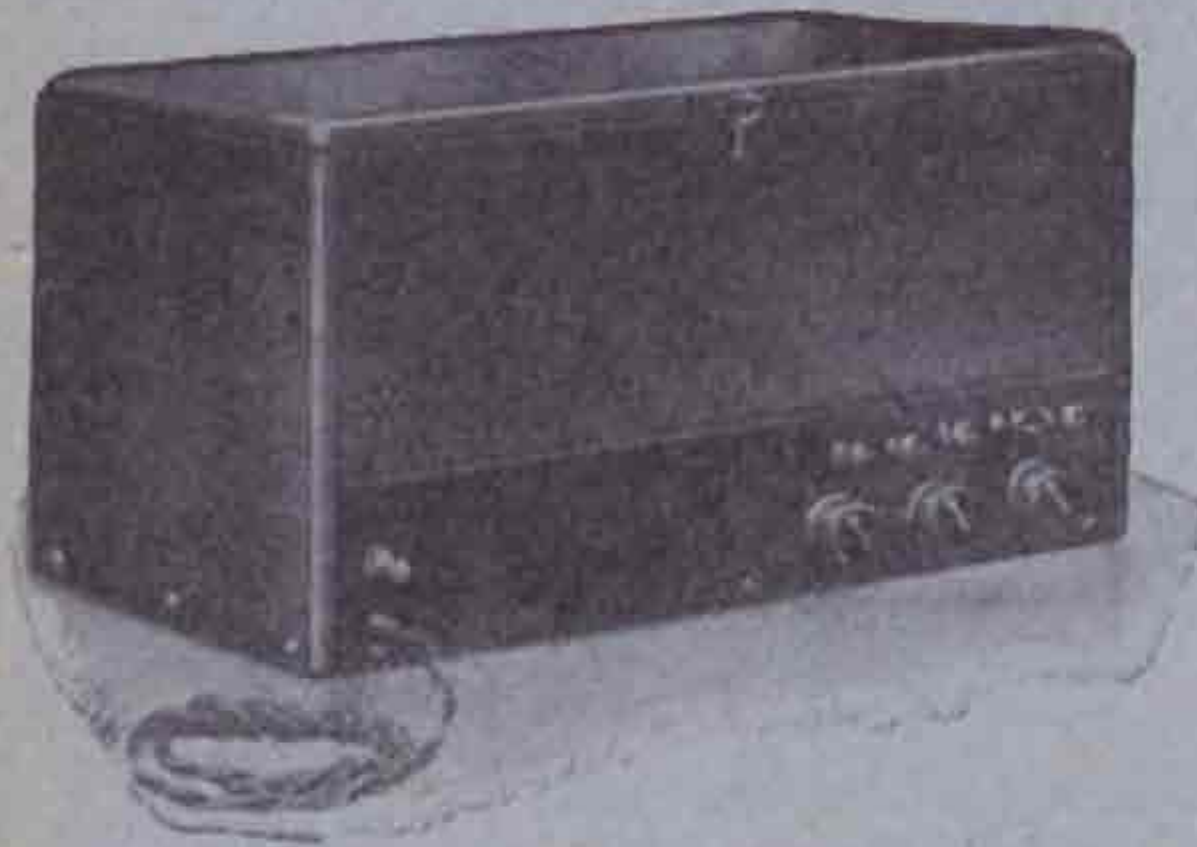

A.C. MODELS.

These Units are not cheap at first cost, but they are far and away the cheapest in the long run. They are positively guaranteed to be entirely free from mains "hum," and each tapping is properly "decoupled." They are designed for powerful receivers. Brief details and prices are given below.

"G.R." KIT.

The Very Heart of "B.A.T." A.C. Eliminators, as well as of units constructed at Home by those who want the best that money can buy: G.R. Type 365 Rectifier Transformer, secondary 275-0-275 @ 80 mA., plus 7.5 V. for amplifier valves, price 38/6; G.R. double choke unit 30 Hys plus 30 Hys, good for 85 milliamperes, price only 35/6. Both properly shielded. (The 2 chokes on separate cores, of course.)



6 MODELS AVAILABLE.

TYPE.	DESCRIPTION.	LIST PRICE.
"4V"	4 Tappings, all Variable (0-300 V.)	£11 5 0
"HV3"	4 Tappings, 1 Power, 3 Variable (do.)	£10 10 0
"3V"	3 Tappings, all Variable (0-300 V.)	£10 7 6
"HV2"	3 Tappings, 1 Power, 2 Variable (do.)	£9 15 0
"2V"	2 Tappings, both Variable (0-300 V.)	£9 12 6
"HVI"	2 Tappings, 1 Power, 1 Variable (do.)	£9 0 0

THESE ARE "RAYTHEON" ELIMINATORS, WITH "G.R." TRANSFORMER AND DOUBLE CHOKE UNIT; CONDENSER BLOCK BY "T.C.C."; METAL CASE; INSOL PANEL; BAT 750-WATT SWITCH. THEY OF COURSE ARE CLAROSTAT EQUIPPED. LOAD DROP ONLY 1.5 V. per mA. PRICES INCLUDE TUBE.

D.C. MODELS.

WE MANUFACTURE AT OUR NEW LIVERPOOL WORKS A COMPLETE RANGE OF D.C. ELIMINATORS. THE SPECIFICATION IS SUBSTANTIALLY AS OUR A.C. TYPES. PRICES RANGE FROM 87/6 to £7. LOAD DROP DOES NOT EXCEED 0.75 V. per mA., THUS GIVING ON 230 V. D.C. MAINS 200 VOLTS @ 50 MILLIAMPERES. THE CIRCUIT IS UNIQUE AND IT IS HUM FREE. MAY BE USED WHETHER POSITIVE OR NEGATIVE MAINS IS "EARTHED." SAFE EVEN WITH SETS HAVING DIRECT-COUPLED AERIALS. CONFORM TO I.E.E. REGULATIONS, ETC., ETC.

L.T. SUPPLY UNITS & HEAVY-DUTY BATTERY-CHARGERS.

FACTORY-BUILT UNITS.

Each Model can be adjusted to give a precise Output Voltage of from a trifle under 2.0 Volts to round about 7.5 Volts. Each Instrument has the following specification: "B.A.T." MAINS TRANSFORMER, CHOKE, AND 750-WATT SNAP SWITCH; "T.C.C." 4000 MFD. CONDENSER; INDICATING TERMINALS; POWER "CLAROSTAT" VOLTAGE CONTROL; MODELS S-1A and S-2A HAVE "FERRANTI" 0.75 V. 200 Ohms per Volt Flush Voltmeter. Models marked (N/M) have no meter fitted. FULL-SIZE CONSTRUCTIONAL BLUE PRINT, post free 1/3. 4-Page Folder, with scale drawings, etc., FREE & POST FREE.

Type.	Price
S-1A (N/M) 2-7.5 V., Cap. 1.0 Amp.	£7 10 0
1-A, 2-7.5 V., Cap. 1.0 Amp.	£8 15 0
S-2A (N/M) 2-7.5 V., Cap. 2.0 Amps.	£8 15 0
S-2A, 2-7.5 V., Cap. 2.0 Amps.	£10 10 0

1 Amp. Charging Kit, only £2 10 6



CLAUDE LYONS LTD
76 OLDHALL ST.
LIVERPOOL

HOME-CONSTRUCTORS' KITS.

COMPLETE KIT FOR 1 AMP. UNIT:
 "B.A.T." Type LV 1-A Transformer £1 5 0
 "B.A.T." Type LT 1-Amp. Choke .. £1 3 6
 "B.A.T." 750-WATT POWER SNAP SWITCH..... 2 6
 WESTINGHOUSE A/3 METAL RECTIFIER £1 3 6
 2 X 2000 MFD. "T.C.C." SPEC. CONDENSERS £1 10 0
 1 POWER CLAROSTAT 1-10 OHMS 11 6
 2 BELLING-LEE TERMINALS .. 1 0
 BLUE PRINT FREE. Total.. £5 17 0
 FERRANTI VOLTMETER 30/- Extra.
 2.0 AMPERE KIT, WITHOUT METER, ONLY £6 18 6
 2.0 AMPERE KIT, WITH VOLTMETER, ONLY £8 8 6
 (The 2 Amp. Models will drive a moving-coil speaker as well as your Radio Receiver l)

2 Amp. Charging Kit, only £3 9 6

COME AND SEE US AT THE -

-MANCHESTER RADIO EXHIBITION.

"G.R." WAVEMETERS.

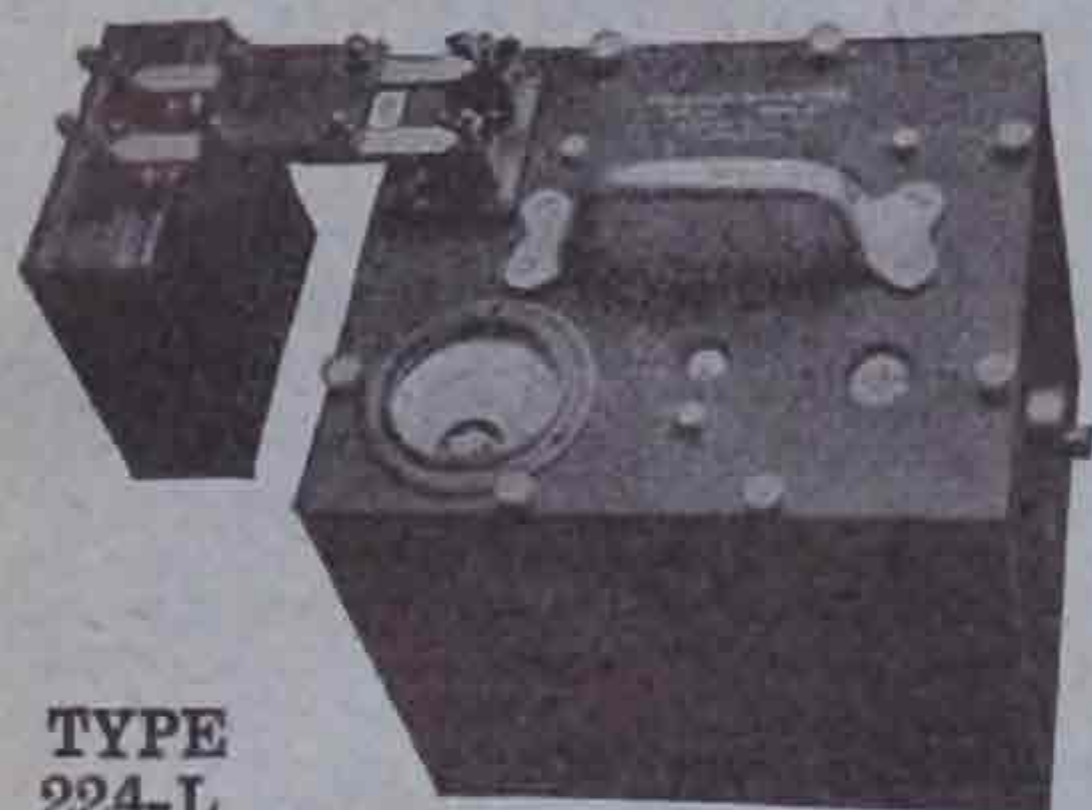

TYPE
224-L.

For well over a decade "G.R." Wavemeters have been the criterion, in every civilised country, by which other makes have been judged. The range extends from the Precision Models, price £57 10s., as illustrated, and as used by the British G.P.O., N.P.L., Department of Scientific and Industrial Research, etc., down to the G.R. Type 247-W, priced at 52/6.

Whilst the Push - Pull Method of Amplification does not increase the voltage amplification per stage, the maximum undistorted output is much more than twice that of a single valve. Distortion due to valve overloading is cancelled out, A.C. may be applied to the last stage without "hum," and quality of reproduction greatly increased, etc., by this method.

"PUSH-PULL" AMPLIFIERS.

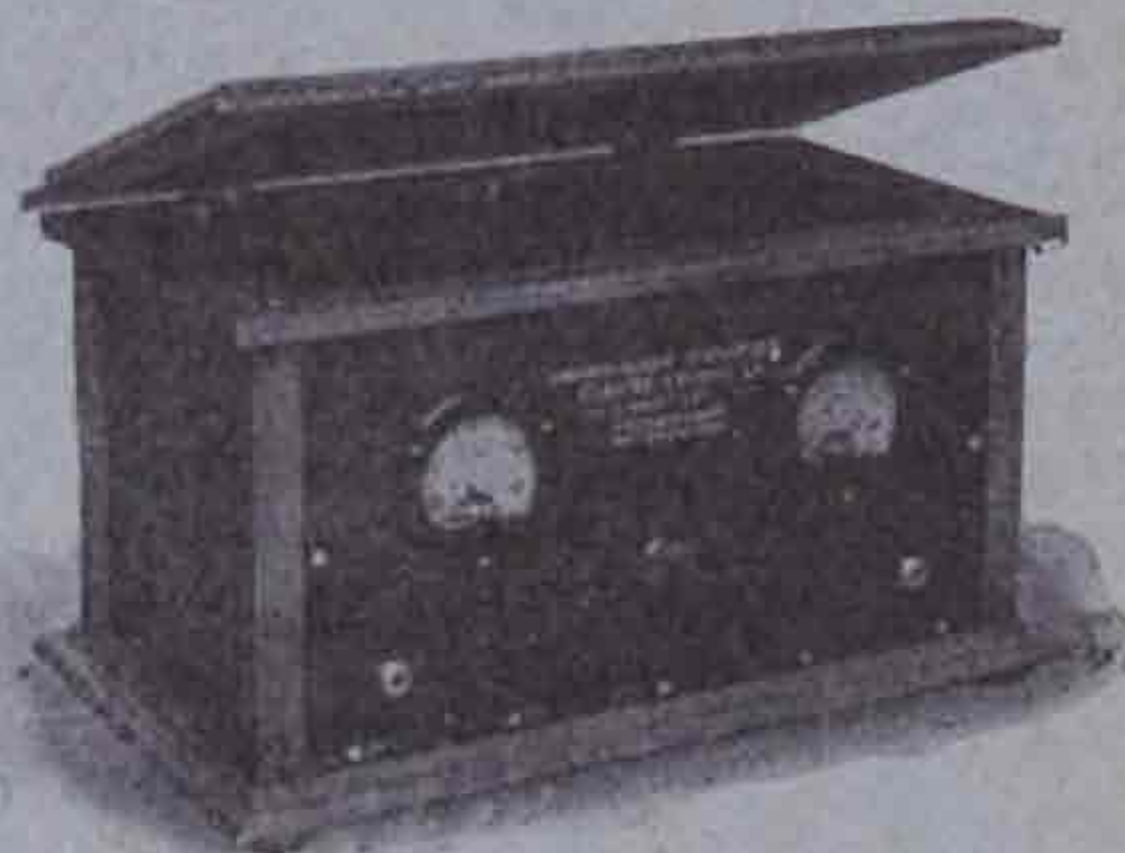

LYONS' 2-STAGE "B.A.T." PUSH-PULL POWER AMPLIFIER, including FERRANTI METERS, £15 15 0

THIS INSTRUMENT HAS BEEN DESIGNED TO AMPLIFY EITHER RADIO SIGNALS FROM THE DETECTOR OF A RECEIVER, OR THE OUTPUT OF A GRAMOPHONE "PICK-UP." WITH THE VALVES RECOMMENDED THE POWER OUTPUT IS LARGE—SUFFICIENT TO PROVIDE ADEQUATE ENTERTAINMENT FOR SMALL HALLS, PICTURE HOUSES, SMALL DANCE ROOMS, RESTAURANTS, ETC.

Furthermore, a complete KIT-SET, with full-size Blue-prints, can be supplied for £10 17 6, including the two Meters, but excluding the genuine Oak or Mahogany Cabinet. Without Meters the Kit-set price is only £7 17 6. (Carriage Paid.) Blue-prints will not be supplied except to Customers. Prompt delivery of assembled Amplifiers or the Kit-sets can be given. Daily demonstrations at our new salon.

WE ARE ALSO IN A POSITION TO DELIVER FROM STOCK COMPLETELY A.C. MAINS OPERATED POWER AMPLIFIERS, PUSH-PULL OUTPUT, IN SEVERAL MODELS HAVING POWER OUTPUTS FROM 5-15 WATTS, THE LARGER MODELS BEING CAPABLE OF PROVIDING COVERAGE FOR SEVERAL THOUSAND PERSONS. SPECIAL CATALOGUE NOW IN PREPARATION.

OUTPUT DEVICES.

An efficient Output Device is not a luxury but a necessity. Modern Receivers draw considerable current at the output stage, which, if permitted to traverse the speaker windings, will result in "burn-out." Apart from this true reproduction is quite impossible.

One of the best types of Output Device is a properly designed Speaker-Filter. The G.R. Instruments are the only ones available on this market and have been "specified" by "WIRELESS WORLD."

The Type 387-A, as illustrated, contains a 30 Hys. special choke; annealed silicon steel core. Also a 2 mF, 1,000 V. D.C. Test foil-wound isolating condenser. The unit is metal shielded. Black coslettized finish. Maximum safe current 50 mA. Currents up to 45 mA. do not in the least impair audio fidelity.

For large currents (up to 110 mA.) use the larger G.R. Type 587-B POWER-SPEAKER-FILTER, which contains a 4 mF, 2,000 V. D.C. Test Condenser in each output lead:

Type 387-A. "G.R." SPEAKER-FILTER List Price 27/6

Type 587-B. "G.R." POWER-SPEAKER-FILTER, List Price 45/-

List Price 45/-

THIS IS THE COMPLETE RANGE.

Type 224 Precision, 70-24,000 Metres £55 0 0

Type 224-L Precision, 15-600 Metres £57 10 0

Type 174-C Direct Reading, 75-1,500 Metres £18 15 0

Type 174-D Direct Reading, 200-4,000 " £18 15 0

Type 384 Heterodyne Wavemeter, 15-30,000 Metres £24 10 0

Type 532 Broadcast Station Frequency Meter £39 0 0

The above six wavemeters are mainly sold to Laboratories, Radio Manufacturers, and Academic Institutions. The following Instruments are made for the advanced "Amateur" and the ordinary listener:—

Type 558-P Amateur-Band Frequency Meter £6 0 0

This Instrument covers the 5, 10, 20, 40 and 80-Metre Amateur Wavebands with an accuracy of 0.25%. It is "approved" by the British G.P.O. for use at British Transmitting Stations, and is the only one so approved to date.

Type 358 Short-Wave Wavemeter Outfit £4 10 0

Covers 14-230 Metres continuously.

Type 458 5-Metre Wavemeter, 3.75-6.75 M. £2 15 0

Type 247-W Combined Wavemeter-Filter £2 12 6

Covers 200-600 Metres. Extra coils may be had from 50 Metres to 1,800 Metres. This Instrument also assists selectivity.

AMPLIFYING TRANSFORMERS.

The "G.R." Type 285 Low-Frequency Transformers are widely employed by discriminating "Amateurs." By employing a pair of Type 285-D, ratio 1:2.7, ample volume is obtainable, together with utter faithfulness of reproduction.

These transformers of course employ LARGE "PERMALLOY" CORES; they are completely shielded; their curves are exceptionally good and the published data is accurate. The curves of most competitive transformers are obviously "faked" to experts, inasmuch as on test the instruments are operated under especially advantageous conditions, not met with in practice.

Where tremendous volume is desired, follow the 285-D with a Type 285-H, ratio 1:6. Under such circumstances the last valve must be capable of accommodating a considerable grid-swing.

Type 285-D, Ratio 1:2.7, List Price 27/6

Type 285-H, Ratio 1:6.0, List Price 27/6



G. R. TYPE 285.



387-A SPEAKER-FILTER.

(Revised 1929/30 Prices)

(Revised 1929/30 Prices)

CLAUDE LYONS LTD
76 OLDHALL ST.
LIVERPOOL

COME AND SEE US AT THE -

-MANCHESTER RADIO EXHIBITION.



AND NOW ABOUT OUR CATALOGUE.

The latest edition of our famous EDUCATIONAL CATALOGUE is now ready. It is indispensable to the Radio Devotee who is anxious to obtain the utmost possible pleasure and satisfaction out of his apparatus. 188 Pages, over 400 Illustrations, Art Paper, Stiff Art Cover. Useful articles, many unique and useful circuits. As full of good advice as an egg is of meat. The edition has cost well over £1,000 to produce. Price 1/3 per copy, post free. Your remittance may be deducted from your first order to us. Early application is advisable.

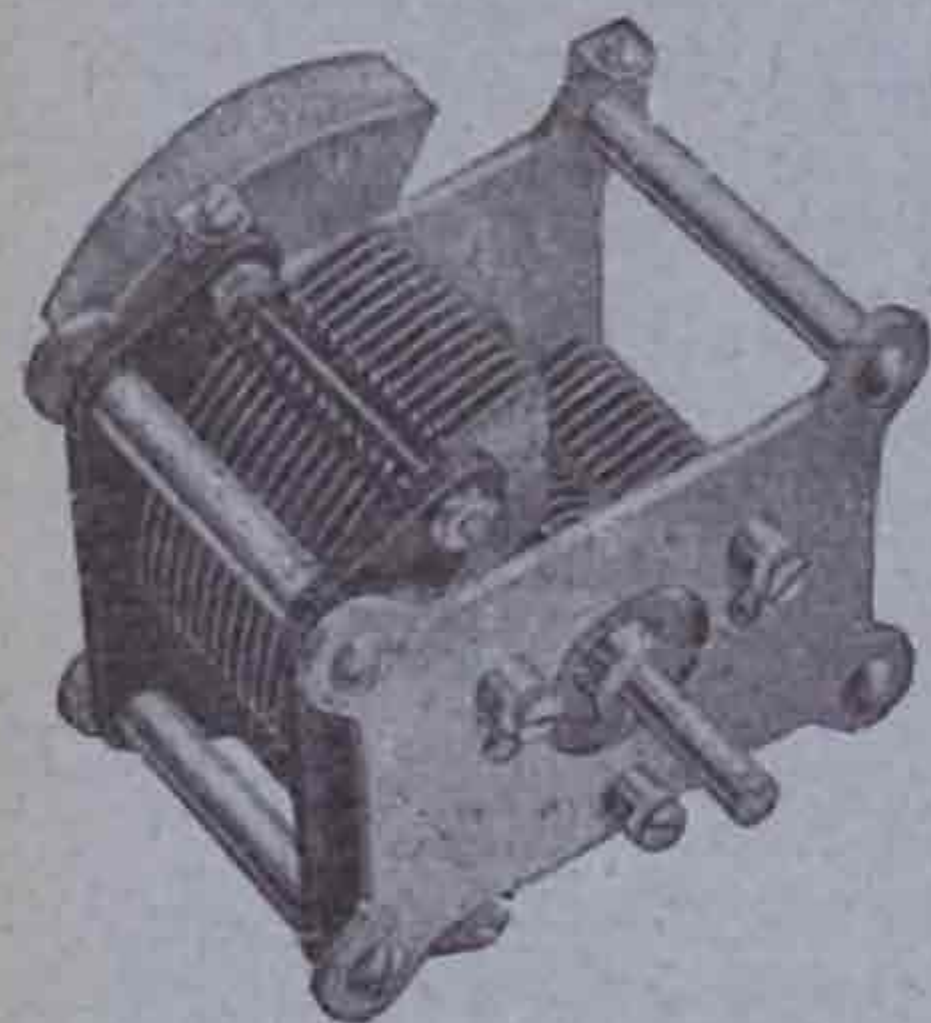

G.R. TYPE 334 VARIABLE CONDENSERS.

These condensers are quite unique. For over 12 years "G.R." variable condensers have been considered the world over the best produced in any country. G.R. condensers are largely supplied to British Government Departments, including the G.P.O. and the National Physical Laboratory. Over 50 types are made, ranging from 5/6 to £26.10.0 each.

The Type 334 all have counterweights, "balancing" them. Stator and Rotor assemblies soldered at three points. Lowest possible losses. Sharp tuning. Models marked * are geared. Models marked § are transmitting condensers, good for peak voltages up to 3,500 v. Prompt delivery of all types.

Type 334-H.* .. '0005 mF. .. 23/6	Type 334-F. .. '0005 mF. .. 19/6
Type 334-P.* .. '00035 .. 22/6	Type 334-N. .. '00035 .. 18/6
Type 334-M.* .. '00025 .. 21/-	Type 334-K. .. '00025 .. 17/6
§TYPE 334-R. (TRANSMITTING MODELS) Max. Cap. '00025 .. 35/-	
§TYPE 334-T. } (having double-spaced	" .. '00010 .. 20/-
§TYPE 334-V. } rotor and stator)	" .. '00005 .. 18/6

"B·A·T" 750-Watt "Q.M.B." SWITCH.

This miniature switch comfortably breaks 3 Amperes at 250 Volts. For H.F., L.F., H.T., L.T. Circuits. For A.C. Sets, Eliminators, Gramo-Motors, etc. "WIRELESS WORLD" said (14.8.29) "functioned quite well on test and did not give any cause to justify doubt as to their ability to handle this wattage" (750 Watts!). "Ideal for use in portable sets and in all types of mains equipment."



"B·A·T" "Q.M.B." POWER SWITCH only 2/6 Each.

WALL-INSULATOR.



Our "B·A·T" Stand-Off or Wall-Insulator is another of our most useful "Gadgets." It is the best Stand-Off Insulator made as well as being the cheapest. It is constructed of strong glazed porcelain, and comes equipped with large nuts and washers as illustrated. The cut is nearly full size. Three nickelled wood screws are also provided.

Uses: For putting up indoor aeriels. For carrying high-voltage leads. For supporting transmitting inductances. Two used with a threaded rod connecting them make an excellent lead-in combination. For indoor or outdoor use.

ONLY 1/6 Each.

GOOD NEWS! REDUCED PRICES.

"CLAROSTAT" (Regd. Trade Mark) VARIABLE RESISTANCES are now reduced seriously, due to immensely increased sales. Over THREE MILLION ClarOstats are in use the world over, and all are giving entire satisfaction. All the models for 1929/30 are now fitted with improved screw terminals. "ClarOstats" have been frequently specified by every Radio Journal the whole world over. There are countless worthless imitations. None are genuine unless Registered Trade Mark is engraved thereon. DO NOT PURCHASE USELESS "SUBSTITUTES." We have enormous stocks. In case of difficulty we will supply direct, post free.

SOLVES EVERY RESISTANCE PROBLEM

CLAROSTAT



"SUPER-POWER," 250 WATTS.

A 250-Watt Variable Resistance for really big jobs, as "reviewed" in "WIRELESS WORLD," Issue dated 14.8.29.

For the control of fractional h.p. electric motors. Variable breakdown resistor for use on voltages up to 550 V., handling large current. Control for many large valves or transmitting tubes in parallel. Many other uses. Several resistance ranges, each priced at 30/-

"POWER," 35 WATTS.

A smaller but still hefty variable resistor, chiefly for use in high-powered eliminators having outputs up to 4/500 Volts.

Made in several ranges: 1/2-10 Ohms (Filament Control); Low Range, 10-100 Ohms; Low Range, 25-500 Ohms; Low Range, 50-2,500 Ohms; Low Range, 75-5,000 Ohms; "UNIVERSAL," 200-100,000 Ohms. Nickel-Plated, with terminals .. NOW 13/6
Stripped Type (Brass Finish) as Illus. NOW 11/6



STANDARD CLAROSTAT, 18 WATTS.

The Standard "ClarOstat" has long been the accepted variable control of output voltage tapings of well-built A.C. and D.C. H.T. Eliminators. As supplied by us to the Manufacturers of "ATLAS," "EKCO," "BENJAMIN," "DYNIC," "REGENTONE," and other well-known British Eliminators. Standard in 73 famous Foreign Eliminators. Made in the same ranges as the "Power ClarOstat" except that the Standard "Universal" Model covers 200 Ohms to approx. 5 Megohms. Handles 18 Watts. All Ranges .. NOW 9/6
"STRIPPED TYPE," Brass Finish, Solder Tags, NOW 8/6



OTHER "CLAROSTATS."

A number of other interesting types of "ClarOstat" are made, including the "HUM-DINGER" (a patented variable centre-tap resistor for balancing A.C. filament circuits, thus suppressing entirely mains "hum" in A.C. Operated Receivers).

All are dealt with in a ClarOstat Booklet (which also contains many useful mains, circuits, etc.) This booklet is FREE AND POST FREE.

"TABLE TYPE," etc.

The ordinary panel-mounting VOLUME CONTROL CLAROSTAT (not illustrated) has been reduced from 8/6 to 7/6. This is the "TABLE-TYPE," or distant control model of volume and/or tone. Statuary Bronze Finish: N.P. Base: Felt Bottom: Speaker Connector and generous length cords. 1928/9 price was 13/6.

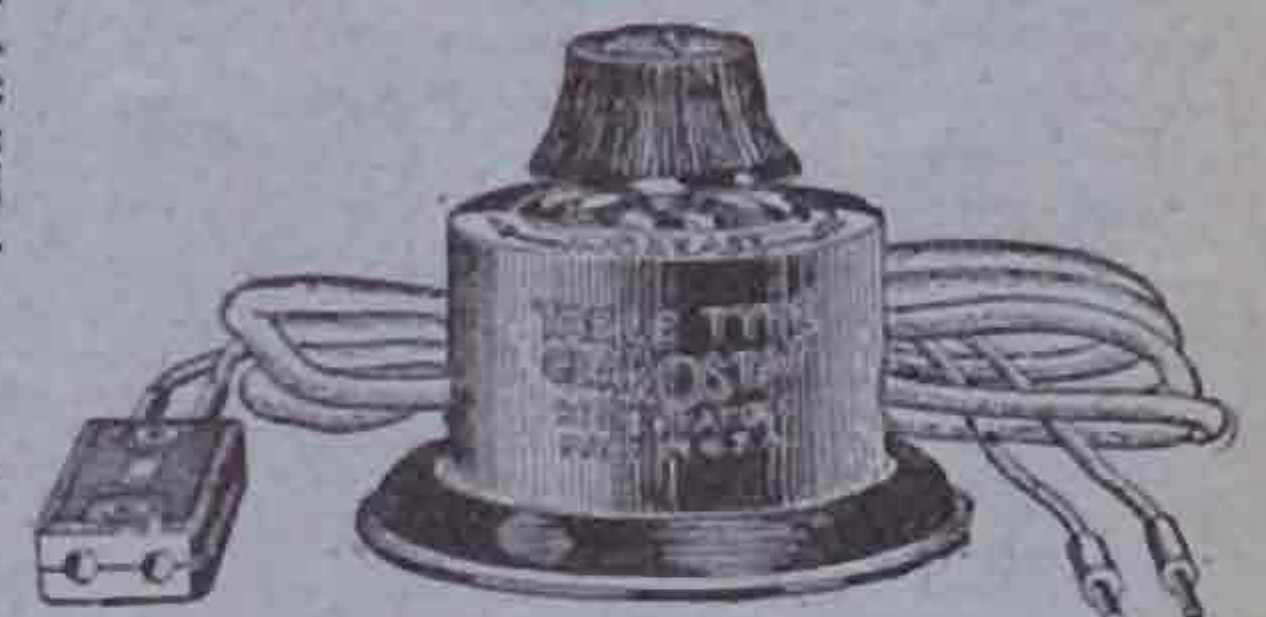

AT THE MANCHESTER

CLAUDE LYONS LTD
76 OLDHALL ST.
LIVERPOOL

EXHIBITION—STAND No. 95

Ammeters and Voltmeters.

By E. M. UGLOW (BRS240).

The writer does not entirely approve of articles of highly technical nature appearing in a BULLETIN devoted to amateurs. The profession of the average wireless amateur is not connected with Radio; hence on returning from his daily toil he does not wish to read literature which involves mental exertion, he having probably been subjected to head-work all day long. The calculations in this article will therefore be reduced to a minimum.

Let us first study the simple galvanometer.

SN is a bar magnet suspended horizontally, around which is an induction, the top and bottom shown in Fig. 1 as P and Q. The plane of the coil or induction is placed in the magnetic meridian. Lines of force are set up at right angles to SN when a current "i" is passed through the coil, thus forming a couple which acts in the direction of the arrows (C and D). This deflecting couple, as it is called, tends to rotate the magnet into a new position S₁N₁. The earth's magnetic field, however, exerts a force on each of the poles S and N. This is called the restoring couple.

Thus the magnetic lines of force from the inductance pull in the direction D and C, and the earth's magnetic force H pulls at A and B.

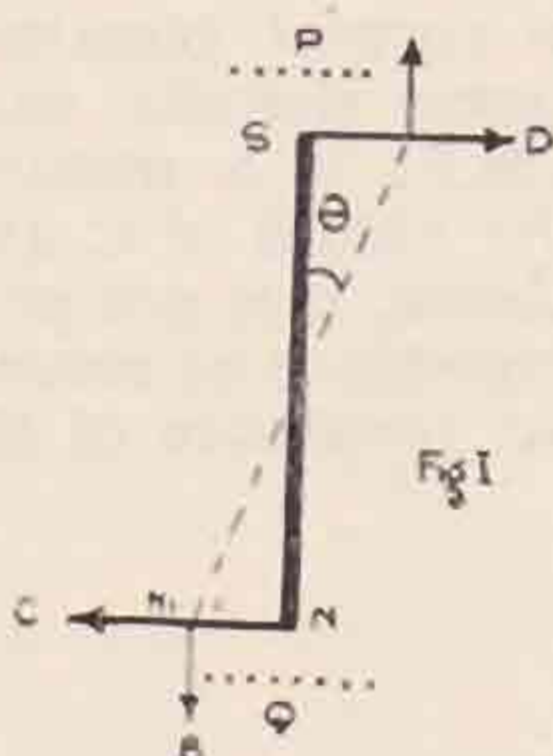

Now the deflecting couple due to the inductance is equal to FM cos θ, where θ is the angle of deflection, M is the magnetic moment of the magnet, and F what we may call the strength of the lines of force; in this case F is equal to $\frac{2\pi ni}{r}$

where n is the number of turns in the inductance,
 „ i is the number of absolute units of current flowing in the inductance,
 r is the radius of the inductance.

π ("pi") is of course 3.1416, or the "number of times the diameter of a circle is contained in the circumference."

The deflecting couple (arrows D and C) therefore equals $\frac{2\pi ni}{r} M \cos \theta$.

The restoring couple of the earth is known to be equal to HM sin θ where H is the strength of the earth's magnetic field.

Let us take the deflecting couple to be equal to the restoring couple.

$$\therefore \frac{2\pi ni}{r} M \cos \theta = H M \sin \theta.$$

Now since galvanometers measure current, we want to find what i is equal to in the above equation. Multiply all through by r.

$$\therefore 2\pi ni M \cos \theta = H M r \sin \theta.$$

$$\therefore i = \frac{H M r \sin \theta}{2\pi n M \cos \theta}$$

$$= \frac{2\delta n \cos \theta}{\sin \theta}$$

$$\text{now } \tan \theta = \frac{\cos \theta}{H r}$$

$$\therefore i = \frac{2\pi n}{2\pi n} \tan \theta$$

We now see that the number of absolute units of current flowing in a tangent galvanometer is

$$\text{equal to } \frac{H r}{2\pi n} \tan \theta$$

but one ampere (I) equals ten absolute units of current.

$$\therefore I = \frac{10 H r}{2\pi n} \tan \theta$$

The common type of ammeter works on almost the same principle as the galvanometer described, except that for great sensitivity we abandon the tangent law. We do this by attaching a pointer to the magnet, the former passing over a determined scale of amperes when the current is applied. The scale is measured by sending a series of known currents through the galvanometer and noticing where the pointer indicates.

The ammeter may be transformed to a voltmeter with ease. If we have a milliammeter and place in series with it a resistance of 1,000 ohms, then by Ohm's law—

$$E = I R.$$

i.e., Volts = current × resistance.

$$\therefore \text{Volts} = .0001 \times 1000.$$

= 1 volt. Thus the milliammeter now reads in volts.

Thus—

By placing a suitable resistance in series with an ammeter, we can make the latter into a voltmeter.

An extremely interesting type of ammeter used a great deal in Radio is the hot-wire ammeter.

This type is extremely simple in its working, and depends only upon the heat that is generated in a wire connected in an electric circuit.

Unfortunately we all know only too well the effect of heating that a large E.M.F. has upon a delicate valve filament.

An E.M.F. being applied across A and B (Fig. 2) would cause some of the current to flow through the resistance, and some through ACB.

AC consists of a piece of platinum iridium wire, which is very sensitive to heat.

(Continued on previous page.)

Curing Interference.

By J. E. JOHNSON (G2ZN).

I wonder how often the average amateur dare even meditate the possibilities of "key-pushing" during B.C.L. hours. Many resign themselves to fate and wait until the small hours before attempting a rag-chew.

However, providing suitable precautions are taken, it should be quite easy to work at all times of the day on our shorter bands, especially with a low-power transmitter. Let us consider these precautions.

We must, of course, key in a suitable manner. It has often been said that keying in the negative supply lead is taboo if one desires to minimise key-clicks. The writer has not, however, found this very troublesome. A high resistance across the key helps enormously. It must be really high, otherwise we shall radiate an annoying spacer, which *just isn't done* in these days of congested bands.

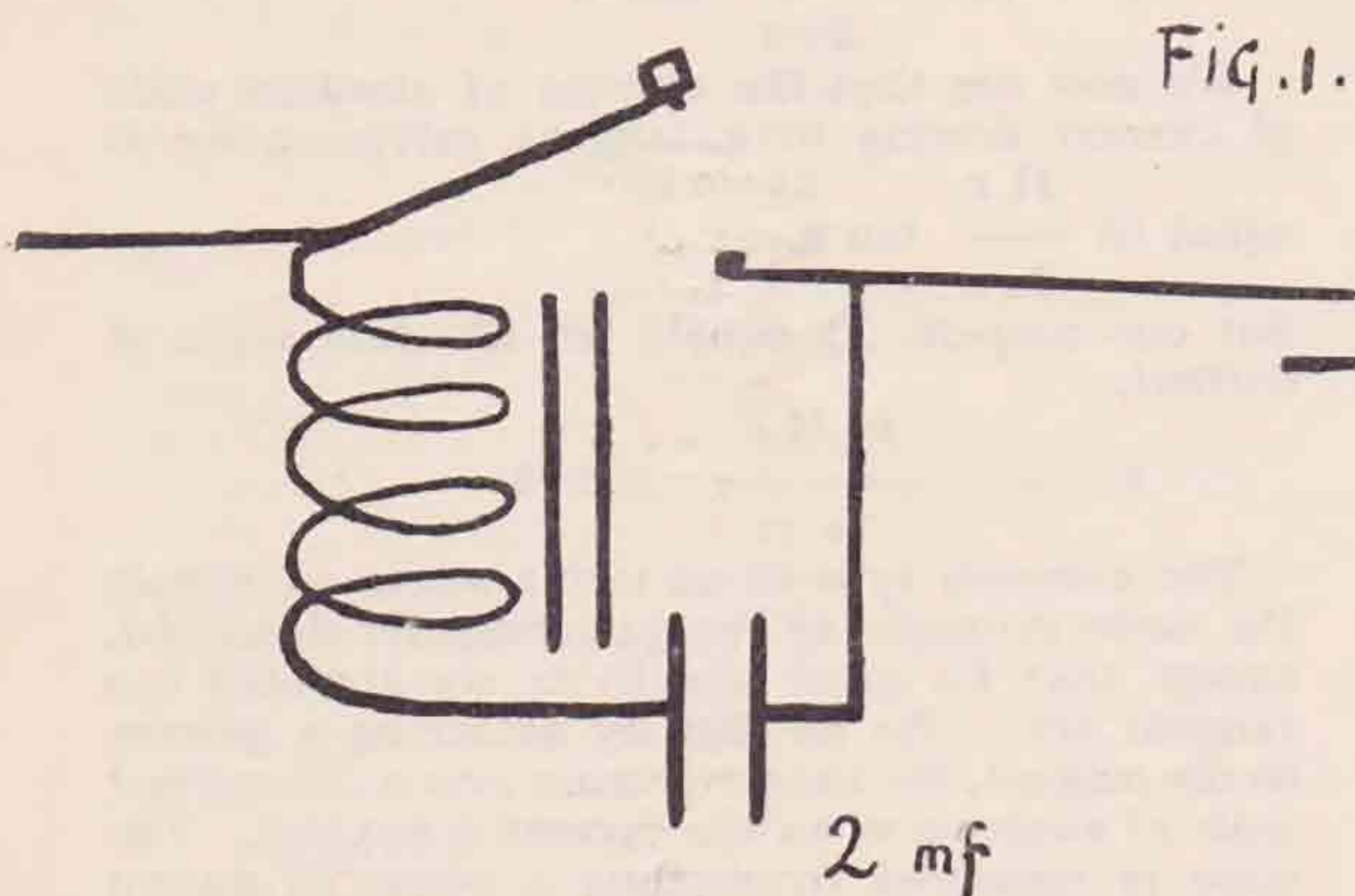

This is the first step towards a key-filter; quite an effective and simple one is shown in Fig. 1. The best value of choke should be found by experiment. It is essential that it should not be too low, because when the key is up the condenser will tend to discharge and maintain oscillation, thus causing tailing-off and chirp.

Attention should also be paid to the antenna. Voltage feed systems seem prone to cause interference more than others. The remedy is obvious.

And now, if you still get complaints, make a diplomatic visit into the enemies' camp and see what can be done there. Persuade him to try the effect of a few extra (or less) feet on his aerial. It is just possible that his aerial has inconveniently managed to get a harmonic in the particular band you want to use, and is resonating. The last but most effective cure (in the writer's opinion), and one used most effectively at this station, is nothing more or less than a rejector wave-trap connected in the aerial lead as shown in Fig. 2.

Theoretically, the ideal trap would be one wound to resonance. As this is not possible in practice, we must wind a coil approximately to resonance and tune with a condenser. Wind about 12 turns of 18 D.C.C. on a 3 in. former (for 40 ms.) and tune with a .0001 mf. condenser. The condenser *must*

be small for effective trapping. Simple though this is, the writer has found that the next-door neighbour, with aerial running parallel, gets not the slightest trace of clicks, whereas before his programme was a medley of blot-outs and thuds. In passing, it might be interesting to note that a S.W. H.F. choke has been found effective in a few cases (*i.e.*, instead of the trap).*

Although for effective trapping the coil and condenser should be really low-loss, it is possible to overdo this; we do not want a sharply-peaked resonance curve, otherwise with every adjustment of the transmitter we shall have to readjust our trap.

A few theoretical considerations will not be out of place. It is a common fallacy that at resonance the trap offers a high impedance to incoming signals. As a point of fact the reverse is true. At resonance the impedance of the trap should be approximately its "ohmic" resistance. Thus, a perfect trap, with a zero impedance at resonance *cannot* have a voltage set up across it; therefore no signal voltage is passed on to the valve. As we de-tune the trap from the resonance point its impedance increases rapidly. A current passing through it will therefore generate a voltage across it. An elementary consideration of Ohm's Law clearly shows this. We have:

$$CR = E.$$

If R, the resistance, is equal to 0, obviously, however large the current (C) is, the E.M.F. (E) must of necessity also be nil.

However, if the current remains constant and the resistance is some definite value, it is quite clear that the E.M.F. is a measurable quantity dependent upon the values of C and R.

In practice, of course, it is not possible to have a trap with a zero impedance at resonance. There is always the inherent resistance of the wire to con-

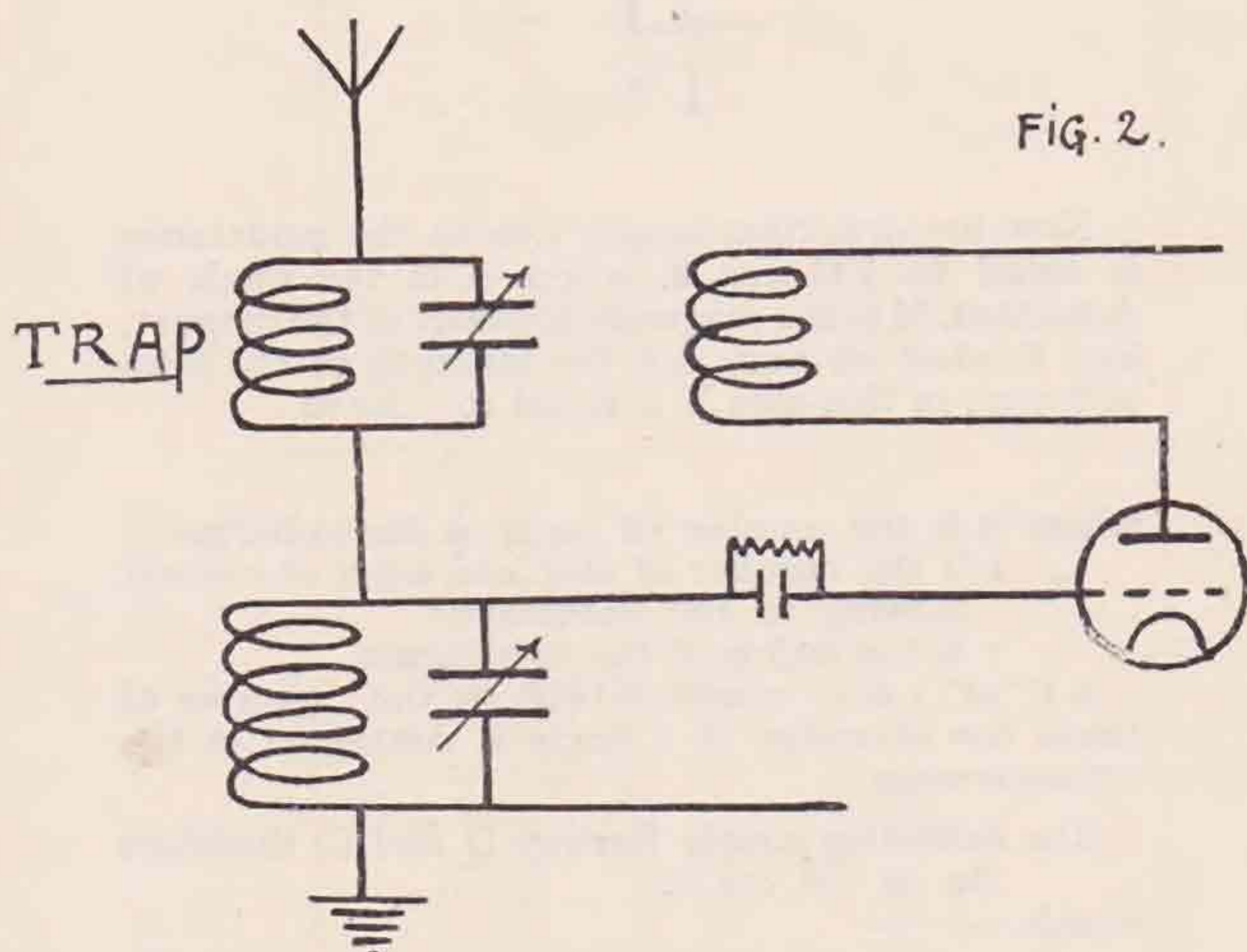

sider, which, however small, is sufficient to give a definite small value to E in the above formula.

*See also T. & R. BULLETIN, January, 1928, page 12.

Alternating Currents and the Magnetic Circuit.

A SHORT SURVEY FOR THE NON-TECHNICAL.

By "INCONNU."

An electric current is a drift of electrons in a conductor, *i.e.*, a drift of tiny electric charges and their associated electric fields. The motion of an electric field sets up what we know as a magnetic field, therefore a magnetic field will always be present when the electrons are moving and hence constituting an electric current.

The magnetic field due to a current is the space in which a magnetic effect is felt, not by the senses but, *e.g.*, by a permanent magnet, say a compass needle. It is soon apparent to the experimenter that if the direction of the current in the conductor is reversed the magnetic effect on the compass needle is reversed; if the current is strengthened the magnetic effect is increased; and that the direction of the magnetic force on the needle depends on the relative positions of the needle and the conductor.

Further experimentation shows that if we decide upon a conventional *direction* of the force, we can plot a map of the field—very much like a contour map of a piece of country. The conventional direction of the magnetic force is that in which the north-seeking pole of the compass is urged.

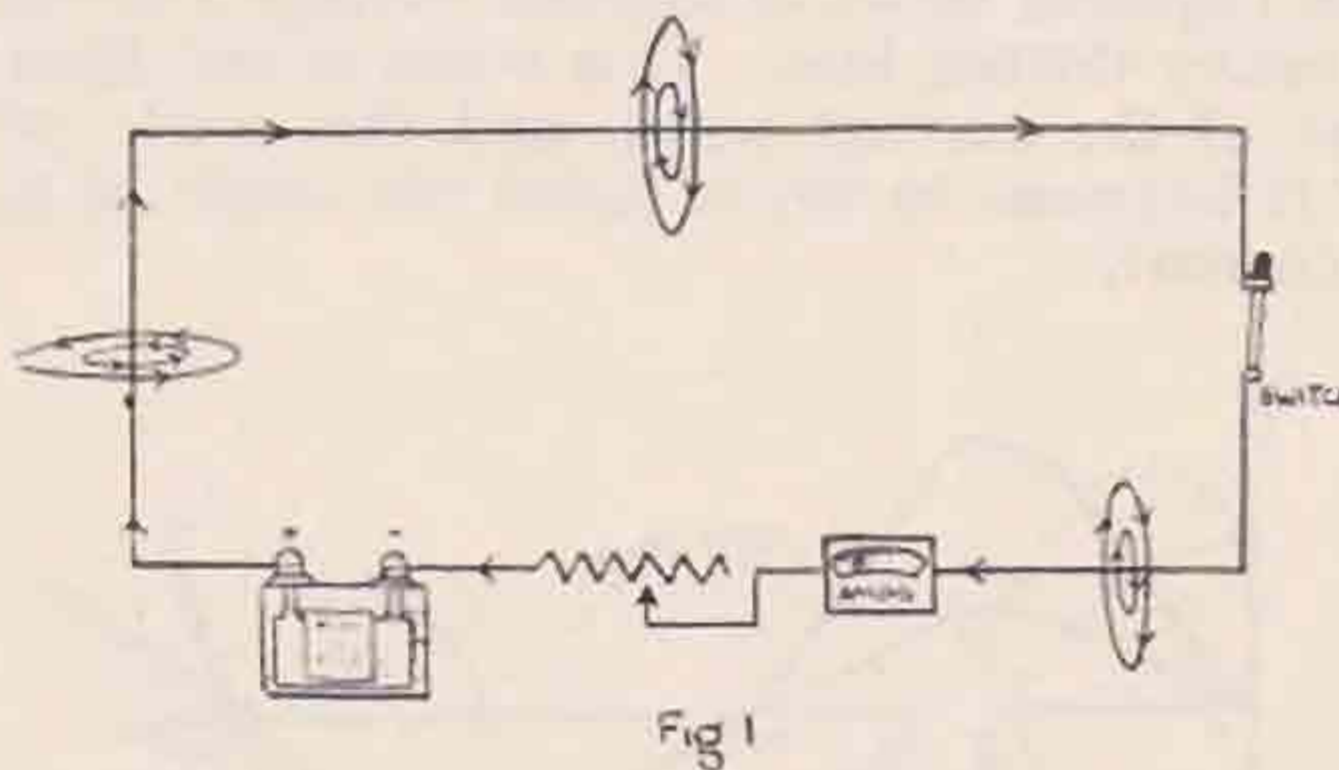

The direction of the contour lines on our magnetic map gives the direction of the force at the point under consideration. Though we draw lines which are, of course, limited in number, there is an unlimited number of possible lines. This is important to remember, because we speak of a definite number of lines in a magnetic field as a measure of the strength of the field; but this is merely a convention and is to assist calculation.

The lines of force round a straight conductor are in concentric circles; the rule for remembering the directions of current and magnetic force is the "screw rule"—drive an ordinary screw, in imagination, of course, in the direction of the current and the direction of rotation of the screw will indicate the direction of the lines round the conductor.

Fig. 1 shows an electric circuit; a few lines have been drawn to indicate the direction of the magnetic field. It will be noticed that the electric circuit and the magnetic lines link one another. This must always be so, because the magnetic lines are always closed loops. If the switch shown is opened, the lines will disappear, the magnetic effect being

absent when the current ceases. If the battery leads are reversed, the lines will be set up again, but in the reverse direction. By stopping the current we reduce the linkages to zero, and by reversing the current we create new linkages; if we had used a reversing switch, the change of linkages would have been from N in one direction to $-N$ in the other, *i.e.*, a change of $2N$ linkages. An alternating current is constantly reversing, so the linkages will be constantly changing the same number of times per second.

We can increase the linkages by making coils in the electric circuit, so that one line may link the circuit a number of times. This brings us to the solenoid where the magnetic field links a large number of turns in the electric circuit. Say we have T turns in the coil and there are ϕ lines of force (assuming a finite number of lines as a means of measuring the magnetic effect), then ϕ lines link with each turn, so that we have $N\phi$ linkages.

Just as the movement of an electric field produces a magnetic field, the reverse is true. The collapse of the magnetic field on opening the switch produces an electric field. You may have heard often that when a magnetic field cuts a conductor a voltage is set up in the conductor; the electric field is there whether the conductor is present or not, and the conductor only allows us to "collect" the electro-motive force and produce a current in a circuit.

The direction of the E.M.F. produced in a conductor is at right angles to the magnetic field and also at right angles to the movement, therefore it is evenly produced round the turns of the electric circuit.

The strength of the voltage or E.M.F. produced depends on the rate at which the linkages are changing; or, considering only one turn, on the rate of "cutting" of the magnetic lines by the field.

Fig. 2 shows a magnetic field produced by the current in a coil. When the current is suddenly stopped the lines must collapse through the turns of the coil, and therefore set up an electro-motive force in the turns. The direction of this induced E.M.F. is such as to oppose the change that is taking place; if the current is being stopped, the E.M.F. will be in such a direction as to tend to keep it flowing; if the current is being started, the E.M.F. will oppose the current and the current will then not rise to its normal value immediately.

When keying, we are sometimes starting and stopping a current—the plate current—and to prevent clicks being radiated it is desirable to start the oscillations comparatively gradually. This can be done by inserting a coil, which has a good magnetic field when excited by the plate current, in the H.T. lead. The back E.M.F. prevents the current suddenly rising to a maximum when the key is closed, and makes the oscillation build up comparatively slowly.

Other considerations make us use a condenser as well, but the coil must be capable of producing a

strong field and so an iron core is used with a large number of turns; this is to produce sufficient E.M.F.

The circuit which is capable of reacting on itself in this way is called an inductive circuit, and the process is called self-induction for obvious reasons.

Only when the magnetic field is in motion is there an E.M.F. induced in the coil, so there is no E.M.F.

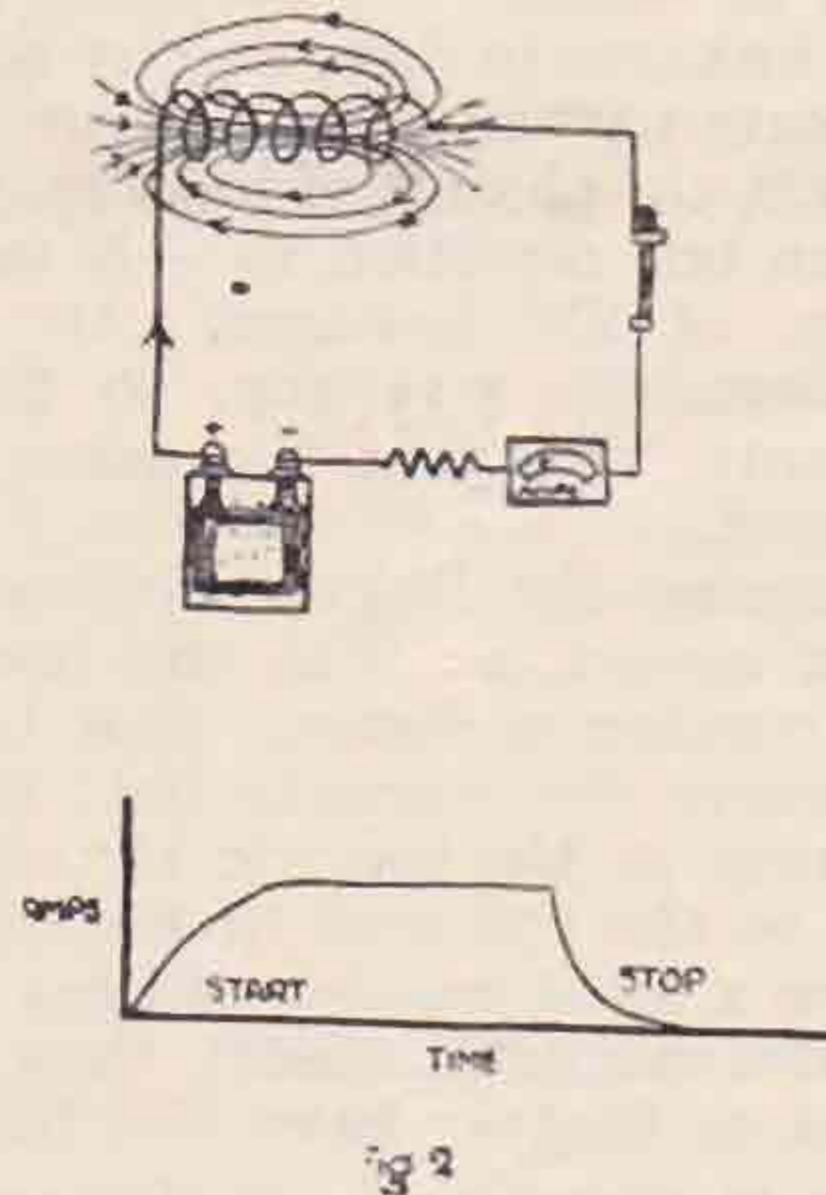

due to self-induction in a D.C. circuit except on variation of the current and the consequent variation of the magnetic field.

Alternating currents, whether high or low frequency, are a different proposition, as the current is reversing periodically. The magnetic field is directly dependent on the strength of the current, and the changing of the field will produce a back E.M.F. The applied voltage must provide the drop in voltage due to the ohmic resistance, and must off-set the back voltage as well.

Fig. 3 shows the conventional sine wave of current, and we will assume that this wave occurs to the circuit shown. In this circuit the inductance is assumed to have no resistance and the resistance to have no inductance; in practice it is possible to approximate to this condition.

When 100 million linkages are changed per second the circuit will have an induced back voltage of 1 volt. Therefore we can write:—

$$\text{Back volts} = \frac{\text{Rate of change of linkages}}{100,000,000}$$

As the number of turns is fixed in a coil, and the core is usually of a constant type, the rate of change of linkages will depend upon the rate of change of current. Let us say that a certain number of lines are set up by every ampere in the electrical circuit; if we know this, we can calculate the linkages per ampere. This, multiplied by the number of amperes increase or decrease per second, will give the change of linkages per second:—

$$\text{Back volts} = \frac{\text{Linkages per amp.} \times \text{rate of change of amps.}}{100,000,000 \text{ linkages per amp.}}$$

It is clear that the $\frac{100,000,000}{100,000,000}$ is a constant of the circuit, whereas the rate of change of current will depend upon the nature of the applied

source. (This is not *exactly* true, as the linkages per amp. will depend on the saturation of the iron).

This constant is called the CO-EFFICIENT OF SELF-INDUCTION of the circuit. When 100,000,000 linkages are set up per amp., the value of the constant is unity, that is, 1 HENRY. L is used as a symbol for the self-induction of a circuit.

From this formula for the back volts, it is clear that when the current is changing most rapidly, the back volts will be a maximum. This occurs when the current is changing from a positive value to a negative one. When the current is a maximum the magnetic field is, for that particular instant, stationary in space; there will be no back E.M.F. at this instant. The dotted line shows the value of the back E.M.F. for the same time scale as the current. The rate of change of a sine wave is another sine wave, so the back E.M.F. is a sine wave—that is one reason why a sine wave is chosen for the form of an alternating current.

To offset this voltage the applied voltage must supply a wave equal and opposite, *i.e.*, the wave represented by the chain line. As well, the applied voltage must supply the ohmic drop due to the resistance of the circuit. The value of this is Current \times Resistance (Ohm's Law), and therefore the ohmic drop is proportional to the current at every instant, giving the variation shown by the thin solid line. The applied voltage must be equal to the sum of the back volts and the ohmic drop at every instant. Adding the instantaneous ordinates of the two waves, a third wave is obtained—the required wave of applied voltage—shown by the heavy dotted line. This wave is less than 90° ahead of the current wave, and this angle (whatever it happens to be) is called the angle of lag of the current.

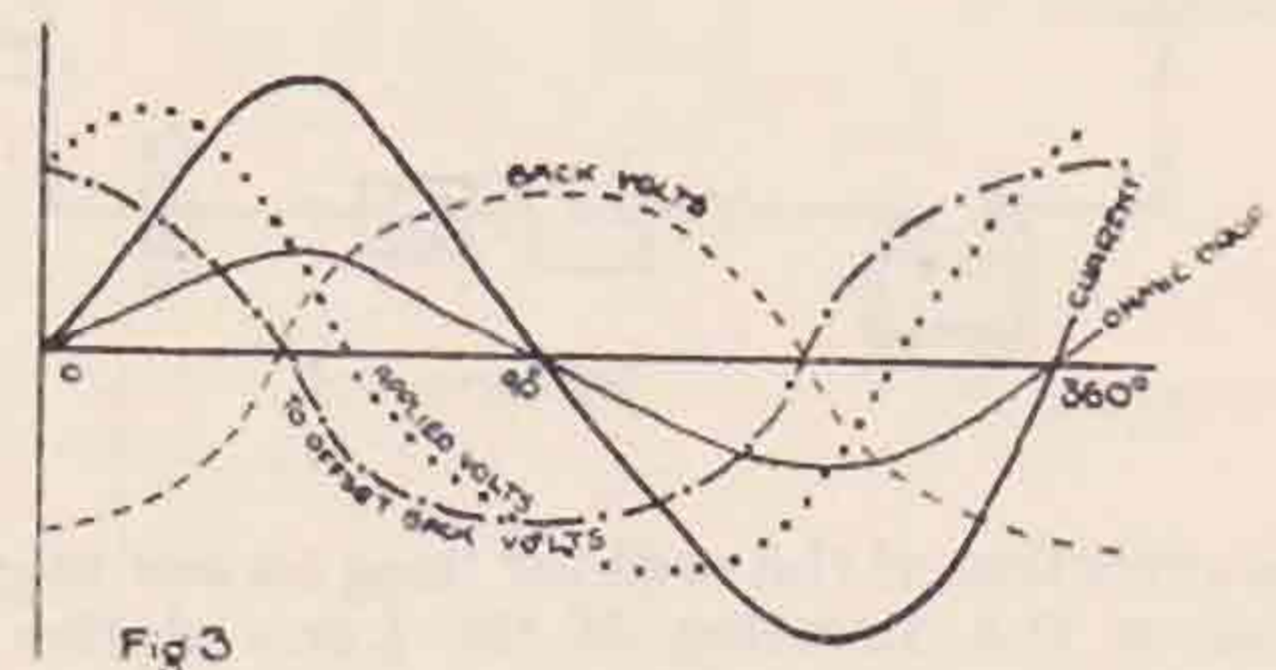

It will be noticed that when pure resistance only occurs in the circuit, the angle of lag is zero, *i.e.*, the current is in step or in phase with the applied voltage. The effect of inductance in a circuit is therefore to make the current out of phase with the volts (except under resonance conditions when capacity also is present).

The back E.M.F. of a circuit limits the current, and if the L of a circuit is known we can predetermine the current from any given source.

The lines set up per amp. of exciting current in a given uniform iron-cored coil is:—

$$1.25 \times \text{turns} \times \text{permeability} \times \text{area of core} \div \text{length of core.}$$

Take all measurements in centimetres. The linkages per amp. will be this quantity multiplied by the turns. The co-efficient of induction (L) is then found by dividing by 100,000,000.

(Continued at foot of column 1 opposite page.)

“R.S.G.B. SHORT WAVE 4”

described in this issue

B & J Coils Specified

COILS, 8/6 each ;

BASES, 1/6 ;

FORMERS, 4/6

SPECIALISTS IN

ALL TYPES OF COILS, SCREENS, RESISTANCES, ETC.

B & J WIRELESS CO.

2, 3 & 4, Athelstane Mews, Stroud Green Rd., London, N.4

Telephone : Archway 1659.

(Continued from previous page.)

$$L = \frac{1.25 \times (\text{Turns})^2 \times \text{permeability} \times \text{area of core}}{100,000,000 \times \text{length of core.}}$$

The area of core is the cross-sectional area of the iron in the core.

The maximum rate of change of a sine wave is given by $2\pi \times$ maximum value of wave ; for a current wave this can be stated :—

$$\text{Max. rate of change} = 2\pi \cdot I \text{ amps. per second.}$$

We have already shown that the back E.M.F. is given by :—

$$\text{Volts} = L \times \text{rate of change of current.}$$

Therefore :

$$\text{Maximum value of back E.M.F.} = L \times 2\pi I \text{ volts.}$$

Or :—

$$\text{Effective value of back E.M.F.} = L \times 2\pi \times \text{eff. value of } I.$$

$$\text{Written as } E = 2\pi LI \text{ volts.}$$

The applied voltage across the inductance must be E, therefore the ratio of volts to amps. will be :—

$$\frac{E}{I} = 2\pi L.$$

This ratio in a direct current circuit is called the resistance, but here it is called the “Reactance,” and is stated in “apparent” ohms because of its resemblance to resistance in the formula of Mr. Ohm, without the power absorbing properties of the “real” ohms.

Adjusting the Length of Radiators.

By COL. M. J. C. DENNIS (EI2B).

Having recently had the misfortune to cut off too much from the radiator of a Zeppelin aerial during tests, the writer devised the plan shown in the figure, by means of which temporary alterations for test purposes can be quickly made. A permanent join can, if necessary, be made so soon as the correct length has been determined.

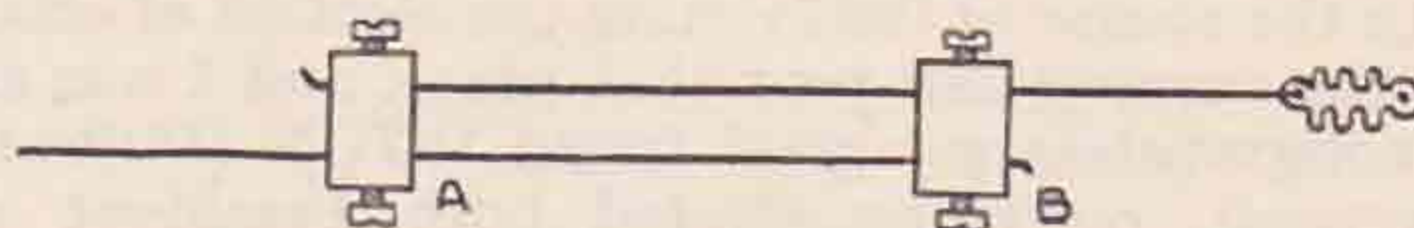

It will be seen that A and B are simply two small blocks of brass drilled with two holes for the aerial wire *close together*, and each fitted with two set screws for clamping the wire. The end of the radiator thus becomes in effect telescopic. The wires between the two blocks can, if desired, be twisted round one another.

Where is your Article ?

My Visit to the American Seventh District.

By W. H. ANDREWS (G2YG).

In the course of my work as a seagoing radio operator, I was, some nine months ago, transferred to a vessel calling at Pacific Coast ports of the U.S.A. and Canada.

This seemed an excellent opportunity to get in touch with some American amateurs, so while at Tacoma I wrote to W7PP of Portland, Oregon. On arrival there I received a letter from him inviting me to the local club's meeting that same evening.

W7PP has a 50-watt TPTG set fed from a mercury arc, and a V.F. Hertz aerial. The receiver is constructed from the 4-tube short-wave design described in the November issue of *QST*, and is installed in the next room to the transmitter, in conjunction with a really good control panel.

We proceeded to the meeting of "The Rose City Amateur Radio Club." (Portland is famous for its roses.) The meeting was held on the mess-deck of the old battleship *Oregon*, lying at a convenient landing-stage. Here I received a real ham welcome, and met quite a number of local transmitters. They were keen to know about amateur licensing conditions in Britain. In a short chat, I mentioned the principal points in connection with our new licence conditions, and was asked to convey the deepest sympathy of the meeting to British amateurs on account of the restrictions imposed on us. By contrast, our American friends are allowed *all* the amateur bands and the full width of each band; and a power input up to one kilowatt. There is no insistence on crystal controlled sets or resonators. The neon lamp type of wavemeter is in general use, and **THERE ARE 135 LICENSED TRANSMITTERS IN THE PORTLAND AREA ALONE!**

The club set, W7AJW, is housed in the battleship's radio cabin, and is of the TPTG type with V.F. Hertz, an arrangement which seems to be very popular among the club members. I literally took off my hat to the fine workmanship of W7FE on the transmitter, and that of W7UN and W7PP on the power supply unit. The receiver was to be of the *QST* 4-tube 1929 type, and was being constructed by W7UN, who, by the way, was responsible for building the one in use at W7PP's station.

In the course of the evening the election of officers for the ensuing half-year took place, and I was able to congratulate my good friend W7UN (Wilbur S. Claypool), on being elected both President and Section Communications Manager.

The annual general meeting of any organisation is proverbially a rather dull affair, but this one was not without humour. At a previous meeting, one of the members had protested that if ladies were to be admitted to membership without subscription he proposed to don feminine attire. On this occasion the President formally presented him with a very "chic" apron, which he was forced to put on in the presence of the meeting. But he didn't get let off paying his sub.!

After the business, "hot dogs" and coffee followed, and I was made to feel almost as a guest of honour—but it involved a further speech from me! I gathered that quartz crystals are considerably cheaper in our own country than in the States, but

in view of the necessarily much bigger demand for them here, several of the Portland Club members announced their intention of coming to England to set up in business as quartz crystal merchants!

On the following morning W7MO visited me aboard the ship. He was greatly intrigued by a demonstration of the working of the automatic SOS alarm with which the station was fitted. When examining the 1½ k.w. quenched spark transmitter, he said: "One and a half kilowatts of 220 volt A.C. at 500 cycles!" Oh! boy, two fifty-watt tubes in a self-rectifying set would sure give wonderful results here!" I heartily agreed with him, but I had to point out that not only was a 100 watt transmitter out of the question under an administration which occasionally allows ten-watt stations to be set up, but that even reception was impossible on a motor vessel, owing to the considerable vibration. This vibration was due to the auxiliary generators, and not to the main engines. It was therefore present in port as well as at sea, and I had previously found that conditions for short-wave reception on board that vessel were well-nigh hopeless.

W7MO then took me to his station, which uses a 50-watt TPTG set and a vertical antenna. The receiver was a 1-v-1, employing a screen-grid tube in the R.F. stage. We donned the phones and found the 7,000 k.c. band was fairly quiet, as it was mid-day. However, a CQ call raised W7EK, of Everett, Washington.

From KGW we proceeded to W7UN's station, where there is a TPTG set with about 35 watts input, remotely controlled from the receiver room. The receiver is a 4-tube, similar to the one W7UN is constructing for the club set. A CQ call on the 7,000 k.c. band raised W7ABY, Whitman College, Walla Walla, Washington. I took the key and had a long QSO with him. He finally thanked me for giving him the chance to work a G at last!

I may mention that while in Vancouver about a month earlier, the s.s. *Ixion* lay, for one day, in the next berth to my ship. On such occasions I often go aboard "the next ship" and look up the operator. This time I didn't, because the *Ixion* was only making a short stay. You can guess that I kicked myself for not doing so when I found afterwards that the operator was another amateur transmitter—G5WQ!

I still had hopes of encountering the *Ixion* again, but on my arrival in Glasgow at the end of the voyage a new development occurred. By a stroke of good fortune I was given a shore position. This will enable me to start up again as G2YG about next October, from an address in the S.E. London area. At present I am stationed in Glasgow, with no facilities for transmitting, but I got in touch with G5YG and he kindly invited me to the last meeting of the Glasgow "gang" at his house, before the summer break.

In conclusion, whilst I am sorry to have no further opportunities for visiting amateurs in other countries, I think any sea-going operator will agree with me that " 'Tis a far, far better thing that I do."

A Simple Aerial System.

By H. C. PAGE (G6PA.)

Several times lately I have been asked how I manage to work without using separate aerials for each. There is really nothing unusual in the arrangements here, but for the benefit of those who have experienced difficulty in finding an aerial suitable for the 2, 7 and 14 M.C. bands I propose to give a few details of the system in use here.

I will commence with the aerial in use for the 7 and 14 M.C. bands. This is a Zeppelin fed Hertz 65 ft. long with twin feeders 16 ft. long. The average height of the aerial is over 25 ft., the far end being 40 ft. high. The only switching required to switch from one band to the other is a DPDT porcelain mounted aerial switch. The diagram makes the switching quite clear, so I shall not describe it further.

Soon after this aerial was put up I found I wanted to work on the 2 M.C. band. Now a Hertz aerial is not an ideal radiator for this band, especially when it is designed for a much higher frequency, so I decided to use a counterpoise in conjunction with the Hertz aerial. This counterpoise is connected straight to the 2 M.C. transmitter, and as it is not used in any other band no switching is required. The total length is one hundred feet at a height of seven feet. Any decrease in the length gives a drop in aerial current. Probably a multiple wire counterpoise would be more efficient.

The aerial is connected to the transmitter by a SPDT switch. In one position the switch throws the live feeder to the 2 M.C. transmitter, and in the other to the DPDT switch, which feeds the 7 and 14 M.C. transmitters. The presence of the dead feeder, when working on the 2 M.C. band, does not seem to matter.

The aerial and counterpoise are coupled directly to the 2 M.C. transmitter, the aerial being connected to the plate end of the coil and the counterpoise to the centre. This will, of course, depend on the characteristics of your aerial system.

With the above aerial system, and an input of ten watts, an aerial current of just under half an ampere is obtained from an Ultraudion transmitter.

While a great deal of time has not been spent in the use of the 2 M.C. set, it has been possible to work distances of over three hundred miles on C.W. Telephony is reported as good strength up to about seventy miles. On the other bands the usual amount of DX work has been done, the results on 14 M.C. proving quite satisfactory.

The above aerial could be used on the 28 M.C. band, though I do not think it would be very satisfactory. An aerial half the length would be much better. In any case the design of aerials for frequencies above 14 M.C. is beyond the scope of this article.

In conclusion, I should like to say a few words about the advantages of using a separate transmitter for each band, wherever possible. Not only is a great deal of time saved, but one is able to leave any one transmitter set to the same adjustment for weeks on end, thus enabling one to test out any particular setting very thoroughly. With such switching it is possible to change from one band to another in less than half a minute. We all know how annoying it is to hear a station we wish to call working on a band to which the transmitter is not adjusted.

Aerial Wire.

By A. M. HOUSTON-FERGUS (G2ZC).

It seems to be that the aerial is of vital importance for the transmission of signals, and I noted in the May issue of THE BULLETIN that one Ham does not use 7-strand wire owing to the uneven lengths of the wire. We all know that the ideal is a large flow surface for R.F. currents, but how many know that such an aerial wire has been on the market for several years, in the shape of Messrs. Sparklets (of soda water fame) "Magnatone" aerial wire. This is sold in 70-ft. lengths, and consists of 32 strands of copper strip, woven into the form of a hollow tube, not unlike the flexible gas tubing we know. The strip is thin, and thus we get a tube of about $\frac{1}{2}$ in. diameter, without much extra weight over the 7/22 type, though, of course, the wind resistance surface is very considerably more. This aerial is a little more expensive than the usual wire, and is only made in tinned copper, but at the same time I have used it for the past four years, and find it satisfactory in every way. I may add that I have no interest in the firm, and that I do not mean this to be in any way an advertisement, but at the same time, having proved its merits, I pass the information on for the benefit of other Hams. Living as I do near the sea, the only fault I have is that the makers do not make it in enamelled strip, but even so, I have one in use now that has been up over 2 $\frac{1}{2}$ years, and which still looks good. There is one other small point that I bring up, as I have seen so many cases where it is overlooked, and that is, that it is very important to have a lead-in as efficient as the aerial. It is no use having a good aerial and a bad lead-in, but if the same wire, or heavy copper strip, be used the loss of efficiency will be small.

Stray.

M. S. Killen, of the W.V. Radio Club, Horta, Fayal, Azores, requests reports of reception of CT2AD on July 20 or 21. The station is the club's mobile outfit, working on 14,000 kc., and using 5 watts. It was situated on Pico Mountain, Azores, 5,000 ft. above sea level. Further tests are intended in the future and reports will be very welcome.

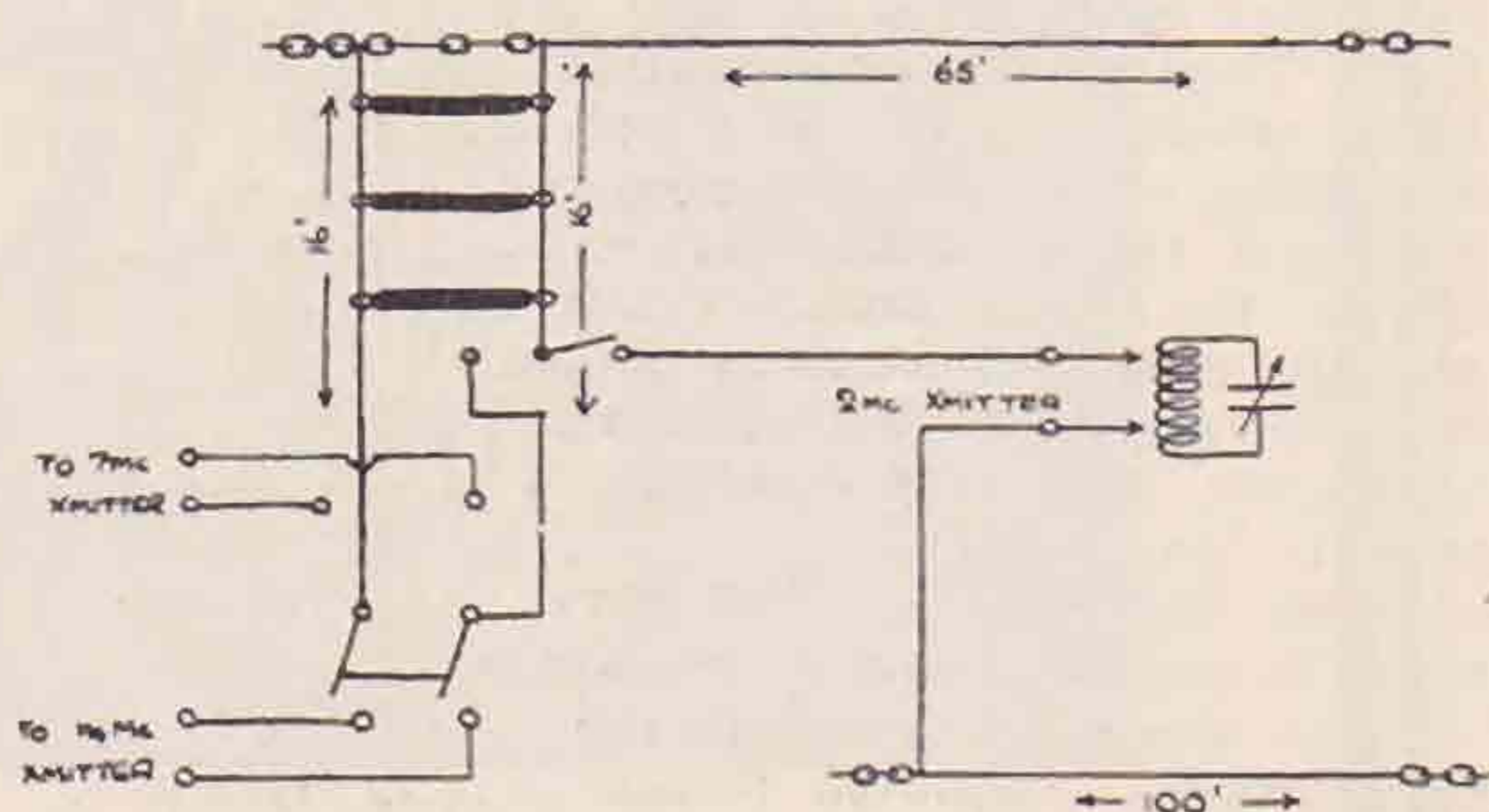

AERIAL SYSTEM AT G6PA

Rugby.

The twenty-one London members who took part in the trip to Rugby on Saturday afternoon, July 20, will not forget their experience in a hurry. Collecting at Euston Station at 1 p.m., we placed ourselves under the paternal guidance of our President and Honorary Treasurer. We were very pleased to welcome a very old friend of British amateurs and one who has spoken to many of us over the 12,000 miles which separates England from the Antipodes; I refer to Brenda Bell. Although Brenda has been living in obscurity, one or two of us have been lucky enough to find her hiding place. The trip was all the more interesting to Brenda, because she has heard the Post Office stations in New Zealand, and all the more the short-waves, which naturally skip this country. We felt very much like Sunday School children going for our annual treat. We were duly shepherded into the 1.40 and undertook a journey which is mainly memorable upon account of the great heat. Still, this did not prevent us enjoying the trip, but we were not sorry when Rugby was reached. Here we met a party of about half-a-dozen Midland hams.

We packed ourselves into a charabanc while the photographers of the party did their worst. Our President was not to be contented with ordinary snapshots so he brought a cinematograph camera. Leaving the station, we perceived the pavements lined with crowds who cheered and waved to us. Turning into the main street the crowds grew denser and denser, and then we perceived that they were not collected to do honour to the R.S.G.B., but in connection with a charitable fête. Finally, we found ourselves in a procession of decorated cars and comic costumes. Our pace was reduced to the crawl customary to such occasions. This gave the young lady collectors a chance to extort toll from the R.S.G.B. boys, who, to their credit, paid up handsomely. At length we got out of the procession and our driver found his top gear. We soon struck the forest of tall masts which compose the Rugby station and appeared to take a circular tour round them before entering the long drive leading up to the main building.

Here we found some more of our Midland friends and, to the number of 32, entered the station; we then divided into two parties, each guided by one of the engineers.

How can we describe the station—everything was on such a gigantic scale and full of interest from the tuning fork control to the 820 feet masts. To stand below one of the latter and gaze upwards towards its summit required a neck made of india-rubber, and when we were told that the top swayed eight feet in the wind we did not even dispute the fact. Then we went into the machine hall, where those whose hearing was good no doubt heard something of the description and functions of each unit and the various panels of the switchboard above the indescribable din. The station is roughly divided into three groups, *i.e.*, the long wave telegraphy and telephony and the short-wave telephony. The latter is the last installed and is only in its development stages, a new building at some distance remote from the main building being in course of erection for this branch.

From the machine room we went on into the valve room. Here we learnt a good lesson in systematic station tidiness and the absence of loose

connections. The method in which the signals coming from the transmitting station in London were received, amplified and passed on to the water-cooled oscillator valves were all carefully explained, and each of us felt that we would have to spend many days there before we got the hang of the various circuits. They seem to have thought of every possible contingency to guard against failure at Rugby, and even our experts could not find a flaw in their armour. From this room we went up to a gallery where we saw the main A.T.I. and other coils, each about ten feet diameter, all mounted upon white wood formers. I forget how many million strands there were in the Letz rope forming the winding, each of which had to be cleaned. No metal was used in the construction of the roof; even the ties of the roof were fitted with fibre bolts.

In the short-wave section we were more at home and able more to hold our own with our guides. Unfortunately this came at the end of the round when we were somewhat pressed for time, as we would have liked to have stayed here longer.

The two parties having rejoined, everyone concurred in the thanks conveyed to our hosts, Mr. Faulkner and Mr. Cook, who had shown us round and taken such care to explain every detail of this splendid station. Packing ourselves again into the charabanc, we went back to Rugby station and said good-bye to our Midland friends. At Rugby station we raided the refreshment room and caused surprise among the natives at our capacity for cooling drinks. We barely had time to do justice to our thirst before our train arrived and we separated up into little bands wherever we could find room.

The journey back will long be remembered for the heat, coupled with a somewhat slow train, and the thunderstorm at the end. The latter was perhaps one of the worst many of us ever encountered. The vividness of the lightning and the torrential rain were a fit ending to the sultry atmosphere we had encountered.

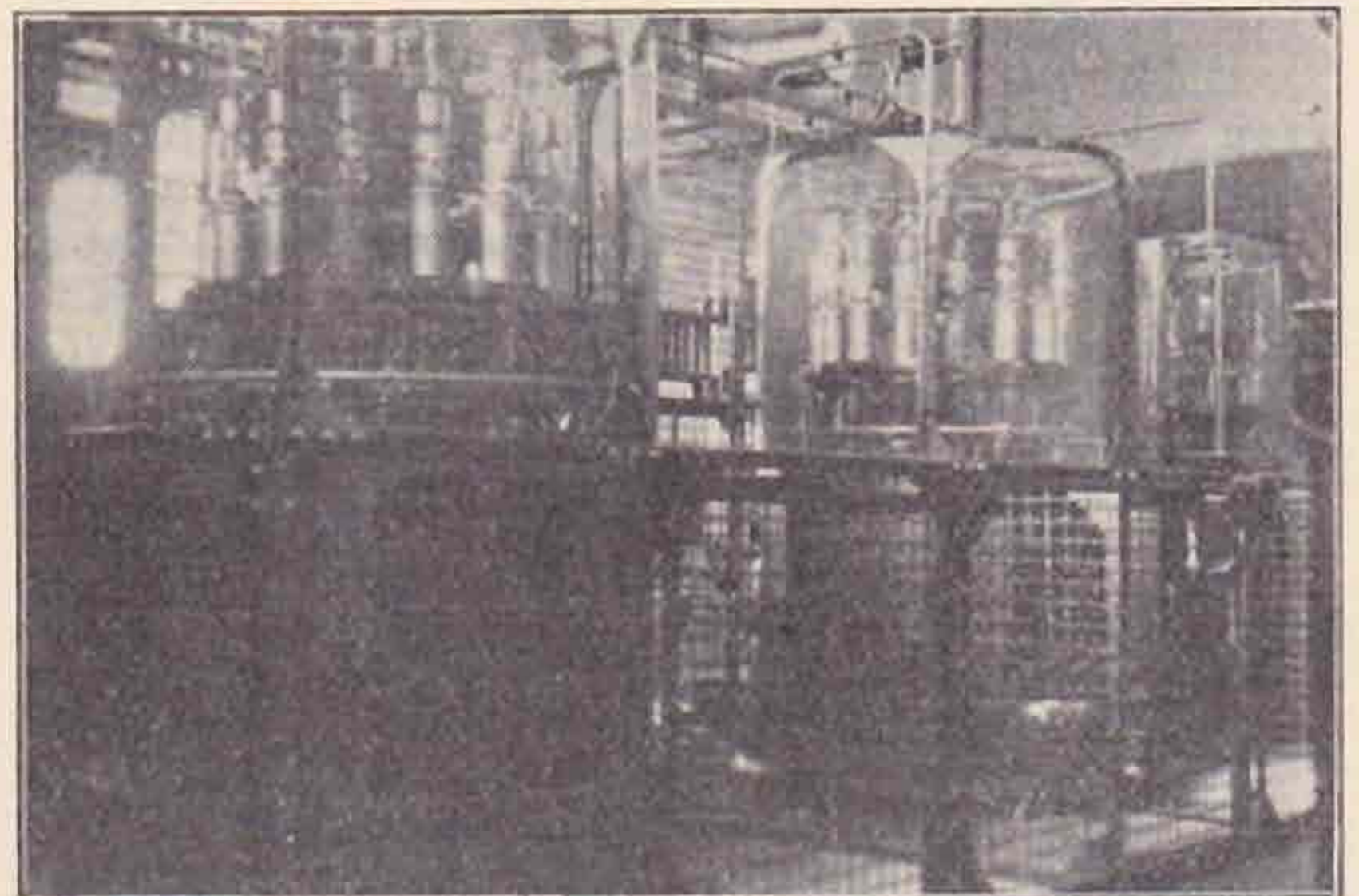

THE TRANS-ATLANTIC TELEPHONY TRANSMITTER AT GBR. RUGBY.

Assistance.

REPORTS REQUIRED BY:—

G5HJ, from stations using very low powers for phone work on 7 mc.

G5UM, from stations receiving his 161 metre C.W. Particulars of signal strength, fading and type of receiver requested.

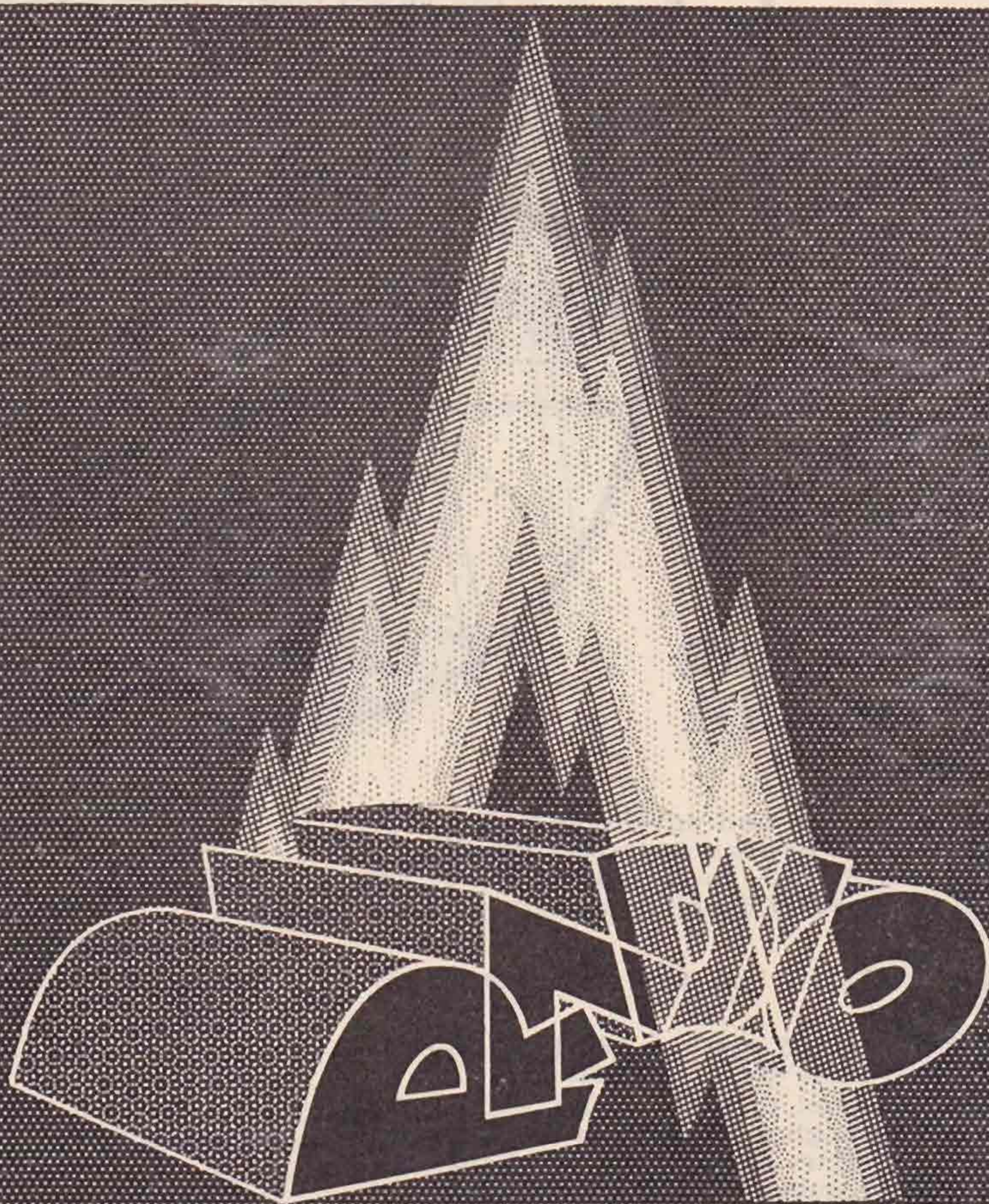

THE NATIONAL RADIO
EXHIBITION
OLYMPIA (NEW HALL)

SEPT. 23 - OCT 3 11 A.M. TO 10 P.M.

ADMISSION 1/6 DAILY

TUESDAY SEPT. 24 & OCT. 1 UP TO 5 P.M. 2/6

A Wonderful Discovery

Wireless Enthusiasts are daily discovering the advantages of placing Polar Condensers behind their Panels. Place them behind your panel and recapture the old thrill of exploring the ether in search of new stations—and discovering them!

THE NEW POLAR DRUM CONTROL CONDENSER

has many points of interest and advantage which will appeal not only to those who are already confirmed users of Polar Condensers, but to those who have not yet experienced the pleasure of handling a really superior condenser.

This new Polar Condenser has both Quick and Slow Motion control.

The scale, 0—100, is clearly marked, and gives definite hair-line readings, which are easily read.

The condenser is secured to the panel by two screws. These screws pass through and hold the neatly designed Bakelite Escutcheon, thus entirely insulating the condenser from the panel and cutting out all possibility of shocks through the screws.

Dead true fixing. Very robust mounting.

Drums and Escutcheons are supplied in either Black, Walnut or Mahogany finish.

PRICES: Complete with Escutcheon and Fixing Screws.
·0005, 15/-; ·00035, 14/9; ·0003, 14/6.

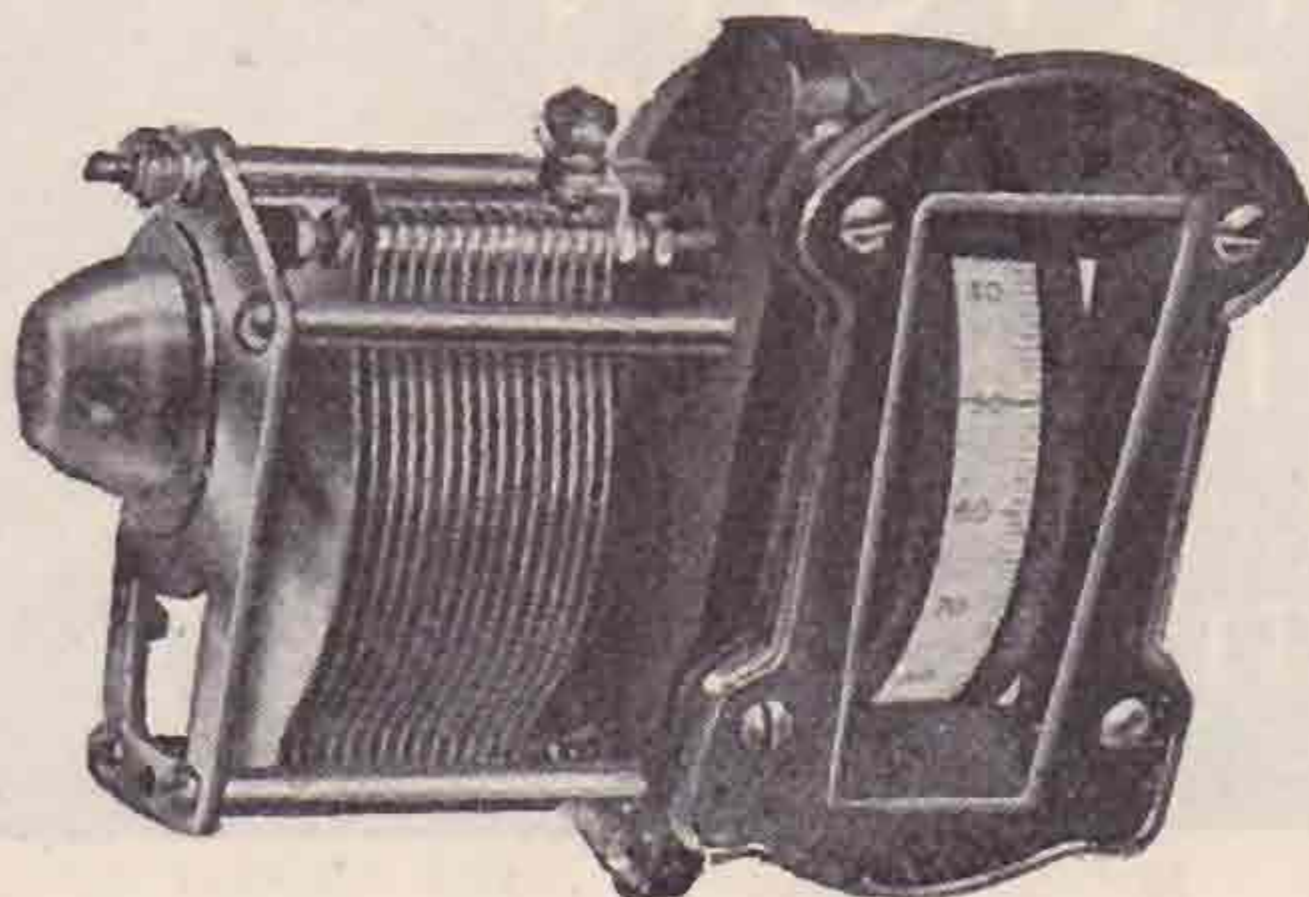

POLAR CONDENSERS

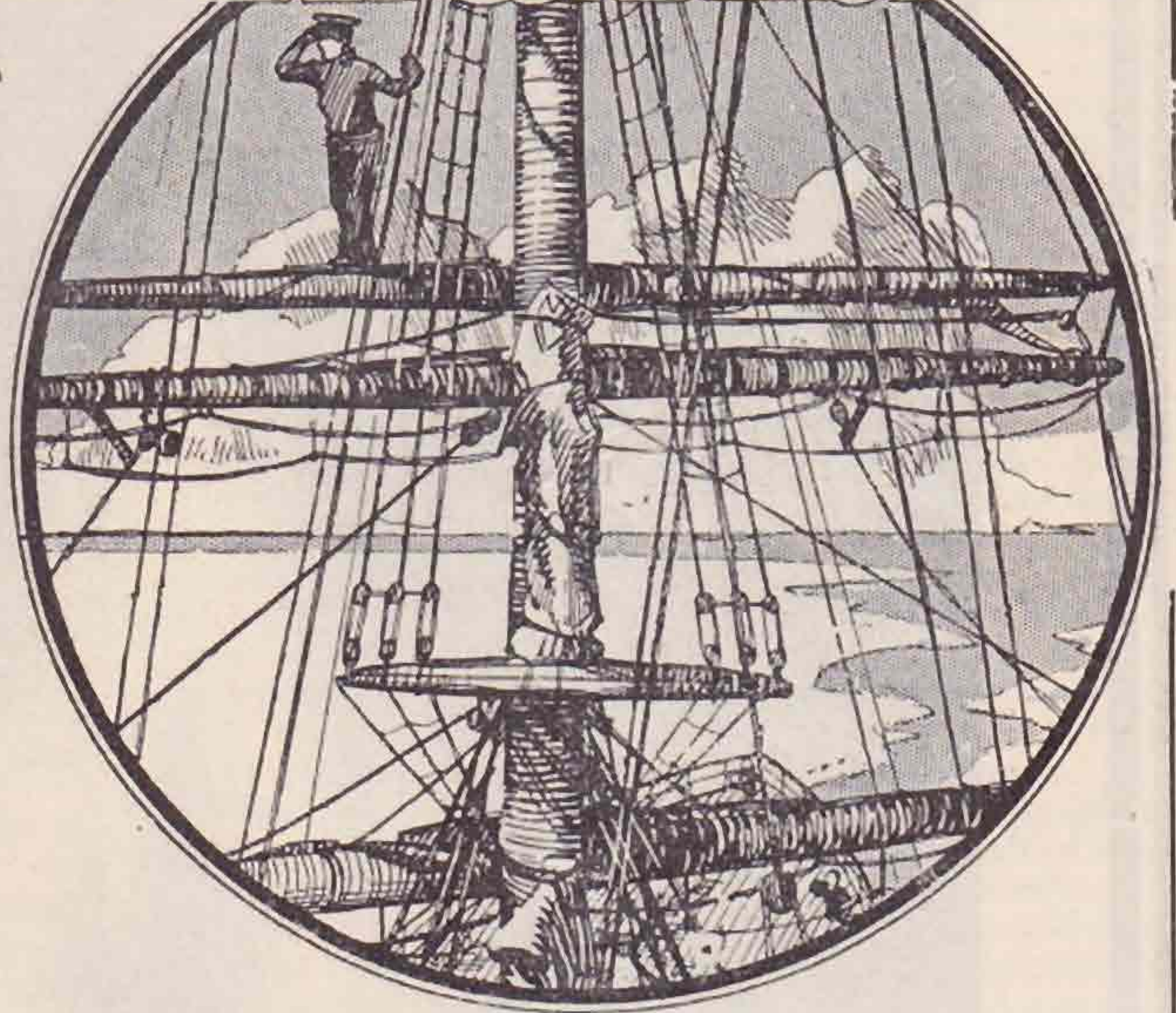

POLAR "IDEAL"

·0005	-	-	12/6
·00035	-	-	12/3
·0003	-	-	12/-

POLAR "VOLCON"

·00025	-	-	6/-
·00015	-	-	5/9
·0001	-	-	5/6

POLAR "Q.J."

·00025	-	-	10/6
·00015	-	-	10/3
·0001	-	-	10/-

The full range of Polar Condensers are illustrated and described in our new Catalogue "T.R."

WINGROVE & ROGERS, LTD.

STANDS 128 & 133, OLYMPIA. 188-189, Strand, London, W.C.2.

NOTES & NEWS FROM THE BRITISH ISLES.

DISTRICT No. 3.

Representative: JOSEPH NODEN (G6TW), Coppice Road, Willaston, Nantwich.

Reports rather scanty this month, and I presume we must blame the holidays for it. I hope to meet some of the men from this Area at the Convention. If anyone has any point they wish me to put forward please let me know in good time. G5FC now going strong on 7 M.C.; DX includes Nijni Novgorod. 2BHI found conditions very bad for 7 es 14 M.C. He is very interested in the 1.75 M.C. band, and would like to hear more stations there. BRS234 found DX on all bands poor. He wants to know if something can be done to bring more stations on the 1.75 M.C. band. G2OA, with 6 watts, has worked a number of new countries on 14 M.C. Morse practice sent out on 168 metres at 1300 B.S.T. each Sunday, also on QRP group work for C.B. G6TW still carrying on with 56 M.C. work for C.B., and time fully occupied with schedules.

DISTRICT No. 4.

Representative: E. R. MARTIN (G6MN), Castle-mount, Worksop.

BRS225 has applied for A.A. ticket, and is anxiously awaiting reply. G5BD is working America almost nightly with good reports. G5CY receives good reports from Europe on 7 and 14 M.C. G6MN has had a few QSO's, using a DE5B as power amplifier to COFD. Is expecting a new 50-watt valve. As these will probably be the last District Notes written by him, he wishes to thank all who have supported him, and to those who have been unable to find time to send in notes, he hopes they will support the new D.R.

DISTRICT No. 5.

Representative: D. P. BAKER (G2OQ), Crescent House, Newbridge Crescent, Tettenhall, Wolverhampton.

G2YX has been at camp, and has done work with Army 100-watt sets. G5BJ still maintains regular contacts with five continents, but has not yet raised Oceania. He would be thankful if DX men will ask Oceania to look out for his calls. G6CC has been listening on 14 M.C. band, but found reception too bad to even start the generator. G6CI reports conditions bad on 14 M.C., but has worked South America. VO8AE and RVIG were worked before going on holiday. G6XJ has returned from East Anglia after doing good work with portable outfit. He reports 7 M.C. good, but 14 M.C. very poor. We are pleased to report that several stations had the pleasure of a visit from ON4CK. BRS149 reports good reception on 7 M.C. The best station heard was VK6AG on fone.

DISTRICT No. 6.

Representative: G. W. THOMAS (G5YK), 169, Hills Road, Cambridge.

G5YX has been doing very well this month, having been twice reported R9 in U.S.A., as well as obtaining QSA5 from India and Singapore. Nothing has been heard of the other Cambridge stations. G5YK has been on the air each week-end, but has nothing to report. I have to welcome a new member to the district, Mr. Featherby (BRS268), of Bishops Stortford, and I sincerely hope we may hear more of him later.

Essex.

By 2ABK.

G5RV has been active with 1 watt on 7,000 K.C. and worked OH2NAS for an hour solid. He would like reports on QRP tests on this frequency, and calls "Test QRP" every Monday at 19.30 G.M.T. 2BVR reports nothing doing except to push up his hay wire quartz resonator. BRS261 is welcomed as a new member, and has logged over fifty U.S.A. stations this month. Is also busy with a 56,000 K.C. receiver. BRS233 and BRS191 have both been active with the receiver. 2ABK is again ready for any 28,000 K.C. tests, early mornings preferred.

DISTRICT No. 7.

Representative: H. C. PAGE (G6PA), Newgardens Farm, Teynham, Kent.

This month seems to bring me more reports than usual, for which I am glad.

Surrey.

By G2VV.

G2DZ is doing fine work with 10 watts input. On 14 M.C. he has already worked 25 countries, including SU, YM, and W. Has worked W1BUX three times at 12.00 G.M.T. His transmitter is a T.P.T.G., with a C.F. Hertz aerial. G5CM is still doing some fine QRP work, and can raise FM at any time, with any power on 14 M.C. He is trying out a new R.F.B. transmitter, and contemplates altering his aerial. G2RT is another QRP man. On 14 M.C. he has worked PY1AX, getting R4 with an input of 5 watts. G5GS is working with QRP, but has had more trouble with his R.A.C. outfit. G6LK is keeping skeds with PAUX, he is a member of G2DT's 56 M.C. C.B. Group. He hopes to be working on that frequency soon with a UX220 and 10 watts input. G2VV is still working new countries on 7 and 14 M.C. His best DX now is VK4RB, who reported him R4. His input is 5 watts from dry batteries. He is using a CT25X valve, and a new V.F. Hertz aerial. G5WP has been active on the 7, 14 and 28 M.C. bands. Preliminary efforts on 56 M.C. with T250, T40 and LS5 seemed to indicate that the LS5 would be the most likely valve. G5GS is just starting up again with a chemical rectifier.

Sussex.

By G5UY.

BRS257 is now G2RM. We wish him the best of luck. He hopes to be on the air very soon now. G5AQ has at last got his crystal to control properly. He has had some very nice reports on his grid control phone. G2DT hopes to be on the air in a short while. G5UY has only been on the 7 M.C. band. He has been comparing the Ultraudion and T.P.T.G. and finds that the U./A. gives a rougher note than the T.P.T.G. He is now investigating the effect of local rain on his signals, as he has a lot of fir trees at the end of his aerial.

Kent.

By G6PA.

2AHU is leaving us to go to Rugby. We wish him the best of success. G6PA has little to report. A new supply of Ripaults batteries has been obtained, and power is up to 10 watts again. DX conditions have been very patchy, especially on the 14 M.C. band.

DISTRICT No. 9.

Representative: G. COURTENAY PRICE (G2OP),
2, St. Anne's Villas, Hewlett Road, Cheltenham.

Conditions during the first fortnight of August were good, but after this date, which coincides with the forecast of the large sunspot, conditions on the 14 M.C. band have been bad; at the time of writing there seems an indication of an early return of good DX on this band. I am looking forward to meeting many of you at the Convention. G2ZP was licensed in May last, and within two weeks had W.A.C. on 14 M.C., using a DO40; best results being WI2348, VK35, ZS, FK, ZL, SU, LU, PY, YI, PK. (What power, OM?) G2YX has been on military training, after which he will be building a new outfit. G2OP has been busy on 7 and 14 M.C., and is using C.C. G5FS is away, but will be starting up again in September. G5QA has been mostly on 7 M.C. and is QSO all Europe. On 14 M.C. he reports a QSO with W1, using $3\frac{1}{2}$ watts only. G6RB during the beginning of August W.A.C. best DX being VK2RX, VK2JY, PY1ID, W6DWP, W5ATF, TI2HV. Is constructing a new receiver. G6RR is using an indoor current-fed Hertz on 40 m., also reports QSO with W138 on 14 M.C. Has visited BRS212 and G6ZR. G6WT has sent a most interesting description of his outfit, which, I think, should form the subject of a separate article. (Editor, please note.) Is now using C.C. on 7069 kcs. to a DET1SW at 600 volts from batteries. BRS212 is still at Rugby and has visited G6WO, G6MC, G5ML, G6SO. Is using a 1-valve portable, with which he has logged four continents and 25 countries. BRS242 reports more building than listening, but has not yet completed his 56 M.C. receiver.

DISTRICT No. 10.

Representative: J. CLARRICOATS (G6CL), "Ciel,"
Hartland Road, London, N.11. Telephone:
Finchley 3512.

Very few reports have been received, which is not surprising considering the small number of North London stations who are at present active.

One of our livest wires—Mr. Bradley (G2AX)—has now deserted us for the wilds of South London. Good luck, old man, at your new QRA. In his last report he states that 14 M.C. DX was good during July and August.

G6PP has little to report, but, as will be seen elsewhere, much time has been devoted to bringing the QRA lists up to date. G6UN has been inactive since his vacation, but will probably be working on 14 M.C. in September. He has been reported in Australia, so is looking forward to an early contact. G5HJ has done some local 7 M.C. low-power work and is installing a "Pertrix" supply. G5CX is now on the air in spite of difficulties, as mentioned last month! Brazil has been raised, but, judging by his strength at G6CL, he should have no difficulty in W.A.C. soon. He finds operating conditions changed since his earlier days of activity. G6CL has had several PY and W contacts, but new countries are elusive. Input has been 7 watts from "Pertrix." Tests on 7 M.C. without an aerial have proved interesting and should be worth following up. FM was worked with 0.8 watts on 14 M.C., which is best QRP work done recently from this station. During vacation G6WI and G5QV were visited. Such meetings are one of the pleasures of a holiday. SM4ZF, who is

staying at G6CL, had an enjoyable personal QSO with G2ZC during his stay in Jersey. G5UM has continued his 1.7 M.C. work and reports consistent reception of G5GY (Cheshire), who uses an input of only 2.5 watts. Mr. Hum is anxious to receive reports from stations on his .161-metre transmissions, with particular reference to signal strength, fading and type of receiver used. G6GZ was visited by G5UM during vacation. G5QF has done little active transmitting, but is continuing his 56 M.C. experiments.

DISTRICT No. 11.

Representative: L. H. THOMAS (G6QB), 66,
Ingram Road, Thornton Heath, Surrey.

G5SH explains that his "modified G5WK circuit" mentioned in the last "BULL" should read "modified G5YK." He has worked during the past month XAU8AN, at Samarkand. He has also received a report from the "Bremen" well across the Atlantic. G6HP has rebuilt his transmitter again with G.R. transmitting condensers, but thinks there is room for further improvement. He works 28 M.C. on Sundays and wants reports badly. G6QB is starting up again and means to put out a signal that will burn out someone's phones. BRS190 finds little activity on 28 M.C. He is interested in 56 M.C. work, but complains of a lack of stations willing to co-operate. Is there anyone in the area that will show signs of interest in 56 M.C. work besides BRS190? BRS250 sends his first report. Among the more interesting things he has heard are SN1AA (QRA?), WFAT and VP5OUX (Oxford University Expedition in British Guiana). I don't know what you all think about it, OM's of District No. 11, but it seems to me that reports from five stations out of an area of this size are a sign of either sleepy sickness or lack of interest. I could list fifteen stations known to be on regularly who haven't reported this month. I propose to drop the reports altogether next month if a dozen don't arrive before the 20th. G6WY and G2CX report later with apologies. G6WY has been endeavouring to get his note better on 14 M.C., but so far without much success. He has also worked VP5OUX. G2CX is putting all available time on the job of rebuilding and will be heard on the air before these notes are in print. He has OZ2Q (7JS) staying with him and is trying to show him that London can be as hospitable as Copenhagen.

DISTRICT No. 12.

Representative: L. J. FULLER (G6LB), 13, Seagry
Road, E.11.

G2ZN has worked CT with ultra low power on 7 M.C. and has commenced testing on 14 M.C. We are pleased to know he has recovered from his recent operation. G6UT has now obtained a D.C. note, but using D.C. instead of A.C. on the filaments. His VF Hertz has come back into use, and South America has been consistently worked. G6FY is still experimenting with his nickel rod oscillator, whilst G6LB has had an R6 from Brazil using an indoor end on Hertz with a 6-watt input.

DISTRICT No. 13.

Representative: H. V. WILKINS (G6WN), 81,
Studland Road, W.7.

Holidays seem to have reduced reports to a minimum, but an improvement will doubtless occur next month. G6VP has been active every day and has worked considerable DX. A DET1 has now

been installed for 28 M.C. Valve rectification has been tried in place of chemical rectification, but discarded as being not so reliable or efficient. G6WN has again WAC on 14 M.C., whilst schedules with G6VP have been carried out on 28 M.C. The shack was flooded during July and the receiver badly damaged. G5LY has rebuilt his 14 M.C. transmitter and his receiver, and has gone back to a Hertz antenna.

DISTRICT No. 14.

Representative: J. WYLLIE (G5YG), 31, Lubnairg Road, Newlands, Glasgow.

This month I have to comment on your failure to make a single nomination in respect of the approaching election of district representative. The personal slight I can overlook as I begin to know you all fairly well, but what I shall not allow to pass without comment is your apathy toward the affairs of your society. It is reprehensible to a degree, and its effect on the enthusiasm of your executive is more far-reaching than you in your masterly inactivity can imagine. The view of most of you seems to be that your responsibility ends when your annual subscription is paid, and a more deadly fallacy never existed. You completely lose sight of the fact that the R.S.G.B. is an AMATEUR society and that its very life-blood is co-operation. With one exception, the executive posts are honorary, each and all of these executives giving of his or her best that your interests may be catered for. How do you repay them? I have no difficulty in answering that question, and if you are honest with yourselves, neither will you. Of course, the British temperament being what it is, none of your executives look for or expect thanks, but they do look for your interest, and have a right to demand your support. At the moment of going to press, I do not know whether or no I shall be your district representative for 1930, but should I decide to accept office, I sincerely trust I shall never again have occasion to address you as in this issue. I have received several letters anent the recent attack on the R.S.G.B. by the "Wireless World and Radio Review." Personally I have nothing to add to Mr. Swift's letter which appeared

in that journal, and only hope that our editor will consent to throw some light on the matter in this issue. My attention has also been drawn to a circular emanating from the Wireless Amateur QSL Card Exhibition, Wellington, New Zealand, asking for specimens of British QSL cards. I know nothing of the *bona fide* of this Exhibition, and once again call upon Mr. Editor for information. "A" District men and others are reminded that the first of the winter session monthly "ragchews" takes place at 5YG on Wednesday, September 25, when all will be welcome.

Now for the District Notes:—

"A" DISTRICT.

Representative: DAVID B. MARSHALL (G2MA).

G2MA has succeeded in getting a T8 note when using rectified 25-cycle A.C. plate supply, and claims that the secret lies in the D.C. filament supply. G5CL, G5YG and G5XQ on holiday. G6MS has had his old call sign reissued and has been very active on 7 M.C., using about 5 watts to the amplifier of an MOPA TX. He has had several T9 reports, and has worked all active countries in Europe. He has also done a little telephony on the 2 M.C. band. G6NX is still working on 14 M.C. and claims that there is hardly a night on which he does not raise some DX station. His power is 20 watts and his best contacts have been with the Argentine, Brazil and Persia. G6WL has been very active on 56 M.C. with fone, and has succeeded in making his voice heard at a distance of one mile. He reports good 14 M.C. conditions towards the end of July and had contacts with India, Argentina and several of the more distant W's. Transmitting conditions on 28 M.C. were found to be bad, but several European amateurs were heard.

"B" DISTRICT.

Representative: E. J. Ingram (G6IZ), 20, Cairnfield Place, Aberdeen.

G6IZ has been doing a little on 150 K.C. with considerable success, having worked many G's, also I, PA, OK, ON, EU, F, etc. He also worked on 14 M.C., but complains that QRN on that band rendered consistent working impossible.

No reports from "C" and "D" Districts.

Strays.

Mr. E. N. Penrose (W6DZY-W6BEQ) asks us to say that he would be very pleased to receive reports on his 14 M.C. signals from BRS stations, and adds that every correct report will be acknowledged by card.

* * *

W2JN, W2ACN, W2TP and W4NH will be transmitting on 28,000 K.C. every Sunday at 14.00 G.M.T. using CC from now onwards.

* * *

GI6MU and EI7C (Brothers Scott) and GI6YW viewed the Ulster Road Race and kept in touch with it by means of a portable receiver.

Capt. McDowell (another GI transmitter) put up some good speeds on a new Ford. 6YW remarks

that the "O.M." ought to have been driven by a 'Ham'!

Calibration Service.

Calibration waves will be sent from G5YK on September 22 as follows:—

13.00 G.M.T. 7,050 K.C. (nominal).

13.05 G.M.T. 7,250 K.C. (nominal).

Similar schedules will be transmitted on October 13, commencing at 10.00 G.M.T., and on October 27 at 14.00 G.M.T. The call will be R.S.G.B. DE G5YK, followed by a two-minute dash and the frequency used. The accuracy may be taken as better than plus or minus two kilocycles.

B.E.R.U. News.

IRISH FREE STATE.

Representative: COL. DENNIS (EI2B).

I am afraid that there is very little to report this month as many stations have either been off the air or have failed to send in a report, though I have waited until the last minute. EI4D has been testing fone modulation systems on 7 M.C. EI7C has been away on holiday. Since his return he reports conditions on 14 M.C. to be improving. He worked PY with only 4.6 watts input QSA 2 to 3, R3. EI2B worked W1 and 3 districts on 14 M.C., with 7 watts input.

CHANNEL ISLANDS.

Representative: A. M. HOUSTON-FERGUS (G2ZC),
La Cotte, St. Brelades, Jersey.

We have been pleased to welcome SM4ZF to Jersey and look forward to renewing acquaintance with the brothers G6WN. Mr. Clark (G6OT) has been over, but we were unable to see him. G5GW is returning to do a naval signal course and expects to be active for a while shortly. After my two months' rest I found that both harmonically-controlled transmitters worked perfectly. This came as a surprise as I had been led to believe that a harmonically-operated crystal improved with use.

CANADA.

Activity in the second district seems to be mostly concentrated on the 14,000 K. C. band. VE2BB is an old Englishman by birth and was for twenty years in the P.O., consequently the minute he hears a G it supersedes even ZL or VK! Please give him your co-operation. VE2BE needs no introduction: Alex is the SCM and an old hand at the game. VE2GA is a true ham, and if you look for a long QSO, just follow his footprints (or rather his fist). VE2BD is another "bloke" from London and is dying to be an R.S.G.B. member, as well as to have many QSO's with G stations. VE2BH is Jimmy, born in England also; you can't send fast enough to suit his taste; he is an exclusive believer in the superiority of the 14,000 K.C. band. VE2AL, who comes on once in a while as a mail pilot and is down on 14,000 K.C. for DX. VE2BG is Tommy Letts, a jolly fellow and a good ham. VE2AP is quite inconsistent, having been bitten by the "fone" craze. The rest of the boys are on 7,000 K.C. and 3,500 K.C., and occasionally use the DX band. But please don't forget, fellows, that we are always keen to chat with any of you, and that if we are a big family of brothers, we can't afford not to act as brothers. So, from now onwards let it be: "I say, are you there . . . ?"

Correspondence.

We're Sorry to Lose You, OM!

To the Editor of T. & R. BULLETIN.

DEAR SIR,—As I have been compelled by force of circumstances to retire from activity in the sphere of amateur radio, and have relinquished my amateur transmitting licence, I should like to take this opportunity of thanking the two or three thousand amateurs of many nations with whom I have been in contact, in person, by radio or by correspondence, during the past four years for their co-operation, friendship or hospitality.

Yours faithfully,

ERIC MEGAW.

Arden, Fortwilliam Drive, Belfast.

August 20, 1929.

QRA Section.

BY M. W. PILPEL G6PP.

NEW QRA's.

- G2AX. C. S. BRADLEY, 91, Shirley Road, Shirley, Croydon, Surrey.
- G2BY. H. E. WHATLEY, 37, Paddenswick Road, London, W.6.
- G2DW. B. WICKHAM, "Osmonde," Woodstock Road, St. Albans.
- G2ZL. H. W. HAYDON, 158, Bristol Road, Gloucester.
- G5CD. D. N. CORFIELD, 10, Holders Hill Gardens, London, N.W.4.
- G5CZ. R. A. COLBY CUBBIN, Strathallin Cliff, Douglas, I.O.M.
- G5QY. H. C. D. HORNSBY, The Quarry, Cramlington, Northumberland.
- G6NM. NORTH MIDDLESEX RADIO SOCIETY. Hon. Secretary: H. LAISTER, 7a, Station Road, London, N.21.
- G6WH. G. H. WHEATLEY, 5, Eliot Bank, London, S.E.23.
- 2AUT. J. H. GOODLIFF, 609, Queen's Road, Sheffield.
- IKT.—W. H. HOEY, Esq., Kitale, Kenya Colony.
- G6BJ.—D. J. BEATTIE, Esq., 14, Rosehill Mount, Manchester Road, Burnley, Lancs.
- VP5OUX.—OXFORD UNIVERSITY EXPEDITION, British Guiana.

**BOOK YOUR
CONVENTION
DINNER SEAT
NOW**

NEW MEMBERS ARE WANTED.

Trade Notices.

Messrs. Parr's Advertising, Ltd., will be found on Stand No. 224 at the Olympia Exhibition. They will show a selection from the actual products which they advertise for some of their clients, together with reproductions of Advertisements, Showcards, Catalogues and Leaflets prepared and published by them. They are also reproducing in colour the poster design which secured second place out of 500 entrants in the Open Poster Competition, for advertising the Radio Exhibition. One of their principals will always be available on the stand to supply any information desired.

* * *

CLIX need no introduction to the British transmitter: their range is so extensive that it can be but skimmed over here. An illustration of the new All-In Plug and Socket is shown. All metal parts are completely insulated, and the engravings are produced on the upper surface in every case. The flex portions on high voltage values are red and cannot make contact with the panel portions in other values. A few other specialities include CLIX Accumulator knobs to keep corrosion from terminals and ensure clean contact; spiral wander plugs, parallel plugs, "lox" wander plugs and power plugs each have their special use; pin terminals, "fit-all" spade terminals, hook and ring terminals and panel terminals are also worthy of mention. Look after your contacts in future by visiting Stand No. 261 at Olympia.

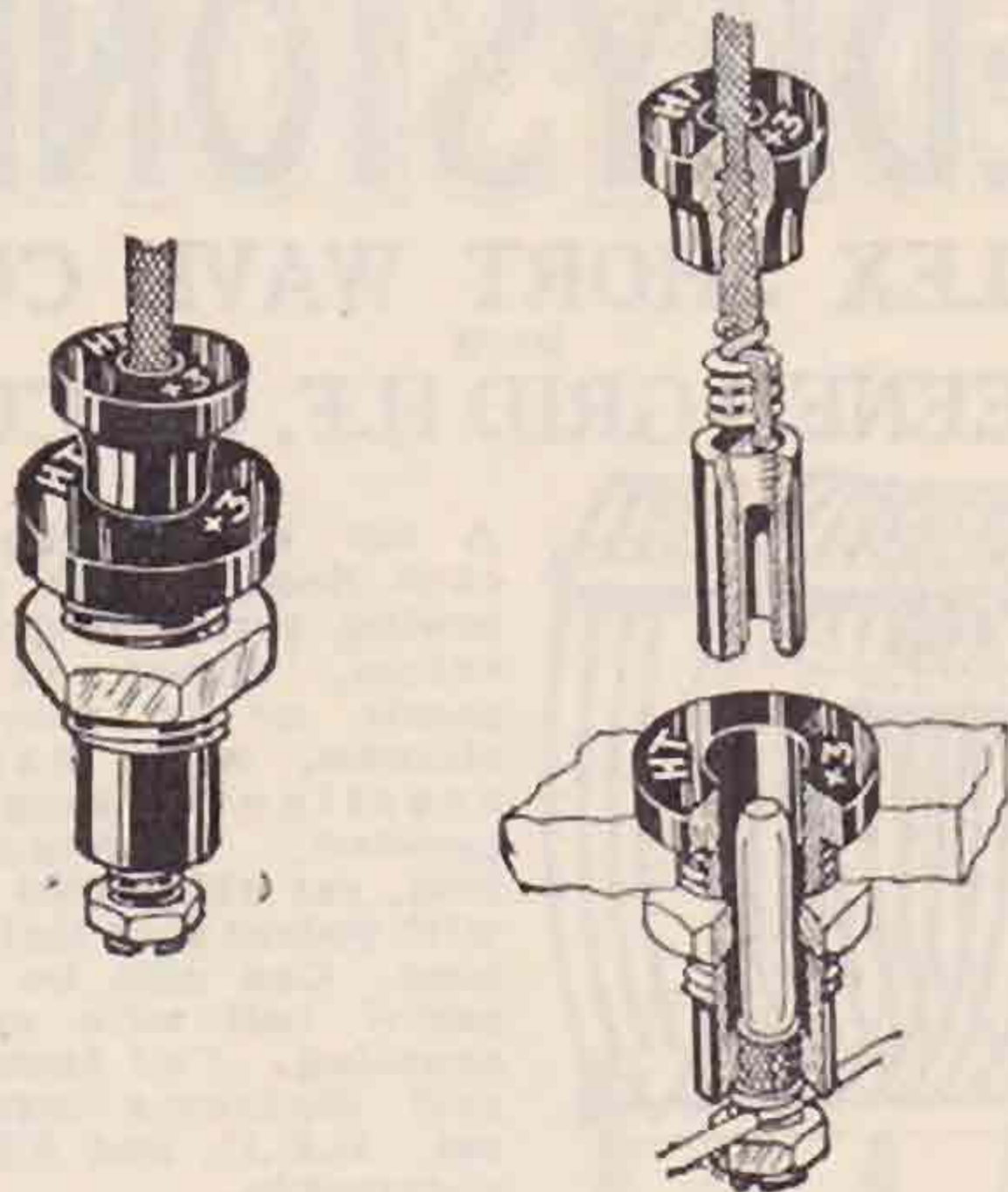

"G.R." TRANSMITTING CONDENSERS.

We have recently had the opportunity of examining three samples of "G.R." transmitting variable condensers, through the courtesy of Messrs. Claude Lyons, Ltd., of Liverpool. The three types had capacity values of 50, 100 and 250 mmfds. They are constructed on rigid lines, and embody the necessary requirements of a condenser designed to carry

heavy currents at high frequencies. Both moving and fixed plates are of .03" brass, the moving ones being of the taper pattern. The separate plates of each set are soldered together at three different points, thus making good electrical contact a certainty. The minimum of ebonite insulation is used at a point where the field is weakest. In designing the condenser, the makers realised that the bearings would have to carry a heavy current, and no pig-tail is used. From the mechanical point of view the bearings are smooth enough to permit easy and accurate adjustment, yet grip sufficiently so that the condenser will "stay put" afterwards; as an additional guarantee that the vanes shall not slip the moving plates are counterweighted. The spacing between the plates when closed is .1", and the condensers are designed for voltages up to 2,500 R.M.S. (3,500 peak).

We have no fault to find with the general construction and the samples under review have given highly satisfactory results when in practical use.

NEW MEMBERS.

- H. C. ST. JOHN, Esq. (VK2RX), 82, Gibbes Street, Rockdale, N.S.W., Australia.
 R. N. FOX, Esq. (VU2DR), Brookside, Pachpedi, Jubbalpore, India.
 F. CHATER, Esq., Craiglea, Stonyholm Road, Kilbirnie, Ayrshire.
 P. NICOLL, Esq., Oak Hill, 167, Todmorden Road, Burnley, Lancs.
 W. P. FOSTER, Esq. (G2ATX), 10, Queen Street, Northwich, Cheshire.
 G. R. M. GARRATT, Esq., 35, Abbey Road, London, N.W.8.
 P. D. WALTERS, Esq., 58, Carlton Hill, St. John's Wood, London, N.W.8.
 LUIS DE LA TAPIA, Esq. (EAR117), Tavern 26 (S.G.), Barcelona, Spain.
 W. SHOLES, Esq., 321, Greenacres Road, Oldham, Lancashire.
 F. W. FEASEY, Esq., 61, The Cottages, Rosendale Road, Herne Hill, S.E.24.
 J. W. NICHOLS, Esq., 29, Park Parade, Harrogate.
 G. FEATHERBY, Esq., 30, Lindsey Road, Bishops Stortford.
 A. G. SANDFORD, Esq., 37, Morris Avenue, Morristown, New Jersey, U.S.A.
 W. A. MAKEPEACE, Esq., "H.Q." Wing, 1st Bn., The Worcestershire Regt., McPherson Barracks, Allahabad, India.
 S. F. HANKS, Esq., 11, Cornwall Road, Twickenham, Middlesex.
 W. H. HOEY, Esq., P.O. Kitale, Kenya Colony.
 S. HOBSON, Esq., 43, Jubilee Road, Doncaster.

B.R.S. NUMBERS ISSUED.

- 266.—F. CHATER, Esq.
 249.—T. W. GREGSON, Esq.
 (published as BRS 255 in error).
 267.—J. W. NICHOLS, Esq.
 268.—G. FEATHERBY, Esq.
 269.—P. NICOLL, Esq.
 270.—S. HOBSON, Esq.

B.R.S. NUMBERS RELINQUISHED.

- 140.—Now G2BIR.—J. C. WICKS, Esq.
 152.—Now G5FC.—F. D. CAWLEY, Esq.
 177.—Now G2BMV.—L. H. SHERSBY, Esq.
 218.—W. D. PATERSON, Esq.

HELP US TO GET THEM.

QSL Section.

By J. D. CHISHOLM, G2CX.

I should like to say a word or two this month about the requests for "special treatment" of QSLs that are received here from time to time. There has been quite an epidemic of them lately, and I think it would not be out of place to explain the attitude of the Section. The first consideration is, of course, to run the QSL Section so that it is of the greatest benefit to the greatest number, and to this end we shall always be pleased to consider any reasonable requests, and will do our best to carry them out.

Any instructions that are necessary should be written in the top left-hand corner of the envelope under the call sign, but I would ask everyone to be as sparing with them as possible, as they clog the machinery of the Section badly.

Many requests are received asking us to destroy reports or European cards. Some want 14 M.C. reports only, whilst others do not want RK or DE reports. Whilst I should be very glad to be able to do these things if the whole service were run by me personally, I feel that it is impracticable in the present circumstances, as the greater part of the sorting is done by the staff at headquarters, who cannot be expected to distinguish between valuable cards and worthless rubbish.

My thanks are due to PB7 for his help in compiling a list of the lesser known QSL agencies.

The list of envelope defaulters has swollen again this month, and is as follows:

2.—av, ci, cs, dx, gf, hd, hp, ii, iz, kf, km, lz, rk, sa, sc, sn, xv.

5.—cy, ba, fg, gl, gs, hv, ir, jv, lf, pj, qf, qk, ro, sk, sz, tz, uv, ug, us, vm, wk, wp, xd, yu.

6.—bd, cd, cn, da, dh, dr, fa, fh, fy, ga, gz, ko, nz, oo, pa, qc, ql, rk, rw, ta, td, tz, uo, uy, vo, vp, wl, wo, wt, xb, xc, xl, xp, yc, yq.

BRS 105, 116, 191, 251, 261.

EXCHANGE & MART.

Rates 1d. per word, minimum 1/6. First line in capitals if desired. 2d. per word where all capitals are required. Minimum 3/-.

FOR SALE.—1/5th H.P. Motor, 230 volts, coupled to 1500 volt Generator. M.L. 12/600 Rotary Transformer and 2 Mullard Transmitting Valves. Six Cardwell Transmitting Condensers.—Particulars, 6CC.

HEAVY POWER TRANSFORMER, 240 v. to 600-0-600, 100 mills., plus two 8v. 5 amp. C.T. windings. £2 15s.; little used; cost £4 5s. Mullard 0/40, little used, 25s.; 3,000 v., fixed, .002 oilfilled, 10s.—G5YU, The Retreat, Kempshott, Basingstoke.

FOR SALE.—DET I.—OFFERS.—G5CY, SUTTON-ON-SEA, LINCS.

EXPERIMENTAL WORK—Mechanical, Electrical, Photographic. Inventions developed, models made, television discs.—JOHN SALTER, (estab. 1896), 13, Featherstone Buildings, High Holborn, W.C.1. 'Phone: Chancery 7408.

MORTLEY GENERATOR, Type CF/248, H.T. 2,250 volts, 125 MA., L.T. 13.5 volts 10 amperes. Belt coupled to Century 3/4 H.P. 220 volt single phase A.C. motor complete with starter. Generator can also be run as rotary transformer. Perfect order, as new. Every continent in world worked with above outfit. Also 1 Mullard 250 watt valve type S.W.2; little used; lot cost £42. What offers?—G5SZ, West Point, Menston, Yorks.

WANTED.—A thousand or so members to advertise their surplus gear for sale in these columns.

EDDYSTONE

**DUPLEX SHORT WAVE COILS
FOR
SCREENED GRID H.F. CIRCUITS**

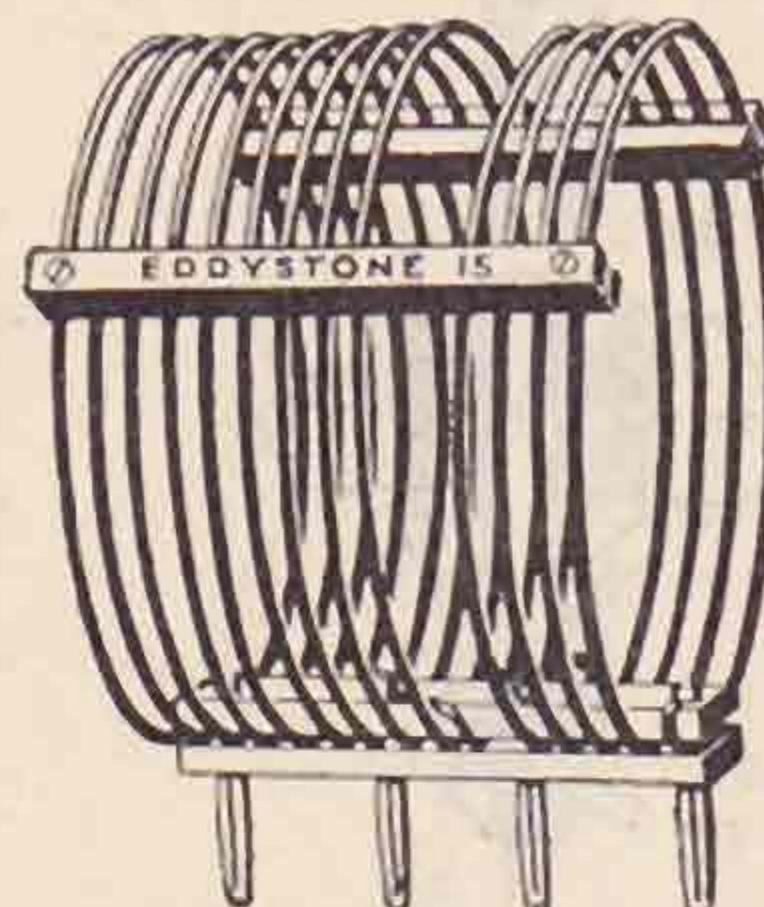

A set of interchangeable coils designed for use following screened grid H.F. valves, either in tuned anode or in tuned grid circuits, with Reinartz reaction winding incorporated. Absolutely low loss, yet rigid and strong, with patent four leaf contact pins. Can also be used as aerial coil with aperiodic coupling. Full instructions and diagrams with each set. B.B.C. and 5XX coils obtainable.

Coil D.2. For 14-39 metres.
Coil D.3. For 28-63 "
Coil D.4. For 43-100 "
 with stand.

PRICE 19/- PER SET OF THREE.

Send for complete list (T) of "EDDYSTONE" short wave apparatus.

**STRATTON & CO., Ltd., Bromsgrove St.,
BIRMINGHAM.**

London Service Depot:—
Webb's Radio Electric Stores, 164, Charing Cross Road, W.C.2.

SUPPORT THE SOCIETY AND TRADE ONLY WITH YOUR SUPPORTERS.

In a recent competition held by a well-known London Radio Society

The WINNER

of the cup for the best all-round performance used a set built with

D X COMPONENTS

Plug-in Coils, H.F. Chokes, L.F. Transformers, etc.

SEND FOR LISTS MENTION "T. & R."

D X COILS LTD
LONDON E 8

TRANSFORMERS

We invite your enquiries for all types of Transformers and Chokes. Special heavy duty eliminators supplied to meet any requirements. Transformers for Transmitting.

CHESTER BROS.,
244, Dalston Lane, London, E.8.

1929 CONVENTION.

The Quartz Crystal Co., extend a welcome to all hams visiting London for the Convention to call and inspect the complete 50 watt 7 and 14 m.c. Crystal controlled transmitter in operation at G2NH at 63a, Kingston Road, New Malden (20 minutes from Waterloo on the Southern Railway). We shall be only too pleased to discuss any Crystal Control problems and generally talk on matters of mutual interest. Until the Convention then,

73.

THE QUARTZ CRYSTAL CO. (G2NH & G5MA).



CLIX-LOX WANDER PLUG

Adjustable to fit any socket. A turn of the insulator locks it. Special short insulator. Red, Black, and Green ... **2½d.**

CLIX HOOK TERMINAL.

Ideal for speedy connection and sure contact. Lead coated for L.T., Nickel-plated for H.T. Red and Black **2d.**

CLIX "ALL-IN" PLUG & SOCKET

Ideal for use when complete insulation is essential. Better than a screw terminal and cheaper. Black **8d.** Price complete Flex Portion, 4d. Panel Portion, 4d. Both portions engraved.



CLIX

CLIX COIL PIN.



A boon to Home Constructors ... **2d.**

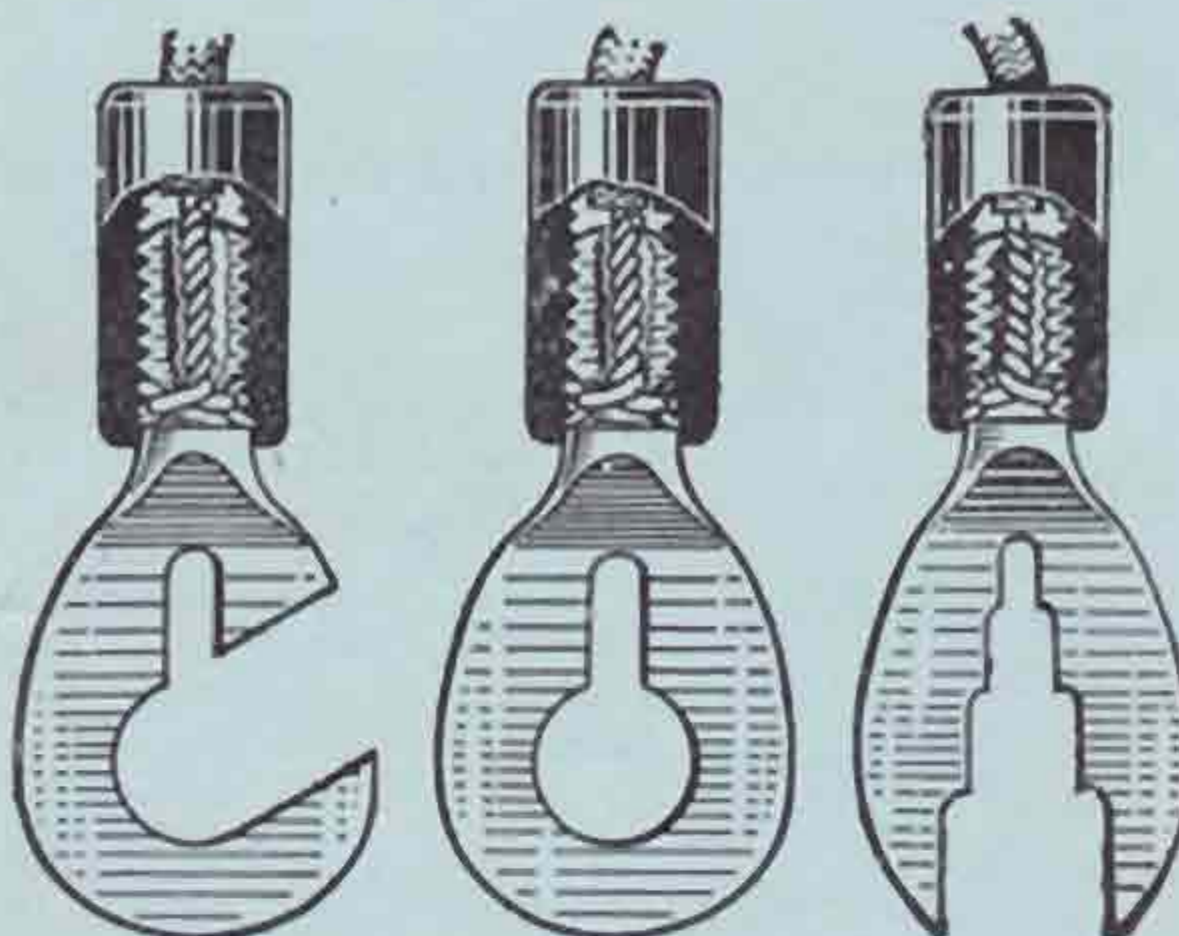

CLIX RING TERMINAL. An ideal fitment for permanent contact. Red and Black **2d.**

ILLUSTRATED LEAFLET FREE.

CLIX POWER PLUG.

The combination of Plug, Socket and Safety Bush makes a perfect method of contact for Battery Eliminators, chargers, etc. Price complete, 6d. Power Plug, Red and Black ... **2½d.**

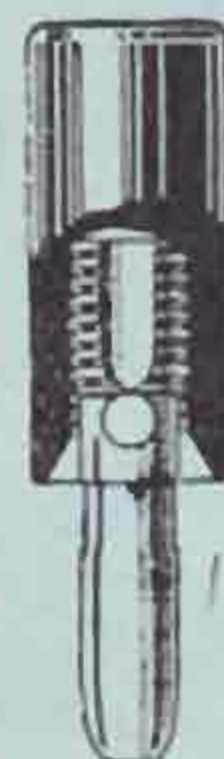

CLIX POWER SOCKET.

With one locknut ... **2d.**

CLIX SAFETY BUSH

Red and Black ... **1½d.**

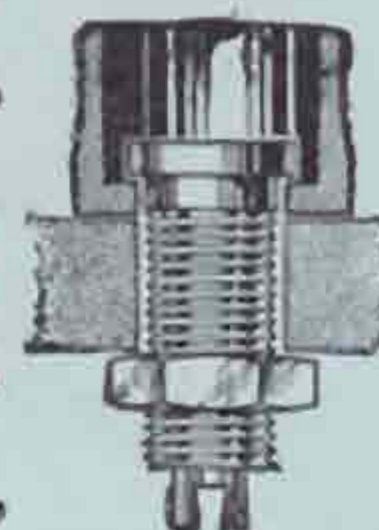

CLIX "FIT-ALL" SPADE TERMINAL.

Fits all sizes of screw terminals. Lead coated for L.T., Nickel-plated for H.T. Red and Black ... **2d.**

CLIX TERMINAL BRACKET

A ready means of converting permanent connections to the plug and socket system ... **1d.**

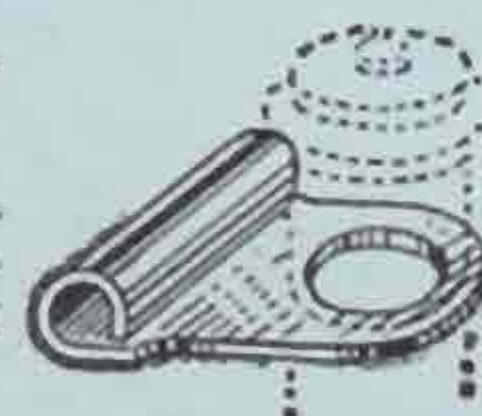

LECTRO LINX, LTD.,
254, VAUXHALL BRIDGE ROAD, LONDON, S.W.1

LOW TEMPERATURE FILAMENT TRANSMITTING VALVES.

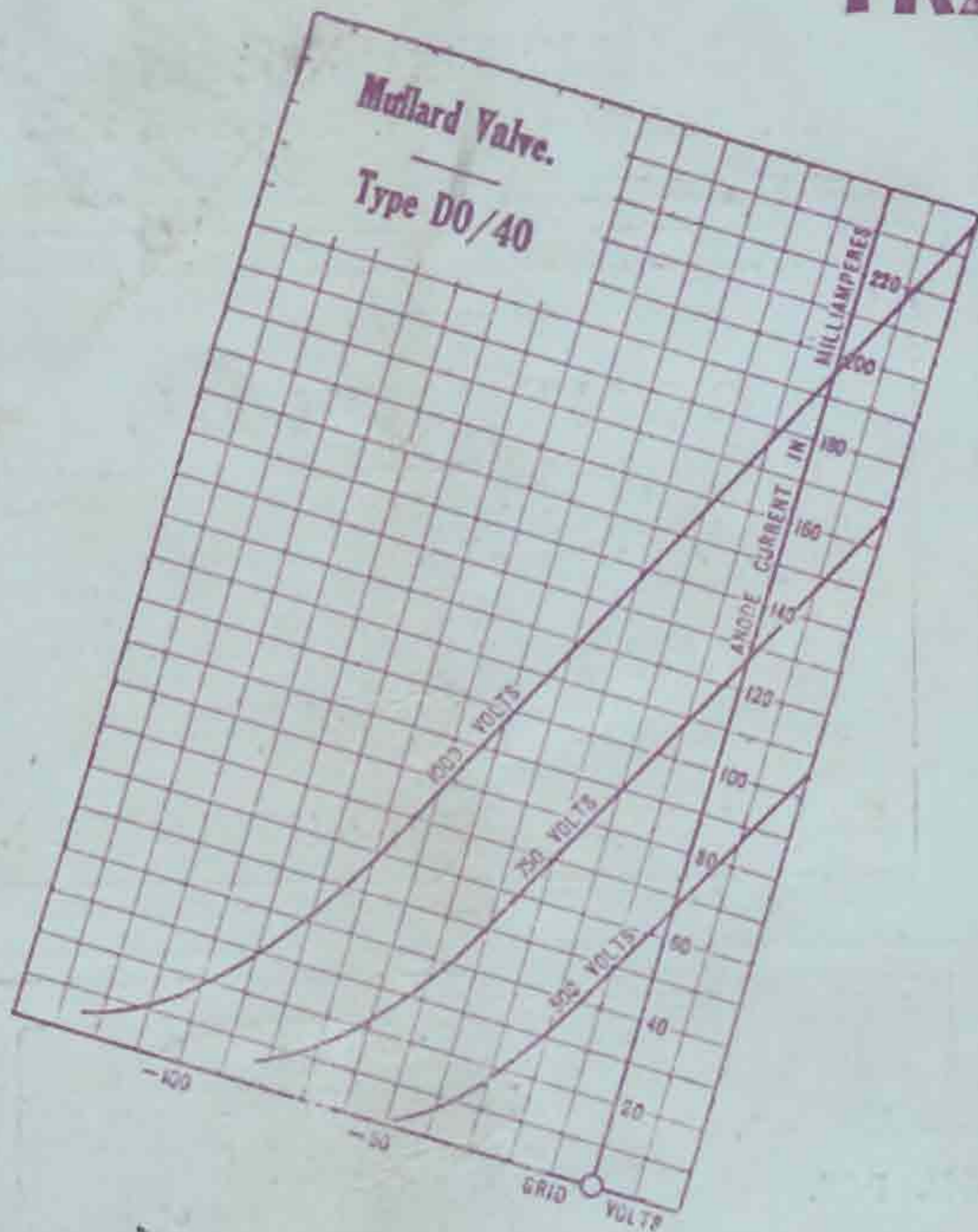

The Mullard D.O/40 is a dull emitter transmitting valve capable of working on anode voltages up to 1,000 volts and tested dissipating 40 watts at the anode.

The D.O/40 has a low impedance, and is suitable for use as a modulator in choke control transmitters. It is also suitable for short wave transmission (down to 40 metres).



Max. Filament Voltage	6.0 volts
Filament Amps.	2.0 amps.
Max. Anode Voltage	1,000 volts.
Total Emission	300 mA.
Impedance	4,000 ohms.
Mutual Conductance	2 mA/Volt.
Amplification Factor	8

PRICE £5-5-0

Mullard

THE · MASTER · VALVE

The Mullard Wireless Service Co., Ltd., Mullard House, Charing Cross Road, London, W.C.2.