

# **RADIO** **FOR THE** **MILLION**

PRICE

**1/4**

**COMPLETE WITH FULL SET OF BLUE PRINTS**

Published Quarterly.

Vol.1. No.1. Dec.1926.

## **No. 1.**

### **IN THIS ISSUE**

- Q** Introduction.
- Q** The choice of a receiver.
- Q** The FRANKLIN P.M.  
A three-valve local station loud-speaker receiver, giving Pure Music.
- Q** The RODNEY P.M.  
Three valves arranged for loud-speaker reception up to 50 miles.
- Q** The NELSON P.M.  
A four-valve loud-speaker receiver, giving a choice of several programmes.
- Q** The GRENVILLE P.M.  
Enables crystal set owners to enjoy loud-speaker reception from local station.
- Q** Radio Terms explained.
- Q** The Valves to use and why.

**RADIO FOR ALL**  
**From £2-15-0 upwards**

*In the design of this, the first series of P.M. Master Radio Receivers, we have set out to give our readers what must be recognised as a group of highly successful sets which, when constructed faithfully to our simple instructions, and ultimately fitted with Mullard P.M. Master Radio Valves, will present Mr. and Mrs. Everyman with instruments capable of giving pleasing and endless musical entertainment.*

# INTRODUCTION

**I**N this book "Radio for the Million," to be issued quarterly, we have set out to give to those who have no knowledge of the technicalities of modern broadcasting reception all the essential constructional details of perfect radio receivers in a simple and understandable form. So clearly and concisely written will the man in the street find our instructions, that the million will be able to build, both quickly and easily, the Mullard P.M. Master Radio Receivers chosen and described by Britain's foremost radio engineers.

Providing ordinary care is taken in their construction, every constructor may be certain of obtaining not only good results, but a performance which will convince him that, in the possession of a good receiver, he holds the key to the illimitable magic of the most fascinating science the world has yet evolved.

There are millions of people, we feel sure, who would now be enjoying the pleasures of perfect broadcast music and speech which radio brings into their homes, were they able to do this in an inexpensive way. It is the achievement of the P.M. series of Master Radio Valves with the wonderful Mullard P.M. filament that has done more to make this ideal possible than any other advance in radio science since broadcasting began.

The whole success of the first series of P.M. Master Receivers described in this book, is due to the combining of the very best receiving circuits available to-day with the additional qualities of the valves with the wonderful Mullard P.M. Filament.

Every owner of a radio receiver will impress upon you the immense importance of selecting and using the correct valves. Upon this choice particularly turns the question of your radio upkeep costs.

With that viewpoint in mind, it is of immeasurable interest to every reader of this book to know that his choice of valves leaves little room for doubt or experiment, particularly when it is universally recognised that Mullard P.M. Master Valves consume so little current that a three-valve receiver to-day will give endless enjoyment and entertainment for the negligible sum of one penny per day.



The wonderful P.M. Filament operates at so low a temperature that it can never become crystallised. This high filament efficiency means that fragility is eliminated and that after thousands of hours of useful life, it remains so tough that the P.M. Filament can be tied in knots.

There is, however, another and equally outstanding necessity which must be remembered in the purchase of valves, in addition to that of an almost negligible current consumption. It is longevity of the valve filament.

The recommended valves for the P.M. series of Master radio Receivers besides consuming *minimum* current operate at the highest efficiency for a *maximum* life—a fact which has been proved by the National Physical Laboratory certificate, recently issued to the manufacturers of the P.M. series of Master Radio Valves.

Moreover, when sets are fitted with Mullard P.M. Master Valves, all risks of damage to the filament from accidental shocks are eliminated, since this unique filament cannot be broken except by the very roughest handling.

You may at once enter the wonderland of radio through the pages of this book, confident that your work to produce a good receiver will be endowed with success, and that many years of enjoyment will be yours at little cost, if you insist that your P.M. Receiver is fitted with MULLARD MASTER P.M. VALVES.

***Mullard Master  
P.M. RADIO VALVES  
will improve any  
radio receiver.***

# How to Choose your Receiver

**I**F you lived in my town, what type of set would you build?—A question, doubtless, which many of us have heard many scores of times, and perhaps in turn have passed on to the more knowledgeable and technical experts to be counted among our circle of friends or acquaintances.

It would appear, however, from our experience of this eternal question, that its mysteries do not end with its constant repetition in and out of place. For it must be generally acknowledged that the great problem of which set to build, presentable in so many forms and with so many diverse qualifications, makes it well nigh impossible at any rate, to suggest any one receiver for universal use.

A universal receiver! One that should serve the million whatever their varying requirements might be, must certainly be an invention of science, and as yet to come. The present solution will be found in the few notes comprising this chapter, at the conclusion of which every reader will have at his disposal invaluable information such as could only be in the possession of the world's foremost valve manufacturers.

Every post brings us hundreds of enquiries for master circuits. During the course of a year, many thousands of consistent users of Mullard P.M. Master Valves request circuit arrangements which for efficiency and performance, equal the universally acclaimed merit of Mullard Master P.M. Valves.

"P.M. Master Valves," they write, "are worthy of master circuits. Their outstanding merits are limited by the inefficient performance of receivers at present popular. Produce for us better circuits!"

These better circuits are published in this book, and it is proposed to give the million an opportunity to peep into the secret of our radio research department by publishing valuable hints to guide the choice of our readers towards their ideal receiver.



This graphic photograph shows the unequalled strength of the Mullard P.M. Filament.

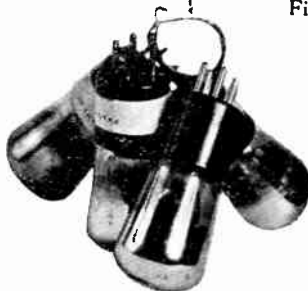

On counts of low initial cost, economy of upkeep, a highly efficient performance, ease of handling and suitability for individual requirements, this group of P.M. Master Radio Sets is the most praiseworthy effort yet produced for the benefit of the nation. The four circuits with which we are dealing include every desirable feature, particularly those we have briefly enumerated in this paragraph.

Many people are content with the programmes from their local station, with the possible alternative of the high-power station at Daventry. Others are more ambitious, and wish to receive the many Continental programmes which are now available in addition to those from other British stations.



400 P.M. Valve Filaments will lift a man. It is interesting to note that the man weighs over ten stone.

On this account, choice becomes divided into two main groups—receivers for the reception of the local station, and designs for distant reception.

As we have previously indicated, no one receiver has yet been devised whereby distant reception can be obtained without serious sacrifice. For sacrifice it is, and we now propose to explain to you just why these two widely opposed requirements must be served by different receivers. However, we wish to impress upon our friends the very important fact that, if their wish is to obtain the utmost efficiency on the local station, it will be necessary to forego, to a certain degree, many features which are fundamentally essential to the long distance set.

It will be gathered that the Franklin P.M. Receiver which we are recommending solely for the reception of the local station, should not be constructed by those who wish an alternative programme on the lower broadcast waveband.

*This set will, however, always provide the listener with the programme from Daventry.*

We have succeeded in the production of a design which, although not incorporating reaction of any kind, will prove an excellent receiver for those who reside within 20 miles of the local station.

Reaction has been omitted for two reasons—the first, that traces of any reaction effects may introduce distortion, and on this account, pure music would be difficult, if not entirely impossible, to obtain. The second consideration being that without reaction, no danger exists of interfering with the reception of one's neighbours.

Purity of reproduction is the main feature of the Franklin P.M. Receiver, and we have, therefore, included a scheme of low-frequency amplification which, on every hand, is approved for true and faithful reproduction. Reference to the diagram printed elsewhere in the book will show that this method is known as Resistance-Capacity-Coupling.

Without going too far into technical explanations, our readers will have great interest in knowing that of the three different methods of L.F. Amplification—Transformer, Choke or Resistance-Coupling—the latter is preferable where absolute faithfulness is desired.

It is commonly expressed that with this system an enormous H.T. Battery is necessary. This, however, is an exaggerated opinion since, with the correct valves and suitable anode resistance values, the Franklin P.M. functions perfectly with 100 volts high tension.

Most of you who now have the intention of building the Franklin P.M. with the object of simply receiving the local station will be very interested to know that whatever the notes of the piano heard coming from the loud-speaker, your set has amplified them equally. By carefully putting into practice the operating hints given in the description of the Franklin P.M., we have every confidence in your success. You can confidently look forward to hearing music beautifully different from that which previously may have discouraged you from entering into the wonderland of radio.

For perfect reproduction within 20 miles of a local station—free of harsh background noises, blasting on high notes, throaty lifeless speech—then decide on the FRANKLIN P.M. A set such as this is extremely cheap to construct—in point of fact £2 15s. od., will purchase all the necessary components. Operating controls are reduced to a minimum and once the local station has been tuned in, the receiver may be controlled by a simple on and off switch.

We must now give the enthusiast, who is served by a broadcast station no nearer than 40 to 50 miles, a receiver which, while satisfying his musical tastes, gives an ample margin of signal

*Read this interesting  
extract from a letter  
we have received:—*

*“P.M. Master  
Valves are worthy of  
Master Circuits.”*



strength to operate a loud-speaker comfortably without pressing the set to its utmost. It is of the greatest importance to have this margin of power available, for, as experience has probably already shown you, quality of reproduction suffers irreparably in the attempt to reach out farther than the capabilities of the receiver.

## THE RODNEY P.M.

Range and good selectivity in the Rodney P.M. have been secured by the incorporation of a very efficient stage of neutralised high frequency amplification, assisted by a form of capacity reaction controlled by a variable condenser.

It must be stated here that very close attention must be given to the instructions concerning the neutralising of the high frequency stage, for when

this is properly neutralised, the Rodney P.M. will not radiate, or in other words, cause any interference, spoiling the programmes of other listeners.

Transformer Coupling is advised with this receiver ; a glance at the test report will prove very helpful in weighing up the ability of the Rodney P.M. to conform with the conception of the ideal receiver already formed in your mind.

Compare your aerial with the best aerial system owned by any one of your many friends ; if you are able to decide that it is reasonably good, you can settle on the Rodney P.M., happy in the knowledge that by simply adjusting two tuning dials correctly, a score or so of varying programmes will always be at the call of your fancy, many of which will be at comfortable loud-speaker strength.

In passing, we might add a word or two to the many, many thousands who are less fortunate since their aerial lies under the shadow of a moderately powerful local station.

Indeed, their problem is one equally concerned with reaching out,

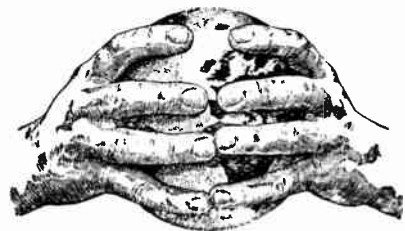

## Spans the World



as in the elimination of powerful signals emanating from a nearby station from ships, perhaps, or from harmonics from high power land stations. In these cases the employment of high frequency amplification is strongly recommended, and should be included as an essential feature in any receiver with which the owner wishes to reach out or "cut through" the unwanted signals—from whatever variety of source these may come.

Due to the many outstanding characteristics of the Rodney P.M., tuning may be sharpened up and resort may be made to reaction, while still retaining high musical quality, one of the principle distinctions applicable to every circuit published in "Radio for the Million."

### THE NELSON P.M.

It is to be hoped that our readers have postponed the reading of this section of a most interesting chapter until the "local-set" has been built, tested out and is now giving better results than any set you have before heard or constructed.

Reference can now be made therefore, to the third receiver in our series—The Nelson P.M. The photographs and diagrams accompanying the description of this set tell at a glance the story of its performance, and it will be noted that it presents many attractive features. The appeal made by the Nelson P.M. will be one which the lover of radio cannot but find almost irresistible.

Installed in the home of any ardent radio enthusiast, every radio station in Europe is within its grasp. In the early hours of the morning, a few degrees from Hamburg's setting—a certain American broadcast station, under favourable conditions, might come within range. It is the Station W.G.Y. in our mind . . . .

A very moderate opinion expressing the merit of the Nelson P.M. would estimate at least twelve stations at good loud-speaker strength with approximately twenty others good in the headphones.

Extremely simple to construct—particularly if in its construction you are wise enough to adhere closely to the design of the original receiver and to make use of the blue print, free with this book—surprisingly inexpensive for the remarkable performance of which it is capable, incorporating as it assuredly does, range, selectivity and power, there is little room for hesitation.

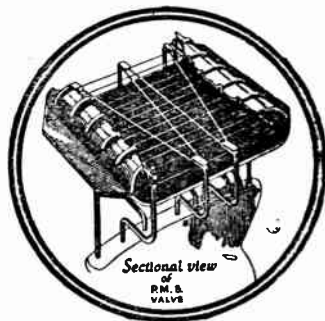

If your particular needs call for distance, if you are a modern "rover," then build the Nelson P.M.—it will serve all your radio fancies without undue expense.

## THE GRENVILLE P.M.

Surely this book would be incomplete unless a way were shown whereby the user of a crystal set could taste of the pleasures of listening to the favoured local station without the headphones?

Designed for use with every type of crystal set—whether commercially or home-constructed—the Grenville P.M. Two Valve Amplifier is the name we have given to a very easily and cheaply built instrument, enabling the use of loud-speaker for the reception of the local station.

Imagine for a brief moment what untold pleasure and enjoyment would be yours if you could only put down the headphones to waltz to the rhythmic melody of a favourite dance? Think of the wonderful music often spoiled by the irritating thought of the untiring pressure of headphones wrapped around your head.

A pound or two spent in a few inexpensive components will enable you to increase the strength of the music to full loud-speaker power. Every care has been taken in the design of the Grenville P.M. to ensure loud-speaker music of "crystal-purity," and remember too, that there are special Mullard P.M. Master Valves for handling volume—the P.M. 254 and the P.M. 256.



### P.M. Super Power Valves

When situated close to a broadcasting station or when several stages of L.F. amplification are being used the quality of the reproduction may be greatly improved by the use of a P.M. super power valve in the last stage of the receiver.

The large grid swing, *i.e.* the great ability to handle power without distortion, available in these special Mullard P.M. Valves secures rich and life-like purity from the loud-speaker.

For 4-volt L.T. supply use the P.M. 254 (0.25 amp.) Price 22/6

For 6-volt L.T. supply use the P.M. 256 (0.25 amp.) Price 22/6

# *A Personal Letter to You*



S. R. MULLARD, M.B.E., A.M.I.E.E.  
*Chairman and Managing Director of the  
Mullard Wireless Service Co., Ltd., and  
Managing Director of the Mullard Radio  
Valve Co., Ltd.*

DEAR READER,

There have been so many applications from the tens of thousands of our P.M. friends for circuits that would be equal to the advanced design of our P.M. Radio Valves, that we felt compelled to meet their wishes.

We now have pleasure in presenting such circuits in the first issue of "Radio for the Million," which will give all our old and new friends complete satisfaction.

We recommend you, however, to look for No. 2 of this book in a short time. There will be something good for all who have constructed the Master P.M. Receivers in this edition.

Go into the work with the power of P.M. behind you, and you will succeed.

Good Luck!

*S. R. Mullard*

# 3 VALVES FOR PURE MUSIC

## THE FRANKLIN P.M.

For faultless loud speaker reception of your local station anywhere within a radius of 20 miles, no more suitable receiver could be designed. 55/- will be found sufficient to purchase the components, an extremely moderate sum.

This instrument combines all the features of a reliable radio receiver with delightfully rich and mellow reproduction.

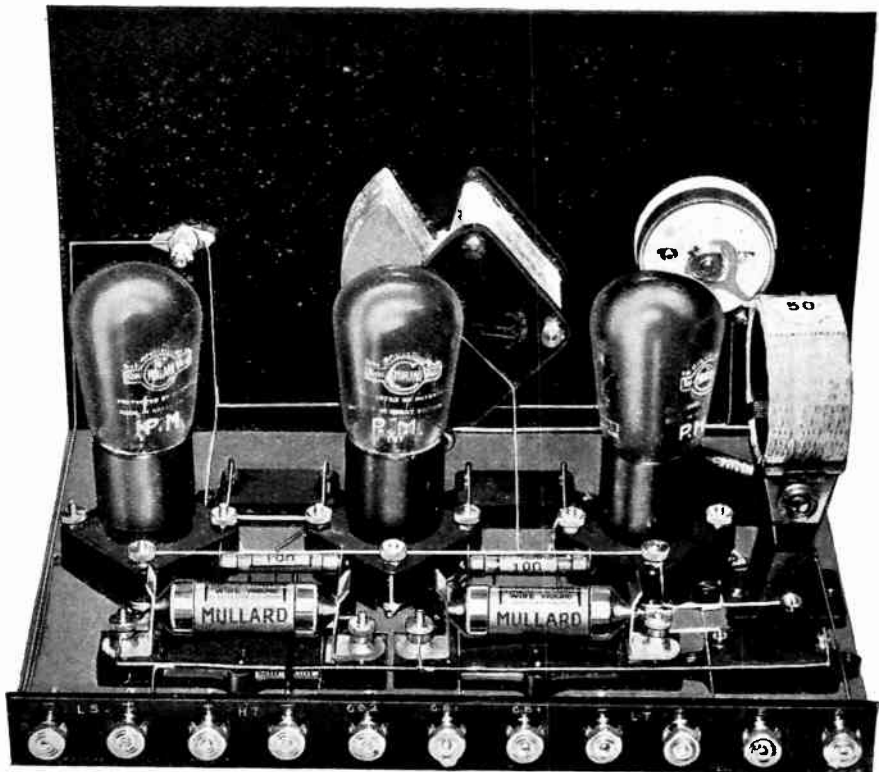

*Little difficulty should be experienced in laying out the various components if the suggestion offered by this view is followed.*

## POINTS ABOUT THE CIRCUIT

In the FRANKLIN P.M. no attempt has been made to secure *extreme* sensitivity—but the set which we have produced is an ideal local station receiver giving loud signals of *extreme* purity.

Reference to the list of parts will give you an intimate idea of the small amount of money required to provide yourself and your family with this ideal “local-set.” Just so long as you are the possessor of a breast-drill, pliers, a screw-driver, a soldering iron, flux and solder, you can construct this extraordinarily efficient receiver in a few hours.

There are only two variable controls in the Franklin P.M., one a variable condenser for tuning-in your particular local station, and the other, a rheostat for adjusting the filament temperature of the detector valve. This rheostat, by the way, also serves as a very convenient method of volume control.

The circuit diagram printed on the next page shows the FRANKLIN P.M. to consist of a simple detector stage followed by two stages of audio-frequency amplification. In addition to the reasons already given for not including reaction, it will be seen that its incorporation would have involved a further variable control necessitating considerable experience to obtain perfect results.

Simplicity has been the aim of our research engineers—simply tune the set until the signals reach maximum strength, after which, the children can operate it for themselves—simply switching on and off by means of a small battery switch.

## RESISTANCE-CAPACITY FOR PURITY

The secret of the delightfully rich tonal quality of the FRANKLIN P.M. is easily and quickly told—Two stages of Resistance-Capacity-Coupling! This form of interval coupling, when used with the modern P.M. Master Valves, specially designed for the Resistance-Capacity-Coupling, provides a degree of amplification practically equal to that obtainable with a transformer.

The sacrifice, if sacrifice it is—of this signal strength is unnoticeable, particularly when Mullard Wire-Wound Resistances are used in conjunction with the correct P.M. Master Valves. There is, however, an almost incredible improvement in the quality of music and speech, that when hearing this receiver for the first time you will feel so wildly enthusiastic that your friends will quickly follow the wisdom of your choice.

*“I would never have believed that radio could bring so many hours of real enjoyment for so little cost.”—A writer in Bristol.*

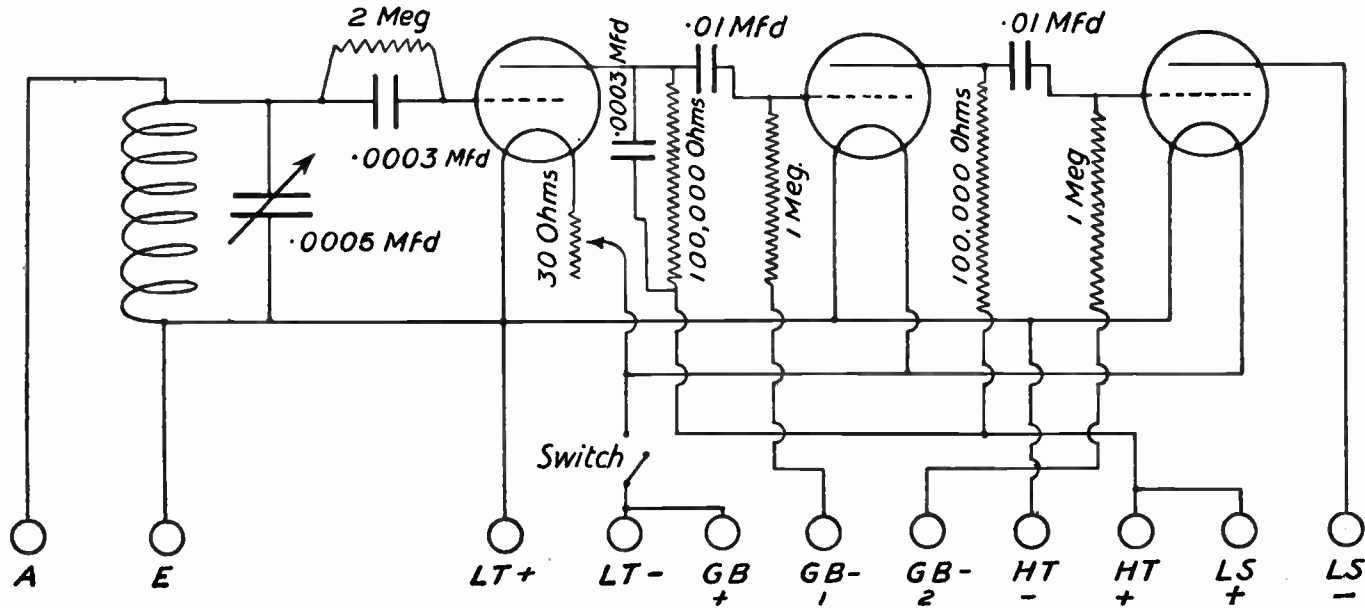

If you are accustomed to the reading of theoretical circuit diagrams, this example will be found simplicity itself. Referred to in conjunction with the free Blueprint No. 101 during the process of wiring, nothing but success will await you immediately upon installation of the receiver.

More advanced readers will probably have the inclination to try varying values of Anode Resistances. As a suggestion—250,000 ohms, 300,000 ohms or 400,000 ohms could be tried, in which case the value of the coupling condenser may be reduced from .01 mfd., to .005 mfd.

## ASSEMBLING THE PARTS

Before commencing any constructional work, we advise our readers to make a very careful examination of the free Blueprint No. 101 which accompanies this gift book. Much experimental work has been done to assure the layout being the most efficient and practical obtainable; convenience in wiring is also an important consideration. For these reasons it is recommended that the layout indicated by our prints of photographs and free Blueprint No. 101 is strictly followed.

The following procedure should therefore be adopted in assembling the set. The front panel should first be drilled to take the variable condenser, the rheostat, and the switch. The necessary holes may also be made along the lower edge of the panel to take the screws for fixing panel to the base-board.

The exact size of the holes which must be drilled for the variable condenser, the switch, and the rheostat, will depend upon the components chosen. The positions for these holes are clearly indicated on the blueprint. No difficulty should therefore be experienced.

Reference to the free Blueprint No. 101 also shows the disposition of the components affixed to the baseboard by suitably sized wood screws. When this has been done, the panel may be screwed to the baseboard.

The terminal strip, with eleven terminals must next be assembled and screwed to the baseboard. The terminals should be spaced equidistant—one inch separating the centres—starting with the centre terminal.

We are now ready for wiring.

### PARTS REQUIRED

- 1 Front panel, 12 in.  $\times$  7 in.  $\times$   $\frac{1}{4}$  in. (this may be of ebonite or of wood as preferred).
- 1 Wood baseboard, 12 in.  $\times$  8 in.  $\times$   $\frac{3}{8}$  in.
- 1 Ebonite strip for terminals, 12 in.  $\times$   $1\frac{1}{4}$  in.  $\times$   $\frac{1}{4}$  in.
- 3 Valve holders.
- 1 Two pin coil socket.
- 1 .0005 mfd. Variable Condenser, with knob and dial.
- 1 .0003 mfd. Mullard Grid Condenser with clips for grid leak.
- 1 2 megohm Mullard grid leak.
- 2 100,000 ohm Mullard Wire Wound Anode Resistance with holders.
- 2 .01 mfd. Mullard fixed mica condensers.
- 1 .0003 mfd. Mullard fixed mica condenser.
- 2 1 megohm Mullard grid leaks.
- 2 Holders for grid leaks.
- 1 Filament rheostat with knob.
- 1 "Push-pull" filament switch.
- 11 Terminals, screws, wire, sleeving.  
Plug-in-coils, Long Wave and Broadcast Wave.

¶ Your usual local dealer has a key to this book, showing alternative types of components which are suitable for the Franklin P.M. Master Radio Receiver, who can supply you at once with the necessary details and parts.

*"The purity of the Franklin P.M. is so true to life that at times the reproduction in our home is quite startling. We have even been asked by our neighbours: 'Who was playing the cello at your place on Sunday?'"*

## WIRING AND INSTALLING

The wiring up of the Franklin P.M. may be accomplished by the least experienced, without any qualms, if the blueprint is followed carefully in conjunction with the "point-to-point" wiring instructions given on this page.

### POINT-TO-POINT WIRING FRANKLIN P.M.

Wire No.

- 1 Join terminal E to terminal L.T.+
- 2 Join terminal L.T.—to terminal G.B.+
- 3 Join terminal H.T.+ to terminal L.S.+
- 4 Join one side of filament switch S to wire No. 2.
- 5 Join F— terminal of valve holder V.2 to F— terminal of valve holder V.3.
- 6 Join the other side of switch S to wire No. 5.
- 7 Join one side of filament rheostat R.1 to wire 6.
- 8 Join other side of rheostat R.1 to F— terminal of valve holder V.1.
- 9 Join aerial terminal A to "fixed vane" terminal F of variable condenser C.5.
- 10 Join one side of coil socket H to wire 9.
- 11 Join one side of grid condenser C.1 to wire 9.
- 12 Join other side of grid condenser C.1 to G terminal of valve holder V.1.
- 13 Join P terminal of valve holder V.1 to one side of condenser C.2.
- 14 Join other side of condenser C.2 to G terminal of valve holder V.2.
- 15 Join P terminal of valve holder V.2 to one side of condenser C.3.
- 16 Join other side of condenser C.3 to G terminal of valve holder V.3.
- 17 Join P terminal of valve holder V.3 to terminal L.S.—.
- 18 Join G terminal of valve holder V.2 to one side of grid leak R.4.
- 19 Join other side of grid leak R.4 to terminal G.B.— 1.
- 20 Join G terminal of valve holder V.3 to one side of grid leak R.5.
- 21 Join other side of grid leak R.5 to terminal G.B.— 2.
- 22 Join the free side of coil socket H to the F.+ terminals of all three valve holders V.1, V.2 and V.3.
- 23 Join wire No. 22 to wire No. 1.
- 24 Join one side of condenser C.4 to one side of anode resistance R.2.
- 25 Join this same side of anode resistance R.2 to the P terminal of valve holder V.1.
- 26 Join the other side of condenser C.4 to the other side of anode resistance R.2 and to one side of anode resistance R.3.
- 27 Join wire 26 to wire 3.
- 28 Join wire 22 to terminal M (moving vanes) of variable condenser C.5.
- 29 Join terminal H.T.—to wire 22.
- 30 Join terminal P of 2nd valve to free end of anode resistance R.3.

The wires should be placed in position and connected up in the order shown.

Before actually soldering any wire into position take a confirming glance at the free Blueprint No. 101, check up with the point-to-point wiring system. When you have satisfied yourself upon the correctness of the connection, solder the wire into its appointed place.

### VALVES TO USE

For 2 volt L.T. supply:—

Detector stage: P.M.1 H.F.  
1st L.F. stage: P.M.1 H.F.  
Last L.F. stage: P.M.2.

For 4 volt L.T. supply:—

Detector stage: P.M.3.  
1st L.F. stage: P.M.3.  
Last L.F. stage: P.M.4.  
P.M.254\*.

For 6 volt supply:—

Detector stage: P.M.5B.  
1st L.F. stage: P.M.5X,  
P.M.5B.  
Last L.F. stage: P.M.6,  
P.M.256\*.

\* The valves are the most suitable to use when strong signals are being handled.

Full reference will be found later in this book giving High Tension voltages, Grid bias and complete characteristic curves which every builder of this receiver is recommended to study.



## OPERATING

First of all connect Aerial, Earth and Loud-speaker leads to their appropriate terminals on the set. If the terminals on the loud-speaker itself are marked positive and negative, the lead marked negative should go to the terminal on the receiver connected to the plate of the third valve. This ensures that the H.T. current passing through the loud-speaker windings is in the right direction.

## FILAMENT BATTERY

Connect next the filament battery to the L.T. + and L.T. - terminals by means of twin flex, care being taken to connect the leads to the set before actually making connection to the accumulator terminals.

## GRID BIAS

Connect a 9 volt grid battery to the appropriate terminals on the set. Short single flex leads should be used with suitable wander plugs at the ends. A red plug should be used for the lead going to positive end of the battery, and two black plugs for the leads which go to the terminals marked G.B.—1 and G.B.—2. If 90 volts or over are used for the H.T., then it may be found necessary to connect 2 nine volt grid bias batteries in series in order to obtain sufficient negative bias for the last valve. The following will be a guide for preliminary adjustment:—

G.B.—1 to— $1\frac{1}{2}$  volts.

G.B.—2 to—9 volts.

## H.T. SUPPLY

Connect up the H.T. battery which may be from 60 to 120 volts; to H.T.— and H.T. +, care being taken to connect to the set terminals before making final connection to the H.T. Battery. A loud click should be heard in the loud-speaker when final connection is made to the H.T. battery, assuming, of course, that the filament switch is on.

## TUNING IN LOCAL STATION

Insert suitable plug-in coil (35 for low wave, 150 for long wave), have filament rheostat full out, and turn variable condenser until loud-speaker gives greatest volume. Adjust grid bias—particularly G.B.2—until good quality is obtained. Volume thereafter may be adjusted by the rheostat control on Detector filament.



The FRANKLIN P.M. reproduces music from this instrument with great fidelity.

*It will be noted that with the exception of the Mullard Wire-Wound Resistances, fixed condensers, and grid leaks, which are recommended as essential components for reliability and extreme purity of reproduction, we have not specified any particular makes or types of components. Full details of the components used in the original receivers are in the possession of your local dealer.*

## TEST REPORT

When tested 14 miles N.W. of London, the Franklin P.M. gave excellent results. The aerial used was of average efficiency, strung between two trees at a height of 35 feet. Full loud-speaking strength for a large drawing-room was obtained both from London and Daventry with a pronounced faithfulness of reproduction throughout the whole musical range. A number of friends present during the course of the test, commented upon the rich quality of the lower notes such as those for which the violin-cello, and the bass viol are responsible.

The three series of suitable Mullard P.M. Master Valves—2, 4 and 6 volt—were tried with equally successful and commendable results.

From 60–100 volts H.T. was used. While the receiver operated quite satisfactorily on the former figure, it is advisable to use not less than 100 volts. It was judged that up to and including 20 miles from any main B.B.C. station, full loud-speaker results would be obtainable.

Those readers who wish to rely upon Daventry for their broadcast programmes may also build this receiver with the utmost confidence of obtaining good loud-speaker results even under somewhat poor conditions.

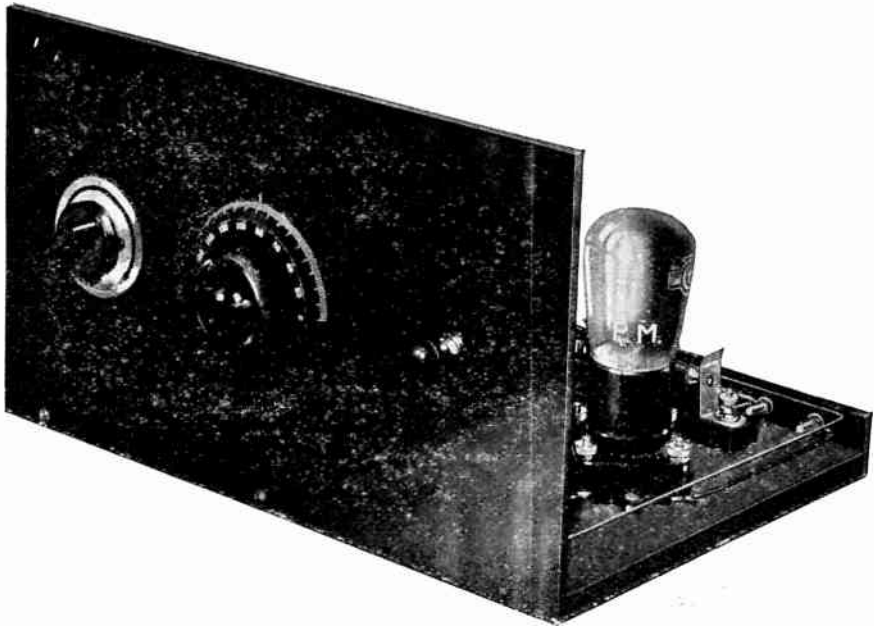

### ANODE RESISTANCE VALUES

The whole value of resistance-capacity coupling as a means of securing purity of reproduction, turns on the degree of constancy that can be obtained in the anode resistance under all conditions.

In this connection, Mullard Wire-Wound Anode Resistances are so skilfully designed that the resistance value is *guaranteed* constant.

For normal use a resistance of this type of 100,000 ohms is adequate, but higher values are recommended for greater amplification where expense is no object.

The workmanship of Mullard Wire-Wound Anode Resistance is such that the application of high H.T. voltages will not damage these resistances in any way.

## IN THE DRAWING ROOM

Our photographs of THE FRANKLIN P.M. do not show any cabinet. Here again we would suggest that you consult your local dealer, who will almost certainly have many suitable types in stock. Alternatively he could obtain one for you from one or other of the manufacturers who specialise in this class of work. There is a very wide choice of styles made to fit the FRANKLIN P.M. since we have been particularly careful to specify standard panel and baseboard dimensions.

On the other hand, many of you would rather spend an evening or two in making a suitable cabinet, in which case the measurements given in our description will provide the necessary details.

## LISTENING TO DAVENTRY

We know that many thousands make consistent use of Daventry. In certain areas far removed from any main B.B.C. station there is no alternative. Again, in other parts of the country the high power station in the Midlands appears to "come over" better. Nor have we forgotten, in the design of the FRANKLIN P.M., the thousands of radio enthusiasts abroad who through Daventry keep in daily touch with Britain.

In these cases the only additional requirement is an extra plug-in coil to take the place of the smaller one used (No. 35 or 50), on the lower broadcast waveband. Owing to varying aerial characteristics it is not possible to specify the correctly numbered coil; for long aerials or systems with long earth leads, No. 150 will be found suitable, while for our readers with very short aerials No. 200 may be found to be the most satisfactory.

In the case of residents living close to a main station, which may cause slight interference when listening to Daventry, it will be found advisable to use an equivalently numbered Gent (150 or 200) T Coil. It will be observed that, over and above the connections formed by the usual pin and socket, a third terminal appears on the plug. This introduces a more selective method of aerial coupling, known as auto-coupling, and will eliminate any interference from powerful low wave stations. When employing this arrangement, simply disconnect the aerial lead from its terminal on the strip at the back of the set, and attach it to the small terminal on the base of the Gent T Coil.

In the reading of this book, produced under the direction of the world's most successful manufacturer of radio valves, we wish you to bear in mind that the highly efficient and satisfactory performance of your radio receiver can only result when your set is constructed with highly efficient apparatus, which, after having passed rigorous tests for mechanical and electrical perfection will, when assembled, provide musical reproduction of irreproachable tone quality.

# LOUD SPEAKING THE LOCAL AT FIFTY MILES

## THE RODNEY P.M.

The design of this admirable receiver solves many of the problems with which thousands of our readers are confronted. The original receiver constructed by the Mullard Research Engineers possesses many outstanding qualities, and we thoroughly recommend its construction by reason of its eminent suitability for those who reside in the provinces, or rather those with aërials placed some thirty to fifty miles from the nearest local station. Its features, among many others, include :—

- ¶ Three Valves economically employed.
- ¶ A good margin of power from the output of the last valve.
- ¶ Selectivity of a high order with the retention of perfect quality.
- ¶ Sensitivity to a satisfactory degree of long range efficiency, while, still retaining its usefulness for the reception of a favourite station within a radius of forty to fifty miles.
- ¶ A stable stage of neutralised high frequency amplification which, properly adjusted, prevents radiating to the annoyance of your neighbours.
- ¶ An easily controlled form of reaction—a method known as “throttle control.”
- ¶ A single stage of audio frequency amplification which allows for the loud-speaker reception of broadcast from a nearby station, with the headphone reception of twenty or more British and European Stations on any evening.
- ¶ Extreme simplicity of control—two tuning dials only. When once the dial readings have been recorded, any member of your family can readjust the dials to a given setting, with the consequent joy of hearing stations which otherwise only greater experience in the art of tuning could bring in.
- ¶ Very inexpensive to install.
- ¶ Negligible upkeep costs when Mullard P.M. Master Valves are used throughout.

## THE CIRCUIT

The last two years of radio progress has brought the system of neutralisation to the forefront, and it has deserved popularity. It reduces to practical non-existence the bug bear of radiation ; or more simply, the selfish propensity to set a receiver oscillating, which even in the case of single valve sets, may produce howling and squealing in every set installed over an area of a few square miles.

A circuit embodying a form of neutralised high frequency is therefore included in The RODNEY P.M. Master Radio Receiver. It comprises also a second stage—a rectifier operating on the leaky grid principle ; the third and last stage amplifies the signals, so that these become audible in the loud-speaker.

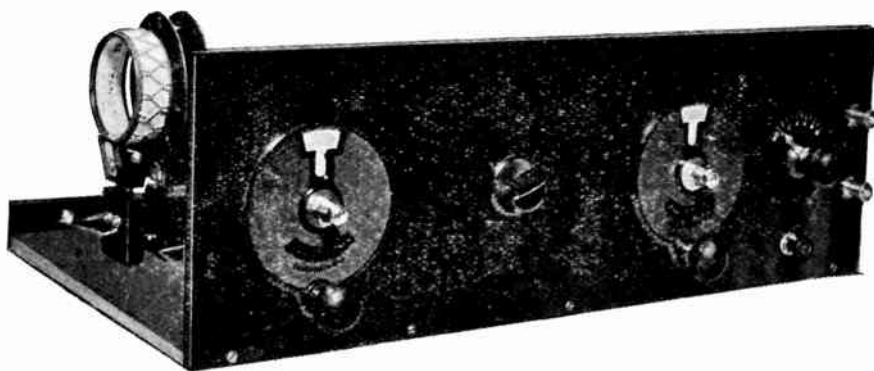

A cursory reference to the circuit diagram of the RODNEY P.M. reveals many interesting points which at first sight may appear to require detailed explanation by virtue of their apparent novelty. Anything, however, in the nature of untried modifications, has been carefully avoided, since our aim has been to provide an arrangement which, while possessing exceptional merit, has been proved not only in the research department but in the hands of people whose technical knowledge of radio is limited.

The high efficiency of the RODNEY P.M. is due to the combination of a stage of neutralised H.F., uniformly stable, with a very easily controlled method of reaction operating on the rectifying valve.

### REACTION CONTROLLED BY CONDENSER

With the neutralising condenser properly adjusted, the RODNEY P.M. can be made to oscillate without interference. This makes searching for distant

stations comparatively easy. The reaction control is a .0003 mfd. variable by-pass condenser connected in the anode circuit of the rectifying valve.

## THE LAST STAGE

In order to obtain the maximum audio-frequency amplification possible with one valve, transformer coupling is employed between the detector and the power amplifying valve. There is no doubt that, when using only one stage of audio-frequency amplification, excellent reproduction can be obtained by using a scientifically designed low frequency transformer. The choice of this particular product will play a very important part in the correct functioning

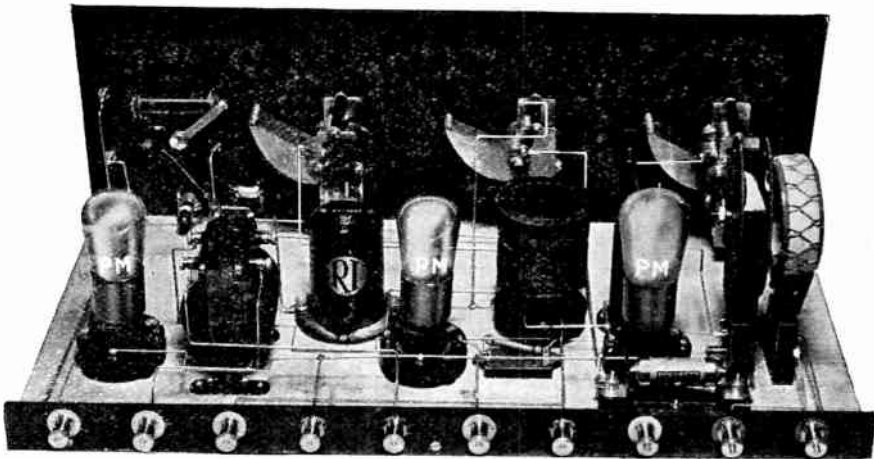

of the set, and we feel impelled to warn intending builders of the RODNEY P.M. to purchase it only with the greatest of all possible care and after considerable thought.

Many excellent low frequency transformers are available, and it is false economy to make any endeavour to save a shilling or two at the expense of the efficiency of your set. Scientific design, both from the point of view of the electrical engineer and of the musician, is not a characteristic of every L.F. transformer. Remember that the quality of reproduction you are destined to obtain depends entirely upon this harmless looking instrument. Also, one good transformer is infinitely preferable to a couple of the nondescript type on the question of pleasant volume, particularly on the score of musical quality.

## AT YOUR DEALERS

We must impress upon home constructors how imperative it is that proved components should be used throughout the construction of the RODNEY P.M. The efficiency of the complete receiver is wholly dependent upon making an expert choice. Be guided, therefore, by our experience. Go to your usual local dealer and ask his advice, for he has the key to the actual components built into the original receiver.

## TEST REMARKS

When tested on an average aerial 35 ft. high, a number of British and foreign stations were heard at good loud speaker strength without interference from 2LO. The tuning was sharp and the set was easy to control, and there was no difficulty in neutralising the H.F. Valve. London was very loud, and excellent quality was obtained. Two, four, or six volt valves gave good results although, for the loudest signals from the local station, either 4 or 6 volt valves gave the best results.

### PARTS TO CHOOSE

- 1 Front panel, 21 in.  $\times$  7 in.  $\times$   $\frac{1}{4}$  in.
- 1 Base board, wood, 21 in.  $\times$  10 $\frac{1}{2}$  in.  $\times$   $\frac{3}{8}$  in.
- 1 Terminal strip, 21 in.  $\times$  1 $\frac{1}{4}$  in.  $\times$   $\frac{1}{4}$  in.
- 12 Terminals.
- 3 Valve-holders.
- 2 Two pin coil holders.
- 2 Tuning condensers .0005 mfd.
- 2 Slow motion indicator dials.
- 1 Variable Reaction Condenser .0003 mf. complete with knob and dial.
- 1 Neutralising Condenser.
- 1 Six pin coil base.
- 1 High frequency transformer six-pin (magnetic reaction) low wave (250 to 550).
- 1 Ditto long wave.
- 1 Grid condenser .0003 and-grid leak 2 megohms. Mullard.
- 1 Filament rheostat.
- 1 Radio frequency choke.
- 1 Resistance, fixed 100,000 ohms. Mullard.
- 1 Holder for resistance.
- 1 Audio frequency transformer.
- 1 Filament switch (push-pull).
- 2 Tuning Coils (Centre Tapped) long and Broadcast Wave.
- 2 Aerial Coils (long and Broadcast Wave).

### VALVES TO USE

- 2 volt L.T. supply :—
  - H.F. stage : P.M.1 H.F.
  - Detector stage : P.M.1 L.F.
  - L.F. stage : P.M.2.
- 4 volt L.T. supply :—
  - H.F. stage : P.M.3.
  - Detector stage : P.M.3.
  - L.F. stage : P.M.4 or P.M.254.
- 6 volt L.T. supply :—
  - H.F. stage : P.M.5X or 5B.
  - Detector stage : P.M.5X.
  - L.F. stage : P.M.6 or P.M.256.

Full references will be found later in this book giving High Tension voltages, Grid Bias and complete characteristic curves which every builder of this receiver is recommended to study.

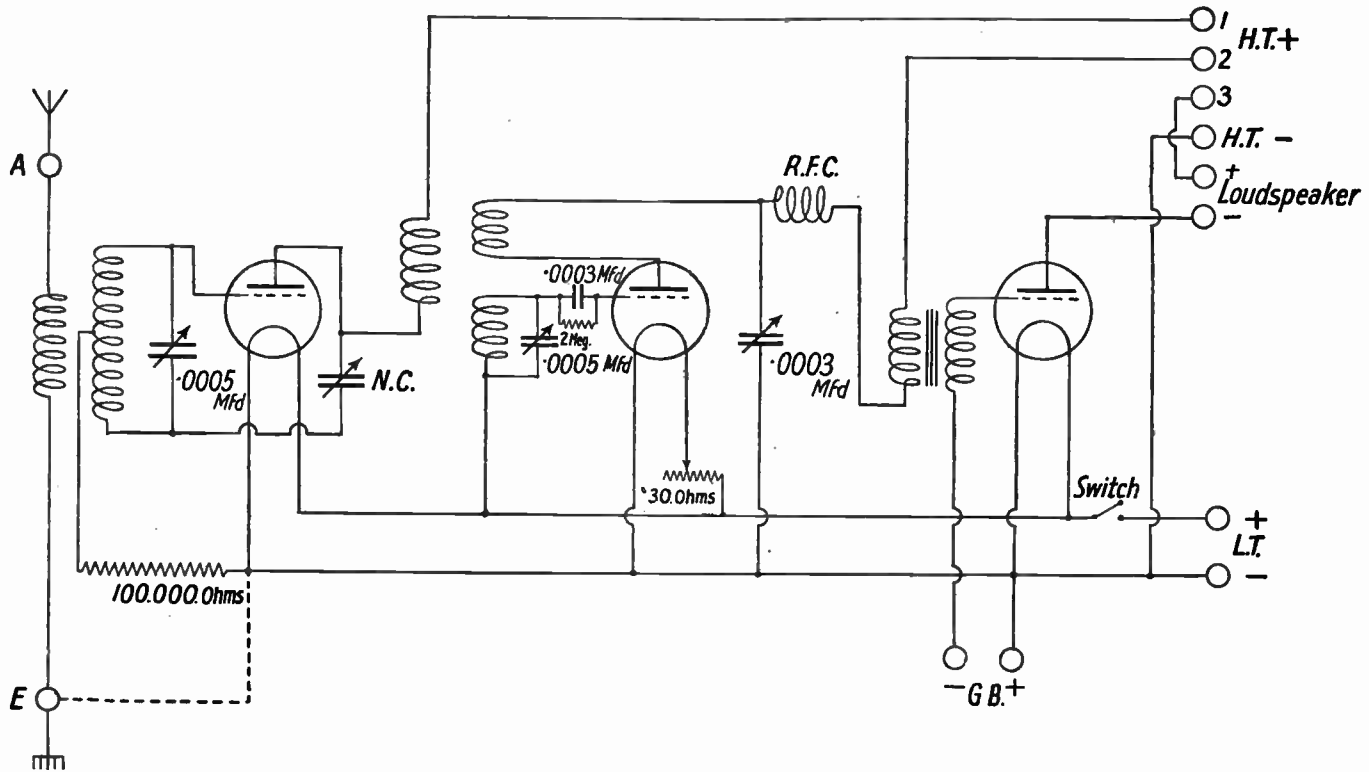

The essential features of the RODNEY P.M. include one of the most successful circuit arrangements of neutralised High Frequency. It should be noted that in the unlikely event of hand capacity effects being present, the dotted connection between the filament of the H.F. Valve and earth should be made permanent.

Magnetic reaction forms a part of the detector circuit. A specially designed Six-Pin Transformer, known as the "Magnetic Reaction" Type, is incorporated in this set. It will be found that the variable by-pass condenser connected across the anode of the detector and the L.T.— enables a wonderfully smooth control to be obtained.



# OF VITAL IMPORTANCE TO ALL VALVE USERS



No P.M.  
Receiver is  
perfect  
without P.M.  
Valves

*Astounding  
Proof that the  
Wonderful  
P.M. Filament  
makes an 18/6 valve  
worth 18/- after a year's  
broadcasting service.*

A batch of Mullard P.M. Valves from stock was submitted for test to the National Physical Laboratory. The report of this recognised impartial commercial test proves

That after 1000 hours life an average of more than 97% of the original purchase price was available.

That during the 1000 hours life the current consumption remained constant and equivalent to one-seventh of that of any bright filament valve.

That due to the generous emission the operating efficiency remained constant during the whole 1000 hours life test.

The secret is the wonderful P.M. Filament which has no equal and which is found only in Mullard P.M. Valves.



## Mullard

**THE • MASTER • VALVE**

THE ONLY VALVE WITH A PUBLISHED NATIONAL PHYSICAL LABORATORY TEST

## RECEIVING DAVENTRY ON THE RODNEY P.M.

It will be understood that the same set of coils will not serve for the reception of the broadcast working on wavelengths from 250 to 600 metres, as well as the long wave stations such as Daventry, Hilversum and Radio Paris. Where those stations are desired it will be necessary to change the coils in the aerial circuit, the first circuit of the first H.F. Valve and also the six-pin coil, coupling this valve to the detector circuit. For the convenience of those who wish to listen to these stations, we give the values :—

<b>For B.B.C. Stations up 500 metres</b>	<b>For Daventry</b>
<b>Aerial Circuit</b>	

Aerial Coil ... ..	35	100
Grid Coil (H.F. Valve) (with centre tap) ... ..	60	150-200

### High Frequency Six-pin Transformers

*The various manufacturers of this component usually mark each coil "low wave, 250 to 550" or "Long wave 1200 to 1800 metres." It is worthy of note that when purchasing be certain of emphasising that these coils are required for the Mullard RODNEY P.M. Master Radio Receiver. In the case of the Rodney P.M., ask your dealer for the Magnetic Reaction Type.*

### POINT-TO-POINT WIRING

- |  |  |
|--|--|
| <ol style="list-style-type: none"> <li>1 Join terminal L.T.- to terminal G.B.+</li> <li>2 Join terminal A to one terminal of aerial coil holder H.A.</li> <li>3 Join terminal E to the other terminal of aerial coil holder H.A.</li> <li>4 Join one terminal of secondary coil holder H.S. to terminal F (fixed vanes) of variable condenser C.1.</li> <li>5 Join this same terminal of coil holder H.S. to terminal G of valve holder V.1.</li> <li>6 Join the other terminal of coil holder H.S. to one side of the neutralising condenser C.5 and on to terminal M (moving vanes) of variable condenser C.1.</li> <li>7 Join terminal L.T.+ to one side of switch S.</li> <li>8 Join other side of switch S to one side of Rheostat R.1.</li> <li>9 Join this same side of switch S to terminal 2 of six-pin coil holder.</li> <li>10 Join wire 9 to terminal M (moving vanes) of variable condenser C.3.</li> <li>11 Join F+ terminal of valve holder V.3 to F+ terminal of valve holder V.1.</li> <li>12 Join wire 9 to wire 11.</li> <li>13 Join terminal H.T.+1 to terminal 3 on six-pin coil holder.</li> <li>14 Join F- terminals of all three valve-holders V.1, V.2 and V.3 together.</li> <li>15 Join terminal G.B.+ to wire No. 14.</li> <li>16 Join terminal H.T.- to wire No. 14.</li> <li>17 Join one end of resistance R.2 to wire No. 14.</li> <li>18 Join terminal M (moving vanes) of variable condenser C.2 to wire No. 14.</li> </ol> | <ol style="list-style-type: none"> <li>19 Join terminal P of valve holder V.1 to free terminal of neutralising condenser C.5.</li> <li>20 Join terminal 5 of six-pin coil holder to wire 19.</li> <li>21 Join terminal 4 of six-pin coil holder to one terminal of H.F. choke.</li> <li>22 Join terminal F (fixed vanes) of variable condenser C.2 to wire No. 21.</li> <li>23 Join terminal 1 of six-pin coil holder to terminal F of variable condenser C.3.</li> <li>24 Join one side of grid condenser C.4 to wire 23.</li> <li>25 Join other side of grid condenser C.4 to terminal G of valve holder V.2.</li> <li>26 Join terminal 6 of six-pin coil holder to terminal P of valve holder V.2.</li> <li>27 Join terminal F+ of valve holder V.2 to free terminal of Rheostat R.1.</li> <li>28 Join free terminal of H.F. choke to "Plate" terminal of L.F. transformer.</li> <li>29 Join H.T.+ terminal of L.F. transformer to terminal H.T.+2.</li> <li>30 Join "Grid Bias" terminal of L.F. transformer to terminal G.B.-</li> <li>31 Join earthing terminal on carcass of L.F. transformer (if provided) to wire No. 14.</li> <li>32 Join "Grid" terminal of L.F. transformer to terminal G on valve holder V.3.</li> <li>33 Join terminal L.S.- to terminal P on valve holder V.3.</li> <li>34 Join terminal L.S.+ to terminal H.T.+3.</li> <li>35 Join a piece of flexible wire, about six inches long, to the free terminal of resistance R.2. This wire is for making connection to the centre tap of the secondary coil.</li> </ol> |
|--|--|

## MAKING A START

As our illustrations indicate, this receiver is surprisingly simple to construct. Two evenings only are necessary to enable its assembly in a manner of which you should have every reason to be proud.

The dimensions of the panel and baseboard allow ample space between any components which, when placed too closely together, may give rise to interaction. Troubles, consequent upon factors of this kind entering into activity, will not be encountered by the wise constructor who takes advantage of the experience of our research engineers.

The panel is now drilled in accordance with the layout advised by the Free Blueprint No. 102, first making certain that your panel is accurately squared up and your punch marks correctly calculated to suit the particular components you have chosen to use. Attach the panel to the baseboard whereon place—again following the blueprint—the necessary pieces of apparatus. The three variable condensers, the battery switch and the rheostat may now be placed in their respective positions.

Wiring should now be commenced.

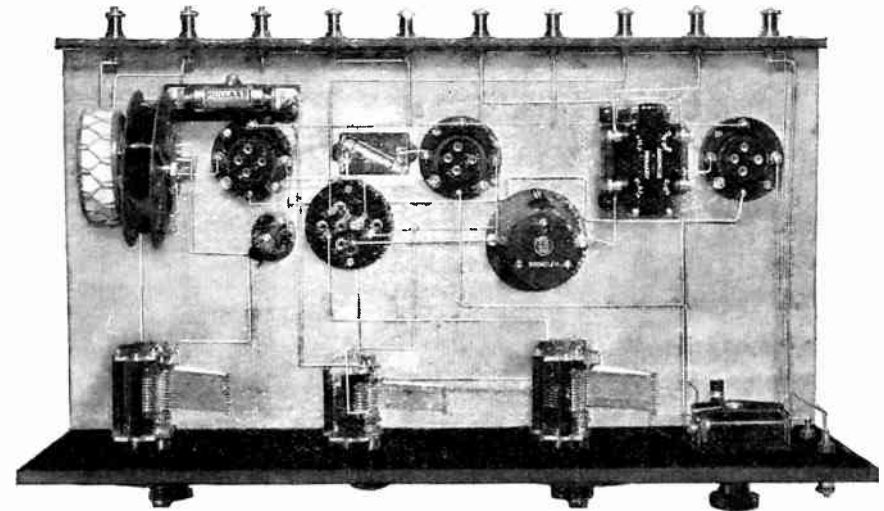

Having equipped yourself with a good soldering outfit, a pair of cutting pliers, a pair of round-nosed pliers, and a quantity of 16 or 18 gauge tinned-copper wire, spread out on your bench within easy sight, the Blueprint No. 102. Connect up the various components in the order suggested by the "point-to-point" method appearing on page 26 and make every wire follow the direction indicated by the Blueprint. In this way the final wire will be reached without either hesitation or error.

For the sake of absolute certainty make a complete wire-by-wire check, using the information contained in the point-to-point instructions.

## Operating Instructions

Connect up aerial, earth, loud-speaker and batteries to the appropriate terminals on the set, the usual care being exercised.

On this Receiver three H.T. terminals are provided so that the full H.T. voltage need not be applied to the anode of the H.F. Valve and detector valve. If 60 volts only are used, the three H.T. + terminals can be connected together and the full H.T. connected to all the valves. If 120 volts are available, it will usually be found preferable to employ reduced voltage to the H.F. and detector valve. The correct values should be decided by experiment.

There being only one stage of audio frequency amplification, one negative bias terminal is provided which should be connected to the grid battery.

Before proceeding to tune in to any broadcasting station, the high frequency valve should be properly neutralised. This can easily be done by first of all removing the aerial coil, setting reaction condenser (centre condenser) to zero, the second circuit tuning condenser to about 90, and turning grid tuning condenser of No. 1 valve (left hand dial). If this set is not properly neutralised a click will be heard in the loud-speaker or telephones, every time the condenser passes the tuning point corresponding to the second circuit tuning. The neutralising condenser should be adjusted until no such click is heard. It can be assumed that the set is now properly neutralised, and the aerial coil can be replaced. Do not forget to connect the flexible lead to the centre of the coil.

No station will be heard until both the tuned circuits are in resonance. Tuning should be carried out by very slowly rotating one of the condensers with one hand whilst the second condenser is slowly moved backward and forward, until the desired signal is heard. The reaction control (right hand dial) should at the same time be adjusted until the set is just off the oscillating point. Excessive reaction will cause serious distortion.

It is only a matter of practice before one becomes an adept in tuning in to any desired station.

*No useful object is served by controlling (individually or otherwise) either H.F. or L.F. Valves by rheostats, by fixed resistors or by any other form of current control, by reason of the fact that the design, construction and formation of the wonderful P.M. Filament renders the Mullard P.M. Master Valve extremely robust. You will incur no risk of either over-running the filament or shortening the life of the valve.*

# EUROPE MAPPED OUT IN YOUR LOG BOOK

## The Nelson P.M. Master Radio Receiver

Who among us could resist the fascination of a receiver such as this? In appearance it assuredly constitutes a new conception of modern receiver design. On the count of performance THE NELSON P.M. is amazingly supreme. No other four-valve combination—regardless of source or country of origin—can offer you a receiver with which you will be able to spend so many delightful hours.

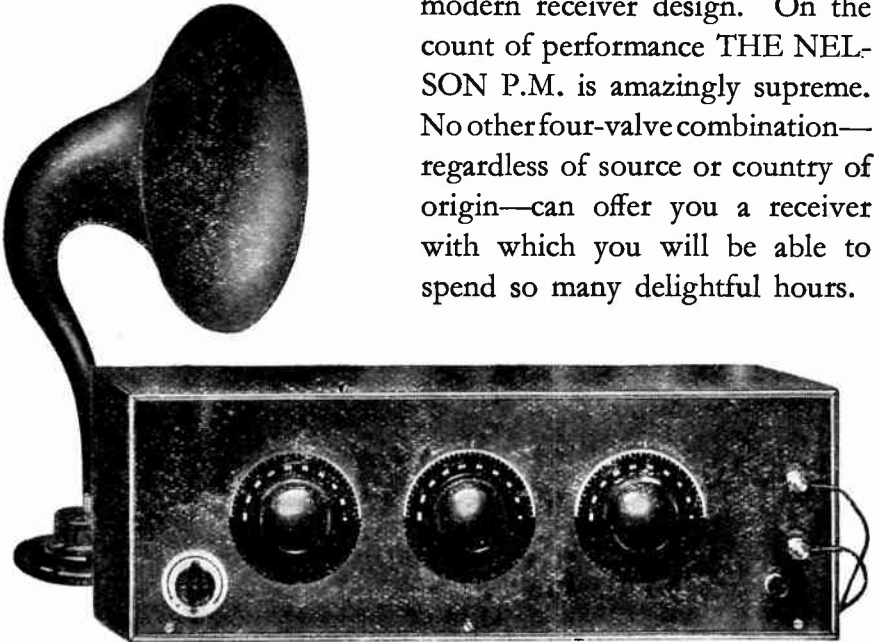

*Comment on this front panel design is almost unnecessary. Apart from the three tuning dials and loud speaker terminals, the remaining two controls are the rheostat controlling the detector valve and a simple "on and off" battery switch. These are placed on the extreme left and extreme right hand bottom corners of the panel.*

With a receiver such as this in your possession, every radio station in Britain and on the Continent is within range. Several stations—25 practically—will nightly provide varying programmes at ample loud-speaker strength.

The NELSON P.M. will give your home something more than Radio. You have often dreamed of that wonderful cosmopolitan life—Paris, Madrid, Rome, Berlin, Leipsic, Vienna, Hamburg and scores of others. Ah! If you could only roam the world . . . . THE NELSON P.M. will bring you into closer and more intimate touch than anything else science has yet invented.

## THE FASCINATION OF DISTANCE

In various places in this book, we have endeavoured to show our readers that no one receiver can serve as the ideal "local set" and also as a "distance set."

We have advised the possession of two entirely separate receivers. The highest efficiency can only be obtained on both counts when receivers are designed for either one or other purpose. Although the inclusion has been made in the NELSON P.M. of an excellent system of low frequency amplification which gives exceedingly faithful reproduction, it is recommended that where consistent long distance reception is contemplated, the NELSON P.M. should be constructed and used exclusively, a purpose it serves with high distinction.

Doubtless, many of you who are reading these pages have not as yet tasted of the pleasures of bringing in distant stations. You have probably heard from an unsuccessful friend that "distant stations are not worth listening to." There was, without a doubt, a large amount of truth in his complaint, but we wish to hasten into an explanation of his apparent misfortune by repeating that his receiver could not have been designed for distant work.

The successful design of the NELSON P.M. disposes of this type of ill-success, and we can confidently recommend this particular receiver to be extraordinarily and eminently suitable.

When you have successfully constructed this set, you may promise yourself a new interest in radio. Wonderful opera from Germany and Spain; irresistible dance music from Berlin and Paris; language lessons from Sweden and Italy—truly a magical world.

### The Circuit

The system of neutralised high frequency incorporated in this receiver, in our experience has proved so wonderfully stable that in conjunction with the fact that it also gives a very high degree of amplification, it has persuaded us to make it one of the outstanding features of the NELSON P.M. Those who are considering its construction need have no qualms that any difficulty will be experienced in adjusting this circuit to its best operating efficiency.

The coupling employed between the first and second valves uses the Reinartz form of reaction which, as is well known, provides a reaction control of the utmost simplicity and efficiency.

An interesting point in connection with this circuit will reveal itself when one examines the grid return lead of the detector valve. Provision is made so that either "leaky-grid" or "anode bend" rectification may be employed. This is achieved by taking G.B.—1 either to negative bias or L.T.+.

Coming to low-frequency side, every advantage has been taken of the exceptional musical properties of Resistance Capacity when used in conjunction with a stage of well-designed transformer coupling. The most casual listener among your friends will be impressed by the striking purity of reproduction, especially upon the type of music which formerly has offended your musical ear.

## CHOOSING THE COMPONENTS

In a receiver of this kind extreme care should be displayed in purchasing the components necessary, and we would again advise you to do this in conjunction with your local dealer, who, by the way, has a key to the apparatus incorporated in the original receiver built by the Mullard Engineers.

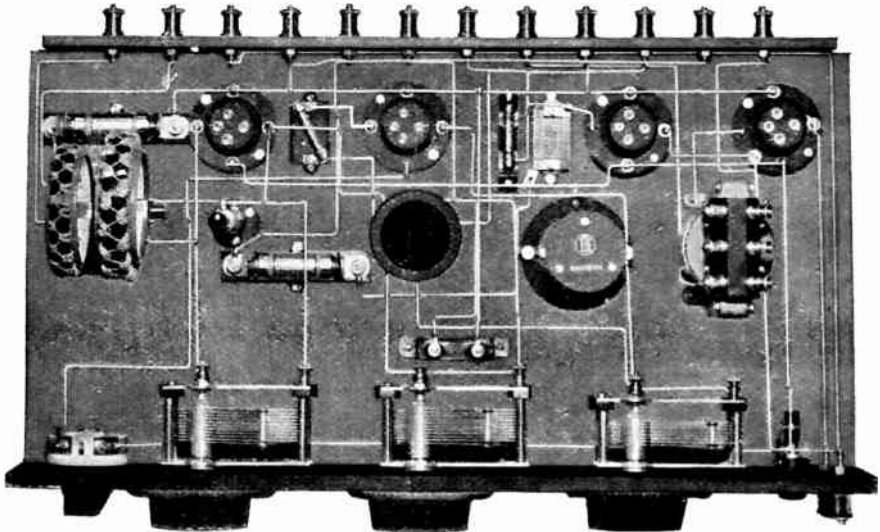

## THIS LIST WILL SAVE YOU TIME

- |   |   |
|---|---|
| 1 Front panel, 21 in. x 7 in. x $\frac{1}{4}$ in.                 | Centre-tapped Aerial (Secondary) coil, long (E) and broadcast wave (B). |
| 1 Baseboard, 21 in. x $10\frac{1}{2}$ in. x $\frac{3}{8}$ in.     | 1 Fixed mica condenser 0.01 mfd. Mullard Type MB.                       |
| 1 Terminal strip, 21 in. x $1\frac{1}{2}$ in. x $\frac{1}{4}$ in. | 1 Radio frequency choke.  |
| 14 Terminals.   | 1 Special wire-wound anode resistance 100,000 Ohms. Mullard Ever-rest.  |
| 4 Valve holders anti-microphonic.                                 | 1 Special holder for anode resistance. Mullard.                         |
| 2 Plug-in coil holders.   | 1 Grid leak 1 meg. Mullard.   |
| 2 Variable condensers .0005 with knobs and dials.                 | 1 Holder for above.   |
| 1 Variable condenser .0003 with knob and dial.                    | 1 Audio frequency transformer.  |
| 1 Neutralising condenser.   | 1 Filament switch "push-pull."  |
| 1 Resistance, 100,000 ohms. Mullard.                              | 1 Filament rheostat.  |
| 1 Holder, suitable for above.                                     | 1 Six-pin coil base.  |
| 1 Condenser .0003 with 2 meg. grid leak. Mullard.                 | 2 H.F. transformer (split primary type), long and broadcast wave.       |
| 1 Fixed condenser .002 mfd. Mullard Type MB.                      |   |
| Aerial Coil long (100) and broadcast wave (35 or 50).             |   |

## PREPARING FOR THE SOLDERING IRON

We do not propose to explain at great length the procedure of mounting the components on the panel and the baseboard. The Blueprint, No. 103, which we are presenting free with every copy of "Radio for the Million," indicates both clearly and precisely the relative positions of the various components.

It is perhaps not necessary for us to reiterate our injunctions with regard to the manner in which you follow our instructions, but we would like to add that in connection with this receiver, the Editor is offering a very handsome prize.

He feels very certain in his own mind that the fortunate winner will not surpass the example set by the original receiver. This remark, although

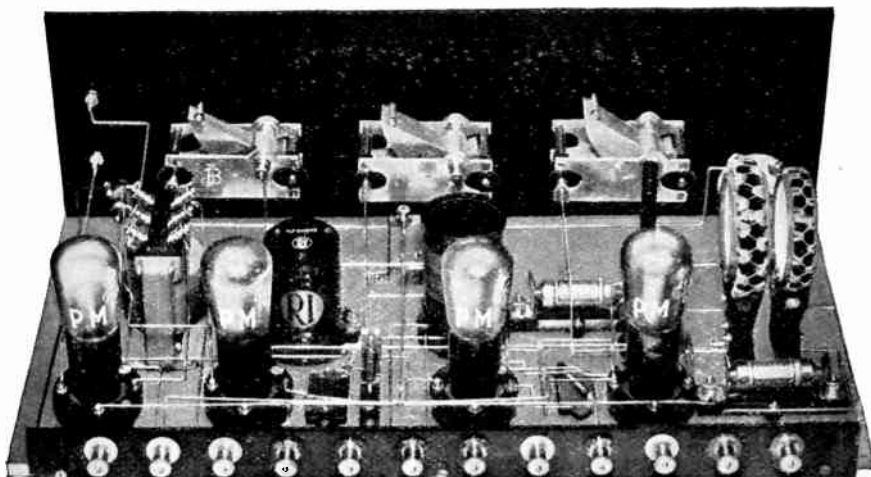

possessing the ring of a challenge, is intended to be taken as a word to the wise—those enthusiasts who are only content with their work when it is accomplished in the most workmanlike way.

It is our own belief, therefore, that your shortest way to success lies in the strictest adherence to the free Blueprint, No. 103, which will show you the direction every wire should take. Reference to the "point-to-point" system, which details the beginning and ending place of every individual wire should be constantly used, when, upon reaching the last wire, a complete check-over should be made again, using the "point-to-point" details.

*Consult your nearest radio dealer on any component query you may have when constructing these P.M. Receivers. You will find him ready to help you because he knows that every P.M. Valve user will always be a satisfied customer.*

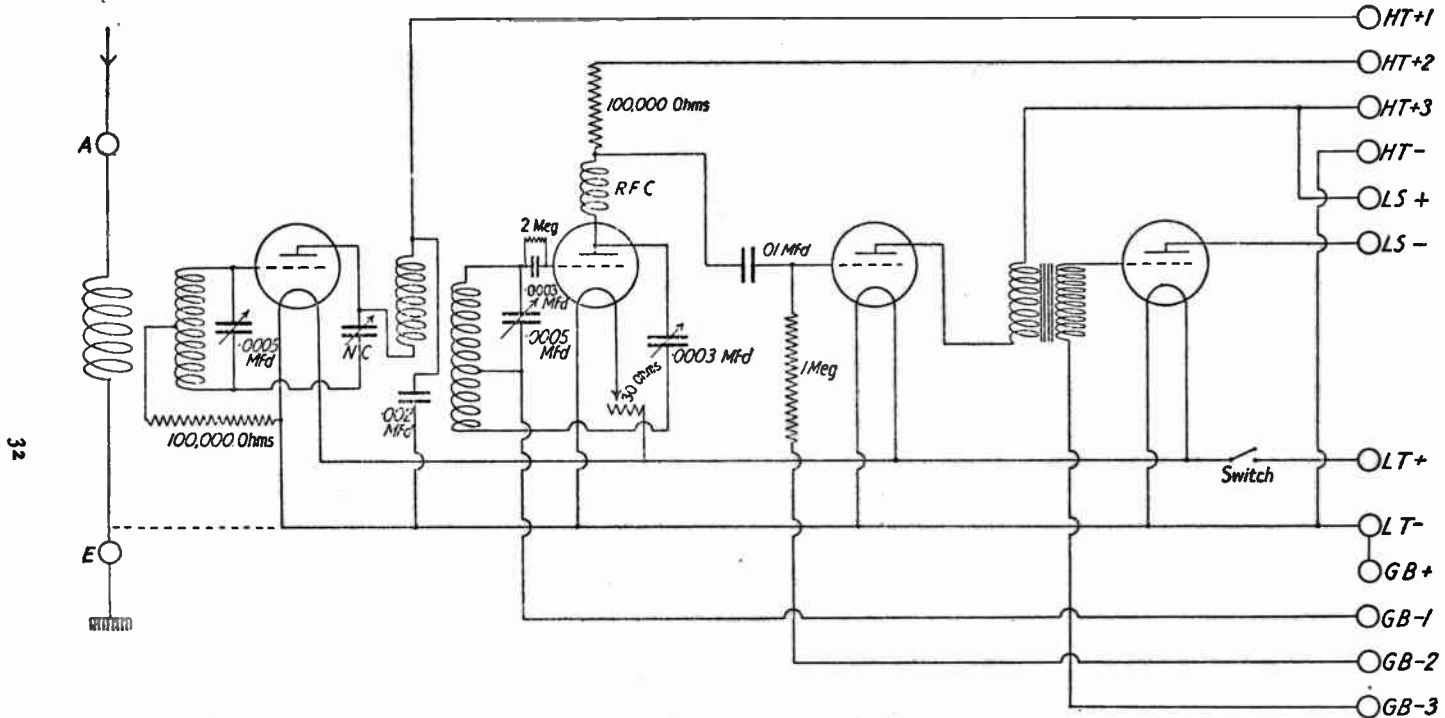

32

In this receiver Pin No. 4 of the Six-pin **Split Primary Transformer**, coupling the H.F. and Detector Valves, is left free. So that a smooth reaction control can be obtained, give a little attention to the filament temperature of the detector valve.

Here again the enthusiast who is able to claim experience will find that experiment with the value of the resistance in the anode circuit of the detector valve may produce greater amplification.



## NELSON P.M.

### Point-to-Point Wiring

#### Wire No.

- 1 Join terminal L.T.+ to one side of switch S.
- 2 Join other side of switch S to F+ terminal of valve holder V.4.
- 3 Join this same side of switch S to one side of rheostat R.1.
- 4 Join one side of aerial coil holder H.A. to terminal E.
- 5 Join other side of coil holder H.A., to terminal A.
- 6 Join terminal L.S.— to terminal P of valve holder V.4.
- 7 Join terminal LS + to terminal P.O. of (multi-ratio) transformer.
- 8 Join this same terminal P.O. of transformer to terminal H.T. + 3.
- 9 Join terminal S.2 of (multi-ratio) transformer to terminal G.B.—3.
- 10 Join terminal G.B. + to terminal L.T. —.
- 11 Join terminal F (fixed vanes) of variable condenser C.2 to terminal 1 of six-pin coil holder.
- 12 Join one side of resistance R.3 to one side of H.F. Choke and on to one side of condenser C.6.
- 13 Join other side of H.F. Choke to terminal F (fixed vanes) of variable condenser C.3.
- 14 Join this same side of H.F. choke also to P terminal of valve holder V.2.
- 15 Join terminal M (moving vanes) of variable condenser C.3 to terminal 6 of six-pin coil holder.
- 16 Join terminal M (moving vanes) of variable condenser C.2 to terminal 2 of six-pin coil holder.
- 17 Join terminal GB—1 to wire No. 16.
- 18 Join one side of secondary coil holder H.S. to one side of neutralising condenser C.7 and on to terminal F (fixed vanes) of variable condenser C.1.

- 19 Join one terminal of resistance R.2 to F— terminal of valve holder V.1 and on to terminals F— of valve holders V.2, V.3, and V.4.
- 20 Join terminal LT— to wire No. 19.
- 21 Join terminal HT— to wire No. 19.
- 22 Join free end of resistance R.3 to terminal HT+2.
- 23 Join free terminal of rheostat R.1 to F+ terminal of valve holder V.2.
- 24 Join terminal M (moving vanes) of variable condenser C.1 to terminal G on valve holder V.1.
- 25 Join free terminal of secondary coil holder HS to wire 24.
- 26 Join terminal HT+1 to terminal 3 of six-pin coil holder.
- 27 Join one side of condenser C.4 to wire No. 26.
- 28 Join together terminals F+ of valve holders V.1, V.3 and V.4.
- 29 Join terminal P of valve holder V.1 to terminal 5 of six-pin coil holder.
- 30 Join terminal P of valve holder V.1 also to free terminal of neutralising condenser C.7.
- 31 Join terminal 1 of six-pin coil holder to one side of grid condenser C.5.
- 32 Join other side of grid condenser C.5 to terminal G of valve holder V.2.
- 33 Join one side of grid leak R.5 to terminal GB—2.
- 34 Join other side of grid leak R.5 to free side of condenser C.6 and on to terminal G of Valve holder V.3.
- 35 Join free side of condenser C.4 to wire No. 19.
- 36 Join terminal G of valve holder V.4 to terminal SO of (multi-ratio) transformer.
- 37 Join terminal P of valve holder V.3 to terminal P.2 of (multi-ratio) transformer.
- 38 Join a flexible lead to the free terminal of resistance R.2, about 6 inches in length, for connection to centre tap of secondary coil.

#### Valves to use

For 2 volt L.T. supply:—

- 1st H.F. Valve : P.M.1 H.F.
- Detector Valve : P.M.1 H.F.
- 1st L.F. Valve : P.M.1 L.F.
- Last L.F. Valve : P.M.2.

For 4 volt L.T. supply:—

- 1st H.F. Valve : P.M.3.
- Detector Valve : P.M.3.
- 1st L.F. Valve : P.M.3, P.M.4\*.
- Last L.F. Valve : P.M.4, P.M.254\*.

For 6 volt L.T. supply:—

- 1st H.F. Valve : P.M.5B, P.M.5X.
- Detector Valve : P.M.5B, P.M.5X.
- 1st L.F. Valve : P.M.5X, P.M.6\*.
- Last L.F. Valve : P.M.6, P.M.256\*.

\* These valves are most suitable in cases where very powerful signals are to be handled.

Full references will be found later in this Book, giving High Tension Voltages, Grid bias, and complete characteristic curves which every builder of this receiver is recommended to study.

#### Test Remarks

Tested on a good aerial and with the exception of Bournemouth, all British Main Stations, in addition to many well-known Continental Stations, were clearly received at good loud speaker strength without any interference from 2 LO.

Quality of reproduction was excellent. There was no difficulty in neutralising the H.F. circuits, and the set was extremely stable. There was no difficulty in tuning in the various stations.

Daventry and Radio Paris were received at full loud speaker strength.

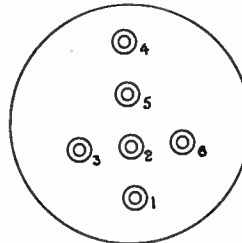

This diagram indicates very clearly the numbering of the "Six Pin" coil base referred to in the point-to-point connections.

Although complete installing and operating instructions appear elsewhere in this admirable book, for the convenience of those readers who have constructed this receiver, we are reproducing here every detail which may be considered necessary.

## Operating Instructions

Connect up aerial, earth, loud-speaker and batteries to the appropriate terminals on the set, the usual care being exercised.

On this Receiver three H.T. terminals are provided so that the full H.T. voltage need not be applied to the anode of the H.F. Valve and detector valve. If 60 volts only are used, the three H.T. terminals can be connected together, and the full H.T. connected to all the valves. If 120 volts are available, it will usually be found preferable to employ reduced voltage to the H.F. and detector valve. The correct values should be decided by experiment.

There being two stages of audio frequency amplification, two negative bias terminals are provided for the L.F., while a third G.B.-terminal (G.B.-1) enables anode bend rectification to be used, in which case G.B.-1, should be connected to negative grid battery.

Before proceeding to tune in any broadcasting station, the high frequency valve should be properly neutralised. This can easily be done by first of all removing the aerial coil, setting reaction condenser (right hand dial), to zero, the second circuit tuning condenser to about 90, and turning grid tuning condenser of No. 1 valve (left hand dial). When not properly neutralised a click will be heard in the loud-speaker or telephones every time the condenser passes the tuning point corresponding to the second circuit tuning. The neutralising condenser should be adjusted until no such click is heard. It can now be assumed that the set is properly neutralised, and the aerial coil can be replaced. Do not forget to connect the flexible lead to the centre of the Aerial (secondary) coil.

No station will be heard until both the tuned circuits are in resonance. Tuning should be carried out by very slowly rotating one of the condensers with one hand whilst the second condenser is slowly moved backward and forward, until the desired signal is heard. The reaction control (right hand dial) should at the same time be adjusted until the set is just off the oscillating point. Excessive reaction will cause serious distortion.

.....  
Readers are particularly requested to note that the Six-Pin H.F. Transformer used in the Nelson P.M. is a "Split Primary." Blueprint No. 103 shows that Pin No. 4 of this component is not connected.  
.....

# £10 Prize in our Free Competition and 10 Consolation Prizes of P.M. Master Valves

Here is an interesting competition which should appeal strongly to those of our readers whose sets, when constructed, show the neatness and tidy layout of good craftsmanship.

We are offering a prize of £10 for a photograph of the interior of the Nelson P.M. Master Radio Receiver which, in the Editor's opinion, shows the neatest and most workmanlike construction, together with a short article of about 200 words giving your reasons for choosing this particular receiver, and the results you have so far obtained with it. Ten consolation prizes of Mullard Master P.M. Valves will also be distributed. Your entry should be received on or before Thursday, February 10th, 1927.

*All entries should be addressed to :—*

THE EDITOR,  
"RADIO FOR THE MILLION,"  
63, LINCOLN'S INN FIELDS,  
LONDON, W.C.2.

All attempts are accepted on the condition that Mullard P.M. Master Valves are used in the set. The Editor's decision in all matters must be regarded as final, and no correspondence can be entered into.

## £1 for Bright Ideas

We shall also be pleased to receive any bright ideas you may have either on the construction of sets or upon improvements which might be made to this publication, and for any of which we make use, we will award a prize of £1.

# LOUD SPEAKING FROM YOUR CRYSTAL SET

## THE GRENVILLE P.M.

With the price of radio valves within the reach of every purse, this efficient Two Valve Amplifier is included in this admirable book with the conviction that many, many thousands will once and for all dispose of their headphones when the advantages of loud-speaker reception may be secured at such a nominal cost.

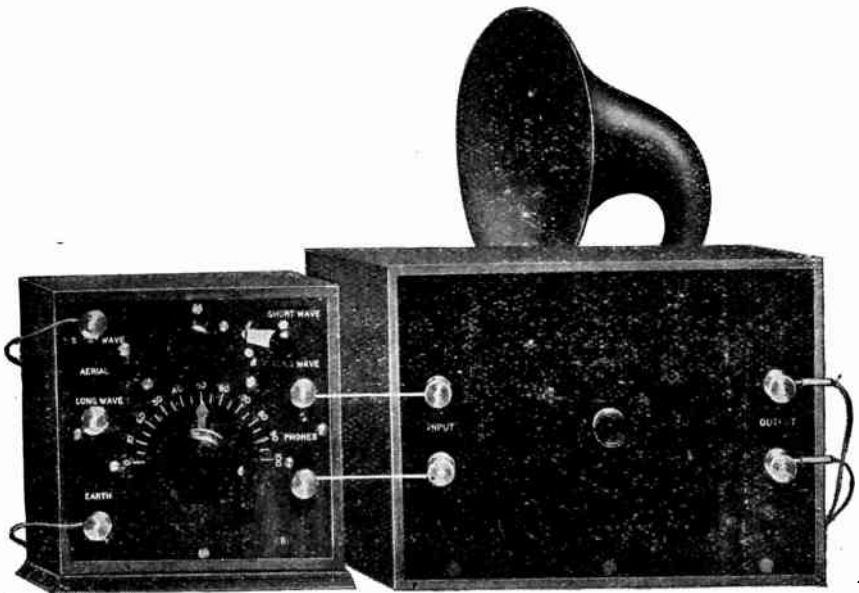

Perhaps there has been some doubt in many minds regarding a possible loss of purity so inherently characteristic of the crystal. This extremely compact Two Valve Amplifier, which by the way presents quite a pleasing appearance to the eye, has been very carefully designed with the object of retaining this life-like reproduction of speech and music. On test, when a speaker, requiring a large input of power was used, this instrument conducted itself with great distinction:

The Grenville P.M. is designed to meet the requirements of the very large number of crystal set users who wish to convert their set, which may be either commercially or home constructed, into a full volume loud-speaker receiver, securing excellent quality. This amplifier may be very easily built up and may be operated by anyone.

## THE CIRCUIT

The Grenville P.M. is a two stage audio-frequency valve amplifier, an iron core step-up transformer forming the coupling between the crystal set and the grid circuit of the first valve. The second stage of L.F. amplification incorporates the well-known resistance-capacity coupling between the first and second L.F. valves. The anode resistance used for this purpose is the specially designed Mullard Wire Wound Anode Resistance, which is ideal for the work, and which, besides being absolutely constant, amplifies musical frequencies evenly throughout the entire range.

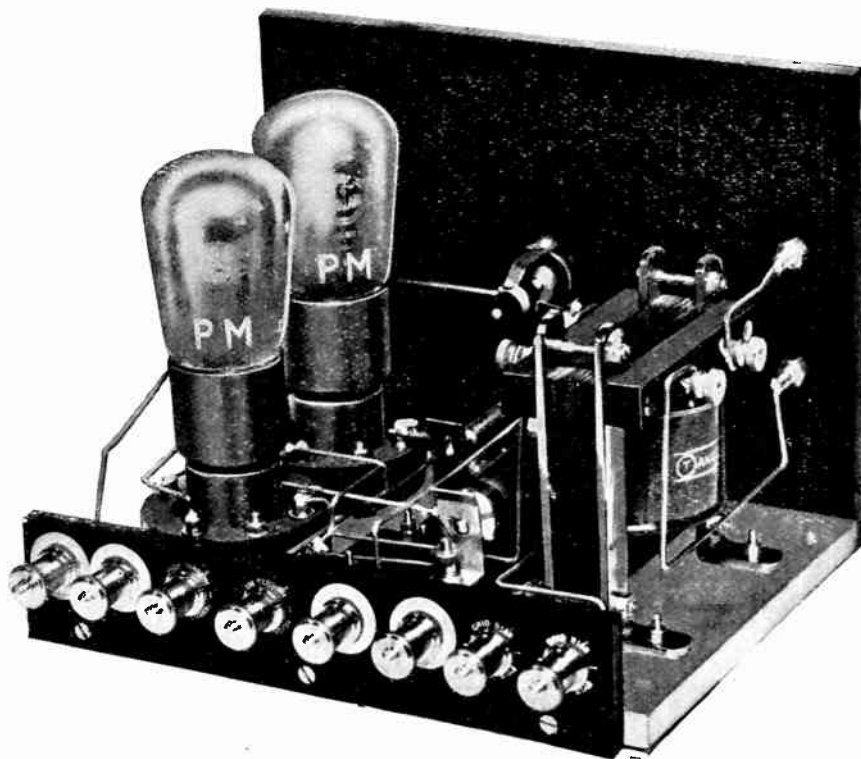

The following component parts must first of all be purchased from your local wireless dealer. Referring to those to which we have attached no make, you are advised to consult your dealer who possesses the key.

- |  |                                 |
|--|---------------------------------|
| 1 Front panel, 8 in. x 6 in. x $\frac{1}{4}$ in.                 | 1 Holder for above. Mullard.    |
| 1 Base board, 8 in. x 6 in. x $\frac{3}{8}$ in.                  | 1 Audio frequency transformer.  |
| 1 Terminal strip, 8 in. x $1\frac{1}{2}$ in. x $\frac{1}{4}$ in. | 1 Grid leak 1 meg. Mullard.     |
| 12 Terminals.  | 1 Fixed mica condenser .01.     |
| 2 Valve holders.   | Mullard Type M.B.               |
| 1 Wire wound anode resistance. Mullard                           | 1 Grid leak holder.             |
| “Ever-rest” 100,000 ohms.  | 1 Filament switch. “Push-pull.” |

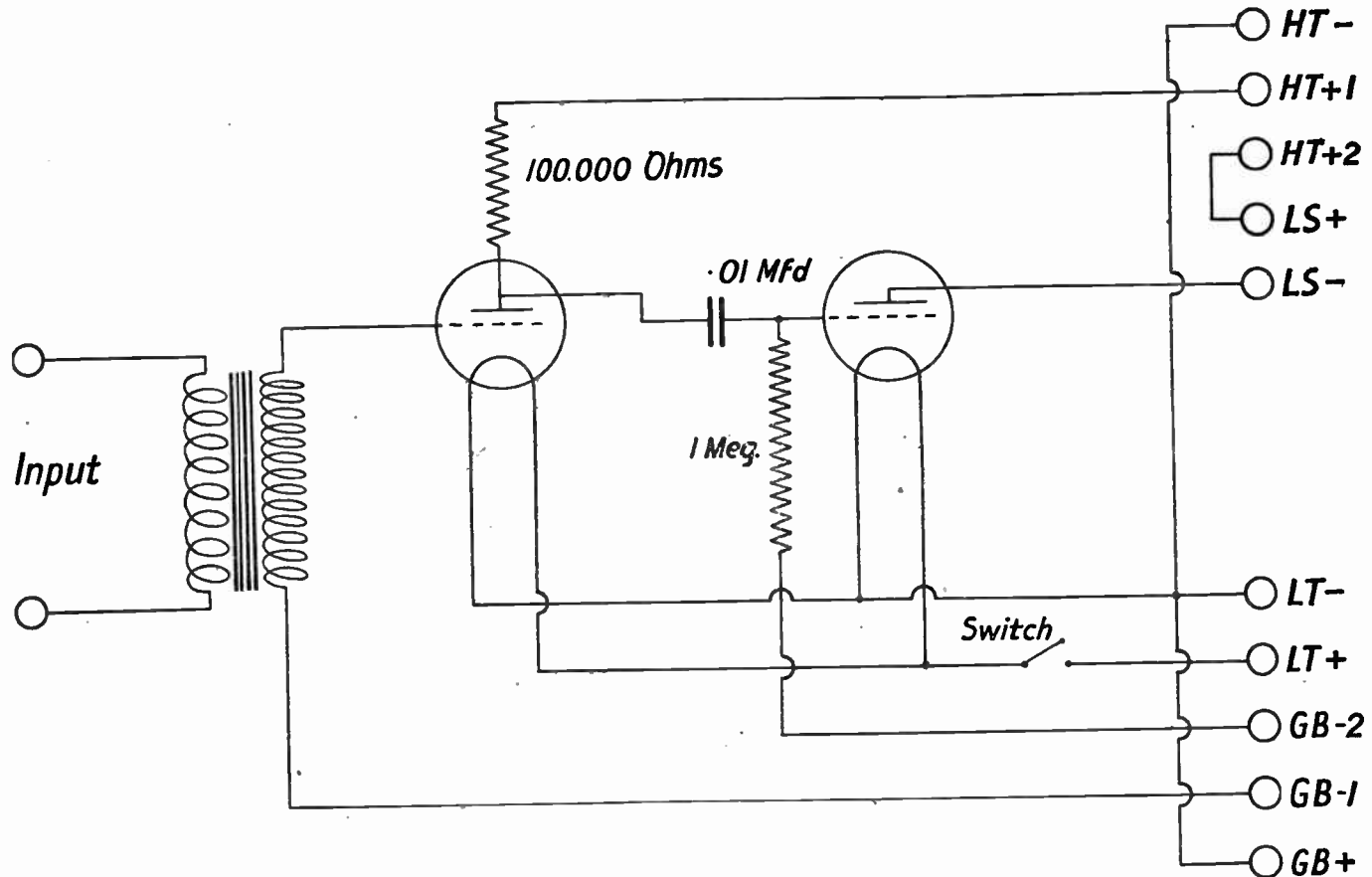

This diagram is simplicity itself and should present no complications whatsoever. Remember that if you experience any difficulty in reading the various symbols, confine yourself to working to the Free Blueprint, No. 104, which is presented to every possessor of "Radio for the Million."

## The Front Panel

This may be of good dry wood or ebonite, 8 in. x 6 in. x  $\frac{1}{4}$  in. It should be suitably drilled so that two pairs of terminals can be mounted on the front as shown in the photograph and Free Blueprint, No. 104. In the centre of the panel a hole should be drilled suitable for mounting the filament battery on and off switch. This single adjustment automatically controls the amplifier.

## Baseboard

This consists of another dry piece of wood, 8 in. x 6 in. The component parts should be laid out in accordance with the photographs and Free Blueprint, No. 104, and then screwed into position with suitable wood screws. The base board can now be secured to the front panel by means of three screws at the lower edge of the panel.

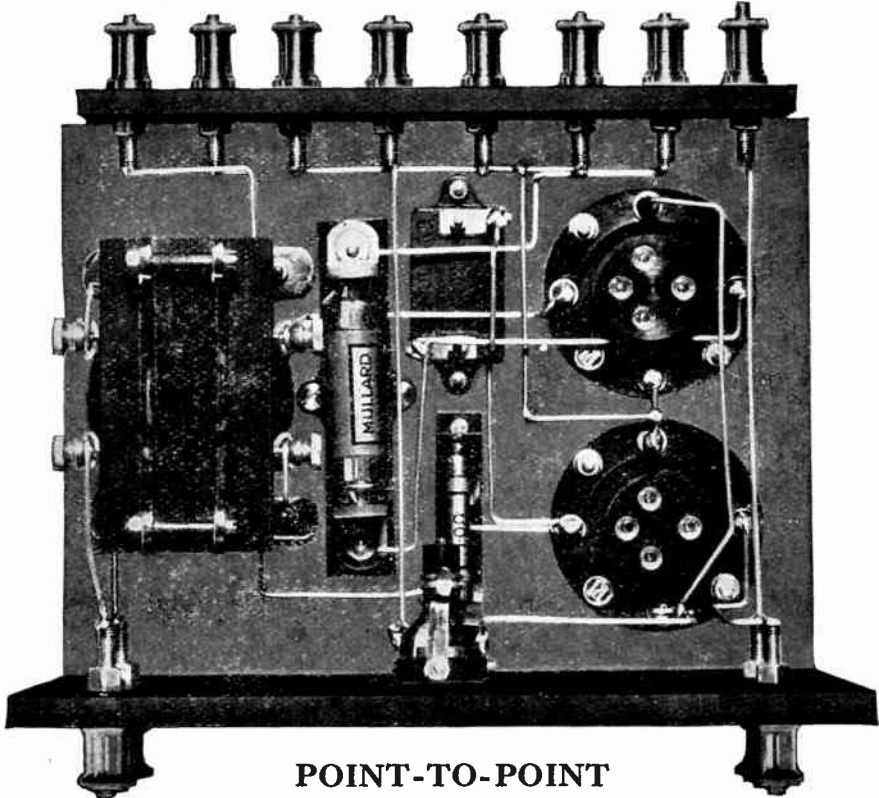

## POINT-TO-POINT

- 1 Join terminal G.B.+ to terminal L.T.-
- 2 Join terminal L.T.- to terminal H.T.-
- 3 Join top input terminal to O.P. terminal of transformer.
- 4 Join bottom input terminal to I.P. terminal of transformer.
- 5 Join top output terminal to P terminal of valve holder V.2.
- 6 Join bottom output terminal to terminal H.T.+2.
- 7 Join one side of switch S to F+ terminal of valve holder V.2.
- 8 Join F- terminal of valve holder V.1 to F- terminal of valve holder V.2.
- 9 Join G terminal of valve holder V.1 to O.S. terminal of transformer.
- 10 Join I.S. terminal of transformer to terminal G.B.-1.
- 11 Join H.T.+1 terminal to one end of anode resistance R.1.
- 12 Join other end of anode resistance R.1 to one side of condenser C.
- 13 Join this same side of condenser C to P terminal of valve holder V.1.
- 14 Join wire 8 to wire 2.
- 15 Join free side of condenser C to G terminal of valve holder V.2.
- 16 Join G terminal of valve holder V.2 to one side of grid leak R.2.
- 17 Join other side of grid leak R.2 to terminal G.B.-2.
- 18 Join free side of switch S to terminal L.T.+
- 19 Join terminal F+ of valve holder V.1 to terminal F+ of valve holder V.2.

## ACCESSORIES

Either a two, four or six volt L.T. battery will be required, depending upon the type of P.M. Master Valve you propose to use. The capacity of this battery need not exceed 40 ampere hours actual.

Any good make of H.T. battery from 60 to 120 volts can be used although the accumulator type of battery is to be preferred as it gives longer life and has a lower internal resistance.

To obtain the greatest possible volume of sound, the higher voltage battery should always be used, but in no case should 120 volts be exceeded. It should be noted that it is much preferable to use a good 60 volt battery than to employ a partially run down 120 volt battery.

One or two 9 volt grid bias batteries will be required depending on whether 60 or 120 volts H.T. is being used. The greater the H.T. voltage, the greater will be the grid bias required.

---

---

### VALVES TO USE

For 2 volt L.T. Supply :—

1st L.F. Valve : P.M.1. H.F.

2nd L.F. Valve : P.M.2.

For 4 volt L.T. supply :—

1st L.F. Valve : P.M.3.

2nd L.F. Valve : P.M.4, P.M.254\*.

For 6 volt L.T. supply :—

1st L.F. Valve : P.M.5B, P.M.5X.

2nd L.F. Valve : P.M.6, P.M.256\*.

*\* These valves are most suitable in cases where very powerful signals are to be handled.*

Full references will be found later in this book giving High Tension voltages, Grid Bias and complete characteristic curves, which every builder of this receiver is recommended to study.

### TEST REMARKS

When tested at 14 miles from London on an average aerial, 35 ft. high, using an ordinary simple crystal receiver, the signals from 2LO and Daventry were amplified from ordinary telephone strength to good loud speaker volume. Excellent quality was obtained.

It was judged that up to a distance of ten to fifteen miles, the GRENVILLE AMPLIFIER would prove suitable for the purpose of providing ample loud speaker results from any crystal receiver.



# The Same Reasons

that directed you to the choice of Mullard P.M. Valves will decide you in favour of Mullard Wire-Wound Anode Resistances.

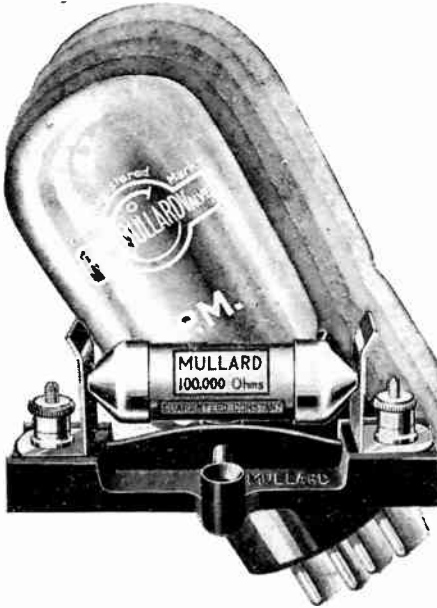

**SILENT  
CONSTANT  
ROBUST**

When one research organisation controls several products the same high standard of efficiency characterises each. The costly patient research which has resulted in the finest valve lies behind THE MULLARD WIRE-WOUND ANODE RESISTANCE, and it is placed on the market with the certain knowledge that its efficiency equals the efficiency of the world's pre-eminent valve.

A resistance wound on a textile fibre core perfectly covered, and interlayered with the same material, alone can ensure the elimination of all self-capacity, and also renders the fine metallic wire absolutely free from every particle of mechanical shock.

The temperature co-efficient is negligible, since the resistance is not set in wax, but only covered with a thin layer of wax to allow a perfect dissipation of heat.

## PRICES, ETC.

Mullard EVER-REST Wire-Wound Anode Resistance (80,000 and 100,000 ohms) 5/-  
Complete with Holder ... .. 6/6

*Also supplied in any intermediate values*

Mullard Grid Leaks and Condensers,  
Type Grid B 0.5 to 5.0 megohms ... 2/6  
Type Grid B combined with .0003 mfd.  
Condenser Type MA ... .. 5/-  
Type MA Condenser .0001 to .0009 mfd. 2/6  
Type MB Condenser .001 to .01 mfd.... 3/-



**WIRE-WOUND ANODE RESISTANCE**

*Advt.—The Mullard Wireless Service Co., Ltd., Mullard House, Denmark Street, London, W.C.2.*

## MULLARD P.M. MASTER VALVES TO USE, AND WHY!

Volume, purity, range and economy can only be achieved successfully by the choice of Mullard P.M. Valves.

We cannot emphasise too strongly the vital necessity for the amateur radio constructor to select with the greatest care the valves for the receiver he is building.

Practical experience has proved that the true procedure for the circuit designer is to build his circuits around a definite series of valves in order to utilise to the full, the merits of each type of valve.

You can judge, therefore, how very essential it is for the amateur constructor to follow the plan of the designer.

In the four circuits given in this book, every advantage has been taken of the superior qualities of the valves with the wonderful P.M. Filament. This series of Mullard P.M. Valves, embodying the unique P.M. Filament, has qualities so marked that they often improve inefficient receivers.

Make absolutely certain of the very best results by using the P.M. Valves, recommended under "Valves to use," given in each of the circuits described.

As an additional help we give below the characteristic curves, and valuable notes for each Valve in the Mullard P.M. Series. You cannot go wrong if you demand Mullard P.M. Valves for P.M. Circuits.

Purpose.	Remarks.	2-volt.	4-volt.	6-volt.
H.F. Amplifier ..	General .. ..	P.M.1.H.F.	P.M.3.	P.M.5X P.M.5B
Detector .. ..	Followed by transformer-coupled L.F. amplifier.	P.M.1.L.F.	P.M.3.	P.M.5X
	Followed by resistance-coupled L.F. amplifier	P.M.1.H.F.	P.M.3.	P.M.5B
L.F. Amplifier followed by transformer coupling	Early stages .. ..	P.M.1.L.F.	P.M.3.	P.M.5X
	Later stages .. ..	P.M.1.L.F. *P.M.2.	P.M.4.	P.M.6.
L.F. Amplifier followed by resistance-coupling	Early stages .. ..	P.M.1.H.F.	P.M.3.	P.M.5B
	Later stages .. ..	P.M.1.L.F. *P.M.2.	P.M.3. *P.M.4.	P.M.5X *P.M.6.
Power Amplifier ..	For last stage of multi-valve L.F. amplifiers	P.M.2.	P.M.4. *P.M.254.	P.M.6. *P.M.256.

\* These valves are most suitable in cases where very powerful signals are to be handled.

## P.M. Valves for 2-volt supply

### P.M.1. H.F.

This is an excellent valve to use as a high frequency amplifier, and we can also thoroughly recommend its use in the intermediate frequency stages of "Superhets."

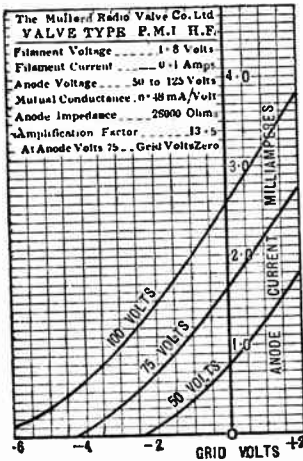

In general, it should only be used as a detector when followed by a resistance capacity coupled low frequency amplifier. Under these conditions it is suitable for "anode bend" or grid-leak rectification. The P.M.1 H.F. valve should also be used as a low frequency amplifier when followed by a resistance capacity coupling. It has a high amplification factor and its comparatively high impedance is not detrimental under the above conditions.

When the P.M.1 H.F. is used as an L.F. amplifier in resistance coupled circuits, negative grid bias should be used as follows:—

High Tension	50	75	100	125	volts.	
Grid Bias	...	0.5	1.0	2.0	3.0	volts.

Price 14/-

### P.M.1. L.F.

This is the best valve to use as a detector when followed by a transformer-coupled stage of low frequency amplification.

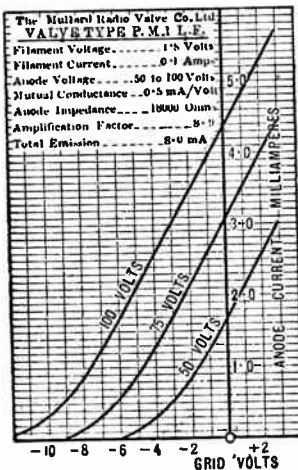

It also gives excellent results in the early stages of transformer coupled low frequency amplifiers.

For instance, two P.M.1 L.F. valves would make an excellent combination for a two-valve receiver employing a detector and one stage of transformer coupled L.F. amplification.

As an L.F. amplifier the P.M.1 L.F. can handle a very considerable signal strength without distortion, provided that the correct grid bias is used in accordance with the following table:—

High Tension	...	50	75	100	volts.
Grid Bias	...	1.5	2.5	3.5	volts.

Price 14/-

## P.M. Valves for 2-volt supply

### P.M.2

The P.M.2 is the "power-amplifier" of the two-volt series. In its class it is unbeatable in its capacity for handling power without distortion.

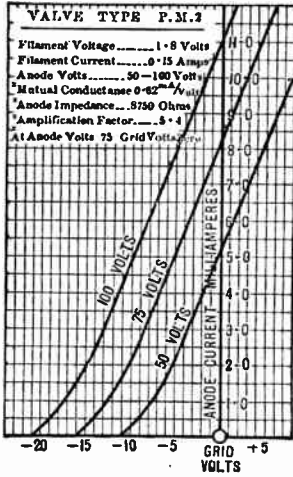

It should always be used in the last stage of low frequency amplifiers (transformer or resistance coupled) where really great volume of loud-speaker reproduction is required.

The characteristic curve of the P.M.2 has a steeper slope than that of either of the P.M.1 valves, and also far greater "grid swing," and these are the two factors which are important where the handling of power without distortion is the main consideration. With the P.M.2 valve the provision of the correct "grid bias" is of great importance, both from the point of view of prevention of distortion and also of economy in H.T. current consumption.

The following table shows the correct grid bias to use:—

High Tension	... 50	75	100 volts.
Grid Bias	... 4	7	10 volts.

**Price 18/6**

## P.M. Valves for 4-volt supply

### P.M.3

The uses of the P.M.3 valve resemble those of the P.M.1 H.F., but are rather wider, owing to the fact that it has a lower impedance while its amplification factor is almost the same.

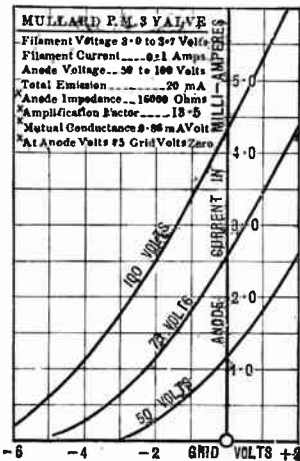

Besides working excellently as an H.F. amplifier, or as an intermediate frequency amplifier in "superhets," it can be used equally well as a detector whether followed by a resistance-capacity or a transformer coupled stage of L.F. amplification. It is also excellent as an L.F. amplifier in resistance-capacity coupled circuits and will work well in the earlier stages of transformer coupled L.F. amplifiers.

In fact its capabilities may best be summed up by saying that the only purpose for which it is unsuitable is that of power amplification.

As an L.F. amplifier, whether transformer or resistance coupled, the grid bias should be as follows in order to get the utmost efficiency without distortion:—

High Tension	... 50	75	100 volts.
Grid Bias	... 1	2	3 volts.

**Price 14/-**



## P.M. Valves for 4-volt supply

### P.M.4

This is essentially a power-amplifier for use in the last stage of low frequency amplifiers.

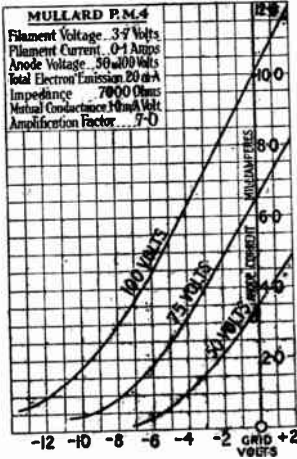

The low impedance and high amplification factor combine to give a characteristic curve with a very steep slope; and with a high tension voltage of 100 the "grid swing" is more than 12 volts.

The P.M.4 valve is capable of supplying ample power to all but the very largest loud speakers without a trace of distortion, provided that the correct grid bias is employed.

While the P.M.4 valve is especially a power amplifier, there are many circuits in which its use is advisable in other capacities: notably as a combined H.F. and L.F. valve in some reflex circuits, and also as an H.F. valve and detector in some of the American Neutrodyne Receivers.

When used as a power amplifier the correct grid bias for the P.M.4 is as follows:—

High Tension	...	50	75	100 volts.
Grid Bias	...	2.5	4	7 volts.

Price 18/6

## P.M. Valves for 6-volt supply

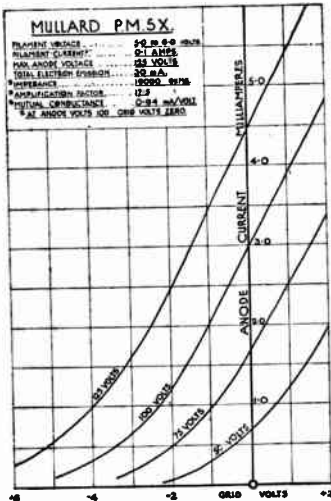

### P.M.5X

The P.M.5X valves resembles the P.M.3 in that its sphere of utility is very wide.

It is a thoroughly good H.F. amplifier, and detector, and can be used with equal success in resistance coupled L.F. amplifiers and in the earlier stages of transformer coupled L.F. amplifiers.

It is not a power amplifier and no attempt should be made to use it as such.

When using the P.M.5X as an L.F. amplifier the correct grid bias to apply is as follows:—

High Tension	50	75	100	125 volts.
Grid Bias	...	1	1.5	2 3 volts.

Price 14/-



## P.M. Valves for 6-volt supply

### P.M.5B

This valve has been designed especially for use as a high frequency amplifier, and also as a detector or low frequency amplifier in circuits employing resistance capacity coupling.

The very high amplification factor makes this valve ideal for these purposes, while the comparatively high impedance of the valve is not at all detrimental under these conditions, where it is associated with high impedance circuits.

When this valve is used as a resistance coupled L.F. amplifier, the anode resistance may have a high ohmic value (we should suggest a resistance of the order of 500,000 ohms).

The correct grid bias is as follows:—

High Tension	75	100	125	150 volts.
Grid Bias ...	0.75	1.0	1.25	1.5 volts.

Price 14/-

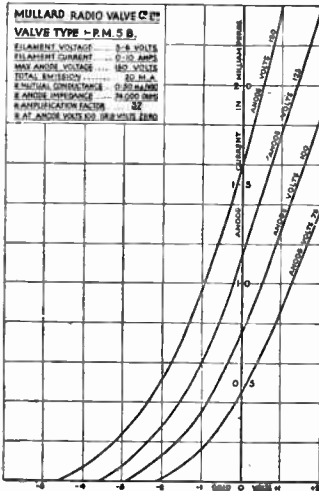

### P.M.6

This is a power-amplifier for use in the last stages of L.F. amplifiers.

It is, in fact, the 6-volt equivalent of the P.M.4.

We would mention, however, that this valve has also been found to be extremely satisfactory as an H.F. amplifier and also as a detector in many neutrodyne receivers of American design which require low-impedance valves for these purposes.

When the P.M.6 is used as an L.F. or power amplifier the correct grid bias to apply is as follows:—

High Tension ...	50	74	100 volts.
Grid Bias...	2	4	6 volts.

Price 18/6

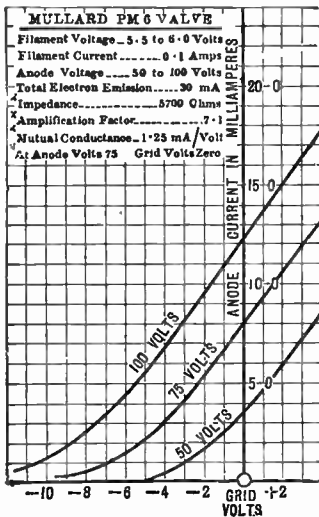

# P.M. Super Power Valves

For 4-volt supply

## P.M.254

The P.M.254 is the "super" power amplifier in the four-volt class.

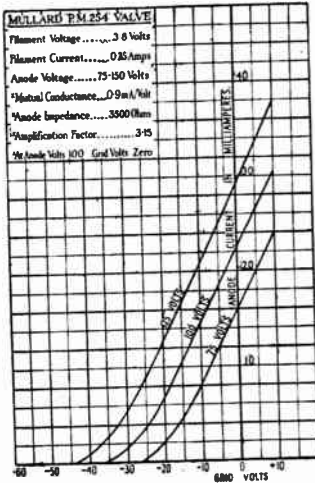

The impedance is approximately one-half that of the P.M.4. The slope of the characteristic curve is almost the same, while the "grid swing" is more than double with the same H.T. voltage. This valve has a total emission of 50 milliamperes, which is a remarkable figure to attain with a filament consuming less than 1 watt.

The P.M.254 will operate the largest loudspeakers to the limit of their power-handling capacity without distortion.

Grid bias must be applied as follows :—

High Tension	50	75	100	125	150 volts.	
Grid Bias	...	5	9	12	17	22 volts.

Price 22/6

For 6-volt supply

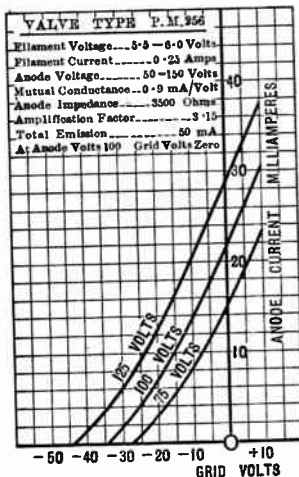

## P.M.256

We have already described the P.M.254 valve, and reference to the characteristic curves will show that the P.M.256 is the 6-volt equivalent of this valve.

It is a "super" power amplifier capable of handling without distortion sufficient energy to operate even the largest loudspeaker.

The grid bias requirements are as follows :—

High Tension	50	75	100	125	150 volts.	
Grid Bias	...	5	9	12	17	22 volts.

Price 22/6

# RADIO TERMS EXPLAINED

+ **Positive.**

— **Negative.**

**A. Aerial.**

**Anode Bend Rectification.**—Gives less distortion than Grid Leak rectification.

**Amplification.**—The increase in signal strength due to use of valves in a set.

**Anode Resistance.**—Anode Resistance coupling is a form of L.F. Amplification giving not quite such high amplification as transformer coupling, but has the advantage that it gives more even response over the whole range of sound frequencies. It is important that the anode resistance, usually of 100,000 ohms. or more, should be absolutely constant in value; that is why Mullard Wire Wound Anode Resistances are used in P.M. Circuits.

**Detection** is the method which converts high frequency signals received in the aerial into the low frequency or signals of audible frequency which can be converted directly into sound by telephones. This conversion of the signal is generally called rectification. Both valves and crystals will act as detectors or rectifiers under suitable conditions.

**E. Earth.**

**Filament Battery** supplies the valve filaments with sufficient energy to raise them to a suitable operating temperature for the emission of electrons. In the case of P.M. Valves this working temperature is so low that great economy is effected. Two volt, four volt or six volt accumulators or equivalent dry cells are required with P.M. Valves.

**G.B. or Grid Bias Batteries.**—These are similar to H.T. dry batteries, but of lower voltages and with tappings at every  $1\frac{1}{2}$  volts to obtain different values. The greater the H.T. voltage applied, the greater is the correct grid bias voltage required. (See valve data).

**Grid Condenser** is a small fixed condenser connected in series with the grid circuit of the detector valve.

**Grid Leak** is a very high electrical resistance, usually of a megohm or more, used with a small grid condenser. Grid Leaks are also used in Resistance Capacity Amplifiers.

**Grid Leak Rectification.**—This is the most usual method of valve rectification. With the P.M. valves it is necessary to connect the grid circuit to the positive lead of the filament circuit.

**H.F. or High Frequency Amplification** means amplification of the signal in the form in which it is received on the aerial, *i.e.* before passing detector valve.

**H.T.** High Tension.

**High Tension Battery.**—With P.M. Valves an H.T. Battery of from 60 to 120 volts is required.

**L.F. or Low Frequency Amplification** means amplification of a signal after passing detector valve.

**L.F. Transformer** consists of two windings wound on an iron core; amplifies and transfers signals to the next valve in the set.

**L.T.** Low Tension.

**L.S.** Loud Speaker.

**Mfd.** Microfarad, a unit of capacity applied to condensers.

**Meg.** Megohm, a million ohms.

**Neutralising.**—The Balancing out, or neutralising of reaction effects caused by the internal capacity between the grid and anode of the valve.

**Neutralising Condenser or N.C.**—A small variable condenser suitable for neutralising.

**Ohms.** Unit of Electrical Resistance.

**Radio Frequency Choke or R.F.C.**—A coil to prevent the high frequency oscillations from passing into the L.F. part of the receiver.

**Radio Frequency or High Frequency (H.F.).**—Terms used to denote the high Radio Frequencies as differentiated from the Low or Audio Frequencies.

**Reaction.**—The term applied to any form of electrical interaction between valve grid and anode circuits of a valve. A limited amount of reaction increases sensitivity but excessive reaction causes serious distortion.

**Tuned Circuit.**—An arrangement of coil and variable condenser to enable any required wave length, within limits, to be tuned in.



**NOTE** the great length, thickness and resilient supports of the wonderful P.M. Filament shown in this sectional view of the P.M.5. These features of the P.M. Filament give you copious electron emission, better results and long, useful life, with economical upkeep.

