

**RADIO**

PRICE

**1<sup>1</sup>/<sub>2</sub>**

**FOR THE**

**MILLION**

**THE RADIO OWNER'S MAGAZINE**

Published Quarterly.

Vol.2. No2. March 1928



**AMERICAN RECEPTION FOR EVERY  
MULLARD MASTER THREE OWNER**



The Mullard Pure Music Speaker  
with the wonderful harmonic response.

Model "D" £5.5.0 Model "E" £3.5.0

**Mullard**  
MASTER · RADIO

---

# MUSITORIUM

*where the Editor discusses a very important aspect of the Mullard Master Three Receiver and at the same time recounts the interesting fact that it is the most widely built and used receiver throughout the World to-day.*

IT is unutterably bewildering to visualise the vast concourse of people who eagerly await this issue of "Radio for the Million." Boys at school; youths in their teens; young men whose inexperienced hands have but the slenderest grip upon the lower rungs of the ladder of life; successful men in their prime who see below them others steadily climbing—a few quickly, many slowly; then the fathers' fathers—content to leave the battle to the strong.

Our mind's eye takes leave of us when, with arms outstretched, we see this immense multitude of men span from London to Edinburgh.

Dear readers of the sterner sex, have you, in even your most generous moments, ever imagined your sisters to compose a rapidly increasing group of radio enthusiasts? Most of us, that is, if we confessed truly, must perforce admit that we had looked upon radio as a man's business—essentially for the man with a flair for mechanical things, who, for sheer pleasure's sake, with dexterity skilfully builds with his own hands in precious leisure hours, apparatus of which he and his family are rightly proud.

If a peep into the Editor's mail bag discloses one thing, it is that another of man's treasured domains has apparently fallen to the siege laid by the fair. Thus we know that, among the half-a-million or more people who have become familiar with the simple details of The Mullard Master Three we must surely include wives as well as husbands, and sisters no less than brothers.

A thought or two directed towards this reality brings into the forefront of our mind the realisation that with this tremendously growing interest of the womenfolk, radio becomes more firmly cemented into our home-life. . . .

## **Advancing the cause of radio**

While fearing to express known facts, we say now that the Mullard Master Three has been wholly responsible for and alone instrumental in advancing the cause of radio for everybody at home. Before the publication of this wonderfully popular receiver, many, many thousands of homes were deprived of radio's fascinating joys. Small purses, unacquaintance with the usually and uselessly complicated blue-prints, diffidence to acquire needlessly the difficult art of soldering and doubt whether an ample reward really awaited the expenditure

---

## FAME SPREADS ACROSS CONTINENTS

---

of time and money, mainly accounted for the absence of radio in no fewer than six million homes in Britain. From Friday, December 9th, these difficulties and uncertainties existed no longer—all were abolished. Regular readers will recall that details of The Mullard Master Three became available to everybody upon that day.

After the release of what has since proved to be the world's most widely built and used receiver, radio came within the reach of all. Four months have elapsed, until to-day, owners of Mullard Master Three Receivers are to be located in every city, town, village and hamlet through the country.

Its fame is not confined to Britain alone . . . it has bridged the Atlantic, crossed the narrow Channel and spread as the sunshine over the Continent into France, Germany, Italy, Spain, Switzerland, Czecho-Slovakia and Russia on to Scandinavia; Australia and India, too, must be included. The Mullard Master Three—magic words indeed when their potentialities have been experienced and consequently really and thoroughly understood.

### **Within the reach of all**

Radio in every home is now practicable. It is not limited by any manner of means to the skilful handicraftsman or to the trained mechanic. With The Mullard Master Three, radio is within everybody's capabilities. Extremely satisfactory results are as certain for the inexperienced as for the experienced home set-builder. It gives to an irreproachable degree high musical quality without necessity for any additional modifications. A very wide choice of broadcast programmes is available, including American and Australian on the very short waves. This, we repeat, is within the reach of, and is actually at the command of anyone able to recognise and to place into position a few components in accordance with the published brief and lucid description.

### **Short wave reception on Master Three**

The world-wide fame of The Mullard Master Three will find a new impetus in this issue of "Radio for the Million." As will be seen elsewhere in these pages, we are covering its application to the very short waves upon which many American, Continental and one Australian Broadcast Station regularly transmit. This, we feel, will once more emblazon the words Mullard Master Three across Britain as upon December 9th of last year.

At this point it should be remarked that with the publication of this application the universality of this receiver is at once apparent. In a few seconds any owner of the set is able to tune into stations allocated over the three wavebands—20 to 90 metres, 200 to 550 metres and 1,000 to 1,800 metres. This comprehensive wavelength range is only obtained by the particular system of interchangeable coils which permits maximum efficiency on each of the three wavebands. And, apart from any other of its numerous outstanding

---

## SUPERSEDES YOUR CRYSTAL SET

---

features, this one alone, irrespective of the others, decides finally which receiver you should build to gain universality with a supreme performance at minimum cost.

### The utility of two-valves

In addition to the article on the Mullard Master Three we are glad to devote further space to another popular P.M. receiver—the Mullard Mikado. This receiver follows the circuit design of the Master Three in that it employs an identical detector stage. It is not at all important for us to dwell here upon the merits of the arrangement. We would refer our readers interested in two-valve sets to the group of letters which we have published testifying to the performance of the Mullard Master Three. It is well within reason to suggest that in so far as distance is concerned there is nothing to choose between either receiver. Of course, on really distant stations it would not be possible to rely entirely upon a speaker for reproduction. Where the reception of distant stations was desired it would be necessary to have resort to headphones.

For all that the Mullard Mikado Receiver serves admirably for the reception of three stations on the speaker—the local, 5GB, and 5XX., except in really dead spots when, to ensure ample signal strength, it is advisable to build the Mullard Master Three.

The fact that the Mullard Master Three is so easily and readily adaptable to the very short waves also applies to the Mikado P.M. This is extremely interesting. As a matter of fact, the really enthusiastic short-wavist prefers to pursue the multitudinous short wave stations on a two-valve receiver. Naturally use is made of headphones.

### Headphone short wave reception

Those who live in town and consequently are compelled to refrain from disturbing the neighbourhood during the small hours of the morning, might do very well for themselves to consider seriously making number one a present of the Mullard Mikado Receiver with the object of regularly listening to our cousins' broadcasts from across the Atlantic. While in the case of the Master Three, American stations come over at full speaker strength, very strong headphone strength is true of the Mikado P.M.

With this receiver it would be possible to sit through the night listening with enthusiasm to really excellent programmes without even awakening one's family asleep in the house. The idea of spending summer nights in this way provides something for all of us when the long light evenings come along to make distant reception a little difficult. Moreover, those of us who, feeling the summer all too short, make the most of it by living in the open air, will, in the possession of a Mikado Receiver, be able to continue their radio activities on the short waves upon their return home after darkness has fallen.

---

## NEW THOUGHTS ON AN OLD SUBJECT

---

### The Mullard Permacore L.F. Transformer

Lastly, this issue of "Radio for the Million" contains a review by the Editor of the Mullard Permacore L.F. Transformer. It should be stated here that far too little attention is given to the L.F. side of the average radio receiver. More radio enthusiasts than one cares to think about are quite happy to build only indifferent L.F. transformers into their sets with the inevitable result.

It is not human to be content with only a second rate performance when better is obtainable. In actual practice, a really good transformer makes it almost possible to save a valve. At least, one is able to say that an efficient L.F. amplifier after the detector makes just that difference between hearing a number of faint chirps or listening to recognizable music and intelligible speech. There is great satisfaction in the moderate speaker reception of very low-powered stations while one's receiver will bring in thirty or so others at full speaker strength; but in the light of what is known to be a good performance, there is no ground for complacency when the sum total of the "bag" is a few far-distant sounding chirps.

We know that L.F. cannot affect the range of a receiver in any way; but we do know that while a given receiver may reach out, it does not finish there. The measured output from a detector valve is surprisingly low, as is easily demonstrated by placing headphones across the input of the first L.F. coupling device. For your own information make the experiment and then compare the signal strength with the speaker volume you will require for comfortable listening. Little doubt but that the importance of L.F. will become immediately apparent.

### The Editor's point of view

Linked with this point of view of amplification there is the question of what is generally called the musical performance of an L.F. transformer. Much ink has been spilt on the subject; it is certain that more will flow. The matter provides a happy hunting ground for tongues as well as pens. At the moment we only wish to say that it is the resultant performance of the receiver with which we are really concerned, and it is this point of view which the Editor has taken in his review appearing in subsequent pages.

This thought brings us to our final point. If the universal popularity of The Mullard Master Three means anything at all, it is that we see confirmed in a very profound manner the amazing results which are to be obtained from three valves. Four years ago we did much work on various three-valve arrangements but without ever reaching the success which is to be secured to-day with a Master Three. By way of experiment we delved into the store cupboard and found three obsolete valves which were then put into our Master Three.

*[Concluded at foot of page 9]*



---

## RECEIVING AMERICA ON THE MULLARD MASTER THREE

---

*In this article an interesting application of the Mullard Master Three is covered. It should be read by every present and intending owner of this highly popular set.*

IT would appear from a first glance at the accompanying illustration of the Mullard Master Three Receiver that it is unlike the conventional radio set that one is accustomed to see. In legal parlance, one might say that, it is possible to drive a carriage and pair round the very few components. At any rate, it would be quite an easy matter to count the connecting wires without resort to pencil, paper or pointer.

If you run your eye over the picture you will count up to twenty—that is all. The majority would have said that it was not technically possible to reduce the number of connections to this extremely small number and continue to obtain an inimitable performance. But such is the case as the hundreds of letters received by the Editor confirm.

### First considerations in Design

Two factors were served in the design of the Mullard Master Three—the first, a maximum output from three valves to a degree greater than that of any previously published three valve arrangement. Utter simplicity was the second.

So far as the latter attainment is concerned, we leave it to the judgment of readers. In referring to the former, we do not think that it would be possible to call in a more impartial witness than the British radio public itself. In another section of this issue we are printing a number of letters chosen to represent the consensus of opinion on the performance of the set. Space does not permit quoting them here; but we feel very certain that not one reader will miss reading them through word for word.

Gratifying as this universal satisfaction with the Mullard Master Three is, we suggest to any present reader who is not yet an owner of a radio receiver that the experiences which

are recounted in those letters will most assuredly be his also. The fact that in the Mullard Master Three we have attained simplicity to the irreducible, liberates any intending builder from the necessity of technical experience even to the smallest degree. This we must say is peculiar to and only characteristic of the Mullard Master Three Receiver.

### First tests confirmed

Our recommendations of this receiver are made without reservation. For the past six months we have had a model on the test bench, using it in much the same way as any reader might; and it may come of interest to record that the present words are being written to the accompaniment of music reproduced by this model. Our constant association with the receiver in this manner fully corroborates our early experiences.

We are able to repeat that: "If you can turn a screw-driver—that is the only qualification—you may begin your first radio set with absolute faith that the finished receiver will give you hours of delightful entertainment every evening. . . . The least experienced will have three sources of music at speaker strength—the local broadcast station and the two Daventry transmissions. Having found how easy these are to tune-in, this number will be quickly doubled and trebled."

### Commands universal approbation

In the light of present radio scientific developments and our own practical knowledge of the performance of the receiver, it is not possible to improve upon the original design in any way. To the least important detail the arrangement continues to command the approbation of the experts as well as the golden opinions of the listener-in who demands from his Mullard Master Three everything that radio has to offer.

---

## THE FASCINATION OF THE SHORT WAVES

---

As the title to this article suggests, we propose to deal with a very fascinating side of radio short waves. Present owners of the Mullard Master Three who follow the art assiduously will have already made use of this application of the set. To them we have little to say except to congratulate them upon their wise choice of the Mullard Master Three, and of course, to extend the wish that their future all-night sittings will be attended with still greater success, and if it is possible, with still greater pleasure.

### Only two coils required

These notes then, are written expressly for those who have never had the wish to receive short wave stations whether or no they are present owners of a Mullard Master Three. If you are a fortunate possessor of this receiver, all that it is necessary for you to do will be to fit yourself out with the short wave coils, two of which cover the American, Continental, Australian and British short wave stations.

Once and for all free your mind of the erroneous idea that the reception of short wave stations is extremely difficult and is something which only the expert is able to do successfully. Nothing is more removed from the truth. In point of fact, the reception of stations located across the other side of the Atlantic is many times more easy than the picking-up of many of the very familiar Continental stations which you have already heard on your Mullard Master Three. Unless you have had the indescribable pleasure of receiving broadcast from the United States of America we know you will find this remark difficult to understand. Nevertheless, it is actually the case,

as your own experience will quickly prove to you.

Few will credit the statement that without even the aid of slow-motion dials 2XAD New York—a station operating on 21.96 metres—is amazingly quickly tuned-in. This station, by the way, is the lowest on the short wave tuning scale that readers will have at their command. People at one time held the opinion that unless very special precautions were taken, short wave reception was a practicable impossibility. One recalls knowledgeable persons who insisted that low-g geared slow-motion dials were imperative, that special valves were necessary, that ultra low-loss layouts were compulsory and that no one but the amateur boasting a call sign could hope for the slightest spark of reward for his patience. Time, however, has shown this to be an opinion to which no importance need be attached—at least, so far as the owner of a Mullard Master Three is concerned.

### Includes short waves

In the opening paragraphs of this article reference was made to desiderata governing the final design of the Mullard Master Three. Every reader will come to his own conclusion that if this receiver were to claim universality among its many distinctions it was essential it should cover *all* wavebands to the highest degree of efficiency. The specified system of interchangeable coils is at once delightfully simple and highly efficient. It enables the inclusion of the very short waves into its waveband. This we believe to be a feature of the Mullard Master Three which without exception will be welcomed by every reader of this magazine.

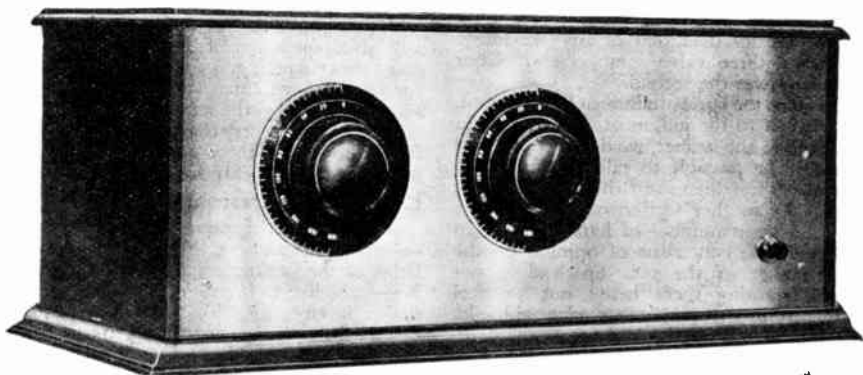

The original Mullard Master Three was not equipped with slow-motion dials. For the 20-90 metre waveband some readers may wish to avail themselves of this aid to tuning. Many standard makes are available.



## EFFICIENT SHORT WAVE PERFORMANCE

Frankly, we do not believe that any reader would wish to go to the expense of a special receiver for the short waves, particularly as he now knows that there is little if anything to be gained by so doing. In confirmation of this statement we recently read a letter from an owner of a Mullard Master Three which clearly and definitely stated that the short wave performance of the receiver was better than that of a certain special set expressly designed and constructed for these short waves. Exhaustive tests have been conducted on the test bench with the object of proving this for ourselves and we have no hesitation in saying that the performance of the Mullard Master Three on this waveband leaves nothing to be desired. It is delightfully controllable over the range of both coils. Oscillation is readily obtained to assist in picking up the carrier waves. Owing to the fact that the spindles of both condensers are at earth potential there are no troubles from hand-capacity effects. The use of resistance-capacity coupling for the first L.F. stage eliminates any possibility of threshold growl on the extremely short waves.

feet to a main water pipe. Both aerial lead-in and earth wire follow electric light cables far too closely. However with this, or rather these, limitations some amazing results have been obtained. Readers endowed with efficient aeriols would not greatly surpass the wonderful reception which we have experienced. It is preferable, of course, to avoid a long earth wire and aerial lead-in, the harmful effects of which are noticeable. Beyond this care it is not at all necessary to scrap your existing aerial and earth system, since you will quickly discover that a very inefficient indoor aerial serves satisfactorily for the short waves.

### From eleven o'clock

Providing you have fixed yourself up with a Mullard Master Three there is nothing to prevent you from listening to certain well-known American stations. You may think to yourself that their reception involves you sitting-up half into the night. We therefore hasten to remark that, although these stations broadcast throughout our night, it is possible to tune-in to their

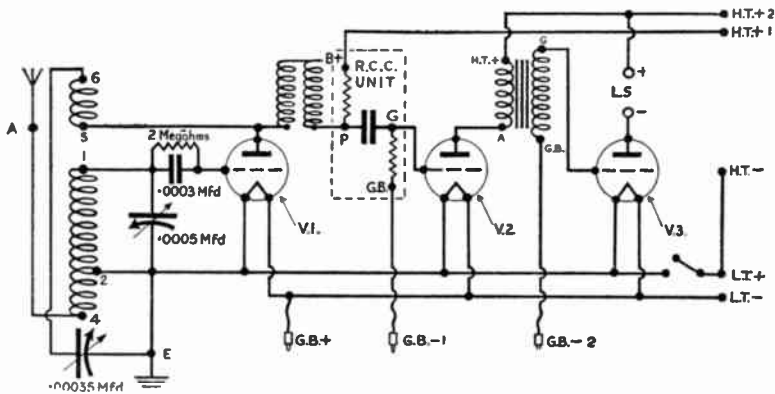

This diagram traces out the circuit of the Mullard Master Three. The fact that the spindles of both variable condensers are at earth potential accounts mainly for the ease of control on the three wavebands.

### A word on the aerial

The short wave tests described here were made on the usual test aerial, which is by no means ideal in any circumstances. It meanders from the garden, through the house, to the study situated at the front of the building—very inefficiently arranged even for ordinary broadcast reception. About twenty feet in height and twenty feet in length arc measurements which convey its governing dimensions and pick-up abilities. The earth lead wanders twelve

transmissions an hour or two before the average reader turns into bed.

New York Stations come over from eleven o'clock onwards. At this hour, of course, the sun continues to shine over New York and at a certain point on the Atlantic one would at this time pass through a band of gradually decreasing light into darkness.

Those of you with any experience of daylight reception will understand its difficulties. In the general way, except of

---

## THE CHANGE-OVER IS MADE QUICKLY

---

course when one wishes to test the daylight range of a set, long distance work is postponed towards the latest hours of the evening, when excellent results are not only easily obtained but are almost to be guaranteed. The new comer to radio very quickly discovers that greatly improved results are obtainable an hour or two after the sun has gone down.

### No complete fade out

Judging by this early reception of American stations this does not apply to the short waves. For example, 2XAD comes through at full speaker strength at eleven o'clock in the evening. On the night which was scheduled for the purpose of the official Short Wave Tests, the above mentioned station was heard at intervals for two hours or more without one single complete fade out. Such an experience does not hold good with any of the very powerful stations allocated on the B.B.C waveband. It does not always happen so. Upon other occasions fading has slightly interfered with the performances, but, it must be said, to no greater degree than any Continental Station. Intermittent fading, however, is something which in no way detracts from the illimitable pleasures attendant upon the reception of very far distant stations upon the extremely short waves.

We cannot imagine any owner of a Mullard Master Three Receiver who is not

thoroughly familiar with the B.B.C and long wavebands. Each will know that one coil covers stations allocated over 200 to 550 metres and the other must be inserted into the six-pin coil base when it is desired to receive broadcast programmes from stations operating between 1,000 and 1,800 metres. The change over is simplicity itself. It is not possible to make any mistake. To receive on the 20 to 90 metre waveband is just as simple and the change over is made just as rapidly and as freely as is the case with the alternation of the B.B.C. and long waves. Simply insert the correct coil to cover the waveband in which the desired station operates and tune-in as you would were you working on either of the higher wavebands.

### Using the reaction condenser

While in the process of tuning-in do not fall into the trap of working with the reaction condenser many degrees beyond the point of oscillation. With the aerial condenser set at minimum, the reaction condenser would be set at about 30 degrees and as one increases the capacity of the aerial condenser the capacity of the reaction condenser—which is controlled by the right hand dial on the panel—advances at approximately a similar speed. It will be found that over the upper ten degrees of the aerial tuning condenser reaction will not be obtainable. This is technically

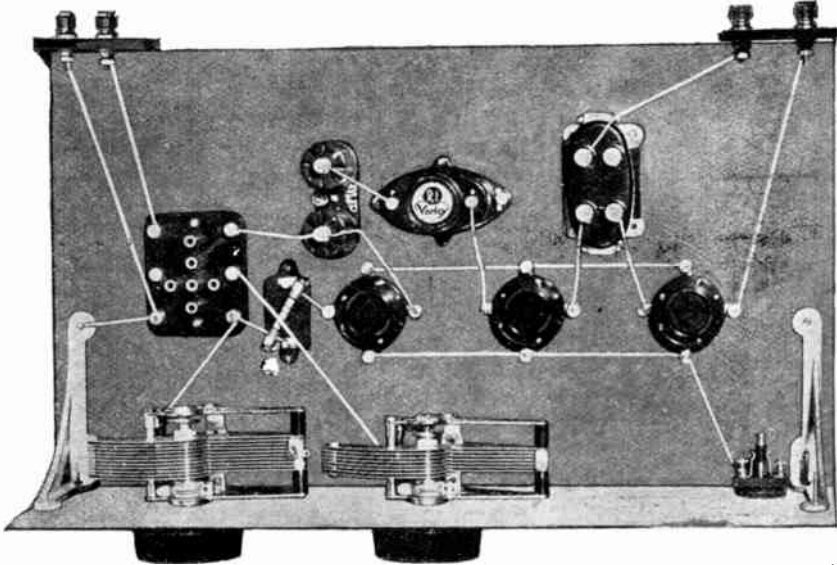

A baseboard view of the famous Mullard Master Three from which it is evident that in its design simplicity has been achieved.

in order. At whatever aerial condenser dial reading you may be searching, maintain the receiver a degree—no more—beyond the point at which oscillation occurs. Should you rock the aerial condenser over three or four degrees with the receiver in this condition, you will quickly hear the familiar heterodyne of the carrier-wave. It is then only necessary to retard the reaction condenser to the verge of oscillation and make any final adjustment to the tuning condenser, if necessary, in order to hear the station.

### Many excellent amateurs

In addition to the numerous American short wave transmissions, there are many excellent amateur transmissions on the air between the usual hours of broadcasting. These are as easily picked up as the well-known stations the other side of the great Atlantic. Space does not permit giving details of their call signs and wave lengths, although they may be heard as regularly as any of the nationally organised transmissions. It is extremely interesting to listen to the technical interplay of enthusiastic amateurs as well as to hear their musical items, some of which, by the way, reach a very high standard of quality. Then, of course, one is able to hear a host of amateur stations sending out the familiar dot, dash, dot—but, perhaps too many have such unfavourable recollections of unwanted morse interference from ships and high-powered commercial stations that the reception of it would not be pursued by choice.

### Tuning on the short waves

In the main we are disposed to believe that owners of a Mullard Master Three have not had any experience with short wave reception and for this reason we are giving below a few tuning points which will serve as a guide in the preliminary stages of their experiments. On page 31 is to be found a fairly comprehensive list of short wave stations which are to be heard at regular intervals through the week. Special attention is drawn to 5SW., the Chelmsford Short wave station which relays 5XX for those interested in British programmes abroad and in the Colonies.

### TUNING POINTS FOR S.W. COIL No. 1

- |     |       |                       |               |
|-----|-------|-----------------------|---------------|
| 32  | 2 XAD | (Schenectady, G.E.C.) | 21.96 metres. |
| 98  | 2 XAF | (Schenectady, G.E.C.) | 31.4 metres.  |
| 148 | KDKA  | (Pittsburg)           | 43 metres.    |

### TUNING POINTS FOR S.W. COIL No. 2

- |    |      |             |              |
|----|------|-------------|--------------|
| 12 | KDKA | (Pittsburg) | 43 metres.   |
| 68 | KDKA | (Pittsburg) | 62.5 metres. |

## WINDING S.W. COILS AT HOME for the Master Three and Mikado P.M. Receivers.

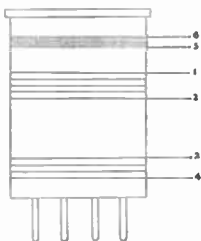

For the convenience of readers who may prefer to wind their own coils for the extreme short waves for the Mullard Master Three or the Mullard Mikado P.M. Receivers we are printing details for their guidance.

The necessary blank

Colvern six-pin formers are obtainable from the usual wireless dealer from whom you purchased the other components.

#### SHORT WAVE COIL No. 1, 20 to 45 METRES.

Reaction Coil, between Pins Nos. 6 and 5, 6 turns.

Grid Coil, between Pins Nos. 1 and 2, 5 turns.  
Aerial Coil, between Pins Nos. 2 and 4, 3 turns.

#### SHORT WAVE COIL No. 2, 40 to 90 METRES.

Reaction Coil, between Pins Nos. 6 and 5, 9 turns.

Grid Coil, between Pins Nos. 1 and 2, 13 turns.  
Aerial Coil, between Pins Nos. 2 and 4, 3 turns.

Wind with 26 gauge D.S.C. wire. If you are able to wind successfully with a thicker gauge better results may be expected. The reaction coil may be wound with turns touching but in the case of the aerial and grid coils the turns should be spaced three or four diameters. The diagram shows the 20 to 45 metre coil. It will be seen that the aerial winding is placed at the bottom of the former well distanced from the grid coil while the reaction winding is separated from the aerial winding by about a quarter of an inch. \* \* \* \*

## MUSITORIUM

*Concluded from page 4*

Truth to tell, we quickly discovered the reason for the lack of success with three valves four years ago. As a result of this informative experience we have no hesitation in saying that the wonderful results which are to-day being secured with The Master Three are given by Mullard P.M. valves. Any reader who happens to be able to make a similar experiment with his set should do so. He will find that by making this simple comparison, three Mullard P.M. valves give a performance to gain which, in the old days, one had to use four valves. Moreover, constant experiment also shows very clearly that the use of three Mullard P.M. valves greatly improves any three-valve receiver, regardless of the fact whether such comparison is made with modern or obsolete valves.

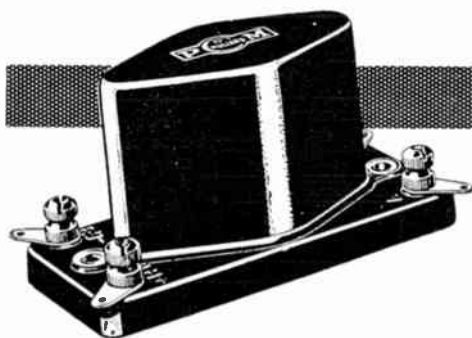

## The MULLARD PERMACORE TRANSFORMER JUDGED BY A MAN IN THE STREET

In this article the Editor looks at radio reproduction from a new angle. Here, you will read about his impressions on the musical performance of a Mullard Master Three incorporating the new Mullard Low Frequency Transformer.

MULLARD enthusiasts are all aware that a month ago a new Mullard product was released for sale in the Mullard Permacore L.F. Transformer. We feel sure that the majority are looking forward to this issue of RADIO FOR THE MILLION to read first-hand the opinion of the Editor. Although the title of this article does not suggest this review to come from the editorial pen, the truth is that the Editor, upon this occasion, has vacated the editorial chair and placed himself in the latitude and longitude of the man in the street who listens to his radio set, day by day, giving but little, if any, thought to the degree of efficiency which may be attributed to it.

### Read treatise and thesis

From this standpoint, a few words directed towards L.F. amplification quickly prove that there is much to be said about L.F. transformers which has never been said before. Too often have we read treatise and thesis in the hope that we shall be able to discover the hidden secret to transformer preference. For weeks together we have sat into the cold wintry nights seeking the magic stepping stones which mark the way towards dry land. Our figure of speech is happy.

The usual questionnaire addressed to fellow radio enthusiasts brings the whole conception down as a pack of cards. Each has his own ideas on the matter and we had despaired of ever arriving on something which had the semblance of *terra firma*. The more we delved into the treatise, the deeper we sank into the water and the greater our care in the study of the thesis, the more increased became our difficulties.

The average radio owner is not confronted with technical problems any more than he is beset with any pet notions. He builds his many radio receivers with the one avowed intention of listening to the score or so of excellent broadcast programmes which are so easily obtained to-day. In this pursuit he is happy and content just so long as the *results* are up to the standard which are predetermined in his mind by those secured by his friend along the street.

This frequently recurring word *results*: What do we understand by it and what does it mean to our present readers? Immediately upon switching on a newly-built receiver we hazard a guess that the majority of us turn to the non-technical onlooker to say: "Well, old chap, what do you think of the new set?" Most anxiously we await the considered reply for such it always is. "The quality is very good," comes the response.

### Judging a musical performance

This question of quality, therefore, is the first impression. It may never have been realised but our observations, at least, name it thus. Quite apart from any other outstanding features of the set, which of course would be known to the builder, the ear of the non-technical onlooker receives the first impression and his reply to your enquiry will be dictated in accordance with his hearing.

Let this point have its share of consideration in the scheme of things. It is rather important and contains much that might be talked about. As average radio owners we all have different ideas on the three categories good, bad and indifferent. That

---

## OTHER COMPONENTS HAVE AN INFLUENCE

---

which is good to one may to the ear of another fall into the indifferent group and what one considers bad may to the ear of a friend deserve to be promoted to the good class. And so one could go on quoting case after case where there is serious divergence of opinion, leaving us as far away as ever we were from the true facts of the situation.

This difference of opinion on musical performance is not confined to the radio set. Musical critics load their pens with fire upon occasions, when in their opinion, an artist fails to interpret the music to the standard held by them. Famous orchestral conductors have been strongly criticised when the bass lacked strength and when too great a prominence has been given to the bass. "The brass was 'over-emphasised,'" they write; or that "the strings were thin and lifeless." The moral of all this is clear.

### Lifting the mist

If eminent musicians—and most of our critics are noteworthy in this respect—disagree, what chance does the average radio owner claim to reach agreement? In the instances we have referred to in the above paragraph difference of opinion was concerned with interpretation. It does not remain there since opinion is always divided on any artistic, or shall we say æsthetic, subject. Just as strongly marked, we see opposite impressions received when two minds review the same artistic performance. In passing judgment upon the performance of a radio set, we are as much in the hands of our artistic tastes as we are when in the concert hall or opera house.

Here is a view which introduces into the criticism of the quality of a radio set something which lifts the mist from the issue.

### Importance of the speaker

The average radio owner, therefore, receives his impression of the performance of a radio set to the degree of musical appreciation he has cultivated . . . by widening his experience in musical matters it is certain that he will expect better and better results from his radio set. This brings us to the choice of the speaker.

It is not unknown for a radio owner to exercise extreme care in the purchase of the various components for a receiver, but when choosing the speaker, to make the error of wishing to save a few shillings.

Laboratory perfect receivers are of little satisfaction if the final transformation of the electrical impulses is at the mercy of imperfect speakers. Again, belief was once held that the speaker possessed some charm in that it could correct even the faults of an imperfect set. This, of course, cannot be true. Speakers have their limitations in that however near to perfection it is not to be expected of them to be able to correct imperfections introduced by faulty components in the set. On the other hand speakers, as we have stated before, have so important a bearing on the final transformation of electrical impulses into sound, that, whatever the intrinsic merit of the receiver itself it is always preferable to put as much money into the purchase of this accessory as funds will permit.

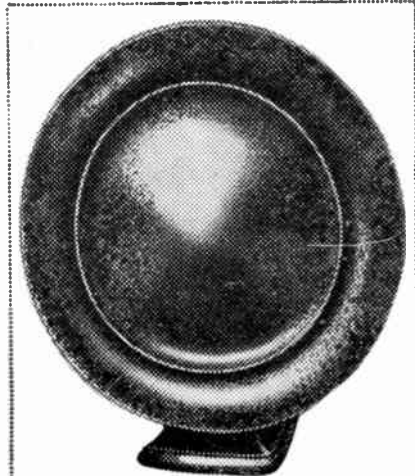

Here we illustrate the Mullard Pure Music Speaker for which is claimed the distinction of being highly responsive to harmonics. Such a merit is decidedly important since the speaker is responsible for the final translation of electrical impulses into sound.

In the possession of a speaker which has the merit of translating faithfully the impulses fed into it, only then is one in the position to discriminate between the good, bad and indifferent radio receivers. To own a speaker which enjoys the distinction of being highly responsive to harmonics is just as important as listening to your set when it is connected to a speaker with a uniform frequency-response curve. Bear

## WHAT WE HEAR MATTERS MOST

in mind that your set will only be perfect when the speaker is perfect. The speaker you connect to the output terminals of your set colours the audible sounds you hear as music and speech in accordance with its characteristics. If these are good, then with a good set you will obtain faithful results. But to expect a high musical performance from your set when your speaker is not up to standard is demanding the impossible.

### Governed by experience

Remembering that the characteristics of your speaker influence the audible speech and music you hear it comes to mind that the good features of many sets remain obscure. But for the purpose of this article on the Mullard Permacore L.F. Transformer we are to suppose that our readers have seen the wisdom of operating their sets with the best speaker they were able to afford. And in this direction so far as science has been able to help us in the design and manufacture of speakers, the merits of the Mullard Permacore L.F. Transformer are to be heard and appreciated to a degree only governed by your knowledge and experience of what faithful reproduction really is.

The viewpoint could be taken that our ears deceive us. Whether they do or not really does not matter when it is generally admitted that our entire enjoyment from radio is derived from what we actually hear and not from what measurement may have to tell us.

### All keen on quality

Naturally, the trained musician will not be so easily satisfied as his friend who, perhaps, has not had the opportunity of taking a musical training. Speaking for the former and in this respect we speak for ourselves, he is able to enjoy hearing music from his radio set as much as the latter. It has been said that the more musically technical a listener might be, the less chance there was for him to secure maximum pleasure from radio music. This, however, is not true with the nine hundred and ninety-nine. To be critical of the quality given by one's radio set is something which we are all very keen upon encouraging as it will assuredly result in greatly increasing the popularity of radio.

The nine hundred and ninety-nine enthusiasts in every thousand of Britain's millions

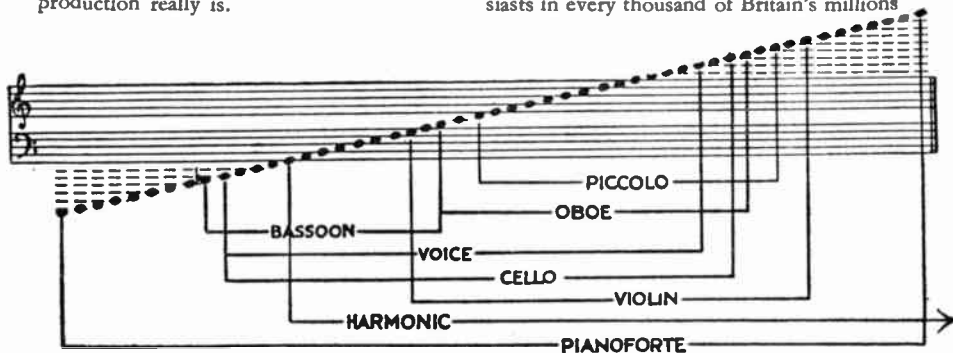

This diagram shows the frequency range of typical musical instruments. If one realises that middle C has a frequency of 256, and an octave below or an octave above half or double this frequency respectively, the actual frequency range of any instrument can be calculated quite easily providing one knows its range in terms of the keyboard.

It is rather a striking fact that while two transformers upon measurement with accurate instruments will give equal amplification at a certain frequency, upon applying the audible test one or the other appears to produce greater signal strength. This is a factor which comes into the scheme of things to a very considerable degree. Upon this account it cannot be ignored, particularly as we have said, for the reason that we are chiefly, if not wholly, interested in exactly what we hear.

of radio owners know what the urge for faithful quality means. We believe that it is responsible for the construction of more receivers than the desire for distance. At any rate, this has been the state of affairs for the past year or so. Really in these days of wonderful receiving valves distance is so easily attained that it no longer is something elusive. But in the desire for faithful quality we seek a fugitive which may always escape unless we are guided by experience. That in the past this desire for

---

## AUDITORY TESTS ON P.M. SETS

---

faithful quality has not been satisfied obviously makes its attainment a far more interesting thing than the mere reception of distant stations.

For your radio set to possess the merit of faithful quality does not demand gadgets here and there. That attachments of this kind appear to be necessary most certainly implies serious faults with the essential components in the receiver itself. Their use is a curative of something wrong in the set. It is by no manner of means a fact that faithful quality cannot be obtained unless curative measures are adopted. The real situation is exactly to the contrary. If you have found that the performance of your radio set is improved by such additions, then you may rest assured that the L.F. side is not functioning up to the standard of present-day apparatus of which the Mullard Permacore Transformer is most noteworthy.

### Quality on simple sets

We can only recount from this point of view of hearing, our impressions of the Mullard Permacore L.F. Transformer. After all is said and done it is only these impressions which interest our readers. Much scientific data could be prepared for this magazine which, while meaning much from the laboratory standpoint, actually would not carry the minds of readers to the sounds they hear when listening to their sets.

**This illustration shows the Mullard Mikado P.M. Receiver which is described elsewhere in this issue. Broadcast Music is to be heard on this set to a very satisfactory degree of pleasing quality.**

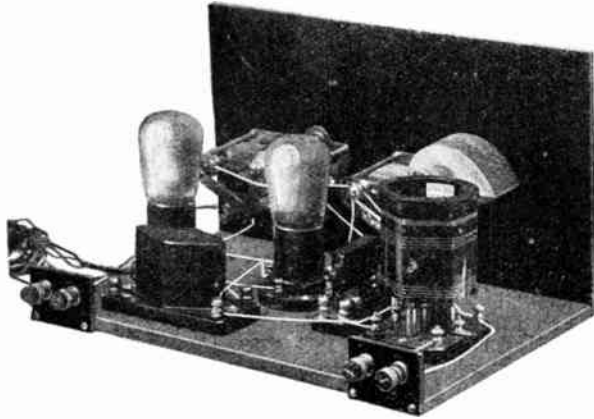

Our auditions, as we propose to describe them, were carried out on the two Mullard P.M. Receivers referred to in this issue—the Mullard Master Three and the Mullard Mikado P.M. These receivers were chosen because it is believed that being representative of those used by at least 50 per cent. of

our readers, our impressions would be of greater value and assistance than had less popular sets been employed. Furthermore, it was also wished strongly to emphasise the fact that even the simplest receiver when embodying the correct components, enables every one to attain faithful quality without running either to greater expense or to the ownership of complicated receivers.

### Judging quality

It may not have occurred to many of our readers that there are two ways of judging the quality given by a broadcast receiver. It is certainly true that most are inclined to judge according to ideas derived from the hearing of other sets. This is good so far as it goes but, unfortunately, it does not take us very far. Comparisons of this type enable us to decide whether or no one set gives a better performance than another. It even permits us to settle in our own minds the degree of improvement which has been effected by the use of a more efficient L.F. transformer, although by this means, one creates a new standard of performance as increased degrees of improvement are maintained.

Really, of course, this is not a truly critical method. Since we are endeavouring to enjoy not merely good reproduction but a faithful representation, in miniature as it were, of an actual musical programme,

comparison should be made with the living music rather than with the ability of another or former set.

By way of experiment, take the first opportunity to visit a concert hall or even a restaurant where music is provided. Ask your friends with you—preferably addressing

---

## THE NEW ANGLE EXPLAINED

---

your question to those without musical training—which of the many instruments composing the orchestra appears to their ears to carry over with the greatest intensity. Without any hesitation they will reply that this instrument is the double bass.

Bearing in mind that the human ear falls in sensitivity at the very low frequencies, it would appear that the overpowering strength of the bass corrects the decreasing sensitivity of the ear to these low frequencies. So far as we are able to hear, this is the state of affairs, as the intensity of the bass in a correctly balanced orchestra, comes over very strongly and without any effort on the part of the executant it is to be heard louder than the rest of the instruments.

When comparing our radio sets, it must be admitted that this degree of sound intensity at the bass end is not usually attained. Assuming that one employs a speaker which is able faithfully to reproduce the lower frequencies, the fact that we do not hear the bass to the true degree of intensity tells us something to be amiss with the L.F. transformers in the set itself.

As it happens, great care is exercised by those in charge of the transmissions to avoid damage to the microphone by the powerful bass instruments which for this reason are placed at the back of the studio. This little fact rather carries our thoughts a little further.

### Relevant facts

It was recently published that the B.B.C. engineers had taken various curves covering their transmissions. These were printed and show that the intensity of sound impulses transmitted gradually falls from about 40 with an intensity factor of 10 to 10,000 where the intensity factor is 2. There is a little hump on this curve between about 500 and 1,000 peaking at an intensity factor of 8.5.

This is very interesting in view of our own impressions of a musical performance. Our ears have gathered that commencing from the bass instruments, we have a sound intensity curve which drops gradually to the instruments whose frequency range is high. It goes largely to prove now what we knew by the actual experience of listening that the B.B.C. transmissions are exceptionally good and possess a remarkably faithful agreement in orchestral balance to an original musical performance.

In listening to a military band which is capable of producing great volume when all

the various instruments are played to the maximum strength, it should be noted that this robustness of the bass does not prevent us from hearing the little piccolo with its trills and high-pitched runs. Although this particular instrument has not the power of the bassoon by a very long way, its characteristic shrillness catches the ear. Such points as this are more closely concerned with orchestration, although upon this occasion they are very relevant to our reading of musical reproduction in radio sets.

If we are to hear broadcast music after the original, the microphone must collect the intensity of the musical sounds as our ears would be impressed. The engineers of the B.B.C. have then to maintain through the amplifiers the relative intensity over the whole band of audible frequencies. This they do very successfully as a really correctly designed set will quickly confirm.

### The standard of quality

Therefore, there is every reason for us to expect faithful quality from our radio sets. To attain faithful quality, our radio sets should be capable of delivering to our ears music which from the sound intensity standpoint, adheres, or rather conforms, to that transmitted. Thus it is clear why L.F. amplifying systems should possess straight line properties. Not for the reason that we only desire the equal amplification of all frequencies between 30 and 10,000 but that the ultimate sound we hear at the speaker adheres in sound intensity to that which is transmitted. Equal amplification is desired not for itself but for what it retains.

With these thoughts in mind we have judged the Mullard Permacore L.F. Transformer. We dismissed from our mind everything but the conception of an actual performance drawn from our long experience in the concert hall, in the opera house, at the chamber concert, at the song recital, at the theatre, on the organ and piano stools. Our views are printed as a record to indicate to our readers what they may expect in the way of a musical performance when they incorporate The Mullard Permacore L.F. Transformer into their sets.

Our impressions were obtained from a Mullard Master Three, into which we had connected the transformer under this critical auditory test. Through the medium of trained musical ears we had to judge its capabilities of retaining for radio music the sound intensity of an original performance. We asked ourselves whether, if it had been

*[Concluded on page 36.]*





## A PEEP INTO OUR NOTE-BOOK

### A few pertinent questions

A few evenings ago a very personal friend rang through on the telephone and asked a few pertinent questions. He began:

"This evening I am building a Master Three for which to-morrow I wish to purchase a set of Mullard P.M. Valves. I notice in your specification that you name 2-volt, 4-volt and 6-volt. Which type do you really advise?"

Mark you, this particular instance is not recorded because of its singularity, but for the reason that it is asked by everyone at some time or another during the course of their radio activities. Every one wishes to know . . . every one wishes to believe himself the user of the most efficient type . . . how is he to decide? Our friend's request, therefore, was very heavily earmarked and as a result was underlined to be included in this section of the world's greatest radio magazine.

For reasons best known to radio enthusiasts themselves, 2-volt valves are generally preferred. Doubtless, each one of you considers, primarily, the low-tension battery situation rather than the valve standpoint. Of course, this is not as it ought to be. Radio owners with the desire to obtain the maximum results from their receivers should settle their minds on accessory matters only after the more important components are chosen on grounds of maximum efficiency. Naturally the domestic exchequer has something to say about things . . . charging accounts from the local garage . . . young Jack objects to carrying the accumulator to the charging station more frequently than once a month. Rather precipitately, then, you hit upon 2-volt valves, forgetting that by so doing you are depriving yourself of really maximum efficiency.

We know that from the human point of view every one is in the favour of 2-volt

valves, but when one views the situation from the technical angle all is very far from favourable. And such remarks are true of every 2-volt valve, irrespective of make or type.

It is not within the means of every pocket to invest in a full series of valves for any given receiver. Most have to be content with one voltage type only, decided upon under conditions quite apart from valve efficiency. It would not be practicable in the little space devoted to this feature to outline, even very briefly, the technical reasons which have persuaded us to prefer 4-volt valves on our tests. For the information of our readers, in whose minds this question has often recurred, logical thought will prove that there is everything in favour of 4-volt valves over 2-volt. A cursory glance at the respective curves and data definitely confirms this remark. So far as the comparison between 6-volt and 4-volt valves is concerned, the curves and data also show that little if any advantage is held by the former.

In practice, of course, these opinions are readily corroborated. Therefore, where possible, use 4-volt valves.

### \* \* \* \* \*

### The supremacy of the P.M. 254

Such a preference is not acquired by coincidental effects. As a matter of fact, where one has the opportunity of making definite comparisons on high-powered receivers in which the use of super-power valves is imperative, the higher efficiency of the 4-volt class is audibly noticeable. It is recommended in the case of the P.M. 252 not to exceed 125 high-tension volts on the anode, whereas up to 150 volts may be used when the P.M. 254 is employed as the output valve. Moreover, the maximum permissible grid bias for the P.M. 252 at the maximum anode voltage is 15 volts while 22.5 grid volts applies to the P.M. 254 at maximum plate voltage. This goes to show that the

maximum grid-swing of the P.M. 252 is 30 volts when the P.M. 254 claims 45 volts. Most readers will know that maximum grid-swing is another way of expressing the maximum signal strength which a valve is able to handle without overloading.

One sees that the P.M. 254 has a 50 per cent. better performance than the similar type valve in the 2-volt class from the viewpoint of handling power. Bearing in mind that the Mullard P.M. 252 easily outclasses any other 2-volt power valve available, the gain in efficiency by the use of the P.M. 254 is obvious after a moment's consideration.

The radio public has not yet appreciated the super-power valve . . . it does not know that in the case of the Mullard Master Three a small power valve is overloading on the transmission of the local station . . . it is easily possible also to overload the last valve on certain American short-wave transmissions! The use of a set in such circumstances, of course, results in the loss of that high degree of quality which is so easily obtainable providing use is made of the correct output valve.

That every reader does not take full advantage of the Mullard range of Super Power Valves is a matter which every lover of good musical reproduction views with concern.

#### Ample H.T. imperative

It is believed that this diffidence is due largely to the eternal question of high-tension supply. Reaching this point brings to mind that without ample H.T. supply the best cannot be obtained from any receiver, and, in referring to these special L.F. Valves, this fact cannot be too strongly emphasised. Once more radio enthusiasts must consider the alternative—the initial outlay for a goodly supply of H.T. or the sacrifice of musical quality.

The increase of volume has few opponents. Unfortunately, the same state of affairs is not true when speaking of quality. It is difficult to understand all the reasons for it, except perhaps that, of the two, the improvement of the standard of reproduction presents far greater difficulties.

Let it be said, however strange it may sound, that quality is dependent upon an ample supply of high-tension. The use of H.T. voltages up to the maximum values advised by the Mullard Company should be adhered to very assiduously. Do not attempt to operate your set at greatly reduced values . . . the result will be far from that to which you are really entitled.

While on this question of high-tension, we often hear of the performance of a receiver suddenly dropping after a month's continued use. This is extremely interesting and very definitely indicates that some readers—and we hope only a very few—expect too much of the high-tension supply.

Dry batteries have a limited output; high-tension accumulators also have a limited

output. The majority of us misuse the supply—a few knowingly, many unknowingly. Strangely enough, many of us have been guilty of doubling-up the number of valves and, very thoughtlessly, expected the same H.T. supply to carry the additional burden. Naturally, the H.T. battery will run down in a month or so under these unfair conditions. It is, of course, very necessary to make certain that your H.T. supply will deliver the current, and that under a certain current drain it will last for a reasonable period before replacement in the case of dry batteries and before recharge, should your H.T. be drawn from high-tension accumulators.

\* \* \* \*

#### A Word on metal panels

Many builders of the Mullard Master Three do not appreciate the fact that metal is used as a material for the panel for very definite reasons. Briefly, it is employed to obtain a common earth arrangement, which saves quite a number of extra connections. With the circuit adopted for the Mullard Master Three it will be noted that the spindles of the two variable condensers are at earth potential. Since these spindles should be connected to the L.T. battery, the technical advantage of a metal panel is at once obvious and an economy. By arranging to give the L.T. on and off switch a live spindle, that is, with the spindle in direct metallic contact with the panel, just as soon as the switch is placed into the "on" position, the panel is connected direct to L.T. and to earth also through the panel bracket and socket No. 2 of the six-pin coil base.

Should a switch with an insulated spindle be used, or should the builder of a Mullard Master Three insulate the spindle of the switch from the panel, a number of things happen. For example, the L.T. battery will not be earthed, with the result that the receiver will be "up in the air" and will emit, in consequence, an uncontrollably terrific screeching noise.

Owing to the thin panel, it may be necessary to use a packing washer. This may be of metal or ebonite, it does not matter which, except, as we have said, that it is not used to insulate the spindle of the switch from the panel. It is as well, should you prefer to use a black-enamelled aluminium panel, to be certain in addition to the switch fixing nut making good metallic contact with the panel, that the fixing nuts of the two variable condensers are similarly in good metallic contact with the panel.

\* \* \* \*

#### Flat spots on the short waves

Elsewhere in this issue the use of the Mullard Master Three on the short waves is dealt with. It sometimes happens on the short waves that over ten or more degrees of the aerial tuning condenser oscillation is

# READERS RESIDENT THROUGHOUT BRITAIN EULOGISE THE MASTER THREE



From E. J. L., Cranleigh, Surrey

"I thought you might be interested to know that within five minutes of completing your 'Master Three' I was listening to WPG, Atlantic City, N.J., on 272.6 metres, time 4.5 a.m., Sunday Morning, February 12th.

"The time was now 4.20 a.m., not the best for American reception, yet I also received within the next forty minutes all at good 'phone strength

KDKA, 315.6, Pittsburgh, Pa.  
WGY, 333.1, Schenectady, N.Y.  
WBZ, 379.5, Springfield, Mass.

"I should also like to say that I have listened to American Broadcasting since 1923, for which I have confirmation letters reporting O.K. received chiefly on four and five valve sets, yet this 'Master Three' brought them in with greater ease.

"With regard to the stations you claim it will bring in on the Loud Speaker the majority I can endorse in one evening (February 12th, Sunday).

"I hope to test this set again next Sunday morning from 1 a.m. to 4 a.m. to see what it really will do.

"Wishing the 'Master Three' the very best."

From G. M. G., London, N.W.5

"I recently purchased a set of components for the Mullard 'Master Three' from Messrs. Jones Bros., Holloway, N., which I assembled in accordance with the blue print instructions and I am pleased to say I am getting exceedingly good results, although I have only an indoor aerial. Schenectady, N.Y., WGY, came through soon after midnight just recently on the loud speaker, and although rather soft the announcements were distinct."

From J. F. L., Leicester

"I wish to congratulate you on your success in placing a REAL wireless set on the market. It is simply wonderful. My last set was a Four Valve, but the 'Master Three' simply takes it a walk, both in volume and purity of tone, to say nothing of the number of stations one can get. Last Sunday night, between the hours of 6 and 7 p.m., I tuned in nearly thirty foreigners, one half on the Loud Speaker. I am running two Speakers on it, so you can judge the strength of it. In conclusion, let me say that whoever named it the 'Master Three' were quite right, it is a Real Master."

From T. W., Belvedere, Kent

"I received a blue print from you on Wednesday, 25th. I obtained the components from my local dealer on Saturday, I started to build the set at 4 p.m. and at 6.10 p.m., two hours and ten minutes later, I had completed it and tuned in nine Foreign stations and five English, but from then I have tuned in 20 stations all told. I have tried three sets in eighteen months which has cost me a lot, but this set cost me a great deal less to build and I think it is marvellous for what it takes to build it. Have recommended it to some of my friends—two have purchased the components since, scrapping their old ones as I have. Will certainly boost it to all I know."

From D. T., London, S.E.1

"I connected up according to diagram and in detail the 'Mullard Master Three,' and the results I obtained were rather gratifying for such a neat and straightforward circuit. I am working on an aerial of the 'T' type, approximately 25 ft. high and 75 ft. long, with lead in at dead centre and earth wire 10 ft. long direct to earth tube in ground.

"On test between 6 p.m. and 8 p.m. on the same evening, 26 stations were tuned in on the loud speaker. No head phones were used as they were not required. I am situated approximately 3½ miles from 2LO, and can just clear that station when working, and tune in 5GB. The station that was most pleasing later the same evening was Madrid from about 11 p.m. to 1.15 a.m., with a continuous programme of dance music, with not a blemish on the reception, although perhaps a little fading.

"It is certainly a receiver I would recommend for the man in the street, as the main requirements from his point of view are simplicity and ease of control."

From W. F. P., Newbury

"I have now obtained a Broadcast Colvern Coil for Mullard Master Three set, which I built and must say how delighted I am with results. I built it with slow motion dials instead of the dials you give as there is such fine tuning. On Sunday evening I picked up 31 Stations and 25 of them at loud speaker strength. This I consider excellent."

From F. C. C., Weybridge

"I should like to express my great satisfaction with the Mullard Master Three. Although I have not much mechanical skill and had no previous experience of wireless, except as a listener, I was able to get the set going in one afternoon. By evening I was getting perfect reception from 2LO and Daventry. I also got Langenberg and another continental station very clearly.

"For simplicity in construction and operation as well as for purity and power of reception, the Master Three is a most excellent set."

From J. L., Hull

"Although I have owned six or seven receiving sets during the last year or two, none have ever given me the satisfaction as has this one. It is without doubt the most powerful and selective three-valver that it has been my pleasure to hear.

"Of course these results are due to your series of 'P.M.' valves, which are, in my estimation, the best to be obtained.

"It will no doubt interest you to know that I have, by winding a coil for the short waves, received KDKA, 2XAG, 2XAF, 2XAD and PCJI."

From J. R. C. S., Newport, Mon.

"I am extremely obliged to you for sending me "Radio for the Million No. 5, together with Chart, etc., for constructing the Mullard Master Three. I have now made up this set and am very pleased with the result, as in addition to being able to get 5XX, 5GB, Cardiff and Bournemouth. I have brought in several continental stations at good strength through Loud Speaker.

"I may say I have been using Mullard valves and some of your other products for the past two years with every satisfaction. I also have that feeling 'all is well if its Mullard.'

"Kindly keep me posted with any further publications of yours, as I like to keep up-to-date in the wireless world, and I feel that you lead the way in this respect."

## FIVE VERY APPRECIATIVE LETTERS

### From J. E. M., Manchester

"Rather belatedly, I am writing to thank you for the particulars of the 'Mullard Master Three' which you sent me.

"I have built the set absolutely to specification and to say that I am pleased and satisfied is to put the matter mildly.

"It is quite the best set I have ever had the pleasure of listening to, both as regards simplicity of operation and purity.

"I am situated within 3 miles of the Manchester Station and consequently I have great difficulty in entirely tuning out that station. Also my aerial and earth systems are undoubtedly poor, but that I am at present rectifying.

"On the high waves I was able to listen to 'La Tosca' from Berlin at 7.0 p.m., and the reception from 5XX is all that could be desired."

### From F. C., Southport

"I am pleased to inform you that using a Master Three set I heard at fine loud speaker strength on three mornings this week WIOD (Miami, Florida) and WPG (Atlantic City). I listened to their programmes for over two hours. I also got a number of other American stations but did not wait to hear call letters.

"This set gets all over the Continent and for selectivity and power I think it the most remarkable I have yet tried."

### From C. J. G., Whitley Bay

"I wish to inform you that I have made your set up, the Master Three, and am greatly delighted at the results obtained from this set.

"I am only a novice at wireless and I can safely say that all is as simple as you say and more than that the results obtained are Pure, Sweet and 'Perfect Music,' 'no distortion whatsoever.'

"I have used all parts recommended by you to use in the set and to complete the set to perfection I have bought your Mullard P.M. Speaker, type "D." Now, after all stations were closed down on Monday night I received on the loud speaker, 'America' sending out the 'weather forecast.' Time was just about 11.40 p.m. I could not understand exactly from the loud speaker all that was said, but I decidedly did hear him send out 'Now the weather forecast' and in proper American accent. If I had connected the 'phones on I am sure I could have told you all that was said, but as the set is in the corner of the room I thought I might lose America by shifting the set.

"This was on the B.B.C. Coil, as I have not yet received the Long Wave Coil. I am going to make an alteration to the set by fixing on two slow motion dials as I find the same will greatly improve the tuning in of different stations."

### From A. T., Birmingham

"Please accept my sincerest thanks for copy of 'Radio for the Million' and blue prints duly received, also for your help re Amplifier.

"I am pleased to tell you I have now completed my Master Three and being possessed of what my friends call an ideal aerial, in an ideal situation, I can assure you the results have astonished everyone.

"I now receive at full L.S. strength, stations I have never heard of before on my old three-valve set.

"I am more than pleased, and may you receive all the success you deserve."

### From H. B., Surbiton

"On Wednesday night I 'hooked up' this receiver (it was only thrown together) and finished at 12.0 midnight. Connected up and got one station (Spanish) on speaker.

"Until to-day, I have not been able to give the set a good test, when I obtained 27 stations on a Mullard Pure Music Speaker—I never use phones. This with the worst aerial and earth system ever erected. My aerial runs over a lead roof and when windy, actually touches it. The average height above roof is 6 feet, length 20 feet, with lead in from centre. My earth is to a gas pipe (soldered) which has to roam over four floors before reaching the ground.

"As suggested in the Broadsheet I removed 5 turns of wire from pin No. 4 on the Aerial Coil, with an excellent improvement in selectivity.

"There was no trace of London (the local station) or any other station. There must have been other stations not working at the time, that can be brought in; however, my list gives quite sufficient choice for even the greatest 'fan.'

"I will wind a 'short-wave' coil and will let you know results. Use this letter if you wish—The Mullard Master Three is by far the best three-valve receiver I have ever handled.

"P.S.—I was using PM5X, PM5X, PM6. I did not have a PM5B available.

Since writing above, I have had three more stations."

not obtainable, while it is perfect at lower dial readings. This is a very puzzling effect which may be encountered by readers upon their early short-wave experiments.

The trouble itself is resultant upon the aerial system coming into tune with the tuned circuit, which condition prevents the receiver oscillating. Do not be tempted to modify the reaction turns on the six-pin coil or to move the reaction winding from its position, in the belief that such alterations will produce reaction effect. Mark you, it may do so at the particular point where it was previously absent, but the chances are that the same trouble may appear elsewhere on the tuning scale.

In the case of the system of interchangeable coils used in the Master Three, the juxtaposition of the respective windings is constant. Were the aerial winding capable of variable coupling with the grid coil, other suggestions for producing oscillation would be made. But in the instance before us, where the coupling between the various windings is fixed, flat spots on the short waves are overcome in an extremely practical way which does not involve any internal alteration to the set itself.

Most of you will have on hand a spare .003 mfd. variable condenser. Take the aerial lead to one terminal and connect by means of a short piece of flex the remaining terminal to the normal aerial terminal. The adjustment of this series aerial condenser will produce oscillation over the whole tuning range of the aerial condenser.

### A.B.C. Connecting Links for the Mikado P.M.

Readers who are interested in the very efficient Mullard Mikado P.M. Receiver, will welcome the news that A.B.C. Connecting Links have been placed on the market to facilitate the construction of this receiver. Although there are only 16 wires to place into position there are thousands of people who, being without previous experience of set building, would still hesitate before attempting even so simple a receiver except with the assistance of A.B.C. Connecting Links, the idea of which is a very brilliant feather in the cap of this magazine.

### The new Mullard receiving valve

Elsewhere in these pages reference is made to the addition of the Mullard P.M.4D to the Mullard series of radio receiving valves, and it is quite possible that many readers will be interested to know the precise use of this valve, which, as its characteristics show, has no equivalent on the British market to suggest its merits.

Most readers will already know that for a given place in a set there is a right valve. Hence there are what we call H.F. valves,

L.F. valves and detector valves. These three groups considered separately show that there may be two or more valves in each, although from this, it must not be understood that they are equally efficient for a particular purpose. For example, we have L.F. power valves of the P.M.4 type and L.F. super-power valves of the P.M.254 type. Both valves have definite jobs and it is right to say that under given conditions overall efficiency indicates one or the other.

In the general way, the same remarks are true in the case of the Mullard P.M.4D. As the characteristics on page 32 of this number show, the P.M.4D has a low impedance and a comparatively high amplification factor and is therefore suitable for use as a detector or first L.F. valve.

Dealing first with the use of the valve as an L.F. amplifier. From the standpoint of overall efficiency from the complete stage, it is required that in practice the impedance of the primary of the L.F. transformer should be as high as possible as compared with the impedance of the preceding valve. By this arrangement, we are able to secure maximum amplification from the valve added to which we have the step-up ratio of the L.F. transformer.

We have to obtain faithful quality as well as maximum amplification. This is where the Mullard P.M.4D plays a very important part. Employed with a Mullard Permacore L.F. Transformer this valve gives a greatly improved bass note performance than would be the case with the P.M.3, as the impedance ratio remains favourable for the very low frequencies.

As we see from the respective amplification factors there is a drop of 1, but this is wiped out and the balance actually falls in favour of the P.M.4D as this valve has a lower impedance. Therefore, we have in the Mullard P.M.4D an extremely useful valve which we are certain will quickly find its way into the sets of readers of the magazine. It should be remembered that as a first L.F. valve the P.M.4D will handle signals up to the limit governed by its grid swing.

It is as the detector valve followed by a Mullard Permacore Transformer that the P.M.4D provides us with its best. Its high mutual conductance—over two milliamperes per volt—gives a high degree of sensitivity. Either leaky-grid or anode bend will be found highly satisfactory.

In passing it should be remarked that the Mullard P.M.4D enables the home- constructor to improve the quality given by his set whatever type of L.F. transformer he may happen to be using. Remember this valve is essentially a highly sensitive detector and on signals of moderate strength is an excellent first L.F. valve.

# A FEW MORE WORDS ABOUT THE MULLARD MIKADO P.M. RECEIVER

*"I have made the set and I am delighted with the results. All who have heard it say it is the best two-valve set they have heard, both for volume and purity. I have a Mullard loud speaker and I ascribe the purity to this.*

*"I have a friend who wants to make the Mikado two. Will you please send him details of the set. I can get many stations besides Manchester, such as Daventry, Langenberg, Stuttgart, Breslau, Leeds—Bradford, Liverpool, London, Madrid and others."*

**I**F report has it true, this receiver enjoys a following only second to that of the Mullard Master Three which, as we hear from every side, is at once the world's most talked about receiver. In the Mikado P.M. we have a similar set so far as the circuit arrangement goes. It differs in the actual components used and more particularly in that it constitutes a two-valve receiver.

## Music sans headphones

The detector valve is connected into circuit exactly the same, reaction is obtained similarly, and on points of range, selectivity and simplicity of control, it is up to the high standard of the Master Three. Now that A.B.C. Connecting Links may be obtained for this receiver, there is every excuse for taking a peep into the future, and to visualise that those at present listening into broadcast by means of crystal sets, will study very seriously the advantage of using a receiver which will provide music without headphones. These links—16 in number—duplicate the wiring of the original receiver, the first description of which appeared in the last issue of this magazine.

We suppose users of crystal sets have very good reasons for continuing their use. Mainly, we believe their loyalty is due to reluctance to begin an acquaintance with batteries. If this is really a true analysis of the situation, then we should take this opportunity of stressing the fact that the much maligned batteries are more sinned against . . . The batteries necessary to run a Mullard Mikado P.M. would not involve a large initial expense, nor would their weekly upkeep cost more than a score or so cigar-

ettes. While speaking of the battery point of view, it should be stated that Mullard P.M. valves play their part in extending the periods between the recharging of the low-tension accumulator.

It may be that recurring recharging is one of the chief reasons for the crystal user's lack of enthusiasm when considering the installation of a valve receiver. Each morning, on the way to the office, they see someone carrying an accumulator to be charged . . . they see the dark side of it. But after all is said and done, this periodical journey to the charging station is only an insignificant item, many times repaid by the many, many hours of generous enjoyment which a speaker receiver is capable of giving.

## Recharging not very frequent

This recharging business for that matter may be avoided, since almost every city, town or village has a collecting and charging organisation which, for a few pence, will take away from you all the responsibility of carrying the accumulator to the charging station and also relieve you of the necessity to remember when it is due for charging.

With an Exide D.F.G. or Three Star N.S.30 using the specified 4-volt Mullard P.M. valves in the Mullard Mikado P.M. Receiver, recharging would be called for every month. This is not excessive and cannot really justify the absence of a good modern radio set from your home.

It is sometimes said that a crystal set is to be preferred because everyone in the house is able to switch it on and off. This is perfectly true. But the same ability holds good for the Mullard Mikado also. The simple on and off switch fitted on the panel

---

## MULLARD P.M. VALVES GIVE QUALITY

---

may be operated by the youngest child without any difficulty. Tuning is quite as elementary as it is with the crystal set. For the reception of the local and Daventry stations no more skill is required to secure perfect results than with the simplest crystal set.

### The new standard

Then we have heard it expressed that there is an inherent purity of music with the crystal set. This belief has become a password in radio. It is used as a symbol by everyone to express the peak of perfection, to represent the ideal, though elusive, standard of radio reception. Countless advertisements have driven home the fact that crystal purity is the standard by which all things radio are judged. The crystal has become to radio what Rolls-Royce is to the world of motors. . . . This may have been true three years ago; it may then have been our nearest point to the ideal. If our judgment means anything to us, we are going to say that to-day crystal purity is a shibboleth of the past. The modern Mullard P.M. valve correctly operated will produce results about which many a crystal would be proud to boast.

Tests in this direction could be made so very easily . . . made, they would at once dispose of the timeworn theory that only the crystal enjoyed the merit of faithfulness. Readers of these notes who are sceptical and hesitate to make the change on account of the idea that by going over to valves they will lose quality, would do well to place a pair of headphones across the primary of the transformer in the Mullard Mikado P.M. They would be very agreeably surprised.

### Where the valve scores

Apart from this standpoint, one must consider that the valve has the merit of possessing range. It is possible with a pair of headphones to bring in a large number of stations including some as far distant as America. The great advantage of the valve lies in the fact that it amplifies and that with a little additional apparatus it enables the efficient use of the speaker. We have never heard of radio enthusiasts reverting to headphones after once they had tasted of the pleasure of listening un-

hampered by headphones. And with this thought expressed we propose to deal with the utility of the A.B.C. Connecting Links.

In the general way we shall be very near the truth if we say that the majority of those who have already built the Mullard Mikado P.M. Receiver had never previously tackled building a set at home. The same remarks will most probably apply to future builders of the set. In the past, the first radio set was indeed a venture into uncharted seas. Mysterious designations which conveyed nothing, incomprehensible blue-prints and perplexing instructions—all served to complicate an otherwise comparatively simple affair.

### A boon to new-comers

A scheme was essential which would enable the least experienced to undertake successfully the home-construction of a radio set. It appeared that most stumbled when it came to connecting up the various components. Soldering added to the difficulty. Just as one could purchase a panel drilled to specification, why not also be able to procure a set of connecting wires cut to length according to specification?

So successful has the idea been in connection with the Mullard Master Three that it is now extended to the Mullard Mikado. We feel certain this extension will provide a vast public with the successful means to build for itself a very efficient little receiver. In each packet there are 16 wires which coincide in length with those of the original set; so there can be no question of misfits. It is simply a matter of picking out each wire correctly and connecting it between two points as indicated by the simple blue-print published for this set. A further check

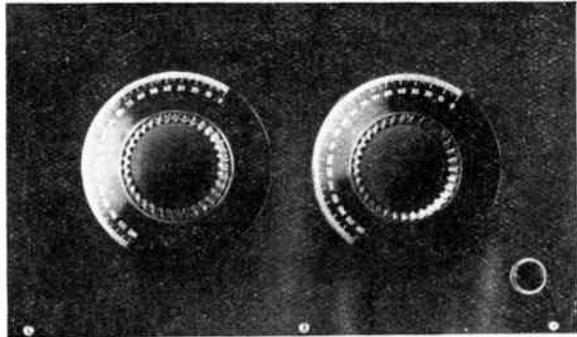

The left hand dial controls the wavelength over which the receiver will tune for a given coil while the right hand dial controls reaction. The L.T. battery switch may be seen in the lower right hand corner of the panel.

---

## SELF-EXPLANATORY BLUE-PRINT

---

is supplied by the point-to-point wiring details contained in the written description.

Before actually attaching any wire, it is just as well to lay out the 16 wires and to place them into the order already arranged by the point-to-point wiring. One would then avoid any possibility of connecting any link between incorrect terminals. Where the link is designated to be fixed under a terminal at either end it will be noticed that an eyelet is provided at each end of the link. This would select a certain number of connections. Again, other links are eyeleted at one end only, which names them for connection to the speaker or aerial and earth terminals.

### To embody the Mullard "Permacore" Transformer

In this continuation article of the Mullard Mikado P.M. Receiver, the opportunity is taken to reprint certain essential information as there is every likelihood of it being required by present readers who do not happen to have a copy of the last issue in their possession.

For example, those readers who have read the Editor's review upon the new Mullard Permacore L.F. Transformer and would like to build this set to embody this component, will find the reprinted section of the original article very helpful if not indispensable. Naturally, while copies of the December issue last out we shall be pleased to send one to anyone applying to the Editor, but it will be understood for the reason that it contains notes on the Master Three this particular number will be out of print

sooner than we wish. When this state of affairs comes into existence, radio enthusiasts wishing to obtain a copy, will be compelled to resort to the act of borrowing from a friend or enemy. Should it be from the latter, then, of course, there is every chance of possession becoming nine points of the law.

### Mounting the components

The key to connections, or point-to-point wiring as it is sometimes called, gives the correct terminal markings for the Mullard Permacore Transformer.

The same remark applies to the circuit diagram.

Apart from this alteration the other reprinted details are exactly identical with those appearing in the December number.

The simple blue-print is self-explanatory, as every component is reproduced full-size and in the correct relative position to allow every builder to proceed from the start with every distance marked out for him. Commencing with the panel, which your dealer will probably be able to sell you already drilled, mount the two variable condensers and the on and off battery switch. Then fix the two terminal strips at the rear of the baseboard so that the outer ends of each come flush with the side edges of it. Note that these terminal strips are screwed on to the back edge of the baseboard. Now take the blue-print and lay it on the baseboard so that you will be able to pierce through the points indicated as screw holes for fixing down the respective components,

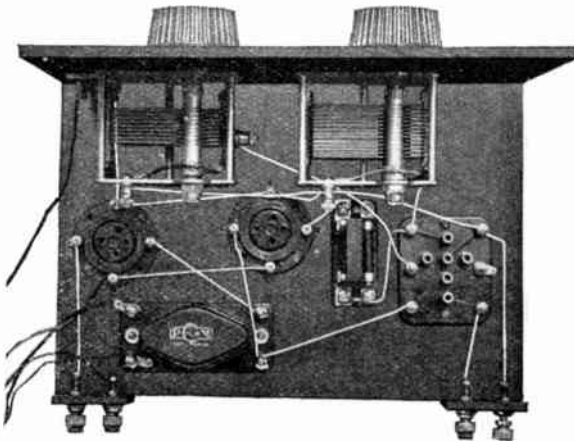

Readers wishing to build this receiver will see in this illustration a plan aspect which indicates the lay-out of the various components. Where the set is intended for extreme short wave work an H.F. Choke may become necessary for which component there is ample space between the six-pin coil and the L.F. Transformer.

## THE MODIFICATION FOR SHORT WAVES

These are shown by a cross enclosed within a circle; in all there are 13 such points. Remove the blue-print, lay out the parts according to the plan and secure into position by means of suitable wood screws. If you have been moderately careful in squaring up the print and the baseboard it will be found that the incisions made will enable you to screw down the components without further delay. As there are only two parts of the same physical shape—valve-holders and variable condensers—no difficulty will be encountered in the recognition of the correct piece for a certain place. Care should be taken to fix the six-pin base the right way round—that is with socket numbers 5 and 4 nearest to the rear of the baseboard. It should also be noted that the two valve-holders must be correctly placed.

### An H.F. Choke for short waves?

Although a transformer is included in the anode of the detector valve it was found upon trial that reaction was obtainable on the ultra short waves without the insertion of an H.F. choke. The valve used as V.1 was a P.M.4 D. It is not possible to say if this will be the case with every set as reaction was obtained by the application of 100 volts to the anode of the detector valve by means of battery lead number three.

If you have this voltage available—and we trust you all have, as really excellent results cannot be secured without a goodly supply of high-tension current to the anodes of the valves—and you propose to operate on the very short waves, first try your set to make certain reaction effects are obtainable. If there is any doubt about it incorporate an H.F. choke.

If however, you intend to limit the use of the set to the B.B.C. and long wavebands this latter component will not be necessary at all. In this event wire number ten will join terminal A of valve-holder V.1 to the terminal marked Anode of the Mullard Transformer, where it forms a junction with one end of wire number nine. This connection proceeds to terminal number five of the six-pin coil base.

Should you wish, however, to make use of the 20 to 90 metre waveband and perhaps decide to include an H.F. choke to ensure reaction on a low

anode voltage, what virtually happens is that wires number nine and ten are detached at the junction formed at the anode terminal of the Mullard Transformer and fixed under one terminal of the H.F. choke. A short piece of wire is then eyeleted and attached at one end to the free terminal of the H.F. choke and at the other end to the anode terminal of the Mullard Transformer. The Free Blue-print No. 209A shows exactly how this modification is effected. The solid lines represent the direction given by the blue-print while the dotted lines trace out the slightly different wiring involved by the addition of the H.F. choke. The extra wire is identified as connection number 10a.

### Speaker reception from continent

These few notes would not be complete without reference to the results which every owner of the Mullard Mikado Receiver will be able to obtain. What would you say if it is recorded here that on the evening of Easter Sunday Langenberg, Hamburg and Radio Toulouse were received at moderate speaker strength? The speaker in question being a Mullard Type E. On the one hand, you would be justified in remarking that such results were above the average to be expected from a simple two-valve receiver. On the other hand, recalling the very limited pick-up ability of the test aerial, a similar performance should be the happy outcome of the hour or so occupied in its construction.

If for no other service, the reception of the above stations under the conditions named gives a very accurate conception of

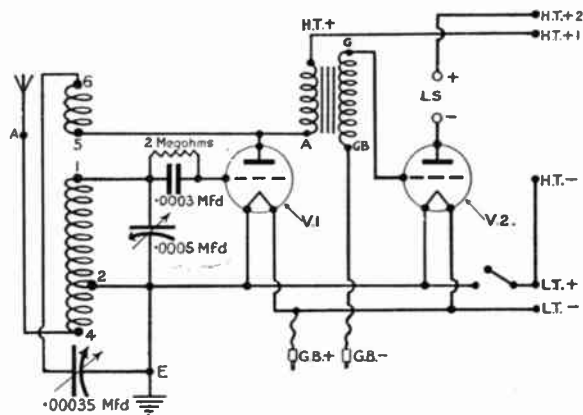

Here we reproduce the circuit diagram of the Mullard Mikado P.M. Receiver. Examination will reveal the similarity of the detector arrangement with that of the Mullard Master Three.



## THE FOUR MAIN FEATURES

the speaker range of the set when the builder is only concerned with the local station, 5GB and 5XX. All three of the continental stations named above are known to come over very well, and it is a fair comparison to class them in the same category as the three British stations mentioned. Whether you are fortunate to own a good aerial or not decides how many stations in addition to the local you will receive at speaker strength. Within a hundred miles of the Midland high power stations you are assured of three, although judging by the speaker reception of three popular continental stations it is quite possible that this very moderate claim may be doubled, and that in these circumstances the speaker range of the set would be increased to two hundred miles on powerful stations.

### The crystal now obsolete

The great utility of the Mullard Mikado P.M. is that on certain stations, such as your local, speaker reception may be enjoyed to the same degree of purity and strength as is possible on a three or four valve set. This one feature alone makes the set infinitely preferable to the obsolete crystal set.

Secondly, while within range, both 5GB and 5XX are also receivable on the speaker by the use of increased reaction as the distance between the set and either station increases.

Thirdly, on the 200-550 metre waveband one has at his command a host of broadcast programmes from Britain and the Continent, all of which would be heard very strongly in the headphones. A pair or two of extra headphones would enable members of your family to listen to the best foreign stations, just as they have done in the case of the local far too long with the old crystal set. It should not be forgotten that the 1,000 to 1,800 metre waveband also provides a number of exceptionally good programmes which should appeal to coast dwellers troubled by morse interference on the B.B.C. waveband.

### Short wave long distance reception

Fourthly, we come to the reception of stations operating the very short waves. As we have pointed out, if this group of stations is to be received it is necessary to modify slightly the set to include an H.F. choke. With this modification effected all the popular short-wave American stations are within headphone range, as also is the well-known Australian station 2FC which is so often relayed by the B.B.C.

We do not think that any question exists as to the superiority of the Mullard Mikado P.M. Receiver over the crystal set. The two sets are as far removed on the points of utility, comfortable listening, range, universality and entertainment as the Poles.

### Dial Readings for the Mikado P.M.

LONG WAVE COIL	Dial
Radio Paris ... ..	163
Daventry ... ..	146

BROADCAST WAVE COIL.		Dial
Munich ... ..	162	Cardiff ... .. 98.5
Vienna ... ..	157	Praque ... .. 90
Brussels ... ..	155.5	Barcelona ... .. 94
Aberdeen ... ..	152	Paris ... .. 92.5
Daventry (5 GB) ... ..	149	Koenigsburg ... .. 87
Berlin ... ..	147	Bournemouth ... .. 85
Langenberg ... ..	142	Breslau ... .. 84
Oslo ... ..	140	Dublin ... .. 83
Paris ... ..	139	Newcastle ... .. 81
Rome ... ..	136.5	Belfast ... .. 79
Bruenn ... ..	133.5	Nurnberg ... .. 78
Frankfurt-on-Main ... ..	129	Liverpool ... .. 77.5
Berne ... ..	123	Hull ... .. 77
Glasgow ... ..	120	Edinburgb ... .. 76
Plymouth & Cork ... ..	118	Dortmund ... .. 75.5
Haniburg ... ..	117	Leeds ... .. 74.5
Toulouse ... ..	115	Nottingham ... .. 73.5
Manchester ... ..	112	Sbeffield ... .. 73
Stuttgart ... ..	110.5	Malmo ... .. 70
Madrid ... ..	107.5	Toulouse ... .. 68.5
Paris ... ..	107	Kiel ... .. 66.5
Leipzig ... ..	104.5	Bradford ... .. 65
London ... ..	102	Muenster ... .. 58.5

For the guidance of the many thousands of readers who will employ this receiver for the reception of ultra-short wave transmissions, we are printing various dial readings over the 20-90 metre waveband. It will be noticed that tuning points are given for each coil. A few hints on short wave reception are to be found on page 8.

### TUNING POINTS FOR Short Wave COIL No. 1 (20-45).

38 2 XAD	(Schenectady, G.E.C.)	21.96 metres.
81 2 XAF	(Schenectady, G.E.C.)	31.4 metres.
135 KDKA	(Pittsburg)	43 metres.

### TUNING POINTS FOR Short Wave COIL No. 2 (40-90).

12 KDKA	(Pittsburg)	43 metres.
86 KDKA	(Pittsburg)	62.5 metres.

## AN IDEAL 4 VOLT RECEIVER

As in this receiver a Mullard Permacore L.F. Transformer is embodied, owners will be able to take full advantage of the Mullard P.M. 4D, details of which appear in another page of this issue. Since for reasons of efficiency we give our strongest recommendations to this voltage range, it strikes us that the Mullard Mikado Receiver presents the opportunity for new comers to radio, as well as those making the change over from crystal sets, to begin their experiences with valve receivers at the peak of efficiency.

Without sidestepping into technical considerations here, it is sufficient to say that

Transformer went through the research department into the great Mullard factory together. Each has gone through the numerous and various stages of development in conformity with time schedules which were identical in so far as the important dates were concerned. It was intended that with the release of the Mullard Permacore L.F. Transformer the British radio public should also be able to use in conjunction with it the correct Mullard P.M. Valve.

Therefore, if you would obtain the maximum signal strength from your Mullard Mikado Receiver instruct your local wireless

### COIL WINDING DIRECTIONS

The simplicity of the coils for the Mullard Mikado Receiver permits of their being wound at home with every assurance of satisfaction. Blank Colverners may be obtained from your usual wireless dealer. Winding should be commenced from pin number six to which is attached one end of the reaction winding. Pin number five takes the finish of this winding. Leaving a space of about two diameters of the wire, start at pin number one and wind on the grid coil

which is completed at pin number two. Again making a space of two diameters, wind on the aerial coil starting at pin number two and continue winding for the required number of turns which completes the coil at pin number four. It will be necessary to solder the ends of each winding to the pins and care should be taken to use only the smallest trace of flux and solder for this purpose. Preferably, resin-cored solder should be employed.

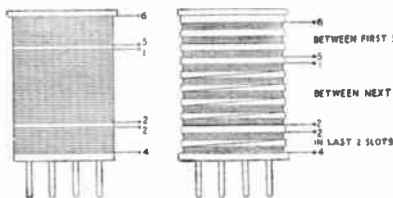

Use 28 gauge D.S.C. wire for B.B.C. coil.  
Use 32 gauge D.S.C. wire for long wave coil.

#### LONG WAVES:

Reaction, between Pins No. 6 and 5:—150  
Grid Coil, between Pins No. 1 and 2:—200  
Aerial Coil, between Pins No. 2 and 4:—100

#### BROADCAST WAVES:

Reaction, between Pins No. 6 and 5:— 30  
Grid Coil, between Pins No. 1 and 2:— 65  
Aerial Coil, between Pins No. 2 and 4:— 15

#### SHORT WAVES:

The winding specification for the ultra-short wave coils is given on page 9 in the article on the Mullard Master Three to which readers are referred.

the Mullard P.M. 4D, and the Mullard Permacore L.F. Transformer provide the radio set builder with an ideal L.F. combination. Whether in the possession of technical knowledge or not, we have all heard it said that there is a right valve for use in conjunction with a particular transformer. As a matter of fact the importance of arranging for the best combination is not to be neglected, if we intend to obtain maximum efficiency from the low-frequency side of our receivers.

Here is a little secret. The Mullard P.M. 4D and the Mullard Permacore L.F.

dealer to supply you with a 4-volt low-tension battery which will enable you to take the advantage of the inimitable merits of the Mullard Permacore L.F. Transformer and the Mullard P.M. 4D. Very briefly, the employment of this combination in addition to giving maximum signal strength, assures an extremely high degree of quality. While this point attracts every one, its strongest appeal will be made to the crystal user who may be on the verge of at last deciding to invest in the pleasures of a highly satisfactory valve receiver.

\* \* \* \*

## KEY TO CONNECTIONS

Work from the back of the set—

- Wire No. 1.**—Connect together furthest terminals of valve holders V<sub>1</sub> and V<sub>2</sub>.
- Wire No. 2.**—Connect together nearest terminals of valve holders V<sub>1</sub> and V<sub>2</sub>.
- Wire No. 3.**—Connect furthest terminal of valve holder V<sub>2</sub> to right hand terminal of switch S.
- Wire No. 4.**—Connect left-hand terminal of valve holder V<sub>2</sub> to terminal LS—.
- Wire No. 5.**—Connect right-hand terminal of valve holder V<sub>1</sub> to nearest terminal of grid condenser C<sub>3</sub>.
- Wire No. 6.**—Connect furthest terminal of grid condenser C<sub>3</sub> to terminal No. 1 of coil holder H.
- Wire No. 7.**—Connect earth terminal to terminal No. 2 of coil holder H.
- Wire No. 8.**—Connect aerial terminal to terminal No. 4 of coil holder H.
- Wire No. 9.**—Connect terminal No. 5 of coil holder H to terminal A of L.F. transformer.
- Wire No. 10.**—Connect terminal A of L.F. transformer to left-hand terminal of valve holder V<sub>1</sub>.
- Wire No. 11.**—Connect terminal G of L.F. transformer to right-hand terminal of valve holder V<sub>2</sub>.
- Wire No. 12.**—Connect terminal No. 1 of coil holder H to terminal on right-hand side of variable condenser C<sub>1</sub>.
- Wire No. 13.**—Connect terminal No. 6 of coil holder H to terminal on right-hand side of variable condenser C<sub>2</sub>.
- Wire No. 14.**—Connect together terminals on end plates of variable condensers C<sub>1</sub> and C<sub>2</sub>.
- Wire No. 15.**—Connect terminal on end plate of variable condenser C<sub>1</sub> to terminal No. 2 on coil holder H.
- Wire No. 16.**—Connect terminal on end plate of variable condenser C<sub>1</sub> to furthest terminal of valve holder V<sub>1</sub>.
- Battery Lead No. 1.**—A piece of flexible wire 3 ft. long should be fitted with a black wander plug at one end. At a point 12 inches from this same end the insulation should be carefully cut away from the wire and the wire itself should be doubled at this point and inserted into a red spade terminal. The free end of the flexible wire should be bared and connected to the left-hand terminal of switch S.
- Battery Lead No. 2.**—A piece of insulated flexible wire, 2 ft. long, should be fitted with a black spade terminal at one end—the other end to be connected to the nearest terminal of valve holder V<sub>2</sub>.
- Battery Lead No. 3.**—A piece of insulated flexible wire, 2 ft. long, should be fitted at one end with a red wander plug, the other end should be connected to terminal H.T.+ of the L.F. transformer.
- Battery Lead No. 4.**—A piece of insulated flexible wire, 2 ft. long, should be fitted at one end with a red wander plug, the other end should be connected to terminal L.S.+.
- Battery Lead No. 5.**—A piece of insulated flexible wire, 9 ins. long, should be fitted at one end with a red wander plug. The other end should be connected to the nearest terminal of valve holder V<sub>1</sub>.
- Battery Lead No. 6.**—A piece of insulated flexible wire, 9 ins. long, should be fitted at one end with a black wander plug, the other end should be connected to terminal G.B. of L.F. transformer.

## SELECTED MULLARD VALVES FOR THE MIKADO RECEIVER

- A 2-volt L.T. Accumulator will require for:—**  
 V.1 or detector valve—P.M.1 H.F. (Detector Valve).  
 V.2 or L.F. output valve—P.M.2 (Power Valve).
- A 4-volt L.T. Supply:—**  
 V.1 or detector valve—P.M.4D (High Slope).  
 V.2 or L.F. output valve—P.M.4 (Power Valve).
- A 6-volt L.T. Supply:—**  
 V.1 or detector valve—P.M.5X (G.P. Valve).  
 V.2 or L.F. output valve—P.M.6 (Power Valve).
- The correct Mullard Super Power Valves for the Mullard Mikado Receiver are:—
- For 2-volt L.T. Supply—P.M. 252.**  
**For 4-volt L.T. Supply—P.M. 254.**  
**For 6-volt L.T. Supply—P.M. 256.**

### H.T. VALUES.

- Battery Lead No. 1 to H.T.—(negative).**  
**Battery Lead No. 3 (or H.T.+1) 40 upwards**  
**Battery Lead No. 4 (or H.T.+2) to 108 volts** positive in the case of a P.M.2, P.M.4, or P.M.6. Increased quality is obtained by the use of a Mullard Super power Valve when a high capacity H.T. battery should be employed. The voltage on battery lead No. 4 with the P.M. 252, should be 120 volts, whereas with the P.M. 254 or P.M. 256 it may be as high as 150 positive.

### G.B. VALUES.

- Battery Lead No. 5 to G.B.+(positive).**  
**Battery Lead No. 6 (or G.B.—) to 7½ volts** negative with a P.M.2, P.M.4, or P.M.6 and 18-22 volts in the case of the P.M. 252, P.M. 254, or P.M. 256.

## COMPONENTS

- One ebonite panel, 12" × 7" × ½" (Redferns).  
 One baseboard, 12" × 8" (Camco).  
 One variable logarithmic condenser, '0005 mfd. (Ormond).  
 One variable logarithmic condenser, '00035 mfd. (Ormond).  
 One six-pin coil base (Lewcos).  
 One combined grid condenser ('0003 mfd.) and leak (2 megohms) (Mullard).  
 L.F. transformer (Mullard Pennacre).  
 Two valve holders with terminals (Lotus).  
 Two terminal strips, 2" × ¼" × ¼".  
 Four terminals: (Aerial, Earth, LS+, LS—) (Belling-Lee).  
 Five wander plugs (2 black, 3 red) (Eelex).  
 Two spade terminals (1 red, 1 black) (Eelex).  
 One filament on and off switch (L. & P.).  
 One suitable cabinet (Camco).  
 Set of A.B.C. Mikado Connecting Links (Junit).  
 A quantity of red and black flex.  
 Two Mullard P.M. valves, suitable for the accumulator. These are detailed under "Selected Valves" (Mullard).  
 One broadcast wave Master Three coil (Colvern).  
 One long wave Master Three coil (Colvern).  
 One Mullard P.M. Speaker (Mullard).  
 One 2, 4 or 6-volt accumulator. (Exide or Three Star).  
 One high-tension battery (108 volt) Siemens.  
 One grid bias battery (9-volt) Siemens.  
 Two of the above batteries will be required if use is made of a Mullard Super Power valve in the last stage.

# THIS LONG DISTANCE SET FEATURES EVERY WISH OF THE RADIO OWNER

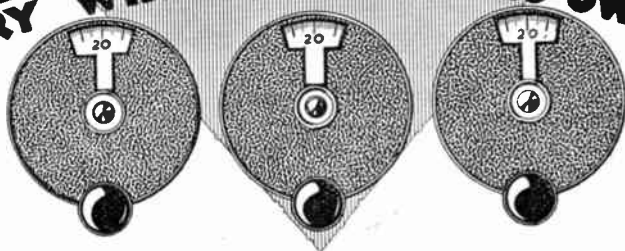

## NOTES ON THE MULLARD RALEIGH P.M.

Most present readers will have in their possession a copy of the Autumn Double Number of "Radio for the Million" in which was described The Mullard Raleigh P.M. Receiver. It will be recalled that this set employs five Mullard P.M. valves which are arranged so that two function as high-frequency amplifiers, another as a leaky-grid rectifier, the fourth and fifth as L.F. amplifiers—R.C.C. and transformer respectively. The way in which these last three Mullard valves are used calls for little comment here except to say that, during this radio season, this system has enjoyed unrivalled popularity. So far as the present series of published Mullard P.M. sets are concerned the scheme has been standardised. To a very considerable degree the radio public has appreciated the method, and the lead given in this direction by our designs has been followed by it with few, if any, demands for an alternative.

### A formidable test

In this brief notice we propose to touch upon one or two interesting points about this receiver which we know to remain the outstanding multi-valve radio set six months or more after its publication. Naturally, everyone is not in the position to own an ambitious set such as this. Its appeal is limited to those who are willing to satisfy their radio fancies at a cost of nearly twenty pounds for component parts, to which must be added, the price of five Mullard P.M. valves, a Mullard Speaker and suitable current supply batteries. Readers will understand, however, that there is a world of difference between the performance of a five-valve receiver and the capabilities of a three-valve set. Frankly, it is not really practicable to make any comparison. The two high-frequency stages of the Raleigh P.M. are capable of bringing in even extremely low-powered stations at full speaker strength.

It is interesting to recount that one evening towards the latter end of last year, the set was put through further tests in order to

gain additional data on its power and range. A visitor was asked to name a broadcast station working on minimum power and located as distant as possible. The station chosen was Halmstad (Sweden) which we know to be operating on '25 kw.

Regular readers will be familiar with the test aerial. A brief description of it appears in the article on the Mullard Master Three. It will be apparent that all the odds were against the set. Very little margin of safety was left for any of the usual difficulties encountered in long distance work. When it became known what was to be expected of the set, we confessed to a little agitation of mind. It was, to say the least of it, rather a tall order. For all that, the set came out of the test with flying colours. Within thirty seconds the station was heard on the speaker, its identity was checked against the Emerald and confirmed a few minutes afterwards by the station itself making its usual *entr'acte* announcement.

### Surpassed performance

The original receiver has also had extended tests a few miles South of London on the Surrey Downs, where we understand, its published performance was easily surpassed without pressing the receiver to deliver its utmost.

Readers who contemplate becoming owners of a more powerful set should refer to the description of the Mullard Raleigh P.M. appearing in the September issue of this magazine. Speaking for a large number, one is able to say that, just as one commences a motoring career by the purchase of a car of moderate power, so have many, many thousands joined the great radio family by means of the Mullard Master Three. A very large percentage will remain permanently satisfied with it. Its simplicity of operation, low-running cost and its extraordinary high performance will maintain for it an immense band of followers. But there is certain to be a number who, in the

## HINTS ON NEUTRALISING THE RALEIGH

same way as many car owners in the choice of a new car, fix their desires upon one with increased power, will feel that a more powerful set would give them greater pleasure. In this case no better set than the Raleigh P.M. could be recommended.

It will be seen in this number of "Radio for the Million" that a rather novel system is adopted for its construction. The work of building is conveniently divided into six evenings and it is therefore possible to proceed according to a helpful plan devised to be both simple and rapid. Complete stage screening is made use of for the H.F. side of the receiver and since there are three such compartments, this part of the construction is logically allotted to the first three evenings, while two further evenings are sufficient to finish the building. The set should be ready for testing on the sixth. The specified screens are sold complete with mounted terminal strips. In order to facilitate the wiring-up of the various components upon the screen baseboards, it will be found that, if two recesses are cut into these and the terminal strips screwed into position, wiring up may be almost completed before dropping into the screen. After this, the variable condenser should be mounted into position on the screen and then wired-up. This allows for convenient working.

### A remark on valves

It should be pointed out that the six-point switch serves to cut out the first L.F. valve and its associated circuit. This arrangement places the high-impedance detector in the primary of the L.F. transformer when the first L.F. valve is switched out. For local work, therefore, it is desirable to change the detector valve and use in

place of the specified R.C.C. valve another type suitable for the transformer. In this case V 3 valve-holder would take the same valve as is recommended for V 4 valve-holder—the P.M. 1 L.F., P.M. 3, or P.M. 5X, according to the voltage of the L.T. battery being used.

On distant work, make a practice of always employing the full number of valves, when, upon the reception of very loud signals, slight detuning will reduce volume to comfortable speaker strength. This method is preferable since it permits the use of the high-magnification factor of the R.C.C. valve with a resultant increase of signal strength.

### The first method

For the assistance of owners of this receiver we are printing two suitable methods of neutralising, both of which are excellent ways of doing this rather important though far from difficult job. It is suggested that you first try the "squeal" method. Usually, it will be found that neutralising the receiver in this manner is simple, effective and rapid. Here it is—

Place correctly into the appointed screens the specified coils which are marked in the following manner—Raleigh Aerial Coil, Raleigh 1st H.F. Coil, Raleigh 2nd H.F. Coil.

With the panel to the front, insert the aerial coil into the coil-holder in the left-hand screen; the first H.F. coil into the coil-holder in the centre screen, and the 2nd H.F. coil into the coil-holder in right-hand screen.

Switch on all valves by inserting the speaker plug into the jack; switch off the first L.F. valve by means of the switch provided. Proceed then to tune-in the local station with reaction at zero.

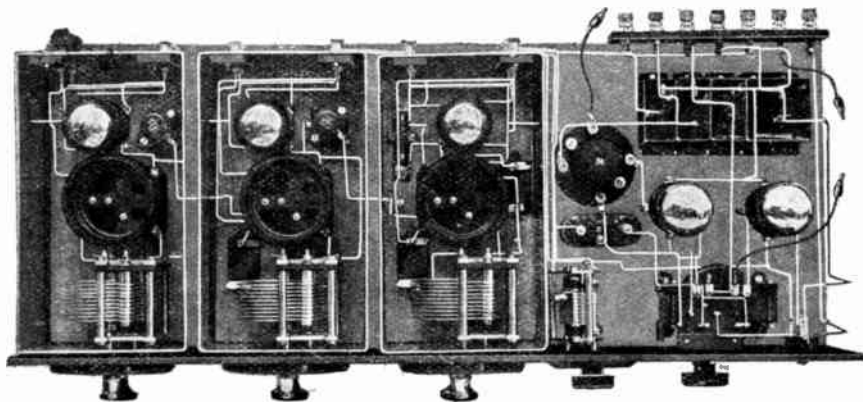

An informative view of the Mullard Raleigh P.M., which shows the efficient design of the receiver.

---

## AN IDEAL SET . . . EASILY HANDLED

---

Commence with the 2nd H.F. tuning condenser (i.e., the third condenser on the panel); balance out by means of the neutralising condenser in the centre screen, all squeals which are produced by rocking the tuning condenser.

Turn your attention to the 1st H.F. condenser (i.e., the second condenser on the panel); balance out by means of the neutralising condenser in the left-hand screen all squeals which are produced by rocking the tuning condenser.

Revert then to the 2nd H.F. tuning condenser and test for completeness of neutralisation. Make any slight adjustment which may be necessary. The same test should again be applied to the 1st H.F. tuning condenser.

### Many may prefer this second way

Tune in your local station as loudly as you can, but using no reaction: then remove the connection between terminals L-L on TS 2 and TS 3 and adjust the neutralising condenser (NC 1) until a position is found where the local station is cut out. The first H.F. stage is then neutralised.

Then remove the connection between terminals M-M on TS 4 and TS 5 and take a temporary connection from terminal M on TS 5 to terminal L on TS 2. Adjust the neutralising condenser (NC 2) until the local station is almost, or entirely, cut out, and then remove the temporary connection. Replace the connection between terminals M-M on TS 4 and TS 5, and also between terminals L-L on TS 2 and TS 3. The set is then correctly neutralised.

### Using the spare primary former

Reference to the list of parts for this receiver shows that the specified coils are sold in complete kits. The manufacturers supply an additional unwound primary former the object of which is a matter for conjecture in the minds of many readers.

It is intended that the set be tested out on the standard coils as obtained from your dealer, when, should it be found that the receiver is not quite selective enough for your requirements, the extra primary former will enable you to wind a more suitable aerial coil. Should you wish for increased selectivity, remove the primary former inside the aerial coil; the standard winding between pins 5 and 4 is fifteen turns. On the spare former wind, say, ten turns between these pins and place inside the large former. Test for selectivity. If you are very close to a powerful broadcast station you may have to reduce the number of turns to eight—

perhaps five. Of course, you will only have occasion to use so few turns in the aerial when you wish to receive stations working extremely near the wavelength of your local. If wishing to receive distant stations during hours when the local is closed down, one would revert to the standard aerial primary. In ninety-nine cases out of a hundred the standard primary gives all the selectivity required as it would only be necessary to have resort to the reduced turn numbers within a mile or so of a very powerful local station.

### "Equally good on long waves"

From T. W. W., Rossendale, Lancs.

"At the last Manchester Radio Exhibition, I obtained a copy of 'Radio for the Million,' No. 4, and after some time commenced to build the Raleigh P.M. Receiver, which, owing to lack of spare time, I have only just been able to complete, but I am so delighted with its performance that I feel it a duty to write and tell you so, although I have not yet, I know, tested out all its capabilities.

"I have built many multi-valve sets, including two Super-Hets, but this beats them all easily, and every word in your article is true. With the H.T. voltages given, I get so much volume that my loud speaker can hardly cope with same on four valves, especially on Manchester's transmissions, and the quality is enough to satisfy one who is a keen amateur musician and a pianist—and better than I have obtained using three stages of R.C. coupling in other receivers I have built.

"As you say it is equally good in the long-waves and anyone who wants an ideal set, easily handled, they cannot do better than build this Raleigh P.M."

From S. W., Stoke-on-Trent

"Some few weeks ago you kindly sent me a copy of 'Radio for the Million' together with four blue-prints of your sets.

"I am no novice so far as wireless is concerned and was building sets when only Holland was to be heard on Sunday afternoons.

"I have built countless sets, but now I have made a *real* set, viz., your wonderful Raleigh P.M. Receiver.

"This has exceeded my greatest expectations, and I tender you my best thanks for designing such a set and putting same within the reach of the wireless public.

"I am less than half a mile from the Stoke transmitter, but this no longer troubles me and although I only completed the set last week I have logged 21 stations and there are many more to be brought in I know.

"So selective is the set that I can get Stuttgart without a trace of Manchester, although there are only 4 metres difference and Manchester is 35 miles away."

From S. E. S., Lewisham, S.E.13.

"Many thanks for the double-number of 'Radio for the Million.'

"I have constructed the Ralcigh P.M. Receiver according to instructions and presented it as a wedding present to a friend, my brother provided the P.M. H.T. supply unit and my sister, your model 'D' speaker. The combination is acknowledged to be the best present received.

"Your claims for this masterpiece are extremely modest, for simplicity of construction, thanks to your blue prints and ample directions, and operation I have never known better, or any even as good. It is perfect. I speak from experience gained with twenty-two receivers spread over fifteen years, except the War period."

### H.T. from the Mains

Judging by our correspondence many readers are depriving themselves of really good results by failing to invest in a satisfactory high tension supply. In our own case we are very attentive on this score as we know from experience that to starve one's set of H.T. results in an audible loss of signal strength and impaired quality.

It cannot be emphasized too strongly that the valve makers' recommendations on this point should be followed and that the maximum permissible voltages be used. Speaking for ourselves we must confess that we have occasionally been guilty of the use of plate voltages in excess of those advised, so greatly does ample H.T. improve the performance of a set.

If your house is wired for electric current there is no better source of H.T. than the mains. Should these be A.C. a very suitable unit is manufactured by Mullards which will supply up to 150 volts on the highest tapping. This H.T. supply unit makes use of full wave rectification thereby utilising both the positive and the negative half cycles.

The recent reduction in price of this unit to £6 10s. od. makes the initial cost small in consideration of the utility and efficiency provided. For three hours per day, the running cost works out at less than eight shillings per year. By using the electric

mains one is assured of a constant H.T. supply at a never-failing voltage.

So far as D.C. is concerned, there are a number of very suitable units on the market. It is advisable to purchase a reputable make capable of delivering sufficient current and embodying an efficient smoothing system. We understand from various manufacturers of D.C. units that they have produced special models for use in conjunction with the Mullard Master Three and the Mullard Mikado P.M. Receivers.

### SHORT WAVE STATIONS

EH <sub>0</sub> XD	85	Zürich (Radio Club).
WBZ	70	Springfield (Mass.).
OHK <sub>2</sub>	70	Vienna.
AFK	67.65	Döberitz.
6XAL	66.04	Los Angeles (California).
8XF	66.04	Cleveland (Ohio).
2XAQ	65.4	Newark (N.J.).
WAAM	65.18	Newark (U.S.A.).
2XBA	65.18	Newark (New Jersey), (S.W. of WAAM).
KFBC	65.18	San Diego.
WABC	64	Richmond Hill (New York).
KDKA	62.5	Pittsburgh East (Westinghouse Electric) (U.S.A.).
9XU	61.06	Council Bluffs (Iowa).
GC	61	Paris (Radio LL).
RFN	60	Russia.
3XL	59.96	Bound Brook (N.J.), 30 kw.
AGJ	56.7	Nauen.
8XJ	54.02	Columbus (Ohio).
2XBB	54.02	Coney Island (N.Y.), 0.15 kw.
WCGV	54	Brooklyn (N.Y.).
7XAO	53.54	Portland (Oregon), 0.1 kw.
8XAL	52.05	Harrison (Ohio), 0.5 kw.
WLW	52.02	Cincinnati (Ohio).
RFN	50	Karlsborg (Sweden).
1AX	50	Russia.
	45	Rome (Italy).
	44.4	Vienna, 0.24 kw.
WIZ	43.35	New Brunswick (N.J.).
KDKA	43	Pittsburgh East (Westinghouse Electric).
7RL	42.12	Copenhagen.
YR	40.20	Lyon (Rhône).
	38	Agen.
JHBB	37.5	Ibarakiken (Japan).
	37	Radio Vitus.
6XAR	37	San Francisco (Cal.).
6AG	32.9	Perth (W.A.).
EH <sub>0</sub> XD	32	Zürich (Radio Club).
3LO	32	Melbourne.
JB	32	Johannesburg.
EH <sub>90</sub> C	32	Berne (Switzerland).
	32	Paris, Eiffel Tower.
2BL	32.5	Sydney.
8XAO WJR	32	Detroit (Mich.).
2XAF	31.4	Schenectady (G.E.C.).
ANE	31.93	Bandoeng, Java (Radio Service)
	31.25	Bergen.
	31.5	Helsingfors.
2XAL	30.91	New York.
PCJJ	30.2	Hilversum, Holland.
LGN	30	Bergen (Norway).
2FC	28.5	Sydney.
2XAG	26.02	New York.
8XK	26.8	Pittsburgh.
2XAB	24	New York.
5SW	24	Chelmsford (15 kw. Aer).
2XAA	22.99	Houlton (Maine).
WOWO	22.8	Fort Wayne (Indiana).
	22.2	Vienna, 0.24 kw.
2XE	22.1	Richmond Hill (N.Y.).
2XAD	21.96	Schenectady (G.E.C.).

# CHARACTERISTICS OF MULLARD P.M.4D.

## The New Mullard Combined Condenser and Leak

A glance at the illustrations in this number of the Mullard Mikado Receiver shows this new component in use to effect leaky-grid rectification. Where the leak is in parallel with the condenser the coupling strap should be left in position. This direction holds good for the Mullard Master Three as well as the Mikado P.M.



Showing the new Mullard Combined Condenser and Leak.

Should readers wish to connect the leak in series the connecting strap must be removed. The common terminal would then be connected to the grid of the detector valve, while another wire would join the free end of the condenser to the tuned circuit and a third wire would link the free end of the grid leak to the filament.

The advantage of providing your set with interchangeable fixed condensers and leaks will be apparent. It is possible by the system to make an immediate comparison between different values in order to arrive at that capacity, in the case of the condenser or that resistance in the case of the leak, which gives the best results. Not only so, but it enables you to try the alternative scheme of placing the leak in parallel or in series with the grid condenser. By the way, the holder is sold separately and may be purchased from your usual dealer.

## A New Mullard Highly Sensitive Detector Valve

For the information of readers we are printing below technical data on the new Mullard P.M.4D which followed by a Mullard Permacore L.F. Transformer provides an extremely efficient L.F. combination. Comparison with the P.M.3 reveals that the new valve has a similar amplification factor—12.5 as against 13.5—but the great advantage of a much lower impedance—6,000 as against 16,000. In our opinion the Mullard P.M.4D will become a very popular valve for the reason that it greatly improves the performance of the L.F. amplifier from the point of view of bass note response. It may be used in place of the P.M.3 where this valve is now employed as detector or as first L.F.

- Max. Filament Voltage .. 4.0 volts.
  - Filament Current .. 0.1 amp.
  - Max. Anode Voltage .. 125 volts.
  - \*Anode Impedance .. 6,000 ohms.
  - \*Amplification Factor .. 12.5
  - \*Mutual Conductance .. 2.1 mA-Volt.
- \*At Anode Volts 100, Grid Volts zero.*

## Mullard Valve Type P.M. 4.D.

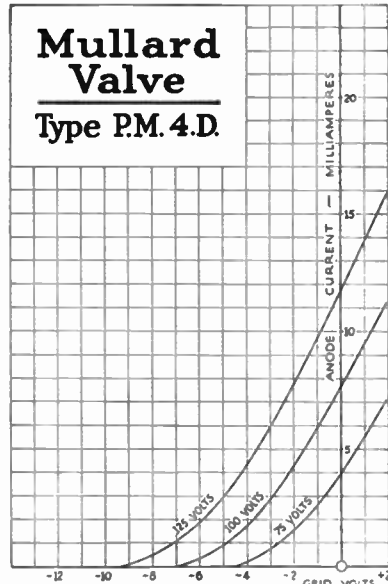

Grid Bias Table for P.M.4D when used as L.F. Amplifier

Anode Voltage.	Negative Grid Bias Voltage.
50	1.5
75	3.0
100	4.5
125	...





# The Worlds Best 4 valve set...they say

We have heard it echo in radio circles that the Mullard Nelson P.M. de Luxe is the most popular four-valve set ever released to home-constructors. Our correspondents are equally enthusiastic in their remarks about Mullard P.M. Valves

Here we are in the happy position of being able to devote a little space in this issue of "Radio for the Million" to another wonderfully popular Mullard P.M. receiver. As the title piece implies the radio public has passed judgment upon it. Later in these pages we are reprinting a few letters which reflect the general tone of the hundreds sent to the Editor.

Similarly to The Mullard Raleigh P.M., also the subject of an article in this number, the detailed description of this set appeared in the September issue, or, as it is more generally known, The Autumn Double Number. And as copies of it are rapidly becoming very scarce, any new reader is advised to apply for his before it runs out of print, when it will not be possible to read the constructional details unless one is able to count among one's friends a fellow radio owner willing to loan his.

## A system easily neutralised

In the Mullard Nelson de Luxe four Mullard valves are employed in a way which in our experience cannot be improved upon. An easily neutralised system of high-frequency precedes a leaky-grid rectifier, which in its turn is followed by two stages of low-frequency amplification. The first L.F. coupling is that known as R.C.C., while the input is fed into the fourth valve by transformer coupling. The details of these L.F. arrangements are too well known to need repetition here. A word or two about the H.F. scheme embodied into this set might prove interesting to any reader, who, after having read the appreciative comments of owners of the set, may be disposed to build for himself a duplicate of the original set.

Much has been written about neutralised receivers and quite as much has been said about them. The general impression in

and about town is that this type of set is difficult to operate for the reason that extreme skill is required effectually to neutralise the H.F. valve. This may be so if all else is laboratory perfect. As this degree of perfection is confined to the laboratory, there is no ground for the belief that the average radio owner is destined for inevitable trouble.

Ever since the introduction of neutralised sets the story has gone the rounds when really the root cause of the difficulty lies in the fact that the importance of adhering strictly to the published design is not sufficiently realised. It usually happens, for reasons best known to the complainants themselves, that some departure is made from the published wiring. The chances are that however slight or apparently trivial the alteration trouble will follow. At any rate, we have lost count over a few years of the number of times an obstinate set has behaved itself just as soon as the wiring has been made to conform to the original design.

## Adhere to published design

Therefore, regardless of all the arguments you may have in favour of making a wiring modification just put every one into the melting pot and leave them there to be forgotten; it is by far the best plan. Remarks of the same character could also be directed towards the temptation to change the layout of a set which if put into operation may considerably influence the working of individual components and in turn the functioning of the whole receiver.

This undeniably is the case with the H.F. side of a neutralised receiver. Coils produce a magnetic field which on no account must link up with the field of an adjacent coil belonging to another part of the circuit. Bringing, by way of example the two coils

---

## “ SIXTY-ONE STATIONS ON SPEAKER ”

---

in the Nelson de Luxe, any interaction between these components will make it impossible to effect neutralisation. Should the set have been built so that the coils are nearer together than the published blue-print directs it will soon be discovered that something has gone astray. In these circumstances nothing is to be done except to begin again and to place the coil bases in their correct relative positions.

By following the published design carefully no trouble with neutralising will be met, and as we are now interested to read what our readers have written to the Editor we will pass on to their letters.

### From G. H., Sheffield

“ At the same time that I am making application for No. 5 of ‘Radio for the Million,’ I thought it may be of interest to you to hear of what I think is an achievement on the ‘Nelson De Luxe.’ At 12.25 a.m. this morning, Sunday, January 15th, I tuned in a station which at first I thought was Union Radio, Madrid (I very often listen to his transmissions), only I thought he had altered his wave length as he very often does, or else that my dial had slipped a couple of degrees. They were playing on Hawaiian guitars at the time, and at 12.30 this was followed by dance music, which continued until about six minutes past one. My times are approximate, as the watch I had on is rather erratic. During each item there were announcements, and I thought I caught several English words, but I could not be sure as there was so much oscillation going on at the time. Then at six minutes I got the first clear words, which were (Saturday night in the Studio) in an unmistakable

American voice. At 1.50 I definitely got the station’s identity by hearing the following announcement : (Just stand by, you are now listening to the G.E.C. Station, WGY, Schenectady, New York). The quality was good throughout, I was amazed, not a bit like the B.B.C.’s relays of America, and excepting for the usual mush which we expect from long distance work, it was perfect. At 3 a.m. atmospheric and fading began again very bad, so I gave it up. The reason why I claim this to be a feat is because, as I told you when I wrote about the old Nelson, I have only an indoor aerial, and I think it is a poor one. Well, Sir, I must congratulate you and thank you for an excellent circuit, it is 25 per cent. better than the old Nelson, and that was an excellent set. My log up to now is 61 stations on the loud speaker.”

### From C. H. S., Gosport, Hants

“ Having had wireless sets one, two, three and four valves and then discarded them and left wireless alone for two years.

One day see friend studying blue print of wireless set, he ask my opinion ; well to cut long story short, was a Nelson P.M., which I built faithful to every detail, including your £6 6s. loud speaker for myself, results were very good. Another friend hearing I had Mullard loud speaker, came along to hear it, what happened he now has not only loud speaker but also Nelson P.M. set as well.

I believe another one is on the way, which shows how well Mullard’s goods in all branches recommend themselves. I trust I have not wasted too much of your time, but felt I must write and tell you how satisfied I am with Nelson circuit and Mullard goods and results obtained.”

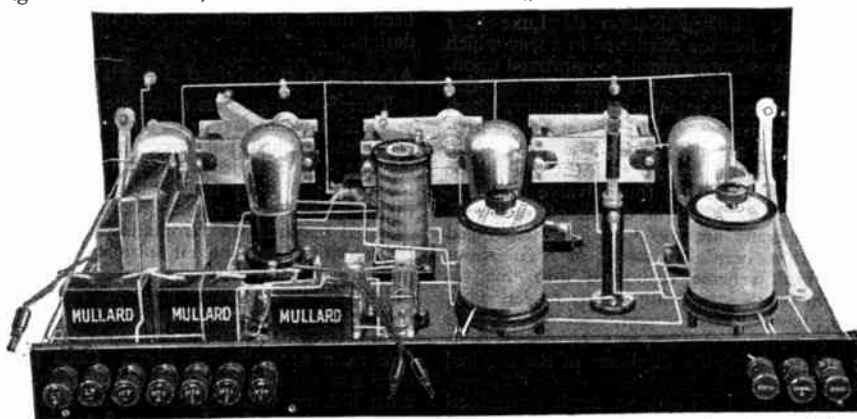

Here the camera looked at the Nelson P.M. de Luxe from the back of the panel and revealed very accurately the general layout.

---

## " EIGHT AMERICAN STATIONS HEARD "

---

**From W. D., London, W.12**

"I wish to express my appreciation of the Mullard Nelson De Luxe.

"Although I have constructed this more or less as a hook-up, the results are very satisfactory, station after station being received with ease. When it is made up properly I hope to have even better results.

"It may also interest you to know that I have received America on the short waves with it. The stations heard were 2XAF and 2XAD, both at loud speaker strength, and 5SW and another station on about 28 metres, the coil is home-made. Thanking you for designing such a handsome set."

**From J. F. T. W., Heswall, Cheshire**

"I recently made the Nelson P.M. De Luxe receiver as given in 'Radio for the Million,' Part 4. I have made a good few sets, but this beats them all for volume, clearness and clarity, together with long distance. I have received nearly all the stations shewn on the Test Report, and what is more, about eight American, including which are, WGY, KDKA, WPB, KGO, WLWL, WB2, WGN and WJZ, all at good loud speaker strength. A lot of friends who have seen it and heard it, say it is the best they have seen and the finest they have heard. I do not think, however, that all the credit is due to the set, but that a good deal is due to the very wonderful P.M. valves, with their wonderful filaments. I shall have no hesitation in recommending this set to anyone who wants a good set, together with purity, volume and distance. I had no bother with the neutralising, and that again is a very considerable point with some people. Also may I congratulate you on bringing out such a fine loud speaker as the Mullard, at such a low price."

**From H. P. E., Bournemouth**

"It will interest you to know I made up one of your 'P.M.' sets, using the 'Nelson' circuit, but three instead of four valves, and the results are astonishing. I am just three-quarters of a mile from 6BM aerial, but have no difficulty in tuning in Langenberg or 5GB, and can also separate these two stations quite easy, and the only signs of the local is during the intervals, and I think this a wonderful performance. On high waves I get Hilversum, 5XX, Radio, Paris, without any trouble. I do not use a wave trap of any description. The first and second valves are P.M.5's and P.M.6 in last stage."

**From J. W. W., Hull**

"I am writing to you regarding the Nelson P.M. De Luxe. I think I ought to have written you before, but had I have done so I could not have told you as much as I can now, for the more I use it the more I can get out of it. I cannot tell you how pleased I am with it. I live a quarter of a mile from our local station, and it cuts it out quite easy. I get quite a lot of continental stations on the speaker, in fact, I have never had a pair of head phones on yet, I can tune in on the speaker. I have had two American stations several times. I was listening at 2 a.m. this morning and could plainly hear it in the next room on the speaker. While I am writing this I am listening to Kalundborg at full strength, and it is midday and the sun shining. Hilversum, Motala, Huizen and several other stations on the big wave length came in well any time.

I am only an amateur at the job, but I made it myself off the blue print, and it went first time. I may say I made the first P.M.4 set and thought it good, but when I altered it to the De Luxe, well, it stands alone. I have lent several people the print, and everyone is satisfied. Hundreds have heard it and they say it is the best they have ever heard. I want to thank you for the books and prints, which I have found very interesting. I may say I put it on at 9 a.m. on Sunday, and it is continually on till 12.30 p.m. at some place or other, always finishing with dance music from Nimbo Restaurant."

**From H. J. T., Grimsby**

"I have just finished building your 'Nelson De Luxe' and I think it is the finest four valver I have ever heard, the way the volume rolls out is terrific, in fact, 5GB is too powerful for four valves. I am giving an invitation night to some of my friends who have built marvellous sets, but I think I can beat them with your set."

**Station after station on  
Mullard Master Three**

**From G. P., Enfield**

"I am glad to be able to tell you it was the trouble with my set, after refixing the switch I tuned into London, which came through excellent, I am now getting station after station at loud speaker strength.

"I am, therefore, more than obliged to you for the attention you have given, and I can recommend this set."

---

## RETAINS CHARACTERISTIC TONE QUALITY

---

*Continued from page 14.*

possible to bring up the bass, we would have desired it. Had it been possible to have weakened the middle registers, we had to consider whether we should have found it an improvement. Then, we had to give thought to higher musical frequencies and decide if there was any audible absence of the higher harmonics. This auditory test continued for a number of weeks and at the end of it we are now to pass our opinion.

With our speaker we are satisfied with the bass performance. Having listened very carefully to all the various types of music, the bass, which after all is the foundation of musical construction, came over very prominently. On the organ it was possible to follow the pedals without effort. On Sunday, April 20th, it was easily possible to hear the theme of Bach's D Minor Fugue being taken up by the pedals on the Liverpool Cathedral organ. We have also heard the bass drum of the Savoy dance bands marking the rhythm. A more satisfactory bass response could hardly be expected.

### **An atmosphere of realism**

In point of fact, any type of music with its correct share of bass sounds complete to the ear, whereas, the lack of it in some receivers, most probably accounts for the absence of realism. Bass to the correct balance imparts interest to the music and for that matter, almost decides whether the reproduced radio music is really worth listening to or not.

Speaking for ourselves, as, indeed, we are upon this occasion, we record the fact that we have derived immense pleasure from these long tests. Apart from the technical interest which was something after the nature of a duty, we have had our pleasures from the artistic point of view. It does appear that with good apparatus an atmosphere of realism is possible with radio.

In the instance of the Mullard Master Three which provided the test set, we have found music as charming and as pleasant to listen to as in the concert hall.

Is not this impression the fullest appreciation of the performance of a radio set? We really think it is. In the same way as a book hides surprise after surprise in its hundreds of pages so does music carry its surprises in every bar. That one should experience this impression speaks very highly of the reproduction of the set concerned. It conveys but one thing to us, that in the Mullard Master Three, which was standard except for the inclusion of a Mullard

Permacore L.F. Transformer preceded by a Mullard P.M.4D as the first L.F. valve, we were in the possession of an exceptional set, the reproduction of which, in our opinion, more closely approached the atmosphere of an original performance than any we had either heard before or had previously possessed.

This review would not be complete did we not make reference to the fact that the extraordinarily high degree of quality given by the arrangement consisting of a Mullard Permacore Transformer and a Mullard P.M.4D is most certainly due to its maintaining the strength of the harmonics. With but one or two exceptions the harmonics are weaker components of the fundamental which combining produce the characteristic tone colour or timbre of every instrument and voice. The suppression or rather absence of these harmonics which are of a higher frequency than the fundamental results in thin, toneless and uninteresting reproduction. Always providing, of course, that your speaker is able to respond to these very delicate shades of tone colour, you will find that the Mullard Permacore Transformer retains this feature of musical instruments and spoken words.

### **High amplification at higher frequencies**

This amplification of the higher musical frequencies is important as the harmonic range extends to 8,000. It is not very difficult to imagine an orchestra composed entirely of flutes. An exaggeration perhaps, but in the absence of tone colour we are not very far removed from it. Therefore, bear in mind that the Mullard Permacore Transformer amplifies faithfully. On the same Sunday evening to which we have already referred, one of the items included a splendid solo part for brass. It came over excellently. That it did so was purely a question of faithful quality given by the combination of the L.F. amplifier and the final translation of the electrical impulses into audible sound.

Finally, let us say that there is no reason whatsoever for your radio set sounding like wireless as we have heard uninitiated comments of radio describe it. Build your sets with this new L.F. arrangement—a Mullard Permacore Transformer preceded by a Mullard P.M.4D. The combination has given us the true and real atmosphere of music in our own study. This we think is really something to write about.

\* \* \*

The new wonder Transformer with the Mullard "Permacore" and the silver winding

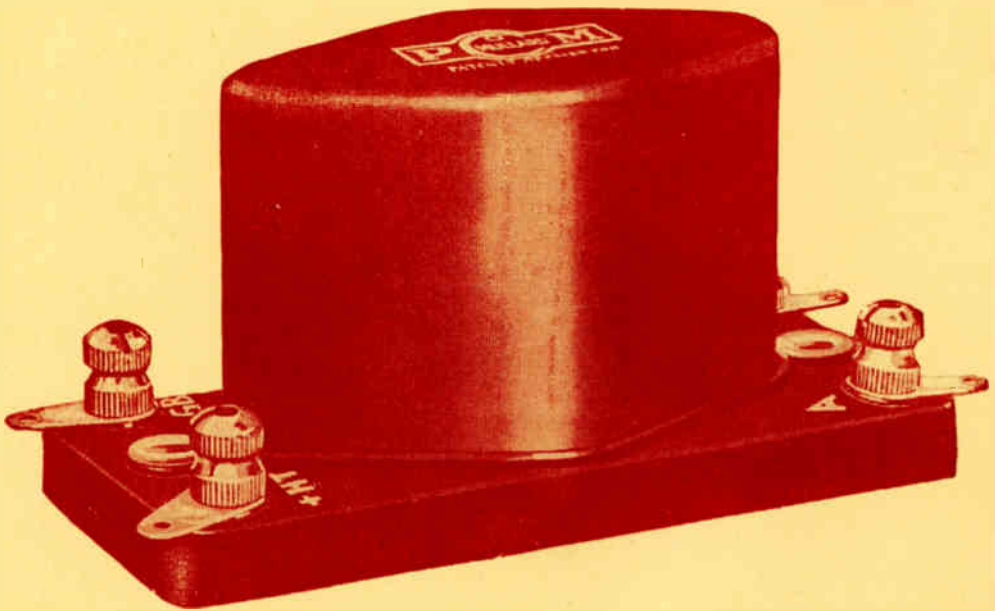

The new Mullard "PERMACORE" Transformer is absolutely revolutionary in design and construction. No transformer so compact and at the same time so efficient has ever been produced. Note these features:—

**25/-**

Small in size: great in amplification  
High flux density without saturation  
No resonant peaks to give unnatural reproduction  
All shrillness eliminated—gives life to every note  
Silver primary, nickel secondary; windings that will not deteriorate

*Obtainable from all radio dealers.*

Ask for  
The Mullard  
"Permacore"  
Transformer.

**Mullard**  
**MASTER · RADIO**

---



The valve with the wonderful  
Mullard P.M. Filament found  
only in Mullard P.M. Radio  
Receiving Valves.

# Mullard

***THE · MASTER · VALVE***

Printed by Waterlow & Sons Limited, London, Dinostable and Watford.  
For the Publishers, Arks Publicity Ltd., 64, Lincoln's Inn Fields W.C.2.