

RADIO & ELECTRONICS

CONSTRUCTOR

NOVEMBER 1979
50p

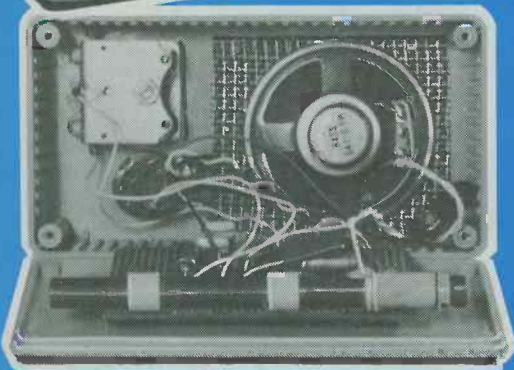

SINGLE CHIP M.W. RADIO

ULTRA SIMPLE MEDIUM WAVE
t.r.f. DESIGN

A.F. SIGNAL TRACER WITH
BUILT-IN AMPLITUDE ASSESSMENT



PEAK MILLIVOLT ASSESSOR

ALSO FEATURED

CMOS WIRE GUARD ALARM
ENVELOPE SHAPER

DIODES/ZENERS			
QTY.			
1N914	100v	10mA	.05
1N4005	600v	1A	.08
1N4007	1000v	1A	.15
1N4148	75v	10mA	.05
1N4733	5.1v	1 W Zener	.25
1N4749	24v	1W	.25
1N753A	6.2v	500 mW Zener	.25
1N758A	10v	"	.25
1N759A	12v	"	.25
1N5243	13v	"	.25
1N52448	14v	"	.25
1N52458	15v	"	.25
1N5349	12v	3W	.25

SOCKETS/BRIDGES			
QTY.			
8-pin	pcb	.16 ww	.35
14-pin	pcb	.20 ww	.40
16-pin	pcb	.25 ww	.45
18-pin	pcb	.30 v/w	.65
20-pin	pcb	.35 ww	1.05
22-pin	pcb	.40 ww	1.15
24-pin	pcb	.45 ww	1.25
28-pin	pcb	.50 ww	1.35
40-pin	pcb	.55 ww	1.45
Molex pins	.01	To-3 Sockets	.35
2 Amp Bridge		100-prv	.95
25 Amp Bridge		200-prv	1.50

TRANSISTORS, LEADS, etc.			
QTY.			
2N2222M	(2N2222 Plastic .10)		.15
2N2222A			.19
2N2907A	PNP		.19
2N3906	PNP (Plastic)		.19
2N3904	NPN (Plastic)		.19
2N3054	NPN		.55
2N3055	NPN 15A 60v		.60
T1P125	PNP Darlington		1.95
LED Green	Red, Clear, Yellow		.19
D.L.747	7 seg 5/8" High com-anode		1.95
MAN72	7 seg com-anode (Red)		1.25
MAN3610	7 seg com-anode (Orange)		1.25
MAN82A	7 seg com-anode (Yellow)		1.25
MAN74	7 seg com-cathode (Red)		1.50
FND359	7 seg com-cathode (Red)		1.25

9000 SERIES			
QTY.		QTY.	
9301	.85	9322	.65
9309	.50	9601	.30
		9602	.45

MICRO's, RAMS, CPU's, E-PROMS	
QTY.	
8T13	2.50
8T23	2.50
8T24	3.00
8T97	1.75
74S188	3.00
1488	1.25
1489	1.25
1702A	4.50
AM 9050	4.00
ICM 7207	6.95
ICM 7208	13.95
MPS 6520	10.00
MM 5314	4.00
MM 5316	4.50
MM 5387	3.50
MM 5369	2.95
TR 16028	3.95
UPD 414	4.95
Z 80 A	22.50
Z 80	17.50
Z 80 P10	10.50
2102	1.45
2102L	1.75
21078-4	4.95
2114	9.50
2513	6.25
2708	11.50
2716 D.S.	34.00
2716 (5v)	69.00
2758 (5v)	26.95
3242	10.50
4116	11.50
6800	13.95
6850	7.95
8080	7.50
8085	22.50
8212	2.75
8214	4.95
8216	3.50
8224	4.25
8228	6.00
8251	7.50
8253	18.50
8255	8.50
TMS 4044	9.95

- T T L -							
QTY.		QTY.		QTY.		QTY.	
7400	.20	7492	.45	74H20	.25	74LS76	.70
7401	.20	7493	.35	74H21	.25	74LS86	.95
7402	.20	7494	.75	74H22	.40	74LS90	.85
7403	.20	7495	.60	74H30	.30	74LS93	.85
7404	.20	7496	.80	74H40	.35	74LS96	2.00
7405	.35	74100	1.15	74H50	.30	74LS107	.90
7406	.25	74107	.35	74H51	.30	74LS109	1.50
7407	.55	74121	.35	74H52	.20	74LS123	1.95
7408	.20	74122	.55	74H53	.25	74LS138	2.00
7409	.25	74123	.55	74H55	.25	74LS151	.95
7410	.20	74125	.45	74H72	.35	74LS153	1.15
7411	.25	74126	.45	74H74	.35	74LS157	1.15
7412	.25	74132	.75	74H101	.95	74LS160	1.15
7413	.45	74141	.90	74H103	.55	74LS164	2.90
7414	.75	74150	.85	74H106	1.15	74LS193	2.00
7416	.25	74151	.95	74L00	.30	74LS195	1.15
7417	.40	74153	.95	74L02	.30	74LS244	2.90
7420	.25	74154	1.15	74L03	.35	74LS259	1.50
7426	.25	74156	.70	74L04	.40	74LS298	1.50
7427	.25	74157	.65	74L10	.30	74LS367	1.95
7430	.20	74161/9316	.75	74L20	.45	74LS368	1.25
7432	.30	74163	.85	74L30	.55	74LS373	2.50
7437	.20	74164	.75	74L47	1.95	74500	.45
7438	.30	74165	1.10	74L51	.65	74502	.45
7440	.20	74166	1.75	74L55	.85	74503	.35
7441	1.15	74175	.90	74L72	.65	74504	.35
7442	.55	74176	.95	74L73	.70	74505	.45
7443	.45	74177	1.10	74L74	.75	74508	.45
7444	.45	74180	.95	74L75	1.05	74510	.45
7445	.75	74181	2.25	74L85	2.00	74511	.45
7446	.70	74182	.75	74L93	.75	74520	.35
7447	.70	74190	1.25	74L123	1.95	74522	.55
7448	.50	74191	1.25	74L500	.40	74540	.30
7450	.25	74192	.75	74L501	.40	74550	.30
7451	.25	74193	.85	74L502	.45	74551	.35
7453	.20	74194	.95	74L503	.45	74564	.15
7454	.25	74195	.95	74L504	.45	74574	.70
7460	.40	74196	.95	74L505	.45	745112	.60
7470	.45	74197	.95	74L508	.45	745114	.85
7472	.40	74198	1.45	74L509	.45	745133	.85
7473	.25	74221	1.50	74L510	.45	745140	.75
7474	.30	74298	1.50	74L511	.45	745151	.95
7475	.35	74367	1.35	74L520	.45	745153	.95
7476	.40	75491	.65	74L521	.45	745157	.98
7480	.75	75492	.65	74L522	.45	745158	.80
7481	.85	74H00	.20	74L532	.50	745194	1.50
7482	.95	74H01	.30	74L537	.45	745196	2.00
7483	.95	74H04	.30	74L538	.65	745257 (8123)	2.50
7485	.75	74H05	.25	74L540	.70	8131	2.75
7486	.55	74H08	.35	74L542	.95		
7489	1.05	74H10	.35	74L551	.75		
7490	.55	74H11	.25	74L574	.95		
7491	.70	74H15	.45	74L575	1.20		

C MOS							
QTY.		QTY.		QTY.		QTY.	
4000	.15	4017	.75	4034	2.45	4069/74C04	.45
4001	.20	4018	.75	4035	.75	4071	.25
4002	.25	4019	.35	4037	1.80	4081	.30
4004	3.95	4020	.85	4040	.75	4082	.30
4006	.95	4021	.75	4041	.69	4507	.95
4007	.25	4022	.75	4042	.65	4511	.95
4008	.75	4023	.25	4043	.50	4512	1.50
4009	.35	4024	.75	4044	.65	4515	2.95
4010	.35	4025	.25	4046	1.25	4519	.85
4011	.30	4026	1.95	4047	2.50	4522	1.10
4012	.25	4027	.35	4048	1.25	4526	.95
4013	.40	4028	.75	4049	.65	4528	1.10
4014	.75	4029	1.15	4050	.45	4529	.95
4015	.75	4030	.30	4052	.75	MC14409	14.50
4016	.35	4033	1.50	4053	.95	MC14419	4.85
				4066	.75	74C151	2.50

I ² L, LINEARS, REGULATORS, ETC.							
QTY.		QTY.		QTY.		QTY.	
MCT2	.95	LM320K24	1.65	LM373	3.95		
8038	3.95	LM320T5	1.65	LM377	3.95		
LM201	.75	LM320T12	1.65	78L05	.75		
LM301	.45	LM320T15	1.65	78L12	.75		
LM308	.65	LM323K	5.95	78L15	.75		
LM309H	.85	LM324	1.25	78M05	.75		
LM309 (340K-5)	1.50	LM339	.75	LM380 (8-14 Pin)	1.19		
LM310	.85	7805 (340T5)	1.15	LM709 (8-14 Pin)	.45		
LM311 (8-14 Pin)	.75	LM340T12	.95	LM711	.45		
LM318	1.50	LM340T15	.95	LM723	.40		
LM320H6	.79	LM340T18	.95	LM725	2.50		
LM320H15	.79	LM340T24	.95	LM739	1.90		
LM320H24	.79	LM340K12	1.25	LM741 (8-14)	.45		
7905 (LM320K5)	1.65	LM340K15	1.25	LM747	1.10		
LM320K12	1.65	LM340K18	1.25	LM1307	1.75		
LM320K15	1.65	LM340K24	1.25	LM1458	.65		

LM3900	.95
LM75451	.65
NE555	.45
NE556	.85
NE565	1.15
NE566	1.25
NE567	.95
TA7205	6.95
76477	2.95
95H90	9.95

CABLE ADDRESS: ICUSD

Telex #697-827 ICUSD SDG

HOURS: 9 A.M. - 6 P.M. MON. thru SUN.

INTEGRATED CIRCUITS UNLIMITED

7889 Clairemont Mesa Blvd. • San Diego, California 92111 U.S.A.

NO MINIMUM

COMMERCIAL AND MANUFACTURING ACCOUNTS INVITED

ALL PRICES IN U.S. DOLLARS. PLEASE ADD POSTAGE TO COVER METHOD OF SHIPPING. ORDERS OVER \$100 (U.S.) WILL BE SHIPPED AIR NO CHARGE.

PAYMENT SUBMITTED WITH ORDER SHOULD BE IN U.S. DOLLARS.

ALL IC'S PRIME/GUARANTEED ALL ORDERS SHIPPED SAME DAY RECEIVED.

CREDIT CARDS ACCEPTED:

Phone (714) 278-4394 BarclayCard / Access / American Express / BankAmericard / Visa / MasterCharge

SPECIAL DISCOUNTS

Total Order	Deduct
\$35-\$99	10%
\$100-\$300	15%
\$301-\$1000	20%

RADIO & ELECTRONICS CONSTRUCTOR

NOVEMBER 1979
Volume 33 No. 3

Published Monthly
(3rd of preceding Month)

First Published 1947

Incorporating The Radio Amateur

Editorial and Advertising Offices
57 MAIDA VALE LONDON W9 1SN

Telephone
01-286 6141

Telegrams
Databux, London

© Data Publications Ltd., 1979. Contents may only be reproduced after obtaining prior permission from the Editor. Short abstracts or references are allowable provided acknowledgement of source is given.

Annual Subscription: £7.50, Eire and Overseas £8.50 (U.S.A. and Canada \$20.00) including postage. Remittances should be made payable to "Data Publications Ltd". Overseas readers, please pay by cheque or International Money Order.

Technical Queries. We regret that we are unable to answer queries other than those arising from articles appearing in this magazine nor can we advise on modifications to equipment described. We regret that queries cannot be answered over the telephone, they must be submitted in writing and accompanied by a stamped addressed envelope for reply.

Correspondence should be addressed to the Editor, Advertising Manager, Subscription Manager or the Publishers as appropriate.

Opinions expressed by contributors are not necessarily those of the Editor or proprietors.

Production— Web Offset.

CMOS WIRE GUARD ALARM — Suggested Circuit
by G. A. French 142

FOLLOW THAT CABI — Notes For Newcomers
by D. Snaith 145

NEWS AND COMMENT 146

PEAK MILLIVOLT ASSESSOR by A. P. Roberts 148

IN NEXT MONTH'S ISSUE 155

SHORT WAVE NEWS — For DX Listeners
by Frank A. Baldwin 156

SINGLE-CHIP M.W. RADIO by R. A. Penfold 158

THE CPU REGISTERS — Databus Series No. 4
by Ian Sinclair 164

BOOK REVIEW 168

ENVELOPE SHAPER by M. V. Hastings 169

REACTION TIMER — In Your Workshop 173

TUNE-IN TO PROGRAMS — Part 9
Some Tunes To Play by Ian Sinclair 179

THE "DORIC" 9 WAVEBAND PORTABLE
— Conclusion by Sir Douglas Hall, Bt., K.C.M.G. 182

TRADE NEWS 185

R.M.S. AND PEAK
Electronics Data No. 51 iii

Published in Great Britain by the Proprietors and Publishers, Data Publications Ltd, 57 Maida Vale, London W9 1SN.

The *Radio & Electronics Constructor* is printed by Swale Press Ltd.

THE DECEMBER ISSUE
WILL BE PUBLISHED
ON 5th NOVEMBER

BREAD BOARD

1979



There's a lot going on at Breadboard!

Seventy exhibitors showing and selling everything that the hobby electronics enthusiast could want! Demonstrations of electronic organs – computer kits – audio gear.

Radio Station S22 broadcasting throughout the show. See your voiceprint! Get your own weather details direct from Tiros M! Test your reactions – and your strength.

Careers in Electronics – get the advice and information that could start you off on a rewarding and interesting career.

It's worth going to Breadboard!

**Royal Horticultural Halls Elverton Street
Westminster London SW1**

December 4-8th 1979

Admission £1 (students 70p)

<p>MOTORS 1.5-6VDC Model Motors 22p. Sub. Min. 'Big Inch' 115VAC 3rpm Motors 32p. 12VDC 5 Pole Model Motors 37p. 8 track 12V Replacement Motors 55p. Cassette Motors 5-8VDC ex. equip. 70p. Geared Mains Motors (240V) 2.5 rpm 75p. 115VAC 4 rpm Geared Motors 95p.</p>	<p>JUMPER TEST LEAD SETS 10 pairs of leads with various coloured croc clips each end (20 clips) 90p per set.</p>	<p>PANEL METERS Ferranti 0-600VAC 3.5" square £2.95. Japanese type 60 x 47 x 33mm clear plastic type; 50 micro, 100 micro, 1Ma, 2 amp, 25 volts, 300 VAC, 'S', 'VU', all £5.25 each. Larger type 110 x 82 x 35mm; 50 micro, 100 micro £6.35 each.</p>	<p>AEROSOL SERVICE AIDS, SERVISOL Switch Cleaner 226gm 60p. Freezer 226gm 70p. Silicone Grease 226gm 70p. Foam Cleanser 370gm 60p. Plastic Seal 145gm 60p. Excel Polish 240gm 47p. Aero Klene 170gm 55p. Aero Duster 200gm 70p.</p>	<p>TOOLS SOLDER SUCKER, plunger type, high suction, teflon nozzle, £4.99 (spare nozzles 69p each). Good Quality snub nosed pliers, insulated handles, 5" £1.45. Antex Model C 15 watt soldering irons, 240VAC £3.95 Antex Model CX 17 watt soldering irons, 240VAC £3.95. Antex Model X25 25 watt soldering irons, 240VAC £3.95. Antex ST3 iron stands, suits all above models £1.65. Antex heat shunts 12p each. Servisol Solder Mop 60p each. Neon Tester Screwdrivers 8" long 43p each. Miyarna IC test clips 16 pin £1.95.</p>
<p>SEMICONDUCTORS C106D 400V 2.5A SCR 20p. 2N5062 100V 800mA SCR 18p. BX504 Opto Isolator 25p. CA3130 95p. TBA800 50p. 741 22p. 741S 35p. 723 35p. NE555 24p. LM3400 40p. AD181/2 70p. 2N3055 38p. ZN414 75p. BD238 28p. BD438 28p. IN4005 10 for 35p. TIL305 alpha numeric displays £2.50. TIL209 Red Leds 8p each. 0.5" 7 segment Led display. Comm. Cathode, green, full spec. 85p each.</p>	<p>TRANSFORMERS All 240VAC Primary (postage per transformer is shown after price). MINIATURE RANGE: 6-0-6V 100mA, 9-0-9V 75mA and 12-0-12V 50mA all 79p each (15p). 12-0-12V 100mA 99p (15p). 0-6V 0-6V 280mA £1.20 (20p). 0-4-6-9V 200mA these have no mounting bracket, 70p (15p). 12V 500mA 99p (22p). 12V 2 amp £2.75 (45p). 15-0-15V 3 amp Transformer at £2.85 (54p). 30-0-30V 1 amp £2.85 (54p). 20-0-20V 2 amp £3.65 (54p). 0-12-15-20-24-30V 2 amp £4.75 (54p). 20V 2.5 amp £2.45 (54p).</p>	<p>CAR STEREO SPEAKERS Shelf mounting in black plastic pods with 5" 5 watt speaker available in 4 or 8 ohms only £3.95 per pair.</p>	<p>SURPLUS BOARDS No. 1, this has at least 11 C106 (50V 2.5A) plastic SCR's, one relay a unijunction transistor and tantalum capacitors £1.95. No. 2 I.F. Boards, these are a complete I.F. board assembly made for car radios, 465Khz, full set of I.F.'s and oscillator coils, trimmers etc., 40p each. No. 3 Board with two BDY60 Power Transistors, 45p each.</p>	<p>SWITCHES Sub. miniature toggles: SPST (8 x 5 x 7mm) 52p. DPT (8 x 7 x 7mm) 62p. DPT centre off 12 x 11 x 9mm 77p. PUSH SWITCHES, 16 x 6mm, red top, push to make 14p each, push to break version (black top) 16p each. G.P.O. Telephone handsets £1.95p. Electrolytic Caps, can type, 2,200mfd and 2,200mfd 50VDC 35p each.</p>
<p>PROJECT BOXES Sturdy ABS black plastic boxes with brass inserts and lid. 75 x 56 x 35mm 54p. 95 x 71 x 35mm 65p. 115 x 95 x 37mm 75p.</p>	<p>TRIAC/XENON PULSE TRANSFORMERS 1:1 (gpo style) 30p. 1:1 plus 1 sub. min. pcb mounting type 60p each.</p>	<p>MURATA MA401 40kHz Transducers. Rec./Sender £3.50 pair.</p>	<p>POWER SUPPLIES SWITCHED TYPE, plugs into 13 amp socket, has 3-4.5-6-7.5 and 9 volt DC out at either 100 or 400mA, switchable £3.45. HC244R STABILISED SUPPLY, 3-6-7.5-9 volts DC out at 400mA max., with on/off switch, polarity reversing switch and voltage selector switch, fully regulated to supply exact voltage from no load to max. current £4.95.</p>	<p>MICRO SWITCHES Standard button operated 28 x 25 x 8mm make or break, new 15p each. Roller operated version of the latter, New 19p each. Light action micro, 3 amp make or break 35 x 20 x 7mm, 12p each. Cherry plunger operated micro, 2 normally open, 2 normally closed, plunger 20mm long (40 x 30 x 18mm) 25p each.</p>
<p>AMP MULTIWAY IN-LINE PLUGS AND SOCKETS, 3 way 35p, 6 way 45p, 12 way 55p, per pair.</p>	<p>MICROPHONES Min. tie pin. Omni, uses deaf aid battery (supplied), £4.95. ECM105 low cost condenser, Omni, 600 ohms, on/off switch, standard jack plug, £2.95. EM507 Condenser, uni, 600 ohms, 30-18kHz., highly polished metal body £7.96p. DYNAMIC stick microphone dual imp., 600 ohms or 20K, 70-17kHz., attractive black metal body £7.75p. EM506 dual impedance condenser microphone 600 ohms or 50K, heavy chromes copper body, £12.95. CASSETTE replacement microphone with 2.5/3.5 plugs £1.35. INSERT Crystal replacement 35x10mm 40p. GRUNDIG electric inserts with FET preamp, 3-6VDC operation £1.00.</p>	<p>ELECTRICAL ITEMS 13 amp 3 pin plugs plastic 27p, rubber 62p, 13 amp rubber extension sockets 42p, 12 way flexible terminal blocks; 2 amp 20p, 5 amp 24p, 10 amp 33p, 15 amp 47p. Standard batten (BC lampholders 27p.</p>	<p>AMPHENOL CONNECTORS (PL259) PLUGS 47p. Chassis sockets 42p. Elbows PL259/SO239 90p. Double in line male connector (2XPL259) 65p. Plug reducers 13p. PL259 Dummy load, 52 ohms 1 watt with indicator bulb 95p.</p>	<p>PUSH BUTTON UNITS 6 way, 3 DPDT, 3 4 pole c/o 55p, 8 way, 5 DPDT, 3 4 pole c/o 70p. RANK ARENA magnetic cartridge pre-amplifier modules, new with connection details £1.95p.</p>
<p>CHANGEOVER REED SWITCH 2 1/2" Long 35p. Glass Mercury Switch 1 1/2" x 3/4", long leads, 35p.</p>	<p>LIGHT DIMMER 240VAC 800 watts max., wall mounting, has built in photo cell for automatic switch on when dark £4.50</p>	<p>PUSH BUTTON TV TUNERS UHF, not varicap, transistorised new £2.25</p>	<p>BUZZERS MINIATURE SOLID STATE BUZZERS, 33 x 17 x 15mm white plastic case, output at three feet 70db (approx), low consumption only 15mA, four voltage types available, 6-9-12 or 24VDC, 80p each. LOUD 12VDC BUZZER, Cream plastic case, 50mm diam. x 30mm high 63p. GPO OPEN TYPE BUZZER, adjustable works 6-12VDC 27p. 12VDC siren, all metal rotary type, high pitched wail, £7.50.</p>	<p>TAPE HEADS Mono cassette £1.75. Stereo cassette £3.90. Standard 8 track stereo £1.95. BSR MN1330 1/2 track 50p. BSR SRP90 1/2 track £1.95. TD10 tape head assembly - 2 heads both 1/2 track R/P with built in erase, mounted on bracket £1.20.</p>
<p>MULTIMETERS NH55 2,000 o.p.v. 1KV AC/DC. 100ma DC current, 2 resistance ranges to 1meg. £5.95. MODEL 72606 20,000 opv 1,000 volts AC/DC., 250ma DC current, resistance 3 ranges to 3meg, dimensions 127 x 90 x 32mm, mirror scale £11.75p. HANSEN AT10 100,000 opv 1.2KV AC/DC., 12 amps AC/DC current, resistance to 200 meg in 4 ranges, capacitance 200pf-0.2mfd, 1.00pf-1mfd., decibel range, internal safety fuse, dimensions 160 x 105 x 50mm, an excellent meter, £34.50p.</p>	<p>RIBBON CABLE 8 way single strand miniature 22p per metre.</p>	<p>TELEPHONE PICK UP COIL Sucker type with lead and 3.5mm plug 62p.</p>	<p>TERMS: Cash with Order (Official Orders welcomed from colleges etc). 30p postage please unless otherwise shown. VAT inclusive. S.a.e. for new illustrated lists.</p>	<p>STEREO HEADPHONES B ohms adjustable headband with lead and stereo jack, £2.95. CAR AERIAL 5 section telescopic, wing mounting with 2 pull up keys £1.35.</p>
<p>MORSE KEYS Beginners practice key £1.05. All metal fully adjustable type. £2.60.</p>	<p>SPEAKERS 5" Round 8 ohms 5 watts £1.35. 6" round 6 watt 8 ohms with cambric surround £2.75. Elac 8" 8 ohm long throw speaker, 18 watts twin cone £4.75. Mid-Range 5" speaker 850-7khz 20 watts £1.45.</p>	<p>RELAYS Plastic Encap. Reed Relay, 0.1 matrix. 1kΩ coil, 9-12VDC normally open, 35p. Miniature encapsulated reed relay 0.1 matrix mounting, single pole make, operates on 12VDC 50p each. Continental series, sealed plastic case relays. 24VDC 3pole change over 5 amp contacts, new 65p. Printed circuit Mtg., Reed relay, single make, 20mm x 5mm, 6-9VDC, coil, 33p each. Metal Cased Reed Relay, 50 x 45 x 17mm, has 4 heavy duty make reed inserts, operates on 12VDC 35p each. Magnets 1/2" long 1/8" thick with fixing hole, 10 for 40p.</p>	<p>PROGRESSIVE RADIO 31 CHEAPSIDE, LIVERPOOL 2. ALL ORDERS DESPATCHED BY RETURN POST</p>	<p>RADIO AND ELECTRONICS CONSTRUCTOR</p>
<p>MINIATURE LEVEL METERS 1 Centre Zero 17 x 17mm 75p. 2 (scaled 0-10) 28 x 25mm 75p. 3 Grundig 40 x 27mm £1.25.</p>	<p>INTERCOM UNITS (can be used as baby alarm) supplied with 60' cable, with call button, 2 station model £5.25, 3 station model £7.25.</p>	<p>Dalo 33PC Etch Resist printed circuit maker pen, with spare tip, 79p.</p>		

STEVENSON

Electronic Components

CMOS			
4020	50p	4050	25p
4022	50p	4060	80p
4023	13p	4066	30p
4024	40p	4068	13p
4001	13p	4025	13p
4002	13p	4026	90p
4007	13p	4027	28p
4009	30p	4028	45p
4011	13p	4029	50p
4012	13p	4040	55p
4013	28p	4041	55p
4015	50p	4042	55p
4016	28p	4043	50p
4017	47p	4046	90p
4018	55p	4049	25p

FULL DETAILS IN CATALOGUE!

TTL			
7400	10p	7473	20p
7401	10p	7474	22p
7402	10p	7475	25p
7404	12p	7485	55p
7406	22p	7489	135p
7408	12p	7490	25p
7410	10p	7492	30p
7413	22p	7493	25p
7414	39p	7494	45p
7420	12p	7495	35p
7427	20p	7496	45p
7430	12p	74121	25p
7432	18p	74122	35p
7442	38p	74123	38p
7447	45p	74125	35p
7448	50p	74126	35p
7454	12p	74132	45p

OPTO			
LED's	0.125in.	0.2in.	each 100+
Red	TIL209	TIL220	9p 7.5p
Green	TIL211	TIL221	13p 12p
Yellow	TIL213	TIL223	13p 12p
Clips	3p	3p	
DISPLAYS			
DL704	0.3 in CC		130p 120p
DL707	0.3 in CA		130p 120p
FND500	0.5 in CC		100p 80p

SKTS			
8pin	8p	18pin	14p
14pin	10p	20pin	16p
16pin	11p	22pin	17p
24pin	22p	28pin	22p
40pin	32p	40pin	32p
3 lead T018 or T05 socket. 10p each			
Soldercon pins: 100-50p 1000-370p			

PCBS			
Size in.	VEROBOARD		
2.5 x 1	0.1in. 0.15in.	Vero	Cutter 80p.
2.5 x 3.75	14p 14p		
2.5 x 5	45p 45p		
3.75 x 5	54p 54p	Pin insertion	tool 108p
3.75 x 17	205p 185p		
Single sided pins per 100 40p 40p			
Top quality fibre glass copper board Single sided Size 203 x 95mm 60p each.			
'Dato' pens 75p each.			
Five mixed sheets of Affac 145p per pack.			

RESISTORS			
Carbon film resistors. High stability. low noise 5%.			
E12 series. 4.7 ohms to 10M. Any mix. each 100+ 1000+			
0.25W	1p	0.9p	0.8p
0.5W	1.5p	1.2p	1p
Special development packs consisting of 10 of each value from 4.7 ohms to 1 Meg-ohm (650 res) 0.5W £7.50. 0.25W £5.70.			
METAL FILM RESISTORS			
Very high stability. low noise rated at 1/2W 1%. Available from 51ohms to 330k in E24 series. Any mix. each 100+ 1000+			
0.25W	4p	3.5p	3.2p

PLEASE WRITE FOR YOUR FREE COPY OF OUR 80 PAGE CATALOGUE OF COMPONENTS. CONTAINS OVER 2500 STOCK ITEMS.

LINEAR			
LF356	80p	NE531	98p
LM301AN	26p	NE555	23p
LM308	50p	NE556	60p
LM318N	75p	NE567	100p
LM324	45p	RC4136	100p
LM339	45p	SN76477	230p
LM378	230p	TBA800	70p
LM379S	410p	TBA810S	100p
LM380	75p	TDA1022	620p
LM3900	50p	TL081	45p
LM3909	65p	TL084	125p
LM3911	100p	ZN414	80p
MC1458	32p	ZN425E	390p
MM57160	590p	ZN1034E	200p

TRANSISTORS			
AC127	17p	BCY72	14p
AC128	16p	BD131	35p
AC176	18p	BD132	35p
AD161	38p	BD139	35p
AD162	38p	BD140	35p
BC107	8p	BFY50	15p
BC108	8p	BFY51	15p
BC108C	10p	BFY52	15p
BC109	8p	MJ2955	98p
BC109C	10p	MPSA06	20p
BC147	7p	MPSA56	20p
BC148	7p	TIP29C	60p
BC177	14p	TIP30C	70p
BC178	14p	TIP31C	65p
BC179	14p	TIP32C	80p
BC182	10p	TIP2955	65p
BC182L	10p	TIP3055	55p
BC184	10p	ZTX107	14p
BC184L	10p	ZTX108	14p
BC212	10p	ZTX300	16p
BC212L	10p		
BC214	10p		
BC214L	10p		
BC477	19p	1N914	3p
BC478	19p	1N4001	4p
BC548	10p	1N4002	4p
BCY70	14p	ITT Full spec. product.	
BCY71	14p	1N4148	- £1.40/100. £11/1000

DIODES			
1N4006	6p		
1N5401	13p		
BZY88 ser.	8p		

CAPACITORS			
TANTALUM BEAD			
0.1, 0.15, 0.22, 0.33, 0.47, 0.68, 1 & 2.2uF @ 35V			each 8p
4.7, 6.8, 10uF @ 25V			13p
22 @ 16V, 47 @ 6V, 100 @ 3V			16p
MYLAR FILM			
0.001, 0.01, 0.022, 0.033, 0.047, 0.068, 0.1			3p 4p
POLYESTER			
Mullard C280 series			
0.1, 0.015, 0.022, 0.033, 0.047, 0.068, 0.1			5p 7p
0.15, 0.22			10p
0.33, 0.47			14p
0.68			17p
1.0uF			
CERAMIC			
Plate type 50V. Available in E12 series from 22pF to 1000pF and E6 series from 1500pF to 0.047uF			
RADIAL LEAD ELECTROLYTIC			
63V	0.47	1.0	2.2
			4.7
			10
			22
			33
			47
			100
			220
			330
			470
			1000

CONNECTORS			
JACK PLUGS AND SOCKETS			
2.5mm	screened	unscreened	socket
3.5mm	9p	13p	7p
Standard	9p	14p	8p
Stereo	16p	30p	15p
	23p	36p	18p
DIN PLUGS AND SOCKETS			
	plug	chassis socket	line socket
2pin	7p	7p	7p
3pin	11p	9p	14p
5pin 180°	11p	10p	14p
5pin 240°	13p	10p	16p
1mm PLUGS AND SOCKETS			
Suitable for low voltage circuits, Red & black Plugs 6p each Sockets 7p each.			
4mm PLUGS AND SOCKETS			
Available in blue, black, green, brown, red, white and yellow. Plugs 11p each Sockets 12p each			
PHONO PLUGS AND SOCKETS			
Insulated plug in red or black			9p
Screened plug			13p
Single socket	7p	Double socket	10p

SOLDERING IRONS

ANTEX X25 (25W) or ANTEX CX (17W) 390p each
Reel of solder (39.6M) 240p each

LOUDSPEAKERS

56mm dia. 8ohms. 70p 64mm dia. 64ohms. 75p
64mm dia. 8ohms. 75p 70mm dia. 8ohms. 100p
Magnetic earpiece including 2.5 or 3.5mm plug. 15p each
Crstl earpiece including 3.5mm plug. 30p each

SWITCHES

Subminiature toggle. SPDT 70p. DPDT 80p
Standard toggle. SPST 34p. DPDT 48p.



Slide switches (DPDT) miniature or standard 15p.
Push to make switch. 15p. Push to break switch. 20p.
Wavechange switches: 1P12W, 2P6W, 3P4W, 4P3W. 43p

CONTROL KNOBS

Ideal for use on mixers etc. Push on type with black base and marked position line. Cap available in red, blue, green, grey, yellow & black. 14p.



MISCELLANEOUS

Connection cable available in single or stranded packs of eight colours.

	Single	Stranded
8 metre pack	18p	18p
40 metre pack	85p	80p



BATTERY CLIPS

Battery clips for PP3 with lead. 6p each.
Battery clips for PP9 with lead. 10p each.
Miniature crocodile clips in red or black. 8p each.
Red or black probe clips. 20p each.

Murata Ultrasonic Transducers. 180p each. 350p pair.



PANEL METERS

High quality 2" wide view meters. Zero adjustment. Back illumination wiring. Available in 50 uA, 100 uA, 500 uA, 1 mA, 100 mA, 500 mA, 1 A. £4.75 ea. VU meter similar style. £1.40 ea.



SLIDE POTENTIOMETERS

Good quality 60mm travel slider with 80mm fixing centres. Available from 5k - 500k in log and linear. 55p each. Suitable black knobs 6p ea. Coloured knobs 10p ea.



We now offer one of the widest ranges of components at the most competitive prices in the U.K. See catalogue for full details. We welcome callers at our shop in College Rd, Bromley, from Mon-Sat, 9am-6pm (8pm on Weds and Fridays). Special offers always available. We also provide an express telephone order service. Orders received before 5pm are shipped same day. Contact our sales office now with your requirements. TELEPHONE: 01-464 2951/5770.

Quantity discounts on any mix TTL, CMOS, 74LS and Linear circuits. 100+ 10%, 1000+ 15%. Prices VAT inclusive. Please add 30p for carriage. All prices valid to April 1980. Official orders welcome.



Mail orders to: STEVENSON (Dept RE)



76 College Road, Bromley, Kent BR1 1DE.

ALL PRICES INCLUDE 15% V.A.T.

Tecknowledgegey for sale.

The Mark III FM Tuner

DIY Hi-Fi will never seem the same again. Ambit's Mark III tuner system is electrically & visually superior to all others. Some options available, but the illustrated version with reference series modules: £149.00 + £18.62 VAT

With Hyperfi Series modules
£185.00 + £23.12



- Features of the system:**
- * Precision construction & design of all parts
 - * Time/frequency display
 - * State of the art performance with facilities for updates, using modular plug in systems.
 - * Deviation level calibrator for recording
 - * All usual tuner features

Digital Dorchester All Band Broadcast Tuner: LW/MW/SW/SW/SW/FM stereo

A multiband superhet tuner, constructed using a single IC for RF/IF processing - but with all features you would expect of designs far greater complexity. The FM section uses a three section (air gap) tuned FET tunerhead, with ceramic IF filters and interstamper mute; AM employs a double balanced mixer input stage, with mechanical IF filters - plus a BFO and MOSFET product detector for CW/SSB reception. Styled in a matching unit to the Mark III FM only tuner, employing the same degree of care in mechanical design to enable easy construction. MW/LW reception via a ferrite rod antenna. Electronics only (PCB and all components thereon) £33.00 + £4.95 VAT
Complete with digital frequency readout/clock/timer hardware £99.00 + £14.85 VAT
Complete with MA1023 clock/timer module with dial scale £66.00 + £9.90 VAT
Hardware packages are available separately if you wish to house your own designs in a professional case structure. Please deduct the cost of electronics from complete prices.

LW MW FM LCD Digital Frequency Display - July PW feature

Update your old radio, or build this into a new design. Or use it as a servicing aid - this low power unit with LCD display reads direct frequency in kHz/MHz, or with usual AM/FM IF offsets for received frequency. Low power LCD means no RF! - 15.20mA at 9v even with the divide by 100 prescaler. FM resolution is 100kHz, AM 1kHz. Sensitivities better than 10mV
Complete kit £19.50 + £2.93 VAT, built and tested module £27.00 + £4.05VAT



Ambit stocks and distributes a wide range of frequency counter LSI for all types of DFM - part two of the catalogue contains details of the MSM523/4/5/6 range, and the versatile MSL2318 direct by ten or hundred prescaler IC. The DFM1 combined counter for AM, FM SW and direct/clock/stopwatch/timers - details available, but SAE please!

PW SANDBANKS PI METAL LOCATOR

Maintaining our professional approach to home constructor kits, we offer the pulse induction 'Sandbanks'. Now with injection moulded casing for greatly improved environmental sealing. £37.00+£5.55vat

VHF MONITOR RX WITH PLESSEY IC

4/9 channel version of the PW design but using standard (fundex) crystals, and TOYO 8 pole crystal filter with matching transformers. Coil sets from our standard range to cover bands from 40 to 200MHz. Complete module kit £31.25 +£3.90vat .

RADIO AND AUDIO MODULES : Consistently the most advanced

- FOR FM**
- EF5801 3-4 series: 6 stage varicap tuning, all with oscillator output £17.45 + 2.61VAT.
 - 5801 Dual gate MOSFET RF stages, bipolar mixer
 - 5803 Dual gate RF/mixer stages, amplified LO out
 - 5804 'Hyperfi' series, with internal PN diode age, and ultra wide range tuning system £24.95 + 3.74VAT
 - EF5402 4 stage varicap tuner with TDA1062 and LO output. Uses FET/IC input. PIN age £10.75 + 1.61VAT
- FOR 30-200MHz**
- The EF series are available on special order to cover bands (usually approx 20% of the centre frequency) in the range described. Details in our price list.
- FOR FM IFs at 10.7MHz**
- 7030 single 6 pole linear phase filter IF with HA1137E10.95 + 1.64VAT
 - 7130 two 6 pole linear phase filter IF with CA3189E16.25 + 2.44VAT
 - 7230 Hyperfi IF, switched bandwidth, AGC IF preamp, linear phase ceramic filters with diode switched narrow filter £24.95 + 3.74VAT
- DECODERS FOR MPX (STEREO)**
- Various types, guaranteed the world's biggest and best ranges
- LARSHOLD FM TUNERSSETS**
- 7252 MOSFET front end combined with CA3089 IF £26.50 + 3.97VAT.
 - 7252 JFET front end, combined with IF and decoder £26.60 + 3.97VAT
- FM/AM tuning synthesiser, see details elsewhere in this advertisement

COMPONENTS FOR RADIO/COMMUNICATIONS/AUDIO/TV etc.

- As usual, Ambit brings you the latest and best, a small selection of which is shown in this advertisement. The Ambit catalogues contain information on most of the devices mentioned here - and an order for the new part three will ensure you stay up with latest developments. Data photocopying services described in price list info.
- RADIO ICs for FM var**
- CA3089E 1.94 29 SL1610 1.60 24 LM381N 1.81 27
 - CA3189E 2.45 37 SL1611 1.60 24 LM382N 1.85 25
 - HA1137W 2.20 33 SL1612 1.60 24 KB4436 2.53 38
 - HA11225 2.20 33 SL1613 1.89 28 KB4438 2.22 33
 - SN76660N 0.75 11 SL1620 2.17 33 TDA1028 3.50 53
 - SL1621 2.17 33 SL1621 2.17 33 TDA1029 3.50 53
 - SL1623 2.44 37 TDA1074 3.75 56
 - IF AMPLIFIERS SL1624 3.28 49
 - SL1625 2.17 33
 - SL1626 2.44 37
 - SL1630 1.62 24
 - SL1640 1.89 28
 - SL1641 1.89 28
 - SL1642 2.75 41
 - SL630 3.20 48
 - MC1350 1.20 18
 - MC1355 3.12 47
 - MC6347 3.12 47
 - MC1496 1.25 19
 - NE4412 2.55 38
 - NE4413 2.75 41
 - NE4414 1.70 26
- COMMUNICATIONS**
- KB4412 2.55 38
 - KB4413 2.75 41
 - KB4414 1.70 26
- FETs, MOSFETs, Bipolars, and various others: see PL**

MICROMARKET OSTs overflow:

6800P	650P	8212	230P	2102	170a
6820P	600P	8216	195P	2112	340P
6850P	275P	8224	365P	2813	754P
6810	400P	8228	478P	4027	578P
6852	365P	8251	628P	2114	1000P
8080	630P	8255	540P	+15% VAT	

OSTs: Remember all OSTs stocks are obtained from BS9000 approved sources - your assurance that all devices are very best first quality commercial types. Some LPSN TTL is presently in great demand, so please check by phone before ordering

TI: Standard AND LP Schottky

All prices listed in pence %

VOLTAGE REGS:		MAINS EMI FILTERS	
7800 series 1Amp pos	95p	1 Amp in IEC chassis	4.83
7800 series 1Amp neg	100p	6 Amp in IEC	5.83
78M series 1Amp pos	90p	5 Amp wirelin	3.87
78LCP 100mA	35p	(Toroid cores in Cat no. 2)	
78MGT2C variable	175p		
78MGT2C variable	175p		
723CN variable IC	65p		
NE550	73p		
L200 variable V and I	195p		

MSC. Counter/timer, scalar devices.....	
NE555 30p	NE556 78p
NE558 180p	
95H900C divide by 10/11 to 320MHz	780p
11C900C divide by 10/11 to 650MHz	1400p
8629 divide by 100 to 175MHz min	420p
MSL2318 divide by 10/100 to 175MHz min	420p

7 SEG DISPLAYS	
HP5082 series.....	
Red	7653 233p
Green	7653 233p
Yell	7660 233p
White	7663 233p
Grn	7670 233p
Fairchild FND	
500/507	150p

CD 4000

- Varicap tuning diodes for AM/FM/TV - 1.9v AM tuning (Cr 15-1) from TOKO -
- KV1210 double matched 175p 26p vat
 - KV1210 triple matched 245p 37p vat
 - KV1215 triple snap-apart 245p 37p vat
 - MVAM115 single 15v 105p 16p vat
 - MVAM125 single 25v 105p 16p vat
 - MVAM2 double 25v 148p 22p vat
 - BB204/104 double FM 40p 6p vat
 - BA102 single AFC etc 30p 4p vat
 - BA121/TT210 single etc 30p 4p vat
 - BB105B single UHF 40p 6p vat
- PN DIODES, BANDSWITCH types**
- BA109 PIN attenuator 35p 5p vat
 - TDA1061Pi-form 1st. 5p 4p vat
 - BA182 Bandswitch 21p 3p vat
- All RF semiconductors stocked in depth. Please ask for quantity pricing details.

MORE FROM THE GENERAL AMBIT CATALOGUE RANGES:

- MPU controllable digital frequency synthesiser PCB. Preliminary:**
- Serial data controlled, with the standard swallow count system for maximum speed of operation. Multiple time constant filters, suitable for AM/FM and other communications/generator applications. Not for beginners. Full preliminary data package £1 + SAE. No phone enquiries answer on this system for the time being. Watch this space.....
- Projected cost of the controller PCB less than £30: comprises the two modulus counter, prog. div., phase detector, multiple TC loop filter/integrators.
- TOP GRADE LEDs by AEG: PRICES ARE EXC. VAT (add 15%)**
- | Size | Red | Green | Yellow | Orange | Quantity discounts for LEDs: |
|-----------|-----|-------|--------|--------|------------------------------|
| 5mm | 14p | 16p | 15p | 20p | 10 per type - less 10% |
| 3mm | 13p | 15p | 18p | 19p | 100 per type - less 30% |
| 2x5x6 17p | 20p | 20p | 24p | | 100 mix in 10s - less 25% |
- FUTABA FLUORESCENT VACUUM DISPLAYS for CLOCKS etc**
- BLT02 clock display (static drive) with AM/FM plugs £9 + 1.35
 - BLT03 DFM display for MSM5525 LSI counter £9.45 + 1.42 vat
 - BLT06 5 digit DFM display (GI AY581100) mpxed £9.75 + 1.46 vat
- TOKO COILS, FILTERS, CHOKES, etc for AM/FM/TV comms -**
- | TYPE | Size: | 5mm | 7mm | 10mm | (please add VAT @15%) |
|------------|-------|-----|-----|------|----------------------------------|
| AM IF | 55p | 33p | 30p | | Various for ICs, transistor etc. |
| FM IF | 55p | 33p | 33p | | Various for ICs, transistor etc. |
| SW coils | | | | 33p | Two Impedance series |
| OSC coils | 55p | 33p | 33p | | For LW/MW/SW |
| TV vif/ist | | | | 35p | |
- Various coils in the range 20kHz to 300MHz - see TOKO catalogue
- CERAMIC and MECHANICAL FILTERS (inc MURATA TYPES)**
- CF455B/CF455C 60p; CFX014-180p; CFU455C-85p
 - CFY470C-60p; CFU470C-60p
 - MURATA CFU455B and CFU455C ceramic block filters. 1.95a
 - MURATA CFM455 series ladder filters. D, E, F, G, H bandwidths available now (20, 16, 12, 8, 6 kHz) £8.35 ea (metal encapsulated)
 - SFD455B, SFD470A, SFD472B 85p ea
 - CFM2 series mechanical elements types A, B, C, D (4-10kHz bandwidth) - 65p ea. (As used in RCME feature)
- MULTIPLEX/PILOT TONE FILTERS, FM IF FILTERS (see cat and on)**
- CFSE10.7/5FE10.7 - stereo FM IF ceramic filters (aim FM4 etc) 50p
 - CFSE10.7/5FE10.7M1 - mono bandwidth ceramic FM IF filters 50p
 - SF10.7M1 - ultra linear phase stereo ceramic IF filters 70p
 - CDA10.7 - 10.7MHz ceramic discriminator (for CA3089 etc) 70p

Current news: A PCB for the Mullard DC tone and volume control system is now available £3 + 0.45 VAT. HMOS PA modules for 60-100W - kit £14 + £2.10VAT, heatsink £4.10+0.61. FM radio control system crystals £3.75 pair inc VAT (Sept on). MK50366N: static drive clock/timer IC £3.78 + 0.57 VAT. 12kHz channel spacing 8 pole 10.7MHz XTAL filter by TOYO type H4402 £15.50 + £2.32VAT. A further updated price list is now available, and we would like to remind you that enquiries can only be answered if accompanied either by an official business letterhead, or an SAE. STOP PRESS: TOKO's new split-apart triple AM tuning diodes are in stock £2.45 + 37p VAT, (KV1215). S BL1 diode DBM 1.500MHz £.425+0.64p.

Terms: CWO please. Account facilities for commercial customers OA. Postage 25p per order. Minimum credit invoice for account customers £10.00. Please follow instructions on VAT, which is usually shown as a separate amount. Overseas customers welcome - please allow for postage etc according to desired shipping method. Access facilities for credit purchases. Catalogues: Ambit. Part 1 45p, Part 2 50p pp pair. TOKO Euro shortform 20p. Micrometals toroid cores 40p. All inc PP etc. Full data service described in price list supplements. Hours/phone: We are open from 9am - 7pm for phone calls. Callers from 10am to 7pm. Administrative enquiries 9am to 4.30pm please (not Saturdays). Saturday service 10am to 6pm.

ambit international (R) **2 Gresham Road, Brentwood, Essex.**

AMBIT catalogues are guaranteed to contain the most up to date and best informed comment on modern developments and advances in the field of radio and audio. There is no competitive publication that even approaches the broad range of parts/information on modern techniques.

LATEST BOUND VOLUME No. 31 of "Radio & Electronics Constructor"



AUGUST 1977 to JULY 1978

Comprising
768 pages
inc. index

PRICE £5.20 P&P £1.05

**BOUND VOLUME No. 27
(August 1973 to July 1974)**

Price £3.00 P&P £1.05

**BOUND VOLUME No. 28
(August 1974 to July 1975)**

Price £3.20 P&P £1.05

**BOUND VOLUME No. 29
(August 1975 to July 1976)**

Price £3.50 P&P £1.05

**BOUND VOLUME No. 30
(August 1976 to July 1977)**

Price £3.70 P&P £1.05

Limited number of these
volumes still available.

We regret all earlier volumes are now
completely sold out.

Available only from

**DATA PUBLICATIONS LTD.,
57 MAIDA VALE, LONDON, W9 1SN**

GREENWELD

443G Millbrook Road Southampton SO1 0HX

All prices include VAT at 15% — Just add 30p post

£1 BARGAIN PACKS

K101-	16 BC239B N.P.N. Low Noise	£1.00
K102-	15 BC349B N.P.N. Low Noise	£1.00
K103-	10 BC546B N.P.N. 80 Volt	£1.00
K104-	18 BC182B N.P.N. 60 Volt	£1.00
K105-	50 1N4148 Silicon Diode	£1.00
K106-	18 BC184L N.P.N. Low Noise	£1.00
K107-	18 BC213L P.N.P. General Purpose	£1.00
K108-	8 2N5060 30N .8A SCR	£1.00
K109-	15 BC114 N.P.N. Low Noise	£1.00
K114-	15 XK6116 (8F241) N.P.N. 200 MHz	£1.00
K115-	18 SP1218 (2N3702) P.N.P. Gen. Purpose	£1.00
K117-	10 BF450 P.N.P. T.V. IF Amp.	£1.00
K118-	16 ME4101 N.P.N. 60V Low Noise	£1.00
K124-	50 .02uF Disc Ceramics	£1.00
K125-	200 1k 5% 1/4W. CF Resistors	£1.00

1,000 RESISTORS £2.50!!

New stock just arrived — Carbon Film 2% and 5%, 1/4W and 1/2W, all brand new, but have pre-formed leads, ideal for PC mtng. Enormous range of popular mixed values for just **£2.50/1,000, £11/5,000 £50/25,000.**

LINEAR IC BARGAIN

We have just received a large consignment of popular linear IC's that have failed the manufacturers stringent tests. However, on checking through a few hundred we have found that quite a large proportion tested in a simple oscillator circuit are functional, so are offering them in packs as follows:

TYPE	PACKAGE	%GOOD	QTY	PRICE
702	14DIL	65	25	£1.20
709	8DIL	75	20	£1.20
709	14DIL	50	30	£1.20
710	T099	30	40	£1.20
710	14DIL	30	40	£1.20
720	14DIL	80	20	£1.20
741	T099	40	25	£1.20
748	T099	70	15	£1.20

Connection data is supplied. One of each pack. **£8.50**

3W AMP MODULE

Ready built and tested, this handy amplifier will prove very useful around the workshop. Just requires 17V ac source (and 8R spkr) as bridge rect and smoothing cap are mounted on the PCB. The 4 transistor circuit provides enough sensitivity for most applications. Supplied complete with circuit diagram and wiring details. Only **£1.75**. Suitable transformer **£2.20**.

TRANSFORMERS

PA 100V line speaker type. Pri tapped 0.625W — 10W in 5 steps. Sec 4 or 8 ohm **£1.75 10/£15 100/£110**
Mains pri, 3 sec windings, 8, 25 and 40V, each at 100mA. A selection of voltages from 8 to 73V is therefore obtainable. 57x48x38mm with flying leads. **£1.50**
Mains pri, sec 40V @ 250mA **£1.75**

CLOCK CASE BARGAIN

Z472 Oval format, overall size 130x-68x87mm deep, with built in stand. Rear panel drilled to accept 4 switches and alarm **60p**

THE AMAZING GREENWELD CATALOGUE

FEATURES INCLUDE:

- 50p Discount Vouchers
 - Quantity prices for bulk buyers
 - Bargain List Supplement
 - Reply Paid Envelope
 - Priority Order Form
 - VAT inclusive prices
- PRICE **30p** + 15p POST

VERO OFFCUTS

Packs of 100 sq ins of good size pieces about 4 x 3" in the following types:

K541 0.1" copper clad	£1.50
K542 0.15" copper clad	£1.50
K544 0.1" plain	£1.50

Also pieces 2 1/2 x 1" — 10/**£1.20** 100/**£9**
17x3 1/2" x 0.1" sheets — 10/**£16.50**

Large range of Standard Veroboard and boxes/cases in stock. Details in catalogue, **45p**

SCOOP! Verobox type 2522, unused but has 3 1/2" holes in one end and 1 1/2" hole the other, so instead of **£3.96**, we are selling these at **£1.85**

SWITCHES

Push-button banks — 20 types listed on Bargain List No. 8, free with cat (45p) or send SAE. Samples:

W473 3 interlocking 4PCO + 2-independent, **70p**

W481 5 interlocking 4PCO **70p**

Both types supplied with free knobs!

W106 DPCO slide switch 23x15x7mm

10/**£1.20**; 100/**£9**

W107 SPCO min slide switch with 2 wires attached. 10/**90p** 100/**£5**.

W508 SPCO 5A microswitch with 29mm lever 20x12x6mm **38p** 10/**£3.00**

W302 Rocker switch on/off 10A white. **22p** 10/**£1.80**.

W305 Rocker SPCO, centre off, 10A rating, white **30p** 10/**£2.30** 100/**£19**.

AERIALS

X901 Telescopic 8 sections 970mm long extended, 175mm collapsed. Swivel joint. 2BA fixing hole in base. **75p**

X904 Ferrite rod 140mm x 9mm

LW/MW/coupling coils, each independently moveable **64p**

X905 As above, but LW/coupling coil together on moveable former **55p**

BUZZERS & MOTORS

Z401 Powerful 6V DC, all metal construction. 50mm dia x 20mm **70p**

Z402 Miniature type, 3-9V, only 22x-15x16mm. Very neat **65p**

Z450 Miniature 6V DC motor, high quality type 32mm dia x 25mm high, with 12mm spindle. Only **£1**

Z451 12V high torque motor 30mm dia x 40mm high, with 10mm spindle. **65p**

Z452 6V DC motor with gearbox giving final shaft speed 700 rpm. Spindle is threaded OBA. Ex-equip **£1**

Z453 As above, but 300 rpm and un-threaded spindle **£1**.

VU METERS

Voo2 Twin type. 2 meters 40x40mm and driver board, supplied with circuit and connexion data. **£3.50**

Voo3 New type, just in. Twin type moulded in one piece. 80x40mm (No driver board but suitable circuit supplied) **£2.50**

Send SAE for latest 8 page Bargain List with 60 more packs on + lots of other goodies!

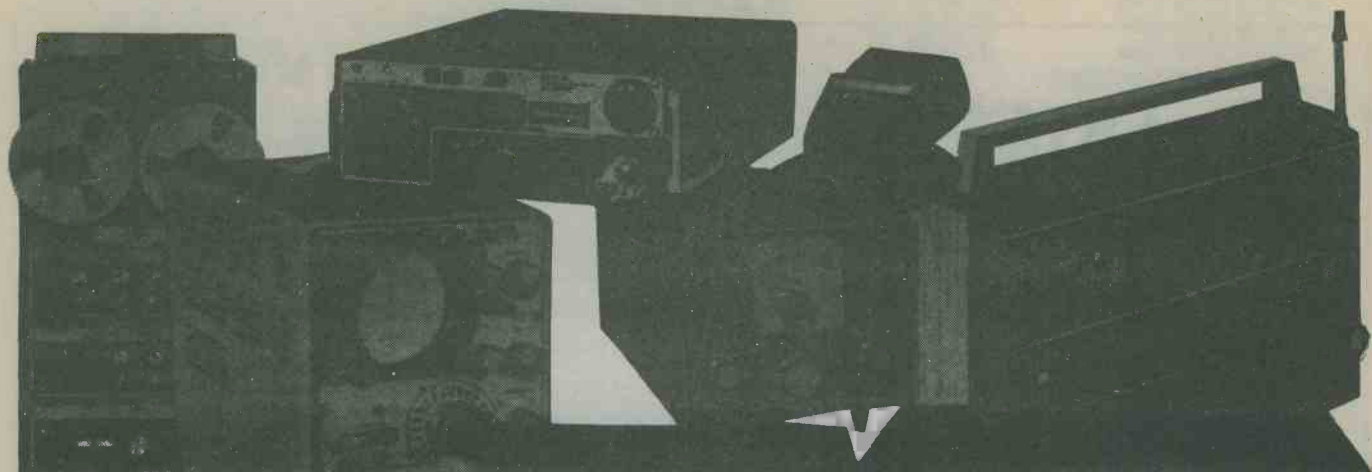

How to make a hobby

The opportunities in electronics, today, and for the future are limitless – throughout the world. Jobs for qualified people are available everywhere at very high salaries. Running your own business, also, in electronics – especially for the servicing of radio, TV and all associated equipment – can make for a varied, interesting and highly remunerative career. There will never be enough specialists to cope with the ever increasing amount of electronic equipment coming on to the world market.

We give modern training courses in all fields of electronics – practical D.I.Y. courses – courses for City & Guilds exams, the Radio Amateur licence and also training for the new Computer Technology. We specialise only in electronics and have over 40 years experience in the subject.

All the training can be carried out in the comfort of your own home and at your own pace.

A tutor is available to whom you can write at any time for advice or help during your work.

and a career.

- COURSES AVAILABLE
- CITY & GUILDS CERTIFICATES IN TELECOMMUNICATIONS AND ELECTRONICS.
- RADIO AMATEUR LICENCE.
- COMPUTER TECHNOLOGY WITH HOME TRAINING COMPUTER.
- DIGITAL ELECTRONICS.
- BEGINNERS PRACTICAL COURSE.
- RADIO AND TELEVISION SERVICE.
- AND MANY OTHERS.

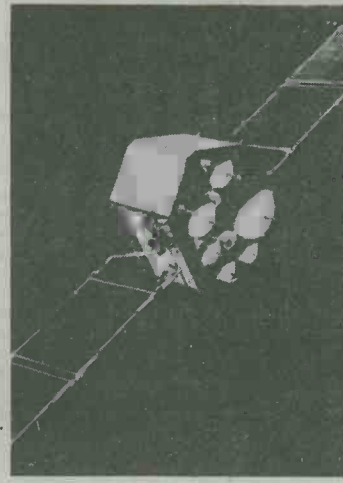

All students enrolling in our courses receive a free circuit board originating from a computer and containing many different components that can be used in experiments and provide an excellent example of current electronic practice.



WE ARE AN INTERNATIONAL SCHOOL SPECIALISING IN ELECTRONICS TRAINING ONLY AND HAVE OVER 40 YEARS EXPERIENCE IN THIS SUBJECT.

NAME.....
 ADDRESS

Post now, without obligation, to: Block Caps Please
BRITISH NATIONAL RADIO and ELECTRONICS SCHOOL
 P.O. Box 156, Jersey, Channel Islands.

Britain's Best Breadboard Buy at Breadboard '79

**FREE
ENTRY TICKET
WORTH £1.00
WITH EVERY PURCHASE**

All over Britain, hobbyists are discovering Britain's Best Breadboard Buys. At the London Breadboard exhibition '79 on Stand Nos. F1, F2 and G1, G2, CSC will be exhibiting their full range of breadboards.

Here is your chance to obtain a special ticket for Breadboard '79 worth £1.00 absolutely FREE.

Cut out the coupon below and take it along to one of our listed dealers, and make a purchase of any of our breadboards and receive your special FREE ticket - see you at Breadboard '79.

Take the coupon to any of these main dealers:

LONDON
Rastra Electronics Ltd., 279-281 King Street, Hammersmith, London W6

Cubegate Ltd., Audio Electronics, 301 Edgware Road, London W2 1BN

Technomatic Ltd., 17 Burnley Road, London NW10 1ED

Precision Instrument Labs., Instrument House, 727 Old Kent Road, London SE15

MANCHESTER
Shudehill Supply Co., 53 Shudehill, Manchester M4 4AW

BUCKINGHAMSHIRE
West Hyde Development, Unit 9, Park Street Industrial Estate, Aylesbury, Bucks HP20 1ET

Best Electronics (Slough) Ltd., Unit 4 Farnburn Ave., Slough, Bucks SL1 4XU

KENT
Lawtronics, 13a High Street, Edenbridge, Kent TN8 5AX

NEWCASTLE
Aitken Bros., 35 High Bridge, Newcastle upon Tyne

SCOTLAND
Marshall's, 85 West Regent Street, Glasgow G2
F. Brown & Co., 45 George IV Bridge, Edinburgh EH1 1E3

LEEDS
Leeds Amateur Radio Club, Cookridge Street, Leeds 1

HERTFORDSHIRE
BI-PAK, 3 Baldock Street, Ware, Herts

CONTINENTAL SPECIALTIES CORPORATION



EUROPE, AFRICA, MIDEAST: **CSC UK LTD.**
Shire Hill Industrial Estate Units 1 and 2
Saffron Walden, Essex CB11 3AQ
Telephone: SAFFRON WALDEN (0799) 21682
TLX 817477

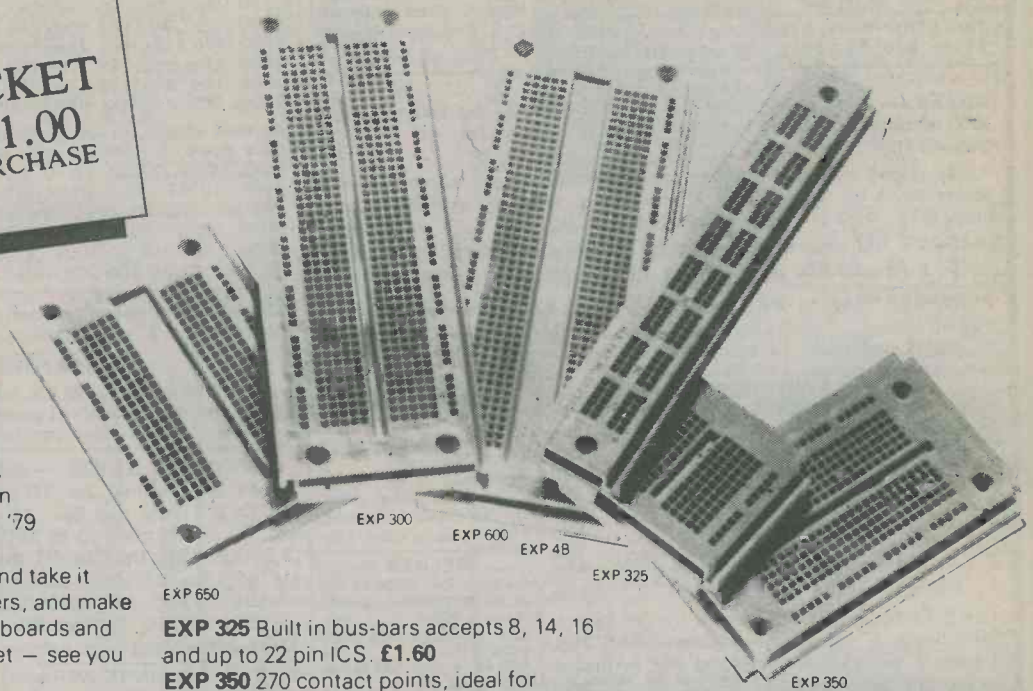

EXP 325 Built in bus-bars accepts 8, 14, 16 and up to 22 pin ICS. **£1.60**

EXP 350 270 contact points, ideal for working with up to 3 x 14 pin DIPS. **£3.15**

EXP 650 For microprocessor chips. **£3.60**

EXP 4B An extra 4 bus-bars in one unit. **£2.30**

EXP 300 The most widely sold breadboard in the UK; for the serious hobbyist. **£5.75**

EXP 600 6" centre channel makes this the Microprocessor Breadboard. **£6.30**

PB6 Professional breadboard in easily assembled kit form. **£9.20**

PB100 Kit form breadboard recommended for students and educational uses. **£11.80**

The above prices do not include P&P and 15% VAT

The Experimentor System

4 ways to order Experimentor Systems

- EXP 300PC which includes one item
A matchboard pre-drilled PCB £1.32
- EXP 302 which includes three items
Three 50-sheet scratchboard workpads - £1.68
- EXP 303 which includes three items
Two matchboards and an EXP 300 solderless breadboard £8.60
- EXP 304 which includes four items
Two matchboards and EXP 300 breadboard and a scratchboard workpad - £9.30

This coupon entitles the holder to a free ticket worth £1.00 to Breadboard '79, with the purchase of any listed breadboards

1. EXP 325 £2.70	Qty. Reqd.	2. EXP 350 £4.48	Qty. Reqd.
3. EXP 650 £5.00	Qty. Reqd.	4. EXP 4B £3.50	Qty. Reqd.
5. EXP 300 £7.75	Qty. Reqd.	6. EXP 600 £8.38	Qty. Reqd.
7. PB6 £11.73	Qty. Reqd.	8. PB 100 £14.72	Qty. Reqd.

Experimentor System

1. EXP 300PC £2.38	Qty. Reqd.	2. EXP 302 £2.79	Qty. Reqd.
3. EXP 303 £11.04	Qty. Reqd.	4. EXP 304 £11.85	Qty. Reqd.

Boxed prices include P&P and 15% VAT

If no dealer in your area contact CSC direct.

Continental Specialties Corporation, (U.K.) Limited, Dept 16cc.
Unit 1, Shire Hill Industrial Estate, Saffron Walden, Essex Tel (0799) 21682

NAME

ADDRESS

FREE catalogue tick box

I enclose cheque/PO for £
or debit my Barclaycard, Access, American Express card

No. Exp. date
or Tel: (0799) 21682 with your card number and your order will be in the post immediately

TRADE COMPONENTS

PAY A VISIT — THOUSANDS MORE ITEMS BELOW WHOLESALE PRICE. CALLERS PAY LESS ON MANY ITEMS AS PRICES INCLUDE POSTAGE. PRICES INCLUDE VAT AND ADDITIONAL DISCOUNT IN LIEU OF GUARANTEE. GOODS SENT AT CUSTOMERS RISKS UNLESS SUFFICIENT ADDED FOR REGISTRATION OR COMPENSATION FEE POST.

OFFERS CORRECT AT 18/9/79 APPLICABLE TO ORDERS RECEIVED DURING OCTOBER

JAP 4 gang min. sealed tuning condensers 40p

VALVE BASES

Printed circuit 87G	7p
Chassis B7-B7G	11p
Shrouded Chassis 87G-B8A	13p
B12A tube. Chassis 89A	13p
Speaker 6" x 4" 5 ohm ideal for car radio	£1.55
4 3/4" diam. 30 Ω	£1.75
2 1/2" diam. 32 or 8 Ω	£1.07

Car type panel lock and key 65p
Transformer 9V 4A £4.00

Aluminium Knobs for 1/4" shaft. Approx. 3/8" x 3/8" with indicator Pack of 5 95p

TAG STRIP—6-way 2 1/2p 5 x 50pF or 1000 + 9-way 4 1/2p Single 2p 300pF trimmers 35p

ELECTROLYTICS Many others in stock

Up to 10V 25V 50V 75V 100V 250V 350V 500V MFD	63—	200—	300—	450—
10 6p	7p	7p	8p	13p
25 6p	7p	7p	8p	13p
50 6p	7p	7p	9p	16p
100 7p	8p	13p	10p	24p
250 12p	11 1/2p	15p	22p	36p
500 13p	15p	22p	30p	55p
1000 16p	25p	50p	54p	25p
2000 28p	47p	35p	93p	£1.20

As total values are too numerous to list, use this price guide to work out your actual requirements 8/20, 10/20, 12/20, 22/50, 47/25. Tub. Tant 24p each 16-32/275v, 100u/150V, 100-100/275V 40p 50-50/385V, 2+2/200V non polar, 32-32-50/300V, 20-20-20/350V 0.1+0.1/500V AC 80p 200V, 100-200-60/300V £1.30 100-300-100-16/300V £1.70 200-200-100-32/350V 85p

RS 100-0-100 micro amp null indicator Approx. 2" x 1 1/2" x 1 1/2" £1.85

INDICATORS

Bulgin D676 red, takes M.E.S. bulb 38p
12 volt, or Mains neon, red pushfit 23p
R.S. Scale Print, pressure transfer sheet 12p

CAPACITOR GUIDE — maximum 500V

Up to .01 ceramic 2p. 10 same value 15p. Up to 0.1 poly etc. 5p. .12 up to .68 poly etc. 8p. Silver mica up to 360pF 10p, then to 2,200pF 13p; then to .01 mfd 21p. 1/750 13p. .01/1000, 8/20, .1/900, .22/900, 4/16, 25/250 AC (600v/DC), 3/600 15p. 5/150, 10/150, 40/150 50p. 1/350 12p. Many others and high voltage in stock.

SONNENSCHNEIDER/POWERSONIC DRI-FIT RECHARGEABLE SEALED GEL (Lead Antimony) BATTERY, 6V 1 amp.hr. (3 3/4" x 2" x 1 1/4") £2.70 6 amp. hr. (4 1/2" x 2" x 3") £4.25 Ex-equipment, little used.

CONNECTOR STRIP

Belling Lee L1469, 4 way polythene. 9p each

1 1/2 glass fuses 250 m/a or 3 amp (box of 12) 20p
Bulgin 5mm Jack plug and switched socket (pair) 40p

Reed Switch 28mm, body length 5p

Aluminium circuit tape, 1/4 x 36 yards—self adhesive. For window alarms, circuits, etc. 95p

TV MAINS DROPPERS

5 assorted multiple units for 75p

100pF air-spaced tuning capacitor 13p
5 1/2" x 2 1/4" Speaker, ex-equipment 3 ohm 65p
2 Amp Suppression Choke 10p
3 x 2 1/2" x 1 1/2" PAXOLINE 5 for 35p
4 1/2" x 1 1/2" x 1 1/2" 10 for 15p
Nylon clip on MES bulb holder 4p
VALVE RETAINER CLIP, adjustable 5 for 15p

Sub-miniature Transistor Transformer 35p
Valve type output transformer 90p

POT CORES with adjuster LA2508-LA2519 43p per pair

16 Watt Power Amp. Module 35v 1A power required, giving 16 watt RMS into 8 Ω £3.45

REGULATED TAPE MOTOR

Grundig 6V approx., 3" x 1 1/2", inc. shock absorbing carrier, or Jap 9V, 1 1/2" diam. £1.05
3.5mm metal stereo plug 30p
Fane 8 ohm 3" sq. heavy duty communications speaker £1.60

RS neg. volt regulator 103, 306-099 (equiv. MPC900) 10A, 100 watt 4-30 volt. Adjustable sort circuit protection. Sacrifice at £2.00

BOXES — Grey polystyrene 61 x 112 x 31mm, top secured by 4 self tapping screws 57p clear perspex sliding lid, 46 x 39 x 24 mm 10p

ABS, ribbed inside 5mm centres for P.C.B., brass corner inserts, screw down lid, 50 x 100 x 25mm orange 65p; 80 x 150 x 50mm black 97p; 109 x 185 x 60mm black £1.52.

DIECAST ALI superior heavy gauge with sealing gasket, approx 6 1/2" x 2 3/8" x 1 3/8" £1.55; 3 1/2" x 2 3/8" x 1 3/8" £1.30.

VARIABLE CAMM PROGRAMMER 10, 12 or 15 pole 2 way, 50VAC motor — series with 1mfd, or 3k 10W or 15W pygmy bulb for mains operation. Ex equipment £4.50.

SWITCHES

Pole	Way	Type	Price
1	2	Slide	15p
6	2	Slide	24p
2	1	Rotary Mains	14 1/2p
2	Alternating	Micro with roller	30p
2	3	Miniature Slide	20p
2	1	Toggle	42p
1	2	Sub-Min Toggle	75p
2	Alternating	2A Mains Push (1/4" hole)	43p
2	Alternating	Slide	15p

RESISTORS

1 1/2-1/4 watt 1 1/2p 10 same value 10p
1 watt 1 1/2p
1 or 2% same price
Up to 15W w/wound 10p, 10 same value 75p

RELAYS

RS/Alma reed relay, 1K12v or 3k 18-30v d.c. coil, normally open 45p
12v d.p.c.o. heavy duty octal 600 Ω 4 p/co min sealed 75p. 8ase 10p. D.I.L. 3.7-12V S.P. £1.00

POTS

Wirewound 38p
Log. or Lin., carbon rotary or slide. Single 30p With switch 40p Dual 45p Dual switch 55p 1.5m Edgetype 10 for 40p

Skeleton Presets Slider, horizontal or vertical standard or submin 6p

THERMISTORS and V.D.R.'s

CZ1/2/6/11/14. KR22, KT150, VA1005/6/8/1010/1033/4/7/8/9 10A/1053/5 / 1066/7/1074/6/7 / 1082/6/1091/6/7/8 / 1100/3/8/8602. Rod with spot blue/fawn/green. E299DDP120 / 218 / 224 / 338 / 340 / 350 / 352 / YF020 E220ZZ/02 KR150 All 22p E23 glass bead 85p YG150-S534 bead, K813, E299 DHP230, 116-121 401 (TH7. VA1104, OD10) 35p. R53 Glass £1.20

S.P.S.T. 10 amp 240v. white rocker switch with neon. 1" square flush panel fitting 39p, 1 pole 2 way 10 amp oblong clip in mains rocker appliance switch 30p

Standard thumb-wheel switch 0-9 in 1248N or B.C.D., or Comp. 1242 also 2p co. £1.20

Standard Lever Key Switch D.P.D.T. locking plus D.P.D.T. and S.P.S.T. Heavy Duty non latching 73p

AUDIO LEADS

3 pin din to open end, 1 1/2yd, twin screened 45p
5 pin din 180° to 2-phono 70p
3 pole jack plug to tag ends, 4ft 45p

COMPUTER & AUDIO BOARDS/ASSEMBLIES VARYING CONTENTS INCLUDE ZENER, GOLD BOND, SILICON, GERMANIUM, LOW AND HIGH POWER TRANSISTORS AND DIODES, HI STAB RESISTORS, CAPACITORS, ELECTROLYTICS, TRIMPOTS, POT CORES, CHOKES, INTEGRATED CIRCUITS, ETC. 3lb for £2.30 7lb for £4.30

1k horizontal preset with knob 10 for 40p 3" Tape Spools 5p 1" Terry Clips 5p 12 Volt Solenoid 40p

ENM Ltd. cased 7-digit counter 2 1/4 x 1 3/4 x 1 1/4" approx. 12V d.c. (48 a.c.) or mains £1.10

Auto charger for 12v Nicads, ex-new equipment £3.95

Miniature 0 to 5mA d.c. meter approx 1/8" diameter £1.25
RS Yellow Wander Plug Box of 12 40p
18 SWG multicore solder 3 1/2p foot
SAPHIRE STYLII. 15 different, dual and single point, current and hard to get types. My mix £2.

BRIAN J. REED

161 ST. JOHNS HILL, BATTERSEA, LONDON SW11 1TQ
Open 10 a.m. till 7 p.m. Tuesday to Saturday. VAT receipts on request.
Terms: Payment with order Telephone: 01-223 5016

Digital count unit. Counts in steps of 1, 2, 5 or 10 with total limit switch (2 x D.I.L. BCD), reed relay remote output. Mains power supply, relay and delay unit. UNUSED. Displays on 2 Minitron. 7 segments sold separately. £5.60

£1.10
£3.25

RELAY 6 amp changeover. Mains coil 200µA F.S.D. level Meter 1 1/4" x 1 1/4"

Capacity 6V 450 m.a.h. at 10 hour rate. Ex-new equipment £3.75

Crouzet 30-minute timer-programmer, multi-variable contacts £7.80

ACOS DUST JOCKEY Automatic record cleaner £1.30

Mail Order Over £50 deduct 10% Over £100 deduct 20%

McMurdo 4 or 8 way plug and socket ex-equipment 50p

"Makaswitch" 1p 10-way wafer 15f Wood cased 8-12V buzzer £2.60

2.5A r.f. thermo-couple and meter 2 1/2" square £3.86

100 Electrolytics £3.00
 100 Resistors 1W £2.00
 100 Wirewound Resistors £4.50
 100 Resistors 2-5W £3.00
 Well mixed values and voltages

100 Capacitors £2.50
 100 Resistors up to 1W £1.00
 100 Resistors 2-5W £3.00
 100 1% & 2% Resistors £3.50

UK — Postal Orders for same day service. Cheques require 8 days from a Tuesday banking to ensure clearance: export banker's draft (sterling) same day service. Foreign currency money orders etc. can lose value and take 4-6 weeks to clear.

SEMICONDUCTORS full spec. by Mullard etc. Many others in stock

AC128/176	16p	BCY40	55p	BF336	31p	2N706A	13p
ACY20	30p	BCY70/1/2	14p	BF274	8p	2N918	30p
ACY29	22p	BD11	32p	BF282 Dual Mosfet	£1.15	2N929	16p
AD161/2 match pr.	70p	BD113	57p	BF761	40p	2N987	45p
AF116	30p	BD115	35p	BFW10/11 F.E.T.	48p	2N1484	£1.15
AF124/6/7	27p	BD116(BRC116T)	54p	BFW30	£1.15	2N1507/2219	18p
AF139	23p	BD130Y	35p	BFW57/58	21p	2N2222A	15p
AF178/80	35p	BD131	29p	BFX12/29/30	23p	2N2401	35p
A-181	33p	BD132	32p	BFX84/88.89	20p	2N2412	27p
AF239	35p	BD133	35p	BFY50/51	13p	2N2483	28p
ASV27/73	35p	BD135/6/7/8	30p	BFY90	50p	2N2904/5/6/7/7A	10p
AU110/113	£1.51	BD139/142	35p	BR101	34p	2N3053	18p
BC107/8/9 + A/B/C	8p	BD140	32p	BR39/56	29p	2N3055 R.C.A.	60p
BC147/8/9 + A/B/C	5p	BD201/2/3/4	85p	BSV64	85p	2N3133/4062	24p
BC157/8/9 + A/B/C	8p	BD232/3/4/5/8	85p	BSV79/80 F.E.T.s	50p	2N3553	56p
BC1718/173	8p	BD233/4/5	45p	BSV81 Mosfet	75p	2N4037	30p
BC178A/8 179B	14p	BD238	30p	BSX20/21/78	18p	2N5484 FET	37p
BC182/184C/LC	8p	BDX77	97p	BSY40	30p	40250(2N3054)	35p
BC186/7	23p	BD437/438	58p	BSY95A	14p		
BC204	12p	BF115/167/173	18p	BU204+Mount Kit	£1.51		
BC212/213U/2148	6p	BF178/9	23p	BU208	£1.86		
BC238	8p	BF180/1/2/3/4/5	18p	CV7042 (OC41/44			
BC327/8 337/8	8p	BF194/195C	5p	ASY83)	12p		
BC547/8+A/B/C	11p	BF200	13p	GET111/E112	45p		
BC556/7/8/9/9	10p	BF258/324	23p	OC45(ME2)	13p		
BCX32/36	15p	BF262/3	35p	QN222	23p		
BCY31	59p			OC2008	£1.73		

RECTIFIERS

Amp	Volt		
M1	88	5p	
1N4001/2	50/100	3p	
1N4004/8	4/800	6p	
1NA4005	100	5p	
1N4007/BYX94	1250	8p	
BY103	1,500	21p	
SR100	1.5	100	9p
SR400	1.5	400	10p
REC53A	1.5	1,250	18p
LT102	2	30	18p
BYX22-200	1 1/2	300	28p
BYX38-300R	2.5	300	48p
BYX38-600	2.5	600	52p
BYX38-900	2.5	900	60p
BYX38-1200	2.5	1,200	68p
BYX49-300R	3	300	36p
BYX49-600	3	600	42p
BYX49-900	3	900	47p
BYX49-1200	3	1,200	60p
BYX48-300R	6	300	47p
BYX48-600	6	600	60p
BYX48-900	6	900	70p
BYX48-1200R	6	1,200	92p
BYX72-150R	10	150	42p
BYX72-300R	10	300	52p
BYX72-600R	10	600	68p
BYX72-300	10	300	36p
1N5401	3	100	13p
1N5402	3	200	15p
MR855	3	600	24p
BYX42-900	10	900	92p
BYX42-1200	10	1,200	£1.07
BYX48-300R	15	300	£1.19
BYX48-400R	15	400	£1.75
BYX48-500R	15	500	£2.00
BYX48-600	15	600	£2.30
BYX20-200	25	200	72p
BYX52-300	40	300	£2.06
BYX52-1200	40	1,200	£2.90
RAS310AF*	1.25	1,250	48p

TRIACS

25	900	8TX94-900	£3.00
25	1200	8TX94-1200	£5.00

Diode Characteristic, Equiv., and Substitution Book 82p

Transistor equivalents and substitution Book 1 38p Book 2 82p

Chrome Car Radio faela 28p

Rubber Car Radio gasket 10p

DLI Pal Delayline 90p

Relay Socket 4PCO or 2PCO 10p

28 pin d.i.l. socket low profile 22p

Colour EHT Tray 3000/3500 £4.05

Nylon self-locking, 31 tie clips 1.5, 10, 22 or 750 µh choke .12p

0-30, or 0-15, black pvc, 360° dial, silver digits, self adhesive 4 1/2" dia. 13p

Mullard Semiconductor, Valve & Component Data Book 50p

BRIDGE RECTIFIERS

BYX10	34p
OSH01-200	30p
Ex Equip	73p
EC433	20p
Texas	£1.10
I.R.	48p
840C 3200	58p

OPTO ELECTRONICS

Diodes 8PX40 57p, 8PX42 92p, 8PY10 92p

Photo transistor 8PX29 92p, OCP71 40p

(VOLIACI) L.E.D.'s: 2" Red Mullard CQY24 9p, TIL209 .25" red 9p or green 13p

Wire and neons 4p

PHOTO SILICON CONTROLLED SWITCH: BPX66 PNP 10 amp £1.15

3" red 7 segment L.E.D. 14 D.I.L. 0-9+D.P. display 1.8V 19mA segment, common anode .95p, RS 0.6in, green £2.25, Mintron 0.3in 3015F filament £1.25

CQY11B L.E.D. Infra red transmitter .£1.15

H15B Photon coupled Isolator I.R. diode & NPN Photo-Darlington amp £1.05, Data Sheet 10p

McMurdo PP108 8 way edge plug 12p

Multicore Solder 1/2kg. 16 or 18 or 20 s.w.g. £5.20

3 inch 8 Ω speaker £1.15

New unmarked, or marked ample lead ex new equipment

ACY17-20	10p	TIC44	17p
ASZ20	10p	2G240	£1.17
ASZ21	35p	2G302	6p
8C186	13p	2G401	8p
BCY30-34	24p	2N711	28p
BCY70/1/2	10p	2N2926	8p
8Y126/7	5p	2N598/9	8p
HG1005	12p	2N1091	10p
HG5009	4p	2N1302	10p
HG5079	4p	1N1907	£1.17
L78/9	4p	Germ. diode	2p
M3	12p	2N3055	50p
OAB1	4p	Motorola	38p
OA47	4p	GET120 (AC128	
OA200-2	4p	in 1" sq. heat	
OC23	27p	sink	22p
OC200-5	24p	GET872	15p
C108 THY	28p	2S2320	34p
		TIS43	15p

MINIATURE EDGE METERS

100uA f.s.d., scaled 0.5, 12V Illuminated blue perspex front, 35mm x 14mm £3.45

200uA level meter, clear front. 10 x 18mm £1.20

TRANSFORMERS

Ferromag C core. Screens 95-105-115-125-200-220-240v input output 17v 1A x 2 + 24-0-24v 1.04A+20v 1mA. These current ratings can be safely exceeded by 50%. £8.00

Cassette Dynamic Microphone with switch and twin plug £1.80

Telephone Pickup, sucker with lead and 3.5 plug. 70p

PAPER BLOCK CONDENSER

0.25MFD 800 volt	87p
1MFD 250 volt	54p
1MFD 400 volt	65p

TV KNOBS

Dark grey plastic for recessed shaft (quarter inch) with free shaft extension 8p

CHASSIS SOCKETS

Car Aerial 11p, Coax 8p, 5 pin 180° 11p, 5 or 6 pin 240° din 8p, speaker din switched 13p, 3.5 mm switched 7p, stereo 1/2" jack enclosed 20p

LINEAR I.C.'s

CA3001	£1.58
CA3028	75p
CA3044	£1.60
CA3048	55p
CA3054	£1.10
CA3086	50p
CA3132	£2.22
CA3146	90p
CA3066	£1.00
CA3083	65p
CA3183	80p
702	53p
709/741	15p
710/720	34p
724	20p
7805 (T03)	55p
2102	80p
82S129	£5.00
LM300	£1.15
LM309	60p
LM1303	£1.00
LM1458	35p
LM3900	40p
LM9311	£1.02
MC1306P	40p
MC1312P	£1.20
IAA283	75p
IAA550 Y or G	23p
TA300	£1.00
TA320	£1.15
TA4700	£2.30
MP300/305 8p Yes!	8p
AY58300	36p

Many others

OTHER DIODES

1N916	4p
1N4009	9p
1N4148	1 1/2p
8A145	17p
Centercol	29p
8ZY61/BA148/OA81	12p
8B103/110 Varicap	24p
8B113 Triple Varicap	43p
8A182/BB103 Varicap	6p
OA5/7/10	17p
BZY88 up to 43 volt	7 1/2p
8ZX61 11 volt	15p
AA133 10p AA119 7p	
BZY96C 10V	34p
BZY95C 33V or 15V	34p

PVC QUALITY TAPE

Lasso 10m x 15mm grey 38p

33m x 33mm green £1.13p

GARRARD

GCS23T Crystal Stereo Cartridge	£1.20
Mono (Stereo compatible) Ceramic or crystal	£1

CATALOGUE

38, 11 x 8 ins illustrated sheets, listing approx. 5,250 items. photo printed on day requested. from constantly updated masters, to ensure latest stock position. 75p (refundable with orders) plus 27p s.a.e. or label

THYRISTORS

1	240	BTX18-200	35p
1	400	BTX18-300	41p
1	240	8TX30-204	35p
4	500	40506	58p
15	500	BT107	£1.00
6.5	500	BT109-500R/SCR957/BRC4444	71p
20	600	BTW92-800RM	£3.40
15	800	BTX95-800R Pulse Modulated	£8.76

DIGITAL I.C.'s

7400/11/2/4/6/10	15p
7413	39p
7417/20/28/30/32	18p
7441 28p	7442 22p
7437/38/50/51/54	18p
7445 42p	7472/76 20p
7473 18p	7474 18p
7480/8280	25p
7482/83	45p
7486 18p	7493 18p
74107 16p	74118 75p
74122 25p	74123 35p
74132 44p	74141 42p
74151 32p	74165 55p
74184/164/175	38p
74167 20p	74173 70p
74192 33p	74193 38p
74196 38p	74293 80p
74490	£1.30
74H Series	38p
00/01/04/10/20/40/50/73	
74L72/54L95	25p
5406/86	30p
5478/80	35p
5480/123	50p

M.O.S. and Sahotcky see Catalogue

HANDLES

Rigid light blue nylon 6 1/2" with secret fitting screws 11p

Belling Lee white plastic surface coax outlet box 40p

Miniature Axial Lead Ferrite Choke formers 5 for 13p

RS 10 Turn pot 1% 250 500 Ω 1K. £1.70

Copper coated board .81" x 2 1/2" 28p

KLIPPON 25A 440v TERMINAL BLOCKS Professional leaf spring clamp, twin with clip-over cover 11p

Strlb of 4. 40A 440V! 16p

VAT & POST PAID

MINIMUM ORDER £3 OTHERWISE ADD 50% FOR SMALL ORDER HANDLING COSTS (UNDER £1.00 TOTAL ALSO INCLUDE 10p S.A.E.)

Due to lack of space, items (i.e. pots, caps, etc.) can only be collectively priced. Catalogue often shows much lower individual value price

ALL ENQUIRIES, ETC., MUST BE ACCOMPANIED BY A STAMPED ADDRESSED ENVELOPE

APEL POWER SUPPLIES

STABILIZED POWER SUPPLIES WITH ELECTRONIC SHORT CIRCUIT PROTECTION

STOCKISTS

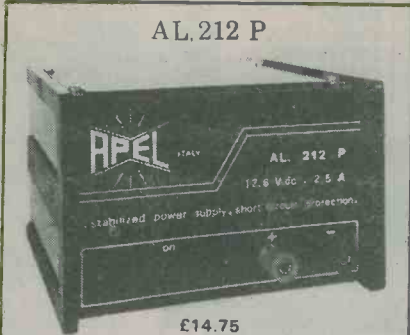

AL.212 P

£14.75

INPUT VOLTAGE	220 V ac \pm 10% 50-60 Hz
OUTPUT VOLTAGE RANGE	12.6 V dc
OUTPUT CURRENT MAX	2.5 Amp
LOAD REGULATION	<0.3% 0-2.2 Amp
RIPPLE	<5mV 2.2 Amp
DIMENSIONS (mm)	W140 x H90 x D140
WEIGHT	1,490 Kg.

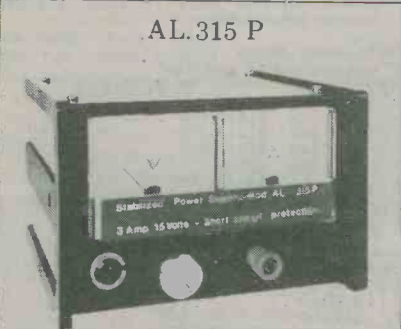

AL.315 P

£29.50

INPUT VOLTAGE	220 V ac \pm 10% 50-60 Hz
OUTPUT VOLTAGE RANGE	1.7-15 V. dc
LOAD REGULATION	<0.2% 0-2.8 Amp
DIMENSIONS (mm)	W140 / H90 / D155
RIPPLE	3mV 2.8 Amp
WEIGHT	2,330 Kg.

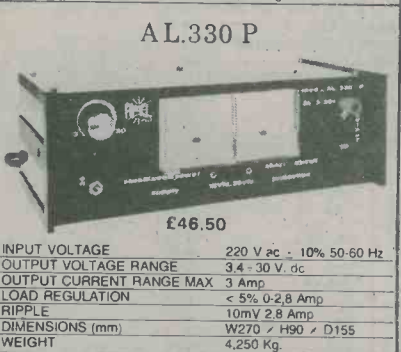

AL.330 P

£46.50

INPUT VOLTAGE	220 V ac \pm 10% 50-60 Hz
OUTPUT VOLTAGE RANGE	3.4-30 V. dc
OUTPUT CURRENT RANGE MAX	3 Amp
LOAD REGULATION	< 5% 0-2.8 Amp
RIPPLE	10mV 2.8 Amp
DIMENSIONS (mm)	W270 x H90 x D155
WEIGHT	4,250 Kg.

Alpha Sound Service,
50 Stuart Road, Waterloo, Liverpool L22 4QT,
England.

Anson Electronics,
1133 Hessele High Road, Hull, England.

Amateur Radio Shop,
13 Chapel Hill, Huddersfield, HD1 3ED,
England.

Brent Electronics,
Seaview Street, Cleethorpes,
Lincolnshire, England.

J. Birkett,
26 The Strait, Lincoln, England.

Bradford Consultants Limited,
25 Regent Parade, Harrogate,
Yorkshire, England.

F. Brown & Co. Ltd.,
44/46 George IV Bridge Street,
Edinburgh, Scotland.

N. R. Bardwell Limited,
Sellers Street, Sheffield, England.

Casey Brothers,
235 Boundary Road,
"Saint Helens,"
Lancashire, England.

Electronic Services Limited,
33 City Arcade, Coventry CU11 HX, England.

A. Fanthorpe Limited,
6 Hepworth Arcade, Silver Street,
Hull, England.

G. W. M. Radio,
Portland Road, Worthing, Sussex.

Leeds Amateur Radio,
27 Cookridge Street,
Leeds LS2 3AG, England.

Target Electric Limited
16 Cherry Lane, Bristol, England.

New Cross Radio,
6 Oldham Road, Manchester,
England.

Progressive Radio,
93 Dale Street, Liverpool L2 2JD,
England.

R. E. Pitt Electrical Services Limited,
60/64 Bath Buildings, Mont Pelier,
Bristol, England.

Peats Electronics,
Parnell Street, Dublin.

R. F. Potts,
68 Bobbington Lane, Derby, England.

Brian A. Pearson Limited,
66 Moncur Street, Glasgow, Scotland.

R M E Supplies Limited,
143 Stockwell Street, Glasgow, Scotland.

Stephan James Limited,
Warrington Road, Leigh, Lancashire.

Stewarts Radio,
4 Chance Street, Blackpool, England.

The Radio Shop,
16 Cherry Lane, Bristol BS 3NG,
England.

Q. C. Trading,
1 St. Michaels Terrace, Woodgreen M22 4FT,
England.

AL.1 P5

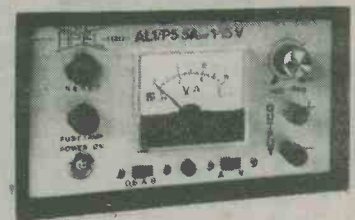

£78.00

INPUT VOLTAGE	220 \pm 10% 50 Hz
OUTPUT VOLTAGE RANGE	1 - 15 V. dc
OUTPUT CURRENT MAX	5 Amp
LOAD REGULATION	< 0.1% 0-4.5 Amp
RIPPLE	< 2mV 4.5 Amp
DIMENSIONS (mm)	W210 x H155 x D250
WEIGHT	5,100 Kg.



AL.212 PS

£18.00

INPUT VOLTAGE	220 V ac \pm 10% 50-60 Hz
OUTPUT VOLTAGE RANGE	12.6 V dc
OUTPUT CURRENT MAX	2.5 Amp
LOAD REGULATION	<0.3% 0-2.2 Amp
RIPPLE	<5mV 2.2 Amp
DIMENSIONS (mm)	W140 x H90 x D140
WEIGHT	1,490 Kg.
AMPEROMETER	

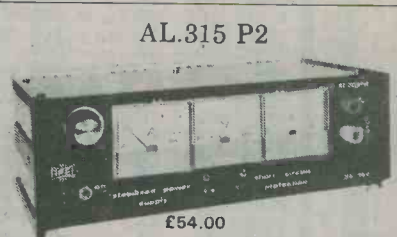

AL.315 P2

£54.00

INPUT VOLTAGE	220 V ac \pm 10% 50-60 Hz
OUTPUT VOLTAGE RANGE	\pm 1.7 \pm 15 V dc
OUTPUT CURRENT RANGE MAX	3 Amp
LOAD REGULATION	< 0.2% 0-2.8 Amp
RIPPLE	< 3mV 2.8 Amp
DIMENSIONS (mm)	W270 x H90 x D155
WEIGHT	4,140 Kg.

Stan Willets Limited,
37 High Street, West Bromwich.

M/S Waltons,
55a Worcester Street,
Wolverhampton WV2 4LL, England.

Distributed in the U.K.
and Ireland by:

PEAT'S WHOLESALE LTD.

Chapel Lane, Parnell St., Dublin 1, Ireland.

PHONE 741746-740678-722845. TELEX 31787.

DO YOUR PROJECTS LACK THE PROFESSIONAL LOOK?

IF SO, TRY OUR HB RANGE

Instrument cases to give any project a professional look. The four separate top, bottom and end panels are made of black p.v.c. coated steel. Front panel and top and bottom trim are satin anodised aluminium for a neat finish; back panel is in plain aluminium. The whole case, including screws, comes in a flat package and may be assembled in minutes.

DIMENSIONS IN INCHES

Model	Width	Depth	Height	Price
HB1	9	6	3	£4.87
HB2	9	6	4½	£5.27
HB3	9	6	6	£5.63
HB4	12	8	3	£5.98
HB5	12	8	4½	£6.80
HB6	12	8	6	£7.26

ALUMINIUM BOXES

Aluminium box with lid and screws.

Model	Length	Width	Height	Price
AL1	3	2	1	52p
AL2	4	3	1½	62p
AL3	4	3	2	72p
AL4	6	4	2	81p
AL5	6	4	3	94p
AL6	8	6	2	£1.27
AL7	8	6	3	£1.43

(Dimensions in inches)

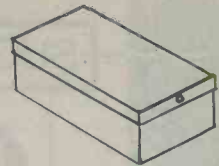

INSTRUMENT CASES

BC Range consists of black P.V.C. coated steel top cover with bevelled front edge, u-shaped aluminium chassis and two fixing screws.

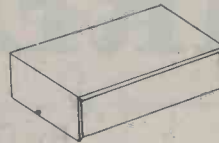

Model	Length	Width	Height	Price
BC1	6	4½	2	£1.61
BC2	6	4	3½	£1.74
BC3	8	5½	2½	£1.99
BC4	10	6½	3	£2.60

(Dimensions in inches)

SHEET ALUMINIUM

Gauge	4 x 6	6 x 9	8 x 12
16	27p	55p	99p
18	18p	40p	66p
20	15p	30p	50p

ELECTROLYTICS

Axial		Radial		
1/25v	4p	1/50v	4p	
10/25v	4p	10/50v	4p	
22/16v	4p	22/25v	4p	
100/10v	5p	33/63v	5p	
100/16v	6p	47/16v	5p	
220/25v	7p	100/35v	6p	
330/25	8p	220/16v	6p	
470/6.3v	8p	220/63v	8p	
470/16v	8p	330/25v	8p	
1000/16v	16p	470/6.3v	8p	
1500/25v	20p	470/16v	8p	
2200/10v	20p	1000/25v	16p	
3300/16v	25p	1000/35v	20p	
4700/10v	30p			
15000µF 10v	CAN			Price: 50p

LINEAR I.C.s

LM741	18p	SN76660N	75p
TAA350	£1.00	SN76013	£1.20
TBA120A	50p	SN76023N	£1.20
TBA820	80p	SN76033N	£1.20
T706 BPC		SN76110N	75p
=TBA641	£1.00	SN76131N	£1.30

TRANSISTORS

AD161/2 MP	60p	BC183A	8p	BF194	8p
BC107	8p	BC207B	10p	BF195	8p
BC108A	8p	BC212L	6p	BF198	10p
BC148	6p	BC213LB	6p	BF200	13p
BC149C	7p	BC308	10p	BFY50	13p
BC149S	8p	BC338	8p	TIP32B	25p
BC171B	8p	BC547	10p	2N2906	10p
BC172B	7p	BD183	70p	2N2907	10p
BC182LB	8p	BF137	10p	2N3055	55p

DIODES

BZY 88C 6v2	5p	BZY 88C 22v	5p
BZY 83C 6v2	5p	BZY 79C 68v	5p
BZY 88C 7v5	5p	1N914	3p
BZX 83C 7v5	5p	1N4148	2p
BZY 88C 8v2	5p	1N4150	2p
BZX 79C 9v1	5p	1N4004	4p
BZY 88C 15v	5p	1N4005	5p
	0A91		3p
BZY 88C 20v	5p		

HORIZONTAL SUB-MIN PRESETS
100R, 1k, 1k5, 4k7, 10k, 22k, 47k.

VERTICAL SUB-MIN PRESETS
470R, 2k2, 4k7, 47k, 100k All 4p each

TANTALUM BEAD CAPACITORS

.22/35v	6p	10/16v	8p
.33/35v	6p	15/16v	8p
.47/35v	6p	22/6.3v	8p
6.8/35v	6p	47/6.3v	8p

TTL

7401	8p	7438	25p	74107	16p
7402	8p	7441	25p	74122	25p
7404	9p	7442	34p	74123	42p
7405	9p	7447	25p	74151	32p
7406	16p	7450	9p	74153	29p
7409	9p	7486	14p	74154	35p
7410	6p	7490	32p	74164	35p
7412	12p	7491	18p	74175	35p
7416	14p	7492	23p	74192	33p
7420	9p	7493	18p	74193	38p
7430	9p	7495	45p	74194	33p
		74196	36p		

MIXED PACKS OF COMPONENTS

60 Polyester Caps.	Price: £2.00
100 Electrolytic Caps.	Price: £3.00
Approx. 500 resistors.	Price: £2.50

Standard Rotary Potentiometers. Single with ¼ inch white nylon shaft. Values: 5k log, 10k log, 50k log, and 250k log. Price: 19p each

Standard Rotary Potentiometers. Dual with ¼ inch metal shaft. Values: 25k log, 50k log, and 500k log. Price: 50p each

4mm Banana plugs Red and Black. Price: 11p each
4mm Banana sockets Red and Black. Price: 12p each
8 section Telescopic Aerial with swivel. 38 inches fully extended. Price: 60p
Anti-surge fuses 20mm 2amp. Price: 6p
4 inch long Heatsink, undrilled, black anodised. Price: 65p
four buttoned pre-set control panel for vari-cap tuners. Price 85p

Single sided, copper clad, printed circuit board. 2½ x 8½ Price: 10p
4½ x 9 Price: 25p

25 Mixed Rubber Grommets Price 16p
16mm screw-on cab. feet. Set of four Price: 5p

14mm square self adhesive feet. Set of four Price: 15p

Din Plugs 5 pin 180° Price 10p
Din Sockets 5 pin 180°. Standard metal type Price: 10p

Magnetic earpieces with 3.5mm plug Price: 12p

Reed Switches Price: 5p
Wire Neons 90 volts Price: 4p

75mm diam. 15 ohm Speaker Price: 60p

125mm x 78mm Oval 50 ohm Speaker Price: 75p

Latchswitch 2p 2w Price: 10p
DPDT Slide Switches Price: 12p

Green Phono Plugs Price: 6p

Bridge Rectifiers
W005 50v 1A Price: 25p

W04 400v 1A Price: 28p

Red L.E.D.s 2 inch Price: 8p

Green L.E.D.s 2 inch Price: 12p

Ceramic Filters 6MHz, SEF 6.0MB Price: 20p

Colour T.V. Crystals 4.433619MHz Price: 90p

PP3 Battery connecting leads Price: 6p

20mm chassis mounting fuse holders Price: 6p

DL500 Displays Common Cathode
.5 inch displays Price: 75p

1p 12w Rotary Switches Price: 40p

All prices include V.A.T. and post and packing. Send for free pamphlet on all our instrument cases, boxes and components. Discount on boxes and instrument cases only, as follows: Orders over £10 5%, over £20 10%, over £30 15%.

HARRISON BROS. P.O. Box. 55, Westcliff-on-Sea,

Essex. SS0 7LQ. Telephone: Southend-on-Sea (0702) 32338.

SUGGESTED CIRCUIT

CMOS GUARD WIRE ALARM

By G. A. French

It is a common sight nowadays to see guard wires threaded through the handles or other apertures of expensive items offered for sale in the larger stores. Shoplifters cannot then steal these items because to do so they would have to cut or otherwise break the circuit completed by the guard wire, with the result that an alarm would be given.

It is possible to construct a comprehensive guard wire system at quite low cost, and this month's "Suggested Circuit" article describes a design in which the protective logic is carried out by two inexpensive CMOS chips. The system is entirely battery operated and draws a quiescent current of the order of $40\mu\text{A}$ from the battery which supplies the CMOS circuitry. This small current means that the battery needs to be replaced only after a very long period of service, with consequent low running costs. The alarm is given by an electric bell which is powered by a separate battery. A feature of the circuit is that the bell is successively turned on and off in 1 second periods, a factor which is even more capable of drawing attention than is a continuous ringing.

THE GUARD WIRE

The guard wire could consist of a single flexible wire through which a current flows continually. The current would then be interrupted, and the alarm consequently given, if the wire were cut. However, such an approach provides little protection from a thief having even an elementary knowledge of electricity, as it is merely necessary to bridge the wire on either side of a point at which it is intended that it be cut.

The bridging could be carried out by means of a second piece of wire connected to pins at each end which would merely need to be passed through the guard wire insulation to make contact with the wire itself. Obviously, a more sophisticated approach is required.

The guard wire technique employed in the present design is illustrated in Fig. 1. Here, the guard wire consists of a length of flexible insulated audio screened wire, in which the outer conductor is braided rather than lapped. The wire is terminated in two coaxial plugs with, of course, the centre wire connecting to the centre conductor of each plug and the braiding connecting to the outer conductor of each plug. The plugs are fitted into sockets SK1 and SK2. The 9 volt supply is that which feeds the CMOS devices in the alarm system.

Under normal conditions the positive supply rail connects via

SK1, the screened wire braiding and SK2 to point B which is, in consequence, normally high (i.e. at the potential of the positive rail). If, for any reason, the circuit provided by the braiding is interrupted, resistor R2 causes point B to be taken low. A second circuit from the negative rail is given through R3, SK2, the centre wire of the screened cable, SK1 and R1, terminating at the positive rail. Because R3 has a much lower value than R1, the voltage at point A is normally very close to the negative supply rail and is consequently low. Should the centre conductor circuit be interrupted, R1 causes point A to go high.

A third eventuality is that the centre wire and the braiding of the screened wire could be short-circuited together, due possibly to a thief passing a pin through the wire or otherwise meddling with it. If this should happen, a circuit is com-

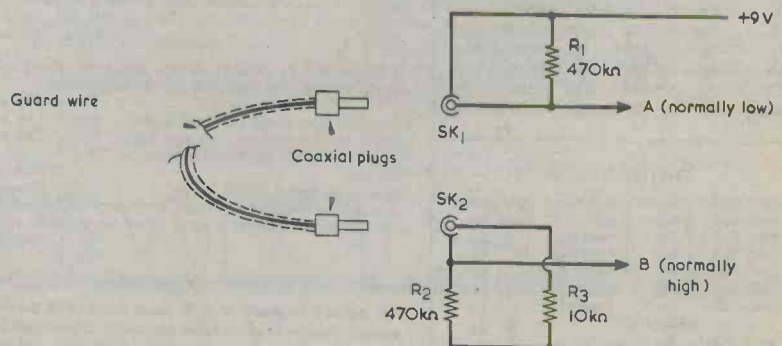

Fig. 1. The basic guard wire circuitry. The potentials at points A and B change to the alarm state if either the screened wire braiding or centre conductor are cut or if they are short-circuited together

pleted from the positive rail to the negative rail through SK1, the screened wire braiding, the short-circuit, the centre conductor of the screened wire, SK2 and R3. The result of the short-circuit is that point A is taken high. The short-circuit current is limited to slightly less than 1mA by R3.

To sum up, point B is normally high and point A is normally low. If the screened wire braiding is cut, point B goes low. Should the screened wire centre conductor be cut, point A goes high. Point A also goes high if the screened wire braiding and centre conductor are short-circuited together. A voltage change at point A or at point B is detected virtually instantly by the CMOS circuitry to which the points connect, and a CMOS latch is tripped which causes the alarm to sound continually even if the circuit break or short-circuit is subsequently made good. The alarm can only be silenced by switching off the 9 volt supply.

The only way the guard wire system of Fig. 1 can be defeated is by removing the screened wire insulation at two points, making gaps in the braiding at these points without cutting it, and then bridging over the braiding and centre conductor by two separate wires before cutting the screened wire between the two points. This bridging process would, furthermore, have to be carried out without accidentally short-circuiting together the screened wire centre conductor and braiding. Hardly a task which would commend itself to even the most dedicated of shoplifters!

The normal quiescent current drawn from the 9 volt supply by the guard wire circuit is that which flows through R1, R2 and R3. This calculates out as $38\mu\text{A}$. An incidental advantage of the screened wire approach is that the screened wire braiding is directly connected to the positive supply rail. Neither the braiding nor the centre conductor can, as a result, pick up stray random electrical noise and give false triggering of the alarm.

COMPLETE CIRCUIT

The complete circuit of the alarm system is given in Fig. 2, and it will be seen that the circuit detail of Fig. 1 appears at the left hand end. Gates G1 to G4 are the four NAND gates in a CD4011 CMOS i.c., and all are used as inverters. Gates G3 and G4 form a latch, and the presence of C1 ensures that, at switch-on, the latch takes up the state where the input to G3 is low. The output of this gate is then high

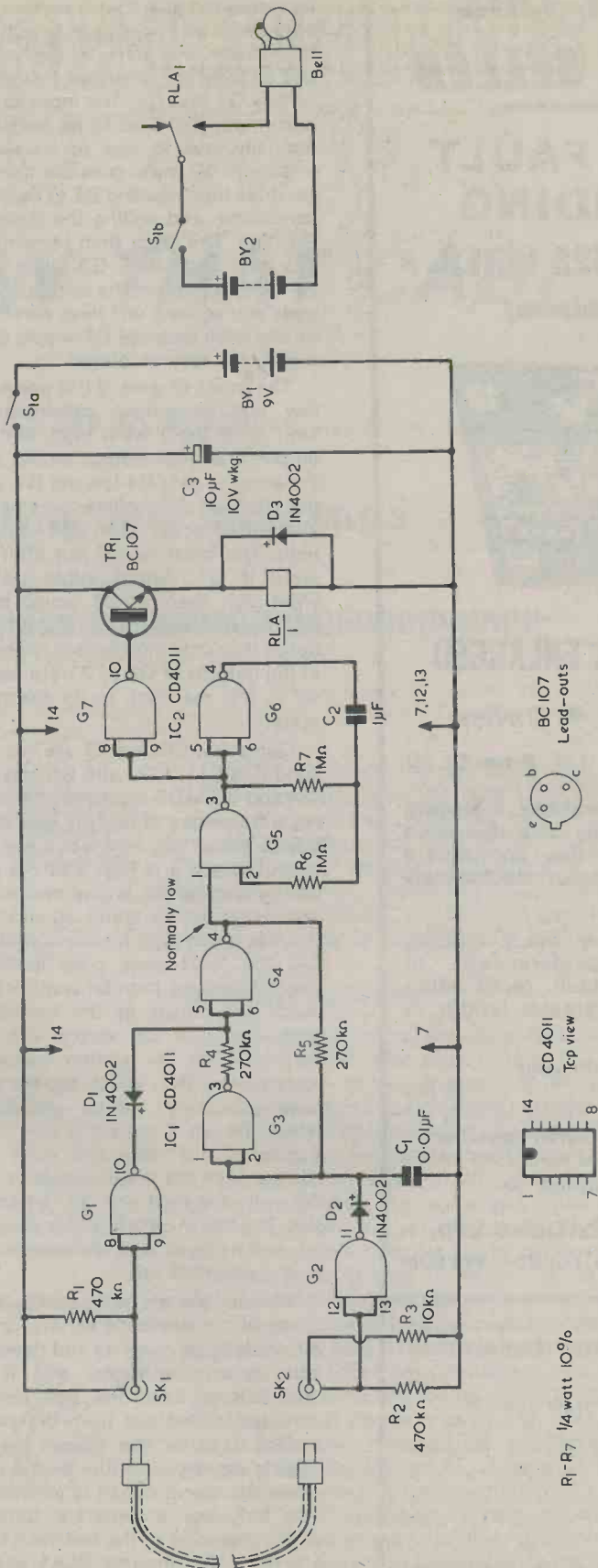
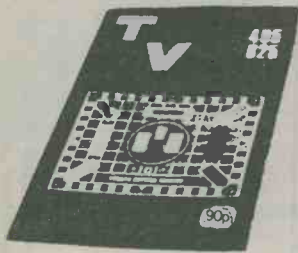

Fig. 2. The full circuit of the alarm. Momentary triggering is all that is required to trip the latch given by gates G3 and G4, after which the bell sounds at 1-second intervals until the alarm is switched off at S1(a) (b)

BUY THIS BEST SELLER

T.V. FAULT FINDING 405/625 LINES

MONOCHROME



REVISED & ENLARGED

Edited by J. R. Davies

132 pages

Price £1.20

Over 100 illustrations, including 60 photographs of a television screen after the appropriate faults have been deliberately introduced.

Comprehensive Fault Finding Guide cross-referenced to methods of fault rectification described at greater length in the text.

Price 120p from your Bookseller

or post this Coupon together with remittance for £1.45 (to include postage) to

DATA PUBLICATIONS LTD.
57 Maida Vale, London, W91SN

Please send me the 5th revised edition of TV Fault Finding, Data Book No. 5

Enclose cheque / crossed postal order for

NAME

ADDRESS

Block Letters Please

and the output of gate G4 low, thus maintaining the latch state.

The point A and B inputs from the screened guard wire section are at too high an impedance to pull the latch from one state to the other, and so they are amplified by the inverters G1 and G2. The input to G2 is normally high and so its output is normally low. If, due to an alarm condition, G2 input goes low its output goes high, causing D2 to become conductive and pulling the input of G3 high. The latch then remains in this new state with G3 input, and G4 output, high. If the output of G2 goes low again it will have no effect on the latch because D2 would then merely be reverse biased.

The input of gate G1 is normally low and its output consequently high. If its input went high, and its output low, that output would pull the input to gate G4 low via D1, and the latch would similarly take up its alternative state with G4 output high. The latch would not alter its state if G1 output subsequently went high again as D1 would then be reverse biased. It should be noted that only momentary changes in the outputs of G2 or G1 are needed to trip the latch to its alternate state.

Gates G5, G6 and G7 are in a second CD4011, IC2, with G5 and G6 forming a CMOS multivibrator having a frequency of slightly less than 0.5Hz. When pin 1 of G5 is low its output at pin 3 is high and the oscillator is inhibited. It commences to run when, under alarm conditions, pin 1 is taken high by the output of G4. Pin 3 at once goes low for about 1 second, high for another second, and so on, as the oscillator runs. Pin 3 of G5 couples via inverter G7 to the emitter follower relay driver, TR1, which causes the relay coil RLA/1 to be energised when the pin 3 output is low. The transistor and relay coil draw no current from the 9 volt supply when G5 output is high and G7 output is low. The fourth gate in IC2 is not used, and its input pins are connected to the negative rail.

Modern electric bells, particularly those of the domestic variety, draw relatively large currents and develop high reverse voltages, and it is desirable to keep the bell circuit completely divorced from the electronics. It is for this reason that a relay is employed to turn on the bell when the alarm circuit is activated. The bell has a separate battery which connects to the bell via S1(b) and the make contacts, RLA1, of the relay. The bell will, in any event, almost certainly require a supply voltage that is lower than the 9

volts used for the CMOS circuitry. The voltage of BY2 should be that which is most suitable for the particular bell employed. It should be noted, in passing, that a bell creates a much louder noise than does any simple electronic audio warning device consuming the same battery power.

On-off switching is provided by the 2-pole switch S1(a) (b). S1(b) is not entirely necessary, since the relay contacts are normally open, and could be omitted if desired. Bypass capacitor C3 prevents bell noise and pulses from the relay coil appearing on the 9 volt CMOS supply rails.

FURTHER POINTS

The alarm assembly may be housed in a plastic case, bearing in mind that the outer conductors of SK1 and SK2 should be insulated from each other. The coaxial sockets and plugs may be TV aerial or phono types. The relay recommended for RLA is the "Open Relay" with 410Ω coil which is retailed by Maplin Electronic Supplies. This has a quick lightweight switching action and requires a comparatively low energising current.

The measured quiescent current drawn from the 9 volt supply by the prototype circuit was approximately 40μA, this rising to some 19mA when the alarm was triggered and the relay was energised. Average alarm current is therefore about half of 19mA. A PP9 battery would be suitable and should offer a long life.

The only feature which cannot be designed into the circuit with complete certainty is the switch-on bias imparted to the G3-G4 latch by C1. The author has checked the circuit with a number of CD4011 i.c.'s, and in all cases C1 caused the latch, after switch-on, to take up the state where G4 output is low. There is, nevertheless, a very slight possibility that C1 will not exert sufficient control with all CD4011 i.c.'s, and it is therefore advisable for the wiring to IC1 to be taken to an i.c. holder. No difficulties then arise if it is found necessary to use an alternative CD4011 in the IC1 position. A quad NOR gate type CD4001 may also be employed for IC1 (but not for IC2).

A final point is that the alarm system is intended for use only in dry indoor conditions. It should not be employed in excessively damp environments or out of doors.

NOTES FOR NEWCOMERS

FOLLOW THAT CAB!

By D. Snaith

Sorting out jack tags

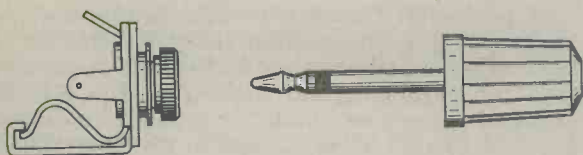

Fig. 1. A 3.5mm. jack socket and plug. The socket is of "open" construction and has a "break" contact



Fig. 2(a). Circuit symbol for the jack socket
(b). The contacts may be identified by the letters A, B and C



Fig. 3(a). The jack socket, as viewed from the rear
(b). The tag letters, read in clockwise order, spell out the word "CAB"

Nearly all of us are familiar with 3.5mm. jack sockets and plugs of the type shown in Fig. 1. The socket interests us most for the moment. It is of "open" construction (i.e. is not insulated) and it has a "break" contact which opens when the jack plug is inserted. Normally this contact is used to mute the speaker in a radio receiver when an earphone plug is fitted in the socket.

CIRCUIT SYMBOL

The circuit symbol for the socket is shown in Fig. 2(a). When the jack plug is inserted its "tip" section connects to the uppermost contact, causing it to be raised and breaking the connection it has with the "break" contact below it. The "sleeve" section of the plug makes contact with the right-hand part of the socket symbol which, with the "open" type, is common with the mounting bush and nut.

The socket symbol is easy to picture mentally, and we can identify its three connection points by the letters A, B and C, as in Fig. 2(b).

When we examine the jack socket physically we find that it doesn't quite match up with the circuit symbol and, also, that visually tracing the contacts to which its three tags connect can be a little difficult. If we hold the socket with its rear towards us, the tag layout appears as in Fig. 3(a). We can overcome all tag recognition problems by simply appending the letters C, A and B to the tags in clockwise order. These fortuitously spell out the word "CAB" and they correspond with the similar letters of the symbol of Fig. 2(b).

So, next time you have to wire up one of these little sockets, bear in mind the symbol of Fig. 2(b), look at the socket tags, then just "follow the CAB" when you make your connections to it.

"OCEAN STAR 240" VHF MARINE RADIOTELEPHONE

For the yachtsman who wishes to telephone his home or office or to other ships and coast stations throughout the UK and Continental waters, a new compact radiotelephone is being marketed by Frank Cody Electronics Limited, utilising up-to-date technology. This set can operate on any 24 switch selected channels in the International

Maritime VHF service. It is delivered factory adjusted to operate on 24 of the most commonly used VHF channels, including Public Correspondence, Coast Guard and Marina Channels. Should it be necessary to alter this selection, it is a simple matter of readjustment in this synthesised radio. No replacement of expensive crystals is necessary.

The "Ocean Star 240" transmits at the full legal limit of 25 watts, and its circuitry enables it to maintain this power when the supply battery has run down to 10 volts (important in sailing craft). It has a built-in loud hailer and intercom facility, and at £225.00 is supplied complete with power lead, press-to-talk fist microphone and universal mounting bracket.

The standard model is small, 70 x 203 x 260 mm, and weighs only 3kgs. The materials and components used are of the highest quality for the marine environment, gaskets and seals resist the entry of moisture.

Further technical data is available from Frank Cody Electronics Limited, Star House, 44 Gresham Road, Staines, Middlesex TW18 2AN.

WARC 79

The World Administrative Radio Conference — **WARC 79** — is being held in Geneva from September 24th to November 30th.

As this year's President of the Radio Society of Great Britain, Mr. John Bazley, G3HCT, said in his installation speech in January:— "This year, in the latter part of September, we shall see the opening of the World Administrative Conference in Geneva — **WARC 79** — where, to quote Mr. Butler, the Deputy Secretary General of the ITU, '**WARC 79 will come forward with a new treaty which will govern the planning and operation of radio communication services well beyond the year 2000**'. Negotiations have been taking place for several years between our Society and the Home Office in preparation for this conference, and I would like to record our appreciation of the sympathetic attitude taken by officials of the Home Office during these discussions."

A Special Preparatory Meeting was held between 23rd October and the 17th November, 1978, in Geneva, in response to a resolution of the ITU Administrative Council which invited the International Radio Consultative Committee (CCIR) to carry out the necessary studies to ensure timely provision of the technical information likely to be needed as a basis for the work of the WARC. During the two years prior to this Special Preparatory Meeting, a great deal of earlier work had been carried out by CCIR Study Groups. Some 350 documents were sent to the 720 delegates who were to participate in the meeting. These documents covered such diverse subjects as Classification of Radio Emissions, Terrestrial services up to 40 GHz, Space services, Monitoring of the Radio Spectrum, Services above 40 GHz, Propagation and so on.

Of particular interest to radio amateurs is, of course, the question of what effect **WARC 79** will have on future allocations within the radio spectrum for radio amateur activities. The UK has proposed three new bands for amateur radio use, viz., 10.1 to 10.2 MHz; 18.568 to 18.768 MHz and 24.0 to 24.3 MHz and four new microwave bands, viz. 40.5 to 41.0 GHz; 49.5 to 50.0 GHz; 71.0 to 76.0 GHz and 160 to 165 GHz.

It should be mentioned of course, that many other of the proposals being put forward at **WARC 79**, whilst primarily of interest to the professional administrators and radio engineers, will also have their repercussions on the radio amateur scene, particularly the SWL's. Numerous proposals are being put up for instance, for the reallocation of SW broadcast stations.

There is a great deal of technical rearrangement proposed, to take account of the recent advances in radio, Space, TV and VHF and UHF broadcasting techniques, and to try and make provision for future technical developments. At the same time there is a need to preserve frequencies which are currently being used by millions of users of radio receivers throughout the world.

From a recent radio-teletype broadcast, the RTTY News Bulletin (put out by the British Amateur Radio Teleprinter Group on Sunday mornings at 1200 hours local time, on 3590 KHz), we learn that the cost will be approximately £3,000,000, exclusive of delegates' expenses for hotels and food.

With the ever increasing demand for space in the radio spectrum, we shall have to wait and see just what finally comes out of the deliberations.

We wish Noel Eaton, VE3CJ and his IARU team every success in their negotiations.

COMMENT

NEW SCOPEX OSCILLOSCOPE

UK oscilloscope manufacturers Scopex Instruments Limited announce the introduction of their latest instrument the 4D10B Dual Trace Oscilloscope featuring full XY operation and Z modulation.

The 4D10B, succeeding the earlier 4D10A range, retains the high accuracy ($\pm 3\%$) and the DC-10MHz bandwidth of its predecessor but now also features enhanced specifications made possible by the incorporation of the latest CMOS Integrated Circuit technology into its design.

In the XY mode Channel 'A' is switched into the horizontal deflection system giving fully matched sensitivities for both X and Y axes over the entire 10mV to 50V/cm range. When used in the conventional YT mode, the vertical amplifiers are complemented by a fully triggered 16 range timebase of $1\mu\text{s}$ to 100ms/cm.

The easy to use single trigger control, pioneered by Scopex in the low cost market, is retained together with all the other "easy to use" facilities for which the Company's oscilloscopes are noted.



The XY mode for example is easily selected on just one position of the timebase switch.

Priced at around £188 (excluding VAT) the 4D10B is less than 5% up on the March 1978 price of the superseded instrument, a fact made possible by virtue of the high volume of production now being carried on at Scopex.

GROUP ONE

A number of our readers are professionally connected with electronics usually either in industry, the teaching profession or in the retailing of components.

Some years ago we gave news of the formation of the organisation, Group One, which by giving a service to retailers of electronics components enabled them, in turn, to aid the hobbyist — we are glad to report that the group has flourished.

Its services are divided into three areas: exchange of information; disposal of surplus stocks; sharing in the benefit of bulk buying at special prices.

Any component retailer readers of this journal who wish to learn more about the organisation should write to its founder, Mr. Alan Sproxton of Home Radio Ltd., 234-240 London Road, Mitcham, Surrey CR4 3HD. There is an entrance fee of £3 and the annual subscription is £5 all of which seems to add up to a very good "buy".

ICS 75th ANNIVERSARY

In the coming winter months many thousands of people will settle down to studying. Their motivations and goals will be very varied — many will be studying for a specific examination to further their career, others to improve their job capability, some just to increase their general knowledge.

Many will study with ICS (International Correspondence Schools) including those wanting to make a career in radio and electronics for whom ICS provide a number of courses.

To mark their 75th Anniversary in the UK, ICS are initiating a new 'Student of the Year' award.

Thousands have benefitted from the various courses that ICS have provided over all these years and we congratulate them on deservedly reaching this milestone and we look forward to congratulating them on their centenary in 25 years time.

AMATEUR RADIO NOVICE LICENCE

Responding to the considerable interest shown in the suggested amateur radio CW only novice licence the Telecommunications Liaison Committee of the Radio Society of Great Britain have set up a sub committee to investigate the matter and then make an approach to the Home Office. Owing to the great pressure on the Committee caused by preparation for the forthcoming WARC 1979 meetings, mentioned on previous page, action is unlikely before early in 1980.

NOVEMBER, 1979



"Pity about that — he's designed an electronic mouse trap and now we can't find anyone plagued by electronic mice!"

PEAK MILLIVOLT ASSESSOR

By A. P. Roberts

A. F. signal tracer with built-in amplitude assessment.

This unit is basically a signal tracer but, unlike the normal type of tracer, it incorporates circuitry which enables the operator to assess the amplitude of the input signal. The circuit uses a technique which is illustrated in simplified form in Fig. 1. The input signal is coupled to an amplifier which has eight switched voltage gains, these being selected by switching in eight close tolerance negative feedback resistors. An amplified output is then available for an earphone or headphones

The amplifier output is also applied to a precision voltage detector i.c. which causes an l.e.d. to light up when it is fed with a positive input voltage in excess of 1.15 volts. If the amplifier is switched to have a voltage gain of 11.5 times then an input signal having a peak amplitude of 100mV or more will light up the l.e.d. The feedback resistors have values which enable the circuit to indicate peak millivolt values of 1, 2, 5, 10, 20, 50, 100 and 200. By finding the lowest gain setting which gives a positive indication from the l.e.d. it is thus possible to obtain an approximate indication of the input signal amplitude.

VOLTAGE DETECTOR

The voltage detector section takes advantage of the 8211 i.c., which is primarily intended for use as a low supply voltage indicator. In this application it appears in a circuit of the basic type shown in Fig. 2, in which it causes a warning to be given, or equipment to be switched off, when the supply voltage falls below a certain critical threshold level.

The 8211 input is fed from the slider of a pre-set potentiometer connected across the supply rails, the potentiometer being set up to apply 1.15 volts with respect to the negative rail when the supply voltage is at its minimum acceptable level. When the supply voltage is above the critical level the 8211 output at pin 4 is virtually floating. Should the supply fall below the critical voltage a constant current generator is turned on inside the i.c. which allows a sink current limited to 7mA to be drawn from the positive supply rail. This output current could light up a warning l.e.d. connected between the output pin and the positive rail or it could operate a switching circuit which cuts the power to the circuits being supplied.

The operation of the 8211 may be improved by taking advantage of the output at its hysteresis pin.

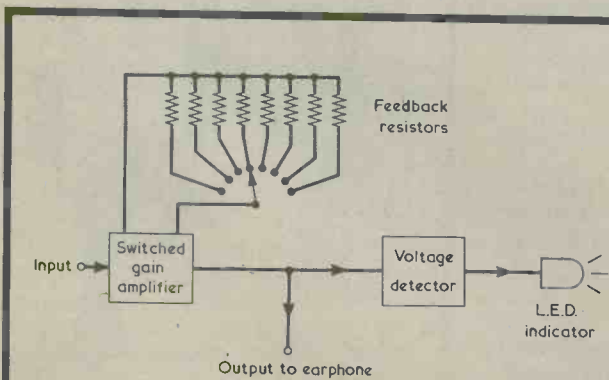

Fig. 1. Basic line-up of the peak millivolt assessor. The gain of the amplifier is successively decreased until a switch position is found at which the l.e.d. extinguishes

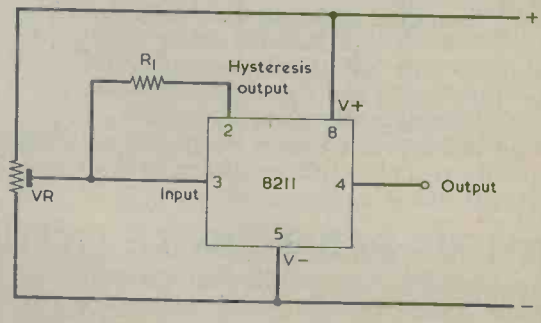
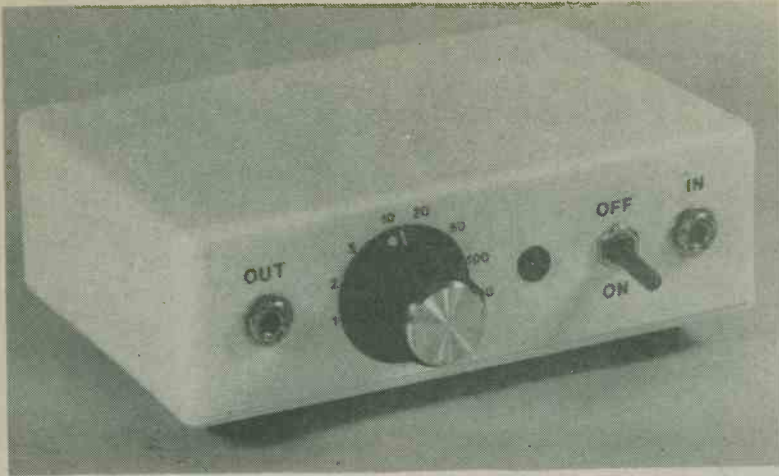

Fig. 2. The 8211 voltage detector is primarily intended for giving warning of low supply voltages; in which application it is connected as shown here



★ ★ ★

The completed millivolt assessor is housed in a small plastic case fitted with four rubber feet

★ ★ ★

When the 8211 input is above the 1.15 volt reference level the voltage on the hysteresis pin is close to that on the positive rail whilst, when the 8211 input is below 1.15 volts the hysteresis output is low and approaches the negative rail voltage. With R1 in circuit VR is adjusted, at the critical supply voltage, so that the input to the 8211 is at 1.15 volts with the hysteresis output high. As soon as the input voltage falls even fractionally below 1.15 volts the hysteresis output starts to go negative, causing the input voltage to go further negative. There is a regenerative action which rapidly results in the input to the 8211 falling well below 1.15 volts, with the hysteresis output fully in the low state. The supply voltage will then have to rise significantly above its minimum acceptable level if the 8211 is to be returned to its previous

state, in which its output is floating and the hysteresis output is high. The supply voltage range over which the hysteresis effect takes place is governed by the values chosen for R1 and the potentiometer.

The advantage of the hysteresis circuit is that it causes the 8211 output to be triggered rapidly to the current sink mode at the threshold voltage level, and it also prevents unstable operation if the supply is just hovering around the minimum voltage level.

CIRCUIT DIAGRAM

The full circuit of the peak millivolt assessor is given in Fig. 3. The amplifier employs the two transistors, TR1 and TR2, in a conventional direct

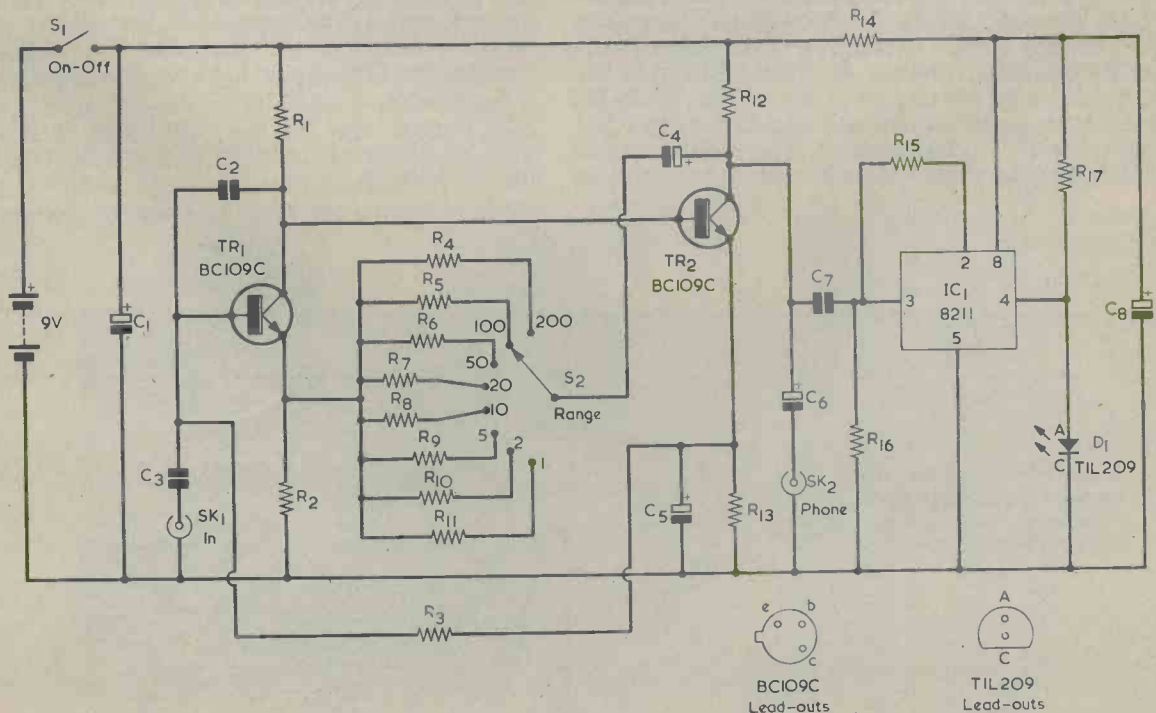

Fig. 3. The full circuit of the peak millivolt assessor. The switched feedback resistors are R4 to R11 inclusive. The numbers at the positions of S2 indicate the corresponding threshold levels in millivolts

COMPONENTS

Resistors

(All $\frac{1}{4}$ watt)

- R1 4.7k Ω 5%
- R2 100 Ω 2%
- R3 1.5M Ω 10%
- R4 470 Ω 2%
- R5 1.1k Ω 2%
- R6 2.2k Ω 2%
- R7 5.6k Ω 2%
- R8 12k Ω 2%
- R9 22k Ω 2%
- R10 56k Ω 2%
- R11 120k Ω 2%
- R12 1k Ω 5%
- R13 1k Ω 5%
- R14 390 Ω 5%
- R15 680 Ω 5%
- R16 100k Ω 5%
- R17 1.2k Ω 5%

Semiconductors

- IC1 8211
- TR1 BC109C
- TR2 BC109C
- D1 TIL209, with panel-mounting bush

Sockets

- SK1 3.5mm. jack socket
- SK2 3.5mm jack socket

Capacitors

- C1 100 μ F electrolytic, 10 V. Wkg.
- C2 39pF ceramic plate
- C3 0.047 μ F type C280
- C4 100 μ F electrolytic, 10 V. Wkg.
- C5 10 μ F electrolytic, 10 V. Wkg.
- C6 2.2 μ F electrolytic, 10 V. Wkg.
- C7 0.22 μ F type C280
- C8 100 μ F electrolytic, 10 V. Wkg.

Switches

- S1 s.p.s.t. subminiature toggle
- S2 1-pole 8-way rotary (see text)

Miscellaneous

- Plastic case (see text)
- Control knob
- Veroboard, 0.1in. matrix
- 9-volt battery type PP3
- Battery connector
- 4 rubber cabinet feet
- 3.5mm. jack plug
- Screened wire
- Test prod
- Crocodile clip
- Nuts, bolts, wire, etc.

coupled arrangement, the overall voltage gain of which is controlled by the amount of negative feedback applied between TR2 collector and TR1 emitter. The eight switched feedback resistors, R4 to R11, give eight levels of voltage gain. This gain is equal to $(R_A + R_B)$ divided by R_A , where R_A is the 100 Ω emitter resistor for TR1 and R_B is the resistor selected by the range switch, S2. With R4 selected, the gain is 5.7 times and it rises to 1,201 times when R11 is switched in. The resistor values are in the E24 series of preferred values and in

most cases they do not cause the input voltages indicated at the switch positions to be amplified to precisely 1.15 volts. However, the voltage gains provided are very close to the exact values required, and it is recommended that all the resistors in the feedback circuit, including the 100 Ω emitter resistor for TR1 should have a tolerance on value of 2% or better. Capacitor C4 provides d.c. blocking and ensures that the d.c. conditions in the circuit are not altered by the selection of different feedback resistors.

Most of the small components are assembled on a Veroboard panel which is bolted to the base of the case

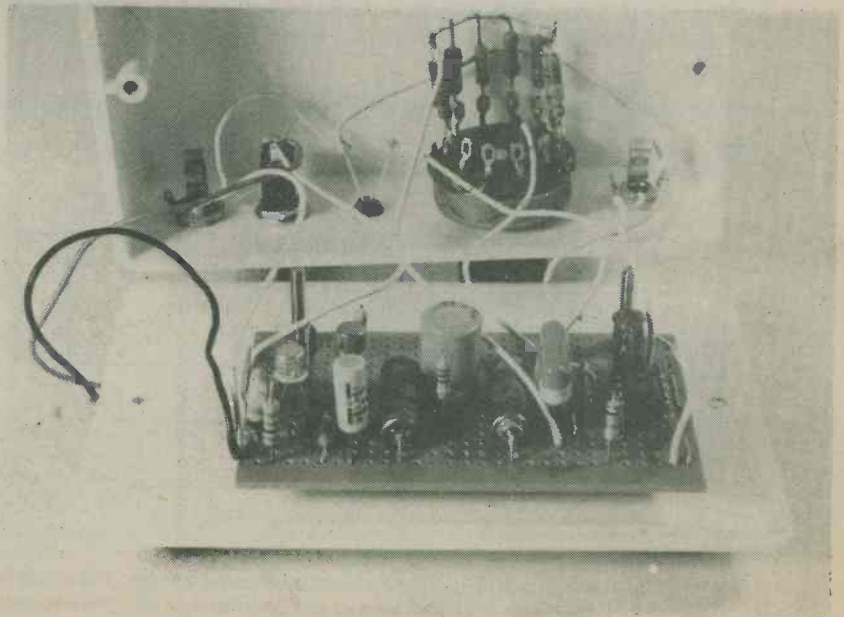

A close-up view of the Veroboard component panel

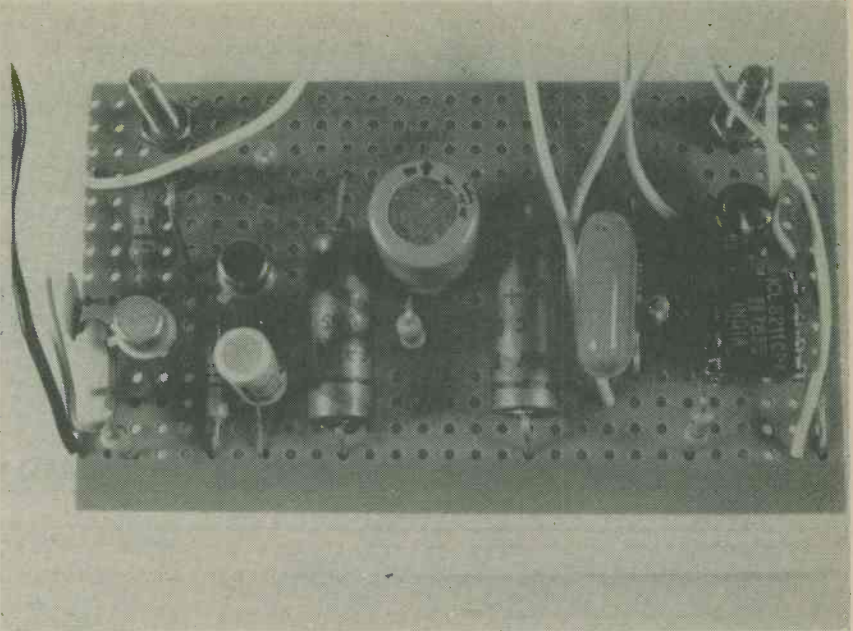

It is desirable for a test instrument of this nature to have a high input impedance so that it places minimal loading on the circuits being checked. The input impedance is actually quite high, varying from about $100k\ \Omega$ on the $1mV$ range to about $1M\ \Omega$ on the $200mV$ range. The output of the amplifier is coupled via C6 to the phone socket SK2, allowing the a.f. signal which is being handled to be monitored. The output at SK2 is suitable for a crystal earphone, a high impedance ($5k\ \Omega$) magnetic earphone or high impedance ($2k\ \Omega + 2k\ \Omega$) magnetic headphones. A low impedance earphone or headphones must not be used as it would load the amplifier output too heavily and would prevent the required voltage gain being achieved.

The output signal is also applied, by way of C7, to the 8211 input at pin 3. This input is biased to the negative supply rail by R16. For input signals below 1.15 volts the 8211 output at pin 4 is low and causes the l.e.d., D1, to be extinguished. When the input signal exceeds 1.15 volts the output becomes

floating and allows D1 to be lit by the current flowing through R17. Without the hysteresis introduced by R16 the l.e.d. would be alight only during the period when the input voltage exceeds the threshold level; with R16 in circuit the l.e.d. is alight for a slightly longer period. This is of advantage, since it increases the brightness of the l.e.d. indication.

Supply decoupling is provided by C1, R14 and C8, with S1 being the on-off switch. The current consumption from the 9 volt battery is approximately 10mA.

Capacitor C6 is specified as having a working voltage of 10 volts, but it will be perfectly satisfactory to employ a component having a much higher working voltage, such as 63 volts. Capacitor C5 may similarly have a higher working voltage than 10 volts if difficulty is experienced in obtaining this component in 10 volts working. Switch S2 is a miniature 1-pole 12-way rotary switch with adjustable end stop set for 8-way working.

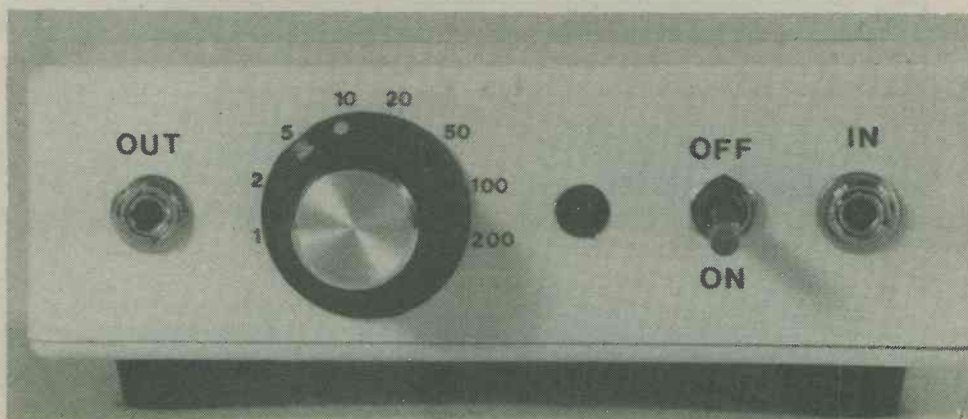

The front panel controls, with letter and number legends taken from "Panel-Signs" Set No. 4

CONSTRUCTION

The project is housed in a white plastic box having nominal dimensions of 114 by 76 by 38mm. This is a case type PB1, obtainable from Maplin Electronics Supplies. The case is also available in black if the constructor prefers this colour. What would normally be the removable back or lid of the case becomes the base panel, and it is fitted with four small rubber cabinet feet. One of the 114 by 38mm. sides of the case is used as the front panel and the front panel components are mounted on this, employing the general layout illustrated in the photographs. Looking at the panel from the front,

SK2 is to the left, with S2 next to it. The l.e.d. is next, followed by S1, with SK1 at the right. SK1 and SK2 are both 3.5mm. jack sockets.

Most of the other components are assembled on a Veroboard panel of .0.1in. matrix having 29 holes by 15 copper strips. This panel has to be cut out from a larger panel by means of a small hacksaw. The two mounting holes, which are clearance size for 6BA or M3, are next drilled out after which the seven breaks in the copper strips are made using a Vero spot face cutter or a small twist drill held in the hand. The components and the two link wires are then soldered in place. The connections required are shown in Fig. 4, which so gives details

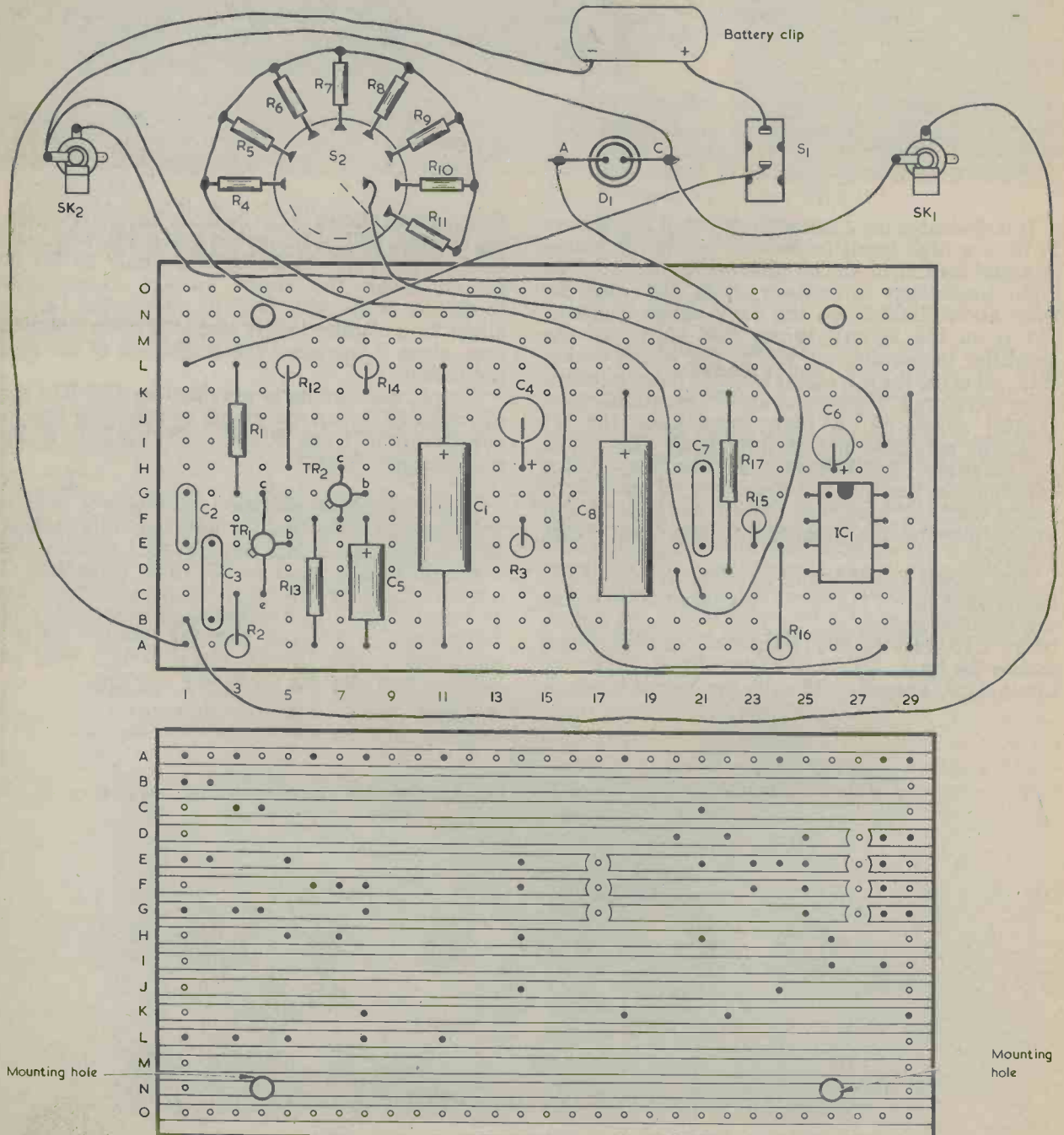

Fig. 4. Component and copper sides of the Veroboard panel. Also shown are the connections to the front panel components

of the wiring to the front panel components. Flexible insulated wires about 4in. long are used between the board and the components on the front panel, and these wires, as well as those to the battery connector, must all be soldered in place before the board is finally mounted.

R4 to R11 are soldered directly to the appropriate tags of S2, and the switch should be mounted so that these tags are near the upper part of the case. This provides greater clearance from the component board. For the same reason, the resistor leads should be kept short. The soldering of the resistors should be carried out quickly, as there is a possibility that excessive heat could cause shifts in resistance values. The board is fitted to the base of the case with the mounting holes towards the front and, again for clearance, should be positioned as near to the rear as possible. The board is secured by two short 6BA or M3 bolts with nuts, spacing washers being passed over the bolts between the underside of the board and the inside surface of the base of the case. Without these washers the board would be strained and could crack when the bolts are tightened up.

There is sufficient space to accommodate the battery to the rear of SK1 and SK2. It will be held quite firmly in place when the base is fitted, and it is not necessary to make a mounting bracket.

USING THE CIRCUIT

The millivolt assessor requires no adjustment or calibration of any kind, and is ready for use as soon as it has been completed. A screened test lead is necessary to reduce stray pick-up. One end is connected to a jack plug which fits into SK1, and the other end is terminated in a test prod with the braiding connected to a short flexible lead ending in a crocodile clip. Normally, the clip is connected to the chassis of the equipment being checked, the test prod being applied to the a.f. check points in the equipment. The equipment must, of course, be given an input signal of some sort so that it may be traced through.

When an a.f. signal is present at any point it will be reproduced in the earphone or headphones plugged into SK2. The amplitude of the signal may be estimated by rotating the spindle of S2 clockwise and noting the highest setting at which the l.e.d. remains alight. The control knob for S2 should be either a pointer type or a round type having a dot or radial line to indicate its position, and

the front panel should be marked with numbers to indicate the millivolt levels corresponding to each switch setting. The author employed numbers cut out from "Panel-Signs" Set No. 4, and these offer a neat and pleasing appearance. The legends at SK2, S1 and SK1 were taken from the same "Panel-Signs" set. ("Panel-Signs" can be obtained from the publishers of this journal.)

The usual signal tracing technique is to start checking at the input of the equipment under test and then proceed through its subsequent stages. If the signal is absent, or has a low amplitude at any point, this indicates a fault in the stage being checked or in the circuitry immediately preceding it. The assessor may also be used to check the functioning of bypass and decoupling capacitors. The test prod is applied to the non-earthly terminal of the capacitor, and no significant signal should be obtained if the capacitor is functional.

R. F. PROBE

A very useful item of ancillary equipment when checking a.m. superhet radio receivers is an r.f. probe, which in many cases will enable the signal to be detected in the i.f. stages and, if there is an adequate signal strength, even in the r.f. and mixer stages as well. The circuit diagram of the r.f. probe used with the prototype is shown in Fig. 5, and is quite conventional in design.

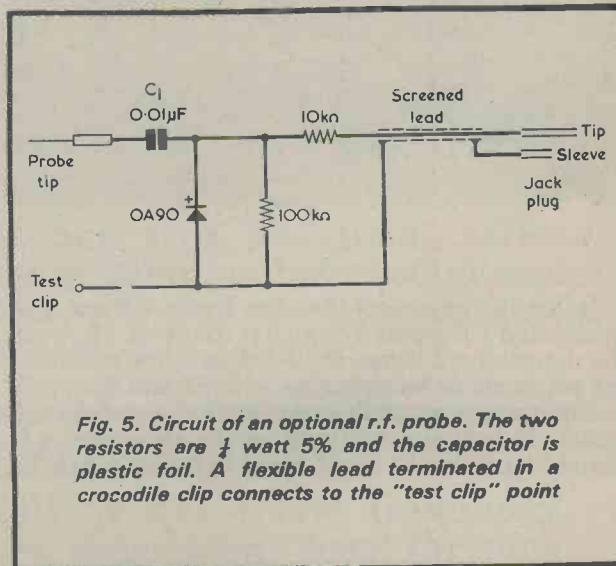
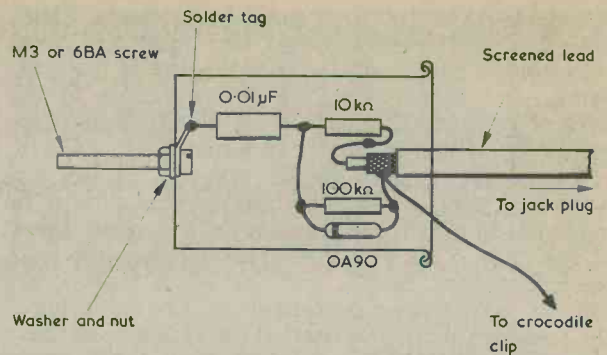

Fig. 5. Circuit of an optional r.f. probe. The two resistors are $\frac{1}{2}$ watt 5% and the capacitor is plastic foil. A flexible lead terminated in a crocodile clip connects to the "test clip" point

The peak millivolt assessor with the optional r.f. probe plugged into the input jack socket



Fig. 6. How the components are wired up in the r.f. probe



The author's r.f. probe was assembled in a 35mm. plastic film can, as illustrated in Fig. 6. The probe is simply a 6BA or M3 bolt about 1½ in. or more long. A flexible lead from the screened lead braiding is terminated in a crocodile clip which is connected to the chassis of the equipment under test.

the superhet oscillator connects, it is possible that some of the r.f. could break through to the assessor and result in misleadingly high millivolt readings. The detected signal, if available at sufficient strength, will still, nevertheless, be audible in the earphone or headphones.

Signal tracing in a t.r.f. receiver using the r.f.

The r.f. probe requires two resistors, a germanium diode and a capacitor. They are fitted in a 35mm. plastic film case

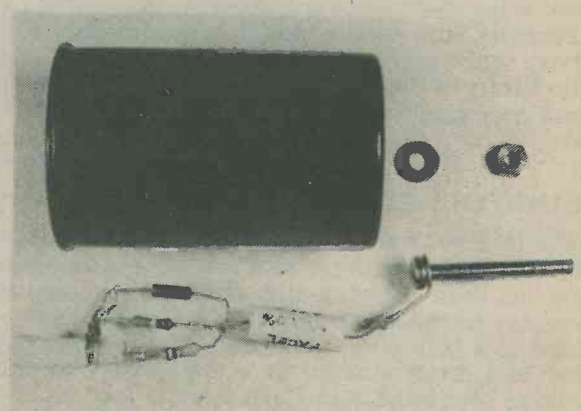

It should be noted that the probe detects the modulated r.f. signal to which it connects, allowing the detected a.f. signal to be heard in the monitoring earphone or headphones, with S2 and the l.e.d. giving indications of the amplitude of the detected signal. If a high amplitude locally generated r.f. signal is present, as could occur at points to which

probe follows similar lines, and there is not then the complication of high amplitude r.f. signals from a local oscillator. High amplitude r.f. signals would, however, be present if the receiver has a regenerative detector which was adjusted beyond the oscillation point or if it was unstable. ■

Mail Order Protection Scheme

The publishers of this magazine have given to the Director General of Fair Trading an undertaking to refund money sent by readers in response to mail order advertisements placed in this magazine by mail order traders who fail to supply goods or refund money and who have become the subject of liquidation or bankruptcy proceedings. These refunds are made voluntarily and are subject to proof that payment was made to the advertiser for goods ordered through an advertisement in this magazine. The arrangement does not apply to any failure to supply goods advertised in a catalogue or direct mail solicitation.

If a mail order trader fails, readers are advised to lodge a claim with the Advertisement Manager of this magazine within 3 months of the appearance of the advertisement.

For the purpose of this scheme mail order advertising is defined as:

"Direct response advertisements, display or postal bargains where cash has to be sent in advance of goods being delivered."

Classified and catalogue mail order advertising are excluded.

RADIO & ELECTRONICS CONSTRUCTOR



DIGITAL TANTALISER

*Match your timing skill
against this ingenious
electronic game*

S.W. AERIAL TUNING UNIT



An aerial tuning unit (or a.t.u.) is one of the simplest accessories for a short wave receiver and yet it can provide quite significant and worth-while improvements in performance.

It has two beneficial effects, these being an increase in signal strength and an attenuation of spurious responses.

CMOS OSCILLATORS

CMOS logic circuits frequently require low frequency oscillators or pulse generators, these being used for such purposes as producing clock pulses or causing light-emitting diodes to attract attention by flashing on and off. It then becomes desirable to use CMOS logic gates themselves in the oscillator circuit.

*Amplifier Clipping Monitor
Suggested Circuit*

*Readers' Hints
In Your Workshop*

IN OUR NEXT ISSUE

SHORT WAVE NEWS

FOR DX LISTENERS



By Frank A. Baldwin

Times = GMT

Frequencies = kHz

CURRENT SCHEDULES

● WEST GERMANY

"Deutsche Welle — the Voice of Germany", Cologne, does not present programmes in English to Europe but they may be logged with English programmes to Central and East Africa from 1715 to 1745 on 9735 and 11965 from the relay station at Kigali, Rwanda and on 15135 and 21600 from Cologne. From 1745 to 1805 to the same area on 15135 and 17730 from Cologne. A broadcast to West Africa in English is made from 1930 to 2000 on 11905, 15150 and on 17795. English programmes to Asia may be heard from 1720 to 1750 on 9590, 11785 and 21620 from Cologne and on 15405 and 17825 from the relay station at Cyclops, Malta.

● EAST GERMANY

"Radio Berlin International — the Voice of the German Democratic Republic", Berlin, radiates programmes in English to Europe as follows: - from 1800 to 1845 on 7260; from 1915 to 2000 on 6080, 6115 and on 7185; from 2045 to 2130 on 7185, 7300 and on 9730.

● TURKEY

"The Voice of Turkey", Ankara, offers a programme in English to South West Asia from 1200 to 1300 on 17775.

● CHINA

The P.L.A. Fujian Front Station operates an External Service, mostly in Standard Chinese directed to Taiwan and other offshore islands. For 'China Chasers', some of the Dx frequencies are listed here — from 1530 to 2230 on 2490; from 1700 to 2144 on 3535; from 1400 to 2314 on 4330; from 1000 to 1659 and from 2145 to 0500 on 5240 and from 1000 to 0500 on 5265.

"Radio Peking" has an External Service in English to Europe from 2030 to 2130 and from 2130 to 2230 on 6860, 7470, 11500 and on 12450.

English programmes during the late afternoon and early evening are transmitted as follows — from 1600 to 1800 to East and South Africa on 6810, 8300, 9860 and on 15315 consisting of a one hour programme repeated; to South Asia from 1800 to 1900 on 12450 and to North and West Africa from 1930 to 2130 on 7620, 9880, 11455, 11695 and on 15095.

● IRAQ

"Radio Baghdad" has an External Service in

which a programme in English is broadcast to Europe from 2130 to 2230 on 9745.

The Domestic Service in Arabic operates on several frequencies during the period 0228 to 2315. Try from 1900 to 2315 on 7170, 7245 and on 11925.

● JORDAN

An English Service from Amman is on the air from 1500 through to 1730 sign-off on 9560. The Domestic Service in Arabic is scheduled from 0330 through to 2330 on several short wave channels. Try from 0930 to 1230 on 9530 or 11920 or from 1900 to 2330 on 7155 or 9530.

AROUND THE DIAL

In which are presented some of the loggings made recently which some readers may find of interest.

● QATAR

Doha on 9570 at 2047, OM in Arabic followed by Koran reading. Identification in Arabic, National Anthem and close at 2105.

● SEYCHELLES

FEBA Mahe on 15325 at 1550, OM with a religious programme in English, identification at 1600.

● GRENADA

Radio Free Grenada (announced) on 15045 at 2155, record requests, announcements in English, identification at 2200.

● ISRAEL

Jerusalem on 11655 at 2004, YL with a newscast in the English programme to Europe, the Middle East, North America and South and West Africa, scheduled on this channel from 2000 to 2030.

● BULGARIA

Sofia on 11720 at 1946, YL with the English programme directed to the UK, scheduled from 1930 to 2000.

● ROMANIA

Bucharest on 11940 at 1950, OM with the English programme for Europe, scheduled from 1930 to 2030.

● ALBANIA

Tirana on 7075 at 1942, YL with a newscast in the English programme for Africa, scheduled from 1930 to 2000. Also logged in parallel on 9500.

RADIO AND ELECTRONICS CONSTRUCTOR

● **WEST GERMANY**

Cologne on 11905 at 1935, OM with a newscast in the English programme for West Africa, scheduled from 1930 to 2000.

● **SOUTH KOREA**

Seoul on 7550 at 2000, OM with identification and a newscast in the English programme for Europe and Africa, scheduled here from 2000 to 2030.

● **GREECE**

Athens on 9530 at 1935, OM with the European Service (in Greek, English, French and German respectively) scheduled from 1900 to 1950.

● **CUBA**

Radio Havana (Moscow Relay) on 17710 at 1813, OM with the Spanish programme to the Middle East and Europe, scheduled from 1800 to 2000.

● **CHINA**

Radio Peking on 11575 at 1805, YL with the Standard Chinese programme for Europe, North Africa and West Asia, scheduled from 1730 to 1830.

Radio Peking on 11515 at 1815, OM with the Persian programme for Iran and Afghanistan, scheduled from 1800 to 1830.

CPBS Peking on a measured 6493 at 2020, Chinese classical music in the Domestic Service 1st Programme, scheduled on this channel from 2000 to 2300.

CPBS Peking on 11610 at 2008, OM with the Domestic Service 1st Programme, scheduled here from 2000 to 0200.

● **U.S.S.R.**

Radio Moscow on 11715 at 1850, YL with the Turkish programme for Turkey (where else!), scheduled from 1830 to 1900.

Radio Moscow on 11780 at 1846, OM with announcements in Russian in the 5th Programme — a relay of the Moscow 2nd Programme 'Mayak', scheduled here from 1830 to 1900. Also logged in parallel in 11790.

Radio Moscow on 11850 at 1856, musical items in the French programme for Europe, scheduled from 1830 to 1900, also logged in parallel on 11880, 11890 and on 12020.

Radio Moscow on 11745 at 1850, OM with the Hausa programme to Africa, scheduled from 1830 to 1900.

● **COLOMBIA**

La Voz del Norte, Cucuta, on 4875 at 0431, OM with pop love song after identification and announcements. The schedule is from 1000 to 0500 and the power is 5kW.

● **ECUADOR**

Radio Zaracay, Santo Domingo, on 3390 at 0230, OM with station identification, announcements, local-style dance music. The schedule is from 1000 to 0500 (closing time is variable) and the power is 10kW.

Radio Iris, Esmeraldas, on a measured 3381.5 at 0225, OM with frequent announcements in Spanish, some news items of local interest with mentioned place-names, short musical interludes — a real mixed bag! The schedule is from 1100 to 0300 (closing time is variable) and the power is 10kW.

Radio Quito on 4920 at 0236, OM with a sports commentary in Spanish, local place-names being quoted. The schedule is from 1030 to 0500 and the power is 10kW.

● **BRAZIL**

Radio Nacional, Boa Vista, on 4835 at 0234, YL with a love song in Portuguese. The schedule is from 0900 to 0400 and the power is 10kW.

Radio Borborema, Campina Grande, on 5025 at 0245, OM with identification followed by a discussion in Portuguese. The schedule is from 0830 to 0500 (variable closing) and the power is 1kW. The frequency of this one can vary to 5023 and it sometimes identifies as "A Princesa do Sul".

Radio Rural de Santarem on 4765 at 2248, OM with a very excitable commentary on a 'futebol' match. The schedule is from 0800 to 0400 and the power is 10kW.

Radio Sociedad, Fiera de Santana, on 4865 at 2250, local-style dance music, OM announcer in Portuguese, identification at 2300.

Radio Aparecida on 5035 at 2325, OM and YL with pop songs, announcements, commercials, identification at 2330.

● **VENEZUELA**

Radio Barquisimeto, on 4990 at 0243, OM with a talk about economics in Spanish. The schedule is from 1000 to 0400 and the power is 15kW.

Radio Bolivar, Ciudad Bolivar, on 4770 at 0256, OM announcer, local pops on records, identification at 0300. The schedule is from 1000 to 0300 and the power is 1kW. This one identifies frequently during programmes.

Radio Universo, Barquisimeto, on 4880 at 2320, OM announcer, light music — palm court style! The schedule is from 1000 to 0400 and the power is 10kW.

Radio Juventud, Barquisimeto, on 4900 at 2350, OM announcer, local-style pops on records. The schedule is from 1000 to 0400 and the power is 10kW. One of the easiest of the Venezuelans.

● **SWAZILAND**

TWR Mpangela on 5055 at 0250, light orchestral music, identification in English at 0252. The published schedule is from 0430 to 0615 and from 1900 to 2030. The power is 30kW. Either an extended schedule or, more likely, testing.



SINGLE-CHIP

M.W. RADIO

By R. A. Penfold

**LM389 i.c. gives r.f. gain, a.f. gain
and power output.**

Ultra-simple medium wave t.r.f. design.

This radio is easy to construct and uses readily available components. It covers the medium wave band and provides an output power of some 100 to 200mW to its internal loudspeaker. For the sake of simplicity a t.r.f. (tuned radio frequency) circuit has been used instead of the more complicated superhet design, with the result that the set is very inexpensive. The results cannot be as good as are given with a superhet, but the receiver still has quite good sensitivity and selectivity. Radios 1, 2 and 3, as well as Radio Luxembourg and a few other stations, are all received quite well at the author's home in South-East England. A further advantage of employing a t.r.f. circuit, and one which will particularly commend itself to the newcomer, is that no complicated alignment procedure is required. All that are needed after construction has been completed are one or two very simple adjustments.

THE LM389 I.C.

The main design feature which gives the receiver its special attributes is the use of a simple integrated circuit to provide both r.f. and a.f. amplification as well as the output power to drive the loudspeaker. There are several i.c.'s available these days which could be used for the receiver application, and the author has chosen the LM389 since it offers a good performance at low costs. What is of particular interest in this i.c. is that it not only incorporates a power amplifier but also has three separate high performance n.p.n. transistors which are brought out to their own individual base, emitter and collector pins. The LM389 has the pin-out arrangement shown in Fig. 1, and it will be seen that the provision of pins for the three separate transistors results in its having the rather large number of 18 pins.

The main part of the i.c. is a Class B audio amplifier with an output power capability of up to 325mW r.m.s. into an 8Ω speaker, or progressively less into higher speaker impedances. The total harmonic distortion is typically only about 0.1% at most output power levels. The amplifier has an inverting input at pin 5 and a non-inverting input at pin 16, and these can either be ground referenced or left floating. An internal negative feedback loop causes the gain of the amplifier to be pre-set at approximately 26dB, although an external capacitor and resistor can be added between pin 4 and the negative supply rail to increase the voltage gain if this is desired. Pin 3 may be coupled to the negative rail via a bypass capacitor if it is required that hum and ripple on the supply to the early stages of the amplifier be reduced. Such a capacitor is not required if the i.c. is supplied by a battery instead of a mains power supply.

The three separate transistors in the i.c. are brought out to pins 6 to 11 inclusive and to pins 13, 14 and 15, as indicated in Fig. 1. These are n.p.n. devices with typical current gains of 275 at collector currents of 1mA, and they can be employed in r.f. circuits as well as in a.f. circuits since they provide useful gain at frequencies extending into the v.h.f. spectrum. In the receiver described here, one of the transistors is employed as a regenerative r.f. amplifier and another as a high gain audio pre-amplifier. The third transistor is not needed, and no connections are made to its pins.

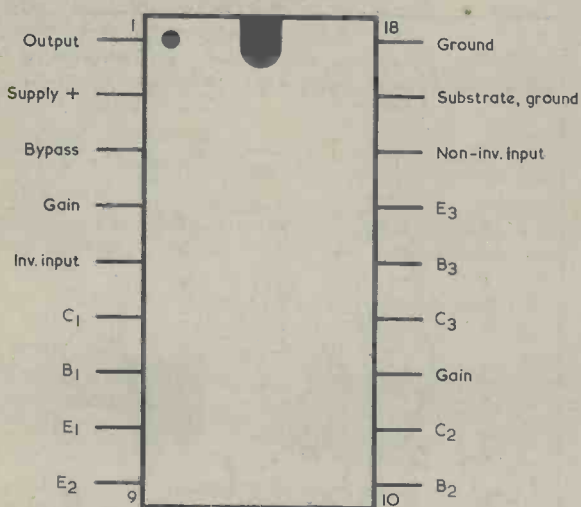

LM389
Top view

Fig. 1. Pin connections for the LM389. The "ground" pins connect to the negative supply rail. In addition to a power amplifier the i.c. has three separate n.p.n. transistors

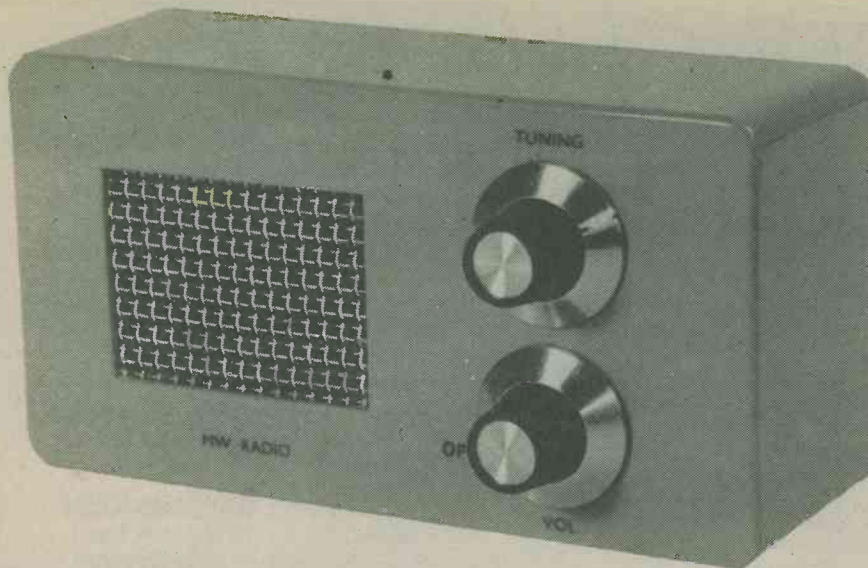

The single-chip receiver employs only one integrated circuit but it offers loudspeaker reproduction of stations in the medium wave band

RECEIVER CIRCUIT

The full circuit of the single-chip receiver is shown in Fig. 2. In this diagram, TR1 and TR2 are shown as separate transistors but they are, in fact, part of IC1. The numbers alongside their symbols are those of the corresponding i.c. pins.

TR1 is in the r.f. amplifier section and is connected in the common emitter mode with R1 providing base bias and R2 functioning as its collector load. L1 is the tuned winding of the ferrite aerial and has the tuning capacitor VC1 connected across it. The low impedance winding, L2, couples the received signals into the base of TR1 via d.c. blocking capacitor C1.

Positive feedback, or regeneration, is provided between the collector and base of TR1 by way of capacitor CX. The result, when CX has the requisite value, is an increase in gain and selectivity. CX needs to have an extremely low value and is not, in practice, an actual capacitor. It consists, instead, of two insulated wires positioned near each other, and its value is altered by the simple process of moving one or both of the wires. For positive feedback it is necessary for the collector of TR1 to be in phase with the upper end of L1, to which CX

connects. Since TR1 collector is out of phase with its base, a second phase inversion is provided by connecting L2 in the manner shown in the diagram.

The collector of TR1 couples via C2 to the diode D1. Despite the apparent lack of a d.c. return to its anode this diode functions in practice as an a.m. detector, with R3 as its load and C4 as an r.f. bypass capacitor. The detected audio signal is fed via C5 to the base of TR2, which has R4 as its base bias current feed resistor and R6 as its collector load. TR2 raises the a.f. signal level to a few hundred millivolts r.m.s., which is more than adequate to feed the main amplifier and output section of the LM389.

The signal at TR2 collector is passed via C6 to volume control VR1, the slider of which couples to the main amplifier inverting input by way of R7. This resistor and C7 form a low pass filter, and they prevent any remanent r.f. breaking through into the main amplifier of the i.c. where it could cause a high level of overall instability. The non-inverting input of the main amplifier is connected directly to the negative supply rail to ensure that it does not receive any stray pick-up of signal.

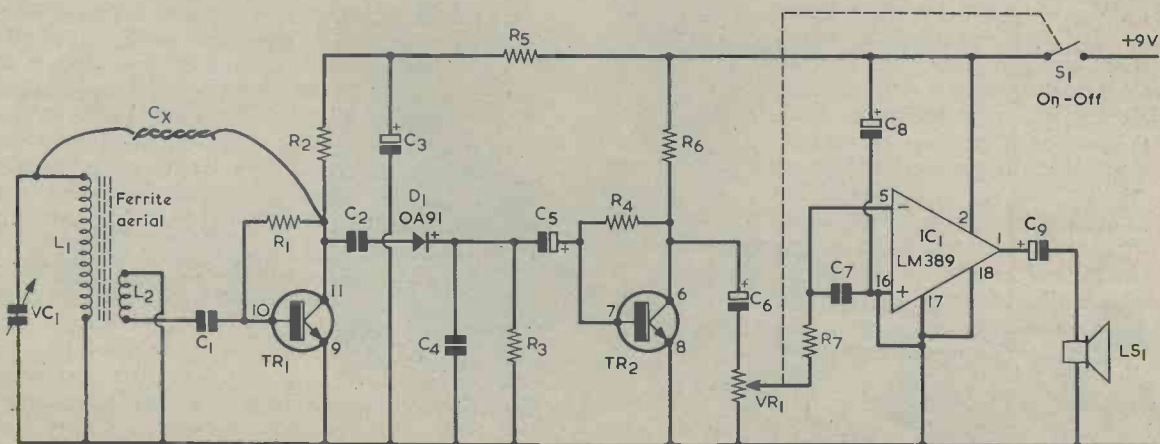
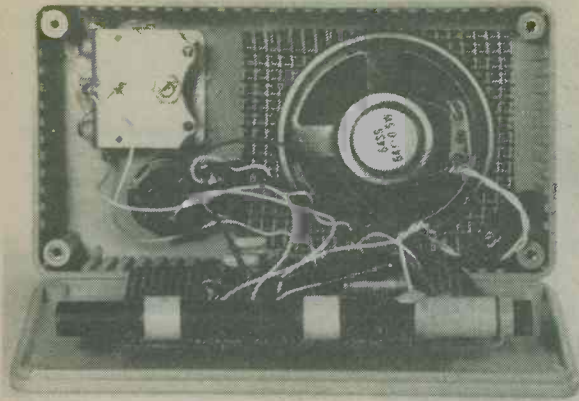

Fig. 2. The circuit of the single-chip medium wave receiver. The two transistors are part of IC1, but are shown separately to enable the circuit to be followed more easily. The "capacitor" CX consists of two insulated leads positioned close to each other



The component board and ferrite aerial are secured to the plastic case lid, which now effectively becomes the rear panel

The output of the LM389 main amplifier drives the speaker by way of d.c. blocking capacitor C9. The speaker is a miniature type and can have any impedance between 40Ω and 80Ω . The output power with a 40Ω speaker is a little less than 200mW r.m.s., and is just under 100mW with an 80Ω speaker. The use of speakers having an impedance lower than 40Ω is not recommended with this circuit. The author employed a 64Ω miniature speaker.

On-off switching is provided by S1, which is ganged with volume control VR1. Although the circuit has very high gain, more than adequate supply decoupling is provided by C3, R5 and C8. The quiescent current consumption from the PP3 9 volt battery is only about 8mA , but this increases to some 30mA at high volume levels.

COMPONENTS

Resistors

(All fixed values $\frac{1}{2}$ watt 5% unless otherwise stated)

- R1 $1.2\text{M}\Omega 10\%$
- R2 $3.9\text{k}\Omega$
- R3 $100\text{k}\Omega$
- R4 $1.8\text{M}\Omega 10\%$
- R5 390Ω
- R6 $4.7\text{k}\Omega$
- R7 $6.8\text{k}\Omega$

VR1 $5\text{k}\Omega$ potentiometer, log, with switch S1

Capacitors

- C1 $0.047\mu\text{F}$ type C280
- C2 $0.047\mu\text{F}$ type C280
- C3 $100\mu\text{F}$ electrolytic, 10V. Wkg.
- C4 $0.01\mu\text{F}$ type C280
- C5 $1\mu\text{F}$ electrolytic, 10 V. Wkg. (see Text)
- C6 $1\mu\text{F}$ electrolytic, 10 V. Wkg. (see text)
- C7 $6,800\text{pF}$ ceramic plate or polystyrene
- C8 $220\mu\text{F}$ electrolytic, 10 V. Wkg.
- C9 $220\mu\text{F}$ electrolytic, 10 V. Wkg.
- VC1 208pF variable, Jackson type "O" (see text)

Inductors

L1/1.2 medium wave ferrite aerial type MW5FR (Denco)

Semiconductors

- D1 OA91
- IC1 LM389

Speaker

LS1 miniature speaker, 40Ω to 80Ω

Miscellaneous

- Plastic case (see text)
- Plain s.r.b.p. perforated board, 0.1in. matrix, $3.75 \times 2.5\text{in.}$
- 9-volt battery PP3
- Battery connector
- 2 control knobs
- 2 cable clips (see text)
- Speaker fabric
- Wire, nuts, bolts, etc.

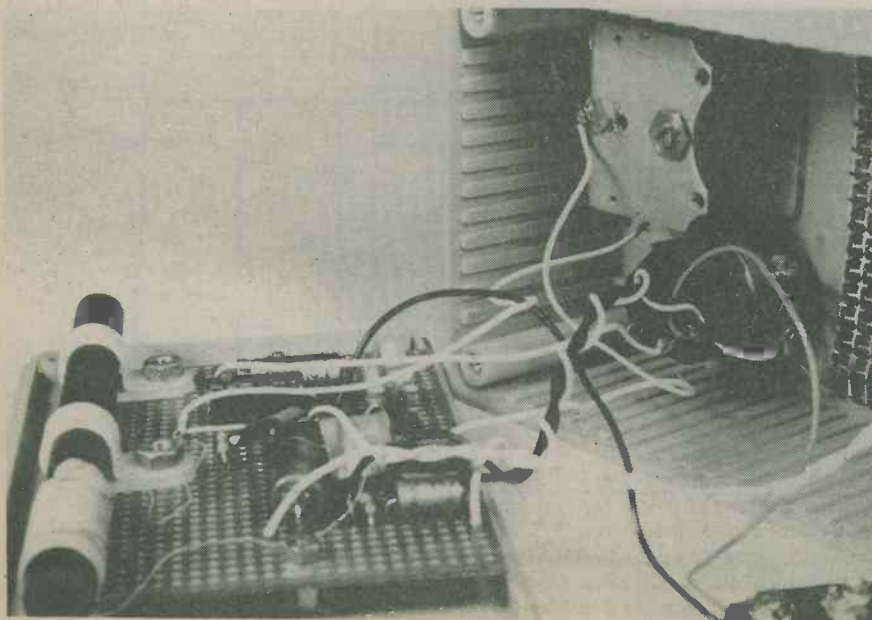

Short flexible leads connect the board to the front panel components

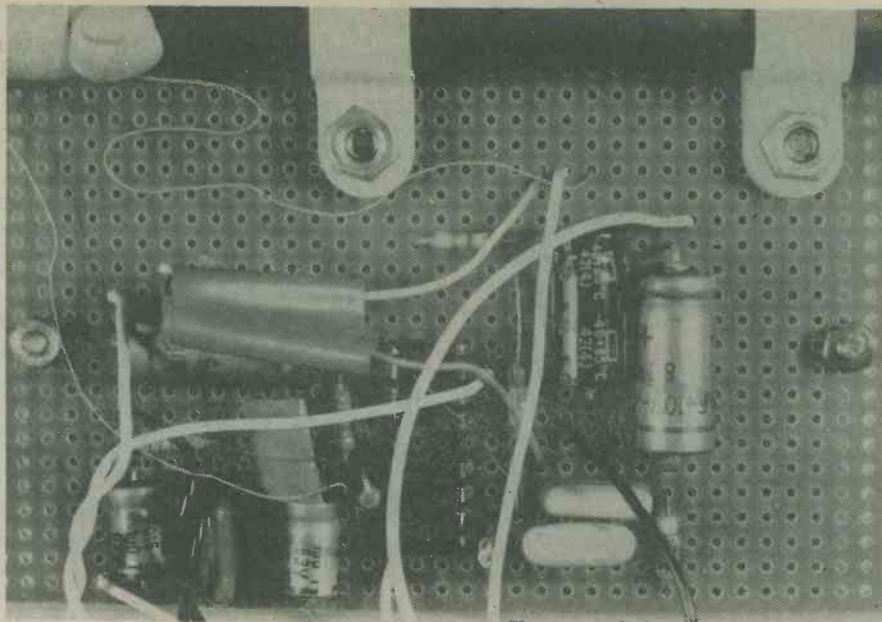

Close-up showing how the "capacitor" CX appears in the prototype receiver. The two insulated wires are maintained at the required spacing by the insulating tape which covers their ends

COMPONENTS

Capacitors C5 and C6 are specified in the Components List as being $1\mu\text{F}$ electrolytic with a working voltage of 10 volts. It will almost certainly be found that $1\mu\text{F}$ electrolytic capacitors with a working voltage as low as this are difficult to obtain, and it is perfectly in order to use capacitors having a much higher working voltage, such as 63 volts.

VC1 is listed as a Jackson Type "O" single gang 208pF component and this can be obtained from a few suppliers. However, a much more readily available component is a Jackson Type "OO" 2-gang capacitor having a 208pF front section and a 176pF rear section, and this may be employed with connection made to the fixed vanes of the front section only. Such a capacitor is employed in the author's receiver. The 2-gang component is normally supplied with integral trimmers. Should this be the case the trimmer for the 208pF front section may simply be fully unscrewed to provide minimum capacitance, and then ignored.

The ferrite rod aerial is a Denco type MW5FR, and this can be obtained direct from the manufacturer, Denco (Clacton) Ltd., 357 Old Road, Clacton-on-Sea, Essex, CO15 3RH. The ferrite aerial is secured to the component board by two plastic clips. These are $\frac{3}{8}$ in. "P" type cable clips (9.5 to 12mm.) and are available from Maplin Electronic Supplies.

The case for the receiver should be a plastic type, without metal front or rear panels, which is large enough to take the component board and the other parts. A case having approximate dimensions of 150 by 80 by 50mm with a lid secured by screws at the corners is ideal, but any other plastic case of around this size or slightly larger may also be used.

CONSTRUCTION

Radio receivers, and particularly t.r.f. types, can be rather critical with regard to component layout, and it is strongly recommended that the receiver be built in the same general manner and with the same layout as the prototype. The accompanying photographs of the receiver clearly show the manner in which the author's receiver is assembled.

What would otherwise be considered the base of the case forms the front panel of the receiver, and the speaker is mounted to the left of this panel as seen from the front. It requires a rectangular cut-out which can be made with a fretsaw or a miniature round file. A piece of speaker "fret" or cloth is glued in place behind the panel, and the speaker is then, in turn, glued to this. A good quality adhesive such as Bostik 1 or an epoxy type, should be used. Care must be taken to ensure that none of the adhesive gets on to the moving diaphragm of the speaker.

The tuning capacitor is situated towards the top of the front panel on the right hand side, with sufficient space below it to allow VR1/S1 to be mounted. The capacitor has three 4BA tapped holes in its front plate through which 4BA bolts may be passed for mounting purposes. The positions of these holes relative to the central hole for the spindle can be marked out on the front panel in the following manner. Cut out a $\frac{1}{4}$ in. diameter hole in a piece of paper and then pass the paper over the spindle of the capacitor. Mark out the positions of the three tapped holes on the paper with a pencil, and then use the piece of paper as a form of template to mark out the corresponding 4BA clear

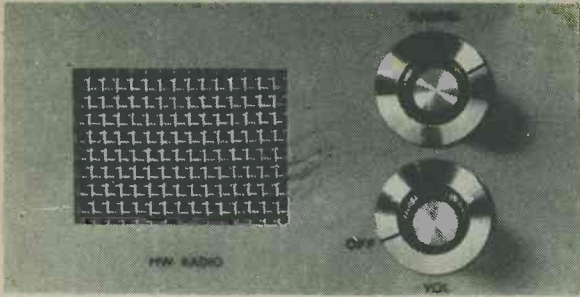

Front panel layout is very simple. To the left is the speaker aperture. On the right, the tuning capacitor is above the combined volume control and on-off switch

holes on the receiver front panel. Drill out these holes and also, of course, a central hole slightly larger than $\frac{1}{4}$ in. for the capacitor spindle. The 4BA mounting bolts must be short in length because their ends must not pass more than fractionally inside the front plate of the capacitor as they would then damage the capacitor fixed or moving vanes. Also, spacing washers, which could in practice be 2BA nuts, should be passed over the mounting bolts between the rear of the case front panel and the front plate of the capacitor. The mounting procedure in the plastic case is somewhat fiddling and a much easier approach, which is admittedly not so mechanically "respectable", is to simply make a hole slightly in excess of $\frac{1}{4}$ in. in diameter through which the spindle and bush surround can pass. The front plate of the capacitor can then be glued to the inside surface of the front panel using a good quality adhesive.

VR1/S1 is mounted below VC1, and merely requires a standard hole of $\frac{1}{8}$ in. diameter.

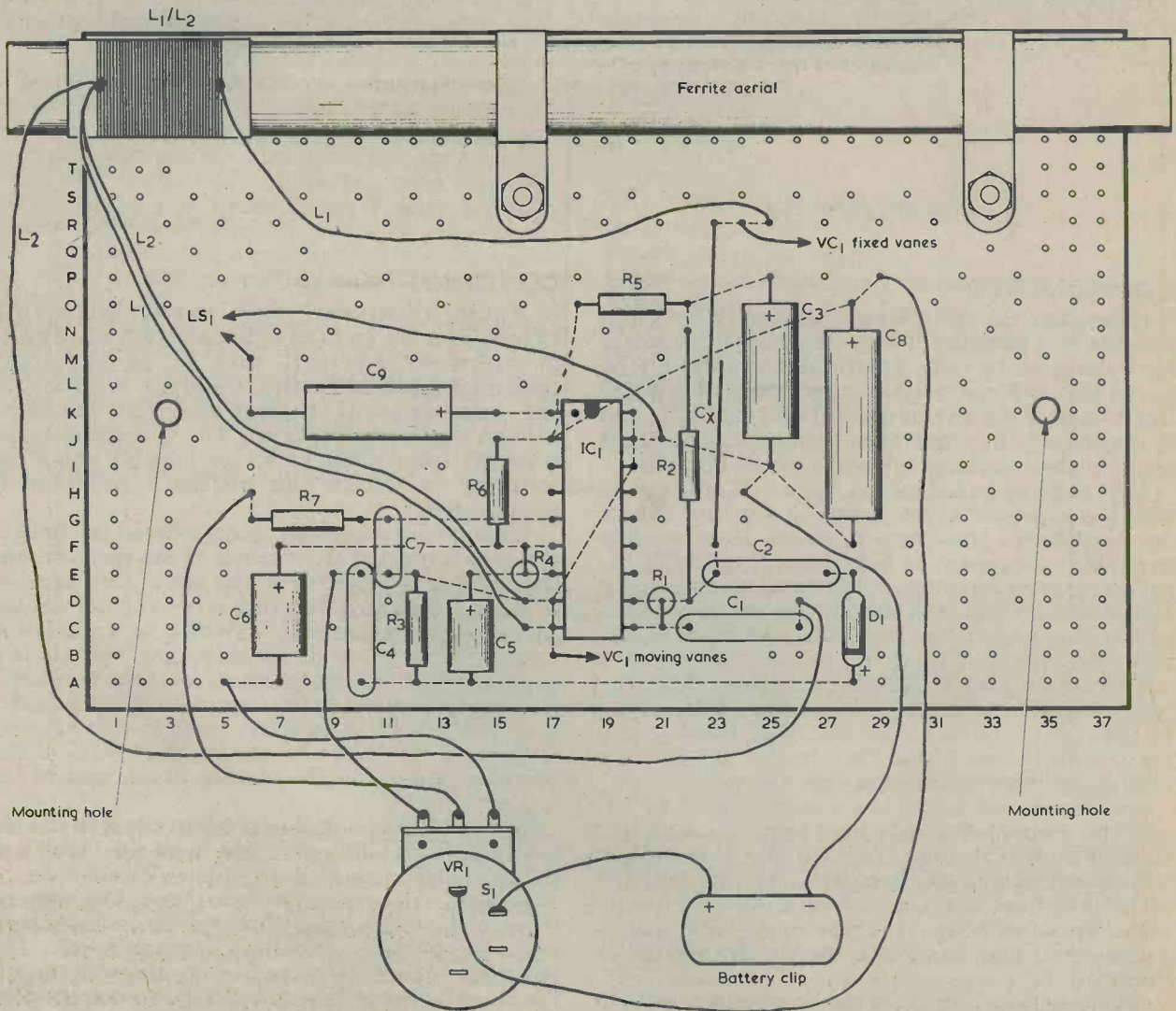

Fig. 3. Apart from the battery and the components on the front panel of the case, all the parts are assembled on a perforated s.r.b.p. board of 0.1 in. matrix. Interconnections below the board are shown in broken line.

CIRCUIT BOARD

The remaining small components are assembled on a plain (i.e. without copper strips) perforated board of 0.1in. matrix which measures 3.75 by 2.5in. This is a standard size in which the board is readily available, and there is no need to cut it down from a larger size. Details of the component layout and wiring are given in Fig. 3.

The two mounting holes are first drilled out, and these can be clearance size for 6BA or M3 screws. The two holes for the ferrite aerial mounting clips are drilled next. These are drilled to take 2BA or M4 screws, which should be about $\frac{1}{4}$ in. long.

The integrated circuit, IC1, is next fitted to the board, its pins being bent out flat against the underside of the board so that it is held in place. The other components are then mounted one by one, their lead-outs being bent at right angles under the board, cut to length and soldered together as shown in Fig. 3, in which the wiring under the board is depicted in broken line. Where lead-out wires are too short, as may occur for instance with the connection between capacitor C5 and diode D1, tinned copper wire of around 22s.w.g. can be employed as extension wire. It is important to ensure that L2 is connected with the correct phasing, and Fig. 4 shows in detail the connections required here.

CX later, the lead from L1 to hole R25 in the board should be kept clear of the wiring around TR1 collector (pin 11 of IC1), as also should the lead from hole R24 to the fixed vanes tag of VC1. CX consists of two single core p.v.c. insulated wires fitted at holes R23 and F23. These should have a length which enables them to overlap each other for about $\frac{1}{2}$ in.

The battery fits into the space beneath the speaker and should be held in place when the rear panel of the case is fitted.

ADJUSTMENT

The set will probably give reasonable results without the two wires which form CX being included. However, the regeneration provided by CX gives substantial improvements in selectivity and sensitivity. As the two wires are brought closer to each other the regeneration is increased until a point is reached at which the r.f. stage breaks into oscillation, causing heterodyne whistles to be given with some or all of the stations which are tuned in. The final setting for CX is that at which regeneration is just below the oscillating condition. This can occur with the wires spaced by quite some distance, and they can be held at that spacing by passing a piece of insulating tape around them.

The frequency coverage of the receiver is

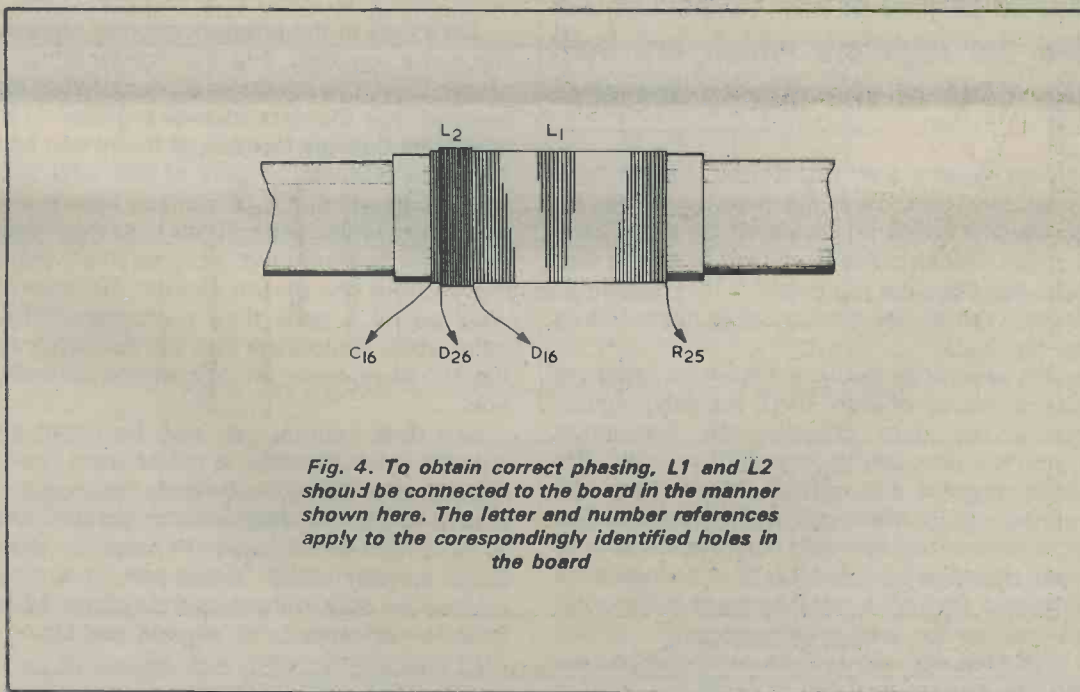

Fig. 4. To obtain correct phasing, L1 and L2 should be connected to the board in the manner shown here. The letter and number references apply to the correspondingly identified holes in the board

The completed component panel is secured to the rear panel of the case by means of two 6BA or M3 screws about $\frac{1}{4}$ in. long, with appropriate nuts. The ferrite aerial should be towards the top when the rear panel is fitted to the case. Spacing washers about $\frac{1}{4}$ in. long should be fitted over the screws between the component board and the rear panel to prevent physical strain on the board when the bolts and nuts are tightened up. Before it is finally mounted in position, the component board must be wired up to VR1/S1, VC1 and the loudspeaker, using flexible p.v.c. insulated wires about 4in. long. The battery clip should also be wired to the board at this stage. To avoid difficulties when setting up

affected by the positioning of the coil on the ferrite rod, and full coverage of the medium wave band may not be given if the coil is well away from its correct position. A lack of coverage at the high frequency end of the band (VC1 vanes unmeshed) can be rectified by moving the coil closer to the end of the rod. Similarly, a lack of coverage at the low frequency end of the board may be corrected by moving the coil further to the centre of the rod. When the coil, has been positioned correctly it may be held in place with a piece of insulating tape. Final adjustments in CX should not be carried out until the correct frequency coverage has been obtained. ■



really explains microprocessors

**series
No. 4**

By Ian Sinclair

The CPU Registers

This fourth article in our 12-part series explains the registers which are built into the CPU of the microprocessor

Remember what a shift register is? Just in case you've forgotten, it's a row of flip-flops connected so that each flip-flop hands on its stored bit to the next flip-flop when a clock pulse is applied to all the flip-flops. If the flip-flops are not clocked, they act simply as a store, a temporary memory of as many bits as there are flip-flops.

There are several particularly important registers built into the microprocessor CPU, the accumulator (A) register, the data counter, the instruction register, and the program counter (PC) register. The accumulator register stores 8-bit information, one byte, and has, naturally enough, eight flip-flops. The program counter register has 16 flip-flops and stores two bytes of binary bits. The accumulator register is used for data bytes, the program counter and data counter for storing addresses.

PROGRAM COUNTER REGISTER

Let's look at the program counter register first. As the name suggests, this is a register which stores, in binary form, the results of a count. What makes this register (and the data counter register) so important is that its outputs (sixteen of them) can be gated to form the address outputs of the CPU so that the number to which the PC register has counted is the address to which the address lines from the CPU are set. The counter part ensures that the program moves from one part to another, because the count goes up by 1 each time a program instruction is completed. The phrase that the textbooks use is that the PC increments on completion of each instruction.

The data counter can also be gated so that its outputs are connected to the address lines, but not, of course, at the same time as the program counter is connected. The data counter register is not usually incremented, because it's used to store an address number which is not part of a program sequence — data rather than program. As far as the CPU is concerned, all signals are binary signals,

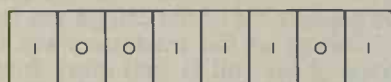

Accumulator, with data stored

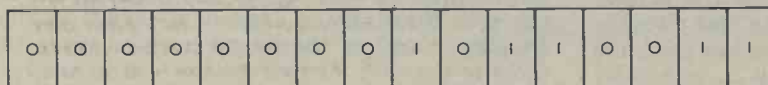

Program counter at step 179 (decimal)

Fig. 1. Representing registers by boxes. The accumulator holds 8 bits, the program counter (PC) holds 16 bits

Fig. 2. The bits held in the program counter can be gated to the address pins so that they form an address number

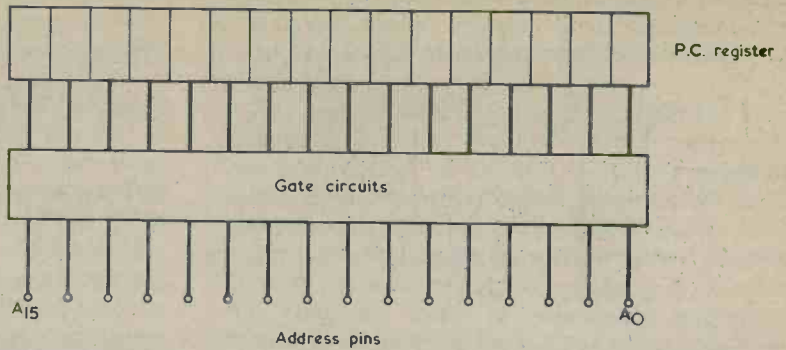

whether they represent program instructions, numbers to be added, or symbols. The separation is achieved by using the program counter to address program bytes, with some exceptions (see later) and the data counter to access data bytes.

You can begin to see a bit more clearly now how a program which is stored in a ROM starts to carry out its work. Imagine the CPU which has been reset so that the PC register like all the other registers, stores zeros in all sixteen bits. Now RESET is an instruction like any other instruction, so at the end of the reset instruction the program counter, which has been reset to zero, counts up (increments) so that 1 is stored. That means that address number 1

to happen to this byte, and they won't be used to clock the PC counter — a gate sees to that. When does the gate open? The answer is that each instruction byte which comes in will take a definite number of clock pulses to carry out, and the form of the instruction byte itself contains a code which allows the CPU to count out the correct number of clock pulses.

The instruction (program) byte is passed from the data pins to an instruction register, which stores the byte until the next instruction comes in. Gates connected to the outputs of this register can detect what instructions have been selected, and arrange

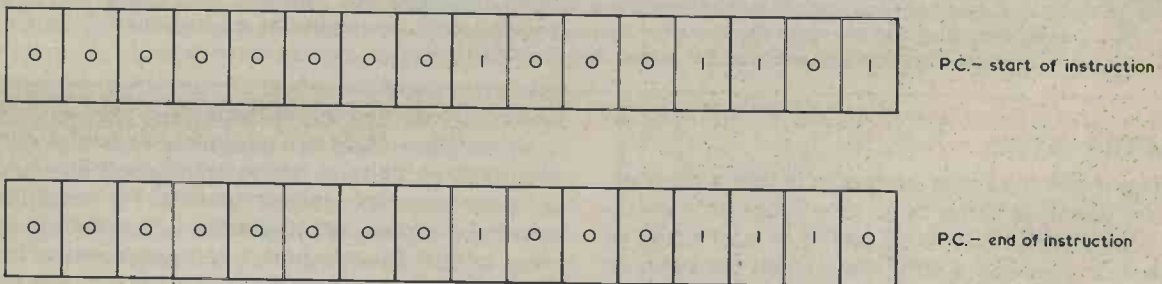

Fig. 3. The program counter increments at the end of an instruction

(decimal) has been selected, and address line A0 has logic 1 on it, with the rest set to zero. See Fig. 4. In a very short time, a matter of nanoseconds later, eight bits of data will connect (from memory) to the data pins of the CPU, carrying the first byte of instructions into the CPU. If there's nothing stored at this address, of course, everything grinds to a halt.

The next few clock pulses will then cause things

for the correct number of clock pulses to be delivered to the right places.

At the end of the instruction, the next clock pulse increments the program counter again, and we get to program step 2 (decimal), a byte ending in 0010 (binary). Once again, this sets address number 2 on the address lines, so that the new data byte coming in from the ROM is the next step of the program.

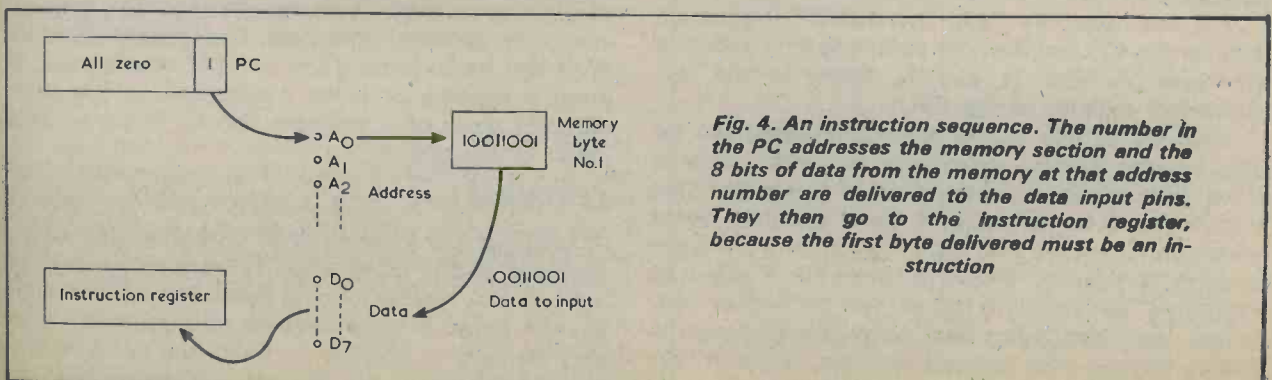

Fig. 4. An instruction sequence. The number in the PC addresses the memory section and the 8 bits of data from the memory at that address number are delivered to the data input pins. They then go to the instruction register, because the first byte delivered must be an instruction

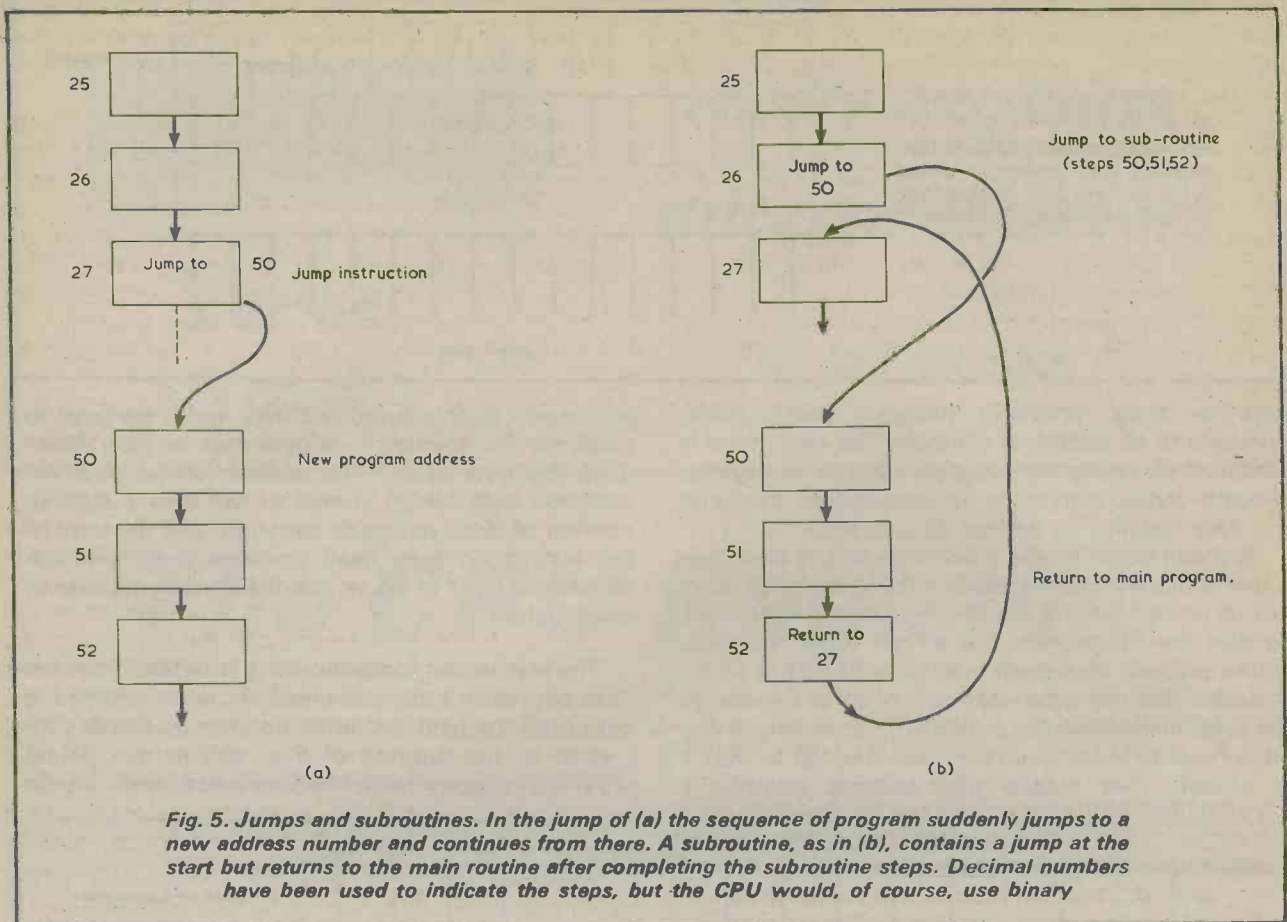

Fig. 5. Jumps and subroutines. In the jump of (a) the sequence of program suddenly jumps to a new address number and continues from there. A subroutine, as in (b), contains a jump at the start but returns to the main routine after completing the subroutine steps. Decimal numbers have been used to indicate the steps, but the CPU would, of course, use binary

NUMBER BYTE

What if the byte that comes in is just a number, not one which is to be used as a program instruction, but one that has to be added or subtracted or whatever? How can a CPU distinguish between an instruction and a number, when they are all 8-bit bytes anyway? The answer is that pure numbers never come into the data inputs unprepared. When a pure number which is to be operated on arrives, the previous byte has been one which sets up a reception committee — one type of such instruction is called "immediate". The "immediate" instruction sets up gates in the CPU which will ensure that the next byte in is treated as a number which will be sent to the accumulator register (see Part 5) to be added, subtracted, multiplied, divided, AND-ed, OR-ed, or whatever the instruction happens to specify.

For example, the "add immediate" instruction sets up the CPU so that the next byte in is added to whatever number is already there in the accumulator register of the CPU.

Now all of this works splendidly when we go step-by-step through a program, but what happens if we want to take something out of sequence? This may happen, for example, if there are data bytes which aren't loaded into the program, or if we want to jump. Readers who have followed the "Tune-in to Programs" series in this Journal will be familiar with jumps and loops, but a brief word of explanation is due to anyone who has not read the "Tune-in" articles.

A program need not progress from one step to the next in line — sometimes another piece of program has to be carried out first. For example, we may have a piece of program in which two numbers have to be added together, but one number has to be obtained by multiplying two other numbers; in algebra this is written as $a+bc$. The normal run of program gets as far as the ADD instruction, then the multiplication can be done in a quite different section of program. In such a simple example, of course, the multiplication could be done as part of the same program, but this is not always convenient when a lot of steps are needed. After the multiplication has been carried out and the result obtained, the main program takes over again — this is an example of a jump-to-subroutine. Another time when a jump out of the normal program routine is needed is when a test is made. A test means comparing the number that is obtained (in the accumulator register) with zero. The program instructions can be to jump if the number equals zero, or jump if positive or jump if negative. In this way, different parts of a program can be followed as a result of the test.

LOOPING

Looping is a jump back to an earlier part of the program and is done when operations have to be repeated. A typical looping operation occurs when several bytes of data have to be transferred from one memory to another — each has to be read in from one memory into the accumulator register and

then read out to the other memory. The instructions are the same for each byte, so that the program consists of a loop of read-then-write, with an increment of the address numbers each time.

Actions like this are carried out by making use of the other registers in the CPU. The total number of registers which can be connected to pins varies considerably from one CPU design to another. The popular SC/MP, for example, has a total of two 8-bit registers and four 16-bit registers; the Z80 has four 16 bit special registers, used for program counting and other program activity, another special-purpose register which is split as two independent 8-bit registers, and eight 16-bit general purpose registers which can also be used as 8-bit units, one of which is the accumulator. There are, in fact, so many registers in a Z80 that no one ever seems to use all of them!

Let's stick for the moment to the program counter and data counter registers. The problem of finding a byte of data which is not part of a program is solved by the use of the data counter. The address number for this place in the memory is loaded into the data counter — we'll see later how this may be done. When the instruction for reading this piece of memory comes in, the instruction byte is transferred from the data input pins to the instruction register. The gates connected to this register then stop incrementing the program counter and switch the address pins to the data counter. The address number which is stored in the data counter now goes out on the address lines, activates the memory, and so causes the byte that is in the memory to be connected to the data lines. By this time, the instructions will have connected the data pins to the accumulator, so that the stored byte is copied into the accumulator. The next step is to disconnect the data pins, and then switch back control of the address lines to the program counter. That's the end of the "memory fetch" instruction, so that the program counter can now increment, setting a new program address, and the data pins can once more be connected to the instruction register for the next instruction byte.

How does the address number get into the data counter register? We'll have to leave details until later, but this isn't an automatic operation like the incrementing of the program counter — the address has to be read into the accumulator, either from memory or from outside the processor (from a keyboard, for example) and then transferred to the data counter. All of this has to be programmed, and this is one of the jobs which must be done by an operating program kept in ROM.

16-BIT ADDRESS

You may have spotted one odd feature in that brief description. An address consists of 16 bits, two bytes, but data comes in single 8-bit bytes — how can we get an address of 16 bits using 8-bit data? The answer is, in two stages, with one byte of data loaded in and then transferred to the lower half of the data counter register. At the next instruction, another byte of data is loaded in, and this time transferred to the higher, half of the data counter

register. This procedure isn't as awkward as it sounds, but doesn't always have to be done because the higher 8-bits of an address often don't need to be changed.

This sort of data fetch is comparatively simple, because it involves switching over address lines from one register to another. A jump instruction is quite a different sort of beast, because the address lines stay connected to the program counter but the program counter shifts from one number to another which is not a simple increment (+1) or decrement (-1). That, by itself, is reasonable enough, the problem is of jumping back if the jump has been for a sub-routine. The exact methods of doing this vary a bit from one CPU to another, but the principle is always the same. When the jump instruction occurs, the number which is stored in the program register is copied, either into another register in the CPU or into a piece of memory called the stack. The stack memory can be inside the CPU, in which case it will be only a small memory, probably 6 to 10 bytes; or it can be a piece of RAM which is addressed by the CPU. Whatever method is used, the copying of the program register preserves the address number which was in the program register, so that the program register can now be changed to the new address number specified by the jump. The new piece of program is carried out, and when the time comes to jump back an instruction at the end of the new piece of program causes the original program

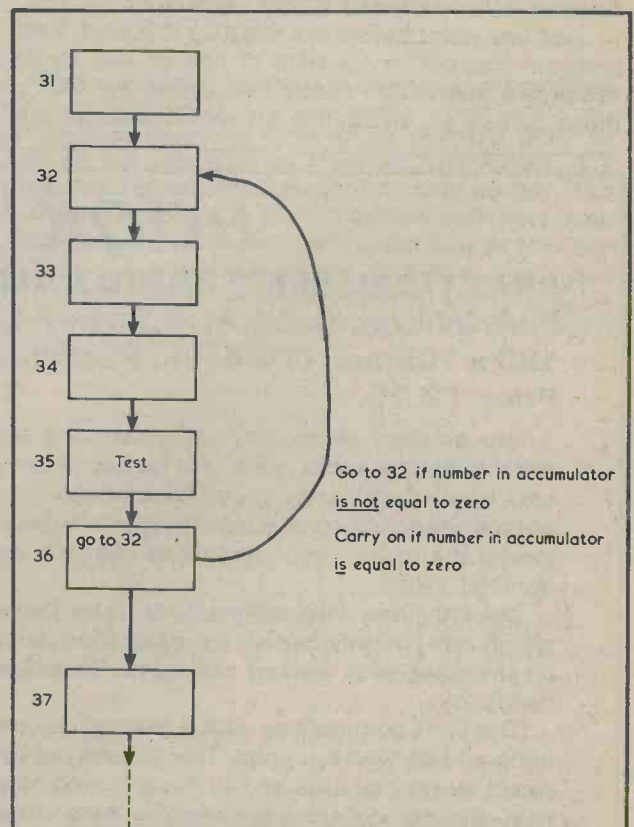

Fig. 6. Looping. The program loops from step 36 back to step 32 (decimal numbers) each time until the number which is in the accumulator at step 35 is equal to zero. The program then continues to step 37

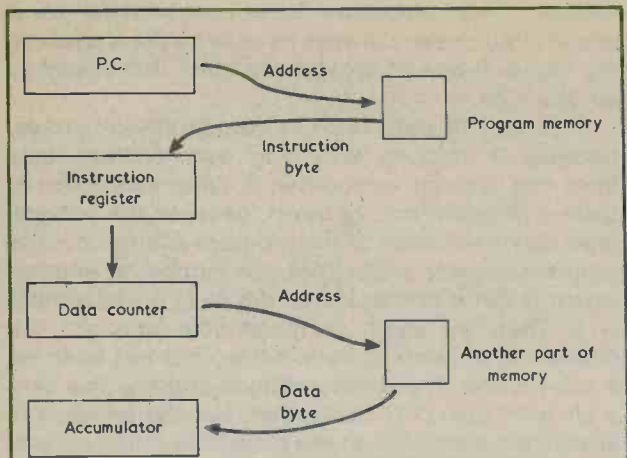

Fig. 7. Finding a data byte in another part of memory. The PC address fetches the instruction byte(s) from program memory. The instruction register then switches the address pins to the data counter, so addressing another part of memory with the number stored in the data counter. The data byte from this part of memory is then guided into the accumulator to be used. Part 5 will deal with this and other ways of reading memory

register address to be returned from wherever it has been stored. This puts the old address back, and at the end of the return instruction the program counter is incremented in the usual way.

Just one point before we wrap up this part. Each program instruction consists of one or two bytes. When the instruction needs two bytes, the first of these carries an instruction bit which ensures that

the second byte is shifted to the correct part of the instruction register. When an instruction byte is followed by a data byte, the instruction byte will contain a bit which ensures that the next byte is transferred to the accumulator register. The byte following a data byte is assumed to be another instruction byte. In this way, each byte that comes in at the data pins prepares the connections for the next one, and it is up to the programmer to see that each byte is correctly placed — that's why a program must be 100% correct.

Next month — how we specify an address for the data register or program counter!

(To be continued)

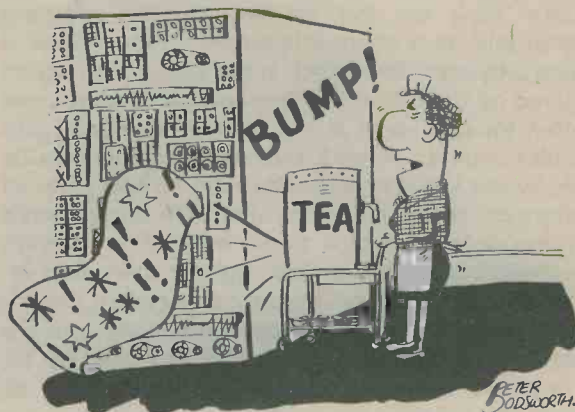

"Hey, watch your language!"

BOOK REVIEW

PRACTICAL ELECTRONIC CALCULATIONS AND FORMULAE. By F. A. Wilson, C.G.I.A., C.Eng., F.I.E.E., F.I.E.R.E., M.B.I.M. 248 pages, 180 x 105mm. (7 x 4½in.) Published by Bernard Babani (Publishing) Ltd. Price £2.25.

Any amateur electronics enthusiast who sets out to design his own equipment will almost inevitably find, at some point, that he has to carry out some calculation, even if this is only at Ohm's Law level. Fortunately, most calculations in electronics are of a relatively simple nature and do not require solutions at a high level of accuracy. Indeed, electronics must be unique in engineering insofar that many circuit quantities can have exceptionally wide tolerances of the order of 10% on nominal value.

Nevertheless, calculations have to be faced and it is of great help if a handbook is available which can not only furnish the basic formulae and equations required but can also give guidance on their use with worked examples. "Practical Electronic Calculations and Formulae" is such a handbook.

The book commences with a chapter on units and constants, part of which deals with basic S.I. units and derived S.I. units. This is followed by chapters dealing with the calculations involved in direct current circuits and in circuits incorporating resistance, capacitance and inductance. The next chapter covers alternating current circuits, and takes in reactance, impedance and the behaviour of resonant circuits. The book then carries on to a chapter on networks and theorems, this including network analysis, waveform analysis, attenuating networks, matching networks and filters. The final chapter in the book discusses measurements.

The book is concisely written and contains a mass of information. In many instances, tables are given to assist in determining quantities for specific circuit requirements.

ENVELOPE SHAPER

By M. V. Hastings

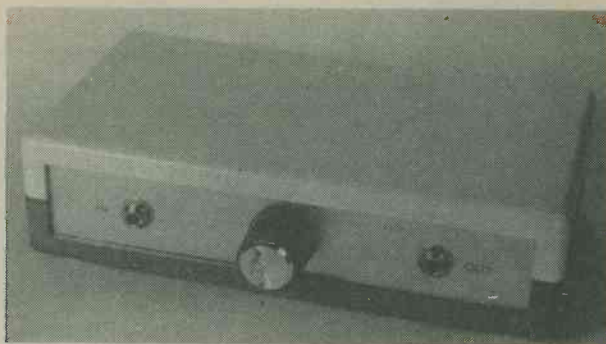

The envelope shaper is housed in a two-tone plastic case with an anodised aluminium front panel

Add further character to the output of last month's "Stylus Organ"

This circuit has been designed as an add-on unit for the "Stylus Organ" which was described in last month's issue. It connects between the tone generator output and the amplifier input in the organ, and it shapes the envelope of the signal produced to give an output amplitude which quickly decays from normal to a lower pre-determined level. Thus, the ordinary constant output level from the tone generator, as in Fig. 1(a), emerges from the envelope shaper with a varying amplitude characteristic, as in Fig. 1(b). The effect is given with every new note selected on the organ.

The result is in the nature of a percussive effect, similar to that of a piano and certain other instruments. However, it must be stressed that the unit is not intended to simulate the sound of a piano, or any other instrument for that matter. The intention is simply to give an interesting effect from the organ and thus increase its usefulness and versatility. To actually simulate the sound of a piano with reasonable accuracy requires quite complex and expensive circuitry, even when using modern devices and techniques.

Fig. 1(a). The output of the stylus organ tone generator is a signal of constant amplitude

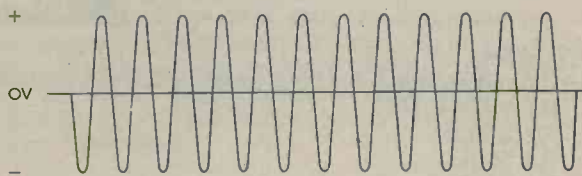

(a)

Fig. 1(b). When passed through the envelope shaper the signal is initially at its full amplitude, after which it falls rapidly to a pre-determined lower level.

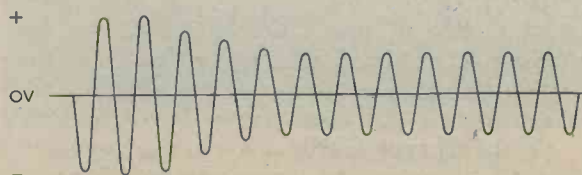

(b)

There is ample space inside the case for the Veroboard module and the 9-volt battery

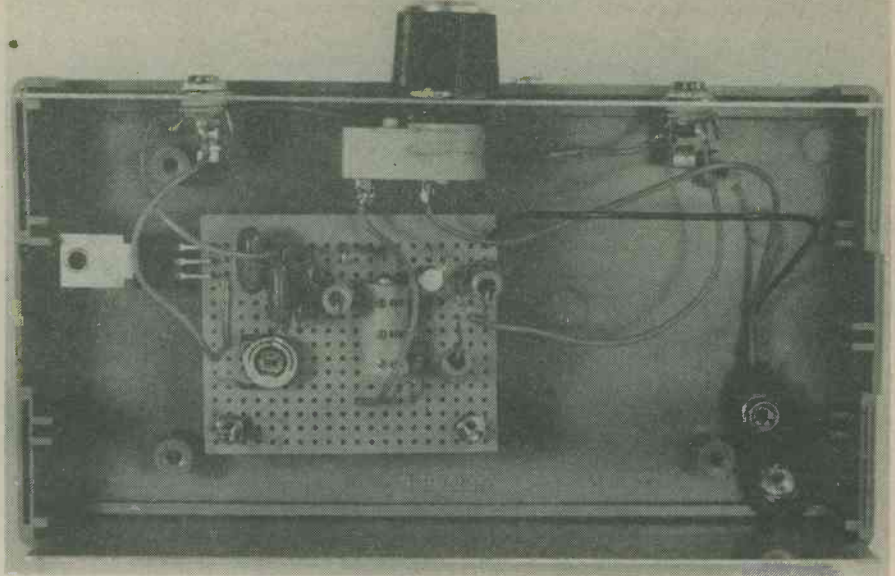

TR2 gate causes this transistor to exhibit a very low drain-to-source resistance of a few ohms only.

If the slider of R5 is set to the bottom of its track the attenuated signal given when TR2 turns on has virtually zero amplitude. This does not give a very musical effect, but it is, of course, possible to adjust R5 so that the amount by which the signal is attenuated can be varied. With R5 slider at the top of its track there is hardly any fading, and it is merely necessary to adjust this potentiometer so that the level of attenuation after TR2 turns on has the most pleasing subjective effect. This will normally be in the region of -20dB .

It is necessary for TR2 to turn off quickly at the end of each note so that the envelope shaper can repeat the fade-out process at the start of the next note from the organ. The requisite gap in organ output is automatically given with a stylus organ since there is inevitably a gap between one note and that following as the stylus is lifted from one key and placed on the next. Although this gap is only very short it is sufficient, in practice, to allow C6 to discharge into R4 to a level that turns off TR2.

The circuit is powered, via on-off switch S1, by a 9 volt battery type PP3. This has an extremely long life as current consumption is only about 1 mA.

The choice of a power f.e.t. as the gain control element may seem unusual, but the fact that it is an enhancement mode device (which is normally in the off state and requires a forward gate bias to turn it on) makes it easier to use than the more common depletion devices. These are normally conductive and are turned off by applying a reverse bias. The VN88AF is available from Maplin Electronic Supplies.

It may be considered at first sight that C2 is connected into circuit with incorrect polarity. The polarity is correct, however, as the output from the stylus organ is obtained from a positive point via an electrolytic capacitor. It follows that C4 similarly has correct polarity, C2, C3 and C4 are very low value electrolytic capacitors and are specified in the Components List as having working voltages of 10 volts. It will almost certainly be found that electrolytic capacitors available in the values listed have working voltages considerably higher than 10

volts, and it is perfectly in order to employ such capacitors in the present circuit.

CONSTRUCTION

With the obvious exceptions of SK1, SK2, S1 and the battery, all the components are assembled on a panel of 0.1 in Veroboard having 15 copper strips by 20 holes. Details are given in Fig. 3.

After cutting out a panel of the correct size the two mounting holes are drilled 6BA or M3 clear. There is just a single break in the strips, which should be made next. The components and the one link wire are then all soldered into position. The unit is housed in a Verobox type 75-1237-J, which has dimensions of 153 by 84 by 39.5 mm. The lead-outs of TR2 need to be bent through 90 degrees before they are passed through the appropriate holes in the Veroboard for soldering. This enables the transistor to lie flat. If it were positioned vertically its height would be too great for the box. TR2 does not, of course, require a heat sink.

The simple and straightforward layout inside the case can be seen from the photograph of the case interior. On the front panel, the rotary on-off switch is mounted in the centre with the input jack socket SK1 to its left and the output jack socket SK2 to its right. The Veroboard module is bolted to the bottom of the case with spacing washers over the mounting bolts to ensure that the board underside is clear of the inside surface of the case. It should not be finally mounted until all the connections to the components external to the board have been completed.

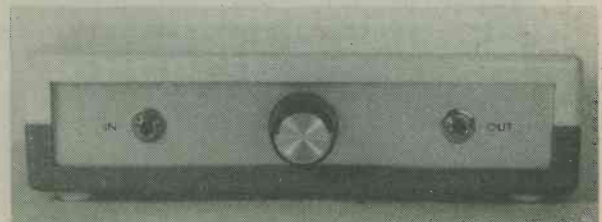

On the left of the front panel is the input socket, with the rotary on-off switch in the centre. The output socket is to the right

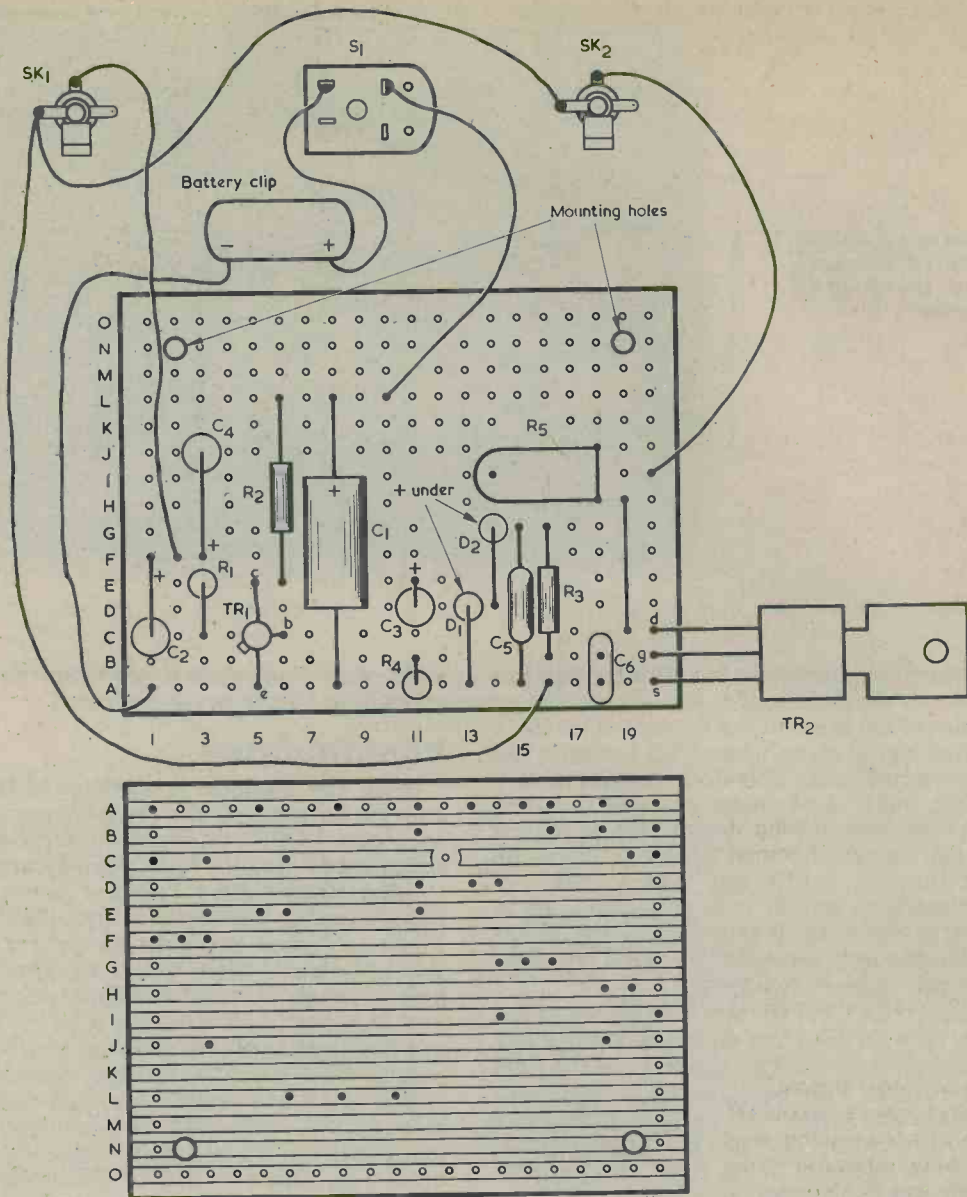
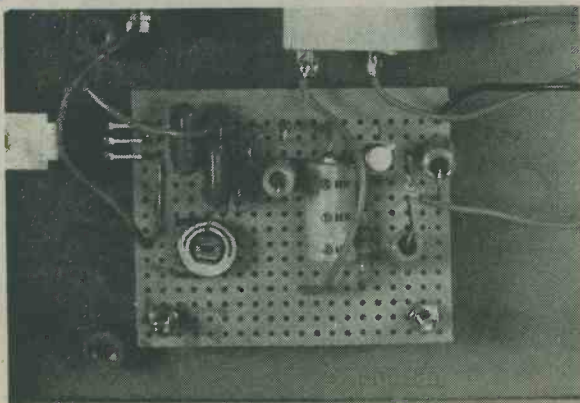

Fig. 3. Wiring up the components in the envelope shaper, including those on the Veroboard panel

ADJUSTMENT AND USE

Two twin leads fitted with 3.5 mm jack plugs at



Close-up of the Veroboard panel

each end are needed to couple the output section of the organ to the input socket of the envelope shaper, and to couple the output of the shaper back to the a.f. amplifier input of the organ. Since low impedance signals at fairly high level are involved, it is not essential to use screened leads. However, it is necessary to ensure that the sleeve and tip connections to the plugs are not accidentally crossed over through the twin leads.

R5 is the only component which needs adjustment, and this is merely given the setting which gives the most pleasing effect. Although unlikely, it is just possible that some devices used in the TR2 position may have a low gate threshold voltage; this will result in an excessively fast decay time, with the circuit also not recovering quickly enough between notes from the organ. Should this effect be encountered it may be cleared up by reducing the value of R4, say to about 270 k Ω or 220 k Ω .

In your work -shop

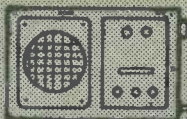

Smithy's

REACTION TIMER

Just a question of timing . . .

"With prices going up the way they are these days," said Dick gloomily, "we'll soon be finding it impossible to live any sort of normal life at all."

Smithy grunted in assent.

"Still," went on Dick more cheerfully as a thought suddenly occurred to him, "at least the price increases will phase out some of the more illegal people who flourish in our midst."

"What sort of illegal people?"

"Why, drunken drivers, of course! With the cost of booze going sky-high, and that of petrol even higher, nobody will be able to indulge in both of them together. So we'll either have sober drivers or drunken pedestrians!"

"Don't you believe it," responded Smithy. "The drunken driver problem is just the same as it always was. If I'm out walking just after chucking-out time at night I take jolly good care to keep well out of the way of any vehicles that come near me. As a matter of fact, we're having a little campaign at my club to bring home to members that they shouldn't drink too much before they drive off home in the evenings. Or, better, that they should leave their cars at home before coming round to the club."

"Are you having any success?"

"A little. In fact I've devised a gadget which is intended to convince the more hard-nosed types that their responses are actually slowed down by indulgence in the sauce, rather than speeded up as they fondly imagine."

REACTION TIMER

Dick's interest was aroused.

"A gadget?"

"Yes," said Smithy. "Actually, it's a reaction timer, with which you press a button when a light comes on. The gadget then tells you what time has elapsed between the lighting of the lamp and the pressing of the button."

"Reaction timer, eh? Aren't peo-

ple likely to get a bit bored with that sort of thing?"

"There is that risk," conceded Smithy, "and so I've tried to make the timer operate in as attractive a manner as possible. The idea is to make people use the timer just for the fun of it. I've also gone to some pains to make it good and accurate."

"How does it work?"

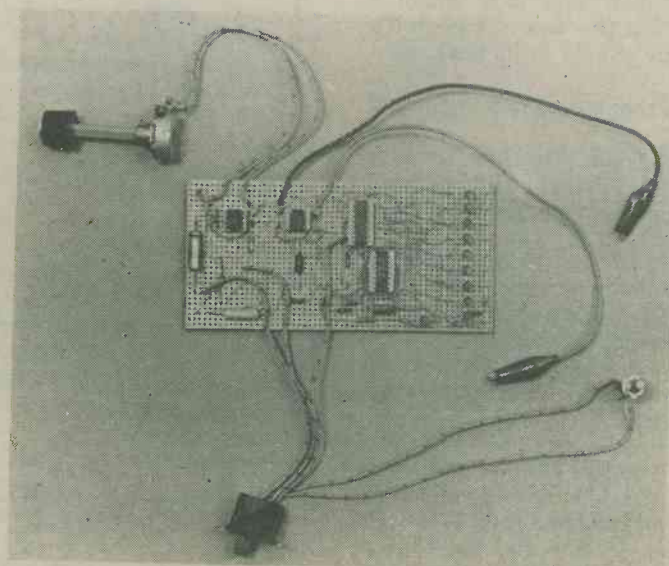

Smithy's prototype reaction timer. This was assembled on a Vero V-Q board, which is extremely useful for the quick construction of experimental circuits. The wiring layout employed for the timer is not critical, and it can be assembled in any normally acceptable manner

"There's a vertical column of l.e.d.'s," explained Smithy, "and at a random moment they start to light up in turn, starting with the l.e.d. at the top. As soon as the first l.e.d. lights up, the chap using the timer presses the button, and the l.e.d. which is alight at the instant of pressing the button stays alight. Each l.e.d. is alight for 0.05 second, and so it is possible to use the timer to measure reaction time with an accuracy of one-twentieth of a second."

"That sounds pretty good to me. What happens if someone is dead slow and presses the button really late?"

"At the bottom of the column of l.e.d.'s are two l.e.d.'s which flash on and off alternately until the timer is reset or switched off. Anyone who is sufficiently slow to let the timer advance to this state has got to be really squiffy!"

"You certainly seem to be in the gadget making business these days, Smithy. The last time we had a gen session you were demonstrating your electronic dice to me."

"These things tend to come in bursts," said Smithy. "And, at any event, they do make a change from servicing. Things are quiet for the moment, so would you like to see the circuit of this timer of mine?"

Dick nodded eagerly in agreement and walked over to Smithy's bench as the Serviceman opened a drawer and pulled out a sheet of paper on which he'd drawn out a circuit diagram. (Fig. 1.)

"Here we are," said Smithy. "As you can see, it's rather more complicated than that dice circuit I showed you last time, although it's still pretty simple in its basic concept."

"I see that it uses four integrated circuits."

"That's right. The first i.c. is a 555 and it provides a random delay before the top l.e.d. in the column lights up. The second i.c. is another 555 and, as soon as it is allowed to go so by the first 555, it produces positive-going pulse edges spaced at intervals of 0.05 second. These positive-going pulses go into the clock input of the third i.c., which is a CD 4017."

"What does that do?"

"It's a decade counter. It has ten output pins, each corresponding to a number from zero to 9. When it's reset the '0' output at pin 3 goes high and all the other outputs go low. If a positive-going pulse is fed to its clock input the '0' output goes low and the '1' output goes high. The next pulse at the clock input causes the '1' output to go low and

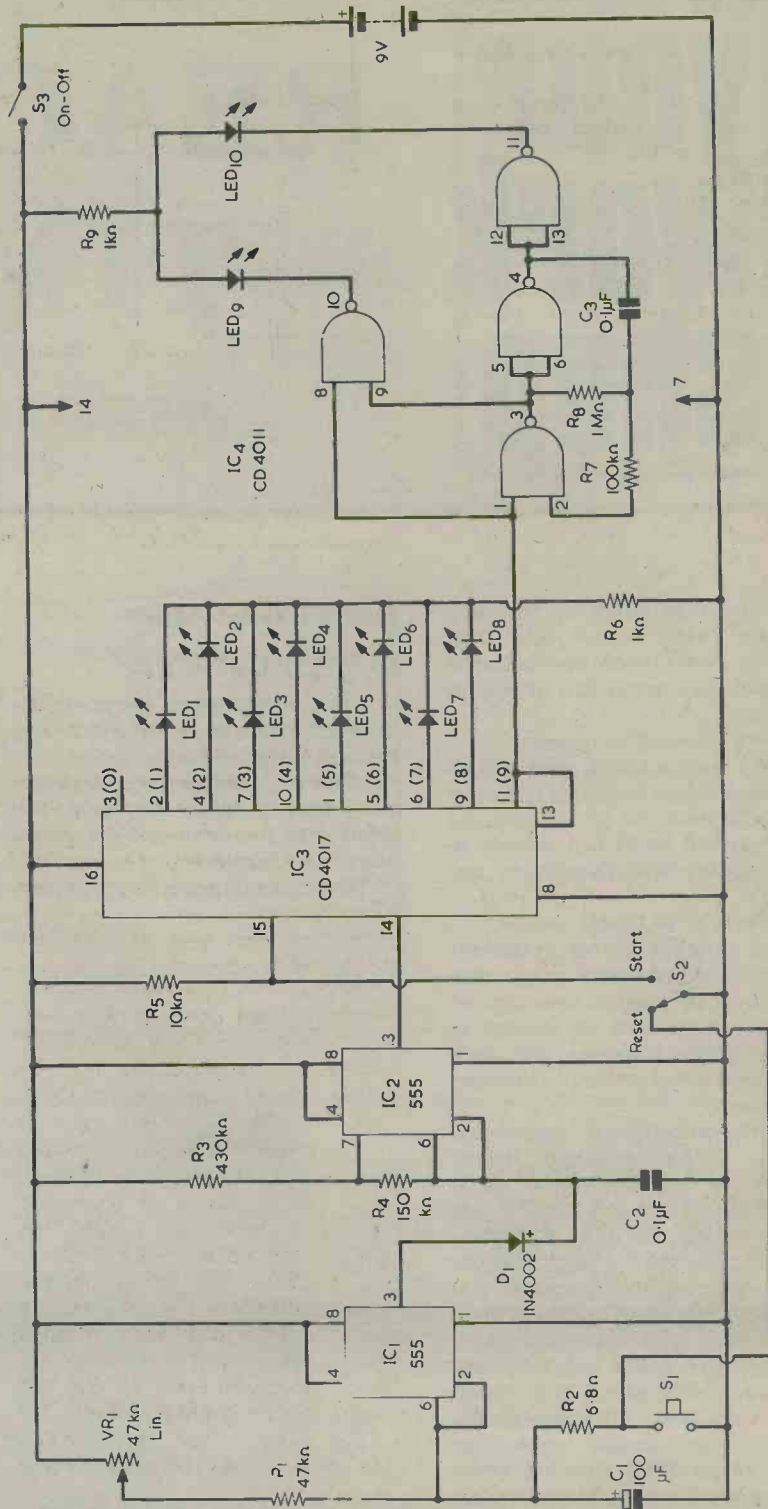

Fig. 1. The complete circuit of the reaction timer. After a delay which can be varied by adjusting VR1, the l.e.d.'s light up successively, starting with LED1 and ending with LED10 flashing alternately

the '2' output to go high. And so the process repeats, with each number output going high in turn for each clock pulse input. The outputs couple into a series of eight i.e.d.'s, so these each light up in turn. They are, of course, the i.e.d.'s in the vertical column."

"What happens when the figure 9 output goes high?"

"The CD4017 counting then stops and the CMOS oscillator given by two of the NAND gates in the fourth i.c., which is a CD4011, turns on. This oscillator causes LED9 and LED10 to continually flash on and off alternately."

Smithy drew another sheet of paper towards him and indicated it to his assistant. (Fig. 2.)

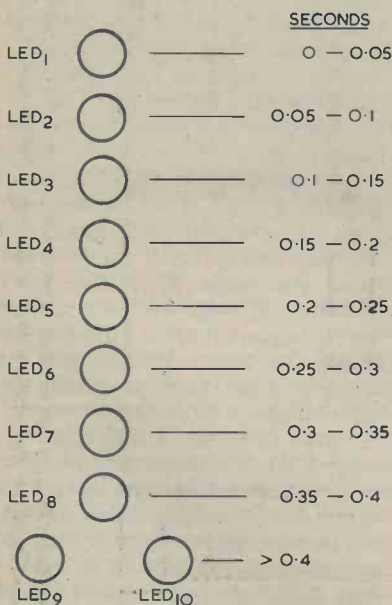

Fig. 2. The i.e.d.'s are arranged in a vertical column, as here. Also shown are the timing periods to which the i.e.d.'s correspond

"When I make up the timer finally and put it in a box," he went on, "I'll have the i.e.d.'s laid out like this on the front panel. Alongside each i.e.d. is the time to which it corresponds. If, for instance, LED5 stays alight when you press the button after the first i.e.d. has lit up, your reaction time is 0.2 to 0.25 second. Got it?"

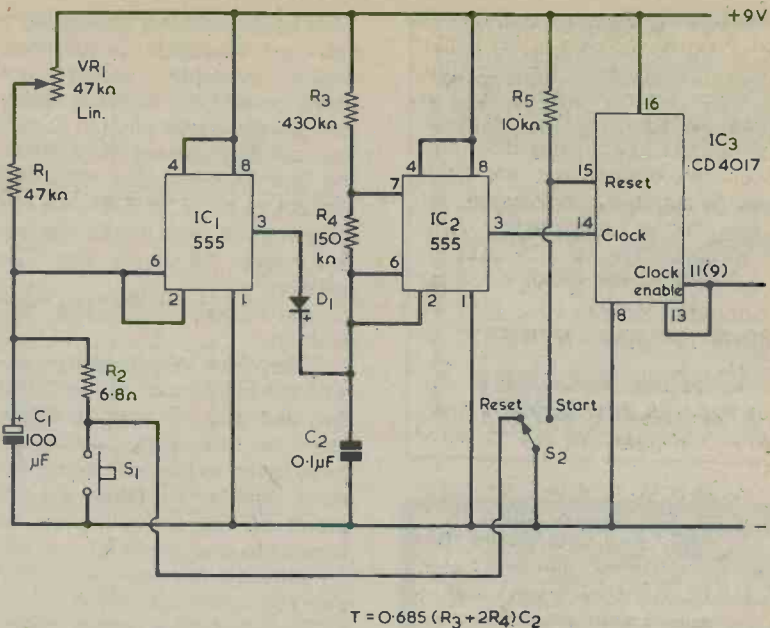

Fig. 3. The circuitry in which IC1 and IC2 appear. The timing display is caused to stop by pressing S1

CIRCUIT DETAILS

"In general, yes," stated Dick. "But I wish you'd go into the circuit in a bit more detail."

"All right," said Smithy obligingly, "we'll work our way along it from left to right. Let's start off by looking at what happens with the two 555 i.c.'s and the clock input to the CD4017."

Dick concentrated on the first section of the circuit. (Fig. 3.)

"Now," continued Smithy, "before we get down to the nitty-gritty, there are three things we need to bear in mind. The first two are concerned with the CD4017. When the CD4017 reset input at pin 15 is high its output is cleared to zero, and when the reset input is taken low it starts to count on successive clock input pulses. The CD4017 has a clock enable input at pin 13. When this pin is low the count proceeds in the manner I've just described, but when it goes high the clock input is inhibited and the count stays fixed at the last number which was high. Okay."

"Yes," said Dick thoughtfully, "that seems clear enough. What's the third thing?"

"That concerns the 555 i.c.'s. When pins 2 and 6 of a 555 are high its output at pin 3 is low, as also is its discharge pin at pin 7. And when pins 2 and 6 are low the output is high and the discharge pin is floating."

"Fair enough," said Dick. "I've

absorbed all that, so let's get down to the explanation."

"Right," responded Smithy briskly. "When we switch on the 9 volt supply, switch S2 should be in the 'Reset' position. This causes the reset pin of the CD4017 to go high via R5 and its '0' output to go high also."

"Hey, hang on a moment! Won't that '0' output cause the first i.e.d. to light up?"

"It won't cause any i.e.d. to light up. If you look at the main circuit diagram you'll see that the '0' output isn't connected to anything. The first i.e.d. is connected to the '1' output."

"Ah yes, so it is. Go on, Smithy!"

"Another thing that S2 does when it's in the 'Reset' position is to short-circuit C1. Forget R2 for the moment, since it has a very low value. Now, if C1 is short-circuited there is zero voltage across its plates and so the input to pins 2 and 6 of the first 555 is low. So what does that mean?"

"It's output at pin 3," replied Dick promptly, "will be high."

"Good. That high output is applied via diode D1 to capacitor C2, causing the upper plate of this capacitor to be close to the potential of the positive rail."

"Let me think now," said Dick.

"This means that pins 2 and 6 of the second 555 will be high and its pin 3 output will be low."

"Excellent," approved Smithy.

THE
MODERN BOOK CO.

Largest selection of English &
American radio and technical
books in the country

19-21 PRAED STREET
LONDON W2 1NP
Tel: 01-402 9176

SAVE MONEY! ON
OUR BARGAIN OFFERS ★

*NOT NEW — BUT IN VERY CLEAN AND USABLE CONDITION
Ideal for taking on holiday!

(2) REMINGTON ROLLERMATIC MAINS SHAVERS, in case
with mains lead etc. £3.75 each plus 50p p&p/ins.
Again not new but in excellent condition

(1) RONSON 21 MAINS SHAVER, Complete in case with mains
lead etc. A Real Bargain at.....£4.25 plus 50p p&p/ins.

(1) ARMAR (Dictaphone) SOLID STATE TAPE RECORDER,
fully portable, and complete with belts/instructions/mike etc. This item
is in Tip Top Condition and represents Real Value for money, on
Today's Prices, at the Bargain Price of.....£8.50 plus 50p p&p/ins.

Write stating preference and we will confirm availability by return

THESE BARGAIN OFFERS ARE TOO GOOD TO MISS!

SIGTRONIC ELECTRONICS ★

27 Malvern Street, Stapenhill
Burton-on-Trent, Staffs. DE15 9DY
Tel: (0283) 46868 special orders

**MORSE MADE
EASY**

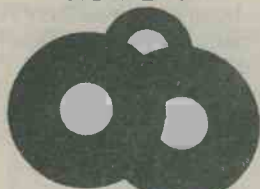

**BY THE G3HSC
RHYTHM METHOD!**

These courses which have been sold for
over 23 years, have been proved many times
to be the fastest method of learning Morse.
You start right away by learning the sounds
of the various letters, numbers, etc., as you
will in fact use them. Not a series of dots and
dashes which later you will have to transkate
into letters and words.

Using scientifically prepared 3 speed records
you automatically learn to recognise the
code, RHYTHM without translating. You
can't help it. It's as easy as learning a tune
18 WPM in 4 weeks guaranteed.

The Complete Course consists of three
records as well as instruction books.

For Complete Course send £5.50 (overseas
surface mail £1 extra).

THE G3HSC MORSE CENTRE

Box 8, 45 Green Lane, Purley, Surrey.
I enclose £5.50 or s.a.e. for explanatory
booklet.

Name.....

Address.....

"The second 555 is connected in a
standard oscillator circuit but it
cannot possibly oscillate under
these conditions. Another factor is
that the discharge pin, pin 7, will be
low, so that current from pin 3 of
the first 555 will flow through D1
and R4 to pin 7, and thence to the
negative rail. And that's the situa-
tion when S2 is in the 'Reset'
position."

"Let's take it to the 'Start'
position."

"Okeydoke. When we do that we
take the reset input of the CD4017
low, and this will start to count as
soon as the first positive-going
pulse is fed to its clock input. At the
same time we've taken the short-
circuit off C1 and this now com-
mences to charge via R1 and VR1."

"Why do you have a pot in the
charging circuit, Smithy?"

"To introduce a random factor in
the timing provided by the first 555.
VR1 can be a panel mounting
potentiometer having a round knob
without markings so that it is dif-
ficult to guess its setting just by
looking at it. Either the person using
the timer or somebody else can ad-
just it in random fashion. Well, C1
continues to charge and, after a
period, causes pins 2 and 6 of the
first 555 to reach two-thirds of the
supply voltage, whereupon its out-
put at once goes low. C1 continues
to charge after this, but this fact is
of no importance so far as circuit
operation is concerned."

MULTIVIBRATOR

"If pin 3 of the first 555 goes
low," said Dick ruminatively, "D1
will become reverse biased, won't
it?"

"That's right. C2 can now dis-
charge via R4 and pin 7 of the se-
cond 555. When the voltage across
the capacitor reaches one-third of
the supply voltage the second 555
triggers and its output goes high,
passing the first positive-going
pulse to the clock input of the
CD4017, and causing its output
count to be advanced to 1. LED1
lights up. The second 555 now
commences to function as a stan-
dard 555 multivibrator having a cy-
cle length of 0.05 second."

"I suppose that cycle length is
0.05 second approximately?"

"The *calculated* cycle length,"
said Smithy, "is virtually 0.05 se-
cond *precisely*. Working to
Signetics data, the length of the
timing period is given by finding the
sum of R3 and twice R4, and then
multiplying this sum by 0.685 and

the value of C2. This works out as
0.05 second to three significant
figures. So we've now got the se-
cond 555 pumping out positive-
going pulses at 0.05 second inter-
vals. Each pulse causes the next
i.e.d. in the vertical column to light
up and the previous one to be ex-
tinguished."

"How do you stop the i.e.d.'s?"

"By pressing push-button S1,"
said Smithy. "This at once dis-
charges C1 and causes pins 2 and 6
of the first 555 to go low and its pin
3 output to go high. The second
555 is immediately inhibited. If, at
the instant of pressing the button,
its output is high, that output is
taken low. And if the output of the
second 555 is low when the button
is pressed, it stays low. The overall
effect is that pressing the button
stops the count and the last i.e.d.
which was lit up stays alight."

"Do you have to keep the push-
button continually pressed?"

"A momentary closure of its con-
tacts is all that's needed, as it's
merely necessary to discharge C1. If
you then put S2 to the 'Reset' po-
sition, C1 will stay discharged until
the next timing run. If, on the other
hand, you leave S2 in the 'start'
position, C1 will gradually charge
until it triggers the first 555, and the
i.e.d.'s will then continue from the
last count until they end up with the
last two i.e.d.'s flashing alternately."

"How long would that take?"

"For C1 to charge up again and
trigger the first 555? The same time
as the initial random delay. This is,
incidentally, about 6 to 12 seconds
according to the setting of VR1. I
said earlier that you should ignore
R2 for the moment. All it's in the cir-
cuit for is to limit the current which
flows when S1 is pressed to short-
circuit C1. Without R2 you could
have a tiny spark at S1 contacts
which could, conceivably, eventually
reduce its efficiency. The same
applies to the 'Reset' contacts of S2
if these happen to short-circuit C1
when it is charged. Whatever the
state of the circuit, putting S2 to
'Reset' always returns it to the state
where it is ready to start another
timing run with all i.e.d.'s ex-
tinguished."

"Gee, all this is pretty neat."

"I'm glad you like it."

"Well, I can see how the first
eight i.e.d.'s are lit in turn. But what
happens when the count gets to 9?"

"That takes place when pin 11 of
the CD4017 goes high," said
Smithy. "And we can see more
clearly what happens then if we
concentrate on the CD4011 part of
the circuit."

Smithy indicated the right hand

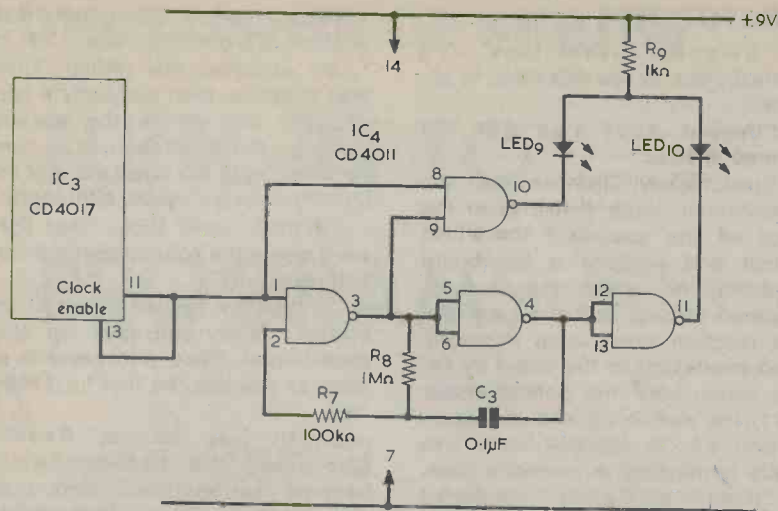

Fig. 4. The four NAND gates in a CD4011 are used to cause LED9 and LED10 to flash alternately

section of the reaction timer circuit. (Fig. 4.)

"At the ninth count," he resumed, "pin 11 goes high. It's connected to the clock enable input at pin 13, so the CD4017 does not respond to further clock input pulses and stays with pin 11 high until the whole circuit is reset by S2. Pin 11 also connects to pin 1 of the CD4011, which has four 2-input NAND gates. The two NAND gates associated with pins 1 to 6 form a CMOS oscillator with a frequency of about 5 Hz. When pin 1 of the oscillator is low, before the count gets to 9, the oscillator is inhibited and pin 3 of the first gate is high. Pin 4 of the second gate is low, causing pin 11 of the gate which follows it to be high. As a result LED10 is not lit up. The high output at pin 3 of the first gate goes to pin 9 of the last NAND gate in the CD4011. But, since pin 8 of that gate is low, because it connects to pin 11 of the CD4017, the output at pin 10 is also high. As a result, LED9 does not light up, either."

"Let's see if I can work out what happens in the CD4011 when pin 11 of the CD4017 does go high at the ninth count."

"Go ahead."

"Well," said Dick slowly, "When this pin 11 goes high it takes pin 1 of the first NAND gate high, and so the oscillator starts to run."

"Good."

"Pin 8 of the last NAND gate goes high, too. That means that when pin 3 in the oscillator section goes high, pin 10 goes low and causes LED9 to light up. LED10 lights up when pin 4 in the oscillator section goes high, because pin 11 of the CD4011 then goes low. Since pins 3 and 4 go high alternately, the two LEDs flash alternately, too."

"And that's it," said Smithy cheerfully. "That's got the whole operation of the reaction timer buttoned up. Quite simple when you get round to it, isn't it?"

"What current does it draw from the 9 volt battery?"

"Oh, about 8mA if none of the LEDs are alight, rising to some 14mA when any of them are alight."

"I see. You said earlier on that S2 should be in the 'Reset' position when you switch on the 9 volt supply. What would happen if it was at 'Start' when the 9 volt supply was applied?"

"There'd be no damage done," replied Smithy, "but you'd find that the CD4017 would be giving a few funny outputs. With my prototype I find that applying the 9 volt supply with S2 at 'Start' causes LED2 and LED5 to be lit, as well as the alternately flashing LED9 and LED10. The circuit reverts to normal as soon as S2 is put to 'Reset'."

PEATS for PARIS
ELECTRONIC COMPONENTS
RADIO & TELEVISION
For the convenience of Irish enthusiasts we supply:

Radio & Electronics
 Constructor Data Books
 Panel Signs
 Transfers

Also a postal service

PEATS
 the world of electronics
 25 Parnell Street, Dublin 1. Telephone 749972

MORSE IMPROVEMENT

C90 Cassettes (A) 1-12 w.p.m. with simple exercises. Suitable for R.A.E. preparation. (B) 12-24 w.p.m. computer produced professional level operator material including international symbols.

Price each: complete with instruction and exercise booklets £4.75 including postage.

Morse Key and Buzzer Unit suitable for sending practice and DIY tape preparation.

Price £4.75 including postage

Overseas Airmail £1.50 extra.

MHEL ELECTRONICS (Dept. R)
 12 Longshore Way, Milton,
 Portsmouth (UK), PO4 8LS

GAREX

V.H.F. Receivers SR-9 for 2-metres F.M., fully tunable 144-146MHz, 2-speed slow-motion dial, also 11 xtal controlled channels. Compact, sensitive, ideal for fixed or mobile listening. Built-in L.S., 12v D.C. operation £47.15 inc. VAT. Crystals, if required: £2.60 each. All popular 2m. channels in stock. Marine band version (156 162MHz) £47.15 (xtals £2.90). Mains psu for above £11.95. Pocket VHF Receiver 12 channel xtal controlled complete with nicad and charger. 4MHz bandwidth in range 140-175MHz £57.95. Amateur and Marine xtals in stock, prices as SR-9.

Amplifier module new, fully assembled 6W IC unit, 12v D.C. Low impedance (4-8 Ω) input and output for extn. speaker amplification, with circuit £2.75.

Neons min wire end 70p/10; £4.50/100

Slide switches min DPDT 20p ea; 5+: 16p

Resistor Kits E12 series, 22 Ω to 1M Ω

57 values, 5% carbon film, $\frac{1}{4}$ W or $\frac{1}{2}$ W Starter

pack, 5 each, value (285) £3.10

Mixed pack, 5 each $\frac{1}{4}$ W + $\frac{1}{2}$ W (570) £5.55

Standard pack, 10 each (570) £5.55

Giant pack, 25 each (1,425) £13.60

BNC Cable mtg socket 50 Ω 25p;

5+: 20p; PL259 UHF Plug & Reducer 75p;

5+: 67p; SO239 UHF Socket panel mtd.

60p; 5+: 50p; Nicad rechargeables

physically equiv. to zinc-carbon types: AAA

(U16) £1.80; AA(U7) £1.30; C(U11) £3.35;

PP3 £5.55. Any 5+: less 10%. Any 10+ less

20%.

We stock V.H.F. & U.H.F. mobile aeriels.

s.a.e. details.

Access — Barclaycard

PRICES INCLUDE UK POST, PACKING & VAT

Mail order only Sole Address:

GAREX ELECTRONICS

7 NORVIC ROAD, MARSWORTH.

TRING, HERTS HP23 4LS

Cheddington (STD 0296) 668684

UNDERSTANDING TELEVISION



by

J. R. DAVIES

Over 500 pages
300 diagrams

- Principles of 405 line reception
- Principles of 625 line reception
- Nature of the television signal
- Receiver tuner units
- A.F. and video amplifiers
- Deflector coil assemblies
- Automatic gain and contrast control
- Receiver aeriels
- The cathode ray tube
- Receiver i.f. amplifiers
- Vertical and horizontal timebases
- Synchronising
- Power supply circuits
- Introduction to Colour TV

£3.95 P. & P.
80p

To: DATA PUBLICATIONS
Ltd., 57 Maida Vale London
W9

Please supply copy(ies)
of "Understanding Television"
Data Book No. 17. I enclose
cheque/crossed postal order for

Name

Address

BLOCK LETTERS PLEASE

PROTOTYPE

"Stap me," said Dick. "I'd certainly like to see this timer in action."

"Would you? I've got my prototype here."

Speechlessly, Dick watched the Serviceman reach down, open the door of the cupboard under his bench and produce a Veroboard assembly on which the four integrated circuits and the l.e.d.'s of the reaction timer were mounted. Also connected to the board by flying leads were the potentiometer VR1, the switch S2 and the push-button S1. In addition were two leads terminated in crocodile clips.

"Dash it all, Smithy," spluttered Dick, "has this been here while we've been talking about it?"

"Why yes," replied Smithy, surprised. "Why shouldn't it be?"

"All this time," complained Dick, "I've been bending my brain trying to visualise how the darned thing works when you could have actually demonstrated it to me!"

"Well," said Smithy soothingly, "here it is now for you to look at. I knocked it up on a Vero V-Q board having 28 copper strips by 58 holes. The strips are divided into 4-hole segments, which makes the board an excellent choice for building up quick circuits, because you don't have to cut any strips. I slightly misjudged the layout of the l.e.d.'s, and LED10 is at the bottom of the vertical column, below LED8, and not to the right of it as it will be in my finalised version. Also, I didn't bother to include the on-off switch, S3."

"All the components on that Veroboard," said Dick, looking at the board critically, "appear to be quite standard types."

"In general they are," confirmed Smithy. "Apart from R3 and R4 all the fixed resistors can be $\frac{1}{4}$ watt 10% or 5%. If a high level of timing accuracy is being aimed at, R3 and R4 could be 2% or even 1% types."

"What about C2?"

"Ideally, that should be a close tolerance component, too. You can get 0.1 μ F capacitors in 5% tolerance quite easily, these being available both in polystyrene and polycarbonate. It is possible to get a 0.1 μ F capacitor in a closer tolerance than 5%, but you will have to hunt round a little for it, and it may tend to be rather expensive. Anyway, let's try out the prototype."

Smithy picked up a PP9 battery and connected the crocodile clips to its terminals.

"Nothing's happening," said Dick.

"I know it isn't," replied Smithy.

"I've got switch S2 in the 'Rest' position. I'll put it to 'start'."

He actuated the switch. There was a pause, then suddenly a spot of light ran down the vertical column l.e.d.'s as each lit in turn, terminating in the two l.e.d.'s at the bottom quickly flashing alternately.

"Blimey," said Dick, "that light went down the column pretty smartish, didn't it?"

"It took 0.4 second to get to the bottom. Now, you pick up that push-button, Dick, and press it as soon as you see the first l.e.d. light up."

Smith put S2 to 'Reset', whereupon the flashing l.e.d.'s became extinguished, and then returned it to 'Start'. Dick picked up the push-button and waited. Almost unexpectedly the top l.e.d. lit up and Dick pressed the push-button quickly. The display was arrested at LED6, which glowed steadily.

"Humph," grunted Smithy, "that's pretty slow."

Smithy actuated the switch once again, and this time Dick was able to halt the display at LED5. At succeeding attempts and with much concentration, he was able to stop the l.e.d.'s at LED4 on several occasions but was unable to improve on this. Smithy took up the push-button and let Dick actuate the switch. Dick also altered the setting of the potentiometer in order to provide a new time delay before the light travelled down the column of l.e.d.'s.

To Dick's fury, Smithy was able to stop the display at LED4 without any apparent effort at all, and on several occasions was even able to do so at LED3.

"How," fumed Dick, "do you manage to beat me at this? Here am I, a heathy youth with all my faculties, yet all I can do is just manage a reaction time of 0.15 to 0.2 seconds. Dash it all, you're able to press that darned button in less than 0.15 second."

"Ah," chuckled Smithy. "I've got a built-in regenerative loop in my nervous system."

Dick stared at him unbelievably. "Come off it, Smithy."

"It's true."

"Then tell me what that regeneration does?"

"It improves my reaction!"

CONCLUSION OF SERIES

TUNE-IN TO PROGRAMS

Part 9

By
Ian Sinclair

Some tunes to play

This part consists simply of programs, with some notes and explanations of how they work, so that you can see what processes of thought, plain or twisted, went into producing the program. No two approach a problem in the same way, and I don't claim that these are the most obvious, the easiest, shortest or simplest programs for these particular problems. They are, however, programs which I wrote from scratch for this series, so that they do at least have some degree of originality about them.

DECIMAL TO BINARY

The first program converts a decimal number (less than 256) into a binary number. The program follows the old-established method of dividing successively by two, and storing the remainder as a number. The decimal number is divided by 2, producing either a whole number or a number with the remainder 0.5; for example, $155 \div 2 = 77.5$. This result is temporarily stored. The fractional part of the number is now taken, making use of the [INV] [Int] procedure, so that the result is either 0.0 or 0.5

according to whether the number was even or odd respectively. This in turn is multiplied by 2 to give 0 or 1, and is again multiplied by 10^0 , giving 0 or 1 again, since 10^0 is just 1. By using [Dsz], a count-down which has started with 9 stored in memory 0 reduces by one, and the instruction [GTO] [4] starts the loop again. The reason for using the figure 9 in store 0 is that only eight digits can be displayed — the [Dsz] instruction is arranged so that if a ninth digit is needed (because the original number exceeded the limit) the program switches to an impossible instruction ([GTO] [5] with no label 5) so causing a flashing display.

On the next loop, the integral part of the number is taken, using [Int], and the division by 2 is carried out again. Once more the remainder is extracted,

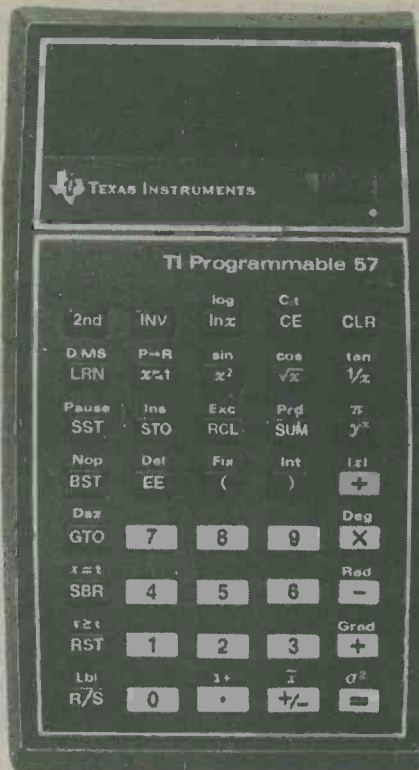

The keyboard of the Texas Instruments TI-57 programmable calculator. Most keys have a second function, whereupon facilities are nearly double the number of keys provided

DECIMAL TO BINARY CONVERSION

Program

```
LRN 9 STO 0 1 STO 2 0 STO 3 0 STO 7 Lbl 4 RCL 1
x=t GTO 1  $\div$  2 = STO 4 INV Int X 2 X RCL 2 =
SUM 3 RCL 4 Int STO 1 10 Prd 2 Dsz GTO 4 GTO 5
Lbl 1 RCL 3 R/S LRN
```

Procedure

Load the decimal number (up to 255) into store 1. Press CLR RST R/S. Display shows binary number. If the decimal number is greater than 255, the display will show a flashing 10.

Test Data: Load 255 STO 1. CLR RST R/S. Answer 11111111.

Load 256 STO 1. CLR RST R/S. Answer 10 flashing.

Fig. 1.

BINARY TO DECIMAL CONVERSION

Program

```
LRN 8 STO 0 0 STO 3 Lbl 0 RCL 1 ÷ SBR 1 = STO
2 Int X (2 y*(RCL 0-1) ) = SUM 3 RCL 2 INV Int X
SBR 1 = STO 1 Dsz GTO 0 RCL 3 R/S Lbl 1 (10y x
(RCL 0-1) ) INV SBR LRN
```

Procedure

Load the binary number into store 1. Press CLR RST R/S. Display shows decimal number.

Test Data: Load 10101010 STO 1. CLR RST R/S. Answer 170.

Fig. 2.

multiplied by 2 to convert 0.5 to 1 and multiplied, this time by 10^1 (which is 10) to place the digit 1 or 0 in the correct place in the display. On the next loop, the multiplier 10^2 (which is 100) will be used, on the loop after that 10^3 (which is 1000) and so on. This tenfold multiplication is carried out on each loop by using the instruction [10] [Prd] [2]. The action stops when there is no number left to divide by 2, and this is detected by the [x=t] step early in the program loop. The number which is set into memory 7 is 0, so that when there is nothing left of the original number after several divisions by 2, there is no skip, and the [GTO] instruction fetches the final result from memory 3 to display.

Note that each complete run of the program starts with the storing of essential quantities. The step [0] [STO] [3] ensures that this store is cleared before a new number is processed. It is good practice to use such clearing steps in the program itself, because if the stores were not cleared old results could be mixed in with the new ones. Store 4 does not have to be cleared in this way, because the first use of this store is the instruction [STO] [4], which automatically wipes out any previous information. Store 3 is used in the form [SUM] [3], however, and would not be cleared in the normal course of the program.

BINARY TO DECIMAL

The binary to decimal conversion in the second program uses a quite different method. The number is keyed into the display as a set of 1's and 0's, like

any binary number. The calculator will treat this as a *decimal* number, so that we must carry out some sort of conversion in the program. The way in which we write decimal numbers, however, is the same as the way in which we write binary numbers, except that each place to the left of the point represents a power of 10 (10^1 , 10^2 , 10^3 and so on) rather than a power of two. The program works by taking each power of ten digit and converting it into the corresponding power of two number, and summing these numbers for each digit.

The number written into the display is divided by 10 to the power of $n-1$, where n is the number stored in memory 0, starting with 8. This detects the highest placed digit of the number, and the [Int] step then takes the 1 or 0 in the 8th place of the display. This number, 1 or 0, is now multiplied by 2 to the power of $n-1$, using the same value of n , so as to give the correct power of two, and the result is collected in store 3 by using [SUM] [3]. The divided number, which was stored in memory 2, is recalled, its fractional part taken, using [INV] [Int], and multiplied by 10 to the power of $n-1$ again to restore the number to its correct value so that it can be replaced in memory 1. The [Dsz] step then decrements memory 0, and the loop is started by the [GTO] [0] instruction.

On the next loop, the next lower power of ten is used, because $n=7$, and the corresponding power of 2. The result is again gathered in store 3, and the loop continues until the contents of memory 0 are decremented to zero, whereupon the program steps

IMPEDANCES IN PARALLEL

The impedances are in the form: $A + jB$; $C + jD$. At the end of the calculation, the figure in the display is the phase angle (degrees). Pressing [x] [t] gives amplitude.

Program

```
LRN 0 STO 2 0 STO 3 Lbl 1 RCL 0 X SBR 0 = SUM
2 RCL 1 X SBR 0 = +/- SUM 3 CLR INV SBR SBR
1 RCL 2 STO 0 RCL 3 STO 1 0 STO 2 0 STO 3 SBR
1 RCL 2 x [t] RCL 3 INV P-R Fix R/S Lbl 0 (RCL
0 x2 + RCL 1 x2) 1/x INV SBR LRN
```

Procedure

Load value of A into store 0, value of B into store 1. CLR RST R/S. When the display clears to 0.00, load value of C into store 0, value of D into store 1. CLR R/S. Final display is phase angle in degrees. Press [x] [t] to get amplitude of total impedance (same units as A, B, C, D).

Test Data: 2 STO 0 3 STO 1 CLR RST R/S.
At 0.00 4 STO 0 5 STO 1 CLR R/S.
Answer 54.52°, 2.309 amplitude.

Fig. 3.

out of the loop into [RCL] [3] [R/S], showing the decimal number. Note that we use a subroutine to calculate the power of ten because this result is used twice in the program.

The setting-up instructions are, as usual, included in the program. The [O] [STO] [3] step is important, as [SUM] [3] is used in the program. We could, of course, clear memory 3 outside the program, but the whole aim of a program is, after all, to reduce repetitive steps.

IMPEDANCES IN PARALLEL

Fig. 3 shows a program for adding two impedances connected in parallel. The impedances are written in "j-operator" form as $A + jB$ and $C + jD$. The A and C figures are the in-phase components of impedance, and the B and D figures are the 90° phase components. This is a particularly useful program, as the calculation is normally very long and tedious. The final answer is expressed in the form of an amplitude (ohms) and phase angle (degrees).

The method is outlined in Fig. 4. The quantities

$$\frac{A}{A^2 + B^2} \quad \text{and} \quad \frac{B}{A^2 + B^2}$$

are added to the quantities

$$\frac{C}{C^2 + D^2} \quad \text{and} \quad \frac{D}{C^2 + D^2}$$

respectively in stores 2 and 3. This is done in steps, with the quantities C and D being keyed into stores 0 and 1 at an intermediate part of the program at which time the display clears. The contents of store 2 and store 3 are now treated in the same way, and stored in memories 2 and 3. The content of memory 2 is now transferred to memory 7 (the t register), by using [x=t], so that the cartesian to polar conversion

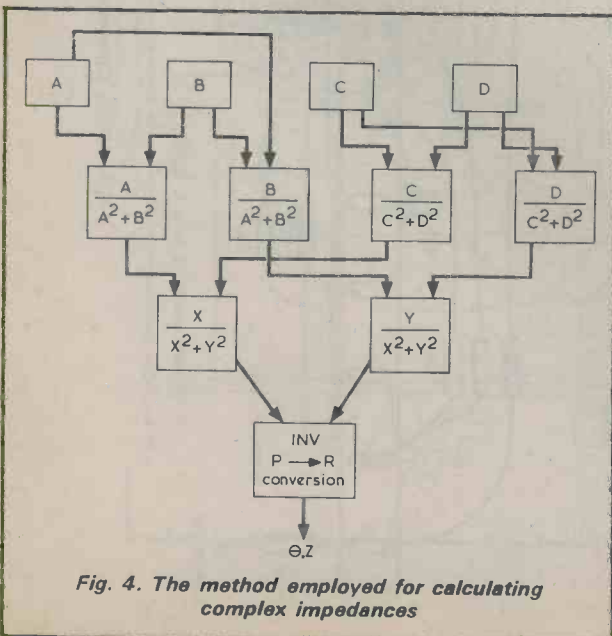

Fig. 4. The method employed for calculating complex impedances

can be carried out. This converts the $A + jB$ form of impedance into the more useful amplitude and phase angle form. The results are read off the display with the phase angle in degrees displayed at the end of the program, and the amplitude displayed when the [x=t] key is pressed. It's not by any means a simple program, but a good illustration of the great power of the calculator.

HARMONIC CONTENT OF A SQUARE WAVE

Formula: $V = A (\cos \theta - 1/3 \cos 3\theta + 1/5 \cos 5\theta - 1/7 \cos 7\theta \dots)$

Program

```

LRN 1 STO 1 5 SUM 2 SBR 0 SBR 1 STO 3 Lbl 2 1
SUM 1 SBR 0 SBR 1 X RCL 4 = SUM 3 RCL 4 +/-
STO 4 RCL 1 x=t GTO 3 GTO 2 R/S RST Lbl 3 RCL
3 R/S RST
Lbl 0 RCL 1 STO 5 2 Prd 5 1 INV SUM 5 Lbl 1 RCL
2 X RCL 5) cos X RCL 0 ÷ RCL 5) INV SBR LRN
  
```

Procedure

Store wave amplitude voltage in STO 0.
Store number of runs required in STO 7 (1 for fundamental plus 1 for each harmonic) 1 STO 4 0 STO 2 Fix 2 CLR RST. R/S gives amplitude of wave plus harmonics for 5°. Each press of R/S subsequently gives the total amplitude for 5° intervals.

Test Data: 10 STO 0 2 STO 7 (only 3rd harmonic) 0 STO 2 1 STO 4 Fix 2 CLR RST.

Amplitude sequence is: 13.18, 6.96, 12.02, 7.73, 9.93, 8.66, 7.33 ...

Note: SBR 0 and SBR 1 could be combined. They have been separated here to show the different steps involved. SBR 0 does not use INV SBR because it is always followed by SBR 1.

Fig. 5

SINE WAVE HARMONICS

Our last illustration is another highly useful one from the point of view of looking at the harmonics of a sine wave. This particular program calculates the total amplitude of a wave plus odd number harmonics up to as many harmonics as you want (if you have time to wait). The formula that is used is shown in Fig. 5, and it allows for the higher harmonics being of low amplitude. Students of electronic engineering will recognise this as a Fourier series. The required number of harmonics is stored in memory 7. A subroutine is used to calculate the odd numbers, using the formula $2n-1$, this is subroutine 0. Subroutine 1 is then used for calculating the cosine of the angle which has been selected from store 2, multiplied by the odd number stored in memory 5. The cosine is then multiplied by the amplitude A (store 0) and divided by the odd harmonic number in memory 5. For each value of angle theta the loop goes round subroutines 0 and 1, adding up the harmonics into memory 4, and reversing the sign of amplitude on each run through. When the correct number of harmonics has been added, the [x=t] step switches out of the loop, so that the

(Continued on Page 185)

THE "DORIC" 9 WAVEBAND PORTABLE

Part 4 (Conclusion)

By Sir Douglas Hall, Bt., K.C.M.G.

Completing the a.m.-f.m. tuner

In this concluding article we complete the construction of the v.h.f. medium and long wave tuner. This, positioned above the amplifier-speaker assembly, is the final unit in the composite "Doric" receiver. As readers who have followed the series will know, this employs a six-band short wave tuner which may be used on its own as a headphone receiver, and an amplifier-speaker unit which can similarly be employed as an amplifier in its own right. The present tuner can also be used, with stereo headphones, as a complete self-contained receiver.

WIRING

A 13-way tagstrip and a 15-way tagstrip are cut from the 28-way tagstrip, and are secured inside the receiver with four small woodscrews. These pass through the tag centres indicated in Figs. 10a (a) and (c). A nut is placed over each screw between the tagstrip and the plywood to space the strip slightly away from the wood.

Wiring is then carried out as illustration in Fig. 10. For clarity, components are shown spread out but, in practice, all connections including in particular those in the v.h.f. section should be short and direct, and the components should all be within the outline of the item of Fig. 8(a).

The switch positions of S5, as its spindle is rotated clockwise, are: Off, Medium, V.H.F., Long. The switch is illustrated as mounted and also lying flat to show how the connections are made to it.

When wiring has been completed, connect a PP3 battery and insert the stereo plug from the amplifier-speaker unit or plug in a pair of stereo headphones. Turn S5 to medium waves and tune in a station at about 250 metres and then one at around 450 metres. Set up VR8 such that a minimum amount of adjustment is required in



The complete "Doric" receiver with all sections assembled together

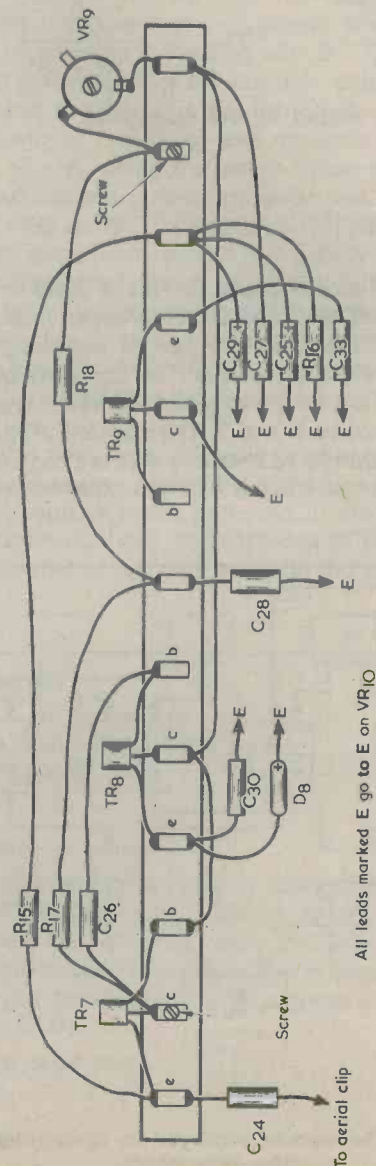

Fig. 10(a). Connections to the 13-way tagstrip

VR7 to keep the receiver in its most sensitive condition — on the edge of oscillation — for all settings between 250 and 450 metres. Next tune in a station at about 200 metres and adjust VC2 so that oscillation starts at about the same setting of VR7. These

two adjustments are most easily carried out with the item of Fig. 9(a) temporarily removed.

Turn to the long wave band to check that all is well here. VR7 will have to be advanced further on this band to obtain oscillation.

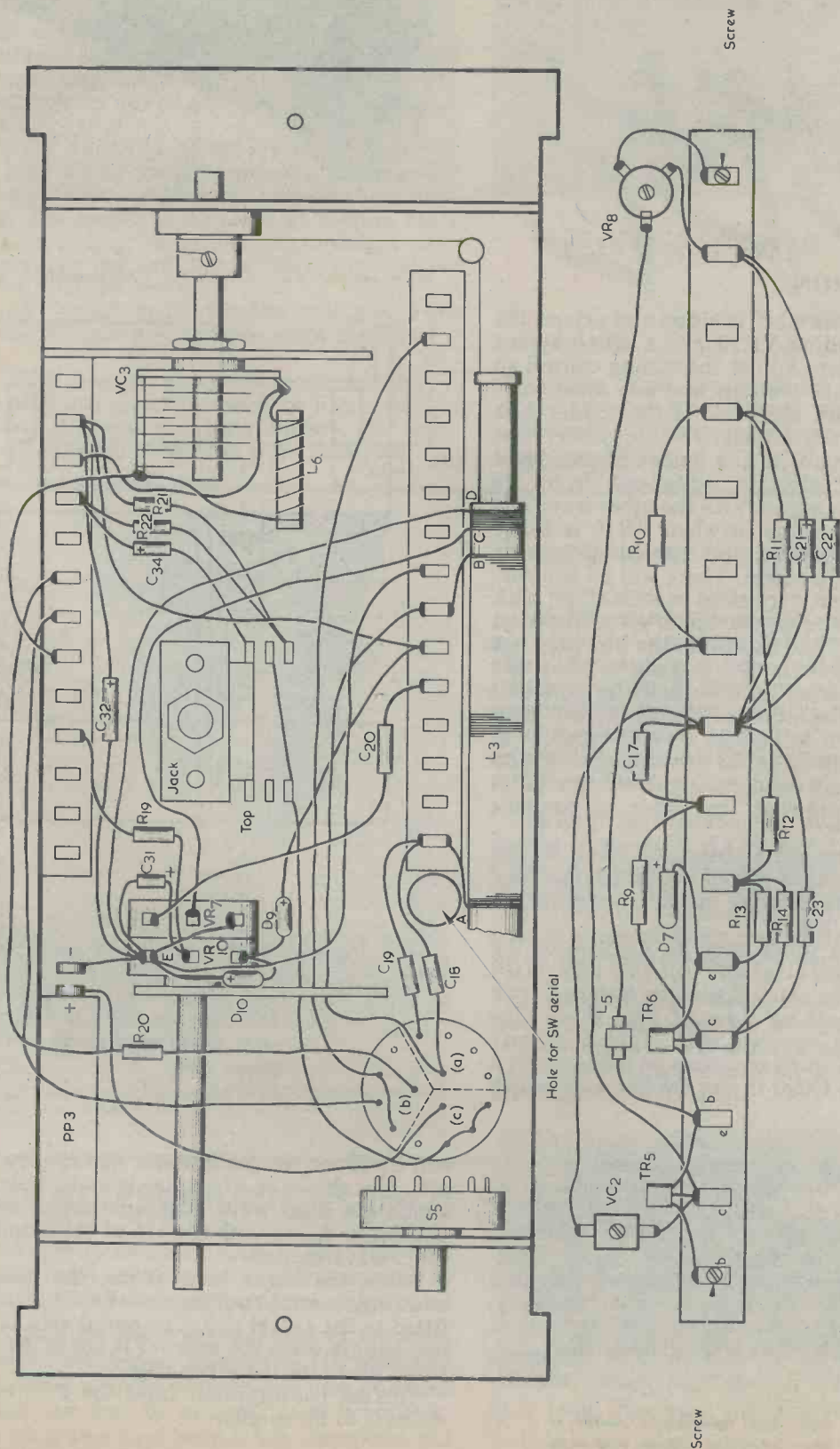
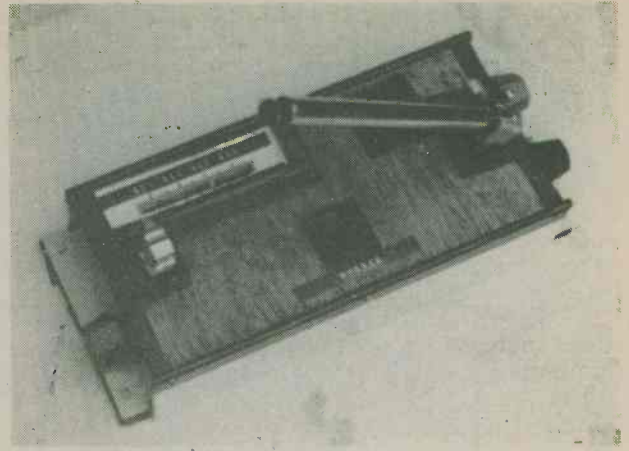

Fig. 10
 (b). The layout on the baseplate of the a.m.-f.m. tuner. Note the hole for the short wave telescopic aerial
 (c). The components which are wired to the 15-way tagstrip

The a.m.-f.m. tuner may be employed, with stereo headphones, as a receiver in its own right



V.H.F. RECEPTION

Next, set S5 to the v.h.f. position and extend the telescopic aerial. Adjust VR10 until a light inherent hiss becomes louder. Adjust the tuning control so that the local B.B.C. stations and any local commercial stations are received. If the louder hiss cannot be obtained, adjust VR9 to insert less resistance into circuit. If the louder hiss appears with VR10 only slightly advanced from its minimum position, adjust VR9 the other way. The louder hiss should come in when VR10 is fairly near its maximum setting, and it should disappear on the reception of a signal. There will be two correct tuning positions, very close to each other, with a tuning point in the centre which gives distorted results. In areas of bad reception the hiss may not disappear, and this is an indication that the receiver is not picking up a sufficiently powerful signal. Careful orientation of the aerial will help here, and it may also help to try the receiver in different parts of the room. In very strong reception areas the aerial may need closing down or even to be completely removed, in order to prevent overloading.

If, with use, the aerial becomes loose on the swivelling clip, another clip of the same type may be passed over the existing one to strengthen its grip on the aerial base.

A cover for the tuner may be made with the items shown in Figs. 11(a) and (b). Two Figs. 11(b) pieces are required, and these are fastened with woodscrews to the long sides of Fig. 11(a). The assembly is then covered with Fablon of any desired colour. A tuning scale can be made up on a piece of card and fitted in the cut out area which

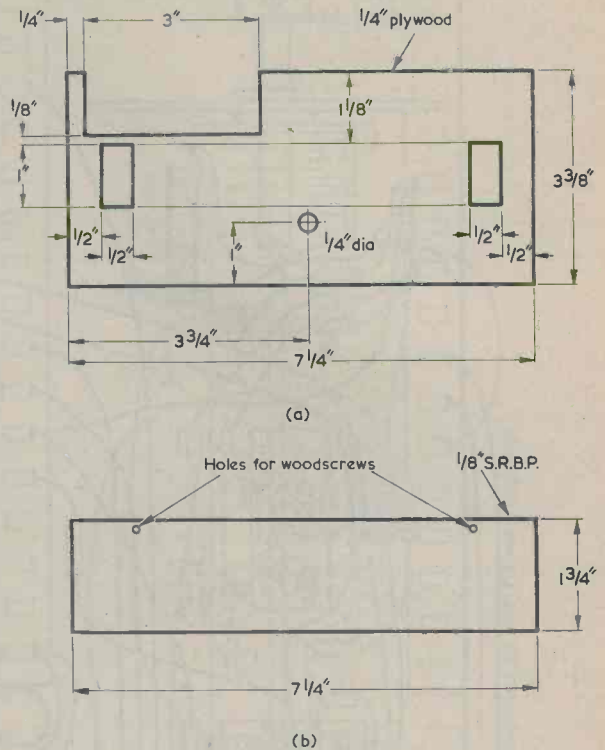

Fig. 11(a) The top section of the cover
(b) The cover has two sides attached to it. These have the dimensions shown here



When out of use, the telescopic aerial is stowed in the non-swivelling clamp and may then be employed as a carrying handle

will lie above the pointer and slot as shown in Fig. 9(f). Not shown in Fig. 11(a) is a $\frac{1}{2}$ in. hole through which the short wave telescopic aerial passes. Its position is found with the aid of the amplifier and short wave section.

When the cover is in place, the base of the telescopic aerial for the a.m.-f.m. tuner may be fitted to the swivel clip. The aerial acts as a carrying handle when the receiver is not in use by being fitted also into the other clip.

Current consumption from the PP3 battery is about 2 to 3mA only.

(Concluded)

Trade News . . .

"VELVET GRIP" HANDLES FOR ELLIOTT LUCAS '1000' RANGE PLIERS

James Neill Ltd., of Napier Street, Sheffield, S11 8NB announce that the ELLIOTT LUCAS '1000' range of pliers will now be supplied with red PVC "velvet grip" covering on the handles. There is no increase in price nor change of catalogue numbers.

The '1000' range of pliers are made from 'A' quality, high tensile steel and specially designed for use by electronics engineers, watchmakers and jewellers. The length is standard at 115mm (4½") and the slim styling, balance and light weight combine to produce the firm but sensitive touch so essential for intricate work.

The red "velvet grip" handles will give even greater control and also provide extra comfort for the user.

The '1000' range, which like all ELLIOTT LUCAS products are guaranteed for life, comprise end cutting & diagonal cutting nippers, flat nose, snipe & round nose pliers and snipe nose side cut-

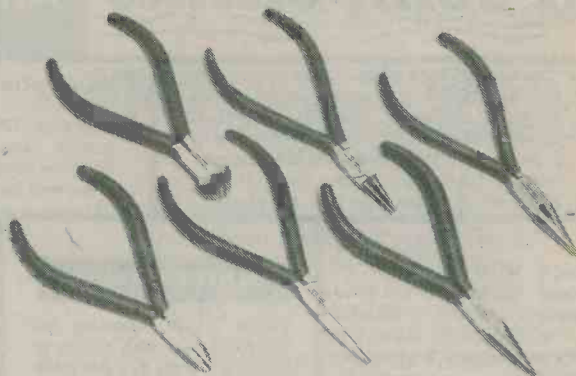

ting pliers. They are available individually or in sets of three or six in handy pocket wallets.

Individual price range is from £3.87 to £7.15 each including VAT.

CAGED NUT INSERTION TOOL

Insertion and removal of caged nuts in electronic equipment racking can be simplified using a new tool from Vero Electronics Limited. The unique tool easily and accurately locates the caged nuts in 19" racks, cabinets and enclosures, reducing assembly time of finished equipment by as much as 50%.

Easy to operate — the caged nut is placed in the jaws-end of the head with the spring clips of the nut facing outwards, squeezing the handle compresses the springs allowing the nut to be pushed into the aperture — the tool is designed for caged nuts to fit a standard 9.5mm (⅜") square aperture.

Priced at £2.67 each, the Caged Nut Insertion Tool may also be used for extraction.

Enquiries to Vero Electronics Limited, Industrial Estate, Chandler's Ford, Eastleigh, Hampshire S05 3ZR.

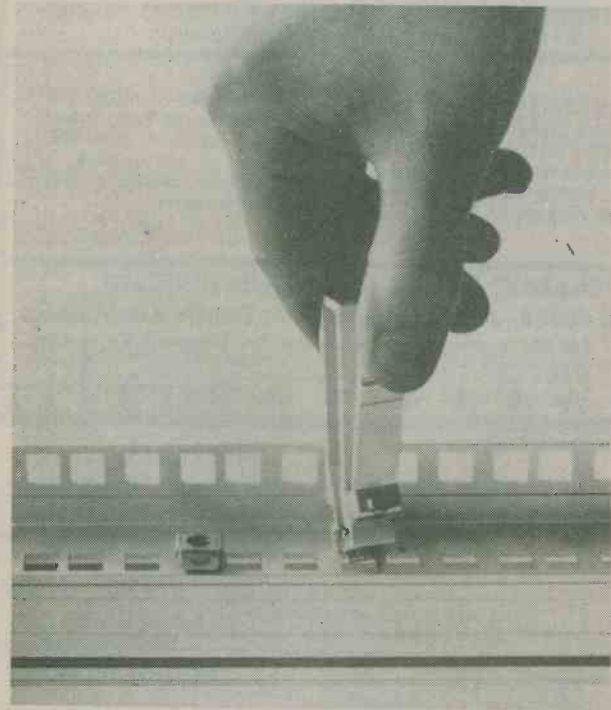

TUNE-IN TO PROGRAMS — Part 9

total amplitude is displayed ([GTO] [3]). The next press of the [R/S] key then increments the angle by 5° ([5] [SUM] [2]) and starts the calculation all over again. To draw the graph shape produced, we enter some convenient amplitude, such as 10, into store 0, and prepare a graph with 5° intervals of angle. Each result can then be entered up as it appears.

These programs have been briefly described, but there should be enough detail for you to follow what

continued from page 181

is going on if you are reasonably familiar with the formulae used in electronics. As for writing your own programs — only practice can help now. Reading other people's programs is interesting, but nothing beats the challenge of devising a program for yourself, debugging it, testing it, and making full use of it. Long may your subroutines loop smoothly!

(Concluded)

ELECTRONICS constructors

save money! with our: 'king size' packs of components

FREE with the first order opened this month, worth £15 — a Rockwell 24RD-11 — value £15.95

★ "Sticky problems solved super fast" with AVDEL BOND the wonder bond, cyanoacrylate adhesive. Bonds: ceramics, plastics, rubber etc; 2 grm phial only 70p or 2 phials for £1.25 (complete with instructions). P&P this item 10p (similar adhesives in shops cost 98p per phial).

* SAVE MONEY NOW ON CASSETTE TAPES

Academy C60 — Super low noise, hi-output, cassette tapes (ferric oxide) 2 x 30 mins recording/playing time. 5 for £3 (post and packing included).

★ **Special Offer** — Super ATZ C60 chromium dioxide, very low noise, hi-output cassette tapes of high quality, 2 x 30 mins recording/playing time. 5 for £5 (p&p included). These are quality tapes and normally sell at £1.20 each.

* **PACK X101:** Contains 35 mixed capacitors, all good usable values, i.e. 1,500pf / 0.01nf / 0.15nf / 0.4nf etc. 48p per pack or 2 packs for only 82p.

REALLY SUPER VALUE

* **PACK X102:** Contains 50 Germanium diodes, similar to OA90/91. Only 42p per pack or 2 packs for only 77p.

* **PACK X103:** Contains 30 mixed transistors, some new and branded NPN & PNP: silicon and Germanium (most usable). Great value at only 65p per pack or 2 packs for only £1.10.

REALLY SUPER VALUE

* **PACK X104:** Contains 50 silicon diodes, similar to 1N4148. A real bargain at 48p per pack or 2 packs for 80p.

REALLY SUPER VALUE

★ **PACK X105:** Contains 50 mixed wattage resistors. Really super value at only 45p per pack or 2 packs for only 80p.

* **PACK X106:** Contains 20 electrolytic capacitors, ideal for transistor circuits. Values like 10 Mfd / 50 Mfd / 220 Mfd / 100 Mfd at £1 per pack or 2 packs for £1.70.

★ **PACK X107:** Contains 20 ceramic caps, ideal for transistor AF/RF circuits. Values like 150 pf / 220 pf / 330 pf / 22 pf / 39 pf etc. Only 50p per pack or 2 packs for 85p.

REALLY SUPER VALUE

* **PACK X108:** Contains 10 full spec devices (transistors) NPN/any mix, you choose, i.e. BC107 / BC108 / BC109 at only 99p per pack. Too good to miss.

* **PACK X109:** Contains 50 full spec devices, i.e. IC's, transistors, diodes, power rec's, etc. like: 741/748 IC's — 1N4001 diodes, BFY50/BF167/BC172/BFR81/transistors plus germ and silicon diodes: OA81/1N914. Super snip at only £1.39 per pack.

★ **PACK X110:** Contains 25 brand new and tested diodes, i.e. 5 power types and 20 mixed types; i.e. power/zener/switching. All new at only 85p per pack.

* **PACK X111:** Contains 25 400MW zener diodes, like BZY88 / HS2027 / OAZ240. Too good to miss at the snip price of 68p per pack or 2 packs for only £1.22p.

★ **PACK XII2:** Contains 10 (slightly out of spec) mixed L.E.D.s, different sizes and colours, all are suitable. A really super bargain at only £1.29 per pack.

SIGTRONIC

★ELECTRONICS★

27 Malvern Street, Stapenhill, Burton-On-Trent, Staffs DE15 9DY
 TELEPHONE: (0283) 46848, after 6 p.m. for all SPECIAL ORDERS & QUOTATIONS
 All prices include V.A.T. — Add 50p to order for P & P. Cheques/Giro Cheques/P.O.'s accepted.
ORDERS FROM OVERSEAS WELCOME: — Please write stating your needs and we will confirm by return amount needed (Due to Exchange Control Currency Regulations)

BUILD YOUR OWN P.A., GROUP & DISCO SPEAKERS by R. F. C. Stephens
 Save money with this practical guide. Plans for 17 different designs, Line source, I.B., Horn and Reflex types, for 8"-18" drive units. £3.95 post free (\$8 overseas).

THE INFRA-BASS LOUDSPEAKER by G. Holliman
 (full constructional details for versions using 15", 12" and 10" drive units.) £2.95 post free (\$6 overseas).

THE DALESFORD SPEAKER BOOK by R. F. C. Stephens
 This book is a must for the keen home constructor. Latest technology DIY designs. Plans for I.B., and Reflex designs for 10-100 watts. Also unusual centre-bass system. £2.20 post free (\$5 overseas).

VAN KAREN PUBLISHING
 5 Swan Street, Wilmslow, Cheshire

Build 50 Interesting Projects on a P.C. Chassis with surplus components from your "Snares Box".

EXPERIMENTER'S PRINTED CIRCUIT KIT

Contents: 4 small boards to suit the enclosed designs, etching powder, resist paint, solvent, degreaser and etching instructions. Also 50 Circuit Diagrams, chassis plans and layouts for simple Crystal Sets, Transistor Receivers, Transmitters, Ring Radio Metal Detector, Radio Control, Ultrasonic Alarm, Intercoms, Amplifiers, Instruments, Gadgets, etc., you can build at negligible cost with 'surplus' or reclaimed parts and transistors you already have.
 Price: £1.70. Postage & pack. 30p

EXPERIMENTAL ELECTRONICS
 335 Battersea Park Road, London S.W. 11 4SL
 Send S.A.E. for full details of all kits and circuits

PHOTOELECTRIC KIT

A kit of basic parts to build a simple, I.R. sensitive photoelectric switch. Contents: phototransistor, transistors, diode, resistors, connector, relay chassis board, case, screws, rivets and full instructions. Also plans for Modulated-Light Alarms. Price: £4.50. Postage & pack. 60p.

OPTICAL KIT

A kit of parts of build an I.R. folded-beam projector and receiver to suit the above kit. Contents: 2 lenses, 2 mirrors, 2 45° blocks, infra-red filter, lampholder, building plans, etc. Price: £3.70. Postage & pack. 30p. Both kits together make an efficient Invisible Beam Burglar Alarm.

SMALL ADVERTISEMENTS

Rate: 12p per word. Minimum charge £2.00

Box No. 30p extra

Advertisements must be prepaid and all copy must be received by the 4th of the month for insertion in the following month's issue. The Publishers cannot be held liable in any way for printing errors or omissions, nor can they accept responsibility for the *bona fides* of Advertisers. Where advertisements offer any equipment of a transmitting nature, readers are reminded that a licence is normally required. (Replies to Box Numbers should be addressed to: Box No. —, **Radio and Electronics Constructor**, 57 Maida Vale, London, W9 1SN.

CONSTRUCT METAL DETECTORS: 1. £120 pulse discriminator (£12 construction cost). 2. £60 model (£6 con/cost). 3. £30 BFO (£3 con/cost). For all three together, written guaranteed d.i.y. plans, send £2. (Dept. RC), J. Lucas, 2 College Road, Grays, Essex. (Established 1973).

COMPLETE REPAIR INSTRUCTIONS for any requested TV, £5 (with diagrams £5.50). Any requested service sheet £1 plus s.a.e. S.a.e. brings free newsletter, details unique publications, vouchers and service sheets from 50p. AUSREC, 76 Church Street, Larkhall, Lanarkshire.

INTERESTED IN OSCAR? Then join AMSAT-UK. Newsletters, OSCAR NEWS Journal, prediction charts, etc. Details of membership from: Ron Broadbent, G3AAJ, 94 Herongate Road, Wanstead Park, London, E12 5EQ.

FOR SALE: Inverter, 12V d.c. to 240V a.c. Suitable running electric shaver, camping, boating, etc. £5.50. Box No. G355.

SOLAR CELLS: Bits, books and bargains. Send 95p for Solar Cell booklet and Data Sheets or stamp for list. — Edencombe Ltd., 34 Nathans Road, North Wembley, Middlesex HA0 3RX.

WANTED: Large and small quantities of transistors, I.C.'s displays, etc., etc. Call any Saturday to: 306 St. Paul's Road, London N.1. Telephone: 01-359 4224.

THE RADIO AMATEUR INVALID & BEDFAST CLUB is a well established Society providing facilities for the physically handicapped to enjoy the hobby of Amateur Radio. Please become a supporter of this worthy cause. Details from the Hon. Secretary, Mr. H. R. Boutle, 14 Queens Drive, Bedford.

FOR SALE: *Foundamentals of Radio Servicing* by B. W. Hicks, published by Hutchinsons Educational, £2.20 post paid. *Handbook of Satellites and Space Vehicles* by R. P. Haviland, £3.50 post paid. — Box No. G366.

P.C.B. DESIGN. Outline drawings, layouts, projects, for the constructor. Cost according to circuit complexity. D. G. Harrington, 25 Poynter Road, Bush Hill Park, Enfield, Middlesex.

RADIO, ELECTRONICS, TELEVISION BOOKS. Largest variety. Lowest prices. Write for list. Business Promotion Bureau, 376 Lajpat Rai Market, Delhi 110006, India.

AERIAL BOOSTERS — B11 VHF/FM Radio — B11A VHF 2 Metre Radio — B45 UHF Television. Price £5. S.A.E. for leaflets, Electronic Mailorder Ltd., Ramsbottom, Bury, Lancs. BL0 9AG.

WANTED: FAX equipment, manuals, service sheets, etc. G2UK, 21 Romany Road, Oulton Broad, Lowestoft, Suffolk. NR32 3PJ.

FOR SALE: Bush cassette tape recorder, battery driven. Microphone, etc. Excellent condition. £10 plus postage. Box No. G375.

(Continued on page 189)



Wilmslow Audio

THE firm for speakers!

SEND 30p FOR THE WORLDS BEST CATALOGUE OF SPEAKERS, DRIVE UNITS KITS, CROSSOVERS ETC. AND DISCOUNT PRICE LIST

AUDAX • AUDIOMASTER • BAKER • BOWERS & WILKINS • CASTLE • CELESTION • CHARTWELL • COLES • DALESFORD • DECCA • EMI • EAGLE • ELAC • FANE • GAUSS • GOODMAN'S • I.M.F. • ISOPON • JR • JORDAN WATTS • KEF • LEAK • LOWTHER • MCKENZIE • MONITOR AUDIO • PEERLESS • RADFORD • RAM • RICHARD ALLAN • SEAS • STAG • TANNAY • VIDEOTONE • WHARFEDALE • YAMAHA • SHACKMAN • TANGENT

WILMSLOW AUDIO DEPT REC

SWAN WORKS, BANK SQUARE, WILMSLOW
CHESHIRE SK9 1HF

Discount HiFi Etc. at 5 Swan Street

Tel: 0625-529599 for Speakers, 0625-526213 for HiFi

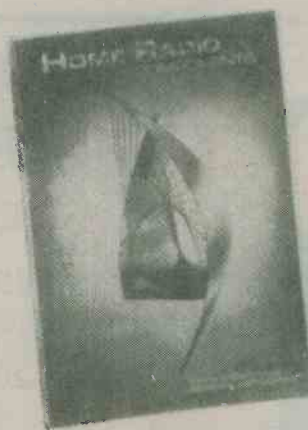

FIRST and STILL BEST

We've been producing our Electronics Components Catalogue for over 20 years. During that time we've learned a lot, not only in the art of catalogue production but in building a business that serves the needs of constructors. Little wonder that we have a reputation *second to none* for our catalogue — *and* for the service that backs it up. Experience both for yourself. Just send £1.30 with the coupon and a catalogue will come by return of post.

- About 2,500 items clearly listed and indexed.
- Profusely illustrated throughout.
- 128 A-4 size pages, bound in full-colour cover.
- Bargain list of unrepeatable offers included free.
- Catalogue contains details of simple Credit Scheme.

HOME RADIO (Components) LTD.
Dept. RC., 234-240 London Road, Mitcham, Surrey CR4 3HD

POST THIS COUPON
with cheque or P.O. for £1.30

Please write your Name and Address in block capitals

NAME

ADDRESS

HOME RADIO (Components) LTD., Dept. RC
234-240 London Road, Mitcham, Surrey CR4 3HD

Regd. No. 912966, London



THE MODERN BOOK CO

PROJECTS IN RADIO AND ELECTRONICS by I. R. Sinclair, Price £2.50

ELECTRONIC PROJECTS IN THE HOME
by O. Bishop Price £2.50

ELECTRONIC PROJECTS IN AUDIO
by R. A. Penfold Price £2.50

OP-AMPS THEIR PRINCIPLES & APPL.
by J. B. Dance Price £2.50

PRINTED CIRCUIT ASSEMBLY
by M. J. Hughes Price £2.10

ELECTRONIC SECURITY DEVICES
by R. A. Penfold Price £1.65

UNDERSTANDING DIGITAL ELECTRONICS
by Texas Inst. Price £4.00

UNDERSTANDING MICRO-PROCESSORS
by Motorola Price £4.30

THE FIRST BK OF MICROCOMPUTERS
by R. Moody Price £3.35

HOW TO BUILD YOUR OWN SOLID STATE OSCILLOSCOPE
by F. G. Rayer Price £1.70

THE OSCILLOSCOPE IN USE
by I. R. Sinclair Price £2.85

AMATEUR RADIO TECHNIQUES
by P. Hawker Price £3.80

THEORY & PRACTICE OF MODEL RADIO CONTROL
by P. Newell Price £4.50

REPAIRING POCKET TRANSISTOR RADIOS
by I. R. Sinclair Price £2.55

MAKING & REPAIRING TRANSISTOR RADIOS
by W. Oliver Price £2.30

WORLD RADIO TV HANDBOOK
by J. M. Frost Price £9.25

PROJECTS IN RADIO & ELECTRONICS
by I. R. Sinclair Price £2.50

ELECTRONIC PROJECTS IN THE HOME
by O. Bishop Price £2.50

SIMPLE CIRCUIT BUILDING
by P. C. Graham Price £2.20

110 SEMICONDUCTOR PROJECTS FOR THE HOME CONSTRUCTOR
by R. M. Marston Price £3.20

HAM RADIO
by K. Ulyyett Price £5.00

BEGINNER'S GUIDE TO DIGITAL TECHNIQUES
by G. T. Rubaroe Price £1.10

UNDERSTANDING SOLID-STATE ELECTRONICS
by Texas Inst. Price £1.80

A SIMPLE GUIDE TO HOME COMPUTERS
by S. Ditlea Price £4.00

HOW TO BUILD A COMPUTER-CONTROLLED ROBOT
by T. Loofbourrow Price £5.30

THE CATHODE-RAY OSCILLOSCOPE & ITS USE
by G. N. Patchett Price £4.00

HOW TO GET THE BEST OUT OF YOUR TAPE RECORDER
by P. J. Guy Price £1.90

A GUIDE TO AMATEUR RADIO
by P. Hawker Price £1.70

RADIO CONSTRUCTION FOR AMATEURS
by R. H. Warring Price £2.80

MAKING TRANSISTOR RADIOS A BEGINNER'S GUIDE
by R. H. Warring Price £2.90

1979 THE RADIO AMATEUR'S H/B
by A. R. R. L. Price £7.86

★ PRICES INCLUDE POSTAGE ★

We have the Finest Selection of English and American Radio Books in the Country
19-21 PRAED STREET (Dept RC) LONDON W2 1NP
 Telephone: 01-402 9176



UNDERSTAND DATA PROCESSING

NEW FOURTH EDITION

DATA PROCESSING, by Oliver & Chapman, is now in its Fourth Edition

200 pages 9 $\frac{3}{4}$ " x 6 $\frac{3}{4}$ " **PRICE £2.75**

P.&P. 40p

PUBLISHED BY D. P. PUBLICATIONS

The primary aim of this outstanding manual is to provide a simplified approach to the understanding of data processing — (previous knowledge of the subject is not necessary).

The 40 chapters and appendices cover the following topics: Introduction to Data Processing; Organisation and Methods; Conventional Methods; Introduction to EDP and Computers; Hardware; Computer Files; Data Collection and Control; Programming and Software; Flowcharts and Decision Tables; Systems Analysis; Applications; Management of EDP, etc.

A Manual for Business and Accountancy Students

Available from: **DATA PUBLICATIONS LTD.,**
57 MAIDA VALE, LONDON W9 1SN.

SMALL ADVERTISEMENTS

(Continued from page 187)

FOR SALE: "Challenge of the Stars" by Patrick Moore and David A. Hardy £2.00. "Destroyers" by Antony Preston £4.00. Box No. G376.

CONSTRUCTORS 200 mixed components £4. 30W soldering irons £2.60. Full refund guarantees. Lists 15p refundable. Mail only. Components bought. Sole Electronics, 37 Stanley Street, Ormskirk, Lancs.

'COLLECTORS' ITEMS. Nearly 50 copies of Radio Society of Great Britain's *Bulletins* covering period 1945 to 1949. In reasonable condition. Offers to: Box No. G377.

JOIN THE INTERNATIONAL S.W. LEAGUE. Free services to members including Q.S.L. Bureau, Amateur and Broadcast Translation, Technical and Identification Dept. — both Broadcast and Fixed Stations, DX Certificates, contests and activities for the SWL and transmitting members. Monthly magazine, *Monitor*, containing articles of general interest to Broadcast and Amateur SWLs, Transmitter Section and League affairs, etc. League supplies such as badges, headed notepaper and envelopes, QSL cards, etc., are available at reasonable cost. Send for League particulars. Membership including monthly magazines, etc., £6.00 per annum. (U.K. and British Commonwealth), overseas \$12.00. Secretary ISWL, 1 Grove Road, Lydney, Glos., GL15 5JE.

VHF/FM TRANSMITTER KIT. New silicon chip design means low price (beats anyone else) and better performance. Very small. Fully tuneable 88-108MHz. Instructions etc., all included. **INTRODUCTORY OFFER** £1.95 plus 30p P&P. (Unlicensable). M. Henry, 30 Westholme Gardens, Ruislip, Middlesex.

FOR SALE Gent's wrist watch, £20. Nurse watch, £12. Box No. G382.

FOR SALE: Copies of *Radio Constructor*, W.W., P.W., P.E., 1956 on, from 5p plus post. S.A.E. enquiries. 1 Hazel Grove, Yelverton, Devon, PL20 6DX.

WANTED: Telford Communications TC10 "Multimode" 2 metre transmitter. Details and price please to Box No. G383.

WANTED: WB. HF1016 speaker. State price. Burton, 24 Holly Road, Birmingham, B16 9NH. (Telephone: 021-454-2046).

POSTAL ADVERTISING? This is the Holborn Service. Mailing lists, addressing, enclosing, wrapping, facsimile letters, automatic typing, copy service, campaign planning, design and artwork, printing and stationery. Please ask for price list. — The Holborn Direct Mail Company, Capacity House, 2-6 Rothsay Street, Tower Bridge Road, London, S.E.1. Telephone: 01-407 6444.

FOR SALE: Metal Detector £10. S.a.e. for lists. Box No. G384.

PARCELS: 200 mixed components £4. 100 £2.75. 10 red LED's 125 90p. 100 mixed branded transistors, new, £2.50. 50 mixed untested i.c.'s 65p. Lists 15p. Sole, 37 Stanley Street, Ormskirk, Lancs., L39 2DH.

FOR SALE: Non-working video tape recorders, complete £50, incomplete £30 plus £6 carriage. Closed circuit cameras £45. Commodore Pet computer £500. Stereo cassette mechanisms £10 and £15. 25 2W zeners 50p. Box No. G385.

X-BAND SPECTRUM ANALYSER for sale or exchange for good multimeter. Telephone Swindon 751112.

DIGITAL MULTIMETER Doram. Cost £68. Also similar multimeter (Watford) £55. Offers, 4 Riversley Road, Gloucester, GL2 0QT.

SIGNAL INJECTORS (AF/RF) £2.50 with full instructions. Pin points faults in radios/amps. quickly. Or send s.a.e. for list of low priced test equipment. Bobker, 29 Chadderton Drive, Unsworth, Bury, Lancs.

(Continued on page 191)

A CAREER IN RADIO

Start training **today** and make sure you are qualified to take advantage of the many opportunities open to the trained person. ICS can further your technical knowledge and provide the specialist training so essential to success.

ICS, the world's most experienced home study college, has helped thousands of ambitious men to move up into higher paid jobs — they can do the same for **you**.

Fill in the coupon below and find out how!

There is a wide range of courses to choose from, including:

CITY & GUILDS CERTIFICATES	TECHNICAL TRAINING
Telecommunications Technicians'	ICS offer a wide choice of non-exam courses designed to equip you for a better job in your particular branch of electronics, including
Radio TV Electronics Technicians'	Electronic Engineering & Maintenance
Electrical Installations Technicians'	Computer Engineering/Programming
Electrical Installation Work	Radio TV & Audio Engineering & Servicing
Radio Amateurs'	Electrical Engineering, Installations & Contracting
MPT Radio Communications Cert.	
EXAMINATION STUDENTS —	
GUARANTEED COACHING	
UNTIL SUCCESSFUL	

COLOUR TV SERVICING

Technicians trained in TV Servicing are in constant demand. Learn all the techniques you need to service Colour and Mono TV sets through new home study course approved by leading manufacturer.

POST THIS COUPON OR TELEPHONE FOR FREE PROSPECTUS

I am interested in

Name Age

Address

Occupation

ICS

Accredited
by CACC
Member of
ARCC

To
International Correspondence Schools
Dept N278 Intertext House, LONDON
SW8 4UJ or phone 01-622 9911 (anytime)

COMPONENT PACKS

PU1: 50 untested, unmarked t.t.l. i.c.'s (mostly 7400 series) **65p**
PU2: Untested, unmarked silicon diodes, some germanium. Pack of 200 (approx.) **65p**

PT1: Tested, marked selection of popular diodes. Contains: 25 x 1N914, 10 x 1N4002, 5 x BY127 **125p**

PT2: Tested selection of popular electrolytic capacitors. Contains: 5 x 1µF, 5 x 4.7µF, 5 x 10µF, 3 x 100µF **150p**

PT3: Five 1/4W 5% resistors of each value from 10 Ω to 1M. Total of 305. Tested. **325p**

PT4: Stranded connecting wire. Five colours each 5 metres. **65p**

PT5: As pack PT4 but solid conductor. **65p**

BARGAIN SPOT

Whilst stocks last

Money refunded if unavailable
2,200µF 25V electrolytic **38p**
AD142 Transistor **30p**
S.P.S.T. Toggle switch **29p**

SEMICONDUCTORS

BC107	12p	7400	12p
BC108	12p	7402	12p
BC109	12p	7408	12p
BC182	12p	741	25p
BC183	13p	NE555	34p
BC184	13p	BY127	15p
BC212	10p	OA200	20p
BC214	10p	1N4002	6p

OPTO-ELECTRONICS

LEDs	0.125" 0.2"	each
Red	TIL209 FLV117	15p
Yellow	TIL211 FLV310	22p
Green	TIL213 FLV410	24p
Clips, either type, extra		2p
DL707 CA Display		90p

DIN PLUGS AND SOCKETS

	Plug	Socket
2-pin	7p	7p
3-pin	11p	9p
5-pin 180°	13p	10p
5-pin 240°	14p	11p

CABLE AND WIRE

	Price per metre
Single Microphone Cable	10p
Mains, 3A 3 core	15p
Twin Lighting Flex	6p

Mail order only. All prices include VAT. Please add 20p for postage (except component packs). Full list available on receipt of large s.a.e.

T. & J. ELECTRONIC COMPONENTS
98 Burrow Road, Chigwell, Essex IG7 4HB

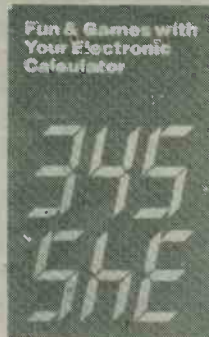
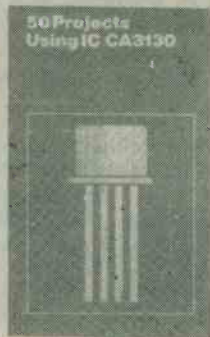
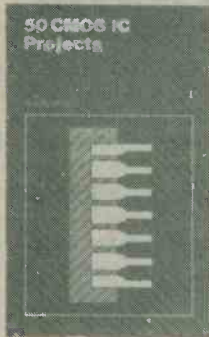

DIRECT READER SERVICE RADIO & ELECTRONICS BOOKS

- | | | | |
|---|-------|--|-------|
| 17. Solid State Power Supply Handbook | 85p | 35. Fun and Games with your Electronic Calculator | 75p |
| 18. 50 Projects Using IC CA3130 | 95p | 36. 50 (FET) Field Effect Transistor Projects | 1.25p |
| 19. 50 CMOS IC Projects | 95p | 37. 50 Simple L.E.D. Circuits | 75p |
| 20. A Practical Introduction to Digital IC's | 95p | 38. How to Make Walkie-Talkies | 1.25p |
| 21. How to Build Advanced Short Wave Receivers | 1.20p | 39. IC 555 Projects | 1.45p |
| 22. Beginners Guide to Building Electronic Projects | 1.25p | 40. Projects in Opto-Electronics | 1.25p |
| 23. Essential Theory for the Electronics Hobbyist | 1.25p | 41. Radio Circuits Using IC's | 1.35p |
| 24. Constructors Manual of Electronic Circuits for the Home | 50p | 42. Mobile Discotheque Handbook | 1.35p |
| 25. 79 Electronic Novelty Circuits | 75p | 43. Electronic Projects for Beginners | 1.35p |
| 26. 52 Projects Using IC741 | 95p | 44. Popular Electronic Projects | 1.45p |
| 27. How to Build Your Own Electronic and Quartz Controlled Watches & Clocks | 85p | 45. IC LM3900 Projects | 1.35p |
| 28. Two Transistor Electronic Projects | 85p | 46. Electronic Music and Creative Tape Recording | 1.25p |
| 29. How to Build Your Own Metal and Treasure Locators | 1.00p | 47. Practical Electronic Calculations and Formulae | 2.25p |
| 30. Electronic Calculator Users Handbook | 95p | 48. Radio Stations Guide | 1.45p |
| 31. Practical Repair and Renovation of Colour TVs (Reprinting) | 95p | 49. Electronic Security Devices | 1.45p |
| 32. Handbook of IC Audio Preamplifier and Power Amplifier Construction | 95p | 50. How to Build Your Own Solid State Oscilloscope | 1.50 |
| 33. 50 Circuits Using Germanium, Silicon and Zener Diodes | 75p | 51. 50 Circuits Using 7400 Series IC's | 1.45p |
| 34. 50 Projects Using Relays, SCR's and TRIACS | 1.10p | 52. Second Book of CMOS IC Projects | 1.50p |
| | | 53. Practical Construction of Pre-Amps, Tone Controls, Fitters & Attenuators | 1.45p |
| | | 54. Beginners Guide to Digital Techniques | 95p |

POSTAGE: 20p PER BOOK. IF MORE THAN 3 BOOKS ORDERED: 10p PER BOOK

To: Data Publications Ltd., 57 Maida Vale, London W9 1SN

Please send me within 21 days copy/copies

Book Nos:.....

.....

.....

I enclose Postal Order/Cheque for £

Name

Address

.....

(Block Letters Please)

(We regret this offer is only available to readers in the U.K.)

SMALL ADVERTISEMENTS

(Continued from page 189)

2 METRE FM MONITOR RECEIVER MODULE. PCB size 5 in. x 2½ in. 6 channel. Complete kit including prewound coils/transformers and ceramic filters £24.30. Matching scanner, 2 mode kit £7.90 inc. LED's. Receiver crystals £2.50 per channel. Details s.a.e. A. Bailey, G3WPO, 9 Alberta Walk, Worthing, Sussex.

INTERCOM/BABY ALARM. 50 ft. lead, volume control. Only £7.95. Refund guarantee. J. Harmsworth (RE2), 34 Victoria Street, Eccles, Maidstone, Kent.

PERSONAL

JANE SCOTT FOR GENUINE FRIENDS. Introductions to opposite sex with sincerity and thoughtfulness. Details free. Stamp to: Jane Scott, 3/Con North St Quadrant, Brighton, Sussex, BN1 3GJ.

FOR HELP with (elementary) Computer, statistical or technical mathematics, send query, s.a.e., paper, P.O. for 50p to: Box No. G380.

BROADLANDS RESIDENTIAL CLUB for elderly people. Are you recently retired and looking for a home? We have a delightful top floor room overlooking Oulton Broad, facing south. Write to: The Warden, Broadlands Residential Club, Borrow Road, Oulton Broad, Lowestoft, Suffolk.

IF YOU HAVE ENJOYED A HOLIDAY on the Norfolk Broads, why not help to preserve these beautiful waterways. Join the Broads Society and play your part in determining Broadlands future. Further details from: — The Hon. Membership Secretary, The Broads Society, "Icknield," Hilly Plantation, Thorpe St. Andrew, Norwich, NOR 85S.

CHI-KUNG for mental/physical health. Discover "Chi" - the life-force/bio-electricity in your body. Send stamp for your Free Literature. The Chi-Kung Society (REC39), 64 Cecil Road, London E13 0LR.

SPONSORS required for exciting scientific project Norwich Astronomical Society are building a 30" telescope to be housed in a 20" dome of novel design. All labour being given by volunteers. Already supported by Industry and Commerce in Norfolk. Recreational. Educational. You can be involved. Write to: NAS Secretary, 195 White Woman Lane, Old Catton, Norwich, Norfolk.

PLEASE MENTION

**RADIO &
ELECTRONICS
CONSTRUCTOR**

**WHEN REPLYING TO
ADVERTISEMENTS**

Random Electronic EASY DICE

Build your own 'EASY DICE' from the 5 intergrated circuits and full components supplied, including box and descriptive instructions.

Complete
or
Kit



PCB.
Layout

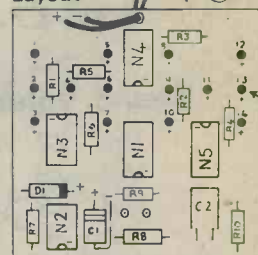

All you need is a soldering iron
TWO DICE FACES TOUCH CONTROL...

- a *Self Assemble Dice £3.95
- b *Ready built Dice £4.75 (INCL. P+P)

Order now from **Fringewood Electronics Ltd**
1 Hatton Court Ipswich Suffolk 0473-210151

Amount enclosed £ _____

Name _____

Address _____

please state amount required in appropriate box a b

REVOR OPTICAL & TECHNICAL

6 SICILIAN AVENUE
LONDON W.C.1
Tel. 01-836 4536

£14.91

**POST
FREE**

4" dia. lens

**FLEXIBLE
MAGNIFIER**

WITH CAST IRON BASE,
PRECISION GROUND AND
POLISHED LENS, CHROME PLATED
FRAME AND FLEXIBLE TUBE.
IDEAL FOR HOBBIES, AND
DETAILED WORK WHICH REQUIRES
BOTH HANDS FREE.

CALLERS WELCOME

(Subject to price ruling at the time of issue)

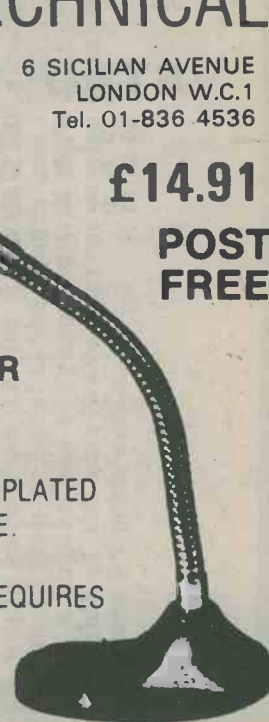

RADIO & ELECTRONICS CONSTRUCTOR

Single Copies

Price 50p each, p&p 15p

Issue(s) required

Annual Subscription

Price **£7.50 inland, £8.50 overseas (including Eire)**

post free, commence with.....issue

Bound Volumes:

Vol. 27. August 1973 to July 1974	Price £3.00 , post & pkg £1.05
Vol. 28. August 1974 to July 1975	Price £3.20 , post & pkg £1.05
Vol. 29. August 1975 to July 1976	Price £3.50 , post & pkg £1.05
Vol. 30. August 1976 to July 1977	Price £3.70 , post & pkg £1.05
Vol. 31. August 1977 to July 1978	Price £5.20 , post & pkg £1.05

CORDEX SELF-BINDERS

With title, 'RADIO & ELECTRONICS CONSTRUCTOR' on spine,
maroon only

Price **£1.95**, post & pkg 45p

With no title on spine, maroon

Price **£1.95**, post & pkg 45p

With no title on spine, green

Price **£1.95**, post & pkg 45p

Prices include V.A.T.

DATA BOOK SERIES

DB5 TV Fault Finding, 132 pages Price **£1.20**, P. & P. 22p

DB6 Radio Amateur Operator's Handbook,
New edition in course of preparation

DB17 Understanding Television, 504 pages Price **£3.95**, P. & P. 80p

DB19 Simple Short Wave Receivers Price **80p**, P. & P. 22p
140 pages

STRIP-FIX PLASTIC PANEL SIGNS

Set 3: Wording — White — 6 sheets Price **£1.00**, P. & P. 9p

Set 4: Wording — Black — 6 sheets Price **£1.00**, P. & P. 9p

Set 5: Dials — 6 sheets Price **£1.00**, P. & P. 9p

Prices include V.A.T.

I enclose Postal Order/Cheque for.....in payment for.....

NAME.....

ADDRESS.....

(BLOCK LETTERS PLEASE)

Postal Orders should be crossed and made payable to Data Publications Ltd.

Overseas customers please pay by International Money Order.

All publications are obtainable through your local bookseller

Data Publications Ltd., 57 Maida Vale, London W9 1SN

PLEASE MENTION THIS MAGAZINE WHEN WRITING TO ADVERTISERS

R.M.S. AND PEAK

The r.m.s. (root mean square) value of an alternating voltage is equal to that of a direct voltage producing the same heat dissipation in a resistance. With a sine wave, the r.m.s. value is 0.707 times the peak value.

To demonstrate this relationship, let us assume that we apply a sine wave alternating voltage of 1 volt peak across a 1Ω resistor. The voltage is shown in (a), and the consequent current in the resistor is shown in (b). Since the resistor has a value of 1Ω the peak current is 1 amp. (The plus and minus signs in (b) indicate different directions of current flow.)

The power dissipated in the resistor is shown in (c) and it has a peak value of 1 watt when both the voltage and current are at their peak values of 1 volt and 1 amp respectively. The power is always positive because heat is dissipated in the resistor regardless of the applied voltage polarity or direction of current flow.

Now it can be shown mathematically, and it is evident from visual inspection, that the power curve of (c) is symmetrical about a line drawn through the 0.5 watt level. The average power dissipated in the resistor is therefore 0.5 watt.

Power is equal to voltage squared divided by resistance and, had a direct voltage been applied to the resistor the direct voltage squared divided by 1 (for 1Ω) would have been 0.5 (for 0.5 watt). The direct voltage would then be equal to the square root of 0.5, or 0.707.

A similar line of reasoning will show that the r.m.s. value of the sine wave current is also equal to 0.707 times its peak value.

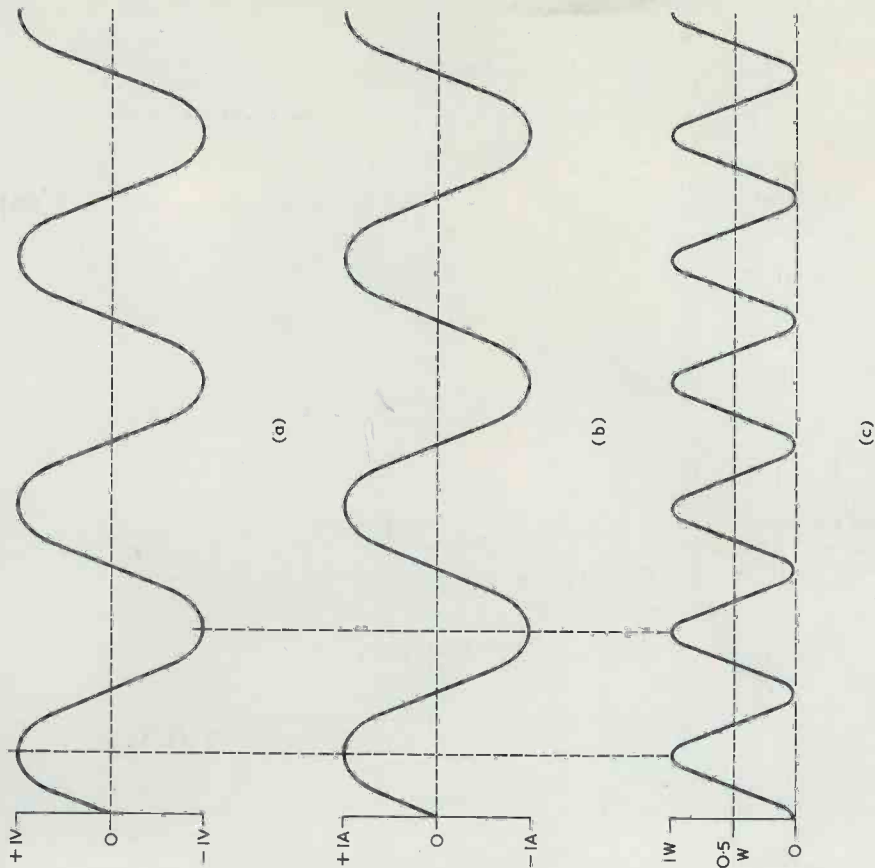

MAPLIN



A 63-key ASCII keyboard with 625-line TV interface, 4-page memory and microprocessor interface. Details in our catalogue.



Our catalogue even includes some popular car accessories at marvellous prices.



A 10-channel stereo graphic equaliser with a quality specification at an unbeatable price when you build it yourself. Full specification in our catalogue.



These are just some of the metal cases we stock. There are dozens of plastic ones to choose from as well. See pages 52 to 57 of our catalogue.



A massive new catalogue from Maplin that's even bigger and better than before. If you ever buy electronic components, this is the one catalogue you must not be without. Over 280 pages - some in full colour - it's a comprehensive guide to electronic components with hundreds of photographs and illustrations and page after page of invaluable data.

Our bi-monthly newsletter contains guaranteed prices, special offers and all the latest news from Maplin.



Mobile amateur radio, TV and FM aerials plus lots of accessories are described in our catalogue.



A digitally controlled stereo synthesiser the 5600S with more facilities than almost anything up to £3,000. Build it yourself for less than £700. Full specification in our catalogue.



A superb range of microphones and accessories at really low prices. Take a look in our catalogue - send the coupon now!



An attractive mains alarm clock with radio switching function and battery back up! Complete kit with case only £18.38 (incl. VAT & p & p) MA1023 module only £8.42 (incl. VAT).

Post this coupon now for your copy of our 1979-80 catalogue price 70p.

Please send me a copy of your 280 page catalogue. I enclose 70p (plus 37p p&p). If I am not completely satisfied I may return the catalogue to you and have my money refunded. If you live outside the U.K. send £1.35 or ten International Reply Coupons. I enclose £1.07.

NAME _____

ADDRESS _____

REC1179



A superb technical bookshop in your home! All you need is our catalogue. Post the coupon now!



A hi-fi stereo tuner with medium and long wave, FM stereo and UHF TV sound! Full construction details in our catalogue.



Add-on bass pedal unit for organs. Has excellent bass guitar stop for guitarists accompaniment. Specification in our catalogue.

MAPLIN

ELECTRONIC SUPPLIES LTD

All mail to:-
 P.O. Box 3, Rayleigh, Essex SS6 8LR.
 Telephone: Southend (0702) 554155.
 Shop: 284 London Road, Westcliff-on-Sea, Essex.
 (Closed on Monday).
 Telephone: Southend (0702) 554000.