

RADIO & ELECTRONICS CONSTRUCTOR

SEPTEMBER/OCTOBER 1977

40p

• The PRINCE •

PORTABLE
FM RADIO

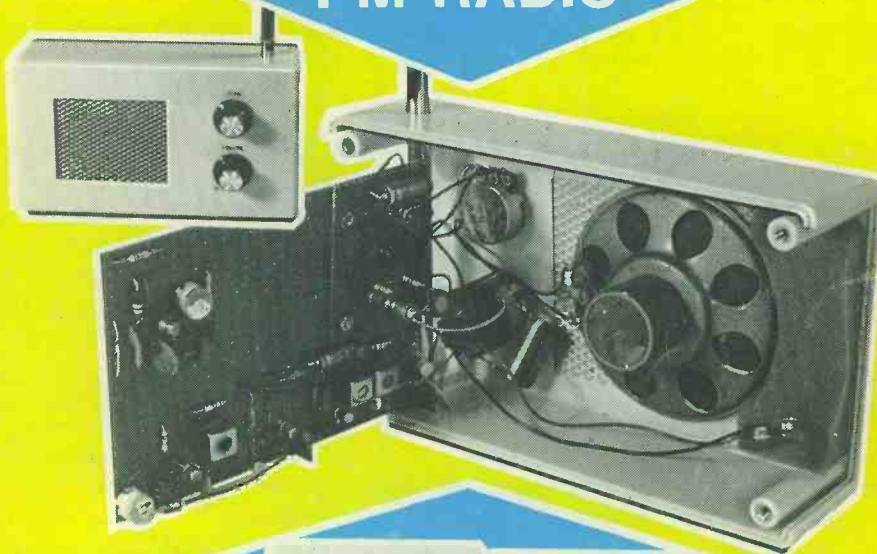

TRIAC LAMP DIMMER

**ALSO
FEATURED**

**MICROPHONE PRE-AMPLIFIER
RECENT TV DEVELOPMENTS**

— **Blob Board Series**

NOEL M. MORRIS

**SEMICONDUCTOR
DEVICES**

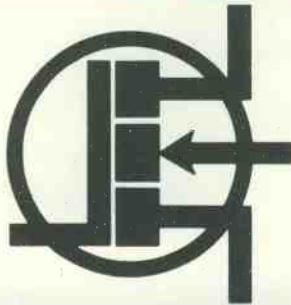

MACMILLAN BASIS BOOKS IN ELECTRONICS

SPECIAL OFFER

For a limited period

By arrangement with Messrs. MacMillan we are able to offer the above book at a special low price to readers of RADIO & ELECTRONICS CONSTRUCTOR.

Normal Price£4.35

SPECIAL OFFER PRICE..... £3.50

Saving 85p

Both prices include postage and packing

In this introduction to semiconductor devices, the author provides a comprehensive survey of modern active and non-active semiconductor technology. Without leaning too heavily on device physics, he explains device functions and then illustrates their use with typical circuits and applications.

Following a summary of the physical basis of semiconductor elements — in non-mathematical terms — a study of bipolar and field-effect transistors leads to considerations of monolithic integrated circuits. More advanced charge-coupled devices, semiconductor memories and optoelectronic devices are studied in some detail.

CONTENTS

1. Semiconductors
2. Basic Semiconductor Devices
3. Semiconductor Diodes and the Unijunction Transistor
4. Bipolar Junction Transistors, Amplifiers & Logic Gates
5. Field-Effect Transistors, Amplifiers and Logic Gates
6. Monolithic Integrated Circuits
7. Charge-coupled Devices
8. Semiconductor Memories
9. Thyristors and other Multilayer Devices
10. Optoelectronics

To: Data Publications Ltd., 57 Maida Vale, London W9 1SN

Please send me within 21 days copy/copies of

SEMICONDUCTOR DEVICES

1 enclose Postal Order/Cheque for £.....

Name

Address

(Block Letters Please)

(We regret this offer is only available to readers in the U.K.)

RADIO & ELECTRONICS CONSTRUCTOR

SEPTEMBER/OCTOBER 1977
Volume 31 No. 2

Published Monthly (1st of Month)
First Published 1947

Incorporating The Radio Amateur

Editorial and Advertising Offices
57 MAIDA VALE LONDON W9 1SN

Telephone
01-286 6141

Telegrams
Databux, London

© Data Publications Ltd., 1977. Contents may only be reproduced after obtaining prior permission from the Editor. Short abstracts or references are allowable provided acknowledgement of source is given.

Annual Subscription: £6.00 (U.S.A. and Canada \$12.00) including postage. Remittances should be made payable to "Data Publications Ltd". Overseas readers please pay by cheque or International Money Order.

Technical Queries. We regret that we are unable to answer queries other than those arising from articles appearing in this magazine nor can we advise on modifications to equipment described. We regret that such queries cannot be answered over the telephone; they must be submitted in writing and accompanied by a stamped addressed envelope for reply.

Correspondence should be addressed to the Editor, Advertising Manager, Subscription Manager or the Publishers as appropriate.

Opinions expressed by contributors are not necessarily those of the Editor or proprietors.

Production.—Web Offset.

TRIAC LAMP DIMMER by A. P. Roberts	76
NEWS AND COMMENT	80
MICROPHONE PRE-AMPLIFIER (Special Series Blob-a-job No. 4) by I. R. Sinclair	82
VINTAGE WIRELESS CATALOGUE	85
"HI-LO" VOLTAGE COMPARATOR (Suggested Circuit) by G. A. French	86
TRADE NEWS	89
OHMS-CONSCIOUS CONTINUITY TESTER by N. R. Wilson	90
SHORT WAVE NEWS—For DX Listeners by Frank A. Baldwin	92
KILOHMS AND MILLIAMPS (Notes For Newcomers) by D. Snaith	94
THE 'PRINCE' PORTABLE F.M. RADIO by R. A. Penfold	96
DR. E. F. W. ALEXANDERSON—Electronic Communications Pioneer — by Michael Lorant	103
OP-AMP LATCH by R. S. Carlman	106
RADIO TOPICS by Recorder	108
THE LARGEST "MOBILE" OPERATION OF ALL TIME by Ron Ham	110
IN YOUR WORKSHOP— Electronic Misconceptions	113
NEW PRODUCTS	119
RECENT TV DEVELOPMENTS—The "Phonovid"; The World's Most Sensitive Solid State TV Camera by Michael Lorant	120
ELECTRONICS DATA No. 26 (For The Beginner — The Silicon Controlled Rectifier)	iii

Published in Great Britain by the Proprietors and Publishers, Data Publications Ltd, 57 Maida Vale, London W9 1SN

The *Radio & Electronics Constructor* is printed by Swale Press Ltd.

THE NOVEMBER ISSUE
WILL BE PUBLISHED ON
3rd OCTOBER

BI-PAK High quality audio e

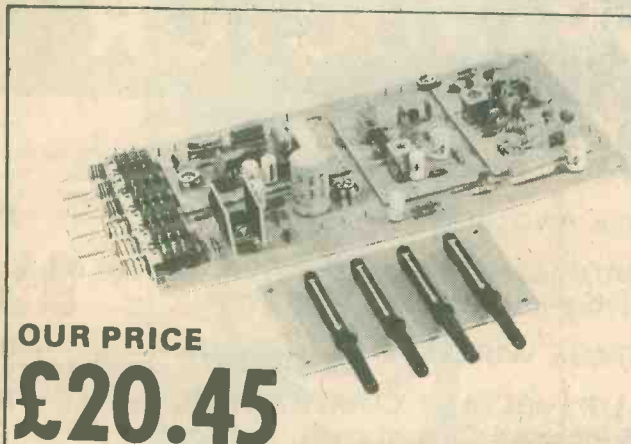

OUR PRICE
£20.45

The 450 Tuner provides instant program selection at the touch of a button ensuring accurate tuning of 4 pre-selected stations, any of which may be altered as often as you choose, by simply changing the settings of the pre-set controls.

Used with your existing audio equipment or with the BI-KITS STEREO 30 or the MK60 Kit etc. Alternatively the PS12 can be used if no suitable supply is available, together with the Transformer T461.

The S450 is supplied fully built, tested and aligned. The unit is easily installed using the simple instructions supplied.

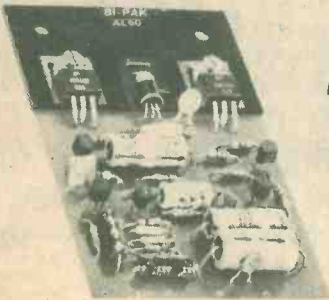

AL
60

VAT
ADD
12½%

25 Watts (RMS)

- Max Heat Sink temp 90C.
- Frequency response 20Hz to 100kHz
- Distortion better than 0.1 at 1kHz
- Supply voltage 15-50v.
- Thermal Feedback
- Latest Design Improvements
- Load - 3, 4, 5 or 16ohms.
- Signal to noise ratio 80db
- Overall size 63mm. 105mm. 13mm.

Especially designed to a strict specification. Only the finest components have been used and the latest solid-state circuitry incorporated in this powerful little amplifier which should satisfy the most critical A.F. enthusiast.

£4.35

Stabilised Power Supply Type SPM80

SPM80 is especially designed to power 2 of the AL60 Amplifiers, up to 15 watts (r.m.s.) per channel simultaneously. With the addition of the Mains Transformer BMT80, the unit will provide outputs of up to 1.5A at 35V. Size: 63mm. 105mm. 30mm. Incorporating short circuit protection.

Input Voltage: 33-40 V.A.C.
Output Voltage: 33V D.C. Nominal
Output Current: 10mA-1.5 amps
Overload Current: 1.7 amps approx.

Dimensions:
105mm x 63mm x 30mm
Transformer BMT80:
£5.30 + 86p postage

£3.75



PUSH-BUTTON STEREO FM TUNER

Fitted with Phase Lock-loop Decoder

- ☆ FET Input Stage
- ☆ VARI-CAP diode tuning
- ☆ Switched AFC
- ☆ Multi turn pre-sets
- ☆ LED Stereo Indicator

Typical Specifications
Sensitivity 3µ volts
Stereo separation 30db
Supply required 20-30v
at 90 Ma max.

STEREO PRE-AMPLIFIER PA 100



A top quality stereo pre-amplifier and tone control unit. The six push-button selector switch provides a choice of inputs together with two really effective filters for high and low frequencies, plus tape output.

Frequency response + 1dB
20Hz-20KHz

Sensitivity of inputs:

1. Tape Input 100mV into 100K ohms
2. Radio Tuner 100mV into 100K ohms

MK60 AUDIO KIT: Comprising: 2 x AL60. 1 x SPM80. 1 x PA100. 1 front panel and knobs. 1 Kit of parts to include on/off switch, neon indicator, stereo headphone sockets plus instruction booklet. COMPLETE PRICE £34.90 plus 62p postage.

TEAK 60 AUDIO KIT: Comprising: Teak veneered cabinet size 16½" x 11½" x 3½", other parts include aluminium chassis, heatsink and front panel bracket plus back panel and appropriate sockets etc. KIT PRICE £13.25 plus 82p postage.

3. Magnetic P.U. 3mV into 50K ohms
P.U. Input equalises to R1AA curve within 1dB from 20Hz to 20KHz. Supply - 20 - 35V at 20mA.
Dimensions:
299mm x 89mm x 35mm

£13.75

P.&P. 45p

STEREO 30 COMPLETE AUDIO CHASSIS



7+7 WATTS R.M.S.

The Stereo 30 comprises a complete stereo pre-amplifier, power amplifiers and power supply. This, with only the addition of a transformer or overwind will produce a high quality audio unit suitable for use with a wide range of inputs i.e. high quality ceramic pick-up, stereo tuner, stereo tape deck, etc. Simple to install, capable of producing really first class results, this unit is supplied with full instructions, black front panel, knobs, mains switch, fuse and fuse holder and universal mounting brackets enabling it to be installed in a record plinth, cabinets of your own construction or the cabinet available. Ideal for the beginner or the advanced constructor who requires Hi-Fi performance with a minimum of installation difficulty (can be installed in 30 minutes).

TRANSFORMER £3.25

plus 50p p&p

TEAK CASE £5.45 plus 70p p&p

£16.25

p. & p. 45p

Equipment mono and other modules for Stereo

**NOW BI-PAK
BRINGS YOU—
The AL80**

35^{RMS} w power Amp!

**ONLY
£6.95**
+ 8% VAT



A High Fidelity Power Amplifier with a maximum Power Output of 35 watt R.M.S., which has a maximum operating voltage of 60v. A MUST for all HI-FI users.

Maximum supply voltage	15-60v
Power output for 2% THD	35 watts R.M.S.
Harmonic distortion	0.1%
Load Impedance	3-8-16 ohm
Input Impedance	50K ohm
Frequency response +3dB	20Hz-40KHz
Sensitivity for 25 watts O/P	280mV R.M.S.
Max. Heat sink temperature	90°C
Dimensions	102mm x 64mm x 15mm
Mounting	2, 4BA fixing holes in heat sink
Fuse requirements	1.5A

**AND for those who need more
P-O-W-E-R**

AL250

125^{RMS} w

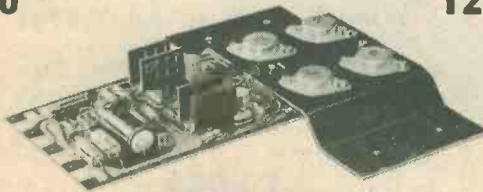

POWER AMP

**Specially designed for use in—
Disco Units, P.A. Systems, high power
Hi-Fi, Sound reinforcement systems**

SPECIFICATION:

Output Power: 125 watt RMS Continuous	Total harmonic distortion 50 watts into 4 ohms: 0.1% 50 watts into 8 ohms: 0.06%
Operating voltage: 50-80	S/N ratio: better than 80dBs
Loads: 4-16 ohms	Damping factor, 8 ohms: 65
Frequency response: 25Hz- 20kHz Measured at 100 watts	Semiconductor complement: 13 transistors 5 diodes
Sensitivity for 100 watts output at 1kHz: 450mV	Overall size: Heatsink width 190mm, length 205mm, height 40mm
Input impedance: 33K ohms	

ONLY £15.95 +8% VAT

**MPA
30**



Enjoy the quality of a magnetic cartridge with your existing ceramic equipment using the new BI-PAK M.P.A. 30 which is a high quality pre-amplifier enabling magnetic cartridges to be used where facilities exist for the use of ceramic cartridges only. Used in conjunction are 4 low noise high gain silicon transistors. It is provided with a standard DIN input socket for ease of connection. Supplied with full, easy-to-follow instructions.

£2.85

**VAT
ADD
12½%**

**POSTAGE &
PACKING**

Postage & Packing add 25p unless otherwise shown. Add extra for airmail. Min. £1.00

**NEW
AL30A**

10w R.M.S. AUDIO AMPLIFIER MODULE

The AL30A is a high quality audio amplifier module replacing our AL20 & 30. The versatility of its design makes it ideal for use in record players, tape recorders, stereo amps, cassette & cartridge players. A power supply is available comprising of PS12 together with a transformer T538, also for stereo, the pre amp PA12.

SPECIFICATION:

- Output Power 10w R.M.S.
- Load Impedance 8 to 16 ohms
- Sensitivity 90mV for full output
- Frequency Response 60Hz to 25KHz - 2db
- Supply 22 to 32 volts
- Input Impedance 50K
- Total Harmonic Distortion less than .5% (Typically .3%)
- Max Heat Sink Temp 80°C
- Dimensions 90 x 64 x 27mm

ONLY £3.65

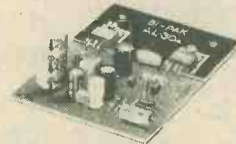

**NEW PA12
£6.70**

NEW PA12 Stereo Pre-Amplifier completely redesigned for use with AL30A Amplifier Modules. Features include on/off volume, Balance, Bass and Treble controls. Complete with tape output.
Frequency Response 20Hz-20KHz (-3dB)
Bass and Treble range ±12dB
Input Impedance 1 meg ohm
Input Sensitivity 300mV
Supply requirements 24V. 3mA
Size 152mm x 84mm x 33mm

PS12

Power supply for AL30A, PA12, S450 etc. Input voltage 15-20v A.C. Output voltage 22-30v D.C. Output Current 800 mA Max. Size 60mm x 43mm x 26mm.

Transformer T538 £3.20

£1.30

BI-PAK

Dept. C. 10 P.O. BOX 6 WARE HERTS

COMPONENT SHOP: 18 BALDOCK STREET, WARE.

Detecknowledghey

Detecknowledghey - the survey of metal locator theory and principles of operation. £1 post paid.

Bionic Ferret 4000 - the VCO system detector with Fe/NonFe discrimination, meter, loudspeaker, low power drain and high sensitivity. Price now, reduced due to volume of demand to £34.26 (inc PP & VAT)

More details in catalogue - demonstrations available

TOKO MFL455 Sideband Mechanical Filter:

SSB filter with 2.1kHz 6dB BW. By popular demand, we now offer this superbly smooth sideband filter - designed for receiver or generator applications. With input/output matching transformers: only £9.95.

Convert our EF5801 to an ultra hi-gain 2m converter: Crystal locked oscillator - details SAE please .

Radio Control and Short Wave Coils

Ambit is pleased to announce the addition of sets of specially designed TOKO coils for applications in model radio control and shortwave receivers, to our unique range of coils and filters.

- 7E High stability IFs for 455-470kHz, 1st, 2nd and 3rd IFs in three basic impedance ranges. 33p each unit or 75p per set of three. Full details in catalogue.
- 7KN High stability RF coils for 27MHz band. Spiral wound units with tap and secondary windings. 33p each.
- 10K Coils for short wave, new leaflet available, or see catalogue.

New modular Elektrick Wireless

7122 -A three stage tuned superhet AM radio module, with 80dB AGC, varicap tuning, ceramic IF filter, meter output. For LW, MW, and now short wave - with the correct coil pack. Not band switched, but using a separate module for each desired band. Better than 10uV sensitivity, and a new easy DIY approach to radio building. SAE for full info. Each module (inc. varicaps and coil pack) £9.00 -kit.

91198 -A three stage tuned AM/NBFM receiver module, being a refined version of above, with mechanical IF, MOSFET RF, NBFM discriminator (for afc), audio notch filter, separate oscillator, provision for 'pi' network input at (with varicaps). Again, not bandswitchable, so as to optimize each module for its specific tuning range. Kit £15.75 each.

Components as previously advertized, including

CA3089	1.94	EF5800	6cct tunerhead FM	14.00
MC1310	2.20	EF5801	as 5800 with osc op	17.45
TBA120	0.75	EC3302	3cct varicap tunerhead	7.50
TBA120S	1.00	7030	linear phase IF system	10.95
uA753	1.80	91196	top spec decoder	12.99
HA1137	2.20	92310	1310 decoder & filter	6.95
HA1196	3.75	91197	varicap MW/LW tuner	11.35
uA720	1.40	7252	LARSHOLT FM tuner set for mono with mosfet head	26.50
TBA651	1.81	7253	FET stereo tuner set	26.50
HA1197	1.40			
LM380	1.00			
LM381	1.81			
LM3900*	0.75			
TDA2020	2.99			
TCA940	1.80			
TBA810S	1.09			
ICL8038C	4.50			
NE561B*	3.50			
NE566B*	2.50			
NE567*	2.50			
uA723*	0.80			
MEM616*	0.57			
MEM680*	0.75			
BF256S	0.34			
MVAM series				
2	1.35			
115	0.95			
125	0.90			
BB104	0.45			

We would like to say more, but space has run out. Please remember p&p (25p) and VAT (12½% except where *) The catalogue has much new info since April. The new sheets will be sent on receipt of an A4 SAE. Or 40p for the complete catalogue and information package. SAE with ALL enquiries please. Callers welcome.

AMBIT INTERNATIONAL wireless specialists
2 Gresham Road, Brentwood, Essex. CM14 4RH
telephone (0277) 216029

NOW AVAILABLE . . .

LATEST BOUND VOLUME No. 29

of

"Radio & Electronics Constructor"



AUGUST 1975 to JULY 1976

Comprising

776 pages

inc. index

PRICE £3.10 P&P 90p

BOUND VOLUME No. 27
(August 1973 to July 1974)

BOUND VOLUME No. 28
(August 1974 to July 1975)

PRICES

VOL. 27

£2.40 per volume P&P 90p

VOL. 28

£2.75 per volume P&P 90p

Limited number of these
volumes still available.

We regret all earlier volumes are now
completely sold out.

Available only from

DATA PUBLICATIONS LTD.,
57 MAIDA VALE, LONDON, W9 1SN

DeC-IT and BLOB-IT

Been Blob-a-jobbing? The Blob-a-job circuits were designed on DeCs — the solderless breadboards for circuit tryouts. Want to try other circuits? Build them on a DeC, try them, alter them, get them right. Now take each component in turn from the DeC and solder it on to the matching Blob-Board. So quick, so simple, just DeC-It and Blob-It. S-DeCs have 14 groups of contacts, match D range of Blob-Board. T-DeCs have 38 groups of contacts, can take 1 Dii IC and match 1-IC Blob-Board. U-DeCs have 43 groups of contacts, can take 2 Dii Ics and match 2-IC Blob-Boards. All DeCs can be clipped together to give multiple units.

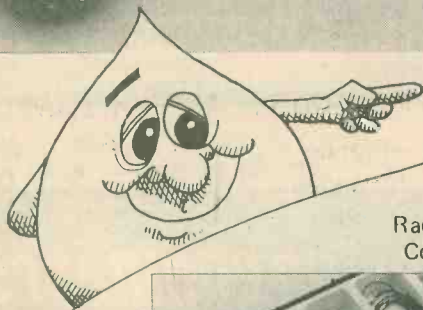
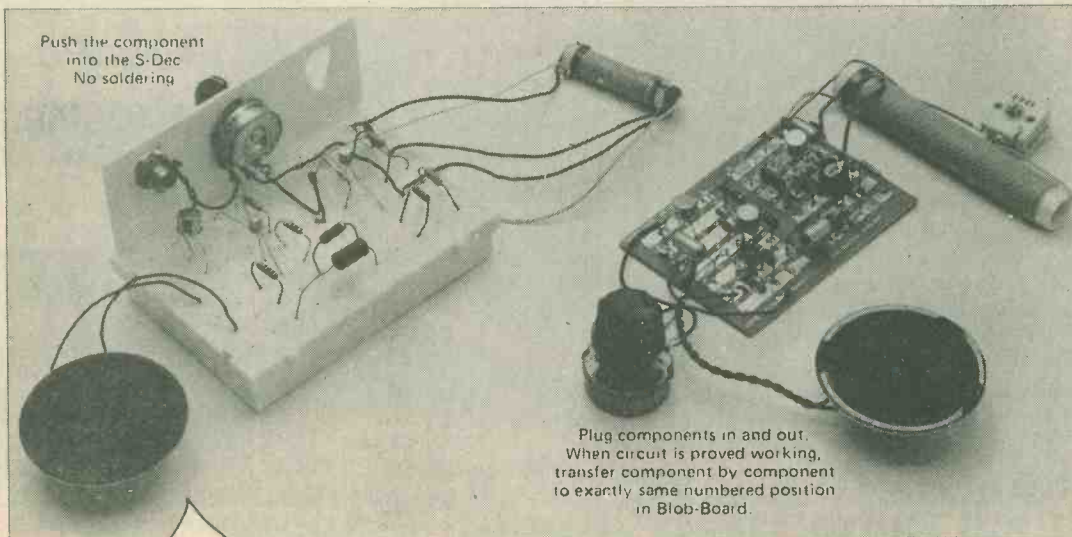

"DeCs and Blob Boards both allow you to re-use your components. Why not try several circuits on the DeC and then solder up the one you like best on Blob-Board".

As a special offer to
Radio and Electronics
Constructor readers



S-De-K-IT

The perfect kit for beginners, students, professionals and all users of discrete components. This S-De-K-IT contains 1 S-DeC + control panel, 9 Blob-Boards, 20 double ended Leads + Instruction book to build (no components) Electronic Flasher + Binary Counter + LC Oscillator + 3 Stage Amplifier, Morse Practice Oscillator, Radio Receiver, Radio-Microphone, Light Operated Switch, CR Oscillator, Wien Network Oscillator, S-De-K-IT complete in ABS box, with component tray

Normally £6.38 only £4.95 + £1.00 Post and VAT

NB The discrete components to build the above S-De-K-IT are listed but not supplied. This is because using discrete or surplus components you can buy all the components very cheaply from your local component supplier.



P.B. Electronics (Scotland) Ltd.
57 High Street, Saffron Walden, Essex. CB10 1AA England
Telephone: Saffron Walden (0799) 22876 Telex: 817185.

THE MODERN BOOK CO

RADIO COMMUNICATION HANDBOOK by R.S.G.B. Vol 1 Price: £9.00 Vol 2 Price: £8.00

MAKE THE MOST OF YOUR
POCKET CALCULATOR

by L. Jansson PRICE: 95p

THE POCKET CALCULATOR GAME
BOOK

by E. Schlossberg PRICE: £1.10

ADVANCED APPLICATIONS FOR
POCKET CALCULATORS

by J. Gilbert PRICE: £3.90

INTRODUCTION TO COMPUTERS

by K. London PRICE: £1.35

BUILD YOUR OWN WORKING ROBOT

by D. L. Helserman PRICE: £3.80

INTRODUCTION TO MICRO-
PROCESSORS

by D. Asplnall PRICE: £5.30

MICROPROCESSORS/MICRO-
PROGRAMMING HANDBOOK

by B. Ward PRICE: £4.00

UNDERSTANDING MICRO-
PROCESSORS

by Motorola PRICE: £3.75

T.V. ENGINEERS' POCKET BOOK

by P. J. McGoldrick PRICE: £5.10

COLOUR T.V. PICTURE FAULTS

by K. J. Bohlman PRICE: £2.80

COLOUR T.V. WITH PART REF. TO
THE PAL SYSTEM

by G. N. Patchett PRICE: £5.80

THE CATHODE-RAY
OSCILLOSCOPE & ITS USE

by Patchett PRICE: £3.90

THE OSCILLOSCOPE IN USE

by I.R. Sinclair PRICE: £2.80

SERVICING WITH THE
OSCILLOSCOPE

by G. J. King PRICE: £4.95

BASIC ELECTRONICS I-V

Schools Council PRICE: £7.60

BEGINNER'S GUIDE TO

ELECTRONICS

by T. L. Squires PRICE: £2.80

OP-AMP CIRCUIT DESIGN &

APPLICATIONS

by J. Carr PRICE: £3.90

99 ELECTRONIC PROJECTS

by H. Friedman PRICE: £2.85

110 OPERATIONAL AMPLIFIER

PROJECTS FOR THE HOME

CONSTRUCTOR

by R. M. Marston PRICE: £2.80

T T L COOKBOOK *

by D. Lancaster PRICE: £8.80

ELECTRONIC CLOCKS & WATCHES

by M. Robbins PRICE: £5.00

BEGINNER'S GUIDE TO AUDIO

by I. R. Sinclair PRICE: £3.00

IMPROVING YOUR HI FI

by J. Earl PRICE: £3.85

CASSETTE TAPE RECORDERS

by J. Earl PRICE: £5.20

RADIO CONSTRUCTION FOR

AMATEURS

by R. H. Warring PRICE: £2.75

STEREO F.M. RADIO HANDBOOK

by P. Harvey PRICE: £2.90

RADIO SERVICING POCKET BOOK

by V. Capel PRICE: £3.25

ILLUST. TEACH YOURSELF RADIO

by D. Gibson PRICE: £1.90

FOUNDATIONS OF WIRELESS &

ELECTRONICS

by M. G. Scroggie PRICE: £4.40

THE PRACTICAL AERIAL HANDBOOK

by G. J. King PRICE: £8.20

RADIO & AUDIO SERVICING

HANDBOOK

by G. J. King £5.45

WORLD RADIO TV HANDBOOK

by J. M. Frost PRICE: £5.70

THE RADIO AMATEUR'S

HANDBOOK 1977

by A.R.R.L. PRICE: £6.70

PRICES INCLUDE POSTAGE

We have the Finest Selection of English and American Radio Books in the Country
19-21 PRAED STREET (Dept RC) LONDON W2 1NP

Telephone 01-723 4185

NEW for electronic design engineers!

FIX-PRINT for printed circuits

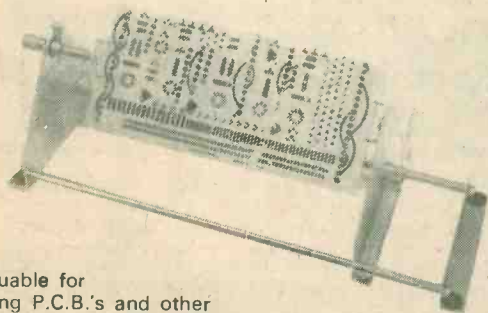

Invaluable for holding P.C.B.'s and other panels when inserting and soldering components. Can be adjusted to suit work up to 280mm, rotating to gain access to reverse side and locks in any position. All metal.

Price **£10** inc. VAT. p&p £1

Write or phone for full details

S2 Drill Stand

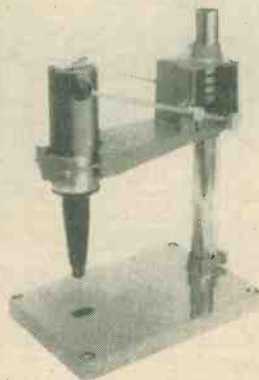

Robust, all metal with ample throat dimensions. Adjustable height cantilever with lever actuated feed. Spring return. Will accept both P1 & P2 drills
Price **£18.50** inc. VAT. p&p 106p

S1 Drill Stand

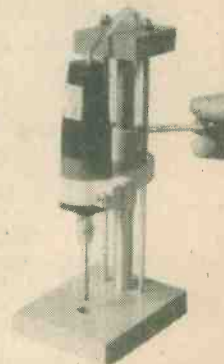

Constructed to take the popular P1 drill and ensure a high degree of accuracy in all types of electrical precision work.
Price **£5.13** inc. VAT. p&p 38p



PRECISION PETITE LTD

119a HIGH STREET TEDDINGTON MIDDLESEX TW11 8HG

TEL: 01-977 0878

A NEW 60 WATT R.M.S AMPLIFIER FROM Stirling Sound

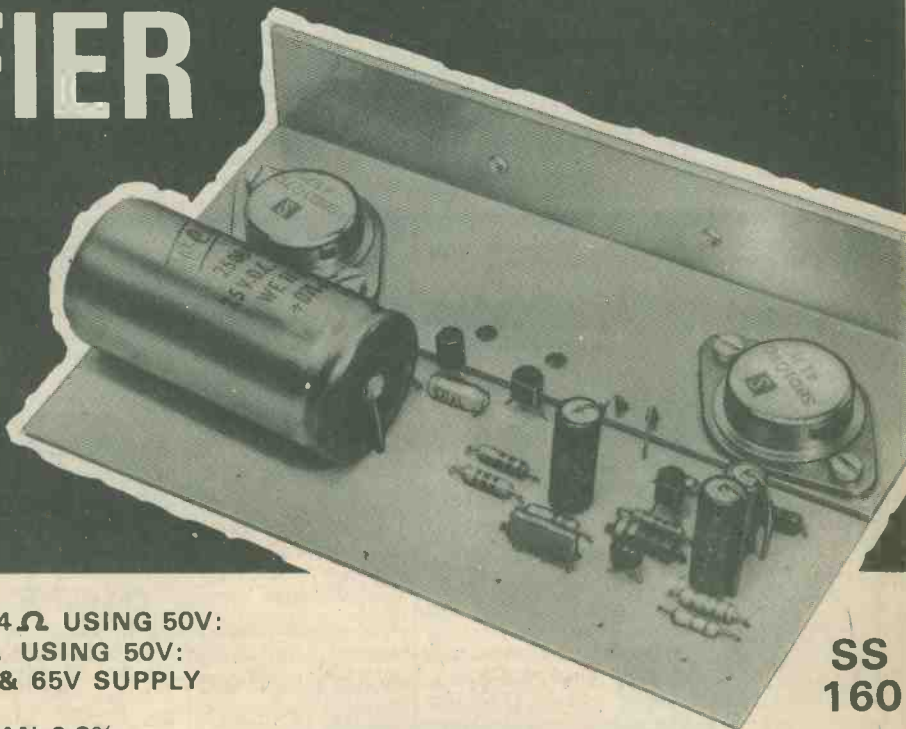

**SS
160**

- A COMPLETELY NEW DESIGN
- 60 WATTS R.M.S. (± 1 dB) INTO 4Ω USING 50V:
35 W.R.M.S. (± 1 dB) INTO 8Ω USING 50V:
- WILL OPERATE BETWEEN 20 & 65V SUPPLY
(Output varies accordingly)
- T.H. DISTORTION BETTER THAN 0.3%
(Typically 0.1%)
- FREQUENCY RANGE 10 TO 50,000Hz.
—3dB AT 10Hz: —3dB at 50kHz
- INPUT 300mV FOR FULL OUTPUT

It's another winner! from Stirling Sound

Coming between SS.140 and SS.1100 the new SS.160 fills a gap in power amplifier modules (3 to 100 watts r.m.s.) that will particularly please those wanting a not-so-big disco or P.A. system as well as those with speakers needing plenty of power to drive them. With circuitry developed around a self-centering mid-rail, excellent results will come also from using as little as 20 volts supply. (Power output will vary accordingly). Because we use heavy duty components able to operate beyond our claimed specifications; you can buy and build with confidence. YOUR SS.160 IS READY NOW AND WE HAVE EVEN MADE A NEW POWER SUPPLY UNIT (SS.360) SPECIALLY FOR IT.

£8.50 POST FREE Large finned heatsink
INCL VAT Post free inc VAT **75p**

Special Stirling Sound Offer

Bought separately SS. 160 costs £8.50, SS. 360 £12.75, heatsink 75p (total — £22.00). Buying all three together (post free and inc VAT) it costs you only **£21**

And the SS.1100 money saver

SS.1100 — £10.50; SS.370 — £14.75; Large finned heatsink — £1.50 (total — £26.75). Buying all three together (post free and inc VAT) saves you £2.00 — at **£24.75**

USE COUPON TO AVOID DELAY

TO STIRLING SOUND, 37 Vanguard Way, Shoeburyness, Essex.

Please Supply

For which I enclose £.....(or by Access or Barclaycard)

Name

Address

REC 9

MORE STIRLING SOUND MODULES

POWER AMPS

All outputs rated in watts, R.M.S. ± 1 dB.

SS. 103 3W/one I.C./mono	£2.85
SS. 103-3 Stereo of above/2 I.C.s	£5.00
SS. 105 5W/3/13.5V	£3.95
SS. 110 10W/4/24V	£4.65
SS. 120 20W/4/34V	£5.15
SS. 140 40W/4/45V	£6.50
SS. 160 60W/4/50V	£8.50
SS. 1100 100W/4/70V	£10.50

TONE CONTROL/PRE-AMPS

SS. 100 Active st./bass/treble	£3.00
SS. 101 St. Pre-Amp for ceramic P.U.	£2.75
SS. 102 St. P.A. for mag. P.U.	£4.45
UNIT ONE St. P.A./tr./Bass/Vol/Bal.	£9.00

UNIT TWO as Unit One but for mag. P.U.s **£12.50**

FM. STEREO DECODER

SS. 203 Phase lock loop with LED	£5.25
----------------------------------	-------

THE POWER SUPPLY UNIT YOU WANT IS HERE

All except SS.312 and SS.300 are fitted with low volt (13-15V) take off points for pre-amps, tuners etc.

SS.312	12V/1A	£6.60
SS.318	18V/1A	£6.95
SS.324	24V/1A	£7.65
SS.334	34V/2A	£8.75
SS.345	45V/2A	£9.98
SS.350	50V/2A	£11.75
SS.360	60V/2A	£12.75
SS.370	70V/2A	£14.75

SS.310/50 Stabilised unit, variable 10V to 50V/2A **£16.89**

SS.300 Add-on Stabilising unit 10-50V adjustable **£5.02**

PAY ONLY THE PRICE YOU READ AND NO MORE

All prices quoted include V.A.T. and goods are sent post free in U.K. Owing to the time between sending our advertisement to this journal and its appearing to the public, prices may be subject to alteration without notice. E.&O.E.

Stirling Sound

37 VANGUARD WAY, SHOEBURYNNESS, ESSEX

Telephone: Shoeburyness (03708) 5543

SHOP: (open all day Saturdays) 220-224 West Road,
Westcliff-on-Sea, Essex SS0 9DF. (0702 351048)

TRADE COMPONENTS

JUST A FEW BARGAINS ARE LISTED - SEND STAMPED ADDRESSED ENVELOPE FOR A QUOTE ON OTHER REQUIREMENTS. PAY A VISIT. OVER 90% OF STOCK BELOW QUANTITY WHOLESALE PRICE. ALL PRICES INCLUDE THE ADDITIONAL DISCOUNT IN LIEU OF GUARANTEE. MINIMUM ORDER GOODS VALUE £1.00.

Goods sent at customer's risk, unless sufficient payment for registration (1st class letter post) or compensation fee (parcel post) included.

VALVE BASES	
Printed circuit B9A-B7G	5p
Chassis B7-B7G	9p
Shrouded chassis B7G-B9A-B8A	10p
Octal chassis B12A tube	10p

Speaker 6" x 4" 5 ohm ideal for car radio 70p

TAG STRIP - 6 way	
3p	5 x 50pF or 2 x 220pF
9 way 5p	Single 1p trimmers

BOXES - Grey polystyrene 61 x 112 x 31mm, top secured by 4 self tapping screws 32½p

Clear perspex sliding lid, 46 x 39 x 24mm 10p
ABS, ribbed inside 5mm centres for P.C.B., brass corner inserts, screw down lid, 50 x 100 x 25mm orange 48p; 80 x 150 x 50mm black 70p; 100 x 185 x 60mm black £1.10

ALUMINIUM			
2½" x 5¼" x 1½"	45p	10" x 4½" x 3"	£1.02
4" x 4" x 1½"	45p	4" x 2¾" x 1½"	45p
		12" x 5" x 3"	£1.20

SWITCHES			
Pole	Way	Type	
4	2	Sub. Min. Slide	18p
6	2	Slide	20p
1	3	13 amp rotary	6p
2	1 (or 1p 2W)	Micro with roller	20p
2	3	Miniature Slide	16p

S.P.S.T. 10 amp 240v. white rocker switch with neon. 1" square flush panel fitting 20p
 S.P.S.T. dot 13 amp, oblong, push-fit, rocker 15p

Siddeen/AFA Very High Security barrel Key Switch. 2 tubular keys £1.50

AUDIO LEADS	
3 pin din to open end, 1½ yd twin screened	35p
Phono to Phono plug, 6ft.	35p

COMPUTER & AUDIO BOARDS/ASSEMBLIES
 VARYING CONTENTS INCLUDE ZENER, GOLD BOND, SILICON, GERMANIUM, LOW AND HIGH POWER TRANSISTORS AND DIODES, HI STAB RESISTORS, CAPACITORS, ELECTROLYTICS, TRIMPOTS, POT CORES, CHOKES ETC.
 3lb for 85p + £1.00 post and packing
 7lb for £1.95 + £1.40 post and packing

1k horizontal preset with knob	3" Tape Spools 3p
	1" Terry Clips 4p
	12 Volt Solenoid 30p

TV KNOB
 Dark grey plastic for recessed shaft (quarter inch) with free shaft extension 5p

ENM Ltd. cased 7-digit counter 2½ x 1½ x 1¼" approx. 12V d.c. (48 a.c.) or mains 75p

ZM1162A INDICATOR TUBE
 0-9 Inline End View. Rectangular Envelope 170V 2.5M/A £1

REGULATED TAPE MOTOR
 9v d.c. nominal approx 1½" diameter 60p

3.5mm metal stereo plug 20p

Ferric Chloride, Anhydrous mil. spec. 1lb bag 40p

Whiteley Stentorian 3 ohm constant impedance volume control way below trade at 80p
 RS Yellow Wander Plug Box of 12 25p
 18 SWG multicore solder 2½p foot

Car type panel lock and key 40p
 18 volt 4 amp charger, bridge rectifier 79p
 GC10/4B £3.00

Aluminium Knobs
 for ½" shaft. Approx. 5/8" x 7/8" with indicator Pack of 5. 50p

RESISTORS
 ¼-½ watt 1p
 1 watt 2p
 Up to 15 watt wire wound 6p
 1 or 2% five times price.
 Cinch 8 way std 0.15 pitch edge connector 20p
 Semiconductor Data Book 171 pages. Covers Japanese types 25A12 through to 2SD335. Type/connection/parameter details £1.50
 No VAT

POTS
 Log or Lin, single or dual, switched carbon or wire-wound, rotary or slider. All types 16p
 1.5m Edgetype 3p

Skeleton Presets
 Slider, horizontal or vertical standard or submin. 5p

THERMISTORS
 VA1008, VA1034, VA1039, VA1040, VA1055, VA1066, VA1082, VA1100, VA1077, VA1005, } 15p

RELAYS
 12 volt S.P.C.O octal mercury wetted high speed 40p
 P.O. 30J0 type, 1,000 OHM coil, 4 pole c/o 40p
 Mains or 12v d.p.c.o heavy duty octal 50p
 700 Ohm 11-31 volt min. field d.p.d.t. 80p

JAP 4 gang min. sealed tuning condensers 20p

ELECTROLYTICS MFD/VOLT. Many others in stock							
Up to 10V				200-300-450-250V 350V 500V			
10	4p	5p	6p	8p	10p	12p	16p 20p
25	4p	5p	6p	8p	10p	15p	18p 20p
50	4p	5p	6p	9p	13p	18p	25p
100	5p	6p	10p	12p	19p	20p	—
250	9p	10p	11p	17p	28p	—	85p £1
500	10p	11p	17p	24p	45p	—	—
1000	13p	22p	40p	75p	—	£1.50	—
2000	23p	37p	45p	—	—	—	—

As total values are too numerous to list, use this price guide to work out your actual requirements
 8/20. 10/20, 12/20 Tubular tantalum 20p each
 16-32/275V. 100-100/150V. 100-100/275V 30p;
 50-50/385V. 12,000/12V, 32-32-50/300V, 20-20-20/350V 60p; 700 mfd/200V £1.00; 100-100-100-150-150/320V £2.00.

RS 100-0-100 micro amp null indicator Approx. 2" x ¾" x ¾" £1.50

INDICATORS
 Bulgin D676 red, takes M.E.S. bulb 30p
 12 volt or Mains neon, red pushfit 18p
 R.S. Scale Print, pressure transfer sheet .10p

CAPACITOR GUIDE - maximum 500V
 Up to .01 ceramic 3p. Up to .01 poly 4p.
 .013 up to .1 poly etc. 5p. .12 up to .68 poly etc. 6p. Silver mica up to 360pF 8p, then to 2,200pF 11p, then to .01 mfd 18p.
 8p. 1/600; 12p. 01/1000, 8/20. 1/900. 22/900, 4/16. 25/250 AC (600vDC) 40p.
 5/150, 10/150, 40/150.
 Many others and high voltage in stock.

FORDYCE DELAY UNIT
 240 volt A.C./D.C. Will hold relay, etc., for approx. 15 secs after power off. Ideal for alarm circuits, etc. £1

CONNECTOR STRIP
 Belling Lee L1469, 4 way polythene, 6p each
 1½ glass fuses 250 m/a or 3 amp (box of 12) 6p
 Bulgin, 5mm Jack plug and switched socket (pair) 30p
 Reed Switch 28mm. body length 5p

Aluminium circuit tape, ¼" x 36 yards—self adhesive. For window alarms, circuits, etc. 60p

MAINS DROPPERS
 66+66+158 ohm, 66-66+137 ohm 5p
 17+14-6 ohm, 266+14+193 ohm 5p
 285+575+148+35 ohm }
 25+35+97+59+30 ohm }

5½" x 2½" Speaker, ex-equipment 3 ohm 30p
 2 Amp Suppression Choke 8p
 3 x 2½ x 1½" } PAXOLINE 4p
 4½ x 1½ x 1½" } 1p
 PCV or metal clip on MES bulb Holder 4p
 VALVE RETAINER CLIP, adjustable 2p

OUTPUT TRANSFORMERS
 Sub-miniature Transistor Type 25p
 Valve type, 40p

STYLII 15p
 ER55B/5MX/HC1/HC2/ER2. Compact X2/X/C/SX. Garrard
 GCM21T/22T/GKM24T/GKS25/GP59. B.S.R. C1/FX1M/
 ST3/CS80/TC8/OP and T, and many other sapphire types.
 Send sample required with payment and s.a.e if in doubt.

KEY EDIT and display boards with up to 132* 12V bulbs, 38 d.t.l. and t.t.l. i.c.'s and other components. (*A few bulbs may be broken). £2.00 plus 75p p&p

Crouzet 30-minute timer-programmer, multi-variable contacts £6.00 plus £1.00 p&p

ACOS DUST JOCKEY record Automatic cleaner £1.00

Wood cased 8-12V buzzer £1.50 plus 80p p&p

McMurdo 8 or 12 or 18-way plug and socket, ex-equipment 36p

THE RADIO SHACK
 161 ST. JOHNS HILL, BATTERSEA, LONDON S.W.11
 Open 10 a.m. till 7 p.m. Tuesday to Saturday. VAT receipts on request.
 Terms: Payment with order Telephone: 01-223 5016

POSTAL ORDERS means quicker service — unless a fee is paid for special clearance it is 15 days from banking to ensure cheques are not returned 'unpaid'. Postal order postage charge is offset by it now costing you 16p (reference Barclays Bank June 1977) bank charges on every cheque written out.

SEMICONDUCTORS

Full spec marked by Mullard, etc. Many other types in stock

AC128/176	8p	BCX32.36	12p	BFW10/11 F.E.T.	40p
ACY28	19p	BCY40	50p	BFW30	£1
AD149	40p	BCY70/1/2	12p	BFW57/58	17p
AF116	161p	BD113	50p	BFX12/29/30	20p
AF124/6/7	25p	BD115/6	31p	BFX84/88/89	17p
AF139	20p	BD131/2/3	35p	BFY50/51/52	13p
AF178/80/81	30p	BD135/6/7/9	30p	BFY90	50p
AF239	30p	BD140/142	30p	BR101	30p
ASY27/73	30p	BD201/2/3/4	80p	BRY39/56	25p
BC107/8/9 + A/B/C	6p	BD232/4/5/8	49p	BSV64	30p
BC147/8/9 + A/B/C/S	6p	BDX77	£1	BSV79/80 F.E.T.s	80p
BC157/8/9 + A/B/C	6p	BD437	50p	BSV81 Mosfet	90p
BC178A/B, 179B	12p	BF115/167/173	15p	BSX20/21	14p
BC184C/LC	9p	BF178/9	15p	BSY40	27p
BC186/7	20p	BF180/1/2/3/4/5	15p	BSY95A	12p
BC213L/214B	10p	BF194/5/6/7	6p	CV7042 (OC41/44 ASY63)	5p
BC261B	8p	BF194A, 195C	6p	GET111	40p
BC327/8, 337/8	8p	BF200, 258, 324	20p	ON222	20p
BC647/8/BA/BC	10p	BF202/3	30p	TIP30/3055	45p
BC555/6/7/8/9	9p	BF336	27p	TIS88A F.E.T.	23p
		BFS28 Dual Mosfet	£1	ZTX300/341	7p

2N2401	30p
2N2412	70p
2N2483	23p
2N2904/5/6/7/7A	15p
2N3053	14p
2N3055 R.C.A.	50p
2N3704	8p
2N3133	20p
2N4037	34p
2N5036 (Plastic 2N3055)	30p
2SA141/2/360	31p
2SB136/6/467	20p
40250 (2N3054)	30p

OTHER DIODES

1N916	6p
1N4148	2p
BA145	14p
Centercel	24p
BZV61/BA148	10p
BB103/110 Varicap	15p
BB113 Triple Varicap	37p
BA182	13p
OA5/7/10	15p
BZY88 Up to 33 volt	7p
BZX61 11 volt	15p
BR100 Diac.	15p

BRIDGE RECTIFIERS

Amp	Volt	Part	Price
1	1,600	BYX10	30p
1	140	OSH01-200	26p
1.4	42	BY164	40p
0.6	110	EC433	6p
6	400	Texas	90p

NEW B.V.A. VALVES

EB91	34p
ECL80	34p
PCC84	34p

TRANSFORMER
Ferromag C core. Screen-95-105-115-125-200-220-240v
Input: output 1.7v $\frac{1}{2}$ A x 2 + 24-0-24v 1.04A + 20v
1mA. These current ratings can be safely exceeded by 50%.
£3.50 + £1.00 p&p.

WOODS 240V A.C.
Approx. 2,500 r.p.m.
continuous rated 5 or 6in. FAN (ex-computer)
£3.60 plus £1 p&p

INTEGRATED CIRCUITS

TAA700	£2.00
TBA800	£1.00
741 8 pin d.i.l. op.	24p
SN76013N	£1.20
TAD100 AMRF	£1
CA3001 R.F. Amp	50p
CD4013 CMOS	36p
TAA300 1wt Amp	£1
TAA550 Y or G	22p
TAA263 Amp	65p
7400	10p
7402/4/10/20/30	14p
7414	56p
7438/74/86	24p
7483	69p
LM300, 2-20 volt	£1
74154	90p
TBA550Q	£1.50

RECTIFIERS

Amp	Volt	Part	Price
1	4/6/800	5p	
1	1,250	5p	
1	1,500	18 1/2 p	
1.5	100	7p	
1.5	400	8p	
1.5	1,250	14p	
2	30	10p	
2.5	300	40p	
2.5	600	45p	
2.5	900	50p	
2.5	1,200	55p	
2.5	300	26p	
3	600	35p	
3	900	40p	
3	1,200	52p	
6	300	40p	
6	600	50p	
6	900	60p	
6	1,200	80p	
10	150	35p	
10	300	45p	
10	500	55p	
10	300	30p	
10	600	65p	
10	900	80p	
10	1,200	95p	
15	300	£1.00	
15	400	£1.50	
15	500	£1.75	
15	600	£2.00	
25	200	60p	
40	300	£1.75	
40	1,200	£2.50	

OPTO ELECTRONICS

Diodes

TIL209 Red	12p
BPX40	50p
BPX42	80p
BPY10	80p

(VOLIAC)

BPY69	80p
BPY68	
BPY77	

Photo transistor

BPX29	80p
OCF71	34p

BiG.L.E.D. 0.2"
2v 50mA max.
ORANGE 14p
YELLOW 14p
RED 14p

PHOTO SILICON CONTROLLED SWITCH BPX66 PNP 10 amp £1.00

3" red 7 segment L.E.D. 14 D.I.L. 0-9+D.P. display 1.9v 10mA segment, common anode 61p

Minitron 3" 3015F filament £1.10

COY11B L.E.D.
Infra red transmitter £1
One fifth of trade

Plastic, Transistor or Diode Holder 1p
Transistor or Diode Pad 1p
Holders or pads 50 pper 100

Philips Iron Thermostat 15p
MoMurdo PP108 8 way edge plug 10p

TO3 HEATSINK
Europlec HP1 TO3B individual 'curly' power transistor type. Ready drilled 12p

Tested unmarked, or marked ample lead ex new equipment

ACY17-20	8p	OC200-5	8p
ASZ20	8p	TIC44	24p
ASZ21	30p	QG240	£1
BC186	11p	2G302	5p
BCY30-34	8p	2G401	5p
BCY70/1/2	8p	2N711	25p
BY126/7	4p	2N2926	4p
HG1005	10p	2N598/9	6p
HG5009	3p	2N1091	8p
HG5079	3p	2N1302	8p
L78/9	3p	2N1907	£1
M3	10p	Germ. diode 1p	
OA81	3p	GET120 (AC128 in 1" sq. heat sink	15p
OA47	3p	GET872	12p
OA200-2	3p	2S3230	30p
OC23	20p		

KLAXON 12-24v 2-tone transistorized Alarm Sounder. Note, pitch and duration variable. Weatherproof alloy case.
£10.00 p&p £1.30

THYRISTORS

Amp	Volt	Part	Price
1	240	BTX18-200	30p
1	400	BTX18-300	35p
1	240	BTX30-200	30p
15	500	BT107	£1
6.5	500	BT101-500R	90p
6.5	500	BT109-500R	£1.00
20	600	BTW92-600RM	£3.00
15	800	BTX95-800R Pulse Modulated	£8.00
30	1000	28T10 (Less Nut)	£3.00

PAPER BLOCK CONDENSER

0.25MFD	800 volt	30p
1MFD	250 volt	15p
2MFD	250 volt	20p
4MFD	250 volt	20p

I.C. extraction and insertion tool 32p

CHASSIS SOCKETS
Car Aerial 9p, Coax 3p, 5 pin 180° 9p, 5 or 6 pin 240° din 6p, speaker din switched 5p, 3.5 mm switched 5p, stereo jack enclosed 10p.

CRAZY OFFERS

2000 mfd.	50v	16p
2500 mfd.	40v	30p
8 mfd.	500v	6p
400 mfd.	16v	4p
.1 mfd.	350/500v	13p
.1 mfd.	1500v	2p
2200 mfd.	25v	30p
1000 mfd.	200v	25p
10000 mfd.	15v	12p
1250 mfd.	35v	10p
6800 mfd.	10v	6p
32+32 mfd.	275v	8p
16+32 mfd.	350v	12p
8+8 mfd.	350v	8p
150 mfd.	35v	4 1/2 p
100 mfd.	70v	4 1/2 p
1 mfd. non-polar	350v	3p
680 mfd.	100v	10p
15 mfd.	160v	3p
4700 pf. sub min	500v	1 1/2 p
4700 mfd.	63v	70p
250 mfd.	300v	16p
4700 mfd.	40v	35p
25000 mfd.	25v	20p
1000 mfd.	63v	30p
1500 mfd.	70v	16p
500 mfd.	150v	16p
250 mfd.	50v	5p
12000 mfd.	12v	12p

G.E.C. 5% Hi-stab capacitors .013, .056, .061, .066, .069, .075, .08, .089 2p each

Push-to-Break or Push-to-Make Panel Switch 24p

ENAM. COPPER WIRE
SWG. PER YD.
24 3p
26 to 42 2.5p

GARRARD
GCS23T Crystal Stereo Cartridge, 66p
Mono (Stereo compatible), Ceramic or crystal 60p

HANDLES
Rigid light blue nylon 6 1/2" with secret fitting screws 5p

Belling Lee white plastic surface coax outlet box 20p

Miniature Axial Lead Ferrite Choke formers 2p

RS.10 Turn Pot 1%
250, 500 Ω , 1K, 50K £1

Copper coated board 10" x 9" approx 25p

TIE CLIPS
Nylon self locking 3 1/2" 2p

Geared Knob 8-1 ratio 1 1/2" diam, black 70p

KLIPPON 25A 440v
TERMINAL BLOCKS professional leaf spring clamp, strip of 12 for 15p or twin with clip-over cover 7p

SMALL ORDERS, ENCLOSE SUITABLE STAMPED ADDRESSED ENVELOPE
LARGE ORDERS, ADD SUFFICIENT FOR POSTAGE, PACKING, INSURANCE, ETC.
TOTAL GOODS PLUS CARRIAGE, ADD V.A.T.

MAIL ORDER CUSTOMERS ONLY ADD 8% VAT-I PAY BALANCE ON 12 1/2% ITEMS ALL ENQUIRIES, ETC., MUST BE ACCOMPANIED BY A STAMPED ADDRESSED ENVELOPE

DIRECT SUPPLY SERVICE TO READERS

TOWERS INTERNATIONAL TRANSISTOR SELECTOR

TOWERS INTERNATIONAL FET SELECTOR

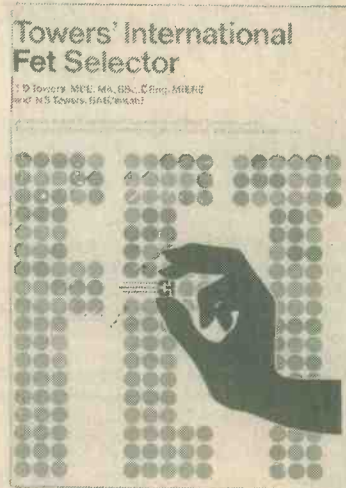

NEW
REVISED
EDITION

This is dead! 

Would this replace it?

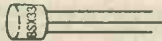

If it takes you longer than 1 minute to find out all about these transistors then you need a copy of TOWER'S INTERNATIONAL TRANSISTOR SELECTOR. Its one of the most useful working books you will be offered this year. And probably the cheapest!

In it you will find a really international selection of 13,000 transistor types — British, Continental European, American and Japanese. And we think that they will solve 90% of your transistor enquiries.

Current and widely used obsolete types were carefully selected and arranged in Numero-Alphabetical order by an author who was uniquely qualified to do the job. With his compendium, all you need to know is the type number and you can learn all about a transistor's specification; who made it and where to contact them; or what to use to replace it.

Price **£5.00** inc P&P

If you deal with field effect transistors, or fet's — whether as a student, a hobbyist, a circuit engineer, a buyer, a teacher or a serviceman — you often want data on a specific fet of which you know only the type number.

Specifications apart, you may be even more interested in where you can get the device in question. And perhaps more important still (particularly with obsolete devices), you may want guidance on a readily available possible substitute.

This fet compendium, a comprehensive tabulation of basic specification, offers information on:

1. Ratings
2. Characteristics
3. Case details
4. Terminal identifications
5. Applications use
6. Manufacturers
7. Substitution equivalents (both European and American)

The many fet's covered in this compendium are most of the more common current and widely-used obsolete types.

It is international in scope and covers fet's not only from the USA and Continental Europe, but also from the United Kingdom and the Far East (Japan).

Price **£4.00** inc P&P

(Please allow 21 days for delivery)

Tower's International Transistor Selector by **T. D. Towers** MBE, MA, BSc, C Eng, MIERE **£5.00** inc. post and packing

To:—DATA PUBLICATIONS LTD.
57 MAIDA VALE
LONDON W9 1SN

Please send me copy/copies to the address shown below

NAME

ADDRESS

.....(Block capitals)

Tower's International FET Selector by **T. D. TOWERS** MBE, MA, BSc, C Eng, MIERE **£4.00** inc. post and packing

To:—DATA PUBLICATIONS LTD.
57 MAIDA VALE
LONDON W9 1SN

Please send me copy/copies to the address shown below

NAME

ADDRESS

.....(Block capitals)

HOME RADIO....
How could I ever forget them?



Yes, I remember it well — Home Radio supplied all the parts for me to make this little project. It's an 8-transistor radio you know. Mind you, this was some time ago, and when a certain doggie got in on the act I rather lost interest.

However, we elephants never forget, and when I returned to the hobby, why bless me, there was good old Home Radio busier than ever dishing out components. And today? Well, have you seen their fabulous catalogue? It's jumbo size — and I should know! It's crammed with all the things the amateur constructor is bound to need. With each catalogue they give a bargain list of unrepeatable offers. Another thing — they have a wonderful credit scheme, simple to join, and it enables members to order by phone. Now, when I need components I just put through a trunk call (get it?) and they're sent off without delay. Why not join the club? You'll need a catalogue first. It has over 200 pages, lists over 5,000 items, with nearly 2,000 illustrations. The cost? A modest £1 plus 40p for packing and postage.

Send the coupon today — now, before you forget!

Please write your Name and Address in block capitals

NAME

ADDRESS

HOME RADIO (Components) LTD., Dept. RC
 234-240 London Road, Mitcham, Surrey CR4 3HD
 Regd No 912966 London

POST THIS COUPON
 with cheque or p.o. for
£1.40

HOME RADIO (Components) LTD. Dept. RC, 234-240 London Road, Mitcham, CR4 3HD. Phone: 01-648 8422

Electronics for nuts...

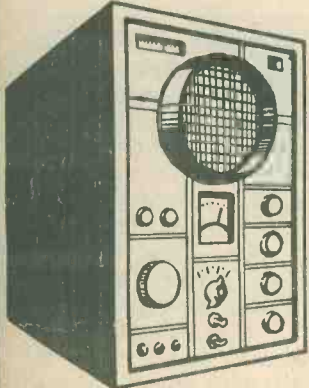

We take you step by step through all the fundamentals of electronics and show you how easily the subject can be mastered using our unique Lerna-Kit course.

- (1) Build an oscilloscope.
- (2) Read, draw and understand circuit diagrams.
- (3) Carry out over 40 experiments on basic electronic circuits and see how they work.

Electronics for hams.

Learn how to become a radio-amateur in contact with the whole world. We give skilled preparation for the G.P.O. licence.

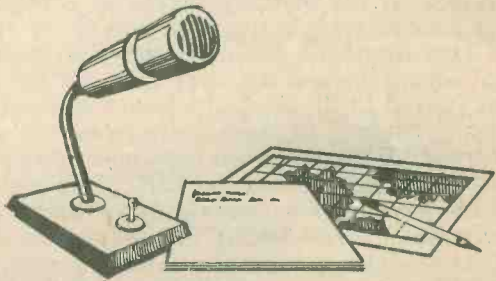

Free!

Brochure without obligation to:

British National Radio & Electronic School

P.O. Box 156, Jersey, Channel Islands.

NAME

ADDRESS

Block caps please

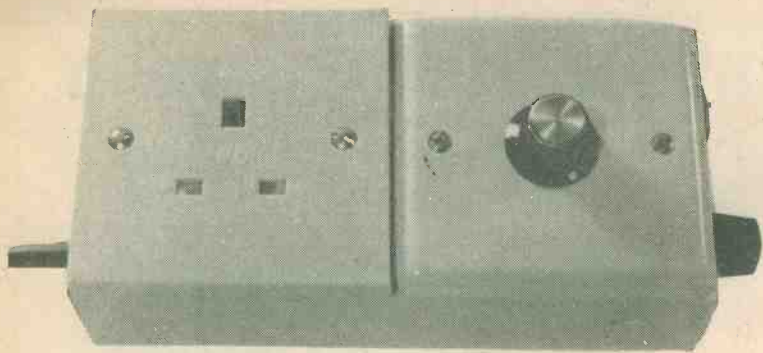

TRIAC

By A. P. Roberts

This article describes a simple lamp dimmer which can be used to control a filament lamp having a power rating of up to 250 watts. The unit incorporates a mains socket so that it can be simply connected between a standard or table lamp and a mains outlet. It employs few components and is very easy to construct. It cannot be used to control fluorescent tubes.

OPERATING PRINCIPLE

When low powers are involved it is quite feasible to vary the current fed to a load by means of a variable resistor connected in series with the load. However, this is not really very practical in domestic applications when controlling something like a 100 watt light bulb, because the power dissipated in the variable resistor could rise, at a setting where an equal voltage is dropped across both, to the same level as that dissipated in the lamp. The variable resistor would need to be an extremely large component and the power dissipated across it would simply be wasted.

A much more satisfactory method is to control the power in the load by means of a switching device connected in series with one of the supply lines. One approach could consist of a switching device which turned off over some of the half-cycles passed to the load, the power dissipated in the load reducing as more half-cycles in a group are turned off. Some power controllers do operate on the principle of removing half-cycles and they have the advantage of generating virtually no r.f. interference. Unfortunately the circuits employed tend to be rather complex and most power controls, including the one described here, use a slightly different method.

Instead of completely removing some half-cycles and leaving others unchanged, part of each half-cycle is eliminated. Thus, if half of each successive half-cycle is removed the load (assuming that this has a constant resistance) receives only half the power. This method of control has the disadvantage that a considerable amount of r.f. interference can be generated unless adequate suppression measures are included in the design. The reason for

the interference is quite simple. If the control device switches on half way through a mains half-cycle, the voltage across the load will rise almost instantaneously from zero to nearly 350 volts. The combination of this very fast rise time and the relatively high currents and voltages involved result in strong harmonics being produced which extend well into the r.f. spectrum.

THE CIRCUIT

The full circuit diagram of the lamp dimmer is given in Fig. 1. The triac, TRI1, is the control element, and this is a two-way device. It is turned on by applying a small trigger current to its gate, and it remains conductive until the current flow between its two anode terminals reduces to virtually zero. It then turns off until another triggering current is applied to its gate. The gate current, and that flowing between the anodes can be in either direction.

The triac is connected in series with the live supply to the lamp. L1 is a suppression choke whilst S1 is the on-off switch for the dimmer. F1 is a 3 amp fuse and is fitted in the mains plug. A diac is connected in series with the gate of the triac and this is also a two-way device. At low voltages it exhibits a very high resistance, this reducing suddenly to a low resistance when the voltage across it exceeds a level of around 20 volts. Thus, the triac does not receive a triggering current until the voltage across C1 reaches the level at which the diac fires.

C1 is charged from the mains supply via VR1 and R1. The charging current also passes through F1, S1 and L1, but these have negligible resistance and do not affect the charging rate of C1. If VR1 is adjusted for minimum resistance the voltage across C1 lags only slightly behind the mains voltage, and so early in each half-cycle the voltage across C1 reaches diac firing level and the triac turns on. The triac stays on until the end of the half-cycle, at which instant there is zero voltage across its two anodes and it turns off, to be switched on again early in the next half-cycle when the voltage across C1 is once more sufficient to fire the

LAMP DIMMER

INCORPORATING A STANDARD TRIAC-DIAC CIRCUIT CONFIGURATION

COMPONENTS

Resistors

R1 33k Ω $\frac{1}{4}$ watt 10%
VR1 470k Ω potentiometer, linear

Capacitors

C1 0.1 μ F 250V Wkg. (see text) type C280 (Mullard)
C2 0.0047 μ F 250V A.C. Wkg.

Inductor

L1 2A suppression choke

Semiconductors

TRI1 TR12A/400
DI1 BR100

Neon

PL1 Neon indicator with integral resistor, 250V A.C.

Switch

S1 s.p.s.t. rotary, 250V A.C. 4A

Miscellaneous

Dual plastic switch or socket box, with mains socket and blank front plate (see text)
2 plastic control knobs
6-way tagstrip (see text)
3-way mains plug with 3A fuse (F1)
3-core mains lead, nylon bolts and nuts etc.

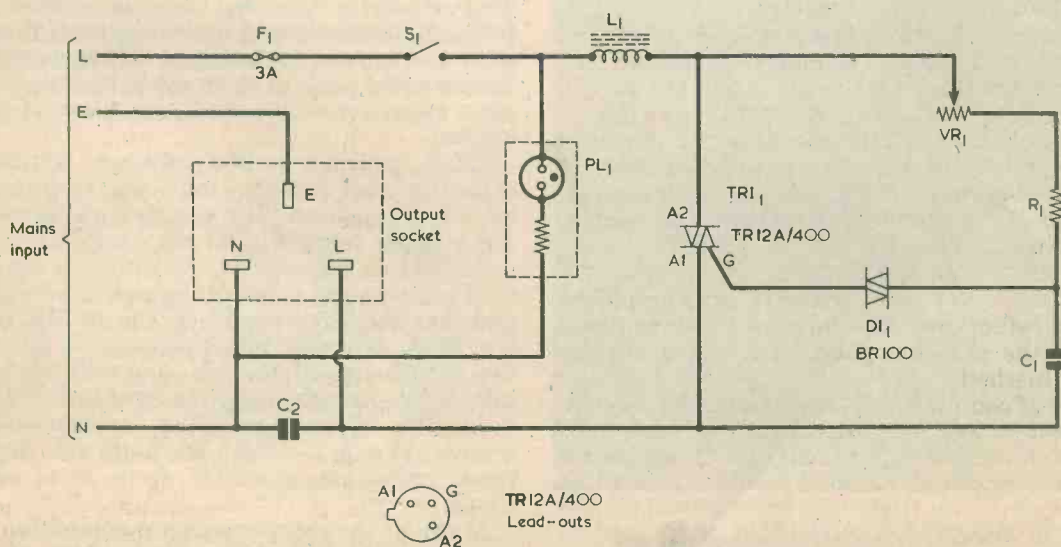

Fig. 1. The circuit of the lamp dimmer. This operates by turning on the triac after the start of each half-cycle, the instant of turn-on being controlled by VR1

diac. The resultant waveform across the lamp is shown in Fig. 2(a). When the triac is turned on, VR1, R1 and the diac play no role in circuit operation since they are effectively short-circuited by the triac.

There is a small loss of power when VR1 is set at minimum resistance, which corresponds to maximum brightness of the lamp. As is evident from Fig. 2(a) the loss is too small to be of any significance.

If VR1 is adjusted for about half maximum resistance the voltage across C1 will lag well behind the mains voltage, and it will be much later in each half-cycle when the triac turns on. Fig. 2(b) shows the waveform across the lamp which is given when the triac turns on about half way through the half-cycle. If the lamp had a constant resistance, the power would be halved.

With VR1 adjusted to insert maximum resistance into circuit the triac is not triggered until each half-cycle is nearly finished, giving the waveform shown in Fig. 2(c). This time very little

power is applied to the lamp. It can be seen, therefore, that the amount of power that is fed to the lamp can be varied by adjusting VR1.

C2 is an interference suppression capacitor, and PL1 is simply a mains indicator neon.

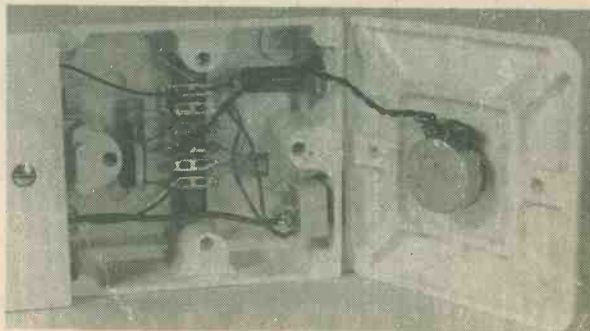

The electronic components are wired to a 6-way tagstrip positioned behind the plain cover

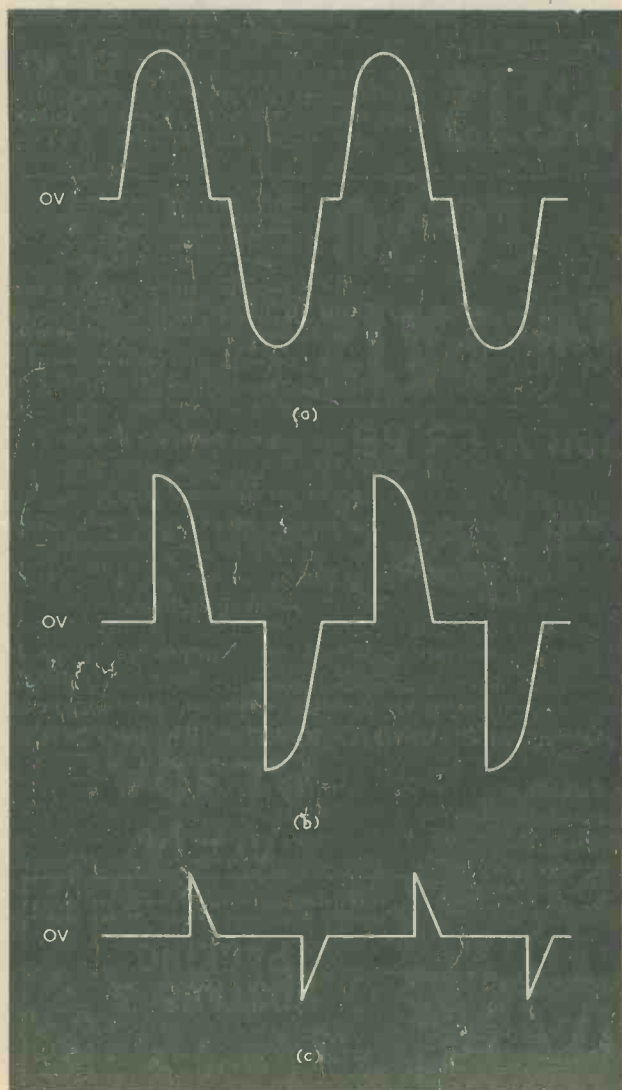

Fig. 2. The voltage waveforms across the controlled lamp when VR1 inserts (a) minimum resistance, (b) half maximum resistance, and (c) maximum resistance

COMPONENTS

VR1 is a standard carbon track potentiometer and should be a type having a plastic rather than a metal spindle. Both the triac and the diac are available from Bi-Pak Semiconductors. The triac is a small device housed in a TO-5 can. PL1 is a panel mounting neon indicator with integral series resistor intended for 240 volt a.c. mains operation. L1 is a 2 amp suppression choke and is available from The Radio Shack.

S1 is a rotary on-off switch, and a heavy duty type rated at 4 amps at 250 volts a.c. is required here. C1 is specified as 250 volts working in the components list, since the voltage across it does not rise above the level needed for firing the diac. This does assume, however, that the circuit always functions correctly and that there are, for instance, no errors or poor connections during construction. Readers who wish to cover such eventualities may use a capacitor with a working voltage of 400 volts instead.

C2 is specified as 250 volts a.c. working. If a capacitor with this working voltage cannot be obtained, a capacitor with a d.c. working voltage of 750 volts or more will be satisfactory.

A suitable housing for the unit can consist of a dual plastic surface mounting switch or socket box, and that used by the author was an MK box, List No. 2025. A plastic blanking panel is mounted on the right hand side of this (and will be drilled to take VR1), and the output socket is fitted in position on the left hand side. The necessary mounting screws are supplied with the plate and socket. All these parts are available from local electrical shops.

Many of the components are assembled on a 6-way tagstrip. This is cut down from a 28-way tagstrip Type B, available from Doram Electronics.

Another view of the dimmer, showing the knob for switch S1 and the neon indicator

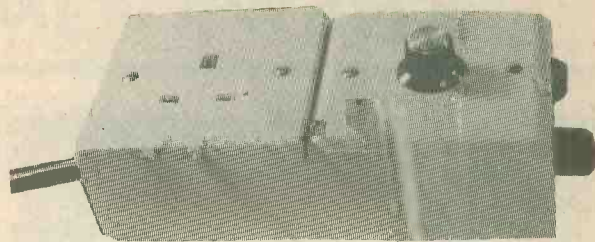

CONSTRUCTION

The plastic blanking plate has a 10mm. diameter hole drilled at its centre, and VR1 is mounted here. S1 is fitted at the lower part of the right hand side of the box, whilst PL1 is mounted on the upper part. These will both probably require 10mm. diameter holes, although some neon indicators will require a somewhat larger one. A hole is drilled in the left hand side of the box for the 3-core mains lead, and this hole is fitted with a grommet.

The 28-way tagstrip is cut down at one end to form a 7-way tagstrip. The end tag is then removed and a mounting hole drilled in its place, to give a 6-way tagstrip with mounting holes at both ends. Two 6BA clear holes for mounting the tagstrip are drilled in the base of the box, and two 6BA nylon bolts are passed through these, being secured by two nylon nuts on the inside. The tagstrip is then passed over the bolt ends and is secured by a further two nylon nuts. Note that metal bolts must not be used for securing the tagstrip.

The positions of the tagstrip, the switch and neon indicator are clearly shown in the photograph of the interior of the box, and the wiring associated with the tagstrip is shown in Fig. 3.

A few connections are not shown in this diagram. The earth wire of the mains lead connects directly to the earth terminal of the output socket. Similarly, the neutral wire of the mains lead connects directly to the neutral terminal of the output socket, a further lead from this terminal passing to PL1. Capacitor C2 is wired across the live and neutral terminals of the output socket. The mains

lead is correctly terminated at its remote end with a 3-way plug fitted with the 3 amp fuse, F1. It should be secured inside the box with a plastic clamp or grip, again using nylon bolts and nuts.

L1, C1, R1 and the triac should be positioned on either side of the tagstrip, as indicated in Fig. 3 and the photograph, to ensure that they, and their connections, are well clear of the rear of VR1 when the blanking plate is screwed down. Both S1 and VR1 are fitted with plastic control knobs. The diac may be connected either way round.

OPERATION

When completed, the mains input to the dimmer is plugged into a 3-way mains socket, and the plug of the lamp is fitted to the output socket on the box. It should be found that the dimmer can vary the brightness of the lamp from its normal intensity down to zero with VR1 adjusted fully anticlockwise. Due to the tolerances in the circuit, it is just possible in some cases that the lamp will not be quite extinguished when VR1 is set fully anticlockwise, and this can be corrected by adding a capacitor of about $0.01\mu\text{F}$ in parallel with C1. Alternatively, it might happen that the lamp is extinguished well before VR1 reaches the fully anticlockwise position. In this case it would be necessary to replace C1 with a capacitor having a somewhat lower value, say $0.082\mu\text{F}$ or $0.068\mu\text{F}$. The added or alternative capacitors may have working voltages of 250 or 400 volts, as explained earlier, according to the preference of the constructor.

Should these alterations prove necessary, they must only be carried out with the mains input plug removed from its socket. No work of any type should be carried out on the internal circuitry in the box unless the mains input plug is removed, as there is otherwise a risk of dangerous shock. The plain cover on which VR1 is mounted should always be screwed in place before the mains input is applied.

Although the unit incorporates interference suppression components, it is virtually inevitable that these will be less than 100% effective. The dimmer will cause some interference to a.m. radios which are operated in close proximity to it, and this is a problem which is common to most lamp dimmer designs. As the majority of a.m. receivers have a directional aerial of some sort, it will in most cases be possible to virtually eliminate any interference by suitable orientation of the set.

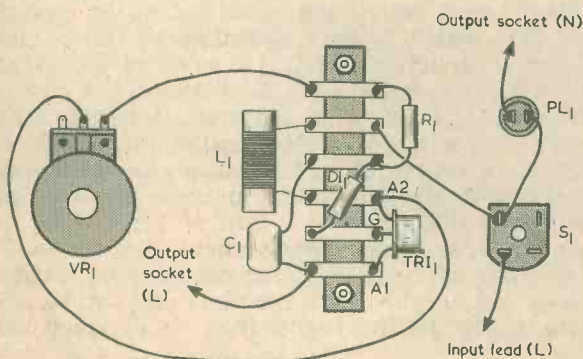

Fig. 3. The wiring around the 6-way tagstrip. Connections to the output socket are discussed in the text

ELECOLIT 340 NOW AVAILABLE TO CONSTRUCTORS



After five years of selling exclusively to industry, Industrial Science Ltd., of Leader House, 117-120 Snargate Street, Dover, Kent, are now introducing one of their most successful products — ELECOLIT 340 — into the consumer electronics market.

ELECOLIT 340 is a pure, silver filled, electrically conductive acrylic paint. It exhibits excellent conductivity because of the pure silver and outstanding environmental protection due to its

acrylic base. ELECOLIT 340 sets by solvent evaporation similar to most good lacquer systems. It forms a tough film with good adhesion to ceramics, glass, rubber, plastic and most plastic films.

Typical applications include R.F. shielding, printed circuit repair, use as a conductive ink, prototype circuit manufacture and one of the most interesting and unusual applications of all which is to repair the rear window demister of a car by means of painting over the existing track which may have either broken or shorted out.

Although ELECOLIT 340 is air drying, conductivity can be improved by heating and typical volume resistivity figures are 0.001 ohm-cm. when cured at room temperature, whereas 0.0005 ohm-cm. when cured at 150°C.

The shelf life is a minimum of 1 year in a closed container, and the operating temperature of ELECOLIT 340 is from -60°C to +175°C.

It can be applied by painting, silk screening or roller, and if necessary it can also be thinned with a solvent to lower the viscosity.

It is expected that electronic constructors and radio enthusiasts will find numerous applications and possibilities for ELECOLIT 340 as well as being of interest to the semi-professional organisation for occasional repair and modifications to printed circuit boards.

The attached photograph shows a typical application for painting a track on to a printed circuit board or for repairing an existing track.

IBA DEMONSTRATES DIGITAL STUDIO TECHNIQUES

— A WORLD FIRST

The Independent Broadcasting Authority has recently demonstrated to other European broadcast organisations the major component parts of an all-digital television studio of the future.

This it is claimed was the world's first demonstration in which it has been shown practical for all major studio vision operations, excluding picture origination, to be carried out with digital, computer-type signals — including digital vision coding and decoding, vision mixing and switching, video tape recording, and the generation of a colour-bar test signal.

The key to the all-digital television studio is the problem of recording digital signals on tape without requiring extremely high-speed tape transport. During these demonstrations a digital tape recorder was shown producing faultless half-width colour pictures. This conclusively demonstrated the feasibility and advantages of digital recording techniques currently under development in the IBA's Engineering Centre at Crawley Court, near Winchester, Hampshire. Further development is required to produce a full-width picture recorder suitable for operational use, but the system demonstrated shows that the fun-

damental problems have been solved successfully, and that tape consumption will be comparable to that of analogue 'Quad 2' type recorders.

The digital mixer and video tape recorder operated with signals sampled at twice colour subcarrier (Sub-Nyquist sampled PAL); these signals were produced by digitally comb-filtering a digital signal that had been sampled at four times colour subcarrier frequency. Before being reconverted to analogue the 'twice colour subcarrier signals' were changed to a 'four-times colour subcarrier' sampling rate, again using a digital comb-filter. This process has been shown to produce only a very small impairment yet has the advantage of greatly reducing the bit rate required. Further work demonstrated included an experimental 34 Mbit/s system in which, for the first time in the world, good quality signals are possible when coding the composite PAL signal.

The IBA's digital development programme is aimed at achieving an international standard for digital television. The experience gained by the team of development engineers in the design of line and field store converters has proved invaluable in looking at the inter-related problems of introducing digital techniques into studios, on the lines network, and at the transmitters.

COMMENT

4 CHANNEL RECEIVER IDEAL FOR MATRIX H CONVERSION

The 'Universal' Four-Channel Receiver — the Sansui QRX 777 — is very suitable for Matrix H conversion.

There is pushbutton selection of: QS — for decoding and reproducing QS-encoded 4-channel records, tapes and FM 'quadcasts'; QS Synthesizer-Surround — for creating a 4-channel sound field spread in a full 360-degree circle around the listener from conventional 2-channel sources; QS Synthesizer-Hall — for preserving original stereo sound "on-stage" while adding concert-hall ambience from the back channels from conventional 2-channel sources; SQ — for decoding and reproducing SQ matrix 4-channel music (the phase matrix section of the QS variomatrix decodes SQ signals with proper front/back separation); CD-4/4 CH Direct — for playing CD-4 (and Quadradisc) records in 4-channel — also for listening to any discrete 4-channel tape or aux source; 2-CH Direct — for channelling regular stereo signals to the front two speaker systems;



The Sansui QRX 777 (or QRX 7001) — with a minimum of 35 watts times four channels and distortion less than 0.4% — is a truly universal four-channel receiver. A facility for receiving Matrix H, the BBC's new quadrasonic broadcasting system can be easily added. All 777's will in future incorporate the adaptation.

Plus Back — for additionally feeding regular stereo signals to the two back speaker systems.
Sole UK distributors are Verniton Limited, of Thornhill, Southampton SO9 5QF.

WORLD RADIO CLUB TRANSMISSIONS

As from Wednesday, 7th September the transmissions of World Radio Club will be as follows:

Wednesday: 0815 — 0830 GMT

Wednesday: 2315 — 2330 GMT

Wednesday: 1330 — 1345 GMT

Friday: 2100 — 2115 GMT

The Sunday transmission at 0815 GMT will be cancelled

SPECIAL OFFER

Have you taken advantage of P. B. Electronics Ltd., Special Offer of FREE Blob-boards with orders for their packs?

Purchase a pack of three 2V5 Blob-boards and you receive one Free 2-IC Blob-board.

Purchase a pack of three 2-IC Blob-boards and you receive one Free 2V5 Blob-board.

See advertisement Page 69 in this issue.

BOOK RECEIVED

We were most interested to receive a non-electronics book recently, the reason being that the author is a very well known figure in the electronic components field — Mr. Alan Sproxtton, Managing Director of Home Radio (Components) Ltd.

In the book 'Starting and Running a Small Business', Mr. Sproxtton passes on the benefit of his many years experience as a successful business man.

Many actual examples are given illustrating the difficulties and the opportunities which the small business will encounter. It is all told with a refreshing humour and its 129 pages are practical and down to earth.

Copies may be obtained for £3.95, inclusive of postage, from Under Writers Publications, Trevail Mill, Zennor, Cornwall.

EDUCATIONAL NEWS

A theory course designed to prepare students for the City and Guilds Radio Examination in May/June 1978 will be held at the Gosforth Adult Association Classes at the Gosforth High School, Gosforth, Newcastle upon Tyne, commencing in September 1977. A morse class will run over the same period.

Although specifically for the R.A.E. the course will be ideal for anyone wanting to get an insight into radio theory.

The theory class will be held on Tuesdays and the morse class will be held on Thursdays.

Enquiries should be addressed to, The Principal, Gosforth Adult Association, Gosforth High School, Knightsbridge, Gosforth.

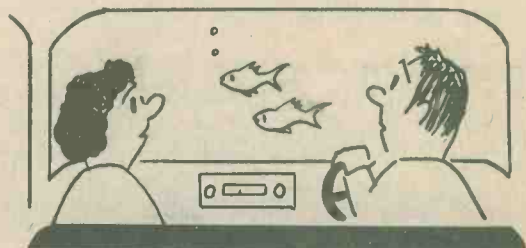

"This is Radio One traffic news — drivers on the A5 are warned to look out for burst mains in the Maida Vale area"



MICROPHONE PRE-AMPLIFIER

By I. R. Sinclair

A simple microphone pre-amplifier specifically designed for coupling low impedance moving-coil microphones to high fidelity amplifiers.

The signal outputs from low impedance moving-coil microphones are generally very low so that a large amount of voltage amplification is needed when these microphones are used with an amplifier of moderate gain. The microphone inputs on tape and cassette recorders are arranged to give the correct amplification for the type of microphone that is supplied with the recorder, but the use of a better quality microphone may be impossible because the gain of the built-in amplifier is insufficient. Sometimes, also, the use of a microphone with Hi-Fi equipment is needed. In this last application the amplifier input marked "MAG" will be sensitive enough but the results will be disappointing because of the equalising circuits which appear after this input; these have the effect of boosting bass and cutting treble, the last thing we want with a microphone signal. Another microphone problem concerns hum when long microphone leads are employed. Because of the very low amplitude signal voltage from a microphone, the slightest trace of hum on the long lines will be amplified to an intolerable level.

PRE-AMPLIFIER

The answer to all of these problems is a microphone pre-amplifier, which will boost the feeble signal from the microphone to a level which better suits other equipment. It will enable us to use very insensitive microphones with tape or cassette recorders by connecting the pre-amplifier between the microphone and the recorder input. We can also use the microphone with Hi-Fi equipment, plugging the microphone into the pre-amplifier and the output of the pre-amplifier into the "AUX" or "TUNER" inputs of the Hi-Fi equipment, since there is no equalisation after

COMPONENTS

Resistors

- (All $\frac{1}{4}$ watt 5%)
 R1 150k Ω
 R2 39k Ω
 R3 5.6k Ω
 R4 1.8k Ω
 R5 47k Ω
 R6 4.7k Ω

Capacitors

- (Working voltages may be higher than stated)
 C1 1 μ F electrolytic, 10 V. Wkg.
 C2 10 μ F electrolytic, 10 V. Wkg.
 C3 10 μ F electrolytic, 10 V. Wkg.

Semiconductors

- TR1 2N3707
 TR2 2N697
 ZD1 BZY88C3V0

Blob Board

- Blob Board type ZB-2V5

Miscellaneous

- Slide switch
 9 volt battery
 Battery connectors
 Jack socket
 Phono socket
 Flexible screened cable
 Metal box.

these inputs. For long microphone cables, the use of the pre-amplifier close to the microphone itself boosts the signal before it is sent down the line, so that the signal needs much less amplification in the main amplifier and any hum that is picked up is amplified much less. In addition, because the pre-amplifier is self-contained and battery operated, the hum introduced by the pre-amplifier itself, assuming that it is enclosed in an earthed metal case, will be negligible.

The design used here is intended to draw very little current from the battery, and has input and output impedances that should match well to most microphones and almost any amplifier. The pre-amplifier is mainly intended for low impedance microphones including the cheaper low-output moving-coil types. The pre-amplifier is not intended for use with capacitor or crystal microphones having output impedances of the order of $1M \Omega$. The voltage gain is high, so that microphones with a very low output level can be used, and the output signal should be enough even for relatively insensitive amplifier inputs.

The pre-amplifier circuit is given in Fig. 1. Here, TR1 is the main amplifying stage, working with its emitter voltage fixed at 3 volts, as set by the zener diode ZD1. The bias at the base of TR1 is obtained by feedback from the emitter of TR2, thereby ensuring that the bias current remains stable. TR1 collector load resistor, R2, has a large value, so that the current flowing through TR1 is small. This is an advantage for a pre-amplifier input stage, because the amount of noise that is generated in a transistor is much less when the collector current is low. The amplified signal at the collector of TR1 is coupled directly to the base of TR2. This transistor uses a small collector load, R4, giving the pre-amplifier a low output impedance. TR2 emitter resistor, R6, is decoupled by C2, and bias current is fed back to TR1 without feeding back signal. The current drawn from the 9 volt supply is approximately 2.2mA.

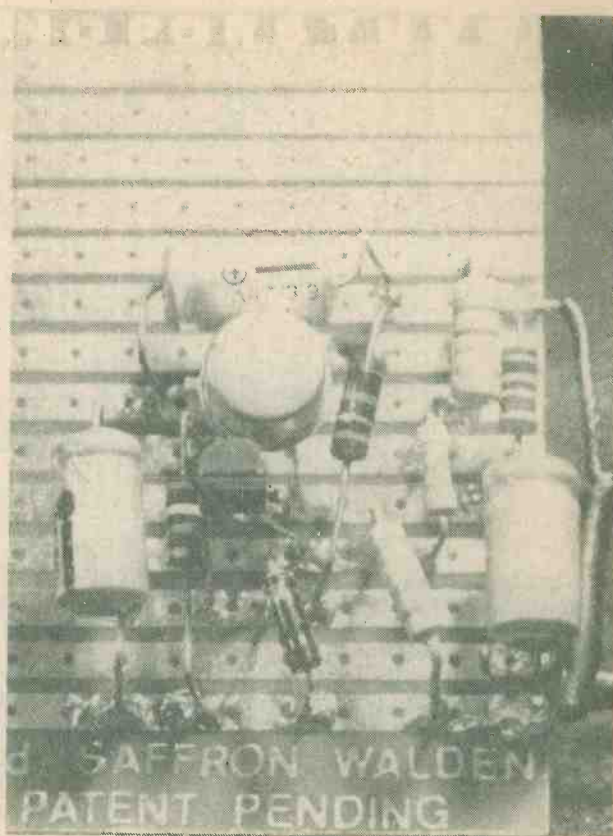

All the components for the microphone pre-amplifier are soldered at one corner of the Blob Board

CIRCUIT ASSEMBLY

The circuit can be built on a piece of ZB-2V5 Blob Board, following the line numbers as shown in the diagram of Fig. 1. Nine lines of the ZB-2V5 Blob Board are used, and the design is arranged so that the input (line 13) and output (line 6) are well separated to assist stability.

Place all the components, one by one, over the Blob Board lines so that the lead-out wires can be cut to the correct length, assuming that the leads are already long. Tin all the ends of the wires, including those of the transistors, so that they can be blobbed in place easily (see "Blob-A-Job No. 1", which appeared in the June 1977 issue). There is no risk of damage when the lead-out wires of the transistors are tinned, as this should take less than a second for each lead.

The Blob Board layout is shown in Fig. 4. Start construction by blobbing C1 between lines 11 and 13. If a capacitor of small physical size is used it can be mounted horizontally, as shown in Fig. 2(a), but a larger type will have to be mounted end-on, as in Fig. 2(b). Remember that the positive end of the capacitor connects to line 11. Now blob on resistors R1 (line 11 to line 14), R5 (line 11 to line 9) and R2 (line 10 to line 7). Check the connections that have been made so far, and if all is well solder in TR1 with its emitter on line 12, its base on line 11 and its collector on line 10. Make sure that you have identified these connections correctly, refer-

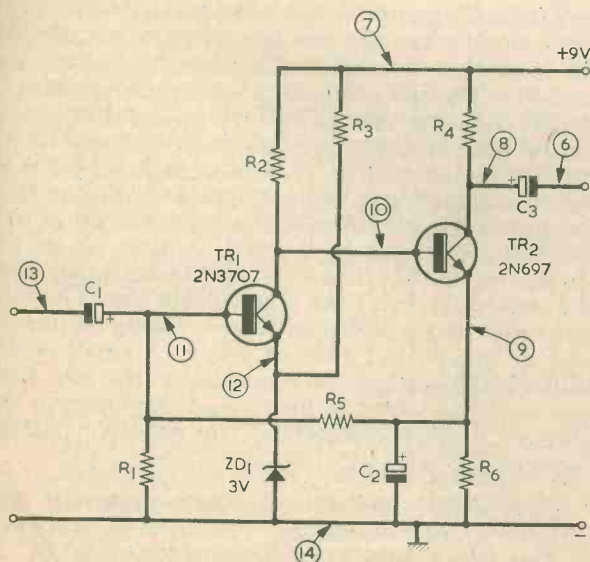

Fig. 1. The circuit of the microphone pre-amplifier. The circled numbers indicate the corresponding tracks on the Blob Board

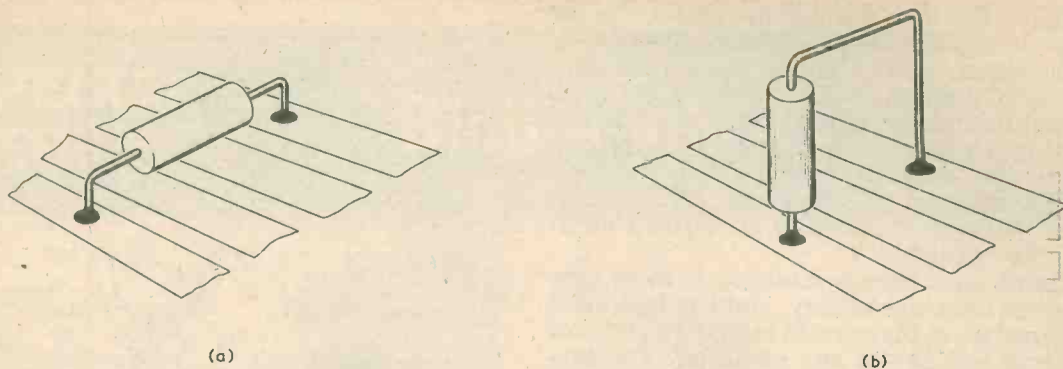

Fig. 2. Components may be fitted to the Blob Board either horizontally as in (a), or vertically as in (b)

ing to the transistor connection diagram of Fig. 3. One of the advantages of Blob Board is that if you have made a mistake at this stage the transistor can be easily removed.

With TR1 in place, blob on resistor R3 (line 7 to line 12) and the zener diode between line 12 and line 14. The cathode of the diode, marked usually by a white band, is blobbed to line 12. Now blob TR2 into place, remembering that its lead-out layout is different from that of TR1. TR2 emitter connects to line 9, its base to line 10 and its collector to line 8. Note also that the metal case of TR2 is connected to its collector, so that the case must not be allowed to touch any bare wires. Finally resistors R4 (line 7 to line 8) and R6 (line 9 to line 14) are blobbed into place, followed by capacitors C2 (line 9 to line 14 with positive at line 9) and C3 (line 8 to line 6 with positive at line 8). The final layout should now look like Fig. 4. Experienced constructors will realise that any layout can be used providing the components are always connected between the correct lines.

SETTING UP

The 9 volt battery for the pre-amplifier can be any size, probably the most convenient being a small PP3. A voltmeter with a resistance of 10,000 Ω per volt is required for setting up, and this is switched to a 10 volt range, or to whatever range provides clear readings of around 7 volts. Connect the battery (CAUTION — make sure that the

polarity is correct) to the pre-amplifier and check the voltage between the negative rail and the collector of TR2. This is done by placing the negative meter lead on line 14 and the positive meter lead on line 8. The voltage we want to find here will be about 7 volts if a fresh 9 volt battery is used. The voltage should not be more than 7.5 volts nor less than 6.5 volts. If the voltage is too high, check your circuit. If the circuit is correct, try the effect of using a higher value for R5, such as 56k Ω instead of 47k Ω , or even 68k Ω if 56k Ω is not enough. If the voltage is too low and the circuit is correctly wired, use a smaller value for R5 (39k Ω or 33k Ω , for example). This check is needed because of the large differences in current gain between samples of transistors, but the values shown in the Components List will ensure satisfactory operation for most samples.

Once the voltage check has been completed, the audio behaviour of the pre-amplifier can be tested. The unit will eventually be fitted in a metal box with a jack socket for the microphone and a phono connector for the amplifier. These two sockets can be attached, using enough screened cable to allow some slack when the pre-amplifier is mounted in the box; this is most easily done by bolting the sockets to the box and taking the screened cables to the Blob Board assembly. The input cable is connected with its outer braiding on line 14 and its inner conductor on line 13. If the jack socket is of open construction it will automatically ensure that the metal box connects to the negative rail at line 14. The socket can be 2.5mm., 3.5mm. or $\frac{1}{4}$ in.; if the microphone to be used is fitted with a jack plug the socket can be of the appropriate size. The output cable is connected with its braiding on line 14 and its inner conductor on line 6. A small on-off slide switch can also be mounted on the box, with one terminal wired to line 7 and the other to the positive battery connector. The negative battery connector is wired to line 14.

Now, with a battery connected, insert the jack plug of a microphone into the input jack socket, and connect through a phono lead to the "AUX" or "TUNER" socket of a Hi-Fi amplifier. Switch on the amplifier, and then the pre-amplifier, with the volume control of the main amplifier at its minimum setting. Blow gently over the microphone, and slowly turn up the volume control

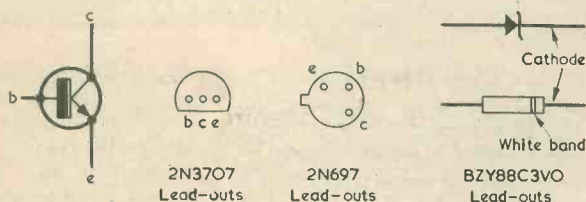

Fig. 3. Illustrating the transistor and zener diode lead-outs together with the circuit symbols. In the two transistor diagrams the lead-outs point towards the reader

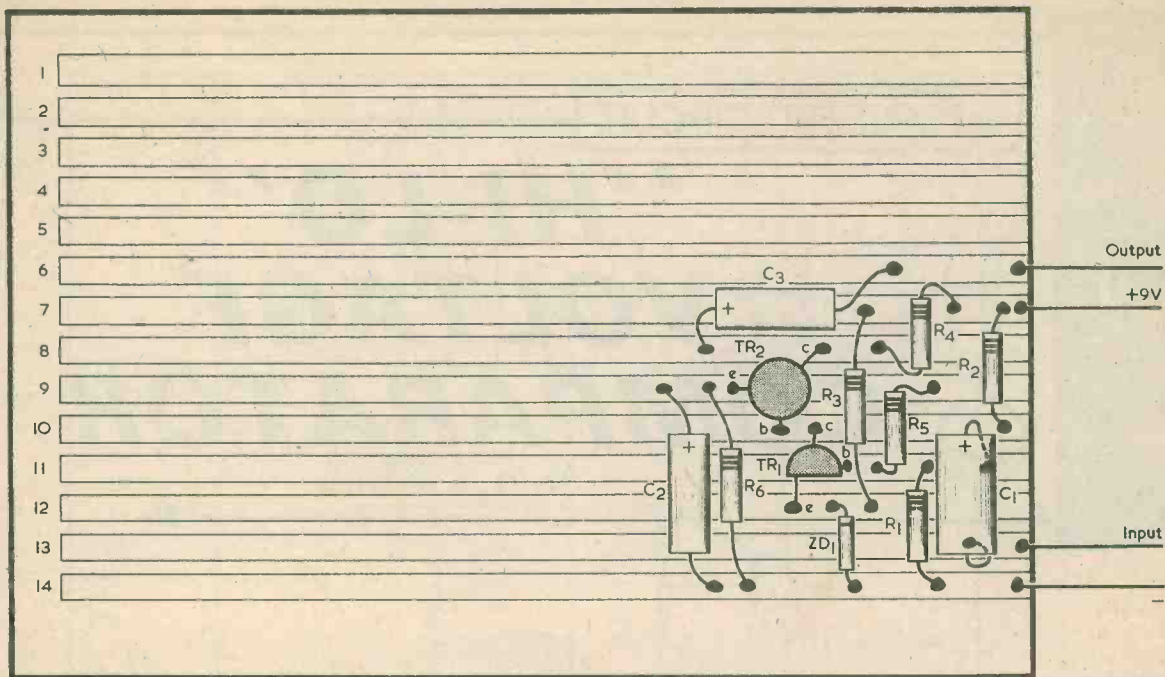

Fig. 4. The final assembly of components on the board. Note how compact the Blob Board layout is, whilst still being capable of easy checking

of the main amplifier until the sound can be heard. Be careful that you do not turn up the volume too much, as the sound from the loudspeaker will then feed back to the microphone, causing howling. When everything is working satisfactorily, switch off and remove the battery and the connections to

the microphone and amplifier. Mount the Blob Board into place in the box using, say, a piece of double sided adhesive material. Clip the battery in place, and fit the battery connectors. Close the box, and your microphone pre-amplifier is ready for use. ■

VINTAGE WIRELESS CATALOGUE

Reflecting the burgeoning interest in early radio equipment is the 1977 Antique Wireless Catalogue issued by The Vintage Radio Shop, 64 Broad Street, Staple Hill, Bristol, BS16 5NL. Excluding pages giving full size reproductions of pre-war advertisements the catalogue has 27 large pages listing very many antique and pre-war components and valves. The valves themselves take up some 13 pages of the catalogue and include such well-known types as the PM2, HL2 and 215SG, together with many others of previous vintage.

Also listed are early components of many types including r.f. coils by Telsen and Tunewell, a very wide selection of service manuals from circa 1928 to 1955 (from which photocopies can be supplied) and a host of other items too diverse to be easily categorised.

The catalogue can be obtained from the vintage Radio Shop for 70p, and should hold as much interest for the frankly nostalgic as for those who are seriously engaged in collecting antique wireless equipment.

MICROPROCESSOR COURSES

Limrose Electronics Ltd, of 241-243 Manchester Road, Northwich, Cheshire, are offering a range of practical workshop-type courses on Microprocessors aimed at giving 'hands-on' experience to engineers who wish to familiarise themselves with microprocessor hardware, software and interfacing techniques or who wish to increase their experience in this field. The two day intensive courses are built essentially around the 8080 and 6800 Microprocessors. Each participant has his own microcomputer to use for the duration of the course and is also provided with comprehensive course notes which are his to keep at the end of the course. The courses also briefly cover other microprocessors available, and since they are limited to a maximum of six people they can be geared to a large extent to suit the participants own particular needs and problems.

The cost is £86.40 per course, inclusive of V.A.T. For further information and dates write to the address given above.

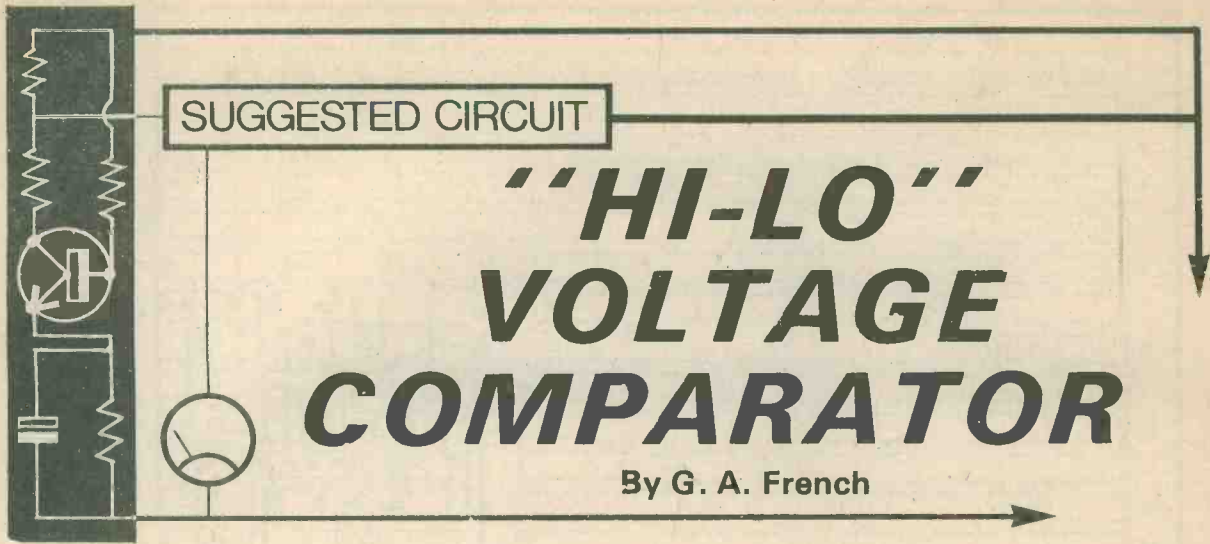

SUGGESTED CIRCUIT

"HI-LO" VOLTAGE COMPARATOR

By G. A. French

Numeric 7 segment light-emitting diode displays have been on the home constructor market for quite a period now, and they lend themselves to a number of interesting applications in which they display figures from 0 to 9. Two 7-segment displays are employed in the voltage comparator which is the subject of this month's "Suggested Circuit" article, but they are used in a manner which is quite different from their normal mode of operation.

VOLTAGE COMPARATOR

The voltage comparator has an input resistance of 2MΩ typical and can indicate whether a voltage is above or below a pre-determined level in the range of 2.5 to 7.5 volts. It may thus be employed to maintain a check on power supply or battery voltage, or for any similar

function in which circuit operation can be defined in terms of voltage level. Voltages higher than 7.5 volts may be applied to the input via a suitable potential divider.

The input voltage level is indicated by two 7-segment displays type TIL302. The TIL302 has a nominal digit height of 0.3in. with the decimal point on the left, and the segments are identified by the letters A to G, as shown in Fig. 1(a). No use is made of the decimal point. The TIL302 has the same pin spacing as a 14 pin dual-in-line integrated circuit, and it can if desired be plugged into an i.c. holder. Pin allocations are given in Fig. 1(b), in which it will be seen that there are three common anodes. There are similar common anode displays, such as the SLA7, which have the same pinning for the cathodes but which have a single common anode for all the segments,

this being connected to pin 14. With these, pins 3 and 9 are "NC" pins. Two SLA7's may be used in the voltage comparator instead of the TIL302's, if desired.

The circuit of the comparator appears in Fig. 2, in which the displays are identified as ND1 and ND2. They are meant to be mounted alongside each other with ND1 on the left and ND2 on the right. IC1 is a 741 op-amp, and the pin numbers shown apply to the 14 pin d.i.l. version of this device. The supply voltage is 9 volts nominal, and it is assumed that this is stabilized. As is shown later, the addition of a zener diode circuit at the input allows a non-stabilized supply to be used.

Pins 7 and 2 of both ND1 and ND2 are coupled to the negative rail via R6, R7, R13 and R14, with the result that segments F and E of both displays are continually illuminated. The voltage to be monitored is connected to the test points with the polarity indicated, so that the positive input is applied to the inverting input of the 741. The slider of pre-set potentiometer VR1 connects to the non-inverting input, and this potentiometer is adjusted such that the circuit responds to the pre-determined voltage level.

If, due to the input voltage being high, the inverting input of the 741 is positive of the non-inverting input, the 741 output at pin 10 goes negative. TR2 is in consequence cut off, whilst TR1 functions as an emitter follower, causing a current to flow at pins 13, 11 and 10 of ND1. Segments B, C and G of ND1 become illuminated, with the result that ND1 and ND2 display the legend "HI", as illustrated in Fig. 3(a).

Should the input voltage be low,

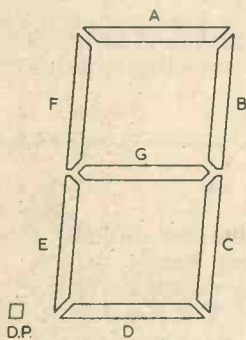

(a)

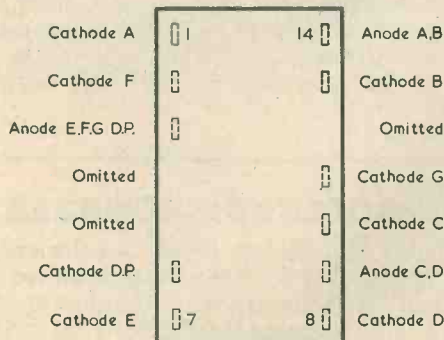

TIL 302
Top view

(b)

Fig. 1(a). The seven segments of a numeric display are identified by the letters A to G

(b). Pin allocations for the TIL302 7-segment display

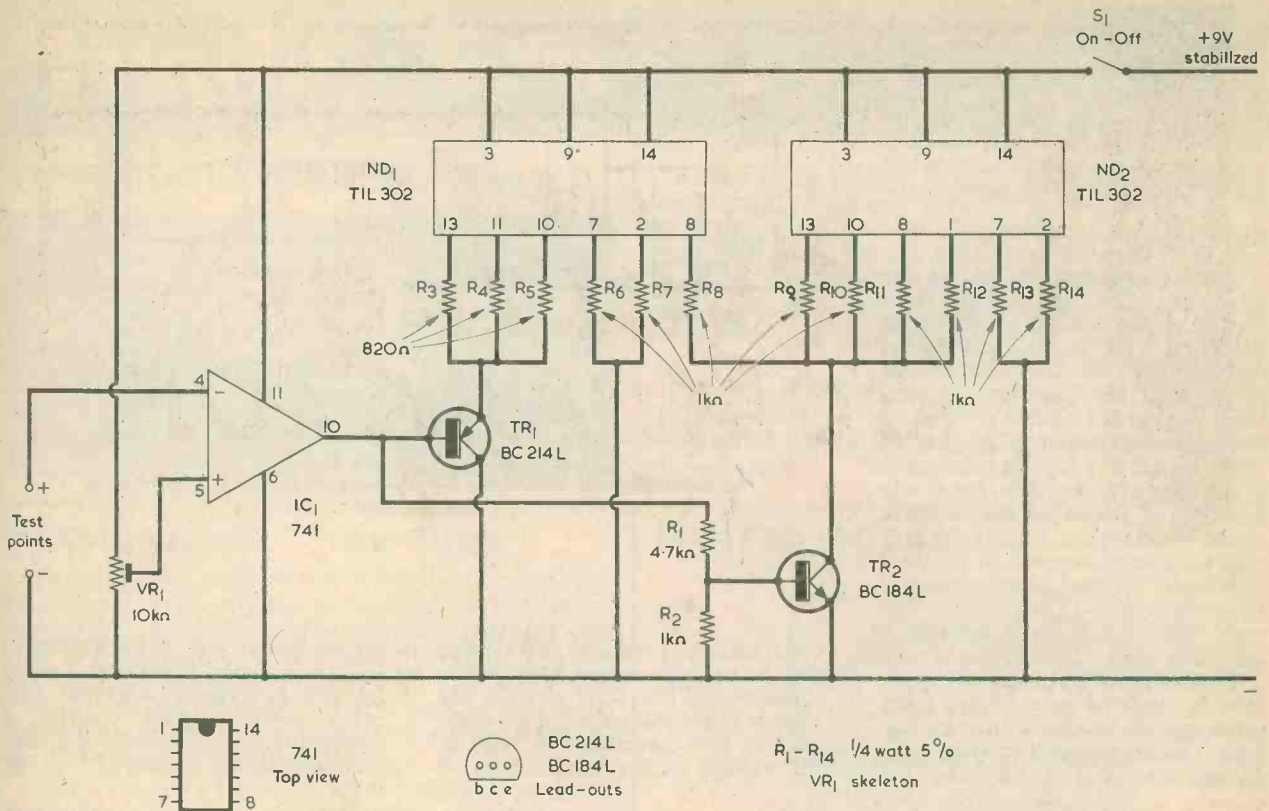

Fig. 2. The circuit of the voltage comparator

the inverting input of the 741 is negative of the non-inverting input and the output goes positive. TR1 does not now conduct because the voltage at its base is too high to allow forward current to flow in the segments of ND1 to which it is coupled. TR2, on the other hand, is turned hard on, and current flows in its collector circuit through resistors R8 to R12 inclusive. Segment D of ND1 and segments A, B,

C and D of ND2 now become illuminated, causing the two displays to present the legend "LO", as in Fig. 3(b).

Thus, the state of the input voltage is exhibited, with no ambiguity, by one of two terms which are often encountered in electronic engineering practice. There is no possibility of these being misread or misunderstood.

CIRCUIT DETAILS

Turning to circuit details, it is necessary to include the potential divider given by R1 and R2 in the drive circuit to TR2 base because the output of a 741 is not fully negative when it goes low. Instead, it takes up a potential, with respect to the negative rail, of slightly less than 2 volts. R1 and R2 ensure that the base of TR2 is well below the 0.6 volt level needed to turn a silicon transistor on when the 741 output takes up its low potential. When TR1 acts as an emitter follower to illuminate segments B, C and G of ND1, its emitter is slightly more than 2 volts positive of the negative rail. Because of this R3, R4 and R5 are given values lower than those of R6 to R14, to ensure that the segments they feed light up at about the same brightness.

The open-loop gain of the 741 is very high, at 200,000 times typical, with the result that the range of input voltage over which the output changes from high to low, or vice versa, is extremely small. In practice, the output will virtually snap over from one state to the other as the input voltage passes the predetermined level. This action will, however, be less well defined if the

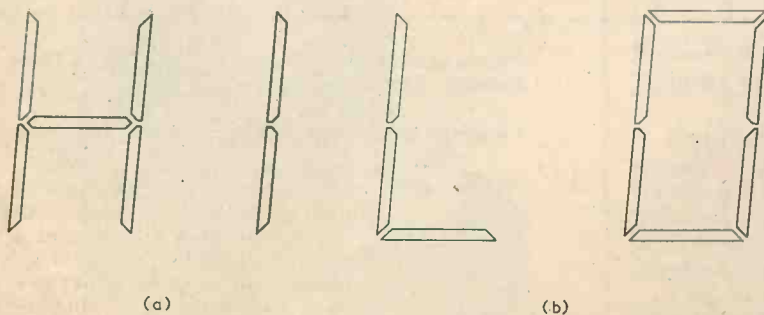

Fig. 3(a). The display which is given when the input voltage is high
 (b). A low input voltage produces this display

positive input lead couples to a high impedance and also picks up a high level of 50Hz mains hum voltage. The inverting input of the 741 can be taken positive up to but not beyond the positive supply rail, and it can be taken negative down to but not below the negative supply rail.

SETTING UP

The comparator is set up by applying the pre-determined voltage to the test points and then adjusting VR1 so that the legend displays are at the changeover state. With the prototype circuit, the practical voltage range available was found to be greater than the 2.5 to 7.5 volts mentioned at the start of this article, but it was felt that it would be desirable to quote conservative figures here to take up possible spread in 741 performance. Current consumption is approximately 38mA when the term "HI" is displayed and 52mA when the term "LO" is displayed.

The need for a stabilized supply may be avoided by modifying the input circuit to that shown in Fig. 4(a). The zener diode stabilizes the voltage across VR1 to nominally 6.8

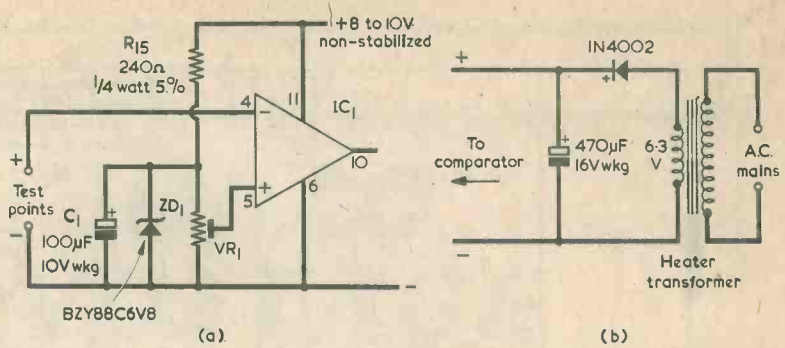

Fig. 4(a). Adding a zener diode circuit at the input enables a non-stabilized supply to be employed
(b). A suitable non-stabilized supply incorporating a 6.3 volt heater transformer

volts, whilst C1 ensures that no ripple is present across the potentiometer. With this circuit the voltage range available for the comparator now becomes 2.5 volts to the voltage of the zener diode. A

simple power supply incorporating a 6.3 volt heater transformer could be used, as shown in Fig. 4(b). Any other power supply offering a voltage of some 8 to 10 volts may alternatively be employed. ■

BUY THIS BEST SELLER— TV FAULT FINDING

405/625 LINES

(Monochrome)

132 pages

Over 100 illustrations, including 60 photographs of a television screen after the appropriate faults have been deliberately introduced.

Price 90p

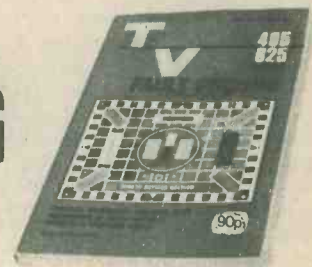

Edited by J. R. Davies

Comprehensive Fault Finding Guide cross-referenced to methods of fault rectification described at greater length in the text.

Price 90p from your bookseller.

or post this Coupon together with remittance for £1.10 (to include postage) to

DATA PUBLICATIONS LTD.
57 Maida Vale, London, W9 1SN

Please send me the 5th revised edition of TV Fault Finding, Data Book No. 5.

I enclose cheque/crossed postal order for

NAME

ADDRESS

BLOCK LETTERS PLEASE

Trade News . . .

ELECTRONIC SERVICE AIDS



The Spring Edition of the fully priced Verospeed catalogue introduces a range of electronic service aids manufactured by Electrolube. Contact Treatment Oil — 2AX — is available in aerosol and dispensing pen form, and a grease containing 2 GAX can be used in mechanical applications as well as electronic. Aerosol application allows it to be used in normally inaccessible parts of equipment. Preclene, Freezer, Contact Cleaning Strips and Silicone Grease complete a range that Verospeed guarantee will be despatched on the day your order is received.

PLATIGNUM'S "TIDY TUBS"

For many years the name of Platignum has been associated with writing materials and drawing equipment. Now they have come up with an idea that is as much at home in the workshop, kitchen or bathroom as it is in the office.

Called "Tidy Tubs", it is a handy 'whatnot' which can be used to keep anything from a baby's rattle to tin tacks out of the way.

Tidy Tubs are six convenient little storage compartments — each a different size — in one compact unit, so there is somewhere to put all the bits and pieces which clutter up a workbench, table or desk.

They cost £1.50 each, can be supplied in different colours and are available from good department stores and stationers.



PANTEC 'DOLOMITI'



Precision Instrument Laboratories, following their recent appointment as main agents for the Pantec range of Portable Test Instruments, have released details of the new range of Pantec multimeters etc, specifically designed to meet the requirements of the Electronics Engineer.

Low-cost, combined with performance, ranges and reliability are the main features. Typical of the range is 'Dolomiti' shown in the photograph.

Sensitivity: 20,000 ohms/V AC/DC; Ranges: 39; Current: To 5 amps AC/DC; Voltage: To 1500 volts AC/DC; Resistance: To 50 megohms; Overload protection. Price £36.50.

For further details contact: Precision Instrument Laboratories, 212 Ilderton Road, London, SE15 1NT.

P.C.B.s FOR 'SIMPLE QUAD. AMPLIFIER'

Ramar Constructor Services of Masons Road, Stratford-on-Avon, Warwickshire, CV36 9NF, inform us that they can supply printed circuit boards for the above project which was described in our June, July and August issues.

The boards which will be of first quality fibreglass laminate, roller tinned and drilled. The cost is £4.89 per set of three including V.A.T. and postage.

OHMS-CONSCIOUS CONTINUITY TESTER

By N. R. Wilson

An inexpensive continuity tester which can be pre-set to any value of resistance from zero to 20 ohms.

Most continuity testers are simple uncomplicated devices which give an indication of continuity for any circuit path having a resistance from zero to quite high values. This performance is adequate for many applications but it does not allow accurate continuity checking to be carried out in circuits where the conductor being traced is connected to other conductors by components having low values of resistance.

The continuity tester to be described here is particularly intended for tracing conductors connected to low resistance components, and can be of considerable assistance in the checking of wiring harnesses and the like. It can be pre-set to respond to any resistance from zero to 20Ω, and its resolution is well below 0.5Ω. If, for instance, it is set up to indicate continuity at 5Ω, it will respond to all circuits where the resistance is 5Ω or less but will be unaffected by circuits having resistances in excess of this figure.

CIRCUIT OPERATION

The circuit of the continuity tester appears in Fig. 1. As will be seen it incorporates an operational amplifier type 741, and advantage is taken of the exceptionally high open loop gain of this device to

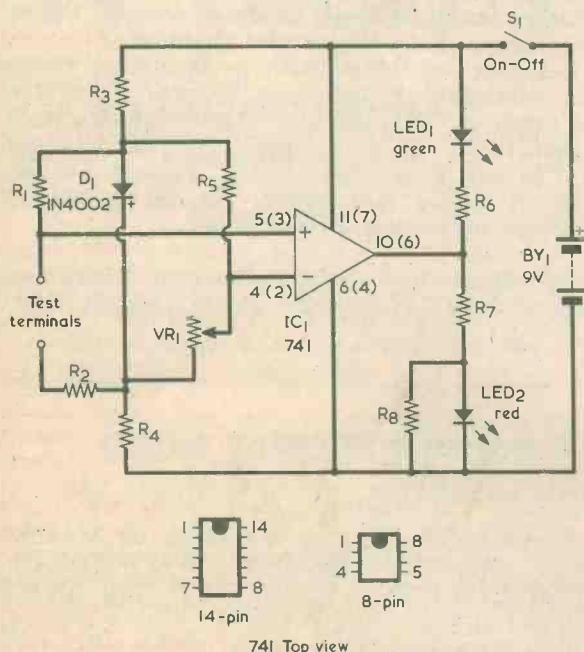

Fig. 1. The circuit of the ohms-conscious continuity tester. The green l.e.d. lights up when the test terminals are applied to a resistance having a value equal to or lower than that selected by VR1

COMPONENTS

Resistors

(All fixed values $\frac{1}{4}$ watt 10%)

R1 120Ω

R2 2.2Ω

R3 330Ω

R4 330Ω

R5 4.7kΩ

R6 1kΩ

R7 1kΩ

R8 820Ω

VR1 1kΩ potentiometer, linear

Semiconductors

IC1 741

D1 1N4002

LED1 light-emitting diode, green

LED2 light-emitting diode, red

Switch

S1 s.p.s.t. toggle

Battery

BY1 9 volt battery

Miscellaneous

Pointer knob

Battery connectors

Plastic or wooden case.

enable low resistances to be sensed when relatively small currents pass through them.

The 9 volt supply is applied via R3 and R4 to the forward biased silicon diode D1, whereupon a stabilized voltage of about 0.6 volt appears across it. The current flowing in R3 and R4 is a little in excess of 12.5mA when the battery voltage is at 9 volts.

The stabilized voltage is applied to the network consisting of R5, VR1, R1, R2 and the test terminals, the latter connecting to the circuit whose continuity is to be checked. This network is basically a Wheatstone bridge, as is illustrated in Fig. 2, in which diagram the resistance between the test terminals is shown as RX.

The bridge can be considered as being balanced when the potentials at the junction of R1 and RX and at the junction of R5 and VR1 are equal. Under this circumstance the ratio of R1 to the sum of RX and R2

Fig. 2. Diode D1 offers a stabilized voltage of 0.6 volt, and this is applied to the bridge consisting of R1, RX (the resistance across the test terminals), R2, R5 and VR1

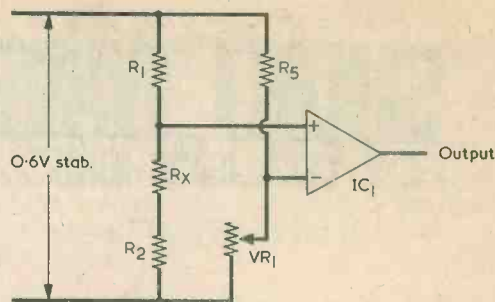

is equal to the ratio of R5 to the resistance inserted by VR1. The bridge is out of balance if the junction of R1 and RX is positive of the junction of R5 and VR1, and this condition causes the output of the op-amp to go positive. The bridge is also out of balance when the junction of R1 and RX is negative of the junction of R5 and VR1, and this time the output of the op-amp goes negative.

Returning to Fig. 1 it will be seen that when the output of the op-amp is positive the red l.e.d., LED2, lights up. When the op-amp output goes negative LED1, the green l.e.d., is illuminated.

Let us next assume that we connect a 10Ω resistor across the test terminals when the slider of VR1 is at the lower end of its track. The non-inverting op-amp input will then be positive of the inverting input and the red l.e.d. will light up. The slider of VR1 is slowly advanced to the point where the red l.e.d. extinguishes and the green l.e.d. is illuminated. If VR1 is left at this setting, the circuit is then in a state where the green l.e.d. will light up for all resistances applied to the test terminals of 10Ω or less, whilst the red l.e.d. will be lit for all resistances higher than this. If two test prods are connected to the test terminals, the red l.e.d. will be continually lit up, giving way to the green l.e.d. only when the test prods are applied across a circuit having a resistance of 10Ω or less. VR1 can be adjusted so that the continuity tester responds similarly to any other resistance within its range.

It might be considered possible for both l.e.d.'s to be alight when the resistance across the test terminals exactly balances the resistance inserted by VR1. However, because of the very high voltage gain of the 741, such a circuit condition corresponds to an extremely small amount of travel of VR1 slider. If a standard potentiometer is employed here it is difficult to find a setting at which both l.e.d.'s are alight. For all intents and purposes, therefore, it can be assumed that the red l.e.d. lights up for all values of resistance across the test terminals above the pre-set value selected by VR1 and that the green l.e.d. lights up for all resistances below. VR1 can be calibrated in units of resistance from zero to 20Ω.

When the test terminals are short-circuited the current flowing in R1 and R2 is approximately 5mA. This is well below the standing forward current in D1 and ensures that the performance of the circuit does not vary with falling battery voltage. With the prototype, the accuracy of the circuit was maintained for supply voltages down to less than 6 volts, at which voltages the obvious dimness of the l.e.d.'s indicated that a new battery was required. The low value resistor, R2, is inserted in series with the test terminals to ensure that VR1 can be adjusted for zero resistance across the terminals. The resistor also allows any small offset input voltage in the op-amp to be taken up.

OTHER DETAILS

Other details of the circuit can next be dealt with. It is necessary to add R8 across LED2 because the output of the 741 does not swing down to zero volts relative to the negative rail when it goes negative. Instead, it takes up a voltage slightly in excess of 2 volts, whereupon R8 ensures that the voltage across LED2 is well below that at which it commences to glow. There is no need to take the same precaution with LED1 because the op-amp output, when positive, is about 1 volt negative of the positive rail.

The 741 can be either the 14 pin d.i.l. or 8 pin d.i.l. version. In Fig. 1, pin numbers for the 8 pin package are shown in brackets after those for the 14 pin version. The current drain from the battery is approximately 17mA when either l.e.d. is illuminated. A large battery such as the PP9 would represent a good choice. The l.e.d.'s can be any small types. The author employed Doram Type 4 l.e.d.'s, which are available from Doram Electronics complete with panel-mounting bushes. With these the anode lead-out (which couples to the positive side of the supply) is the shorter of the two.

VR1 can be a standard sized carbon or wire-wound potentiometer. The latter is to be preferred if serious continual work with the continuity tester is intended.

All the components including the battery can be assembled in a plastic or wooden case with VR1, S1, LED1, LED2 and the test terminals on the front panel. VR1 is wired such that the resistance it inserts into circuit increases as its spindle is turned clockwise. It is fitted with a pointer knob and a scale.

After the unit has been constructed it is necessary to calibrate VR1. This potentiometer is set fully anti-clockwise and the test terminals are short-circuited, after which S1 is turned on. The red l.e.d. will light up. VR1 is slowly adjusted clockwise until the red l.e.d. extinguishes and the green l.e.d. lights up. This is the zero resistance setting for VR1 and its scale is marked accordingly. A few low value known resistances of up to about 20Ω are then connected across the test terminals and the corresponding settings of VR1 found and marked up on its scale. The scale for VR1 should be quite linear and a complete scale from zero to 20Ω may next be prepared from these calibrations. If the unit is to be employed permanently with the same pair of test leads and test prods the initial short-circuit and the subsequent low value resistors should be applied to the test prods. The calibration of VR1 will then take in the resistance of the test leads.

In use, VR1 is set to the desired resistance value. The green l.e.d. will then light up when the test prods are applied to this resistance or any lower value. In all other circumstances the red l.e.d. will remain alight.

SHORT WAVE NEWS

FOR DX LISTENERS



By Frank A. Baldwin

Times = GMT

Frequencies = kHz

Last month I dealt with the subject of the reversed tape transmissions from Radio Peking, such programmes being always in the Russian language. The favourite theory is that these broadcasts are made in this manner to avoid Russian jamming and are directed to Chinese border stations not equipped with landline facilities, these stations then taping and retransmitting them, forwards of course, at a later time.

For myself I cannot accept this theory and here I am joined by a Danish colleague, a leading authority on clandestine stations and a "top flight" Dixer, Carol Feil. Writing in a recent issue of "Shortwave News", the journal of the Danish Short Wave Clubs International, he points out that the Russians are also aware of these broadcasts so why would they not jam them to prevent retransmission? The answer to that query also defeats me, for the fact is that the Russians do not jam them — your guess is as good as mine! If any reader has any plausible theory or theories then I should be pleased to hear about them.

Meanwhile, here are the details of the reversed tape transmissions from Radio Peking in Russian. From 0300 to 0355 on 6995; 8260; 8425; 11455; from 0900 to 0955 on 5220 and on 8260; from 1830 to 1925 on 6550 and on 8345.

The last two periods are of one transmission but the first consists of five transmissions a few seconds apart and are identical. Also, note that some of these channels can vary up to 10kHz either side of nominal. All this information according to the BBC Monitoring Service.

Of course, if you want it really tough, why not try 17490 from 0300 to 0355 when not only is it on a reversed tape but also in the single-sideband mode — oh dear!

CURRENT SCHEDULES

Times and frequencies are sometimes subject to change at short notice, the information presented here being correct at the time of writing.

● CUBA

"Radio Havana" presents an External Service in English to Europe from 2010 to 2140 on 17885.

● EAST GERMANY

"Radio Berlin International — the Voice of the GDR", Berlin, lists programmes in English to Europe from 1830 to 1915 on 6080, 6115, 7185, 7300 and on 9730 and from 2115 to 2200 on 7260.

● SPAIN

"Radiotelevision Espanola", Madrid, offers a programme in English to Europe from 2030 to 2230 on 9505 and on 11840, Sundays excepted.

● SOUTH AFRICA

"Radio RSA — The Voice of South Africa", Johannesburg, beams a programme in English to Europe and to East and West Africa from 2100 to 2150 on 4875, 5980 and on 9585.

● U.S.S.R.

"Radio Moscow" has an External Service in English to the U.K. and Eire from 1130 to 1230 on 9450, 9720, 11705, 11745, 12070 and on 15305; from 1900 to 1930 on 7205, 7250, 7310, 7390, 9550, 9720 and on 11830; from 2000 to 2030 on 7205, 7250, 7310, 7390, 9550 and on 9720; from 2100 to 2200 on 7250, 7390, 9550, 9610, 9720 and on 11805; from 2200 to 2230 on 7390, 9610 and on 11805.

● BULGARIA

"Radio Sofia" broadcasts programmes in English to the U.K. and Eire from 1930 to 2000 on 9700 and 11720 and from 2130 to 2200 on 9745 and on 11750.

AROUND THE DIAL

● ISRAEL

Jerusalem on 12077 at 2000, time-check (5 "pips"), identification and a newscast in the Domestic Service in Hebrew, scheduled on this channel from 0400 to 2305. Also logged in parallel on 9355 and on 11625.

Jerusalem on 11655 at 2005, YL with a newscast in English, also logged in parallel on 9815, scheduled in English on both these channels from 2000 to 2305.

● CHINA

Radio Peking on 7935 at 2016, YL in Chinese in the Domestic Service 1, scheduled here from 2000 to 2300.

Radio Peking on 9080, YL in Chinese in the Domestic Service 1, schedule being from 2000 to 2200 and from 2203 to 1735.

Radio Peking on 7620 at 2005, OM & YL with a Chinese language lesson in the English Service directed to North and West Africa, scheduled from 1930 to 2030.

Radio Peking on 6225 at 2006, YL in Chinese in the Domestic Service 1, scheduled from 2000 to 0100 on this frequency.

● **BULGARIA**

Sofia on 9700 at 1937, YL with a talk about the Bulgarian education system in the English programme scheduled here from 1930 to 2000.

● **COLOMBIA**

Ecos del Atrato, Quibdo, on 5020 at 0300, OM with identification, YL with songs in Spanish. Schedule is from 1100 to 0400 and the power is 1kW.

Emisora Kennedy, Bogota, on 4775 at 0245, OM with identification, and, many mentions of Bogota. Schedule is from 1100 to 0400, the power is 1kW and this one sometimes also identifies as "Voz de Maria".

Emisora Nuevo Mundo, Bogota, on 4755 at 0518, OM with a newscast in Spanish. Schedule is around the clock, the power is 1kW and sometimes identifies as "Radio Caracol". It all adds to the fun you see!

Ecos de Combeima, Ibaque, on 4875 at 0257, OM with commercials, identification then Latin American music. With a 24-hour schedule and a power of 5kW, this one tends to wander in frequency from that quoted above to 4878.

● **DOMINICAN REPUBLIC**

Radio Clarin, Santo Domingo, on 4850 at 0524, Latin American music, commercials, many identifications "Radio Clarin". Schedule is from 1000 to 0415 but sometimes extended to be around the clock and the power is 3kW.

● **VENEZUELA**

Radio Popular, Maracaibo, on 4810 at 0415, Latin American music, OM with identification, presumably on an extended schedule, which is normally from 1000 to 0400, the power being 2kW.

Radio Maracaibo on 4860 at 0420, OM with song in Spanish, also on an extended schedule, usually from 1000 to 0400. The power is 1kW.

Radio Sucre, Cumana, on a measured 4959 at 0314, light orchestral music, OM in Spanish. The schedule is from 1000 to 0600 and the power is 1kW.

La Voz de Carabobo, Valencia, on 4780 at 0333, OM with song in Spanish, local music. The schedule is from 1000 to 0400 and this one sometimes identifies as "Onda Nueva"; the power is 1kW.

Radio Bolivar, Ciudad Bolivar, on 4770 at 0225, OM with commercials, YL with songs in Spanish. Schedule is from 1000 to 0400 and the power is 1kW.

Radio Mundial, Caracas, on 5050 at 0426, guitar music, YL with songs in Spanish. Schedule is on a 24-hour basis, the power is 1kW.

Radio Yaracay, San Felipe, on 4940 at 0230, OM with identification, local folk music. Schedule is from 1000 to 0400 and the power is 10kW.

Radio Libertador, Caracas, OM and YL alternate with commercials, guitar music. Schedule is from 1000 to 0400 and the power is 1kW, the action all being on 3245.

● **ECUADOR**

Emisora Progreso, Loja, on 5060 at 0330, OM with identification, piano music. The schedule is

from 1200 to 0415 and the power is 5kW.

Radio Nacional Espejo, Quito, on a measured 4679 at 0314, OM with sports commentary in Spanish. Schedule is around the clock and the power is 5kW.

Radio Zaracay, Santo Domingo, on 3390 at 0311, OM in Spanish, guitar music, YL with songs. The schedule is from 1000 to 0500 but has been reported as late as 0849; the power is 10kW.

● **PERU**

Radio Quillabamba on 5025 at 0321, OM and YL in Spanish, Andean flute music. Schedule is from 1100 to 0400 but the closing time varies up to as late as 0520. The power is 5kW.

Radio Andina, Huancayo, on a measured 4996 at 0402, OM with announcements in Spanish, local pops on records. The schedule is from 1100 to 0600 but has been reported closing at 0450 on occasions. The power is 1kW.

Radio Andina, Huancayo, on a measured 4996 at 0402, OM with announcements in Spanish, local pops on records. The schedule is from 1100 to 0600 but has been reported closing at 0450 on occasions. The power is 1kW.

● **YEMEN**

Sana'a on a measured 4853 at 1853, Arabic music and songs. Schedule is from 0300 to 0700 and from 1100 to 2110; the power is 25kW.

● **SAO TOME**

Radio Nacional de Sao Tome on a measured 4806.5 at 2004, OM in Portuguese, YL with songs. The schedule is from 0530 to 2300 and the power is 1kW.

● **GHANA**

Ejura on 4980 at 1910, pop recordings (made in U.K.) with announcements in English. Schedule is from 0530 to 0800 (Saturdays and Sundays 2305) and from 1200 to 2305, the power being 20kW.

● **ALBANIA**

Gjirocaster on a measured 5057 at 0542, local music, songs by YL. Schedule is from 0430 to 1830 and the programme is a relay of the Tirana Home Service.

● **BENIN**

Cotonou on 4870 at 0548, OM with a market report in French. This one has a schedule from 0515 to 0830 and from 1615 to 2300 (Saturdays from 1600, Sundays from 1630). The power is 30kW.

● **GUINEA**

Conakry on 4910 at 0305, OM in vernacular, local music, African drums, the schedule being from 1230 to 0830 and the power 18kW.

● **BURUNDI**

Radio Cordac, Bujumbura, on a measured 4901 at 1905, OM in French, the talk being interspersed with short extracts of light music. The schedule is from 0330 to 0515 (Sundays from 0730); 1000 to 1200 and from 1630 to 1930. The power is 2.5kW.

'NOTES FOR NEWCOMERS'

KILOHMS AND MILLIAMPS

Or: "Ohms and Amps".

Or: "Megohms and Microamps".

By D. Snaith

Quite a lot of electronics has to do with the current which flows through a resistor when a certain voltage is applied across it. Voltage provides the "pressure" which causes current to flow, and the amount of current which flows is limited by the resistance.

OHM'S LAW

In Fig. 1(a) we apply a voltage of 1 volt to a

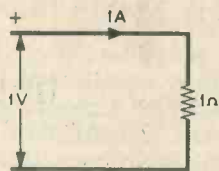

(a)

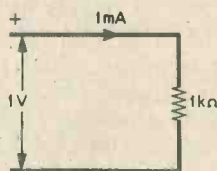

(b)

Fig 1(a) A voltage of 1 volt causes a current of 1 amp to flow in a 1Ω resistor

(b). Similarly, 1 volt gives a current of 1mA in a 1kΩ resistor

resistance of 1Ω. Ohm's Law tells us that the current which flows is 1 amp. If we increase the voltage to 2 volts, twice the current, or 2 amps, flows. If we leave the voltage at 1 volt and reduce the resistance to 0.5Ω, twice the current flows again. In the first instance we are doubling the voltage and in the second instance we are halving the resistance. Both changes result in a doubling of the current.

In Fig. 1(b) the resistance is increased to 1kΩ, which is one thousand times the resistance in Fig. 1(a). If we apply a voltage of 1 volt, one-thousandth of the current, or 1mA, will flow. Most of the currents we deal with in electronics are in milliamps and so it is helpful to think in terms of these units rather than amps. The basic thing we bear in mind is that 1 volt across 1kΩ gives a current of 1mA.

We meet a number of practical examples of how we

may apply this knowledge in Fig. 2. In Fig.2(a) we have an emitter bias resistor of 470Ω, across which a voltage of 1 volt is dropped. What is the emitter current? 1 volt across 1kΩ gives 1mA, the resistor has a value just below a half of 1kΩ, and so the emitter current which flows in it is a little higher than 2mA. If the voltage across the resistor had been 2 volts the current would be rather more than 4mA, and so on.

In Fig. 2(b) we have a series supply decoupling resistor of 220Ω and we find there is a voltage of 3 volts across it. If we say that 220Ω is one-fifth of 1kΩ we can proceed in the following manner. 3 volts across 1kΩ gives 3mA, so 3 volts across one-fifth of 1kΩ gives 15mA. In consequence the current flowing through the resistor, which is that drawn by the stages it supplies, is of the order of 15mA.

These last two examples give results which are accepted as being quite approximate, but they would be adequate if we were measuring the voltages across the resistors to find a fault during servicing. If we require more accurate results then we get the paper and pen out. Note that we have been able to find the values of currents without having to go through the fuss of opening the circuits concerned so that we can insert a current-reading meter.

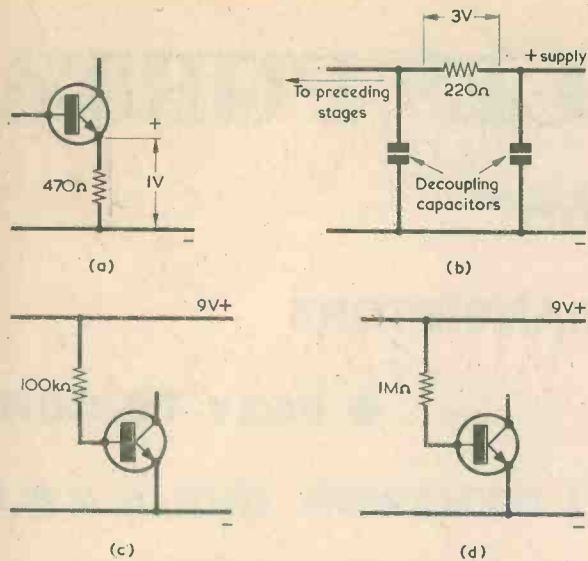

Fig. 2(a). The emitter bias resistor has a voltage of 1 volt across it
 (b). Here, 3 volts are dropped across a supply decoupling resistor
 (c). A simple base bias circuit for a silicon transistor
 (d). The same circuit with a resistor having 10 times the previous value

BASE BIAS RESISTOR

In Fig. 2(c) a 100kΩ base bias resistor is connected between a 9 volt supply and the base of a silicon transistor. What is the base bias current which flows in the resistor? We know that about 0.6 volt is dropped across the base-emitter junction of the transistor, whereupon there must be 8.4 volts across the resistor. 1 volt across 1kΩ gives 1mA, 8.4 volts across 1kΩ gives 8.4mA, 8.4 volts across 10kΩ gives 0.84mA, and 8.4 volts across 100kΩ gives 0.084mA. So, 0.084mA is the answer. A thousandth of 1mA is 1μA, and we could also express the answer as 84μA.

We have a similar set-up in Fig. 2(d) but, this time, the bias resistor has a value of 1MΩ. Instead of working with kilohms we now take a hop to megohms. 1MΩ is equal to 1,000kΩ, so 1 volt across 1MΩ gives a current of one-thousandth of a milliamp, or 1 microamp. In Fig. 2(d) we have the same voltage of 8.4 volts across the resistor. 1 volt across 1MΩ gives 1μA, so 8.4 volts across 1MΩ gives 8.4μA. And that's the current in the resistor. It's also, you may notice, one-tenth of the current in the 100kΩ resistor of Fig. 2(c).

For the record, here are the three Ohm's Law equations:

$$R = \frac{V}{I}$$

$$I = \frac{V}{R}$$

$$V = IR$$

But, for simple approximate calculations of the type we have just carried out, all we need to remember is that 1 volt across 1Ω gives 1 amp, 1 volt across 1kΩ gives 1mA, and 1 volt across 1MΩ gives 1μA. For most electronic work we will use the relationship which takes in the kilohm and the milliamp.

THE RADIO AMATEUR OPERATOR'S HANDBOOK

Essential for the Short Wave Enthusiast

13th EDITION — FULLY REVISED

MAKE SURE OF YOUR COPY NOW!



88 Pages
70p
P & P 13p

- ★ AMATEUR PREFIXES
- ★ AMATEUR CODES
- ★ LOCAL TIME CONVERSIONS
- ★ 8 MAPS
- ★ FREQUENCY/WAVELENGTH CONVERSION TABLES
- ★ HOME OFFICE REGULATIONS

MANY OTHER ESSENTIAL ITEMS

Post this coupon, together with P.O. for 83p (to include postage) to DATA PUBLICATIONS, 57 MAIDA VALE, LONDON, W9 1SN

Please send me the New Edition of "THE RADIO AMATEUR OPERATOR'S HANDBOOK" DATA BOOK No. 6

I enclose cheque/crossed postal order for

NAME

ADDRESS

BLOCK LETTERS PLEASE

'THE PRINCE' PORTABLE

● SUPERHET CIRCUIT

● 5 TRANSISTORS

● EASY TO CONSTRUCT

● HIGH

Most of the entertainment receivers which are described in this and other magazines are a.m. sets for use on the medium and long wave bands. F.M. sets are rarely featured because, although they do have advantages, they also tend to be rather more difficult to construct and align.

The main advantages offered by an f.m. set are an improvement in audio quality (particularly with respect to treble response) and freedom from most types of interference. A disadvantage is that in many areas only B.B.C. Radios 2, 3, and 4 are available, and in a few districts it may not be possible to receive even these. On the other hand, it is presumably the B.B.C. stations that are of primary interest to most listeners, and in a number of areas the three national stations are augmented by local ones.

The author thought that in view of this it would be worthwhile experimenting with a simple f.m. radio design to see if it was possible to produce one that fell within the scope of the average constructor. The receiver which forms the subject of this article is the result, and although it is a little more complicated than the average a.m. superhet radio it is, nonetheless, reasonably easy to construct and its alignment is not too critical.

The receiver is completely self-contained and is capable of good results in areas where f.m. signals are reasonably strong. In fact the prototype is just able to receive four local stations reasonably well (Radio Medway, Radio London, Capital Radio and L.B.C.) even though the author lives a little outside the regions officially served by these stations. The unit can provide an output power of up to 300mW from an internal speaker with a diameter of 3 to 3½ in., and the quality is noticeably better than that produced by most a.m. sets of a comparable size.

RECEIVER CIRCUIT

The complete circuit of the receiver is shown in Fig. 1. Basically this consists of a dual gate MOSFET mixer (TR1), a separate oscillator (TR5), three stages of i.f. amplification (TR2 to TR4), a ratio detector (D1 and D2) and an integrated circuit audio amplifier (IC1).

The dual gate MOSFET mixer stage is quite conventional with the input signal being applied to the g1 terminal, the oscillator signal to the g2 terminal, and the i.f. output signal being taken from the drain via an ordinary 10.7MHz i.f.

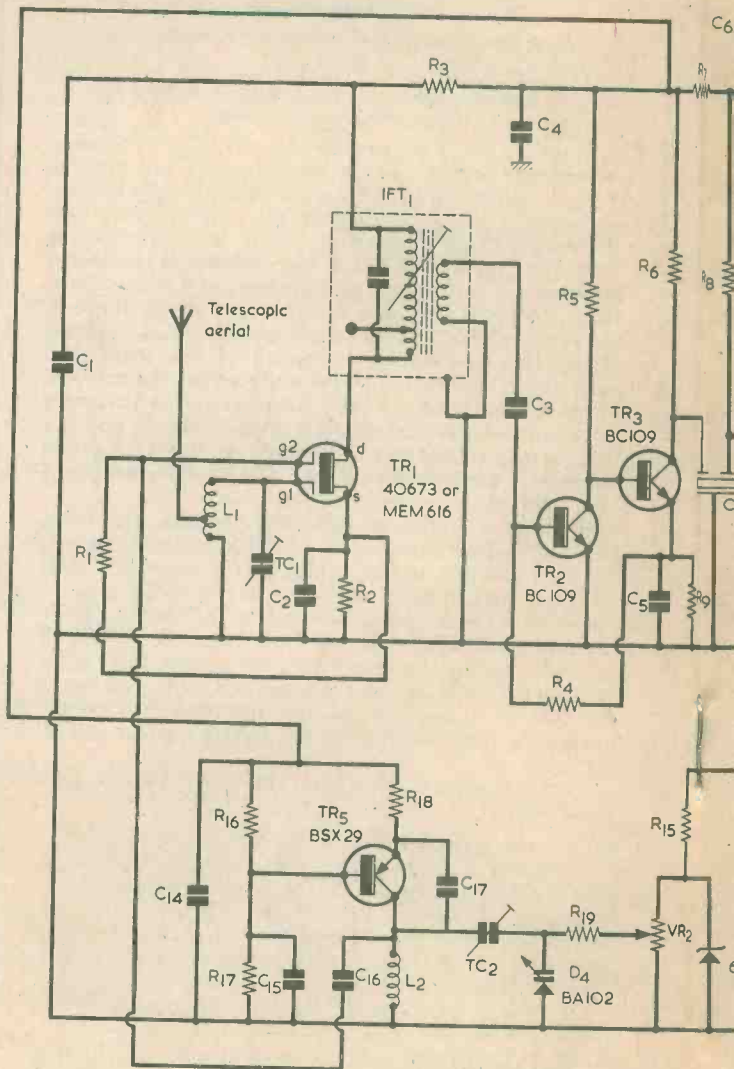

Fig. 1. The complete circuit of the f.m. portable receiver with integrated circuit offering

RINCE' PORTABLE F.M. RA

ET CIRCUIT

By

● 5 TRANSISTORS

● EASY TO CONSTRUCT

● HIGH GAIN AUDIO AMPLIFE

s which are
are a.m. sets
bands. F.M.
ugh they do
rather more

f.m. set are
particularly
edom from
tage is that
3, and 4 are
not be possi-
r hand, it is
e of primary
ber of areas
ited by local

this it would
simple f.m.
produce one
ge construc-
ct of this ar-
a little more
perhet radio
onstruct and

tained and is
e f.m. signals
ototype is just
sonably well
apital Radio
lives a little
ed by these
put power of
aker with a
is noticeably
a.m. sets of a

er is shown in
a dual gate
ate oscillator
tion (TR2 to
) and an in-

stage is quite
ing applied to
to the g2 ter-
ing taken from
0.7MHz i.f.

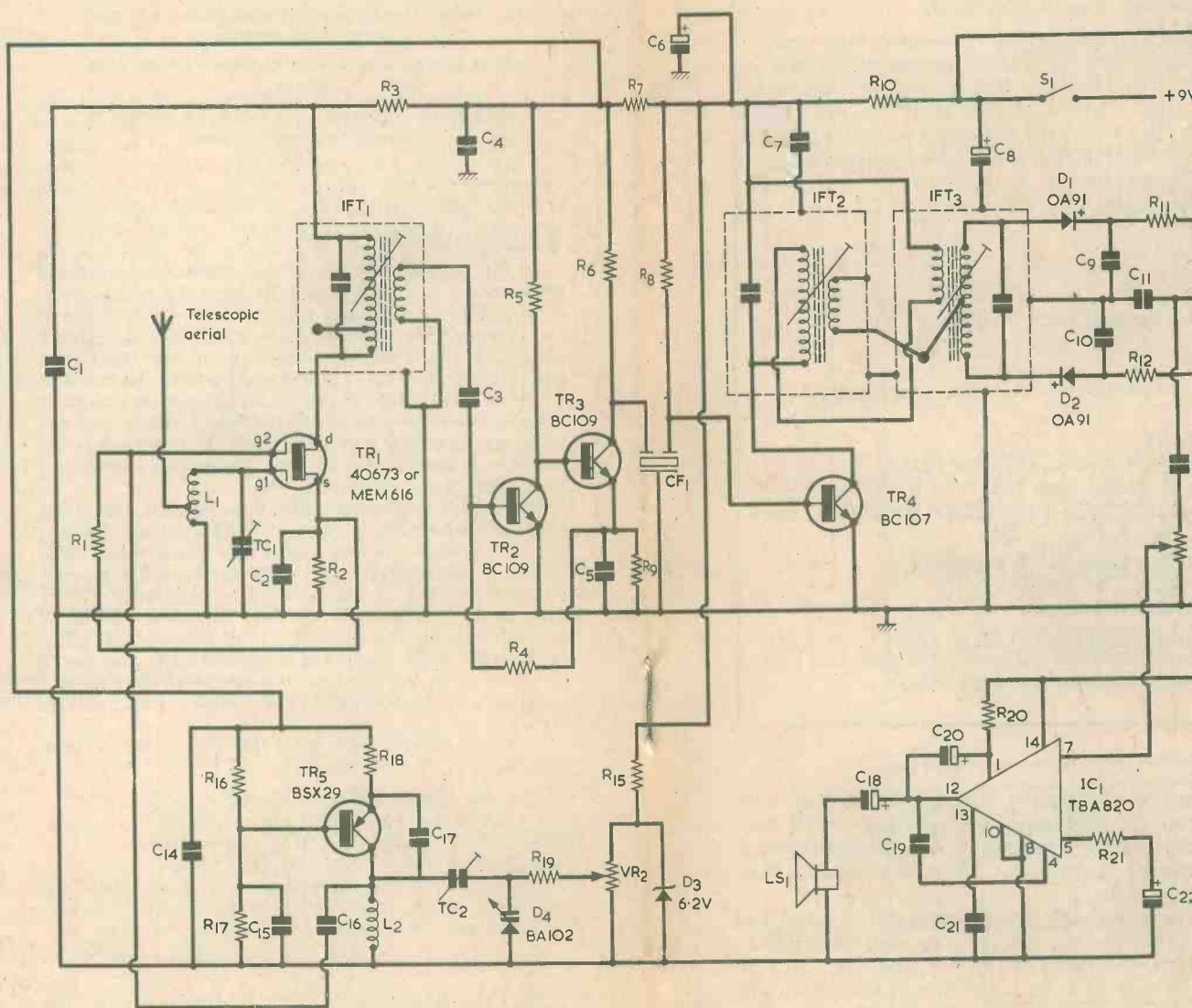

Fig. 1. The complete circuit of the f.m. portable receiver. This has varicap tuning and incorporates an a.f. integrated circuit offering a high level of gain

BLE F.M. RADIO

By R. A. Penfold

STRUCT

HIGH GAIN AUDIO AMPLIFIER I.C.

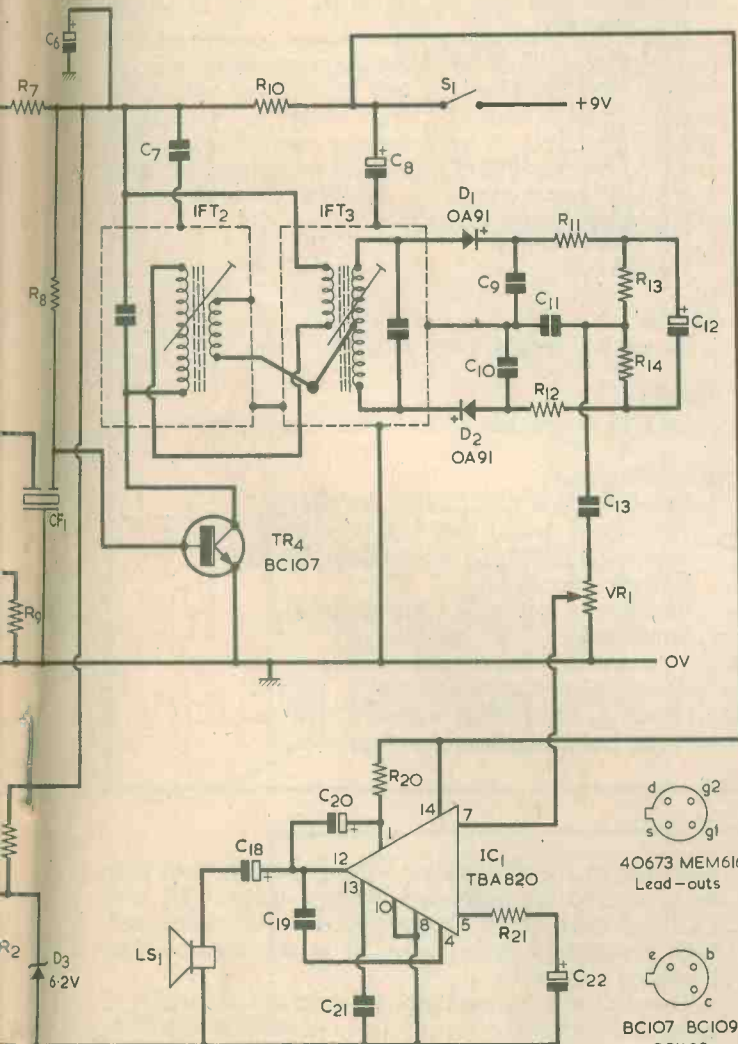
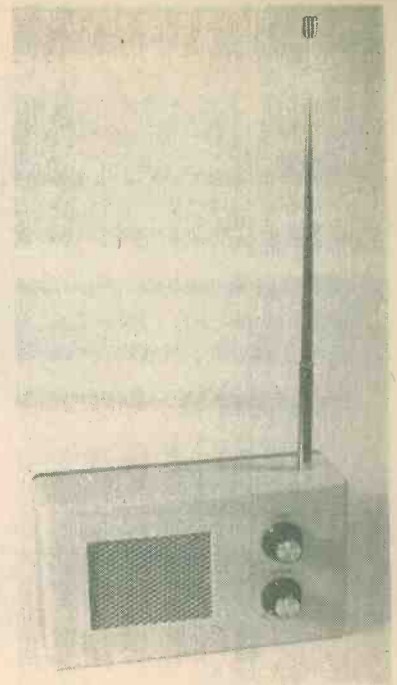

transformer. L1 and TC1 are the input tuned circuit, and this is a broad-band circuit with pre-set tuning. The aerial, which is a telescopic type, couples to a tap in L1.

A Colpitts oscillator circuit is employed and the only unusual feature about this is that it incorporates a p.n.p. transistor in what is a negative earth receiver. The output from the oscillator is extracted from TR5 collector and is coupled to TR1 g2 via C16. Varicap diode tuning is used, and the oscillator tuned coil, L2, is coupled to the tuning diode, D4, via TC2. The latter is adjusted to provide the required tuning range. R15 and D3 form a simple zener shunt regulator circuit which provides a stabilized tuning voltage. The voltage which is fed to the varicap diode by way of R19 can be adjusted by means of VR2, which thus operates as the tuning control.

The secondary winding of the first i.f. transformer is coupled to the base of TR2 by d.c. blocking capacitor C3. TR2 and TR3 are both common emitter amplifiers, and they are connected in a simple direct coupled arrangement which is often employed in audio amplifiers. With the circuit values suitably modified this works very well as a high gain 10.7MHz i.f. amplifier.

The output from the collector of TR3 is coupled to the base of TR4 by way of a 10.7MHz ceramic filter. TR4 is used in the common emitter mode and it is biased by R8.

I.F. transformers IFT2 and IFT3 together provide a ratio detector transformer. These, in conjunction with D1 and D2 and the associated components, constitute the ratio detector circuit of the receiver.

C11 is the de-emphasis capacitor, and it provides a degree of treble cut to the audio output signal. This is necessary in order to compensate for the treble boost, or pre-emphasis, which is provided

receiver. This has varicap tuning and incorporates an a.f. offering a high level of gain

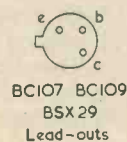
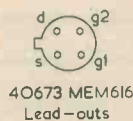

COMPONENTS

Resistors

(All fixed values $\frac{1}{2}$ watt 5%)

R1 120k Ω
 R2 3.9k Ω
 R3 680 Ω
 R4 330k Ω
 R5 820 Ω
 R6 330 Ω
 R7 390 Ω
 R8 560k Ω
 R9 2.2k Ω
 R10 220 Ω
 R11 680 Ω
 R12 680 Ω
 R13 5.6k Ω
 R14 5.6k Ω
 R15 1.8k Ω
 R16 10k Ω
 R17 12k Ω
 R18 1k Ω
 R19 470k Ω
 R20 150 Ω
 R21 10 Ω
 VR1 5k Ω potentiometer, log with switch S1
 VR2 100k Ω potentiometer, linear

Capacitors

C1 0.01 μ F disc ceramic
 C2 0.01 μ F disc ceramic
 C3 0.01 μ F disc ceramic
 C4 0.01 μ F disc ceramic
 C5 0.01 μ F disc ceramic
 C6 100 μ F electrolytic, 10V Wkg.
 C7 0.1 μ F type C280 (Mullard)
 C8 100 μ F electrolytic, 10V Wkg.
 C9 470pF polystyrene
 C10 470pF polystyrene
 C11 0.01 μ F disc ceramic
 C12 10 μ F electrolytic 10V Wkg.
 C13 1 μ F type C280 (Mullard)
 C14 0.022 μ F disc ceramic
 C15 0.01 μ F disc ceramic
 C16 8.2pF ceramic
 C17 5.6pF ceramic
 C18 220 μ F electrolytic, 10V Wkg.
 C19 330pF ceramic
 C20 100 μ F electrolytic, 10V Wkg.

C21 0.1 μ F type C280 (Mullard)
 C22 100 μ F electrolytic, 10V Wkg.
 TC1 20pF ceramic trimmer (see text)
 TC2 60pF ceramic trimmer (see text)

Inductors

L1, L2 see text
 IFT1 10.7MHz i.f. transformer type KALS4520A (see text)
 IFT2 10.7MHz i.f. transformer type 94ACS10516PJ (see text)
 IFT3 10.7MHz i.f. transformer type 94FCS10517STP (see text)

Ceramic Filter

CF1 ceramic filter type CFSA10.7 (see text)

Semiconductors

IC1 TBA820
 TR1 40673 or MEM616
 TR2 BC109
 TR3 BC109
 TR4 BC107
 TR5 BSX29 (see text)
 D1 OA91
 D2 OA91
 D3 BZY88C6V2
 D4 BA102

Switch

S1 s.p.s.t. toggle, part of VR1

Speaker

LS1 25 Ω speaker, 3 to 3.5in. diameter

Miscellaneous

Verobox type 65-2522K (see text)
 Telescopic aerial (see text)
 9 volt battery type PP6 (Ever Ready)
 Battery connector
 Veroboard, plain, 0.15in. matrix
 Veroboard, 0.1in. matrix
 2 control knobs
 Speaker aperture material
 16 s.w.g. enamelled wire (for L1 and L2)
 Nuts, bolts, 4BA solder tag, etc.

ed at the transmitter. The combined effect of using pre-emphasis and de-emphasis is an improved signal-to-noise ratio.

The output from the detector is coupled to the volume control, VR1, by C13. The signal is then fed to the input of the audio amplifier integrated circuit. The internal circuitry of this i.c. is such that no input d.c. blocking capacitor is required. R21, in company with the a.f. bypass capacitor C22, reduces the negative feedback applied internally in the i.c.; R21 is given a low value in the present circuit in order that the i.c. should have a high voltage gain. This is necessary because the output from a ratio detector is comparatively low. C20 and R20 are bootstrapping components and provide an

increase in the maximum output power than can be produced for a given supply voltage. C19 and C21 are needed for frequency compensation and high frequency stability. C18 is the output d.c. blocking capacitor.

Due to the very high overall gain of the circuit it is essential that the supply lines be well decoupled. This function is carried out by C1, R3, C4, C6, R7, C7, R10, C8 and C14. S1 is the on-off switch and is ganged with VR1. The quiescent current consumption of the circuit is about 10mA and this rises to about 50mA at high volume levels.

The components are all standard types but a few comments are necessary concerning the source of some of these. The three i.f. transformers and the

ceramic i.f. filter are all Toko components available from Ambit International, 37 High Street, Brentwood, Essex. Trimming capacitors TC1 and TC2 are Doram Type A, obtainable from Doram Electronics Limited, P.O. Box TR8, Wellington Road Industrial Estate, Wellington Bridge, Leeds. Also available from Doram Electronics are the transistor type BSX29 employed for TR5 and the telescopic aerial. The latter has an extended length of 975mm. with a hinge at the base of the second section.

MAIN CIRCUIT BOARD

Most of the components are mounted and wired up on a plain Veroboard (i.e. without copper strips) of 0.15in. matrix measuring 5 by 3.75in. This is a standard size in which the board is sold. The mixer and i.f. circuitry is wired up near the bottom edge of the board, and this wiring is illustrated in Fig. 2. The three i.f. transformers fit well onto the board, but it is necessary to slightly enlarge the holes for their mounting lugs. Note that connections are made to nearly all of these lugs.

The other components are mounted on the board in the positions indicated in the diagram, their lead-outs being bent flat against the board underside. They are then wired together as shown in the diagram. Tinned copper wire of around 20 s.w.g. may be employed for long wiring runs or where it is necessary to extend a component lead-out. Capacitor C1 is wired under the board between the

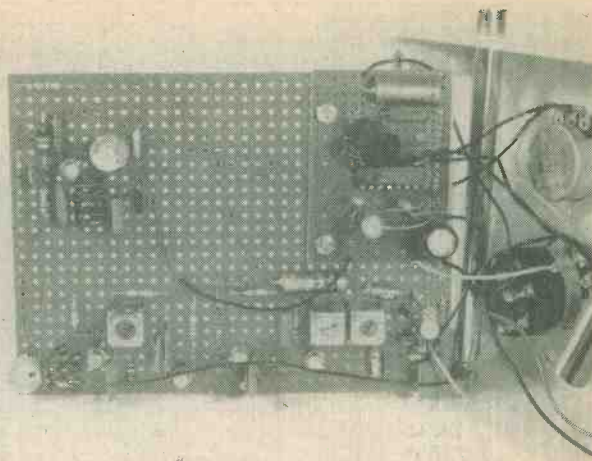

The oscillator, mixer, i.f. amplifier and ratio detector components are mounted directly on the larger perforated board. A separate a.f. amplifier module, assembled on its own Veroboard panel, is then bolted to this

two points "A". Its lead-outs should be covered with sleeving to prevent short-circuits to other wires.

L1 is a home-made coil and is wound with 16 s.w.g. enamelled copper wire. It consists of exactly 5 turns of wire, the coil ends being bent down and

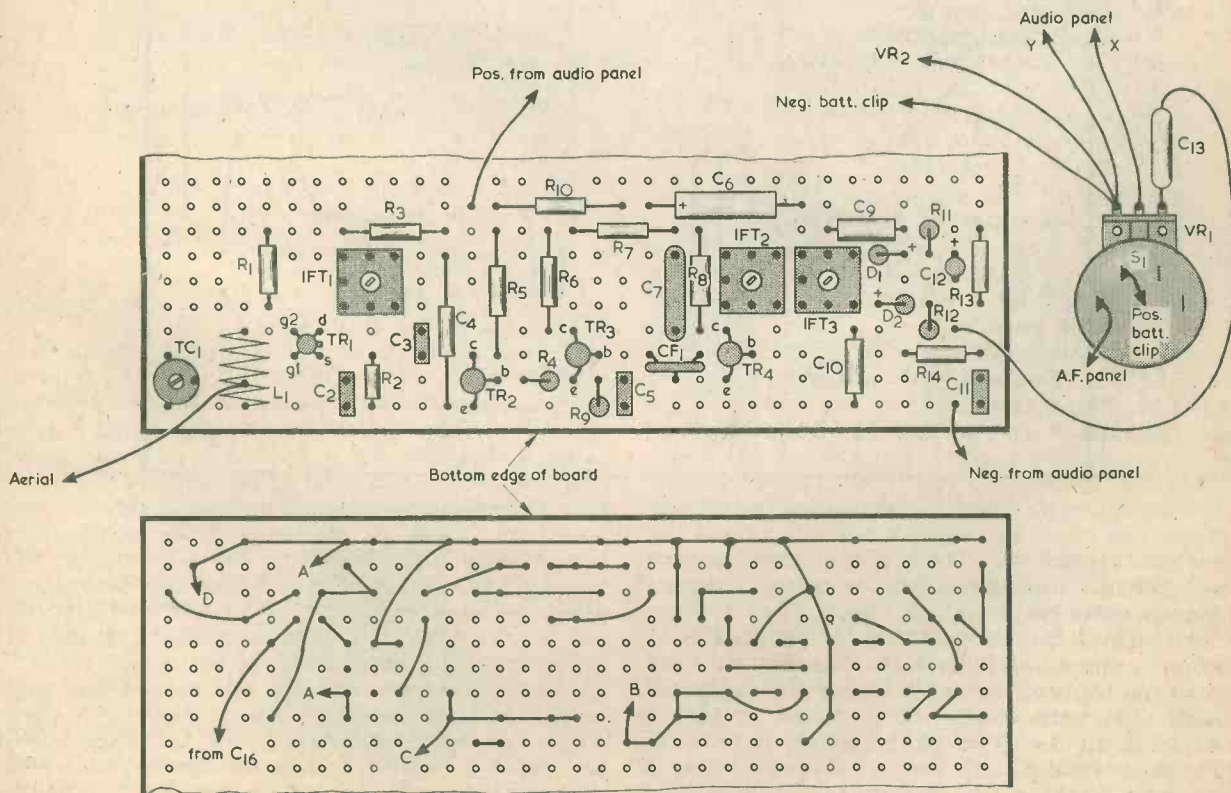
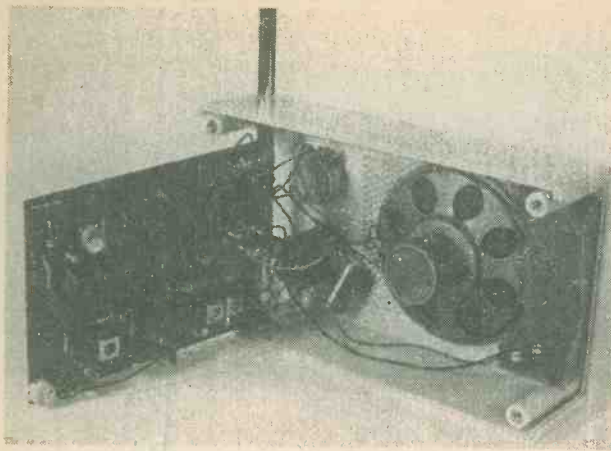

Fig. 2. The mixer and i.f. amplifier wiring. The parts are assembled at the bottom of the main component board



A view inside the receiver with the component panel displaced to show the speaker and panel controls

passed through two holes in the board 0.45in. apart. The coil is then just clear of the upper surface of the board. The coil is self-supporting and is initially wound around any cylindrical object having a diameter of $\frac{5}{16}$ in., the author used the shank of a $\frac{5}{16}$ in. diameter drill. The coil ends are scraped clean of enamel, as also is a point $1\frac{1}{2}$ turns from one end. This forms the tap, to which the aerial connects. The cleaned sections of the coil are tinned with solder and it is then fitted and wired to the board as shown in Fig. 2. The connection to the coil tap is made later.

OSCILLATOR STAGE

The oscillator stage is assembled on the Veroboard panel in the same way as the mixer and i.f. stages. It is wired in the upper left hand corner of the board, diagonally opposite C11. There are three points identified as "B", "C" and "D". These are connected, below the panel and using insulated wires, to the similarly identified points in Fig. 2. An insulated wire below the panel also takes a connection from C16 to R1. The oscillator wiring is shown in Fig. 3.

Coil L2 is wound and finished in exactly the same way as L1, the only difference being that L2 does not have a tap. Capacitor C17 is wired below the board.

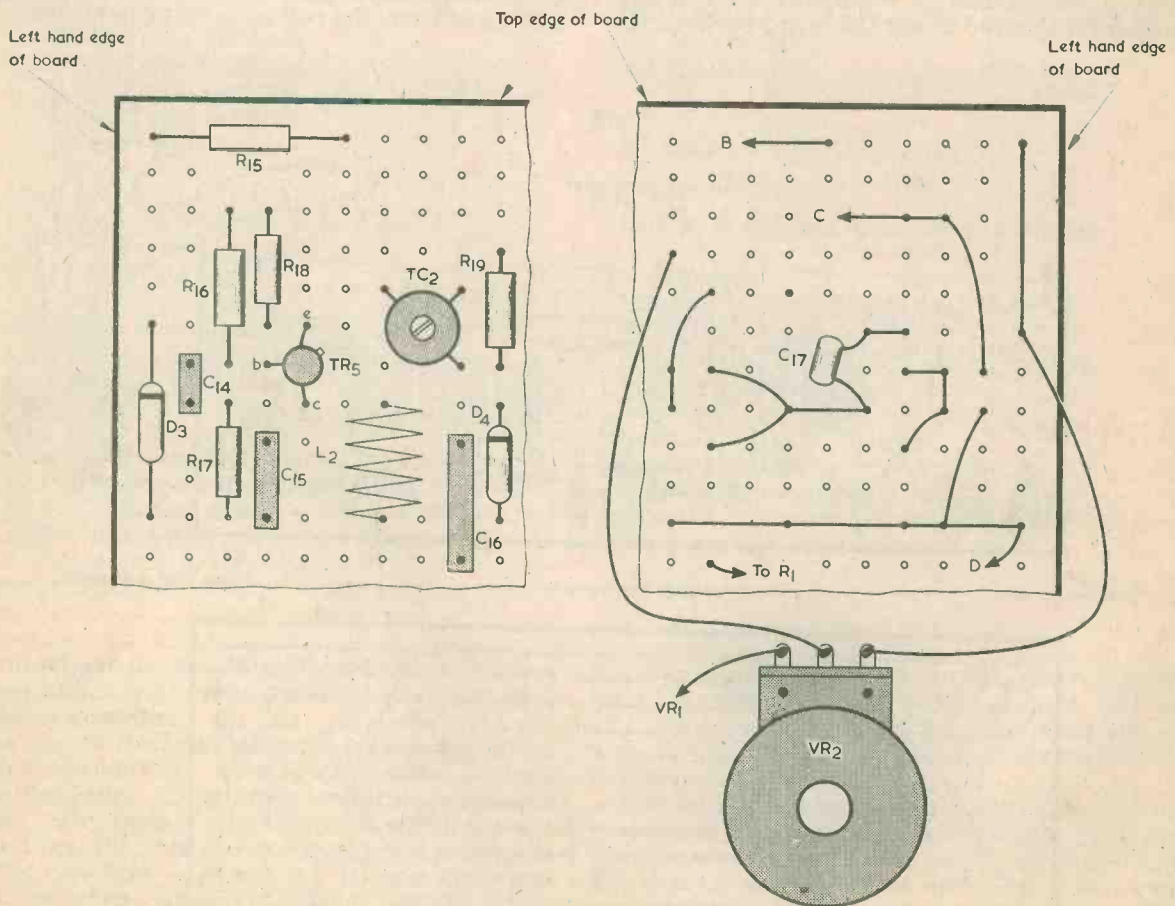

Fig. 3. The oscillator stage, which is assembled at the top left corner of the component board

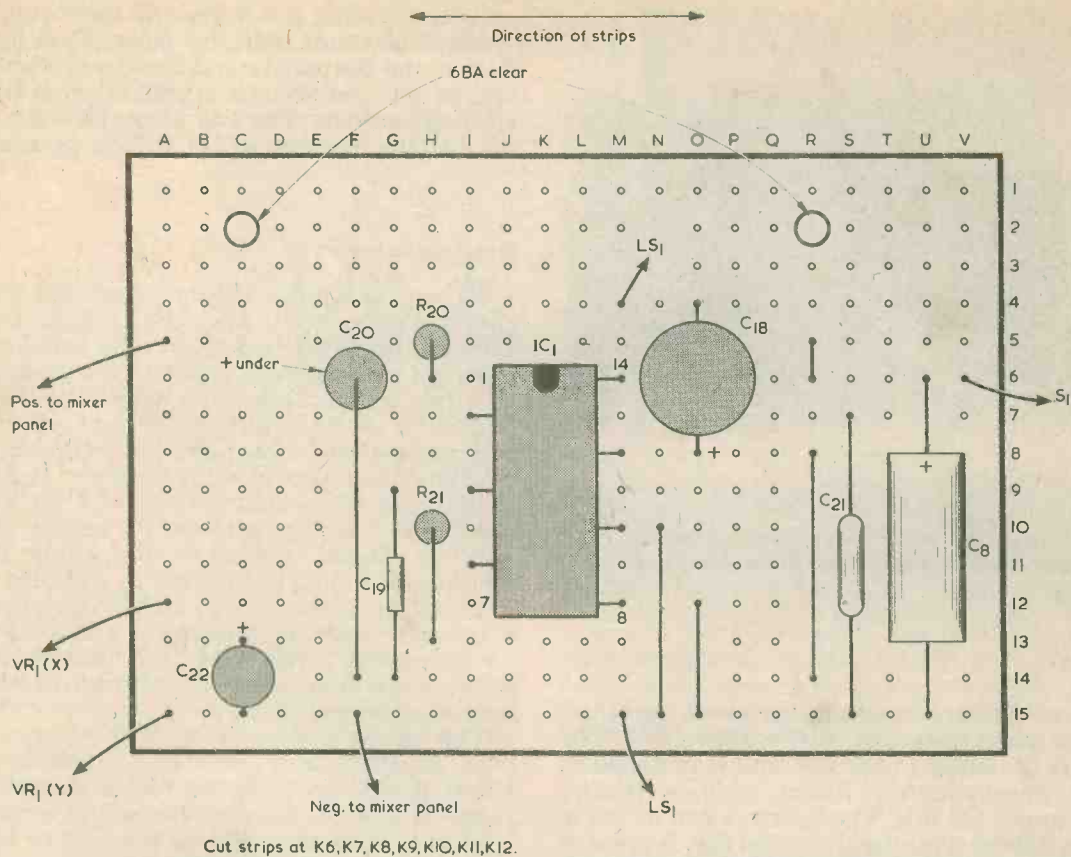

Fig. 4 The a.f. amplifier components are wired up on the Veroboard panel shown here. This is then bolted to the top right corner of the main board

AUDIO PANEL

The audio amplifier is assembled on a piece of ordinary Veroboard with copper strips and a matrix of 0.1in. This board has 22 holes by 15 copper strips. The board is first cut out from a larger piece by means of a small hacksaw, after which the two mounting holes are drilled out 6BA clear. Seven breaks in the copper strips are next made, these being from 'K6' to 'K12' inclusive. The components and link wires are then soldered in place, as illustrated in Fig. 4, with the i.c. being left until last. The i.c. is a quad-in-line device with its pins staggered as shown.

The audio panel is fitted by means of two 6BA bolts and nuts to the right hand top corner of the main component panel, C8 being uppermost. Two 6BA clear holes are required in the main component panel to match those in the audio panel, and small spacing washers are fitted between the two to prevent the solder joints under the audio panel from stressing the main panel. Before the audio panel is finally mounted it must be wired to the rest of the circuit. The remaining wiring is shown in Figs. 2 and 3.

THE CASE

The prototype is housed in a plastic Verobox No. 65-2522K, which has dimensions of 188 by 110 by 60mm. There should be adequate depth in the box for a standard speaker and the main component panel (which fit together in a manner which will shortly be described) but it would be advisable to check the rear speaker dimension before obtaining the box in case the speaker has an excessively large magnet. Any other plastic box having similar or larger dimensions could be used if it will accommodate the speaker and the component panel.

The general layout of the receiver inside the case can be seen from the photographs. A 9mm. diameter hole is drilled in the top of the case for the telescopic aerial and a 4BA clear hole exactly below it in the bottom of the case. The bottom hole is countersunk on the outside. A 4BA countersunk bolt is passed up through this hole and a solder tag fitted over it. The aerial is pushed down through the 9mm. hole and secured by the 4BA bolt, which passes into a tapped hole at the bottom of the aerial. A lead from the solder tag connects to the tap in L1.

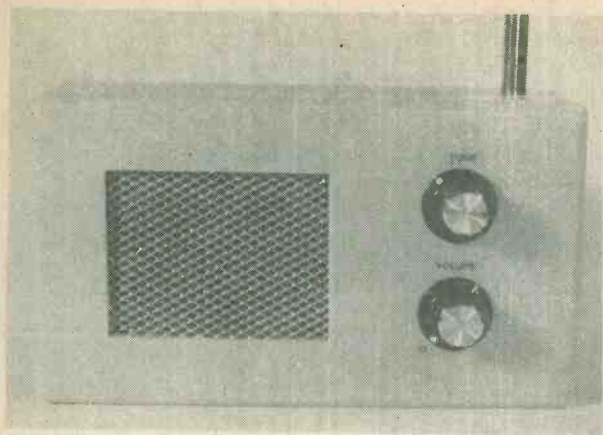

The appearance of the front panel is enhanced by legends taken from "Panel-Signs" set No. 4

VR1 and VR2 are mounted, one above the other, just to the left of the aerial. VR2 is above VR1. The speaker is mounted to the left and a rectangular aperture, approximately 75mm. wide by 60mm. high, is cut out for this. The aperture can be made with a fretsaw or a miniature round file. A piece of speaker fret is glued in place behind the aperture, and then the speaker is glued to this. Take care that the glue is applied only to the rim of the speaker, and that none gets on to the cone or surround. The speaker is positioned so that the back of its magnet coincides with the blank central area of the main component panel when the latter is fitted in place.

In practice, it is advisable to complete the component panel before actually mounting the aerial, speaker and controls on the case. They can then be positioned such that the component panel fits comfortably into the case with the empty space at its centre behind the speaker magnet. Sufficient room must be available at the left hand side of the case for the PP6 battery.

On the prototype a piece of foam rubber is glued to the front of the case where the battery fits. A second piece of foam is placed between the speaker and battery and the component panel. The latter fits, component side forwards, against the foam, and when the back of the case is screwed into position the panel and battery are held firmly in place.

Alternatively the leads between the aerial, speaker, controls and the panel could be made longer, and the panel could then be mounted on the rear of the case using a couple of short bolts with spacing washers. The two pieces of foam holding the battery in place would still be necessary.

ALIGNMENT

Before the unit is finally assembled inside the case it is necessary to align the r.f. and i.f. circuits. With the unit switched on and the aerial extended it should be possible to receive a few stations. Note that for best reception the aerial must be either horizontal or at 45 degrees, and not vertical. Also it is directional and must be swung around to find the position which provides the strongest signal. If no signals can be located, adjust TC2 for increased capacitance and try altering the setting of TC1.

When a signal has been located, adjust TC1 with a plastic trimming tool to peak it, and then similarly adjust the cores of IFT1 and IFT3 in that order. If a fairly sensitive voltmeter is available this can be connected across C12 and used as a tuning meter. Maximum meter deflection corresponds to maximum signal strength.

The setting of the core of IFT2 is not critical. If it is adjusted backwards and forwards over its travel it will probably be found that there is a range of settings towards the centre where audio quality is at its best. This is the area to which the core should be adjusted and left. However, results should be quite satisfactory with IFT2 core at virtually any setting.

TC2 is given a setting which allows all the appropriate stations to be tuned in. If a suitable signal generator is available, TC2 can be adjusted for a tuning range of about 88 to 100 MHz. Should an adjustment in TC2 for adequate tuning range result in stations being lost at the high frequency end of the coverage, the problem may be rectified by stretching out L2 slightly. Should it not be possible to obtain adequate range at the low frequency end, L2 may be compressed slightly.

The final adjustment consists of tuning to a station at or near the centre of the tuning range, and then adjusting TC1 to peak this signal. Should the peak be just outside the range of TC1, coil L1 may be similarly slightly stretched or compressed, as appropriate.

Alignment is then complete. The receiver is finally assembled and is then ready for use.

BACK NUMBERS

For the benefit of new readers we would draw attention to our back number service.

We retain past issues for a period of two years and we can, occasionally, supply copies more than two years old. The cost is 40p plus 12p postage.

Before undertaking any constructional project described in a back issue, it must be borne in mind that components readily available at the time of publication may no longer be so.

We regret that we are unable to supply photo copies of articles where an issue is not available. Libraries and members of local radio clubs can often be very helpful where an issue is not available for sale.

ELECTRONIC COMMUNICATIONS PIONEER —

Dr. E. F. W. ALEXANDERSON

By Michael Lorant

It is not generally realised that transmission of speech by radio, employing a spark transmitter, was accomplished by the American R. A. Fessenden in 1900. Results were unsatisfactory, however, until the introduction of the transmitting high frequency alternator, designed and engineered by E. F. W. Alexanderson. Dr. Alexanderson was a notable pioneer in the development of radio, and this article gives a general outline of his many achievements in American radio, television and electronics.

It was Christmas Eve, 1906. On the storm-tossed North Atlantic the Morse code message "CQ ... CQ" crackled over the earphones of ship radio operators. These code letters signalled that the message to follow would be of general interest to anyone who could hear it.

As the radio operators strained to hear, the Morse code transmission suddenly stopped. Instead, to their amazement, it was replaced — for the first time — by the sound of a human voice; then a woman singing, then someone reading a poem, then a violin solo and then a man making a speech. Thus, the world's first voice radio broadcast passed into history.

HIGH FREQUENCY ALTERNATOR

Behind that achievement stood a young General Electric engineer, Ernst Frederick Werner Alexanderson, who had spent the previous two years designing and constructing the high frequency alternator that made the broadcast possible. The project was undertaken at the request of another pioneer in radio experimentation, Prof. Reginald A. Fessenden, who had asked General Electric to build a high frequency machine that would operate at high speeds and produce a continuous wave transmission. Although the usual generator in those days operated at around 60 cycles per second, Prof. Fessenden wanted one to operate at 100,000 cycles — an idea considered fantastic by most engineers. Dr. Alexanderson, only 26 years old when he was handed the assignment, completed the equipment and installed it in the Fessenden station in time for the historic Christmas Eve broadcast.

That achievement, which gave the United States its start in the field of radio communication, was to prove but one of many during Dr. Alexanderson's career. During his 46 years with General Electric, he was to receive 322 patents, nearly one every seven weeks. He died at the age of 97, on May 14, 1975 as one of the giants of the engineering profession.

Ernst F. W. Alexanderson was born on January 25, 1878, at Uppsala, Sweden, the son of Professor A. M. Alexanderson, then on the faculty of Uppsala University. The young man developed an early interest in electrical engineering which was stimulated by a year of technical work at the University of Lund in 1896. He then spent

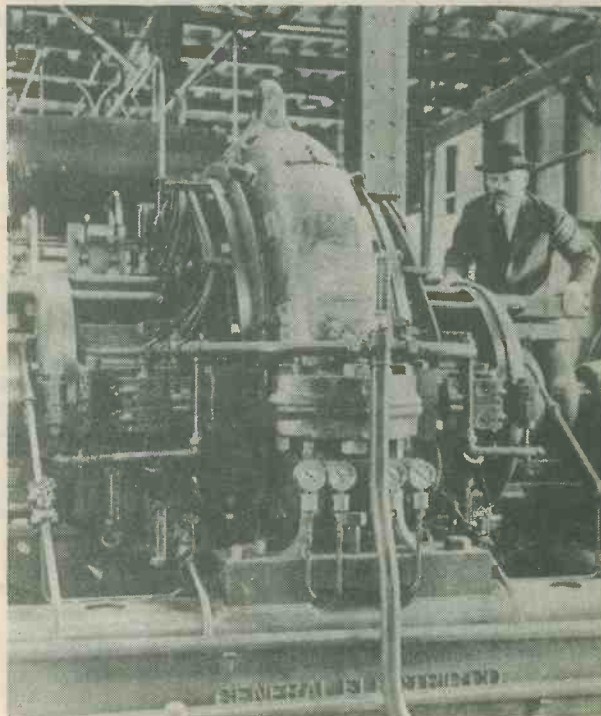

Picture shows Dr. Ernst F. W. Alexanderson inspecting one of the 200 kilowatt high frequency alternators which gave America its start in the field of radio communication. This alternator, one of several designed by Dr. Alexanderson from 1905 to 1920, was used to send transatlantic radio telegraph messages from the Rocky Point, Long Island, station of the Radio Corporation of America. The photograph was taken in 1922

The first facsimile message sent by radio across the Atlantic on June 5th, 1924, to Dr. Alexanderson's father in Sweden

Professor
A. M. Alexanderson
Lund Sweden
Dear Father
It is a great
pleasure to me
to be able to write
my first radio
letter to you. It
makes the distance
seem shorter.
The family is well
much love from
all Ernst

NEWARK 62 JUNE 5TH

three years at the Royal Institute of Technology in Stockholm, from which he graduated in 1900 as an electrical-mechanical engineer. This was followed by a year of post-graduate work at the Technical University in Berlin, Germany.

As the son of a professor of languages, Dr. Alexanderson had learned English, German, French, and Latin in addition to his native Swedish. Thus, when a copy in English of "Alternating Current Phenomena" by Dr. Charles P. Steinmetz, General Electric's mathematical genius, fell into his hands while he was studying at the University of Berlin he was able to read the volume. It made such an impression on him that he decided to move to America to seek work with the author.

In 1901, Dr. Alexanderson arrived in the United States and visited Steinmetz in Schenectady, General Electric's research centre. In 1902, on the mathematician's recommendation, General Electric gave him a drafting job. The following year he took the company's Test Engineering Course and in 1904 he became a member of the engineering staff designing generators under the direction of Steinmetz.

When Steinmetz organized a Consulting Engineering Department in 1910, Dr. Alexanderson became a member of the group. During the next eight years a number of significant developments evolved from the alternator. For example, news of its invention had reached the ears of Guglielmo Marconi, the "father" of radio, and in 1915 he travelled from England to visit General Electric and talk with Dr. Alexanderson in Schenectady. He arranged to have a 50 kilowatt Alexanderson alternator installed in his transatlantic Marconi Company station in New Brunswick, New Jersey.

However, Dr. Alexanderson was not content. A few years later, during World War I, he perfected a 200-kilowatt alternator, and the first unit of this size was installed at the same New Brunswick station. It was used by President Woodrow Wilson, and by Franklin D. Roosevelt, then Assistant Secretary of the Navy, in transmitting messages to the war theatres of Europe. But it was not until October 20, 1918, that the alternator was put to its first important practical test: the transmission of President Wilson's ultimatum to Germany which brought the war to a close.

In 1918 Dr. Alexanderson became head of General Electric's newly organized Radio Engineering Department. The next year, Marconi renewed negotiations — first instituted early in the war — for exclusive rights to the

alternator. It was then that President Wilson appealed to General Electric not to sell and instead to help organize an American company to use the alternator. This led to the formation of the Radio Corporation of America, with Dr. Alexanderson becoming its chief engineer in 1919.

INVENTIVE GENIUS

Meanwhile, Dr. Alexanderson's inventive genius had been hard at work. Among his notable radio developments were the magnetic amplifier, the electronic amplifier, the multiple tuned antenna, the anti-static receiving antenna and the directional transmitting antenna. He also devised radio altimeters, and his studies in the polarisation of radio waves made possible effective radio direction finders.

Dr. Alexanderson's magnetic amplifier utilised the magnetic saturation effect in iron to harness the weak power circuit of the microphone to the high power of the antenna without burning out the microphone. He told E. W. Rice, Jr., then vice president and later president of General Electric, that the device might be used for transatlantic telephony. "Why does the company waste time on such a foolish dream?" Rice was asked by another executive of the company. "Well," answered Rice, "if Alexanderson thinks he has discovered the means of telephoning across the ocean I feel it my duty to look into it." His faith in Alexanderson was amply justified and an ocean telephone service was inaugurated only a few years later.

Dr. Alexanderson himself made the magnetic amplifier obsolete with his invention of the electronic amplifier. This was essentially the application to radio telephony of



The first American home television reception took place in 1927 at the Schenectady residence of Dr. Ernst F. W. Alexanderson. The television screen is in the small square at eye level. A television system developed by Alexanderson and his co-workers transmitted pictures nationwide throughout 1928

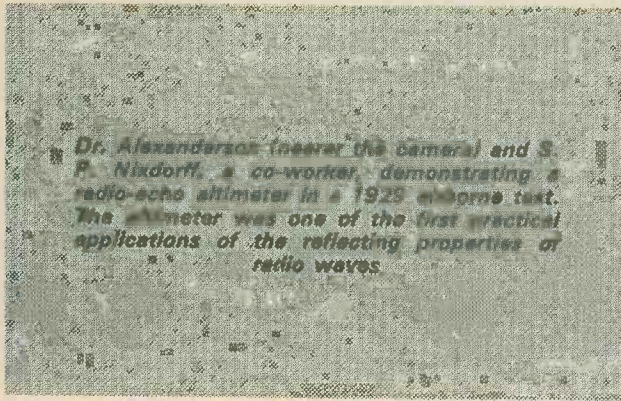

Dr. Alexanderson (center) and S. P. Nixdorff, a co-worker, demonstrating a radio-echo altimeter in a 1929 airplane test. The altimeter was one of the first practical applications of the reflecting properties of radio waves.



the vacuum tube improvements worked out by Dr. Irving Langmuir of the General Electric Research Laboratory. These tubes became the basis for all present-day radio broadcasting.

The anti-static receiver was another World War I development. With German submarines cutting cables and the allies complaining of German stations blanketing their wireless transmission, the U.S. government turned to Dr. Alexanderson for a means of ensuring continual communication with the armies in France. With an assistant he discovered that a wire two miles long stretched in the direction of Europe and another in the perpendicular direction balanced by coils not only eliminated the German radio barrage, but the static as well in the receiver. This system soon became an indispensable part of long-distance commercial radio reception.

From 1919 to 1924 Dr. Alexanderson divided his time between General Electric and the Radio Corporation of America, maintaining his residence and laboratory in

Schenectady, but personally superintending construction of powerful radio stations in Sweden, Poland, England, Hawaii, and California, and on Long Island, New York. At the opening of a transatlantic station at Grineton, in his native Sweden, he received the Order of the North Star from King Gustav V.

In the next few years, Dr. Alexanderson performed pioneering work in American television and the transmission of pictures by radio. Using a perforated scanning disc and high frequency neon lamps, he staged in Schenectady the first home and theatre demonstrations. The first American home television reception took place in 1927 in his home, and a public demonstration was held the following year. The theatre demonstration took place on May 22, 1930 in Schenectady's Proctor's Theatre, whose orchestra was led by the image of a conductor on a seven-foot screen which also carried the faces of other performers a mile away in a General Electric laboratory.

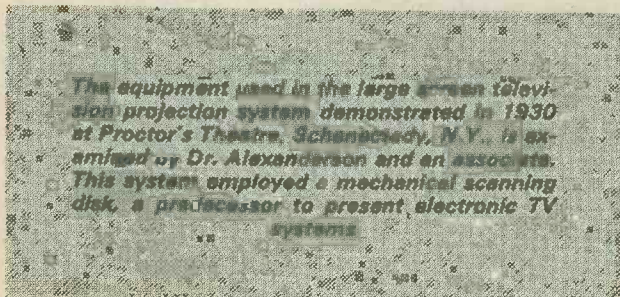

The equipment used in the large screen television projection system demonstrated in 1930 at Proctor's Theatre, Schenectady, N.Y., is examined by Dr. Alexanderson and an associate. This system employed a mechanical scanning disk, a predecessor to present electronic TV systems.



By R. S. Carlman

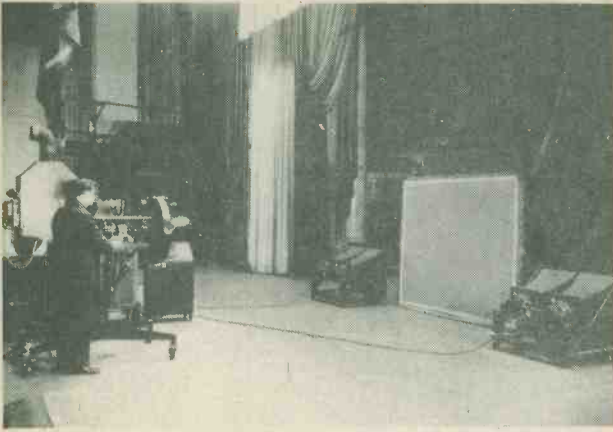

The stage set-up for the large screen television demonstration at Proctor's Theatre. Two pairs of horn loudspeakers are positioned on either side of the screen

With General Electric's withdrawal from the affairs of the Radio Corporation of America in 1933, Dr. Alexanderson devoted himself at GE to the power applications of electronics, such as power transmission with direct current. He also continued his interest in short wave phenomena and in television. In 1933, his company's engineers in the Helderberg Hills near Schenectady regularly began to receive high definition television from New York, 129 miles away. In 1940, GE placed in service in the Helderbergs the first television relay station operating at such a distance, and began to broadcast New York programmes.

In the power and control field, Dr. Alexanderson devoted several years to the design of single-phase motors for railway electrification, and won an international competition conducted by the Melbourne, Australia, tramway authority with a specially ventilated 1,500 volt d.c. motor. He developed the phase converter system for changing single-phase into poly-phase power and vice versa.

Dr. Alexanderson worked out a system of regenerative braking by d.c. series motors represented in the locomotives of the Chicago, Milwaukee and St. Paul Railroad. His development of several new methods of operating induction motors at variable speeds was embodied in the design of electrical equipment for the battleship "New Mexico", the aircraft carrier "Lexington" and many other ships of the U.S. Navy.

The company inventor's laboratory also produced the Amplidyne, an extremely sensitive and powerful system for amplification and automatic control that was successfully applied in steel mills and other places requiring delicate control of continuous operations. The principle of the inverter used in DC power transmission found another application in the development of a variable speed a.c. motor known as a thyatron motor.

Before his retirement, in 1948, Dr. Alexanderson was elected in 1934 to the Royal Academy of Science of Sweden, the body that bestows the Nobel prizes in science. Besides the Swedish Order of the North Star he received the Medal of Honour of the Institute of Radio Engineers (1919), Knighthood of the Polish Order of Polonia Restituta (1924), the John Ericsson medal for outstanding contributions to the field of radio engineering (1928), the Edison medal from the American Institute of Electrical Engineers (1944), the Cedergren Gold Medal from the Royal Technical Institute of Sweden (1945) and the Royal Danish medal for 1946.

In some circuits employing simple logic it is desirable to have a latch, or "memory", which remains in one of two states according to the last information applied to it. Suitable latches can be made up with t.t.l. gates, but it is also possible to employ an operational amplifier.

LATCH CIRCUIT

A latch circuit using a 741 op-amp appears in Fig. 1. R1 and R2 hold the inverting input at a voltage mid-way between the supply rails. A third resistor couples the output to the non-inverting input. The input of the latch is at the non-inverting input of the i.c. and the output is at the i.c. output.

At switch-on the output can take up a high or a low voltage state. It is stable in either of these states because of the positive feedback to the non-inverting input via R3. Let us say that the output is in the high state. If we now momentarily connect the input to the negative rail the output will swing low and stay low when the connection is removed. Should we then momentarily connect the input to the positive rail the output will go high again and remain high.

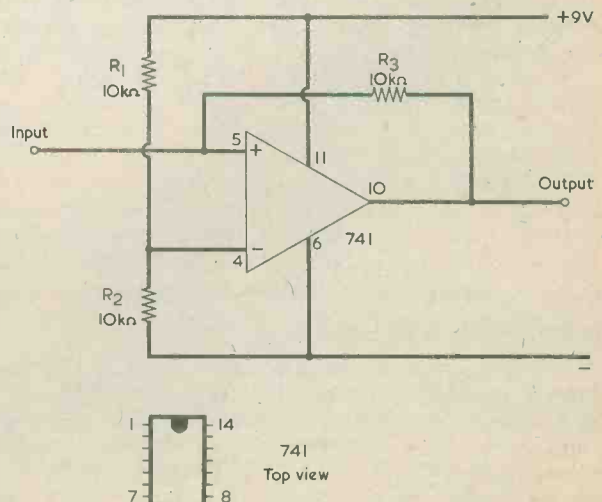
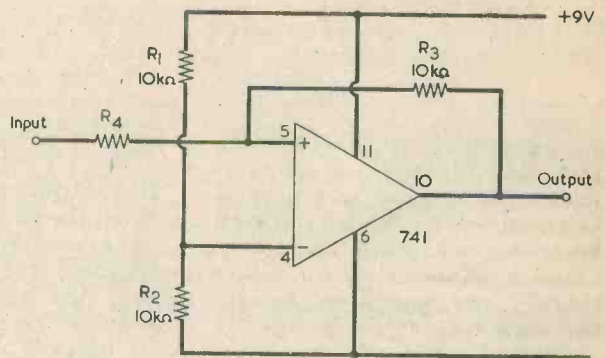

Fig. 1. The operational amplifier latch circuit. The output stays high or low according to the last voltage applied to the input. The 741 is depicted in its 14 pin d.i.l. form

AMP LATCH

A useful circuit configuration incorporating a 741 operational amplifier.

Fig. 2. Adding a resistor in series with the non-inverting input of the i.c. introduces hysteresis



The output will also be triggered low if the input is taken only slightly negative of the junction of R1 and R2, and will similarly be triggered high when the input is taken slightly positive of the junction of the two resistors.

A 9 volt supply is shown, but the circuit will work satisfactorily down to 4 volts or even less. Supply voltages higher than 9 volts may also be employed.

With a 9 volt supply the output voltage in the high state is about 8.5 volts with respect to the negative rail. In the low state the output voltage is approximately 1.8 volts. At a supply voltage of 5 volts the high and low output voltages are about 4.5 and 1.8 respectively. Unfortunately, these voltages prevent the latch from being compatible with t.t.l. The input voltage must not be taken positive of the positive supply rail or negative of the negative rail.

RESISTOR VALUES

A useful feature of the latch is that resistor values are not at all critical. If R1 and R2 have equal values, the latch will always trigger at input voltages positive and negative of the mid-supply voltage. Should R1 and R2 be given different values, triggering occurs at input voltages positive and negative of the voltage at their junction. R3 is necessary to isolate the relatively low impedance i.c. output from the input. The values of 10k Ω shown in Fig. 1 for the three resistors should meet most requirements.

The output of the latch may be employed to drive switching transistors and the like. The 741 is proof against output short-circuits and it is probably desirable to limit practical output current to a maximum of around 5mA, either positive or negative.

If a fourth resistor is added in series with the non-inverting input of the i.c., the latch exhibits hysteresis. This resistor is shown as R4 in Fig. 2, and it can have a value equal to that of R3 or less. Let us assume that R4 is equal to 10k Ω and that the output is in the high state. With a 9 volt supply the output is then at 8.5 volts. R4 and R3 form a potential divider and the output will only swing low when their junction just goes negative of mid-supply voltage, with about 4 volts dropped across R3 and the same voltage dropped across R4. Thus, the output triggers low when the input is approximately 0.5 volt positive of the negative rail.

To take the output high again a voltage of 2.7 volts (4.5 minus 1.8 volts) has to appear across R3 and across R4, whereupon triggering occurs when the input is about 7.2 volts positive of the negative rail. Summing up, the input hysteresis in Fig. 2 when R4 is equal to 10k Ω is in the range 0.5 to 7.2 volts. (In practice the range may be a little less than this as the calculations assume that the output voltages of 8.5 and 1.8 volts are maintained despite current drawn via R3 and R4.) Lower values in R4 will produce correspondingly narrower hysteresis ranges. ■

Radio Topics

By Recorder



Somewhat to my surprise the pun has returned to popular favour as a form of humour. Once more the dreaded phrases, re-emerging from the '30s, "Knock, Knock," and "Who's there?" are heard throughout the land.

Radio and electronics have always produced their own crop of more or less excruciating plays on words, but I did hear two the other day which didn't make me wince quite as much as usual.

If a circuit designer uses three integrated circuits where one would be sufficient the result can be described as an "i.c. waste" (icy waste).

Or, a schoolmaster's mortarboard and gown (do any wear them these days?) may be referred to as a "Sir kit" (circuit).

After which we shall proceed hastily to the next subject.

DOPPLER SHIFT

I am indebted to reader Mark Knight of Shooters Hill, SE18, for the following notes on Doppler shift.

The Doppler shift, i.e. change in frequency observed when a source of sound, or the hearer, moves, is given as

$$\frac{V}{V \pm v_1}$$

when the source moves, and

$$\frac{V \pm v_2}{V}$$

when the observer moves. V is the velocity of sound, v_1 is the

velocity of the source and v_2 the velocity of the observer. In the first formula the sign is minus when the source approaches the observer and plus when it recedes. In the second formula the sign is minus when the observer recedes and plus when he approaches. Here come the questions.

1. If motion is relative, why are the formulae different?
2. What is the formula if both move?
3. What happens if v_2 is equal to V ? (There are two solutions, one for approaching and one for receding.)
4. What happens if v_1 is equal to V ? (Again there are two solutions.) Remember that it is possible these days to move at the speed of sound!

Now for the answers.

The answer to question 1 is that the motion of the source of sound or the observer is relative to the medium of transmission, normally the atmosphere, in which V is constant (for any given temperature).

Turning to question 2, the formula when both move is

$$\frac{V \pm v_2}{V \pm v_1}$$

Question 3 splits up into two parts. If the observer approaches the source at the velocity of sound the frequency is doubled (this is obvious from simple substitution in the formula). And if the observer

recedes at velocity V he never hears the sound — it cannot overtake him! Substitution in the formula gives the frequency as zero.

Finally, question 4 asks what happens if v_1 is equal to V . If the source of sound is receding the frequency is halved (again given by substitution in the formula). But if the source of sound approaches at velocity V the result (shades of Concorde) is a loud bang! The frequency, in theory, is infinity.

THE TWEEZER-LITE

The device shown in the photograph is the "Tweezer-Lite", a product which has

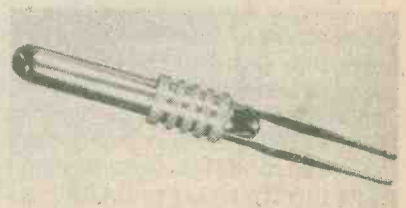

The Tweezer-Lite. The handle contains a battery and bulb which, when lit, provides pin-point illumination at the tweezer tips. Originally conceived in America as a beauty aid, the Tweezer-Lite has found many applications in medical work and in engineering where small objects need to be handled with precision.

achieved remarkable success in the United States where it originated. It is now being marketed in the British Isles by a new company, Tweezer-Lite (U.K.), 3 Cheltenham Road, Gloucester.

The tweezers themselves consist of top grade surgical stainless steel with precision tips capable of holding extremely small objects, and they are attached to a hollow handle containing a battery and bulb. The handle is twisted to light the bulb and provide pin-point illumination at the tweezer tips.

The Tweezer-Lite was designed primarily as a beauty aid, for plucking eyebrows, fixing false eyelashes and removing unwanted hair, etc., with a precision not possible with ordinary tweezers. It has now, however, graduated to applications far removed from its original concept. It is, for instance, valuable for doctors attending night road accidents, who find it ideal for swabbing and removing splinters of glass from wounds. It can also be an important addition to the instrument bag of veterinary surgeons.

The tweezers safely hold the minute screws and wires used in electronic equipment, particularly where instant light is needed in concealed or awkward areas. Philatelists, model-makers, watchmakers and jewellers are finding it an increasingly valuable tool. The Tweezer-Lite can now be bought over the counter at Selfridges and Harrods (House of Fraser).

WIRE STRIPPER

The second photograph illustrates the Rush Model C100 centrifugal wire stripping and twisting machine. This is now available from Fraser International Limited, 2/3 Hampton Court Parade, East Molesey, Surrey, KT8 9HB.

The Model C100 machine is designed for removing all types of extruded insulation from solid and stranded wires. It was especially designed for removing tough p.t.f.e. insulations, but is equally effective with nylon, p.v.c., neoprene, rubber, braided cotton, or any other insulations. The bench mounted machine strips insulation from wire and neatly twists strands of stranded conductors for wire

The Rush Model C100 centrifugal wire stripping and twisting machine. Not only does this strip the insulation off wire ends, it also twists together the strands of multi-strand wire

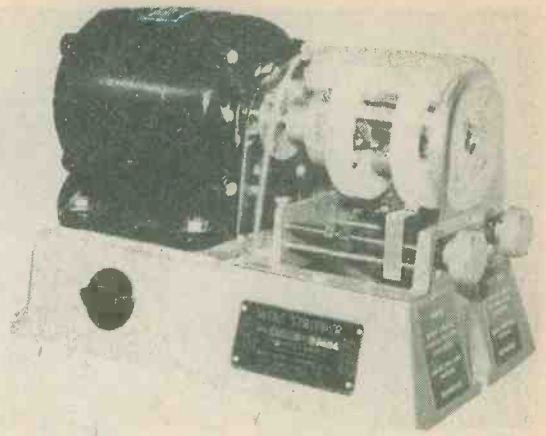

sizes from 0.71mm. to 5.72mm.

Stripping is effected by simply inserting the wire into the front of the machine until the strip length stop is felt. The wire is then withdrawn, with its conductors neatly stripped and twisted. There are no levers or pedals to be operated.

The Model C100 is ideal for production line stripping and all adjustments can be made whilst the machine is running, without removing any covers or safety guards.

HEADPHONE PHASING

Our contributor, Sir Douglas Hall, has been carrying out some interesting experiments with headphone phasing recently. We are all used to listening to headphones which are connected in phase and are coupled to a mono musical signal. Can we detect any difference if we reverse the connections to one of the headphones so that they are working out of phase?

Apparently, the ability to detect a difference varies from person to person. The experiment is quite easy to set up. You wire up a pair of headphones with a switch which can reverse the polarity of one headphone; the headphones are then connected to a mono music signal and the switch operated a number of times so that instant comparisons between the two modes of operation can be made. Generally, the effect with the headphones out of phase is an indefinable change of tonal quality, but the out of phase condition is still quite acceptable. A listener with a trained

musical ear may, however, find out of phase operation distasteful.

It would probably be best to employ headphones offering reasonably good quality rather than the more inexpensive magnetic diaphragm types for the experiment.

PRINTED BOARD COATING

Of interest to those constructors who prepare their own printed circuit boards is a recently developed product which protects the board after etching and cleaning, and assists in soldering. The product is "Circosol", a low viscosity liquid intended for painting on the board.

Apart from the artwork, staining of the freshly etched and cleaned copper surface can be a major problem with home produced printed circuit boards. A clean copper surface is essential for easy soldering, but this is highly susceptible to chemical attack by perspiration and salts from fingerprints. The copper "soaps" formed are a positive hindrance and a badly stained board becomes difficult to "wet" by the molten solder, leading to dry joints. It is also necessary to apply the soldering iron for a longer time, with a consequent risk of component fatigue or failure due to excessive heating.

If Circosol is applied to the board immediately after etching and cleaning, the board is protected by a hard coat and can be handled without the risk of fingerprints. The clean copper surface is therefore preserved. Due to its chemical

nature, the coating also improves the affinity of the copper surface for solder and greatly increases wettability. The copper tracks on the finished board remain bright and shiny, giving a permanent professional finish. The Circosol coat can be soldered through at a later date should component addition be necessary, for example when repairing or prototyping.

Circosol can be obtained direct from Audio Services (Warrington), 13 Hale Street, Warrington, Cheshire, WA2 7BU.

CONSTANT CURRENT I.C.

A constant current i.c. with a difference is announced by SGS-ATES. This is the TDA 1251, and its function is not to

provide a constant current but to ensure that a constant current is drawn from a supply.

In modern solid-state television sets it is common practice to provide power for various sections of the receiver from taps in the line output transformer, the voltages from these taps being rectified and smoothed with conventional circuits. A problem arises when the receiver section which is so powered is an a.f. amplifier incorporating a Class B output stage. The current demand with such a stage can vary from a few milliamps to more than 0.5 amp, according to the level of the sound output signal. These changes in current can cause variations in the width of the picture.

The SGS-ATES i.c. type TDA 1251 can be interposed between the supply voltage derived from the line output transformer and the a.f. amplifier, and it ensures that the current drawn from the line output transformer remains constant. The TDA 1251 is supplied in a 3 pin package, and it operates by diverting to chassis the current which is not drawn by the a.f. amplifier, thereby maintaining a constant total current consumption.

The i.c. has a maximum supply voltage rating of 30 volts and an output current capability of 0.6 amp. Typical load regulation is within 0.01 per cent per milliamp, for output currents ranging from 0.025 to 0.6 amp. ■

THE LARGEST "MOBILE" OPERATION OF ALL TIME

By Ron Ham

It is now more than three decades since the Allied invasion of Europe on D-Day. Particularly instrumental in the success of this operation were the wireless transmitters and receivers used by the Army, and this article describes the all-valve equipment which was employed at that time.

Like many other RSGB members, the author is a civilian wireless instructor with the Air Training Corps, in which mobile radio plays an important part in a squadron's training programme. It is so easy for us, more than three decades after D-Day, to go on exercise with a transmitter and receiver installed in our motor vehicles; we no longer have to consider bulky vibrator packs or rotary transformers to provide the high tension supply for our equipment, nor do we have to produce an abundance of *amps* to heat our valves. All of these problems have gone because of the advent of the transistor, and as we use our Bantams, Cambridges and Westminsterers, or look through the advertisements in our journals and see the exotic mobile equipment on sale today, we must remember that it was not always like this.

Thirty-three years ago, the Southern Counties were involved with the great invasion force which left the United Kingdom for Normandy on June 6th, 1944. Like the rest of the operation, the communications for the D-Day landings were carefully planned, and this rough, tough, job for both men and equipment must have been the largest combination of "mobile" radio systems ever used.

WIRELESS TO WAR

When wireless went to war in 1939, the radio industry answered the Government's call for specialised items of radio equipment to be carried by the foot soldier, concealed by underground agents and installed in a variety of fighting vehicles. Many of these wartime pieces have sur-

The WS-46 mobile transmitter-receiver. This set is now in honourable retirement amongst the author's collection of antique and wartime radio equipment

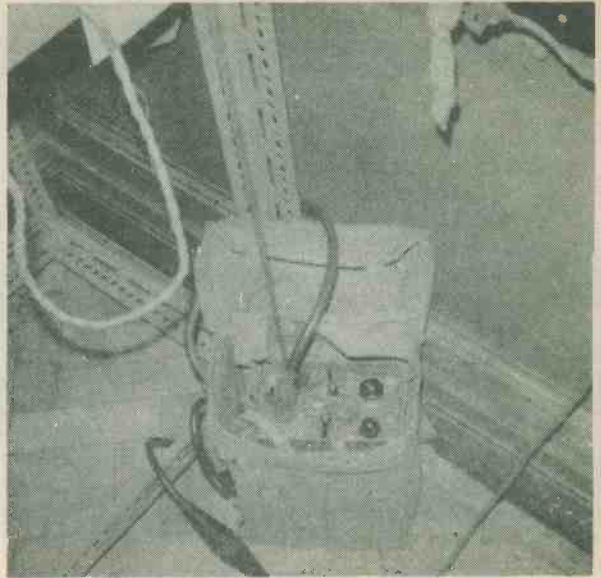

vived the passage of time and are now in the hands of collectors. Some are still in a usable condition.

Amongst the communications equipment which the Army took across the Channel were Wireless Sets Nos. 18, 38 and 46, all of which were powered by dry batteries. Each was simple to operate and designed to be carried by a fighting soldier.

A typical example of simplicity was the WS-38 which had two control knobs, one clearly marked for setting both the receiver and transmitter to any frequency between 6 and 9 MHz and the other for on-off, send and receive. The user carried the set in a harness at breast level together with a small signals satchel which contained batteries, junction box, special headphones for wearing under a steel helmet, throat microphones and a case of five spare valves (four type ARP12 and one type ATP4). The single rod aerial, which plugged into the top of the set, was carried in a 4 foot by 2 inch sling bag over the shoulder.

BACK-PACK SETS

The WS-38 measured 9 by 7 by 4 inches and used the same range of valves as the famous WS-18 pack-set, which measured 18 by 10 by 8in., and the WS-46 pack-set designed for the Commandos. The "Eighteen" set had separate transmitter and receiver units, both tunable through 6 to 9 MHz, and could be used to send both phone and c.w. signals. The battery was housed in the bottom of the set, and the standard headphones, hand microphone, case of spare valves and morse key, which could be attached to the operator's leg, were also carried in a signals satchel. The WS-46, measuring 12 by 6 by 4 inches had three fixed channels and required a pair of 10XJ crystals to select the transmit and receive frequencies. The set, battery, two pairs of headphones (under-helmet types) with throat microphones attached, and spare valves were all packed in a special

haversack, which could be carried on a man's back. A selection of short aerial rods which could be fitted together as required were used for both the WS-18 and WS-46.

VEHICLE SETS

All of these sets could communicate with the mighty WS-19 which was almost as robust as the tank or armoured car in which it was used. This famous transmitter-receiver could be tuned from 2 to 8 MHz and incorporated an intercom amplifier for the tank crew. A special feature of this set, which was years ahead of its time, was the 235MHz v.h.f. transceiver section used for "private" tank-to-tank conversation. Like many other wartime sets the WS-19 used international octal valves (6K7 type) throughout its receiver, amplifier and modulator section. A single CV6 triode was used in the v.h.f. section and an 807 type valve in the p.a. stage of the h.f. transmitter. The latter WS-19 sets were made in Canada, and most of their dial markings were encribed in both English and Russian.

INSTALLATION IN A VEHICLE

In a very short time problems, such as the suppression of radio interference generated by the engine, shock-proof installation of the set inside the vehicle and the flexible mounting of the aerial were overcome, and many of these wartime developments can be seen in use today. Similar problems were experienced when radio equipment was installed in both aircraft and ships.

The expected life of wartime radio equipment was very limited, yet the careful design and the high quality components and workmanship which went into military equipment will stand as a monument to one of the finest achievements of the radio industry. ■

RADIO & ELECTRONICS CONSTRUCTOR

NEXT MONTH'S SPECIAL FEATURES

ANALOGUE FREQUENCY METER



- Covers 0-100kHz in 4 switched ranges
- Direct indications of input signal frequency
- Employs 2 CMOS integrated circuits
- Low current consumption of 4 mA



3 BAND T.R.F. SHORT WAVE RECEIVER

- Simple to construct
- Coverage 1.5 to 36 MHz

PLUS MANY OTHER ARTICLES

ON SALE 3rd OCTOBER

In your workshop

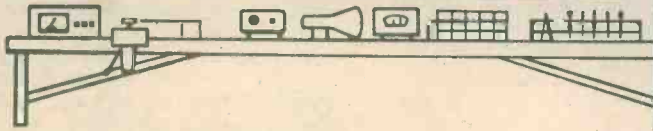

Once again, Dick is able to steer Smithy, the Serviceman away from his normal duties in order to explain some of the mysteries of his trade. On this occasion Smithy deals with a few of the more common misconceptions which arise in electronics and radio.

With a flourish of triumph Dick switched on the a.m.-f.m. radio on his bench and pulled up its telescopic aerial. He tuned through the f.m. band, whereupon the three B.B.C. signals and the local f.m. station were reproduced at good strength and with more than acceptable quality. He selected medium waves and was again able to tune in to a good quantity of signals. Finally, he set the receiver to long waves and brought in the BBC2 signal on 1,500 metres.

"Another job done," he boasted. "That's my fifth successful repair of the morning. I'll be making you redundant yet, Smithy!"

The long-suffering Serviceman sighed and pressed on with tracing the intermittently missing i.f. signal in the colour television chassis on his bench. He had long ago given up trying to explain to his assistant that he purposely chose the sets with the most difficult faults, each of which he looked upon as a challenge to his abilities. Either through luck or design, Dick always managed to land the easy jobs.

FERRITE ROD DIRECTIVITY

Idly, Dick turned round the receiver cabinet so that it was oriented through a full circle. The sound dropped to a low level as he passed through the two nulls given by its internal ferrite rod aerial. (Fig. 1.)

"D'you know, Smithy," he went on chattily, "you'd never get lost if you had a transistor radio! All you'd need to do is to use its ferrite rod aerial as a direction finding aerial. Find the angles of two

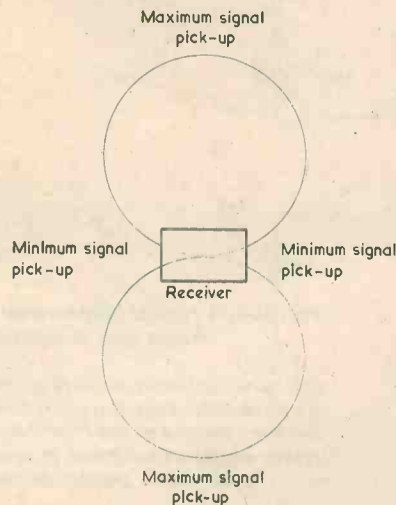

Fig. 1. The signal pick-up pattern of an a.m. radio receiver having a ferrite rod aerial

transmitters of known location and then draw the corresponding lines on a map going through the stations. You'd be where the lines cross each other!"

Despite himself, Smithy was intrigued by the vision of an intrepid Dick trail-blazing through the much signposted wastes of rural England, constantly monitoring his position with the aid of a transistor radio.

"Well," he remarked, "the signals from most medium and long wave stations get bent a bit if you're any real distance from them. Also, when you've found the angle at

which you're receiving the signal you still don't know which end of the receiver ferrite rod is pointing at the direction from which the signal is coming. Both these effects could lead you into error."

A thunderstruck expression passed over Dick's face.

"Don't tell me," he remarked incredulously, "that you would work to the principle that the ferrite rod should point at the signal."

"I would," returned Smithy imperturbably.

"Then," said Dick gleefully, "I have at long last caught you out on a really gi-normous technical clanger. You're making the assumption that you rotate a direction finding aerial for maximum signal strength just like they do in the old spy movies. Now if you had the technical background that an engineer like myself has you'd know that you rotate a direction finding aerial for minimum signal strength. And why? Because the angle over which you get minimum signal strength is very much sharper than the angle over which you get maximum signal strength."

"I know," replied Smithy shortly. "That's exactly what I meant."

"But," protested Dick, "if you point the rod of a ferrite rod aerial at the source of a signal you get maximum pick-up."

"You don't, you know," snorted Smithy, turning off the colour television chassis on his bench. "You get minimum signal strength."

"I don't believe it!"

Wrathfully, Smithy took his pen from his pocket, pulled his note-pad towards him and beckoned towards his assistant.

"Come over here and I'll show you."

Dutifully, Dick walked over to Smithy's bench. The Serviceman was already scribbling out a sketch on his pad.

"Do you," asked Smithy, "remember the old frame aerials they used to have in medium and long wave portable radios before ferrite rod aerials came in?"

"Just about," replied Dick. "One of my aunts had an ancient old portable she'd bought just before the war that had a frame aerial inside it."

Smithy's irritation with his assistant diminished. There could be nothing but commiseration for a person who had such a vast number of aunts as had Dick.

"Well, fair enough," he remarked. "If your memory serves you correctly you will remember that these old frame aerials were normally wound on a rectangular wooden or insulated frame which was as large as the dimensions of the receiver cabinet would allow. A medium wave frame aerial would consist of something like ten turns of thickish enamelled wire of around s.w.g. wound side by side on such a frame."

Smithy indicated the sketch in his note-pad. (Fig. 2(a).)

"Now," he continued, "these frame aerials provided the tuned signal inductance for the receiver and had one section of the receiver 2-gang or 3-gang tuning capacitor connected across them. They worked by reason of the fact that, if they were in line with the incoming signal the signal hit the nearer side of the aerial very slightly before the further side, with the result that there was a very small phase difference in the signal voltages on the opposite sections of the frame. This phase difference meant that the signal voltages on the two frame sections were also slightly different, and so a signal voltage was induced in the turns of the aerial, causing a signal current to flow. Not a very high signal voltage admittedly but, combined with the fact that the frame was resonant at signal frequency, sufficient to give adequate signal pick-up in practice." (Fig. 2(b).)

"I should imagine," remarked Dick tentatively, "that the signal pick-up would at any rate be greater than you'd get with, say, a flat metal plate of the same area as the frame aerial."

"It would be quite a lot greater," confirmed Smithy. "If we rotate the frame so that it is broadside on to the incoming signal, the pick-up drops virtually to zero. This is because the signal has the same phase when it hits all the turns of the frame aerial. They are in consequence all at the same signal voltage and so no signal current flows. This gives the null position

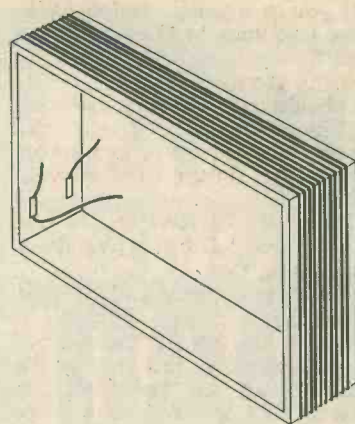

(a)

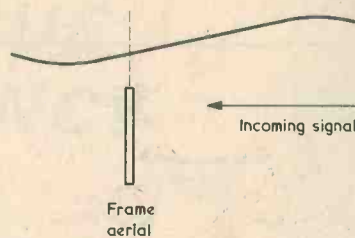

(c)

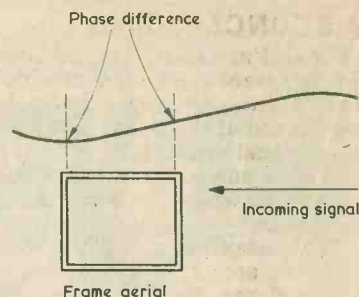

(b)

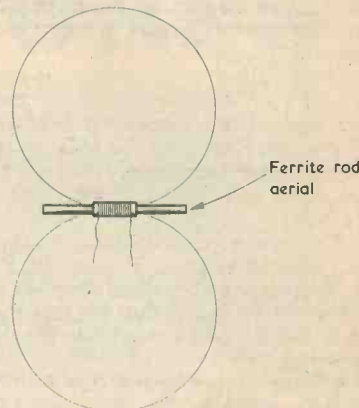

(d)

Fig. 2(a). A typical frame aerial. The aerial is wound on a wooden frame and is resonant at signal frequency

(b). When a frame aerial is in line with the incoming signal there is a phase difference between the signals induced in the nearer and further sections of the frame aerial. The phase difference is shown highly exaggerated here; in practice the signal wavelength would be much greater in relation to the aerial width

(c). When the frame aerial is broadside on to the signal there is no phase difference in the signal voltages picked up in its sections and the aerial is in the null position. Again, signal wavelength is shown greatly reduced

(d). The polar response of a ferrite rod aerial. Contrary to popular belief the nulls are given when the rod points at the source of signal

for the frame aerial. Incidentally, it also gives the null position for any loop aerial, apart from the frame aerials that were used in those old portable radios." (Fig. 2(c).)

"I can see all that," stated Dick, "but how does this tie in with ferrite rod aerials?"

"Because," stated Smithy, "a ferrite rod aerial is a frame aerial with all the inductance concentrated in a small volume. The high

permeability of the ferrite rod distorts the magnetic part of the incoming signal such that there is a greater magnetic signal flux in the rod than there would be in air. But otherwise the ferrite rod aerial behaves just like the frame aerial it replaces. Signal input is at a null when the coil is broadside onto the signal or, in other words, when the rod is pointing at the signal." (Fig. 2(d).)

MISCONCEPTIONS

"Well, I'm dashed," stated Dick. "So you were right after all. Blow me, I'd always thought that pointing the rod at the signal gave maximum signal strength."

"That's one of quite a few misconceptions which you bump into in electronics."

"You mean there are others?"

"There are quite a few. For instance, a very common misconception is that if you have a moving-coil voltmeter connected across a resistor of known value you can always tell the power the resistor dissipates by reading the voltage indicated and calculating the power figure."

"Come on, Smithy! The voltage reading is bound to allow you to work out what power is being dissipated."

"Not always it isn't," stated Smithy. "What's more, I can arrange a little demonstration. See if you can find me a 6.3 volt heater transformer and three 4.7 Ω 2 watt resistors and then I'll give you a surprise."

Dick went to the spares cupboard and delved around, looking for the transformer and the resistors. As he returned, he found that Smithy had also been getting a few items together.

"What I have here," proclaimed the Serviceman, "is a 6 volt 0.06 amp pilot lamp screwed into a bulb holder. Also, a common or garden 3 volt battery. This happens to be an Ever Ready No. 800 which has been knocking around, but any other 3 volt battery would do. I'm going to connect the battery and the pilot lamp in series and then add a couple of crocodile clip leads at the outside ends. Whilst I'm doing that, perhaps you could solder those three resistors in series across the secondary of that transformer. Just use mid-air joints with the outside resistor ends soldered to the transformer tags. Oh, and connect a mains lead to the primary."

"Okey-doke," said Dick obligingly.

There was silence for a few moments as the pair worked at their respective tasks.

"Did you," asked Dick brightly, as he soldered two 4.7 Ω resistors in series, "hear the story about the wolf who strayed onto the railway line?"

"I don't think I did," said Smithy, engrossed.

"Well, it walked onto the lines just as a train came along. In fact, it nearly got clear but the train ran over the tip of its tail and cut it off."

"So?"

"The poor wolf, in panic, looked back towards its tail and the wheels next went over its neck."

"What a horrible story! What on earth did you tell me that for?"

"It points out a moral."

"What moral?"

"If you're a wolf," stated Dick, "never lose your head over a piece of tail!"

Smithy groaned.

"I should have known what to expect," he complained. "Your stories get worse and worse as time goes by. How are you getting on with those resistors?"

"I've just finished connecting them up," said Dick, laying down the soldering iron.

"Good," said Smithy. "We'll get started, then."

He took the heater transformer and connected its primary to the mains. Next, he switched his testmeter to a low d.c. volts range and connected it across the pilot lamp. He then took the two crocodile clips from the lamp and 3 volt battery and clipped them both

to one of the heater transformer secondary tags. The bulb glowed weakly. (Fig. 3(a).)

"There's nothing very startling there," commented Dick disparagingly. "All you're doing is applying 3 volts to a 6 volt bulb."

"I wouldn't argue with that," responded Smithy equably. "Anyway, what does the testmeter say?"

Dick glanced carelessly at the meter.

"It's indicating 3 volts," he stated. "What else could it show?"

Smithy removed one of the crocodile clips and connected it to the adjacent junction of two 4.7 Ω resistors. The lamp now shone with markedly increased brightness. (Fig. 3(b).)

"Humph," grunted Dick

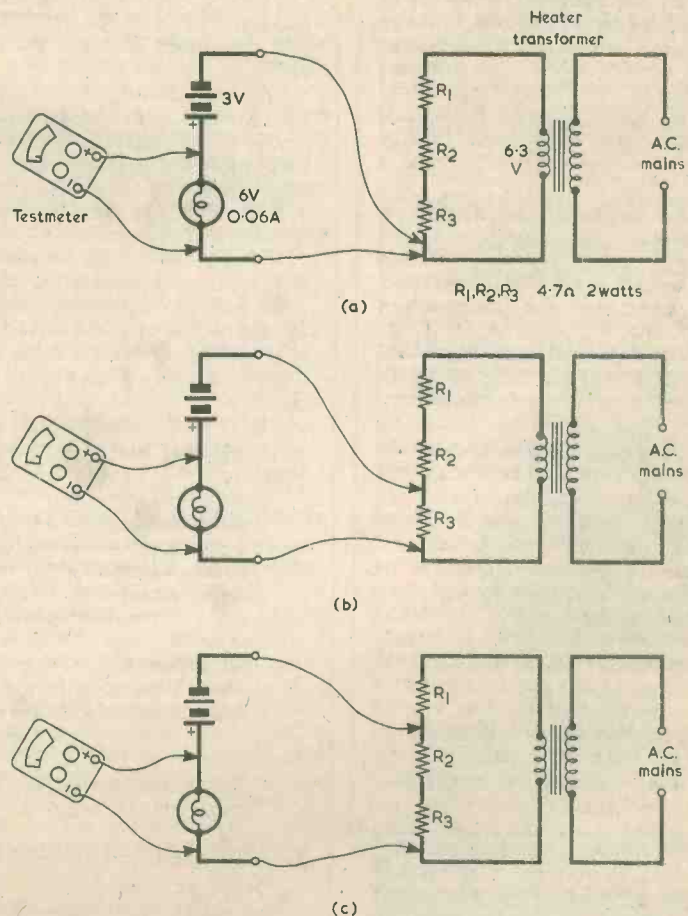

Fig. 3 (a). Smithy initially connected up the components for his demonstration in the manner shown here. The heater transformer can have a secondary current rating of 0.5 amp or more

(b). Smithy next inserted the alternating voltage appearing across R3 in series with the battery and the bulb

(c). Finally, Smithy caused the voltage across two of the resistors to be connected in series

Your Local Supplier

LONDON

THE MODERN BOOK CO.

Largest selection of English & American radio and technical books in the country

19-21 PRAED STREET
LONDON W2 1NP
Tel: 01-723 4185/2926

HAMPSHIRE

MORSE IMPROVEMENT

C90 Cassettes 1-12 w.p.m. with simple exercises. 12-14 w.p.m. computer produced professional level operator material including international symbols.

Price: complete with instruction and exercise booklets £4 including postage. Overseas £1 extra.

Morse Key and Buzzer Unit suitable for sending practice and DIY tape preparation.

Price £4 including postage. Overseas £1 extra.

MHEL ELECTRONICS (R)
12 Longshore Way, Milton
Portsmouth (UK), PO4 8LS

SUSSEX

JEFFRIES

For
Hi-Fi Equipment
Tape Recorders
Television
Transistor Radios

6A ALBERT PARADE
VICTORIA DRIVE
EASTBOURNE, SUSSEX

PEATS for PARTS ELECTRONIC COMPONENTS RADIO & TELEVISION

For the convenience of Irish enthusiasts we supply:

Radio & Electronics
Constructor Data Books
Panel Signs
Transfers

Also a postal service

PEATS
the world of electronics
25 Parnell Street, Dublin 1, Telephone 749972

cautiously. "The lamp must obviously be glowing brighter now because you've got 3 volts d.c. and something like 2.1 volts a.c. across it."

"Take another look at that meter."

Dick looked casually over at the meter scale. An expression of disbelief came over his face and he leaned over to look at it more closely. Suspiciously, he checked to ensure that the testmeter leads were connected correctly across the pilot lamp. Then he scowled distractedly and scratched his head.

"May I presume," probed Smithy gently, "that something ails you?"

"Too true you can presume it," replied Dick unhappily. "In fact, something's ailing me no end."

He glared down at the testmeter. "That darned meter," he continued, "is still reading 3 volts!"

"Well I never did," said Smithy mildly. "Let's move that crocodile clip one more step up the resistor chain."

He removed the clip and reconnected it at the next junction of two 4.7 Ω resistors. This time the little pilot lamp glowed much more brightly again. (Fig. 3(c).)

Reluctantly, Dick forced himself to look at the meter.

"Hell's teeth," he moaned, "it's still reading 3 volts. Stap me, each time you move that crocodile clip the lamp gets brighter but the meter still goes on showing 3 volts. How on earth do you manage that, Smithy?"

"It's just," responded Smithy modestly, "a little electronic jugglery."

"Jugglery?"

"That's right. A more apt term might, perhaps, be legerdemain. Or, if you like, thaumaturgy."

"Hey," protested Dick. "Not only am I out of my depth in electronics with this thing but I'm rapidly getting out of my depth in English!"

"A pity," purred Smithy. "I was about to describe those 3 volt readings as an example of simple scientific prestidigitation."

CONSTANT READINGS

"Hold it," said Dick quickly. "Just hold it right there, Smithy. A young lad like me can undergo traumatic damage when confronted with unexplained mysteries like this. Just tell me why the meter still reads 3 volts despite the fact that the current through the bulb is obviously going up."

"The reason for that constant reading," explained Smithy, "is that a moving-coil voltmeter reads average voltage. When I had the two crocodile clips connected together there was 3 volts d.c. applied to the bulb, which the meter read correctly. But when I

moved one clip to the first resistor junction there was 2.1 volts a.c. from the transformer secondary applied to the bulb in series with the battery. This is 2.1 volts r.m.s. or nearly 3 volts peak, and if we draw the consequent waveform across the bulb we get something like this."

Smithy picked up his pen and sketched out the waveform. (Fig. 4.)

"On one set of half-cycles," he resumed, "the alternating voltage adds to the 3 volts from the battery and takes the waveform up to nearly 6 volts maximum. And on the other set of half-cycles the alternating voltage subtracts from the battery 3 volts and takes the voltage down to a minimum just above zero. The average value of the waveform is still 3 volts, though, and that's what the voltmeter indicated."

"If the average voltage remains the same," queried Dick, scratching his head, "why did the bulb get brighter?"

"Because there are two lots of current going through it," stated Smithy. "There's the direct current from the battery and the alternating current resulting from the 2.1 volts a.c. which is added to it. What you have to remember is that both these currents cause a heating effect even though the alternating voltage isn't indicated by the voltmeter."

"I don't understand it. I've actually seen it happen with my own eyes but I still don't get it!"

"Let's assume," said Smithy, "that we simply applied 6.3 volts at 50Hz to the bulb. If we connected a moving-coil voltmeter across the bulb, what would it read?"

"I suppose," said Dick slowly, "it would read zero."

"Exactly," responded Smithy. "It would be reading zero because that's the average value of the alter-

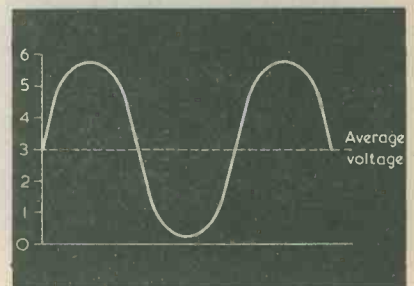

Fig. 4. Waveform given when the alternating voltage across R3 is connected in series with the battery and the bulb. The average voltage is 3 volts. The average voltage is also 3 volts when the alternating voltage across R2 and R3 is similarly inserted.

nating voltage. If the frequency of the alternating voltage were reduced from the 50Hz mains frequency down to something around 5Hz we would very probably get a movement in the meter needle. It would jiggle back and forth in time with the frequency of the alternating voltage, but the jiggling would still be centred on zero."

"I think," said Dick slowly, "that I'm beginning to get with this at long last. To take things a bit further, in the case of the 50Hz alternating voltage the moving-coil meter would read zero as you say, but there'd nevertheless be a heating effect in its coil and in its internal series resistor."

"Now you're getting nearer to the truth," remarked Smithy approvingly. "If you remember that the meter reads zero when only alternating voltage is applied to it, you can more readily understand why it reads 3 volts when a 3 volt battery is put in series with the alternating voltage."

"Yes, I understand that now," replied Dick. "When you start off with alternating voltage and then add a direct voltage, the reason for the meter reading becomes more obvious. Trust you, Smithy, to be crafty and do it the hard way by starting off with direct voltage."

"I just wanted to demonstrate," chuckled Smithy, "that you shouldn't always take moving-coil meter readings at their face value, particularly when there are alternating voltages wandering around. That little experiment also explains why resistors in some circuits cook up a lot more than you'd expect. If, for instance, you have a smoothing resistor in a mains power supply, that resistor could dissipate more heat than you would think from just a moving-coil meter reading of the voltage dropped across it. Not only does a direct current flow through the resistor but so also does what can be quite a sizeable alternating ripple current." (Fig. 5.)

"That clears up another little mystery."

"What's that?"

"Why the smoothing resistors in the older valve TV sets used to have such high wattages," replied Dick.

"I used to look upon that as just one of the inexplicable facts of electronic life, but I can now begin to see why it makes sense. Now there's another thing."

"Yes?"

"You were talking just now about the r.m.s. value of the alternating voltage. I know that the r.m.s. value of a sine wave is 0.707 times its peak value, but I've never understood this really. Why do we have to bother about r.m.s. values? Why not stick to nice easy things like peak values and forget all about the r.m.s. business. So far as I can see, it only confuses things!"

R.M.S. VALUES

"You're now approaching another popular misconception," stated Smithy. "Lots of people seem to think that the r.m.s. value of an alternating sine wave is just something engineers dream up to make life more difficult. It's nothing of the sort. The r.m.s. value of an alternating voltage defines its heating effect, as compared with a direct voltage. Going back to those old days when portable radios had frame aerials, quite a number of houses in the U.K. were supplied by d.c. instead of a.c. mains. Gradually, the old-fashioned d.c. supplies were taken out of the system until, eventually, all the domestic supplies in the U.K. were a.c."

"Then," put in Dick quickly, "we're in advance of America."

"What on earth do you mean?" said Smithy irritably. "All of America must surely be on a.c. mains."

"There's one place that isn't."

"Where's that?"

"Washington," stated Dick. "Washington's D.C."

Smithy turned an exasperated glare at his assistant's grinning face.

"Will you stop doing that? Now I've forgotten where I'd got to."

"You were talking about old houses being on d.c. mains."

"Oh yes, so I was. To resume, let's say that you're in a house which is on 240 volt d.c. mains. This means that the filaments of all the light bulbs in your house are heated to the correct temperature by the

Fig. 5. The power dissipated in a power supply smoothing resistor is given by the direct current and the ripple current which passes through it

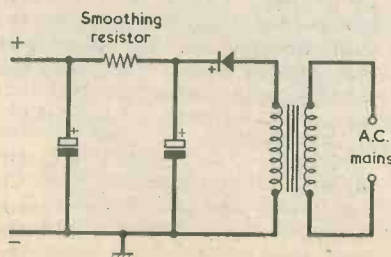

GAREX

2-metre RECEIVER NR56: fully tunable 144-146 MHz, also 11 xtal positions for monitoring specific channels. Compact, sensitive, ideal for fixed or mobile listening. Built-in L.S., 12v DC operation. £54.00 inc. VAT. Crystals, if required: £2.41 each. All popular 2m. channels in stock. Credit terms available. s.a.e. details.

Experimenter's H.T. transformer; multitap primary. 5 sec. windings; 35V 200mA, 75/115V 150mA, 50V 500mA, 150V 300mA, 170/220V 300mA, Wt. 6kg. £5.50

Relays: GPO type 2400 (medium size); 200+200 (1 coil (12-24V), 8A contacts. 4PCO+1M Type 3000 (large); 2k (1 coil (24V) 1B+3M, 2k (1 coil (24V) 2PCO, 8A contacts. 100+100 (1 coil (3-12V) 4PCO.

All new. 60p each, any 5+: 40p
Neons min. wire end. 55p/10; £4/100
Slide Switches min. DPDT 18p ea; 5+: 14p
2 pole, 3 position 22p each; 5+: 18p

Resistor Kits E12 series, 22 Ω to 1M Ω
57 values. 5% carbon film, $\frac{1}{4}$ W or $\frac{1}{2}$ W.
Starter pack, 5 each value (285) £2.40
Mixed pack, 5 each $\frac{1}{4}$ W + $\frac{1}{2}$ W (570) £4.65
Standard pack, 10 each (570) £4.65
Giant pack, 25 each (1,425) £11.65

I.C.'s (new, full spec.) CD4001AE 25p
SN76660 75p NE555 55p 723(TO5) 75p
709 (TO5), 741 (DIL-8) Op. amps 30p each
BNC Cable mtg socket 50 Ω 20p; 5+: 15p
PL259 UHF Plug & Reducer 68p; 5+: 60p
SO239 UHF Socket panel mtd. 55p; 5+: 45p
Nicaid rechargeable cells HP7 size £1.05 each; 4+: 95p; 10+: 88p. Brand new.
We stock amateur V.H.F. equipment and mobile aerials, s.a.e. details.

Distributors for J. H. Associates Ltd.
(switches and lamps)
PRICES INCLUDE UK POST, PACKING & VAT
Mail order only. Sole Address:
GAREX ELECTRONICS
7 NORVIC ROAD, MARSWORTH,
TRING, HERTS HP23 4LS
Cheddington (STD 0296) 668684

MORSE MADE EASY

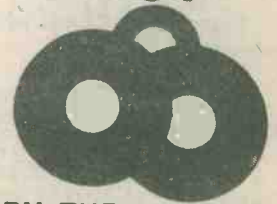

BY THE RHYTHM METHOD!

These courses, which have been sold for over 23 years, have been proved many times to be the fastest method of learning Morse. You start right away by learning the sounds of the various letters, numbers, etc., as you will in fact use them. Not a series of dots and dashes which later you will have to translate into letters and words.

Using scientifically prepared 3-speed records you automatically learn to recognise the code RHYTHM without translating. You can't help it. It's as easy as learning a tune. 18 W.P.M. in 4 weeks guaranteed.

The Complete Course consists of three records as well as instruction books. For Complete Course send £5.00 including P.P.I. etc (overseas surface mail £1 extra).

Now available Shrouded Morse Keys
£2.50

THE MORSE CENTRE

Box 8, 45 Green Lane, Purley, Surrey.
Enclose £5.00 or large s.a.e. for explanatory booklet.

Name

Address

Fig. 6. The voltage and current waveforms when an alternating voltage of 1 volt peak is applied across a 1 Ω resistor. The lowest waveform shows the power dissipated in the resistor

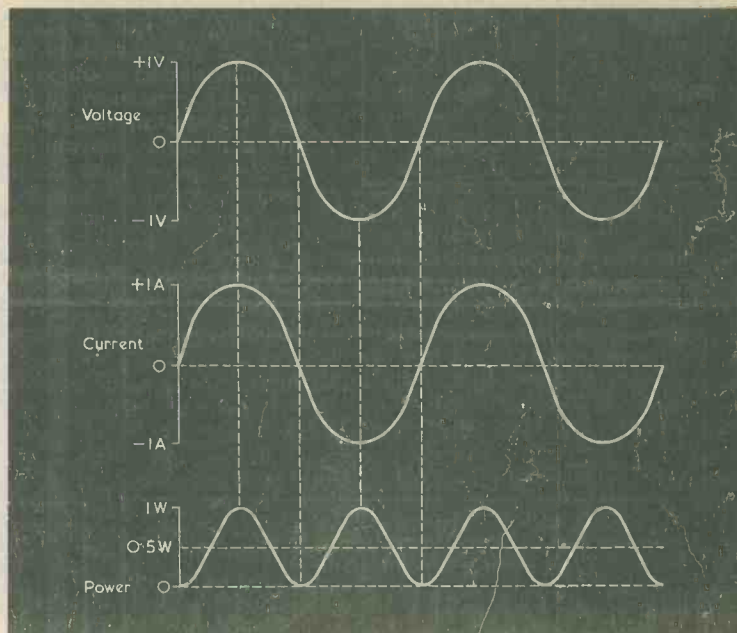

240 volt d.c. supply. The most important job of the electricity supply is to provide light and so if we change the supply over to a.c. we want to choose a supply amplitude which similarly causes the filaments to be heated to the right temperature. This is given if we supply a.c. with an r.m.s. value of 240 volts. So far as his electric lights are concerned, a house-owner will be in just the same position with 240 volts r.m.s. alternating as he was with 240 volts direct."

"His electric fires will be the same too, of course."

"That's right."

"That seems sensible enough," said Dick judiciously, "but it still doesn't explain the 0.707 business."

"I will agree," admitted Smithy, "that that's a bit harder. But it's not too difficult if we take an example with easy numbers in it, and it's simpler if we work from peak volts down to r.m.s. volts. We can kick off by assuming that we have a sinusoidal alternating voltage of 1 volt peak and that we apply it across a resistance of 1 Ω . The current which flows in that resistor is then 1 amp peak. Let's draw out the voltage and current waveforms."

Smithy picked up his pen and carefully sketched the waveforms.

"We'll add below these," he went on, "the waveform for the power dissipated as heat in the resistor. Since 1 volt multiplied by 1 amp is 1 watt, this waveform will have a peak value of 1 watt."

Smithy added the waveform. (Fig. 6.)

"There's something interesting here," said Dick. "Whereas the voltage and current cycles go

negative for half the time the power waveform is always positive. Apart from the zero points, of course."

"That," confirmed Smithy, "is to be expected. The 1 Ω resistor will still dissipate power as heat regardless of the polarity of the voltage across it or the direction of the current flowing through it. Now, by inspection, the power waveform is symmetrical about a line drawn at 0.5 watt level so that, whilst the instantaneous power varies from zero to 1 watt, the average long-term power is 0.5 watt. And so we have arrived at the conclusion that applying 1 volt peak to a 1 Ω resistor causes the power dissipated as heat to be 0.5 watt. Now, power is equal to voltage squared divided by resistance and if it were a direct voltage heating the resistor we would say that the voltage squared, divided by 1 Ω , gave 0.5 watt. It follows from this that the voltage is equal to the square root of 0.5. And that is equal to 0.707!"

"Blimey," gasped Dick. "You got there pretty fast, didn't you? Let's linger on this a bit. We're applying an alternating voltage of 1 volt peak to a resistance of 1 Ω and we find that it gives the same heating effect as a direct voltage of 0.707 volt. Since r.m.s. value applies to the heating effect of the alternating voltage, a voltage of 1 volt peak has an r.m.s. value of 0.707 volt."

"You've got it," said Smithy cheerfully. "You can follow the same route with current. With d.c. the power dissipated in the 1 Ω resistor is equal to current squared multiplied by resistance. Take this through the same process and you find that the r.m.s. value of 1 amp peak is 0.707 amp."

LEGERDEMAIN

"Gosh," breathed Dick, "I never thought it would be that simple."

"We were using easy figures," stated Smithy. "If you follow the procedure with harder figures you still get the same answer. I should of course add, for completeness, that r.m.s. stands for 'root mean square'. If you want to indulge in a few further calculations in the reverse order you will find that the peak value of a sinusoidal alternating voltage or current is 1.414 times the r.m.s. value."

"1.414," mused Dick. "Why, that's exactly twice 0.707."

"It's also," stated Smithy, grinning, "the reciprocal of 0.707. And it's the square root of 2, whilst 0.707 is the square root of $\frac{1}{2}$. Which represents, this time, a little mathematical legerdemain."

"Or — what was the word — thaumaturgy?"

"Thaumaturgy," concurred Smithy, "is a word which provides a good description. But there's an even better term."

"Prestidigitation?"

"Prestidigitation."



New Products



FLUKE INTRODUCES LOW-COST, POCKET-SIZED DMM

The Fluke International Corporation have introduced a new and revolutionary, low-cost, multi-function miniature digital multimeter, intended for use by both the professional engineer and the hobbyist.

Priced at £99, the Fluke Model 8020A digital multimeter features an extremely lightweight and attractive design, to withstand the rigours of frequent field use. It incorporates a $3\frac{1}{2}$ -digit liquid crystal display of $\frac{1}{2}$ in. character height, and has the various function and range push-button selectors so arranged to allow one-handed operation by the user. A custom designed CMOS/LSI circuit provides analogue-to-digital conversion and display decoding and drive. Together, the use of the LSI circuit and LED help to ensure maximum battery life from the small 9V alkaline cell, which consequently gives up to 200 hours operation.

Standard features of the 8020A include autozero and autopolarity, and the instrument has a total of 26 ranges and six functions. These include ten voltage ranges, from $100\mu\text{V}$ to 1kV d.c. or 750V a.c. with a basic d.c. accuracy of $\pm 0.25\%$; six of resistance, from 100 milliohms to 20 megohms with a basic accuracy of $\pm 0.2\%$; three for diode test functions, of 2 kilohms, 200 kilohms and 20 megohms; and two conductance ranges.

With the inclusion of the diode test and conductance functions, the 8020A offers far more comprehensive capabilities than those normally associated with low cost, portable analogue or digital instrumentation.



In the case of the diode test function, for example, sufficient voltage is supplied to turn on a semiconductor junction, so that diodes and transistors can be tested for the correct forward bias voltage in situ. Individual paralleled resistors can also be checked, without the need to disconnect them from the circuit.

The 8020A is ideally suited to a wide range of user applications in both the professional and hobbyist fields.

DESOLDERING WICK

Tele-Production Tools Ltd., of Stiron House, Electric Avenue, Westcliff-on-Sea, Essex, manufacturer of soldering and desoldering tools, claims that the type 3S-Wick is the answer to the problems associated with desoldering, because it is vacuumised.

Manufactured by the Swiss Company, Ernest Spirig, the copper braid is de-oxydised and coated with several layers of flux and protection lacquers under vacuum.

This vacuum technique produces a capillary ac-

tion between the molten solder and the wick, thereby removing the solder and leaving no corrosive residue — the wick contains practically no chlorines or halogenes. The wick is made with very soft chemicals resulting from a unique manufacturing technique.

Spirig wick is available in three standard sizes: AA for small joints; AB medium; and BB large. Each reel contains $5\frac{1}{2}$ ft. of wick and is priced from 45 pence per reel.



VEROSPEED ALARM DEVICE

A miniature audible warning device for use on portable equipment and instrument front panels is now available from Verospeed. Designed to operate on a voltage range from 5 to 30 volts D.C., the device may also be used on A.C. up to 20 volts. A choice of two continuous signals, high or low frequency, is available from one unit, and solid state electronics ensure high reliability with minimum current consumption. The device is mounted via a single hole and is secured with a chromed lock ring. Verospeed guarantee same-day despatch on all orders received before 3 p.m.

Vero Electronics Limited, Industrial Estate, Chandler's Ford, Eastleigh, Hants.

RECENT TV

By Michael Lorant

THE "PHONOVID"

Scientists of the electro-optical research department of Westinghouse Electric Corporation in the United States have developed a sight-and-sound system, called "Phonovid", which reproduces monochrome television pictures from a phonograph record for educational purposes. In the system, sounds and pictures are recorded and played back electronically.

The record is not just an audio recording which triggers pictures from a slide projector. Both the audio signal and the video signal are present in the grooves of the record and both are picked up by the phonograph needle. Up to 400 still pictures and 40 minutes of voice and music are present on the two sides of a 12 inch l.p. recording, described as a "Videodisc". The pictures can be line drawings, charts, printed text or photographs. The quality of the accompanying sound is of high standard.

Phonovid thus provides a complete 400 page educational picture book on a single long-playing phonograph record. It is, in fact, a flexible, easy to operate and inexpensive audio-visual system for a great variety of educational applications, such as classroom instruction at elementary, secondary and commercial training, vocational training, and remedial instruction where repetition and opportunity for drill are essential.



The Phonovid system in operation. Both the turntable and the television receiver are conventional, the information on the Videodisc being stored in an electronic memory which builds up a complete still picture in six seconds. A following picture is built up in the memory while the displayed picture is being shown. The disc also provides simultaneous high quality sound.



Phonovid may also employ tape instead of a record, and a standard reel of audio tape holds no less than 1,200 pictures with accompanying sound. The use of tape and a television camera enables any programme to be prepared. Here the system is demonstrated by Dr. S. W. Herwald, head of Westinghouse electronic components and speciality products group

The recording is played on an ordinary turntable and the pictures and sound appear on any number of television receivers in a classroom or throughout an entire school building. Any part of the recording can be held, skipped or repeated by manually lifting the tone arm. During interruption of the sound, the picture continues to appear on the television screen, allowing discussion, emphasis or interruption of the learning material. The whole operation is no more complicated than playing a record on a hi-fi set at home.

Phonovid uses an inherently low cost high density storage medium, the long playing record, in which a large concentration of information can be stored conveniently and in a small space. Existing audio and TV equipment is compatible with the system. Without modification, Phonovid can be integrated into existing closed-circuit and standard broadcast TV systems. It can also transmit pictures over ordinary telephone lines.

The record player and the TV set which displays the pictures are entirely conventional. The key component which links the two and makes possible the television display consists of a group of electronic circuits making up what is known as a "scan converter". This employs a television scanning technique which resembles that used to obtain television pictures from the signals broadcast by weather satellites and space probes. Information coming from the phonograph record is stored in the scan converter's special memory. The memory is

DEVELOPMENTS

capable of building up and displaying a complete TV picture every six seconds. During instruction, one picture is read out repeatedly and displayed during the time that the next one is being formed from the video information in the grooves of the recording.

The Phonovid system may also be employed with a tape recorder, and 1,200 pictures and accompanying sound can be stored on a standard reel of slow-speed audio tape. With tape it is possible for the educator to prepare his own sight-and-sound programme.

THE WORLD'S MOST SENSITIVE SOLID STATE TV CAMERA

Gerald J. Michon and Hubert K. Burke, staff research scientists of General Electric Research and Development Centre, Schenectady, N.Y., have developed the world's most sensitive solid state

television camera, capable of taking pictures by the glow of a candle.

The new camera is wallet-sized and weighs less than a pound. It can be adapted for use with an ordinary television set to produce exceptionally crisp images even when light levels are extremely low.

The heart of the novel camera is a charge-injection imager — a quarter inch square metal-oxide-semiconductor chip. Covered with 10,000 pairs of miniature capacitors, the light sensing chip performs the same job as the camera tube in conventional television cameras and converts a visual image into an electronic video signal. Since the miniature camera can be fabricated with current solid state manufacturing methods, it could potentially be made for a fraction of the cost of a conventional TV camera.

In the camera, the pairs of capacitors on the imager chip function as individual light-sensing devices. As light falls on the chip each capacitor pair collects a charge proportional to the intensity of the light striking it. To process the electrical charges into a television picture each pair of capacitors is individually addressed by scanning circuits to release its charge, "injecting" this into the base of the chip. Electronic circuits process the charge to reproduce the image on a television screen. The imager can be scanned at speeds compatible with ordinary television sets.

A great advantage of the new camera is that the chip has high tolerance to defects. If a pair of capacitors should fail the result is only one minute dark spot on the screen.

In addition the camera produces the clearest and sharpest pictures known to date with solid state techniques; also, it maintains this high picture quality even under low light levels. ■



Gerald J. Michon holds a solid state imager in front of an experimental model of the newly developed General Electric solid state TV camera, causing its image to appear on the monitor screen. Watching is Hubert K. Burke who also worked on the camera. The imager replaces the bulky video tube currently used in conventional TV cameras and may lead to small inexpensive TV camera for home use.

Use the **NEW Strip-fix Plastic** **PANEL SIGNS**

★ **SET 3 - Wording - WHITE**

★ **SET 4 - Wording - BLACK**

Over 1,000 words and symbols, covering more than 300 terms, in each set

Illustration of actual size = RADIO

★ **SET 5 - DIALS**

6 sheets containing one Large and two Medium scales, Large Horizontal Tuning scale, Frequencies, 12 Control Panels

- Easy to fix
- Stapled in booklet form
- Designed to hang above workbench
- Pocket for loose cuttings
- Professional finish



PRICE

SET 3: 75p

SET 4: £1.00

SET 5: 38p

(P. & P. 8p per set)

ALL PRICES INCLUDE V.A.T.

The Perfect Transfer for the Home Constructor

To Data Publications Ltd., 57 Maida Vale, London, W.9 1SN

Please supply Panel Signs as follows: Set 3 Set 4 Set 5

I enclose cheque / crossed postal order for (Tick which set is required)

NAME

ADDRESS

(BLOCK LETTERS PLEASE)

SMALL ADVERTISEMENTS

Rate: 10p per word. Minimum charge £1.50
Box No. 25p extra

Advertisements must be prepaid and all copy must be received by the 4th of the month for insertion in the following month's issue. The Publishers cannot be held liable in any way for printing errors or omissions, nor can they accept responsibility for the *bona fides* of Advertisers. (Replies to Box Numbers should be addressed to: Box No. —, *Radio and Electronics Constructor*, 57 Maida Vale, London, W9 1SN.

WANTED: Large and small quantities of transistors, I.C.'s, displays, etc., etc., Call any Saturday to: 306 St. Paul's Road, London N.1. Telephone: 01-359 4224.

ANTIQUE WIRELESS: For valves, radios, components and service sheets, 1920 to 1950. Contact The Vintage Radio Shop, 1977 Full Catalogue 70p. 64 Broad Street, Staple Hill, Bristol BS16 5NL. Telephone: (0272) 565472.

LOW COST BOXES and instrument cases. a range of aluminium boxes from as little as 48p including p&p. High quality range of Instrument Cases from 85p including p&p. Sheet aluminium standard and cut to size. Self-tapping screws, BA nuts, bolts, and washers. Send a self stamped addressed envelope for pamphlet to Harrison Bros., P.O. Box 55, Westcliff-on-Sea, Essex SS0 7LQ.

SERVICE SHEETS for Radio, Television, Tape Recorders, Stereo, etc. With free fault-finding guide. From 50p and s.a.e. Catalogue 25p and s.a.e. Hamilton Radio, 47 Bohemia Road, St. Leonards-on-Sea, Sussex.

RESISTORS: E12, 5% 1/3 W — 1p. Diodes 4148 — 3p, 4004 — 5p, LM555CN — 38p. VAT inclusive. 15p postage. Cleveland Supplies, P.O. Box 20, Redcar, Cleveland.

TIRRO ELECTRONICS the mail order division of Ritro Electronics UK, offers a wide range of components for the amateur enthusiast. Large s.a.e. or 20p brings list. Grenfell Place, Maidenhead, Berks., SL6 1HL.

ELECTRONIC DEVICES and Semiconductors. Component kits for this month's projects. S.A.E. for lists. Export welcome. NKM, P.O. Box 65, Eastbourne, Sussex.

BOOKS TO CLEAR: *Introductory Radio — Theory and Servicing*, 1948 (With Teacher's manual) by H. J. Hicks, £1.50. *Klystron Tubes*, by A. E. Harrison, 1947, £1.50. *An Approach to Audio Frequency Amplifier Design*, 1957, G.E.C. Publication, £1.25. *Television Engineers' Pocket Book*, 1954, by Molloy & Hawker, 50p. All prices include postage. — Box No. G329.

WHY NOT TRY something new — RTTY? The British Amateur Radio Teletype Group will give you all the information you need. "RTTY The Easy Way", kits, a Journal and so on. Details from: A. C. Butcher, Hon. Treasurer B.A.R.T.G., 70 Hughenden Avenue, High Wycombe, Bucks.

TREASURE HUNTERS! Construct 11-transistor metal detector giving £300 performance. 10 page illustrated plans, send £1. C. H. Lucas, 241 Upminster Road South, Rainham, Essex.

(Continued on page 125)

CAN YOU DO WITHOUT IT?

VERO

NEARLY ALL CONSTRUCTION PROJECTS REQUIRE SOME TYPE OF CIRCUIT BOARD.

VEROBOARD is offered to you in 15 sizes, 0.1" x 0.1" and 0.15" x 0.15" matrix. Every square inch of 0.1" Veroboard has 100 accurately placed holes for maximum versatility (imagine drilling those yourself!). Vero also manufacture boards for integrated circuits, strip boards, plain boards, tools, pins and a superb range of plastic and metal cases. All these products are available from your local shop or mail order company.



Send for our booklet describing these products. S.A.E. 7" x 9" plus 10p to:-

VERO ELECTRONICS LTD. RETAIL DEPT.
INDUSTRIAL ESTATE, CHANDLERS FORD, HANTS. SO5 3ZR
Telephone Chandlers Ford 2956



Wilmslow Audio

THE firm for speakers!

**SEND 10P FOR THE WORLDS BEST
CATALOGUE OF SPEAKERS, DRIVE UNITS
KITS, CROSSOVERS ETC. AND DISCOUNT
PRICE LIST**

ATC • AUDAX • BAKER • BOWERS &
WILKINS • CASTLE • CELESTION •
CHARTWELL • COLES • DALESFORD •
DECCA • EMI • EAGLE • ELAC • FANE •
GAUS • GOODMAN'S • HELME • I.M.F. •
ISOPON • JR • JORDAN WATTS • KEF •
LEAK • LOWTHER • MCKENZIE • MONITOR
AUDIO • PEERLESS • RADFORD • RAM •
RICHARD ALLAN • SEAS • TANNON •
VIDEOTONE • WHARFEDALE

WILMSLOW AUDIO DEPT REC

**SWAN WORKS, BANK SQUARE, WILMSLOW
CHESHIRE SK9 1HF**

Discount HiFi Etc. at 5 Swan Street and 10 Swan Street
Tel: Wilmslow 29599 for Speakers Wilmslow 26213 for HiFi

THE OPEN DOOR TO QUALITY



4th ISSUE INCLUDES NEW METERS AND SWITCHES as well as items from advanced opto-electronic components to humble (but essential) washers. Many things listed are very difficult to obtain elsewhere. The company's own computer is programmed to expedite delivery and maintain customer satisfaction. Attractive discounts continue on many purchases, Access and Barclaycard orders are accepted.

SEMI-CONDUCTORS ● COMPONENTS ● ACCESSORIES ● TOOLS
 * **FREE POSTAGE** on all C.W.O. mail orders over £2 list value (excluding VAT) in U.K., add 15p handling charge.

144 pages
40p
 Post paid
 inc. refund
 voucher
 worth
40p

All communications to Head Office, Dept. RC9 28 ST. JUDES ROAD, ENGLEFIELD GREEN, EGHAM, SURREY TW20 0HB. Phone Egham 3603 Telex 284475. Hours 9-5.30 daily; 1 pm Sats. NORTHERN BRANCH: 680 Burnage Lane, Burnage, Manchester M19 1NA. Phone 061-432 4945. Hours 9-5.30 pm, 1 pm Sats.

ELECTROVALUE LTD

Digital Alarm Clock Module

A 4-digit clock module which combines a MOS-LSI clock circuit, 4-digit 0.8" high efficiency Red LED display, power supply and other associated discrete components on a single P.C.B. to form a complete electronic clock movement. The user need only add a transformer and switches to construct a 12-hour digital alarm clock. Features include flashing 1 second colon, AM/PM indication, alarm set indication, alarm switched O/P to drive high impedance speaker direct, 'Sleep' and 'Snooze' timers, fast and slow set controls

Our Price £11.95+VAT+P&P Total £13.14

Transformer £2.25+VAT+P&P Total £2.47

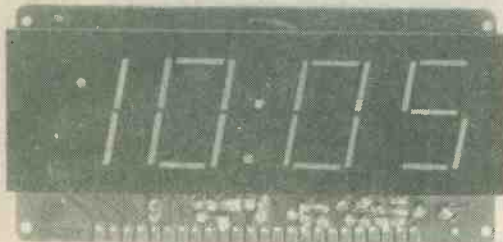

Pin 1.

24

Full details of this and other modules including amplifiers, timers, comparators, power supplies, count/displays, oscillators, digital panel meters etc. are given in our comprehensive catalogue. Also featured are details of our kits and components, all at highly competitive prices with SAME-DAY delivery by FIRST-CLASS LETTER POST. Send 50p for a folder containing our catalogue, new product up-dates and details of our large range of components and Kits. (Sent free with each clock module)



Lascar Electronics Ltd, P.O. Box 12, Second Avenue, Billericay, Essex. Tel. Billericay (02774) 3394



UNDERSTAND DATA PROCESSING

DATA PROCESSING, by Oliver & Chapman, is now in its Third Edition — first published 1972.

200 pages **9 $\frac{3}{4}$ " x 6 $\frac{3}{4}$ "** **PRICE £2.50**
Inclusive of postage

The primary aim of this outstanding manual is to provide a simplified approach to the understanding of data processing — (previous knowledge of the subject is not necessary).

The 40 chapters and appendices cover the following topics: Introduction to Data Processing; Organisation and Methods; Conventional Methods; Introduction to EDP and Computers; Hardware; Computer Files; Data Collection and Control; Programming and Software; Flowcharts and Decision Tables; Systems Analysis; Applications; Management of EDP, etc.

Available from:

D.P. PUBLICATIONS
4 AMPORT CLOSE, WINCHESTER, HANTS SO22 6LP

SMALL ADVERTISEMENTS

(Continued from page 123)

300 PAIRS OF S/H SPEAKERS in 9" x 14" teak cabinets. From £3.50. Edwards, 103 Goldhawk Road, London W12. Telephone: 743 6996.

OUTSTANDING HI-FI FM TUNER. Comprises 7 transistor superhet design with vericap tuning, AFG. Latest silicon circuitry, full coverage 88-102MHz. Supplied built and tested with metal front panel and instruction sheet. Only £9.95 + 30p P. & P. Gregg Electronics, 86-88 Parchmore Road, Thornton Heath, Surrey.

INVENTORS: "Profit from your Invention". Sources of finance and other assistance. Details: Large s.a.e. Delta (RE), 15 St. Mary Street, Southampton, Hampshire.

TV REPAIRS SIMPLIFIED. Full repair instructions in individual British sets £4.50; request free circuit diagram. Stamp brings details of unique TV publications. Auserec, 76 Churches. Larkhall, Lanarkshire.

SILICON SOLAR CELLS: Booklet 75p. — Data on cells in stock 20p or s.a.e. for current price list. Edencombe Limited, 16 Prince's Avenue, London NW9 9JB.

WANTED: Desk-FAX machine, complete or spare parts, with literature, manuals, etc., in the series TR100/1 and TR102/1, made by Creed & Co. Ltd. Details to Box No. G335.

THE RADIO AMATEUR INVALID & BEDFAST CLUB is a well established Society providing facilities for the physically handicapped to enjoy the hobby of Amateur Radio. Please become a supporter of this worthy cause. Details from the Hon. Secretary, Mrs. Rita Shepherd, 59 Paintain Road, Loughborough, Leics., LE11 3LZ.

INTERESTED IN BARGAIN OFFER? Quantity Mullard FX2243 ferrite cups with DT2206 former or similar Siemens. Lomnicky, 28 Caerleon Drive, Andover, Hampshire, SP10 4DE.

FOR SALE: Complete 9.5mm cine "Wide screen" outfit — Cameras, projector, screen, etc. S.A.E. for details. Box No. G336.

INTERESTED IN OSCAR? Then join AMSAT-UK. Newsletters, OSCAR NEWS Journal, prediction charts, etc. Details of membership from: James Keeler, G4EZN, Church Farm Cottage, Banningham Road, Aylesham, Norfolk, NR11 6LS.

FOR SALE: Copies of "Hi-Fi News" January 1975 to October 1975 inclusive, plus December 1975 and January 1976. Mint condition. Offers? Box No. G338.

POSTAL ADVERTISING? This is the Holborn Service. Mailing lists, addressing, enclosing, wrapping, facsimile letters, automatic typing, copy service, campaign planning, design and artwork, printing and stationery. Please ask for price list. — The Holborn Direct Mail Company Capacity House, 2-6 Rothsay Street, Tower Bridge Road, London, S.E.1. Telephone: 01-407 6444.

FOR SALE: Four volumes "Newnes Complete Wireless" about 1935 in very good condition. Offers wanted including carriage. Box No. G339.

FOR SALE: 8 inch 10W speaker, Eagle tweeter 10W 16 ohms, with crossover network and transformer. Teak veneered cabinet free, £12.00 Telephone: 01-455 0740.

(Continued on page 126)

VALVE BARGAINS

Any 5-64p. 10-£1.20. 50-£5.00. Your choice from the list below.

ECC82, EF80, EF183, EF184, EH90, PCF80, PCF802, PCL82, PCL84, PCL85, PCL805, PL504, PYB1/300, PY88, 30PL-14, 6F28, PFL200.

Colour Valves— PL508, PL509, PL519, PY500/A. All tested. 35p each.

Aerial Splitters— 2-way, 75 OHMS, Inside Type, £1.50.

AERIAL BOOSTERS

Aerial boosters can produce remarkable improvements on the picture and sound, in fringe or difficult areas.

B11— For the stereo and standard VHF/FM radio.

B12— For the older VHF television—Please state channel numbers.

B45— For Mono or colour this covers the complete UHF Television band.

All boosters are complete with battery with Co-ax plugs and sockets. Next to the set fitting. £4.20

250,000

Capacitor Clearance Sale

ALL MULLARD C280 and C281 RANGE OF POLYESTER FILM CAPACITORS 250 AND 400 VOLTS WORKING. VERY GOOD MIXED SELECTION OF VALUES FROM .01µ to 1.5µ f.

PRICE 100 - £1.50, 500 - £7.00, 1000 - £12.00

ALL PRICES INCLUDE VAT. P&P 30p PER ORDER, PLEASE SEND UNCROSSED P.O. OR CHEQUES FOR RETURNING IF WE ARE OUT OF STOCK OF CAPACITOR BARGAIN PACKS. EXPORTS WELCOME AT COST.

ELECTRONIC MAILORDER LTD.

62 BRIDGE STREET, RAMSBOTTOM, BURY, LANCS.
Telephone: RAMS (070 682) 3036

FANTASTIC GOLDRING SAVINGS

GOLDRING G103 Belt Drive Turntable

Famous name turntable slashed to near half price. Complete with plinth, cover and leads. Accepts any standard cartridge (not included) FULL 12 MONTH GUARANTEE



OUR PRICE
£29.95

R.R.P. £54 (+p/p & Ins £2.25)

SAVE OVER £24

Build your own GOLDRING CK2 Belt Drive Turntable

Beautifully engineered unit from the famous Goldring company, comes complete with instructions and all necessary parts. Ready to incorporate into your design plinth and cover. The pleasure of assembling your own deck.

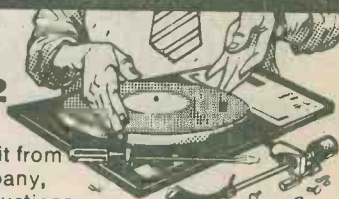

ONLY
£16.95

(+ p.p & Ins. £1.50)

(Plinth, cover and cartridge not included). Usually sold for £54.95 with plinth and cover.

ALL PRICES INC. VAT

Call in or send cheque, P.O., M.O., Access, Barclaycard, Diners Club or American Express Number.

Sonic Sound Audio

248/250 TOTTENHAM COURT ROAD, LONDON W1. TEL: 01-637 1908

PLAIN-BACKED NEW STYLE SELF-BINDERS

for your other magazines

(max. format $7\frac{1}{2}$ " x $9\frac{1}{2}$ ")

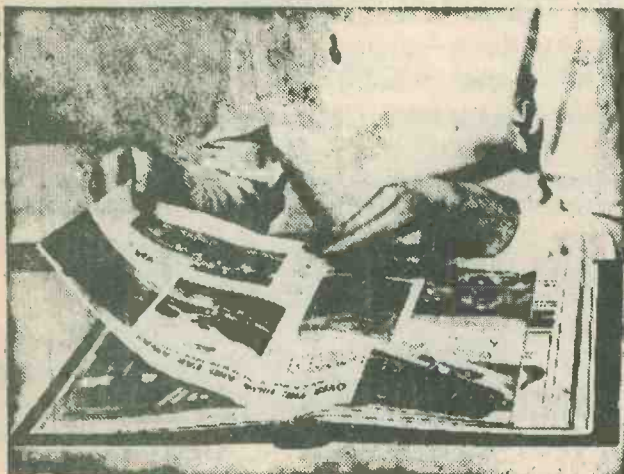

The "CORDEX" Patent Self-Binding Case will keep your copies in mint condition. Issues can be inserted or removed with the greatest of ease. Specially constructed Binding cords are made from Super Linen of great strength, very hard twisted and twice doubled. They are attached to strong RUSTLESS Springs under tension, and the method adopted ensures PERMANENT RESILIENCE of the Cords. Any slack that may develop is immediately compensated for, and the Cords will always remain taut and strong. It is impossible to overstretch the springs, as a safety check device is fitted to each.

COLOURS: MAROON OR GREEN

(If choice not stated, colour available will be sent)

PRICE £1.15 P. & P. 30p

Available only from:—

Data Publications Ltd.
57 Maida Vale London W9 1SN

SMALL ADVERTISEMENTS

(Continued from page 125)

BOOKS TO CLEAR: *The Radio Constructor* Vol. 15 August 1961 to July 1962, Bound, £2.30. *Practical Wireless*, Bound, Vol. 28, January to December 1952, £2.20. *Short Wave Magazine*, Bound, Volume VIII, March 1950 to February 1951, £2.00. *Newnes Television & Short Wave Handbook*, by F. J. Camm, 1935, £2.00. All prices include postage. Box No. G340.

MAGAZINE COLLECTORS. Disposing of very early issues of *Radio Constructor*. Complete years 1957, 1958, 1959 and 1960, £2.00 for each year. Also various odd issues dating from 1950 to 1956 at 25p each. Prices include postage. Box No. G341.

FOR SALE: Clearing out back issues of *Radio Constructor* to 1950's. Projection TV lens and tube, etc. Offers? Telephone Medway 408427.

SEND 10p IN STAMPS for latest list of aids for DX Listening, tuners, filters, etc. Stephens-James Ltd., 47 Warrington Road, Leigh, Lancs, WN7 3EA.

FOR SALE: Unmarked BZY88, 100 — 75p. Unmarked 2W zeners, 75 — 50p. Unmarked transistors (BC107/8/9) 40 — 50p. Ferric chloride 1lb. pack 50p (p&p 50p). 10. 15p. 12V miniature relays 50p. Ferranti silicon solar cells 50p. 8 No. 625 mercury cells 20p. 100 high wattage 75p. Stereo cassette mechanism £10.00. As above with pushbuttons and auto stop £15.00. Video recorder non-working £75.00. Ni-cad battery chargers £1.00. Tachometer motor 3V at 1000 rpm £1.55. Kodak Brownie cine camera £5.00. 8mm super projector and cine camera £10.00. Croydon ST08 cine camera £7.50. Hanimex 126 camera £4.00. 35mm camera £3.00. Super Servisol switch cleaner 75p. 4mm plugs and sockets 20p pair. Insulated post terminals 15p. Box No. G342.

FOR SALE: Copies of *Radio & Electronics Constructor* October 1956 to July 1977. (April, June and September 1975 missing). Offers? Telephone: 01-398 1991.

JOIN THE INTERNATIONAL S.W. LEAGUE. Free services to members including Q.S.L. Bureau, Amateur and Broadcast Translation, Technical and Identification Dept. — both Broadcast and Fixed Stations, DX Certificates, contests and activities for the SWL and transmitting members. Monthly magazine, *Monitor*, containing articles of general interest to Broadcast and Amateur SWLs, Transmitter Section and League affairs, etc. League supplies such as badges, headed notepaper and envelopes, QSL cards, etc., are available at reasonable cost. Send for League particulars. Membership including monthly magazines, etc., £3.75 per annum. (U.K. and British Commonwealth), overseas \$10.00 or £4.00. Secretary ISWL, 1 Grove Road, Lydney, Glos., GL15 5JE.

STAMP FOR LISTS of new and used components. Box No. G343.

FOR SALE: 1949-71 *Wireless World*, and *Radio Constructor* Volumes 3-28. Offers to: Mr. Hanson, 67 Pine Walk, Carshalton, Surrey.

FREQUENCY LIST TRANSFERS. We have a limited supply of sheets of Dial Frequency Transfers in black. Short Wave frequencies 1.8Mc/s to 32Mc/s and 144Mc/s and 146Mc/s. Includes amateur band marker frequencies at 100kc/s points and other short wave frequencies from 2 to 32Mc/s at every 500Kc/s points. Each frequency is repeated. Two sheets for 5p., five sheets for 10p., postage 7p. Data Publications Ltd., 57 Maida Vale, London, W9 1SN.

(Continued on page 127)

SMALL ADVERTISEMENTS

(Continued from page 126)

FOR SALE: Volumes 27 & 28 of *Radio & Electronics Constructor*. Also some earlier. Offers with s.a.e please. Box No. G344.

WANTED URGENT: Power Supply unit or circuit for frequency meter BC221. Hamilton, 67 Caswell Close, Farnborough, Hants.

FOR SALE: R/E, E/E, P/W. 75 in all. From October 1974. Best offer. R. Plant, 5 Molyneux Place, Stoke, Plymouth, Devon.

PERSONAL

JANE SCOTT FOR GENUINE FRIENDS. Introductions to opposite sex with sincerity and thoughtfulness. Details free. Stamp to: Jane Scott, 3/Con North St. Quadrant, Brighton, Sussex, BN1 3GJ.

IF YOU HAVE ENJOYED A HOLIDAY on the Norfolk Broads, why not help to preserve these beautiful waterways. Join the Broads Society and play your part in determining Broadlands future. Further details from: — The Hon. Membership Secretary, The Broads Society, "Icknield," Hilly Plantation, Thorpe St. Andrew, Norwich, NOR 86S.

SPONSORS required for exciting scientific project. Norwich Astronomical Society are building a 30" telescope to be housed in a 20' dome of novel design. All labour being given by volunteers. Already supported by Industry and Commerce in Norfolk. Recreational. Educational. You can be involved. Write to: NAS Secretary, The Manse, Back Lane, Wymondham, Norfolk.

ESSEX GARDENERS. Buy your Bedding and rock plants, shrubs, etc., also cacti from May's Nurseries, 608 Rayleigh Road, Hutton, Brentwood, Essex. Callers only. Monday to Saturday.

Give for those who Gave

WINGS APPEAL



During September



THE DALESFORD SPEAKER BOOK

By R. F. C. Stephens

This book is a must for the keen home constructor. Latest technology DIY speaker designs. Contains full plans for infinite baffle and reflex designs for 10-100 watts, also unusual centre-bass system for those who want hi-fi to be "heard and not seen". £1.95 (£2.20 post paid. \$5 Overseas).

VAN KAREN PUBLISHING,
5 SWAN STREET, WILMSLOW, CHESHIRE.

NEW ELECTRONIC BOOKS

Making & Repairing Transistor Radios	£3.00
Basic Colour TV Course	£3.00
Build Your Own Working Robot	£4.95
Pictorial Guide to Colour TV Problems	£2.55
Build It Book of Miniature Test Instruments	£3.95

Mail order only. Books post paid from:

FINBARR BOOKS

16 London Street, Folkestone, Kent

PHILIPS



YOU & PHILIPS HI-FI KITS

The top sellers for home assembly in Europe — now available in the U.K.

Now — read all about the Philips range of quality kits for home assembly — mixers, amplifiers, speakers, etc, etc. Send today to S.S.T. Distributors (Electronic Components) Ltd., West Road, Tottenham, London N17 0RN

Please send me, quickly, the new colour catalogue. REC 81

Name _____

Address _____



Postcode _____

free SEND TODAY!

S.S.T. Distributors is a member of the Philips Group of Companies.

PRINTED CIRCUITS AND HARDWARE

Comprehensive range Constructors' hardware and accessories. Sheet aluminium and lightweight sections. Selected range of popular components. Printed circuit boards for individual designs. Drawing materials for printed circuits. Resist coated laminate, epoxy glass for the d.i.y. man. Full processing instructions, no unusual chemicals required.

Send 15p for catalogue

Ramar Constructor Services

Masons Road · Stratford-on-Avon · Warwks CV37 9NF

MULLARD FERRITE CORES — LA3 100 to 500 kHz, 75p; LA5 30 to 100 kHz, 100p; LA7 10 kHz, 100p LA13 for W.W. Oscilloscope, £2.00.

SPECIAL OFFER — Metallised Polyester Capacitors by Erie, Mullard, etc. Values include: .01/160V, .01/250V, .015/160V, .022/160V, .033/160V, .047/160V, .068/160V, .1/160-250V, .22/160V, etc. This is a bargain not to be missed. 100 for £3.00. 1N4148 **SWITCHING DIODES**, 10 for 30p; 50 for £1.25; 100 for £1.50; 1,000 for £12.50.

TRANSISTORS — All branded BC147, BC148, BC149, BC157, BC158, BC159, BF194, BF195, BF196, BF197, 10p each or 100 for £7.50.

Please note all prices include UK Postage and appropriate VAT @ 8% or 12½%

XEROZA RADIO

306 ST. PAUL'S ROAD, HIGHBURY CORNER, LONDON N1
Tel: 01-226 1489

RADIO & ELECTRONICS CONSTRUCTOR

Single Copies

Price 40p each, postage 12p

Issue(s) required

Annual Subscription

Price £6.00, post free, commence with.....issue

Bound Volumes:

Vol. 27. August 1973 to July 1974	Price £2.40, post & pkg 90p
Vol. 28. August 1974 to July 1975	Price £2.75, post & pkg 90p
Vol. 29. August 1975 to July 1976	Price £3.10, post & pkg 90p

CORDEX SELF-BINDERS

With title, 'RADIO & ELECTRONICS CONSTRUCTOR' on spine,
maroon only

Price £1.20, post & pkg 30p

With no title on spine, maroon

Price £1.15, post & pkg 30p

With no title on spine, green

Price £1.15, post & pkg 30p

Max. Format 7½" x 9½"

Prices include V.A.T.

DATA BOOK SERIES

DB5 TV Fault Finding, 132 pages	Price 90p, P. & P. 20p
DB6 Radio Amateur Operator's Handbook, 88 pages	Price 70p, P. & P. 13p
DB17 Understanding Television, 504 pages	Price £3.25, P. & P. 70p
DB19 Simple Short Wave Receivers 140 pages	Price 80p, P. & P. 20p

STRIP-FIX PLASTIC PANEL SIGNS

Set 3: Wording — White Price 75p, P. & P. 8p

Set 4: Wording — Black Price £1.00, P. & P. 8p

Set 5: Dials Price 38p, P. & P. 8p

Prices include V.A.T. on Panel Signs

I enclose Postal Order/Cheque for.....in payment for.....

NAME

ADDRESS

(BLOCK LETTERS PLEASE)

Postal Orders should be crossed and made payable to Data Publications Ltd.

Overseas customers please pay by International Money Order.

All publications are obtainable through your local bookseller

Data Publications Ltd., 57 Maida Vale, London W9 1SN

PLEASE MENTION THIS MAGAZINE WHEN WRITING TO ADVERTISERS

FOR THE BEGINNER

THE SILICON CONTROLLED RECTIFIER

The silicon controlled rectifier has the circuit symbol shown in (a). When the anode connects to a positive and the cathode to a negative supply the device exhibits a very high resistance. If a current is allowed to flow, even momentarily, into the gate, the device turns on and the resistance between anode and cathode falls to a very low value. The device can only be returned to its high resistance state by reducing the anode to cathode current to a low level.

The silicon controlled rectifier consists basically of the p.n.p.n. structure shown in (b). To explain its functioning, this can be considered equivalent to the interconnected p.n.p. and n.p.n. structures of (c) and, in turn, to the interconnected p.n.p. transistor and n.p.n. transistor illustrated in (d).

In (e) these two transistors are connected via a load resistor to a d.c. supply. In the absence of gate current the transistors are non-conductive and only a very small leakage current flows. If, as in (f), the gate is taken positive of the cathode a forward current flows in the base-emitter junction of the lower transistor, which then draws an amplified collector current through the base-emitter junction of the upper transistor. The latter current causes an amplified collector current to flow through the base-emitter junction of the lower transistor. There is an overall regenerative effect resulting in both transistors maintaining each other in the "hard on" condition, and the voltage between anode and cathode becomes typically of the order of 1 volt. The transistors can only be turned off again by reducing the current flowing through them to a low value. In (f) the arrows indicate current flow from positive to negative.

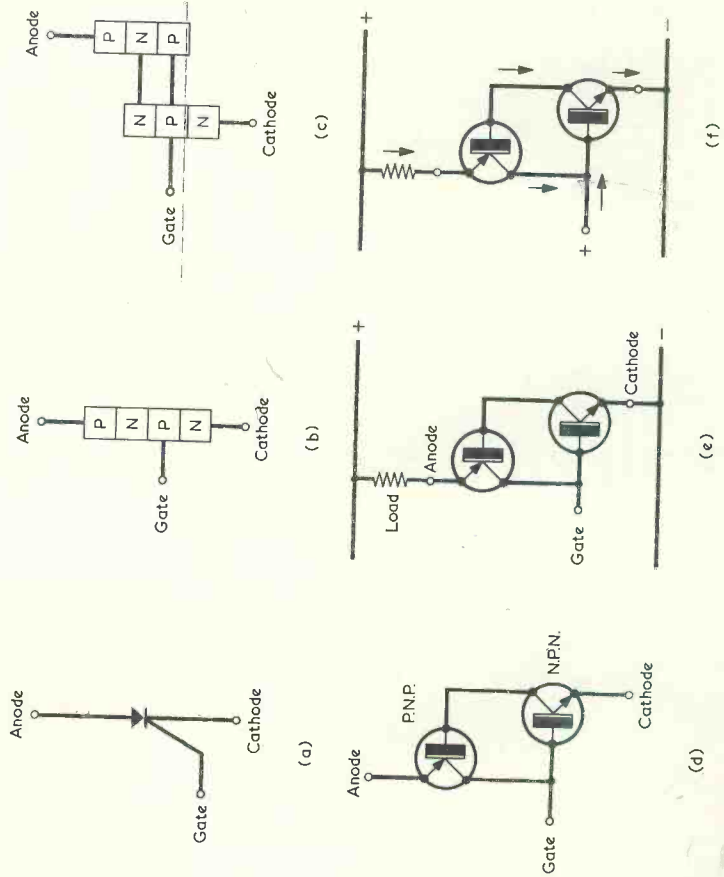

MAPLIN



ELECTRONIC ORGAN

The only organ you can build in stages and tailor to your requirements as you go along—and at each stage you'll have a fully working instrument! We haven't got the gimmicks (yet—they're coming soon), but we have got the most beautiful sounds—you won't find them on any organ less than twice our price. So get our MES50 series leaflets now! 65p buys the three available so far.

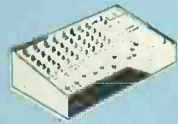

GRAPHIC EQUALISER



This high quality Graphic Equaliser will enhance even the most sophisticated system at a fraction of the cost of a ready-made equaliser of equal quality. You can get all the parts from us (except woodwork) including drilled and printed metalwork. Construction details in our leaflet: 15p.



TOOLS



We stock an excellent range of tools especially for the electronics enthusiast. From miniature wiring tools to multimeters including soldering irons and desoldering tools, screwdrivers, cutters, pliers, strippers, miniature electric drills for p.c.b.'s, transistor tester etc. Full details on catalogue pages 167 to 176.

PEDAL UNIT

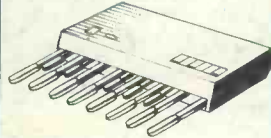

A completely self-contained pedal unit. 13-note, 2-octave range, 4 organ stops. It can be added to any organ! A really unusual extra is the bass guitar stop which uses four envelope shapers to give a real bass guitar sound. A must for the solo guitarist. Full construction details in our catalogue—post the coupon below now!

T.V. GAME

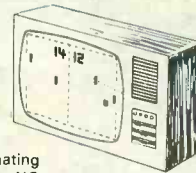

Play fascinating games NOW on your own t.v. in your own living room. The kids will think it's magic when the scores pop up on the screen. Lay your bets — anyone could win — with Maplin's prices everyone can win. Complete kit to play four games only £24.50. Add 35p for copy of construction details. See our August newsletter for details of rifle kit.

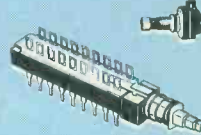
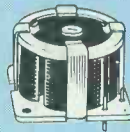
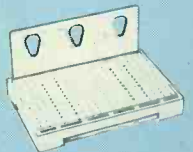

IT'S A FANTASTIC BESTSELLER!

216 big (11" x 8") pages! Over a thousand illustrations! Over 30 pages of complete projects to build! Thousands and thousands of useful components described and illustrated! No wonder it's a bestseller!

DON'T MISS OUT! SEND 60p NOW!

POST THIS COUPON NOW FOR YOUR COPY OF OUR CATALOGUE PRICE 60p

Please rush me a copy of your 216 page catalogue by return of post. I enclose 60p, but understand that if I am not completely satisfied I may return the catalogue to you within 14 days and have my 60p refunded immediately.

REC8

NAME _____

ADDRESS _____



Our bi-monthly newsletter keeps you up to date with latest guaranteed prices — our latest special offers (they save you pounds) — details of new projects and new lines. Send 30p for the next six issues (5p discount voucher with each copy).

MAPLIN ELECTRONIC SUPPLIES

P.O. BOX 3 RAYLEIGH ESSEX SS6 8LR

Telephone: Southend (0702) 715155

Shop: 284, London Road, Westcliff-on-Sea, Essex

(Closed on Monday) Telephone: Southend (0702) 47379