

RADIO & ELECTRONICS CONSTRUCTOR

DECEMBER 1975

30p

WIEN BRIDGE AUDIO SIGNAL GENERATOR

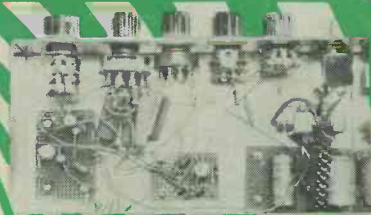

Continuously
variable range
from 7.5Hz
to 75kHz.

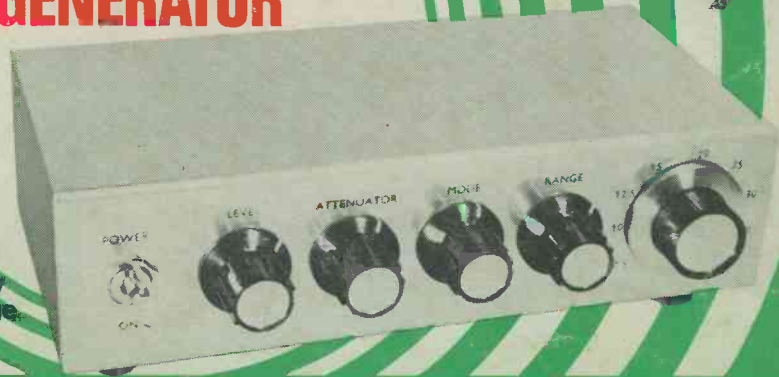

THE 'DRAGHNA'

S.W. & V.H.F. PORTABLE

PART 1 (2 PARTS)

**ALSO
FEATURED**

'IN SITU' TRANSISTOR CHECKER



Each £3 unit of Home Unit Insurance gives you protection up to the limit shown

This is the simplified insurance you have been waiting for. Not just cover on the contents of your home but a package of personal protection you and your family need. And it's how we save you so much money: just ONE policy to issue instead of nine! You can build up to the cover you need by additional units

(or 1/4 units after the first) up to a maximum of five. So simple. So easy. Apply to your Broker, Agent or local office of a General Accident company. The Home Unit Policy can replace your existing insurances. And remember - as you buy more possessions just add more Home Units at any time. *Quote Ref. 20/9468*

THE GENERAL ACCIDENT FIRE & LIFE ASSURANCE CORPORATION LTD

Metropolitan House, 35 Victoria Avenue,
Southend-on-Sea, Essex, SS2 6BT

It pays to be protected by a **General Accident** company

Please send me further particulars of the Home Unit Insurance.

Name.....

Address.....

20/9468

RADIO & ELECTRONICS CONSTRUCTOR

DECEMBER 1975
Volume 29 No. 5

Published Monthly (1st of Month)
First Published 1947

Incorporating The Radio Amateur

Editorial and Advertising Offices
57 MAIDA VALE LONDON W9 1SN

Telephone 01-286 6141 Telegrams Databux, London

© Data Publications Ltd., 1975. Contents may only be reproduced after obtaining prior permission from the Editor. Short abstracts or references are allowable provided acknowledgement of source is given.

Annual Subscription: £5.00 (U.S.A. and Canada \$11.00) including postage. Remittances should be made payable to "Data Publications Ltd". Overseas readers please pay by cheque or International Money Order.

Technical Queries. We regret that we are unable to answer queries other than those arising from articles appearing in this magazine nor can we advise on modifications to equipment described. We regret that such queries cannot be answered over the telephone; they must be submitted in writing and accompanied by a stamped addressed envelope for reply.

Correspondence should be addressed to the Editor, Advertising Manager, Subscription Manager or the Publishers as appropriate.

Opinions expressed by contributors are not necessarily those of the Editor or proprietors.

Production.—Web Offset.

CONTENTS

THE 'DRACHMA' S.W. AND V.H.F. PORTABLE Part 1 — by Sir Douglas Hall, K.C.M.G.	270
'IN SITU' TRANSISTOR CHECKER — (Suggested Circuit 301) by G. A. French	275
UNITY GAIN INVERTER by J. R. Davies	278
NEWS AND COMMENT	280
TOUCH TUNING CONTROL by J. B. Dance	282
BOOK REVIEW	283
THE 6/12 AMPLIFIER — Part 2 (Conclusion) by J. T. Neill	284
WIEN BRIDGE AUDIO SIGNAL GENERATOR by R. A. Penfold	287
CHOOSING THE RIGHT BATTERY by Vivian Capel	293
SHORT WAVE NEWS — For DX listeners by Frank A. Baldwin	296
TOUCH SWITCH by S. V. Essex	298
RADIO TOPICS by Recorder	305
IN YOUR WORKSHOP — SN76013 Audio Amplifier I.C.	307
ELECTRONICS DATA — No. 5 (For the Beginner — Wavelength and Frequency)	iii

Published in Great Britain by the Proprietors and Publishers, Data Publications Ltd, 57 Maida Vale, London W9 1SN

The *Radio & Electronics Constructor* is printed by Swale Press Ltd.

JANUARY ISSUE WILL BE
PUBLISHED ON 2nd JANUARY

COMPONENTS

HOBBYIST - PROFESSIONAL - DOMESTIC - SURPLUS - INDUSTRIAL
 JUST A FEW OF OUR BARGAINS ARE LISTED BELOW - SEND STAMPED
 ADDRESSED ENVELOPE FOR A QUOTE ON OTHER REQUIREMENTS.
 PAY US A VISIT. OVER 90% OF STOCK BELOW QUANTITY
 WHOLESALE PRICE. RETURN POSTAL SERVICE UNLESS CHEQUE.

Goods sent at customer's risk, unless sufficient payment for insurance included (2p per £1 Min 7p) British Isles only.

VALVE BASES	
Printed circuit B9A - B7G	2p
Chassis B7 - B9G - B7G	4p
Shrouded chassis B7G - B9A	6p
B8A - B9A chassis - B12A tube	6p

Speaker, 6" x 4", 5 ohm, ideal for car radio etc. £1

TAG STRIP - 6 way	3p	VHF Radio Tuner Head	80p
9 way	5p	Single	1p

1 1/4 glass fuses - 250 m/a or 3 amp (box of 12)	18p
3" tape spools	8p
1 Terryclips chrome finish	4p
Brand new Boxed 6K7G	25p
1.5m, log edge pot	8p
PVC or metal clip on M.E.S. bulb holder	5p
Geared Knob, Inner to Outer Ratio 8:1	60p
Bulgin, 5mm Jack plug and switched socket (pair)	30p
12 volt solenoid and plunger	30p
250 RPM 50 c/s locked frequency miniature mains motor	50p
200 OHM coil, 2 1/4" long, hollow centre	10p
Belling Lee white plastic surface coax outlet Box	30p
R.S. 12 way standard plug and shell	20p

SWITCHES		Type	
Pole	Way		
4	2	Sub. Min. Slide	18p
6	2	Slide	20p
4	2	Lever Slide	15p
2	2	Slide	12p
1	3	+ off Sub. min. edge	10p
1	3	13 amp small rotary	12p
2	2	Locking with 2 to 3 keys	£1.50

2	1	2 Amp 250V A.C. rotary	24p
Wafer Rotary, all types			30p
S.P.S.T. 10 amp 240v. white rocker switch with neon. 1" square flush panel fitting			30p

1 1/2" METER AUDIO LEAD	
5 pin din plug 180° both ends	80p
3 pin din to open end, 1 1/2yd twin screened lead	35p

COMPUTER AND AUDIO BOARDS
 VARYING PANELS WITH ZENER, GOLD BOND, SILICON, GERMANIUM, LOW AND HIGH POWER TRANSISTORS AND DIODES, HI STAB RESISTORS, CAPACITORS, ELECTROLYTICS, TRIMPOTS, POT CORES, CHOKES ETC.

3lb for 85p + 75p post and packing
 7lb for £1.75 + £1 post and packing

Skeleton Presets	Clear Plastic Boxes
Slider, horizontal or vertical standard or submin. 5p	For component storage or projects, sliding lid. 1 1/2" x 1 1/2" x 1" 10p

KNOB
 SILVER METAL PUSH ON WITH POINTER, OR WHITE PLASTIC, GRUB SCREW WITH POINTER AND SILVER CENTRE 8p EACH.
 1" DIAM. WITH 1 1/2" SKIRT SPUN ALUMINIUM GRUB SCREW FIXING, 1/2" 30p EACH.

ZM1162A INDICATOR TUBE
 0-9 Inline End View. Rectangular Envelope 170V 2.5M/A £1.50

RESETTABLE COUNTER
 English Numbering Machines LTD.
 MODEL 4436-159-989

6-14 volt, 6 digit, illuminated, fully enclosed. £2.50
 Ferric Chloride, Anhydrous mil. spec. 1lb. bag 50p

TO3 or TO66	
Mica Washer	2p
18 volt 4 amp charger, bridge rectifier	50p
GC10/4B	£3.00

Telescopic aerial
 Closed 9 1/2", open 38 1/2"
 Fitted right angle TV plug, 50p

1/4 1/4 watt	1p
1 watt	2p
Up to 5 watt wire wound	10p
10 watt wire wound	12p
15 watt	14p

RESISTORS	
Philips transformer, safety fused. In 200-220-240v. Out 240v 60ma + 6.3v 1a approx 2" x 2 1/4" x 2 1/2"	£1.50

POTS	
Log or Lin carbon	13p
Switched	25p
Dual Pots	38p
Dual & switch	50p
Lin wirewound	25p
Slider Pot	25p
Dual Slider	35p

THERMISTORS	
VA1008, VA1034, VA1039, VA1040, VA1055, VA1066, VA1082, VA1100, VA1077, VA1005, VA1026	10p

RELAYS	
12 volt S.P.C.O octal mercury wetted high speed	75p
P.O. 30:00 type, 1,000 OHM coil, 4 pole c/o	60p
Mains or 12v d.p.c.o. heavy duty octal	60p

Boxed GEC KT88 valve £2

JAP 4 gang min. sealed tuning condensers New 25p
 Ex-eqpt. 2 or 4 gang 15p

ELECTROLYTICS MFD/VOLT. Many others in stock	
70-	200-300-450-
Up to 10V 25V 50V 75V 100V 250V 350V 500V MFD	
10 4p 5p 6p 8p 8p 12p 16p 20p	
25 4p 5p 6p 8p 8p 15p 18p 20p	
50 4p 5p 6p 9p 13p 18p 25p	
100 5p 6p 10p 12p 19p 20p	
250 9p 10p 11p 17p 28p	85p £1
500 10p 11p 17p 24p 45p	
1000 13p 17p 40p 75p	£1.50
2000 23p 37p 45p	

As total number of values are too numerous to list, use this price guide to work out cost of your actual value requirements, i.e. 2MFD, 30V would be 5p, or 330MFD, 50V would be 14p, etc. etc. 8/20, 10/20, 12/20 Tubular tantalum 15p each
 16-32/275, 32-32/275, 100-100/150, 100-100/275 50-50/300 20p each
 50/50-385 30p
 12,000/12, 32-32-50/300, 700/200 100-100-100-150-150/320 50p each
 20-20-20/350 40p each

INDICATORS	
Bulgin D676 red, takes M.E.S. bulb	20p
12 volt red, small pushfit	20p
Mains neon, red, pushfit	20p

CAPACITOR GUIDE - maximum 500V
 Up to .01 ceramic 2p. Up to .01 poly 3p.
 Up to 1000PF silver mica 5p. 1,200PF up to .01 silver mica 10p. .013 up to .25 poly etc. 4p.
 .27 up to .68 poly etc. 6p
 Over 500 volt order from above guide and few others listed below.
 6p. .1/600: 10p. .01/1000, 1/350, 8/20, .1/900, .22/900, 4/16. .25/250 AC (600vDC) .1/1500 40p. 5/150, 9/275AC, 10/150, 15/150, 40/150.

TRIMMERS, 20p each	
100PF Ceramic, 30PF Beehive, 12PF PTFE	
2500PF 750 volt, 33PF MIN. AIR SPACED	
5PF, MIN. AIR SPACED, 50PF CERAMIC.	

CONNECTOR STRIP	
Belling Lee L1469, 4 way polythene.	3p each
Strong grey plastic box same design as die cast ali 4 3/8" x 2 3/8" x 1 1/2"	40p

MAINS DROPPERS	
1" or 1 3/8" or 2" CAN CLIPS	2p
36+79 ohm	15p
66+66+158 ohm, 66+66+137 ohm	
17+14+6 ohm, 266+14+193 ohm	20p
50+40+1k5 ohm	
285+575+148+35 ohm	30p
25+35+97+59+30 ohm	

5 1/2" x 2 3/4" Speaker, ex-equipment	3 ohm	30p
2 Amp Suppression Choke		5p
3 x 2 1/2" x 1 1/8" PAXOLINE		2p
4 5/8" x 1 1/2" x 1 1/8"		2 for 1p
220K & 100 ohm 3 watt resistors		4p
VALVE RETAINER CLIP, adjustable		2p

OUTPUT TRANSFORMERS	
Sub-miniature Transistor Type	25p
Valve type, centre tapped or straight	40p

THE RADIO SHACK
 161 ST. JOHNS HILL, BATTERSEA, LONDON S.W.11
 Open 10 a.m. till 7 p.m. Monday to Saturday - Also Sunday afternoons
 Terms: Payment with order Telephone: 01-223 5016

12 volt 250M/A or 6 volt 1/2 A Transformers £1
 Whiteley Stentorian 3 ohm constant impedance volume control way below trade at 80p
 Drive Cord 1p per yd.

SEMICONDUCTORS

Full spec. marked by Mullard, etc. Many other types in stock

AC107	12p	BC179B	11p	BF180/1/2/3	20p
AC128	5p	BC184C	9p	BF184/5	15p
AC176	9p	BC186/7	13p	BF194/5/6/7	5p
ACV28	18p	BC213L/214B	9p	BF194A/195C/200	10p
AD149	40p	BC261B	10p	BF258/262/263	24p
AD161/2 matched pr.	69p	BC327	12p	BF336	25p
AF116	12p	BC328	10p	BFS28 Dual Mosfet	92p
AF124/6/7	20p	BC337/8	12p	BFW10/11 F.E.T.	26p
AF139/178/180/181	30p	BC547/558A	7p	BFW30	£1.35
AF239	20p	BC548/557	9p	BFW57/58	20p
ASY27/73	25p	BCX32/36	12p	BFX12	20p
BC107A or B	9p	BCY40	60p	BFX29/30/84/88	16p
BC107/8/9	6p	BCY70/1/2	9p	BFX89	35p
BC108A/B/109B/C	10p	BD112/3/5/6	40p	BFY50/1/2	12p
BC147/8/9	6p	BD131/2/3/5/7/9	30p	BFY90	50p
BC147A/B	8p	BD201/2/3/4	£1.00	BR101	30p
BC148A/B, 9B/C/S	8p	BD232/4/5	46p	BRY39	31p
BC157/8/9	6p	BDX77	£1.40	BRYS6	34p
BC158A/B	11p	BF115	12p	BSV64	40p
BC159B/C, 157A	11p	BF167/173	15p	BSV79/80 F.E.T.s	£1
BC178A/B	12p	BF178/9	20p	BSV81 Mostet	90p

BRIDGE RECTIFIERS

Amp	Volt		Amp	Volt			
1	1,600	BYX10	30p	2	30	LT120 type	30p
1	140	OSH01-200	20p	0.6	110	EC433	15p
1.4	42	BY164	28p	5	400	Texas	75p

RECTIFIERS

	Amp	Volt	
IN4004	1	400	3p
IN4005	1	600	
IN4006	1	800	4p
IN4007	1	1,000	
BY103	1	1,500	15p
SR100	1.5	100	7p
SR400	1.5	400	8p
REC53A	1.5	1,250	14p
LT102	2	30	10p
BYX38-600	2.5	600	40p
BYX38-300R	2.5	300	36p
BYX38-900	2.5	900	45p
BYX38-1200	2.5	1,200	50p
BYX49-600	2.5	600	34p
BYX49-300	2.5	300	26p
BYX49-900	2.5	900	40p
BYX49-1200	2.5	1,200	52p
BYX48-300	6	300	40p
BYX48-600	6	600	50p
BYX48-900	6	900	60p
BYX48-1200	6	1,200	80p
BYX72-150R	10	150	35p
BYX72-300R	10	300	45p
BYX72-500R	10	500	55p
BYX42-300	10	300	30p
BYX42-600	10	600	65p
EYX42-900	10	900	80p
BYX42-1200	10	1,200	95p
BYX46-300*	15	300	£1.00
BYX46-400*	15	400	£1.50
BYX46-500*	15	500	£1.75
BYX46-600*	15	600	£2.00
BYX20-200	25	200	60p
BYX52-300	40	300	£1.75
BYX52-1200	40	1,200	£2.50

*Avalanche type

Amp	Volt	TRIACS	
6	400	Plastic	74p
25	900	BTX94-900	£4.00
25	1200	BTX94-1200	£6.00
12-0-12 50M/A Min. Txmfr.			90p
Pair of LA2407 Ferro cores with adjuster			25p
Chrome Car Radio fascia			15p
Rubber Car Radio gasket			5p
DLI Pal Delayline			50p
Relay socket Take miniature 2PCO relay			10p
B7G or B9A valve can			2p
0-30, or 0-15, black pvc, 360° dial, silver digits, self adhesive, 4½" dia.			10p

OPTO ELECTRONICS

BPX40	65p	Photo transistor	
BPX42	£1.00	BPX29	£1.00
BPY10	£1.00	OCF71	30p
(VOLIAC)		BIG L.E.D. 0.2"	
BPY68	} £1.00	2v 50mA max.	
BPY69		RED	
BPY77		ORANGE	
		GREEN	
Diodes		YELLOW	

PHOTO SILICON CONTROLLED SWITCH BPX66 PNP 10 amp £1.00

3" red 7 segment L.E.D. 14 D.I.L. 0-9 + D.P. display 1.9v, 10mA/segment 65p

CQY11B L.E.D. Infra red transmitter £1 One fifth of trade

Wire ended glass neons 5p

Plastic, Transistor or Diode Holder 1p Transistor or Diode Pad 1p Holders or pads 50pper100

Philips Iron Thermostat 15p Bulgin 2-pin flat plug and socket 10p McMurdo PP108 8 way edge plug 10p

T03 HEATSINK Europlec HP1 TO3B individual 'curly' power transistor type. Ready drilled 20p

Tested unmarked, or marked ample lead ex new equipment

ACY17-20	8p	OC71/2	5p
ASZ20	8p	OC200-5	10p
ASZ21	15p	TIC44	24p
BC186	11p	2G240	2-50
BCY30-34	10p	2G302	6p
BCY70/1/2	8p	2G401	10p
BF115	10p	2N711	25p
BY127	7p	2N2926	7p
BZY88 series	5p	2N598/9	6p
HG1005	2p	2N1091	8p
HG5009	2p	2N1302	8p
HG5079	2p	2N1907	2-50
L78/9	2p	Germ. diode	1p
M3	10p	GET120 (AC128 in 1" sq. heat sink)	
OA81	2p	GET872	12p
OA47	2p	2S3230	30p
OA200-2	3p		
OC23	20p		

BSX20/21	13p	2N3133	18p
BSY40	28p	2N3704	10p
BU105-01	93p	2N4037	35p
CV7042 (OC41 OC44, ASY63)	7p	2N5036	60p
GET111	40p	2SA141/2/360	31p
OC35	32½p	2SB135/6/457	20p
ON222	30p	40250	60p
TIP30	43p		
TIP3055	50p		
TIS88A FET	23p		
ZTX300	8p		
ZTX341	15p		
2N393/MA393	30p		
2N706	8p		
2N929	14p		
2N987	35p		
2N1507/2219	17p		
2N2401/2412/2483	25p		
2N2904/5/6/7	13p		
2N2907A	15p		
2N3053	13p		
2N3054/3055 (or equiv)	35p		

OTHER DIODES

1N916	6p
1N4148	1-5p
BA145/148	12p
Centercel	10p
BZY61	10p
BB103/110 Varicap	18p
BA182	18p
OA5/7/10	10p
BZY88 Up to 33 volt	6p
BZX61 11 volt	16p
BR100 Diac.	19p

INTEGRATED CIRCUITS

TAA700	£2.95
741 8 pin d.i. op. Amp 18p	
TAD100 AMRF	£1.00
CA3001 R. F. Amp	£1.00
TAA300 1wt Amp	£1.25
NE555v Timer	42p
TAA550 Y or G	31p
TAA263 Amp	65p
7400/2/10/20/30	13p
7404	14p
7414	45p
7438/74/86	27p
7483	80p
LM300, 2-20 volt	50p
74154	£1.44

THYRISTORS

Amp	Volt		
1	240	BTX18-200	50p
1	400	BTX18-300	65p
1	240	BTX30-200	40p
15	500	BT107	£1.00
6.5	500	BT101-500R	90p
6.5	500	BT109-500R	75p
20	600	BTW92-600RM	£3.00
15	800	BTX95-800R Pulse Modulated	£8.00
30	1000	28T10 (Less Nut)	£3.00

SOLDER
Multicore - 2½p foot
ENAM. COPPER WIRE
SWG. PER YD.
20-24 2p
26-42 1p

GARRARD
GCS23T or GP93/1 Crystal Stereo Cart-ridge £1.00

HANDLES
Rigid light blue nylon 6½" with secret fitting screws 5p
14 D.I.L. socket, gold plated contacts, NOT cheap type 13p
Miniature Axial Lead Ferrite Choke formers 2p

DEE PLUG
McMurdo DA15P 15 way chassis plug 10p

Fairway 18009 Coax. socket 3p

TIE CLIPS
Nylon self locking 7" or 3½" 2p

CINCH 150
12 way edge socket 10p

11b Mixed nuts, bolts, washers etc. 35p

PAPER BLOCK CONDENSER
0.25MFD 800 volt 30p
1MFD 250 volt 15p
2MFD 250 volt 20p
10MFD 500 volt 80p
4MFD 250 volt 20p
15MFD 150 volt 50p

METAL CHASSIS SOCKETS
Car Aerial
Coax
5 or 6 pin 240° din
Speaker din switched
3.5mm Switched Socket

8 way Cinch standard
0.15 pitch edge socket 20p

U.E.C.L. 10 way pin connector 2B6000
OA1P10 10p
U.E.C.L. 20 way pin connector 2A60000A1P20 20p

U.E.C.L. 10 way pin socket 2B606001R10 10p
U.E.C.L. 20 way pin socket B260800A1R20 20p

3.5mm STEREO PLUG Metal screened 35p

Philips electronic engineer kits add on series E1004 £1.00 each

RG4-1250 Mercury vapour rectifier £5.00

SMALL ORDERS, ENCLOSE SUITABLE STAMPED ADDRESSED ENVELOPE LARGE ORDERS, ADD SUFFICIENT FOR POSTAGE, INSURANCE, ETC. TOTAL GOODS PLUS CARRIAGE, ADD V.A.T.

MAIL ORDER CUSTOMERS ONLY ADD 8% V.A.T.



WILMSLOW AUDIO

THE Firm for speakers!

SPEAKERS

Baker Group 25, 3, 8 or 15 ohm	£8.64
Baker Group 35, 3, 8 or 15 ohm	£10.25
Baker Group 50/12, 8 or 15 ohm	£14.00
Baker Deluxe 12", 8 or 15 ohm	£13.75
Baker Major 3, 8 or 15 ohm	£11.87
Baker Superb 8 or 15 ohm	£18.12
Baker Regent 8 or 15 ohm	£10.00
Baker Auditorium 12"	£16.25
Celestion PST8 (for Unilex)	£3.75
Celestion G12H 8 or 15 ohm	£15.95
Celestion G12M 8 or 15 ohm	£12.95
Celestion G15C 8 or 15 ohm	£26.95
Celestion G18C 8 or 15 ohm	£34.50
Celestion MH1000 8 or 15 ohm	£13.50
EMI 13 x 8, 150 d/cone, 8 ohm	£2.94
EMI 13 x 8 type 350, 8 or 15 ohm	£9.56
EMI 13 x 8.25 watt bass	£9.00
EMI 5" 14A/730 mid-range 8 ohm	£3.50
EMI 6 1/2" 93850 4 or 8 ohm	£2.90
EMI 8 x 5, cer. mag. 8 ohm	£1.87
EMI 8 x 5, 10 watt, d/c roll/s 8 ohm	£3.95
EMI 10 x 6 93870 8 ohm	£2.69
EMI 14" x 9" base, 8 ohm	£13.25
Elac 9 x 5, 59RM109 15 ohm, 59RM114 8 ohm	£3.44
Elac 6 1/2" d/cone, roll surr. 8 ohm	£4.06
Elac 6 1/2" d/cone 8 ohm	£3.12
Elac TW4 4" tweeter	£1.75
Elac 10" 10RM239 d/c 8 ohm	£3.12
Elac 8" 3 ohm	£2.87
Eagle Crossover 3, 8 or 16 ohm	£1.75
Eagle CT5 cone tweeter 8 ohm	£2.06
Eagle CT10 tweeter 8 or 16 ohm	£3.00
Eagle DT33 dome tweeter 8 ohm	£6.31
Eagle FF5 3 way crossover	£3.62
Eagle SN75 crossover with tw. contro	£4.69
Eagle FF28 multicell, horn	£9.00
Eagle HT15 horn tw. 16 ohm	£4.40
Eagle HT21 horn tw. 8 ohm	£6.81
Eagle MHT10 horn tw. 8 ohm	£4.44
Eagle FR4 4" full range	£6.12
Eagle FR65 6 1/2" full range	£9.62
Eagle FR8 8" full range	£12.31
Fane Pop 15 watt 12"	£5.25
Fane Pop 25T 30 watt 12"	£7.50
Fane Pop watt 12"	£12.00
Fane Pop 55 12" 60 watt	£13.95
Fane Pop 60 watt 15"	£17.25
Fane Pop 100 watt 18"	£25.95

SPEAKERS

Fane Crescendo 12A 8 or 15 ohm	£34.50
Fane Crescendo 12B 8 or 15 ohm	£36.50
Fane Crescendo 15, 8 or 15 ohm	£47.50
Fane Crescendo 18, 8 or 15 ohm	£62.95
Fane 910 horn	£14.95
Fane 920 horn	£33.95
Fane 152/12a 15" 15 ohm	£16.00
Fane 801T 8" d/cone roll surr.	£9.95
Fane 808T 8" d/cone	£3.95
Fane 807T 8" d/cone roll surr.	£5.75
Goodmans 8P 8 or 15 ohm	£5.50
Goodmans 10P 8 or 15 ohm	£5.80
Goodmans 12P 8 or 15 ohm	£13.95
Goodmans 12P-D 8 or 15 ohm	£16.95
Goodmans 12P-G 8 or 15 ohm	£15.95
Goodman 12AX 100 watt 8 or 15 ohm	£36.50
Goodmans 15AX 100 watt 8 or 15 ohm	£40.25
Goodmans 15P 8 or 15 ohm	£21.00
Goodmans 18P 8 or 15 ohm	£36.00
Goodmans Hifax 750	£16.00
Goodmans Axent 100 tweeter & crossover	£8.44
Goodmans Audiom 100, 15 ohm	£13.90
Goodmans Axiom 401, 8 or 15 ohm	£20.00
Goodmans Twinaxiom 8" 8 or 15 ohm	£10.14
Goodmans Twinaxiom 10" 8 or 15 ohm	£10.75
Gauss 12" full range 8 ohm	£73.00
Gauss 12" Bass 8 ohm	£73.00
Gauss 15" full range 8 ohm	£73.00
Gauss 15" Bass 8 ohm	£83.00
Gauss 18" full range 8 ohm	£110.00
Gauss 18" Bass 8 ohm	£110.00
All the above Gauss (American) speakers are fitted with 4 1/2" voice coils and can handle 200 watts RMS.	
Kef T27	£6.06
Kef T15	£6.94
Kef B110	£8.37
Kef B200	£9.50
Kef B139	£16.95
Kef DN8	£2.31
Kef DN12	£5.99
Kef DN13	£4.50
Richard Allan CG8T 8" d/c roll surr. 8 ohms	£7.50
STC 4001G super tweeter	£6.56
2 1/2" 64 ohm, 70mm 8 ohm, 70mm 80 ohm	.77
2 1/2" 75 ohm	.55
7" x 4" 3, 8 or 15 ohm	£1.63
8" x 5" 3, 8 or 15 ohm	£1.75
10" x 6" 6, 8 or 15 ohm	£2.69

SPEAKER KITS (Carr. 75p each, £1.50 pair)

Baker Major Module 3, 8 or 15 ohm	each	£13.44
Goodmans Mezzo Twinkit	pair	£47.19
Goodmans DIN 20 4 ohm	each	£14.75
Helme XLK30	pair	£19.00
Helme XLK35	pair	£24.00
Helme XLK40	pair	£35.00
Helme XLK50	pair	£56.00
Kefkit 1	pair	£53.00
Kefkit 3	each	£48.00
Peerless 20/2	each	£17.44
Peerless 30/2	each	£24.38
Peerless 20/3	each	£26.56
Peerless 50/4	each	£40.50
Richard Allan Twinkit	each	£10.95
Richard Allan Triple 8	each	£16.50
Richard Allan Triple	each	£23.95
Richard Allan Super Triple	each	£28.75
Richard Allan RA8 Kit	pair	£42.00
Richard Allan RA82 Kit	pair	£63.00
Wharfedale Linton 2 kit	pair	£23.12
Wharfedale Glendale 3 kit	pair	£40.62
Wharfedale Dovedale 3 kit	pair	£63.12

PA/DISCO AMPLIFIERS (Carr. and ins. £1)

Baker Major 100 watt	£57.25
Linear 30/40	£30.00
Linear 40/60	£35.00
Linear 80/100	£58.95
Linear 100 watt slave	£44.00
Eagle PRO A120, 120 watts RMS	£135.00
Eagle PRO A65, 65 watts RMS	£108.00
Eagle PRO A35, 35 watts RMS	£82.00
Eagles TPA40 mains/12v mobile	£50.00
Eagle HHS 36 watts, mobile 12v.	£37.50
Eagle TPA20 paging amplifier	£45.50
Eagle RA859 Reverb (p. & p. £1.50)	£19.75
Eagle RA856 Reverb (p. & p. £1.50)	£12.50

MICROPHONES (p. & p. 50p)

Shure 515 SB Low Impedance	£17.31
Shure 515 SA High Impedance	£18.25
Shure 545 Dual Impedance	£34.69
Shure 588 SB Low Impedance	£23.12
Shure 588 SA High Impedance	£23.75

Prices correct at 14.11.75

FREE with loudspeaker orders over £7 - "HiFi Loudspeaker Enclosures" book

All items guaranteed new and perfect

Prompt despatch

Carriage: 50p per speaker 12" and up 75p each, 30p per tweeter, crossover or 2 1/2" / 70mm speaker kits 80p each (£1.60 pair)

Including VAT — 25% on Hi-Fi 8% on PRO and PA

Send stamp for free booklet 'Choosing a speaker'

Big discounts on Grundig, IIT, Koyo, etc. Send stamp for list

WILMSLOW AUDIO

DEPT RC

LOUDSPEAKERS: SWAN WORKS
BANK SQUARE, WILMSLOW, CHESHIRE

AMPLIFIERS, RADIO ETC.
10 SWAN ST., WILMSLOW, CHESHIRE

The Ultimate Radio!

GRUNDIG SATELLIT 2000

You've got your yacht, private aircraft, Rolls Corniche? — then all you need for a full set of status symbols is this latest model Grundig Satellit, Germany's top radiol. Radio performance, appearance and sound quality are all superb. VHF/FM, MW, LW 10 SW bands plus bandspread, 27 transistors and 22 diodes. Battery/Mains (110/240v.), 2 speakers, 57" telescopic aerial.

Our Price **£181.45**
inc. VAT, carr. & ins.

Big discounts on Grundig, IIT, Koyo, etc. Send stamp for list.

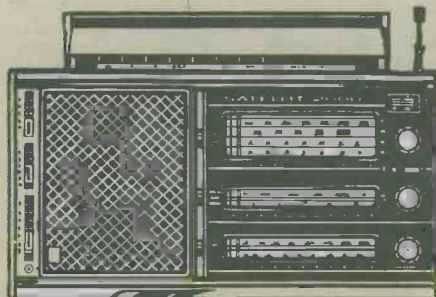

WILMSLOW AUDIO, 10 SWAN STREET, WILMSLOW, CHESHIRE

At Home Soldering?

You should be – with the LITESOLD CONQUEROR

A superbly handling lightweight iron, fully insulated and earthed for safety. Bits are interchangeable, non-seize, and are available in 16 different shapes and sizes, from 1/16" up to 1/4", in copper and long-life types. (Standard fitting, 1/8" copper single chisel shape). Covers a range of work often needing several different irons.

A special spring stand gives safe, easy location of the iron and spare bits. The heavy heat-resistant base is complete with non-slip pads and bit cleaning sponge.

Send cheque/PO direct, or ask for leaflet.



Conqueror Iron Only	£3.35
Iron & Spring Stand	£5.66
Iron, Stand & set of 4 spare copper bits	£7.30
(Prices include 8% VAT and p. & p.)	

LIGHT SOLDERING DEVELOPMENTS LTD

97-99, Gloucester Road, Croydon, CRO 2DN. 01-689 0574

LS/M

1. Understand electronics.

Step by step, we take you through all the fundamentals of electronics and show you how easily the subject can be mastered using our unique Lerna-Kit course.

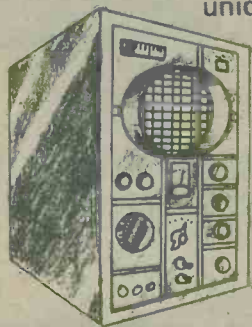

- (1) Build an oscilloscope.
- (2) Read, draw and understand circuit diagrams.
- (3) Carry out over 40 experiments on basic electronic circuits and see how they work.

2. Become a radio amateur.

Learn how to become a radio-amateur in contact with the whole world. We give skilled preparation for the G.P.O. licence.

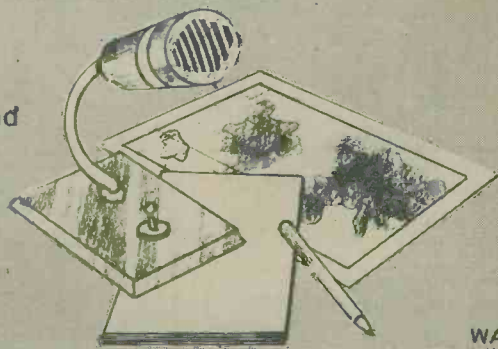

WAA

Free!

Brochure, without obligation to:
BRITISH NATIONAL RADIO & ELECTRONICS SCHOOL, Dept. REX 125
 P.O. Box 156, Jersey, Channel Islands.

NAME _____

ADDRESS _____

Block caps please

PHILIPS SEMICONDUCTORS

TRANSISTORS

BRAND NEW FULLY GUARANTEED

Type	Price	Type	Price	Type	Price	Type	Price	Type	Price
AC107	0.20	BSY40	0.29	AF118	0.35	ORP51	0.41*	BC172	0.15
AC113	0.19	BSY41	0.29	AF124	0.35	ORP51	0.51*	BF167	0.22
AC115	0.20	BSY95	0.13	AF125	0.31	P346A	0.20	BF173	0.22
AC117K	0.30	BSY95A	0.13	AF126	0.29	P397	0.43	BF176	0.36
AC122	0.12	BU105	0.24	AF127	0.29	ST140	0.13	BF177	0.36
AC125	0.18	CU11E	0.51	AF139	0.31	ST141	0.18	BF178	0.31
AC126	0.18	C400	0.51	AF178	0.51	TP129	0.44	BF179	0.31
AC127	0.19	C407	0.31	AL103	0.58	UT46	0.52	BF190	0.31
AC128	0.19	C424	0.26	AF180	0.51	TP131A	0.56	BF191	0.31
AC132	0.15	C425	0.51	AF181	0.51	TP132A	0.68	BF192	0.41
AC134	0.15	C426	0.36	AF186	0.51	TP141A	0.68	BF193	0.41
AC137	0.15	C428	0.20	AF239	0.38	TP142A	0.81	BF194	0.26
AC141	0.19	C441	0.31	AL102	0.68	TH843	0.31*	BF195	0.26
AC141K	0.30	C442	0.31	AL103	0.68	UT46	0.52*	BF197	0.28
AC142	0.19	C444	0.36	ANY26	0.26	ZN414	1.11	BF198	0.41
AC142K	0.26	C450	0.22	ASY27	0.31	2G301	0.19	BF199	0.12
AC151	0.16	MAT100	0.19	ASY28	0.26	2G302	0.19	BF199	0.12
AC154	0.20	MAT101	0.20	ASY29	0.26	2G303	0.19	BF196	0.15
AC155	0.20	MAT120	0.19	ASY50	0.26	2G304	0.25	BF197	0.15
AC156	0.20	MAT121	0.20	ASY51	0.26	2G306	0.41	BF200	0.46
AC157	0.25	MJE521	0.58	ASY52	0.26	2G308	0.36	BF202	0.36
AC165	0.20	MJE2956	0.68	ASY54	0.26	2N2926 G	0.13	BF257	0.46
AC166	0.20	MJE3055	0.57	ASY55	0.26	2N2926 Y	0.11	BF258	0.61
AC167	0.20	MJE3440	0.51	ASY36	0.26	2N2926 O	0.10	BF259	0.87
AC168	0.25	MPP102	0.43	ASY57	0.26	2N2926 R	0.10	BF262	0.58
AC169	0.15	MPP104	0.38	ASY58	0.26	2N2926 B	0.10	BF263	0.58
AC176	0.20	MPP105	0.38	ASY73	0.26	2N3010	0.11	BF270	0.38
AC177	0.25	OC19	0.36	ASZ21	0.41	2N3011	0.13	BF271	0.31
AC178	0.29	OC20	0.65	BC107	0.08	2N3053	0.18	BF272	0.61
AC179	0.29	OC22	0.47	BC108	0.08	2N3054	0.47	BF273	0.36
AC180	0.20	OC23	0.49	BC109	0.08	2N3055	0.42	BF274	0.36
AC180K	0.30	OC24	0.57	BD136	0.41	2N3319	0.15	BF280	0.61
AC181	0.20	OC25	0.60	BD137	0.46	2N3319 A	0.17	BF282	0.28
AC181K	0.30	OC26	0.30	BD138	0.51	2N3302	0.15	BF284	0.28
AC187	0.22	OC28	0.51	BD139	0.56	2N3393	0.15	BF285	0.31
AC187K	0.23	OC29	0.51	BD140	0.61	2N3494	0.15	BF286	0.22
AC188	0.22	OC35	0.43	BD155	0.61	2N3395	0.18	BF287	0.25
AC188K	0.23	OC36	0.51	BD175	0.61	2N3402	0.21	BF288	0.25
AC187K	0.23	OC37	0.43	BD176	0.61	2N3403	0.21	BF289	0.25
AC187	0.23	OC38	0.43	BD177	0.61	2N3404	0.29	BF290	0.25
AC187	0.23	OC39	0.43	BD178	0.67	2N3405	0.43	BF292	0.20
AC187	0.23	OC40	0.43	BD179	0.71	2N3414	0.16	2G309	0.37
AC187	0.23	OC41	0.43	BD180	0.71	2N3415	0.16	2G339	0.20
AC187	0.23	OC42	0.43	BD183	0.67	2N3416	0.29	2G339A	0.17
AC187	0.23	OC43	0.43	BD186	0.67	2N3417	0.29	2G344	0.19
AC187	0.23	OC44	0.43	BD187	0.67	2N3425	0.77	2G345	0.17
AC187	0.23	OC45	0.43	BD188	0.71	2N3611	0.69	2G371	0.17
AC187	0.23	OC46	0.43	BD189	0.77	2N3615	0.76	2G371B	0.12
AC187	0.23	OC47	0.43	BD190	0.77	2N3616	0.76	2G373	0.18
AC187	0.23	OC48	0.43	BD195	0.67	2N3646	0.09	2G374	0.18
AC187	0.23	OC49	0.43	BD196	0.67	2N3702	0.12	2G377	0.31
AC187	0.23	OC50	0.43	BD197	0.67	2N3703	0.12	2G378	0.17
AC187	0.23	OC51	0.43	BD198	0.67	2N3704	0.12	2G381	0.17
AC187	0.23	OC52	0.43	BD199	0.98	2N3705	0.12	2G382	0.17
AC187	0.23	OC53	0.43	BD200	0.98	2N3706	0.12	2G401	0.31
AC187	0.23	OC54	0.43	BD205	0.81	2N3707	0.13	2G414	0.31
AC187	0.23	OC55	0.43	BD206	0.81	2N3708	0.08	2G417	0.28
AC187	0.23	OC56	0.43	BD207	0.81	2N3709	0.09	2N388	0.36
AC187	0.23	OC57	0.43	BD208	0.98	2N3710	0.09	2N388A	0.56
AC187	0.23	OC58	0.43	BD209	0.98	2N3711	0.09	2N404	0.29
AC187	0.23	OC59	0.43	BD210	1.02	2N3711	0.09	2N404A	0.29
AC187	0.23	OC60	0.43	BF115	0.25	2N3819	0.29	2N524	0.43
AC187	0.23	OC61	0.43	BF117	0.46	2N3820	0.51	2N524	0.43
AC187	0.23	OC62	0.43	BF118	0.71	2N3821	0.36	2N527	0.50
AC187	0.23	OC63	0.43	BF119	0.71	2N3822	0.29	2N528	0.43
AC187	0.23	OC64	0.43	BF120	0.46	2N3823	0.29	2N529	0.46
AC187	0.23	OC65	0.43	BF121	0.46	2N3824	0.29	2N530	0.46
AC187	0.23	OC66	0.43	BF122	0.51	2N3825	0.31	2N536	0.13
AC187	0.23	OC67	0.43	BF123	0.51	2N3826	0.29	2N597	0.14
AC187	0.23	OC68	0.43	BF124	0.46	2N3827	0.29	2N598	0.25
AC187	0.23	OC69	0.43	BF125	0.46	2N3828	0.29	2N599	0.25
AC187	0.23	OC70	0.43	BF126	0.51	2N3829	0.29	2N600	0.25
AC187	0.23	OC71	0.43	BF127	0.51	2N3830	0.28	2N601	0.25
AC187	0.23	OC72	0.43	BF128	0.56	2N4058	0.12	2N602	0.25
AC187	0.23	OC73	0.43	BF129	0.46	2N4059	0.10	2N603	0.25
AC187	0.23	OC74	0.43	BF130	0.46	2N4060	0.12	2N604	0.25
AC187	0.23	OC75	0.43	BF131	0.46	2N4061	0.10	2N605	0.25
AC187	0.23	OC76	0.43	BF132	0.46	2N4062	0.10	2N606	0.25
AC187	0.23	OC77	0.43	BF133	0.46	2N4063	0.10	2N607	0.25
AC187	0.23	OC78	0.43	BF134	0.46	2N4064	0.10	2N608	0.25
AC187	0.23	OC79	0.43	BF135	0.46	2N4065	0.10	2N609	0.25
AC187	0.23	OC80	0.43	BF136	0.46	2N4066	0.10	2N610	0.25
AC187	0.23	OC81	0.43	BF137	0.46	2N4067	0.10	2N611	0.25
AC187	0.23	OC82	0.43	BF138	0.46	2N4068	0.10	2N612	0.25
AC187	0.23	OC83	0.43	BF139	0.46	2N4069	0.10	2N613	0.25
AC187	0.23	OC84	0.43	BF140	0.46	2N4070	0.10	2N614	0.25
AC187	0.23	OC85	0.43	BF141	0.46	2N4071	0.10	2N615	0.25
AC187	0.23	OC86	0.43	BF142	0.46	2N4072	0.10	2N616	0.25
AC187	0.23	OC87	0.43	BF143	0.46	2N4073	0.10	2N617	0.25
AC187	0.23	OC88	0.43	BF144	0.46	2N4074	0.10	2N618	0.25
AC187	0.23	OC89	0.43	BF145	0.46	2N4075	0.10	2N619	0.25
AC187	0.23	OC90	0.43	BF146	0.46	2N4076	0.10	2N620	0.25
AC187	0.23	OC91	0.43	BF147	0.46	2N4077	0.10	2N621	0.25
AC187	0.23	OC92	0.43	BF148	0.46	2N4078	0.10	2N622	0.25
AC187	0.23	OC93	0.43	BF149	0.46	2N4079	0.10	2N623	0.25
AC187	0.23	OC94	0.43	BF150	0.46	2N4080	0.10	2N624	0.25
AC187	0.23	OC95	0.43	BF151	0.46	2N4081	0.10	2N625	0.25
AC187	0.23	OC96	0.43	BF152	0.46	2N4082	0.10	2N626	0.25
AC187	0.23	OC97	0.43	BF153	0.46	2N4083	0.10	2N627	0.25
AC187	0.23	OC98	0.43	BF154	0.46	2N4084	0.10	2N628	0.25
AC187	0.23	OC99	0.43	BF155	0.46	2N4085	0.10	2N629	0.25
AC187	0.23	OC100	0.43	BF156	0.46	2N4086	0.10	2N630	0.25
AC187	0.23	OC101	0.43	BF157	0.46	2N4087	0.10	2N631	0.25
AC187	0.23	OC102	0.43	BF158	0.46	2N4088	0.10	2N632	0.25
AC187	0.23	OC103	0.43	BF159	0.46	2N4089	0.10	2N633	0.25
AC187	0.23	OC104	0.43	BF160	0.46	2N4090	0.10	2N634	0.25
AC187	0.23	OC105	0.43	BF161	0.46	2N4091	0.10	2N635	0.25
AC187	0.23	OC106	0.43	BF162	0.46	2N4092	0.10	2N636	0.25
AC187	0.23	OC107	0.43	BF163	0.46	2N4093	0.10	2N637	0.25
AC187	0.23	OC108	0.43	BF164	0.46	2N4094	0.10	2N638	0.25
AC187	0.23	OC109	0.43	BF165	0.46	2N4095	0.10	2N639	0.25
AC187	0.23	OC110	0.43	BF166	0.46	2N4096	0.10	2N640	0.25
AC187	0.23	OC111	0.43	BF167	0.46	2N4097	0.10	2N641	0.25
AC187	0.23	OC112	0.43	BF168	0.46	2N4098	0.10	2N642	0.25
AC187	0.23	OC113	0.43	BF169	0.46	2N4099	0.10	2N643	0.25
AC187	0.23	OC114	0.43	BF170	0.46	2N4100	0.10	2N644	0.25
AC187	0.23	OC115	0.43	BF171	0.46	2N4101	0.10	2N645	0.25
AC187	0.23	OC116	0.43	BF172	0.46	2N4102	0.10	2N646	0.25
AC187	0.23	OC117	0.43	BF173	0.46	2N4103	0.10	2N647	0.25
AC187	0.23	OC118	0.43	BF174	0.46	2N4104	0.10	2N648	0.25
AC187	0.23	OC119	0.43	BF175	0.46	2N4105	0.10	2N649	0.25
AC187	0.23	OC120	0.43	BF176	0.46	2N4106	0.10	2N650	0.25
AC187	0.23	OC121	0.43	BF177	0.46	2N4107	0.10	2N651	0.25
AC187	0.23	OC122	0.43	BF178	0.46	2N4108	0.10	2N652	0.25
AC187	0.23	OC123	0.43	BF179	0.46	2N4109	0.10	2N653	0.25
AC187	0.23	OC124</							

PO BOX 6 WARE HERTS

SUPER UNTESTED PAKS

Pak No.	Description	Sp	Price
U 1	120 Glass sub-min. General purpose Germ. diodes		0-60
U 2	50 Mixed Germanium transistors AF/BF		0-60
U 3	75 Germanium gold bonded sub-min. like OA5, OA47		0-60
U 4	30 Germanium transistors like OC81, AC128		0-60
U 5	60 200mA sub-min. silicon diodes		0-60
U 6	30 8H. Planar trans. NPN like BSY95A, 2N706		0-60
U 7	16 8H. rect. TOP-HAT 750mA VLTG. RANGE up to 100		0-60
U 8	50 8H. planar diodes DO-7 glass 250mA like OA200/202		0-60
U 9	20 Mixed voltages, 1 Watt Zener Diodes		0-60
U 10	20 BAY50 charge storage diodes DO-7 glass		0-60
U 11	20 PNP 8H. planar trans. TO-5 like 2N1132, 2N2904		0-60
U 12	30 PNP-PNP 8H. transistors OC200 & 28104		0-60
U 13	150 Mixed silicon and germanium diodes		0-60
U 14	20 NPN 8H. planar trans. TO-5 like 2N896, 2N697		0-60
U 15	10 1Amp sil. rectifiers stud type up to 1000 PIV		0-60
U 16	30 Germanium PNP AF transistors TO-5 like ACY 17-22		0-60
U 17	8 6 Amp sil. rectifiers BYZ13 type up to 600 PIV		0-60
U 18	20 Silicon NPN transistors like BC 108		0-60
U 19	12 1.5 Amp sil. rectifiers top hat up to 1000 PIV		0-60
U 20	30 AF Germ. alloy transistors 2N3000 series & OC71		0-60
U 21	25 MADT's like MHz series PNP transistors		0-60
U 22	20 Germ. 1 Amp rectifiers GJM series up to 300 PIV		0-60
U 23	25 300 MHz NPN silicon transistors 2N706, BSY27		0-60
U 24	30 Fast switching silicon diodes like 1N914 Micro-Min		0-60
U 25	10 1 Amp SCR's TO-5 can. up to 600 PIV CRS1/25-600		£1-20*
U 26	25 Zener diodes 400 mW DO-7 case 3-33 volts mixed		0-60
U 27	15 Plastic case 1 Amp sil. rectifiers 1N4000 series		0-60
U 28	30 Silicon PNP alloy trans. TO-5 BCY28 28302/4		0-60
U 29	25 Silicon planar transistors PNP TO-18 2N2906		0-60
U 30	20 Silicon planar NPN transistors TO-5 BFY50/51/52		0-60
U 31	30 Silicon alloy transistors 80-2 PNP OC200, S2322		0-60
U 32	20 Fast switching silicon trans. NPN 400 MHz 2N3011		0-60
U 33	30 P.P. Ger. PNP transistors 2N1303/5 TO-5		0-60
U 34	10 Dual transistors 6 lead TO-5 2N2060		0-60
U 35	25 Silicon trans. plastic TO-18 A.F. BC113/114		0-60
U 36	20 Silicon trans. plastic TO-5 BC115		0-60
U 37	7 3A SCR. TO66 up to 600 PIV		£1-20*
U 38	20 Unijunction transistors similar to T1843		0-60*
U 39	10 TO220AB plastic triacs 50V 6A		£1-20*
U 40	9 NPN Sil. power transistors like 2N3055		£1-20
U 41	12 NPN Sil. plastic power trans. 60W like 2N5294/5295		£1-20

Code Nos mentioned above are given as a guide, to the type of device in the pak. The devices themselves are normally unmarked.

QUALITY TESTED PAKS

Pak No.	Quality Tested Paks	Price
Q 1	20 Red spot transistors PNP	0-60
Q 2	16 White spot R.F. transistors PNP	0-60
Q 3	4 OC 77 type transistors	0-60
Q 4	6 Matched transistors OC44/45/81/81D	0-60
Q 5	4 OC 75 transistors	0-60
Q 6	5 OC 72 transistors	0-60
Q 7	4 AC 128 transistors PNP high gain	0-60
Q 8	4 AC 128 transistors PNP	0-60
Q 9	7 OC 81 type transistors	0-60
Q 10	7 OC 71 type transistors	0-60
Q 11	2 AC 127/128 Complementary pairs PNP/NPN	0-60
Q 12	3 AF 116 type transistors	0-60
Q 13	3 AF 117 type transistors	0-60
Q 14	3 OC 171 H.F. type transistors	0-60
Q 15	7 2N2926 Sil. Epoxy transistors mixed colours	0-60
Q 16	5 NPN 2 x ST.141, & 3 x ST.140	0-60
Q 17	4 MADT'S 2 x MAT 100 & 2 x MAT 120	0-60
Q 18	3 MADT'S 2 x MAT 101 & 1 x MAT 121	0-60
Q 19	4 OC 44 Germanium transistors A.F.	0-60
Q 20	4 AC 127 NPN Germanium transistors	0-60
Q 21	20 NKT transistors A.F. R.F. coded	0-60
Q 22	10 OA 202 Silicon diodes sub-min	0-60
Q 23	8 OA 81 diodes	0-60
Q 24	15 1N 914 Silicon diodes 75 PIV 75mA	0-60
Q 25	8 OA85 Germanium diodes sub-min-1N69	0-60
Q 26	2 10A 600 PIV Silicon rectifiers 1S425B	0-60*
Q 27	2 Silicon power rectifiers BYZ 13	0-60
Q 28	4 Sil. transistors 2 x 2N696, 1 x 2N697, 1 x 2N698	0-60
Q 29	7 Silicon switch transistors 2N706 NPN	0-60
Q 30	6 Silicon switch transistors 2N708 NPN	0-60
Q 31	3 PNP Sil. trans. 2 x 2N1131, 1 x 2N1132	0-60
Q 32	3 Silicon NPN transistors 2N1711	0-60
Q 33	7 Sil. NPN trans. 2N2369, 500MHz (code P397)	0-60
Q 34	5 Silicon PNP TO-5 2 x 2N2904 & 1 x 2N2095	0-60
Q 35	7 2N3646 TO-18 plastic 300 MHz NPN	0-60
Q 36	2 2N3055 NPN Silicon transistors	0-60
Q 37	5 PNP transistors 3 x 2N3703, 2 x 2N3702	0-60
Q 38	5 NPN transistors 3 x 2N3704, 2 x 2N3705	0-60
Q 39	5 NPN transistors 3 x 2N3707, 2 x 2N3708	0-60
Q 40	3 Plastic NPN TO18 2N3904	0-60
Q 41	5 BC 107 NPN transistors	0-60
Q 42	5 NPN transistors 3 x BC 108, 2 x BC 109	0-60
Q 43	3 BC 113 NPN TO-18 transistors	0-60
Q 44	3 BC 115 NPN TO-5 transistors	0-60
Q 45	4 NPN high gain transistors 2 x BC 157, 2 x BC 168	0-60
Q 46	3 BCY 70 PNP transistors TO-18	0-60
Q 47	3 PNP transistors 2 x BFY 51, 1 x BFY 52	0-60
Q 48	7 BSY 28 NPN switch transistors TO-18	0-60
Q 49	7 BSY 95A NPN transistors 300MHz	0-60
Q 50	8 BY 100 type silicon rectifiers	£1-20
Q 51	25 Sil. & Germ. trans. mixed all marked new	£1-50
Q 52	6 TIL 209 Red LED	£1-20*

VISIT OUR
COMPONENT SHOP
18 BALDOCK STREET, WARE, Herts (A10)
Open Mon-Sat 9-5.30 p.m. Tel. 61593

MAMMOTH I.C. PAK

APPROX. 200 PIECES
Assorted full-out integrated circuits, including: Logic, 74 series, Linear, Audio and D.T.L. Many coded devices but some unmarked—you to identify.
OUR SPECIAL PRICE £1.20p

WORLD SCOOP

JUMBO SEMICONDUCTOR PAK
Transistors—Germ. and Silicon. Rectifiers—Diodes Triacs—Thyristors—I.C.'s and Zeners. ALL NEW AND CODED

APPROX 100 PIECES
Offering the amateur a fantastic bargain PAK and an enormous saving—identification and data sheet in every pak.
ONLY £1.85p

UNTESTED LIN PAKS

Manufacturers "Fall Outs" which include Functional and part Functional Units. These are classed as 'out-of-spec' from the makers' very rigid specifications, but are ideal for learning about I.C.'s and experimental work.

Pak No.	Contents	Price
ULIC709	10 x 709	0-60
ULIC710	7 x 710	0-60
ULIC741	7 x 741	0-60
ULIC747	5 x 747	0-60
ULIC748	7 x 748	0-60

C280 CAPACITOR PAK

Containing 75 of the C280 range of capacitors assorted in values ranging from .01uF to 2.2uF. Complete with identification chart.

FANTASTIC VALUE
ONLY £1.20p.

SIL. G.P. DIODES

300 mW 40 PIV (min) SUB-MIN FULLY TESTED!
Ideal for Organ builders
30 for 50p, 100 for £1.50, 500 for £5, 1000 for £9.

G.P. SWITCHING TRANS

TO18 SIM. TO 2N706/8 BSY27/28/95A
All usable devices. No open and shorts. ALSO AVAILABLE IN PNP similar to 2N2906, BCY 70 20 for 50p, 50 for £1, 100 for £1.80, 500 for £3, 1000 for £14
When ordering please state NPN or PNP

G.P. 300

115 WATT SILICON TO3 METAL CASE
Vebro 100V, Vebro 60V, IC 15A, Hfe. 20-100 suitable replacement for 2N3055, BDY11 or BDY20
1-24 25-99 100+
50p 48p 46p

INDICATORS

Minitron 7 Segment Indicator £1.11p*
MAN 3M L.E.D. 7 SEGMENT DISPLAY
O.127" High Characters £1.76p*

ZENER DIODES

FULL RANGE IN STOCK
VOLTAGE RANGE 2-33V

400 mw 8p	1.5 w 17p	10 w* 30p
-----------	-----------	-----------

V.A.T. STOP PRESS TRANSISTORS

Transistors, metal or plastic, over 3A + 8% V.A.T.
All others + 25%

EXCLUDE VAT
AT 25% TO ALL
*ADD 8%
≠ NO VAT
add 25p Overseas
Minimum order 75p

VOLTAGE REGULATORS

TO-3 Plastic Encapsulation

TO-3 Plastic Encapsulation	Sp	Price
UA.7805/1.129 5V (Equip. to MVR5V)	£1-25p	
UA.7812/130 12V (Equip. to MVR12V)	£1-25p	
UA.7815/131 15V (Equip. to MVR15V)	£1-25p	
UA.7818 18V (Equip. to MVR18V)	£1-25p	

THYRISTORS

PIV	0-6A	0-8A	1A	3A	5A	5A	7A	10A	16A	30A
	TO18	TO92	TO5	TO66	TO66	TO64	TO48	TO48	TO48	TO48
10	0.13	0.15								
20	0.15	0.18								
30	0.19	0.22								
50	0.22	0.25	0.20	0.25	0.36	0.36	0.48	0.51	0.54	£1.18
100	0.25	0.30	0.25	0.25	0.48	0.48	0.51	0.57	0.58	£1.43
150	0.31	0.38								
200	0.38	0.44	0.25	0.30	0.50	0.50	0.57	0.62	0.62	£1.83
400			0.30	0.39	0.55	0.57	0.62	0.71	0.77	£1.78
600			0.39	0.48	0.69	0.69	0.78	0.89	0.90	
800			0.58	0.65	0.81	0.81	0.92	£1.22	£1.39	£4.07

DIODES

Type	Price	Type	Price	Type	Price	Type	Price
AA119	0-08	BY101	0-12	BYZ16	0-41	OA85	0-09
AA120	0-08	BY105	0-18	BYZ17	0-38	OA90	0-07
AA129	0-08	BY114	0-12	BYZ18	0-38	OA91	0-07
AA130	0-08	BY124	0-12	BYZ19	0-28	OA95	0-07
AAZ13	0-10	BY127	0-18	CG62		OA900	0-07
BA100	0-10	BY128	0-16	CG65E	0-08	OA202	0-07
BA116	0-21	BY128	0-16	CG65I (OA70)		SD10	0-06
BA126	0-22	BY130	0-17	OA79	0-07	SD19	0-06
BA148	0-15	BY133	0-21	OA5 Short		1N34	0-07
BA154	0-12	BY164	0-51	Leads	0-21	1N34A	0-07
BA155	0-15	BYX38/300-43		OA10	0-14	1N914	0-08
BA156	0-14	BYZ10	0-30	OA47	0-07	1N916	0-06
BA173	0-15	BYZ11	0-31	OA70	0-07	1N4148	0-06
BB104	0-16	BYZ12	0-31	OA79	0-07	18021	0-10
BY100	0-16	BYZ13	0-26	OA81	0-07	18951	0-70

UNTESTED T.L. PAKS

Manufacturers "Fall Outs" which include Functional and part Functional Units. These are classed as 'out-of-spec' from the makers' very rigid specifications, but are ideal for learning about I.C.'s and experimental work.

Pak No.	Contents	Price	Pak No.	Contents	Price
UI000	12 x 7400	0-60	UI072	8 x 7472	0-60
UI001	12 x 7401	0-60	UI073	8 x 7473	0-60
UI002	12 x 7402	0-60	UI074	8 x 7474	0-60
UI003	12 x 7403	0-60	UI075	8 x 7475	0-60
UI004	12 x 7404	0-60	UI076	8 x 7476	0-60
UI005	12 x 7405	0-60	UI080	5 x 7480	0-60
UI006	8 x 406	0-60	UI081	5 x 7481	0-60
UI007	8 x 7407	0-60	UI082	5 x 7482	0-60
UI010	12 x 7410	0-60	UI083	5 x 7483	0-60
UI013	8 x 7413	0-60	UI086	5 x 7486	0-60
UI020	12 x 7420	0-60	UI090	5 x 7490	0-60
UI030	12 x 7430	0-60	UI091	5 x 7491	0-60
UI040	12 x 7440	0-60	UI092	5 x 7492	0-60
UI041	5 x 7441	0-60	UI093	5 x 7493	0-60
UI042	5 x 7442	0-60	UI094	5 x 7494	0-60
UI043	5 x 7443	0-60	UI095	5 x 7495	0-60
UI044	5 x 7444	0-60	UI096	5 x 7496	0-60
UI045	5 x 7445	0-60	UI100	5 x 74100	0-60
UI048	5 x 7448	0-60	UI121	5 x 74121	0-60
UI047	5 x 7447	0-60	UI141	5 x 74141	0-60
UI048	5 x 7448	0-60	UI151	5 x 74151	0-60
UI050	12 x 7450	0-60	UI154	5 x 74154	0-60
UI051	12 x 7451	0-60	UI183	5 x 74183	0-60
UI053	12 x 7453	0-60	UI189	5 x 74189	0-60
UI054	12 x 7454	0-60	UI199	5 x 74199	0-60
UI060	12 x 7460	0-60	UI125 Assorted 74's	£1-50	
UI070	8 x 7470	0-60			



"I MADE IT MYSELF"

Imagine the thrill you'll feel! Imagine how impressed people will be when they're hearing a programme on a modern radio you made yourself.

Now! Learn the secrets of radio and electronics by building your own modern transistor radio!

Practical lessons teach you sooner than you would dream possible.

What a wonderful way to learn - and pave the way to a new, better-paid career! No dreary ploughing through page after page of dull facts and figures. With this fascinating Technatron Course, you learn by building!

You build a modern Transistor Radio... a Burglar Alarm. You learn Radio and Electronics by doing actual projects you enjoy - making things with your own hands that you'll be proud to own! No wonder it's so fast and easy to learn this way. Because learning becomes a hobby! And what a profitable hobby. Because opportunities in the field of Radio and Electronics are growing faster than they can find people to fill the jobs!

No soldering - yet you learn faster than you ever dreamed possible. Yes! Faster than you can imagine, you pick up the technical know how you need. Specially prepared step-by-step lessons show you how to read circuits - assemble components - build things - experiment. You enjoy every minute of it!

You get everything you need. Tools. Components. Even a versatile Multimeter that we teach you how to use. All included in the course. **AT NO EXTRA CHARGE!** And this is a course anyone can afford. (You can even pay for it by easy instalments).

So fast, so easy, this personalised course will teach you even if you don't know a thing today!

No matter how little you know now, no matter what your background or education, we'll teach you. Step by step, in simple easy-to-understand language, you pick up the secrets of radio and electronics.

You become a man who makes things, not just another of the millions, who don't understand. And you could pave the way to a great new career, to add to the thrill and pride you receive when you look at what you have achieved. Within weeks you could hold in your hand your own transistor radio. And after the course you can go on to acquire highpowered technical qualifications, because our famous courses go right up to City & Guilds levels.

Send now for **FREE 76 page book** - see how easy it is - read what others say!

Find out more now! This is the gateway to a thrilling new career, or a wonderful hobby you'll enjoy for years. Send the coupon now. There's no obligation.

POST TODAY FOR FREE BOOK

To: ALDERMASTON COLLEGE
DEPT. CRE 12, READING RG7 4PF

Also at our London Advisory Office, 4 Fore Street Avenue, Moorgate, London, EC2Y 5EJ Tel: 01-628 2721 Yes, I'd like to know more about your course. Please send me free details - plus your big, 76-page book that tells about all your courses.

NAME

ADDRESS

POSTCODE

HOME OF BRITISH INSTITUTE OF ENGINEERING TECHNOLOGY

ELECTROVALUE CATALOGUE 7

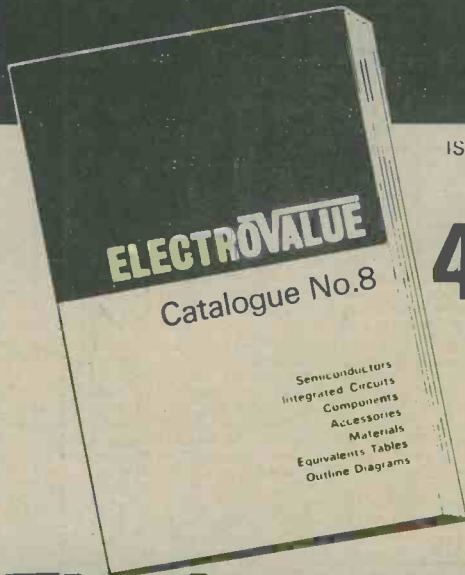

ISSUE 3

40p

including 40p Refund Voucher

Up-dated information and prices.

The best yet!

144 pages (plus covers) and our best yet! Practically all items in catalogue 8 are there as the result of information fed by our computer, enabling us to control stock-buying in relation to demand with greater accuracy and real benefit to customers. This means that your orders, which we microfilm for record keeping, are handled with utmost speed and efficiency. EV prices remain keenly competitive and with our new 3-month period price-stabilization policy, you can order in confidence. In addition there are discounts as well, to give you further savings.

Send 40p now for EV Catalogue 8 Issue 1. It includes a refund voucher for 40p allowable on orders for £5 or more list value.

● **PRICE STABILIZATION**

As from April 1st, Electrovalue prices are held for periods of 3 months without change (except in cases of violent market fluctuation) and reviewed thereafter at the end of each 3 month period instead of making day to day changes.

● **DISCOUNTS**

Available on all items except for a few shown at NETT PRICE

5% on orders from £5 to £14.99 list.

10% on orders £15 and over.

● **WE PAY POSTAGE**

and packing in U.K. (except Baxandall speaker cabinets) For mail orders for £2 list value and under, there is an additional handling charge of 10p.

● **GUARANTEE OF QUALITY**

All items guaranteed fully to makers' specifications. Everything brand new - no "seconds", makers' rejects or clearance offers.

ELECTROVALUE LTD

Dept. 6/12, 28 St. Judas Road, Englefield Green, Egham, Surrey TW20 0HB Telephone Egham 3603 Telex 264475

All mail orders and communications to above address

● **NORTHERN BRANCH**

680 Burnage Lane, Manchester M19 1NA. Tel: 061-432-4945 Hours (both addresses) 9.00-5.30. Saturdays 9.00-1.00 p.m.

RADIO & ELECTRONICS CONSTRUCTOR

BI-PRE-PAK

Bargains in Semi-Conductors, components, modules & equipment.

Bargains from our FREE Catalogue

20 large pages, filled with real bargains in transistors, I.C.s, components, equipment, etc. Send large S.A.E. with 10p stamp for your FREE copy of the latest edition by return. Meanwhile, for prompt delivery order from this month's ad. NDV.

TRANSISTOR PACKS ALL 60p each TESTED AND GUARANTEED

B79	4	IN4007 Sil. diodes. 1,000PIV 1 amp. plastic	H39	6	Integrated circuits 4 gates BMC 962. 2 flip flops BMC 945
B81	10	Reed Switches, 1" long & dia. High-speed P.O. type	H41	2	BD131/BD132 Complementary Plastic Transistors
H35	100	Mixed Diodes, Germ. Gold bonded, etc. Marked and Unmarked	H65	4	40361 Type NPN Sil. Transistors TO-5 can comp. to H66
H38	30	Short lead Transistors, NPN Silicon Planar types	H66	4	40362. Type PNP Sil. Transistors TO-5 can comp. to H65

UNMARKED & UNTESTED

B1	50	Germanium Transistors PNP, AF and RF	H20	20	BY126/7 Type Silicon Rectifiers 1 amp. plastic. Mixed volts
B66	150	Germanium Diodes Min. glass type	H34	15	Power Transistors. PNP. Germ. NPN Silicon TO-3 Can
B84	100	Silicon Diodes DO-7 glass equiv. to OA200, OA202	H67	10	3819N Channel FET's plastic case type
B86	100	Dil. Diodes sub. min. IN914 and IN916 types			

SILICON POWER TRANSISTORS—

40 WATT ●			PLASTIC	
Type	Gain	VCE	PNP	Price
40N1	15	15	PNP	20p
40N2	40	40	PNP	30p
40P1	15	15	PNP	20p
40P2	40	40	PNP	30p
90 WATT ●				
90N1	15	16	NPN	25p
90N2	40	40	NPN	35p
90P1	15	15	PNP	25p
90P2	40	40	PNP	35p

NEW X-HATCH GENERATOR Mk. 2



Essential for Colour T.V. alignment of 4 patterns. Featuring plug in IC's and a more sensitive sync. pick-up circuit. The case is virtually unbreakable—ideal for the engineer's toolbox—only measures 3" x 5 1/2" x 3". Operates from 3 U.2 type batteries (extra).

kit or complete **£7.93** Complete kit **£9.93** Ready built unit only **£9.93**

OVER 1,000,000 TRANSISTORS IN STOCK!

CAPACITOR DISCHARGE IGNITION UNITS Transistorised. Simple to Fit. Improves performance, cuts fuel costs P & P add 30p £7.50	MNFRS. AM/FM CHASSIS To clear. NO instructions or tuning drives, useful for experimenters. Not too difficult to get working. Make good portables EACH £1
--	--

SUNDRY

Metrication Pocket Charts 12p. 8 assorted relays £1.00 (8). Rev. counter device (for cars) £1.00. U.H.F./TV Tuner Units, 625 lines. Rotary Tuning £2.50. L.M.380 Audio I.C. £1.00 and technical books of all kinds.

TERMS OF BUSINESS

V.A.T. Prices shown do NOT include V.A.T. Please add 25% to total value of your order, except for items marked with a * or (8%) for which the V.A.T. rate is 8%. No V.A.T. on overseas orders.
POSTAGE Except where stated, add 25p for postage & packing in U.K. Overseas—add £1, any difference being charged or refunded.
PAYMENT Cash with order, Cheque or money order. Minimum value—£1. You can also pay by ACCESS.

IMPORTANT—Every effort is made to ensure accuracy of prices and description at time of preparing this advertisement and going to press. Prices are subject to alteration without notice.

BI-PRE-PAK LTD

Co Reg No B207119

222 224 WEST ROAD, WESTCLIFF-ON-SEA, ESSEX SSO 9DF.

TELEPHONE: SOUTHEND (0702) 46344.

WRITE ORDER SEPARATELY AND ATTACH COUPON IF REQUIRED

XMAS OFFER!

Batt/Mains Stereo F.M. Tuner/Amp

TO SHOW YOU A SAVING OF **£12**

if you buy all 4 units together for £18. Bought singly you save 33 1/3 off regular price of each unit

1 **F.M. TUNER FROM END**
Ganged tuning; A.F.C. facility. Reduction-gear drive, 88 — 108 MHZ.
Usual price inc. VAT £8.01 — **£5.34**

2 **I. F. BOARD**
Using I.C. Designed for use with above front-end. Usual price inc. VAT £6.76 — **£4.50**

3 **STEREO DECOVER, USING I.C.**
Designed for use with above modules, can also be used with other mono F.M. tuners. Ready aligned. (L.E.D. for stereo beacon available at 20p)
Usual price inc. VAT £7.22 — **£4.82**

4 **5 + 5 watt MUSIC POWER I.C. AMP**
Useful stereo power amplifier with good performance, at economy price.
Usual price inc. VAT £8.01 — **£5.34**

TOTAL VALUE AT REGULAR ADVERTISED PRICE **£30.00**

- ★ Prices include VAT and postage and packing in U.K.
- ★ Total Value £30 — You pay £18.00
- ★ Satisfaction guaranteed
- ★ Order now — delivery by return

SS.300 POWER SUPPLY STABILIZER

Delivers 12 to 50 volts, variable by its fixed pre-set pot. By substituting a remote-control potentiometer, a voltmeter and milliammeter may be incorporated to permit workbench and experimental applications. Protected against shorting. Easily connected. Ensures better performances wherever its use is indicated **£3.25**

To BI-PRE-PAK, 224-226 WEST RD., WESTCLIFF-ON-SEA, ESSEX

Please send

for which I enclose inc. V.A.T.

Name

Address

REC 12

Have you seen
this years most important
component catalogue yet?

**HENRY'S
CATALOGUE
IS NOW AVAILABLE**



Don't buy another electronic component until you've consulted the Henry's 1975 issue! It's packed with more items than ever before - over 5000 in all, making the Henry's range of electronic components the largest in the UK for the home constructor. There are literally dozens of new lines and new ranges to get excited about! And many components are selling at reduced prices. Get your copy soon, and start reading these 200 pages of vital statistics about electronic components. If you don't, you'll miss out on a lot of kits, projects and test gear, apart from all the other products.

ONLY 50p
+20p p & p

Complete with
FREE 50p
Discount Voucher!

FREE to Educational
Establishments when ordered
on official headed notepaper.

Get your copy NOW - send remittance of 70p (cheque or P.O.).

**Henry's
RADIO**

LONDON.
EDGWARE ROAD LONDON W2
40/46 Electronics Centre & Supermarket 01-402 8381
303 Bargain Centre
309 Electronics Supermarket
TOTTENHAM COURT ROAD W1
231 Electronics Centre & Supermarket 01-580 3459

YOUR NEAREST STORE

**OUT OF TOWN
NOTTINGHAM**
94/9 Electronics Centre Nottingham 42668
ALL MAIL ORDERS TO 303 EDGWARE ROAD W2
Prices correct at time of preparation.
Subject to change without notice. E & OE.

Barclaycard & Access welcome
ALL PRICES INCLUDE VAT

**ELECTRONIC FOOTBALL & TENNIS
WITH THE FABULOUS
VIDEO SPORT
ON YOUR OWN TV**

Play three exciting electronic ball games FOOTBALL, TENNIS, HOLE IN THE WALL on your own TV! Just plug Video Sport into the aerial socket of your TV and away you go. Completely safe for you, your children and your TV. Mains operated.



**OUR INCREDIBLE PRICE
£29.50 inc VAT**

DEMONSTRATIONS NOW IN ALL CENTRES!

**SPECIAL OFFER
GARRARD CT4 STEREO CASSETTE
TRANSPORT MECHANISM**

Features:
★ Stereo Heads
★ Built in Motor Stabiliser
★ Auto Stop Eject.
Robust, precision engineered mechanism based on the "STARR" patented design. Ideal for use in Car stereo cassette players, Hi-Fi stereo cassette recorders, industrial and many other applications. Suitable for the 'PW' Ascot Stereo Cassette Deck.



£13.50 incl. VAT P. & P. 35p

AM/FM MODULES LP1179 LP1171

Combined AM/FM tuner modules, together with a small number of R - C's Ferrite Aerial, make up a sensitive FM/MW/LW tuner. 6 Volts supply, supplied with data and circuit sheets.

LP1171 combined IF strip £4.60
LP1179 FM front end and AM gang £4.60.
£8.62 the pair.
Suitable Ferrite aerial 87p.



ALL HENRY'S PRICES INCLUDE VAT



Barclaycard & Access welcome
ALL PRICES INCLUDE VAT

**TEXAN
STEREO AMPLIFIER**

Features glass fibre PC board, Gardners low field transformers, 6-Cls. 10-transistors plus diodes, etc. Designed by Texas instruments engineers for Henry's and P.W. 1972. Overall size 15½ x 2½ x 6½ in. Mains operated. Free teak sleeve with every kit.



£29.95
(p&p 50p)
(also built and tested £39.95)

TEXAN STEREO FM TUNER

Features capacity diode tuning, LED and tuning meter indicators, mains operated. High performance and sensitivity. Overall size in teak sleeve 8 x 2½ x 6½ in. Complete kit with teak sleeve.

£26.25
(p&p 50p)
(also built and tested £31.20)

UHF TV TUNERS

625 line receiver UHF transistorised tuners U.K. operation. Brand new. (Post packing 25p each)
TYPE A variable tuning slow motion drive £3.50.
TYPE B 4-button push button (adjustable) £4.60.
TYPE C variable tuning £2.90.
TYPE D 6-button UHF/VHF tuner £5.75

NOW AVAILABLE . . .



Comprising
768 pages
inc. index

**AUGUST 1974
to JULY 1975**

**LATEST BOUND
VOLUME No. 28**

of
**"Radio & Electronics
Constructor"**

**FOR YOUR LIBRARY
PRICE £2.75 P&P 65p**

BOUND VOLUME No. 25 (August 1971 to July 1972)

PRICE £2.00 p. & p. 65p

BOUND VOLUME No. 27 (August 1973 to July 1974)

PRICE £2.40 p. & p. 65p

Limited number of these volumes still available

We regret all other volumes are now completely sold out.
Available only from

DATA PUBLICATIONS LTD., 57 MAIDA VALE, LONDON, W9 1SN

THE MODERN BOOK CO

NEW EDITION

RADIO VALVE & SEMICONDUCTOR DATA

By A. M. Ball

Price £2.50

FOUNDATIONS OF WIRELESS AND ELECTRONICS

by M. G. Scroggie PRICE £4.25

PRINCIPLES OF TRANSISTOR CIRCUITS

by S. W. Amos PRICE £3.50

SOLID STATE HOBBY CIRCUITS

by RCA PRICE £1.30

ABC OF HI-FI

by J. Earl PRICE £4.15

THE OSCILLOSCOPE

by G. Zwick PRICE £2.05

PRINCIPLES OF TELEVISION RECEPTION

by W. Wharton PRICE £1.95

ELECTRONICS UNRAVELLED

by J. Kyle PRICE £2.20

RADIO CONSTRUCTION FOR AMATEURS

by R. H. Warring PRICE £2.70

RADIO COMMUNICATION

by J. M. Reyner PRICE £5.55

RADIO SERVICING POCKET BOOK

by V. Capel PRICE £2.20

SERVICING TRANSISTOR RADIOS

by L. D'Airo PRICE £2.25

PRACTICAL TRIAC/SCR PROJECTS FOR

THE EXPERIMENTER

by R. W. Fox PRICE £2.10

RADIO TECHNICIAN'S BENCH MANUAL

by H. W. Hellyer PRICE £3.45

PRACTICAL INTEGRATED CIRCUITS

by A. J. McEvoy PRICE £1.30

ELECTRONICS SELF-TAUGHT ...

WITH EXPERIMENTS & PROJECTS

by J. Ashe PRICE £2.15

UNDERSTANDING IC OPERATIONAL

AMPLIFIERS

by R. Melen PRICE £2.35

110 SEMICONDUCTOR PROJECTS FOR THE

HOME CONSTRUCTOR

by R. M. Marston PRICE £2.00

IMPROVING YOUR HI-FI

by J. Earl PRICE £3.30

ALL PRICES INCLUDE POSTAGE

We have the Finest Selection of English and American Radio Books in the Country

19-21 PRAED STREET (Dept RC) LONDON W2 1NP

Telephone 01-723 4185

RADIO & ELECTRONICS

Pricelist free with sae.
Product info folder 40p

CONSTRUCTED.

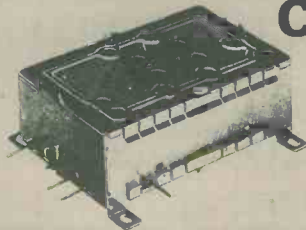

EF5600: Varicap FM tunerhead, AFC/AGC/MOSFET input. £10.00.



455kHz mechanical filters
£1.45 ea (4 or 7 kHz BW)

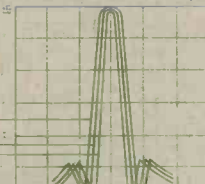

CFS
10.7MHz



ceramic FM
IF filter 40p



18 VHF coils
POA

Ambit is the wireless specialist. We supply tuners, tunerheads, components, modules and accessories specifically to provide a 'one stop' wireless constructor's source.

Here's a brief selection from our full range of ICs, components & modules:

AM radio system:
EC720 varicap tuned MW radio tuner with ceramic IF filter, and IC signal processing system. ... kit £8.00.
Three gang tuning diode MVAM1 : £2.75 each. 2 gang MVAM2: £1.05.

FM radio System:

Larsholt 7252 tuner. An electronically tuned 88-108 MHz receiver module. 1uV for 26dB S/N, mute, AFC, AGC, 'scan and hold', meter outputs for signal strength, tuning & frequency indication. Built and tested for £24.00.

Tuning Accessories:

WS150 150mm WW slider pot for direct scale readout. ... £3.00
9932 6 button preset pot. bank for pretuned station selection. ... £3.40
Meters (illuminated) for frequency, sig. strength, tuning. ... £2.50 each
Selection of 78 series voltage regulators for total stability, see lists.

AMBIT INTERNATIONAL 37 High Street, Brentwood, Essex.

All prices quoted exclude VAT. Postage 20p per order. Min CWO £2. Min. invoice £7.50.



AUDIO AMPLIFIERS

Edited by J. R. Davies

16 Transistor and Valve Designs for the Home Constructor Amplifiers for Tuner Units, Record Players, Tape Recorders, Public Address, etc., etc.

124 pages

Includes contributions by such well-known authors as

- A. S. Carpenter, A. Kinloch, E. Govier,
G. A. French, F. G. Rayer,
P. F. Bretherick, K. Jones, D. Aldous,
R. Murray-Shelley, C. Swires,
G. A. Stevens and V. E. Holley.

PRICE

53p

p&p 14p

ENTER THE **BI-PAK** GREAT CHRISTMAS COMPETITION!

WIN A 22" COLOUR T.V. FREE!



2nd Prize: A complete Hi-Fi outfit comprising a Legionaire Amplifier, Record Deck and EMI Speaker Kits.

3rd Prize: Black and White mains/battery Television.

4th Prize: An Electronic Calculator.

PLUS: 49 runner-up prizes of Electronic Slide Rules.

HOW TO ENTER

You are allowed one line for every £1.00 spent with Bi-Pak. Opposite you will find illustrated, 20 electronic symbols. Just choose the correct descriptions for these from the 30 alternatives shown and enter the numbers of the descriptions in the entry coupon alongside the letter indicating the symbol — should you need more columns you will find a coupon in every electronic publication. Then write a slogan of not more than 10 words but including the name BI-PAK.

RULES

There is no entry fee but one line is allowed for every £1.00 spent with BI-PAK (See our advertisement on Page 262). Every entry must be made on a proper entry coupon and must bear the entrant's full name and address.

All accepted entries will be examined and the Adjudicating Committee will award the FIRST PRIZE of a COLOUR TELEVISION to the competitor they consider to show the correct answers and who submits the best slogan. The remaining prizes will be awarded for the next best entries in order of merit.

Closing date February 29th. Entries arriving after the closing date will be disqualified, as will any received incomplete, illegible, mutilated or altered or not complying with the instructions and rules exactly. No responsibility can be taken for entries lost or delayed in the post or otherwise. Proof of posting will not be accepted as proof of receipt. All decisions of the adjudicating Committee will be final and legally binding. No correspondence will be entered into. Winners will be notified and the result published in the earliest possible issues of this magazine.

The competition is open to all except employees (and their families) of Bi-Pak Semiconductors. We regret that this competition is restricted to U.K. residents only. Entrants must agree to abide by the rules of the competition.

All entries become the property of Bi-Pak Semiconductors and any slogan submitted may be used at the discretion of the company.

1. Unijunction Transistor
2. Electrolytic Capacitor
3. Thermistor
4. Hexode Valve
5. Diac
6. Light Dependent Resistors
7. Gas Filled Discharge Tube
8. Field Effect Transistors
9. NPN Transistor
10. Capacitor
11. L. F. Choke
12. Microphone
13. Thermo-Couple
14. Aerial (General)
15. Earth
16. Neon
17. Zener Diode
18. Tetrode Valve
19. PNP Transistor
20. Resistor (Variable)
21. Selenium Cell
22. Aerial (Transmitting)
23. Preset Resistor
24. Electro Magnet
25. Plug and Socket
26. Fuse
27. Silicon Controlled Rectifier
28. Rectifier
29. Spark Gap
30. Coaxial Plug & Socket

A	B	C	D	E	F	G	H	I	J										
K	L	M	N	O	P	Q	R	S	T										
A	B	C	D	E	F	G	H	I	J	K	L	M	N	O	P	Q	R	S	T

SLOGAN: _____

Name _____

Address _____

Send to: BI-PAK, P.O. BOX 6, WARE, HERTS.



I can just imagine the old chap bawling at Rudolph "Here's another nice mess you've landed us in!" And there's Rudolph smirking all over his face, fondly imagining he's another Biggles. They've certainly a lot of ground to cover to deliver all those toys, not to mention all those gorgeous Home Radio Components Catalogues! Don't worry . . . they'll soon carry out some make-shift repairs and your catalogue will arrive on time. That is, assuming you have ordered one! You *have* ordered one . . . haven't you? If not, please order right away. It certainly is the most useful present you could give the electronics enthusiast. So, if you have a son, grandson or nephew who's

been bitten by the electronics bug, just send them one, and then every time they use it (which will be often) they'll think "what a clever feller you are!"

Of course, you already own one yourself? No? Then treat yourself right away . . . you deserve it! The catalogue has 240 pages listing about 6,000 items, of which nearly 2,000 are illustrated. The cost for that little lot is 85p plus 45p postage and packing, but the catalogue has 14 vouchers, which when used as directed enable you to claim back 70 pence. Send the coupon below, with your cheque or P.O. for £1.30 today.

I showed this advert to my grand-daughter and she asked "Is a victory roll something you eat?" It therefore occurred to me that the point of the cartoon might escape our younger readers, so here is the explanation. During World War Two, if one of our fighter pilots shot down an enemy aircraft, when he returned to base he did a slow roll over the aerodrome before landing; hence the term "Victory Roll".



**A Happy
Christmas
to all our
readers.**

Please write your Name and Address in block capitals

NAME

ADDRESS



HOME RADIO (Components) LTD., Dept. RC
234-240 London Road, Mitcham, Surrey CR4 3HD

Regd. No. 912966, London

HOME RADIO (Components) LTD. Dept. RC, 234-240 London Road, Mitcham, CR4 3HD. Phone: 01-848 8422

THE 'DRACHMA' S.W. AND V.H.F. PORTABLE — Part 1

This receiver covers the short wave band from 5.5 to 22MHz and the v.h.f. band from 75 to 105MHz. The ingenious reflex circuit allows reception of both a.m. and f.m. signals. Circuit operation and the first steps in construction are described this month, and the constructional information will be completed in next month's concluding article.

By

Sir Douglas Hall, K.C.M.G.

This receiver was designed by the author for use by him while on a visit to a rather distant country where local stations operate on v.h.f., and where the short wave bands from about 22MHz to about 5.5MHz are required for listening to the B.B.C. and other European broadcast stations. The receiver covers both these ranges, and switching between short waves and v.h.f. is carried out automatically by the short wave bandset control. When v.h.f. is selected the coverage is about 75 to 105MHz, and either a.m. or f.m. signals may be received.

CIRCUIT DESCRIPTION

The circuit appears in Fig. 1. With S1 in the position shown, the short wave bands will be received. The signal is picked up on a telescopic aerial and is applied via VC1 to the emitter of TR1, which functions as a common base amplifier. The amplified signal at TR1 collector appears across the r.f. choke L3 and then passes through C2 and C3 to L1 (which is air cored and has a very low inductance) and L2, which is the permeability tuned short wave coil. Coarse tuning of L2 is achieved by varying the position of a ferrite rod within it, and the relevant control forms the band setter. Fine tuning is carried out by VC2, which acts as a band spreader.

The signal across the tuned circuit is applied to the base of TR2. This, functioning as a common collector device, causes a current amplified signal to appear across D1, which provides detection. The detected a.f. signal is now amplified by TR2, working this time in the common base configuration. Regular readers will recognise the author's "Spontaflex" arrangement for TR2 and its associated components. The amplified a.f. signal at TR2 collector is built up across R3 and is fed back to TR1, which acts now as a common emitter audio frequency amplifier. Because of the

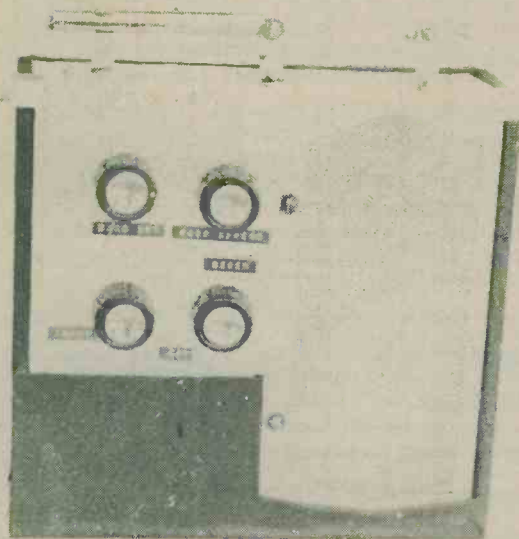

*The short wave and v.h.f. portable in its case.
The telescopic aerial is fitted to the three clips
at the top to function as a carrying handle*

WE WISH ALL OUR READERS
— A VERY HAPPY CHRISTMAS —

relatively high value of R3, TR1 requires negative feedback to increase its input base impedance. This negative feedback is given because R1 in its emitter circuit is not bypassed. Despite the feedback, quite a useful degree of amplification is provided by TR1 due to the high output load offered by the primary of T1.

If the band set control is adjusted so that the ferrite rod is completely removed from L2, S1 is automatically switched over to v.h.f. This removes L2 and C2 from the circuit, allowing L1 and VC2 to form the v.h.f. tuned circuit, with coupling from L3 being given by C3 only.

Positive feedback to provide reaction for a.m. reception, or synchronous oscillation for f.m. reception, is given by a Colpitts configuration, with VC3, VC4 and VC5 providing the requisite capacitive tap. VC3 is ganged to the band set control to provide consistent reaction over the whole of the short wave band, and its capacitance decreases as the ferrite rod is taken out of coil L2. The method by which regeneration is controlled is new. In addition to giving very smooth operation, it allows increased efficiency to be obtained.

As has been pointed out, TR2 acts as a common collector device at radio frequencies, whereupon its base input impedance is equal to its emitter load impedance multiplied by its current amplification factor. But at audio frequencies TR2 functions as a common base amplifier, and in this configuration it will

give greatest a.f. gain when the emitter load impedance is as low as possible and the collector output load impedance is as high as possible. If, however, too high a value of resistor were employed in the collector circuit of TR2, the current in the transistor would be so restricted as to make it function as a negative feedback detector rather than as an efficient reflex amplifier. Also, if a low impedance diode were chosen to keep the audio input impedance low, there could be a refusal on the part of the transistor to oscillate at the higher radio frequencies because of the consequent damping of the tuned circuit connected to its base.

With medium and long wave designs, the solution to these problems consists of employing a Darlington pair of transistors followed by a low impedance diode. The very high current gain of the Darlington pair then ensures that the damping of the tuned circuit at the input base is very small. But it is difficult in practice to make a Darlington pair work satisfactorily at higher frequencies, and in any case most low impedance diodes are inefficient at these frequencies. In the present design a normal high impedance diode is employed, and it is connected in a circuit which allows a controlled forward current to flow through it in addition to the emitter current of TR2. As the additional forward current increases the impedance of the diode reduces. When the additional current is low the diode has a high impedance and the damping of the tuned circuit at TR2 base is small, allowing the circuit to os-

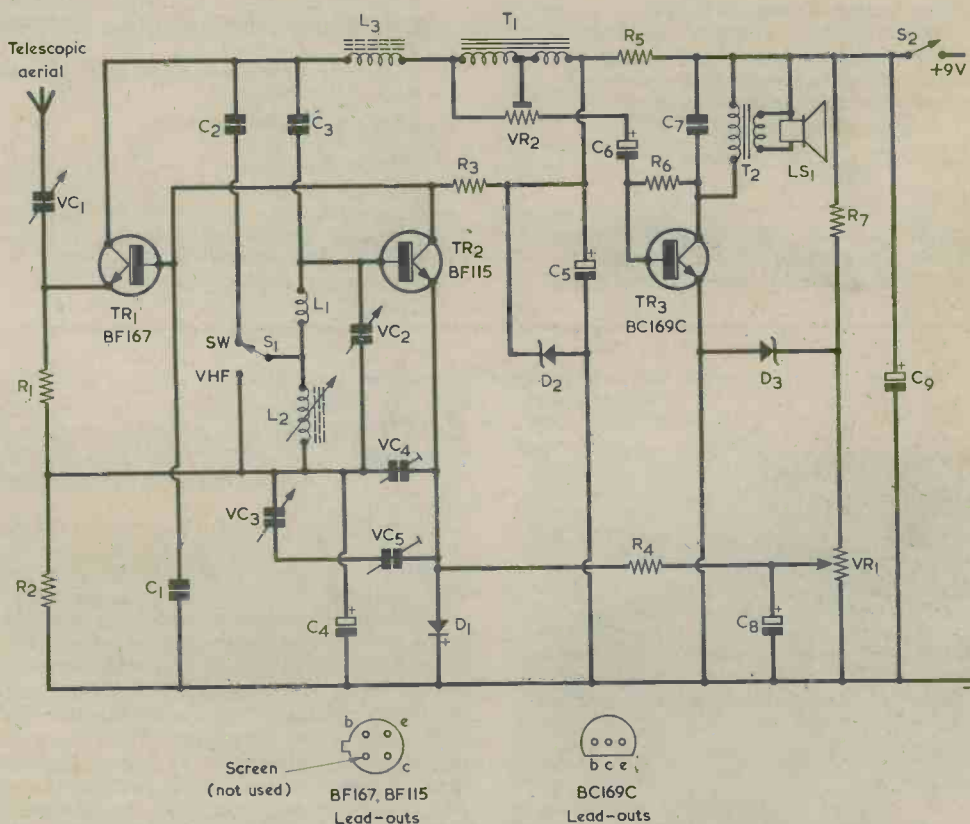

Fig. 1. The circuit of the short wave — v.h.f. portable. The connections to the two transformers are indicated in the wiring diagram, to be published in next month's issue

COMPONENTS

Resistors

(All fixed values $\frac{1}{4}$ watt 10%)

- R1 180 Ω
- R2 1k Ω
- R3 47k Ω
- R4 2.2k Ω
- R5 680 Ω
- R6 470k Ω
- R7 2.7k Ω
- VR1 10k Ω potentiometer, linear, with switch S2, type P20 (Electrovalue)
- VR2 22k Ω pre-set potentiometer, skeleton

Capacitors

- C1 470pF silvered mica or ceramic
- C2 6.8pF silvered mica or ceramic
- C3 3.3pF silvered mica
- C4 100 μ F electrolytic, tantalum or aluminium, 2.5 V Wkg.
- C5 100 μ F electrolytic, 10 V Wkg.
- C6 4.7 μ F electrolytic, tantalum or aluminium, 10 V Wkg.
- C7 0.047 μ F plastic foil
- C8 2.2 μ F electrolytic, tantalum or aluminium, 10 V Wkg.
- C9 1,000 μ F electrolytic, 10 V Wkg.
- VC1 100pF variable, 'Dilecon' (Jackson)
- VC2 15pF variable, type C804 (Jackson)
- VC3 50pF variable, type C804 (Jackson)
- VC4 20pF trimmer, mica
- VC5 140pF trimmer, mica

Inductors

- L1 see text
- L2 see text
- L3 2.5mH r.f. choke type CH1 (Repanco)
- T1 Driver transformer type LT44 (Eagle)
- T2 Output transformer type LT700 (Eagle)

Semiconductors

- TR1 BF167
- TR2 BF115
- TR3 BC169C
- D1 OA90
- D2 zener diode, 6.8V, 250 or 400mW
- D3 zener diode, 2.7, 3.0 or 3.3V, 250 or 400mW

Switches

- S1 see text
- S2 part of VR1.

Speaker

- LS1 3 Ω speaker, 7 x 3 $\frac{1}{2}$ in.

Aerial

- Telescopic aerial type TA10 (Eagle)

Battery

- 9 volt battery type PP9 or equivalent

Miscellaneous

- 18-way tagboard, "Standard" (R.S. Components)
- Ferrite rod, 4 x $\frac{1}{2}$ in. dia. (see text)
- Ball drive type 4511/F (Jackson)
- 3 brackets type LK-2311 (Lektrokitt)
- 3 spring clips type LK-2721 (Lektrokitt)
- 1 $\frac{1}{2}$ in. tuning drive drum type 4028 (Jackson-Home Radio)
- 2 spindle extenders type 4827 (Jackson - Home Radio)
- 24 s.w.g. enamelled wire
- Nylon drive cord
- Elastic (See text)
- Speaker fabric
- 2 screw hooks
- Plywood, hardboard, Formica or s.r.b.p.
- Fablon or Contact
- Bolts, nuts washers, etc.

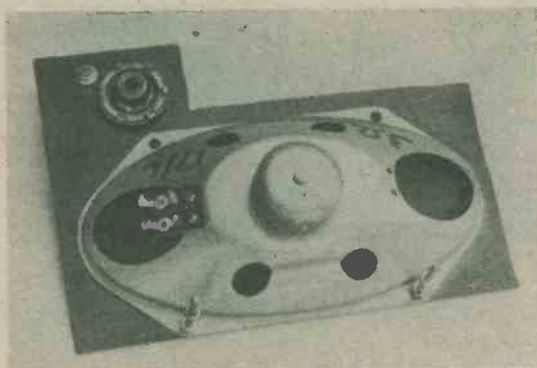

The loudspeaker panel with the ball drive fitted

cillate. If the additional current is increased it will reach a level where the reduced impedance of the diode causes sufficient damping of the tuned circuit for oscillation to cease. Under this condition, also, a high level of audio frequency amplification will be provided by TR2.

The additional forward current for the diode is controlled by VR1, which in consequence becomes the reaction control for the receiver. The current from VR1 slider is limited by series resistor R4, whilst the voltage across the potentiometer is stabilized by zener diode D3. The method of reaction control used here should not be confused with that employed by the author in three recent designs where oscillation was produced by *increasing* the current through a silicon diode to lower its impedance. With the present design oscillation is produced by *decreasing* the current through a germanium diode to raise its impedance.

Another zener diode, D2, stabilizes the collector supply for both TR1 and TR2. Thus, in the interests of tuning stability the reflex stages have a supply of constant voltage, this being especially important for the reception of v.h.f. signals.

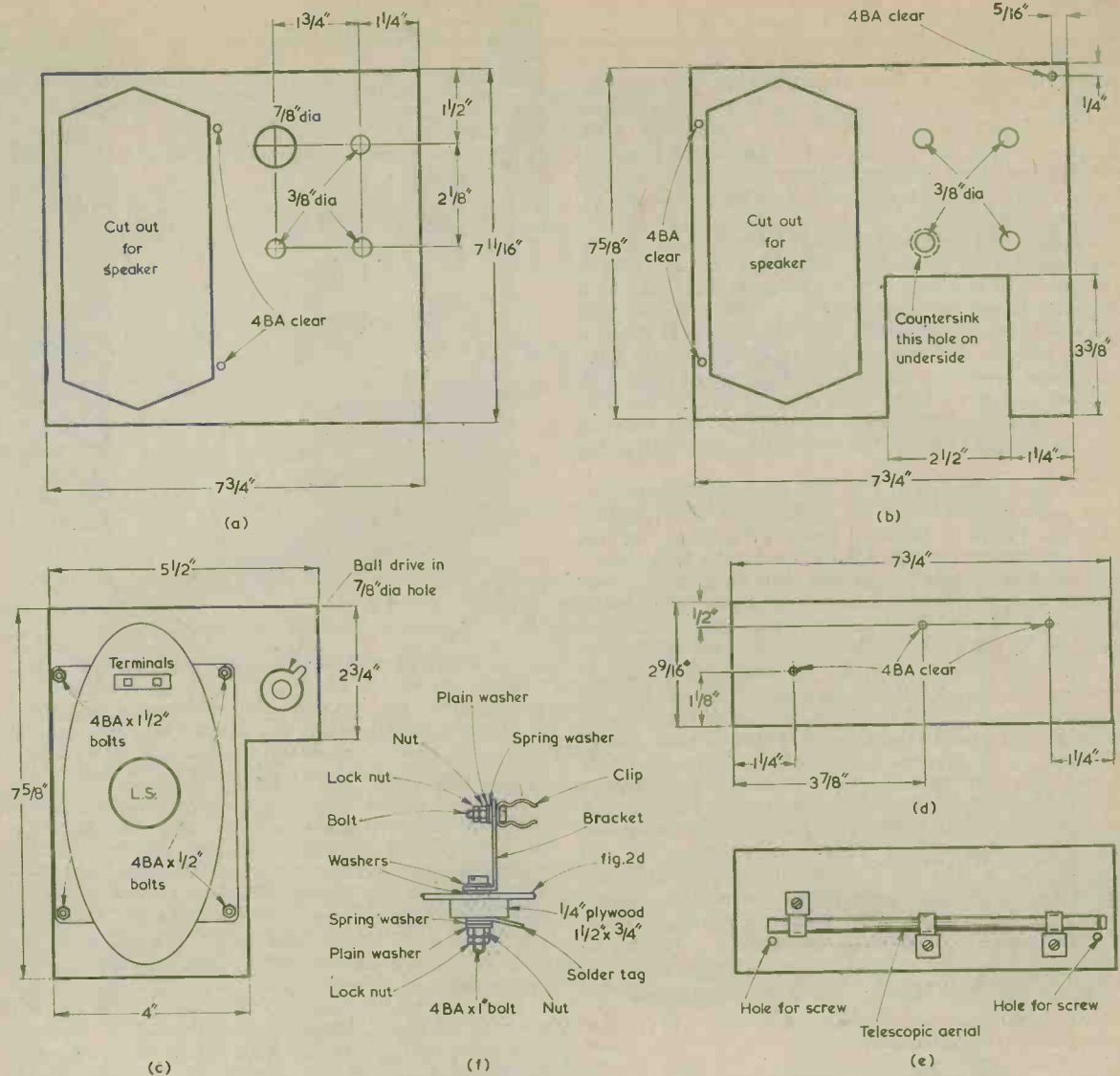

Fig. 2(a). Rear view of the front panel of the receiver
 (b). The rear of the component panel
 (c). The speaker panel, also seen from the rear
 (d). The top of the receiver, viewed from the underside
 (e). The three bracket-clips mounted on the other side of the top piece
 (f). Detail of the centre bracket-clip

The audio output from TR1 is transformer coupled by T1 to TR3. The section of VR2 track between its slider and L3 helps to equalise the collector load of TR1 through the audio spectrum and prevents any tendency to threshold howling. The remaining section of VR2 track keeps radio frequency currents away from TR3. R5 and C5 are decoupling components for the reflex stages. C9 is the usual large-value capacitor across the power supply.

The output transistor, TR3, couples to the speaker via output transformer T2. The value of R6 is chosen so that, with typical transistors, TR3 will pass about 10mA collector current.

No difficulties should be experienced in obtaining

the parts required for the receiver. If any component requires special comment this will be given when it is referred to in the constructional details which now follow.

CONSTRUCTION

Construction may be started by cutting out and drilling the various sections which together make up the "chassis" of the receiver. These parts are fitted together as described in next month's concluding article and any queries concerning the purpose of some of the holes, etc., will be cleared up then.

The section in Fig. 2(a) will be the visible front of the receiver. It should consist of s.r.b.p. ("Paxolin")

or Formica $\frac{1}{16}$ in. thick and, after it has been completed, covered with Fablon or Contact. The speaker is not fitted directly to this section but is mounted on Fig. 2(c) which will be fitted directly behind Fig. 2(a). In consequence the cut-out for the speaker in Fig. 2(a) will be backed by speaker fabric sandwiched between the two parts. At the time being, drill out the three $\frac{3}{8}$ in. and the $\frac{1}{2}$ in. holes only.

Section 2(b) is made of $\frac{1}{2}$ in. plywood, and will be fitted spaced off behind Fig. 2(c) by about $\frac{1}{4}$ in. Mark out and drill the four $\frac{3}{8}$ in. holes using Fig. 2(a) as a template to ensure that they coincide with the $\frac{3}{8}$ in. and $\frac{1}{2}$ in. holes in the latter. The lower ends of the two pieces are at the same level when they are later assembled, leaving a gap above Fig. 2(b) of $\frac{1}{16}$ in. The speaker aperture in Fig. 2(b) may be left for the moment. The 4BA clear hold at the top right hand corner may be drilled but not the remaining two 4BA clear holes.

The speaker panel of Fig. 2(c) should be about $\frac{3}{8}$ in. thick and may consist of hardboard or a similar material. When it is fitted behind Fig. 2(a) the left hand and bottom edges will be level with each other. Cut out the speaker aperture and four 4BA clear mounting holes for the speaker, positioning these to suit the particular speaker employed. The speaker is specified in the Components List as 7 by 3 $\frac{1}{2}$ in. This size is sometimes advertised by retailers, and it is possible also that some speakers with nominal dimensions of 7 by 4 in. will actually have a width of 3 $\frac{3}{4}$ in. although this point cannot be guaranteed. Alternatively a 7 by 3 in. speaker could be used, and this should be more than adequately narrow for the present design. Using Fig. 2(c) as a template, drill out the two 4BA clear holes in Fig. 2(a) and the remaining two 4BA clear holes in Fig. 2(b). The aperture for the speaker in Fig. 2(b) can also be cut out, remembering that this is to provide clearance for the speaker frame. The speaker aperture in Fig. 2(a) may also be cut out. The speaker is not fitted at this stage.

The epicyclic slow-motion drive is fitted to Fig. 2(c) as shown, and this requires a $\frac{1}{2}$ in. hole matching the



The other side of the loudspeaker panel

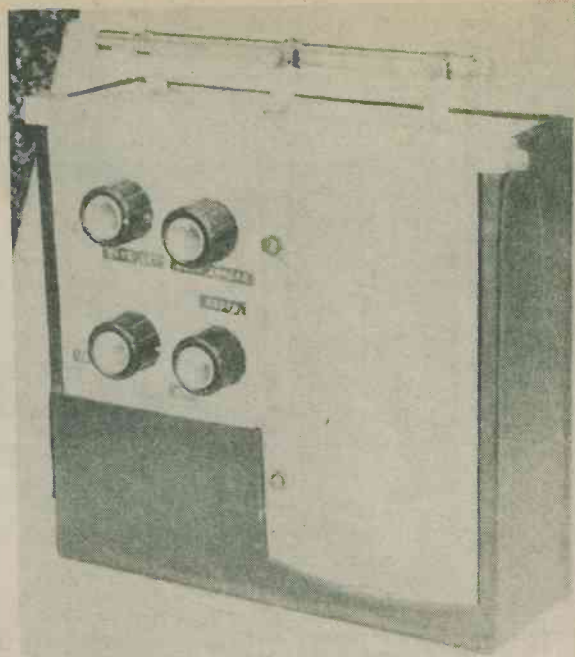

Another view of the completed receiver

$\frac{1}{2}$ in. hole in Fig. 2(a). The latter may be used as a template for positioning the hole in Fig. 2(c). Also required in Fig. 2(c) is a 6BA clear hole for a bolt to secure the anchor lug of the drive.

Fig. 2(d) shows the piece which forms the top of the receiver from the underside and this consists of $\frac{1}{4}$ in. s.r.b.p. or Formica. Fig. 2(e) shows this from the top with the three bracket-clips for the telescopic aerial fitted. The aerial is clipped into all three when it is used as a carrying handle for the receiver. When it is employed as an aerial its lower end is fitted to the central clip, which is arranged so that the aerial may be set to point in any direction.

This central bracket-clip is shown in Fig. 2(f) and consists of one Lektrokitt bracket LK-2311 and one Lektrokitt spring clip LK-2721. Both these items are available from Home Radio in packets of ten. Although it is not assembled until later Fig. 2(f) shows, for information, the arrangement of washers and nuts which are used to enable the bracket and clip to be rotated to any desired position. The 4BA bolt which passes through Fig. 2(d) is 1 in. long, and it will be noted that there is a solder tag underneath for connection to the aerial. The two end bracket-clips are the same as Fig. 2(f) except that each clip is secured to each bracket by a bolt and nut only, as also is each bracket to Fig. 2(d). The rotatable facility is not required with these end bracket-clips. The two small holes for screws in Fig. 2(e) are drilled later. Since its upper surface is visible this piece is covered with Fablon before the bracket-clips are fitted.

Fig. 2(f) also shows a piece of plywood measuring 1 $\frac{1}{2}$ by $\frac{3}{4}$ in. This is cut out later.

NEXT MONTH

Constructional details will be completed in next month's concluding article. The full Components List is given in this issue but it should be pointed out that details concerning some of the parts will be published next month.

(To be concluded)

RADIO & ELECTRONICS CONSTRUCTOR

'In situ' transistor checker

By G. A. French

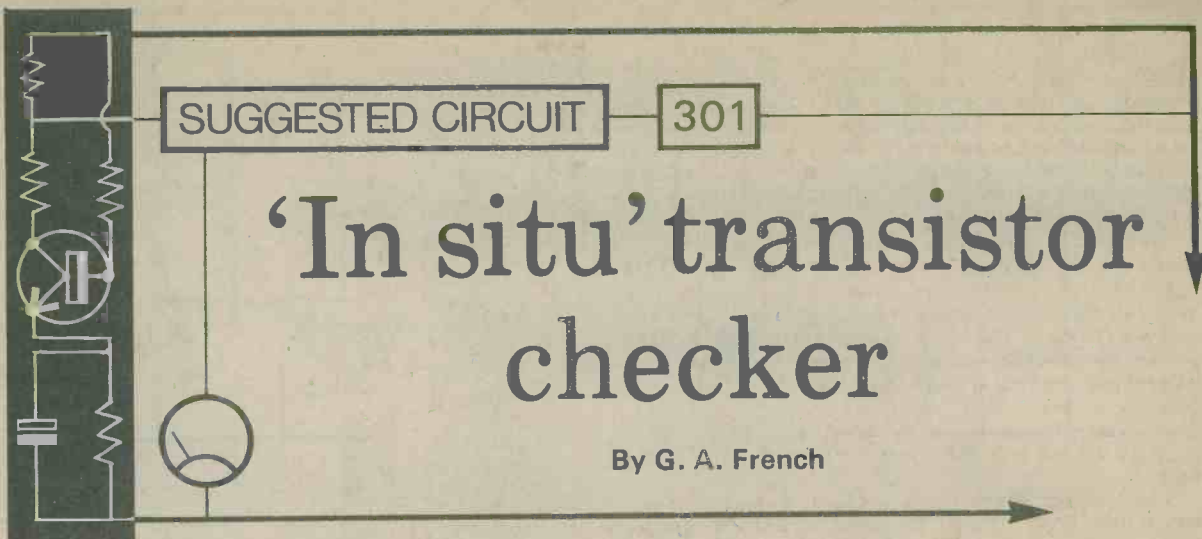

The device to be described in this article is intended for testing small signal amplifying transistors without removing them from the circuits in which they are wired. It operates by temporarily increasing the base current of the transistor and checking that there is a corresponding increase in collector current. The checker is intended only for testing small signal amplifying bipolar transistors in battery operated radio receivers and a.f. equipment. It may not be employed for checking output transistors nor may it be used for testing transistors in mains-driven equipment, where the higher voltages that are present may cause damage to the transistor being checked.

Despite these limitations the circuit is still of quite considerable use, and it has the advantage of extreme simplicity. It is capable of checking both n.p.n. and p.n.p. transistors without polarity switching. When employed for checking transistors on a printed circuit board, the process of applying the test prods requires a little more concentration than is needed for such operations as taking voltage measurements with two test prods.

SERIES RESISTANCE

The transistor checker functions by reason of the fact that in virtually all battery operated small signal amplifying stages there is resistance in series with the transistor emitter, the transistor collector or both. Fig. 1(a) illustrates a standard transistor bias circuit, in which it is assumed that the collector load is an i.f. transformer winding, which will have negligible d.c. resistance. As can be seen, the biasing circuit includes a resistor in series with the emitter.

An i.f. amplifier stage of the type shown in Fig. 1(a) will probably have further resistance in the collector circuit, this being given by a decoupling resistor, as illustrated in Fig. 1(b).

If the transistor is an a.f. amplifier with a resistive collector load, the resistance of the load will add to any emitter bias and decoupling resistance that may be present. If the transistor is a driver coupling directly to the bases of the output transistors, as in Fig. 1(c), no harm will result if the driver transistor is caused to pass a high collector current, as its collector is, in any case, intended to take the output transistor emitters nearly to the lower supply rail on the appropriate half-cycles of signal.

Fig. 1(d) shows a driver transistor with the primary of a driver transformer appearing between the collector and the upper supply rail. The latter may connect directly to the battery of the equipment without any series decoupling resistor. The resistance of the driver transformer primary will be low and the only relatively large resistance in circuit is given by the bias resistor between the emitter and the lower supply rail. In all normal instances the value of the bias resistor will be sufficiently high to allow the transistor checker to be employed.

It is extremely unlikely that a circuit of the type shown in Fig. 1(e) will be encountered in commercially designed equipment. Here, the supply rails connect direct to the battery without any series decoupling resistance, and there is no significant resistance in either the emitter or the collector circuits. If an attempt were made to check transistor operation by increasing its base current the transistor, particularly if it had a high current gain, could dissipate excessive power and be damaged. Fortunately, the first step in carrying out the transistor check automatically reveals the existence of a circuit condition such as that shown in Fig. 1(e), and the check is not then continued. The low resistance load in the diagram could be a driver transformer primary or an r.f. or i.f. coil. Since it is improbable that a commercial design would include a

stage in which the transistor has no series protective resistance, the load could very well consist of an acceptable load which has, due to a fault condition, become short-circuited.

BASE CURRENT

The transistor check consists of connecting a sensitive voltmeter across the emitter and collector of the transistor being checked and then applying a $47k\Omega$ resistor between the collector and the base. If the transistor is in working order its collector current will increase whereupon, due to the series resistance in its circuit, the voltage between the emitter and collector will drop. This voltage drop will be indicated by the voltmeter. The amount of voltage drop will depend on the gain of the transistor, the level of resistance in its emitter and collector circuits and the standing current in the base bias potential divider when this is of the type shown in Fig. 1(a). In some instances, a driver transistor in a circuit of the type shown in Fig. 1(c) may not exhibit a significant drop in emitter-collector voltage when the base current increases due to d.c. negative feedback in the circuit. The transistor checker may not, in consequence, be as effective with this particular circuit as it is with the others discussed.

Making the arbitrary assumption that the transistor being checked should not be made to pass more than 20mA when the $47k\Omega$ resistor is applied between its collector and its base, the series resistance in its emitter and collector circuits should not be less, for the circuits of Figs. 1(a), (b) and (d), than 600Ω with equipment supplied by a 12 volt battery, 450Ω with a 9 volt battery, and 300Ω with a 6 volt battery. The required levels of resistance should be found in standard battery operated equipment. In practice there is a further margin of protection against excessive collector current because the extra base current passed by the $47k\Omega$ resistor is derived from

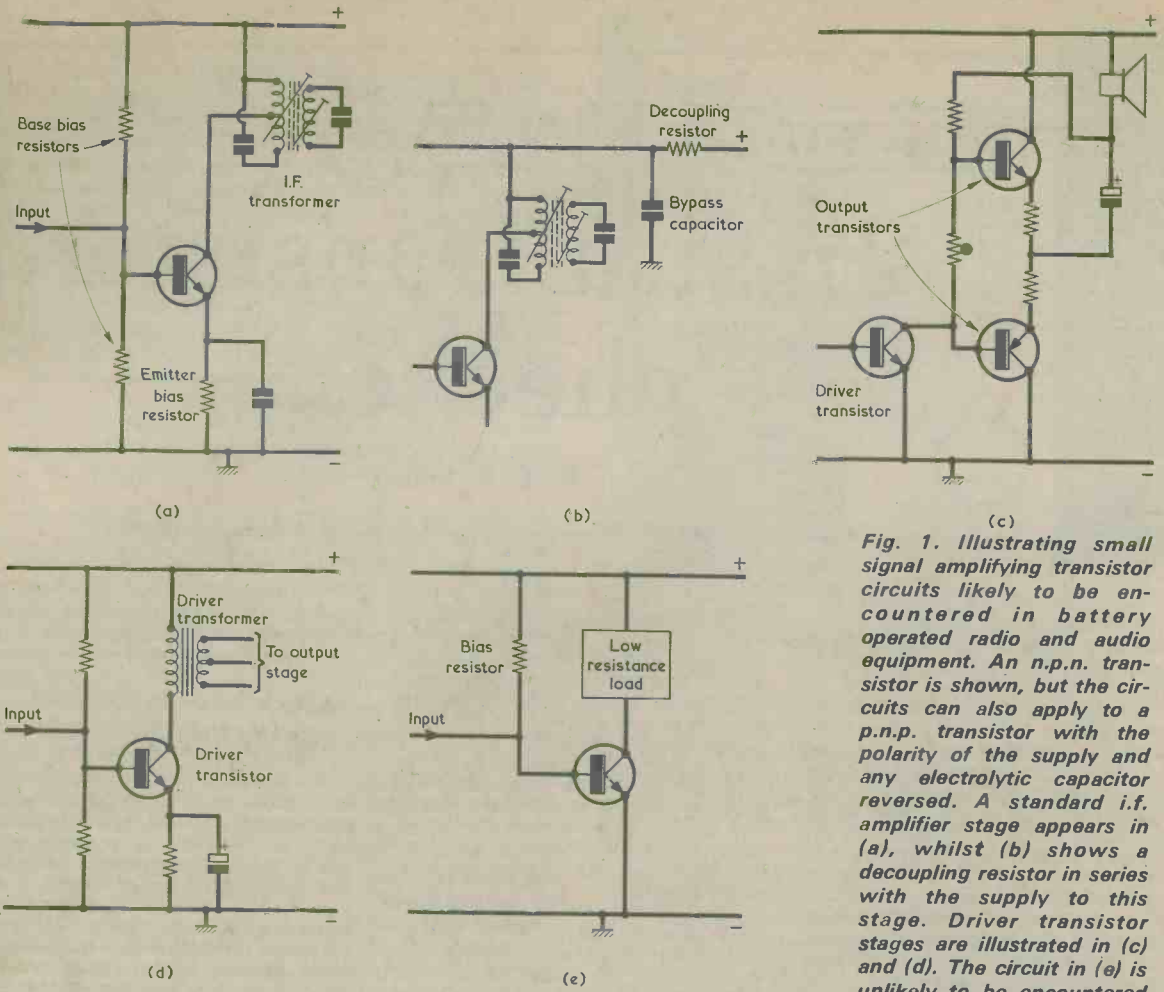

Fig. 1. Illustrating small signal amplifying transistor circuits likely to be encountered in battery operated radio and audio equipment. An n.p.n. transistor is shown, but the circuits can also apply to a p.n.p. transistor with the polarity of the supply and any electrolytic capacitor reversed. A standard i.f. amplifier stage appears in (a), whilst (b) shows a decoupling resistor in series with the supply to this stage. Driver transistor stages are illustrated in (c) and (d). The circuit in (e) is unlikely to be encountered in commercial equipment except under fault conditions

the transistor collector. As collector voltage falls so does the extra base current.

The circuit of the transistor checker is shown in Fig. 2. Two contacts of the test prods connect to the emitter and collector of the transistor being checked and the voltage across these is measured by the voltmeter given by M1, R3, R4, R5 and R6. The base test prod is then applied to the base of the transistor whereupon, if this is serviceable, the voltage reading will fall.

When the transistor being checked is an n.p.n. type the emitter-collector prods are applied as shown in Fig. 3(a). Applying the base test prod causes the 47kΩ resistor, R1, to be connected between collector and base. The remaining 47kΩ resistor, R2, connects between base and emitter, and the current which flows in it is negligibly low because the voltage across it will only be that existing across the base-emitter junction. This will be about 0.6 volt for a silicon transistor and about 0.2 volt for a germanium transistor.

A p.n.p. transistor is checked in the manner illustrated in Fig. 3(b). This

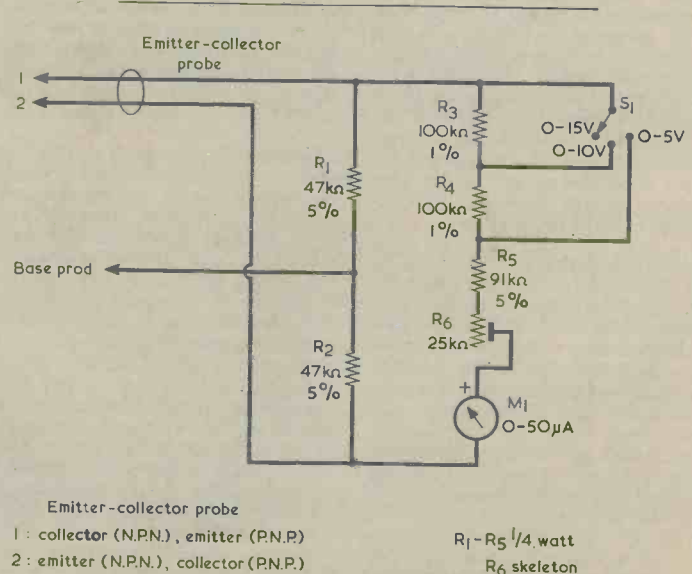

Emitter-collector probe
 1: collector (N.P.N.), emitter (P.N.P.)
 2: emitter (N.P.N.), collector (P.N.P.)
 R1-R5 1/4 watt
 R6 skeleton

Fig. 2. The circuit of the transistor checker

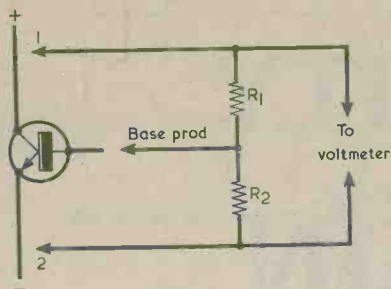

(a)

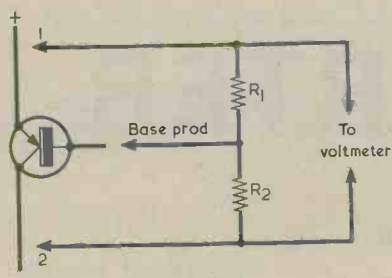

(b)

Fig. 3(a). The transistor checker is applied to an n.p.n. transistor in the manner shown here
(b). Method of connection to a p.n.p. transistor

time it is R2 which appears between the collector and the base, whilst R1 is now connected between the base and the emitter. It will be apparent that it is not necessary to know whether the transistor being checked is p.n.p. or n.p.n., or even to know its lead-out layout. The collector-emitter prods are simply applied to the two lead-outs which cause the voltmeter to give the highest forward reading. The base prod is then applied to the remaining lead-out.

TEST PROBES

A little ingenuity is called for in making up the collector-emitter probe as this requires two prods in the one assembly and has to be home constructed. The general requirement is illustrated in Fig. 4(a) where the prod tip spacing of $\frac{1}{4}$ in. should enable connection to be readily made to the appropriate copper sections of a printed circuit board. If the two prods can be sprung in the same way as the contacts in a bayonet lamp socket are sprung, use of the probe will be considerably eased as it will not then have to be held at exactly the correct angle to the printed circuit board.

An alternative approach towards making up the two-prod probe is suggested in Fig. 4(b). This requires flat springy metal strips which could be cut from the negative contact of a 4.5 volt torch battery, and it is held at a small angle to the printed circuit board. The base prod is, of course, a standard single contact test prod.

The voltmeter section of the unit can be switched by S1 to read 0.5 volts, 0-10 volts or 0-15 volts. R3 and R4 are both 1% 100kΩ resistors, whilst R5 is a 5% resistor in series with

the pre-set potentiometer R6. The latter is adjusted so that the total resistance given by R5, R6 and the internal resistance of the meter is also 100kΩ. A simple method of setting up R6 consists of connecting the negative terminal of the meter and the junction of R5 and R4 to a 4.5 volt battery, as in Fig. 5. Also connected to the battery is

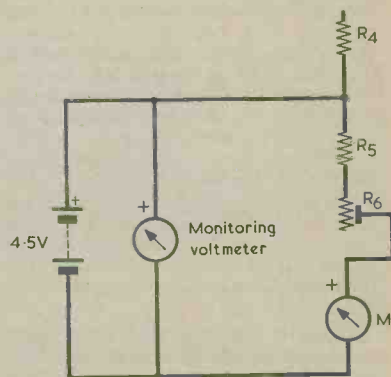

Fig. 5. R6 can be set up with the aid of a 4.5 volt battery and an external voltmeter

a separate voltmeter. R6 is then adjusted so that meter M1 gives the same reading as the monitoring voltmeter.

The resistors required for the unit may be assembled in a small wooden or plastic box with meter M1 and range switch S1 mounted on the front panel. Flexible leads passing through holes at one side can then connect to the prods.

Before the transistor checker is employed, the voltage of the battery supplying the equipment to be tested should be measured with the equipment switched on. S1 is set to a suitable range and the emitter-collector prods applied to the emitter and collector of the transistor being checked. If the lead-outs are not known, the prods are applied to the two lead-outs which give the highest forward voltage reading in the meter, as was just mentioned.

Should the emitter-collector voltage be equal to or very nearly equal to battery voltage, no further tests are carried out with the transistor checker and the following possibilities then exist. First, the transistor stage may be in a circuit condition of the type shown in Fig. 1(e), in which case applying the base test prod could damage the transistor. Second, the transistor could be receiving no base bias and a fault should be looked for in the base bias circuit. Third, the transistor could have gone open-circuit. These possibilities can be examined using normal fault-finding techniques.

If the voltage across the transistor is very low, say between 1.5 and 1 volt, a fault condition probably exists, causing the transistor to draw too much

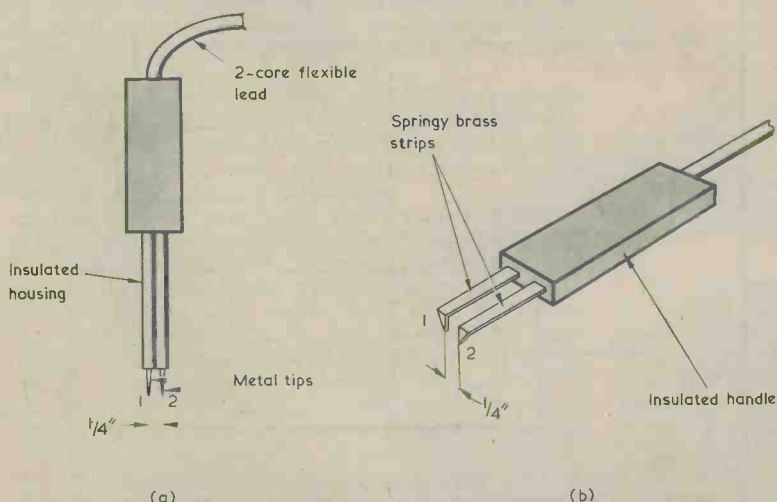

Fig. 4(a). Basic requirements for the emitter-collector probe
(b). An alternative construction for the probe which may be simple to assemble

current. Possible causes are a reduction in resistance in the emitter bias circuit due, perhaps, to a short-circuited emitter bypass capacitor or an open-circuit or high value in the lower resistor of the base potential divider when this is of the type shown in Fig. 1(a). A further possibility is that the series collector resistance has gone high in value. These points should be checked before proceeding further. The reduction in voltage across the collector and emitter when the base prod is applied will be less pronounced, or even hardly noticeable, when there is a very low voltage across the transistor. Although rather unlikely, the transistor itself could be causing the low voltage condition.

Should the voltage across the transistor be lower than 1 volt, the same fault conditions as in the previous case can exist and it is more probable that the transistor itself is causing the trouble.

When it is found that the voltage across the transistor is in excess of 1.5 volts and is at least a volt or more lower than battery voltage then the base prod may be applied. With a serviceable transistor the voltage across the collector and emitter will fall, proving that the transistor is giving correct transistor operation and can therefore be considered in working order.

With germanium transistors whose emitters connect directly to the lower supply rail, as in Fig. 1(c), it may be difficult to initially find the two lead-outs which give the highest forward voltage in the meter, as the voltage between collector and base will be very nearly the same as the voltage between collector and emitter. The simple solution here is to first check with the emitter-collector probe connected to one pair of lead-outs and the base prod applied to the remaining lead-out. If this does not give the desired drop in voltage then the emitter-collector probe is connected to the other possible pair of lead-outs and the test repeated.

S1 can, of course, be switched to a lower range if the initial voltage found across the emitter and collector warrants this.

Connecting the base prod to the transistor base will cause additional current from the emitter and collector circuits to pass through the appropriate $47k\Omega$ resistor, R1 or R2. Where there is a high series emitter and collector resistance, this fact could, of itself, cause a small drop in voltmeter reading. If such an effect is suspected the magnitude of the drop due to the $47k\Omega$ resistor on its own can be checked by temporarily applying the base prod to the emitter, whereupon a similar voltage drop will be given. In most instances the voltage drop due to current in the $47k\Omega$ resistor will be negligibly low, and the voltage drop due to correct transistor operation will be considerably higher and much more noticeable. ■

UNITY GAIN INVERTER

By J. R. Davies

Comments on a basic circuit configuration.

Occasionally, an a.f. amplifier design requires that a unity gain phase inverter be inserted in a signal chain. A possible instance occurs when a speaker is driven by a full bridge amplifier as in Fig. 1. This arrangement provides a voltage swing at the speaker which is twice that available from a single amplifier. With a single amplifier the peak positive or negative voltage swing at the speaker is nearly half the supply potential; with the bridge arrangement the peak voltage swing is nearly the full supply potential.

A unity gain phase inverter is inserted at the input to one of the amplifiers to ensure that the two amplifier outputs are in anti-phase.

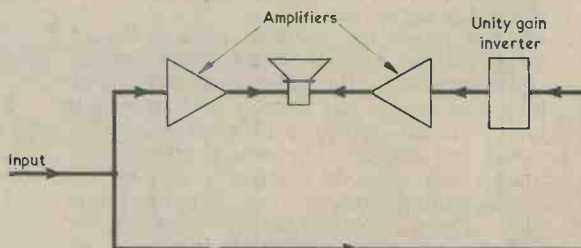

Fig. 1. A full bridge amplifying arrangement. The two individual amplifiers have identical characteristics

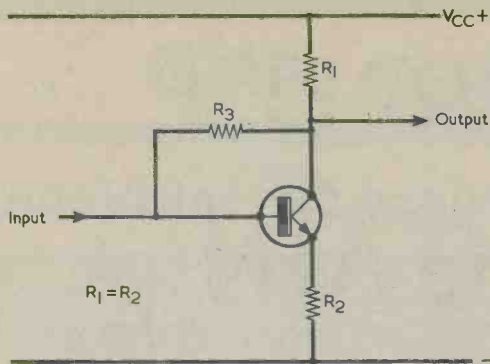

Fig. 2. The unity gain inverter circuit. For clarity, input and output coupling capacitors are omitted

PHASE INVERTER

A very simple but effective phase inverter is shown in Fig. 2. There is nothing new about this circuit but some comments concerning its operation may be of interest to constructors. Resistors R1 and R2 have equal values. Bias resistor R3 has a value which, ideally, causes the emitter to be at $0.25V_{cc}$ and the collector to be at $0.75V_{cc}$ under quiescent conditions. The circuit functions by reason of the fact that, when the transistor has a reasonably high current gain, the collector current can be assumed to be equal to the emitter current.

If an input signal takes the base of the transistor positive, emitter follower action causes the emitter to go positive by the same amount. The emitter current increases and so also, by an equal amount, does the collector current. Since R1 and R2 have equal values the increased voltage now appearing across R1 will be the same as the increased voltage across R2. Thus, taking the base of the transistor positive causes the collector of the transistor to go negative by an equal amount.

The converse will also hold true. If the transistor base is taken negative, the emitter and collector suffer an equivalent excursion, with the collector going positive. In consequence, the circuit carries out the function of a unity gain inverter.

Assuming the quiescent emitter and collector voltages just mentioned and ignoring forward voltage drops in the transistor, the peak negative input voltage which the circuit can handle is that which takes the emitter to the negative rail, with no current flowing in either R1 and R2. The peak positive input voltage is that which takes the emitter to very nearly half the supply voltage, whereupon the collector is only very slightly positive of the emitter. Under these conditions, the maximum peak-to-peak input voltage is half the supply potential. In practice, it would be wise to assume that the maximum useful peak-to-peak input voltage is about 75% of half the supply voltage. This will take in tolerances on value in R1 and R2, and gain spread in the transistor. Normally, the circuit would be run at much lower input voltages.

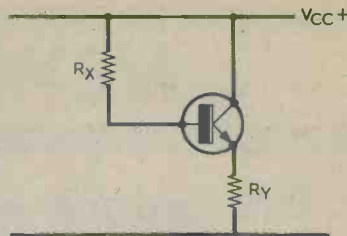

Fig. 3. A transistor configuration which is used to demonstrate the relationship between base bias and emitter load resistors

BIAS RESISTOR

The optimum value for the bias resistor, R3, can be readily calculated. In an earlier article, "Finding Bias Resistance Values" which appeared in the June 1973 issue of *Radio & Electronics Constructor*, the author showed that when a transistor is connected up as illustrated in Fig. 3 the emitter will be at around half the supply voltage when the value of resistor RX is equal to the value of the emitter load resistor RY multiplied by a "central" figure in the hFE gain spread of the transistor. This "central" figure is one-third of the way up from the lower figure in the gain spread. If the transistor is a BC107 it has an hFE spread of 110 to 450. The difference between these figures is 340, and one-third of 340 is, for the level of accuracy required here, 110. So, with a BC107 a suitable value for RX in Fig. 3 is 110 plus 110, or 220 times the value of RY.

With the inverter circuit of Fig. 2 it is required that, under quiescent conditions, the emitter be at one-third instead of one-half of collector potential, so that twice the voltage dropped across R2 is dropped across R3. In consequence, the value required in R3 of Fig. 2 is twice the value calculated for RX of Fig. 3.

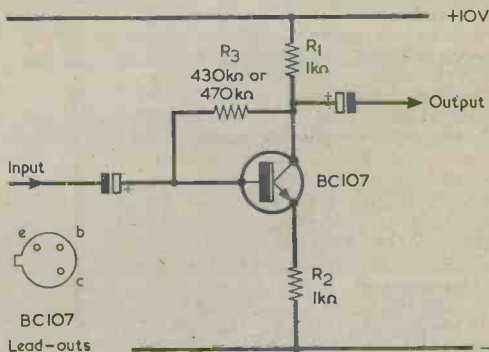
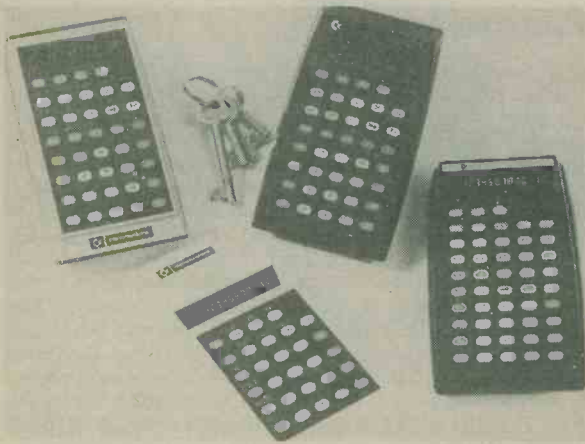

Fig. 4. A practical unity gain inverter. The input and output coupling capacitors have values suitable for the frequencies to be handled

Fig. 4 shows a practical unity gain inverter circuit. R1 and R2 have been arbitrarily given values of $1k\Omega$, which means that the quiescent current flowing in these resistors is approximately $2.5mA$. The transistor is a BC107 and the value required in R3 is $1k\Omega$ multiplied by 440 (double the multiplier required with a BC107 in the Fig. 3 circuit). In practice a $430k\Omega$ or $470k\Omega$ resistor would be suitable.

In addition to its use as a unity gain inverter, the circuit of Figs. 2 and 4 may also be employed as a phase splitter, outputs being taken from the emitter and collector. The signal voltages at these points are equal in amplitude and opposite in phase. ■

CBM launch scientific standard for calculators



CBM Business Machines Limited recently announced the launch of a comprehensive range of three new hand-held calculators designed to create a meaningful standard for all scientific calculator users. The complete range utilise CBM's own integrated circuit design capability with the use of their own exclusive chips in every model.

The models are priced at £29.95, £39.95 and £49.95 excluding V.A.T. After the initial launch it is planned to build the entire range at CBM's British factory in Eaglescliffe, near Stockton, and export throughout Europe.

A special feature of this CBM range is that these machines all calculate to 14 digits and include at least 8 digits in the mantissa, plus two in the exponent. This provides a degree of accuracy considerably greater than most other calculators on the market. Two independent memories are included throughout the range as well as parenthesis on all three models. In addition to all the usual trig, log and power functions, these models have "Exponent shift keys". When depressed, these keys will shift the decimal point of the mantissa, as the exponent is simultaneously increased or decreased to the required power. Special features also included on these models are mean and standard deviation for statistical work, plus polar to rectangular coordinate conversions.

CBM Business Machines Limited operate from offices at 446 Bath Road, Slough, Bucks, and a factory at Eaglescliffe. Together with associated companies in Germany, France and Switzerland, they serve the whole European market.

EF.10X electronic air purifier

With present day pollution reaching alarmingly high levels, the EF.10X electronic air purifier has been developed to provide the ultimate in efficient and economical air cleaning. Ideal for homes and offices alike, it provides a high rate of purification.

Even with continuous 24 hours operation, running costs are less than for a 60 watt light bulb.

Heat loss is reduced as the same room air is recycled, e.g. the air in a room of 2,500 cu.ft. is filtered 7 times per hour. This eliminates the need to open windows for ventilation, during the winter.

The whole unit measures only approx. 21in. long x 12in. high and 10in. deep, with a rich rosewood finished front panel surrounded by a robust black satinised metal case. Weighing only 34 lbs., it can be carried (see special carrying handle) from room to room as required and placed on a shelf or table — the only installation required is to fit a 13 amp plug.

Normal, stale polluted room air is drawn in at the back of the unit by a quiet but powerful suction fan, and forced through four individual internal filters, each scientifically designed to remove a certain size range of particle.

Price: £168.75 including VAT. Stockists: Harrods, Heals and Selfridges, or direct from Humidifier Sales Ltd., 21 Napier Road, Bromley, Kent BR2 9JA.



COMMENT

New radio telescope to see stars born?

Jodrell Bank radio astronomy centre is to have yet another radio telescope aerial dish, costing about £2m, it was reported on BBC World Service.

The new aerial will be used to listen to radio sources both in our own galaxy and way outside it, with a particular hope that the astronomers will be able to eavesdrop, so to speak, on the moments when a star is being born in the depths of the heavens.

The Jodrell Bank radio astronomers will use the new dish aerial as part of a system involving their existing aerials. The new dish will be 25m in diameter, and sited some 100 km away from the Jodrell Bank headquarters at a place called Knockin, on the border between England and Wales.

The dish of a radio telescope aerial gives an enormous magnification of the very weak signals from outer space, but Jodrell's technique with the new dish, as it is with others spaced away from the main centre, will be to use it to form what's called an interferometer.

This involves using two or more widely-spaced small aerials, just tens of metres across, as if they were parts of a much bigger aerial, a hundred or more kilometres across. This does not make the aerials magnify as well as a real big aerial would do, but it does have a different and even more valuable effect.

The bigger an aerial, the finer the detail it can see — small aerials give fuzzy pictures, and big ones sharp pictures. The effect of combining the signals from two or more wide spaced small aerials in this way is to produce an extremely detailed picture, showing very small things clearly, and giving very exact information on the positions of radio sources so that they can be correlated with pictures from optical telescopes.

Swiss S.W. service 40 years old

In 1934, the Swiss community in Quito, the capital of Ecuador, asked the Swiss Broadcasting Corporation (SBC) to broadcast a radio programme to South America in honour of August 1st, the Swiss National Day. SBC, fascinated by this pioneering idea, acted on the request, and on August 1st, 1935 a Swiss broadcast was transmitted to Latin America by short wave over the transmitters of the League of Nations in Geneva, which had kindly agreed to provide facilities for this historic event.

The broadcast was such a striking success that in autumn 1935, SBC began a regular service of programmes for listeners abroad, mainly intended for Swiss citizens living in North and South America.

At the end of the 1930s, SBC finally acquired its own short-wave centre, situated at Schwarzenburg, near the capital, Berne.

Adjustable bit for Solon soldering iron

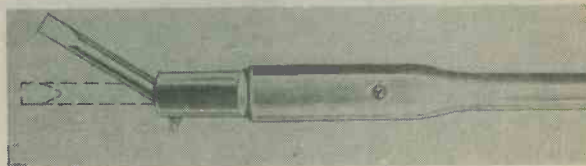

Alternative positions of the bit

A significant modification has been made to the 65-watt Solon soldering iron. Flexibility in use has been improved by the introduction of an adjustable pencil bit.

The new model gives choice of a straight or angled bit. The simple turn of a screw enables the angle of the bit to be adjusted for use in near-inaccessible parts, or to aid visibility.

The 65-watt iron is now obtainable with three types of bit: adjustable-angle pencil, straight pencil and oval tapered. All parts are replaceable and obtainable as spares.

The iron is ideal for general workshop or household use, the two types of pencil bit being especially suitable for wiring connections and similar light work.

COVER PRICE INCREASE

We regret that, because of rising costs, commencing with the next issue the cover price of *Radio & Electronics Constructor* will be increased to 35p.

Annual Subscriptions will be £5.00 per annum, and for copies sent to U.S.A. and Canada the cost will be \$11.00, all inclusive of postage.

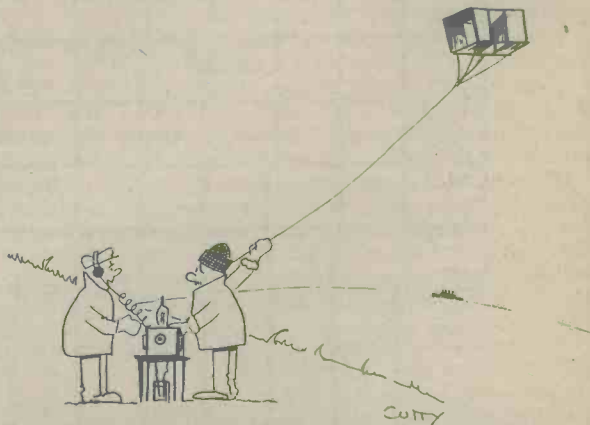

"It's a message from some guy in England calls himself Marconi — and says 'Compliments of the Season to all Radio & Electronics Constructor readers'."

TOUCH TUNING CONTROL

By J. B. Dance

Details of an MOS integrated circuit which allows television receiver channels to be selected by touch buttons or by a remote switch.

Most television receivers employ one of the conventional mechanically switched push-button types of tuner unit for programme selection. An alternative system is available for both colour and monochrome receivers which involves the use of a touch tuning system incorporating a specially designed integrated circuit.

THE ETT6016

The Hughes ETT6016 MOS touch tuner is a 16 pin dual-in-line integrated circuit. It provides facilities for selecting any programme from up to six signals and for indicating the selected channel by means of a neon bulb.

The very high input resistance of the MOS circuit enables it to detect the impedance of a person's finger placed across the two contacts of a sense plate, and it then carries out the channel switching according to the particular set of contacts which are touched.

The same integrated circuit can also be employed in a remote control circuit which causes it to switch through the various channels successively until the required one is reached.

CIRCUIT

A typical ETT6016 circuit is shown in Fig. 1. The device operates from a 33 volt supply, this being normally the supply used to control the varicap tuning

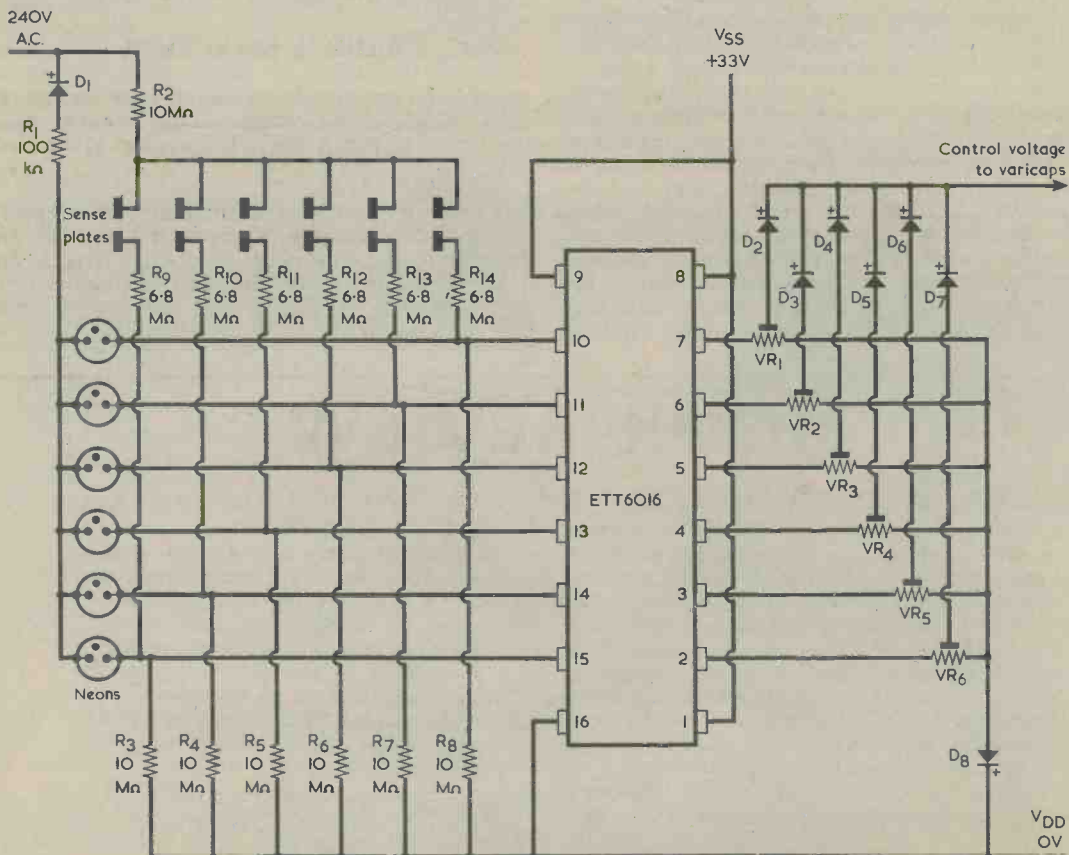

Fig. 1. Typical circuit for an ETT6016 tuning system

capacitors. If this supply is positive, V_{SS} is 33 volts positive and V_{DD} is zero volts, as in Fig. 1. Alternatively, a negative supply can be used in which case V_{SS} is zero volts and V_{DD} is 33 volts negative.

Pins 10 to 15 of the ETT6016 are the "sense inputs" which detect the current flowing through the finger of the operator; they also control the neon bulbs. Pins 2 to 7 provide the voltage outputs to the varicap tuning capacitors.

The $10M\Omega$ resistors R3 to R8 determine the impedance of the sense input circuits. One side of each touch plate is connected via one of the resistors R9 to R14 to the corresponding sense input, and the other side via a $10M\Omega$ protective resistor, R2, to the 50Hz mains or alternatively to a positive supply of a similar voltage.

The sensitivity of the switching system is determined by the value of the resistors R3 to R8 and the value of the alternating voltage at the upper end of R2.

SWITCHING

When the potential between the sense input and V_{DD} reaches 15 volts (equivalent to a current of $1.5\mu A$ through the finger touching the plate) the channel concerned will be latched on and all of the others switched off. The potential of the chosen sense input is switched by a low impedance MOS switch to the value V_{SS} and the corresponding neon will glow.

The alternating mains voltage is rectified by diode D1. The use of a half-wave rectified unsmoothed supply to drive the neons minimises the voltage appearing across the MOS circuit during turn-off.

Potentiometers VR1 to VR6 are set so that each one provides the voltage required by the varicap diode in the tuner unit to tune to the corresponding programme.

Diodes D2 to D7 isolate each channel from the others. D8 is a temperature compensation diode which matches the diodes D2 to D7.

STEPPING SYSTEM

In the circuit of Fig. 1, pin 9 is held at a potential equal to V_{SS} . If a negative-going pulse (relative to V_{SS}) is applied to pin 9 for a period of between $100\mu S$ and $1mS$, the operating channel will be

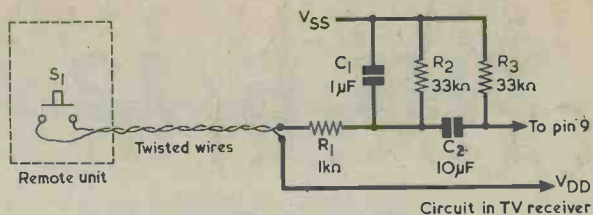

Fig. 2. Remote tuning using the ETT6016. Channels are selected in succession by closing the switch in the remote unit

changed by one step so that the next channel comes into use.

The remote control system shown in Fig. 2 may be employed using a 2-wire link (with twisted wires) and a single switch, S1, in the remote control unit.

The components R1 and C1 act as a filter which removes any spurious pulses due to contact bounce at S1. R2 of Fig. 2 discharges C1 between the channel stepping operations.

The value of C2 determines the length of the pulse applied to pin 9 of the integrated circuit; this capacitor is discharged by R3. The suggested values of $1\mu F$ and $10\mu F$ for C1 and C2 of Fig. 2 may be varied somewhat, depending on the amount and type of contact bounce at the switch contacts.

INITIAL CHANNEL SELECTION

If a $1\mu F$ capacitor is connected between one sense input and V_{SS} , the corresponding channel will be selected when the power is first applied to the circuit. This requires that a steady d.c. sense voltage supply be employed.

Further information and an applications report are available from Hughes Microelectronics Ltd., 12-18 Queens Road, Weybridge, Surrey. Circuits which employ only one touch contact per channel can be used with the ETT6016, but the double contact system shown in Fig. 1 is more reliable.

BOOK REVIEW

A GUIDE TO AMATEUR RADIO, 16th Edition. By Pat Hawker, G3VA. 112 pages, 250 x 185mm. (9 $\frac{1}{2}$ x 7 $\frac{1}{4}$ in.) Published by Radio Society of Great Britain. Price 90p.

One wonders how many British amateur transmitters made their first steps in the direction of their licences with the aid of this well-known publication. Now in its 16th edition, it continues to offer excellent practical advice on passing the licence examinations. And, as always, it gives helpful information on many other aspects of the hobby.

This latest edition has been extensively revised and enlarged to take in latest trends, with particular attention to s.s.b. techniques and semiconductor applications. An entirely new chapter on amateur radio equipment includes a survey of over 160 commercial receivers, transmitters and transceivers. Also provided are full constructional details of two simple transistor receivers and a phone-c.w. transmitter.

A Guide To Amateur Radio is virtually a must for anybody entering the field of amateur radio transmission. It can, if necessary, be obtained direct from Radio Society of Great Britain, 35 Doughty Street, London WC1N 2AE, for £1.14 post paid.

THE 6/12 AMPLIFIER

Part 2

by J. T. Neill

6 watt continuous, 12 watt peak

The circuit operation of this amplifier was described in last month's issue. In this concluding article details are given of construction and setting up.

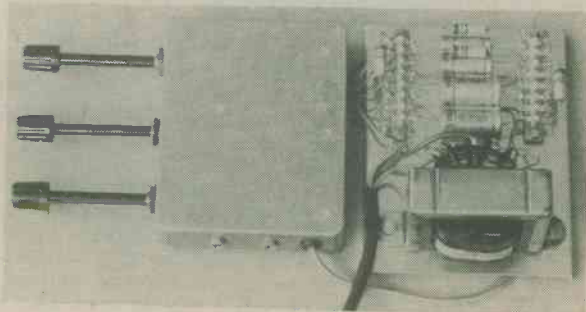

In last month's issue we completed our examination of the circuit functioning of the "6/12" amplifier and its power supply. Also given was the complete Components List for the amplifier and power supply. We next deal with constructional details.

CONSTRUCTION

Leads from the power supply to the amplifier can be up to 18in. in length; there are in fact six of them in all. This total is made up of two positive rails, two negative rails and two earth returns. One of the earth lines (E1 in Figs. 2 and 6, both published last month) is the return from the loudspeaker and the other (E2) is the return from the remainder of the circuitry. This separation of earth lines is necessary to eliminate unwanted coupling between stages arising from large output signal currents flowing in the same impedance as earth currents to earlier stages. Distortion, or even oscillation, can be caused if only one earth return is used. The two earth lines are brought together on the power supply, close to the transformer secondary centre tap, which is firmly bonded to the mains earth.

As the photographs and specification which appeared last month indicate, the "6/12" is very compact. All but the power supply is contained in a robust die-cast box, as specified in the Components List. The two input sockets are on one short side and the output socket on the other. All three controls are on one long side, which means that the internal strengthening rib in the centre of that side will have to be removed. Such a task is easily carried out by means of a *small* cold chisel, followed by filing. Ensure throughout the operation that the box is firmly held in a vice.

The power leads enter through a hole and grommet as shown and terminate at the 6-way tagstrip mounted close to one side of the box. This tagstrip is readily visible in the photograph of the amplifier interior.

The jack sockets are of the insulated variety, with their earth connections insulated from the chassis. The earth return for the output is taken to one tag on the 6-way tagstrip and thence to the earth point on the power supply, via a separate lead as already described. Earth returns from the two signal input sockets are made by joining them together and connecting them to chassis using a solder tag under one of the fixing nuts for the tagstrip. This point is also the chassis connection for the remainder of the circuitry and is taken back to the main earth point on the power supply via the second earth lead.

Both output transistors are bolted to the flat of the box, using a mica washer as insulation between the box and collector. The collector is connected internally to the metal pad visible on one large side of the device. If available, use some silicone grease, or other heat sink compound, on either side of the mica washer. Do not overtighten the nut and bolt used for fixing.

The output transistors have the outlet connections given in the main circuit diagram of Fig. 2. Note that the centre lead is the collector. Both output collectors are joined together, and the output transistors are mounted sufficiently close to each other for this to be done without further wiring. The safety resistor R21 is then used to take the output signal to the appropriate jack socket.

VEROBOARD ASSEMBLY

Most of the remaining circuitry is contained on a piece of 0.15in. pitch Veroboard having 23 holes by 13 strips. The layout used in the prototype is given in Fig. 7, and it is strongly recommended that this be followed. In particular, note that D1 and D2 are so positioned on the board that they lie close to TR2 and TR4 for a measure of temperature compensation, as described earlier. No connection is made to pin 5 of either integrated circuit, and this lead is left clear of the board in both cases.

The Veroboard is mounted on the bottom of the box using two 6BA screws and nuts. For insulation between the box and copper strips on the board, each screw is first held in place with a 6BA nylon nut. A piece of thick cardboard, the same size as the board and with two holes capable of passing over the nylon nuts, is then so positioned that when the Veroboard is dropped into place no contact is possible with the box. The nylon nuts are then in contact with the copper side of the board. Metal nuts may be used on the component side.

Resistors R1, R2 and R3 are wired directly on the input sockets, while some of the resistors and capacitors associated with the tone controls are mounted between VR1, VR2, VR3 and the component board. These are illustrated in Fig. 7. The three potentiometers take up the same relative positions on the die-cast box side as in Fig. 7, i.e. VR3 is in the centre, VR1 is at the input socket end and VR2 is at the output socket end.

All connections to the board, both for components and for other wiring, are made to the correct size Veropins; these are inserted from the copper side and then soldered in place. It will be noted that C7 and R8 in Fig. 7 connect to a Veropin fitted to what is otherwise an isolated copper strip. This Veropin is merely used as an anchor point for the two components and serves no other function.

Detailed construction of the power supply will depend to some extent on the physical sizes of the components used. The layout is in no way critical and can be adjusted to suit individual circumstances. In the prototype a piece of aluminium sheet measuring 5½ by 4½in., with each long side bent down at right angles

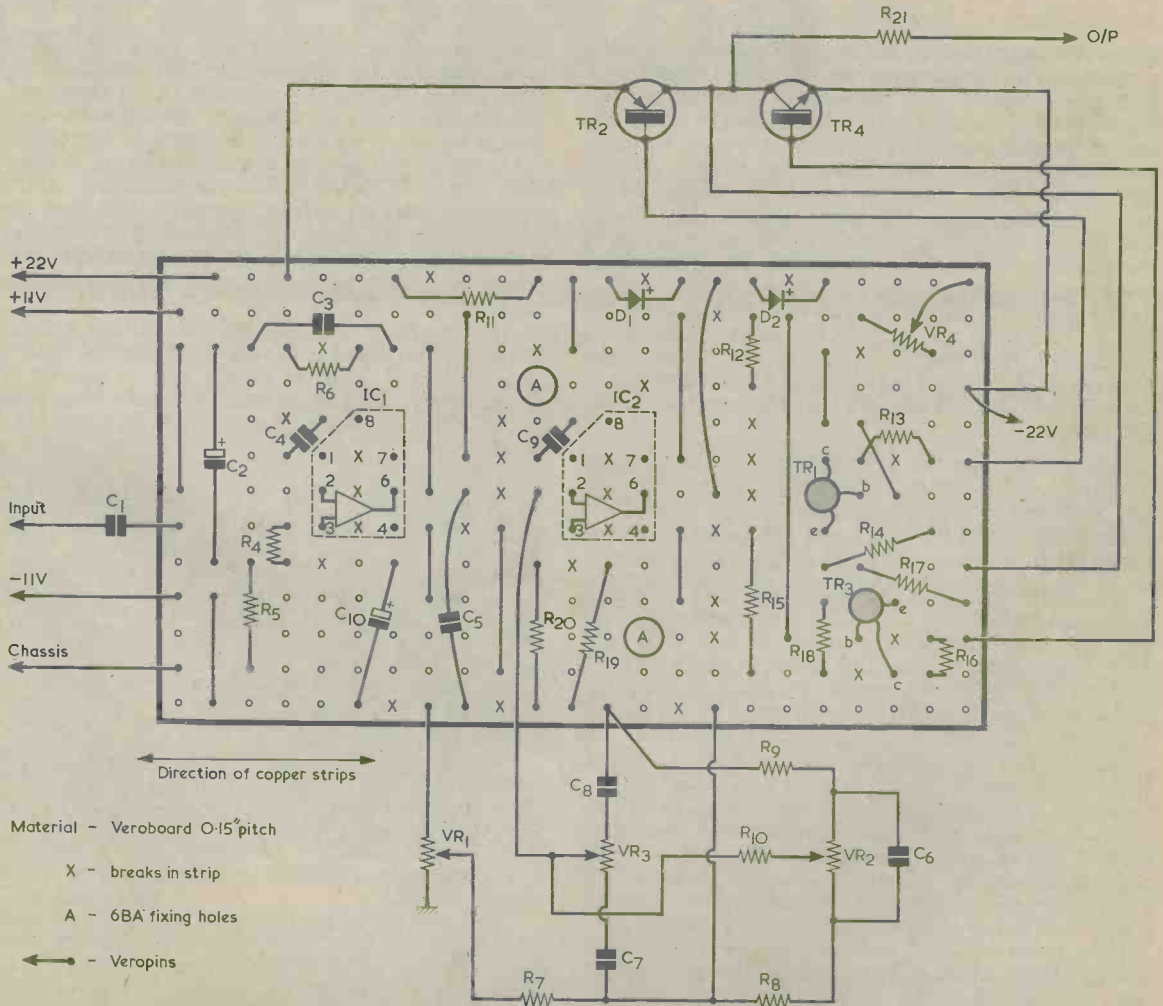

Fig. 7. The component side of the Veroboard panel on which most of the parts are assembled

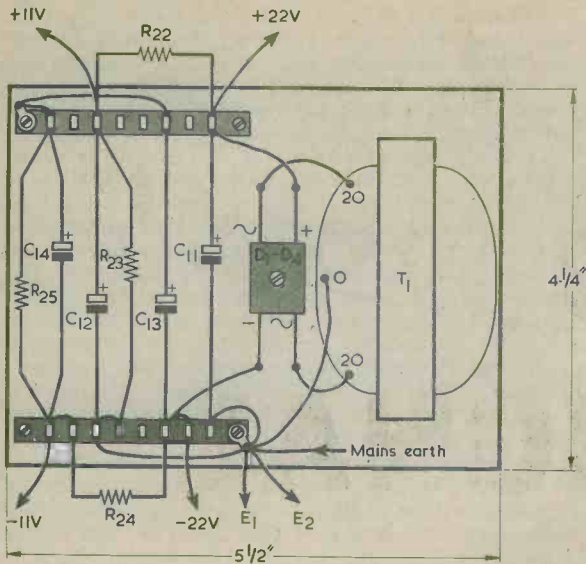

Fig. 8. A suitable layout for the power supply components

about $\frac{1}{4}$ in. from the edge for strength, was employed as a chassis. The transformer was mounted at one end, and the resistors and capacitors located on two tagstrips fixed parallel to the chassis longer sides. The bridge rectifier was a 100 volt 2 amp type in a plastic encapsulation and was fitted, by a bolt passing through its central fixing hole, near the middle of the power supply chassis. The earth point for the E1, E2 leads was a solder tag under a screw securing one of the tagstrips. The mains earth and the transformer secondary centre-tap also connected to this point.

The general layout of the power supply is shown in Fig. 8. This does not include the connections of the mains live and neutral wires to the transformer primary. For 240 volt mains these should connect to the zero volt and 245 volt primary taps, and *not* to the 225 volt tap.

Before connecting the power supply to the amplifier, check its output voltages. Off load, they should be about 30 volts positive and negative and 15 volts positive and negative.

TESTING

When all wiring is complete set VR4 to insert minimum resistance, i.e. fully anti-clockwise. This will result in minimum current through TR2 and TR4. Insert a current reading meter in series with the positive supply to the output stage; a multi-range testmeter set to its highest current range for safety will suffice. Do not connect a load to the amplifier at this stage. Switch on and rapidly note the current reading. It should be about 10mA, ignoring any initial switch-on surge. If it is greater than about 20mA, switch off at once; a fault is probably present and should be located and rectified before proceeding further. With all in order, set the testmeter to a suitable range and slowly increase VR4 until a reading of about 15mA is given; this is the output stage standing current.

If an audio oscillator and oscilloscope are available, inject a 1kHz signal of appropriate level at either input and monitor the output waveform. Set the amplifier gain about half-way and then adjust the oscillator to give about 1 volt peak-to-peak output signal.

Connect an 8Ω load, which may be either a loudspeaker or a dummy load. At the output level present, about 16mW, there should be no crossover (or other) distortion. If crossover distortion is seen it should be cured by a *slight* increase in the setting of VR4, which will give an increased current in the output stage. Without the audio oscillator and oscilloscope it would be best to keep to the 15mA quiescent current. If subsequent listening tests at low levels indicate the possibility of crossover distortion an increase in the setting of VR4, again *slight* only, may be made.

Next measure the standing d.c. voltage present at the output terminal with respect to chassis, both with and without a load. It should not be greater than about 30mV. If it is, a fault is most likely present which either prevents the negative feedback at d.c. from being 100% effective over the tone control and output stage, or a standing d.c. voltage is present at the volume control slider. It is important not to have a large standing d.c. voltage at the output since no coupling capacitor is employed in series with the loudspeaker, nor is one necessary in normal use.

Full power testing can then be carried out. A continuous output power of 6 watts in 8Ω should be available with bursts of 12 watts possible for short periods. These power levels correspond to 6.9 volts r.m.s. and 9.8 volts r.m.s. respectively. Readers who are using a 15Ω speaker or who do not have the requisite test equipment may omit this last test.

Finally, how best to mount the amplifier? Being so small and totally enclosed, room can readily be found for it in most record player plinths in such a position that there is easy access to the three controls. A little more care is called for in locating the power supply but since it is remotely situated no great trouble should arise.

The question of loudspeakers and their enclosures is, as most constructors realise, a subject on its own. In this case, personal choice and cost will largely determine what to use; but be sure that the unit is of a suitable impedance and can handle the power required. ■

WIEN BRIDGE

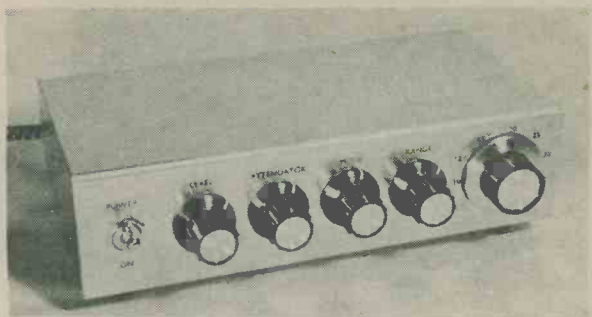

AUDIO SIGNAL GENERATOR

By R. A. Penfold

Offering a continuously variable range from 7.5Hz to 75kHz, this mains powered audio signal generator employs an ingenious method of automatic gain control for its op-amp sine wave oscillator. A second op-amp provides an alternative square wave output.

This audio signal generator is of modern design and incorporates two high gain operational amplifiers. The circuit is based on the popular 748 integrated circuit, and the very high gain of this device allows an extremely pure sine wave output to be obtained. A square wave output is also available. Frequency coverage is continuously variable from less than 7.5Hz to more than 75kHz. There are four ranges and the coverage in each is shown in the accompanying table.

The basic signal output level is approximately 1 volt peak-to-peak on both sine and square wave outputs. A 3-position attenuator provides further output amplitudes of 100mV and 10mV peak-to-peak, and a continuously variable attenuator of the volume control type is also included in the circuit.

A quite compact design has been achieved, and the prototype has outside dimensions of 8 by 4 by 2in., excluding feet and control knobs. The generator is mains powered.

WIEN BRIDGE

The signal generator incorporates a Wien bridge oscillator. The basic circuit diagram of the Wien bridge is shown in Fig. 1. In practical versions of the bridge, R_1 is almost invariably equal to R_2 and C_1 to C_2 . The operating frequency of the bridge is then given by the equation included in the diagram.

At this operating frequency there is no phase shift between the input and output of the circuit, whereas some degree of phase shift occurs at all other frequencies. In a Wien bridge oscillator the bridge is connected between the input and output of an amplifier having a voltage gain of 3 times or more, the gain being necessary to compensate for the losses in the

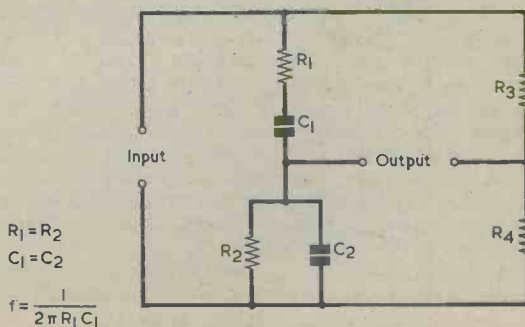

Fig. 1. A basic Wien bridge circuit

bridge circuit. The amplifier must also have its input and output terminals in phase, so that it is positive feedback that is supplied by the bridge.

Fig. 2 shows how an operational amplifier can be incorporated into a Wien bridge oscillator. The Wien bridge network is connected between the output and non-inverting input of the amplifier, and R3 and R4 are not required here as the input impedance of the amplifier is extremely high.

For a pure sine wave output the overall amplifier gain must be just sufficient to maintain oscillation. Otherwise, the Wien network will permit sufficient feedback for oscillation to occur at frequencies other than the central frequency of operation, and this would result in distortion of the output waveform.

In an operational amplifier circuit the gain of the amplifier can be controlled by a potential divider connected between the output and the inverting input. This is given in Fig. 2 by R5 and R6. Theoretically it would seem possible to give these two resistors fixed values which would provide just the right degree of gain, but such an approach is not feasible in a practical circuit. In order to maintain the amplifier gain at just the correct level over a wide range of frequencies it is necessary to resort to some form of automatic gain control.

PRACTICAL CIRCUIT

The full circuit diagram of the audio signal generator is shown in Fig. 3. IC1 is used in the Wien bridge oscillator, and R1, R3 and VR1(a)(b) are the resistors of the Wien bridge oscillator. As VR1(a)(b) enables the two resistive elements of the network to be varied in value it also enables the operating frequency to be varied. By switching the capacitive values (C1 to C8) in the network, four ranges are covered.

The automatic gain control action required to just maintain oscillation is provided by TR1. This is a field effect transistor, and at low applied voltages the devices to source terminals present what is effectively an ordinary resistor, the value of which can be controlled by varying the gate to source voltage. When the gate has the same potential as the source, the drain to source resistance is only a few tens or hundreds of ohms.

The voltage gain of IC1 is equal to the sum of R13,

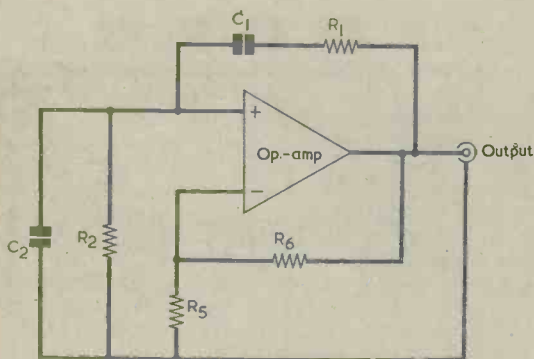

Fig. 2. A Wien bridge oscillator incorporating an operational amplifier

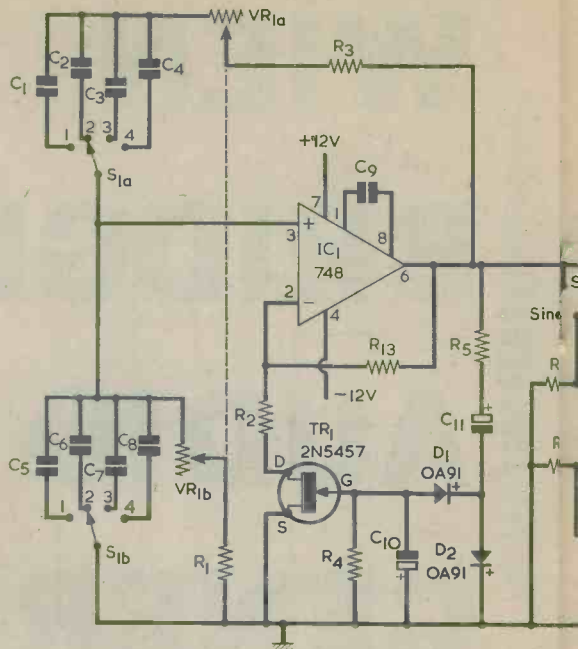

Fig. 3. The circuit of the Wien bridge audio signal generator

Resistors

(All fixed values miniature 1/4 watt 5%)

- R1 680Ω
- R2 27kΩ
- R3 680Ω
- R4 220kΩ
- R5 390Ω
- R6 1kΩ
- R7 56Ω
- R8 100kΩ
- R9 680Ω
- R10 6.2kΩ
- R11 620Ω
- R12 68Ω
- R13 68kΩ
- VR1 10kΩ + 10kΩ dual gang potentiometer, carbon linear
- VR2 1kΩ potentiometer, carbon linear

Capacitors

- C1 2.2μF plastic foil
- C2 0.22μF plastic foil
- C3 0.022μF plastic foil
- C4 0.0022μF plastic foil
- C5 2.2μF plastic foil
- C6 0.22μF plastic foil
- C7 0.022μF plastic foil
- C8 0.0022μF plastic foil
- C9 10pF ceramic
- C10 25μF electrolytic, 10 V Wkg.
- C11 10μF electrolytic, 25 V Wkg.
- C12 1.8pF silvered mica (see text)
- C13 1,000μF electrolytic, 16 V Wkg.
- C14 1,000μF electrolytic, 16 V Wkg.

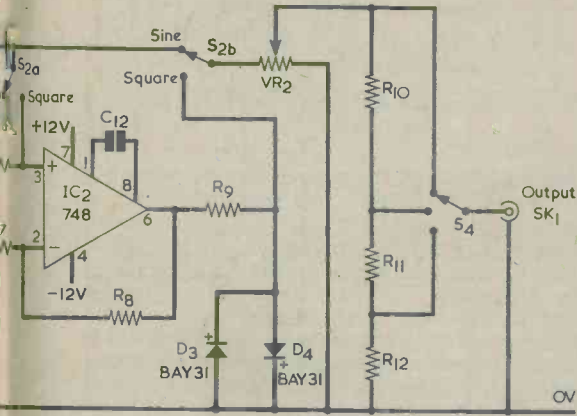
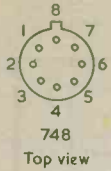

signal generator less the power supply section

TABLE

Signal Generator Frequency Ranges

Range	Frequency Coverage
1	7.5 - 75Hz
2	75 - 750Hz
3	750Hz - 7.5kHz
4	7.5 - 75kHz

R2 and the drain to source resistance of TR1 divided by the sum of R2 and the drain to source resistance of TR1. With TR1 gate at the same potential as its source, this gain will obviously be well in excess of 3, and the circuit will initially oscillate violently. A proportion of the output of the i.c. is fed via R5 and C11 to a voltage doubler rectifier and smoothing circuit consisting of D1, D2 and C10. These produce a negative voltage at TR1 gate which is proportional to the amplitude of oscillation. The negative bias has the effect of increasing the drain to source resistance of TR1, and so it reduces the gain of the amplifier as well. As the amplifier gain reduces so also does the amplitude of the oscillation and thus the negative bias on the gate of TR1, and a point of equilibrium is reached at which the circuit is just gently oscillating.

This a.g.c. action, together with the large amount of negative feedback around the i.c., produces an extremely pure sine wave output. The negative feedback also provides the circuit with a low output impedance.

The a.g.c. action also plays the important role of maintaining the output signal amplitude of IC1 at a constant level.

C9 is a compensating capacitor, and is necessary to prevent IC1 from becoming unstable.

Capacitors C1 to C8 should preferably have a tolerance of 5% or less. Capacitors having wider tolerances will work in the circuit and can be used with some loss in frequency calibration accuracy. It may be noted here that Mullard type 296 polyester capacitors, available in 0.0022 μ F, 0.022 μ F and 0.22 μ F, have tolerance on value of 10%.

COMPONENTS

Transformer

T1 Miniature mains transformer, secondary 9-0-9V at 100mA (see text)

Semiconductors

- IC1 748 in round TO5 encapsulation
- IC2 748 in round TO5 encapsulation
- TR1 2N5457
- D1 0A91
- D2 0A91
- D3 BAY31
- D4 BAY31
- D5-D8 1N4002

Switches

- S1 2-pole 4-way rotary (see text)
- S2 2-pole 2-way rotary (see text)
- S3 d.p.s.t. toggle
- S4 1-pole 3-way rotary (see text)

Socket

SK1 Flush fitting coaxial socket

Miscellaneous

- Chassis, 8 x 4 x 2in. 16 s.w.g. aluminium, with base plate (see text)
- 5 knobs
- 4 rubber feet
- Veroboard, 0.1in. matrix
- Plain Veroboard, 0.15in. matrix
- Veropins for 0.1in. Veroboard
- Mains lead and plug

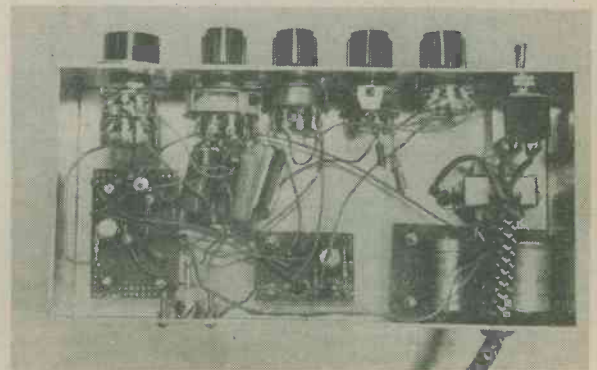

Looking down into the case of the signal generator. This view shows the positioning of the three circuit boards

SQUARE WAVE OUTPUT

Switch S2(a)(b) selects sine or square wave output. When it is in the sine wave position, the output of IC1 is coupled to the output socket by way of the attenuator network. When S2(a)(b) is in the square wave position the output of IC2 is connected to the attenuator network, and the output of IC1 is connected to the non-inverting input of IC2.

As we have already seen, the voltage gain of an operational amplifier can be determined by two resistors coupling back to the inverting input, and these are R7 and R8 in the case of IC2. They cause IC2 to have a voltage gain of about 1,800 times. Obviously, the output of IC1 will only need to swing a few millivolts positive or negative to send the output of IC2 fully positive or negative. The sine wave input signal to IC2 therefore produces an almost square wave signal of about 20 volts peak-to-peak at its output.

This amplitude is far larger than is required and so the signal is fed to a simple clipping circuit consisting of R9, D3 and D4. The diodes are silicon types, and they become conductive at forward voltages a little in excess of 0.5 volt, thereby clipping the signal at about plus and minus 0.5 volt. This provides a square wave output of about 1 volt peak-to-peak, which is about the same as the output level from the sine wave generator. The clipping circuit also improves the shape of the output waveform.

If desired, the rise time of the square wave can be improved slightly by experimentally reducing the value of C12. Care must be taken not to reduce the value of this component to a level which results in IC2 becoming unstable.

The two i.c.'s employed for IC1 and IC2 are type 748 in the round TO5 (or TO99) encapsulation. These are available from several suppliers.

POWER SUPPLY

Fig. 4 shows the circuit of the power supply section. To those unfamiliar with operational amplifier circuitry this may look a little unusual, but it really only consists of two ordinary full-wave rectifier and smoothing circuits. D6, D7 and C13 provide a supply which is positive of the central earth point while D5, D8 and C14 provide a supply which is negative of this central point. Equal positive and negative supplies are thus provided.

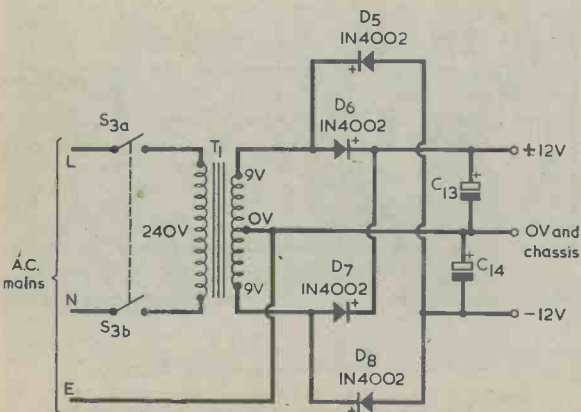

Fig. 4. The circuit of the power supply section

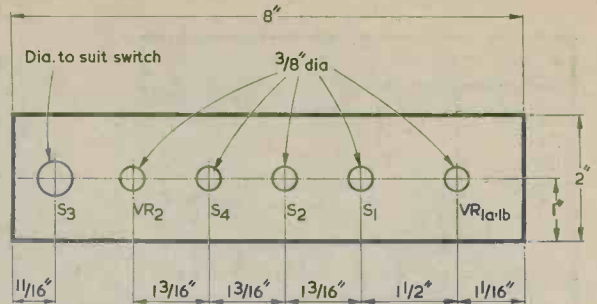

Fig. 5. Drilling details and control layout on the front panel

The ripple content on the supply section output is higher than would normally be permissible for a signal generator, but this does not matter here as one of the advantages of using operational amplifiers is their ability to reject the ripple on their supply lines.

In the prototype, T1 was a miniature mains transformer having a secondary rated at 9-0-9 volts at 100mA. If necessary, a transformer having a 9-0-9 volt secondary rated at a higher current may be employed. For instance, Home Radio list a transformer offering 9-0-9 volts at 300mA.

THE CASE

A suitable housing for the generator consists of an 8 by 4 by 2in. 16 s.w.g. aluminium chassis with base plate, and this may be obtained from H. L. Smith & Co. Ltd., 287 Edgware Road, London, W.2. One of the 8 by 2in. sides is used as the front panel, and the baseplate is used as the lid. The baseplate is a tight push fit into the chassis, and should be secured in place with four small self-tapping screws.

The layout of controls on the front panel, together with drilling requirements, is shown in Fig. 5. This is quite straightforward. The approximate layout of the main components and the three component panels inside the case can be seen by referring to the accompanying photographs. Precise positioning is not essential, but the components and panels should be sensibly placed so that the generator can be wired up easily. Also required are four holes near the corners of the case bottom to take mounting bolts for rubber feet, and holes in the rear panel for the mains lead and the output socket.

CONSTRUCTION

The electrical construction begins with the wiring of the power supply section. The rectifiers and smoothing capacitors are mounted on a plain Veroboard panel of 0.15in. matrix. The layout and wiring on this are shown in Fig. 6. Start construction by cutting down a panel having 16 by 10 holes, and then make the two 6BA clearance mounting holes using a No. 31 drill.

Next mount the components in the positions shown in Fig. 6 and connect up their lead-outs on the underside of the panel. The underside wiring is represented by the broken lines in the diagram. The mounting holes for the panel and for T1 can then be drilled in the bottom of the case. The panel is wired up to T1 secondary before being finally mounted in position. Three 7in. leads are fitted to the panel for the 12 volt positive and negative outputs and the zero volt output. These will later connect to the sine wave oscillator panel.

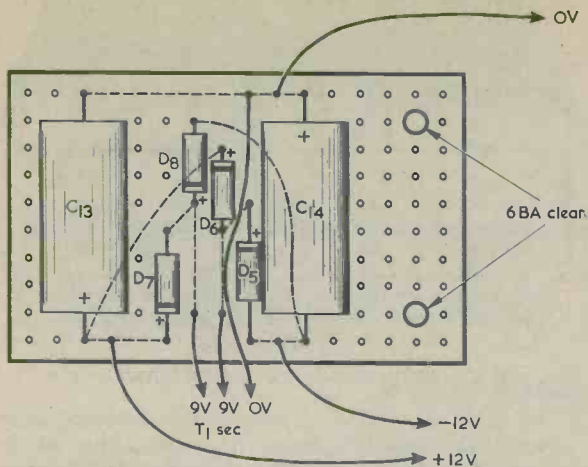

Fig. 6. The power supply components are assembled on a piece of plain perforated board

Use extra nuts over the mounting bolts for the power supply panel so that the wiring on the underside of the panel is spaced clear of the case bottom. To complete the power supply section, wire up S3 to the transformer primary and the mains lead. It is essential that the hole in the rear panel of the case for the mains lead be fitted with a grommet. Also the case must be connected to the mains earth. This is accomplished by connecting the earth wire of the mains lead to a solder tag under a mounting nut for T1.

SINE WAVE PANEL

The sine wave oscillator and squarer circuits are assembled on separate boards. The component layout of the sine wave oscillator panel is shown in Fig. 7. This employs a piece of 0.1in. matrix Veroboard having 21 strips by 14 holes.

When a board of the appropriate size has been cut

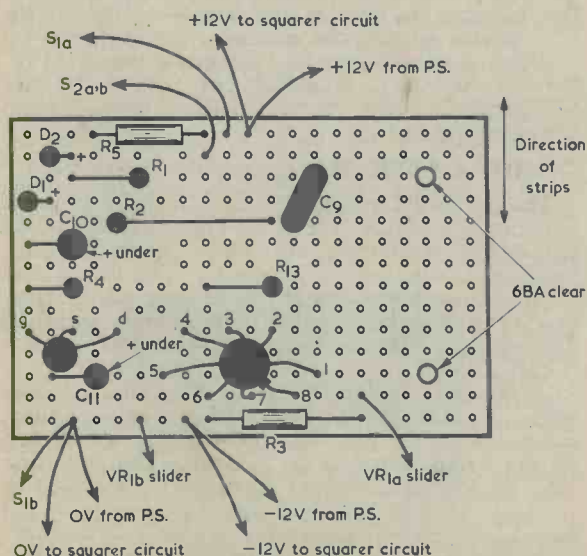

Fig. 7. The component side of the sine wave oscillator panel

out and the two mounting holes have been drilled, all the components can be soldered into circuit. There are no breaks in the copper strips on this board. 0.1in. Veropins are fitted at the points where external leads will connect to the panel.

The board is mounted on the base of the case, behind VR1(a)(b) and with the TR1 end nearer the front. It is spaced off the bottom of the case in the same way as was the power supply panel. External connections are then completed.

In order to reduce the number of interconnecting leads, R10 to R12 are mounted on S4, and C1 to C8 are mounted on S1(a)(b). The controls are wired up to conform with the circuit diagram given in Fig. 3. The 2-gang potentiometer VR1(a)(b) is wired up such that the resistance each section inserts into circuit reduces as the spindle is turned clockwise. S1(a)(b) is a 3-pole 4-way switch with only 2 of the poles used. S2(a)(b) is a 2-pole 2-way rotary switch. In the prototype a 3-pole 4-way switch with adjustable end stop set to give 2 ways was employed, but a standard 2-pole 2-way rotary switch could be used instead. The switch fitted in the S4 position was a 4-pole 3-way component with only one pole used.

SQUARE WAVE PANEL

The squarer circuitry is assembled on a second Veroboard of 0.1in. matrix. This has 11 strips by 16 holes, and its component layout is shown in Fig. 8. It is constructed and wired into circuit in the same way as the sine wave generator panel, and it should be noted that it has six breaks in the copper strips. It is fitted to the bottom of the case near the rear, with the 6BA clear mounting holes nearer the sine wave oscillator panel.

After a final thorough check of the wiring has been completed, the unit is finished and is ready for its initial testing. It is advisable to make a comprehensive check of the control functions to test for possible errors in the control wiring.

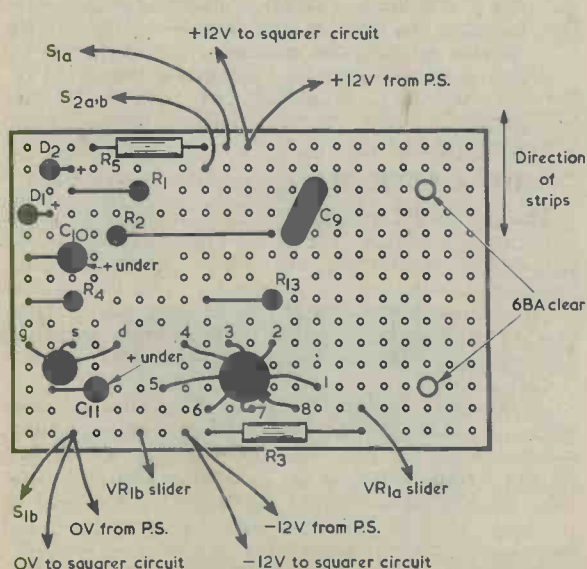

RADIO & ELECTRONICS CONSTRUCTOR

NEXT ISSUE FEATURES OSCILLOSCOPE TRACE DOUBLER

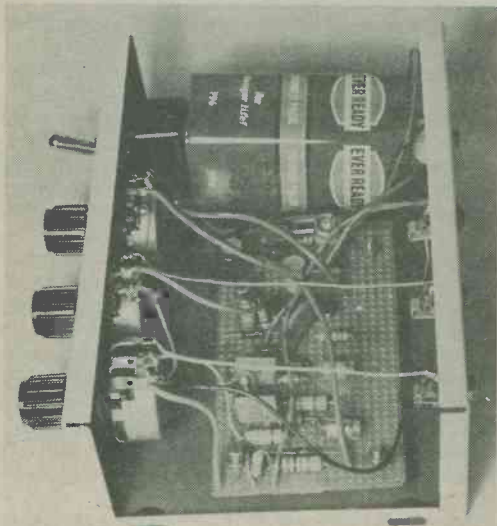

Employing a novel technique, this trace doubler presents alternate inputs to the oscilloscope on each succeeding trace sweep.



HEADPHONE RECEIVER

Describes a simple medium and long wave receiver which can feed a pair of stereo headphones with a mono signal of good quality.

PLUS MANY OTHER ARTICLES EXTRA PAGES

PRICE 35p

Copies may also be obtained direct from the Publishers, 46p including postage. Published by Data Publications Ltd., 57 Maida Vale, London

RADIO & ELECTRONICS CONSTRUCTOR

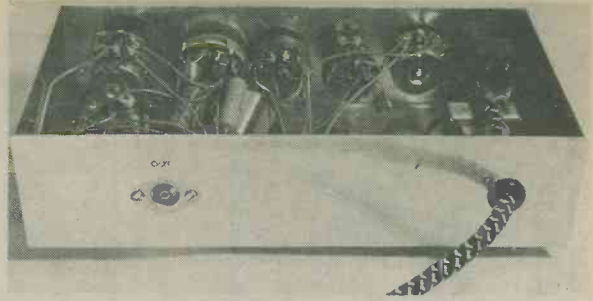

A view from the rear, illustrating the positions of the output socket and the mains lead entry point

CALIBRATION

In order to provide an accurately calibrated scale around the control knob of VR1(a)(b), either an oscilloscope with an accurately calibrated timebase or an oscilloscope and an accurately calibrated signal generator are required. Some form of audio frequency meter could alternatively be used, if available.

It is more than likely that the constructor will not have access to such equipment, whereupon the scale reproduced full-size in Fig. 9 can be traced and used instead. This will indicate approximate output frequencies.

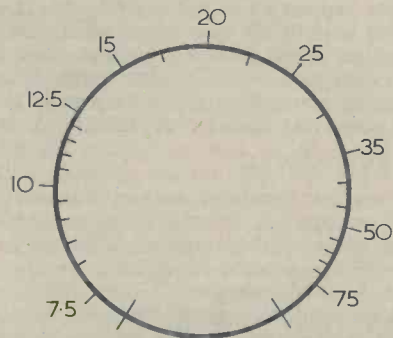

Fig. 9. If frequency calibration equipment is not available the scale shown here can be used to provide approximate calibration for VR1(a)(b). The scale is reproduced full size and may be traced

The generator can be calibrated against an oscilloscope timebase by connecting its output to the Y input of the oscilloscope. With sync switched out the timebase and signal generator will be operating on the same frequency when a stable trace displaying one complete cycle is present on the screen of the oscilloscope.

Calibration against a second signal generator with the aid of an oscilloscope is possible, using the Lissajous figure method.

If the constructor has a musical ear it is even possible to calibrate the unit against a second generator by listening to the output of both and adjusting them to produce the same note. A similar process can be used to calibrate the unit against a musical instrument, except that here the signal generator is adjusted to produce the same note as is played on the instrument and then a table is consulted to establish the frequency of the note. A table showing the frequencies of concert pitch notes was published in the October 1973 issue of *Radio & Electronics Constructor*. ■

CHOOSING THE RIGHT BATTERY

By Vivian Capel



There is usually one battery which is best suited for a particular application. This article demonstrates how the correct battery can be chosen, bearing in mind discharge current, size and economy.

One of the features of transistor circuits is that, being operated at low voltage, they can conveniently be battery powered, and so the majority of commercial products as well as home constructed designs use batteries. The snag is that there seem to be so many battery types and sizes that the constructor in particular can be at a loss as to the best type to choose. The user of commercially built equipment has at least the guidance of the equipment maker, and the size of battery is fixed by the dimensions of the battery compartment, but even here there is a choice of several types.

CELL TYPES

In order to make a knowledgeable choice for the particular piece of equipment we need to power, we should know something of the construction of the various types and how they work. The two main divisions of battery cells are primary cells and secondary cells. Typical secondary cells are those used in car batteries that can be recharged; they are especially suited to provide heavy discharges for sustained periods. Primary cells would be quickly exhausted under such conditions and their use would be very uneconomical.

A familiar sight, the PP9 9 volt battery is the most popular in the Ever Ready range of layer cell types (Photographs courtesy The Ever Ready Company [Great Britain] Limited)



There are several types of secondary cell, but the most common and efficient to date is the familiar lead-acid variety. Disadvantages are weight and the presence of corrosive sulphuric acid which could escape through the necessary air vents if the cell is tipped over. In the early days of battery valve radios, Varley dry and jelly-acid types were popular to overcome the latter problem.

Although not usually considered rechargeable, it is possible to charge primary torch cells to a limited extent, and with escalating costs this appears to be an increasingly attractive prospect. However, charging efficiency is low and the number of recharges limited. Attempted recharging of layer cells, which are also of the primary type, is not recommended.

The modern dry battery is based on the Leclanche cell. In its simplest form the cell employs a zinc negative electrode and a carbon positive electrode immersed in a solution of ammonium chloride, known commonly as sal-ammoniac. A potential difference of about 1.5 volts is produced by the chemical reaction which eats the zinc away in the process, and also liberates bubbles of hydrogen gas. These bubbles form around the carbon and effectively insulate it by preventing contact with the solution, and thus the action of the cell is inhibited. The cell is then said to be polarised, and it must be rested to allow the gas to clear away before it can be used again.

Polarisation is one of the main problems with this type of cell as it restricts the amount of continuous current it can give. The effect is minimised by introducing a chemical such as manganese dioxide as a depolarising agent. This has a strong affinity for hydrogen, and the reaction is for one of its oxygen atoms to combine with a pair of hydrogen atoms to form a molecule of water, leaving manganese oxide in its place. Thus the hydrogen is removed and the only adverse effect is slight dilution of the electrolyte by the generated water. The chemical action, though, takes time, and it is still possible for the cell to become polarised by hydrogen being liberated faster than it can be disposed of if the discharge current is too heavy. So, the effectiveness of the depolariser sets the maximum limit for continuous discharge current.

In a round dry cell the negative electrode is form-



Five 1.5 volt alkaline manganese cells in the Ever Ready range. Of these the most popular are the MN1400, MN1500 and MN2400

ed by a zinc case which contains the electrolyte in the form of paste. With modern cells the zinc is usually surrounded by a steel outer shell to protect equipment from corrosive leakage if a battery is retained after it is exhausted. The positive electrode takes the form of a carbon rod in the centre, around which is packed the depolariser. Between this and the case is a porous container which holds the electrolyte.

SIZES AND RATINGS

Although many different sized Leclanche-type dry cells are made, the voltage remains the same. The reason for this can be appreciated if we consider a large cell to be the same as a small one except for greater surface areas of the electrodes. The large cell may be regarded as two or more small ones connected in parallel, which according to basic theory would give the same voltage but higher current. Thus multi-cell batteries, in which cells are series connected, always have nominal voltages which are multiples of 1.5 volts, such as 4.5 volts, 6 volts, 9 volts and 12 volts.

It follows, then, that the cell size determines the current it will deliver for a specified time. For small cells a suitable unit of capacity is the milliamp-hour, and at first sight it could appear that a 1,000mAh cell will give 1,000mA for 1 hour, 100mA for 10 hours, 10mA for 100 hours, or any other discharge level in proportion. In practice, though, various factors make the time-discharge relationship non-linear, so that in our example the discharge time at 1,000mA would probably be much less than 1 hour, while at 10mA it could be greater than 100 hours. Generally, the heavier the discharge the less the proportional time. The milliamp-hour capacity is therefore specified at one particular rate of discharge or length of time. At other discharge rates the time will be only roughly proportional, and only then if the discharge does not vary too greatly from that specified.

Another factor is whether the discharge is continuous or intermittent. The more intermittent it is the longer the proportionate life, so that a cell which may give 100mA for 5 hours continuous could give the same current for 10 hours if discharged for say half an hour a day, or even longer for half an hour a week. Short usage and long rests give long life, which is why testmeter and doorbell batteries usually last for considerable periods. Makers rarely quote mAh capacity figures and, considering the factors that can influence cell life so considerably, this is understandable.

TORCH CELLS

Capacity, then, is governed by size, which also affects the maximum continuous current before the

cell polarises and the maximum discharge for economical use. Although intended for use in torches, the standard round cells can be used with transistor equipment to give 6 or 9 volts by employing a plastic container or battery holder which houses four or six cells in series. Starting with the largest and using Ever Ready type numbers, the round cells are SP2, SP11, U12 and U16. There are also the two-cell No. 8 torch battery and the No. 800 cycle lamp battery.

Comparing the capacity with cost we find that (at the time of writing) the U12 is about two-thirds the cost of the SP2, yet has only about one-seventh the capacity. The SP11 is only marginally cheaper than the SP2, and has less than half its capacity. From this it can be seen that the larger the cell the more economical it is, and the SP2 is without doubt the best value for moderate discharges in this range of torch cells. Its size and weight could be a disadvantage in small equipment and for low discharges would be unnecessarily large. Normally though it is well worth making room for if possible, but if space is restricted use the SP11 size. The U12 is uneconomical for supplying transistor equipment, and this size should only be used where space is very much at a premium or the discharge current is very low. (See also the later comments concerning highpower cells.) The U16 is more uneconomical for transistor supply purposes and should be ignored except for sub-miniature extra-low discharge applications.

Polarisation is an important factor where continuous operation is concerned. Working from his own and a colleague's experiences with these cells, the author suggests the following approximate maximum continuous currents which the cells will deliver without resting: SP2, 150mA; SP11, 70mA; and U12, 25mA. Higher currents can be obtained for short periods because the cells are in fact intended for use in torches where the discharge is usually of the order of 300mA.

HIGH POWER CELLS

Some applications require high discharge levels for long periods. Battery tape recorders are an example in which the motor can take between 100mA and 300mA, and would soon cause standard cells, especially the smaller ones, to be polarised.

For this and other applications where motors are involved, the high power range has been developed. The

The High Power 1.5 volt cells type HP2, HP11 and HP7. These are particularly recommended for motorised applications where relatively high discharge currents exist





The PP3 layer type battery together with a newcomer, the PP3-P battery. The latter, which is not dealt with in this article, is distinguishable by its gold jacket and gives up to 30% more life in transistor radio applications than does the standard PP3

chemical formula and construction is slightly different, very thin paper separators are used and also a high grade manganese depolariser. This gives fast depolarising and so allows higher maximum continuous currents. These cells are the same size as the standard cells type SP2, SP11 and U12, and can be fitted in their place. Starting with the largest and again using Ever Ready type numbers, they are HP2, HP11 and HP7.

To illustrate the difference between high power and standard cells, it is found that an SP2 will run for about 18 minutes at a current of 500mA before polarising, whereas the HP2 will run at the same current for approximately 3½ hours. At the time of writing they cost about one and a half times more, except the HP7 which is only slightly dearer than the U12. In view of this and also the low capacity of the U12 cell, it is recommended that the HP7 be used for all transistor supply applications in place of the U12. With the other sizes it is, in the author's opinion, uneconomical to use high power cells in place of standard cells for intermittent or low current uses because the overall capacity is about the same and so there is no advantage.

ALKALINE MANGANESE CELLS

Alkaline manganese cells are quite different from the standard or high power cells. Potassium hydroxide is used as the electrolyte, and compressed manganese dioxide forms the positive electrode instead of a carbon rod, and it thus serves as its own depolariser. The voltage is the same at 1.5 volts, but the cell capacity is some five times greater than the standard unit. It can be even higher than that at heavy discharge currents, which as we have seen reduce standard cell capacity considerably, because alkaline cells are specially suited to continuous heavy discharges. Additionally they have a long shelf life, a low internal resistance and are not affected by extremes of temperature.

The Ever Ready type numbers, again starting from the largest torch equivalent size, are MN-1300, MN-1400 and MN-1500. There is also the MN-2400 which is equivalent in size to the U16. At the time of writing, cost is about three times higher than the standard cells except for the MN-1300 which is about five times that of the SP2. There is then a cost advantage

except for the large size which just breaks even. Capacity figures in mA are quoted for these cells, being 10,000mAh for the MN-1300, 5,000mAh for the MN-1400, 1,500mAh for the MN-1500 and 750mAh for the MN-2400.

LAYER-TYPE BATTERIES

These are made up of rectangular Leclanche sections instead of the usual cylindrical cells. They are particularly suited for supplying low to medium current transistor circuits. The 9 volt pack is the most common but 6 volt batteries are also available. Again working from experience, the author suggests the following approximate maximum continuous currents for five of the most common types: PP3, 10mA; PP6, 25mA; PP7, 35mA; PP9, 65mA; and PP10, 150mA. As with the torch cells, the cost-capacity ratio improves as the size increases, so it pays to use the largest that can be accommodated unless the discharge current is to be very low. The PP3 is the least economical and is best used only for miniature low current applications. On the other hand, the PP10 is both large and costly and is not very convenient unless large currents are required.

MERCURY CELLS

Mercury cells use zinc as the negative electrode and potassium hydroxide as the electrolyte, as in the alkaline cells, but the positive electrode consists of compressed graphite and mercuric oxide. Off load the terminal voltage is usually 1.35 volts dropping to 1.2 volts with the rated load. Unlike other types of cell, the voltage remains at a steady level throughout the whole of its life, then drops rapidly below 1 volt when it is exhausted. This is a useful feature where a constant voltage is required. Other features are low internal resistance to the end of its life, no polarisation effects and hence no need for rest periods.

In comparison with the alkaline cells, mercury cells have about 1½ to 2 times the capacity at about twice the cost, so there is little economic advantage. Apart from the small hearing aid type of battery, there are no equivalents to the standard torch sizes.

Probably the most useful versions of the mercury cell for electronic applications are the "button" types, which range from about 8 to 16mm. in diameter with heights of only 3 to 5mm. Capacities of up to 350mAh can be obtained, which is very useful for sub-miniature low voltage low discharge applications such as electronic watches, tie microphones and hearing aids.

SUMMARY

It can be seen that the large variety of batteries is not as bewildering as at first it may appear, since each type has its own applications. We can summarise these as follows. For a supply of 9 volts at less than 100mA intermittent, one of the layer-type batteries is most suitable, normally the largest that can be accommodated. A pack of round cells can be employed for a 6 volt or 9 volt supply, using standard torch types for 150mA continuous or less, or for larger intermittent currents. For continuous currents of 200mA upward the high power versions should be used, but not for short duration use. For longest life and best economy at medium to high discharges, intermittent or continuous, use alkaline manganese cells. As with the layer type, use the largest round cell that can be fitted to the equipment for the sake of economy, and avoid the smallest ones for all except very small current applications. Employ mercury cells for low voltage sub-miniature uses.

SHORT WAVE NEWS

FOR DX LISTENERS



By Frank A. Baldwin

Times = GMT

Frequencies = kHz

Now is the time for broadcast band Dxers to listen for those elusive signals from the East and Far East on the Tropical Bands. In the last issue, mention was made of several such stations that could be logged by the newcomer to the hobby and in this edition more transmissions from this area of the world are listed.

An easy one to start with would be Kabul, Afghanistan, on **4775**. Listen from around 1500 onwards, or, if conditions are good, from 1400 to 1430 when the programme language is English. Kabul radiates the Home Service 1 from 0128 to 0830 and from 1430 to 1730; the Foreign Service is radiated from 1300 to 1430 and the power is 100kW.

Next, try Tibet. Transmissions from Lhasa may be heard on **4035** from 1400 onwards till 1545 when radiating the Home Service in Tibetan providing good conditions prevail. Lhasa may also be heard from 1600 to 1800 when relaying the Radio Peking Hindi Service. Whilst around this area of the dial, try for Huhehot, Inner Mongolia, on **4068**. Listen from 1400 to 1500 when it is relaying Radio Peking's Mongolian Service.

A more difficult one would be Rangoon, Burma, on **4725**. The schedule is from 1100 to 1415 and the power is 50kW, listen from 1400.

Radio Bangkok, Thailand, on **4830** will provide quite a challenge to most Dxers, the channel is a difficult one owing to commercial QRM. The schedule of this one is from 2300 to 1600 and the power is 10kW, listen from around 1430.

Then there is Ulan Bator, Mongolia, on **5053**. To log this one, listen at 2155 when the station opens the evening transmission (evening to us here in the UK but morning to the Mongolians).

CURRENT SCHEDULES

● GHANA

"Radio Ghana — the Voice of the Revolution", Accra, operates two Domestic Services as follows — GBC-1 on **3350** from 0530 to 0805, 1600 to 2305 from Mondays to Fridays; from 0530 to 0900, 1600 to 2305 on Saturdays and Sundays. On **4915** from 0530 to 0805, 1200 to 2305 Mondays to Fridays; from 0530 to 2305 on Saturdays and Sundays. On **5990** from 1200 to 1600. Mondays to Fridays and from 0900 to 1600 Saturdays and Sundays. Programmes are in English and various local dialects.

GBC-2 on **3366** from 0530 to 0805, 1600 to 2305 Mondays to Fridays, from 0530 to 0900 and from 1600 to 2305 on Saturdays and Sundays. On **4980** from 0530 to 0805, 1155 to 2305 Mondays to Fridays; from 0530 to 2305 Saturdays and Sundays. On **7295** from

1200 to 1600 Mondays to Fridays, from 0900 to 1600 Saturdays and Sundays. All programmes are in English.

● ZAMBIA

Zambia Broadcasting Services, Lusaka, has an External Service which operates on Sundays from 0550 to 0715 and from 1050 to 1215 on **11880** and **17895**. From 1650 to 2000 on **6060**, **6165**, **7235** and on **9580**. Sign-on during weekdays is at 1550 on the latter four channels and sign-off is at 2100 Mondays to Thursdays, 2045 on Fridays and at 2030 on Saturdays.

● LIBYA

The "Radio of the Popular Revolution from the Libyan Arab Republic", Tripoli, has a Domestic Service, in Arabic, from 0400 to 2200 on **6185**.

● IRAQ

"The Broadcasting Service of the Iraqi Republic", Baghdad, has a main programme in Arabic on various channels from 0228 through to 2315. Listen from 1000 through to 2300 on **6168**, **7180**, **11785** and on **17770**. The "Voice of the Masses" programme in Arabic is from 0220 through to 2320 on **7225**, on **3952** from 1600 to 1930. The Kurdish programme is from 0258 to 0855 and from 1230 to 2200 on **3243** and **6030**. The Syriac transmission is from 1500 to 1630 on **3195**, the Turkmen programme from 0900 to 1225 on **3243** and on **6030**.

● NIGERIA

The Nigerian Broadcasting Corporation, Lagos, operates a Domestic Service from 0430 sign-on to 2305 sign-off as follows — from 0430 to 1000 and from 1500 to 2305 on **4990**; from 0700 to 1630 on **7255**, most of the programmes being in English.

● MALAYSIA

Radia Malaysia, Penang, on **4985**, is scheduled from 0930 to 1630, from 2230 to 0130 (Sundays through to 1630) and from 0530 to 0630 (Saturdays through to 1630).

● INDONESIA

RRI Jakarta on **4805** nominal (often measured by us on **4804.5**) operates from 1000 to 1600 and from 2200 to 0100, radiating the Programme Nasional.

RRI Medan on 4764 should also be listened for at this time of the year, schedule is from 1000 to 1600.

● LIBERIA

ELWA, Monrovia, on 4770 has a Home Service in English from 0600 to 0815 and from 1530 to 1800 from Mondays to Fridays inclusive. Saturdays from 0600 to 1800, Sundays from 0700 to 1800 and daily from 1900 to 2300. Programmes in West African vernaculars are broadcast daily from 1800 to 1900.

● AFGHANISTAN

Kabul on 4775 radiates the Home Service 1 in Pushto and Dari from 0128 to 0830, from 1430 to 1730 and the Foreign Service from 1300 to 1430 (in English from 1400 to 1430.)

AROUND THE DIAL

Several interesting transmissions have been logged on the 90 metre band, they are listed here in frequency order for the convenience of those who like to explore this part of the spectrum.

● 90 METRE BAND

3200 PLA Fukien, China, talk in Chinese apparently illustrated with short excerpts of Chinese music at 1859 GMT.

3330 Peshewar, Pakistan, radiating their appealing interval signal consisting of a few bars of local music repeated, at 1613. The afternoon/evening schedule of this one is from 1415 to 1810 but has been observed closing as late as 1900 on some occasions. The power is 10kW.

3396 Kaduna, Nigeria, light music Palm Court style with announcements in English at 1834. The evening schedule is from 1630 to 2305 and the power 10kW. From November to April however Gwelo, Rhodesia, operates on this channel with a 100kW transmitter and it is therefore unlikely that the station you will now hear on this channel is, in fact, Kaduna!

3400 Rawalpindi, Pakistan, OM with a talk in dialect in the West Pakistan Home Service which operates from November to February from 1415 to 1620 and from March to October from 1700 to 1800. The power is 10kW and can also be heard in parallel on 4835. Logged at 1613.

3450 Peking, China, a talk in Chinese in the Home Service 1 followed by a rousing choral rendition of a marching song at 2023. Schedule is from 1000 to 1735 and from 2000 to 2200, also in parallel on 4905.

3886 Praia, Cape Verde Is., guitar music with songs and announcements by YL at 1955. This one is listed on 3883 but has, in fact, been on a measured 3886 when observed by us over the past few months. Radio Clube Cabo Verde has an evening schedule from 2000 to 2400 and the power is 5kW.

● 75 METRE BAND

3917.5 Seoul, South Korea, womens choir, local music, OM announcer in local dialect in Home Service 1, at 2040. Seoul operates on this channel from 2000 to 1700; the power is 5kW and, like many 75 metre band channels, is a difficult one owing to the commercial QRM. Several weeks of 'watching' produced this logging.

3925 Delhi, India, OM with a talk in vernacular in

the Home Service programme. Schedule of this well-reported transmitter is from 1330 to 1735, listen for the newscasts in English at 1430, 1530 and at 17.30. Logged at 1607 and the power is 10kW.

HERE AND THERE

● CHINA

A Radio Peking channel not often reported is that of 4460, logged at 2030 when radiating a programme of local music in the Home Service 1. Schedule on this channel is from 1130 to 1735 and from 2000 to 2330.

● NORTH KOREA

Pyeongyang on a measured 6589.5 at 2016, YL with song in Korean, local music, choral songs. This is the Domestic Service, schedule is from 1500 to 1800 and from 2000 to 0830, this being listed as 6600. The service is also radiated in parallel on 6288.5 (measured), listed 6290 and also on 11350 (measured and found correct!).

● CLANDESTINE

Voice of the Thai People on a measured 9422.5 at 1535, OM with harangue in Thai, military music followed by YL with a further harangue. The transmitter is thought to be operating from North Vietnam.

● SOUTH YEMEN

Aden on 11770, OM with a talk in Arabic in the "Voice of the Omani Revolution" programme arranged by the Popular Front for the liberation of Oman. The schedule of this transmission is from 1600 to 1700.

60 METRE BAND

● TANZANIA

Dar-es-Salaam on 5050 at 1932, YL with song in a programme of local pops, all vocals in Swahili. This 20kW transmitter operates the National Service from 0300 to 0700 and the Commercial Service from 1400 to 2015.

● PERU

Radio Atlantida, Iquitos, on 4790 at 0420, typical Andean songs and Altiplano music, identification by OM at 0431. Transmission schedule commences at 0900 and closes, on occasions, at 0600 but the actual sign-off time is extremely variable, even being sometimes noted with a 24-hour transmission period. The power is 1kW.

Radio Samaren, Iquitos, on 4815 at 0433, guitar music, songs in Spanish, announcements by OM, identification at 0445 as "Radio Samaren". The schedule of this one is also variable but in general operates from 1100 to 0500 (sometimes heard as late as 0600). The power is 1kW but beware, has been reported identifying as "Voz de la Revolucion Peruana".

Radio Andina, Huancayo, on 4966, Andean music with plaintive song by YL. This 1kW transmitter operates from 1100 to a variable 0600 (heard as late as 0900 on occasions). Logged at 0457.

Radio Huancavelica, Huancavelica, on 4885 at 0441, songs in Spanish, guitar, announcements and identification at 0445. Schedule 1100 to 0500, power 1kW.

TOUCH SWITCH

By

S. V. Essex

This switch is actuated by touching a contact pad mounted on its front panel. An internal J-K flip-flop allows the controlled circuit to be successively turned on and off at each touch of the finger.

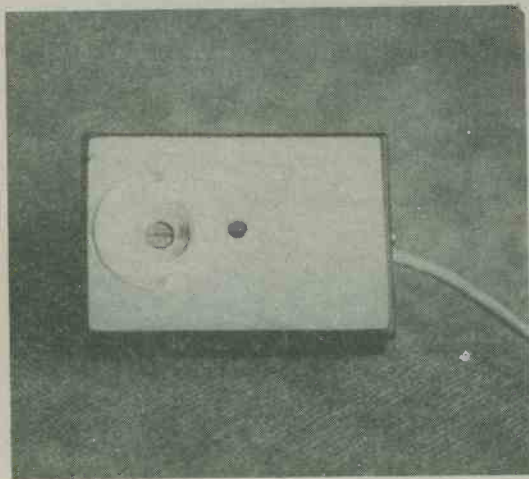

The only parts visible on the front panel of the switch are the touch contact assembly and the light-emitting diode which indicates that the internal relay is energised

This article describes a touch switch which is capable of switching lights or electrical appliances on and off by successive applications of a finger to a pair of metal contacts. It can be used to replace a conventional on-off switch, either as a novelty or where a switch is required which can be operated with very little force or vibration. The touch switch can be built into a wall as a permanent feature or it may be built as a free-standing unit (as was the prototype) if it is inconvenient to incorporate it into the piece of equipment with which it is to be used. Leaving the touch switch permanently connected to the mains is not expensive in terms of electricity costs, as the unit consumes less than 1 watt.

CIRCUIT DESCRIPTION

The circuit diagram is shown in Fig. 1. As can be seen from this, the two touch switch contacts form a break in the circuit between R13 and the positive side of the reservoir capacitor C1. Thus, when these contacts are bridged by placing a finger across them a current will flow through the skin resistance of the finger and through R13. A voltage is then produced across R14 and R15, and this voltage is applied to the base of TR5.

TR5, TR4 and TR3 form a Schmitt trigger, which acts in the following manner. When there is no voltage applied to the base of TR5 this transistor does not pass any collector current, and in consequence no current flows through the base-emitter junction of TR4. Since TR4 is thus unbiased, it does not pass any collector current and its collector takes up a high potential. A proportion of the voltage at the collector of TR4 is applied to the base of TR3 via the potential divider formed by R8 and R10. As a result, TR3 is biased on, causing a voltage to be developed across R9, which is common to the emitter circuits of both TR3 and TR4.

If a voltage is applied to the base of TR5 which is greater than the voltage across R9 plus the base-emitter voltages of TR5 and TR4, TR5 starts to pass collector current, thereby biasing TR4 on. When this occurs the collector voltage of TR4 falls, reducing the bias current applied to TR3. This in turn reduces the collector current of TR3 and lowers the voltage developed across R9, thereby biasing TR4 even further on. The resistor values are chosen to ensure that a regenerative action occurs, so that when the voltage applied to the base of TR5 exceeds a certain level the circuit very quickly changes over from one state (TR4 off and TR3 on) to the other state (TR4 on and TR3 off).

When TR3 turns off, TR2 is biased on. Thus, the "clock" input of the integrated circuit is grounded by TR2 whenever the touch switch contacts are touched. The 7472 flip-flop, IC1, is one of the 74 series of t.t.l. integrated circuits, and is used here because it is cheaper than a flip-flop composed of discrete components. It also simplifies the construction of the touch switch and saves space. The 7472 i.c. is described as a "J-K master-slave flip-flop" and was designed for much more complex circuit applications than the use it is put to here; in consequence most of the input terminals are left unused.

The internal circuitry of the integrated circuit is complicated and it is best to consider it as a circuit "block". There are two output terminals, these being designated Q and not-Q (i.e. Q with a bar over it). One of these is at a high potential and the other is at a low potential. When the "clock" input is grounded, the

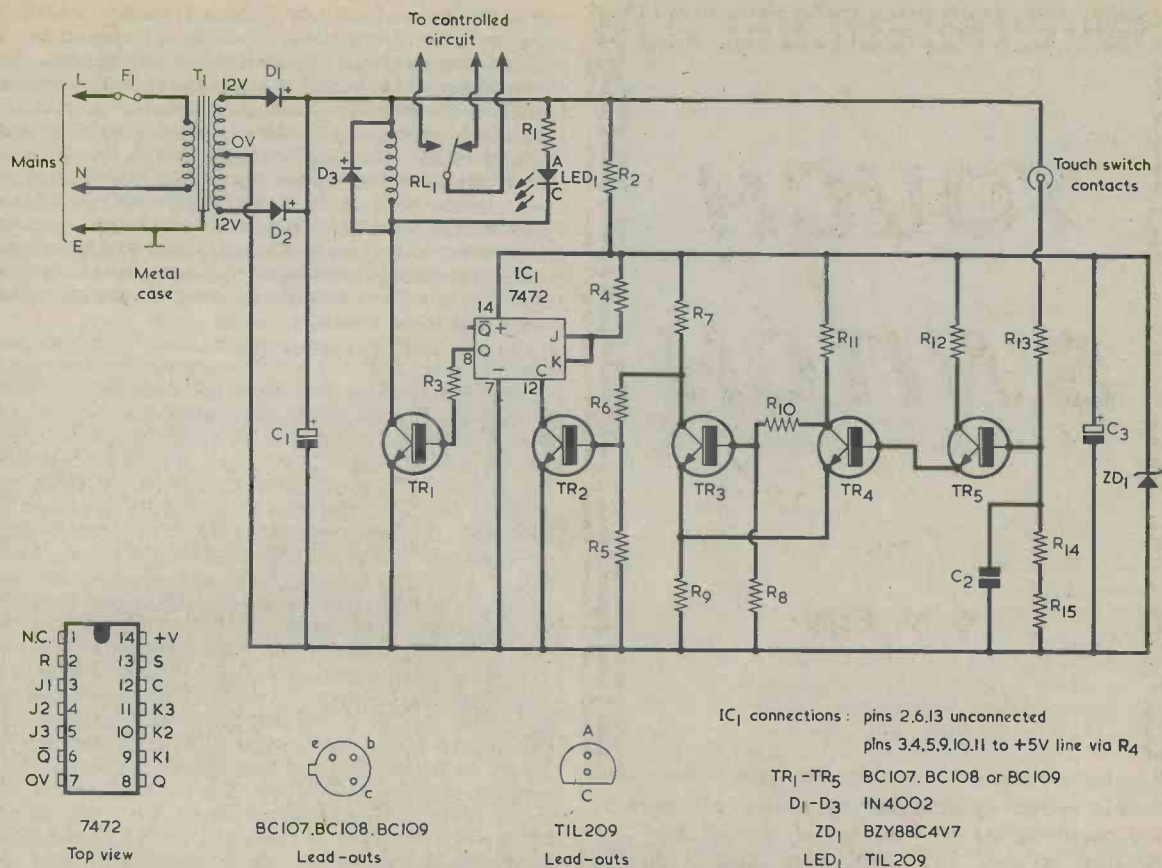

Fig. 1. The circuit diagram for the touch switch

COMPONENTS

Resistors

(all $\frac{1}{4}$ watt 10% unless otherwise stated)

R1 1.2k Ω
R2 560 Ω $\frac{1}{2}$ watt
R3 10k Ω
R4 1k Ω
R5 10k Ω
R6 33k Ω
R7 6.8k Ω
R8 18k Ω
R9 2.2k Ω
R10 22k Ω
R11 10k Ω
R12 100k Ω
R13 1M Ω
R14 10M Ω
R15 10M Ω

Capacitors

C1 220 or 250 μ F electrolytic, 25V Wkg.
C2 0.022 μ F, type C280 (Mullard)
C3 500 μ F electrolytic, 6V Wkg.

Transformer

T1 Mains transformer, secondary 12-0-12V at 50mA,
'Sub-Miniature Mains Transformer, 12V Type',
(R.S. Components)

Semiconductors

TR₁-TR₅ BC107, BC108 or BC109
IC₁ 7472
D₁-D₃ 1N4002
ZD₁ BZY88C4V7
LED₁ TIL209 (with mounting bush)

Relay

RL1 'Miniature Open P.C. Relay', 12V, 1,640 Ω coil,
type 913 (R.S. Components)

Fuse

F1 50mA cartridge, 20mm, with chassis-mounting
fuseholder

Miscellaneous

Aluminium box type AB9, 4 x 2 $\frac{1}{2}$ x 1 $\frac{1}{2}$ in.
Plug and socket assembly type P360 (Bulgin)
Recess plate (see text)
Veroboard 0.1in. matrix, 21 strips by 14 holes
I.C. holder, 14 way d.i.l.
S.R.B.P.
Mains lead and grommet
4 rubber feet
2 cable clamps
Formica
Nuts, bolts, washers, etc.

output that was high goes low and the output that was low goes high. In other words, the two outputs change state every time the touch switch contacts are touched. The Q output terminal is connected to TR1 base via R3, so that when Q goes high TR1 is biased on and energises the relay in its collector circuit. Since the Q terminal changes state every time the contacts are touched, the first touch will energise the relay (assuming it was released initially) and the relay will remain energised until the contacts are touched again, whereupon it will release.

The external circuit which is to be switched is connected to the relay contacts. For safety reasons there is no connection between the relay contact circuit and the circuitry of the touch switch.

Diode D3 is connected across the relay winding to suppress the high back-e.m.f. generated when the current flowing through the winding is cut off. A light-emitting diode, in series with a resistor, is also connected across the relay winding; this indicates when the relay is energised. If the l.e.d. were omitted there would be no way of knowing whether power was being supplied to a piece of equipment, and this could be dangerous if a fault developed in the equipment which prevented it from working. If, for instance, the touch switch was connected to an ordinary light bulb and the bulb failed, without the l.e.d. indication it would be impossible to know if the bulb socket was live or not.

The power supply for the touch switch is obtained by means of mains transformer T1 and rectifiers D1 and D2. C1 smooths the resultant voltage. The nominal 5 volt supply for the flip-flop and the Schmitt trigger is obtained via resistor R2, and is stabilized and decoupled by zener diode ZD1 and C3 respectively.

C2 is connected across the two high value resistors R14 and R15 to remove any alternating voltages which could appear at the base of TR5, and it thus prevents instability. R13 limits the maximum base current of TR5 to a low value. The maximum current that could pass through the finger of the person operating the switch is less than $15\mu\text{A}$.

COMPONENTS

The Components List gives details of the transformer and relay used in the prototype. The relay specified has s.p.d.t. contacts rated at 5 amps at 250 volts a.c. The prototype used an integrated circuit holder to mount the flip-flop; this makes it easier to connect the i.c. into circuit and eliminates the possibility of its being damaged by excessive heat during soldering.

The transistors can be any member of the BC107, BC108, BC109 family. The mains fuse is rated at 50mA, although the actual rating is not important as long as it is not more than 500mA. A 20mm. type was used in the prototype to save space.

The aluminium box type AB9 is available from several suppliers including Home Radio and Electrovalue. Details of the parts employed for the touch contacts are given in the constructional information.

CONSTRUCTION

The touch switch contacts can be either integral with the aluminium box, as in the prototype, or they can be situated some distance away and connected to the rest of the circuitry with wires. These should not be excessively long as there may then be unwanted

signal pick-up, which could affect the operation of the touch switch.

The contacts can be made in a number of ways, and the author of this article tried several alternatives before settling on the method of construction finally employed. Two brass strips taken from old batteries worked well but tarnished rapidly. A piece of Veroboard with alternate copper strips interconnected also worked well at first. However, when a damp finger was applied across the strips some moisture was transferred to the insulating material and formed a conductive path that stopped the switch from working until the moisture had evaporated, a process which sometimes took several minutes.

The method of construction finally adopted is shown in Fig. 2. This uses a recess plate intended for mounting a jack socket, and which is available both from Home Radio and Electrovalue. The hole at the bottom of this is about $\frac{7}{16}$ in. in diameter, and around this there is a round flat "ledge" which is about $\frac{3}{8}$ in. across. A round piece of aluminium with a diameter of $\frac{3}{8}$ in. and having a $\frac{3}{8}$ in. hole in its centre is placed on this ledge and forms one of the touch contacts (it does not matter which one). The aluminium piece can be made by drilling a $\frac{3}{8}$ in. hole in a piece of aluminium sheet, this hole then being used as the centre for a $\frac{3}{8}$ in. chassis punch. This will punch out a bent piece of aluminium. The aluminium is then flattened in a vice and any slight imperfections are cleared with emery cloth. Rubbing lightly over the surface with the emery cloth will also give a matt finish and improve the appearance of the aluminium. The piece fits into the bottom of the recess plate and is secured by two 6BA countersunk screws. These also secure, below the recess plate; a round piece of s.r.b.p. ("Paxolin") which has a diameter of about 1in. A 2BA cheese-head screw, whose head forms the centre touch contact, is fitted to the centre of the s.r.b.p. piece. The s.r.b.p.

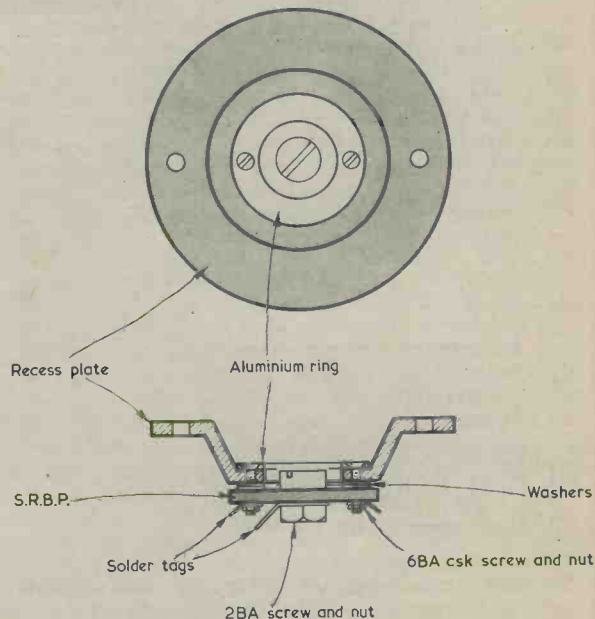

Fig. 2. Details of the touch contact assembly

item is spaced off from the bottom of the recess plate by washers on the 6BA bolts so that the top of the 2BA screw is just a little lower than the surrounding aluminium ring. The finger's natural curvature will then bridge the two contacts without the finger needing to be pressed hard. All screws used in this assembly should be nickel or chromium plated to prevent tarnishing. Their lower ends should not protrude excessively below their nuts.

Because there is nothing but air between the two contacts at the level where the finger touches them, this contact design eliminates the drawback which was evident with the Veroboard. The recess plate requires a 1½ in. hole in the surface to which it is mounted and this can be made with an Octal valveholder chassis punch. If the recess plate is fitted in the same box as the remainder of the components, as occurs with the prototype, great care *must* be taken to ensure that all parts of the contact assembly and its connections are well clear of the circuitry, including in particular the mains connections to the transformer and the relay contacts. It should be mentioned here that the metal frame of the relay specified is common with its moving contact. When a metal box is used it must be connected to the mains earth.

Because, as just stated, the relay frame is common with its moving contact, it cannot be bolted direct to the metal box. It requires an insulated mounting and this is provided by the s.r.b.p. piece shown in Fig. 3. The relay is secured to this by means of two short 8BA bolts and nuts, with the bolt heads underneath. The s.r.b.p. piece is then in turn secured to the case with 6BA bolts and nuts. Spacing washers are fitted on the 6BA bolts to ensure that the 8BA bolt heads are well clear of the inside surface of the case. The tags of the relay should be well below the undersurface of the case top when this is fitted. If necessary, they can be cut down slightly.

METALWORK

The aluminium box may next be prepared, but it will be found helpful to first drill the two 6BA clear holes in the Veroboard, as indicated in Fig. 5. The board may then be employed as a template in ensuring precise positioning of the corresponding holes in the box. The s.r.b.p. item of Fig. 3 may be similarly employed as a template when marking out its securing holes. Before drilling any holes in the box, the layout diagram of Fig. 6 and the photograph of the box interior should be studied to obtain a general idea of component layout.

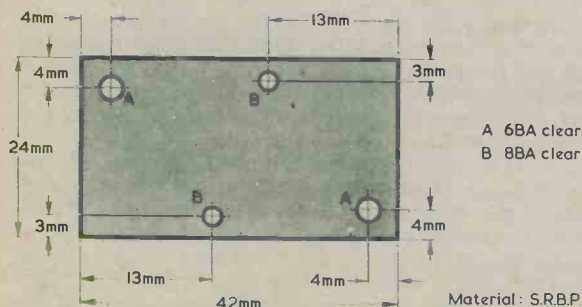
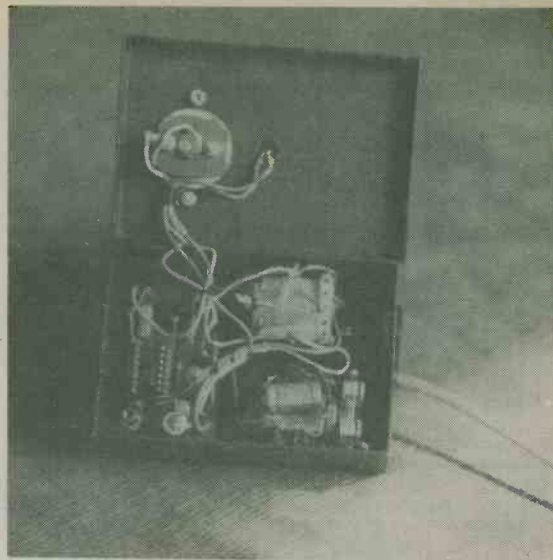

Fig. 3. The relay is mounted on an insulating plate having the dimensions shown here



The components and Veroboard assembly inside the metal box. As is explained in the text, the touch contact bolts, with advantage, be orientated through 90°.

Fig. 4(a) shows the holes required in the base of the box as seen from below. The mounting holes for the Veroboard and the relay insulated mounting plate are indicated. The remaining three holes are for the mains transformer and the mains lead clamp. Also required are four holes for rubber feet. These are not shown in the diagram.

Fig. 4(b) shows the holes required in the top, as seen from above. The recess plate requires two 6BA clearance holes, but these are not indicated. In the photograph of the box interior, it will be seen that a line drawn through the 6BA bolts of the touch contact assembly runs parallel to the length of the box. An increase in clearance from the relay is given by having the line drawn through the 6BA bolts run parallel to the width of the box, and this is recommended. The two 6BA clear holes in the box top for the recess plate can then be marked out, using the recess plate as a template. The other hole in the lid is for the l.e.d. and this should have a diameter to suit the mounting bush employed.

Only one short side requires holes and these are shown in Fig. 4(c). The large hole is for the panel-mounting section of the P360 plug and socket assembly, and the smaller hole is for the grommet through which the mains lead passes. A hole slightly larger than ¼ in. diameter may be made here if necessary.

The touch switch in use. Here, it is controlling a small table lamp

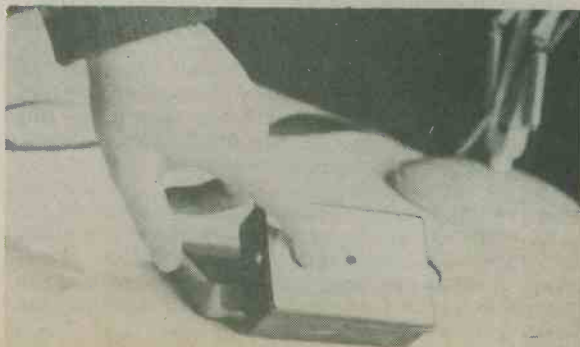

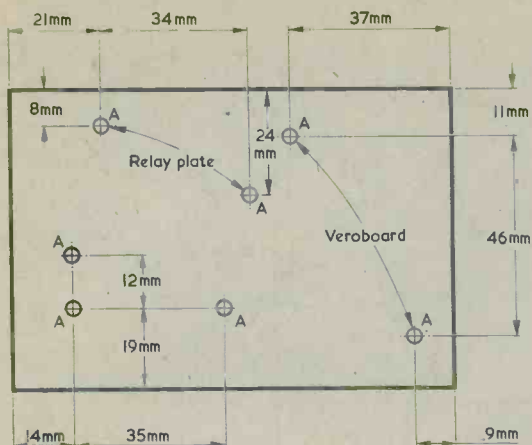

A: 6BA clear

(a)

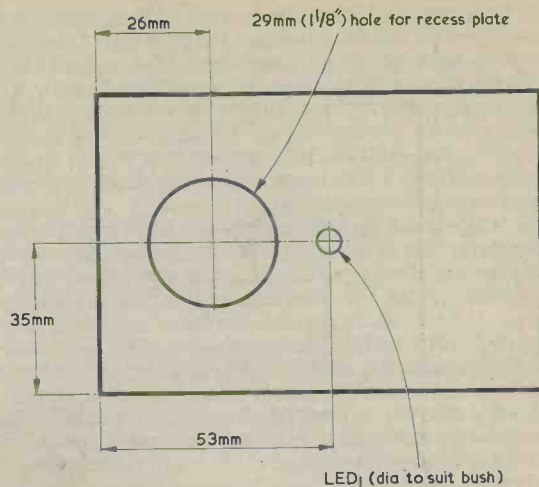

(b)

Fig. 4(a). Drilling details for the box base, as seen from below (b). The holes required in the top for the light-emitting diode and the touch contact assembly (c). Two holes are needed in the short side through which the mains lead passes

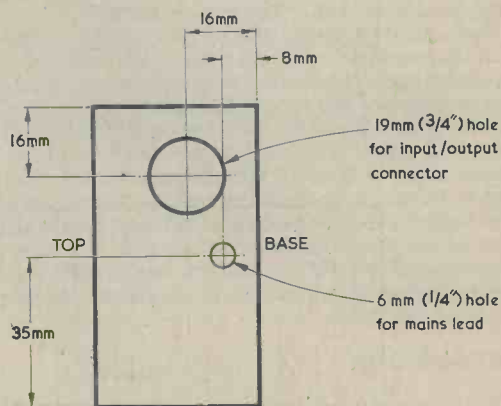

(c)

VEROBOARD

The component and copper sides of the Veroboard are shown in Fig. 5. This will already have its 6BA clear mounting holes drilled, and the next process is to cut the copper strips at the points indicated. The components may then be soldered in place. Note that R14 and R15 are connected together by a "mid-air joint" off the board. An integrated circuit holder is soldered to the Veroboard, the i.c. being fitted into this after all soldering is completed. No force should be used when inserting the i.c. as the pins are easily bent.

Flying leads of thin insulated flexible wire leave the board at the points indicated to connect to external components. These leads can be fairly long at this stage, being cut to the required length later. Leads to the l.e.d. and touch contacts need, however, to be long enough to allow the top to be held alongside the box when the box is open. These leads may be held by a clamp under one of the nuts securing the recess plate. The light-emitting diode mounting bush is first pressed into the hole provided and then the diode is gently pushed into place. Care must be taken not to bend the

l.e.d. lead-out wires too close to the body, and the connections to it should be kept clear of the case and of each other.

The assembled Veroboard is mounted on the case bottom with 6BA nuts and bolts, spacing washers being fitted over the bolts to space the Veroboard away from the inner surface of the case. The mains transformer is secured in the position indicated in Fig. 6, the fuseholder being held under one of its mounting nuts. A solder tag is fitted under the other mounting nut and the earth wire of the mains lead is soldered to this, thus earthing the transformer core and the metal box. The mains lead is secured inside the case by the clamp shown.

D1, D2 and C1 are mounted on top of the transformer. Diode D3 is wired across the relay coil tags. Take care to ensure that all three diodes are wired in correctly. Damage will result if any diode is connected wrong way round. The three contact tags of the relay are wired to the three pins of the P360 plug.

As a final point, a piece of Formica was glued to the top of the box with the prototype. This enhances its appearance and provides a surface around the touch contacts which is easy to clean.

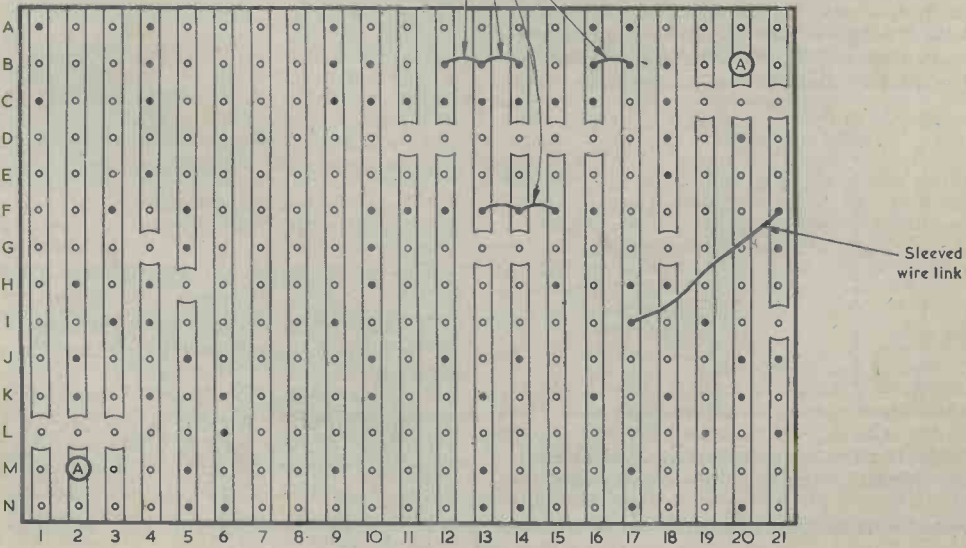
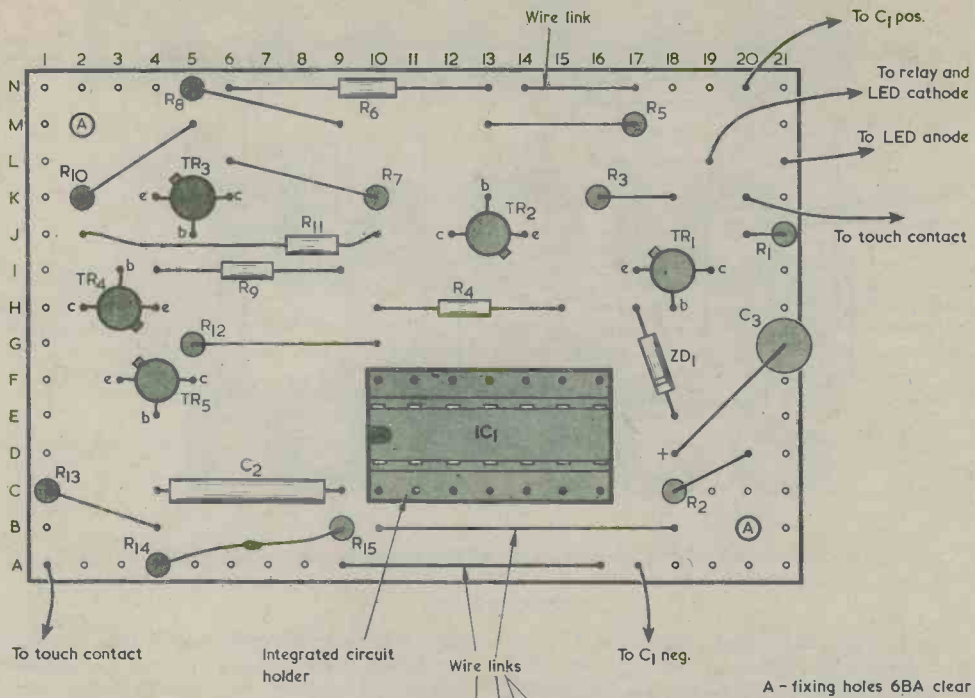

Fig. 5. Component and copper sides of the Veroboard assembly

SENSITIVITY

The prototype touch switch was extremely sensitive and would operate if the resistance presented to the contacts was as high as 30MΩ. It was found that young people needed only the lightest of touches to operate the switch, whilst older people had to press the contacts harder due to their higher skin resistance.

A quirk of the circuit is that the relay energises for a split second when the touch switch is first supplied with power. This is not bothersome, in fact it is quite useful as it supplies a click to confirm that the circuit has indeed been turned on. Also, the relay clicks when the power to the circuit is removed.

Although no steps have been taken to ensure that the touch switch always starts with the relay de-

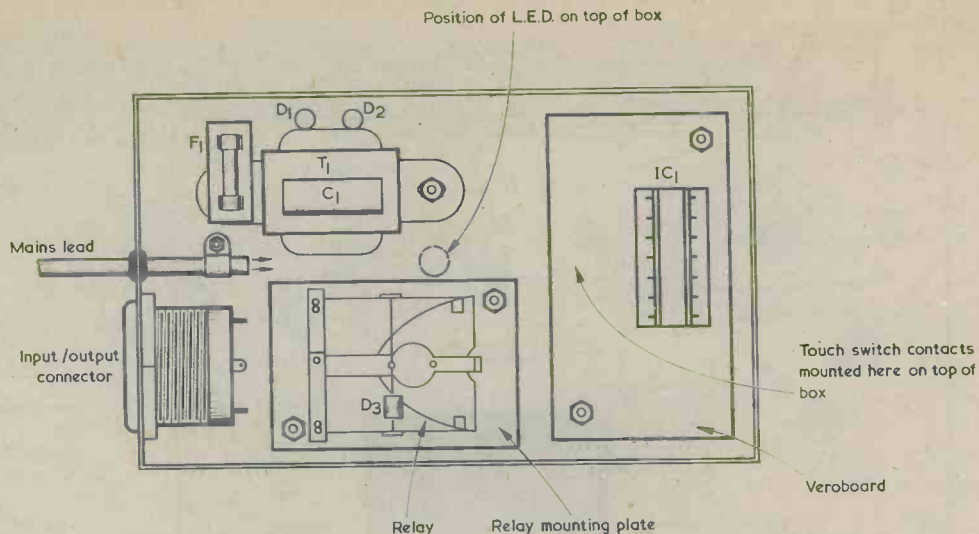

Fig. 6. The layout of the various parts of the touch switch in its aluminium box

energised (apart from the brief instant just mentioned) the prototype has always done so, even when several different integrated circuits have been tried. If an i.c. is employed that habitually starts off in the

state where Q is high, and if this is considered undesirable, the resistor R3 could be connected to the non-Q output. One would expect that the i.c. would start off in one state for 50% of the time, and in the other state for the other 50%, but this does not (luckily) seem to happen.

In simple switching arrangements the connections to the relay contacts should be made such that the circuit is fail-safe; i.e. if a fault develops in the touch switch and the relay de-energises, no power is applied to the appliance being switched. This will then also be the case if the power supply to the touch switch fails.

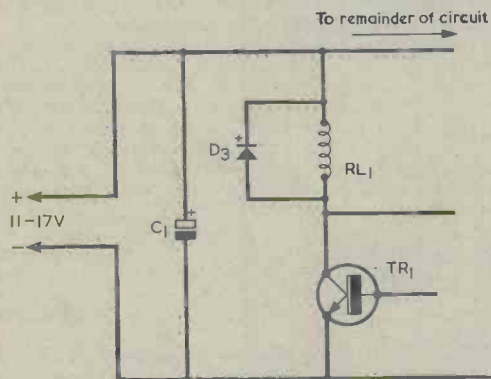

Fig. 7. The touch switch can operate from a low direct voltage by applying this direct to C1

BATTERY OPERATION

The touch switch can be operated from a 12 volt battery supply as shown in Fig. 7. Here, the transformer and rectifiers D1 and D2 are omitted, and the supply connects directly to C1. This makes operation feasible in a car, or where the touch switch needs to be independent of the mains supply. The circuit will work with any power supply voltage between 11 and 17 volts provided the voltage is fairly stable. It is important to ensure that the supply polarity is correct.

BACK NUMBERS

For the benefit of new readers we would draw attention to our back number service.

We retain past issues for a period of two years and we can, occasionally, supply copies more than two years old. The cost is the cover price stated on the issue, plus 11p postage.

Before undertaking any constructional project described in a back issue, it must be borne in mind that components readily available at the time of publication may no longer be so.

We regret that we are unable to supply photo copies of articles where an issue is not available. Libraries and members of local radio clubs can often be very helpful where an issue is not available for sale.



RADIO TOPICS

By Recorder

Metri-cation in dimensions isn't of course a great problem and the millimetres and centimetres gradually creep up on us, to be absorbed gently into the body electronic. Not without a bit of indigestion, though.

Take integrated circuits for a start. When the first dual-in-line i.c.'s appeared, someone had the nice standardising idea of having the pins spaced out at 0.1in. intervals, with the two lines of pins separated by 0.3in. What, on the face of it, could be more sensible and straightforward?

MILLIMETRE SPACING

But, alas, we should say nowadays that the pins are spaced, along the line, by 2.54mm., and that the two lines of pins are spaced away from each other by 7.62mm. We should be thinking of Veroboard not in terms of 0.1 and 0.15in. matrix, but as 2.54 and 3.81mm. matrix. We don't do this, of course, and it will probably be a very long time before those 0.1 and 0.15in. Veroboard dimensions finally disappear from the scene.

There are a few other inch dimensions that will remain with us for quite a while yet. Jack plugs afford a good example, coming as they do in 25mm., 35mm. and $\frac{1}{2}$ in. Control spindles still appear at $\frac{1}{4}$ in. too, and the holes we bash out in front panels for most of them remain at $\frac{1}{4}$ in. Cartridge fuses give quite a motley mixture, the popular sizes being $\frac{1}{8}$ in., 20mm., 1in., and $1\frac{1}{2}$ in. Loudspeakers cling tenaciously to their inch dimensions, as also do television picture tubes.

This intermixture of millimetres and inches is not, surprisingly, a new thing. From the early days of Mullard

valves, a section of the then inch-orientated industry had to deal with millimetres. This is because all Mullard products were dimensioned in metric units to allow interchange of drawings with the Philips plant at Eindhoven. Nowadays it is the millimetres which predominate, whereas in those days it was the inches.

VEROBOARD DESIGN

Talking of Veroboard, this material certainly lends itself both to quick and to more leisured design work. If you want to knock up a circuit in a hurry, a good approach is to use a fairly narrow long piece of Veroboard, with the strips running across the width. This offers a good quantity of individual strips or connection points and you can connect to these as you go along, building up the circuit. The technique involves the use of link wires for carrying earth and supply rails along the length of the board, but this is no great snag.

What I like doing better, however, is to make a more detailed and considered layout, using as little of the Veroboard as is reasonably possible. The design can be worked out on paper first, employing squared paper as is found in children's exercise books. Simply draw lines in ink to represent the copper strips and then work on in pencil, so that errors or layouts to be changed can be easily rubbed out. It is then a matter of ensuring that such things as transistor leads fit neatly into position, with TO5 and TO18 device leads passing into three holes in a triangular layout, the leads of TO92 devices passing into three holes in a row, and so on. Breaks in the strips can be marked on the paper with crosses.

When the pencil layout is complete it can be inked in, and the actual work of cutting the copper strips at the right points and of then soldering in the components can start.

It is usual to drill out a couple of the Veroboard holes to take 6BA mounting screws, and it is always advisable to isolate these holes from the rest of the circuit by cutting the strips on either side. It is advisable also to provide isolation for the two neighbouring strips at each hole, these being cut at corresponding points to ensure that there is no risk of short-circuit to a 6BA mounting nut or washer. If you're really pushed for space a useful tip is to simply drill out the mounting holes and then employ 6BA nylon nuts and bolts. These are available nowadays for just a few pence only.

The satisfaction to be obtained from achieving a really neat Veroboard layout is akin to that of correctly solving a difficult crossword puzzle. You have to obtain the desired final answer within the constraints imposed by the Veroboard strips or the lines in the puzzle.

VARICAP TUNING

Varicap tuning of u.h.f. TV tuner units is now becoming the order of the day. Instead of having the usual ganged tuning capacitor inside such units, each section is tuned by a varicap diode. Probably the greatest advantage afforded by varicap tuning is that the tuner unit can be fitted anywhere inside the TV receiver cabinet. With variable capacitor tuning it has to be mounted in a position which allows the capacitor spindle to be mechanically adjusted from the

front of the receiver.

Varicap diodes are of course reverse biased silicon diodes whose capacitance decreases as the reverse voltage across them increases. The tuning control then becomes a potentiometer, or one of a bank of pre-set potentiometers selected by a switch or touch-button system.

There is no reason why the r.f. and oscillator circuits of a TV receiver should not be assembled with the remainder of the circuit on a common chassis, as occurs with the corresponding stages of, say, a short wave communications set. But ever since the advent of multi-channel television, design thinking has almost always made the tuner unit a separate entity on its own. Two separate entities, indeed, in many of the 405/625 line receivers!

The TV receiver tuner unit has always had problems which do not appear in other parts of the receiver. To begin with, it operates at much higher frequencies and one of the greatest difficulties in tuner design is to reduce oscillator frequency drift. This was particularly the case with TV receivers employing valves, which generated much more heat than their semiconductor successors.

Because of factors such as these, tuner unit design became a speciality, and still remains so today. The result is that the tuner unit occupies its own little box, with aerial input, i.f. output and supply connections passing to it conveniently. And also, in its latest form, a reverse tuning voltage for its integral varicap diodes.

WIPER DELAY UNIT

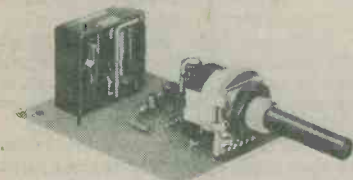

The Variwipe, an automatic windscreen wiper delay unit introduced by Scientronics. Two versions are available, allowing connection into all types of wiper motor switching likely to be encountered.

The above photograph illustrates the "Variwipe", a windscreen wiper delay unit recently introduced by Scientronics. The parts for this unit are assembled on a printed circuit board measuring 50 by 63mm., and there are a maximum of four connections to the car electrics. The unit can be mounted by means of a single hole behind the car's dashboard. Alternatively, it can be fitted inside a black case and mounted at any other convenient position.

Scientronics state that whilst the principle of an electronic unit for

windscreen wiper delay is not new, their solution is. The main problem in putting a unit of this nature on the market is the apparent wealth of variations in types of windscreen wiper motors and switches in different cars. There are, however, basically four variations only, and the instructions provided with the Variwipe enable these to be identified and the appropriate connections made.

Two versions of the Variwipe are available. The "ST" version is for the older type of car which uses a single-throw switch with two wires for the motor. The second, "DT", version is for cars with a changeover switch and three wires. The "DT" unit can be employed as a replacement for the "ST" version.

The Variwipe is switched off by turning the potentiometer fully clockwise. To turn it on, the potentiometer is turned sufficiently clockwise to operate its switch. The wipers then give an immediate wipe. At this setting the timing delay is about 50 seconds between wipes. When turned fully clockwise the delay is at its lowest, with only about 2 seconds between wipes.

To operate the Variwipe the control is turned on to give the immediate first wipe. When the desired time interval has elapsed the potentiometer is advanced until another wipe is given. Successive wipes will then occur automatically, with the same time interval as that between the first two wipes.

Further details are available from Scientronics, 40 High Street, Somersham, Huntingdon, Cambridgeshire, PE17 3JA.

OH DEAR

I am indebted to J. A. Egerton of Crewe for the following.

Q. What sort of telegram would you send to a duck?

A. A coax cable.

U.H.F. CRYSTALS

I note that the Marconi Research Laboratories of GEC-Marconi Electronics have just achieved a major breakthrough in crystal technology. They announce the development of quartz crystal controlled oscillators having fundamental operating frequencies of 1GHz, or 1,000MHz. This has been achieved by using surface acoustic waves (SAW) on quartz crystal substrates rather than the bulk acoustic waves employed in traditional crystal oscillators.

The 1GHz SAW oscillators are capable of being frequency modulated, making them suitable for telemetry. They are also expected to find wide applications in signal processing systems. The high spectral purity achieved by using the high fundamental frequency and the overall ruggedness of the SAW units could permit their use in applications which cannot be undertaken by bulk crystals.

Measurements of short term stability of the SAW oscillators have shown them to be comparable with bulk crystal oscillators. The devices exhibit parabolic frequency — temperature characteristics similar to those of BT-cut bulk crystal oscillators. Also, the zero frequency temperature coefficient point of these characteristics can be varied between -20°C and $+70^{\circ}\text{C}$ by using different cuts of quartz crystal.

SOLDERING

Perhaps the most important ability the home constructor has to acquire is that of good soldering. These days there is hardly any skill to it at all because wires, component lead-outs and tags are, in almost all instances, given a finish which permits instant tinning and soldering. The newcomer to the hobby is strongly advised to obtain a little practice with odd pieces of wire and spare tags before embarking on a constructional project. This advice is not intended to give discouragement, since 15 minutes practice is about all that is required to attain the knack of adequate soldering. When the molten solder flows over the surfaces of both items being joined, then you know that you are making a good joint. The iron can be removed as soon as this flow is observed. And, of course, it is essential to use a proper rosin-cored solder. Never use paste or liquid flux.

The standard solders employed for electronic work are described as "60/40", which infers that the solder is an alloy of 60 parts by weight of tin to 40 parts by weight of lead. Ersin "Savbit" is very nearly the same as 60/40 solder except that a small proportion of copper is included in the alloy. This helps to prevent migration of copper from the soldering iron bit, and extends its life.

The 60/40 solder alloy does not solidify immediately as it changes, on cooling, from the molten to the solid form. At about 188°C the solder goes into a "pasty" state, and then becomes solid at about 183°C . If you disturb the parts being soldered as the solder is going through the pasty stage you'll get a poor joint.

There is one solder alloy, 63/37, which has no pasty stage at all as it cools. This solder changes directly from the molten to the solid state at 183°C . This is, however, too much of a good thing because a joint made with the solder becomes excessively sensitive to vibration at the instant of setting. The 60/40 alloy, with its small pasty temperature range, offers the best performance in practice.

It's a good plan for the home hobbyist to keep any left-over pieces of solder, even if they're only about an inch long, in an odd box or tin. It is almost inevitable that a day will dawn when you suddenly find you've run out of solder and the shops are shut. You'll be glad that you kept those odd scraps then! ■

In your work-shop

This month we find Dick and Smyth embroiled in the usual rush of Christmas repairs. They are, however, able to service all the faulty equipment in good time, finishing with a television receiver having an SN76013ND audio amplifier section.

It was the very Eve of Christmas, and once again the Workshop was in the throes of the Christmas rush.

As the lay public went happily and uncaringly about their Yuletide activities, Dick and Smyth pressed on manfully to clear the mammoth quantity of radios, television receivers, tape recorders and record players which, unaccountably, always managed to become unserviceable in the week leading up to Christmas Day. This phenomenon had taken place for as long as Dick and Smyth could remember, and they now accepted as natural the annual strain on the symbiotic relationship between service engineer, as supplier of repaired equipment, and set-owner, as supplier of bread.

DECORATIONS

As always, Dick had set the scene for a Christmassy atmosphere by hanging brightly coloured paper-chains between the Workshop corners and a large paper bell from the bulb at the centre of the ceiling. His work in this respect had been sternly supervised by the Serviceman, due to an unfortunate lapse of the previous year

when the enthusiastic Dick had stuck all the decorations in position with Araldite, whereupon they couldn't be got down again afterwards.

The shelf above Dick's bench was gaily covered with Christmas cards from all his aunts. Smyth's display of cards was noticeably more austere, and comprised six cards in all. In five of these a reindeer pulled a sledge over to the right. The sixth card exhibited a disturbing quadrature, and depicted a reindeer pulling a sledge upwards. There was always a depressing sameness about Smyth's Christmas cards.

As the day wore on the stocks of equipment on the 'For Repair' rack gradually lessened, whilst those on the 'Repaired' rack rose encouragingly. Inevitably, the moment approached when only a single item, a modern mains-driven 17 inch monochrome television receiver, stood in isolation on the 'For Repair' rack. Oblivious of each other's presence, Dick and Smyth approached this receiver simultaneously. As they reached out to pick it up, their arms crossed.

"Corblimey," said Dick. "Don't say you're after this one as well."

Smyth dropped his arms, pulled out a handkerchief and mopped his brow. He turned round and looked at the Workshop, untidy now after the day's labours, with tools and test equipment strewn in a disorderly fashion over the benches, and star-splashes of solder on the floor beneath the bench stools. He turned to gaze back to the rack on which the television set stood, and started.

"Ye gods," he gasped, "it's the last one!"

"Stap me," said Dick jubilantly, "so it is. Hey, Smyth, this means that, yet again, we have beaten the Christmas panic."

"It does indeed," replied Smyth, his voice taking on a noticeably more cheerful tone. "What say we do it together? Me trouble-shooting and you doing the donkey work?"

"Suits me," stated Dick enthusiastically. "We'll take it over to my bench. If there's any soldering to do, I like to do it with my own iron."

Grimming happily, Dick carried the TV set to his bench, plugged it into the mains and connected the u.h.f. aerial. He switched on. Smyth brought his stool over and sat beside him.

"It sounds very quiet," grunted Smyth. "I know this model. It's all-semiconductor and the sound should come on straight away."

After a few further seconds the tube screen began to glow, revealing a picture of good brightness and resolution. Smyth checked on the remaining local channels, to find that these offered equally acceptable pictures. He turned the volume control to full.

"Hush," said Dick, "I think I can hear something."

They listened intently. The sound accompanying the picture was very faint, and was just audible from the

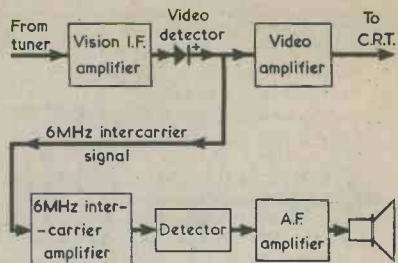

Fig. 1. The signal-handling stages in a 625 line television receiver. The 6MHz intercarrier sound signal is taken off after the video detector

speaker. Smyth returned to the other channels. Each produced the same low level of sound. He switched off the set.

"It doesn't sound tinny or distorted or anything like that," remarked Dick. "It's good quality sound but just very weak. And there's no background hiss at all."

"Well, at any rate," stated Smyth. "We won't have far to look in locating the fault. This is a 625 line set with intercarrier sound. We know that the vision i.f. is getting to the video detector properly because we're getting a good picture which is synching in well on both line and frame. So there must be a snag between the 6MHz intercarrier take-off point after the video detector and the loudspeaker." (Fig. 1.)

"That," commented Dick, "will take in the 6MHz intercarrier amplifier and detector, and the a.f. amplifier up to the speaker."

"True," agreed Smyth. "I'll go and rustle up the service manual for this set. You might as well get the back off and have a look round for obvious faults."

As Smyth walked towards the filing cabinet, Dick removed the back of the receiver. He looked around unsuccessfully for simple visible faults. Next he opened out the printed circuit board on its hinges and examined this closely.

"Any luck?" queried Smyth, returning with a service manual.

"Everything seems to be in apple-pie order," replied Dick. "No wires adrift, no rough-looking joints and no signs of any component cooking."

"Humph," grunted Smyth. "Well, let's take a look at the circuit."

He opened the service manual and smoothed out its circuit diagram.

"Oh dear," said Dick.

"What d'you mean, oh dear?"

"It's the a.f. amplifier," stated Dick unhappily. "It uses an integrated circuit. See?"

Dick pointed at the a.f. amplifier section in the service manual. This consisted of an SN76013ND integrated circuit and its associated components. (Fig. 2.)

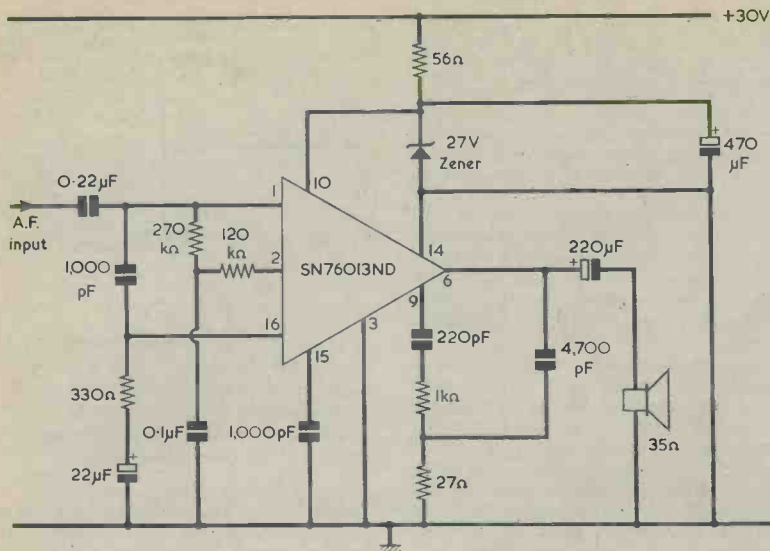

Fig. 2. A television receiver a.f. amplifier stage incorporating an SN76013ND integrated circuit. This circuit is employed in the Thorn 1600 Series of television chassis

I.C. AMPLIFIER

"What's so wrong with an integrated circuit?" returned Smithy. "You've seen plenty of integrated circuits before now."

"I know I have," admitted Dick. "But I never feel quite at home with them when I'm checking the circuits they're in. When you've got circuits made up of discrete components you can always trace a signal path through them. But with integrated circuits all you have are an input and an output together with a lot of capacitors and resistors hanging off the pins in between."

"I must admit," concurred Smithy, "that you have to think along rather different lines when you're servicing sets with i.c.'s in them. The main thing you should bear in mind is that you must resist the temptation to declare that an i.c. is duff itself before you've checked the components and voltages around it. Now, I've got a feeling in my vitals that the weak sound we're getting here is due to the fact that this a.f. amplifier i.c. isn't doing much amplifying. If the lack of gain had been in the 6MHz intercarrier amplifier we should have at least got a noticeable background hiss when we turned the volume up."

"D'you feel we should start operations around this a.f. amplifier i.c., then?"

"It wouldn't be a bad idea," stated Smithy. "Switch on again, and I'll take a few voltage readings."

Obediently Dick turned on the receiver. Smithy pulled his assistant's testmeter towards him and switched it to a 0-50 volt range. He then studied

the printed board closely to familiarize himself with the layout of the components and connections around the a.f. amplifier integrated circuit.

"The obvious thing to do first is to check that there's power getting to the i.c.," he remarked. "So I'll check between pin 3 and pin 10. As you can see from the circuit diagram, there's a 27 volt zener diode across these two points."

Smithy applied the test prods. (Fig. 3(a).)

"The meter," announced Dick, "is

reading 27 volts. Or as near 27 volts as dammit."

"Right," commented Smithy. "I'll check next between pin 3 and the output at pin 6. This should give us a half supply voltage reading."

Smithy applied the negative test prod to pin 3 and the positive prod to pin 6. (Fig 3(b).) As the prod touched pin 6 the speaker gave a chirpy clicking noise and Smithy frowned.

"The meter," remarked Dick, "is reading just over 14 volts."

"That seems near enough," remarked Smithy. "The d.c. feedback network should be working all right if we're getting a reading of that order." He removed the test prod from pin 6. The clicking noise from the speaker was repeated.

"That output pin seems to be a bit lively," he said thoughtfully. "Normally, the output should be at low impedance and virtually dead so far as external circuits are concerned. Bring over the a.f. signal tracer from my bench, Dick."

"Don't tell me," snorted Dick in disbelief, "that you're going to use that grotty old-fashioned thing to check a modern integrated circuit. Why, it's almost sacrilege!"

"Of course I'm going to use it," retorted Smithy, affronted. "And in no way is it old-fashioned. Let me tell you that I made up that signal tracer fifteen years ago and it's given excellent service ever since."

"But it uses valves, Smithy. This is the semiconductor age."

"I know it uses valves," replied Smithy. "Or, rather, it uses one valve and that's an ECL82 triode-pentode, with one input at the grid of the triode and another at the grid of the pentode to give two different sensitivities. But valve or not, it has an extremely simple circuit and it's very robust. What's more, it's virtually immune to damage

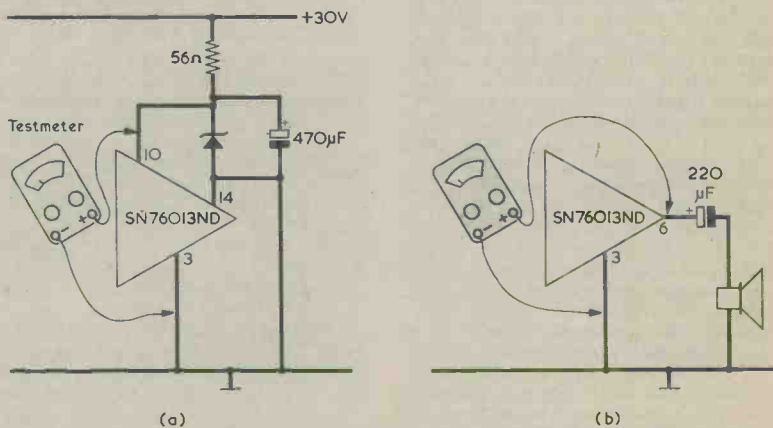

Fig. 3(a). The first and obvious check carried out by Smithy was to measure the supply voltage applied to the integrated circuit (b). The second check was to measure the quiescent voltage at the output pin

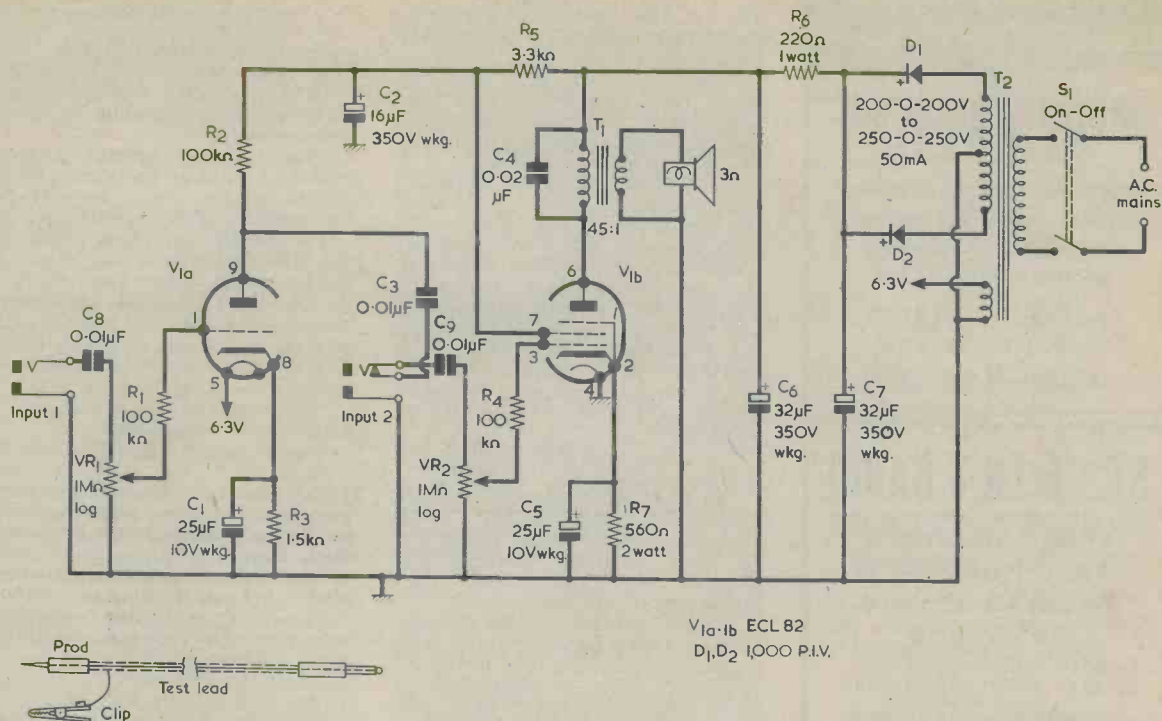

Fig 4. Although derided by Dick as being old-fashioned, this a.f. signal tracer is not unattractive for present-day servicing. Its main advantages are reasonable simplicity, versatility, robustness and the ability to withstand very high input voltages. VR2 is set to its maximum volume position when Input 1 is in use

if you accidentally apply a high input to it. And even if the valve *does* get damaged due to a really high input all you have to do is whip it out and plug in a new one." (Fig. 4.)

Reluctantly, Dick walked over to Smithy's bench and picked up the a.f. tracer. This was housed in a small battered box with an aperture for the speaker on the front panel, together with the on-off switch and the two volume controls and jack sockets. Smithy took the tracer from him, plugged it into the mains and switched it on. He then fitted its screened input test lead to the jack socket connecting to the triode grid, clipped the test lead braiding to the chassis of the television receiver, and applied the test prod to pin 1 of the integrated circuit. (Fig. 5 (a).) The television sound channel became audible from the speaker of the signal tracer. Smithy adjusted the signal tracer volume control for a comfortable level of sound in the tracer loudspeaker.

"That," he remarked, "is the audio that's going into the integrated circuit."

"The quality sounds O.K. to me," said Dick, listening critically. "what are you going to do next, Smithy?"

"See what the sound level is like at the i.c. output," responded Smithy. "Here goes!"

He transferred the signal tracer test

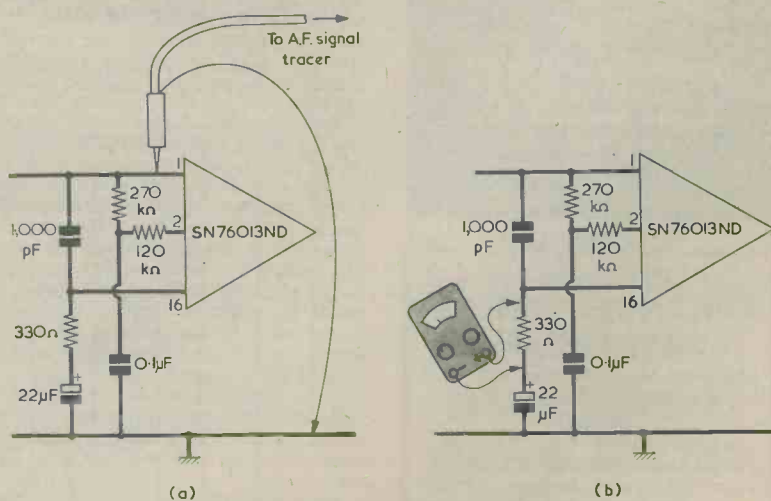

Fig. 5(a). Using the a.f. signal tracer to check the input at pin 1 of the i.c.

(b). Subsequently, Smithy checked the resistance of the 330 nΩ resistor in the a.c. feedback circuit

Your Local Supplier

LONDON

THE MODERN BOOK CO.

Largest selection of English &
American radio and technical
books in the country.

19-21 PRAED STREET,
LONDON, W2 1NP
Tel: 01-723 4185/2926

ST. HELEN'S RADIO

Hi-Fi Equipment
Tape Recorders
Radio Receivers
Television

SPECIALISTS IN RADIO
& ELECTRONIC TEXTBOOKS

ST. HELENS GARDENS
LONDON, W.10
Tel: 01-969 3657

HAMPSHIRE

BOURNEMOUTH

LARGEST HI-FI AND
RADIO COMPONENT
STORE IN THE SOUTH

FORRESTERS NATIONAL
RADIO SUPPLIES LTD.

70-72 Holdenhurst Road
Bournemouth
Telephone 25232

Closed all day Wednesday

SURREY

WITWORTH TRANSFORMERS

TV Line out-put transformers

Manufacturers of the largest range in
the country. All makes supplied.

Modern

BAIRD, BUSH, GEC, PHILIPS
Replacement types ex-stock.

For "By-return" service, contact
London 01-948 3702

Tidman Mail Order Ltd., Dept. R.C.
236 Sandycombe Road,
Richmond, Surrey TW9 2EQ

Callers welcome.

prod to pin 6 of the integrated circuit. The signal was again audible from the signal tracer loudspeaker, but only at a fractionally higher level.

"Well," conceded Dick, "that old signal tracer does seem to have some uses after all. One thing it shows us is that the i.c. isn't doing much amplifying. It must have gone faulty."

"I told you just now," remarked Smithy severely, "that you must avoid the temptation of suspecting an integrated circuit before you check the components and voltages around it. Now, we know that the d.c. feedback is working O.K. because we're getting half the supply voltage at the output pin. What has probably happened is that there's far too much a.c. feedback, and this would explain why the output pin was so lively when I connected the testmeter to it."

"All right," said Dick. "How do you test the a.c. feedback circuit?"

"By checking the external feedback components," replied Smithy. "In this circuit they're the 330Ω resistor and the 22μF capacitor which connect between pin 16 and chassis. Let's check the resistor first."

Smithy switched off the receiver, then set Dick's testmeter to an ohms range. After zeroing the meter, he applied the meter test prods across the 330Ω resistor. (Fig. 5(b).) The testmeter needle barely moved.

"Blood first time," said Smithy exultantly. "I can't quite make out the resistance reading I'm getting here but I'm not much worried because it's obviously a lot higher than 330Ω."

"Blimey," said Dick, impressed. "That was a swift bit of fault-finding, wasn't it? How is it that you were so ready to go for the 330Ω resistor?"

"It was a pretty obvious suspect," responded Smithy. "Also I've been doing a bit of genning-up on these a.f. amplifier i.c.'s recently and I know which pin to look for and the sort of a.c. feedback circuit to expect. Anyway, don't let's waste any more time. Pop a new 330Ω resistor in that set and we'll see if it does the trick."

As Dick busied himself with replacing the faulty resistor, Smithy switched off his a.f. signal tracer, regarded it fondly as one regards a trusted old friend, then unplugged it and carried it back to his bench. After some moments he returned to Dick's bench. He carried a mysterious flat package wrapped in colourful paper bearing a motif of snowmen dressed as Santa Claus with a background of holly leaves, and placed it carefully at the side of Dick's bench.

"Job done," called out Dick cheerfully as he returned his soldering iron to its stand. "I've put the new 330Ω resistor in, so let's see how this TV works now."

He switched on the set, to be at once rewarded with a very loud sound output from its speaker. Hastily, he reduced the volume to a more acceptable level. The audio quality was obviously as it should be. Dick checked on the alternative channels, to find

that the sound signal was reproduced in a similarly satisfactory manner.

CHRISTMAS PRESENTS

"That's it!" said Dick exuberantly. "This completes our final job before Christmas."

"Yes," agreed Smithy, grinning, "we can now relax and start thinking of the holiday. Gosh, we certainly cleared out a pile of work today."

The pair looked happily at the now full "Repaired" rack and the completely empty "For Repair" rack. Smithy settled himself contentedly, then reached down and picked up the package at the side of Dick's bench. Gravely, he handed it over to his assistant.

"Here you are," he announced. "A little present for Christmas."

"Gee thanks, Smithy. This looks interesting."

Quickly, Dick removed the wrapping paper, to reveal a large calendar having a separate page for each month. Each page carried a countryside scene and was headed with the name of the month, followed by the year: 1976.

"This is super, Smithy," said Dick appreciatively. "Very many thanks indeed. It's just what I want for my bedroom at home."

"I'm glad you like it."

"Oh, I do. Now here's a Christmas present for you."

Dick opened a drawer in his bench and produced a package which he passed to the Serviceman. This was wrapped in colourful paper printed with a design consisting of snowmen dressed as Santa Claus and having a background of holly leaves.

Smithy tore off the wrapping paper, to find a large box of chocolates inside. On the Cellophane covering was stuck a gift label bearing the words, "To Smithy from Dick." Smithy pulled at the Cellophane.

"Dear me," he remarked. "This seems to be a bit loose. Ah, here we are."

Smithy opened the box, to reveal a layer of shiny milk chocolates, each lodged in its own dark brown crinkled paper nest.

"Do you like it?" asked Dick anxiously.

"Oh definitely," returned the Serviceman. "I love chocolates. Thank you very much indeed, Dick."

"Don't mention it."

"Now let's see," said Smithy, studying the guide to the chocolates which was printed on the inside of the box lid. "Ah yes, I think I'll start off with a Strawberry Creme."

He glanced over the chocolates, then frowned in bewilderment.

"Shouldn't there be raised patterns on the chocolates to tell you what they are?" he asked. "These chocolates are all smooth on top."

"You can distinguish them by their shape," said Dick quickly. "Here you are, that one is a Strawberry Creme."

Smithy picked up the chocolate indicated by Dick's finger and popped it

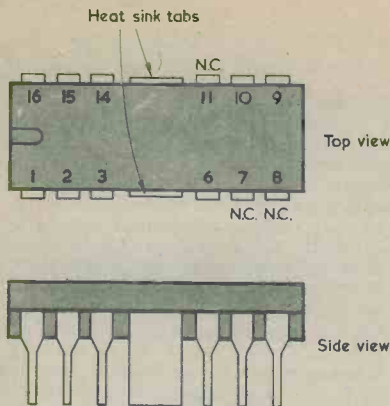

Fig. 6. Four of the SN76013ND pins are replaced by the heat sink tabs

feedback components?"

"As I said," stated Smithy, chewing vigorously. "I've been doing a little genning-up on these a.f. amplifier i.c.'s lately. You know how often integrated circuits from different sources happen to have identical internal circuits. Well, the integrated circuit in this set is a Texas Instruments SN76013ND, and I found out recently that this has the same internal circuitry as the early 'A' versions of the Sinclair Super IC-12."

"But," protested Dick, "all the pictures I've seen of the Super IC-12 show it with a radiating heat sink on it. The i.c. in that set hasn't got a heat sink at all."

"There is a heat sink," stated Smithy, "but it's not all that obvious. One version of the SN76013 also has a radiating heat sink, but the 'ND' type which is used here has two heat sink tabs instead. These pass through the printed circuit board and are then soldered to a large area of copper underneath. The copper provides the heat sink. If you look at the i.c. you'll see that it's really a 16 pin dual-in-line job with pins 4, 5, 12 and 13 replaced by the heat sink tabs." (Fig. 6).

"Yes, I can see that now," said Dick, peering at the integrated circuit. "I wonder what the internal circuit looks like."

"I can show you that now."

Smithy rose, put another chocolate in his mouth then walked over to his bench. He returned with a small booklet and opened it at a page bearing a circuit (Fig. 7.)

"This," he said indistinctly through

into his mouth. A look of bliss spread over his face.

"Delicious," he remarked. "Quite delicious. Here, you have one."

Smithy offered the box to Dick.

"Er, not for the moment," said Dick hesitantly. "Perhaps I'll have one later."

"Fair enough," commented Smithy, picking out another chocolate. "These certainly are excellent chocolates. They're the best I've had for ages. Thanks again, Dick."

"Think nothing of it," returned Dick. "Now, I know we've finished servicing up till Christmas, but I'm still a bit puzzled about that feedback fault you just cleared. How did you know so promptly where to find those

Fig. 7. The internal circuitry of the early 'A' version of the now discontinued Sinclair Super IC-12, and also of the SN76013. Later versions of the Super IC-12 (and, incidentally, the SN76023) have R1 and R2 omitted, with the base of TR1 connecting directly to pin 16

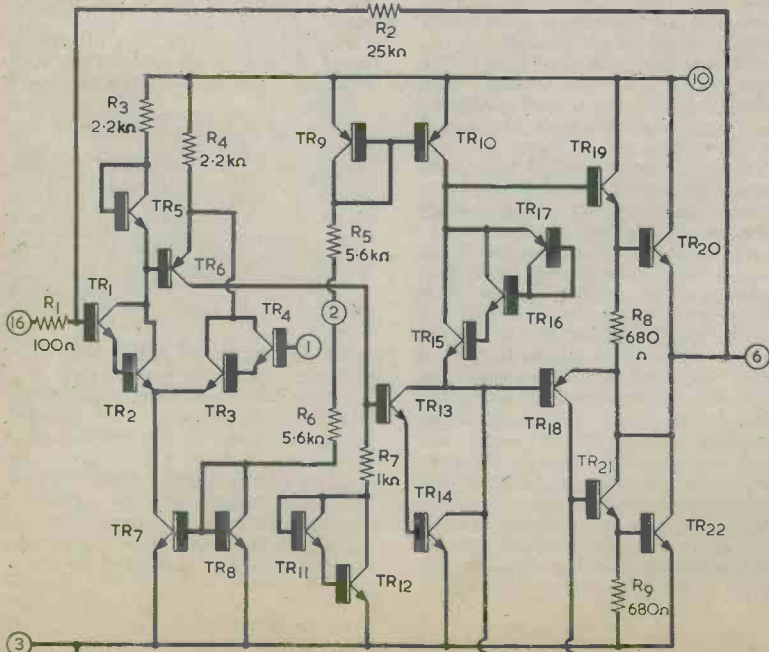

Your Local Supplier

SUSSEX

JEFFRIES

For
Hi-Fi Equipment
Tape Recorders
Television
Transistor Radios

6A Albert Parade
Victoria Drive,
EASTBOURNE SUSSEX

EIRE

PEATS for PARTS

ELECTRONIC COMPONENTS
RADIO & TELEVISION

For the convenience of Irish
enthusiasts we supply
Radio & Electronics
Constructor
Data Books and
Panel Signs Transfers
Also a postal service

Wm. B. PEAT & Co. Ltd.
28 PARNELL STREET
DUBLIN 1

RADIO & ELECTRONICS CONSTRUCTOR

ANNUAL
SUBSCRIPTIONS
to this magazine
may be obtained
through your
newsagent
or direct from the
publishers

ONLY £4.50
per year, post free

Please send remittance with name
and address and commencing issue
required to:

DATA PUBLICATIONS LTD
57 Maida Vale London W9 1SN



the audio amateur?

What a trip old Richard's Rhine journey could have become had he built his own mixers, 900 watt amps, octave equalizers, 24 inch woofers, electronic crossovers, and home brew electrostatics. Sounds what sounds!

Ask our Rhine maidens for details.

the Audio Amateur Yellow Oak Cottage
Tillington nr. Hereford HR48LQ

Send now for a free prospectus.

Craig Stark of STEREO REVIEW says:
"Top quality, only U.S. publication devoted to the serious audiophile constructor."

Name

Address

R

GAREX

Modulation transformers
Valve type 747, for 30W Tx £2.85
Transistor type, p/p NKT404 to QQV03-20a (or QQV03-10), with driver transformer to match - special offer - the two £1.45
Audio transformers - driver and output (2W) p/p NKT404 to 3Ω the two 70p
NKT404 20p each; 5+: 17p
Mains transformer (multitap primary) 250-0-250V 200mA, 6.3V 5A, 5V 2A, fully shrouded, (suitable for 30W Tx - matching style to mod. transf.) £5.95
Connection data supplied with transformers.
H.T. chokes 5H 80mA, 1-8H 125mA £1.25
Relays GPO type 2400, 12V coil, 8A contacts, 4PCO or 2P make 40p each; 5+: 25p
Neons min. wire end, 55p/10; £4/100
Slide Switches min. DPDT 15p ea; 5+: 12p
2P3W 22p each; 5+: 18p
PL259 UHF Plug & Reducer 60p; 5+: 50p
BNC cable mtg Socket 50Ω 15p; 5+: 12p
Resistor Kits 10E12 ½W 5% C-Film, 10 each valve 22Ω to 1M (570 pcs) £5.30
Numericators ZM1080 75p each; 5+: 63p
I.C.'s (new, full spec.) CD4001AE 40p
SN76660 FM Quad. detector £1.25
723 Voltage reg. TD5 metal case 90p
NE555 Timer 75p
Niced rechargeable cells HP7 size £1 each.
4+: 90p. 10+: 85p.

Prices include UK Post, Packing & VAT

Mail order only

Sole address:

GAREX ELECTRONICS
7 NORVIC ROAD, MARSWORTH,
TRING, HERTS HP23 4LS
Cheddington (STD 0296) 668684

the chocolate. "is the internal circuitry of the 'A' type Super IC-12 and also of the SN76013. It's pretty straightforward, and it has two inputs, at pins 1 and 16, going to a differential amplifier consisting of TR1, TR2, TR3 and TR4. This differential amplifier acts just like the differential amplifier following the inputs of an op-amp."

"I wonder," queried Dick musingly, "which is the inverting and which is the non-inverting input."

"We can soon find that out by tracing a signal through. Let's commence by saying that the input at pin 1 goes positive. The two collectors of TR3 and TR4 will then go negative. These connect to the emitter of TR6, and the collector of this transistor will also go negative. It couples to the input base of the Darlington pair given by TR13 and TR14, whereupon the collectors of these two transistors will go positive. If you then trace through the two emitter followers TR19 and TR20 you will see that the output, at pin 6, must also go positive. If, alternatively, you follow the signal path through TR18 collector, TR21 and TR22 you'll also get a positive-going output, although this time there are two phase inversions in the path, these occurring at TR18 and TR22."

INVERTING INPUT

"So," said Dick musingly, "if pin 1 goes positive so also does the output at pin 6."

"That's right," confirmed Smithy. "Whereupon pin 1 becomes the non-inverting input. Following from this, pin 16 must be the inverting input. Or, to be more precise, the base of TR1 is the inverting input. Now, there's a resistor, R2, coupling back from pin 6 to this inverting input, with the result that, assuming there are no d.c. connections to earth at pin 16, the i.c. works as a voltage follower at d.c. with pin 6 taking up the same potential as that at the non-inverting input."

"Oh yes, I can see that," said Dick brightly. "We've been talking about voltage follower op-amps recently and this is the same sort of circuit arrangement."

"I'm glad you've remembered," said Smithy approvingly. "The next thing to note is that there is a reference point at half-supply voltage which is provided inside the i.c. itself. This is given at pin 2, which connects to the junction of the equal-value resistors R5 and R6. If you go back to the television receiver circuit, you'll see that pin 2 couples back to pin 1 via a 120kΩ resistor, a 0.1μF bypass capacitor to chassis and a 270kΩ resistor. The 270kΩ resistor is the input resistor for the incoming a.f. signal and the 120kΩ resistor and the 0.1μF capacitor decouple its lower end from any signal voltages appearing on the supply lines for the integrated circuit. And the two resistors give a d.c. coupling to pin 1 which ensures that, under quiescent conditions, the output at pin 6 is held at half-supply

voltage." (Fig. 8(a).)

"Gosh," said Dick excitedly, "this is all crystal-clear now. I can also see the a.c. negative feedback set-up, too. The output couples back to the inverting input at the base of TR1 via R2 inside the i.c., after which you have R1 and the external 330Ω resistor which goes down to chassis via the 22μF electrolytic. The electrolytic acts as an open-circuit at d.c. and doesn't upset the d.c. feedback arrangements. But at a.f. it's almost a dead short, whereupon the a.c. feedback is governed by the values of the three resistors." (Fig. 8(b).)

"That's right," confirmed Smithy. "The overall voltage gain then becomes equal to the sum of the three resistors divided by the sum of the internal 100Ω resistor and the external 330Ω resistor. If we call that last resistor RX, to cover the cases where it has other values, we can then write out a general formula for voltage gain."

He took out a pen and scribbled an equation in the margin of the service manual. (Fig. 8(c).)

"That explains," said Dick, "why the voltage gain of the amplifier dropped so much when the 330Ω resistor went high in value."

"True," agreed Smithy, popping yet another chocolate in his mouth. "So there's no more mystery there."

Idly, he picked up the Cellophane which had been wrapped around the box of chocolates. As he glanced through the transparent material at the underside of the gift label, he noticed what appeared to be the back of another label. Intrigued, he picked at a corner of the top label and was soon able to peel it off. Underneath was a second label: "To Auntie Eff with love from Dick."

"That's funny," remarked Smithy. "How comes it that there's a label meant for your Auntie Eff underneath the one meant for me?"

"I originally bought the chocolates for Auntie Eff," explained Dick hastily. "Then I thought you'd like them better."

"Oh, I see."

Smithy pondered on this fact, and also on the apparent looseness of the Cellophane when he had originally unwrapped it and, further, on the unusually smooth finish of the chocolates. An unwelcome thought rose, unbidden, in his mind. He dismissed it but, inexorably, it returned.

"Doesn't," he asked gently, "your Auntie Eff keep rather a large number of cats?"

"Er yes, well I suppose she does, rather."

"There's more to these chocolates," he went on accusingly, "than just one label stuck on top of another, isn't there?"

Dick maintained an unhappy silence.

"Isn't there?"

There was still no reply.

"Isn't there?" roared Smithy.

Dick looked up fearfully at the

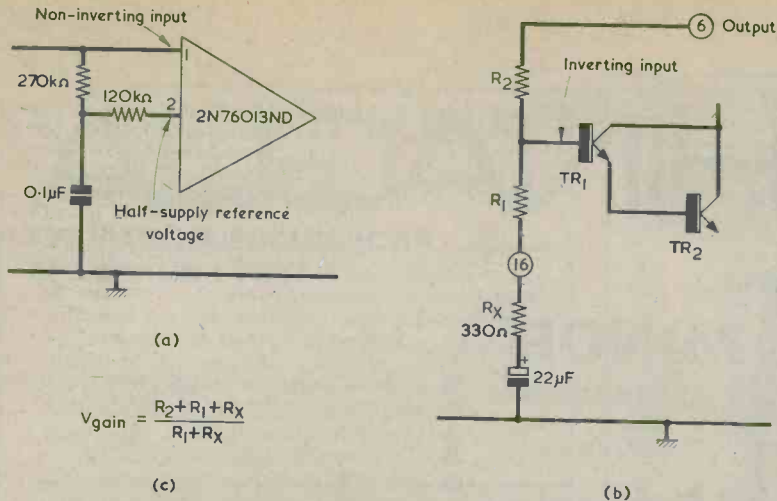

Fig. 8(a). Illustrating the manner in which the half-supply reference voltage is applied to the non-inverting input
 (b). The a.c. feedback network. R_1 , R_2 , TR_1 and TR_2 are inside the integrated circuit
 (c). The voltage gain of the i.c. amplifier is governed by the values of R_1 , R_2 and R_X

furious Serviceman, who now hovered over him menacingly.

"Now, Smithy, take it easy, please."

"What happened to them?"

"Well," said Dick hesitantly, "I took the chocolates to my Auntie Eff last night and we opened them and put them to one side. But when we went to get them later we found that one of her cats had licked all the patterns off them."

"After that," went on Dick quickly, anxious to complete his story, "neither my Auntie Eff or me fancied the chocolates any more. So I thought I'd give them to you as a Christmas present."

"Ye gods," grated Smithy in a tone of utter disillusion. "Talk about the Season of Goodwill! I'll probably get distemper or hard-pad after eating all those darned cat-licked chocolates. And to think of all the trouble I went to in getting you a nice Christmas present."

"Yes, it is a nice present," agreed Dick, eager to propitiate the Serviceman.

He picked up the calendar.

"It's got a smashing picture for January," he continued, turning over the first sheet, "and an even better one for February. Hey, just a minute."

"What's wrong?"

"there's something odd here," remarked Dick slowly. "Isn't 1976 a Leap Year?"

"Blimey," said Smithy uncomfortably, "is it?"

"Yes, of course it is," returned Dick. "But the February page in this calendar you gave me only goes up to the 28th."

He turned a puzzled glance on the calendar and examined it more closely. Suddenly, he started turning the pages over rapidly one after the other.

"Why, you tight-fisted mean old buzzard," he snorted. "This is a 1970 calendar. You've been through all the pages changing the 1970's to 1976's!"

"Well, so what?" retorted Smithy defensively. "I don't believe in throwing away old calendars because if you wait long enough you're bound to find a year when the dates fit again. Both 1970 and 1976 start on a Thursday."

"Ah yes," returned Dick viciously with a demoniacal delight at having, at long last, scored off the Serviceman. "But you slipped up this time, didn't you? You forgot that 1976 is a Leap Year and 1970 wasn't."

SPIRIT OF CHRISTMAS

For once, Smithy had no reply to make. The pair sat, glowering at each other.

Dick quickly put the printed circuit board of the television receiver to its normal position and replaced the back of the set. He reconnected the aerial and switched the set on for its final check. At once, the Workshop was filled with the sound of Bing Crosby singing "I'm Dreaming of a White Christmas."

Gravely they shook hands. The magic of Christmas had yet again woven its spell.

"Merry Christmas, Smithy."

"A Merry Christmas to you too, my lad," returned Smithy warmly.

He rose and walked towards the spares cupboard, then returned accompanied by the pleasant clink of glass against bottle. He charged the two glasses and handed one to Dick, after which they both stood, holding their glasses high.

"Let us now," stated Smithy, "wish a very Merry Christmas, and a truly Happy New Year, to all the readers who've put up with our antics over the last twelve months."

They drank deeply.

"And," concluded Dick, "let us once more finish, as on so many previous Christmases, by saying, 'God bless us, every one!'"

NEW PRACTICAL PAPERBACKS FROM FOULSHAM-TAB

ELECTRONIC TEST EQUIPMENT — and how to use it £1.85
 by Joe Risse

COLOUR TV TROUBLES — Problems & Solutions (Fact Book) £2.30
 by the Editors of Electronic Technician/Dealer

ELECTRONICS UNRAVELLED — A New Commonsense Approach £1.90
 by James Kyle

SIMPLIFIED COMPUTER PROGRAMMING — The Easy RPG Way £1.95
 by Kelton Carson

INSTALLING TV & FM ANTENNAS £1.75
 by Leo G. Sands

JAPANESE CONSUMER ELECTRONICS SCHEMATIC/SERVICING MANUAL £2.50
 by TAB Editorial Staff

MODERN GUIDE TO CAR TUNE-UP AND EMISSION CONTROL SERVICING £1.95
 by Paul Dempsey

SERVICING TRANSISTOR RADIOS £1.95
 by Leonard D'Airo

PRACTICAL TRIAC/SCR PROJECTS FOR THE EXPERIMENTER £1.80
 by R. W. Fox

BASIC COLOUR TELEVISION COURSE £2.20
 by Stan Prentiss

ELECTRONIC CIRCUIT DESIGN HANDBOOK £4.50
 by Editors of EEE Magazine

For free catalogue please write to:

DEPT. REC



FOULSHAM-TAB LTD.
 YEOVIL ROAD, SLOUGH, BERKS.



CHINAGLIA

PROFESSIONAL QUALITY
TEST EQUIPMENT



TRADE ENQUIRIES WELCOMED

THE MINOR

33 RANGES
20k Ω / V d.c.
4k Ω / V a.c.

WITH

- ROBUST CLASS 1.5 PRECISION MOVEMENT
- ACCURACY 2.5% D.C. AND 3.5% A.C.
- 12 MONTH GUARANTEE
- SELF-POWERED AND POCKET-SIZED
- OPTIONAL 30kV D.C. PROBE

PRICE £19.00 Inc. VAT (P. & P. 80p)
PROBE £9.50

For details of this and the many other exciting instruments in the Chinaglia range, including multimeters, component measuring, automotive and electronic instruments please write or telephone:

CHINAGLIA
(U.K.) LTD. 19 Mulberry Walk, London
SW3 6DZ Tel: 01-352 1897

SHORT WAVE MAGAZINE

- Covers the whole field of Amateur Radio and SWL interests.
- Is independent, Unsubsidised and now in its 33rd Volume — established 1937, nearly 40 years under the same Editorial direction and control.
- Subscription £4.80 for a year of 12 issues (about 720 pages), post free. **Sample copy 45p.**
- Stocks a wide range of books for the Radio Amateur and SWL. Some selected titles, English and American: *Working with the Oscilloscope*, £1.85. *The ARRL VHF Manual*, £2.65. *Advanced Communication Systems*, £8.97. *Sun, Earth and Radio*, £2.60. *DX Zone Map* (four colour, great circle, centred on the U.K.), £1.50. *ARRL Antenna Handbook*, £2.60 — and many others (see any issue "Short Wave Magazine").
- Delivery from stock, despatch within day or two of order, prices include postage and careful packing.

SHORT WAVE MAGAZINE LTD.,
29 High Street, Welwyn, Herts., AL6 9EE
Telephone: 04-3871 (Welwyn) 5206/7

SMALL ADVERTISEMENTS

Rate: 5p per word. Minimum charge 75p
Box No. 10p extra.

Advertisements must be prepaid and all copy must be received by the 4th of the month for insertion in the following month's issue. The Publishers cannot be held liable in any way for printing errors or omissions, nor can they accept responsibility for the *bona fides* of Advertisers. (Replies to Box Numbers should be addressed to: Box No. —, **Radio and Electronics Constructor**, 57 Maida Vale, London, W9 1SN.

BUILD THE MULLARD C.C. TV CAMERA. Complete kits now available from Crofton Electronics. Send large s.a.e. for details to:— 124 Colne Road, Twickenham, Middlesex, TW2 6QS. Telephone: 01-898 1569.

TO CLEAR BOOKSHELVES: *Handbook of Satellites and Space Vehicles* by R. Haviland, £3. *Medical Radiation Biology* by F. Ellinger, £3. *Space* by Patrick Moore, £2. *Rocketry and Space Exploration* by Haley, £2. *Health Physics* by Rees, £3. Box No. G274.

SERVICE SHEETS for Radios/TV's etc. 50p and s.a.e. Catalogue 20p and s.a.e. Hamilton Radio, 47 Bohemia Road, St. Leonards-on-Sea, Sussex.

FOR SALE: Complete Widescreen film outfit. 9.5mm camera and projector with widescreen lens, screen, film, etc. Would exchange for other photo or radio gear or w.h.y.? S.A.E. for details to Box No. G276.

LOUD 6V DC SIRENS. £1.25. 12V plug-in relays dp. c/o 40p. 3-digit counters 15p. 1000mfd 63V 42p each. BC108, 5 for 48p. Add 10p postage. Bargains list 9p. Grimsby Electronics, 64 Tennyson Road, Cleethorpes, Humberside. Callers to Lambert Road (Saturdays only).

TREASURE HUNTERS! Construct highest performance electronic metal detector for under £2. Equals models costing up to £50. For simple illustrated plans send £1. Colin Lucas, 241 Upminster Road South, Rainham, Essex.

FOR SALE: 555 Timer d.i.l., 42p. 7490 counter 14 pin, 40p. FET.OPA +10 - +18V, £4.10. Zener 1.3W/12V, 12p. Triac 6A/400V, 70p. Trimmer capacitors 200pF, 5p. BC461 15p. P & P 10p. Mayday Electronics, 297A Green Street, London E.13.

FOR SALE: 2m converter, mains operated. 24-26MHz. £8. Box No. G278.

UNIQUE VHF KITS, 80-180MHz. Receiver, tuner converter. World wide sales. Send £5 or s.a.e. for literature. Johnsons Radio (C), Worcester, WR1 3QQ.

NEW COMPANY offers their list, wide range of popular components from transistors, resistors, diodes, condensers, hard ware, etc. Competitive prices, free V.A.T. S.A.E. please. Heddon Valley Electronics, Bumpsley Mill, Parracombe, Barnstaple, North Devon.

FOR SALE: Polarised relays. Suitable for RTTY terminal units, etc. £1.00 each. Box No. G281.

(Continued on page 317)

BENTLEY ACOUSTIC CORPORATION LTD.

All prices inclusive of V.A.T. at 25%

The Old Police Station, Gloucester Road, LITTLEHAMPTON Sussex. PHONE 6743

OB2 .45	10P14 2.34	E180F 1.17	EH90 .44	PCL82 .45	UM80 .60
1A7GT .60	12A6 .75	EA50 .40	EL32 .60	PCL83 .50	UM81 .50
3V4 .82	13A6 .90	EAC80 .40	EL34 .60	PCL84 .50	UY85 .50
3U4G .50	12AD6 .90	EA50 .40	EL41 .60	PCL805 .70	X41 1.00
5Y3GT .55	12AE6 .90	EAC91 .65	EL84 .36	PCL86 .55	X66 1.46
3Z4G .55	12AT6 .47	EAC92 .88	EL96 .40	PEL200 .82	XT6M .85
6J0L2 .80	12AU6 .53	EAF80 .80	EM80 .53	PL16 .70	Z759 5.85
6AH6 .80	12AV6 .59	EB91 .23	EM81 .76	PL81 .53	AC165 .33
6AQ5 .53	12BA6 .53	EBC41 .88	EM83 .64	PL82 .43	AD140 .47
6AT6 .53	12BE6 .59	EBC81 .45	EM84 .47	PL83 .50	AD149 .64
6AL6 .40	12BH7 .59	EBF40 .40	EM87 1.10	PL84 .50	AD161 .59
6AV6 .53	12BY7 .85	EBF83 .50	EY51 .50	PL504 .82	AD162 .59
6BA6 .41	12K5 .17	EY89 .40	EY87 .60	PL508 1.10	AF114 .33
6BE6 .41	19AQ5 .65	EC92 .55	EY88 .60	PL509 1.65	AF115 .33
6RH6 .75	20P4 1.17	ECC33 2.00	EZ40 .35	PY33/2 .50	AF121 .39
6BJ6 .64	30C15 .80	ECC35 2.00	EZ41 .35	PY81 .40	AF126 .23
6B7A .64	30C17 .85	ECC40 1.20	EZ80 .35	PY82 .40	BC107 .16
6BR7 1.20	30F5 .75	ECC81 .40	EZ81 .35	PY83 .45	BC108 .16
6BR8 1.25	30FL1 1.10	ECC82 .39	GY501 .82	PY88 .47	BC109 .16
6BW6 1.00	30FL2 1.10	ECC83 .39	GZ34 .80	PY89 1.11	BC113 .33
6BW7 .65	30FL14 .82	ECC84 .40	GZ34 .80	PY800 .45	BC118 .29
6B26 .57	30L15 .82	ECC85 .47	KTW62 .176	PY801 .45	BC211 .49
6C4 .47	30L17 .76	ECC88 .55	KTW62 .176	PZ30 .50	BF158 .23
6C6 .47	30P12 .80	ECC907 .41	KTW62 .176	QQV03/10	BF159 .33
6C9 2.00	30P19 .88	ECF80 .50	KTW63 .176	R19 .210	BF163 .26
6CL6 .76	30P11 1.00	ECF80 .50	KTW63 .176	R19 .210	BF163 .26
6CD5 .88	30P12 .80	ECF82 .50	KT66 2.93	U25 .70	BY100 .23
6E5 1.17	30P13 1.20	ECF86 .88	PABC80 .40	U26 .65	BY126 .20
6F1 .80	30P14 1.29	ECF80A .40	PC86 .45	U191 .50	BY127 .23
6F6G .60	35L6GT .88	ECH35 1.60	PC86 .70	U801 .0A9	OA9 .12
6F18 .64	35W4 .60	ECH42 .80	PC88 .70	UA8C80	OA95 .12
6E23 .80	35Z4GT .82	ECH42 .80	PC88 .70	UA8C80	OA95 .12
6F28 .78	50B5 .100	ECH81 .40	PC97 .42	UAF42 .60	OC25 .49
6H6GT .29	50C5 .70	ECH82 .45	PC97 .42	UAF42 .60	OC25 .49
6L5GT .53	30L6GT .50	ECH84 .50	PC84 .40	UBC81 .60	OC44 .13
616 .35	85A2 1.00	ECL80 .50	PC85 .50	UBF80 .47	OC45 .14
6K7G .35	85A2 .75	ECL82 .45	PC88 .65	UBF89 .47	OC46 .20
6K8G .53	807 .176	ECL86 .47	PC88 .65	UC92 .60	OC70 .16
6L6GT .68	5763 1.76	ECL86 .47	PC88 .65	UC92 .60	OC70 .16
607G .50	ATP4 .50	EF22 1.00	PCF80 .47	UCC84 .90	OC71 .14
60TGT .60	AZ1 .60	EF40 .88	PCF80 .47	UCC84 .90	OC71 .14
60S7 .52	DAF91 .40	EF41 .82	PCF82 .50	UCF80 .90	OC74 .29
65J7 .64	DAF96 .60	EF80 .30	PCF86 .50	UH42 .88	OC75 .14
6V6G .30	DF91 .30	EF81 1.45	PCF200	UH81 .47	OC78 .20
6V6GT .53	DF96 .65	EF85 .40	PCF200	UH81 .47	OC78 .20
6X4 .47	DK91 .50	EF86 .50	PCF201	UH81 .47	OC78 .20
6X5GT .50	DK92 1.15	EF89 .35	PCF201	UH81 .47	OC78 .20
7B6 .88	DK96 .70	EF91 .50	PCF801 .65	UF41 .82	OC81D .14
7Y4 .80	DL92 .47	EF92 .60	PCF802 .50	UF41 .82	OC81D .14
9D7 .70	DL96 .64	EF98 .95	PCF805 .85	UF80 .41	OC82D .14
10E .88	DY876 .41	EL183 .60	PCF806 .60	UF80 .41	OC82D .14
10F18 .60	DY802 .47	EF184 .40	PCH2001.00	UL84 .45	OC205 .55
10P13 .88	E88CC 1.20				

All goods are unused and boxed, and subject to the standard 90-day guarantee. Terms of business: Cash or cheque with order only. Despatch charges.—Orders below £10, add 25p extra per order. Orders over £10 post free. Same day despatch. Terms of business available on request. Any parcel insured against damage in transit for only 5p extra per parcel. Please enclose S.A.E. with any enquiries. Many other types in stock.

ENGINEERS



This 76 page
FREE book
shows how!

YOURSELF FOR A

BETTER JOB WITH MORE PAY!

Do you want promotion, a better job, higher pay? "New Opportunities" shows you how to get them through our low-cost home study course. There are no books to buy and you can pay-as-you-learn.

This helpful guide to success should be read by every ambitious engineer. Send for this helpful 76 page FREE book now. No obligation and nobody will call on you. It could be the best thing you ever did.



CUT OUT THIS COUPON
CHOOSE A BRAND NEW FUTURE HERE!

Tick or state subject of interest. Post to the address below.

Build-As-You-Learn	Electronic-Engineering	Transistor Technology
PRACTICAL RADIO AND ELECTRONICS (with kit)	Computer Electronics	CITY & GUILDS Installations and Wiring
Electrical Engineering	Computer Programming	CITY & GUILDS Electrical Technicians
Electrical Installations and Wiring	Colour TV Servicing	CITY & GUILDS Telecommunications Radio Amateurs' Exam etc. etc.
Electrical Draughtmanship	C. & G. Radio, TV and Electronic Mechanics	G.C.E. 'S' 'O' & 'A' LEVELS
Electrical Mathematics	General Radio and TV	Coaching for many major examinations
	Radio Servicing, Maintenance and Repairs	

To ALDERMASTON COLLEGE, Dept. ERE 12, READING RG7 4PF
Also at our London Advisory Office, 4 Fore Street
Avenue, Moorgate, London, EC2Y 5EJ Tel: 01-528 2721

ERE12

NAME (Block Capitals Please)

ADDRESS

POSTCODE

Other subjects

Age

Accredited by C.A.C.C.

Member of A.B.C.C.

HOME OF BRITISH INSTITUTE OF ENGINEERING TECHNOLOGY

PRECISION

POLYCARBONATE CAPACITORS

ALL HIGH STABILITY - EXTREMELY LOW LEAKAGE

440V AC (+-10%)	63V DC Range	+1%	+2%	+5%
0.1µF (1" x 1/2")	0.47µF	67p	50p	43p
0.22µF (1" x 3/4")	1.0µF	82p	62p	52p
0.25µF (1" x 1")	2.2µF	96p	75p	61p
0.47µF (1" x 1 1/4")	4.7µF	£1.62	£1.13	94p
0.5µF (1" x 1 1/2")	6.8µF	£1.96	£1.38	£1.13
0.68µF (2" x 1/2")	10.0µF	£2.40	£1.95	£1.64
1.0µF (2" x 3/4")	15.0µF	£3.22	£2.79	£2.24
2.0µF (2" x 1")	22.0µF	£4.28	£3.68	£3.08

TANTALUM BEAD CAPACITORS - Values available: 0.1, 0.22, 0.47, 1.0, 2.2, 4.7, 6.8µF at 15V/25V or 35V; 10.0µF at 16V/20V or 25V; 22.0µF at 6V/10V or 16V; 33.0µF at 6V or 10V; 47.0µF at 3V or 6V; 100.0µF at 3V. ALL AT 10p EACH; 10 for 95p; 50 for £4.00.

TRANSISTORS:

BC107/8/9	9p	*BC183/183L	11p	*BF194	12p	BFY51	20p
BC114	12p	*BC184/184L	12p	*BF196	13p	BFY52	20p
BC147/8/9	10p	*BC212/212L	14p	*BF197	13p	OC71	12p
*BC153/7/8	12p	*BC547	12p	AF178	30p	2N3055	50p
*BC182/182L	11p	*BC558A	12p	BFY50	20p	*2N3702/411p	
1N914	6p; 8 for 45p; 18 for 90p.	1N916	8p; 6 for 45p; 14 for 90p.				
1S44	5p; 11 for 59p; 24 for £1.00.	1N4148	5p; 6 for 27p; 12 for 48p.				

LOW PRICE ZENER DIODES: 400mW; Tol. +5% at 5mA. Values available: 3V; 3.6V; 4.7V; 5.1V; 5.6V; 6.2V; 6.8V; 7.5V; 8.2V; 9.1V; 10V; 11V; 12V; 13V; 13.5V; 15V; 16V; 18V; 20V; 22V; 24V; 27V; 30V. All at 7p each; 5 for 33p; 10 for 65p. SPECIAL: 100 Zeners for £6.00.

***RESISTORS:** High stability low noise carbon film 5%, 1/4 W at 40°C; 1/4 W at 70°C. E12 series only - from 2.2Ω to 2.2MΩ ALL AT 1p EACH; 8p for 10 of any one value; 70p for 100 of any one value. SPECIAL PACK: 10 of each value 2.2Ω to 2.2MΩ (730 resistors) £5.00.

***SILICON PLASTIC RECTIFIERS** - 1.5 Amp - Brand new wire ended D027: 100 P.I.V. - 7p (4/26p); 400 P.I.V. - 8p (4/30p).

BRIDGE RECTIFIERS: 2 1/2 Amp. 200V - 40p; 350V - 45p; 600V - 55p.

SUBMINIATURE VERTICAL PRESETS - 0.1W only: ALL AT 5p each; 50Ω, 100Ω, 220Ω, 470Ω, 680Ω 1K, 2.2K, 4.7K, 6.8K, 10K, 15K, 22K, 47K, 100K, 250K, 680K, 1M, 2.5M, & 5M.

PLEASE ADD 8% VAT TO ALL ITEMS EXCEPT THOSE MARKED WITH * WHICH ARE 25%. PLEASE ADD 15p POST AND PACKING ON ALL ORDERS BELOW £5.00.

Send S.A.E. for lists of additional ex-stock items. Wholesale price lists available to bona-fide companies. ALL EXPORT ORDERS ADD COST OF SEA/AIRMAIL.

MARCO TRADING

Dept. C6, The Old School, Edstaston, NR. WEM, Salop.
Tel: WHIXALL (Salop) 4645 (STD 094872) (Props: Minicost Trading Ltd.)

RADIO MODELLER

ELECTRONIC BOOKS

MODEL RADIO CONTROL

Detailing both Theory and Practice, this book, by leading authority Paul Newell, has become the standard reference work. A brief historical survey leads up to a detailed description of proportional systems, with over 100 illustrations, including theoretical circuits and p.c. layouts for an advanced digital system.

134 pages.

Price £2.25

U.K. Packing & Postage 32p

ON SALE NOW

at all leading shops
or direct from:-

RADIO MODELLER
BOOKS DIVISION,

64 Wellington Road,
Hampton Hill. Middx.

theory and
practice of
**MODEL
RADIO
CONTROL**

development of systems
proportional explained
digital system design
practical examples and
full circuit details

Paul Newell



BUY THIS BEST SELLER

NEW EDITION
OF

T.V. FAULT FINDING 405/625 LINES



REVISED & ENLARGED

Edited by J. R. Davies

132 pages

PRICE 90p

Over 100 illustrations, including 60 photographs of a television screen after the appropriate faults have been deliberately introduced.

Comprehensive Fault Finding Guide cross-referenced to methods of fault rectification described at greater length in the text.

Price 90p from your bookseller.

or post this Coupon together
with remittance for £1.07
(to include postage) to

DATA PUBLICATIONS LTD.

57 Maida Vale, London, W9 1SN

Please send me the 5th revised edition of TV Fault Finding. Data Book No. 5

I enclose cheque/crossed postal order for

NAME

ADDRESS

BLOCK LETTERS PLEASE

SMALL ADVERTISEMENTS

(Continued from page 315)

MAKE A CHEAP STEREO AMP. from surplus components. Send 20p and s.a.e. for details to: 19 Reginald Road, Eastney, Portsmouth, Hampshire.

WANTED TO PURCHASE: All early books on radio, preferably before 1925. Box No. 282.

AERIAL BOOSTERS. Improve weak radio and television reception. Price £3.20. P. & P. 20p. S.A.E. for leaflets. **BARGAIN PACK POLYESTER (C280) CAPACITORS.** 250V/W and 400V/W. Very good mixed selection from 0.01µF to 2.2µF. Price 100 £1, P. & P. 15p. (Our choice). **VALVE BARGAINS,** 10p each, P. & P. 10p. ECC82, ECL80, EF80/183/184, PC86/88, PCF80/802, PCL82/84, PCL85/805, PL36/504, 30PL14, PY33/81/800. COLOUR VALVES, 12p each, P & P. 10p PL508, PL509, PY500A. Lancashire Mail Order (R), 6 William Street, Stubbins, Ramsbottom, Bury, Lancs.

TO CLEAR: Xtals 2306, 2381KHz, 3/4" pin spacing, £1 each. Sigma type 72AOZ, 160TG TCP, polarised relays, octal base, £2 24V d.c. miniature model motor 2' x 1 1/4' diam, 1/16" shaft, £1. Cold cathode tube GC10B, £1. R.E.P. 3-reed tuned relay, £2. Miniature R.E.P. R/C relay, £1. 2 1/4" mic. insert 25p. Radiospares miniature output for personal receiver, 50p. Transformer 3.2 ohm/600 ohm £1. Ditto 3000 ohm/600 ohm, £1. 7X electric torch map magnifier, £1. Box No. G283.

THE RADIO AMATEUR INVALID & BEDFAST CLUB is a well established Society providing facilities for the physically handicapped to enjoy the hobby of Amateur Radio. Please become a supporter of this worthy cause. Details from the Hon. Secretary, Mrs. Rita Shepherd, 59 Paintain Road, Loughborough, Leics., LE11 3LZ.

FOR SALE: Solartron CD513.2 oscilloscope, v.g.c., £25. Cossor WM8 working 'scope, £20. Cossor WM16 oscilloscope, working, £30. Various 'scopes for sale from £6. Wanted: Avometers irrespective of condition, good prices paid. 'Q' Services Electronic Camberley Ltd., 29 Lawford Crescent, Yateley, Camberley, Surrey. Telephone: 0252-871048.

FOR SALE: Teletypewriters Creed Type 47 (Post Office Type 11). Price £10 o.n.o. S.A.E. for details to R.W.L. Limebear 60 Willow Road, Enfield, Middlesex.

JOIN THE INTERNATIONAL S.W. LEAGUE. Free services to members including Q.S.L. Bureau, Amateur and Broadcast Translation, Technical and Identification Dept. — both Broadcast and Fixed Stations, DX Certificates, contests and activities for the SWL and transmitting members. Monthly magazine, *Monitor*, containing articles of general interest to Broadcast and Amateur SWLs, Transmitter Section and League affairs, etc. League supplies such as badges, headed notepaper and envelopes, QSL cards, etc., are available at reasonable cost. Send for League particulars. Membership including monthly magazines, etc., £3.75 per annum. (U.K. and British Commonwealth), overseas \$10.00 or £4.00. Secretary ISWL, 1 Grove Road, Lydney, Glos., GL15 5JE.

FOR SALE: Personal portable receiver chassis, contains speaker, transistors, I.F.'s, etc. £2. Box No. G288.

VALVES, Radio, TV, Transmitting, Industrial. 1930 to 1975. 2200 types in stock. Many obsolete. List 20p. Quotations s.a.e. Postal export service. We wish to buy all types of valves. Wholesalers, dealers, etc., stocks purchased. Cox Radio (Sussex) Ltd., The Parade, East Wittering, Sussex. Telephone: West Wittering 2023.

(Continued on page 318)

BUILD YOURSELF A 25W AMP FOR ONLY

£29-95
+ 4-05 VAT

**COMPLETE
KIT SUPPLIED**

DORAM, one of Britain's leading mail-order distributors of audio accessories & components brings you the 'INTERNATIONAL 25' - a 25W per channel Stereo Amp. - that you can build yourself! This 'real-value-for-money' kit is supplied with clear assembly instructions and reliable components to give you a big sound to be proud of.

- * Triple Op-amp pre-amplifier
- * Power 'Darlington's' in output stage
- * 25W per channel into 8 ohms
- * Modern, elegant styling

The International 25 was originated and designed by ETI

GENUINE
BIG-SOUND VALUE!

MANY MORE INTERESTING
AUDIO KITS AND COMPONENTS
LISTED IN DORAM'S CATALOGUE
PRICED AT ONLY 60p



DORAM

DORAM ELECTRONICS LTD
P.O. Box TR8, Leeds LS12 2UF
Tel: Leeds (0532) 34222
An Electrocomponents Group
Company

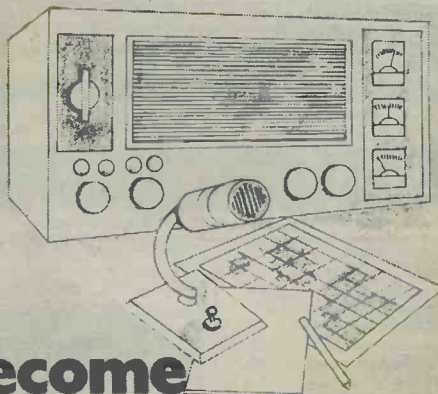

Become a radio amateur.

Learn how to become a radio-amateur in contact with the whole world. We give skilled preparation for the G.P.O. licence.

WAA

Brochure, without obligation to:

REB 125

**BRITISH NATIONAL RADIO
& ELECTRONICS SCHOOL, Dept**
P.O.Box 156, Jersey, Channel Islands.

NAME _____

ADDRESS _____

(Block caps please)

Free!

ESSENTIAL BOOKS!

POWER SUPPLIES FOR ELECTRONIC EQUIPMENT. J. R. Nowicki. Published recently in 2 vols. A full treatment of all power supplies is given. Includes rectification, inverters, transverters, silicon diodes and other electronic devices. With full circuit diagrams and component values. Originally published at £4.50 per volume. Bargain price £4 for the 2 volumes incl. postage.

THE MOBILE RADIOTELEPHONE EQUIPMENT HANDBOOK. Gives circuits, data and illustrations plus some valuable modification details for COMMERCIAL RADIOTELEPHONE equipment. Price of this edition including postage £6.25.

HOW TO MAKE WALKIE-TALKIES FOR LICENSED OPERATION. 40p, p.p. 15p.

HOW TO MAKE 2M & 4M CONVERTORS FOR AMATEUR USE. Fully comprehensive. Contains circuits layouts, component lists, diagrams and full instructional notes. Price 60p, p.p. 15p.

THE GOVERNMENT SURPLUS WIRELESS EQUIPMENT HANDBOOK. Gives circuits, data and illustrations plus valuable information for British/USA receivers, transmitters, trans/receivers. £4 including postage.

DIRECTORY OF GOVERNMENT SURPLUS WIRELESS EQUIPMENT DEALERS! Gives details of surplus wireless equipment stores and dealers including addresses plus equipment and spares that they are likely to have available. A valuable book only 50p, p.p. 15p.

GETTING THE BEST FROM YOUR COLOUR TV. R. Maude. Essential advice for colour TV engineers and owners. Could save you pounds. 50p, p.p. 15p.

THE THEORY OF GUIDED ELECTROMAGNETIC WAVES. The most comprehensive book yet written about waveguides, transmission lines, cavity resonators. Over 500 pages. Ideal for anyone interested in Radar and UHF. Published at £11.50. Special offer £4.50 p.p. 50p.

INTERNATIONAL DICTIONARY OF SEMICONDUCTORS. A 2-volume electronics dictionary published at £16 available at less than half price. In 7 languages it proves an invaluable addition to any collection of electronics reference books. Contained are 1373 pages packed with information. In leather styled finish. Only £6.50, p.p. 50p.

THE RADIO CONTROL MANUAL. Contains numerous plans, photographs and instructions. A large format hardback book published at £1.25. Bargain price 60p, p.p. 20p.

THE THEORY AND DESIGN OF MAGNETIC AMPLIFIERS. 487 pages. Published at £1.75. Bargain price 75p, p.p. 25p.

WORKED EXAMPLES IN ALTERNATING CURRENT. A must for the student, technician and electrical engineer. Contains numerous examples and how they were arrived at. Published at £1.25. Bargain price 60p, p.p. 20p.

THE BARGAIN BOOK GAZETTE. Contains thousands of interesting new and out of print books at bargain prices. Subjects include all types of hobbies, collecting. 1001 interests. Published regularly and sent free on request.

Dept. R. C. GERALD MYERS (Publisher & Bookseller), 138 Cardigan Rd., Headingly, Leeds 6, Yorks. (Calls Welcome).

CJL

CJL LTD, P.O. BOX 34, CANTERBURY, CT1 1YT

ALL PRICES INCLUDE P&P AND V.A.T.

HAND DRILLS Leytool compact, 5/16" chuck, Gears, totally enclosed, S/L bearings	£3.99	3/32", 1/8", 3/16" bits—each	£0.47
SOLDERING IRONS (ANTEX)		'X25' Elements	£1.15
15W, 'C' miniature irons, slide on & off 3/32" bit	£2.30	Soldering KIts, 'SK1', 'C' iron, 2 spare bits 3/32" & 5/32", heat sink, solder base booklet	£3.85
3/32", 1/8", 3/16" bits—each	£0.45	Stands (all models), High grade base, springs, sponges, bit space	£1.10
'C' Elements	£1.10	SOLDER - In handy Bib dispenser	£0.43
15W, 'CCN' miniature irons, low leakage, slide on & off 3/32" bit	£2.70	WIRE STRIPPERS & CUTTERS	
3/32", 1/8", 3/16" bits—each	£0.45	Bib 8B, 8 gauge selector, automatic opening, easy grip handles	£0.85
'CCN' Elements	£1.50	EARPHONES Stethoscope style, 8 ohm dynamic	£1.20
25W, 'X25' irons, low leakage, slide on & off 1/8" bit	£2.30	Crystal earphone—lead & plug	£0.65

MORSE MADE EASY BY THE RHYTHM METHOD!

FACT NOT FICTION. If you start RIGHT you will be reading amateur and commercial Morse within a month. (Normal progress to be expected.)

Using scientifically prepared 3-speed records you automatically learn to recognise the code RHYTHM without translating. You can't help it. It's as easy as learning a tune. 18-W.P.M. in 4 weeks guaranteed. For Complete Course 3 Records & Books send £4.95 including P.I.I. etc. (overseas surface mail £1 extra.)

For further details of course Ring 01-660 2896 or send large S.A.E. for explanatory booklet to:—S. BENNETT, G3HSC (Box 38) 45 GREEN LANE, PURLEY, SURREY

SMALL ADVERTISEMENTS

(Continued from page 317)

POSTAL ADVERTISING? This is the Holborn Service. Mailing lists, addressing, enclosing, wrapping, facsimile letters, automatic typing, copy service, campaign planning, design and artwork, printing and stationery. Please ask for price list. — The Holborn Direct Mail Company Capacity House, 2-6 Rothsay Street, Tower Bridge Road, London, S.E.1. Telephone: 01-407 1495.

RADIO. LEARN FROM THE BEGINNING. 16 vintage circuit diagrams, receivers and transmitters with notes, £1.00. Allister, 58 Wavell Road, Maidenhead, SL6 5AD.

WANTED URGENTLY suitable complete working amplifier assembly for "Collaro Studio" 2-track T-deck. All letters answered. Box No. G291.

WINDMILL HEATING SYSTEMS, vertical generators, professional drawings, books, constructional articles, plans, obtainable library, 90 references, bibliography, £2 plus s.a.e. As above solar bibliography £2 plus s.a.e. Stuart & Stuart Engineering, Loversall, Nr. Doncaster, Yorks, DN11 9DG.

FOR SALE: Light diodes (produce up to 1mA from light) 10p. 25 unmarked BC107/8/9 50p. 25 unmarked 2W zeners 50p. 50 unmarked BZY88 50p. 25 3-5-7W resistors 50p. 0.5V 60mA silicon solar cells £2.00. Box No. G293.

SELLING: Lafayette HE-30 general coverage receiver, £30. P.O. relays 150 Ω 22p each. Carriage extra. Box No. G294.

BURGLAR/FIRE ALARMS. Emergency lighting. Professional and D.I.Y. equipment. Catalogue 25p. Castle Alarms, Box W06, Windsor, Berks.

FREQUENCY LIST TRANSFERS. We have a limited supply of sheets of Dial Frequency Transfers in black. Short Wave frequencies 1.8Mc/s to 32Mc/s and 144Mc/s and 146Mc/s. Includes amateur band marker frequencies at 100kc/s points and other short wave frequencies from 2 to 32 Mc/s at every 500Kc/s points. Each frequency is repeated. Two sheets for 5p., five sheets for 10p., postage 6p. Data Publications Ltd., 57 Maida Vale, London, W9 1SN.

FOR SALE: Dual trace oscilloscope Marconi TF1331 DC-15MHz, 14 x 11 x 23, in DP. Original price £395. Sale price £125 with manual and probes. Ring: 01-444-8216 evenings or write: Box No. G295.

WANTED: "Everyday Electronics", January 1975. Whole issue or copy of articles. Price ? John Hunt, 251 West Bruceton, Pittsburgh, PA 15236, U.S.A.

NEW DESOLDERING BRAID for I.C.'s, T.R.'s, etc. Quick and clean. Special offer 50p for 1.5 metres (elsewhere 90p) plus 15p P. & P. Orders to Box No. 297. Discount for quantity.

RECITALS OF RECORDED MUSIC. The second Saturday evening of each winter month. Next recital: December 13th, 1975, 8 p.m. at Woodford Green United Free Church, Woodford Green, Essex. Bus routes 20, 20A, 179 & 275 — alight at "The Castle" stop. Programme includes works by Bach, Gabrieli and Handel.

(Continued on page 319)

SMALL ADVERTISEMENTS

(Continued from page 318)

PERSONAL

JANE SCOTT FOR GENUINE FRIENDS. Introductions to opposite sex with sincerity and thoughtfulness. Details free. Stamp to: Jane Scott, 3/Con North St. Quadrant, Brighton, Sussex, BN1 3GJ.

IF YOU HAVE ENJOYED A HOLIDAY on the Norfolk Broads, why not help to preserve these beautiful waterways. Join the Broads Society and play your part in determining Broadlands future. Further details from: - The Hon. Membership Secretary, The Broads Society, "Icknield," Hilly Plantation, Thorpe St. Andrew, Norwich, NOR 85S.

MENTAL TRAINING COURSES. Towards a greater state of memory. Price 8 Gns. **DYNAMIC THINKING.** A course to increase reading, reasoning and calculating speeds. Price 5 Gns. Mitchell, 27 Brookland Square, Deepwater Road, Canvey Island, Essex.

SPONSORS required for exciting scientific project. Norwich Astronomical Society are building a 30" telescope to be housed in a 20' dome of novel design. All labour being given by volunteers. Already supported by Industry and Commerce in Norfolk. Recreational. Educational. You can be involved. Write to: NAS Secretary. The Manse, Back Lane, Wymondham, Norfolk.

ESSEX GARDENERS. Buy your Bedding and rock plants, shrubs, etc., also cacti from May's Nurseries, 608 Rayleigh Road, Hutton, Brentwood, Essex. Callers only. Monday to Saturday.

YOUNG MAN DISABLED needs work at home. Electronic/wire assembly. Would collect and deliver. Mr. B. Grimes, Llainwen, Glanrhyd, Cardigan, Wales, SA43 3PE.

CLEARANCE BARGAINS

SPECIAL OFFER - Metallised Polyester Capacitors by Erie, Mullard, etc. Values include .01/160V, .01/250V, .015/160V, .022/160V, .033/160V, .047/160V, .068/160V, .1/160-250V, .22/160V, etc. This is a bargain not to be missed, 100 for £2.00.

ASSORTED CAPACITORS, Silver Mica, Tubular and Disc Ceramics, Polystyrene. Tremendously good selection 300 for £1.70.

MULLARD FERRITE CORES LA3 54p, LA4 81p, LA2100 54p. OUT OF SPEC. 2N 3055 5 for £1.08

CERAMIC FORMERS L23mm Diam. 13mm Bore 1 end 8mm other end 4mm 100 for £1.88.

ROTARY SWITCHES very good quality 1P x 18 way x 3 banks 65p
Please note all prices include Postage and V.A.T.

**MAIL ORDER ONLY
XEROZA RADIO**
1, EAST STREET,
BISHOPS TAWTON,
DEVON

FINE COPPER BRAID - FOR FLEXIBLE CONNECTIONS AND -
DONT ALL RUSH - BUT SOME OF OUR CUSTOMERS HAVE
ACTUALLY BEEN KNOWN TO USE THIS FOR DESOLDERING -
IT'S CERTAINLY CHEAP ENOUGH!

5 yds. 1/16" Tinned Copper Braid (Pack W45) 30p
10 yds. 1/32" Plain Copper Braid (Pack W44) 30p
10yds. 1/32" Rolled Flat (Pack W44A) 30p

ALL ABOVE INCLUDE VAT & POSTAGE THIS MONTH
TERMS CHEQUE OR P.O. WITH ORDER (CROSSED)
10p stamp for list or free with order if requested. Mail order only.
ATLANTA E.S.P. LTD. (R & E.C.)

10 DRYDEN CHAMBERS, 119 OXFORD STREET, LONDON W1R 1PA

REVOR OPTICAL & TECHNICAL

12/13 HENRIETTA ST.,
LONDON W.C.2
Tel. 01-836 4536

£6.00
POST
FREE

4" dia. lens

FLEXIBLE MAGNIFIER

WITH CAST IRON BASE,
PRECISION GROUND AND
POLISHED LENS, CHROME PLATED
FRAME AND FLEXIBLE TUBE.
IDEAL FOR HOBBIES, AND
DETAILED WORK WHICH REQUIRES
BOTH HANDS FREE.

S.A.E. FOR CATALOGUE

(Subject to price ruling at the time of issue)

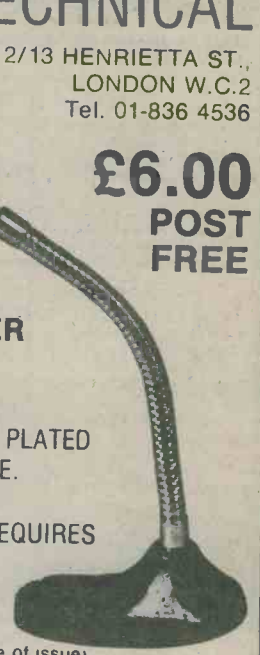

ENGINEERS

FREE

YOURSELF FOR A BETTER JOB WITH MORE PAY!

Do you want promotion, a better job, higher pay? "New Opportunities" shows you how to get them through our low-cost home study course. There are no books to buy and you can pay-as-you-learn.

This helpful guide to success should be read by every ambitious engineer. Send for this helpful 76 page FREE book now. No obligation and nobody will call on you. It could be the best thing you ever did.



POST NOW

CUT OUT THIS COUPON
CHOOSE A BRAND NEW FUTURE HERE!

Tick or state subject of interest. Post to the address below.

- | | | |
|--|--|---|
| Prac. Radio & Electronics (with kit) <input type="checkbox"/> | Motor Mechanics <input type="checkbox"/> | Inst. Eng. & Techs <input type="checkbox"/> |
| Electronic Eng. Cert. <input type="checkbox"/> | C & G Motor V Mechs <input type="checkbox"/> | Maintnec Eng. <input type="checkbox"/> |
| Gen. Elec. Eng. Cert. <input type="checkbox"/> | Gen. Auto Eng. <input type="checkbox"/> | Welding <input type="checkbox"/> |
| C & G Elect. Install. <input type="checkbox"/> | A.M.I.M.I. <input type="checkbox"/> | Computer Prog. <input type="checkbox"/> |
| Elect. Install & Work <input type="checkbox"/> | Air Regn. Brd. Certs. <input type="checkbox"/> | Inst. of Cost - Management Accts <input type="checkbox"/> |
| C & G Elect. Techs. <input type="checkbox"/> | M.A.A./I.M.I. Dip. <input type="checkbox"/> | Gen. Draughtamp. <input type="checkbox"/> |
| Colour TV Servicing <input type="checkbox"/> | Heat, Ventilating & Air Conditioning <input type="checkbox"/> | A.M.I.E.D. <input type="checkbox"/> |
| C & G Telecoms. Tech. <input type="checkbox"/> | Architectural Draughtmanship & Design <input type="checkbox"/> | Elec. Draughtamp. <input type="checkbox"/> |
| C & G Radio, TV & Electronics Mech. Cert. <input type="checkbox"/> | L.I.O.B. <input type="checkbox"/> | |
| Radio & TV Eng. Course <input type="checkbox"/> | Carpentry & Joinery <input type="checkbox"/> | |
| Radio Serv. & Rep. <input type="checkbox"/> | Plumbing Tech <input type="checkbox"/> | |
| Radio Amateur's Exam <input type="checkbox"/> | General Building <input type="checkbox"/> | |
| | Painting & Deco. <input type="checkbox"/> | |
| | A.M.S.E. (Mech.) <input type="checkbox"/> | |
| | General Mech. Eng. <input type="checkbox"/> | |

GCE 58 '0' and 'A'
level subjects - over
10,000 group passes

Coaching for many major examinations

To **ALDERMASTON COLLEGE, Dept. TRE12, READING RG7 4PF**

Also at our London Advisory Office, 4 Fore Street

Avenue, Moorgate, London, EC2Y 5EJ Tel: 01-628 2721

TRE12

NAME (Block Capitals Please).....
ADDRESS.....
POSTCODE.....other subjects..... Age.....
Accredited by C.A.C.C. Member of A.B.C.C.

HOME OF BRITISH INSTITUTE OF ENGINEERING TECHNOLOGY

SMALL ADVERTISEMENTS

Use this form for your small advertisement

To: The Advertisement Manager, Data Publications Ltd., 57 Maida Vale, London W9 1SN

Please insert the following advertisement in theissue of RADIO & ELECTRONICS CONSTRUCTOR

15 words at 5p
= 75p.

ALL WORDING
IN
BLOCK LETTERS
PLEASE

I enclose remittance of.....being payment at 5p a word. MINIMUM 75p.
Box Number, if required, 10p extra.

NAME.....
ADDRESS.....

Copy to be received four weeks prior to publication. Published on the 1st of every month.

DATA BOOK SERIES

- DB5 TV FAULT FINDING**
132 pages. Price 90p, P. & P. 17p
- DB6 RADIO AMATEUR OPERATOR'S HANDBOOK**
88 pages. Price 70p, P. & P. 12p
- DB16 RADIO CONTROL FOR MODELS**
Now out of print
- DB17 UNDERSTANDING TELEVISION**
504 pages. Price £3.25, P. & P. 50p
- DB18 AUDIO AMPLIFIERS**
128 pages. Price 53p, P. & P. 14p
- DB19 SIMPLE SHORT WAVE RECEIVERS**
140 pages. Price 80p, P. & P. 17p

I enclose Postal Order/Cheque for.....in payment for.....

NAME.....

ADDRESS.....

(BLOCK LETTERS PLEASE)

Postal Orders should be crossed and made payable to Data Publications Ltd.
Overseas customers please pay by International Money Order.
All publications are obtainable through your local bookseller.
Data Publications Ltd., 57 Maida Vale, London W9 1SN

PLEASE MENTION THIS MAGAZINE WHEN WRITING TO ADVERTISERS

ELECTRONICS DATA

FOR THE BEGINNER

WAVELENGTH AND FREQUENCY

The position that a radio signal takes up in the electromagnetic wave spectrum is defined in terms of its wavelength or its frequency. Wavelength may be expressed in metres and frequency in cycles per second.

In (a) a transmitting aerial radiates a radio signal. This can be pictured as an alternating wave, as in (b) where the wave is travelling to the right. Its velocity is the same as the velocity of light, which is almost exactly equal to 300,000,000 metres per second.

The wavelength of the signal is the distance between two similar points on two successive cycles. In (c) the wavelength is measured between the crests of two waves.

A stationary observer at line XY is introduced in (d) with the task of counting the number of wave crests which pass him in 1 second. This number will represent the frequency of the signal in cycles per second.

If the wavelength of the signal were 1 metre then, since the signal velocity is 300,000,000 metres per second, the number of wave crests, or cycles, passing the observer in 1 second would be 300,000,000. Had the wavelength been 1,000 metres the number of cycles in 1 second would be 300,000. In these, and all other instances, the wavelength in metres multiplied by frequency in cycles per second is equal to 300,000,000. Because of this relationship, frequency decreases as wavelength increases, and vice versa.

Modern usage employs the Hertz (Hz) as the unit of frequency, with 1 Hertz being equal to 1 cycle per second. The two examples just quoted are then expressed as: 1 metre corresponds to 300,000,000Hz, or 300MHz; and 1,000 metres corresponds to 300,000Hz, or 300kHz.

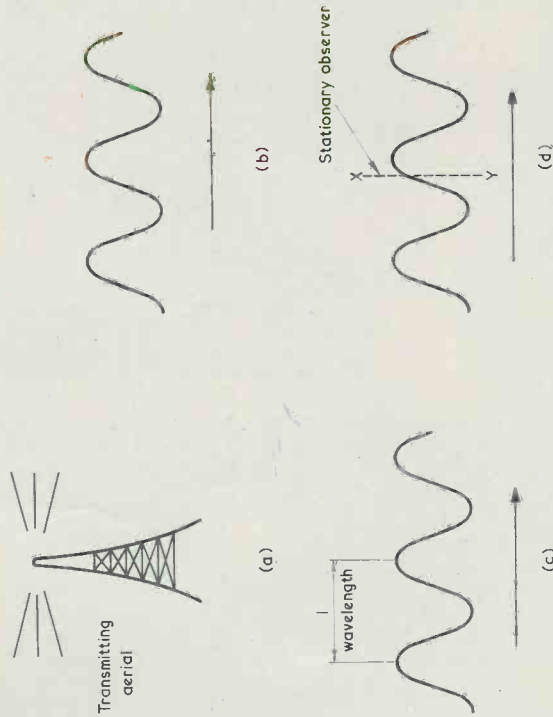

DIRECT SUPPLY SERVICE TO READERS . . .

TOWERS INTERNATIONAL TRANSISTOR SELECTOR

This is dead!

If it takes you longer than 1 minute to find out all about these transistors then you need a copy of TOWER'S INTERNATIONAL TRANSISTOR SELECTOR. Its one of the most useful working books you will be offered this year. And probably the cheapest!

In it you will find a really international selection of 10,000 transistor types - British, Continental European, American and



Japanese. And we think that they will solve 90% of your transistor enquiries.

Current and widely used obsolete types were carefully selected and arranged in Numero-Alphabetical order by an author who was uniquely qualified to do the job. With his compendium, all you need to know is the type number

and you can learn all about a transistor's specification; who made it and where to contact them; or what to use to replace it.

Would this replace it?



Look at the entry for 2N909

TRANSISTOR NUMBER	PKG. TYPE	PACK-AGE	LEAD INFO	V _{CB} MAX	V _{CE} MAX	V _{EB} MAX	I _C MAX	T _J MAX	P _{TOT}	F _T MIN	C _{OB} MAX	H _{FE}	H _{FE} BIAS	USE	MFR	EURO EQVT.	USA EQVT.	ISS
2N909	NS	TO18	LO1	60V	30V	5V	200MA	175C	500mW	50M	25P	110MN	50MA	AMG	SGI	BSX33	2N731	0

This is what you will learn from it

TYPE NO	PKG. MAT	OUTLINE	LEAD IDENT.	V _{CB} MAX	V _{CE} MAX	V _{EB} MAX	I _C MAX	T _J MAX	P _{TOT}	f _T	C _{OB} MAX	h _{FE}	I _C (H _{FE} BIAS)	USE	SUPPLIER	UK SUB	USA SUB	ISS
(EXAMPLE) 2N909	NS	TO18	LO1	60V	30V	5V	200 MA	175C	500mW	50M	25P	110 MN	50 MA	AMG	SGI	BSX 33	2N 731	0

NUMERO-ALPHABETIC LISTING

N - NPN
P - PNP
G - GERMANIUM
S - SILICON

REFER TO CASE-OUTLINES APPENDIX C

REFER TO LEAD DETAILS - APPENDIX B

MAXIMUM PERMISSIBLE COLLECTOR - BASE VOLTAGE WITH EMITTER OPEN - CIRCUIT

MAXIMUM PERMISSIBLE COLLECTOR - EMITTER VOLTAGE WITH BASE OPEN - CIRCUIT

MAXIMUM PERMISSIBLE EMITTER - BASE VOLTAGE WITH COLLECTOR OPEN - CIRCUIT

MAXIMUM PERMISSIBLE COLLECTOR CURRENT

MAXIMUM PERMISSIBLE JUNCTION TEMPERATURE

MAXIMUM PERMISSIBLE DEVICE DISSIPATION - "P" - IN FREE AIR AT 25°C, "C" - WITH CASE SURFACE HELD AT 25°C, "M" - IN FREE AIR AT 25°C WITH METAL HEAT SINK ATTACHED TO DEVICE

MINIMUM FREQUENCY CUT OFF, F_c, INDICATED IN K - KILOHERTZ M - MEGAHERTZ G - GIGAHERTZ

F_c - FREQUENCY AT WHICH COMMON-EMITTER CURRENT GAIN DROPS TO UNITY, TYPICAL F_c CAN BE TAKEN AS ROUGHLY TWICE F_c

SUGGESTED EIA-JEDEC "2N" STANDARD POSSIBLE SUBSTITUTE

SUGGESTED PROELECTRON STANDARD POSSIBLE SUBSTITUTE

CODE INDICATION POSSIBLE SUPPLIER OF DEVICE - SEE "SUPPLIER" APPENDIX F

CODE INDICATION OF APPLICATION USAGE - SEE APPENDIX A

BIAS CURRENT AT WHICH CURRENT GAIN h_{FE}, IS CHARACTERISED

CURRENT GAIN, NORMALLY D.C. (BUT SOMETIMES RELATED A.C. GAIN) AT I_C, BIAS SPECIFIED - WHERE MIN ("MIN") ONLY IS SPECIFIED TYPICAL ("TYP") CAN BE TAKEN AS TWICE MIN AND VICEVERSA

MAXIMUM COLLECTOR CAPACITANCE (TYPICAL USUALLY 1 TO 1 MAX) - NORMALLY EMITTER OPEN - CIRCUIT AND INDICATED BY "P" - PICOFARAD OR "N" - NANOFARAD - FOR HF DEVICES C_{OB} IS GIVEN AND PICOFARADS THEN INDICATED BY "W" INSTEAD OF "P"

Tower's International Transistor Selector

by T. D. TOWERS
MBE, MA, BSc, C Eng, MIERE

£3.30
inc. post and packing

To:—DATA PUBLICATIONS LTD.
57 MAIDA VALE
LONDON W9 1SN

Please send me copy/copies
to the address shown below

NAME

ADDRESS

(Block capitals)

RADIO & ELECTRONICS CONSTRUCTOR