

RADIO & ELECTRONICS CONSTRUCTOR

FEBRUARY 1974

20p

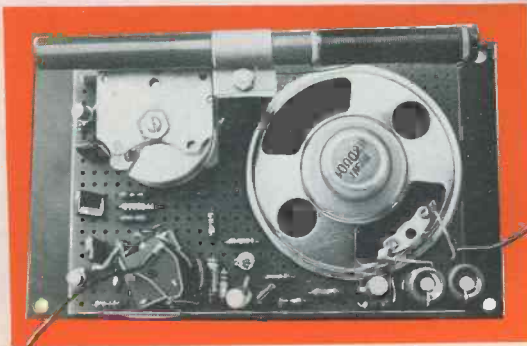
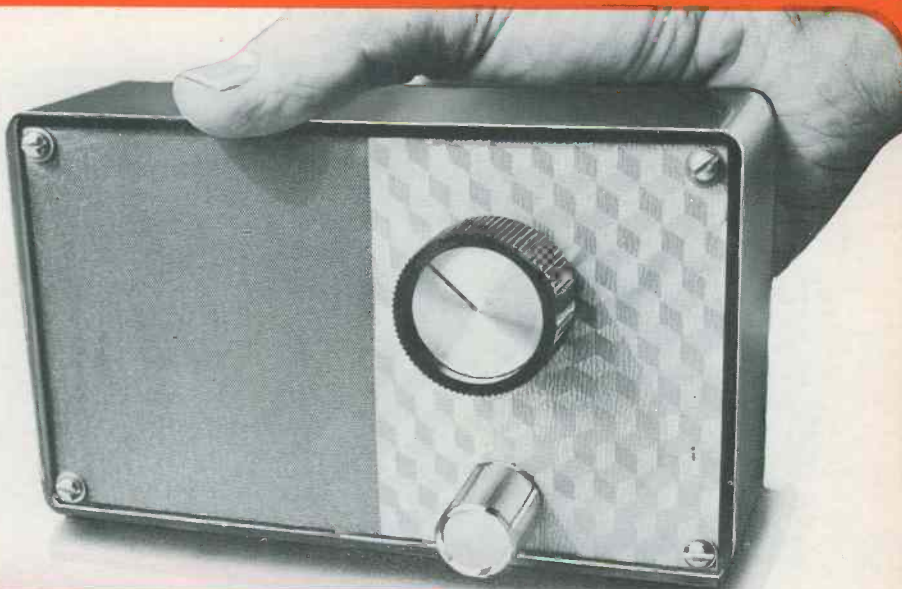

**IC Plus four
portable**

**ALSO
FEATURED**

MULTI-MATCH SPEAKER

Radio Control Kits from **AMTRON**

New from AMTRON—these Radio Control units in kit form. Enjoy building your own Radio Control Receivers and Transmitters and Field Strength Meters.

An accurate setting up of Radio Control Transmitters can be made with the help of the UK 555 Field Strength Meter.

3 transistors, 1 diode plus meter make this unit a very sensitive device.

PRICES

UK 300 Four Channel Radio Con. Transmitter	£6.55
UK 310 Radio Control Receiver	£3.28
UK 345 Radio Control Receiver	£6.55
UK 555 Field Strength Meter	£10.61

All prices inclusive of VAT



THE BIG NAME IN ELECTRONIC KITS



4 & 7 CASTLE STREET HASTINGS SUSSEX TN34 3DY TEL : HASTINGS 2875

BI-PRE-PAK

SUPPLIERS OF SEMI-CONDUCTORS TO THE WORLD



Telephone Corner

COMPLETE TELEPHONES
EX. G.P.O. NORMAL
HOUSEHOLD TYPE

Only **£1-05p**

POST & PACKING 45p EACH
TELEPHONE DIALS

Standard Post Office type. Guaranteed in working order.

Only **27 1/2p** POST & PACKING 16p

Tested and Guaranteed Paks



TESTED AND GUARANTEED PAKS

B79	4	IN4007 Sil. Rec. diodes, 1,000 PIV lamp plastic	55p
B81	10	Reed Switches, 1" long, 1/2" dia. High speed P.O. type	55p
B99	200	Mixed Capacitors. Approx. quantity, counted by weight P & P 15p	55p
H4	250	Mixed Resistors. Approx. quantity counted by weight P & P 15p	55p
H35	100	Mixed Diodes. Germ. Gold bonded, etc. Marked and Unmarked.	55p
H38	30	Short lead Transistors. NPN Silicon Planar types.	55p
H39	6	Integrated Circuits. 4 Gates BMC 962, 2 Flip Flops BMC 945	55p
H41	2	Sil Power transistors comp pair BD131/132	55p



Unmarked Untested Paks

UNMARKED UNTESTED PAKS

B1	50	Germanium Transistors PNP, AF and RF	55p
B66	150	Germanium Diodes Min. glass type	55p
B84	100	Silicon Diodes DO-7 glass equiv. to OZA200, OAZ202	55p
B86	100	Sil. Diodes sub. min. IN914 and IN916 types	55p
H16	15	Experimenters' Pak of Integrated Circuits. Data supplied	55p
H20	20	BY126, 7 Type Silicon Rectifiers 1 amp plastic. Mixed volts.	55p
H34	15	Power Transistors. PNP, Germ. NPN Silicon TO-3 Can.	55p

Make a rev counter for your car

The "TACHO BLOCK". This encapsulated block will turn any 0-1mA meter into a linear and accurate rev. counter for any car with normal coil ignition system.

£1-10p each

A Cross Hatch Generator £3-85 post paid

YES, a complete kit of parts including Printed Circuit Board. A four position switch gives X-hatch, Dots, Vertical or Horizontal lines. Integrated Circuit design for easy construction and reliability. This was a project in the September 1972 edition of Television.

Electronic Transistor Ignition

Now in kit form, we offer this "up to the minute" electronic ignition system. Simple to make, full instructions supplied with these outstanding features—

Transistor and conventional switchability, burglar proof lock up and automatic alarm, negative and positive compatibility. This project is a "star" feature in the September edition of "Electronics Today International" magazine. Our kit is recommended by the ETI magazine.

Owing to a huge demand, our kit is now reduced from £7.92

COMPLETE KIT including V.A.T p. & p. 11p.

£6-60p

Ready built and tested unit £9.90 including V.A.T.

New Paks

Tested & Guaranteed

H63	4	2N3055 Type NPN Sil. power transistors. Below spec. devices	55p
H64	4	3819 N Channel F.E.T.'s 2N3819 in plastic case	55p
H65	4	40361 Type NPN Sil. transistors TO-5 can comp. to H66	55p
H66	4	40362 Type PNP Sil. transistors TO-5 can comp. to H65	55p
Untested, Unmarked			
H67	10	3819 N Channel F.E.T.'s plastic case type	55p

Over 1,000,000 Transistors in stock

We hold a very large range of fully marked, tested and guaranteed transistors, power transistors, diodes and rectifiers at very competitive prices. Please send for free catalogue.

Silicon Planar Plastic Transistors

Unmarked, untested, factory clearance. A random sampling showed these to be of remarkably high quality.

Audio PNP, similar to ZTX500, 2N3702 3, BCY70 etc.

Audio NPN, similar to ZTX300, 2N3708 9, BC107 8 9, BC168 9 etc.

ALL AT 500 for £3.30, 1,000 for £5.50, 10,000 for £44 P. & P. 11p 1.000

Please state Audio NPN or Audio PNP when ordering.

Our very popular 4p Transistors

TYPE "A" PNP Silicon alloy, TO-5 can.
TYPE "B" PNP Silicon, plastic encapsulation.
TYPE "E" PNP Germanium AF or RF.
TYPE "F" NPN Silicon plastic encapsulation.
TYPE "G" NPN Silicon similar ZTX 300 range
TYPE "H" PNP Silicon similar ZTX 500 range

8 RELAYS FOR £1-10p p. & p. 27 1/2p.

Plastic Power Transistors

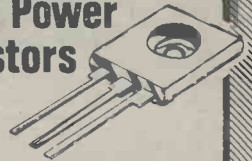

NOW IN TWO RANGES

There are 40W and 90W Silicon Plastic Power Transistors of the very latest design, available in NPN or PNP at the most shatteringly low prices of all time. We have been selling these successfully in quantity to all parts of the world and we are proud to offer them under our Tested and Guaranteed terms. Range 1, VCE. Min. 15. HFE Min 15.

40 Watt	1-12	13-25	26-50
90 Watt	22p	20p	18p
	26p	24p	22p

Range 2, VCE. Min 40. HFE Min 40.

40 Watt	1-12	13-25	26-50
90 Watt	33p	31p	29p
	38p	36p	33p

Complementary pairs matched for gain at 3 amps. 11p extra per pair. Please state NPN or PNP on order.

INTEGRATED CIRCUITS

We stock a large range of I.C.s at very competitive prices (from 11p each). These are all listed in our FREE Catalogue, see coupon below.

METRICATION CHARTS now available

This fantastically detailed conversion calculator carries thousands of classified references between metric and British (and U.S.A.) measurements of length, area, volume, liquid measure, weights etc. Pocket Size 15p Wall Chart 18p

LOW COST DUAL IN LINE I.C. SOCKETS

14 pin type at 16 1/2p each } Now new low profile type
16 pin type at 18p each

BOOKS

We have a large selection of Reference and Technical Books in stock, details are in our latest catalogue' send for it TODAY using the coupon below.

Send for lists of publications

Our famous P1 Pak is still leading in value

Full of Short Lead Semiconductors and Electronic Components, approx. 170. We guarantee at least 30 really high quality factory marked Transistors PNP & NPN, and a host of Diodes & Rectifiers mounted on Printed Circuit Panels. Identification Chart supplied to give some information on the Transistors.

Please ask for Pak P.1. only **55p**

Please send me the FREE Bi-Pre-Pak Catalogue

NAME _____

ADDRESS _____

All prices include 10% V.A.T.

MINIMUM ORDER 50p. CASH WITH ORDER PLEASE. Add 11p post and packing per order. OVERSEAS ADD EXTRA FOR POSTAGE

BUY THESE GOODS WITH ACCESS

BI-PRE-PAK LTD

Co Reg No 820919

Dept C, 222-224 WEST ROAD, WESTCLIFF-ON-SEA, ESSEX.

TELEPHONE: SOUTHEND (0702) 46344.

COMPONENTS

HOBBYIST - AMATEUR - DOMESTIC SURPLUS - INDUSTRIAL - BULK OFFERS
JUST A FEW OF OUR BARGAINS ARE LISTED BELOW - PAY US A VISIT OR SEND STAMPED ADDRESSED ENVELOPE FOR A QUOTE ON YOUR REQUIREMENTS

MAINS POWER SUPPLY UNIT. 400m/A, 6-7.5-9-12 VOLT MADE TO SELL AT £5.25 OUR PRICE £3.50

VALVE BASES	
Printed circuit B9A - B7G	3p
Chassis UX7 - UX5 - B9G - B7G	3p
Shrouded chassis B7G - B9A	4p
B11A chassis (relay)	8p
B8A - B9A chassis	5p

TAG STRIP	WRIST COMPASS
6 way 2p Single 1p	20p with Needle Lock

1 1/2 glass fuses— 250 m/a or 3 amp (box of 12)	12p
3" tape spools	4p
FX2236 FerroX Cores	5p
PVC or metal clip on M.E.S. bulb holder	3p
All metal equipment Phono plug	2p
Bulgin, 5mm Jack plug and switched socket (pair)	20p
12 volt solenoid and plunger	25p
250 RPM 50 c/s locked frequency miniature mains motor	50p
200 OHM coil, 2 1/4" long, hollow centre	10p
Relay, P.O. 3000 type, 1,000 OHM coil, 4 pole c/o	60p
R.S. 12 way standard plug and shell	50p

SWITCHES			
Pole	Way	Type	
4	2	Sub. Min. Slide	10p
6	2	Slide	15p
4	2	Lever Slide	10p
6	4	} Wafer Rotary	15p each
4	3		
3	7		
2	5		
1	3	+ off Sub. min. edge	10p
1	3	13 amp small rotary	12p
2	2	Locking with 2 to 3 keys	£1.50
2	1	2 Amp 250V A.C. rotary	20p
1	2	Toggle	10p

COMPUTER AND AUDIO BOARDS
HOST OF QUALITY, REASONABLE LEAD TRANSISTORS, SOME POWER, SILICON, GERMANIUM, ZENER DIODES, POT CORES HI-STAB RESISTORS, SOME WIREWOUND, CONDENSERS, CHOKES, TRIMPOTS, ELECTROLYTICS, ETC.

3lb. for 75p + 25p post and packing
7lb. for £1.50 + 40p post and packing

SUBMIN VERTICAL SKELETON PRESET
100, 220, 470, 680 OHM 1, 2.2, 4.7, 6.8, 10, 15, 22, 47, 68, 100, 220 K OHM.
ONLY 3p EACH

KNOB
SILVER METAL PUSH ON WITH POINTER, OR WHITE PLASTIC, GRUB SCREW, WITH POINTER AND SILVER CENTRE 5p EACH.

ZM1162A INDICATOR TUBE
0-9 Inline End View. Rectangular Envelope 170V 2.5M/A £1.70

RESETTABLE COUNTER
English Numbering Machines LTD.
MODEL 4436-159-989
6-14 volt, 6 digit, illuminated, fully enclosed. £2.50

TO3 Mica Washer	2p
3" Standard Tape - Boxed	15p
GP91-1 Cartridge, turnover stylii	65p
GC10/4B Cold Cathode	£5.00
Brand New Boxed 6K7G	25p

12p	4p
5p	3p
2p	20p
50p	25p
10p	60p
50p	

RESISTORS	
1/2 1/2 watt	1p
1 watt	1 1/2p
Up to 10 watt wire	8p
15 watt wire wound	10p

SKELETON PRESETS	
5K or 500K	4p

SAFETY PINS	
Standard size, 10 for 4p	

WIREWOUND POTS	
250, 300 OHM, 1K, 4 watt, 10K, 11K, 20K, 50K, all at	10p each

5K switched volume control	15p
5K Log Pot	10p
1meg Tandem Pot	15p

THERMISTORS	
VA1040	} 10p each
VA1055	
VA1066	
VA1100	
VA1077	13p

STEEL BOX WITH LID	
10 x 5 1/2 x 3" grey hammer finish	£1

RELAYS	
6 volt, 2 pole c/o heavy duty contacts	50p
Mains 3 pole c/o heavy duty contacts ex equipment	35p

ELECTROLYTICS	
Mullard C426, TCC, CRL, CCL, Cullins, Hunts, STC Subminiature, etc	2p
MFD/VOLT	2.5/64, 12/50, 12/20, 100/6, 6/3, 8/6, 200/3, 25/3.
3p	25/6.4, 500/6, 250/6.
4p	20/12, 100/25, 100/12, 25/12, 100/15, 64/10, 125/10, 50/50, 50/10, 100/18, 6/25, 2/350.
9p	8/500, 100/200, 400/40, 100/250-275.
5p	8/50, 8/20, 8/40, 150/25, 260/12, 4/60, 15/35, 6p 250/18, 400/16, 250/30, 550/12, 50p 8/800, 12,000/12, 2000/50. 32-32-50/350.
	20p 100-100/150, 100-100/275, 32-32/275.

INDICATORS	
Arcoelectric green, takes M.E.S. bulb	10p
Bulgin D676 red, takes M.E.S. bulb	15p
12 volt red, small pushfit	15p
Mains neon, amber, pushfit	15p

CAPACITORS	
Mixed type PFDS, 2p, 3.3, 4.7, 10, 16, 18, 22, 24, 25, 27, 30, 33, 37, 39, 47, 50, 56, 68, 88, 100, 110, 150, 200, 220, 250, 270, 300, 350, 470, 500, 600, 680, 800, 1000, 2200, 3000, 3300, 5000.	
Poly, met., film, paper, etc. MFD/Volt, 3p.	.001/1250, .005/250, .03/350, .022/70, .03/12, .03/200, .033/100, .0068/70, .056/350, .061/350, .069/350, .075/350, .08/350, .1/350, .1/500, .13/350, .25/150.
4p.	1500, 1800, 2200, 3000, 3300, 6800, 8200 PFD. .01/350, .013/350, .02/250, .05/125, .05/250, .25/350.
5p.	.033/100, .1/250, .25/500, .5/350.
6p.	.1/600, .1/1500, .22/250, .5/250
10p.	.01/1000, 1/350, 2/150, 2/200, 2/250.
40p.	5/150, 9/275AC, 10/150, 15/150, 40/150.

TRIMMERS, 10p each	
100PF Ceramic, 30PF Beehive, 12PF PTFE, 2500PF 750 volt, 33PF MIN. AIR SPACED.	

CONNECTOR STRIP	
Belling Lee L1469, 12 way polythene. 5p each	
CAN CLIPS	

1" or 1 1/8" or 3/4"	2p
----------------------	----

LABGEAR MAINS DROPPER	
36 ohm 25 watt + 79 ohm 9 watt	15p

TUNING CONDENSERS 33 or 50PF, 20p	
-----------------------------------	--

2 Amp Suppression Choke	5p
-------------------------	----

PAXOLINE	
3 x 2 1/2 x 1 1/2"	2p
4 3/8 x 1 1/2 x 1 1/2"	2 for 1p
220K 3 watt resistors	2p

VALVE RETAINER CLIP, adjustable	2p
---------------------------------	----

OUTPUT TRANSFORMERS	
Sub-miniature Transistor Type	20p
Valve type, centre tapped or straight	40p

3 pin din to open end, 1 1/2yd twin screened lead	35p
---	-----

10 mtrs loudspeaker extension lead fitted 2 pin din plug and socket	40p (retail 80p)
---	------------------

THE RADIO SHACK

161 ST. JOHNS HILL, BATTERSEA, LONDON S.W.11

Open 10 a.m. till 7 p.m. Monday to Saturday Phone 01-223 5016

If payment by cheque allow time for clearance, otherwise by return.

SEMICONDUCTORS

Full spec. marked by Mullard, etc. Many other types in stock

AC127	12p	BC159C	13p	BF178	25p
AC187/8	12p	BC178	14p	BF179	30p
AD149	35p	BC186/7	22p	BF180	20p
AD161/2	26p	BCY40	25p	BF181/2	32p
AF116/7	12p	BCY70	13p	BF183	28p
AF124/7	20p	BCY71	12p	BF184/5	17p
AF139	31p	BCY72	8p	BF194/5/6/7	12p
AF178	32p	BD115	62p	BF200	32p
AF180	40p	BD131	40p	BF262/3	22p
AF239	37p	BD132	50p	BF336	28p
BC107A or B	10p	BD135	33p	BFX29/30	25p
BC107/B/9	7p	BD203	£1.00	BFX84	24p
BC108A/B	10p	BD232	65p	BFX88	20p
BC147/B/9	8p	BD234/5	48p	BFY50/1/2	13p
BC148B/9B	10p	BF115	20p	BSV64	40p
BC157/B/9	11p	BF167	20p	BSX21	20p
BC158A	13p	BF173	20p	BU105/01	£1.30

BRIDGE RECTIFIERS

Amp	Volt RMS		Amp	Volt RMS			
1/2	1,600	BYX10	30p	2	30	LT120	30p
1	140	OSH01-200	25p	0.6	6-110	EC433	
1.4	42	BY164	35p	Encapsulated with built-in heat sink			15p

1 AMP RECTIFIERS

IN4002	100 volt	4p
IN4003	200 volt	5p
IN4004	400 volt	6p
IN4005	600 volt	7p
IN4006	800 volt	8p
IN4007	1,000 volt	8p

HIGH POWER RECTIFIERS

	Amp	Volt	
LT102	2	30	10p
BYX38-600	2.5	600	25p
BYX38-300	2.5	300	20p
BYX38-900	2.5	900	28p
BYX38-1200	2.5	1,200	30p
BYX49-600	2.5	600	25p
BYX49-300	2.5	300	20p
BYX49-900	2.5	900	28p
BYX48-300	6	300	27p
BYX48-600	6	600	32p
BYX48-900	6	900	40p
BYX48-1200	6	1,200	60p
BYX72-150R	10	150	24p
BYX72-300R	10	300	35p
BYX72-500R	10	500	43p
BYX42-300	10	300	40p
BYX42-600	10	600	45p
BYX42-900	10	900	55p
BYX42-1200	10	1,200	75p
BYX46-300*	15	300	£2.50
BYX46-400*	15	400	£2.90
BYX46-500*	15	500	£3.20
BYX46-600*	15	600	£3.80
BYX20-200	25	200	35p
BYX52-300	40	300	£1.75
BYX52-1200	40	1,200	£2.25

*Avalanche type

N50 ohm free plug (UG21D/U) 50p
N50 ohm square socket (UG58A/U) 50p

1* Terryclips black plastic coated, or chrome finish 4p

Cinch 10-way terminal block 15p

Pair of LA2407 Ferroxc cores with adjuster 25p

Chrome Car Radio fascia 15p
Rubber Car Radio gasket 10p

DLI Pal Delayline £2.00

Relay socket 12p
Take miniature 2PCO relay

B9A valve can 2p

0-30 in 5 segments, black pvc, 360° dial, silver digits, self adhesive, 4 1/2" dia. 15p

OPTO ELECTRONICS

ORP12	48p	Photo transistor	
BPX40	25p	BPX29	80p
BPX42	£1	OC71	£1
BPY10	£1.50		
BPY68	75p		
BPY69	£1		
BPY77	75p		

Diodes

PNPN PROGRAMMABLE UNIUNCTION BRY39 30p

F.E.T.'s
BFW10 25p
BSV79 90p
BSV80 80p

N. Channel
BSV81 M.O.S.T. £1
BFS28 Dual M.O.S.T. 90p

Plastic, Transistor or Diode Holder 1p
Transistor or Diode Pad 1p
Holders or pads 50p per 100

Phillips Iron Thermostat 15p
Bulgin 2-pin flat plug and socket 10p
McMurdo PP108 8 way edge plug 15p
300 ohm moving coil insert 4103D 1 1/2" diameter. Make ideal mike or speaker for communication work 25p

Tested unmarked or marked ample lead ex new equipment

AC128	6p	OC71/2	6p
ACY17-20	8p	OC200-5	6p
ASY28/9	8p	2G302	6p
ASZ21	8p	2N2926	5p
BCY70/1/2	8p	2N598/9	6p
BCY30-34	10p	2N1091	8p
BY127	8p	2N1302	8p
BZY88 series	6p	Germ. diode	3p
OA5/7/10	10p	GET111	20p
OA47/81	4p	GET120	
OA200-5	5p	(AC128 in 1"sq. heat sink)	20p
OC23	20p	100v 1 amp diode	3p
OC29	25p		
OC44	6p		

OC35	34 1/2p	2N2904	18p
TAA570	1-50p	2N2905	22p
TAD100	1-25	2N2906	15p
2N706	10p	2N2907	20p
2N2219	20p	2N3053	15p
2N2401 (ASY26-27)	25p		

Amp	Volt	THYRISTORS	
1	240	BTX18-200	30p
1	240	BTX30-200	30p
6.5	300	BT102-300R	42p
6.5	500	BT102-500R	60p
10	700	BT106	90p
15	500	BT107	90p
6.5	500	BT101-500R	68p
6.5	500	BT109-500R	90p
20	600	BTW92-600RM	£3.00
15	800	BTX95-800R Pulse Modulated	£12

OTHER DIODES

Centercel	5p	5lb New Mixed Components	
IN916	4p	£2 plus 40p p & p	
BA145	15p		
BA182	24p		

TRIACS

Amp	Volt		
25	900	BTX94-900	£6.50
25	1200	BTX94-1200	£9

CQ11B Infra red transmitter £4
WESTINGHOUSE 28T10 30 AMP 1000 VOLT THYRISTOR WITHOUT NUT £6

PHOTO SILICON CONTROLLED SWITCH BPX66 PNPN 10 amp £1

PAPER BLOCK CONDENSER

0.25MFD	800 volt	30p
1MFD	400 volt	15p
2MFD	250 volt	20p
2MFD	1.5 kv	50p
4MFD	350 volt	20p
15MFD	150 volt	25p

METAL CHASSIS SOCKETS

Car Aerial	5p
Coax	6p
5 or 6 pin 240° din	6p

ALL ORDERS OVER £3 POST FREE OVER £6 V.A.T. FREE

8 way Cinch standard 0.15 pitch edge socket 20p

U.E.C.L. 10 way pin connector 2B6000 OA1P10 20p

U.E.C.L. 20 way pin connector 2A6000OA1P20 30p

U.E.C.L. 10 way pin socket 2B606001R10 20p

U.E.C.L. 20 way pin socket 2B60800A1R20 30p

BELLING LEE L1354 TV Aerial diplexer 10p

Philips electronic engineer kits add on series A20, E1004, E1005 £1.00 each (parts worth more)

DIAC BR100 30p

TAA300 T0-74 1 Watt A.F. AMPLIFIER I.C. 4.5 to 9v £1.62 1/2

WIREWOUND SLIDER 150 Ohm, 250 Ohm 5K 4p each

HANDLES Rigid light blue nylon 6 1/2" with secret fitting screws 5p

Rotor with neon indicator, as used in Seafarer, Pacific, Fairway depth finders 20p each

Miniature Axial Lead, Ferrite Choke formers 2p

DEE PLUG McMurdo DA15P 15 way chassis plug 20p

Fairway 18009 Coax. socket 5p

TIE CLIPS Nylon self locking 7" 2p

CINCH 150 12 way edge socket 10p

1lb Mixed nuts, bolts, washers etc. 25p

SMALL ORDERS, ENCLOSE SUITABLE STAMPED ADDRESSED ENVELOPE
LARGE ORDERS, ADD SUFFICIENT FOR POSTAGE, INSURANCE, ETC.
TOTAL GOODS PLUS CARRIAGE, ADD 10% V.A.T.

THE RADIO SHACK

161 ST. JOHNS HILL, BATTERSEA, LONDON S.W.11
Open 10 a.m. till 7 p.m. Monday to Saturday Phone 01-223 5016



WILMSLOW AUDIO

THE Firm for speakers!

SPEAKERS

EMI 13 x 8, 3, 8 or 15 ohm £2.03
 EMI 13 x 8, 150 d/c 3, 8 or 15 ohm £2.25
 EMI 13 x 8, 450 t/tw 3, 8 or 15 ohm £3.60
 EMI 13 x 8 type 350 8 ohm £8.25
 EMI 6 1/2" 93850 4 or 8 ohm £2.80
 EMI 8 x 5 D/Cone Roll/s 8 ohm £2.50
 Baker Group 25 3, 8 or 15 ohm £6.60
 Baker Group 35 3, 8 or 15 ohm £7.50
 Baker De Luxe 12" d/cone £9.62
 Baker Major 12" £7.50
 Kef T27 £4.67
 Kef T15 £5.50
 Kef B110 £6.16
 Kef B200 £7.42
 Kef B139 £10.72
 Kef DN8 £1.92
 Kef DN12 £4.12
 Kef DN13 £2.75
 Fane Pop 100 watt 8/15 ohm £21.45
 Fane Pop 60 watt 8/15 ohm £12.26
 Fane Pop 50 watt 8/15 ohm £10.17
 Fane Pop 25/2 25 watt 8/15 ohm £5.94
 Fane Pop 15 watt B/15 ohm £4.40
 Fane Crescendo 15" 8 or 15 ohm £27.50
 Fane Crescendo 12A 100w 8 or 15 ohm £24.20
 Fane Crescendo 12B bass £24.20
 Fane 807T 8" d/c roll/s 8 or 15 ohm £3.85
 Fane 808T 8" d/cone 8 or 15 ohm £2.64
 Goodmans Axent 100 tweeter £6.60
 Goodmans 8P 8 or 15 ohm £3.80
 Goodmans 10P 8 or 15 ohm £4.49
 Goodmans 12P 8 or 15 ohm £11.55
 Goodmans 15P 8 or 15 ohm £17.05
 Goodmans 18P 8 or 15 ohm £29.70
 Goodmans Twinaxiom 8 £6.79
 Goodmans Twinaxiom 10 £7.61
 Elac 9 x 5, 59RM109 15 ohm, 59RM114 8 ohm £2.53
 Elac 6 1/2" d/c roll/s 8 ohm £3.22
 Elac 6 1/2" d/cone 8 ohm £2.59
 Elac 4" tweeter TYV4 £1.21
 Wharfedale Super 10 RS/DD £9.80
 Coral 6 1/2" d/cone roll/s 8 ohm £2.42
 Siran 6 1/2" 3 or 8 ohm £1.44
 Richard Allan 12" c/c 3 or 15 ohm £2.20
 10" x 6" 3, 8 or 15 ohm £1.92

8" x 5" 3 or 8 ohm £1.38
 7" x 4" 3 or 8 ohm £1.38
 2 1/2" 64 ohm or 70 mm 80 ohm .65
 Adastra Hiten 10" 10w 8 or 15 ohm £2.80
 Eagle DT33 dome tw. £5.45
 Eagle HT15 tweeter £3.66
 Eagle CT5 tweeter £1.25
 Eagle CT10 tweeter £2.54
 Eagle MHT10 tweeter £3.74
 Eagle FR4 £4.45
 Eagle xover CN23, 28, 216 £1.15
 Sp. matching transformer 3-15 ohm £1.10
 Celestion MF1000 25w horn 8 or 15 ohm £10.45
 Celestion P58 (for Unilex) £2.16
 Celestion G12M 8 or 15 ohm £12.00
 Celestion G12H 8 or 15 ohm £15.00
 Celestion G15C 8 or 15 ohm £24.00
 Celestion G18C 8 or 15 ohm £33.00

SPEAKER KITS

Wharfedale Unit 3 £8.25
 Wharfedale Unit 4 £14.50
 Richard Allan Twinkit £7.95
 Richard Allan Triple 8 £11.75
 Richard Allan Triple Assem. £17.50
 Richard Allan Super Triple £20.75
 Goodmans DIN 20 £8.58
 Fane Mode One £9.00
 Kefkit 2 £24.75
 Kefkit 3 £35.50
 Peerless 2-8 £5.50
 HELME XLK25 (Pair) £18.17

HELME XLK50 (Pair) £37.18
 Peerless 10-2 £8.47
 Peerless 20-2 £10.41

Stephenspeaker kits and cabinets - send for free booklet "Choosing a Speaker".
 Prices include V.A.T. Carriage and insurance 75p per kit.

RADIOS/CASSETTES/AMPS

Grundig RF310 £21.25
 Grundig Signal 500 £27.00
 Grundig Marliner TR865 £32.00
 Grundig Elite Boy 500 £24.00
 Grundig Melody Boy 500 £24.00
 Grundig Melody Boy 1000 £35.00
 Grundig Yacht Boy 210 £31.00
 Grundig RF430 mains £23.75
 Grundig RF310 mains £21.00
 Grundig Top Boy £16.75
 Grundig Satellit 1000 £116.00
 Grundig C402 cassette £27.00
 Grundig C230 cassette £28.00
 Tandberg TP41 £37.75
 BASF 9301 radio/cassette £58.00
 Bush VTR178 5 band (inc. air) £29.00
 Trio KA2000A £33.00
 Trio KA2002 £41.00
 Gec. C200 radio/cassette £31.00
 ITT/COLT £9.95
 ITT/KB Golf Preset £21.25
 ITT/KB Weekend Auto £16.00
 ITT/KB Europa £18.00
 ITT/KB SL53 cassette £22.82
 ITT/KB Studio 60M cassette £29.32
 ITT/KB Studio 73 stereo cassette £44.00
 Koyo KTR1664 8 waveband £40.00
 Koyo KTR 1770 11 waveband £56.50
 Koyo KTR1883 5 band (inc. air) £23.50

Prices include V.A.T. Carriage and insurance 75p.

PA/DISCO AMPLIFIERS. (carriage and insurance £1.00)

Baker 100 Watt £46.00
 Linear 30/40 £25.00
 Linear 40/60 £30.00
 Linear 80/100 £50.00



FREE

With speaker orders over £7 "Hi-Fi Loudspeaker Enclosures" book.

All units guaranteed new and perfect. Prompt despatch.

Carriage and insurance 35p per speaker (tweeters and crossovers 20p)

ALL PRICES QUOTED INCLUDE V.A.T.

WILMSLOW AUDIO Department R.C.

LOUDSPEAKERS: SWAN WORKS, BANK SQUARE,
 WILMSLOW, CHESHIRE. SK9 1HF

RADIOS ETC: 10 SWAN ST. WILMSLOW, CHESHIRE. SK9 1HF
 TELEPHONE WILMSLOW 29599

UNDERSTANDING TELEVISION



by

J. R. DAVIES

Over 500 pages
 300 diagrams

£2-10

POSTAGE
 20p

- Principles of 405 line reception
- Principles of 625 line reception
- Nature of the television signal
- Receiver tuner units
- A.F. and video amplifiers
- Deflector coil assemblies
- Automatic gain and contrast control
- Receiver aerials

- The cathode ray tube
- Receiver i.f. amplifiers
- Vertical and horizontal timebases
- Synchronising
- Power supply circuits
- COLOUR TELEVISION - 80 page section deals comprehensively with this subject

Available from

Data Publications Ltd., 57 Maida Vale, London, W9 1SN

THE MODERN BOOK CO

NEW EDITION - RAPID SERVICING OF TRANSISTOR EQUIPMENT

Systematic Guide to Servicing of Transistor Radio, T.V., Tapes and Hi-Fi Equipment by G. J. King Price £2.00

THE HI-FI & TAPE RECORDER HANDBOOK
by G. J. King PRICE £2.25

TRANSISTOR AUDIO & RADIO CIRCUITS
by Mullard PRICE £1.90

TEN MINUTE TEST TECHNIQUES FOR ELECTRONICS SERVICING
by Carlson PRICE £1.10

THE HOUSEHOLDER'S ELECTRICAL GUIDE
by G. Burdett PRICE £1.05

TROUBLESHOOTING SOLID STATE ELECTRONIC POWER SUPPLIES
by Gaddis PRICE £1.45

SERVICING WITH THE OSCILLOSCOPE
by G. J. King PRICE £2.00

AUDIO TECHNICIAN'S BENCH MANUAL
by J. Earl PRICE £3.20

TRANSISTOR EQUIVALENTS
by De Muiderkring PRICE £1.90

SERVICING RECORD CHANGERS
by H. Mileaf PRICE £1.50

FOUNDATIONS OF WIRELESS & ELECTRONICS by M. G. Scroggie PRICE £2.00

TRANSISTOR PROJECTS by Foulsham-Tab PRICE £1.40

RADIO TECHNICIAN'S BENCH MANUAL by H. W. Hellyer PRICE £3.20

HOW TO BUILD SOLID-STATE AUDIO CIRCUITS by M. Horowitz PRICE £1.90

RADIO, T.V. & AUDIO TEST INSTRUMENTS by G. J. King PRICE £4.00

HOW TO TEST ALMOST EVERYTHING ELECTRONIC by J. Darr PRICE £1.40

INTEGRATED CIRCUIT POCKET BOOK by R. G. Hibberd PRICE £2.60

99 ELECTRONIC PROJECTS by H. Friedman PRICE £1.60

BASIC THEORY & APPLICATION OF TRANSISTORS PRICE £1.00

ALL PRICES INCLUDE POSTAGE

We have the Finest Selection of English and American Radio Books in the Country

19-21 PRAED STREET (Dept RC) LONDON W2 1NP

Telephone 01-723 4185



GIRO NO. 331 7056
C.W.O. only. P. & P. 10p on orders below £5
Discount: £10-10%, £20-15% (except net items)
Export Order enquiries welcome (VAT free)

Official Orders accepted from
Educational & Government Departments

ALL PRICES INCLUDE VAT

SPECIAL RESISTOR KITS

10E12 1W KIT: 10 of each E12 value, 22 ohms—1M, a total of 670 (CARBON FILM 5%), £3 10 net

10E12 1/2W KIT: 10 of each E12 value, 22 ohms—1M, a total of 670 (CARBON FILM 5%), £3 20 net

25E12 1/2W KIT: 25 of each E12 value, 22 ohms—1M, a total of 1425 (CARBON FILM 5%), £7 35 net

25E12 1W KIT: 25 of each E12 value, 22 ohms—1M, a total of 1425 (CARBON FILM 5%), £7 35 net

20E12 1/2W KIT: 20 of each E12 value, 10 ohms—1M, a total of 1220 (METAL FILM 5%), £7 50 net

15E12 1W KIT: 15 of each E12 value, 10 ohms—1M, a total of 915 (METAL FILM 5%), £8 15 net

10E12 2W KIT: 10 of each E12 value, 10 ohms—1M, a total of 610 (METAL FILM 5%), £12 65 net

MULLARD POLYESTER CAPACITORS C280 SERIES
250V P.C. Mountings: 0.01µF, 0.015µF, 0.022µF, 0.033µF, 0.047µF, 3p.p. 0.068µF, 0.1µF, 4p.p. 0.15µF, 4p.p. 0.22µF, 5p.p. 0.33µF, 8p.p. 0.47µF, 9p.p. 0.68µF, 11p.p. 1µF, 15p.p. 1.5µF, 22p.p. 2.2µF, 25p.

MULLARD POLYESTER CAPACITORS C296 SERIES
400V: 0.001µF, 0.0015µF, 0.0022µF, 0.0033µF, 0.0047µF, 2p.p. 0.0068µF, 0.01µF, 0.015µF, 0.022µF, 0.033µF, 3p.p. 0.047µF, 0.068µF, 0.1µF, 4p.p. 0.15µF, 6p.p. 0.22µF, 8p.p. 0.33µF, 12p.p. 0.47µF, 14p.

160V: 0.01µF, 0.015µF, 0.022µF, 2p.p. 0.047µF, 0.068µF, 3p.p. 0.1µF, 0.15µF, 4p.p. 0.22µF, 5p.p. 0.33µF, 6p.p. 0.47µF, 7p.p. 0.68µF, 11p.p. 1µF, 14p.

MINIATURE CERAMIC PLATE CAPACITORS
50V: (pF) 22, 27, 33, 39, 47, 56, 68, 82, 100, 120, 150, 180, 220, 270, 330, 390, 470, 560, 680, 820, 1K, 1K5, 2K2, 3K3, 4K7, 6K8, 1µF to 0.01, 0.015, 0.022, 0.033, 0.047, 2p.p. each, 0.1, 30V, 4p.p.; 0.1, 100V, 5p.p.

POLYSTYRENE CAPACITORS 160V 5%
(pF) 10, 15, 22, 33, 47, 68, 100, 150, 220, 330, 470, 680, 1000, 1500, 2200, 3300, 4700, 4p.p. 6800, 10,000, 4p.p.

RESISTORS

CF—High Stab Carbon Film, 5% MF—High Stab Metal Film, 5%

W. Type Range	1-9	10-49	50-99	100-249	250-499	500-999	1000 -	Size mm
CF 22-1M	1	0-8	0-65	0-62	0-55	0-5	0-45	2-4 7x5
CF 22-1M	1	0-8	0-65	0-62	0-55	0-5	0-45	3-9x10-5
CF 22-1M	1	0-8	0-65	0-62	0-55	0-5	0-45	5x16
MF 10-2M7	1	0-9	0-8	0-7	0-65	0-65	0-6	3x7
MF 10-2M2	1	0-9	0-8	0-7	0-65	0-65	0-6	4-2x10-8
MF 10-10M	1	5	25	1	1	0-95	0-88	6-6x13
MF 10-10M	3	25	2	2	1	1-75	1-6	8x15

For value mixing prices, please refer to our catalogue. (price in pence each)
VALUES AVAILABLE—E12 Series only. "NET PRICES ABOVE 100"

PRESET SKELETON POTENTIOMETERS

MINIATURE 0.25W Vertical or horizontal 6p each 1K, 2K2, 4K7, 10K, etc. up to 1MΩ

SUB-MIN 0.05W Vertical, 100Ω to 220KΩ 1/2 5p each

(R.C.) 61 CHEDDINGTON ROAD, PITSTONE, NR. LEIGHTON BUZZARD, BEDS, LU7 9A Q
Tel.: Cheddington 668446 (Std. Code 0296)
PLEASE WRITE FOR FREE CATALOGUE

B. H. COMPONENT FACTORS LTD.

Miniature Mullard Electrolytics

1.0µF 63V	6p	68µF 16V	6p
1.5µF 63V	6p	82µF 63V	12p
2.2µF 63V	6p	100µF 10V	6p
3.3µF 63V	6p	100µF 25V	6p
4.0µF 40V	6p	100µF 63V	14p
4.7µF 63V	6p	150µF 16V	6p
6.8µF 63V	6p	150µF 63V	15p
8.0µF 40V	6p	220µF 6-4V	6p
10µF 16V	6p	220µF 10V	6p
10µF 25V	6p	220µF 16V	8p
10µF 63V	6p	220µF 63V	21p
15µF 16V	6p	330µF 16V	12p
15µF 63V	6p	330µF 63V	25p
16µF 40V	6p	470µF 6-4V	9p
22µF 25V	6p	470µF 40V	20p
22µF 63V	6p	680µF 16V	15p
32µF 10V	6p	680µF 40V	25p
33µF 16V	6p	1000µF 16V	20p
33µF 40V	6p	1000µF 25V	25p
32µF 63V	6p	1500µF 6-4	15p
47µF 10V	6p	1500µF 16V	25p
47µF 25V	6p	2200µF 10V	25p
47µF 63V	8p	3300µF 6-4	26p

VEROBOARD 0 | 0-15

2 1/2 x 5"	28p	28p
2 1/2 x 3 1/2"	26p	19p
3 1/2 x 5"	32p	33p
3 1/2 x 3 1/2"	28p	28p
2 1/2 x 1 1/2"	7p	7p
2 1/2 x 5" (Plain)	—	14p
2 1/2 x 3 1/2" (Plain)	—	12p
5 x 3 1/2" (Plain)	—	22p
Insertion tool	59p	59p
Track Cutter	44p	44p
Pins, Pkts. 25	10p	10p

TRANSISTORS

AC127 16p	BC212L 12p
AC128 22p	BC213L 12p
BC107 11p	BC214L 17p
BC108 12p	OC44 18p
BC109 13p	OC71 13p
BC148 12p	OC81 16p
BC149 12p	OC170 23p
BC182L 12p	TS43 33p
BC183L 12p	2N2926 11p
BC184L 13p	2N3702 11p

POTENTIOMETERS

Carbon Track 5KΩ to 2MΩ, log or lin. Single, 16p Dual Gang 46p. Log Single with switch 26p

Slider Pots. 10K, 100K, 500K, 30mm, 34p, 45mm, 47p, 60mm, 55p.

DIODES

IN4001 6p	DIN 2 Pin 12p
IN4002 7p	3 Pin 13p
IN4003 9p	5 Pin 180° 15p
IN4004 9p	Std. Jack 14p
IN4005 12p	2.5mm Jack 11p
IN4006 14p	Phono 5p
IN914 7p	
IN916 7p	
8A100 10p	
OAS 42p	
OA47 9p	
OAB1 11p	
OA200 9p	Phono 5p

PLUGS

DIN 2 Pin 12p
3 Pin 13p
5 Pin 180° 15p
Std. Jack 14p
2.5mm Jack 11p
Phono 5p

SOCKETS

DIN 2 Pin 10p
3 Pin 10p
5 Pin 180° 12p
Std. Jack 14p
2.5mm Jack 11p
Phono 5p

ELECTROLYTIC CAPACITORS, Tubular & Large Cans

(µF V): 2-2.25, 2.2 63, 4 7 10, 4-7.25, 4-7.63, 22 10, 22 25, 22 63, 5p, 2 10, 10 10, 50 10, 100 10, 10 25, 50 25, 10 50, 5p

200 10, 100 25, 50 50, 6p, 500 10, 200 25, 100 50, 9p, 1000 10, 500 25, 200 50, 11p, 2000 10, 1000 25, 500 50, 16p, 1000 50, 500 100, 66p, 2000 25, 27p, 2500 12, 17p, 2500 25, 33p, 2500 50, 62p, 3000 50, 72p, 5000 25, 66p, 5000 50, 94p, 7000 50, 60p, 25000 25, 74p, Hi-VOLT: 8 350, 14p, 16 350, 19p, 32 350, 25p, 50 250, 18p 100 500, 33p.

METALLISED PAPER CAPACITORS
250V: 0.05µF, 0.1µF, 0.25µF, 5p, 0.5µF, 6p, 1µF, 9p, 500V: 0.025µF, 0.05µF, 4p, 0.1µF, 5p, 0.25µF, 6p, 0.5µF, 9p, 1000V: 0.01µF, 10p, 0.022µF, 12p, 0.047µF, 0.1µF, 16p, 0.22µF, 22p, 0.47µF, 39p.

QUANTITY DISCOUNT
SPECIAL BULK BUY PRICES
ARE AVAILABLE BY
QUOTATION FOR LARGE
PROJECTS AND TRADE

The Sinclair Cambridge... no other calculator is so powerful and so compact.

Complete kit-£24.95! (PLUS VAT)

The Cambridge – new from Sinclair

The Cambridge is a new electronic calculator from Sinclair, Europe's largest calculator manufacturer. It offers the power to handle the most complex calculations, in a compact, reliable package. No other calculator can approach the specification below at anything like the price – and by building it yourself you can save a further £5.50!

Truly pocket-sized

With all its calculating capability, the Cambridge still measures just $4\frac{1}{2}'' \times 2'' \times \frac{11}{16}''$. That means you can carry the Cambridge wherever you go without inconvenience – it fits in your pocket with barely a bulge. It runs on ordinary U16-type batteries which give weeks of life before replacement.

Easy to assemble

All parts are supplied – all you need provide is a soldering iron and a pair of cutters. Complete step-by-step instructions are provided, and our service department will back you throughout if you've any queries or problems.

The cost? Just £27.45!

The Sinclair Cambridge kit is supplied to you direct from the manufacturer. Ready assembled, it costs £32.95 – so you're saving £5.50! Of course we'll be happy to supply you with one ready-assembled if you prefer – it's still far and away the best calculator value on the market.

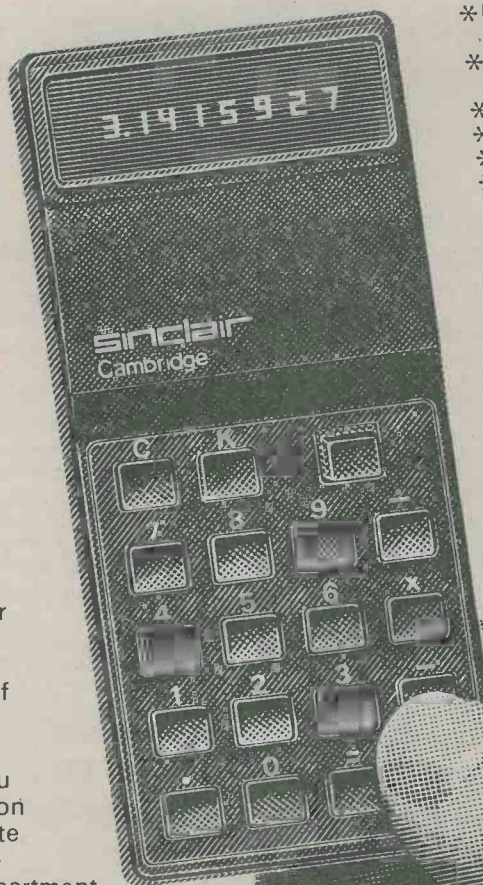

Features of the Sinclair Cambridge

- * Uniquely handy package. $4\frac{1}{2}'' \times 2'' \times \frac{11}{16}''$, weight $3\frac{1}{2}$ oz.
- * Standard keyboard. All you need for complex calculations.
- * Clear-last-entry feature.
- * Fully-floating decimal point.
- * Algebraic logic.
- * Four operators (+, -, x, ÷), with constant on all four.
- * Constant acts as last entry in a calculation.
- * Constant and algebraic logic combine to act as a limited memory, allowing complex calculations on a calculator costing less than £30.
- * Calculates to 8 significant digits, with exponent range from 10^{-20} to 10^{79} .
- * Clear, bright 8-digit display.
- * Operates for weeks on four U16-type batteries. (MN 2400 recommended.)

A complete kit!

The kit comes to you packaged in a heavy-duty polystyrene container. It contains all you need to assemble your Sinclair Cambridge. Assembly time is about 3 hours.

Contents:

1. Coil.
2. Large-scale integrated circuit.
3. Interface chip.
4. Thick-film resistor pack.
5. Case mouldings, with buttons, window and light-up display in position.
6. Printed circuit board.
7. Keyboard panel.
8. Electronic components pack (diodes, resistors, capacitors, transistor).
9. Battery clips and on/off switch.
10. Soft wallet.



This valuable book – free!

If you just use your Sinclair Cambridge for routine arithmetic – for shopping, conversions, percentages, accounting, tallying, and so on – then you'll get more than your money's worth.

But if you want to get even more out of it, you can go one step further and learn how to unlock the full potential of this piece of electronic technology.



How? It's all explained in this unique booklet, written by a leading calculator design consultant. In its fact-packed 32 pages it explains, step by step, how you can use the Sinclair Cambridge to carry out complex calculations!

Why only Sinclair can make you this offer

The reason's simple: only Sinclair – Europe's largest electronic calculator manufacturer – have the necessary combination of skills and scale.

Sinclair Radionics are the makers of the Executive – the smallest electronic calculator in the world. In spite of being one of the more expensive of the small calculators, it was a runaway best-seller. The experience gained on the Executive has enabled us to design and produce the Cambridge at this remarkably low price.

But that in itself wouldn't be enough. Sinclair also have a very long experience of producing and marketing electronic kits. You may have used one, and you've almost certainly heard of them – the Sinclair Project 60 stereo modules.

It seemed only logical to combine the knowledge of do-it-yourself kits with the knowledge of small calculator technology.

And you benefit!

Take advantage of this money-back, no-risks offer today

The Sinclair Cambridge is fully guaranteed. Return your kit within 10 days, and we'll refund your money without question. All parts are tested and checked before despatch – and we guarantee a correctly-assembled calculator for one year.

Simply fill in the preferential order form below and slip it in the post today.

Price in kit form: £24.95 + £2.50 VAT. (Total: £27.45)

Price fully built: £29.95 + £3.00 VAT. (Total: £32.95)

To: Sinclair Radionics Ltd, London Road,
St Ives, Huntingdonshire, PE17 4HJ

REC12/74

Please send me

a Sinclair Cambridge calculator kit at
£24.95 + £2.50 VAT (Total: £27.45)

a Sinclair Cambridge calculator ready
built at £29.95 + £3.00 VAT
(Total: £32.95)

*I enclose cheque for £ _____, made
out to Sinclair Radionics Ltd, and
crossed.

*Please debit my * Barclaycard/Access
account. Account number _____

*Delete as required.

Name _____

Address _____

PLEASE PRINT

sinclair

Sinclair Radionics Ltd, London Road,
St Ives, Huntingdonshire
Reg. no: 699483 England
VAT Reg. no: 213 8170 88
FEBRUARY, 1974

ELECTROVALUE CATALOGUE 7

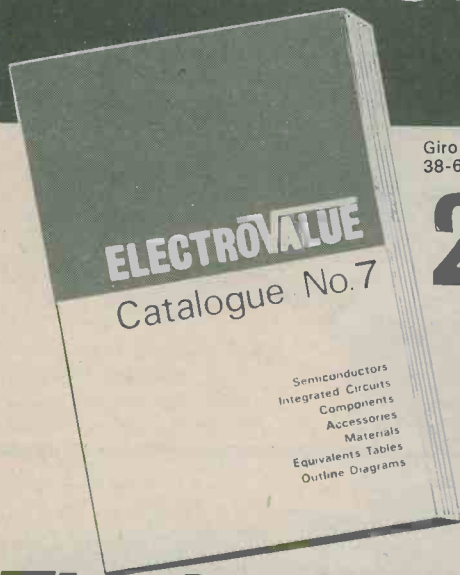

Giro Account No.
38-671-4002

25p

including
25p Refund
Voucher

The best yet!

112 pages (plus covers) and our best yet! Practically all items in catalogue 7 are there as the result of information fed by our computer, enabling us to control stock-buying in relation to demand with greater accuracy and real benefit to customers. This means that your orders, which we micro-film for record keeping, are handled with utmost speed and efficiency. EV prices remain keenly competitive and in addition there are discounts as well, to give you further savings. Among the well known firms whose products we carry are those of SIEMENS, NEWMARKET, RADIOHM, SOLDERSTAT, GUEST INTERNATIONAL as well as Texas Instruments, Mullard and others.

Send 25p now for EV Catalogue 7. It includes a refund voucher for 25p allowable on orders for £5 or more list value.

● DISCOUNTS

Available on all items except those shown with NETT PRICES.

10% on orders from £5 to £14.99 list.

15% on orders £15 and over.

● WE PAY POSTAGE

and packing in U.K. For mail orders for £2 list value and under, there is an additional handling charge of 10p.

● GUARANTEE OF QUALITY

All items guaranteed fully to makers' specifications. Everything brand new—no "seconds", makers' rejects or clearance offers.

ELECTROVALUE LTD

Dept REC. 2, 28 St. Jude's Road, Englefield Green, Egham, Surrey TW20 0HB Telephone Egham 3603 Telex 264475

All mail orders and communications to above address

● NORTHERN BRANCH

680 Burnage Lane, Manchester M19 1NA

Hours (both addresses) 9.00-5.30. Saturdays 9.00-1.00 p.m.

398

'WORTH WAITING'

A JOINT ANNOUNCEMENT FROM

IMHOFS



Due to contractual commitments both at home and overseas Eddystone Receivers are in short supply. Whilst the manufacturers are doing their best to meet these requirements we would ask your forbearance and understanding of the present delivery situation. Limited supplies of the ever popular EC10 and EB37 will continue to be available. Apologies for the necessity to "DIM THE LIGHT" — normal brilliance will be resumed as soon as possible.

IMHOFS
112-116 New Oxford St.
London WC1A 1HJ
telephone 01 636 7878

EDDYSTONE RADIO Ltd.
Alvechurch Rd.
Birmingham B31 3PP
telephone 021 475 2231

R85

**TWO NEW
SOLDER
SIPPERS
MAKE DE-
SOLDERING
QUICK &
EASY**

**A SUPER
PRESENT
ANYTIME!**

Longs

Longs Ltd.
Hanworth Lane
Trading Estate
Chertsey Surrey
KT16 9LZ.



Maxi-Super HT 1810 and Maxi-Mini HT 1800 Solder Sippers

Designed for use when working or re-working P.C. Boards. Permits removal of molten solder from Multi-leg components, enabling easy extraction. The solder is 'sipped' through the nozzle, and automatically ejected when the instrument is next used. A Swiss precision instrument manufactured to a high degree of accuracy.

The anti-corrosive outside casing has a knurled finish for more positive grip, and encases plated internal parts.

The Maxi-Super has been designed with a 3.5 kg. spring action recoilless plunger, whilst the Maxi-Mini with its conveniently shaped operating button, has a 2.5 kg. spring action plunger, protected by a channel guard. Both models have been designed with an easy-to-replace 'dupont' teflon screw-in nozzle.

PLEASE FORWARD without obligation further details.	PLEASE SUPPLY Maxi-Super HT 1810 at £6.60	PLEASE SUPPLY Maxi-Mini HT 1800 at £4.95
<input type="checkbox"/>	<input type="checkbox"/>	<input type="checkbox"/>
I enclose cheque value £ _____		
NAME _____		POSITION _____
COMPANY _____		
ADDRESS _____		
Prices include VAT		SIGNED _____
		Reg. England 68496

RADIO & ELECTRONICS CONSTRUCTOR

LATEST BOUND VOLUME No. 26

of
"Radio & Electronics
Constructor"
FOR YOUR LIBRARY



Comprising
792 pages
plus index

AUGUST 1972
to JULY 1973

PRICE £2.10 P&P 30p

BOUND VOLUME No. 24
(August 1970 to July 1971)

BOUND VOLUME No. 25
(August 1971 to July 1972)

Limited number of these
volumes still available.

PRICES

£2.00 per Volume P & P 30p.

We regret all earlier volumes are now
completely sold out.

Available only from

DATA PUBLICATIONS LTD.,
57 MAIDA VALE, LONDON, W9 1SN

Now! A FAST EASY WAY TO LEARN BASIC RADIO & ELECTRONICS



Build as you learn with the exciting
new **TECHNATRON** Outfit! No mathe-
matics. No soldering—you learn the
practical way.

Learn basic Radio and Electronics at home - the fast, modern way. Give yourself essential technical 'know-how' - like reading circuits, assembling standard components, experimenting, building - quickly and without effort, and enjoy every moment. B.I.E.T.'s simplified study method and the remarkable **TECHNATRON** Self-Build Outfit take the mystery out of the subject, making learning easy and interesting.

Even if you don't know the first thing about Radio now,
you'll build your own Radio set within a month or so!

... and what's more, you will understand exactly what you are doing. The **TECHNATRON** Outfit contains everything you need, from tools to transistors - even a versatile Multimeter which we teach you to use. All you need give is a little of your spare time and the surprisingly low fee, payable monthly if you wish. And the equipment remains yours, so you can use it again and again.

You LEARN - but it's as fascinating as a hobby.

Among many other interesting experiments, the Radio set you build - and it's a good one - is really a bonus. This is first and last a teaching course, but the training is as fascinating as any hobby and it could be the springboard for a career in Radio and Electronics.

A 14-year-old could understand and benefit from this course - but it teaches the real thing. The easy to understand, practical projects - from a burglar-alarm to a sophisticated Radio set - help you master basic Radio and Electronics - even if you are a 'non-technical' type. And, if you want to make it a career, B.I.E.T. has a fine range of courses up to City and Guilds standards.

Specialist Booklet

If you wish to make a career in Electronics, send for your **FREE** copy of "NEW OPPORTUNITIES". This brand new booklet - just out - tells you all about **TECHNATRON** and B.I.E.T.'s full range of courses.



FREE

**BRITISH INSTITUTE
OF ENGINEERING
TECHNOLOGY**

Dept. BRE 22 ALDERMASTON COURT, READING

RG7 4PF

Accredited by the Council for the Accreditation
of Correspondence Colleges.

POST THIS COUPON FOR FREE BOOK

CL BRE 22

NAME..... AGE.....
(BLOCK CAPITALS)

ADDRESS.....

.....

SUBJECT OF INTEREST.....

Which type of Shopper are YOU ?



Shopper A, enthusiastic to a fault, is determined to track down the components he needs for his next project. We'll overlook the fact that he'll probably end up with pneumonia!

Shopper B learnt his lesson long ago – now he simply sits back and orders all his requirements from his Home Radio Components' catalogue. The worst that could happen to him is that, being so absorbed in the catalogue, he might burn his toast! That's a small price to pay though for the comfort, convenience and economy of ordering components this way.



You too can join the blissful "B's" – there must be about 100,000 of them! To get your catalogue (240 large pages packed with 6,800 items, 1,770 of them illustrated) simply post the coupon with your P.O. or cheque for 77p. (55p plus 22p post and packing.) Every catalogue contains 5 vouchers, each worth 10p when used as directed. Regularly updated price lists are supplied to you free, and full details of our popular Credit Account Service are given in the catalogue.

The price of 77p applies only to catalogues purchased by customers in the U.K. and to BFPO addresses.



POST THIS COUPON with your cheque or postal order for **77 pence**

Please write your Name and Address in block capitals

Name.....

Address.....



HOME RADIO (COMPONENTS) LTD., Dept. RC
234-240 London Road, Mitcham, Surrey CR4 3HD.

RADIO & ELECTRONICS CONSTRUCTOR

RADIO & ELECTRONICS CONSTRUCTOR

FEBRUARY 1974

Vol. 27 No. 7

CONTENTS

Published Monthly (1st of Month)

First Published 1947

Incorporating The Radio Amateur

Editorial and Advertising Offices
57 MAIDA VALE LONDON W9 1SN

Telephone
01-286 6141

Telegrams
Databux, London

© Data Publications Ltd., 1974. Contents may only be reproduced after obtaining prior permission from the Editor. Short abstracts or references are allowable provided acknowledgement of source is given.

Annual Subscription: £2.70 (U.S.A. and Canada \$7.00) including postage. Remittances should be made payable to "Data Publications Ltd". Overseas readers please pay by cheque or International Money Order.

Technical Queries. We regret that we are unable to answer queries other than those arising from articles appearing in this magazine nor can we advise on modifications to equipment described. We regret that such queries cannot be answered over the telephone; they must be submitted in writing and accompanied by a stamped addressed envelope for reply.

Correspondence should be addressed to the Editor, Advertising Manager, Subscription Manager or the Publishers as appropriate.

Opinions expressed by contributors are not necessarily those of the Editor or proprietors.

Production.—Web Offset.

MULTI-MATCH SPEAKER by F. G. Rayer	402
SELECTIVE REFLEX RECEIVER by J. B. Jobe	406
RECENT PUBLICATIONS	409
NEWS AND COMMENT	410
ADJUSTABLE A.F. CLIPPER (Suggested Circuit 279) by G. A. French	412
NEW PRODUCTS	415
SHORT WAVE NEWS – For Dx Listeners by Frank A. Baldwin	416
OHMMETER SCALES by R. J. Caborn	418
THE I.C. PLUS FOUR PORTABLE by F. G. Rayer	420
S.S.B. RECEIVER FILTER by R. A. Penfold	427
EUROPEAN EXHIBITIONS	429
PRESS BUTTON SWITCH CIRCUITS by A. Jefferson	430
COTTON REEL TIPS by V. S. Evans	432
THE 'WYVERN' 30 WATT STEREO AMPLIFIER — Part 3 by John R. Green	434
IN YOUR WORKSHOP 'The Decision Maker'	438
CONSTRUCTOR'S DATA SHEET No. 83 (Wavelength – Frequency, Table II)	iii

Published in Great Britain by the Proprietors and Publishers, Data Publications Ltd, 57 Maida Vale, London, W9 1SN

The Radio & Electronics Constructor is printed by Carlisle Web Offset.

MARCH ISSUE WILL BE
PUBLISHED ON 1st MARCH

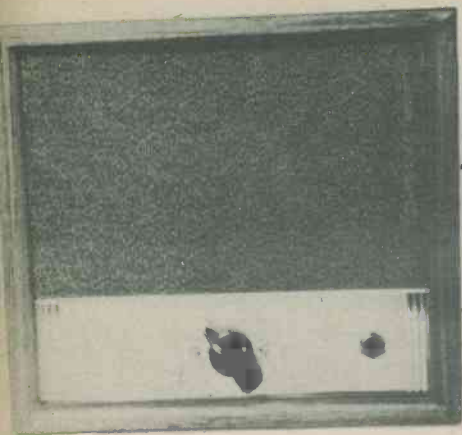

MULTI-MATCH SPEAKER

by F. G. Rayer, T.Eng. (CEI), Assoc.I.E.R.E., G30GR.

This speaker unit may be coupled to any low power a.f. output stage and it offers impedances from 3Ω to 75Ω

A LOUDSPEAKER WITH A WIDE RANGE OF IMPEDANCES which can be used with almost any equipment is a very useful unit. By fitting a home-wound transformer the multi-match speaker described here caters for impedances of 3Ω, 8Ω, 15Ω, 25Ω, 35Ω and 75Ω. This meets almost all the matching requirements likely to be encountered. Maximum power handling capacity of the transformer is 2 watts, which is adequate for most purposes, but can be increased if required.

APPLICATIONS

The speaker is suitable for regular use with an amplifier or receiver, or for improving sound volume and quality with midget pocket portables having only a miniature internal speaker. It can also be used with tape recorders and other audio equipment, or, with a long lead, for extension purposes.

Where the exact impedance is not available, a near impedance will be satisfactory and will give almost identical results. The 3Ω connection is suitable for valve and transistor equipment having a nominal output impedance of 2 to 3Ω. The 8Ω load is also satisfactory for 7.5Ω. Some complementary output stages require a 15Ω or 16Ω load, and for these the 15Ω load can be used. Portable radios or amplifiers with 30Ω or 40Ω output circuits can use the 35Ω load. The 75Ω load is suitable for small complementary output stages designed for speakers of 70Ω to 80Ω.

When using the multi-purpose speaker with transistor radios and amplifiers, take care not to switch to a low impedance where a high load impedance is required, as this may cause the output transistors to be damaged. As an example, if a 15Ω load is normal, the speaker impedance should be adjusted for this and not for 8Ω or 3Ω. Avoiding the overloading of transistor output stages is, of course, a sensible precaution in any case.

IMPEDANCE MATCHING

The speaker incorporates a 6-way rotary switch in conjunction with tappings in an autotransformer, as shown in Fig. 1. The 3Ω speaker is permanently connected across part of the winding.

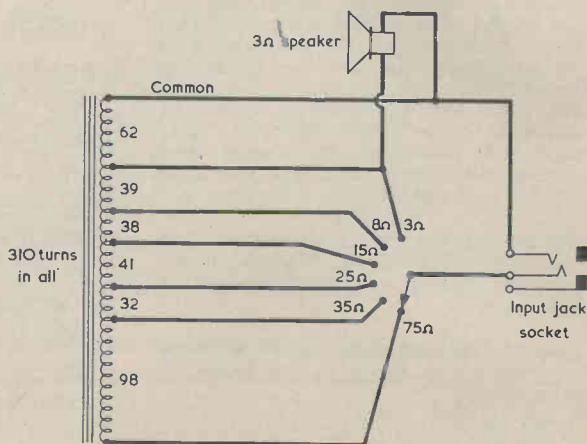

Fig. 1. The circuit of the multi-purpose speaker. The winding turns are based on a transformer core which requires 62 turns for the 3Ω section. As is explained in the text, the turnsΩ required depend on those originally employed in the transformer which is to be rewound

The turns ratios for the winding taps are found from the equation

$$\text{Ratio} = \sqrt{\frac{Z1}{Z2}}$$

where Z1 is the wanted input impedance and Z2 is the speaker impedance. In the present instance, Z2 is 3Ω. So the ratios required are:

3Ω - 1:1	25Ω - 2.9:1
8Ω - 1.63:1	35Ω - 3.42:1
15Ω - 2.24:1	75Ω - 5:1

The tappings need only be to the nearest turn, and a single tapped winding, as is used here, allows any of these impedances to be chosen.

TRANSFORMER TURNS

It is cheaper to use laminations from a discarded 3Ω speaker transformer than to attempt to purchase them. The procedure also allows good use to be made of what may otherwise be a discarded component. The transformer employed by the author was taken from an old valve receiver, had an open-circuit primary and was rated at 2 watts. Larger transformers, rated at 4 to 5 watts, are fitted in many old valve mains receivers and such transformers could also be employed. The wattage rating of the multi-tap autotransformer will be the same as that of the old transformer which provides the laminations.

Transformers which have been varnish impregnated are best avoided, as these types are difficult to take apart. A component with a bobbin which can be rewound is the most handy. The laminations should be pulled out and set on one side so that they can be replaced in exactly the same way later.

The windings are next unwound, taking care to count the number of turns on the 3Ω secondary. It is essential to know the number of turns here because this figure indicates the turns required for the 3Ω section of the new winding on the particular set of laminations being employed. The 3Ω secondary of the transformer unwound by the author had 62 turns. The accompanying table for the new winding was then made out, working on the basis of 62 turns for the 3Ω section and multiplying by the appropriate ratio figures. Thus the 8Ω winding required 62 turns multiplied by 1.63, or 101 turns total, the 15Ω winding required 62 turns multiplied by 2.24, or 139 turns total, and so on. The third column in the table shows the number of turns required from the previous tap. For example, the 8Ω winding includes the 62 turns in the 3Ω winding, plus a further 39 turns to make up the 101 turns required. All figures are calculated to the nearest whole turn.

TABLE

Calculated turns for autotransformer having 62 turns for 3Ω section.

Ratio	Total Turns	Added from Previous Tap
1:1	62	—
1.63:1	101	39
2.24:1	139	38
2.9:1	180	41
3.42:1	212	32
5:1	310	98

It is unlikely that a transformer unwound by a reader will have the same figure of 62 turns for the 3Ω secondary. With larger transformers the figure may well be lower, say 40 turns. In this case the 8Ω winding will be

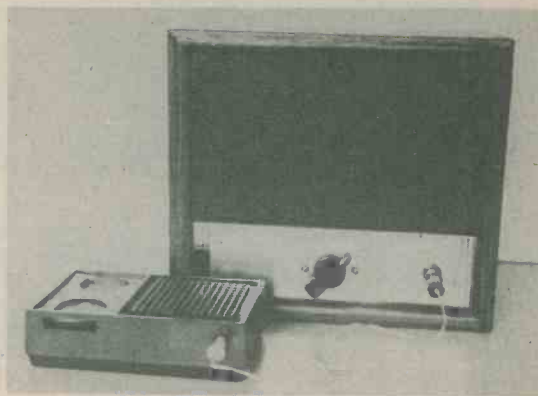

The multi-purpose speaker coupled to a portable radio

40 multiplied by 1.63, or 65 turns, and so on. The overall procedure consists of first finding the number of turns which were previously wound on the 3Ω secondary of the transformer and then entering this against the 1:1 ratio in the 'Total Turns' column of a table similar to that shown here. Then, the 'Total Turns' figures for the ratios below this are filled in by multiplication. Finally, the third column of the table is completed by listing the number of turns required from each preceding tap.

Remove all the old windings from the bobbin, taking care not to damage it. A new bobbin could be made from card, if needed.

REWINDING

The wire used in the autotransformer should ideally be of the same gauge as that employed for the original 3Ω winding. This was 26 s.w.g. enamelled with the author's transformer, and the new winding employed this gauge throughout. Thinner wire could be used for the higher impedance sections, e.g. from the 25Ω or 35Ω tap to the 75Ω tap, but there is little point in doing this except to conserve space with a small bobbin.

COMPONENTS

- 3Ω speaker, 7 by 4in.
- Switch, 1 pole 6 way rotary
- Pointer knob
- 3Ω speaker transformer (for rewinding)
- Enamelled wire, as required
- 3.5mm. or ¼in. insulated jack socket
- Leads with plugs and connectors, as required
- Plywood (see Fig. 2)
- 7 by 2in. 'Universal Chassis' flanged runner, (Home Radio Cat. No. CU136)
- ¼in. quarter-round wood strips, 2-off 7in., 2-off 6¼in.
- 2-off 2in. ribbed plastic beading
- Pegboard (see text)
- Speaker fabric, as required
- Fablon

A series of small holes is required in one cheek of the bobbin to allow the passage of the start of the new winding and the taps. Pass the wire at the start through the innermost hole. This is the 'common' lead. Next wind on the 3Ω section (62 turns in the writer's case) keeping the turns even. Each tap is made by forming a small loop of wire and passing this out through one of the holes in the bobbin cheek. Apply p.v.c. insulating tape on both sides where a tap wire crosses at right angles to the turns, and identify the taps with coloured sleeving or by bringing them out in regular order. After the 3Ω tap, wind on the turns required to take the winding up to the 8Ω tap (39 turns with the author's transformer), then the turns to the 15Ω tap (38 turns with the author's transformer) and so on. All turns are in the same direction, and finish with the full number of turns (310 turns with the author's transformer).

The laminations are then replaced in the same manner as they were fitted originally, and if a tag strip is available the tapplings can be soldered to the tags. If not, solder connecting leads to the tap loops and cover the joints with sleeving.

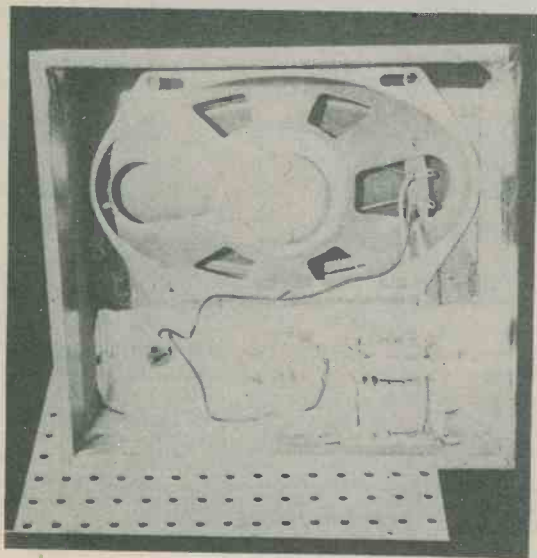

A view into the back of the completed speaker unit

First, cut out the top and bottom and the two sides. The lengths of the top and bottom are given as 7 3/8 in., but in practice the lengths should be such that the flanged runner fits comfortably in the position shown. The runner is not fitted yet but the four pieces cut out are now fixed together by spreading adhesive on meeting surfaces and securing with small panel pins. Dust is then brushed off and the case as so far assembled is covered with Fablon or similar self-adhesive material. Varnishing or staining is an alternative finish.

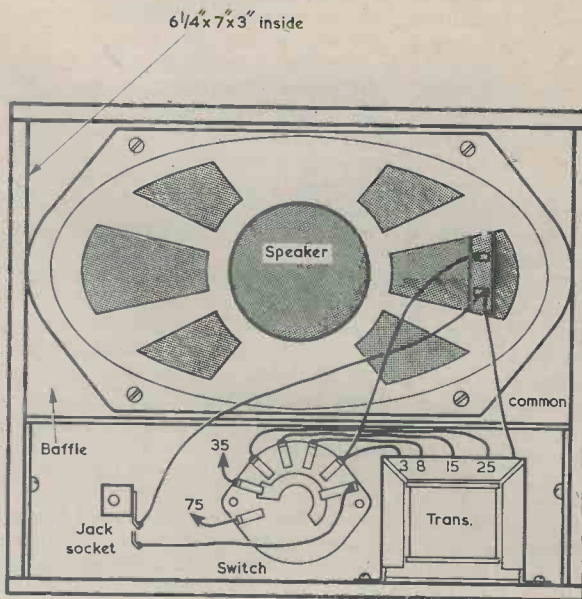

Top and bottom	7 3/8" x 3"	} 3/16" plywood
Sides (2 off)	6 1/4" x 3"	
Baffle	7 3/4" x 1/2"	
Panel	7 1/2" x 2" flanged runner	

Fig. 2. Back view of the cabinet, showing also the wiring required. Some of the dimensions shown may need to be slightly altered, and these are discussed in the text

CABINET

The cabinet is shown in Fig. 2, and is intended to take a 7 by 4 in. oval speaker.

The panel at the bottom, on which the switch and jack socket are mounted, is a 7 by 2 in. 'Universal Chassis' flanged runner. The dimensions for the plywood sections are nominal in some respects and final dimensions are taken by measuring against the runner itself.

The baffle comes next. This has nominal dimensions of 7 by 4 1/2 in. but its actual dimensions may need to be a little smaller. It is intended to fit into the space available above the flanged runner after speaker fabric has been applied. First cut out the speaker aperture and then cover the baffle with speaker fabric, this being held taut by adhesive at the edges and back of the board.

The baffle is then glued into the case, being inset $\frac{1}{4}$ in. by quarter-round strips at the front. These strips are fitted to the inside front periphery of the case, and have 45° cuts at the corners where they meet. The speaker is mounted, using short wood screws which will not penetrate the front of the baffle.

The flanged runner has a central hole drilled for the rotary switch and one at one side for the input jack socket. The runner is then mounted, under the baffle and with its front surface up against the quarter-round strips, by passing short wood screws from inside through the holes at the sides. A 2 in. piece of ribbed plastic beading is stuck at each end of the runner to cover the unwanted holes which appear at the ends.

A suitable back for the cabinet is given by a piece of pegboard measuring approximately $6\frac{3}{8}$ in. by $7\frac{1}{4}$ in.



It is helpful to provide a number of connecting leads, each terminated in different plugs or clips

CONNECTIONS

The switch is wired as in Fig. 2. It is fitted with a pointer knob, so that the impedance selected can be readily identified.

The jack socket allows a suitable lead to be plugged in. It is handy to have a number of interchangeable leads, each with a plug to fit the socket. The other ends of the leads can be terminated in a standard jack plug, a 3.5mm. jack plug, a 2.5mm. jack plug, two wander plugs and two miniature crocodile clips. These leads allow immediate connection to almost any equipment.

The speaker can be used with short-wave and communications receivers of the type having a separate speaker, or with experimental amplifiers, etc., as well as for extension purposes, tests, and for other occasions where it is necessary to have a speaker of reasonable power-handling capacity and 3Ω to 75Ω impedance ■

FEBRUARY, 1974

Use the NEW Strip-fix Plastic PANEL SIGNS



★ SET 3 - Wording - WHITE

★ SET 4 - Wording - BLACK

Over 1,000 words and symbols,
covering more than 300 terms, in
each set

Illustration of actual size = RADIO
SET 5 Dials, 6 sheets containing one
Large and two Medium scales, Large
Horizontal Tuning scale, Frequencies
12 Control Panels

- Easy to fix - Just cut out words required remove backing and press down
- Stapled in booklet form
- Designed to hang above workbench
- Pocket for loose cuttings
- Professional finish

38p per set

including V.A.T.
(postage 3p)

The Perfect Transfer for
the Home Constructor

Available from

Data Publications Ltd.

57 Maida Vale, London W9 1SN

SELECTIVE REFLEX RECEIVER

by J. B. Jobe

The medium wave receiver described here combines two of our earlier designs to obtain an enhanced overall performance.

THE AUTHOR TEACHES AT A SCHOOL FOR BOYS WHERE he runs a radio and electronics club. Most of the boys start off by building the ubiquitous crystal set and some of them eventually graduate to the construction of G. W. Short's "Silicon Transistor Reflex T.R.F."¹

This is, in the writer's opinion, the best set of its type yet published, being virtually fool-proof, almost guaranteed to work first time and extremely tolerant as regards transistor types, component values and layout. There is, however, one comment which is frequently heard from boys who have completed the set, and this concerns its rather low selectivity. In the writer's region the local Radio 4 programme is on 285 metres and, with the reflex receiver, this signal interferes with the weaker Radio 1 programme on 247 metres.

MODIFICATION

It was therefore decided to see what could be done to improve the selectivity of this otherwise excellent set. Any modification which was to be made had to conform to the following rules: it must not detract from the basic simplicity of the receiver, the set must be reliable and sure to work after completion, and the modification should add as little as possible to building costs.

The original design has a single tuned circuit with the coil being wound on a ferrite rod. A second coil on the same rod couples the tuned winding to the first transistor. It was considered that the low input impedance of the first transistor was damping the tuned circuit.

The idea of adding a second tuned circuit to increase selectivity was discarded as this would not adhere to the requirement that the modification must not detract from the simplicity of the receiver. The possible use of an f.e.t. input stage was also ruled out as it was felt that f.e.t.'s were expensive and too delicate to be handled by young newcomers to radio.

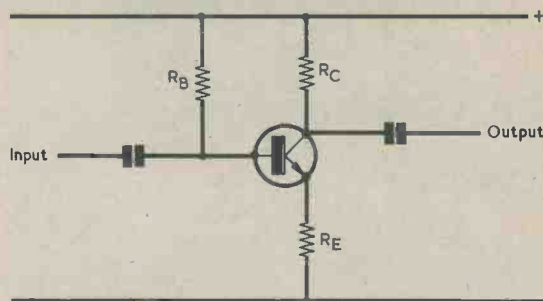

Fig. 1. A high to low impedance 'converter' circuit

What was needed was a simple high impedance unity gain buffer stage incorporating a bipolar transistor, this stage being easy to construct and requiring as few components as possible. The basic circuit eventually chosen is shown in Fig. 1. This has been described before, also by G. W. Short, but for a.f. applications only. It was subsequently found to function very well at r.f. as well.²

The voltage gain of this circuit is approximately RC divided by RE and the input impedance is given roughly by the parallel combination of RE multiplied by the small signal current gain, and RB . Since RC has to provide a reasonable match to the following stage a value of $10k\Omega$ is chosen for it, this offering a useful compromise. A high gain transistor is employed, enabling a high value to be used for RB and, consequently, giving the circuit a high input impedance.

¹ G. W. Short, "Silicon Transistor Reflex T.R.F.", *The Radio Constructor*, January 1968.

² G. W. Short, "Simple 'Impedance Converter'," *The Radio Constructor*, April 1969.

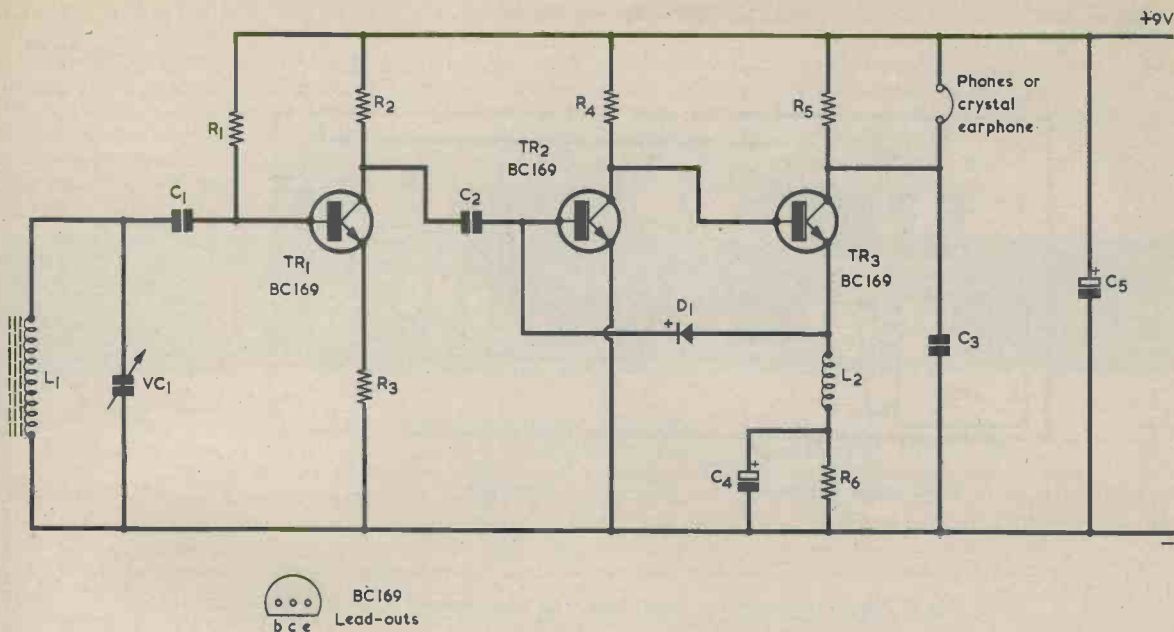

Fig. 2. Circuit of the receiver. TR1 presents a high impedance to the aerial tuned circuit, which is connected directly to its base

COMPLETE CIRCUIT

The complete circuit of the new receiver may be seen in Fig. 2. The circuit to the left of C2 is the same as that of the "Impedance Converter" previously published, and that to the right of C2 is virtually the same as the reflex t.r.f. receiver. The resistor values are unaltered.

The signal from the tuned circuit given by L1 and VC1 is applied via C1 to the high impedance buffer stage incorporating TR1 and thence, by C2, to TR2 where it is amplified and fed to the directly coupled transistor TR3. TR3 operates as an emitter follower at r.f., and the r.f. signal is detected by diode D1 and fed back to the base of TR1. The detected signal is again amplified, this time at a.f., by TR2 and TR3, and is finally fed to the headphones or earphone connected across R5.

R5 is only strictly necessary if a crystal earphone is to be used and it may be omitted if magnetic earphones are employed. However, it is worth including R5, as it increases the versatility of the set and enables it to be coupled up, also, to an a.f. amplifier.

EDITOR'S NOTE

The January 1968 and April 1969 issues of 'The Radio Constructor' referred to in this article are now out of print and cannot be obtained from us. They are not, of course, necessary for the building of the receiver described here, as the present article gives all the assembly and constructional information that is required

COMPONENTS

Resistors

(All values $\frac{1}{4}$ or $\frac{1}{2}$ watt 10%)

R1	10M Ω
R2	10k Ω
R3	10k Ω
R4	15k Ω
R5	3.9k Ω
R6	680 Ω

Capacitors

C1	1,000pF ceramic
C2	1,000pF ceramic
C3	0.01 μ F paper or plastic foil
C4	32 μ F electrolytic, 4 V. Wkg.
C5	50 μ F electrolytic, 10 V. Wkg.
VC1	300pF variable, solid dielectric, "Dilemin" (Jackson Bros.)

Inductors

L1	Ferrite slab aerial - see text
L2	R.F. choke - see text

Semiconductors

TR1, 2, 3	BC169
D1	OA81

Miscellaneous

Headphones, 2000 Ω , or crystal earphone
9 volt battery
Battery connectors
Knob
Plywood baseboard

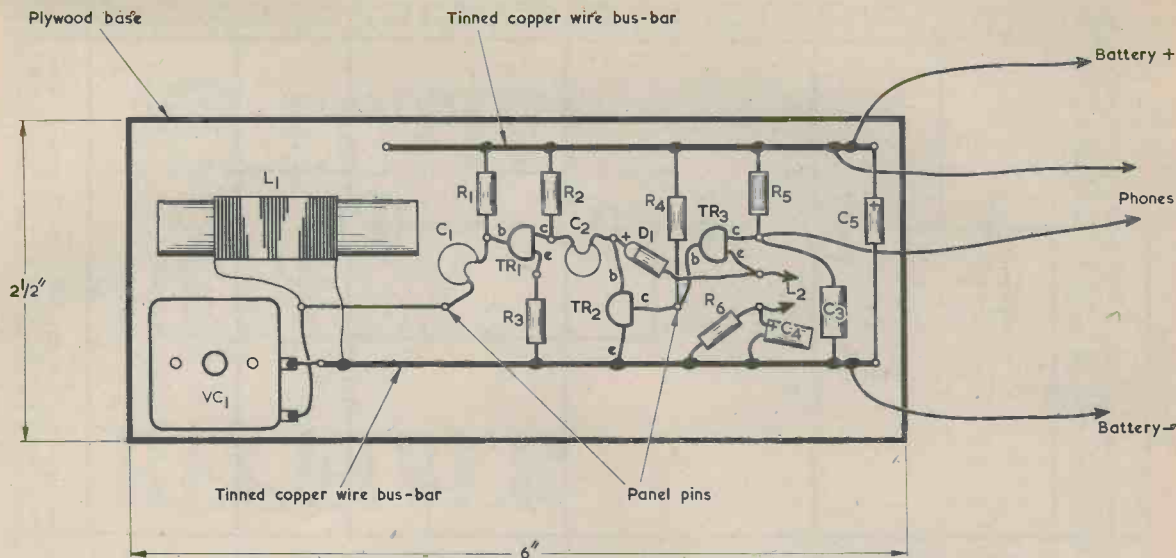

Fig. 3. How the receiver is assembled. The baseboard is a piece of plywood

CONSTRUCTION

The method of construction favoured by the author's pupils is shown in Fig. 3. This extremely economical approach involves the use of a plywood baseboard measuring 6 by 2½ in., into which cheap panel pins are driven at the appropriate connection points. Component lead-outs are then soldered to these pins. The general layout of the components is shown in the diagram, and it is by no means critical. The tuning capacitor, VC1, may be secured by a suitable bracket made from scrap aluminium sheet, or similar.

A little experimenting is required with the ferrite slab aerial to obtain precise coverage of the medium wave band. The author's version consists of approximately 65 turns close-wound of 30 s.w.g. enamelled wire on a 2½ in. ferrite slab, as shown in Fig. 4. However, ferrite slabs of this size are not generally available, and a suitable alternative would be the 2½ in. slab that is obtainable from Amatronix Ltd., 396 Selsdon Road,

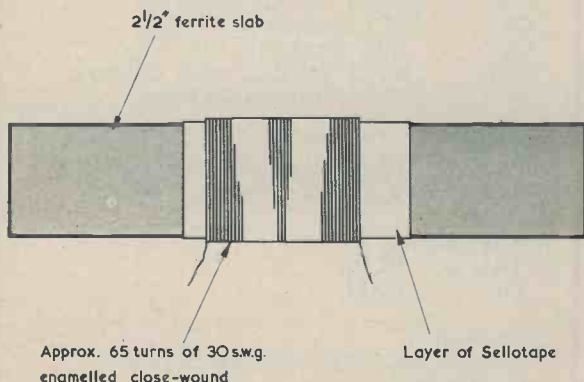

Fig. 4. Details of the ferrite aerial employed with the prototype

South Croydon, Surrey, CR2 0DE. Longer ferrite rods could also be used and these would require fewer turns. The best approach is to purposely wind on too many turns, say 75, at first and then remove these as required after the receiver has been brought into working order.

Choke L2 simply consists of 150 turns of thin wire around 36 s.w.g. pile-wound on a match-stick or an insulated 'former' of similar small dimensions. Lead-out wires of 28 s.w.g. tinned copper may be secured to this 'former' for connection into the circuit. These lead-outs should be some 3 to 4 in. long so that the choke can be moved around the board until the best position is found for it. The choke inductance is of the order of 1mH.

TESTING

A wide variety of transducers was tried with the prototype, best results being obtained with high impedance headphones, as specified in the Components List. Good results were also given with a crystal earphone and balanced armature headphones; even a 3Ω speaker gave audible - albeit faint - results!

To test the completed receiver, connect up the headphones or earphone and a 9 volt battery. Tune in a station and rotate the set horizontally for maximum volume. (The ferrite aerial is highly directional.) L2 may now be moved around. It will be found that some positions of this component will cause the set to oscillate whilst in others signal strength will decrease or the signal will disappear completely. The choke may be experimentally turned, to alter its coupling with L1, whilst finding its optimum position. The best position for L2 will probably be found to be perpendicular to L1 and as far away from it as possible. Some regeneration can be obtained, if desired, by allowing L1 and L2 to interact, but this can be a finicky business and should not normally be necessary as selectivity and sensitivity are quite adequate without it. To give an idea of performance, good signals are received from Radio Luxembourg on the prototype, which is sited in the Midlands.

COMPONENTS

The components are not very critical. Any small resistors or capacitors of the stated values may be used. C4 and C5 can have high working voltages than those specified. It is desirable for the transistors to be high gain silicon types, and BC169's were used in the author's version. The "Dilemin" capacitor specified for VC1 is available from Home Radio under Cat. No. VC40B.

CONCLUSION

Up to the time of writing, about a dozen samples of this receiver have been built by club members and all have worked first time with very little trouble being experienced in the constructional work. The sensitivity of these sets has been very good and there have been no complaints about lack of selectivity.

RECENT PUBLICATIONS



104 HAM RADIO PROJECTS. By Bert Simon, W2UUN.

196 pages, 135 x 215mm. (5½ x 8½ in.) Published by Foulsham-Tab Limited. Price £1.25.

This book is in the Foulsham-Tab list of American texts with an added introductory chapter for the guidance of the English reader.

It may seem improbable that no less than 104 projects, very many of which consist of complete transmitters, can be squeezed into a book having 196 pages. However the feat is achieved here, and it is done by presenting the information in circuit diagram form with a minimum of descriptive text. Coil winding data, where applicable, is given in the parts list for each project.

The projects cover a very wide field and range from simple clipping filters to a 35 watt transmitter for 2 metres. The transmitter projects make up 42 of the total projects in the book. Most of the circuits employ valves, but there is a leavening of transistors. The style of the text is easy-going, with quite a little wry humour. Two of the more inexpensive projects are, for instance, described as a '6 Metre El Cheapo' and a 'Mini' El Cheapo'.

Further titles in the Foulsham-Tab list, and having the same page size, are detailed below.

TV TROUBLE DIAGNOSIS MADE EASY. By A. Margolis.

262 pages. Price £1.40.

Although the television receivers dealt with in this book are American models operating on the 525 line system, they are in many respects similar to British models and are subject to much the same types of fault. This book is full of practical and detailed advice, and it will offer much of interest to the newcomer to servicing.

GETTING STARTED WITH TRANSISTORS. By Louis E. Garner, Jr.

166 pages. Price £1.20.

This book describes the history of transistors, then proceeds to the interpretation of circuit diagrams. Later chapters deal with basic transistor operation, transistor amplifiers and the manufacture of transistors. The last two chapters cover the identification of transistor types, the avoidance of damage to transistors and testing methods. A useful and informative book for the beginner.

COMPUTER TECHNICIAN'S HANDBOOK. By Brice Ward.

486 pages. Price £2.25.

'Computer Technician's Handbook' is intended to help provide the essential training needed to turn an ordinary electronic engineer into a computer maintenance specialist. Since English and American approaches to the computer are virtually the same, the American text of this book is fully applicable to the engineering techniques encountered on this side of the Atlantic.

The book starts right at the beginning by discussing the overall functioning of the computer, but it soon takes the reader well into the deeper intricacies of the subject. Points are dealt with clearly and succinctly and the work is strongly recommended for the experienced engineer who wishes to break into this important new field.

ELECTRIC MOTOR TEST AND REPAIR. By Jack Beater.

166 pages. Price £1.30.

Written for the practical man, this book covers the rewinding and repair of electric motors. The rewinding is concerned in particular with the armatures of motors having commutator feeds. As anyone who has examined the armatures of such motors will surely agree, the process of rewinding these is one requiring a thorough understanding of the connections and the winding positioning involved.

Also given is information on test equipment, much of which can be home constructed, and on the testing of motors. The electric motors dealt with consist of all types which are large enough to make their repair, without expensive coil winding equipment, a profitable enterprise.

NOISE-CANCELLING MICROPHONES

AB Pearl Mikrofonlaboratorium, Astorp, Sweden, announce new noise-discriminating (noise-cancelling) microphones, available in two versions in UK from their sole agents - Allotrope Ltd., of 90 Wardour Street, London. The military version (Model M68) features:

1. A noise-discriminating ceramic capsule, which reduces background noise by 80 to 95%.
2. A fully environmentally protected case and a capsule which is magnetic-field-free.
3. An internal amplifier which provides high output line level (4.5 volts at 1% distortion into 600 ohms).

Designed to a Swedish military specification, this lightweight robust hand microphone is suitable for use in situations where high ambient noise, or feedback or a combination of these, prevents the use of normal microphone techniques.

The transistorised amplifier housed in the microphone body is controlled by a sealed non-locking push-button switch. This switch has an additional contact for switching auxiliary equipment, via 6-conductor extensible cable.

The M68 microphone's frequency response is restricted to the range 500 to 5000 Hz. An alternative version is available with an extended low-frequency response.

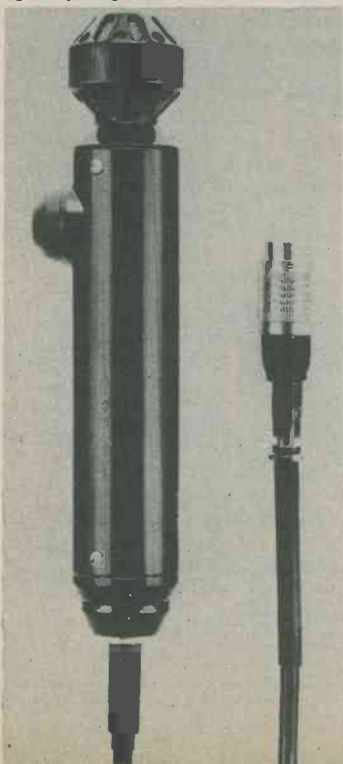

TEMPKIT ELECTRONIC THERMOMETER

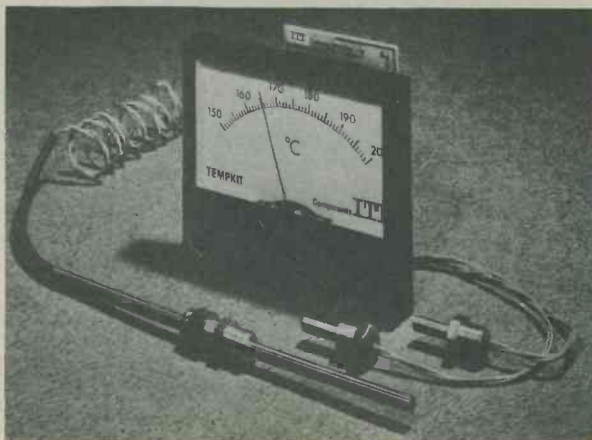

Tempkit is a versatile new electronic thermometer usable over a much wider field of applications than any comparable device hitherto.

Introduced by ITT Components Group, it consists essentially of a small metal-clad temperature-sensing probe connected by a lead of any desired length to an indicating instrument.

The advantages of Tempkit are that it: 1. is accurate without being expensive; 2. is easy to install; 3. operates off a small dry battery or coarse power supply without need for regulation; 4. permits long distances between probe and indicator without special cables; 5. does not need calibrating.

Tempkit can therefore readily be used as a laboratory instrument, or as a means of remotely monitoring temperatures in industrial processes, heating and ventilation systems, greenhouses, silos, other horticultural and agricultural installations, hospitals and laundries. It may be conveniently incorporated in customer's own system designs.

The temperature-sensitive component in the probe is a thermistor. Any one instrument will give a reading over a 50°-wide band, which is wide enough for most applications. Nine temperature ranges are available: from -25°C. to +25°C up to 175°/225°C in 25°C steps.

Tempkit is supplied ready for panel mounting, although this is not necessary for its use. The instrument panel can be up to 200 metres from the measuring point.

Tempkit is a trade mark of ITT.

For further information contact the Sales Office, ITT Components Group Europe, Thermistor Product Division, Stephen Street, Taunton, Somerset.

"HOW TO LISTEN TO THE WORLD"

The complete guide to international, medium and shortwave broadcasting, 'How To Listen To The World' has been published by Billboard Publications.

This eighth edition of a book that has become an invaluable aid to short and medium wave radio fans is notable for the special section written by BBC experts. Included in the section are articles on the BBC international news service, sports coverage and popular and classical music programmes. Technical as well as programme matters are fully dealt with in this section.

For those interested in the international aspects of broadcasting, there are chapters dealing with short and medium wave listeners in North America, South East Asia and the Pacific area.

'How To Listen To The World', produced in association with the BBC, has over 160 pages and is on sale at £1.90 at book shops.

RADIO & ELECTRONICS CONSTRUCTOR

COMMENT

ELECTRONIC GAMES FOR DISABLED

Electric chess and electronic dice are just two of many ideas developed by engineers working in co-operation with doctors helping the disabled. They were on show recently at Queen Mary's Hospital for Children near London when their new Medical Engineering unit was opened.

From a BBC science report we understand that one technical college has designed electronic dice and another what it calls 'electronic chess'.

With the electronic dice a 'throw' is simulated by electronic circuits set off by pushing a giant button - or any other special mechanism designed for a patient's handicap.

Electronics can produce a random 'throw' just as easily as real dice. And the result comes up on a panel of lights. The number of games that can be played with this is legion - and easy, too, to adapt the system to function as a training aid.

IN BRIEF

● The 20th anniversary of the founding of the Radio Amateur Invalid & Bedfast Club is celebrated this month.

There are more than 400 handicapped amateurs and S.W.L. members in fourteen countries.

Any readers who feel they can help this excellent organisation should write to the Hon. Secretary, Mrs. Frances Woolly, G3LWY, Woodclose, Penselwood, Wincanton, Somerset, BA9 8LT. An S.A.E. for a reply would be appreciated.

● The Tandy Corporation (U.K.) recently opened their first store in Hall Green, Birmingham. The Corporation is a branch of the Tandy Corporation of America where it operates a chain of 2,000 retail outlets under the name of 'Radio Shack'.

A wide range of electronic project kits, audio and communications equipment, is sold on a direct from factory basis, backed by a spares and service organisation.

● An eight-man British climbing team led by Don Willans is to attempt the first successful ascent of the 8,000ft. Torre Eggar mountain in South America. The team will take several cassette tape recorders and a supply of C60 and C90 SM.BASF cassettes and 5 and 3in. reels of BASF LH tape.

Because of their compactness and ease of operation the cassettes and their recorders will be used during the actual climb. Although not a particularly high mountain, its walls are virtually perpendicular capped by a pinnacle of ice 200ft. high, and the weather conditions are reported to be the worst in the world.

● The Royal Television Society's 1973 Shoenberg Memorial Lecture was given by Dr. Walter Perry, Vice-Chancellor of the Open University.

Dr. Perry's subject was 'The Open University: A Progress Report and Hopes for the Future'.

LOWTHER LOUDSPEAKERS-MORE FOR HOME MARKET



Lowther Loudspeakers being assembled in the company's new production centre in Maidstone, Kent.

Lowther Acoustics Ltd., of St. Mark's Road, Bromley, Kent, announce that following the recent move of their manufacturing division to larger premises in Maidstone, turn round on export orders has increased to the extent that it is hoped that Lowther loudspeakers will soon be more readily available on the home market.

The company state that they will shortly be able to offer a 24-hour reconditioning service on the loudspeakers which automatically includes a replacement diaphragm so that the customer is returned what is virtually a new unit.

PUBLICATION DELAYS

We regret the recent delays in publishing due to the national emergency measures, and we are doing everything that lies within our power to remedy the situation.

We much appreciate the loyalty and understanding readers have shown to us in these difficulties.

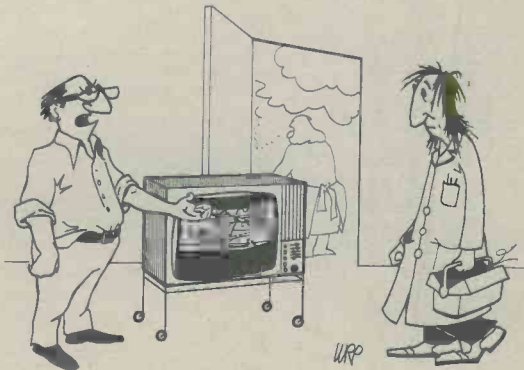

"I told the wife it's due to the energy crisis, so she's looking for the coalman!"

ADJUSTABLE A.F. CLIPPER

by G. A. FRENCH

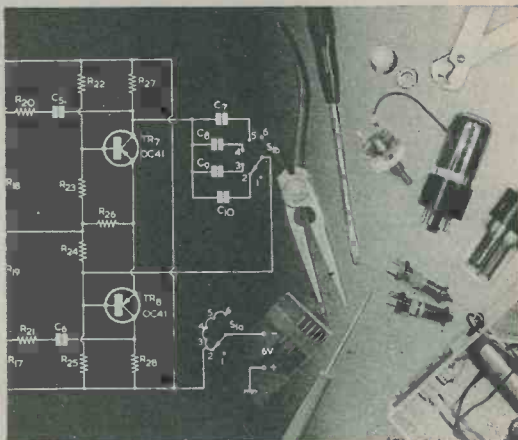

A HAZARD WHICH IS FREQUENTLY evident during short-wave listening with headphones is the accidental tuning in of a powerful transmission when the receiver a.f. volume control is set to a high level. The excessive sound amplitude which is then given in the headphones can, to say the least, be trying on the nerves, and it can even approach the threshold of discomfort. A similar effect is given with receivers which do not have a noise limiter by sudden bursts of interference or static whilst listening to a weak signal with the receiver gain controls at maximum.

This effect can be guarded against by the use of a clipper circuit which limits the amplitude of the a.f. signal fed to the headphones to a pre-determined level. The audible amplitude of the powerful signal cannot then exceed the clipping level. The clipping process will inevitably cause distortion of the signal being clipped, but this is a minor disadvantage if its audible level is kept within comfortable limits.

The device to be described in this month's article is a clipper circuit which can be interposed between the a.f. output of a receiver and a pair of high impedance 2,000Ω headphones. It could also be employed as a speech clipper in the a.f. modulator stages of a transmitter provided the input and output impedances are similar to those encountered in the headphone application. The circuit does not require any battery for the biasing of series or shunt diodes, and it offers a continuously variable control over the clipping amplitude. This can range from around 1.2 volts peak-to-peak to about 7.5 volts peak-to-peak.

REGULATING CIRCUIT

The circuit is based on the basic voltage regulator shown in Fig. 1. Popularly referred to as a 'rubber zener' circuit, this offers a performance similar to that of a zener diode but with the added advantage that the voltage at which the low slope resistance commences to appear can be controlled by the potentiometer. The transistor is a silicon device.

Consider first the case when the slider of the potentiometer in Fig. 1 is at the top of its track, so that the base of the transistor is effectively connected to the collector. A gradually increasing voltage with the polarity illustrated, is then applied to the two terminals. When this voltage reaches approximately 0.6 volt current flows into the transistor base, whereupon the transistor becomes conductive and passes an amplified collector current.

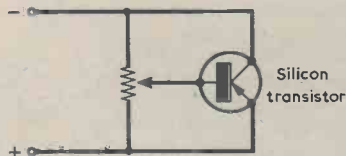

Fig. 1. A silicon transistor connected in the manner shown here offers a low slope resistance at a voltage selected by the potentiometer

Any attempt to increase the voltage above this turn-on point causes continually increasing collector current to flow, with the result that the circuit behaves in a similar manner to a zener diode and tends to hold the voltage fixed at 0.6 volt.

If, next, the slider of the potentiometer is set half-way along the track, the voltage at the terminals can increase to 1.2 volts before 0.6 volt is applied to the base of the transistor. Once more, collector current begins to flow, this increasing heavily if an attempt is made to further increase the voltage. There is once more a regulating action similar to that given by a zener diode, and this takes place at 1.2 volts across the terminals.

Should the slider of the potentiometer be set one-third of the way up the track the applied voltage can rise to 3 times 0.6 volt, or 1.8 volt, before the regulating effect takes place. Moving the slider further down the track enables higher regulating voltages to be given. The circuit does not offer as low a slope resistance as does a zener diode at these higher voltages, but the fact that the regulating voltage is adjustable still makes it useful in applications where a very low slope resistance is not needed.

It will be seen that it is essential to employ a silicon transistor rather than a germanium transistor. This is due to the fact that a silicon transistor exhibits an abrupt turn-on when its base voltage exceeds 0.6 volt. An n.p.n. transistor is shown in Fig. 1. An n.p.n. transistor will function in the same way, provided that the voltage polarity at the two terminals is reversed.

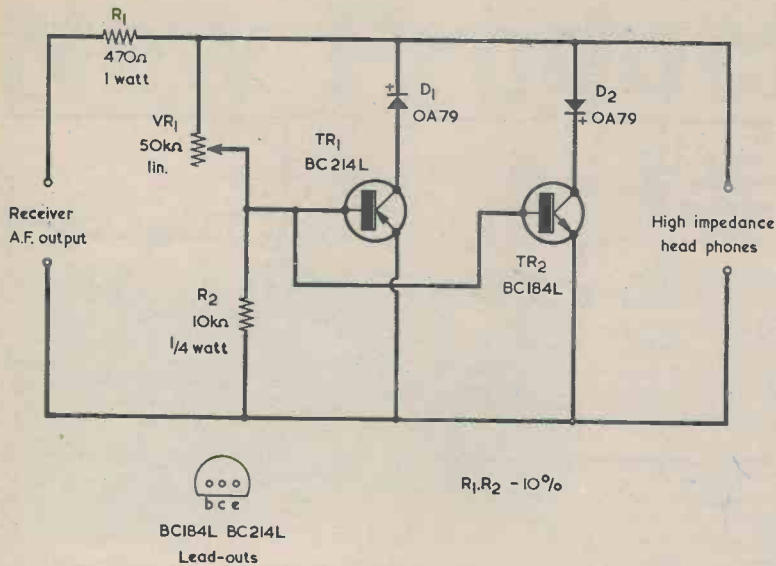

Fig. 2. The circuit of the a.f. clipper unit. This gives symmetrical shunt clipping at any level between 1.2 and 7.5 volts peak-to-peak

COMPLETE CIRCUIT

The complete circuit of the a.f. clipper is given in Fig. 2. The a.f. output of the receiver which would normally be fed to the headphones is applied to the two terminals at the left, the earthy side of the output being connected to the lower of the terminals. The headphones connect to the two terminals at the right.

The circuit around TR1 and TR2 provides a clipping effect for both negative and positive half-cycles of the incoming signal. When the signal amplitude is lower than the clipping level TR1 and TR2 do not conduct and the signal is slightly attenuated by the series resistor R1. If the signal exceeds clipping level the transistors conduct, ensuring that the signal fed to the headphones does not exceed this level. The extra voltage is then dropped across R1.

To examine circuit operation in detail let us first consider the case where clipping occurs on a half-cycle of the signal which causes the upper rail to be negative. As soon as this signal takes the base of TR1 negative by about 0.6 volt with respect to the lower rail the transistor conducts, drawing collector current through diode D1. When the slider of VR1 is at the top end of the track the clipping level is at 0.6 volt. It might at first be thought that the clipping level would be 0.6 volt plus the forward voltage drop in D1. However, the collector of a silicon transistor can assume a voltage lower than 0.6 volt when it is turned on, and it does so in the present instance, taking up the forward voltage drop in

D1. When the slider of VR1 is at the bottom end of its track, the clipping level takes place at around 3.5 to 4 volts. This is to be expected because the voltage across R2 is then one-sixth of the total voltage across R2 and VR1 in series, whereupon the clipping voltage is, roughly, 6 times 0.6 volt. Intermediate settings of VR1 produce clipping voltages between minimum and maximum values.

On the alternate half-cycles, when the upper rail is positive, it is TR2 which provides clipping. It functions in just the same way as does TR1

except that the polarities and direction of current are reversed. To accommodate the reversed current, D2 is connected into circuit the opposite way round to D1. As with TR1, clipping occurs at around 0.6 volt when the slider of VR1 is at the top end of its track, and at around 3.5 to 4 volt when the slider is at the bottom end of the track. Thus the clipping is symmetrical, with both sets of half-cycles being clipped at the same level, as selected by VR1.

It is quite in order to have the bases of the two transistors connected directly together and to the junction of VR1 and R2. During the half-cycles when the upper rail is negative the base of TR2 is simply reverse-biased by whatever voltage is present on TR1 base. Similarly, the base of TR1 is reverse-biased on the half-cycles which cause the upper rail to go positive.

Interaction between the two transistors can, however, occur in the collector circuits, and this is prevented by the two diodes. If D1 were omitted, current could flow through the collector-base junction of TR1 on half-cycles which cause the upper rail to be positive. The current would then flow into the base of TR2 and would cause this transistor to clip at a lower voltage than that selected by VR1. If D2 were omitted, a similar effect would occur on the alternate half-cycles, with unwanted current flowing to the base of TR1 via the collector-base junction of TR2. These undesirable cross-couplings are completely eradicated by the presence of the two diodes.

STATIC CURVES

Curves showing the performance of the circuit under static conditions are given in Fig. 3. These were drawn by applying a variable direct voltage

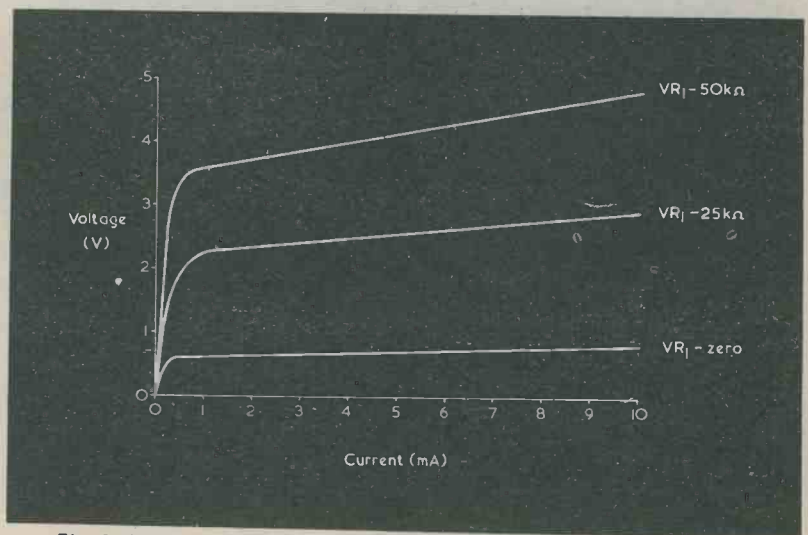

Fig. 3. Static curves showing the performance of the clipping circuit for different settings of VR1

across the input terminals with the upper terminal positive and with a current reading meter in series, and then monitoring the direct voltage at the output terminals for different values of input current up to 10mA. The lowest curve corresponds to the case where VR1 slider is at the top of its track, and the middle curve to the instance where VR1 slider is at the centre of its track, thereby inserting 25kΩ into circuit. The top curve shows the condition when VR1 slider is at the bottom of its track and the potentiometer inserts 50kΩ into the circuit. It will be seen that the slope resistance increases as the clipping voltage is raised, but the slope resistance is still low enough for the present application. When the variable input voltage and the two meters are reversed in polarity, a similar set of curves for negative voltage is given.

With VR1 inserting zero resistance the peak-to-peak amplitude of the clipped signal is twice 0.6 volt, or 1.2 volts. When VR1 inserts its full resistance the peak-to-peak clipping voltage is around 7.5 volts.

The circuit of Fig. 2 is suitable for all cases where the receiver headphone output is provided by an a.f. output transformer. It is also suitable for use with valve receivers in which the headphone output is taken, via a blocking capacitor, from the anode of the a.f. amplifier valve which precedes the output valve. It is not suitable for mains-driven valve receivers in which the headphone output is taken, via a blocking capacitor, from the anode of the output valve itself, particularly when the latter feeds an output transformer as shown in Fig. 4(a). Receivers falling into this category are few and are usually home-constructed. It is possible for signal amplitudes of the order of 100 volts or more to appear at relatively low impedance in a power output anode circuit of the type shown in Fig. 4(a), and these

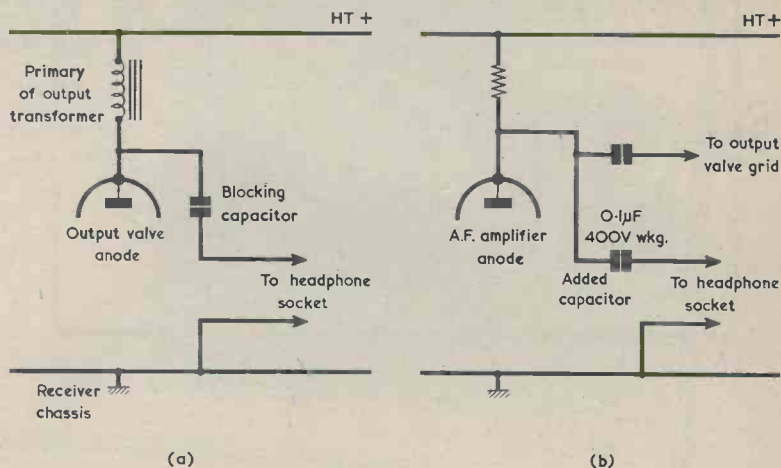

Fig. 4(a). The clipper unit cannot be used with mains-driven valve receivers having a headphone output circuit of the type shown here

(b). With such receivers, the headphone output should be taken from the a.f. anode preceding the output valve

voltages would cause excessive dissipation in the two transistors in the clipper unit. In consequence, the receiver should be modified and a headphone output for the unit taken from the a.f. anode preceding the output valve. An 0.1µF blocking capacitor in series can be employed and the required circuitry is illustrated in Fig. 4(b).

Construction of the clipper unit should present no problems. All the

parts can be assembled in a small metal, wooden or plastic case fitted with an output jack socket into which the headphones can be plugged and having VR1 fitted to the top panel. A flexible input lead from the unit can then couple to the receiver headphone output socket or terminals. If the components are mounted in a metal case, this can be made common with the lower rail in Fig. 2.

BACK NUMBERS

For the benefit of new readers we would draw attention to our back number service.

We retain past issues for a period of two years and we can, occasionally, supply copies more than two year old. The cost is the cover price stated on the issue, plus 6p postage.

Before undertaking any constructional project described in a back issue, it must be borne in mind that components readily available at the time of publication may no longer be so.

We regret that we are unable to supply photo copies of articles where an issue is not available. Libraries and members of local radio clubs can often be very helpful where an issue is not available for sale.

New Products

DESOLDERING STRIP



Deconex desoldering strip in use, assisting the removal of components from a p.c.b.

Prodecon Laboratories Ltd., a new division of the suppliers of the very successful Decon-Dalo 33 PC etch-resist marking pen, have just announced Deconex,

a new desoldering strip, which they say is the fastest, easiest and most economical way to desolder components and wires. Deconex is a chemically-treated pure copper braid that is simply applied to the solder point and held down with a hot iron. As the solder melts it is absorbed by the braid, and lifts straight off when the braid is removed.

Prodecon say that this is the ideal means of solder removal, for correcting mistakes, effecting repairs, or salvaging valuable components. There is no danger of flux contamination, and Deconex is far cheaper than vacuum desoldering apparatus.

Deconex costs just 75 pence (including VAT and postage) for a 1.7 metre roll, in a polyethylene 'flying saucer' dispenser. For a limited period Prodecon will send a free sample of Deconex to readers wishing to evaluate it. Write to: Prodecon Laboratories Ltd., Ellen Street, Portslade, Brighton, BN4 1EQ.

ADJUSTABLE WRENCH

Thunder Screw Anchors Ltd., of Victoria Way, Burgess Hill, Sussex, have announced an addition to their range of tools with the introduction of an 8 in. adjustable wrench. The main feature of the wrench is the thumb control button, giving faster and more accurate control, which adjusts the head to the size of the nut. The button is pushed towards the head of the wrench to close it, and it also self locks, the

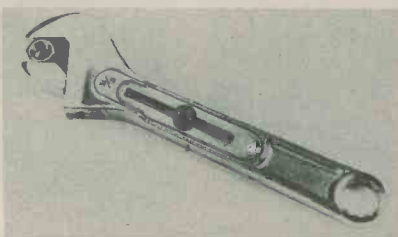

button is then pushed down to open it. The maximum opening is $\frac{1}{8}$ in. A.F. (24mm), the length 8 in. (203mm), and the weight 12 $\frac{1}{4}$ ozs. (347gr). The tool is made from Chrome Vanadium steel, and incorporates at the other end an $\frac{1}{8}$ in. A.F. (17mm) ring spanner. The recommended retail price excluding V.A.T. is £2.72 each and they are individually carded.

MOBILE P.A. AMPLIFIER

For all occasions when public address equipment must be mobile the powerful new HH5 P.A. amplifier from Eagle International has what it takes. Providing a 36 watts output with a frequency range of 100-11,000Hz the unit comes complete with mounting bracket for quick and simple installation in positive or negative earth systems.

Controls include independent levels for microphone and auxiliary inputs with a master tone control for both channels, ideal for touring coaches and commercial pleasure craft requiring facilities for piped music and announcements.

The 35 watt amplification of the Eagle HH5 P.A. amplifier offers a considerable advantage when applied to outdoor events such as gymkhanas, festivals or electioneering campaigns. Supplied complete with fuse and wiring harness the unit has a mic. input of 5mV at 600 ohms and auxiliary input of 150mV at 100,000 ohms. Output impedance is 8 and 16 ohms, and operating voltage is 12 watts DC. Overall dimensions are 145 x 65 x 235 mm.



SHORT WAVE NEWS

FOR DX LISTENERS



By Frank A. Baldwin

Times = GMT

Frequencies = kHz

Signals from Singapore on the 60 metre band can be heard here in the U.K. both during the mid-afternoon and late-night periods subject, of course, to conditions and the annual cycle. Generally speaking, Far Eastern stations may be heard from around late September through to March, progressing from weak to strong and back to weak signal strengths throughout this period. It is during this time that the short route signal path is mostly, or wholly, in total darkness. During this month however, the signal path is in darkness (short route) to the Balkans and from thence in varying degrees of daylight to the U.K. The peak period for Singapore is therefore past but there is still some time remaining for those who have not yet logged this part of the Commonwealth.

Singapore has a Chinese Service on 5010 and an English Service on 5052. They can be heard around 1530 and also 2230 in general terms but surprises are always just around the corner in the short wave world. Recently, one Sunday afternoon, the author logged both channels from 1538 through to 1545 and found them to be *in parallel* with a session of recorded light music with songs and announcements in English.

CURRENT SCHEDULES

● NIGERIA

"The Voice of Nigeria", Lagos, currently operates an English Service to Europe from 0555 through to 0735 on 7255, 11900 and on 15185. From 1800 to 1930 on 7275, 11770 and on 15120. Lagos also has an English Service to Africa and the Middle East from 1530 to 1700 on 7275, 15120 and on 15185.

● CZECHOSLAVAKIA

"Radio Prague" operates in English to the U.K. and Eire from 1500 to 1530 on 6055 and on 9505; from 1630 to 1700 and from 1900 to 1930 on 5930 and 7345; from 2200 to 2230 on 6015. A service in English to Europe is provided from 1530 to 1630 on 5930, 6055, 7345, 11990, 15110, 17840 and on 21670.

● SWEDEN

"Radio Sweden", Stockholm, has a service in English to Europe from 100 to 1130 on 9630 and 21690; from 1230 to 1300 on 1100 9605 and 9630; from 1600 to 1630 on 6065 and 11790; from 2045 to 2115 on 6065 and on 9715.

● CHINA

"Radio Peking" radiates programmes in English to Europe from 2030 to 2130 and from 2130 to 2230 on 6270, 6825, 6860, 7590 and on 9030.

An area of China that will prove of interest to the Dxr is Inner Mongolia. Hailar (49.15N 119.41E)

operates from 1400 to 1500 in Mongolian on 3900, 4815 and on 4880. Huhehot (40.49N 111.37E) in Mongolian during the same time period on 4070 and on 6974. Lhasa in Tibet (29.41N 91.10E) may be heard when carrying the Hindi programme from Peking from 1600 to 1700 and from 1700 to 1800 (rebroadcast of previous programme) on 4035, 5935 and on 9490.

From the Fukien province of China, bordering the Formosa Straight, the P.L.A. Fukien Front station broadcasts to offshore islands and Taiwan in Standard and various Chinese dialects. Sign-on in Standard Chinese and Amoy is at 2005 on 2430, 2600, 2800, 3200, 3400, 3535, 3900, 4140, 4380 and on 4840. Other likely time periods to log this station here in the U.K. would be from 2230 to 2300 when in Amoy on the above channels and, additionally, on 5170, 5240 and, from 2300 on 6400. From 1530 through to 2000 sign-off on 4380, 4840 etc., as first listed.

AROUND THE DIAL

On the higher frequency bands some of the interesting stations recently logged have been -

● PAKISTAN

Radio Pakistan with a programme of local music from 1225 with station identification by YL at 1231, on 15520.

● NEW ZEALAND

ZL18 Wellington at 0855 on 9520 with the Bell Bird interval signal, station identification at 0857, short hymn, march, 6 pips at 0900 and then a local newscast by OM announcer.

● NIGERIA

Lagos (see Current Schedule) at 1620 on 15120 with station identification and programme review in English.

● AUSTRALIA

R. Australia at 1940 on 7290 in English with programme about the drug problem (directed to U.K. from 1900 to 2000). The channel selected for this evening service to the U.K. is a poor one and may be subjected to change before this appears in print.

R. Australia may be logged in the afternoons at 1500 on 7150 and on 7235 with the world news in English. The latter channel offers best reception conditions here in the U.K.

For morning listening, try 15320 at 0700 when a newscast in English, directed to the U.K. is radiated.

● SPAIN

Madrid in English with station identification and the news at 0100 on 6065.

RADIO & ELECTRONICS CONSTRUCTOR

● JORDAN

Amman at 1720 on 9560 with identification, news in English by YL, closing announcements 1730, further announcements in Arabic till 1731 then off.

● SEYCHELLES

FEBA with religious programme in English at 1745 on 11860, identification at 1800.

● URUGUAY

CXA19 Radio El Espectador, at 2318 on 11835 with LA music, YL announcer.

● BRAZIL

Radio Nacional de Brasil at 2308 on 11720 with local news items in English, identification at 2309 by YL, LA music. Also in parallel on 9665 and 15445. In the early evenings, turning the bandswitch to 15MHz, one can often log PRK9 R. Inconfidencia on 15190; R. Tupi on 15155; ZYK33 R. Journal de Comercio on 15145 and ZYN32 R. Soc. da Bahia on 15135 (formerly 15125), all from around 2030 onwards. Try particularly on Sunday evenings when, from the time quoted, they all radiate sports commentaries in Portuguese, and rather excitedly at that!

QSX

Returning to the LF bands we have -

● LATIN AMERICAN AREA

TIHB R. Capital, Costa Rica on 4832 which can be heard throughout late nights and early mornings here in the U.K., being logged at 0555 with LA music and identification at 0600.

HIAS Onda Musical, Santa Domingo, on 4775 at 0300 with identification followed by the usual LA music etc.

In English, there is HRVC Voz Evangelica, Honduras Republic, at 0315 on 4820, complete with address for reports (at 0330) and details of IRC's required for airmail reply.

On 4905 there is ZYZ20 R. Relogio, Brazil, with a talk in Portuguese at 0015 complete with superimposed pips every second and six pips at every minute.

On 4790 at 0410 we have HCVP2 Sistema da Emisora Atalaya, Ecuador, with LA music, songs, etc.

A regular booking is YVMG R. Maracaibo, Venezuela, on 4810 around 0200, being last entered here at 0329 with the world news in Spanish.

Nearby there is R. Bucaramanga, Colombia, on 4845 at 0244 with a newscast of local events in Spanish, both Bucaramanga and Colombia being mentioned several times.

R. Grenada at 0022 on 5015 with identification and time-check followed by a talk in English.

EAST AND FAR EAST

● MALAYSIA

Penang on 4985 at 2240 with a programme of light classical music and announcements in English.

BBC Tebrau on 3915 at 2307 with programme in Chinese dialect.

● THAILAND

Bangkok on 4830 (if the teletype is absent) at 2315 with slow drum beats, music on stringed instruments and YL singing, OM announcer.

FEBRUARY, 1974

● INDONESIA

RRI Palembang on 4855 at 2320 with Asian-type light music.

RRI Banda Atjeh, 4955 at 1500 with chimes, OM in Indonesian till 1510 then local music.

● INDIA

AIR Delhi on 3905 at 2304 with a newscast in English.

AIR Hyderabad on 4800 at 1610 with a programme of local music and songs.

AIR Madras on 4920 at 0043, Indian music, songs, YL announcer.

● NEPAL

R. Nepal at 0049 on 4999.5 with local music and songs, also at 1515, similar programme.

● PAKISTAN

R. Pakistan on 4735 at 1448 with local music and songs by YL.

● SAIGON

On 4877 at 2304 with a talk in Vietnamese by YL, hetro QRM. Also at 1435.

● CHINA

PLA Fukien (see Current Schedules) on 4840 at 2231; R. Peking on 4814.5 at 2308; R. Peking on 4800 at 2223; Wuhan on 3940 at 2125 and Foochow on 4975 at 2216.

● CAMBODIA (KMERE)

Phnom-Penh on 4907 at 2217 with continuous Buddhist chants.

AFRICA

● GHANA

Ejura on 4980 at 1953 with a talk in English about Ghana education service, also at 2100, drums, identification and local news by YL after time-check "Time is 9 o'clock".

● NIGERIA

Benin City on 4932 at 2108, OM with world news in vernacular till 2112 then local music programme.

Lagos on 4990 at 1710 with local music and talk in vernacular.

● IVORY COAST

R. Abidjan on 4940 at 2248, African chants, drums, announcements in French.

● S. AFRICA

Springbok Radio on 4795 at 2126 with music and song records, announcements in English and advertisements.

● MOZAMBIQUE

R.C. Mozambique on 4855 at 2120, typical Portuguese music. Also on 4925 at 1932 with similar programme.

● MAURITANIA

R. Mauritania on 4850 at 2016 with OM in French followed by music rendered on flute-like instruments.

● UGANDA

Kampala on 4972 at 2104 with programme of jazz records, European-style.

OHMMETER SCALES

by

R. J. Caborn

It is possible to use a standard ohms scale for all home-constructed series ohmmeters

WE ARE ALL FAMILIAR WITH THE OHMS RANGES OF standard multi-testmeters and the fact that the resistance scales over which the meter needle travels are very non-linear, becoming progressively more and more cramped as the resistance value increases. What may be a little puzzling to the uninitiated is the fact that when a testmeter has two resistance ranges the same scale is used for both of these, the figures on it being multiplied by a suitable factor. Even when a meter has three ranges, the same resistance scale is still employed. A typical instance would be given in a meter which has, say, one range 'R' on which all resistance readings are direct, another range '100R' on which all resistance readings are multiplied by 100, and a third range '10,000R' on which all readings are multiplied by 10,000.

STANDARD SCALE

How is it possible for a single scale to cope with all these widely varying ranges? The answer is that there is a standard resistance scale which can be used with any series ohmmeter!

Fig. 1(a) shows a typical series ohmmeter circuit. Here, a battery connects via a resistor R to a meter and the test terminals. We shall assume for the moment that, firstly, the battery and meter both have zero internal resistance and, secondly, that the circuit values are such that the meter reads full-scale deflection when the test terminals are short-circuited. Thus, f.s.d. in the meter corresponds to zero test resistance.

If we now connect a resistor R_x across the test terminals, as in Fig. 1(b), we will obtain a reading in the meter which corresponds to the value of its resistance. Let us start with a resistor in the R_x position which has the same value as R. Obviously, half the f.s.d. current will now flow in the meter and it will give a half-scale reading. If the value of R_x is twice that of R, then the current in the meter will be one-third of the f.s.d. value. When R_x is three times the value of R, the current in the meter is one-quarter of the full-scale value, and so on.

If the value of R_x is one-half that of R, the meter current will be $\frac{2}{3}$ of f.s.d., which works out as 0.67 of f.s.d. With R_x equal to lower fractions of R, we can similarly work out the corresponding current readings as a fraction of f.s.d. current.

This has been done in the accompanying table, which shows meter indications as a fraction of f.s.d. for different ratios of R_x to R. The same results are shown in graphical form in Fig. 2. If you look at the resistance scale of your own testmeter, you will find that it has the same graduation layout as is given in Fig. 2.

Usage of the scale of Fig. 2 is based entirely on the half-scale point. When the half-scale resistance value is known (an easy matter to arrange as it is equal to R) all the remaining points on the scale drop into place. If the half-scale resistance value is $20k\Omega$ then the point marked '2' on the resistance side corresponds with $40k\Omega$, that marked '3' corresponds with $60k\Omega$, and so on. Similarly, the point marked '0.5' indicates $10k\Omega$, that marked '0.1' indicates $2k\Omega$, and so on in the right-hand direction. The outermost numbered points are '20' ($400k\Omega$) and '0.05' ($1k\Omega$).

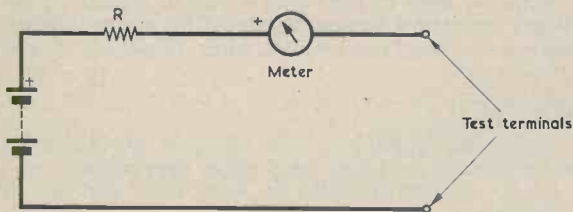

(a)

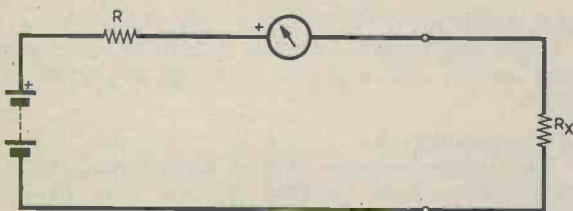

(b)

Fig. 1 (a). Basic circuit of a series ohmmeter
(b). Adding resistor R_x across the test terminals

TABLE

$\frac{R_x}{R}$	Meter Current (f.s.d. = 1)
0.05	0.95
0.1	0.91
0.2	0.83
0.3	0.77
0.4	0.71
0.5	0.67
0.6	0.63
0.7	0.59
0.8	0.56
0.9	0.53
1	0.5
1.5	0.4
2	0.33
3	0.25
4	0.2
5	0.17
6	0.14
7	0.13
8	0.11
9	0.1
10	0.09
15	0.063
20	0.048

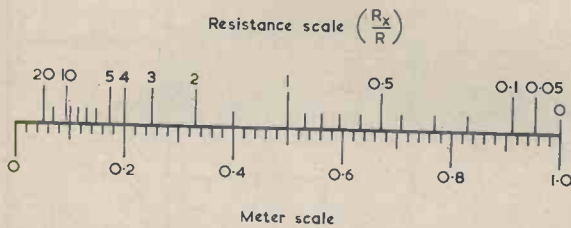

Fig. 2. The relationship between test resistance and meter reading. It is assumed that the meter is scaled from zero to 1.0. The relationship holds true for any series ohmmeter where zero test resistance gives f.s.d.

In practice, we will need to provide a zero-set control to enable the meter to be set accurately to f.s.d. when the test resistance is zero. This may be carried out with the circuit given in Fig. 3, in which a variable shunt is connected across the meter. And we may also have to take into account the internal resistances of the battery and the meter. These may be looked upon as being in series with R.

WORKED EXAMPLE

We can now take a quick example. Let us say that we have a 0-1mA meter with an internal resistance of 100Ω, and that we want to put this in a series ohmmeter circuit which has a half-scale value of 1kΩ. From Fig. 2, this will give us useful outside readings of 20kΩ at the left-hand end and 50Ω at the right-hand end. The effective value of R required inside the ohmmeter is 1kΩ and it would be safe in this instance to ignore the much lower internal resistance of the battery. But we cannot do the same with the internal resistance of the meter.

FEBRUARY, 1974

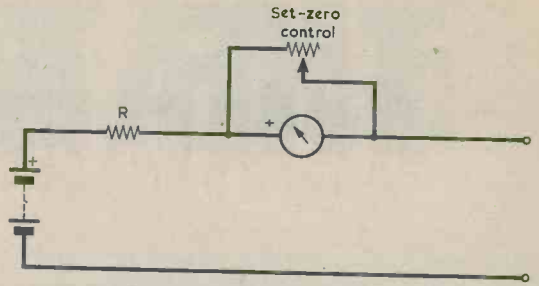

Fig. 3. Providing a set-zero control

If we use a 1.5 volt energising cell, the current which will flow through a resistance, R, of 1kΩ when the test terminals are short-circuited is 1.5mA. We therefore require a shunt across the meter which allows 0.5mA to flow through it and lets the remaining 1mA flow through the meter. The shunt value will be twice the meter resistance, or 200Ω, and the effective meter resistance will then be 100Ω and 200Ω in parallel, giving 67Ω. The value required for R now becomes 1kΩ minus 67Ω, or 933Ω. As we can't get resistors with tolerances lower than 1% we would settle for 930Ω, and this could be given in practice by 600Ω and 330Ω in series.

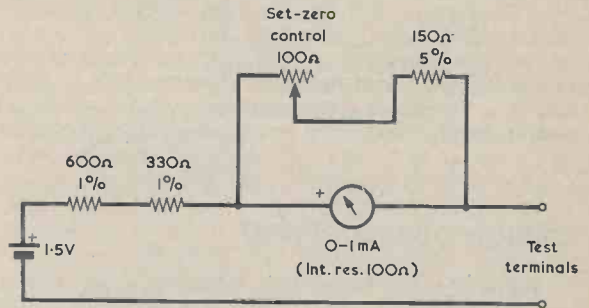

Fig. 4. A practical circuit, as described in the text

Fig. 4 shows the final circuit. The shunt, which calculated at 200Ω, is now given by a 150Ω fixed resistor and a 100Ω variable resistor in series. When the cell voltage is exactly 1.5 volts, the variable resistor will, at zero-set, insert a resistance into circuit which causes the shunt value to be 200Ω. To obtain a zero-set with cell voltages above and below 1.5 volts, the variable resistor will insert less resistance and more resistance respectively, thereby introducing the errors which are inevitable in any series ohmmeter circuit. But these errors will only be due to the consequent change in the value of R inside the ohmmeter. An altered f.s.d. current in the meter does not affect the fact that the half-scale reading is still equal to R.

THE I.C. PLUS



by F. G. Rayer, A

Incorporating the popular Ferranti integrated circuit type ZN414, this receiver offers loudspeaker reproduction over the medium wave band. Due to the use of the ZN414 there are no tuned circuits to adjust.

THE JUNE ISSUE 1973 of *Radio & Electronics Constructor* contained details of a pocket portable based on the ZN414 10-transistor silicon network.* The ZN414 *F. G. Rayer, 'Silicon Network Pocket Portable', *Radio & Electronics Constructor*, June 1973. is ideal for receivers of this kind, as it incorporates automatic gain control, and requires only a tuned circuit as its input, giving an audio output which can operate headphones or be passed to an audio amplifier.

DESIGN DEVELOPMENT

To some extent the present receiver is a development of the previous portable, but it is modified to provide increased sensitivity, greater volume, and an easier form of construction. To the latter, end, the *whole* receiver, including the speaker, is assembled as a working unit on a single insulated board which carries components on one side and wiring on the other. Wiring has also been arranged so that there are no cross-overs. In fact, the radio could be built on a printed circuit panel. This is not done, however, as it is easier and quicker to run wire conductors from point to point.

When the receiver is assembled, all the components and connections are easily reached on both sides of the board, and operation can be checked before fitting a front panel and case.

These points, the overall simplicity of the circuit and the excellent loudspeaker volume obtained, should make the receiver a good project for the beginner who does not want anything too complicated, as well as for the more advanced constructor who wishes to build a receiver for general listening.

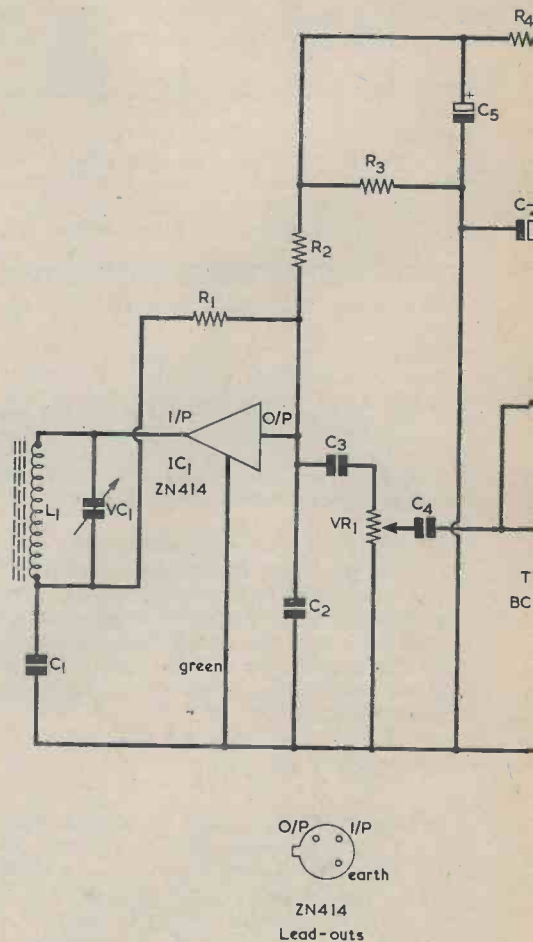
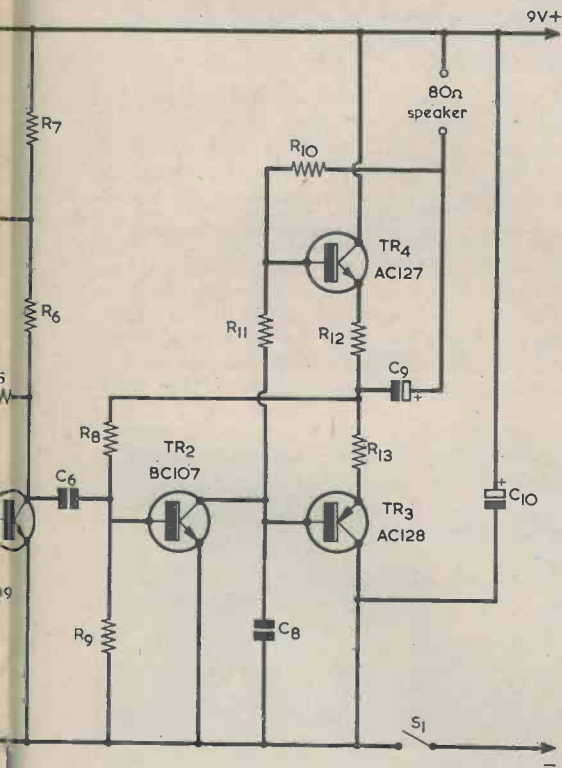
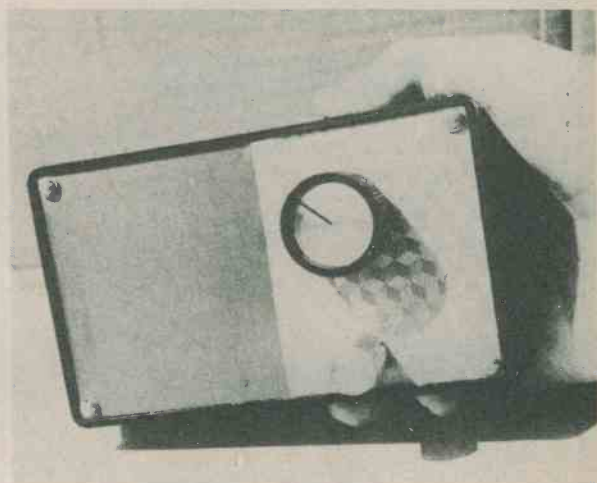

Fig. 1. The circuit of the receiver. This incorporates a variable capacitor with...

FOUR PORTABLE



Assoc. I.E.R.E., G30GR



Use a ZN414 i.c. and four transistors. VC1 is a 2-gang capacitor with two sections in parallel

The receiver circuit is shown in Fig.1. L1 is the ferrite rod aerial, and employs a 6in. rod tuned by the air-spaced capacitor VC1. This provides higher efficiency and a little more signal pick-up than does a shorter rod. The aerial is intended for medium waves only, the omission of long waves avoiding the need for a further winding and waveband switching.

The maximum value of VC1 is 384pF and is given by a Jackson Brothers type '00' 208+176pF 2-gang capacitor with both sections in parallel. This capacitor, normally employed in superhets, was used because it is a readily available component and, with its two sections in parallel, offers a capacitance which gives more than adequate medium wave coverage. The capacitor is produced both with and without trimmers. If a component with trimmers is to hand all that needs to be done is to unscrew these to the fully open position.

R1 is the input bias resistor and R2 the output load resistor. The recommended supply voltage for the ZN414 is 1.2 to 1.6 volts (earlier Ferranti literature quoted 1.1 to 1.8 volts) and resistors R3 and R4 form a potential divider giving approximately 1.5 volts at their junction. C5 is the bypass capacitor for this point.

The values specified for R2, R3 and R4 are likely to give good results at once without any need for experiment. However, changing the i.c. supply voltage by even 0.1 volt only can cause a significant difference. It will be found that when the voltage is rather low, at around 1.2 to 1.3 volts with respect to the negative supply rail, sensitivity to weak signals is somewhat reduced. On the other hand, increasing the voltage to its upper limit of 1.6 volts, while increasing volume and sensitivity, may cause oscillation on some frequencies. This does not mean that the voltage is extremely

critical and readers who do not wish to experiment may simply work to the values given for R2, R3 and R4. Should there be any trouble with oscillation, the value of R4 may be increased slightly up to 2.7k Ω . It will be clear that, with the use of 5% resistors for R3 and R4, the voltage figure given at their junction can vary slightly with any two particular resistors. On no account should R3 and R4 be given values which cause the voltage at their junction to exceed 1.6 volts. Any attempts to measure the voltage at this point should be made with a *high resistance* voltmeter only.

COMPONENTS

Resistors

(All fixed values $\frac{1}{4}$ watt 5%)

R1	100k Ω
R2	560 Ω
R3	470 Ω
R4	2.2k Ω
R5	2.2M Ω
R6	8.2k Ω
R7	2.7k Ω
R8	270k Ω
R9	220k Ω
R10	680 Ω
R11	47 Ω
R12	2.2 Ω
R13	2.2 Ω
VR1	10k Ω potentiometer, log track, with switch (see text)

Capacitors

C1	0.01 μ F plastic foil
C2	0.1 μ F plastic foil
C3	0.05 μ F plastic foil
C4	0.05 μ F plastic foil
C5	8 μ F electrolytic, 4 V.Wkg.
C6	0.1 μ F plastic foil
C7	20 μ F electrolytic, 10 V.Wkg.
C8	0.05 μ F plastic foil
C9	100 μ F electrolytic, 10 V.Wkg.
C10	100 μ F electrolytic, 10 V.Wkg.
VC1	208 + 176pF 2-gang variable, type '00', (Jackson Brothers)

Inductor

L1	Ferrite aerial (see text)
----	---------------------------

Semiconductors

IC1	ZN414
TR1	BC109
TR2	BC107
TR3	AC128
TR4	AC127

Switch

S1	s.p.s.t., part of VR1
----	-----------------------

Miscellaneous

80 Ω speaker, 2 $\frac{1}{2}$ or 2 $\frac{3}{4}$ in. diameter
 Ferrite rod, 6 by $\frac{3}{8}$ in
 24 s.w.g. enamelled wire
 Plain Veroboard; 0.15in. matrix
 9-volt battery type PP4 (Ever Ready)
 Battery clips
 2 knobs
 Insulated case
 Speaker fabric

TR1 is a high gain audio pre-amplifier, and is followed by the driver transistor TR2. This transistor and the output pair, TR3 and TR4, have overall d.c. feedback to stabilize working conditions. The output is fed to the 80 Ω speaker and volume is adequate for all the ordinary purposes for which a receiver of this kind would be used.

Current drain from the 9 volt battery is around 10mA with no signal or at modest volume, rising to peaks of 20mA or so with volume turned up to about the maximum likely to be required. This will allow a long useful working life for even a PP4 type of battery.

So far as components are concerned, it is necessary for the potentiometer VR1 to be a small component with a body diameter of, at most, $\frac{3}{8}$ in. The speaker is a low cost 'replacement' type having a diameter of 2 $\frac{1}{2}$ or 2 $\frac{3}{4}$ in. In the author's receiver the speaker had an impedance of 80 Ω , but it would be in order to use speakers having impedances of 35 Ω , 40 Ω or 75 Ω instead. These lower impedances will allow a slightly higher output power to be given, and there will be an increased battery drain at high volume levels. Speakers with impedances lower than 35 Ω must not be used.

The non-electrolytic capacitors can conveniently be plastic foil types with side wires, such as Mullard Miniature Foil Type C280.

INSULATED BOARD

In the prototype the insulated board for the components was plain Veroboard (i.e. without copper strips) of 0.15in. matrix, cut to have 20 rows of holes one way and 32 rows of holes the other way. The measured dimensions are then approximately those shown in Fig. 2.

It would be possible to use plain Paxolin $\frac{1}{16}$ in. thick instead of the Veroboard. If so, the component lead-out holes can be made with a $\frac{1}{16}$ in. drill, working from the layout of Fig. 2. This involves rather more work, though it need not take too long if a number of guide lines are systematically scribed on the Paxolin with a sharply pointed tool. The positioning of the holes

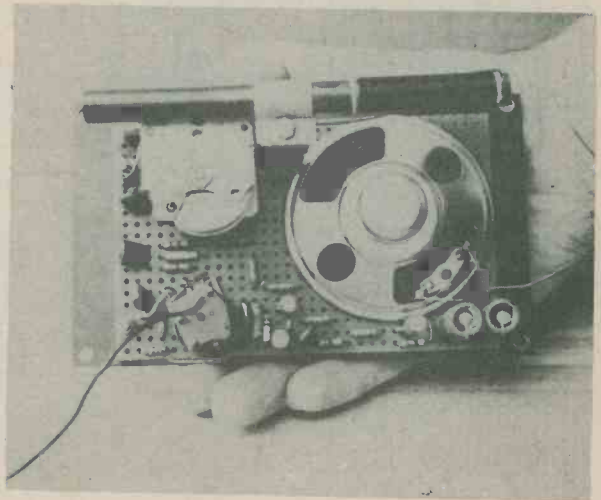

The component side of the Veroboard. Apart from the battery, this board takes all components, including the speaker

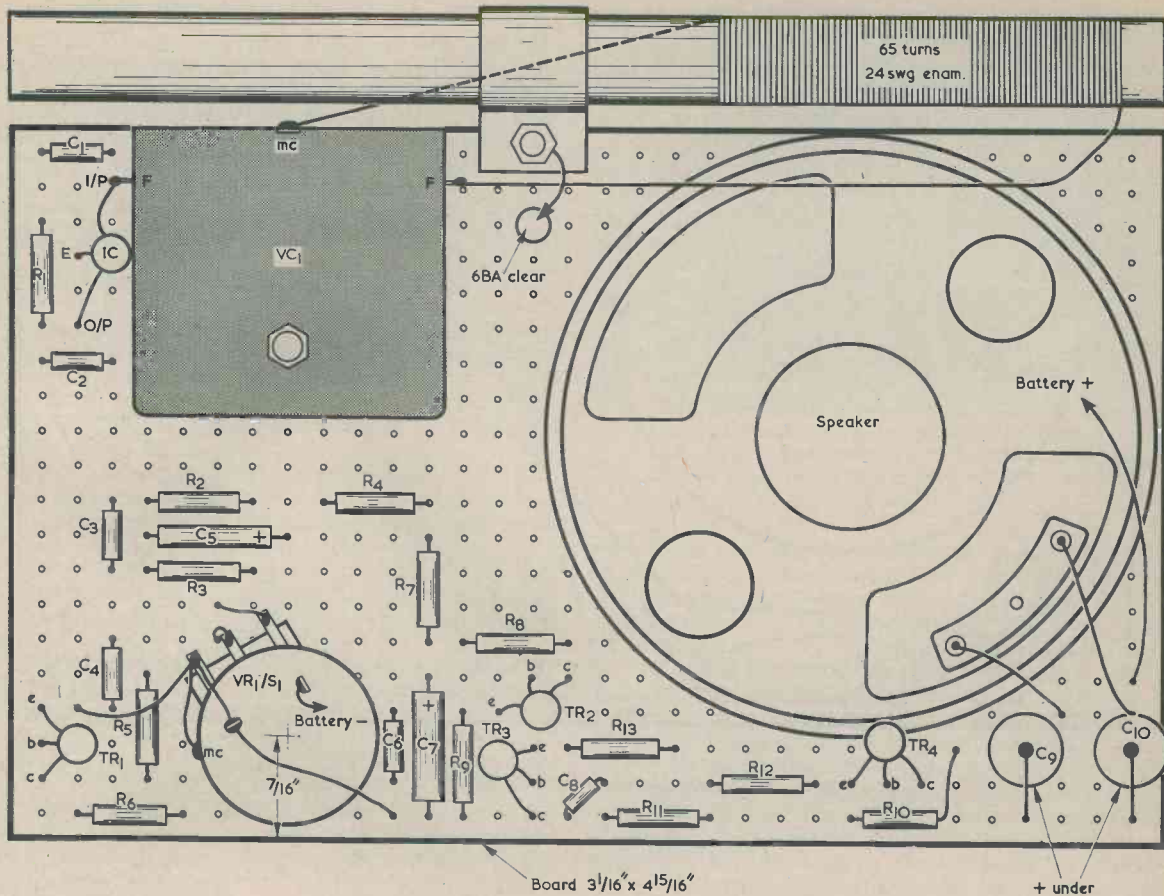

Fig. 2. Component layout on the insulated board. This is plain Veroboard of 0.15in. matrix

required can be observed from Fig.2, remembering that hole spacing on the Veroboard panel shown is 0.15in.

A circular opening about 2in. in diameter is cut for the speaker. This can be done with a large screw-up chassis type punch, or with an adjustable tank or washer cutter. If the latter is employed, grip the Paxolin and a scrap wooden board in a vice, so that when the centre of the cutter penetrates the Paxolin it passes into the board, which gives support while cutting. It is also possible to make this opening by drilling a ring of holes, and finishing off with a half-round rasp or file, or by using a small keyhole or pad saw.

Drill a hole for the bush of VR1 and another to clear the spindle bearing of VC1. This capacitor is secured by three 4BA bolts. To position the corresponding holes in the board, press a piece of paper on to the front of the capacitor and mark the three hole centres on this. Then place the paper on the board, mark through it with a sharp tool, and drill the board. If any holes are not quite correct, they can be enlarged or elongated with a small round file. The capacitor rests flat on the panel. It is *essential* that the 4BA bolts do not project inside the thickness of the front tapped plate of VC1 as they will then either damage the capacitor irreparably

by distorting the vanes or short-circuit it. A minor complication here is that two of the 4BA bolts securing the capacitor in place also hold the component board to the front panel of the case, and details of these are given later. In the view of the wiring side of the board given in Fig. 3, these two bolts pass through the holes marked 'X'. The third bolt, at the top, also secures a solder tag. If sufficiently short 4BA bolts are not available, these may consist of longer bolts which have been cut or filed down to the requisite length.

A 6BA clear hole is also required for the ferrite aerial mounting, and this hole may be drilled at this stage. Its position is shown in Fig. 2. Neither the speaker, the ferrite aerial, nor VC1 are fitted yet. VR1 may, however, be mounted in position.

COMPONENT FITTING

It is as well to carry out most of the other wiring before fitting the i.c. and the transistors. Bend resistor lead-outs at right angles, at such a distance from the resistor body that they pass down through the holes as in Fig. 2. The electrolytic capacitors C5 and C7 are also fitted in this way.

The 100µF capacitors C9 and C10 stand vertically.

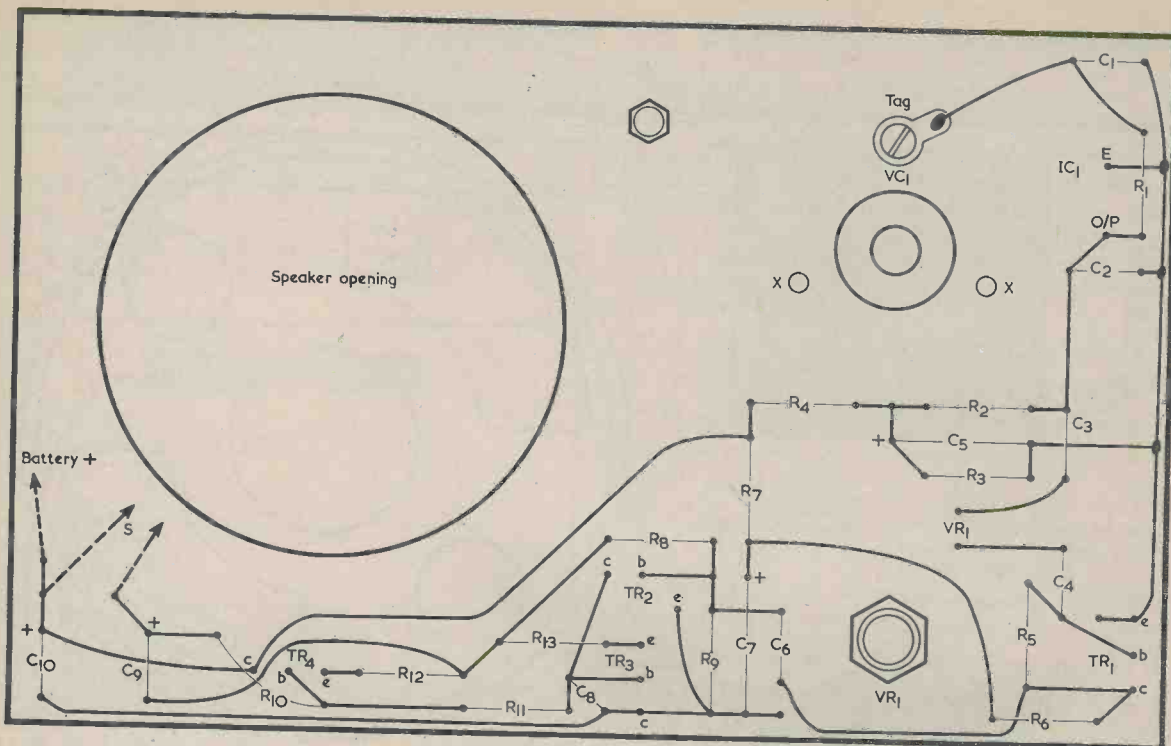

Fig. 3. Interconnections on the wiring side of the board

Bend the negative leads completely round the body, as in Fig. 4, so that the leads can pass through the board. The tape round the capacitor and negative lead is not essential, but it results in a firmer support for the components.

Resistors and capacitors are inserted a few at a time, and the board is turned over and wired as in Fig. 3. If this is virtually a first attempt at receiver construction, each component and lead can be marked in coloured pencil on the wiring diagrams as it is fitted. It is then virtually impossible to miss anything. When all the components and wires in each diagram are coloured, construction is complete.

All connections can be made with 26 or 24 s.w.g. tinned copper wire, following Fig. 3. Lengths of 1mm. sleeving can be put on wires which run close to other wires or connections. In many places the component lead-outs will themselves reach the appropriate connection points. All wiring should be kept neat and flat against the board, excess wire being snipped off close to the joints.

Assuming that new resistors and capacitors with clean lead-outs are employed and that the soldering iron is well tinned and has been allowed to reach full temperature, this part of the work is likely to prove perfectly easy and straightforward. It is essential to use a radio-type cored solder, such as Ersin Multi-core or Savbit. Uncored solder and a separate paste or liquid flux should never be employed for a wiring job of this nature. Do not 'cook' a joint by holding the

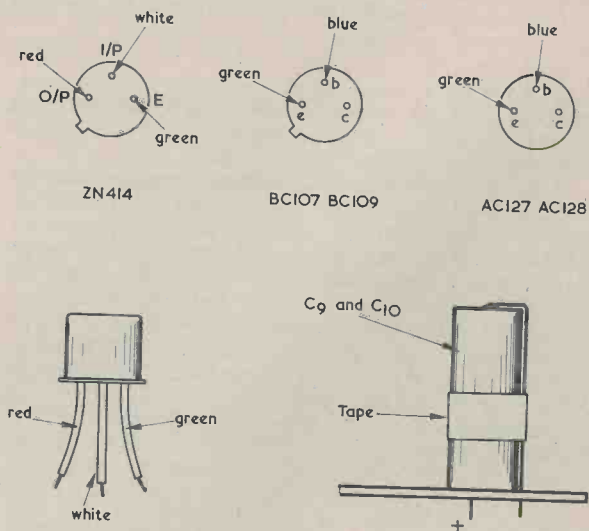

Fig. 4. Wiring is eased and error avoided if the integrated circuit and transistor lead-outs are fitted with coloured sleeving. Also shown is the method of mounting C9 and C10

iron on it after the solder flows and the joint is visibly made. Usually, the iron need only be held on the joint being made for about 1 to 3 seconds.

Remember to fit the electrolytic capacitors with correct polarity, and note that the metal case of VR1 is connected to the negative supply line. This can be done by soldering a wire to the case, as at the point marked 'MC' in Fig. 2. Most potentiometers have double-pole switches, and only a single section is required for the present circuit. If there is any doubt about the tags which connect to each switch section, these may be identified with the aid of an ohmmeter or continuity tester.

A thin black flexible lead runs from the switch, and is terminated in a negative battery clip. A red flexible lead runs from the positive lead-out of C10, and this is fitted with a positive battery clip. These leads should be sufficiently long to enable the battery to be positioned at either end of the board.

VC1 may be fitted by means of a single bolt with a solder tag under its head, as in Fig. 3. This single bolt will be adequate during the testing of the receiver after construction. A lead runs from the solder tag to C1 and this provides the connection to the frame and moving vanes of VC1. Keep the moving vanes of VC1 fully closed during construction to prevent damage to them.

When the board is later fitted to the front panel of the case, two 4BA bolts pass through two suitably positioned holes in the front panel, through two spacing washers about $\frac{1}{4}$ in. thick, through the two holes marked 'X' in Fig. 3 and into the threaded holes in the front plate of VC1. The two spacing washers provide clearance for the wiring shown in Fig. 3. As already mentioned, the two 4BA bolts must have a length which does not permit their ends to protrude past the inside surface of the capacitor front plate.

SEMICONDUCTORS

When a transistor is clear of the circuit board and can be viewed from below, its lead-outs are readily identified. But identification is not so easy when the transistor is soldered in place. For this reason, it is recommended that coloured sleeving be put on the leads, as in Fig. 4. All the pieces of sleeving can be $\frac{1}{2}$ in. to $\frac{3}{4}$ in. long, and they will then also serve to keep the transistor bodies at a suitable distance from the board. Coloured sleeving of the same length may also be fitted to the ZN414.

The semiconductors can then be fitted, as in Figs. 2 and 3, and their leads soldered and cut down as required. A heat shunt on the leads, to prevent damage from excess temperature, is not really required provided the iron is removed immediately the joint is seen to be correctly made.

The white sleeved lead of the i.c. does not run to the board, but to the nearby front fixed vane tag of VC1, marked 'F', as in Fig. 2.

FERRITE AERIAL

The ferrite aerial consists of 65 turns of 24 s.w.g. enamelled wire close-wound on the ferrite rod. The wire is anchored about $\frac{1}{8}$ in. from one end of the rod by binding it with cotton or thread, applying a little adhesive such as Evo-Stik at the same time. The coil is then wound on, the wire being secured at the inside end by the same means.

The beginning of the winding connects to the second

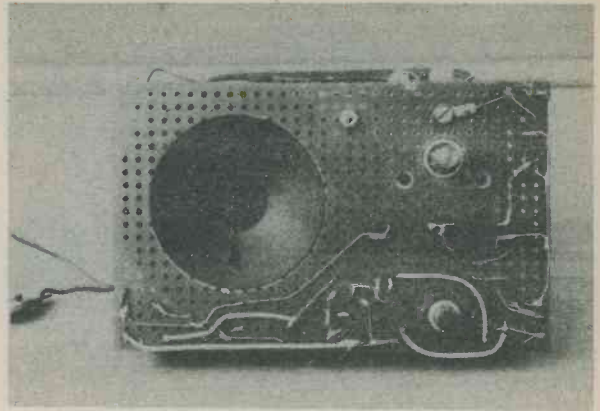

The wiring side of the board. Note that the two 4BA clear holes below the tuning capacitor spindle have no screws fitted to them at this stage

front fixed vane tag 'F', as shown in Fig. 2. This tag is connected by a short wire to the rear fixed vanes tag on the same side, thereby connecting the two sections of the variable capacitor together. The end of the aerial winding connects to the small tag which is present on the metal frame of the variable capacitor, at the point indicated as 'MC' in Fig. 2.

The rod is mounted about $1\frac{1}{2}$ in. clear of the board by means of a long 6BA bolt or length of 6BA studding with suitably positioned nuts. In the authors' case, it was possible to obtain a spacing pillar about $1\frac{1}{2}$ in. long by drilling through the centre of the length of insulated shaft cut from VR1. (If this may appear an almost impossible task to carry through successfully, try the following method. Grip the $\frac{1}{2}$ in. diameter piece in a vice and drill a small dent centrally in the end. Then grip the drill in the vice and put the shaft to be bored in the drill chuck. Operate as usual, letting the work follow its own centre, and the drill should emerge at the centre of the other end of the rod.)

A strap of stout card passes round the rod, gripping it when the nut is tightened.

The speaker is fitted to the board with adhesive, and Evo-Stik is again suitable. Its tags should be positioned as in Fig. 2. The lead-outs of C9 and C10 may be long enough to pass through and reach the speaker tags. If not, solder on suitable leads to give the speaker connections.

TESTING

After an examination of connections, knobs can be temporarily fitted, and the receiver can be tested. With the variable capacitor specified and the aerial wound as directed, coverage will be for the usual medium wave band, with a little to spare. There are no alignment or similar adjustments.

A number of the more powerful stations should give adequate loudspeaker volume with the audio gain control VR1 turned about one-quarter from the 'Off' position.

Circuits of this type prove to be less selective than superhets, but selectivity is adequate for most ordinary reception purposes.

The ferrite rod aerial is directional, and this point can be used to advantage in some circumstances. A powerful local station may occasionally overload the ZN414. If so, the receiver should be rotated to reduce

signal pick-up. With weak signals the receiver may be orientated for best volume. Occasionally it may prove worthwhile to position the receiver to give minimum pick-up of signals which break through on a weaker transmission at an adjacent frequency. Usually, however, it is merely necessary to switch on and adjust tuning and volume as required.

CASE

Any plastic or wooden case of suitable size may be used to house the receiver. That employed by the author is bakelite, and has outside dimensions of approximately 6½ by 3½ by 2in. This has threaded brass inserts at each corner and can take a Paxolin panel measuring about 6 by 3½in. It was obtained from J. Bull (Electrical) Ltd., 7 Park Street, Croydon, CRO 1YD.

With a panel of these dimensions, a hole for VR1 spindle appears 1½in. in from one short edge and ½in. from the long bottom edge. Working from the component board itself, holes may then be cut for VCI spindle and for the two 4BA bolts which will run into the two holes 'X' of Fig. 3. Also required is a 2in. diameter hole in front of the speaker.

Fix the panel and component board together securely with the two 4BA bolts, taking care that they are of suitable length, as already discussed, and fitting spacing washers about ¼in. thick between the panel and the board.

Some potentiometers appear to have a very short threaded bush; others have a bush long enough to pass through both the component board and the panel. If

the potentiometer used for VR1 has a long bush of this type, put washers over this between the board and panel to make up about ¼in. clearance, then fit the securing nut for the bush on the outside of the panel. If the bush is too short to allow this method of fixing to be carried out, its fixing nuts then appears between the component board and the panel. The two bolts at points 'X' will still be adequate on their own for securing the assembly.

A piece of silk material 3½ by 3½in. is cemented over the left hand part of the panel to cover the speaker opening. It is easier to cut this material oversize, and glue it in position. Then when the adhesive is dry, the edge can be cut to match the panel exactly, using a sharp blade or sharp scissors.

A piece of self-adhesive material, as sold for covering shelves and boxes, etc., is cut to fit over the projecting spindles, and it covers the remaining part of the panel. This too, can be cut exactly to size as described.

It is then only necessary to fit the knobs. The battery can be positioned in either the right or left hand side of the case, as convenient. A piece of cardboard can be cut to fold over and prevent its being too loose and possibly turning so that its clips touch other metal parts. Other equally simple methods of retaining the battery in place may be devised.

Exactly the same form of construction, with everything assembled on a single panel, could be adopted if one of the easily obtainable and inexpensive transparent boxes were used for the case. If so, the material should be drilled and cut with care, working slowly, as it may otherwise crack. The box lid would then form the receiver panel. Other kinds of case could also be used, but not a metal box, which would screen the aerial. ■

RADIO & ELECTRONICS CONSTRUCTOR

IN NEXT MONTHS ISSUE AUDIO FREQUENCY METER by A. P. Roberts

An inexpensive Frequency Meter capable of accommodating a wide variety of input waveforms both at low and high impedances.

SWITCH-OFF REMINDER by S. Jeffrey

MANY OTHER
ARTICLES

ON SALE 1st MARCH
20p

MAKE VERY CERTAIN OF YOUR COPY

ORDER NOW!

S. S. B. RECEIVER FILTER

by R. A. Penfold

Our contributor discusses basic aspects of simple crystal filters, after which he describes an experimental lattice filter incorporating ceramic resonators. Also dealt with is an oscillator circuit employing a trans-filter as the frequency determining element.

THE AMATEUR BANDS ARE NOW ALMOST COMPLETELY dominated by s.s.b. in the phone sectors. However, most published designs for amateur band receivers do not really have a sufficiently narrow bandwidth, or sharp enough selectivity to fully take advantage of the benefits of s.s.b. transmissions.

An i.f. bandwidth of only about 3 to 3.5kHz is required for s.s.b. reception, and using a bandwidth greater than this will result in an increase in noise and adjacent channel interference, but will add nothing to the desired transmission.

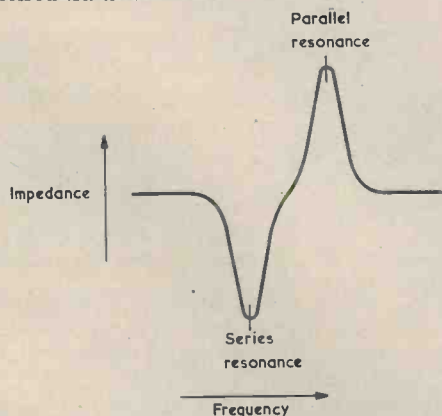

Fig. 1. Changes in impedance of a quartz crystal at its resonant frequencies

At most frequencies a quartz crystal exhibits a fairly high impedance, but at a certain frequency this will suddenly drop to a very low level. The frequency at which this occurs is called the series resonant frequency. At a slightly higher frequency the impedance peaks up to an extremely high level, and this is the parallel resonant frequency. A diagram illustrating these effects is shown in Fig. 1.

Crystals exhibit very high Q's, and can therefore give very sharp selectivity when used in i.f. filters.

LATTICE FILTERS

A circuit diagram of a basic crystal lattice filter is given in Fig. 2. This is a form of bridge circuit. Theoretically, there will be infinite attenuation between the input and the output when crystals 'A' have the same impedance as crystals 'B', a circumstance which is given at all frequencies except their resonant frequencies. One way of employing the circuit is to choose crystals for the 'A' positions whose parallel resonant frequencies are the same as the series resonant frequencies of crystals 'B'. The two 'A' crystals are identical, as also are the two 'B' crystals.

The attenuation of the circuit will drop when the impedances of the two sets of crystals become dissimilar. As the sets of crystals have slightly different resonant frequencies, their impedances will become significantly different over this small range of frequencies.

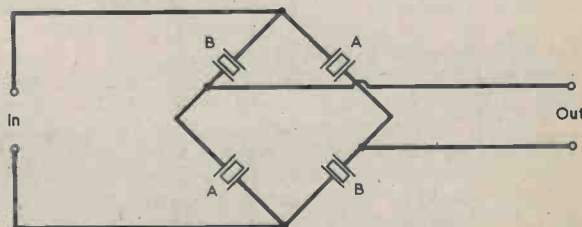

Fig. 2. The basic circuit of a crystal lattice filter

QUARTZ CRYSTALS

The most usual method of obtaining the required sharp selectivity and narrow bandwidth for s.s.b. reception is to use a crystal filter. A piezoelectric quartz crystal has quite well-known properties. The ones with which we are concerned here are those regarding resonant frequencies of the crystals.

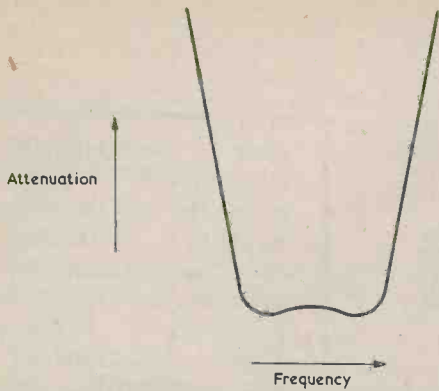

Fig. 3. Ideally the lattice crystal filter has the response shown here

Providing the filter is looking into a fairly low impedance, a relatively flat passband with steep sides, like that shown in Fig. 3, is obtained. If the filter drives a high impedance, the passband develops spurious dips and peaks.

A simplified version of the lattice filter is usually employed. This is known as a half-lattice crystal filter, and the basic circuit is shown in Fig. 4. This uses only two crystals and has a performance similar to that of a full lattice filter. A centre-tapped i.f. transformer winding is required; alternatively, a capacitive centre-tap may be provided at the junction of two equal-value series capacitors connected across the outside ends of the winding. At the resonant frequencies of the crystals their impedances become different, the circuit becomes unbalanced and there is an output from the filter.

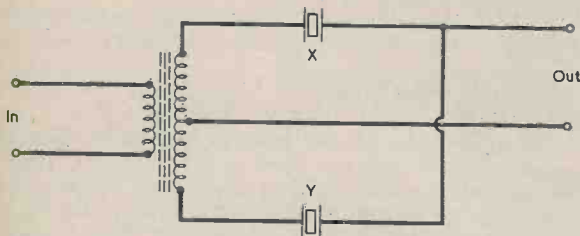

Fig. 4. Basic circuit of a half-lattice filter

CERAMIC FILTER

Ceramic devices with characteristics similar to quartz crystals are now available. These are the TF2D5 ceramic resonators manufactured by Vernitron Ltd., and retailed by Amatronix Ltd., 396 Selsdon Road, South Croydon, Surrey, CR2 0DE.

These resonators are in four frequency groups around the i.f. frequency of 455kHz. TF2D5-1 is resonant between 453.5 and 454.4kHz, and TF2D5-4 between 455.6 and 456.5kHz, and so a resonator from each of these two groups would have a typical spacing of 2.1kHz. The manufacturer's data sheet states that the difference in frequency between the series and parallel resonant frequencies of a resonator is between 1.8 and 3.3kHz. The Q of the devices is given as being greater than 1,000 which, while not being as high as that of a quartz crystal, is still extremely high. It was therefore

thought worth-while to try a half-lattice filter using a couple of these devices.

A circuit diagram of the filter constructed by the author using these is shown in Fig. 5. A stage of i.f. amplification is included in order to compensate for losses in the filter. The filter is best inserted immediately after the frequency changer.

I.F. transformers for use in transistor circuits are not available with a centre-tapped secondary, and a standard transformer has to be modified to obtain a capacitive centre-tap. This is achieved by first carefully opening up the i.f. transformer and cutting out the fixed capacitor connected across the secondary. The transformer is reassembled and two capacitors of double the

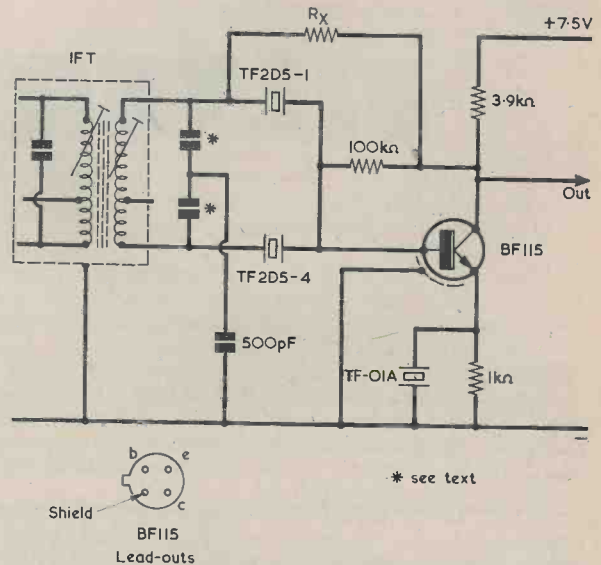

Fig. 5. The author's filter circuit incorporating transformers

value of that which was removed are then connected in series externally across the secondary. The transformer to be modified must, of course, be a type having a tuned secondary.

Due to the very narrow bandwidth of the filter, alignment will be difficult if ordinary i.f. transformers are used in the i.f. stages of the receiver. It is possible that alignment would be much simplified if transfilters were used, the only i.f. alignment then required being the adjustment of the cores of the i.f. transformer feeding the ceramic filter.

Assuming that a 465 or 470kHz i.f. transformer is used in the circuit, the best method for alignment of the filter is to connect a signal generator tuned accurately to 455kHz at the input, and then gradually screw each core of the transformer inwards alternately, about half a turn at a time. When a signal is obtained at the output, the cores may be peaked in the normal way.

Results with the filter fitted in a receiver were promising, although at first the bandwidth was slightly wider than was required, and the sides of the passband were not as steep as had been hoped. This may have been due to the relatively high impedance of the i.f. transformer secondary. Performance was greatly improved by the use of positive feedback by way of resistor Rx. The exact value required in this resistor will vary between one circuit and another, and is the lowest which can be employed without the circuit breaking into

oscillation. From the writer's experience, the value will be around 33kΩ.

With positive feedback, the filter bandwidth was far too narrow for the proper reception of a.m. signals, speech becoming very deep in tone and very difficult to understand, with only the bass and some of the middle frequencies being passed by the filter. The only way a clear understandable signal could be obtained was by slightly off-tuning the receiver, so as to receive only the carrier and one sideband. By off-tuning the receiver a little further, the carrier is given a certain amount of attenuation, and a signal rather like an ordinary s.s.b. one is obtained.

OSCILLATOR CIRCUIT

Quartz crystals are often used as the frequency determining element in r.f. oscillators, as they give far superior frequency stability when compared with coil and capacitor tuned circuits. It was therefore thought to be worth-while trying an oscillator using a TF2D5 resonator instead of a crystal.

The circuit of the oscillator is shown in Fig. 6. This is a common emitter Pierce oscillator. It was found to work very well and to give very stable oscillation, changes in supply voltage having virtually no effect on the operating frequency. The latter is at or near the nominal frequency of the resonator.

The most obvious uses for the circuit are as a b.f.o. or as an i.f. alignment oscillator. The circuit is especially useful for alignment of the filter shown in Fig. 5.

It is interesting to note that a TF-01A transfilter can also be employed in this circuit, and that it causes the oscillator to give a higher output than when a TF2D5 resonator is used.

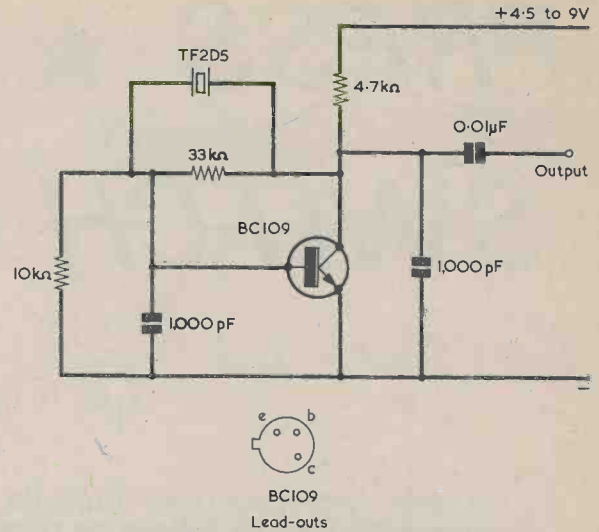

Fig. 6. Oscillator circuit with a*transfilter giving frequency determination

EDITOR'S NOTE

We have been informed that, due to spreads in the resonant frequencies of the ceramic resonators used in the circuit of Fig. 5, there is a possibility that the narrow passband obtained by the author will not be given by some resonators of the same nominal frequency. In consequence the circuit has to be placed in the experimental category, for use by the more experienced constructor who likes trying out new approaches. ■

EUROPEAN EXHIBITIONS — 1974

Prince Claus will open the European Conference on Electrotechnics, EUROCON 74, to be held in Amsterdam on 22-26 April, 1974.

This major European Conference is the first to be organised jointly by the Institute of Electrical and Electronics Engineers and fourteen European professional engineering institutions. More than 200 papers have already been received and some 700 delegates are expected.

17th SALON INTERNATIONAL DES COMPOSANTS ELECTRONIQUES

The above exhibition sponsored by the French Federation of Electronic Industries (F.N.I.E.) will be held in Paris at the Parc des Expositions, Porte de Versailles, from Monday, 1st April to Saturday, 6th April.

There will be four sections: Electronic Components - Measuring Instruments - Electronic Industry Materials - Equipment and Products specific to the manufacture and application of Electronic Components. In addition there will be conferences and other meetings.

4th EUROPEAN MICROWAVE CONFERENCE AND MICROWAVE 74

The Management Committees of the European Microwave Conference and the Directors of Microwave Exhibitions and Publishers Ltd., have combined their respective resources for the organisation and sponsorship of the 1974 Microwave Convention.

The combined four-day Conference and Exhibition will take place in Montreux, from 10th to 13th September, in the new purpose-built Maison des Congres overlooking Lake Geneva. The exhibition centre has space for 185 stands and the two conference halls each have a 500-seat capacity.

This exhibition follows the very successful one held last year in Brighton.

FIRATO 74

This international exhibition of electronics will be held at the RAI Exhibition Centre in Amsterdam from 29th August to 8th September.

FIAREX 74

The biennial Electronics Trade Fair, FIAREX 74, will be held from Monday, 28th October to Friday, 1st November, also at the RAI Exhibition Centre in Amsterdam.

The exhibits will include components, semiconductors, tubes, integrated circuits and the appropriate test equipment; electro-acoustic equipment for industrial and scientific purposes; electronic intercom installation for use in industry; equipment for central aerial systems; mechanical aids and tools.

PRESS ★ BUTTON SWITCH CIRCUITS

by A. Jefferson

Circuits incorporating multiple press-button switches are not always as easy to follow as those which employ rotary switches.

WE ARE ALL FAMILIAR WITH MULTIPLE PRESS-BUTTON switch assemblies of the type which are used in transistor radios for waveband switching. The most commonly encountered multiple press-button switch has a latching mechanism which causes any depressed button to be released when another is pressed, so that only one button remains held down at any time. There are, also, variations on this basic design in which, for instance, the operation of one button may be independent of that of the others.

CIRCUIT DESIGN

Circuits employing press-button switching are frequently more difficult to follow than are circuits incorporating rotary switches. There are two reasons for this. Firstly, the switch contact circuit symbols and their positioning in a circuit diagram do not always represent switching functions as obviously as occurs with rotary switch symbols. Secondly, press-button switch wiring often takes advantage of connection techniques which are one step removed from those employed with rotary switches. Some simple examples of these techniques will be given later in this short article.

In general, multiple press-button switches have one or more switch sections for each button. In some instances, the switch section actuated by a particular button in an assembly may consist of a 2 pole on-off type suitable for switching a.c. mains circuits. In virtually all other cases, the switch sections for each button employ low current contacts of the type associated with wavechange usage, and may consist of one or more changeover (i.e. single-pole double-throw) switch sections. A single button may operate as many as six individual changeover switch sections.

In a circuit diagram incorporating a multiple press-button switch, it is necessary to include a drawing of the switch outline and contact tag positions so that the wiring to these may be traced through. A typical example is given in Fig. 1, which illustrates a press-button assembly having four buttons. It is assumed that this assembly is of the type in which pressing one button

causes any other button to be released. In practice the assembly could appear in a battery transistor portable radio offering selection of, say, Long Waves, Medium Waves, F.M. and On-Off. Since the latching mechanism is such that one button is always held down, it is necessary for one button to be shown depressed in the outline drawing. In Fig. 1, the arbitrary choice is made to have button 1 depressed.

In the assembly of Fig. 1, each button controls four changeover switch sections. One of the changeover switch sections for S₁ in vertical row 'A' connects to contact tags 1, 2 and 3, with contact tag 2 corresponding with the 'arm' of the switch section. When button 1 is released contacts 2 and 1 are closed, and when button 1 is pressed contacts 2 and 3 are closed. Similarly, when button 1 is released, contacts 5 and 4 in row 'A' are closed; whilst contacts 5 and 6 in row 'A' are closed when the button is pressed. The same action occurs at all the other groups of three contact tags.

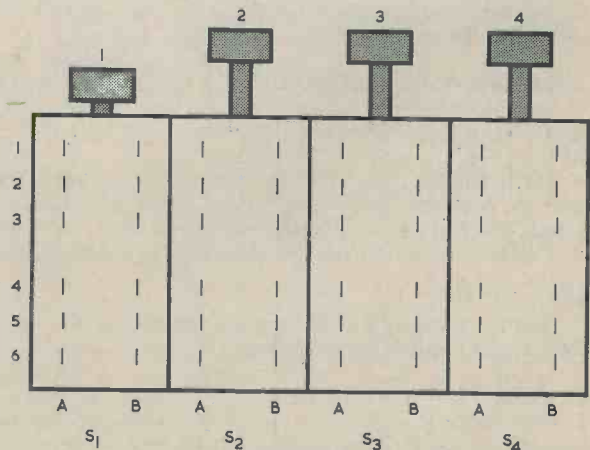

Fig. 1. Outline drawing for a typical multiple press-button switch with one button depressed

RADIO & ELECTRONICS CONSTRUCTOR

Switch assemblies encountered in commercially made receivers and similar equipment are usually tailor-made to meet the requirements of that equipment, and they do not normally include changeover switch section groups which are not needed. As an example, one button in an assembly may actuate, say, four changeover switch sections whilst the remainder of the buttons each actuate two changeover switch sections only. Occasionally, switch assemblies are made in which one press-button actuates no contacts at all, its purpose being to merely operate the latching mechanism and release any other button when it is pressed.

Symbols for the individual changeover switch sections can appear anywhere in a circuit diagram, and they are shown in the condition which corresponds to whether the associated button is pressed or not, as indicated in the outline drawing of the assembly. The three contacts of the switch section are depicted as small circles and the switch 'arm' as a black bar alongside them. Fig. 2 shows the symbol for contacts 1, 2 and 3 in vertical row 'A' of switch S2. The bar is alongside contacts 1 and 2, showing that these two are connected. This corresponds with the fact that button 2 is released in the outline drawing of Fig. 1. If button 2 were pressed, the bar would go down alongside contacts 2 and 3, indicating that these two contacts are then connected together.

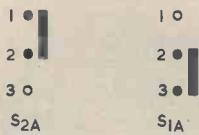

Fig. 2. Circuit symbols indicating switch conditions at contacts 1, 2 and 3 of S2A and S1A

Fig. 2 also shows the switch section for contacts 1, 2 and 3 in row 'A' of switch S1. Since the outline drawing of Fig. 1 shows button 1 depressed, the switch section symbol shows the bar in the corresponding position, alongside contacts 2 and 3.

It is desirable to depict the contacts which are connected together in a switch section as fully blacked-in circles, as illustrated in Fig. 2. Unconnected contacts are shown as black circles with a white centre. This practice is not, however, carried out universally.

WIRING TECHNIQUES

A few examples will now be given to demonstrate how multiple press-button switch circuits differ from rotary switch circuits. These should give the reader an insight into what may at first sight be inexplicable peculiarities in the switching circuits found in receiver servicing manuals and the like. All the circuits will be based on the outline drawing of Fig. 1, with button 1 depressed. The switch sections employed will be those connecting to contacts 1, 2 and 3 in vertical row 'A' for the buttons concerned, and it is assumed that the remaining switch sections can be usefully employed for allied switching operations.

In Fig. 3(a), we have a 4-way rotary switch which is capable of connecting point A to points B, C, D or E. Fig. 3(b) shows the switching circuit transferred to the

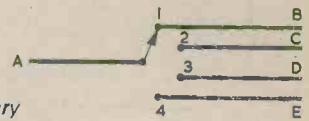
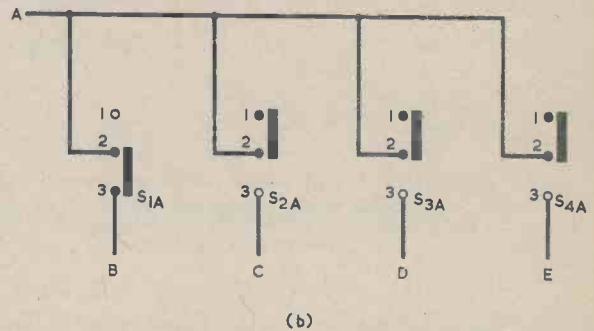

Fig. 3(a). A 4-way rotary switching circuit
(b). The equivalent 4-button circuit



4-button switch. Button 1 is already depressed, and so point A connects to point B via switch section S1A. If we press button 2, button 1 will be released, thereby breaking the circuit to B. Switch section S2A will then connect point A to point C. Pressing button 3 will similarly connect point A to point D, and pressing button 4 will connect point A to point E. The circuit of Fig. 3(b) is quite straightforward and simple to understand.

We turn next to Fig. 4(a), in which the rotary switch connects point A to points B and C as before. On both the positions 3 and 4, point A is connected to point D. Fig. 4(b) shows the corresponding circuit for the 4-button switch. As shown, button 1 is pressed, connecting point A to point B. If button 2 is pressed, button 1 releases, connecting point A to contact 2 of S2A. Switch section S2A then connects point A to point C. If button 3 is pressed, button 2 releases, and S2A connects point A to point D, as is required. The same thing happens if button 4 is pressed. The circuit of Fig. 4(b) carries out the same function as does that of Fig. 4(a), but it is only necessary to make connection to two of the press-button switch sections.

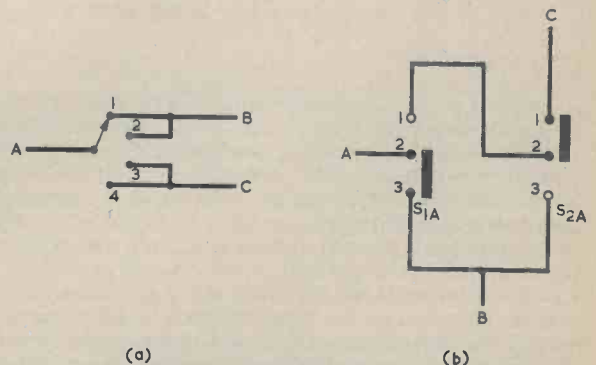
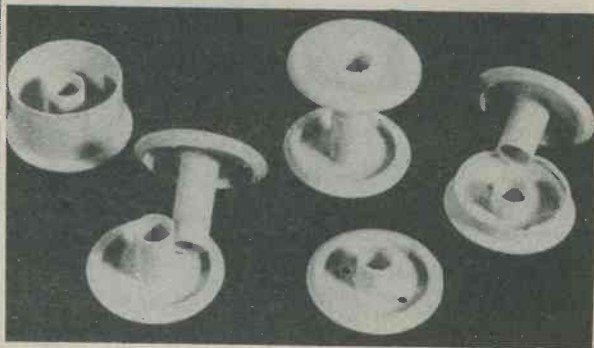

Fig. 4(a). Another 4-way rotary switch circuit
(b). The press-button equivalent requires only two changeover switch sections

COTTON



MODERN COTTON REELS LOOK EXACTLY LIKE THEIR wooden predecessors, but there the similarity ends. The modern reels are made of plastic, are hollow and have a built-in plastic tube through the centre. This mode of construction offers many uses for the electronic handyman.

AERIAL INSULATOR

As they stand, cotton reels can be used as aerial insulators, as shown in Fig. 1. Being hollow, they offer a fair degree of insulation, and they do not absorb damp.

The reels can be cut in various ways for different purposes. For instance, a small hacksaw may be used to cut round the outer shell at one end, close to the rim, taking care not to touch the centre tube. The process is next repeated at the other end. The outer shell is then squashed between finger and thumb until it splits and can be removed. This leaves a handy bobbin with high

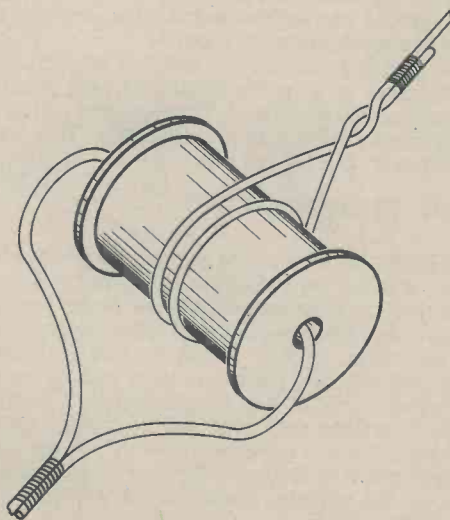

Fig. 1. A plastic cotton reel may be employed as an insulator in lightweight aerial installations

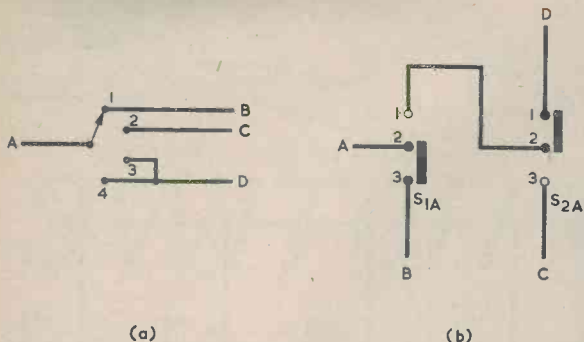

Fig. 5(a). In this circuit, switch positions 1 and 2 and positions 3 and 4 are paired
(b). The press-button version still requires two switch sections

Fig. 5(a) shows the 4-way rotary switch wired so that positions 1 and 2 connect point A to point B and positions 3 and 4 connect point A to point C. The 4-button switch version appears in Fig. 5(b), and again only two switch sections are required. With button 1 depressed, point A connects via S1A to point B. With button 2 depressed, point A connects via S1A, in the released position, and S1B to point B. When either buttons 3 or 4 are pressed, buttons 1 and 2 are released, causing point A to connect to point C.

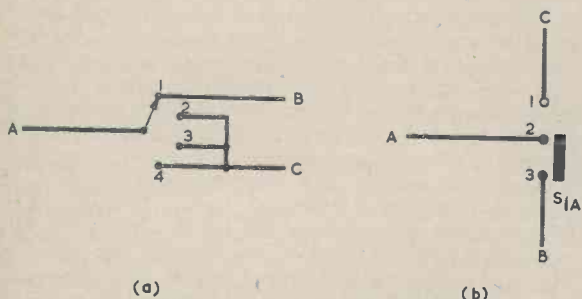

Fig. 6(a). Here, positions 2, 3 and 4 of the rotary switch are coupled together
(b). The corresponding press-button circuit employs only one switch section

A final example is given in Figs. 6(a) and (b). In Fig. 6(a), the 4-way switch connects point A to point B in position 1, and to point C in positions 2, 3 and 4. In the 4-button switch equivalent, shown in Fig. 6(b), only one switch section, S1A, is needed. With button 1 depressed, point A connects via S1A to point B. When any of the other buttons is pressed, button 1 releases, and point A connects via S1A to point C.

These examples all demonstrate that press-button switch circuits can be quite different from those for rotary switches. The most commonly encountered press-button switch circuits differing from the rotary switch equivalents are probably those like Figs. 4(b) and 5(b), in which the fact that two buttons select the same circuit makes it possible to achieve the desired switching action with only two changeover switch sections. ■

REEL TIPS

by V. S. Evans G4AVT

Some unusual applications for a homely domestic object.

cheeks, on which can be wound spare wire from old coils and chokes, etc. See Fig. 2(a).

Fig. 2(b) shows a faceplate and anti-chafe collar, which can be fitted to finish off sharp-edged holes in metal cabinets. The cotton reel is cut as for the bobbin of Fig. 2(a), after which a cut is made through the centre tube about $\frac{1}{4}$ in. from one end. This projection passes through the cabinet hole. Two small holes are drilled through the faceplate, enabling it to be secured neatly to the cabinet with round head bolts.

Another variant is the coil former of Fig. 2(c). The reel is cut as for the bobbin, after which one end is cut off leaving a full length tube at the centre. Two small mounting holes are again required, to bolt the former to the chassis.

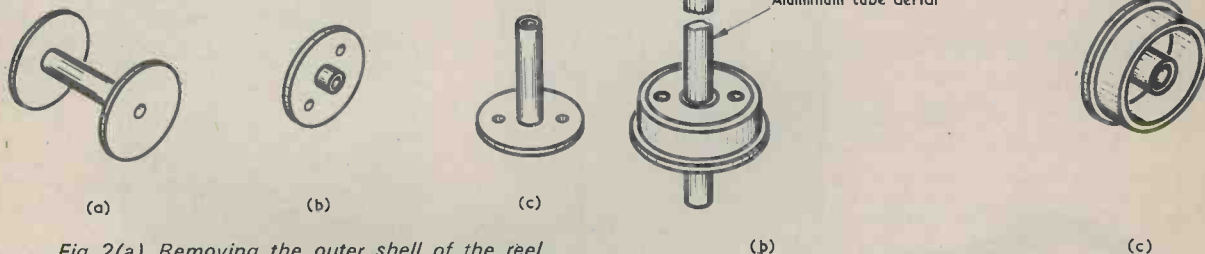

Fig. 2(a). Removing the outer shell of the reel results in a small bobbin with high end cheeks

(b). Cutting the reel in the manner shown here produces a faceplate and collar

(c). A coil former is given if the centre tube has its full length

FERRITE ROD HOLDER

The coil former of Fig. 2(c) can also be employed as a ferrite rod holder. It will take, and hold firmly, a $\frac{1}{8}$ in. ferrite rod, as in Fig. 3(a).

A vertical aerial holder is shown in Fig. 3(b), and this will be useful for field strength meters, model control transmitters and similar equipment. The coil former of Fig. 2 could be used here, but a stronger job is given by cutting both the outer shell and the tube about $\frac{1}{4}$ in. from one end. The space between the outer shell and the

FEBRUARY, 1974

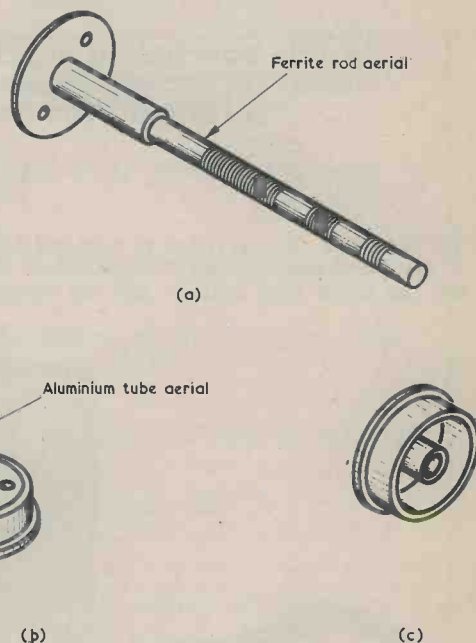

Fig. 3(a). The former of Fig. 2(c) may be employed also as a holder for a ferrite aerial rod

(b). The cotton reel is cut here so that it can function as a vertical aerial mounting

(c). Retaining part of the outer shell also enables a wheel for a robot to be produced

centre tube can then be filled in with 'Plastic Padding' or a similar material. Note the two holes which are required for mounting purposes.

The same assembly, without the mounting holes, may be employed for robot wheels, as indicated in Fig. 3(c). 'Spin-offs' from the procedures just described consist of short lengths of plastic tube and circular end pieces. These can be used as spacers and insulated washers, and in allied applications.

The 'WYVERN'

30 watt Stereo Amplifier

Part 3

by John R. Green, B.Sc., G3WVR

In this concluding article the main power supply and the chassis construction are described, after which details are given for setting up the power amplifier bias potentiometers.

IN THE FIRST TWO ARTICLES IN THIS SERIES, THE OPERATION and construction of the R.I.A.A. law equalizers, the active tone controls and the power amplifiers

were discussed in detail. So also was the regulated voltage supply section.

Next to be dealt with is the main power supply.

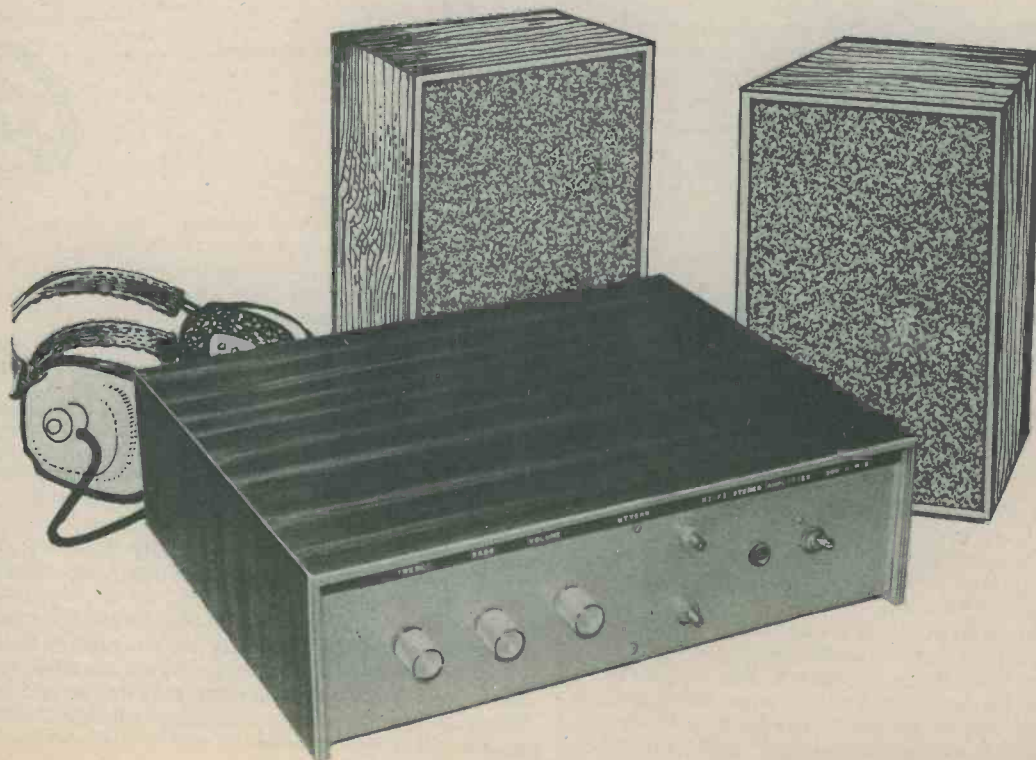

POWER SUPPLY UNIT

This section is very simple and straightforward to construct, as may be seen from the circuit diagram given in Fig. 16 and the accompanying photograph of the chassis interior.

The mains transformer should be capable of delivering the total average current required when both amplifiers are running at full (sine wave) output.

The requirement for each amplifier channel is given by the formula

$$I = \frac{\text{r.m.s. load current}}{1.1} \times \frac{1}{2},$$

plus a few milliamps for the pre-amplifier and driver stages.

The factor 1.1 converts the r.m.s. load current to 'average' current, and the factor of $\frac{1}{2}$ is introduced since the power supply only delivers output current on positive half-cycles of audio, whereas current is supplied by the output capacitor on negative half-cycles.

The output of each amplifier is 6.4 amps peak-to-peak, and this corresponds to 2.25 amps r.m.s. The requirement for both amplifiers is therefore

$$\frac{2.25}{1.1} \times \frac{1}{2} \times 2,$$

the factor 2 being added for the 2 channels. This gives just over 2 amps total.

The four silicon rectifiers should be rated at 3 amps or greater at 100 p.i.v., and should be mounted on insulated brackets or a Paxolin sheet.

A smoothing capacitor of at least 2,000 μ F and a working voltage of 40 volts or more is required for C23. The prototype amplifier power supply used 4,500 μ F here.

The mains transformer employed was the Douglas type MT106AT (Home Radio Cat. No. TMM16). This has a tapped secondary rated at 4 amps, the 25 volt tap being used. This gives 35 volts rectified, off load. However the cheaper MT3AT (Henry's Radio) or MT3 transformer (Home Radio Cat. No. TMM1) is quite suitable. This is rated at 2 amps and the 24 volt secondary tap is employed.

The power supply may be built onto a flat aluminium plate (which is described shortly) and the complete assembly then bolted to the main chassis, or the power supply components may be secured directly to the main chassis. The method of construction is illustrated in the

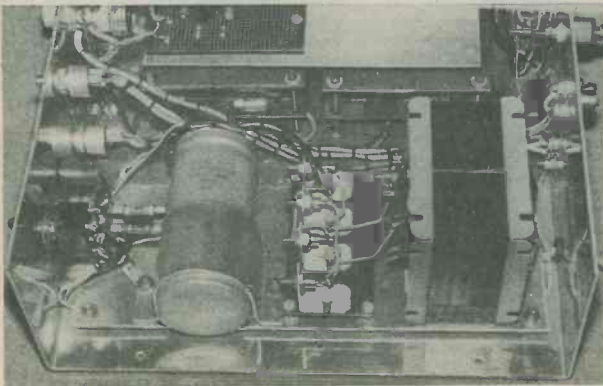

A close-up view of the main power supply section

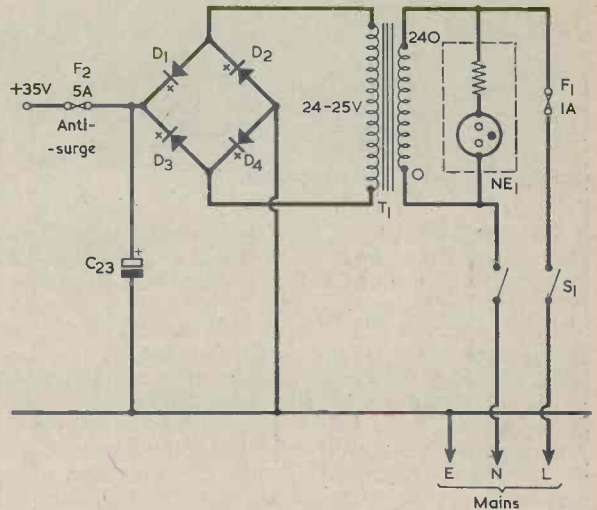

Fig. 16. The circuit of the main power supply, of which one only is required

COMPONENTS

Resistors

2-off high wattage resistors for testing (see text)

Capacitor

C23 1-off 4,500 μ F electrolytic, 40 V. Wkg.

Diodes

D1-D4 Silicon rectifiers, minimum ratings 3A at 100 P.I.V.

Transformer

T1 1-off mains transformer (see text)

Fuses

F1 1-off 1 amp cartridge fuse
F2 1-off 5 amp anti-surge cartridge fuse

Neon

NE1 1-off neon assembly with integral resistor

Switch

S1 1-off d.p.s.t. switch, toggle

Miscellaneous

3-off knobs
1-off 2-way chassis-mounting fuseholder
2-off coaxial input sockets
4-off output terminals
Mains Flex
Screened cable
Lacing cord
Paxolin
Aluminium sheet, 14 to 16 s.w.g.
 $\frac{1}{4}$ in. plywood
 $\frac{1}{2} \times \frac{1}{2}$ in. hard wood battens
Nuts, bolts, etc.

accompanying photograph. If any doubt exists concerning rectifier diode polarity, complete all wiring except the connections to capacitor C23. Then check the rectified (and unsmoothed) output from the rectifiers with a moving-coil meter. If this is of correct polarity, the capacitor may then be safely wired in.

STABILIZED SUPPLIES

It is worth mentioning the use of stabilized supplies at this stage since these have certain advantages in amplifier applications. The most important advantage of a stabilized supply is that it provides a constant voltage output irrespective of load current. This prevents modulation of the supply voltage by low frequencies which the smoothing capacitor may be unable to handle, and consequent cross-modulation, non-linear distortion and intermodulation between channels.

In practice, however, the negative feedback employed in the power amplifiers tends to overcome these short-comings in performance, since it ensures that amplifier gain is less dependent on supply voltage variations. With the present amplifier, the effects of supply voltage modulation have only been observed at full output on high level bass pedal organ notes, where most power amplifiers 'sag off' into a 'strangled burp'. To be fair, nevertheless, it should be pointed out that it is very easy to 'use up' 15 watts at bass frequencies without realising that an amplifier has reached its limits.

Constructors who are intent on providing their neighbours with free entertainment or embarking on house vibration testing can achieve an output of 30 watts r.m.s. per channel by running the amplifier from a 45 volt 4 amp supply. The circuit of Fig. 14 is recommended here, and the electrolytic capacitor working voltages have to be increased to suit.

CHASSIS LAYOUT

The main chassis, measuring 15 by 11½ by 4 in., is shown in Fig. 17, and the layout of modules in Fig. 18. Detailed positioning dimensions are not given, and these are left to the constructor to decide after the main modules have been assembled. The material is 14 to 16 s.w.g. aluminium sheet.

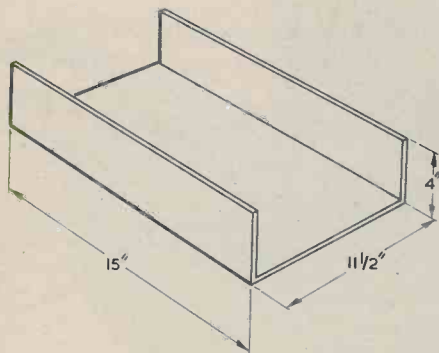

Material: 14-16 swg aluminium

Fig. 17. The main chassis is of simple construction and requires two bends only

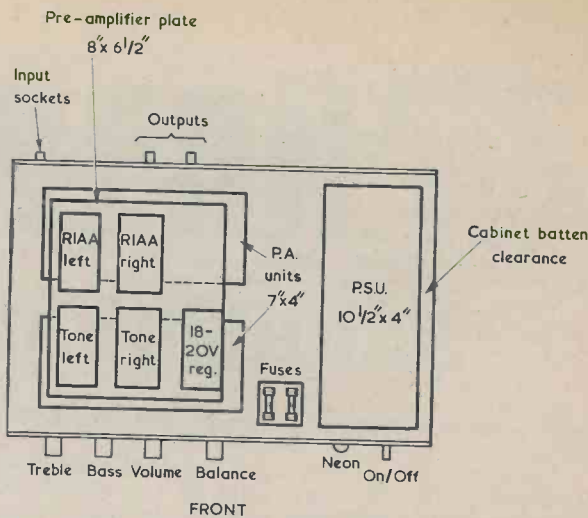

Fig. 18. Layout of modules on the main chassis

Also required, in addition to the main chassis, are two plates measuring 7 by 4 in. for the power amplifier heat sinks, one plate measuring 8 by 6½ in. for the pre-amplifiers and supply voltage regulator board and a further plate for the power supply (assuming that the power supply components are not mounted directly to the main chassis) measuring 10½ by 4 in. All these are in 14 to 16 s.w.g. aluminium. The appearance of the complete amplifier can be visualised from the photograph of the interior given in Part 1 of this series. The photographs show a vertical tagstrip fitted behind the front panel between the volume control and balance potentiometers. This was included in the prototype to provide a distribution point between the main power supply and the power amplifiers and voltage regulator unit, but it is not really necessary and is not included in the Components List.

The completed amplifier should be free of earth loop problems, although to avoid mains hum the turntable and pick-up should be earthed only via the amplifier.

No difficulties have been experienced with h.f. instability with the layout given. In the unlikely event that this does occur in the power amplifier, the cure is to connect a 'slugging' capacitor across R26 of Fig. 12. This capacitor should be as small in value as possible since it reduces the open loop gain and, consequently, the transient response. A possible maximum value, is say, 0.01µF.

When wiring up, the braiding of all screened leads is earthed at the relevant modules. The wiring between the active tone controls and the bass and treble potentiometers may consist of ordinary unscreened flex, as screening here is not required.

The chassis may be left 'bright' or it may be given a 'brushed' effect by glasspapering lengthwise and then washing and scrubbing with scouring powder.

The cabinet construction is shown in Fig. 19 and consists of ¼ in. plywood with reinforced corners. The chassis is screwed, by means of wood screws passing up from underneath, to the two lower ½ by ½ in. runners. These are set ¼ in. above the lower edges of the cabinet sides. The dimension identified in Fig. 19 by the legend 'see text' is such that, when the chassis is screwed in position, the upper edges of its front and rear panels just meet the underside of the 12 by 15½ in. top plywood panel. This dimension will be of the order of 4 in., but it is best to find what is required here by measuring from

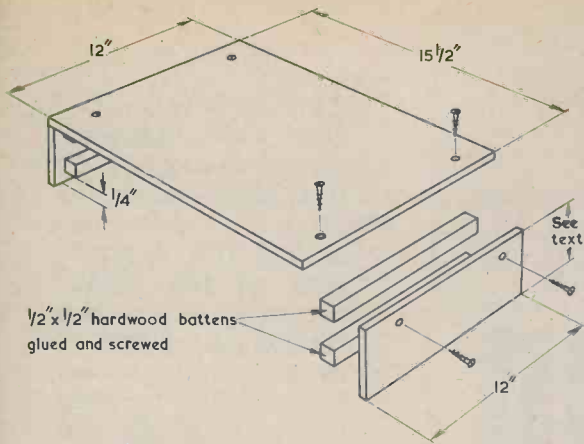

Materials

Top - 1/4" plywood 12" x 15 1/2" 1 off

Sides - 1/4" plywood 12" x 4" 2 off

Note! top overlaps sides

Hardwood battens 1/2" x 1/2" x 11" 4 off

Woodscrews - c'sk steel size 6 x 3/4" long

Fig. 19. Construction of the cabinet

the chassis after it has been bent into shape. This procedure takes up any small discrepancies given in the bending operation. The hardwood battens are both screwed and glued in place, the glue being a suitable impact adhesive from the Bostik or Evostick ranges, this being used in the manner described in the manufacturer's instructions.

The finished cabinet may be covered with teak or sapele veneer, and then varnished to give a 'professional' finish.

ADDITIONAL FACILITIES

A photograph of the rear panel of the prototype accompanies this article and readers will, no doubt, notice that this incorporates a number of switches and sockets not shown in the chassis layout diagram of Fig. 18.

The switch and coaxial socket adjacent to the input coaxial sockets allow a direct radio input to be switched to the volume controls RV1. The switch cuts off the equaliser outputs and parallels the two subsequent channel inputs. The circuit is given in Fig. 20. The radio input should be of the order of 100mV r.m.s. If this facility is not required, the equaliser outputs should be wired up in the manner already described.

The two input sockets to the left are direct inputs to the power amplifiers, and they are wired to the balance controls RV4. These are two separate potentiometers in

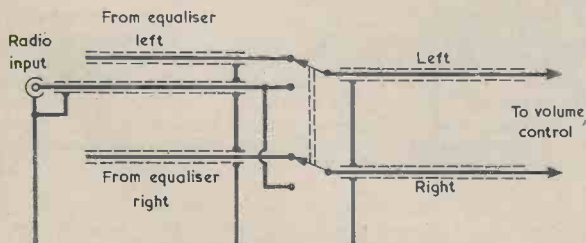
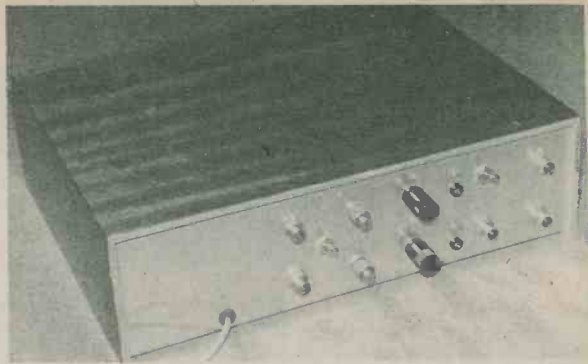

Fig. 20. An optional switching facility which is included in the prototype amplifier



The rear panel of the prototype amplifier

the prototype. The switch next to them is wired to connect these inputs in parallel when it is closed.

The speaker outputs are duplicated in the form of wander plug sockets and screw terminals.

The parts employed for these additional facilities are not included in the Components List.

TESTING

The power supply section may be tested prior to connection to the amplifier, and it should provide a voltage of approximately 35 volts off-load when a 25 volt secondary tap is used on the mains transformer. A 24 volt tap will give an off-load rectified voltage of about 33.5 volts.

A high wattage resistor, ideally at least 30 watts, of around 30Ω should be inserted in series with the positive supply to each power amplifier, and the 'set bias' potentiometer RV5 in both amplifiers adjusted so that the slider is at the TR7 collector end of the track. The current in TR10 collector should be monitored and the 'set bias' potentiometer slowly adjusted, so that its slider travels towards the TR7 emitter end of the track, until a quiescent current of 20mA is obtained. If the current flicks up to a high value as the output transistors start to conduct then this is a sign of amplifier instability, which has already been discussed. To protect the meter this should be set to a relatively high range whilst adjusting RV5 and then returned to a low range to give precise measurement of quiescent current when it appears safe to do so. The setting up process is carried out in turn on both power amplifiers.

The monitoring meter may then be removed and the collector circuit of TR10 in both amplifiers completed again. The amplifier may next be tested at low output level by feeding a suitable signal across the balance controls. If all is well, the 30Ω resistors may be removed.

The output of the 18 to 20 volt regulator section can be checked with a voltmeter and, finally, the pre-amplifiers should be wired in and the whole amplifier tested with a suitable pick-up cartridge. The output terminals must not, of course, be accidentally short-circuited when the amplifier is in use.

In conclusion, it can be stated that it is possible to get the amplifier working with the minimum of fuss, as the pre-amplifier sections are of reputable design and the power amplifier has been built by the author and friends in more than a dozen forms for various applications with complete success.

Genuine marked semiconductors must be used, however, particularly in the power amplifier stages. With a self-biasing design, failure in one device can result in the destruction of several others, as the author has found out to his cost when using 'unmarked' equivalents.

In your workshop

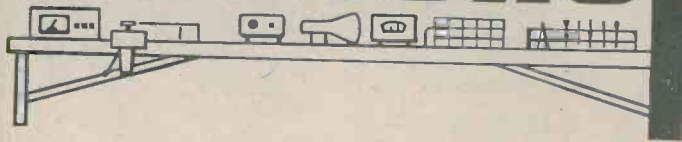

This month Smithy the Serviceman, aided as always by his able assistant Dick, demonstrates the properties of his latest creation, the 'Decision Maker'. In the process he is also able to deal with some of the minor mysteries of flip-flops when these are employed in steering diode circuits.

"AH, THAT'S IT!" WITH A SIGH OF satisfaction, Smithy laid down his soldering iron.

Dick looked up from his magazine. "You sound very pleased with yourself," he commented. "But what are you doing with a soldering iron during lunch-break?"

"Just finishing off a little gadget I've been making for myself," replied Smithy. "It's my Decision Maker!"

"Your what?"

"My Decision Maker," repeated Smithy. "It's an electronic device which makes up your mind whenever you're confronted with a difficult decision."

"This," said Dick, rising from his stool and walking towards the Serviceman, "is something I must see for myself."

He gazed down at the unit which Smithy had been working on. This consisted of a plastic box in which was fitted a small Paxolin perforated circuit board. Wired up on the board were four small transistors, two diodes and a number of resistors and capacitors. On the lid of the box, now held partly open by Smithy, were mounted a toggle switch, a push-button and two small round red objects.

"Hallo," he queried, pointing at the last two items, "what are those?"

"They're light emitting diodes," said Smithy. "Whenever I want to make a decision I turn on this device of mine. Both the l.e.d.'s then light up. I next press the push-button, whereupon only one of the l.e.d.'s remains alight. If it's the left-hand one then the unit is saying 'Yes' to my decision. If it's the right-hand l.e.d., then the unit is telling me 'No'."

"Blimey," said Dick, greatly impressed by this information. "That sounds almost like magic to me."

"Don't take me too seriously," chuckled Smithy. "Actually, I could

toss a coin and get the same result. This gadget of mine is simply a rather complicated toy which gives a completely random illumination of the l.e.d.'s. When I press the button, either one or the other of the l.e.d.'s remains lit up according to the state of the circuit at the instant of pressing the button. It's fairly complex because I wanted to make its operation completely random and free of any bias towards one l.e.d. at the expense of the other."

"Well," said Dick. "The idea sounds jolly interesting to me. Why is it so difficult to get this fully random operation?"

"Because," replied Smithy, "the usual method of making up devices of this nature consists of having an oscillator, such as a multivibrator,

coupled to a self-latching circuit. The multivibrator is stopped at any instant by pressing a button or operating a switch, whereupon the device then gives a 'Yes' answer if one transistor of the multivibrator happens to be turned on at that instant and a 'No' if the other transistor happens to be turned on. It is obviously a matter of pure chance which transistor in the multivibrator is turned on at the moment of stopping it, and so the device is capable of functioning as a random generator. A typical gadget of this nature was described in *Radio & Electronics Constructor* recently. In the last July issue, if I remember correctly." (Fig. 1).

"That multivibrator idea," remarked Dick musingly, "seems to represent a reasonable approach so far as I can

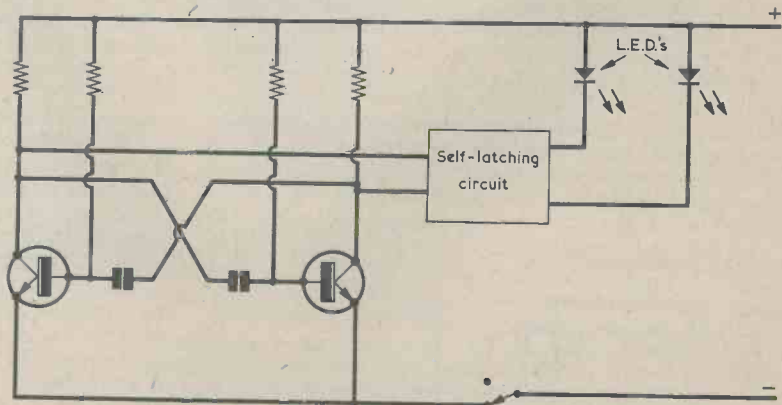

Fig. 1. A typical approach towards obtaining a random 2-way output. When the switch is opened one of the two l.e.d.'s remains illuminated according to the state of the multivibrator at the instant of opening the switch. (A circuit of this nature was described in 'Random Output Generator' by E. F. Whitman in the July 1973 issue.)

sec.”

“It does,” replied Smithy, “if you can get the multivibrator to produce a waveform that is exactly 50:50. If the waveform is, say, 49:51 then there is a 2 out of 50, or 4 per cent, bias towards the longer half of the multivibrator waveform. I use quite a different approach in this gubbins of mine.”

“Do you?” queried Dick. “How does it work?”

“It contains a unijunction oscillator which generates a series of pulses,” explained Smithy, “and these are fed to a flip-flop with diode steering. The flip-flop changes from one state to the other on each successive pulse, with the result that there is no dependence on oscillator waveform. The pulses are bound to be spaced out at regular intervals and so the flip-flop must spend equal times in either of its two states. You obtain an output by pressing a button which disconnects the pulse feed to the flip-flop, whereupon the flip-flop remains in the state it had at the instant of pressing the button. This state is indicated by the lighting of one of the two l.e.d.’s. Once again, it is a matter of pure chance whether the flip-flop is in one state or the other when the button is pressed, and in this case the output is truly random.”

Dick scratched his head and frowned.

“You’re going a bit too fast for me here, Smithy,” he commented. “I haven’t even got the overall picture of this Decision Maker of yours sorted out yet and now you’re carrying on about flip-flops with diode steering! What the heck is a flip-flop with diode steering?”

FLIP-FLOP

Smithy grinned, then pulled his note-pad towards him. He took a ball-point pen from his pocket and sketched out a circuit. (Fig. 2)

“Let’s start at the beginning,” he said. “Now here’s a basic flip-flop using n.p.n. transistors. This circuit is called a flip-flop because it can exist in one of two conditions. Either TR1 is turned on or TR2 is turned on, but not both together. If TR1 is turned on, its collector is only slightly higher in potential than the earth line, whereupon the base of TR2 is negative of its emitter and TR2 is turned off. This allows the requisite base current to flow to the base of TR1 via R4 and R5. In the opposite condition TR2 is turned on, with the result that it is the base of TR1 which is now negative of its emitter, thereby causing TR1 to be turned off. I haven’t shown resistor values in this circuit, but these are chosen such that the requisite voltage conditions can be set up. The values are not, normally, at all critical. I would add also that the circuit is symmetrical, so that R1 is equal to R4, R2 is equal to R5, and R3 is equal to R6.”

“Is that why the circuit is called a flip-flop?” queried Dick. “Because

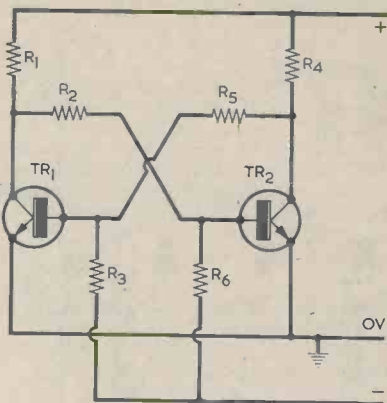

Fig. 2. A basic transistor flip-flop. With suitable resistor values and supply voltages, either TR1 or TR2 is turned on. R3 and R6 are returned to a supply voltage that is negative of the earth line. Supply polarities are reversed if p.n.p. transistors are employed

it can ‘flip’ over to one state and then ‘flop’ over to the other state?”

“That’s right,” confirmed Smithy. “Flip-flops came into prominence around the start of the last war, where they were used widely in radar circuitry. The term was also applied in those days to circuits which had one stable condition only. They could be triggered or ‘flipped’ to the unstable state by an input pulse, then after a while they would ‘flop’ back to the initial stable condition. The delay between the ‘flip’ and the ‘flop’ states was usually governed by the charge or discharge of a coupling capacitor.”

“That sounds,” remarked Dick brightly, “rather like what we would nowadays call a ‘one-shot multivibrator’.”

Smithy turned a surprised glance at his assistant.

“Dear me,” he remarked “You are on the ball today. Circuits with the one stable state are also referred to as ‘monostable’ circuits. Nowadays, we tend to use the term ‘flip-flop’ only for circuits having the two stable states.”

“How,” asked Dick, “can you change that flip-flop of yours over from one state to the other?”

“A common method is to apply pulses to one or other of the transistor collectors,” replied Smithy. “To give you an idea of what I mean, let’s add some switches to that simple circuit of mine.”

Smithy busied himself with his pen. (Fig. 3(a).)

“What I’ve done here,” he went on, “is to add a switch across each of the

AUDIO AMPLIFIERS



16 Transistor & Valve Designs for the Home Constructor

Amplifiers for Tuner Units, Record Players, Tape Recorders, Public Address, etc., etc.

Includes contributions by such well-known authors as

A. S. Carpenter, A. Kinloch, E. Govier, G. A. French, F. G. Rayer, P. F. Bretherick, K. Jones, D. Aldous, R. Murray-Shelley, C. Swires, G. A. Stevens and V. E. Hölley.

Edited by J. R. Davies

124 pages

PRICE 53p

Postage 6p

To: DATA PUBLICATIONS Ltd.,
57 Maida Vale London W9

Please supply copy(ies) of "Audio Amplifiers", Data Book No. 18. I enclose cheque/crossed postal order for.....

Name.....

Address.....

.....RC
BLOCK LETTERS PLEASE

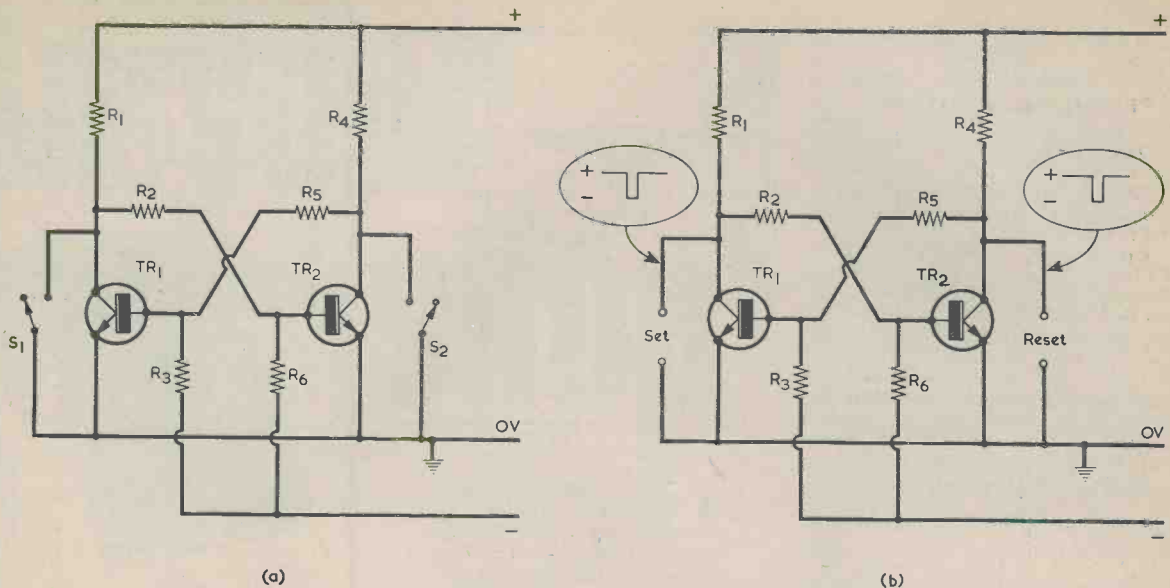

Fig. 3(a). The flip-flop can be changed from one state to the other by momentarily closing a switch across the transistor that is off
 (b). Change-over can also be initiated by applying a negative-going pulse to the collector of the transistor which is turned off

two transistors. Let's say that the circuit is such that TR1 is off, TR2 is on and both switches are open. I next close the switch across TR1. What happens?"

"Well," said Dick, gazing at the circuit, "the collector voltage of TR1 will fall to that of its emitter. This will cut off the bias current for TR2, and TR2 will cut off."

"Fair enough. And what happens when I open the switch again?"

Dick thought for a moment.

"Why, that's dead easy! Since TR2 has been cut off, bias current will flow to TR1 base via R4 and R5. Because of this, TR1 will now be turned on and TR2 will be turned off."

"Exactly," confirmed Smithy approvingly. "By closing and opening the switch across TR1 we have changed the circuit from TR1 off and TR2 on to TR1 on and TR2 off. Even a momentary closing of the switch will be enough to change the circuit over. If we want to change the circuit back to TR1 off and TR2 on, all we have to do is to momentarily close the switch across TR2. Okay?"

"Oh definitely," replied Dick keenly. "Let's hear a bit more about this change of state business."

"Fair enough," said Smithy. "Well now, we can dispense with the switches and apply negative-going pulses to the collectors instead. Like this."

Smithy re-drew his diagram with negative-going pulses. (Fig. 3(b).)

"Let's start off," he said, "by assuming that TR1 is off and TR2 is on.

If I now pass to the collector of TR1 a negative-going pulse whose amplitude is sufficient to momentarily take the collector voltage down to that at the emitter, then TR2 will turn off and TR1 will be on after the pulse comes to an end. In other words, we're doing just the same as we did when we closed the switch across TR1. We can get the circuit back to the original state by applying a pulse of the same type to the collector of TR2."

"Stap me," stated Dick. "This is all new to me. Are there any other ways of changing a flip-flop over by means of pulses?"

"There are," replied Smithy. "You can, for instance, change the flip-flop over by applying a pulse which momentarily pulls one base negative of its emitter. This can be done with a couple of extra transistors, and the whole arrangement then looks like this."

Smithy drew out a further circuit. (Fig. 4.)

"What happens here," he continued, "is that you change the flip-flop over by turning one or other of the flip-flop transistors off. Let's say that TR1 is on and TR2 is off. If we now feed a positive-going pulse to the base of TR3, this transistor will turn on and pull the base of TR1 negative of its emitter. TR1 will then turn off, allowing bias current to flow to the base of TR2, which then comes on and stays on. To get the flip-flop back to its original condition we have to apply a positive-going pulse to the base of

TR4."

"I'm with it," commented Dick. "By the way I see that you've marked the pulse inputs in the last two circuits you've drawn as 'Set' and 'Reset'."

"That's true," concurred Smithy. "It's merely because the two trigger

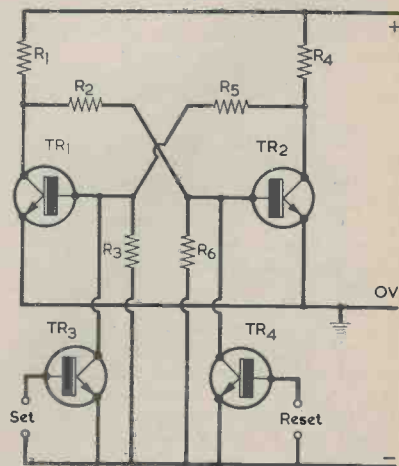

Fig. 4. Another method of controlling a flip-flop. In this case one of the transistors is turned off by the trigger pulse

inputs to a flip-flop are commonly referred to as the 'Set' and 'Reset' inputs."

'SPEED-UP' CAPACITORS

Dick looked at Smithy's last circuit reflectively.

"These flip-flops," he remarked, "are things which we never bump into at all in ordinary radio and TV work."

A thought occurred to him. "Still," he went on cheerfully, "we do get flip-flops with things like pop records."

Smithy steeled himself for the worst. "Go on."

"One side of a pop record," stated Dick airily, "is referred to as the flip side. Whereupon the other side can only be referred to as the flip side!"

Smithy shuddered.

"Very good," he commented hurriedly. "I think we'd better get back to some real flip-flops. Now, all the flip-flop circuits I've shown you had resistors coupling the collectors to the opposite bases. In practice, flip-flops, also have capacitors in parallel with the cross-coupling resistors. The capacitors are added like this."

Smithy drew a flip-flop with the added capacitors. (Fig. 5.)

the opposite base to be reverse-biased, thereby turning the opposite transistor off more quickly. Also if, at any instant during the transition, both transistors happen to be in at least a partly conducting condition, then the capacitors allow a multivibrator effect to take place, and the change-over is speeded up by the consequent regeneration which then exists."

"Those capacitors," commented Dick, "seem to be doing quite a useful job. What value would they normally have?"

"That depends to some extent upon the frequency of the change-overs required in the flip-flop," said Smithy. "Typical values can range from about 20pF up to 500pF or so."

"I see," commented Dick.

His eyes fell on the little unit on Smithy's bench.

"We seem," he remarked, "to be getting away from this gadget of yours."

"No, we're not," replied Smithy. "In fact we're actually leading directly towards it, because the next things I want to tell you about are flip-flops with steering diodes, like I've used in this gadget of mine."

"Ah, good," said Dick. "This will at least clear up that steering diode mystery!"

Smithy sketched out a further circuit. (Fig. 6.)

"Now here," he said, "is a flip-flop having steering diodes. These are D1 and D2 and they are returned via a high value resistor, R7, to a positive supply voltage which is about half-way between the earth line and the top positive supply point. Let's start off with the situation where TR1 is off and TR2 is on. Since TR1 is off, its collector will be near the top positive supply rail in voltage, and a current will flow from the top positive supply rail through R1, D1 and R7 to the half supply voltage point. Since R7 has a high value this current will be quite low and will cause only a small voltage drop across R1. The cathode of D1 - that is to say, its 'plus end' - will have a voltage which is slightly lower than that on the collector of TR1. This is because D1 is now conducting. The cathode of D2 will be at the same potential but, since the collector of TR2 is only slightly positive of the earth line, D2 becomes reverse-biased and does not conduct."

Dick traced out the diode circuits with his finger.

"That seems all right up to now," he stated. "Proceed, Smithy!"

"We next," said Smithy, "apply a negative-going pulse to the two diode cathodes via the input capacitor C3. Because D1 is now conducting, the pulse pulls down the voltage at the collector of TR1, whereupon the speed-up capacitor C1 causes the base of TR2 to go negative, and TR2 turns off. At the end of the pulse TR1 is on and TR2 is off. Which means that the pulse has caused the flip-flop to change

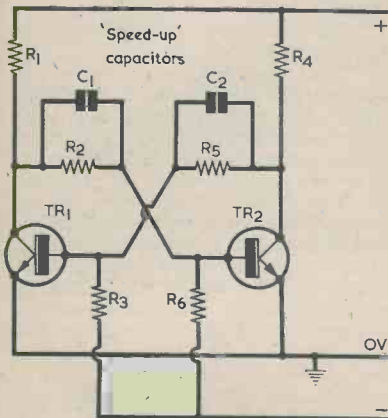

Fig. 5. In practical flip-flops, 'speed-up' capacitors are connected across the cross-coupling resistors

"I've omitted these capacitors up to now," he remarked, "so that I could explain the flip-flops I've shown you more simply. The function of the capacitors is to speed up the transition from one state to the other, and in fact they are often referred to as 'speed-up' capacitors."

"What do they do?" "They cause the change in voltage at a collector to be transferred more abruptly to the opposite base," said Smithy. "When, for example, the voltage at a collector drops at the start of a change-over, the capacitor causes

Your Local Supplier

LONDON

THE MODERN BOOK CO.

Largest selection of English & American radio and technical books in the country.

19-21 PRAED STREET, LONDON, W2 1NP

Tel: 01-723 4185/2926

ST. HELEN'S RADIO

Hi-Fi Equipment
Tape Recorders
Radio Receivers
Television

SPECIALISTS IN RADIO & ELECTRONIC TEXTBOOKS

ST. HELENS GARDENS
LONDON, W.10
Tel: 01-969 3657

CORNWALL

DESOLDERWICK

SOLDER-ABSORBING WICK

Approx 1 cm. completely desolders a P.C.B. joint. Use with any 20-40w soldering iron.

30 cm. pack. 26p inc. p & p etc.

Multipack. Four lengths of wick in various widths. 80p inc. p & p etc.

ORIENTATION LIMITED
Coverack, Cornwall

HAMPSHIRE

BOURNEMOUTH

LARGEST HI-FI AND RADIO COMPONENT STORE IN THE SOUTH

FORRESTERS NATIONAL RADIO SUPPLIES LTD.

70-72 Holdenhurst Road
Bournemouth

Telephone 25232

Your Local Supplier

SURREY

WITWORTH TRANSFORMERS

TV Line out-pu transformers

Manufacturers of the largest range in the country. All makes supplied.

Modern

BAIRD, BUSH, GEC, PHILIPS Replacement types ex-stock.

For "By-return" service, contact London 01-948 3702

Tidman Mail Order Ltd., Dept. R.C. 236 Sandycombe Road, Richmond, Surrey TW9 2EQ

Callers welcome.

SUSSEX

E. JEFFRIES

For your new television set tape recorder, transistor radio and hi-fi equipment

PHILIPS, ULTRA, INVICTA DANSETTE, MASTERADIO, PERDIO, MARCONI, PHILCO FIDELITY

6A Albert Parade Victoria Drive, EASTBOURNE SUSSEX

WARWICKSHIRE

Norman H. Field

HI-FIDELITY

Large demonstration room, Sony, Trio, KEF, B & O, Sanyo, BSR, Toshiba, Goldring, Natiowel etc.

TAPE RECORDERS

Sony, Revox, Tandberg, B & O specialists. Cassette and 8-track

ELECTRONICS

All component parts, cartridges, styli, radios, Self Build Kits, Disco-Group and P.A. Equipment.

Norman H. Field

ALBANY HOUSE, HURST STREET, B'HAM B5 4BJ. Tel. 021-622 2323

Specialist Repair Service

EIRE

PEATS for PARTS

ELECTRONIC COMPONENTS RADIO & TELEVISION

For the convenience of Irish enthusiasts we supply Radio & Electronics Constructor Data Books and Panel-Signs Transfers Also a postal service

Wm. B. PEAT & Co. Ltd. 28 PARNELL STREET DUBLIN 1

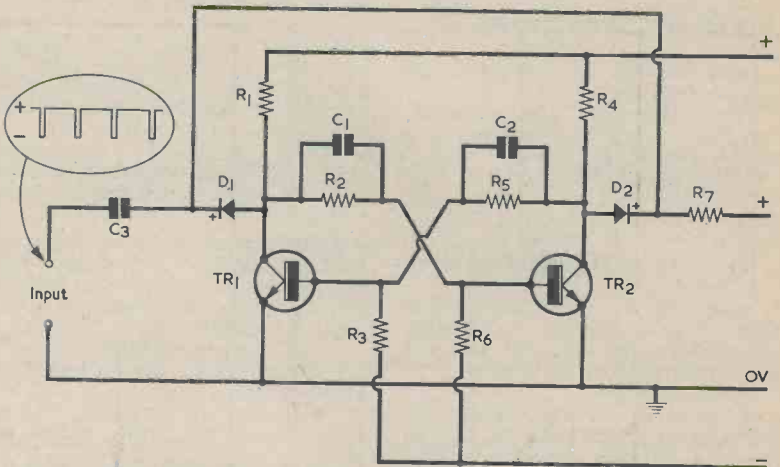

Fig. 6. A flip-flop with input steering diodes, which appear here as D1 and D2. The flip-flop changes from one state to the other on each input pulse. R7 connects to a positive supply voltage which is approximately central between the earth line and the upper positive rail

over."

"That seems reasonable enough," remarked Dick. "What happens next?"

"We bung in another negative-going pulse via C3," said Smithy. "This time, however, it is D2 which is conducting and D1 which is reverse-biased. The result is that the pulse is now 'steered' to the collector of TR2. TR2 collector voltage is pulled down, and C2 causes TR1 base to go negative, whereupon TR1 turns off. At the end of the pulse the flip-flop has returned to its original state, with TR1 off and TR2 on."

DIVIDE CIRCUIT

Smithy stopped and looked at his assistant questioningly.

"There's something hidden under the surface here," remarked Dick, his brow furrowed in thought. "Let's think now! The first pulse changes the flip-flop over to its alternate state, whilst the second pulse brings it back to its initial state. Would a third and fourth pulse do the same thing?"

"They would."

Suddenly the light dawned.

"Why, blow me," said Dick excitedly. "This flip-flop is a divide-by-two circuit! If, for instance, you look at the voltage at TR2 collector, this changes once for every two input pulses. Could you couple TR2 collector to another flip-flop having steering diodes?"

"You could," confirmed Smithy. "And the two would then constitute a divide-by-four set-up. The voltage waveforms in the single flip-flop we have here are like this."

Smithy tore the top sheet off his

note-pad and drew out the waveforms. (Fig. 7.)

"Are there any complications in the operation of the circuit?"

"There are a few," said Smithy, "It is important for the input pulse not to last too long or it will cause the collectors of both TR1 and TR2 to be held down at the same time. When an over-long pulse ceases, the voltages on both collectors will then rise at around the same rate and the flip-flop may change over to either state instead of definitely changing over to the opposite state. The speed-up capacitors are helpful here in initiating the correct change-over, since they cause the

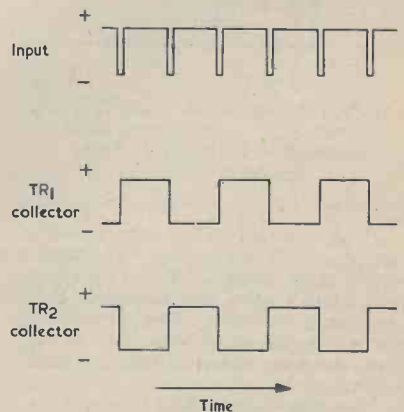

Fig. 7. Voltage waveforms in the steering diode flip-flop circuit of Fig. 6

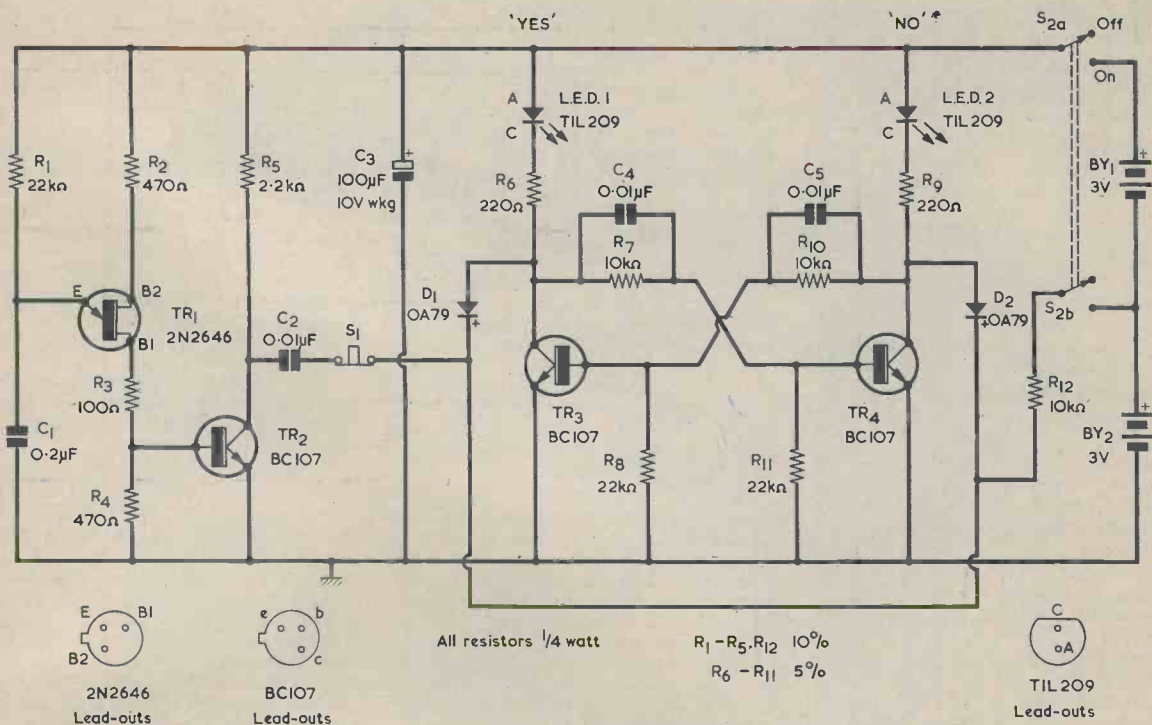

Fig. 8. Complete circuit of Smithy's 'Decision Maker'. TR3 and TR4 change states on each pulse from TR1 and TR2. Pressing S1 causes either LED1 or LED2 to be illuminated. Consumption from the 6 volt supply is approximately 20mA

conducting transistor to be turned off just after the start of the input pulse."

"It certainly seems to be a knobby circuit," said Dick. "I'd be interested to see how you've used it in this Decision Maker of yours."

Smithy reached over to the back of his bench and produced a sheet of paper on which a circuit was already drawn. (Fig. 8.)

"Here we are," he remarked proudly. "This is the complete circuit for my Decision Maker. The flip-flop is given by the circuitry around TR3 and TR4, but we'll leave that for the moment and concentrate on the pulse generator, which employs TR1 and TR2."

"There doesn't seem to be anything very complicated there," said Dick, studying the circuit. "So far as I can see, TR1 is a straightforward unijunction oscillator. Capacitor C1 charges via R1 until the emitter of the transistor reaches the voltage at which it exhibits the negative feedback effect to the base 1 which is given in a unijunction transistor. C1 then rapidly discharges into R3 and the base-emitter junction of TR2, after which C1 charges up once more via R1. The result is a series of current pulses in the base-emitter junction of TR2."

"Very good," commended Smithy. "I couldn't have put it better myself. Incidentally, the unijunction frequency is about 200 pulses per second. The current pulses in the base-emitter junction of TR2 result in negative-going pulses at the collector of this transistor. These pulses are applied via C2 and push-button S1 to the flip-flop steering diodes D1 and D2. S1 is a push-button which remains closed until it is pressed."

"In your previous circuits," Dick pointed out, "you returned the lower base resistors to a supply voltage which was negative of the earth line. You haven't done that here."

"True," agreed Smithy. "In this circuit the lower base resistors are returned to the same negative supply line as the emitters. This is a reasonable approach because both TR3 and TR4 are silicon transistors, which means that their collector voltages, when turned on, are lower than the 0.6 volt needed at the base of a silicon transistor to turn it on. So, when one transistor is turned on, the opposite transistor is fully off, despite the fact that there is no extra negative supply rail. There is a 3 volt positive supply rail. This and this couples to the two diodes via R12. The diodes carry out

the steering process in the manner I've already described, with the result that the transistors turn on and off alternately, changing over at each pulse from TR2. I've given the speed-up capacitors, C4 and C5, rather high values to ensure reliable change-over, and also to cover the fact that the collector currents of TR3 and TR4 are quite a lot higher than they would be in a conventional flip-flop circuit."

"Are these collector currents high because of the l.e.d.'s which the collectors drive?"

"They are," confirmed Smithy. "Resistors R6 and R9 limit the l.e.d. currents to around 15 to 20mA, and this current is quite high enough to enable them to give a good bright glow. I've used Texas Instruments l.e.d.'s type TIL209, and these can be obtained from Henry's Radio. By the way, it's important to connect the l.e.d.'s into circuit with correct polarity."

"Those l.e.d.'s are certainly neat little devices," commented Dick. "I wonder what they look like when they're lit up."

"You can see for yourself right now," said Smithy. "I'd just soldered up the last connection and was all ready to try out the circuit when this discussion started."

**NEW PRACTICAL
PAPERBACKS
FROM
FOULSHAM-TAB**

Handbook of Semiconductor Circuits	£1.95
All-In-One T.V. Alignment	
By J. Shane	£1.75
Basic Electronic Circuits Simplified	
By N. Hibbs	£1.85
Basic Electronic Course	
By N. Crowhurst	£1.85
FET Applications Handbook	
By J. Eimbinder	£1.85
Basic Electronic Test Procedures	
By I. M. Gottlieb	£1.95
Basic Electricity and Beginning Electronics	
By M. Clifford	£1.40
Handbook of IC Circuit Projects	
By J. Ashe	£1.40
Pictorial Guide to Tape Recorder Repairs	
By F. H. Belt	£1.40
Simplified T.V. Trouble Diagnosis	
By Robert L. Goodman	£1.85
Marine Electronic Handbook	
By L. G. Sands	£1.35
Selecting and Improving your Hi-Fi System	
By H. Swearer	£1.40
4-Channel Stereo From Source to Sound	
By K. Sessions	£1.35
Japanese Radio, Record and Tape Player Schematic/ Servicing Manual	
By Homer L. Davidson	£1.90
101 T.V. Troubles From Symptom To Repair	
By A. Margolis	£1.40
Stereo/Quad Hi-Fi Principles and Projects	
By K. Sessions	£1.35
How to Repair Musical Instrument Amplifiers	
By B. Wels	£1.50
Installing Hi-Fi Systems	
By J. Markell and J. Stanton	£1.40
New Ways to Diagnose Electronic Troubles	
By Jack Darr	£1.50
Servicing The Solid-State Chassis	
By H. Davidson	£1.40
Model Car Racing By Radio Control	
By G. Siposs	£1.40



FOULSHAM-TAB LTD.
YEovil ROAD, SLOUGH, BUCKS.

Smithy closed the lid of his unit and switched it on. At once the two l.e.d.'s commenced to glow.

"Why, they're both lighting up," said Dick.

"What's happening," said Smithy, "is that they're each going on and off alternately at a rate of about 200 times a second. This gives the impression of a continual glow. Let's press S1."

Smithy pressed the button. The 'Yes' l.e.d. now glowed on its own, and at a brighter level than it had done previously. Smithy grunted with satisfaction. He released the button, then pressed it again. This time the 'No' l.e.d. became illuminated.

"Things seem to be all right," he remarked, keeping the button depressed. "As I said earlier it is a matter of pure chance whether I press the button when TR3 is on or when TR4 is on."

"The 'Yes' diode hasn't gone out completely," said Dick suddenly. "It's still glowing faintly."

"It will," replied Smithy. "When the 'No' diode is alight transistor TR3 is turned off. However, there's still the small current which passes through R6, D1 and R12 to the 3 volt supply point. This current is just high enough to cause the 'Yes' l.e.d. to give a visible glow, but the glow is much lower than the glow in the l.e.d. which is fully illuminated. For the same reason, you'll get a weak glow in the 'No' diode when the 'Yes' diode is fully lit up."

DECISIONS, DECISIONS

Smithy released the button and both l.e.d.'s lit up again.

"Well now," he said, "let's use this box of tricks to make a few decisions. Seeing that lunch-break is virtually over, let's ask it whether we should resume normal servicing work within the next few minutes."

Smithy pressed the button. The 'No' l.e.d. lit up.

"Ask it," put in Dick, "if we should

start work within the next ten minutes."

Smithy actuated the button. Again, the 'No' l.e.d. lit up.

"Well then," carried on Dick, "within the next quarter of an hour."

Again Smithy pressed the button. Once more the unit indicated 'No.'

"This is getting disastrous," said Smithy. "Let's ask it if we should start work in the next twenty minutes. You press the button this time."

Smithy's grinning assistant pushed down the button. This time the 'Yes' l.e.d. remained illuminated.

"Thank goodness for that," commented Smithy. "That box would have had us taking the whole afternoon off if it had given us any more 'No' decisions!"

"There seemed to be quite a few 'No' answers in a row there," commented Dick. "There were three of them before we got a 'Yes'."

"You'd get the same sort of result if you tossed a coin," replied Smithy. "To check a gadget like this Decision Maker of mine, it has to be operated about a hundred times, counting the number of 'Yes' and 'No' answers it gives. After this number of operations they should be about equal."

"Shall we do just that?" queried Dick, pressing the button.

The Decision Maker stated 'No'.

"This darned thing will be ruling our lives soon," snorted Smithy. "I suggest we switch it off for a bit."

Dick pressed the button again, and this time the Decision Maker stated 'Yes'.

Regretfully, Dick turned the unit off.

"Well, it certainly knows its own mind," he stated, eyeing the box respectfully. "I wonder if it would mind if we *did* start work in less than twenty minutes."

"We'll just," said Smithy, putting the unit purposefully to the back of his bench, "have to keep that a secret from it."





Each £3 unit of Home Unit Insurance gives you protection up to the limit shown

This is the simplified insurance you have been waiting for. Not just cover on the contents of your home but a package of personal protection you and your family need. And it's how we save you so much money: just ONE policy to issue instead of nine! You can build up to the cover you need by additional units

(or 1/2 units after the first) up to a maximum of five. So simple. So easy. Apply to your Broker, Agent or local office of a General Accident company. The Home Unit Policy can replace your existing insurances And remember - as you buy more possessions just add more Home Units at any time. *Quote Ref. 20/9468*

THE GENERAL ACCIDENT FIRE & LIFE ASSURANCE CORPORATION LTD

Metropolitan House, 35 Victoria Avenue,
Southend-on-Sea, Essex, SS2 6BT

It pays to be protected by a **General Accident** company

Please send me further particulars of the Home Unit Insurance.

Name.....

Address.....

20/9468

DENCO (CLACTON) LIMITED

355-7-9 OLD ROAD, CLACTON-ON-SEA, ESSEX

Our components are chosen by Technical Authors and Constructors throughout the World for their performance and reliability, every coil being inspected twice plus a final test and near spot-on alignment as a final check.

Our General Catalogue showing full product range	..	20p
DTB4 Transistor & Valve circuitry for D.P. Coils	..	20p
DTB9 Valve Type Coil Pack Application circuitry	..	20p
MD.1 Decoder Circuitry for Stereo Reception	..	21p

All post paid, but please enclose S.A.E. with all other requests in the interests of retaining lowest possible prices to actual consumers

VALENCE ELECTRONICS
THE FERRANTI SPECIALISTS
 TRANSISTORS-DIODES-I.C.'S-
 OPTO ELECTRONICS-FLASH TUBES
ZN414 RADIO I.C. £1.30
 RED L.E.D. BY HEWLETT-
 PACKARD PANEL

MOUNTING
WITH FREE CLIP 30p

BFS59	15p	ZTX504	43p
BFS60	20p	ZTX510	17p
BFS61	20p	ZTX530	21p
BFS96	15p	ZTX531	22p
BFS97	23p	ZTX550	17p
BFS98	20p	ZTX551	17p
ZTX107	9p		
ZTX108	8p		
ZTX109	11p		
ZTX212	14p		
ZTX213	14p		
ZTX214	15p		
ZTX300	12p		
ZTX301	13p		
ZTX302	17p		
ZTX303	14p		
ZTX304	21p		
ZTX310	9p		
ZTX311	10p		
ZTX312	10p		
ZTX313	11p		
ZTX314	13p		
ZTX320	31p		
ZTX330	15p		
ZTX331	16p		
ZTX382	13p		
ZTX383	15p		
ZTX384	18p		
ZTX450	17p		
ZTX451	17p		
ZTX500	12p		
ZTX501	13p		
ZTX502	17p		
ZTX503	14p		

DIODES

ZS120	8p
ZS121	10p
ZS122	13p
ZS123	16p
ZS124	18p
ZS140	25p
ZS141	43p
ZS142	33p
ZS170	10p
ZS171	13p
ZS172	16p
ZS174	17p
ZS176	23p
ZS178	38p
ZS270	11p
ZS271	16p
ZS272	18p
ZS274	19p
ZS276	26p
ZS278	37p

ZENERS

KSO30A	to
KS180A	
all at	19p

ALL PRICES FULLY INCLUSIVE
 P & P 10p. FREE OVER £2.
 MAIL ORDER ONLY FROM:
VALENCE ELECTRONICS, 2A CANAL
STREET, DROYLESDEN, LANCs.

Simple Short-Wave Receivers



by F. A. Baldwin

FOR ONLY
80p

P. & P. 6p

140 Pages (5½ x 8½ in)

TO DATA PUBLICATIONS LTD 57 Maida Vale London W9 1SN

Please supply..... copy(ies) of 'Simple Short Wave Receivers',

Data Book No. 19. I enclose cheque/crossed postal order for.....

NAME

ADDRESS

SMALL ADVERTISEMENTS

Rate: 4p. (9d) per word. Minimum charge 60p (12/-).
Box No. 10p (2/-) extra.

Advertisements must be prepaid and all copy must be received by the 4th of the month for insertion in the following month's issue. The Publishers cannot be held liable in any way for printing errors or omissions, nor can they accept responsibility for the *bona fides* of advertisers. (Replies to Box Numbers should be addressed to: Box No. —, *Radio and Electronics Constructor*, 57 Maida Vale, London, W9 1SN)

UNIQUE VHF KITS, 80 - 180 MHz. Receiver, tuner, converter. World wide sales. £4.50p. S.W. Kits also available. S.A.E. for literature. Johnsons (Radio C), Worcester, WR1 3QQ.

WORLD RADIO TV HANDBOOK 1974 £3.15. HOW TO LISTEN TO THE WORLD £2.00. Postage and VAT included. David McGarva, PO Box, 114, Edinburgh, EH1 1HP.

50 UNMARKED 2W ZENERS 50p. 25 unmarked tested 2W zeners 50p. 100 feet insulated copper aerial wire 50p, 100 yards £1.40. Selenium solar cells 12p. 4-digit magnetic counters 25p. 100 unmarked BZY88 zeners 50p, 1,000 £2.00. LED'S 20p. 1N4007 diodes 7p. Keyring lights 25p. A.C. adaptors, 6-7½-9V £2.50. J. Fulton, Derrynaseer, Dromore, Co. Tyrone, N. Ireland.

SERVICE SHEETS for Televisions, Radios, Transistors, Tape Recorders, Record Players, etc., from 5p. with free Fault Finding Guide. Catalogue 15p. Please send S.A.E. with all orders/enquiries. Hamilton Radio, 47 Bohemia Road, St. Leonards-on-Sea, Sussex. Telephone Hastings 29066.

CATALOGUE NO. 18, containing credit vouchers value 50p, now available. Manufacturers new and surplus electronic and mechanical components, price 23p post free. Arthur Sallis Radio Control Ltd., 28 Gardner Street, Brighton, Sussex.

BATTERY ELIMINATOR KITS. Our well-known Mini Mains Pack Kits now complete with drilled insulated base 32 x 55mm. Fits into space of most large transistor batteries. Easy wiring instructions. Safe; silent mains transformer, silicon rects., smoothing capacitor, all top grade. For any ONE of these voltages (stage which): 3V, 300mA max.; 6V, 180mA; 9V, 120mA; 18V, 60mA. £1.50, VAT INCLUSIVE. By mail only, U.K. post 5p. Amatnix Ltd., 396 Selndon Road, South Croydon, Surrey, CR2 0DE.

BUILD IT in a DEWBOX robust quality plastic cabinet 2 in. x 2½ in. x any length. S.A.E. for details. D.E.W. Ltd., 254 Ringwood Road, Ferdown, Dorset. Write now - right now.

DIRECT FROM MANUFACTURER - a comprehensive catalogue of UHF & VHF/FM aerials, fixing brackets, chimney lashings, clamps, masts, amplifiers, cable, etc., for the D.I.Y. enthusiast. Complete with useful installation hints. Send 3p stamp to Claydew Enterprises (REC), 261 Hardness Street, London S.E.24.

6" DIA 0-8A A.C./D.C. METER £1.25. Rechargeable cells 2V 400mA 45p. 50 unmarked AC128 60p. 1N4007 diodes 7p. 10 unmarked 2N3055 50p. 5 unmarked tested 2N3055 70p. 10 unmarked 2N3819 50p. 5 unmarked tested 2N3819 70p. Astrad solar radio £23.00. Milford electronic lighter £3.00. J. Fulton, Derrynaseer, Dromore, Co. Tyrone, N. Ireland.

(Continued on page 449)

BENTLEY ACOUSTIC CORPORATION LTD.

All prices inclusive of V.A.T.

The Old Police Station, Gloucester Road, LITTLEHAMPTON Sussex. PHONE 6743

0A2	.40	12AD6	.65	EA F42	.50	EL95	.39	PCL86	.47	UL41	.65	
0B2	.40	12AE6	.65	EA F801	.55	EL180	1.00	PD580	1.44	UL84	.38	
5U4G	.30	12AT6	.35	EB91	.15	EM80	.40	PEN45	.80	UM80	.44	
5V4G	.54	12AU6	.45	EBC41	.55	EM81	.40	PEN45DD	UY41	.40	UY85	.38
6X4	.38	12AV6	.40	EBC81	.35	EM83	.55	PL36	.55	X41	1.00	
6Z4C	.35	12BA6	.30	EBF80	.39	EM84	.40	PL82	.37	XC165	.28	
610J	.60	12BE6	.38	EBF83	.43	EM87	.68	PL81	.44	X66	.65	
6AH6	.50	12BH7	.27	EBF89	.30	EMM803		PL82	.37	XC165	.28	
6AU6	.30	12K5	.95	EC92	.45	EY85	.40	PL82	.37	AD140	.40	
6AV6	.33	14S7	.75	ECC33	1.50	EY81	.40	PL84	.33	AD145	.35	
6BA6	.28	19A05	.42	ECC35	.95	EY83	.54	PL508	.67	AD161	.50	
6BE6	.28	30C17	.90	ECC38	.28	EY87	.33	PL508	.90	AD162	.50	
6B6	.70	30F5	.85	ECC85	.36	EZ80	.24	PL509	1.15	AF114	.28	
6B6E	.28	30F11	.75	ECC88	.44	EZ81	.25	PL82	.37	AF115	.17	
6B6H	.70	30F12	.75	ECC88	.44	EZ81	.25	PL82	.37	AF121	.33	
6B7A	.50	30FL14	.85	ECC88	.44	EZ81	.25	PL82	.37	AF126	.20	
6BR7	.35	30FL15	.75	ECC88	.44	EZ81	.25	PL82	.37	BC107	.14	
6BR8	.85	30L17	.70	ECC88	.44	EZ81	.25	PL82	.37	BC108	.14	
6BW6	.85	30P12	.80	ECC88	.44	EZ81	.25	PL82	.37	BC109	.11	
6BW7	.66	30P19	.75	ECC88	.44	EZ81	.25	PL82	.37	BC113	.28	
6BZ6	.49	30PL1	.66	ECC88	.44	EZ81	.25	PL82	.37	BC118	.23	
6CA	.28	30PL13	.75	ECC88	.44	EZ81	.25	PL82	.37	BC211	.42	
6CL6	.55	30PL14	.80	ECC88	.44	EZ81	.25	PL82	.37	BF159	.28	
6CU5	.75	30PL18	.80	ECC88	.44	EZ81	.25	PL82	.37	BF163	.22	
6E1	1.00	30PL19	.80	ECC88	.44	EZ81	.25	PL82	.37	BF180	.33	
6F1	.70	35L6GT	.55	ECC88	.44	EZ81	.25	PL82	.37	BY100	.20	
6FG6	.50	35W4	.33	ECC88	.44	EZ81	.25	PL82	.37	BY126	.17	
6F8	.50	35Z0T	.42	ECC88	.44	EZ81	.25	PL82	.37	BY137	.20	
6F23	.85	35Z5GT	.40	ECC88	.44	EZ81	.25	PL82	.37	OA91	.10	
6F28	.70	50B5	.85	ECC88	.44	EZ81	.25	PL82	.37	OC23	.42	
6HG7	.18	50C5	.45	ECC88	.44	EZ81	.25	PL82	.37	OC24	.42	
6H6GT	.32	50L6GT	.65	ECC88	.44	EZ81	.25	PL82	.37	OC25	.42	
6K7G	.19	DAF91	.30	ECC88	.44	EZ81	.25	PL82	.37	OC44	.11	
6K8G	.35	DAZ31	.60	ECC88	.44	EZ81	.25	PL82	.37	OC45	.12	
6L6C	.58	DAF96	.44	ECC88	.44	EZ81	.25	PL82	.37	OC46	.17	
6G7G	.50	DF91	.30	ECC88	.44	EZ81	.25	PL82	.37	OC71	.12	
6G7G	.50	DF96	.44	ECC88	.44	EZ81	.25	PL82	.37	OC72	.12	
6V6G	.17	DK91	.38	ECC88	.44	EZ81	.25	PL82	.37	OC73	.17	
6G7G	.50	DK96	.55	ECC88	.44	EZ81	.25	PL82	.37	OC74	.25	
6X4	.30	DL92	.33	ECC88	.44	EZ81	.25	PL82	.37	OC75	.12	
6X5G	.28	EL36	.44	ECC88	.44	EZ81	.25	PL82	.37	OC78	.17	
7B6	.75	EL87	.60	ECC88	.44	EZ81	.25	PL82	.37	OC78D	.17	
7Y4	.65	EL91	.30	ECC88	.44	EZ81	.25	PL82	.37	OC81	.12	
9D7	.65	EL93	.30	ECC88	.44	EZ81	.25	PL82	.37	OC81D	.12	
10C2	.65	EL96	.30	ECC88	.44	EZ81	.25	PL82	.37	OC82D	.12	
10F1	.50	EL97	.30	ECC88	.44	EZ81	.25	PL82	.37	OC83	.22	
10F18	.55	EL98	.30	ECC88	.44	EZ81	.25	PL82	.37	OC84	.26	
12A6	1.00	EA30	.27	ECC88	.44	EZ81	.25	PL82	.37	OC202	.47	
12AC6	.65	EAB80	.30	ECC88	.44	EZ81	.25	PL82	.37			

All goods are unused and boxed, and subject to the standard 90-day guarantee. Terms of business: Cash or cheque with order only. Despatch charges: Orders below £5, add 10p per order up to three items, each additional item 3p extra. Orders between £5 and £10 add 25p total. Orders over £10 post free. Same day despatch by first class mail. Terms of business available on request. Any parcel insured against damage in transit for only 3p extra per order. Please enclose S.A.E. with all enquiries.

Learn to understand electronics for your hobbies

1. Lerna-Kit course

Step by step, we take you through all the fundamentals of electronics and show you how easily the subject can be mastered.

- (1) BUILD AN OSCILLOSCOPE.
- (2) READ, DRAW AND UNDERSTAND CIRCUIT DIAGRAMS.
- (3) CARRY OUT OVER 40 EXPERIMENTS ON BASIC ELECTRONIC CIRCUITS AND SEE HOW THEY WORK.

2. Become a Radio-Amateur

Learn how to become a radio-amateur in contact with the wide world. We give skilled preparation for the G.P.O. licence.

FREE

Brochure, without obligation to:
BRITISH NATIONAL RADIO & ELECTRONICS SCHOOL
P.O. BOX 156, JERSEY, CHANNEL ISLANDS.

NAME _____

ADDRESS _____

BLOCK CAPS PLEASE

PRECISION POLYCARBONATE CAPACITORS

Close tolerance. High stability. Extremely low leakage. All 63v D.C. Plus or minus 1% tolerance:

0.47 μ F - 56p; 1.0 μ F - 66p; 2.2 μ F - 80p; 4.7 μ F - £1.30; 6.8 μ F - £1.64; 10.0 μ F - £2.00; 15 μ F - £2.75.

Also available plus or minus 2% and plus or minus 5%, ex. Stock.

TANTALUM BEAD CAPACITORS

Values available: 0.1, 0.22, 0.47, 1.0, 2.2, 4.7, 6.8 μ F at 15v/25v or 35v; 10.0 μ F at 16/20v or 25v; 22.0 μ F at 6/10v or 16v; 33.0 μ F at 6v or 10v; 47.0 μ F at 3v or 6v; 100 μ F at 3v. All at 10p each; 10 for 95p; 50 for £4.00

TRANSISTORS: BC107, BC108, BC109; all at 9p each; 6 for 51p; 12 for 96p. May be mixed for quantity price. BC182 and BC212 at 10p each; AF178 at 30p each. All brand new and marked. Full spec. devices.

POPULAR DIODES: IN914 - 7p each; 8 for 50p; 18 for £1.00. IN916 - 9p each; 6 for 50p; 14 for £1.00. IS44 - 5p each; 11 for 50p; 24 for £1.00. All brand new and marked.

400mW ZENER DIODES: Values available 4.7, 5.6, 6.8, 7.5, 8.2, 9.1, 10, 11, 12, 13.5, 15 volts. All new and marked. All at 9p each; 6 for 50p; 14 for £1.00. SPECIAL 6 off each voltage (66 zeners) £4.25

RESISTORS: Carbon film 5% $\frac{1}{4}$ w at 40°C, $\frac{1}{2}$ w at 70°C. Range 2.2 Ω -2.2M Ω , E12 series i.e. 10, 12, 15, 18, 22, 27, 33, 39, 47, 56, 68, 82, and their decades. All at 1p each 8p for 10; 70p for 100 of any one value. Special pack 10 off each value 2.2 Ω to 2.2M Ω (730 resistors) for £5.00.

440v A.C. CAPACITORS: 01. μ F, size 1 $\frac{1}{8}$ in x $\frac{1}{2}$ in - 40p; 0.25 μ F (1 $\frac{3}{8}$ " x $\frac{5}{8}$ ") - 55p; 0.47 and 0.5 μ F (1 $\frac{3}{8}$ " x $\frac{3}{4}$ ") - 66p; 1.0 μ F (2" x $\frac{3}{4}$ ") - 85p; 2.0 μ F (2" x 1") - £1.15.

SILICON PLASTIC RECTIFIERS 1.5 amp. Brand new wire-ended DO27. 100 P.I.V. at 7p each; 4 for 26p. 400 PIV at 8p each; 4 for 30p; 800 PIV at 11p each; 4 for 42p.

7p Post and Packing on all orders below £5.00.

Export orders - please add cost of air/sea mail.

PLEASE ADD 10% V.A.T. TO ALL ORDERS

Send S.A.E. for lists of other ex-stock items, L.E.D's, disc capacitors, electrolytics etc. Wholesale price lists available to bona fide companies.

MARCO TRADING

Dept. C2, The Maltings, Station Road, WEM, Salop.
Tel: Nantwich (Cheshire) 63291

ERNIE



ERNIE

As described in R & E, NOV. 1973 MINICOMP 100 is a miniaturised ERNIE that gives purely RANDOM NUMBERS within four ranges:

- * 0-59 POOLS DRAWS
- * 1-36 ROULETTE
- * 1-6 DICE
- * 0-99 BINGO & NUMBER GAMES

Invent your own PARTY GAMES, and have your own rules! Case approx. 7in. x 5in. x 3in. Elegant Nylon finish in Blue or Grey. Silk aluminium panel.

240v. 50Hz. Mains operated or 110v. 60Hz.

U.K. PRICES

Minicomp 100 Kit: £42.50 Built and guaranteed units £45.00
All prices include VAT and p. & p.

TERMS: C.W.O. MAIL ORDER ONLY

Micro Electronics, 51 Mexfield Road,
London SW15 2RG

Tel: 01-870 2368

MICRO

NEW STYLE SELF-BINDER

for "The Radio Constructor"

The "CORDEX" Patent Self-Binding Case will keep your issues in mint condition. Copies can be inserted or removed with the greatest of ease. Rich maroon finish, gold lettering on spine.

Specially constructed Binding Cords are made from Super Linen of great strength, very hard twisted and twice doubled. They are attached to strong RUSTLESS Springs under tension, and the method adopted ensures PERMANENT RESILIENCE of the Cords. Any slack that may develop is immediately compensated for and the Cords will always remain taut and strong. It is impossible to overstretch the springs, as a safety check device is fitted to each.

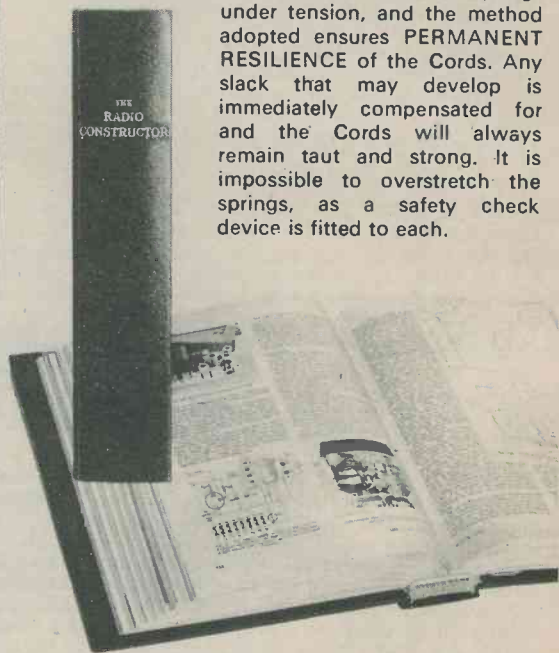

PRICE **90p** P. & P. 14p

including V.A.T.

Available only from:—

Data Publications Ltd.
57 Maida Vale London W9 1SN

SMALL ADVERTISEMENTS

(Continued from page 447)

BUILD THE MULLARD C.C. TV CAMERA. Complete kits now available from Crofton Electronics. Send large s.a.c. for details to: 15-17 Cambridge Road, Kingston-Upon-Thames, Surrey. Reply by post. No callers please.

CASSETTE RECORDER/RADIO BATTERY ELIMINATOR. Constructed in a neat plastic case, size 10 x 6 x 5.5cm. Contains a mains transformer and a transistor regulator giving 8V d.c. at 225mA with internal fuse, and 8V a.c. at 45mA. Circuit and details supplied £1.50 including p. & p. Mail order only. Chris Harries, 2 Newlands Avenue, Shirley, Southampton, SO1 5ER.

CHROMASONIC ELECTRONICS. New list 10p. post free. Data Dept., 56 Fortis Green Road, London, N10 3HN.

WORLD DX CLUB covers all aspects of SWLing on Amateur and Broadcast Bands through its monthly bulletin "Contact". Membership costs £1.60 a year. Enquiries to John Rush, 12 Northfield Road, Thatcham, Berks.

"FROM SEMAPHORE TO SATELLITE", 300-page hard-covered history with 1,000 illustrations, is sent to readers who send £1.99 from their Post Office to David McGarva (Giro account 17 412 0001).

WIDESCREEN CINE OUTFIT, comprising Zenoscope anamorphic lens; reconditioned Prince 9.5mm cine camera, with fitting for lens; widescreen viewfinder, rectangular lens hood; 5 cassettes of Kodachrome II unexposed film; widescreen lens holder for projector and 60 x 30 inch widescreen projection screen. 9.5mm cine camera, reconditioned in leather case. Four super-8, 100 ft. cine film reels in plastic case. For sale or exchange. W.H.Y? Box No. G223.

FOR SALE: Digital frequency counter/timer. Home constructed, for use with Rx's/Tx's, etc. up to 20MHz. Hardly used. £45.00. Knowlman, Bartletts, Culmstock, Cullompton, Devon.

JOIN THE INTERNATIONAL S.W. LEAGUE. Free services to members including Q.S.L. Bureau, Amateur and Broadcast Translation, Technical and Identification Dept. - both Broadcast and Fixed Stations, DX Certificates, contests and activities for the SWL and transmitting members. Monthly magazine, *Monitor*, containing articles of general interest to Broadcast and Amateur SWLs, Transmitter Section and League affairs, etc. League supplies such as badges, headed notepaper and envelopes, QSL cards, etc., are available at reasonable cost. Send for League particulars. Membership including monthly magazines, etc., £2.00 per annum. (U.K. and British Commonwealth), overseas 6 Dollars or £2.50. Secretary ISWL, 1 Grove Road, Lydney, Glos., GL15 5JE.

ULTRASONIC transmitter and receiver £4.50. Capacitors, 1600µF/64V, 2000/50, 5000/30, 40p; 2500/30, 1500/30, 20p. Satellite ornamental lamp £6.00. Disposable torches 40p. Blank cassettes, C60 35p, C90 50p, C120 65p. Battery wall lamps £1.00. J. Fulton, Derrynaseer, Dromore, Co. Tyrone, N. Ireland.

POSTAL ADVERTISING? This is the Holborn Service. Mailing lists, addressing, enclosing, wrapping, facsimile letters, automatic typing, copy service, campaign planning, design and artwork, printing and stationery. Please ask for price list. - The Holborn Direct Mail Company, Capacity House, 2-6 Rothsay Street, Tower Bridge Road, London, S.E.1. Telephone: 01-407 1495.

ANTIQUÉ WIRELESS MARK III crystal tuner (World War I vintage) wanted. Have for trade U.S. Army World War I BC-14A crystal set, National SW-3 and other equipment. L.W. Elias, W4DBT, 3919 Pointdexter Drive, RFD8, Winston-Salem, N.C. 27106. U.S.A.

(Continued on page 451)



MULTIMETER Model 200h
20,000 ohm/volt **£5.28**



4 1/2" x 3 1/2" Meter
30uA, 50uA
or 100uA
£3.00

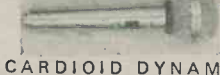

CARDIOID DYNAMIC MICROPHONE Model UD-130 Frequency response 50-15,000 cps. Dual Impedance 50K & 600 ohms **£4.95**



MULTIMETER Model C-7081GN Range Doubler
50,000 ohm/volt High Sensitivity Meter **£12.37**



Small **DYNAMIC MICROPHONE** as pictured or similar with remote on/off switch **£1.27**

Large S.A.E. for List No. 6. Special Prices for quantity quoted on request. Add 10p for P&P on orders under £5.

M. DZIUBAS
158 Bradshawgate, Bolton, BL2 1BA, Lancs.
All above prices include 10% V.A.T.
All items advertised in previous numbers of this magazine still available.

NOW! A FAST EASY WAY TO LEARN BASIC RADIO & ELECTRONICS

Free book shows you how to learn basic Radio and Electronics at home—the fast, modern way. Give yourself essential technical "know-how"—like reading circuits, assembling standard components, experimenting, building—quickly and without effort, and enjoy every moment. B.I.E.T.'s simplified home study method and the remarkable **TECHNATRON Self-Build Outfit** take the mystery out of the subject, making learning easy and interesting.

- | | | | |
|---|--|--|--------------------------|
| General Radio and T.V. Engineering | Television Maintenance & Servicing | Radio servicing, maintenance & repairs | <input type="checkbox"/> |
| Colour T.V. | Practical T.V. | Electronic engineering | <input type="checkbox"/> |
| Radar Technology | Applied Electronics | Radio Amateurs | <input type="checkbox"/> |
| Practical Radio and Electronics | Elementary Electronics Course for (Technatron) Radio | Elementary Physics Course for Radio | <input type="checkbox"/> |
| City and Guilds Radio and T.V. Electrical Mech. | | | |

BRITISH INSTITUTE OF ENGINEERING TECHNOLOGY
Dept. BRE 30, Aldermaston Court, Reading RG7 4PF

POST THIS COUPON FOR FREE BOOK

Accredited by C.A.C.C.

Member of A.B.C.C.

BRE 30

NAME..... AGE.....

ADDRESS.....

SUBJECT OF INTEREST.....

BRITISH INSTITUTE OF ENGINEERING TECHNOLOGY

PLAIN-BACKED NEW STYLE SELF-BINDERS

The "CORDEX" Patent Self-Binding Case will keep your copies in mint condition. Issues can be inserted or removed with the greatest of ease. Specially constructed Binding cords are made from Super Linen of great strength, very hard twisted and twice doubled. They are attached to strong RUSTLESS Springs under tension, and the method adopted ensures PERMANENT RESILIENCE of the Cords. Any slack that may develop is immediately compensated for, and the Cords will always remain taut and strong. It is impossible to overstretch the springs, as a safety check device is fitted to each.

PRICE **85p** P. & P. 14p

Available only from:—

Data Publications Ltd. 57 Maida Vale London W9 1SN

for your other magazines
(max. format 7½" x 9½")

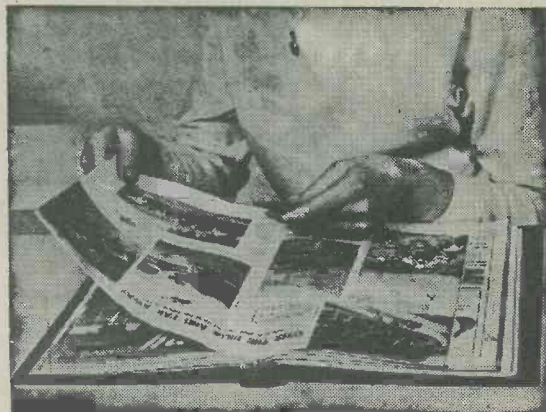

COLOURS: MAROON OR GREEN

(If choice not stated, colour available will be sent)

RADIO MODELLER

ELECTRONIC BOOKS



● MODEL RADIO CONTROL

Detailing both Theory and Practice, this book, by leading authority Paul Newell, will become the standard reference work. A brief historical survey leads up to a detailed description of proportional systems, with over 100 illustrations, including theoretical circuits and p.c. layouts for an advanced digital system.

134 pages. Price £2.25 U.K. Postage 13p

● SINGLET SET

The Singlet Transmitter, Superhet and Super-regen receivers, are now all three available in one book. Complete construction details with full size p.c. layout, components list etc. Ideal introduction to the hobby for the home constructor. 20 pages.

Price 30p. U.K. Postage 3p

● LOW COST PROPORTIONAL

Modellers who want to save money buy this volume when converting single channel equipment to simple proportional. They find a wealth of really up to date information in the clear descriptions, full size practical and working drawings, plus over a dozen circuit modules for pulse proportional units.

Price £1.05 U.K. Postage 11p



ON SALE NOW at all leading shops or direct from:—

RADIO MODELLER, BOOK SALES, 64 Wellington Road, Hampton Hill, Middx.

SMALL ADVERTISEMENTS

(Continued from page 449)

"MEDIUM WAVE NEWS" Monthly during Dx season - Details from: K. Brownless, 7 The Avenue, Clifton, York.

WANTED DEAD OR ALIVE! Cheap SW receiver. Contact: Electronics Club, Monks Dyke High School, Louth, Lincs.

WANTED: Anyone who can fit 60 c/s movements to two 50 c/s clocks, one a clock radio. Reasonable pay. Green, 70 North Side, Wandsworth Common, London S.W.18.

OPENSHAW TECHNICAL COLLEGE, Whitworth Street, Manchester, M11 2WH. Evening courses for radio experimenters, including radio, electronics and model control. All facilities available including professional instruction. For further details telephone 061-223-8282.

MAGNIFIERS: Ideal for the inspection of printed circuit boards, etc. S.A.E. for list to Revor Optical & Technical, 36 Baker Street, London W1M 1DG.

RECITALS OF RECORDED MUSIC. The second Saturday evening of each winter month. Next recital: February 9th, 1974, 8 p.m. at Woodford Green United Free Church, Woodford Green, Essex. Bus routes 20, 20A, 179 and 275 - alight at "The Castle" stop.

BEGINNERS. A new inexpensive course in electronics with the beginner in mind. All components for 22 carefully graded experiments plus a comprehensive instruction booklet. No soldering required. Send £3 to ELECTROLERN, Lyburn Lodge, Nomansland, Wiltshire, SP5 2BP. Post & package 12p. S.A.E. for details of our other instruction and constructional kits.

FREQUENCY LIST TRANSFERS. We have a limited supply of sheets of Dial Frequency Transfers in black. Short Wave frequencies 1.8Mc/s to 32Mc/s and 144Mc/s and 146Mc/s. Includes amateur band marker frequencies at 100kc/s points and other short wave frequencies from 2 to 32Mc/s at every 500kc/s points. Each frequency is repeated. Two sheets for 5p. five sheets for 10p. postage 3p. Data Publications Ltd., 57 Maida Vale, London W9 1SN.

PERSONAL

JANE SCOTT FOR GENUINE FRIENDS. Introductions to opposite sex with sincerity and thoughtfulness. Details free. 3p stamp to: Jane Scott, 50/CON Maddox Street, London W1R 0LY.

IF YOU HAVE ENJOYED A HOLIDAY on the Norfolk Broads, why not help to preserve these beautiful waterways. Join the Broads Society and play your part in determining Broadlands future. Further details from:- The Hon. Membership Secretary, The Broads Society, "Icknield", Hilly Plantation, Thorpe St. Andrew, Norwich, NOR 85S.

ESSEX GARDENERS. Buy your bedding and rock plants, shrubs, etc., also cacti from May's Nurseries, 608 Rayleigh Road, Hutton, Brentwood, Essex. Callers only. Monday to Saturday.

SPONSORS required for exciting scientific project. Norwich Astronomical Society are building a 30" telescope to be housed in a 20' dome of novel design. All labour being given by volunteers. Already supported by Industry and Commerce in Norfolk. Recreational. Educational. You can be involved. Write to: NAS Secretary, The Manse, Back Lane, Wymondham, Norfolk.

FEBRUARY, 1974

ESSENTIAL BOOKS

HOW TO MAKE WALKIE-TALKIES FOR LICENSED OPERATION. 40p p.p. 10p.

HOW TO MAKE 2 & 4 METRE CONVERTERS FOR AMATEUR USE. 60p p.p. 15p.

MOBILE RADIO-TELEPHONE EQUIPMENT HANDBOOK. Gives circuits, data and illustrations plus some valuable modifications for commercial radio-telephone equipment including PYE and other popular makes. Includes modifications for amateur use. £4 including postage.

THE GOVERNMENT SURPLUS WIRELESS EQUIPMENT HANDBOOK. Gives circuits, data and illustrations plus valuable information for British/USA receivers, transmitters, trans/receivers. With modifications to sets and test equipment. Latest impression £3.25 including postage.

DIRECTORY OF GOVERNMENT SURPLUS WIRELESS EQUIPMENT DEALERS. Gives details of surplus wireless equipment stores and dealers including addresses, plus equipment and spares that they are likely to have available. A valuable book only 40p. p.p. 10p.

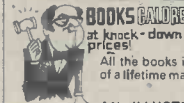

All the books in this section are at greatly reduced prices and are bargains of a lifetime making ideal gifts.

AN ILLUSTRATED ENCYCLOPAEDIA OF BALLOONING. This remarkable book is the result of several years research into aeronautical literature. A beautiful book size 13" x 10" with nearly 200 pictures 20 of which are in colour. Makes an ideal gift. Published at £6.30. Knock down price £3.50. p.p. 50p.

THE FAMILY LAWYER. Provides a volume of answers to everyday problems. 750 pages fully illustrated concentrating on matters that affect the layman. Includes every conceivable aspect of the law. Published at £6.50. Knock down price £3.50. p.p. 50p.

THE THEORY OF GUIDED ELECTROMAGNETIC WAVES. The most comprehensive book yet written about: waveguides, transmission lines, cavity resonators. Over 500 pages. Ideal for anyone interested in Radar & UHF. Published at £11.50. Knock down price £4. p.p. 50p.

THE SCATTERING AND DIFFRACTION OF WAVES. A goldmine of information for the experimenter, amateur and scientist. Profusely illustrated. Published by Oxford University Press at £1.60. Knock down price 80p. p.p. 20p.

PRINCIPLES OF ELECTRICITY AND MAGNETISM. Page & Adams. An important book for the student, electronics engineer and technician who wishes to improve his basic knowledge. 532 pages. Hardback. Fully illustrated. Published at £4.50. Knock down price £1.50. p.p. 25p.

SECOND BOOK OF TRANSISTOR EQUIVALENTS & SUBSTITUTES. Just published. Over 58,000 entries. Includes British, USA and Japanese transistors. Price 95p post free.

HANDBOOK OF SATELLITES AND SPACE VEHICLES. A comprehensive working handbook that provides important data both tabular and graphical enabling space scientists, technicians and telecommunication engineers to acquire a greater working knowledge of satellite and space vehicle design, launching, orbiting etc. Includes a detailed coverage of COMMUNICATIONS IN SPACE. An imposing book of 457 pages. Published at £8.20. Available at the trade price of £6.50 post free.

PERSONAL CALLERS WELCOME AT NEW SHOWROOMS & TRADE COUNTER. 138 Cardigan Rd. Headingley, Leeds 6. The North's largest selection of Radio and Electronics Books, plus thousands of books on all subjects at discount prices.

All mail order to Dept. R.C. Gerald MYERS (Bookseller & Publisher), 18 SHAFTESBURY STREET, LEEDS LS12 3BT.

Callers welcome to new showroom address shown in advert.

TECHNICAL TRAINING

Get the qualifications you need to succeed. Home study courses in Electronics and Electrical Engineering, Maintenance, Radio, TV, Audio, Computer Engineering & Programming. Also self build radio kits. Free details from:- International Correspondence Schools, Dept. 733D, Intertext House, London. SW8 4UJ.

MORSE MADE EASY!!!

FACT NOT FICTION. If you start RIGHT you will be reading amateur and commercial Morse within a month. (Normal progress to be expected.) Using scientifically prepared 3-speed records you automatically learn to recognise the code RHYTHM without translating. You can't help it, it's as easy as learning a tune. 18-W.P.M., in 4 weeks guaranteed. Complete course, 3 Records and Books, £4.50. P.P.I. etc. plus 10%. (Overseas £1 extra). Or details only, 4p. stamp. Or phone S. Bennett, G3HSC, 01-660 2896.

Box 38, 45 GREEN LANE, PURLEY, SURREY.

SYNTHESISER MODULES

Voltage-controlled modules for synthesiser construction and other musical MIRACLES! Catalogue 15p. D.E.W. Ltd., 254 Ringwood Road, Ferndown, Dorset.

MASSIVE CLEARANCE BARGAINS

Bargain component parcels contain Resistors, Capacitors, Potentiometers, Knobs, Rotary, Slide, Key Switches, IF's, Tag Strips, Drive Drums, Springs, Handles, Coil Formers, Wire, Grommets, Relays, Pulley Wheels, Magnets, Transistor Panels etc., etc. Save yourself £s on these well selected parcels 6lbs net weight £1.00, p. p. 40p. Brand new Wire-wound Resistors, 1-7 Watts. Good Selection, 100 for £1 p. p. 15p.

Assorted Computer Panels. These panels are exceptionally good value and contain a minimum of 75 transistors, stacks of diodes plus Trim Pots, Polyester Capacitors, and include a few I.C.s. 10 panels for £1.00, p. p. 27p.

Mullard Ferrite Cores. LA3 50p. LA4 75p. LA2100 50p.

Assorted Electrolytic Capacitors. 6lbs net weight £1.00, p. p. 40p.

Assorted Capacitors, Silver Mica, Tubular and Disc Ceramics, Polystyrene. Tremendously good selection. 300 for £1. p. p. 20p.

Please include 10% V.A.T. to total cost of goods.

MAIL ORDER ONLY
XEROZA RADIO
 1, EAST STREET,
 BISHOPS TAWTON,
 DEVON

RING BOARD with I.C. Add-On



RING BOARD a new concept in standard P.C. boards. No cutting very little looping and no messy chemicals. Full details of method with each board purchased. Two types of I.C. Add-On available.

S.A.E. with enquiries please

FULL BOARD 55p

HALF BOARD 33p

all POST FREE

QUARTER BOARD 22p

I.C. Add-On 25p

RING BOARD (REC 3)
 259 Chesterfield Road,
 Sheffield S8 0RT. Tel. 0742 52178
 ENGLAND

**INTERNATIONAL
 SHORT
 WAVE
 LEAGUE**



Membership £2.00 per annum (U.S.A. \$6.00) including 12 monthly issues of *Monitor* — the League journal. Including free use of all Services, QSL Bureau etc.

**THE LARGEST S.W.L. ORGANISATION
 IN THE WORLD**

For full details write to:

**The Secretary,
 I.S.W.L.,
 1, GROVE ROAD, LYDNEY,
 GLOS. GL15 5JE.**

DATA BOOK SERIES

- DB5 TV FAULT FINDING**
 New edition in course of preparation.
- DB6 RADIO AMATEUR OPERATOR'S HANDBOOK**
 80 pages. Price 45p, postage 6p.
- DB16 RADIO CONTROL FOR MODELS**
 192 pages. Price 75p, postage 10p.
- DB17 UNDERSTANDING TELEVISION**
 512 pages. Price £2.10, postage 25p.
- DB18 AUDIO AMPLIFIERS**
 128 pages. Price 53p, postage 6p.
- DB19 SIMPLE SHORT WAVE RECEIVERS**
 140 pages. Price 80p, postage 6p.

I enclose Postal Order/Cheque for..... in payment for.....

NAME

ADDRESS

(BLOCK LETTERS PLEASE)

Postal Orders should be crossed and made payable to Data Publications Ltd,

Overseas customers please pay by International Money Order.

All publications are obtainable from your local bookseller.

Data Publications Ltd., 57 Maida Vale, London W9 1SN

PLEASE MENTION THIS MAGAZINE WHEN WRITING TO ADVERTISERS

WAVELENGTH-FREQUENCY TABLE II

The Table lists radio frequencies of wavelengths from 73 to 300 metres and completes the information which commenced in the previous Data Sheet. Use the appropriate factor for wavelengths in other decades; thus, 790 metres corresponds with 0.378MHz (= 378 kHz)

Wavelength (metres)	Frequency (MHz)	Wavelength (metres)	Frequency (MHz)	Wavelength (metres)	Frequency (MHz)	Wavelength (metres)	Frequency (MHz)
73	4.11	85	3.52	97	3.09	190	1.58
74	4.05	86	3.49	98	3.06	200	1.50
75	4.00	87	3.45	99	3.03	210	1.43
76	3.95	88	3.41	100	3.00	220	1.36
77	3.89	89	3.36	110	2.73	230	1.30
78	3.84	90	3.33	120	2.50	240	1.25
79	3.78	91	3.30	130	2.30	250	1.20
80	3.75	92	3.26	140	2.14	260	1.15
81	3.70	93	3.22	150	2.00	270	1.11
82	3.66	94	3.19	160	1.87	280	1.07
83	3.61	95	3.16	170	1.76	290	1.03
84	3.57	96	3.13	180	1.67	300	1.00

Henry's

**DONT RELY ON YOUR MEMORY
BUY NOW AT BARGAIN PRICES**
Order your latest Henry's Catalogue Price 55p post paid
complete with Discount Vouchers

Henry's
Catalogue



You pay less
VAT with Henry's
Low Prices

BUILD THE TEXAN

**20 + 20 WATT IC
STEREO AMPLIFIER**

As featured by
Practical Wireless
1972



Now built and used by thousands of satisfied customers. Features slim design overall size in cabinet 152" x 24" x 6 1/2". 6-IC's, 10 transistors, stabilisers, Gardners low field transformer. Fibre Glass PC panel, complete chassis work. Now available built and tested as well as in kit form. HIGH QUALITY & STABILITY ARE PREDOMINATE FEATURES - DEVELOPED BY TEXAS ENGINEERS FOR PERFORMANCE. RELIABILITY AND EASE OF CONSTRUCTION FACILITIES. On/off switch indicator, headphones socket, separate treble, bass, volume and balance controls, scratch and rumble filters, mono/stereo switch, input selector: Mag. P.U. Radio Tuner. Aux. Can be altered for Mic., Tape, Tape-head etc. Constructional details Ref. No. 21 30p. Distributed by Henry's throughout UK. FREE - Teak cabinet with complete kit.

KIT PRICE £28.50 (+VAT 50p carr./packing) or built and tested **£35.00 (+VAT 50p carr./packing)** as illustrated

EARN YOURSELF EASY MONEY, WITH PORTABLE DISCO EQUIPMENT

- DISCO MINI A complete portable disco, fitted mixer/preamp, 2 decks, all facilities. £98.50
- As above but with Slider Controls £118.50
- 100 watt amplifier for above £42.50
- SDLS 100 watt mixer/amplifier with slider controls £69.00
- R50 50 watt mixer/amplifier £49.50
- K100 100 watt mixer amplifier £57.50
- DISCO AMP 100 watt mixer/amplifier chassis unit £73.00
- DISCO MIXER/PREAMPLIFIERS (OP for up to 6-100 watt amplifiers)
- SD11 (rotary controls) £49.50
- SD11 (slider controls) £58.50
- DISCO VOX (slider controls) the complete disco pre-amp £72.00
- DJ100 100 watt power amplifier for above £49.50
- DJ30L 3 channel 3kw sound to light £36.00
- DJ40L as 30L plus built in microphone £47.50
- DIMAMATIC 1 kW adjustable speed auto dimmer £25.00
- Carisbro Reverboration Unit £44.00
- SCENE STROBE £19.00. ROAD STROBE £25.00
- SUPER STROBE £45.00
- Disco anti-feedback microphone £11.95
- Coit 150 watt liquid wheel projector £22.50
- 150 watt Q1 liquid wheel projector £50.00
- 150 watt Q1 and Liquid cassette wheel projector £50.00
- Spare Effects cassettes large range of patterns £6.00
- 6" Liquid wheels £5.00
- Mini spot bank fitted 3 lamps £12.95
- Auto Trilite (mini with flashers) £17.00
- Bubblemaster with 1 gall. liquid Mixer/Mics/Speakers/Lighting UK's largest range U.K.'s largest range of Disco lighting £41.15
- FREE stock list ref. No. 18 on request.

AKG/RESLO DJ/CARLSBRO EAGLE MICS, STANDS, MIXERS, CABINETS, CHASSIS & COMPLETE SPEAKER SYSTEMS, MEGAPHONES, TURNTABLES, PUBLIC ADDRESS COMPONENTS.

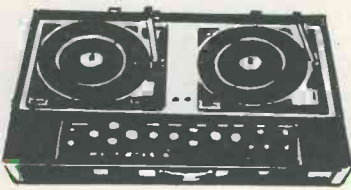

All prices carr. paid (UK) (VAT EXTRA)
Barclaycard/Access, call, write or phone your order 01-723 6963 — easy terms for callers.

TEXAN STEREO SYSTEM

PLUS PRICE SAVINGS



The Texan Stereo Systems include the high quality Texan Stereo amplifier assembled and ready to use. A pair of Type 200 20 watt Speaker-Tweeter systems size 21" x 12" x 10" and a choice of Garrard players built into a plinth with cover with Goldring G800 magnetic cartridge. System 25 uses Garrard SP25 Mk III and system 76 the Garrard AP76 de luxe turntable. All necessary leads are supplied.

System 25 (list approx. £109) £79.50
System 76 (list approx. £117) £89.50
(plus 10% VAT and stock £1.45 carr./packing)

Barclaycard/Access, call, write or phone, your order 01-402 4736
EASY TERMS FOR CALLERS

FREE LISTS

- 36 TRANSISTOR IC'S
- 14 100 KITS TO BUILD
- 17 HI FI TAPE GEAR
- 2 TRANSISTOR RADIO TO BUILD

BUILD THE NEW HENELEC STEREO FM TUNER

A completely new high stability stereo FM tuner. Features variable capacity diode tuning, stabiliser power supply, IC Decoder, high gain low noise, IF stages, LED indicators. Tuning meter, AFC, easy to construct and use. Mains operated. Slim modern design with fibre glass PC. Teak cabinet, etc. Available as a kit to build or ready built. Overall size 8" x 22" x 6 1/2". Produced to give high performance with a realistic price. (Parts list and constructional details Ref. No. 5 30p.) Henry's are sole distributors UK and Europe

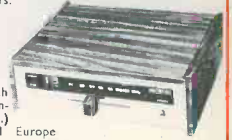

KIT PRICE **£21.00 (+VAT)**
or built and tested **£24.95 (+VAT)**

LIVING SOUND LOW NOISE TOP QUALITY CASSETTES MADE BY EMI TAPES LTD. TO INTERNATIONAL STANDARDS ESPECIALLY FOR HENRY'S. ALL POST PAID LESS THAN REC. PRICES. COMPLETE WITH LIBRARY CASES.

	3 for	6 for	10 for	25 for
C 60	£1.00	£1.80	£2.80	£6.75
C 90	£1.33	£2.57	£4.20	£10.25
C 190	£1.62	£3.15	£5.00	£12.25

Quantity and trade enquiries, invited.
LEARN A LANGUAGE — complete with phrase book. German — French — Spanish — Italian £1.36 per course. £5 for any 4.



LOW COST HI-FI SPEAKERS

SPECIAL OFFERS
EMI 12" x 8" — full range speakers (post 20p each or 30p pair)
*150TC — 8 ohms Twin Cone 10 watt £2.20 each or £4.00 pair.
*450 10 watt C/o Twin Tweeters 3, 8 or 15 ohms £3.50 each or £6.90 pair.
EW 15 watt 8 ohms C/o Tweeter £4.30 each or £7.90 pair.
350 20 watt C/o Tweeters, 8 or 15 ohms £7.50 each or £14.20 pair.
* Polished wood cabinet £4.80 post 35p.



SPEAKER KITS (carr. etc. 35p)

20-2	30 watt	£10.00 each
20-3	40 watt	£15.00 each
LINTON 2	20 watt	£15.95 pair
GLENDALE 3	30 watt	£28.95 pair
DOVEDALE 3	30 watt	£42.00 pair
KEF KK2		£20.40 each
KEF KK3		£32.00 each

BUILD YOURSELF A POCKET CALCULATOR

A complete kit, packaged in a polystyrene container and taking about 3 hours to assemble — that's the Sinclair Cambridge pocket calculator from Henry's. Some of the many features include interface chip, thick-film resistor pack, printed circuit board, electronic components pack. Size 4 1/2" long x 2" wide x 1 1/2" deep. Free of charge with the kit for the more advanced technologist is a 32-page booklet explaining how to calculate Logs, Tangents, Sines etc.



PRICE **£24.95 + VAT**
Also available assembled **£27.20 + VAT**
ready for use

SUPER TESTER 680R— The complete testing system

Volts AC — 11 ranges from 2V to 2500V
Volts DC — 13 ranges from 100mV to 2Kv
Amp DC — 12 ranges from 500A to 10A
Amp AC — 10 ranges from 200uA to 5A
Ohms — 6 ranges from one tenth of Ohm to 100MQ
Reactance — 1 range from 0 to 10MQ
Capacity — 6 ranges from 0 to 500pF and from 0 to 0.5uF and from 0 to 50.000pF
Frequency — 2 ranges from 0 to 500Hz and from 0 to 5000Hz
Output Voltage — 9 ranges 10V to 2500V
Decibels — 10 ranges from —24 to +70dB

price
£18.50

Accessories

Transistor tester	£11.00
Electronic Voltmeter	£18.00
Ampclamp	£11.95
Temperature probe	£11.95
Gauss meter	£11.95
Signal Injector	£5.95
Phase Sequence	£5.95
EHT Probe	£5.95
Shunts	
25/50/100A	£4.50 each

10% VAT to be added to all orders. Export supplied Prices and descriptions correct at time of proof. E & O E.

Henry's RADIO LIMITED

EDGWARE ROAD, W2

404-406 Electronic Components and Equipment 01-402 8381
354-356 High Fidelity and Tape Equipment 01-402 5854/4736
309 PA-Disco-Lighting High Power Sound 01-723 6963
303 Special offers and bargains store
All mail to 303 Edgware Road, London W2 1BW

Open - 9 am-6 pm
6 days a week
(309 closed
Thursday)
All stores open
all day Saturday