

# THE RADIO CONSTRUCTOR

Vol. 23 No. 4

NOVEMBER 1969

THREE SHILLINGS

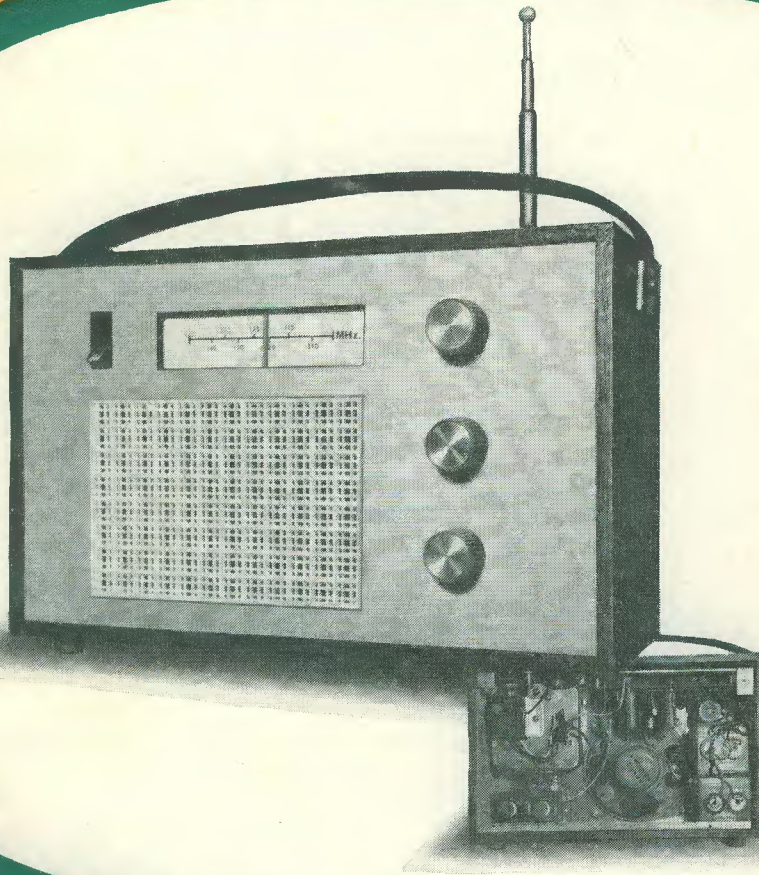

The  
"Airlane"  
7-Transistor  
Aircraft  
Band  
Receiver  
108-140 MHz

**FEATURED  
IN THIS ISSUE**

Miniature Radio 2 Receiver  
Suppressed-Zero Voltmeter

# L.S.T. ELECTRONIC COMPONENTS LTD.

AA119	2/-	BC142	15/-	BY225	31/9	NKT217	13/-	OC24	10/-	2G302	3/9	2N2369	5/6
AA111	21	BC143	15/-	BY242	3/9	NKT218	5/3	OC25	12/-	2G303	5/6	2N2369A	5/6
AA122	17/6	BC144	4/7	BY210	9/-	NKT219	5/6	OC26	12/-	2G304	5/6	2N2423	5/6
AC107	14/6	BC146	3/3	BY212	4/-	NKT222	4/-	OC28	12/-	2G381	5/6	2N2427	18/-
AC126	6/6	BC149	4/7	BY213	5/-	NKT223	6/-	OC29	15/-	2G372	4/-	2N2484	14/-
AC137	6/6	BC154	12/-	C106F1	9/-	NKT224	3/6	OC30	9/6	2N378	8/6	2N2485	10/-
AC127Z	8/6	BCY10	7/6	C111	18/-	NKT224	4/-	OC36	13/-	2N174	24/-	2N2614	7/6
AC138	4/6	BCY12	3/6	C14E	12/-	NKT225	3/6	OC41	4/-	2N352	12/-	2N2646	10/-
AC151	8/6	BCY30	7/2	C400	9/-	NKT226	10/-	OC42	4/-	2N109	13/6	2N2894	13/9
AC176	7/6	BCY71	9/2	C426	8/3	NKT227	5/6	OC43	4/-	2N217	7/6	2N2904A	5/6
AC187	12/-	BCY92	20/5	CA4E	4/-	NKT228	4/-	OC44	4/-	2N352	12/-	2N2904B	5/6
AC188	12/-	BCY33	4/11	CG63	2/-	NKT261	4/3	OC45	3/-	2N386	13/-	2N2925	5/6
AC117	3/9	BCY71	6/6	D133	10/-	NKT270	3/6	OC70	3/-	2N384	17/-	2N3036	30/2
AC118	3/9	BCY38	3/6	E403	3/6	NKT271	5/1	OC71	3/-	2N385A	15/-	2N3053	8/6
AC119	4/5	BCY39	28/-	EC401	5/-	NKT272	5/1	OC72	4/6	2N388A	15/-	2N3054	15/-
AC230	3/7	BCY40	18/-	EC402	4/8	NKT273	4/-	OC73	3/-	2N359	15/-	2N3055	15/-
AC221	4/-	BCY42	4/-	EB383	3/6	NKT274	5/-	OC75	4/6	2N454A	4/2	2N3056	15/-
AC222	3/11	BCY43	4/-	GET102	6/-	NKT275	5/-	OC76	2/6	2N410	6/-	2N3702	3/6
ACY30	9/-	BCY54	17/4	GET103	4/6	NKT276	3/6	OC77	9/3	2N456A	20/-	2N3703	3/3
AD140	15/-	BCY70	4/4	GET104	5/3	NKT279A	2/6	OC81D	3/-	2N458A	33/-	2N3704	3/9
AD149	11/8	BCY72	8/8	GET105	8/-	NKT281	5/-	OC81	4/6	2N511A	30/3	2N3705	3/4
AD161	6/-	BCY74	4/8	GET114	4/-	NKT281	5/-	OC82	4/6	2N513A	118/6	2N3706	3/10
AD162	6/-	BCY87	86/9	GET875	6/-	NKT302	11/2	OC83	2/-	2N514B	192/-	2N3707	4/-
ADT140	12/6	BD123	13/6	GEM451	4/-	NKT303	10/2	OC83	4/6	2N559	9/-	2N3708	5/6
AF102	18/-	BD119	15/-	GMO250	13/5	NKT304	9/8	OC84	4/6	2N601	5/-	2N3709	3/9
AF114	4/4	BD121	18/6	GMO378	11/-	NKT351	8/-	OC123	7/-	2N657	15/4	2N3710	3/10
AF115	4/4	BD123	23/6	GK4511	4/-	NKT352	7/6	OC139	3/9	2N696	5/3	2N3711	3/3
AF116	4/4	BD124	15/-	K815	4/-	NKT402	24/-	OC140	12/-	2N697	5/3	2N3819	8/-
AF117	4/4	BF123	13/6	K830	9/-	NKT403	16/-	OC149	6/-	2N698	4/6	2N3820	18/9
AF118	16/6	BF124	9/-	K350	8/3	NKT404	13/8	OC150	6/-	2N706	3/6	2N3821	18/9
AF124	6/-	BF159	15/-	MAT100	5/-	NKT405	15/-	OC171	6/-	2N706A	3/6	2N3906	7/6
AF126	3/9	BF163	3/9	MAT101	5/6	NKT451	13/8	OC200	6/-	2N710	6/-	2N3908	7/9
AF127	4/-	BF167	6/6	MAT120	5/-	NKT452	13/4	OC201	10/-	2N711	7/6	2N4284	3/6
AF139	8/-	BF173	6/2	MAT121	5/6	NKT453	12/-	OC202	18/10	2N711A	7/6	2N4285	3/-

PRICES FOR QUANTITIES IN EXCESS OF 100 PIECES ON APPLICATION

## FIRST GRADE + FAST SERVICE

When enquiring for types not listed please enclose a STAMPED ADDRESSED ENVELOPE

AF181	12/-	BF178	14/-	ME4102	6/-	NKT674	6/-	OC203	8/3	2N715	7/6	2N4286	3/-
AF186	11/-	BF179	14/-	MES520	15/-	NKT675	6/-	OC204	8/3	2N716	7/6	2N4287	3/-
AF239	12/-	BF180	6/-	MPF102	9/-	NKT676	5/-	OC205	10/6	2N718	7/3	2N4288	3/-
AF211	14/-	BF181	7/6	MPF103	9/-	NKT677	5/-	OC206	10/6	2N743	5/-	2N4289	3/-
AF212	11/9	BF184	7/6	MPF104	9/-	NKT703	5/-	OC207	7/6	2N744	6/-	2N4290	3/-
AS526	4/5	BFX13	4/10	MPF105	9/-	NKT713	7/6	ORP12	9/6	2N753	3/-	2N4291	3/-
AS527	4/5	BFX18	4/10	MPF106	9/-	NKT714	7/6	ORP60	8/-	2N838	12/-	2N4292	3/-
AS528	4/5	BFX44	6/5	MJ480	21/-	NKT774	5/4	ORP61	8/-	2N891	7/6	2N4303	15/-
AS529	6/-	BFX87	6/-	MJ481	21/-	NKT1001	12/6	ORP62	9/-	2N894	4/3	2N4871	6/9
AS531	11/6	BFY50	3/9	NKT121	10/11	NKT1019	12/6	ORP93	24/-	2N918	15/-	25002	15/-
ATZ10	40/-	BFY51	3/9	NKT121	10/11	NKT1039	12/6	OC309	12/-	2N929	5/-	25004	23/-
AU110	9/6	BFY52	3/9	NKT122	6/2	NKT1049	11/3	P246A	6/-	2N930	5/-	25017	15/-
AFY19	16/10	BFY53	3/2	NKT123	6/2	NKT1049	11/3	RAS310AF	15/-	2N1131	7/6	25018	12/6
BA110	6/-	BSX20	3/4	NKT124	9/8	NKT2029	12/6	RAS510AF	15/-	2N1132	7/6	25020	15/-
BA111	6/-	BSX21	3/4	NKT125	6/2	ST2	9/9	ST1	14/3	26124	25/-	25021	15/-
BA112	18/-	BSY27	4/-	NKT127	5/6	OAS	3/8	ST140	4/-	2N1177	14/-	25034	12/6
BA115	3/8	BTX95A	3/4	NKT128	5/10	OAS1	3/8	ST141	5/-	2N1302	4/6	25102	10/-
BA130	3/8	BTX39	3/4	NKT129	5/10	OAS2	3/8	ST144	17/3	2N1305	5/-	25302	6/-
BAY31	2/6	600R	120/-	NKT141	6/11	OA70	1/6	T1543	6/9	2N1304	5/-	25301	7/7
BAY38	3/8	600R	120/-	NKT142	5/10	OA73	1/6	U33AAA	4/6	2N1305	5/-	25302	6/-
BC107	2/9	600R	120/-	NKT143	5/10	OA79	1/6	V405A	9/3	2N1306	6/6	25304	15/-
BC108	2/9	BY87	31/-	NKT144	9/-	OA81	1/6	XA102	6/-	2N1307	6/6	25320	12/6
BC109	3/9	ISOR	31/-	NKT145	9/-	OA88	1/6	XA102	6/-	2N1308	6/6	25322	8/-
BC113	5/-	BY91	47/-	NKT161	5/8	OA90	1/6	T272	19/-	2N1309	8/-	25701	10/-
BC114	7/5	BY92	47/-	NKT162	5/8	OA91	1/6	ZT86	27/6	2N1507	4/8	25702	12/-
BC115	7/11	BY100	5/-	NKT163	5/4	OA95	1/6	ZT270	19/4	2N1613	6/6	2711	23/3
BC116	9/-	BY125	3/6	NKT164	5/4	OA99	2/-	IN23A	20/-	2N1496	3/6	25712	30/3
BC118	3/7	BYX10	8/-	NKT165	5/8	OC202	13/-	IN24A	4/-	2N1711	3/6	25733	9/9
BC125	12/-	BYX36/150	2/6	NKT211	6/-	OC210	6/-	IN60	4/-	2N2147	17/-	40361	13/3
BC126	12/-	BYX36/300	2/10	NKT212	6/-	OC211	9/-	IN64	4/-	2N2148	12/6	40362	16/3
BC134	5/-	BYX36/600	3/8	NKT213	4/-	OC19	9/-	IN82A	6/6	2N2160	14/9	2712	19/-
BC136	7/11	BY21	25/-	NKT214	4/-	OC20	33/-	IN87A	4/6	2N2218	12/-	Z772	19/-
BC137	8/6	BY21	25/-	NKT215	5/-	OC21	13/-	IN91	5/-	2N2243	23/3	Z786	27/6
BC138	12/-	BY223	26/3	NKT216	4/5	OC23	11/-	IN94	4/6	2N2368	6/6	Z7270	19/6

## SILICON RECTIFIERS

PIV	200mA	750mA	2 Amp	10 Amp
50	6d	1/5	2/3	—
100	9d	1/6	2/3	4/6
200	1/3	2/-	2/9	5/-
400	—	2/6	4/-	8/-
600	—	3/9	5/-	11/3
800	—	6/-	6/-	14/-

## THYRISTORS-SCRs

PIV	1A	3A	10A	30A	100A
50	7/6	9/-	7/6	25/-	20/-
100	—	10/-	10/-	30/-	22/-
200	8/6	—	12/6	42/-	35/-
300	—	11/-	—	51/-	—
400	9/6	12/6	15/-	60/-	45/-
600	—	—	20/-	84/-	120/-
800	—	—	—	—	—

## NEW SPECIAL ITEMS!!

- 40602 — Dual Gate MOS-FET 9/- each
  - L148 — Photo-Darlington Amplifier 26/6
  - MGA100 — Gallium Arsenide Infra Red Light Source 35/-
  - 31F2 — Infra Red Detector Diode 28/6
  - 3N84 — Silicon Controlled Switch 29/6
  - TAA320 — Monolithic IC with MOS-FET input followed by Bi-Polar transistor 13/6
- Datasheets 1/- on request — free with above items.

## COMPONENTS

**RESISTORS** 1/2 or 1 Watt 5% LOW NOISE CARBON FILM. 10, 12, 15, 18, 22, 27, 33, 39, 47, 56, 68, 82 ohms and decades (x 10, x100, x1,000, x10,000). Meg. etc. to 8.2 Megaohms (10% tolerance). PRICES: 1-25 4d, 26-99 3d, 100+2d (your selection 1 and/or 1 Watt mixed).

**SKELETON PRESET POTS.** 20% Tol. Linear. Low noise. Available in sub-miniature or standard size, horizontal or vertical. 100, 250, 500, 1k, 2.5k, 5k, 10k, 25k, 50k, 100k, 250k, 500k, 1 Meg, 2.5 Meg, 5 Meg. NEW PRICE: 1/- each or any selection of 12 pieces 10/-.

**ELECTROLYTIC CAPACITORS (Mullard).** -40% to +50% tol. Subminiature (all values in µF).

4V	8	32	64	125	250	400
6.4V	6.4	25	50	100	200	320
10V	4	16	32	64	125	200
16V	2.5	10	20	40	80	125
25V	1.6	6.4	12.5	25	50	80
40V	1.0	4.0	8	16	32	50
64V	0.64	2.5	5	10	20	32
Price	1/6	1/3	1/2	1/-	1/1	1/2

**MIN. POLYESTER CAPACITORS.** Printed circuit type 250 Vdc working. 0.01, 0.015, 0.022, 7d each; 0.033, 0.047, 8d each; 0.068, 0.10, 12d each.

**VEROBOARD 0.15" Matrix FLUX COATED** 2 1/2 x 3 1/2, 3 1/2 x 5, 3 1/2 x 3 1/2, 3 1/2 x 5, 5 1/2, 3 1/2 x 18", 18"-. BARGAIN PACK of 36 square inches all good size pieces only 10/- pack.

**VEROBOARD 0.1" Matrix, 3 1/2 x 2 1/2, 3/9.**

**VEROPINS for 0.15", 36 pieces 3/-.**

**VER CUTTER 9/-** (including free sample pieces).



**Single "DeC"** with accessories and project manual... 29/6  
**"2-DeC"** kit contains two "DeCs" component tray accessories, instruction book, all packed in attractive plastic box... 69/6

**"4-DeC"** kit contains four "DeCs", accessories, manual, etc. ... 117/6

**BOOKS FROM STOCK**  
 General Electric Transistor Manual, 660 pages of data on commercial equipment. Type 10D ... 29/6  
 RCA Transistor Manual, 554 pages includes SCR circuits ... 28/-  
 Designers' Guide to British Transistors. Excellent data book lists over 1,000 common types plus Computer-selected substitution chart ... 25/-  
 (ADD 2/6 POST & PACKING FOR ALL BOOKS)

**NEONS**  
 Signal neons for many types of circuit, type "N" Price 1/6 each or 16/- dozen.

**HEATSINKS.** Suitable for 2 x OC35, etc. As used in commercial equipment. Type 10D ... 6/-

**ALUMINIUM CHASSIS**  
 6 x 4 x 2 1/2" with reinforced corners 6/9 each (P & P 1/6). Ally panel to fit 1/6. Paxolin panel to fit 2 1/2". Many other sizes in stock up to 12 x 8 x 2 1/2" (see catalogue).

**ZENER DIODES.** 400mW 10% Tolerance. Complete range preferred values 3 volt to 30 volt, each 3/6

**SOLAR CELLS**  
 B2M 0.2-0.4 volts @ 2mA Selenium type ... 12/6  
 B3M 0.2-0.4 volts @ 11-2mA Selenium type ... 15/-  
 SIM 0.3-0.4 volts @ 10-16mA Silicon ... 19/-  
 S4M 0.3-0.4 volts @ 25-40mA Silicon ... 33/6

## ULTRASONIC TRANSDUCERS

Operate at 40kc/s. Can be used for remote control systems without cables or electrical links. Type 1404 transducers can transmit and receive. FREE: With each pair our complete transmitter and receiver circuit. PRICE £18.0 Pair (Sold only in pairs)

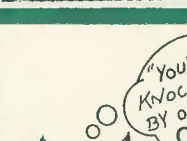

**"YOU'LL BE KNOCKED OUT BY OUR NEW CAT."**

Prices quoted are current at time of going to press and may be subject to variation. Semiconductors offered bear Manufacturers' original markings and are subject to our full replacement guarantee if not to published specifications. WE DO NOT offer "Re-marked" Sem

# VALUE ALL THE WAY

## INTEGRATED CIRCUITS

**BI-PAK MONOLITHIC DIGITAL CIRCUITS** (10 lead TO-5)  
 BP305A, 6-Input AND gate, 9/6 each.  
 BP314A, 7-Input NOR gate, 9/6 each.  
 BP315A, Dual 3-Input NOR gate, 9/6 each.  
 BP316A, Dual 2-Input NOR gate (expandable), 9/6 each.  
 BP320A, J-K-Binary element, 11/6 each.  
 BP332A, Dual 3-Input OR gate, 9/6 each.

## MONOLITHIC AMPLIFIERS

BP709C, Operational amplifier, 15/- each.  
 BP701C, Operational amplifier (with Zener output), 12/6 each.  
 BP702C, Operational amplifier (with direct output), 12/6 each.  
 BP501, Wide band amplifier, 18/- each.  
 BP521, Logarithmic wide band amp., 14/- each.  
 BP201C, General purpose amplifier (TO-5 B lead), (voltage or current amp.), 12/6 each.  
 I.C. Operational Amplifier with Zener output. Type 701C. General Purpose Projects. 8 Lead TO-5 case. Full data.

Our price 12/6 each  
 5 off 11/- each. Large Qty. Prices quoted ex-works.

## OTHER MONOLITHIC DEVICES

BP424, Zero voltage switch, 8/6 each.  
 This device is a monolithic I.C. that acts as combined threshold detector and trigger circuit for controlling a triac. It is designed to pulse the gate of a thyristor at the point of zero supply voltage, and therefore eliminate radio frequency interference when used with resistive loads.  
 D13D1 Silicon Unilateral switch 10/- each.  
 A Silicon Planar, monolithic integral circuit having thyristor electrical characteristics, but with an anode gate and a built-in "Zener" diode between gate and cathode. Full data and application circuits available on request.

**FAIRCHILD (U.S.A.) RTUL MICROLOGIC INTEGRATED CIRCUITS**  
 Epoxy case T8-B lead type. range 15°C to 55°C. UL900, Buffer, 10/6 each.  
 UL914, Dual two-input gate, 10/6 each.  
 UL923 J-K-flip-flop, 14/- each.  
 Complete data and circuits for the Fairchild I.C.'s available in booklet form priced 1/6.

**MULLARD I.C. AMPLIFIERS**  
 TA A243, Operational amplifier, 70/- each.  
 TA A263, Linear AF amplifier, 18/6 each.  
 TA A293, General purpose amplifier, 21/- each.  
**CA3020 RCA (U.S.A.) LINEAR INTEGRATED CIRCUITS**  
 Audio Power Amplifier, 30/- each.  
 Owing to the mass of I.C. printed matter often required by customers in connection with the I.C.'s themselves we ask you to help us in the cost of reproducing this literature by adding 2s. towards same. This is only necessary when a number of different sheets are required.

Sil. trans. suitable for P.E. Organ. Metal O-18 Eqvt. ZTY 300 1/- each. Any Qty.

## ADI61 NPN

## ADI62 PNP

**MATCHED COMPLEMENTARY PAIRS OF GERM. POWER TRANSISTORS.**

For mains driven output stages of Amplifiers and Radio receivers. OUR LOWEST PRICE OF 12/6 PER PAIR.

**HIGH POWER SILICON PLANAR TRANSISTORS. TO-3.**  
 TEXAS 25034 NPN VCB100 1c 4A  
 VCE100 Ptot. 40W hFE(min.) 60 Price 15/- each  
 2N3055, 12/6 each

**FREE**  
 One 10/- pack of your own choice free with orders valued £4 or over.

**NPN DIFFUSED SILICON PHOTO-DUODIODE TYPE I5701 (2N12175)** for Tape Readout, high speed, ins. and measurement indicators. 50V. 250mW. OUR PRICE 10/- EACH, 50 OR OVER 8/6. EACH. FULL DETAILS.

**LOW COST F.E.T.s**  
 Fully Tested, Guaranteed Perameters equit. to 2N3819. MPF 102, 2N5459, 1-24 7/6 each; 25-99 6/3 each; 100 up 5/6 each. Coded FE19. Full data sent. TO-72 case.

**TRICs**  
 2A, 400 PIV. TO-5 case, 20/- each; 6A, 400 PIV. TO-66 case, 25/- each; 10A, 400 PIV. TO-48 case, 35/- each. New and fully tested.

**LUCAS 35A SIL. RECTS.**  
 Branded. 400 PIV. Special Price, stud type, flying lead, 22/6 each.  
**SPECIAL OFFER S.C.R.s**  
 3A, 400 PIV similar to CR53/40AF-BYTR97400R, 2N1777, 10/- each; 25-99, 9/- each; 100 up 8/6 each.

**NPN SILICON PLANAR**  
 BC107/8/9, 2/- each; 50-99, 1/10; 100 up, 1/8 each; 1,000 off, 1/6 each. Fully tested and coded TO-18 case.

**PNP SIL. PLASTIC TRANS.**  
 Similar to 2N3702, uncoded but fully tested, 1/6 each; 25-99, 1/3 each; 100 up, 1/- each.

**"TRANSISTOREN"**  
 Transistor equit. book. New Dutch edition printed in English. Equit. to European, American and Japanese Trans. 190 pages, 15/- each.

**SPECIAL CLEARANCE OF GETI20**  
 PNP Med. Power Trans. complete with heatsink, Pica washers, etc. similar to NKT303, I.C. 2A, 5W, 2/6 each; 12 up, 2/- each.

**BRAND NEW TEXAS GERM. TRANSISTORS**  
 Coded and Guaranteed

Pak No.	EQVT.	Price
T1	8 2G3710	OC71 .. 10/-
T2	8 2G374A	OC75 .. 10/-
T3	8 2G3744A	OC81D .. 10/-
T4	8 2G381A	OC81 .. 10/-
T5	8 2G382T	OC82 .. 10/-
T6	8 2G344A	OC44 .. 10/-
T7	8 2G345A	OC45 .. 10/-
T8	8 2G378	OC78 .. 10/-
T9	8 2G399A	2N1302 .. 10/-
T10	8 2G417	AF17 .. 10/-

## KING OF THE PAKS Unequalled Value and Quality

# SUPER PAKS NEW BI-PAK UNTESTED SEMICONDUCTORS

Satisfaction GUARANTEED in Every Pak, or money back.

Pak No.	Description	Price
U1	120 Glass Sub-min. General Purpose Germanium Diodes	10/-
U2	60 Mixed Germanium Transistors AF/RF	10/-
U3	75 Germanium Gold Bonded Diodes sim. OA5, OA47	10/-
U4	40 Germanium Transistors like OC81, AC128	10/-
U5	60 200mA Sub-min. Sil. Diodes	10/-
U6	40 Silicon Planar Transistors NPN sim. BSY95A, 2N706	10/-
U7	16 Silicon Rectifiers Top-Hat 750mA up to 1,000V	10/-
U8	50 Sil. Planar Diodes 250mA OA/200/202	10/-
U9	20 Mixed Volts 1 watt Zener Diodes	10/-
U10	30 PNP Silicon Planar Transistors TO-5 sim. 2N1132	10/-
U11	30 PNP Silicon Planar Transistors TO-5 sim. 2N1132	10/-
U12	30 PNP Silicon Planar Transistors TO-5 sim. 2N1132	10/-
U13	30 PNP Silicon Planar Transistors TO-5 sim. 2N1132	10/-
U14	150 Mixed Silicon and Germanium Diodes	10/-
U15	30 NPN Silicon Planar Transistors TO-5 sim. 2N697	10/-
U16	10 3-Amp Silicon Rectifiers Stud Type up to 1000 PIV	10/-
U17	30 Germanium PNP AF Transistors TO-5 like ACY 17-22	10/-
U18	8 6-Amp Silicon Rectifiers BYZ13 Type up to 600 PIV	10/-
U19	30 Silicon NPN Transistors like BC108	10/-
U20	12 1.5-amp Silicon Rectifiers Top-Hat up to 1,000 PIV	10/-
U21	30 A.F. Germanium alloy Transistors 2G300 Series & OC71	10/-
U22	30 Mad's like MAT Series PNP Transistors	10/-
U23	20 Germanium 1-amp Rectifiers GJM up to 300 PIV	10/-
U24	25 300 Mc/s NPN Silicon Transistors 2N708, BSY27	10/-
U25	25 300 Mc/s NPN Silicon Transistors 2N708, BSY27	10/-
U26	30 Fast Switching Silicon Diodes like IN914 Micro-min	10/-
U27	Experimenters' Assortment of Integrated Circuits, untested. Gates, Flip-Flops, Registers, etc., 8 Assorted Pieces	20/-
U28	10 1 amp SCR's TO-5 case up to 600 PIV CRS1/25-600	20/-
U29	10 1 amp SCR's TO-5 case up to 600 PIV CRS1/25-600	20/-
U30	15 Plastic Silicon Planar Trans. NPN 2N2924-2N2926	10/-
U31	20 Sil. Planar NPN trans. low noise Amp 2N3707	10/-
U32	25 Zener diodes 400mW D07 case mixed Volts, 3-18	10/-
U33	15 Plastic case 1-amp Silicon Rectifiers IN4000 series	10/-
U34	30 Sil. PNP alloy trans. TO-5 BCY26, 25302/4	10/-
U35	25 Sil. Planar trans. PNP TO-18 2N2906	10/-
U36	25 Sil. Planar NPN trans. TO-5 BFY50/51/52	10/-
U37	30 Sil. alloy trans. SO-2 PNP, OC200 25322	10/-
U38	20 Fast Switching Sil. trans. NPN 400Mc/s 2N3011	10/-
U39	30 RF Germ. PNP trans. 2N1303/5 TO-5	10/-
U40	10 Dual trans. 6 lead TO-5 2N2060	10/-
U41	30 RF Germ. trans. TO-1 OC45 NKT72	10/-
U42	10 VHF Germ. PNP trans. TO-1 NKT667 AF117	10/-

Code Nos. mentioned above are given as a guide to the type of device in the Pak. The devices themselves are normally unmarked.

## QUALITY-TESTED PAKS

60 Matched Trans. OC44/45/81/81BD	10/-
10 Red Spot AF Trans. PNP	10/-
16 White Spot RF Trans. PNP	10/-
5 Silicon Rects. 3 A 100-400 PIV	10/-
2 10 A Silicon Rects. 100 PIV	10/-
2 OC1 140 Trans. NPN Switching	10/-
1 12 A SCR 100 PIV	10/-
3 Sil. Trans. 25303 PNP	10/-
4 Zener Diodes 240mW 3-12V	10/-
3 200 Mc/s Sil. Trans. NPN BSY26/27	10/-
3 Zener Diodes 1W 33V 5% Tol.	10/-
4 High Current Trans. OC26 1 OC35	10/-
5 Silicon Rects., 400 PIV 250mA	10/-
4 OC75 Transistors	10/-
1 Power Trans. OC20 100V	10/-
10 OA202 Sil. Diodes Sub-min.	10/-
2 Low Noise Trans. NPN 2N929/30	10/-
1 Sil. Trans. NPN VCB 100 ZT86	10/-
8 OA81 Diodes	10/-
4 OC72 Transistors	10/-
4 OC77 Transistors	10/-
1 Sil. Rects. 400 PIV 500mA	10/-
5 GET884 Trans. Eqvt. NKT773	10/-
5 GET893 Trans. Eqvt. OC45	10/-
2 2N708 Sil. Trans. 300Mc/s NPN	10/-
3 GT31 LF Low Noise Germ Trans.	10/-
6 IN914 Sil. Diodes 75 PIV 75mA	10/-
8 OA95 Germ. Diodes Sub-min. IN69	10/-
3 NPN Germ. Trans. NKT773 Eqvt.	10/-
2 OC32 Power Trans. Germ.	10/-
2 OC25 Power Trans. Germ.	10/-
4 AC128 Trans. PNP High Gain	10/-
4 AC127/128 Comp. pair PNP/NPN	10/-
3 2N1307 PNP Switching Trans.	10/-
3 OC62H Germ. Diodes Eqvt. OA71	10/-
3 AF116 Type Trans.	10/-
12 Assorted Germ. Diodes Marked	10/-
4 AC126 Germ. PNP Trans.	10/-
4 Silicon Rects. 100 PIV 750mA	10/-
3 AF117 Trans.	10/-
7 OC81 Type Trans.	10/-
2 OC171 Trans.	10/-
5 2N2926 Sil. Epoxy Trans.	10/-
7 OC71 Type Trans.	10/-
2 2S701 Sil. Trans. Texas.	10/-
12 Volt Zener 400mW	10/-
2 10 A 600 PIV Sil. Rects. IS45R	10/-
3 BC108 Sil. NPN High Gain Trans.	10/-
2N910 NPN Sil. Trans. VCB 100	10/-
2 1000 PIV Sil. Rect. 1.5 A 25301 AF	10/-
3 BSY95A Sil. Trans. NPN 300Mc/s	10/-
3 OC200 Sil. Trans.	10/-
2 GET808 Low Noise Germ. Trans.	10/-
1 AF139 PNP High Freq. Trans.	10/-
3 NPN Trans. 1 ST141 & 2 ST140	10/-
4 Mad's 2 MAT101 & 2 MAT120	10/-
3 Mad's 2 MAT101 & 1 MAT121	10/-
4 OC44 Germ. Trans. AF	10/-
3 AC127 NPN Germ. Trans.	10/-
1 2N3906 Sil. PNP Trans. Motorola	10/-
2 Sil. Power Rects. BYZ13	15/-
1 Sil. Power Trans. NPN 100Mc/s TK201A	15/-
6 Zener Diodes 3-15V Sub-min.	15/-
2 2N1132 PNP Epitaxial Planar Sil.	15/-
3 2N697 Epitaxial Planar Trans. Sil.	15/-
4 Germ. Power Trans. Eqvt. OC16	15/-
1 Unijunction Trans. 2N2646	15/-
2 Sil. Trans. 200Mc/s 60Vcb ZT83/84	15/-
1 Tunnel Diode AEY11 1050 Mc/s	15/-
2 2N2712 Sil. Epoxy Planar HEF225	15/-
6 BY109 Type Sil. Rects.	20/-
2 Sil. and Germ. Trans. Mixed, all marked, New	30/-

## FET'S

2N 3819.....10/-  
 2N 3820.....25/-  
 MPF105..... 8/-

OC271 Type. 8/6

## UNIUNCTION

UT46. Eqvt. 2N2646, Eqvt. TIS43. BEN3000

7/6 EACH  
 25-99 5/- 100 UP 4/-

## CADMIUM CELLS

ORP60 ORP61 8/- each

## TESTED SCR'S

PIV	IA	7A	16A	30A
25	5/-	7/6	30/-	30/-
50	7/6	8/6	10/6	35/-
100	8/6	10/-	15/-	45/-
200	12/6	15/-	20/-	55/-
300	15/-	20/-	25/-	60/-
400	3/6	25/-	35/-	80/-
500	30/-	40/-	45/-	95/-
600	40/-	40/-	50/-	100/-

## SIL. RECTS. TESTED

PIV	750mA	3A	10A	30A
50	1/-	2/9	4/3	9/6
100	1/3	3/3	4/6	15/-
200	1/9	4/-	4/9	20/-
300	2/3	4/6	6/6	22/-
400	2/6	5/6	7/6	25/-
500	3/3	6/-	8/6	30/-
600	3/3	6/9	9/-	32/-
800	3/6	6/6	11/-	40/-
1000	5/-	9/3	12/6	50/-
1200	6/6	11/6	15/-	60/-

**BI-PAK**

500, Chesham House,  
 150 Regent Street,  
 LONDON, W.1.

# BOUND VOLUME No. 22 of "The Radio Constructor" FOR YOUR LIBRARY

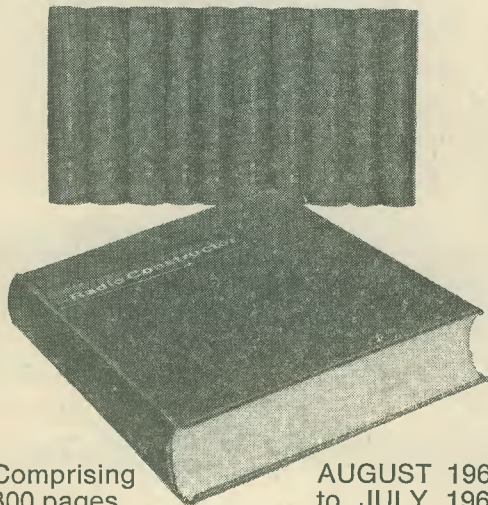

Comprising  
800 pages  
plus index

AUGUST 1968  
to JULY 1969

PRICE **35/-** - Postage 4/6

**Special discount of 10/- for regular readers**

Just cut the heading from each month's contents page, including title and month of issue, and this will be sufficient evidence of readership to qualify for the discount.

Thus regular readers will still retain their copies for workbench use, while having a splendid bound volume containing issues in mint condition.

PRICE 25/- Postage 4/6

**Limited Number of Volume 21**

(August 1967 to July 1968) still available

Price 35/- Postage 4/6

Available only from:-

**Data Publications Ltd.**  
57 Maida Vale London W9

## Now! A FAST EASY WAY TO LEARN BASIC RADIO AND ELECTRONICS



Build as you learn with the exciting new  
**TECHNATRON Outfit!** No mathematics.  
No soldering—but you learn the *practical* way.

Now you can learn basic Radio and Electronics at home—the *fast, modern* way. You can give yourself the essential technical 'know-how' sooner than you would have thought possible—read circuits, assemble standard components, experiment, build . . . and enjoy every moment of it. B.I.E.T.'s Simplified Study Method and the remarkable new **TECHNATRON Self-Build Outfit** take the mystery out of the subject—make learning *easy and interesting*.

Even if you don't know the first thing about Radio now,  
you'll build your own Radio set within a month or so!

and what's more, **YOU'LL UNDERSTAND EXACTLY WHAT YOU ARE DOING.** The Technatron Outfit contains everything you need, from tools to transistors . . . even a versatile Multimeter which we teach you how to use. You need only a little of your spare time, the cost is surprisingly low and the fee may be paid by convenient monthly instalments. You can use the equipment again and again—and it remains your own property.

**You LEARN—but it's as fascinating as a hobby.**

Among many other interesting experiments, the Radio set you build—and it's a good one—is really a bonus; this is first and last a *teaching* Course. But the training is as rewarding and interesting as any hobby. It could be the springboard for a career in Radio and Electronics or provide a great new, spare-time interest.

A 14-year-old could understand and benefit from this Course—but it teaches the real thing. Bite-size lessons—wonderfully clear and easy to understand, practical projects from a burglar-alarm to a sophisticated Radio set . . . here's your chance to master basic Radio and Electronics, even if you think you're a 'non-technical' type. And, if you want to carry on to more advanced work, B.I.E.T. has a fine range of Courses up to A.M.I.E.R.E. and City and Guilds standards.

Send now for free 164-page book. Like to know more about this intriguing new way to learn Radio and Electronics? Fill in the coupon and post it today. We'll send you full details and a 164-page book—'ENGINEERING OPPORTUNITIES'—Free and without any obligation.



### BRITISH INSTITUTE OF ENGINEERING TECHNOLOGY

Dept. 370B, Aldermaston Court,  
Aldermaston, Berkshire.

To: B.I.E.T., Dept. 370B, ALDERMASTON COURT,  
ALDERMASTON, BERKS.

I would like to know more about your  
Practical Radio & Electronics Course. Please  
send me full details and FREE 164-page book.

name.....

address.....

.....age.....



# Fast Mail Order for the Amateur Radio Enthusiast!

## AERIAL EQUIPMENT

**TWIN FEEDER.** 300 ohm twin ribbon feeder similar K25, 8d. per yard. 75 ohm twin feeder, 8d. per yard. Post on above feeders, 2/- any length.

**COPPER WIRE.** 14G, H/D, 140ft. 30/-; 70ft., 16/-; Post & packing 3/9. Lengths are approx. only, actually sold by weight.

**VARIABLE CONDENSERS** "Raymart" 250 pF 8/6 each. P. & P. 2/-.

**EDDYSTONE 817** 240pF .024 spacing. 24/6. P. & P. 2/6d.

**AERIAL INSULATORS.** Ribbed ceramic, 2/6 each. Short stick, 1/- each. Egg, 6d. all plus postage.

**2 METRE BEAM, 5 ELEMENT W.S. YAGI.** Complete in box with 1" to 2 1/2" masthead bracket. Price: £3 7s. Carriage 5/-.

**SUPER AERIAL,** 70/80 ohm coax, 300 watt very low loss, 2/3 per yard. 50 ohm 300 watt 2/6 per yd. P. & P. 2/6.

**TOUGH POLYTHENE LINE,** type MLI (100lb.), 2d. per yd. or 12/6 per 100 yds. Type ML2 (220lb.), 4d. per yd. or 25/- per 100 yds., ML4 (400lb.), 6d. per yd. Ideal for Guys, L.W. Supports, Halyards, etc, Postage 1/6 on all line.

## "RAYMART" SUPER BANDCHECKER

This instrument is an adaptation of the simple Absorption type wavemeter and by utilising a diode and a sensitive meter its application is considerably widened. In addition to the familiar use of checking output frequency the increased sensitivity enables it to be used for many other applications such as:-

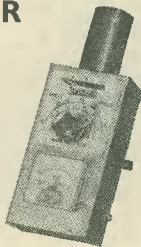

- Checking of Multiplier stages in Multi Stage transmitters.
  - Neutralising R.F. Amplifiers.
  - Standing waves on coax Cables.
  - R.F. pick up in wiring.
  - R.F. pick up in microphone leads, etc.
- Price £4.4.0 (3.5-35 Mc/s)  
or, including 160 Metre Band £4.10.0  
p. & p. 3/-

## Raymart

Transistorised

## SHORT WAVE RECEIVER KIT

- Uses plug-in coils
- 5 ranges available
- Kit supplied with Range 3 coil 1.6-5.3 mc/s.

Full instructions supplied.

Cost of kit **£8** (less speaker and battery)

Extra coils 11/- per range.

p. & p. 4/6



The Widest Range of Components in the Midlands

★ HIRE PURCHASE  
★ PART EXCHANGE

CHAS. H. **YOUNG** LTD.

At your service G2AK, G3LAY, G3VFF  
Please print your address. No C.O.D. under £1.

phone 021-236 1635

170-172 Corporation Street,  
Birmingham 4

## Proved performance high fidelity with specification guarantee

### THE MODULES

Englefield Amplifier Cabinet with front panel, knobs, sockets, cut and stripped wire, fuses, edge connectors, etc. ... £6 0 0

Two Peak Sound PA.12-15 power amp. built modules ... £11 19 0

SCU/400 Pre-amp/Control module, built £15 15 0

PS/45 Power Supply kit ... £4 10 0

**£38 4 0**

Using two PA.25-15 modules at £11/15/- each and PS/68S Stabilized Power Supply Unit at £13/10/-, total price for complete system comes to ... **£58 15 0**

**PEAK SOUND "Cir-Kit" Pack No. 3** as specified for Radio Constructor "Cir-Kit" 6 Receiver - 12/6 (Postage and packing 1/-)

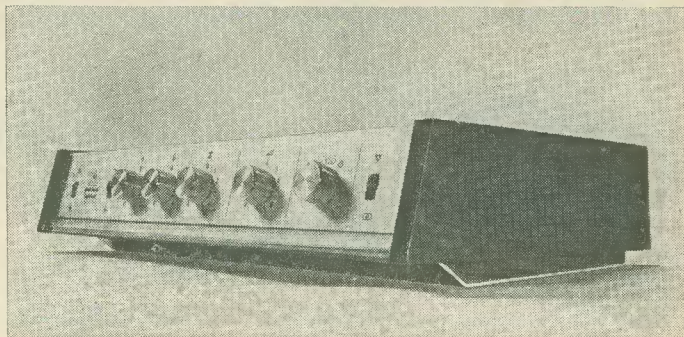

## Peak Sound Englefield

The Peak Sound Englefield comprises a new system which, assembled from laboratory designed modules, provides a cost-performance ratio which has never been bettered in high fidelity. Here is top-flight circuitry housed in a cabinet of elegantly original design which is both beautiful and completely practical back and front. By assembling these units you can own a high fidelity instrument for a cost of about £38. *Matching F.M. Tuner designs available shortly.*

### THE SPECIFICATIONS

Using two Peak Sound PA.12-15's, etc. Output per channel: 13 watts into 15 Ω; 18 watts into 8 Ω; 24 watts into 3 Ω all R.M.S.

Frequency bandwidth: 10 Hz to 45 kHz for 1 dB at 1 watt.

Total Harmonic Distortion at 1 kHz at 11.5 watt into 15 Ω - 0.1%.

Input sensitivities: Mag. PA 3.5 mV, R.I.A.A. equalized: Tape, 100 mV linear; Radio, 100 mV linear.

Overload factor: 29 dB on all input channels.

Signal/noise ratio: -65 dB on all inputs.

Controls: Volume, Treble, Bass, Low-pass Filter. Mono/Stereo: On/off; Balance.

Using two Peak Sound PA.25-15 amplifiers, output is then 28 watts into 15 Ω per channel at 1 kHz.



**GO TO YOUR DEALER** for Peak Sound products, or enquire direct in case of difficulty. **TRADE ENQUIRIES INVITED.**

**PEAK SOUND (HARROW) LTD., 32 ST. JUDE'S RD., ENGLEFIELD GREEN, EGHAM, SURREY. Tel.: Egham 5516**

# SPECIAL GIFT OFFER

## SUPER SWISS WATCHES



### GENTS WRISTWATCH

Ultra-modern styled watch complete with expanding bracelet in luxurious golden finish. 21-jewelled Swiss movement with automatic DAY and DATE indication in black and white clearcut figures. Centre second hand. All hands and 5-minute batons in attractive gold colour. One of the cleanest and clearest dials we've seen. Water protected and anti-magnetic. Electronically timed and tested. Screwback stainless steel back. **SIX MONTHS WRITTEN GUARANTEE.** List Price £6.14.0

Special Offer Price **89/6** plus 3/- P&P

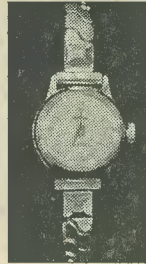

### LADIES WRISTWATCH

Very attractive ladies watch in a luxurious golden finish, with matching expanding bracelet. 21-jewelled Swiss movement with automatic date change. Handsome white dial with golden colour batons and numerals. Centre second sweep hand, minute and hour hands also in gold. This watch was specially selected for its attractive and easy-to-read dial design. Water protected and anti-magnetic. Electronically timed and tested. Screwback stainless steel back. **SIX MONTHS WRITTEN GUARANTEE.** List Price £4.19.6

Special Offer Price **67/6** plus 3/- P&P

## RUSSIAN OPTICAL PRECISION

**SUPERB 35mm CAMERA**

TAKES NEEDLE-SHARP PICTURES BLACK & WHITE OR COLOURS



**FREE CASE** ENABLES ANYONE TO TAKE PROFESSIONAL QUALITY PHOTOGRAPHS

5-speed shutter 1/15th to 1/250th sec. 5 stops f.4 to f.16. Delayed action mech. allows self portraits. Depth of field indicator. Accessory shoe. Flash socket. Supplied complete with instruction booklet & superb P.V.C. Ever Ready Case. LIST PRICE £6.14.6. **Special Offer Price £5.0.0** plus 3/6 P&P

### COSMIC 35 CAMERA

This camera is without doubt the best value camera on the market today. Reviewed by 'Amateur Photographer' in 1964 who judged it excellent value for money and 'capable of making first class exhibition prints of 20 x 16 inches'. SPECIFICATION: 3 element F.4 lens.

## CAR COMPASS

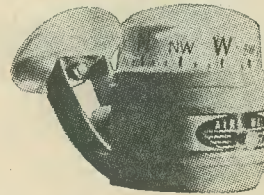

Extremely accurate compass manufactured by Sherrill Corporation of America, suppliers to the U.S. Government and Armed Forces. Fully compensatable with aviation type regulator magnets controlled by nylon gears. Leakproof under a wide range of temperatures. A scientifically designed instrument for all motorists and especially 'mobile' transmitter operators. Easily fitted. List Price 39/6.

Special Offer Price **29/6** plus 2/6 P&P

## FLOAT ON AIR!



## INFLATABLE ARMCHAIRS

Float on Air in a Bubble Chair. Trendsetting inflatable furniture that stores in a drawer. Tough vinyl material ensures long life. (Accidental punctures easily repaired). Available in gorgeous colours: Orange, Blue, Yellow, Black and Transparent. List Price 90/-.

Special Offer Price **69/6** plus 4/6 P&P

## EMBOSSING PRESS

Grange Park, A41



CONWAY VALE A46

ANSTAY HILL A42

Sunningdale A44

1. ALBERT ROAD A43

Emboss your own notepaper, etc. and eliminate printing costs. Most useful home and office accessory that brings prestige to correspondence and avoids errors in replies. Choice of five print styles, as illustrated. Choice of 'in line' or 'staggered' setting. New dies readily available when required. (Please note that there is a limit of 20 letters or figures per line).

SPECIAL PRICE: **39/6** for 4 lines **49/6** for 5 lines POST FREE

Please send the following: (TICK WHERE APPLICABLE)

- Gents Wristwatch.....
- Ladies Wristwatch.....
- Cosmic 35 Camera.....
- Car Compass.....
- Inflatable Armchair.....  
(Colour required .....
- Embossing Press.....  
(Style of type required.....)  
(Address 'in line' or staggered)

I enclose cheque/crossed postal order (made payable to Flairline Supplies) for £.....

NAME.....  
ADDRESS.....  
.....  
.....

BLOCK CAPITALS PLEASE

ALL GOODS SUPPLIED UNDER SEVEN-DAY MONEY-BACK GUARANTEE

**FLAIRLINE SUPPLIES** SUITE 11/12, SECOND FLOOR, 52 SHAFTESBURY AVENUE, LONDON, W.1

# BI-PRE-PAK LIMITED

## FULLY TESTED AND MARKED

AC107	3/-	OC170	3/-
AC126	2/6	OC171	4/-
AC127	2/6	OC200	3/6
AC128	2/6	OC201	7/-
AC176	5/-	2G301	2/6
ACY17	3/-	2G303	2/6
AF114	4/-	2N711	10/-
AF115	3/6	2N1302-3	4/-
AF116	3/6	2N1304-5	5/-
AF117	3/6	2N1306-7	6/-
AF186	10/-	2N1308-9	8/-
AF139	10/-	2N3819	9/-
AF239	12/6	<b>Power Transistors</b>	
BFY50	4/-	OC20	10/-
BSY25	7/6	OC23	10/-
BSY26	3/-	OC25	8/-
BSY27	3/-	OC26	5/-
BSY28	3/6	OC28	7/6
BSY29	3/-	OC35	5/-
BSY95A	3/-	OC36	7/6
OC41	2/6	AD149	10/-
OC44	1/11	AUY10	30/-
OC45	1/9	2N3055	15/-
OC71	2/6	<b>Diodes</b>	
OC72	2/6	AAY42	2/-
OC73	3/6	OA95	2/-
OC81	2/6	OA70	1/9
OC81D	2/6	OA79	1/9
OC83	4/-	OA81	1/9
OC139	2/6	IN914	1/6
OC140	3/6		

## TRY OUR X PACKS FOR UNEQUALLED VALUE

### XA PAK

Germanium PNP type transistors, equivalents to a large part of the OC range, i.e. 44, 45, 71, 72, 81, etc.

PRICE £5 PER 1,000  
POST & PACKING 4/6 U.K.

### XB PAK

Silicon TO-18 CAN type transistors NPN/PNP mixed lots, with equivalents to OC200-1, 2N706a, BSY27/29, BSY95A.

PRICE £4.5.0 PER 500 £8 PER 1,000  
POST & PACKING 2/6 U.K.

### XC PAK

Silicon diodes miniature glass types, finished black with polarity marked, equivalents to OA200, OA202, BAY31-39 and DK10, etc.

PRICE £4.10.0 PER 1,000  
POST & PACKING 2/6 U.K.

ALL THE ABOVE UNTESTED PACKS HAVE AN AVERAGE OF 75% OR MORE GOOD SEMI-CONDUCTORS. FREE PACKS SUSPENDED WITH THESE ORDERS. ORDERS MUST NOT BE LESS THAN THE MINIMUM AMOUNTS QUOTED PER PACK.

## NEW TESTED & GUARANTEED PAKS

B2	4	Photo Cells, Sun Batteries. .3 to .5V, .5 to 2mA.	10/-
B77	2	AD161-AD162 NPN/PNP Trans. Comp. output. Pair	10/-
B79	4	1N4007 Sil. Rec. Diodes. 1000 Piv. 1 amp Miniature.	10/-
B81	10	Reed Switches. Mixed types large and small.	10/-
B89	2	5SP5 Light Sensitive Cells. Light res. 400Ω, Dark 1MΩ.	10/-
B91	8	NKT163/164 PNP Germ. to -5. Equiv. to OC44, OC45.	10/-
B92	4	NPN Sil. Trans. A06=BSX 20, 2N2369, 500 MHz, 360 mW.	10/-
B93	5	GET113 Trans. equivalent to ACY17-21 PNP Germ.	10/-
B94	6	NPN Sil. Planar Epitaxial Trans. CS4 similar to BSY38 or BC108.	10/-
B96	5	2N3136 PNP Sil. Trans. TO-18. HFE100-300. IC.600mA. 200 MHz.	10/-
B98	10	XB112 & XB102 equiv. to AC126, AC156, OC81/2, OC71/2, NKT271, etc.	10/-
B99	200	Capacitors, Electrolytics, Paper, Silver Mica, etc. Postage on this pak 2/6.	10/-
H4	250	Mixed Resistors. Post & packing 2/-.	10/-

**FREE!** Packs of your own choice up to the value of 10/- with orders over £4.

## HUGE CLEARANCE OF UHF/VHF TUNER UNITS REJECTS Stocks Almost Exhausted! Place Your Orders NOW!!! Fantastic Transistor Value!

TU.2. Containing 2 AF186's & 2 AF178's PRICE 10/- each Unit  
TU.3. Containing 2 AF186's & 2 AF178's PLUS Waveband Slider Switch PRICE 12/6 each Unit

P & P 2/6 each Unit. All the Units have many other components, e.g. Capacitors, Resistors, Coils and Tuning Condensors, etc. Connection data supplied with all Tuner Units.

## Return of the unbeatable P.1 Pak.

### Now greater value than ever

Full of short lead semiconductors and electronic components, approx. 170. We guarantee at least 30 really high quality factory marked Transistors PNP and NPN, and a host of diodes and rectifiers. Mounted on printed circuit panels. Identification chart supplied to give some information on the transistors.

**P.1 PLEASE ASK FOR PAK P.1 ONLY 10/-**  
2/- P & P on this Pak.

## NEW UNMARKED UNTESTED PAKS

B78	12	Integrated Circuits, Data & Circuits of types, supplied with orders.	10/-
B80	8	Dual Trans. Matched O/P pairs NPN. Sil. in TO-5 can.	10/-
B82	10	OC45, OC810 & OC81 Trans. Mullard glass type.	10/-
B83	200	Trans. Makers rejects, NPN/PNP. Sil. & Germ.	10/-
B84	100	Silicon Diodes DO-7 glass equiv. to OA200, OA202.	10/-
B66	150	High quality Germ. Diodes. Min. glass type.	10/-
B86	50	Sil. Diodes sub. min. IN914 & IN916 types.	10/-
B87	100	Germ. PNP Trans. equiv. to OC44, OC45, OC81, etc.	10/-
B88	50	Sil. Trans. NPN, PNP, equivalent to OC200/1, 2N706A, BSY95A, etc.	10/-
B60	10	7 Watt Zener Diodes. Mixed voltages.	10/-
H5	16	1 Amp. Plastic Diodes. 50-1000 Volts.	10/-
H6	40	250mW. Zener Diodes DO-7 min. Glass Type.	10/-

**MAKE A REV. COUNTER for your Car.** The 'TACHO BLOCK'. This encapsulated block will turn any 0-1mA meter into a perfectly linear and accurate rev. counter for 20/- each any car. State 4 or 6 cylinder.

## FREE CATALOGUE AND LISTS FOR ZENER DIODES TRANSISTORS, RECTIFIERS FULL PRE-PAK LISTS & SUBSTITUTION CHART

MINIMUM ORDER 10/-. CASH WITH ORDER PLEASE. Add 1/- post and packing per order. OVERSEAS ADD EXTRA FOR AIRMAIL.

## MULLARD DATA BOOK

Semiconductor & Valve Data & equivalents. 3/6 EACH  
Postage 6d.

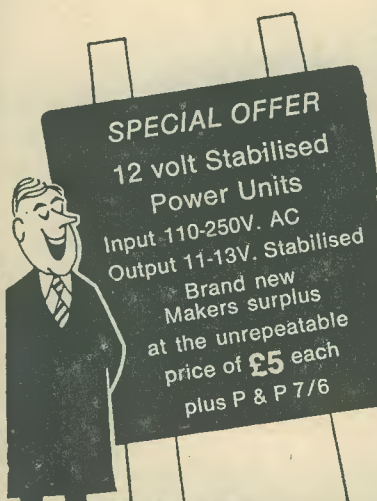

**SPECIAL OFFER**  
12 volt Stabilised Power Units  
Input 110-250V. AC  
Output 11-13V. Stabilised  
Brand new Makers surplus at the unrepeatable price of **£5 each** plus P & P 7/6

**FREE! A WRITTEN GUARANTEE WITH ALL OUR TESTED SEMICONDUCTORS**

**BI-PRE-PAK LTD**

DEPT. C, 222-224 WEST ROAD, WESTCLIFF-ON-SEA, ESSEX  
TELEPHONE: SOUTHEND (0702) 46344

# the BIG one...



# 350

pages

# 8,000

components

# 1,500

illustrations

The HOME RADIO CATALOGUE – the complete and easy answer to the problem of tracking down components. This Catalogue really is a *must* if you are interested in Radio and Electronics. It is one of the largest ever compiled. Also, FREE with each catalogue: a Book Mark giving Electronic Abbreviations, an Order Form and an Addressed Envelope. All for only 8/6 plus 3/6 post, packing and insurance. In addition, every catalogue contains 6 vouchers each worth 1/- when used as indicated.

just a  
phone call  
away



Please write your Name and Address in block capitals.

Name.....

Address.....

HOME RADIO (Components) LTD., Dept RC,  
234-240 London Road, Mitcham, Surrey CR4 3HD



And for users of our Catalogue . . .  
a **CREDIT ACCOUNT SERVICE** to  
simplify and speed up your orders.

You can now order components just by picking up a telephone any time of day or night, including Sundays. No need to bother with postal orders, cheques, registering envelopes, every time you make an order. Special prepaid envelopes and order forms are provided and only one postal order or cheque is required to settle the account each month . . . and no minimum invoice charge. So simple. 8,000 items just as near to you as your telephone. It's well worth the small deposit which enables you to use this Home Radio Deposit Credit Account Scheme. Why not write for more details?



# THE Radio Constructor



Incorporating THE RADIO AMATEUR

NOVEMBER 1969

Vol. 23 No. 4

CONTENTS

Published Monthly (1st of Month)  
First Published 1947

Editorial and Advertising Offices  
57 MAIDA VALE LONDON W9

Telephone 01-286 6141      Telegrams  
Databux, London

© Data Publications Ltd., 1969. Contents may only be reproduced after obtaining prior permission from the Editor. Short abstracts or references are allowable provided acknowledgement of source is given.

Annual Subscription 42s. (U.S.A. and Canada \$5) including postage. Remittances should be made payable to "Data Publications Ltd.". Overseas readers please pay by cheque or International Money Order.

Queries. We regret that we are unable to answer queries other than those arising from articles appearing in this magazine nor can we advise on modifications to equipment described. Queries should be submitted in writing and accompanied by a stamped addressed envelope for reply.

Correspondence should be addressed to the Editor, Advertising Manager, Subscription Manager or the Publishers as appropriate.

Opinions expressed by contributors are not necessarily those of the Editor or proprietors.

Production.—Letterpress.

Miniature Radio 2 Receiver	202
QSO	207
News and Comment	208
Mains-Battery Supply with Automatic Switching (Suggested Circuit No. 228)	210
Suppressed-Zero Voltmeter	212
Automatic Dimmed/Dipped Headlights	214
2-Transistor Converter for 'Ten'	216
Hybrid Transportable Receiver	221
The "Airlane" 7-Transistor Aircraft Band Receiver	224
Can Anyone Help?	234
Measuring Instruments (Understanding Radio)	237
In Your Workshop	242
Radio Topics	249
Radio Constructor's Data Sheet No. 32 (Cube Roots of Numbers)	iii

Published in Great Britain by the Proprietors and Publishers, Data Publications Ltd, 57 Maida Vale, London, W.9.

The Radio Constructor is printed by Kent Paper Company Ltd, London and Ashford, Kent.

NOVEMBER 1969

DECEMBER ISSUE WILL BE PUBLISHED  
ON DECEMBER 1st

201

# MINIATURE RADIO 2 RECEIVER

by

R. D. OWEN

By taking advantage of miniature i.f. transformers, this neat reflexed t.r.f. design provides pre-tuned earphone reception of the BBC Radio 2 programme on 1,500 metres

THE RADIO DESCRIBED IN THIS ARTICLE IS SMALL enough to fit comfortably and unobtrusively in a pocket. It provides fixed station reception of the BBC Radio 2 transmissions on 1,500 metres with a sensitivity equal to that of the average six transistor pocket set, but operating an earpiece instead of a loudspeaker.

The normal line-up for a six transistor superhet is: frequency changer, first i.f. amplifier, second i.f. amplifier, detector, a.f. driver and push-pull output.

Driving an earpiece instead of a loudspeaker cuts the complement of transistors down to four. This can be further reduced to three by reflexing the last i.f. stage. The frequency changer of a superhet gives little amplification and so, by using only two high gain alloy diffused transistors in a fixed-tuned t.r.f. circuit, earpiece performance equivalent to the loudspeaker performance of the average six transistor set can be obtained. The receiver to be described employs the last approach and, for its tuned circuits, uses two

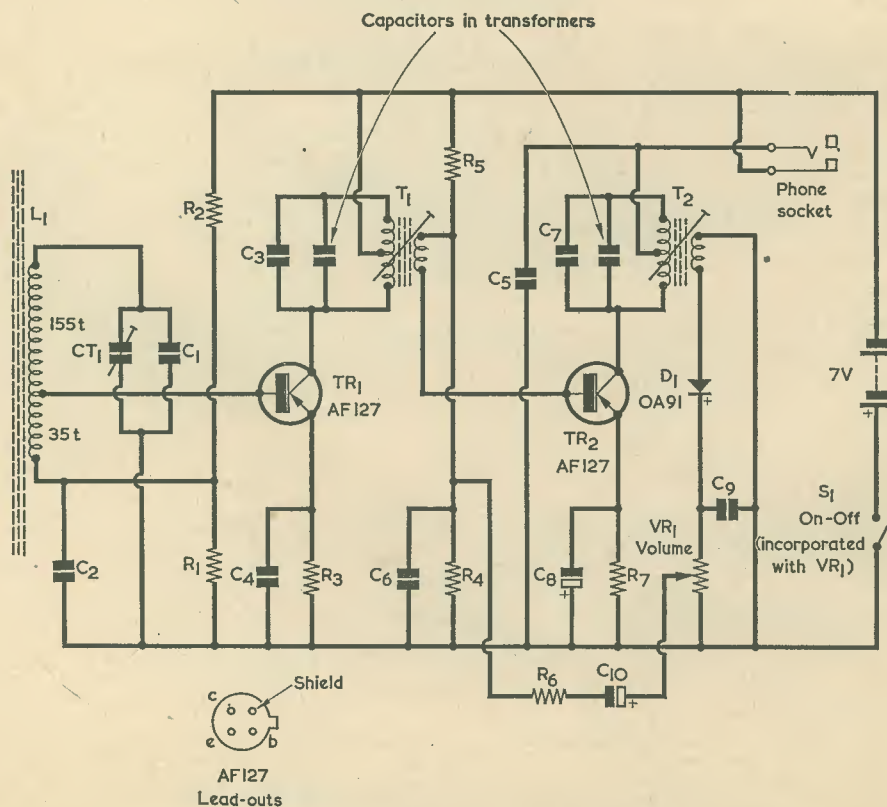
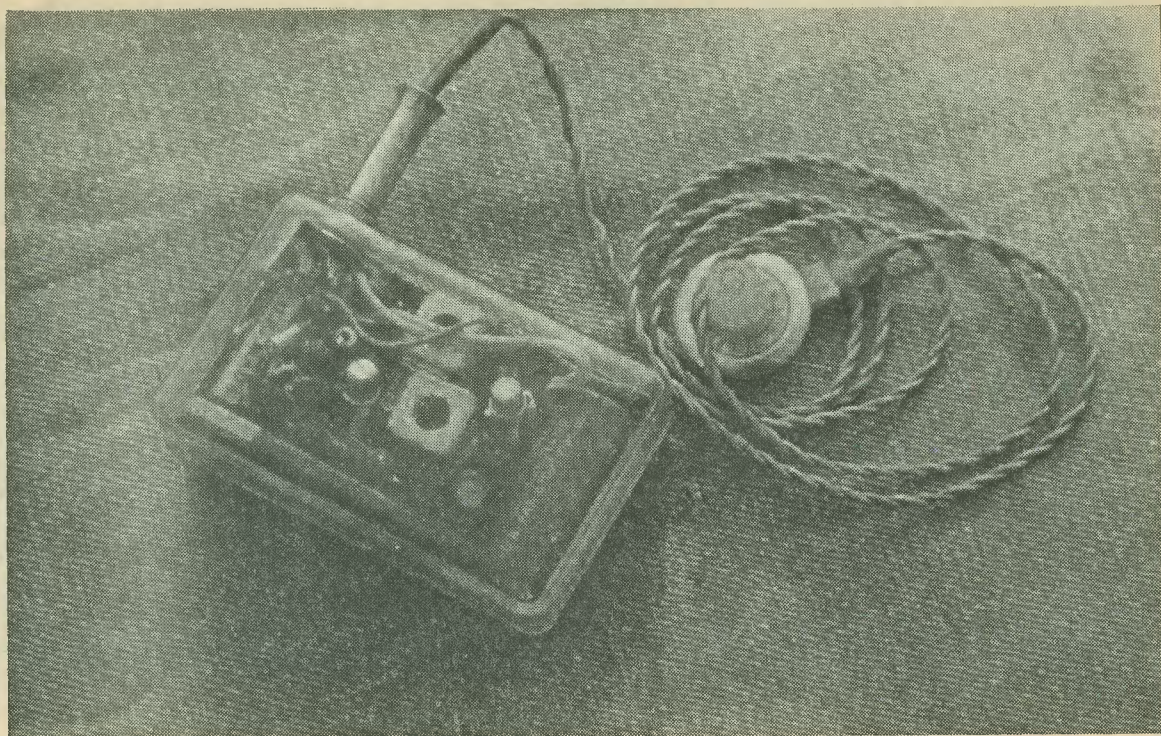

Fig. 1. The circuit of the pre-tuned Radio 2 receiver



Top view of the author's receiver. The i.f. transformers are clearly visible inside the plastic case

single-tuned miniature i.f. transformers with added external tuning capacitance.

The Radio 2 programme is transmitted on a frequency of 200kHz. It is convenient that miniature i.f. transformers can be tuned down to this frequency by the addition of an extra parallel capacitor across the tuned winding. Thus, screened miniature 200kHz tuned circuits are simply produced. By calculation

the extra parallel capacitor requires approximately 4.5 times the value of the existing capacitor already fitted in the transformer. The i.f. transformers employed by the author each needed an extra 1,000pF tuning capacitance, this value giving a tuning range of 160 to 240kHz between the extremes of travel of the iron dust core. The capacitors used were silver-mica types with a tolerance of 10%.

## COMPONENTS

### Resistors

(All fixed values  $\frac{1}{4}$  or  $\frac{1}{2}$  watt, 10%)

R1	12k $\Omega$
R2	56k $\Omega$
R3	1.5k $\Omega$
R4	10k $\Omega$
R5	68k $\Omega$
R6	1k $\Omega$
R7	470 $\Omega$
VR1	5k $\Omega$ potentiometer, log, with switch
S1	

### Capacitors

C1	250pF silver-mica
C2	0.01 $\mu$ F ceramic
C3	see text
C4	0.01 $\mu$ F ceramic
C5	0.001 $\mu$ F ceramic
C6	0.001 $\mu$ F ceramic
C7	see text

C8	30 $\mu$ F sub-miniature electrolytic, 3V wkg.
C9	0.001 $\mu$ F ceramic
C10	1 $\mu$ F sub-miniature electrolytic, 3V wkg.
CT1	100pF mica compression trimmer

### Inductors

L1	see text
T1, T2	see text

### Semiconductors

TR1	AF127
TR2	AF127
D1	OA91

### Switch

S1	s.p.s.t., part of VR1
----	-----------------------

### Earpiece

Magnetic earphone, 1,000 to 3,000 $\Omega$ , or crystal earphone (see text)
Battery (see text)

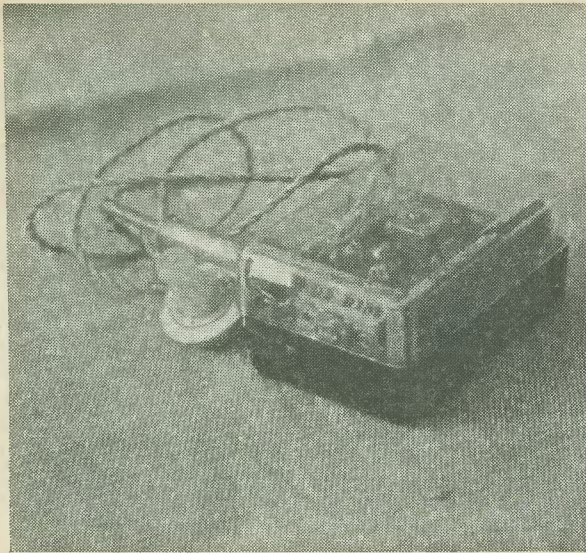

A view from the aerial trimmer end of the receiver

## THE CIRCUIT

The circuit, shown in Fig. 1, is quite straightforward. Signals picked up by the fixed tuned ferrite slab aerial are tapped off and fed to TR1 base. Amplified r.f. at TR1 collector passes through the fixed tuned circuit, T1, to the base of TR2. The signal is again amplified at r.f. and fed through another tuned circuit, T2, to the detector diode, D1. C5 acts as an r.f. bypass for the upper end of T2 tuned winding. The r.f. component in the detected output from D1 is filtered out by C9, R6 and C6. C6 also functions as an r.f. bypass for the earthy end of the base coupling winding of T1. D.C. blocking is carried out by C10, and VR1 acts as detector load and volume control. The a.f. signal is thus fed

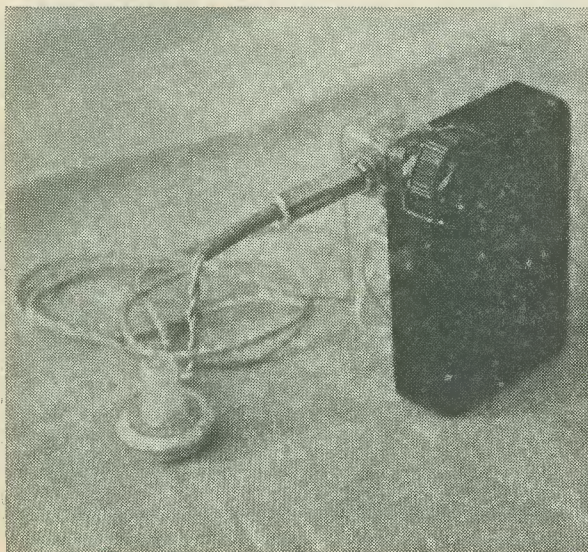

A view from the rear, showing the position taken up by the volume control knob

to TR2 base via T1 secondary winding, whose impedance is negligible at audio frequencies. C8, the emitter bypass capacitor for TR2, is made sufficiently large to prevent a.f. negative feedback. Amplified a.f. is developed across the earpiece in TR2 collector circuit, since at audio frequencies T2 tuned winding has negligible impedance, and C5 presents a high impedance.

The on-off switch S1 is incorporated in the volume control.

Power for the prototype was supplied by a Mallory TR115 mercury battery. However, any convenient 6 or 9 volt battery may be employed instead.

The undistorted output is in excess of 2mW, which is deafening in an earpiece!

## CONSTRUCTION

The author's version of the receiver was built in a plastic case of the type used by B.S.R. to house their crystal pick-up cartridges. Its dimensions are  $2\frac{7}{8}$  by  $1\frac{9}{16}$  by  $1\frac{1}{2}$ . Small plastic boxes of about the same size are widely available, but are slightly weaker.

The components were mounted on a piece of 0.15in. Veroboard, the dimensions and layout for which are shown in Figs. 2(a) and (b). The copper strip breaks can be made by using a sawing action with a sharp knife. The Veroboard was fixed in the case by a single 6BA nut and bolt in a near-central position, as indicated. The case employed has a hole in the base which originally held the pick-up cartridge in place, and this has a recess which will take the filed down head of a 6BA bolt.

It is important to ensure that the metal cans of T1 and T2 are earthed to the positive supply line.

Standard  $\frac{1}{4}$  watt resistors were used, but  $\frac{1}{8}$  watt components would probably facilitate construction, and would still be very conservatively rated. Trimmer CT1 is secured to the board with Araldite.

The ferrite aerial consisted of 190 turns of 36 s.w.g. enamelled copper wire tapped at 35 turns, as indicated in Fig. 1. The wire was wound evenly over 1in. of a ferrite slab measuring  $\frac{1}{2}$  by  $\frac{1}{4}$  by 2in., the slab being taken from a defunct imported radio.<sup>1</sup>

In the circuit as depicted in Fig. 1 the earpiece must be a magnetic type of between 1,000 $\Omega$  and 3,000 $\Omega$  impedance. Alternatively, TR2 collector circuit can be rearranged as in Fig. 3, and a crystal earpiece used instead. Employing this collector circuit, the radio can be connected straight to an amplifier for use as a tuner, or straight to a tape recorder. Audio quality is good.

If the circuitry is left as in Fig. 1 for use with a magnetic earpiece, then the extra load resistor and coupling capacitor of Fig. 3 must be added externally when it is desired to use the unit as a tuner.

## ALIGNMENT

After construction has been completed and checked, connect up the battery. Turn the volume control to maximum. If Radio 2 cannot be heard by adjusting trimmer TC1, a few feet of wire should

1. Henry's Radio offer a ferrite slab measuring  $4\frac{1}{2}$  by  $\frac{1}{4}$  by  $5\frac{3}{32}$ in. which could, with care, be reduced to a length of 2in. Alternatively, the complete slab could be employed with the winding near one end, and the value of C1 reduced experimentally until 200kHz can be tuned in by CT1.—Editor.

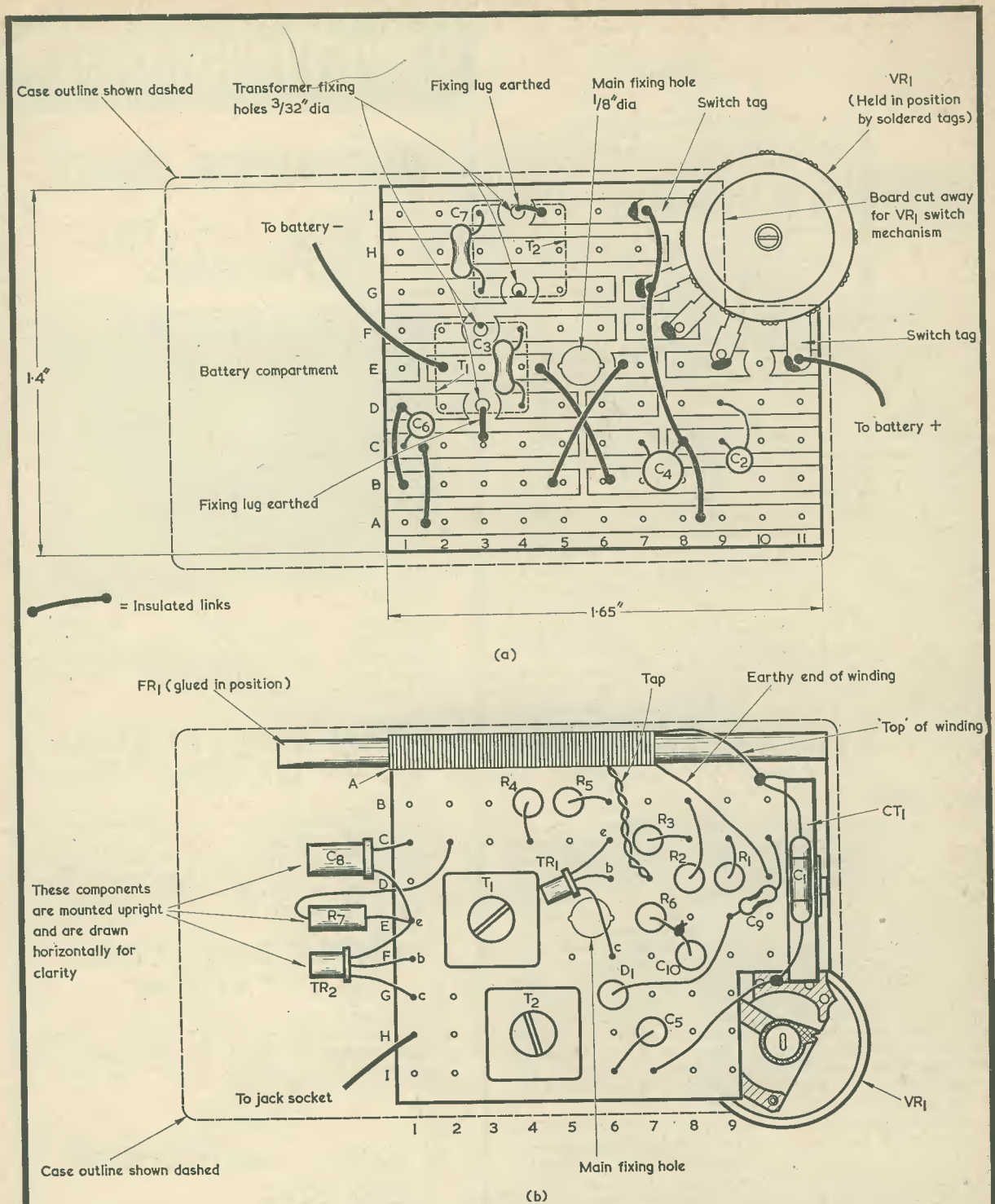

Fig. 2(a). The components in the author's version were assembled on a piece of Veroboard, the copper side of which is illustrated here

(b). The component side of the Veroboard

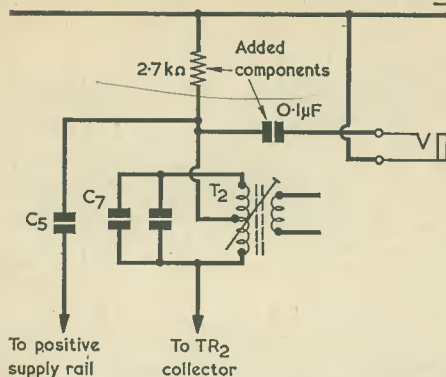

Fig. 3. An alternative output circuit which enables a crystal earphone to be used

be connected to the non-earthly side of L1, whereupon reception of a signal should be ensured. The trimmer, T2, then T1 should be adjusted for best reception, the aerial wire being dispensed with as soon as possible. When the aerial has been disconnected repeat all the adjustments several times until no further improvement can be obtained. Remember that the ferrite aerial is directional and T1 and T2 cores should be adjusted with a non-magnetic tool.<sup>2</sup>

No difficulties due to instability were experienced with the prototype. Should instability appear in a receiver built up to the circuit, add a 10μF electrolytic capacitor of appropriate working voltage between the positive and negative supply rails. The transistor shield lead-outs were left unconnected in the author's version. In the event of instability it may prove helpful to connect these lead-outs to the positive supply rail.

#### Editor's Note

This receiver employs a circuit technique which enables miniature i.f. transformers to be incorporated in a t.r.f. circuit operating at 200kHz (1,500 metres). Any small single-tuned transistor i.f. transformers can be employed, those used by the author being imported 10mm x 10mm x 12mm 465kHz types. Although widely available in component shops, these transformers are not readily obtainable as such from the larger mail order houses (similar transformers appear, however, in the type "C10" set of four superhet coils available from Henry's Radio, Ltd.) and readers who cannot obtain the specific i.f. transformers referred to are advised to use standard British types and make up their own layout around these. Since a few of the other parts (including the case) may similarly not be easily obtainable, the constructional details in this article are presented for guidance only.

2. If the constructor cannot pick up Radio 2, and is uncertain as to the valves required for C3 and C7, considerable time will be saved with the aid of a signal generator. This may be coupled to the base of TR2 via a 0.01μF capacitor and the value of C7 found initially. If both transformers are of the same type, C3 will then require the same value. Both C3 and C7 should be silver-mica.—Editor.

SEE PAGE 236 FOR  
PANEL SIGNS HANDIPAKS

# RADIO CONSTRUCTOR

## DECEMBER ISSUE

### 1MHz. CRYSTAL STANDARD

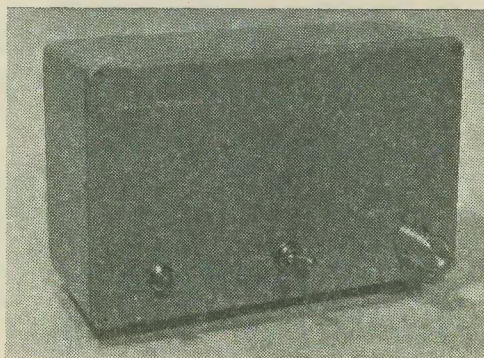

Build this accurate and stable frequency checking unit. Integral power supply (BY100) with voltage stabilisation (OA2). Oscillator circuit employs an EF183 pentode. Checked your receiver calibration lately?

### LIGHT-CONTROLLED TONE GENERATOR

Produces a continual or interrupted a.f. tone whose frequency varies with light intensity. An additional feature is that this solid-state device switches off automatically in the absence of light. Intended for the early riser, it can also be used as an intruder alarm — or provide some fun and games at your Christmas party!

### SIMPLE LOW-COST R-C BRIDGE

Simple circuitry and economy (1 transistor, 1 diode) are combined in this design. It will measure resistance from 1Ω to 1MΩ and capacitance from 330pF to 10μF — how about that!

### PLUS

- OTHER CONSTRUCTIONAL PROJECTS
- DATA SHEET 33
- SUPPORTING FEATURES

ON SALE 1st DECEMBER



# QSLX by

**FRANK A. BALDWIN**  
(All Times GMT)

## ● TOPIC

There are several useful aids one can make good use of at the operating position other than those of ancillary equipments.

One of these, and to the writer's mind the most useful, is the Solariscope. This aid is an instrument designed by Sir Ernest Fisk, a well-known pioneer in the field of Amateur radio. The Fisk Solariscope is of invaluable assistance to the s.w.l. and the instrument consists of a double Mercator projection map in tubular form. Over this is fitted a transparent shadow chart, of which there are a series of four, covering the twelve months of the year. For any given month the daylight and darkness regions of the world may be observed at a glance. The shadow chart is revolved on the tubular map such that the time indicated on the chart corresponds with the GMT prevailing. From the Solariscope it can, for instance, be instantly seen that during the months of February and October, the daylight zone at noon GMT extends to the whole of S. America, the eastern States of the U.S.A. to European USSR, India and the whole of Africa. Darkness, or the shadow zone, occupies the rest of the world.

Stations in the daylight area are often subject to erratic conditions due to sunspot activity, etc. From the use of this instrument, it can be seen at a glance those parts of the world which are in darkness and in which the signal path is less affected than the daylight area.

A further feature of the shadow charts is that they are divided into vertical zones by lines along both the upper and lower edges and are separated from each other by a distance of 15° of longitude. This represents a difference in time of one hour - with a thicker line denoting both noon and midnight. For every place east and west of each particular location the mean time differs and with the aid of the solariscope, the relative mean times at places throughout the world may be instantly seen.

Additionally, both the long and short route signal paths are shown centred upon London, thus the short path from Buenos Aires to London is directly across the S.American continent and the Atlantic. The long

route is via N.Zealand, N.Australia, China, USSR and Finland.

The writer finds the Fisk Solariscope a tremendous aid when planning to receive, for instance, those low-powered Broadcast stations in Asia. The use of the Solariscope predicts the darkness path from Asia to the UK and provides the GMT period during which it is practicable, conditions being favourable, to receive such signals. Thus, during the months of February and October, the Solariscope indicates that a signal from the Indian sub-continent to London, over the short route, has a total darkness path from 1700 to 0030 GMT. Bearing in mind Broadcasting time schedules and the Indian local time, it will be apparent that the peak time to receive signals would be from approximately 1600 to 1700. During this period the signal path is 95% in darkness. Indian local stations tend to close down around 1700 hrs GMT, this representing an Indian local time of 2230.

The Solariscope was freely available on the market some years ago and occasionally one may be seen offered for sale in magazine small advertisements.

## ● AMATEUR BANDS

Conditions on the amateur bands have varied of late from good to not-so-good. Nevertheless, relative Dx has been apparent on the various bands from time to time.

### 1.8MHz

**CW:** GC3LDH/A, GM3CRJ/P, GM3FSV, GM3FXM, GM3HJB, GM3UYF, GM3YOR, GW3GWX, GW3MPB, GW3XJC, K1BPW (1802kHz 0530), OK1AMM, OK1ASD, OK1ATH, OK1KNT, OK1KZH, OK2SUP, OK3CFM, OK3KMW, OK3TOA, OK5SEC, OL1ALM, OL2AKS, OL6AIU, W1EXI (1803kHz 0545), W1BB/1 (1804kHz 0515).

### 3.5MHz

**CW:** K2BZT, K2VOE, W1BGD/2, W3BY, WA1FHU, WA2DQE.

### 7MHz

**CW:** KP4DFA, PY7AZQ, PY7SR, VE3GHO, W2DGJ, W2ELW, WA9LYT, ZS6OS, 8P6AH.  
**SSB:** ZL3GQ, YV4TI.

### 14MHz

**CW:** CR6AI, CR6AL, CR6AR, HP9UC/MM, JA5BXJ, KC4USM (Marie Byrd), KH6AG, KH6GLA, KP4AB, KP4DDO, KZ5BR, OY1X, VK4DU, VK7CH, VP8BK, ZC4CB, ZL1AYH, ZL2AFZ, ZL2QM, ZL4CA, ZS1A, 8R1J, 8R1PE.

**SSB:** CR6IV, CR6LX, EP2BQ, HC1RJ, HC1RM, HI9DL, HK3AVK, HK3BED, HK4BS, K6JGS/P/HKØ (San Andres), KG4AA, KG4AL, KP4AST, KV4AA, VK3ANZ, VK3II, VK3XB, VK7RX, VP2VI, VP8JT, XE1DX, XE1FP, ZE3JC, ZC4AK, 5Z4LW, 9J2BR.

### 21MHz

**CW:** CR6AL, CR6LK, EL8RL, JAØAJH, JAØYAK, JA1ODC, JA7BA, KZ5IS, VK5DS, 6W8GE, 6W8XX, 9Q5YP.

## ● BROADCAST BANDS

The season for reception of Far Eastern and Asian stations is now in full swing and enthusiasts wishing to log stations in these areas should initially listen on 4790kHz around 1530 to 1630 for Penang, Malaysia (10kW) to ascertain reception conditions prevailing at the time of operations.

**3260kHz 1928** Radio Niger, Niger, with talk in vernacular.

**3320kHz 1922** Paradys, South Africa, with a programme of songs.

**3380kHz 1910** Blantyre, Malawi, with African songs and music. Continuous heterodyne on channel.

**4680kHz 0525** HCWE1 Radio National Espejo, Ecuador, with Latin American songs and music.

**4725kHz 1628** Rangoon, Burma, with native songs and music. Teletype QRM on channel.

**4740kHz 1630** Radio Maldives, Maldivo Rep., with talk and 'commercial' in English. CW QRM.

**4760kHz 1625** All India Radio, Delhi, India, with typical Eastern type music.

**4770kHz 0420** YVQE Radio Bolivar, Venezuela, with Latin American music.

**4775kHz 1620** All India Radio, Gahauti, India, with sitar music.

**4790kHz 1610** Penang, Malaysia, with songs in vernacular. Station identification "Ini-lah Penang" at 1613.

**4800kHz 1648** All India Radio, Hyderabad, India, with programme of Indian songs and music. Continuous heterodyne on channel.

**4839kHz 1835** Bukuvu, Congo Dem. Rep., with African songs and music.

**4844kHz 1840** Gaberones, Botswana, with African drums and chants.

**4904kHz 2050** Fort Lamy, Chad, with choral music. This station appears to operate intermittently.

**4950kHz 1655** Radio Malaysia, Sarawak, with songs and music, in Eastern style. CW QRM. Tentative logging.

**4968kHz 1650** Colombo, Ceylon, with native songs and music.

**4990kHz 1655** All India Radio, Delhi, India, with talk in vernacular.

**21690kHz 1840** Radio Kuwait, with Arabic songs and music.

**21455kHz 1900** Lagos, Nigeria, with news commentary and identification in English.

## PORTABLE UNIT RAPIDLY ALIGNS INSTRUMENTATION TAPE RECORDERS

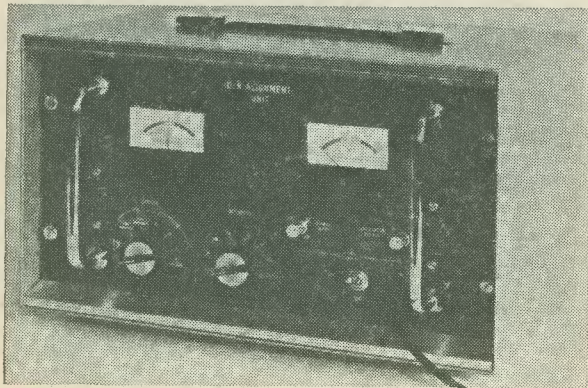

A new alignment device, which is claimed to reduce by approximately a factor of ten the time required for setting up multi-channel instrumentation tape recorders, has been developed by James Scott (Electronic Engineering) Ltd., of Glasgow. The unit shown above, also shown in use below, combines in a small case measuring 14.34in. x 9.31in. x 8.37in. (364mm x 237mm x 213mm) all the signals and measuring circuits necessary to align the record and reproduce amplifiers of D.R. (direct record) systems operating in the I.R.I.G. (Inter Range Instrumentation Group) intermediate band. A 14-channel tape recorder can be aligned in under 30 minutes, compared with the normal requirement of up to half a day when using standard laboratory equipment.

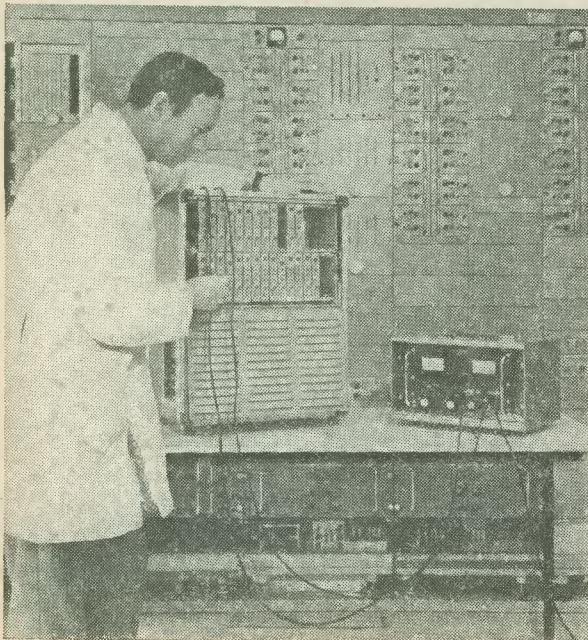

## AMSAT – RADIO AMATEUR SATELLITE CORPORATION

At a meeting of the Communications Satellite Corporation Radio Club in January last at Comsat in Washington, U.S.A., George Jacobs, W3ASK, suggested the formation of an East Coast based group to build new Communication Satellites for amateur radio use. He drew attention to the fact that there were in the Washington D.C. area a considerable number of radio amateurs employed by Government and Industrial laboratories associated with Satellite Communication activities, who could contribute very materially to the successful formation of such a group. As a result of this suggestion, AMSAT was formed.

This organisation has the backing of many famous centres of space system expertise. The organisers of Project Oscar also welcomed the formation of AMSAT, to whom they offered whatever help they could give.

Briefly, AMSAT is a non-profit making, scientific and educational organisation whose purpose is to provide satellites for experimentation and communication by radio amateurs throughout the world. It hopes to design, build and launch communication satellites to operate in the VHF and UHF amateur bands, and to encourage and sponsor similar activities by other amateur radio clubs, groups and organisations. They hope to be able to obtain surplus equipment from completed space projects for conversion to amateur radio satellite use. Two classes of membership have been designated: Class A for individual members, and Class B for clubs, groups and organisations. Membership is open internationally to any person or group indicating an interest in supporting the purposes, objectives and activities of the Corporation. A Newsletter has already been started, the first number appearing in June last.

The first major activity of AMSAT will be the launching of "AUSTRALIS OSCAR", a 35lb. satellite constructed by a group of Australian radio amateurs. This satellite was to have been launched by the "Project Oscar" group on the West Coast of U.S.A. but they were unable to find suitable launching facilities. It is interesting to note that an approach is to be made to AMSAT by the IARU Region 1 Oscar Project organisers to see if they can help with the transponder satellite constructed by DJ4ZC.

AMSAT intends to finance its activities from membership subscriptions and grants from sympathetic organisations. The subscription for individual members is five dollars per annum, for clubs and groups the subscription is ten dollars p.a. The address of AMSAT is: P.O. Box 27, Washington D.C., 20044. The British representative is G2AOX, Wm. Browning, 47 Brampton Grove, London, N.W.4., who it will be remembered was the UK and Eire Oscar Project Co-ordinator.



# COMMENT

## SPRAYED-ON CENTRAL HEATING

Electric central heating panels may soon be sprayed on walls like paint. Work on new materials by Britain's Paint Research Station suggests that this idea is now becoming commercially practicable.

Reporting in a BBC broadcast, our contributor George Short said that workers at the Paint Research Station tried out sprayed-on central heating in their own recreation room. They sprayed an area of 80 square feet on a wall, and passed an electric current through the film of special paint. This produced about as much heat as a 2-kilowatt electric fire.

What are the advantages? Convenience, certainly – it is handy to be able to spread heating elements over walls, especially as, with this system, you can still decorate the walls afterwards. Comfort, too. A large area radiating gentle heat is better than a small source of intense heat. Finally, capital economy. Estimates suggest that the cost of installing the new system is no more than that of installing a conventional electrical central heating system.

The new system is a low-voltage one, operating at not more than 40 watts. This makes for safety, but it does put up the cost by making necessary the use of a large transformer to step down the mains voltage. But there could be economies here if the system caught on and large transformers were produced in bigger quantities than they usually are.

What is the "central heating paint" made of? The Paint Research Station isn't saying, but it is black, which suggests carbon, and there seem also to be an inference that it contains silicate materials.

### QUOTE

"The performance of the human brain's operating system makes the most advanced computer system look ridiculous."

Professor Gordon Black of Manchester University, formerly director of the National Computing Centre.

### 21st ANNIVERSARY

The British Amateur Television Club will be celebrating its 21st Anniversary next year. To mark the occasion there will be a special convention in Cambridge.

The convention will be held on Saturday and Sunday, 25th and 26th July 1970, and accommodation where required will be provided in Churchill College. Details of the programme, costs of accommodation, etc. will be issued later this year.

NOVEMBER 1969

## THE LAST OF A LINE OF OVER 10,000,000 RECORD CHANGERS



On Tuesday, September 2nd, at 1.15 p.m., the last of the world-famous UA.15SS and UA.25 record changers rolled off the production lines of BSR.

Since its introduction in 1963, over 5½ million UA.15SS units have been produced by the company, the largest manufacturer of record changers in the world. The UA.25 made its appearance a year later and, on discontinuation, over 4,840,000 units had been produced.

Replacing the UA.25, the new C109 is an automatic record changer with a large 10½ in. turntable and manual record size selection. This dependable unit is available with a choice of tubular or moulded arm, and either a battery or mains-operated motor.

The UA.15SS changer is being replaced by the impressive C110 automatic turntable model. A record changer unit that will add a sophisticated appearance to any audio unit or radiogram, the four-speed C110 includes manual record size selection, brushed aluminium turntable trim, a heavy pressed-steel, large diameter turntable, and a lightweight cartridge shell.

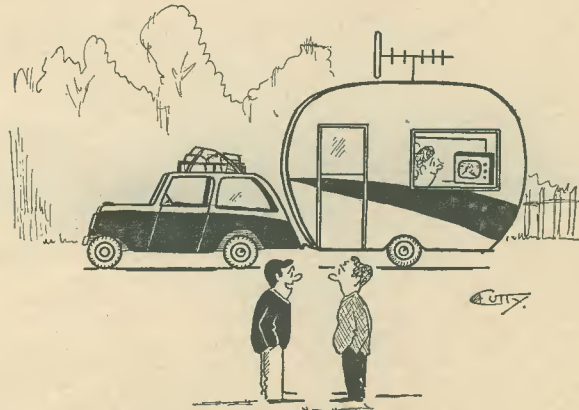

"... and the interference is shocking every time we pass a house"

# MAINS-BATTERY SUPPLY WITH AUTOMATIC SWITCHING

by G. A. FRENCH

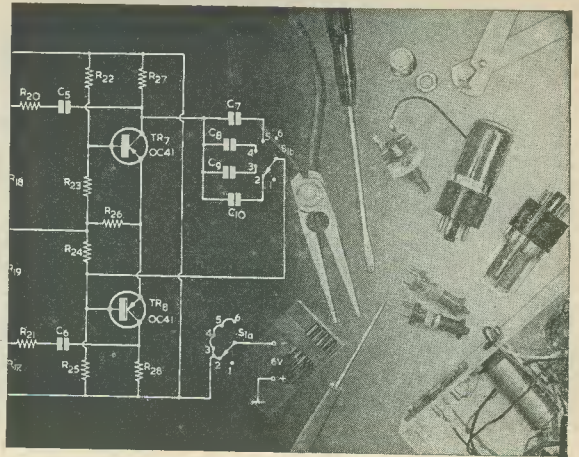

SOME YEARS AGO THE AUTHOR devoted an article in this series to transistor equipment power supply circuits which were capable of switching over automatically to battery operation in the event of mains failure.\* A number of circuits were discussed, the last and probably the best being one in which a power transistor operated as an emitter follower when the mains supply was applied, but which changed function and provided a forward-biased emitter-base junction to allow the passage of battery current when the mains supply was disconnected. This circuit had the disadvantage that a current of several milliamps could be drawn from the battery when the mains supply was applied.

The circuits aroused some interest amongst readers at the time and the writer decided that it would be of value to return to the circuit using the power transistor at a later date to see whether it could be improved. The present "Suggested Circuit" represents the result of this later investigation and is offered as a power supply for transistor equipment operating at 9 volts and drawing a current between 5 and some 50mA. Such a category includes most transistor radio receivers, as well as transistorised baby alarms, intercom amplifiers, and similar equipment.

## POWER SUPPLY CIRCUIT

The present version of the circuit appears in the accompanying diagram. It takes up some of the basic points in the previous design, but now includes an extra transistor. A current is still drawn from the battery when the mains supply is connected but this is now much smaller.

Let us first examine the circuit when the a.c. mains supply is applied. When S1(a) (b) is closed the mains supply is connected to the primary of T1, causing a secondary voltage of 12.6 to be fed to rectifier D1 and reservoir capacitor C1. A rectified and unsmoothed voltage is then applied to the collectors of TR1 and TR2, these being connected as a Darlington pair. The base of TR2 connects to the negative terminal of 9-volt battery B1, and the two transistors function as a composite emitter follower, with the result that slightly less than battery voltage is applied to the receiver or equipment circuits. A current is drawn from the battery. Ignoring transistor leakage current and the presence of R1, this current is equal to the current taken by the receiver or equipment circuits divided by the product of the gains of the individual transistors.

Since the output voltage applied to the receiver circuits is controlled by the potential of the battery, it follows that this output voltage will be well regulated. The regulation is still maintained at the ripple frequency in the unsmoothed supply from C1, whereupon the ripple on the output voltage at TR1 emitter becomes negligibly low. Thus the two transistors, in combination with the battery, not only offer a stable direct voltage but also provide a high level of smoothing as well. No other smoothing components are required.

If, whilst S1(a) (b) is closed, the a.c. supply is removed, the rectified voltage across C1 disappears. TR1 and TR2 now cease to act as a composite emitter follower. Instead, they allow forward current to pass from the negative terminal of the battery to the receiver or equipment circuits via their base-emitter junctions. Should the mains supply be re-applied, TR1 and TR2 resume their previous function as a

composite emitter follower, and allow the supply current to be obtained from the a.c. mains once more.

To sum up, the supplied receiver, or other equipment, is switched on and off by S1(a) (b). When the a.c. mains is applied, this provides virtually the whole output current. When the a.c. mains is disconnected, the output current is automatically taken from the battery. There is no break in the supply when changing from battery to mains supply or vice versa. The only disadvantage with the circuit is that a very small current continues to be drawn from the battery when the power supply operates from the mains.

## CIRCUIT NOTES

Despite its apparent simplicity, the power supply circuit incorporates several points which require a little further explanation.

It is desirable for TR1 and TR2 to be germanium rather than silicon transistors. If silicon transistors were employed there would be a drop of some 0.5 volts across each base-emitter junction for both the mains and the battery supply functions, and such a drop is too high for the present application. The voltage drop across the two germanium transistors employed is much lower, and is quite acceptable for most practical purposes.

Both TR1 and TR2 are specified as OC36, this being a power type with a maximum total dissipation figure of 30 watts. To employ such a large transistor in an application where the total current requirement is only 50mA might seem to be the electronic equivalent of using a sledge-hammer to crack a nut. However, the reason for specifying the OC36 for TR1 and TR2 is that the receiver or equipment being supplied will almost inevitably have a

THE RADIO CONSTRUCTOR

\* "Automatic Mains-Battery Supply Circuits", Suggested Circuit No. 191, *The Radio Constructor*, October, 1966.

large-value electrolytic capacitor across its supply rails, whereupon a heavy surge current can flow from the battery through the transistor base-emitter junctions if S1(a) (b) is closed without a mains supply connected. As checked by the writer, the short-circuit current capability of a brand-new PP9 9-volt battery is about 1.2 amps and, whilst it is doubtful whether quite so high a current would flow at the instant of connecting such a battery to a discharged large-value electrolytic capacitor, it would seem reasonable to assume an instantaneous surge current of some 500mA or more. Taking the last point into account and making the further assumption that a battery with a greater current capability than the PP9 may be used in the present circuit, it was decided to specify the OC36, which has a maximum instantaneous base current rating of 2 amps. The use of this transistor for TR1 and TR2 gives an adequate safety margin for surge currents and obviates the necessity for limiter resistors in the battery supply circuit.

If desired, other transistors from the OC28 series (i.e. OC28, OC29 or OC35) may be employed instead of the OC36. The OC28 and OC35 have somewhat lower gain figures than the OC29 and OC36, and might cause marginally increased currents from the battery when the mains supply is applied.

Because of leakage current in TR2, it is recommended that the receiver or equipment circuits supplied draw a standing current of 5mA or more. Such a current will inevitably be drawn by normal transistor receivers and amplifying equipment. The reason for this recommendation is that, at very low load currents, there is a tendency for the output of the power supply to rise above 9 volts due to amplified leakage current in TR2. With the prototype circuit this tendency existed for output currents of less than 1mA, and the writer has arbitrarily chosen the higher 5mA figure to allow for variations in TR2 leakage current when the unit is in use. Resistor R1 bypasses a small leakage current which might otherwise flow into the battery for low load currents. It also ensures that the output voltage is less than 9 volts at low load currents if the battery should happen to become disconnected whilst the mains supply is applied.

Switch S1(a) (b) is the on-off switch for the supplied receiver or equipment. If the latter is already fitted with a double-pole on-off switch which is suitable for mains voltages this could be employed for S1(a) (b). It must be pointed out, however, that the on/off switches on many transistor receivers and other equipment are not suitable for mains voltages, and that such

switches must not be incorporated into the present circuit. Instead, a separate switch suitable for mains voltages must be added. As examples, the on-off switches on miniature edge-operated volume controls or push-button wavechange assemblies are not suitable for mains voltages and these must not be employed in the power supply circuit.

The transformer used in the prototype circuit for T1 was a small heater transformer having two 6.3 volt windings which were connected in series to provide 12.6 volts. Any small mains transformer with an isolated secondary offering about 12 volts will be satisfactory. The simple and inexpensive half-wave rectifier circuit offered by D1 and C1 is quite adequate at currents up to 50mA, bearing in mind the high level of smoothing offered by TR1 and TR2.

## CONSTRUCTION AND TESTING

The construction of the power supply should offer few difficulties and the components may, in some cases, be installed inside the cabinet of the supplied equipment. Neither of the transistors need be mounted on a heat sink as the maximum dissipation (in TR1) is only of the order of  $\frac{1}{4}$  watt. Nevertheless, it would be to advantage not to fit the transistors close to T1 if the latter is a very small component which may run warm, as increased temperature can cause a rise in transistor leakage current.

When the supply circuit has been assembled and checked, it should be tested. It is desirable to employ a new battery for this process. First connect a 180 $\Omega$  1 watt resistor across the output terminals, this representing a 50mA load at 9 volts. The

output voltages across this resistor for mains and battery operation should be similar to those obtained with the author's prototype (which are given later in this article). Next repeat the process with a 1.8k $\Omega$   $\frac{1}{4}$  watt resistor, to represent a 5mA load.

Finally, connect a 10k $\Omega$   $\frac{1}{4}$  watt resistor across the output. This causes a load current of slightly less than 1mA to flow. If, with the mains applied, the output voltage is higher than battery voltage with the battery connected, or higher than some 4.5 volts with the battery disconnected, reduce the value of R1 until both these requirements are satisfied. From experience with the prototype it is doubtful if R1 will need changing in value unless a transistor with a particularly high leakage current is fitted in the TR2 position, or if TR1 has an unusually high gain.

## RESULTS WITH THE PROTOTYPE

The prototype was checked out with a new PP9 battery in the B1 position. For the 50mA load, the output voltage was 9 volts for mains operation and 8.6 volts for battery operation. At 5mA load, the output voltage was 9.4 volts for mains operation and 9.25 volts for battery operation. These last figures were maintained with the 10k $\Omega$  load resistor, and the output voltage dropped to around 3 volts for this load when the battery was disconnected with the mains applied. It will be noted that the output voltage falls slightly when changing from mains to battery, this being due to the change in function of the two transistors.

For mains operation with the 50mA load, battery consumption

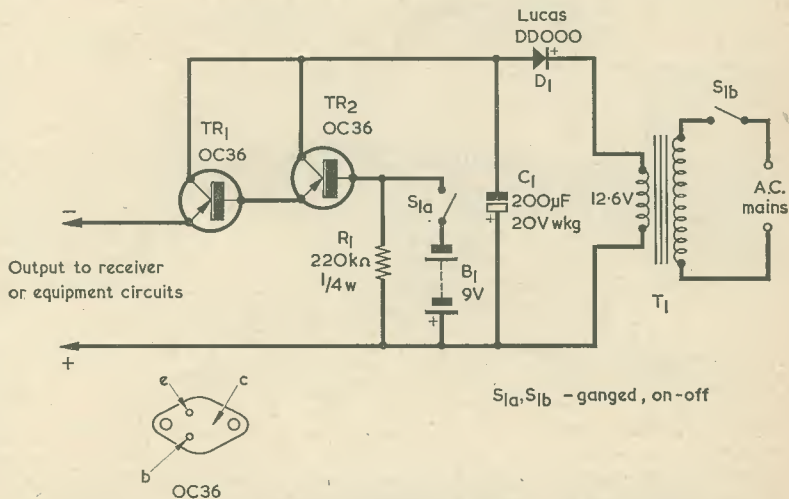

The circuit of the mains-battery power supply. This changes automatically to battery operation if the mains supply is disconnected, and vice versa

was 0.1mA. When the 5mA load was connected battery consumption fell to 0.04mA.

The power supply was next coupled to a standard 9-volt transistor superhet receiver. This operated normally both for mains and battery supply, there being no interruption in its performance when changing from mains to battery or vice versa. There was no trace of hum in the output of the receiver when the a.c. mains was applied to the power supply.

### FINAL POINTS

Two final points need to be mentioned.

Apart from ensuring that the out-

put voltage does not rise above 9 volts, the setting-up procedure involving R1 which has just been described also ensures that no reverse current flows in the battery when operating from the mains supply. This reverse current would be due to leakage current in TR1 and would be of the order of tens of microamps only. Such a current represents a "charging" current and despite its small value could conceivably result in the liberation of gases in the battery, or other damage, if allowed to continue for a very long time. Provided the setting-up procedure for R1 just described has been followed, and provided that the power supply always subsequently has a load current of 5mA

or more drawn from it, the current in the battery will be in the discharge direction. This fact can, of course, be checked by inserting a meter in series with the battery.

There was no evidence of modulation hum (i.e. hum which is only evident with received carriers) when the prototype, operating from the mains supply, was connected to the transistor receiver. If modulation hum does occur it should be capable of being cleared by reversing the connections to the a.c. mains. If the transformer used for T1 has an electrostatic screen (which is intended, amongst other things, to combat modulation hum) this should be connected to the positive rectified supply line.

# SUPPRESSED-ZERO VOLTMETER

by

R. M. MARSTON

A voltmeter to indicate the voltage of its battery is a useful adjunct in any car. This article describes how a 0-5mA meter may be employed as a battery voltmeter for 12-volt cars, an added attraction being that full scale range extends from some 10 to 16 volts only

A USEFUL ACCESSORY IN ANY CAR IS A PANEL-mounted voltmeter for indicating the state of the battery. Fig. 1 shows the circuit and scale of a conventional voltmeter as could be used for this application. Note that the scale reads all the way from zero to 16 volts. Now, the actual voltage of a car battery in good condition is nominally about 12.6 volts, but may in practice vary between about 10 volts and 16 volts, depending on the state of the battery and its charging circuit. Only the final three-eighths of the scale of the conventional voltmeter of Fig. 1 is thus of practical value, the remaining five-eighths serving no useful purpose.

Fig. 2 shows the circuit and scale of an alternative type of voltmeter, in which all voltages below 10 volts are suppressed; the scale reads voltages in the range 10 to 16 volts only. The full scale length of the meter is thus put to practical use.

This type of instrument is known as a 'suppressed-zero' voltmeter, and its operating principle is very simple. The 10 volt zener diode ZD1 and multiplier resistor R1 are wired in series with the 5mA f.s.d. current meter. At voltages less than 10 volts ZD1 is non-conductive, and zero current passes through the meter. At potentials above 10 volts, on the other hand, ZD1 conducts and has 10 volts developed across it, the remaining voltage being developed



(a)

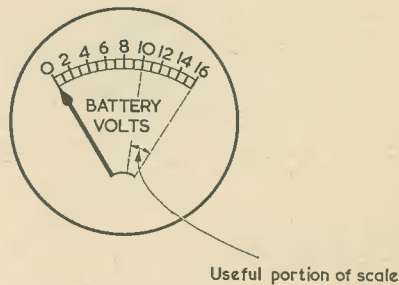

(b)

Fig. 1(a). A car battery voltmeter using a 0-5mA meter movement could be made up as shown here

(b). The meter will read from zero to 16 volts, whereupon only a fraction of its scale is of use

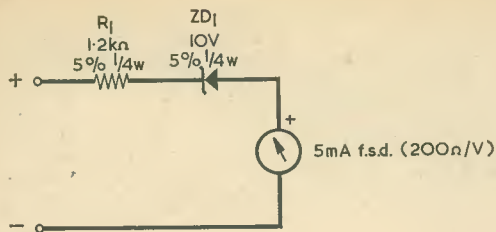

(a)

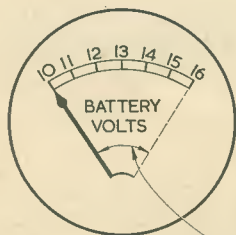

Useful portion of scale

(b)

Fig. 2(a). Inserting a 10 volt zener diode causes the meter to give zero deflection for voltages below about 10 volts

(b). The meter of (a) has a totally useful scale as is shown, in idealised form, here

across  $R_1$ . The current through  $M_1$  is then equal to this remaining voltage divided by the value of  $R_1$ . A 5mA f.s.d. meter has a basic sensitivity of  $200\Omega/\text{volt}$ , so  $R_1$  is given a value of  $6 \times 200\Omega = 1.2k\Omega$ , to give an f.s.d. range of 6 volts, i.e. a reading range of 10 to 16 volts.

## CONSTRUCTION AND USE

Construction of the unit is perfectly simple, and  $R_1$  and  $ZD_1$  can be wired directly to the meter

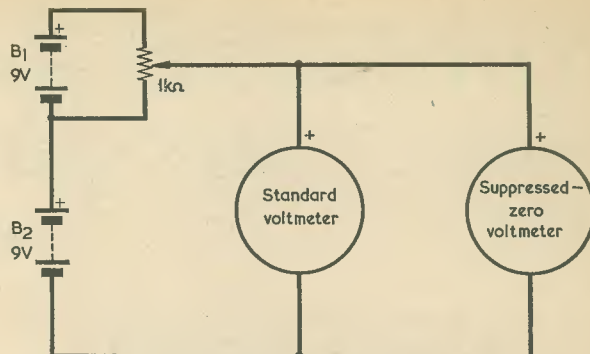

Fig. 3. The suppressed-zero voltmeter is calibrated against a standard meter with the aid of this test set-up

terminals. Take care to connect  $ZD_1$  in the correct polarity. When construction is complete, the suppressed-zero voltmeter can be calibrated against a standard voltmeter using the circuit shown in Fig. 3. Calibration is necessary because  $ZD_1$  will not become conductive at *exactly* 10 volts but at a voltage, within its tolerance, which is close to 10 volts. The old scale markings can be removed with a scraper or sharp knife, and the new ones put on with marking ink.

When construction and calibration is complete, install the meter in the car and connect it to the vehicle's battery via the ignition switch, taking care to connect the meter leads in the correct polarity.

When using the meter, note that the 'correct' voltage of the battery is about 12.6 volts. If the battery readings are consistently less than 11 volts, suspect a faulty battery cell; if readings are consistently in the range 11 to 12.5 volts, suspect a faulty dynamo. Finally, if readings are consistently above about 14 volts, suspect a defective voltage regulator.

(A suitable 10 volt zener diode is the type Z10, available from Henry's Radio, Ltd.—Editor).

## BATTERY CASES IN BP POLYSTYRENE

Premier Injection Mouldings Limited are now using BP Polystyrene to produce parallel-sided cases for 'Nife' batteries. The development of injection moulding techniques for these tall rectangular boxes, which are completely taperless and have a wall thickness tolerance of only 0.005 in., represented a significant advance in plastics engineering. After much field testing, Premier have found that BP Plastics CP 90 grade of polystyrene is the ideal material for this application.

High impact strength, easy mould-flow properties and good translucency (for quick visual inspection of electrolyte level) were the main requirements; a difficult combination of properties to achieve in a relatively inexpensive thermoplastic material, but BP Polystyrene has proved completely effective on all counts.

Nife batteries are made by Alkaline Batteries Limited of Redditch, Worcs., for use in emergency power supplies, boats, caravans and the like. The parallel sides of the box permit easy side-stacking without movement or wasted shelf space, and easy insertion of the battery functional components.

Premier Injection Mouldings Limited of Newhaven, Sussex (a subsidiary of Judge International), hold patents on the manufacture of parallel-sided mouldings above 6in. in length.

BP Polystyrene is manufactured and marketed by BP Plastics, Devonshire House, Piccadilly, London W1X 6AY.

# AUTOMATIC DIMMED/DIPPED HEADLIGHTS

by

D. G. FRIPP

Intended for the reader who is familiar with car electrics, this article describes an ingenious circuit modification which allows dipped and dimmed headlights to become available at driving speeds

SOME YEARS AGO THE AUTHOR BECAME AWARE THAT driving a car on sidelights alone was not perhaps as safe as it might appear, although complying with statutory regulations at their minimum. It was felt that more light was needed spread over a larger area, to be seen with rather than to see by. Attention was therefore given to a dipped/dimmed headlight modification, since full brilliance dipped headlamps tend to produce a certain amount of glare under certain conditions, such as occur with wet roads, etc., and can be especially troublesome to pedestrians. They also seem somewhat out of place on fairly well-lit roads.

Several schemes were evolved with varying degrees of success, the latter being mainly concerned with their operation for if one forgot to operate this switch or that the facility was not operational just when it should have been.

## FINAL CIRCUIT

Fig. 1 shows the final circuit in a basic lighting diagram applicable to most cars. This circuit overcame all previous drawbacks, since it is very simple to instal and operation is virtually automatic. It has been fitted to a number of different cars with equal success and has given complete satisfaction on the first vehicle so fitted for nearly five years to date.

From the diagram it can be seen that the relay coil is connected, in effect, in parallel with the generator output, thus operating only at driving speeds, i.e. in the same manner as the cut-out. By connecting the earth return of the relay coil via the main beam filaments the relay is automatically released when the main beam switch is operated. Similarly, by taking the feed to the resistor for the dimmed/dipped headlamps from the sidelights feed after the switch, operation of the normal dipper switch to the dipped position short-circuits the resistor, allowing normal brilliance.

At idling engine speeds, therefore, only the sidelights are on, which is an added safety factor at traffic lights and halts, since headlights, dimmed or otherwise, should not be alight on a stationary vehicle.

For 12 volts systems the dimming resistor needs to be approximately  $0.6\Omega$  at 20 watts for 40 watt dipped filaments, and about  $0.75\Omega$  at 15 watts for 36 watt dipped filaments. These values cause both types of lamp to operate at slightly over half power.

For 6 volt systems, the resistor may be  $0.2\Omega$  at 15 watts with 36 watt bulbs.

## RESISTOR CONSTRUCTION

The actual construction of the resistor is left to the individual. As a pointer, a piece one twenty-fifth of the total length of a 1kW 240 volt fire spiral element gives a resistance of  $2.4\Omega$ . Four such pieces cut off and arranged in parallel give  $0.6\Omega$ . The wire can be wound on any suitable ceramic former, such as a portion of a pencil type element.

Alternatively, the wire may be wound on mica of, say,  $\frac{1}{16}$  in. thickness, sandwiched between two other pieces of mica somewhat larger in size but of half the thickness, the whole sandwich being then

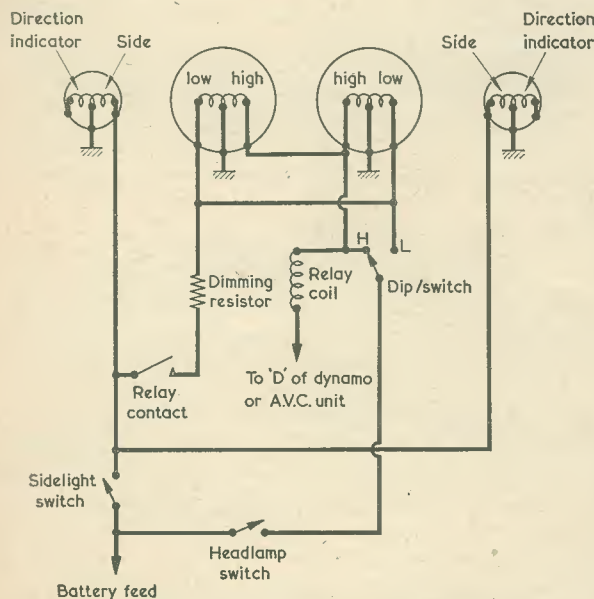

Fig. 1. The circuit for automatic dimmed/dipped headlamps. It is applicable to either polarity

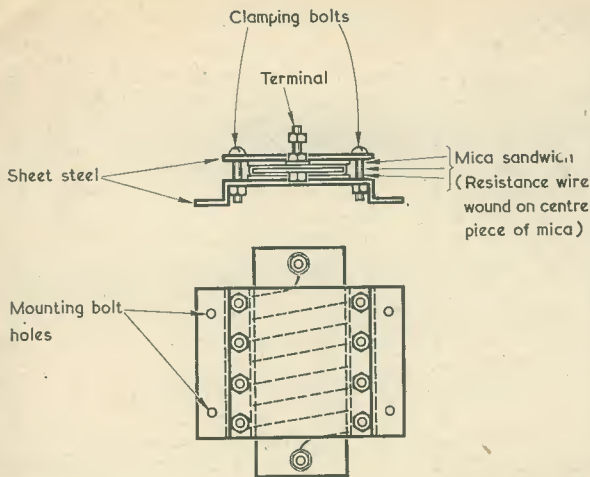

Fig. 2. One method of making the dimming resistor

clamped between sheet steel plates. The assembly is then attached by self-tapping screws to some convenient part of the engine bay, the ends of the wires being securely clamped between washers held tight by nuts and bolts which also form the terminals. The general construction is shown in Fig. 2. Such a resistor is just warm to the touch even after three hours' continuous use as it uses the metalwork of the car as a heat-sink.

One neat and successful resistor was made, by the writer, from a portion of a mains dropper which had gone open-circuit. The coating, windings and tag straps were removed and the former cut to size (2in. long in this case) by grinding. New tag straps were made of sheet brass  $\frac{1}{4}$ in. wide, these being pierced and shaped on one end to accept snap-on connectors and fixed around the former by 6BA nuts and bolts. Four lengths of electric fire spiral, obtained in the manner just mentioned, were lightly twisted together and had their ends brazed to the straps before they were finally fitted to the former<sup>1</sup>. Excess threads were trimmed from the bolts and the whole resistor assembly was given a liberal coating of fire cement. See Fig. 3. The cement was allowed to dry slowly and thoroughly before the resistor was put into use, mounted on small angle brackets in the car engine bay. Such a resistor may, however, be beyond the facilities of some constructors.

Alternatively, a number of wirewound manufactured resistors may be purchased and used in a combination network to give the desired result.

A typical example is given by using, for the 0.6 $\Omega$  20 watt resistor, six 1 $\Omega$  5 watt resistors. Two banks of three in parallel (giving 0.33 $\Omega$ ), with the banks in series, provide 0.66 $\Omega$  with wattage to spare.

Again, four 3 $\Omega$  5 watt resistors in parallel would be satisfactory for the 0.75 $\Omega$  resistor. Also, the 0.2 $\Omega$  resistor could be given by eight 0.5 $\Omega$  3 watt resistors (each giving 0.125 $\Omega$ ), the two banks in series resulting in 0.25 $\Omega$ .

1. It is in order to twist the four wires together, to form what is in effect a single stranded resistance wire, in this and the mica resistor assembly because the four individual wires will have an equal potential gradient along their lengths and current will not flow from any one of them to its neighbours.—Editor.

No doubt constructors will think of many other combinations to suit their own requirements, but these networks are not inexpensive and a purpose-made resistor of adequate size is preferable and is less hazardous<sup>2</sup>.

Care must be taken how and where networks of manufactured resistors are mounted, as some makes run quite hot when dissipating their rated power. It must also be remembered that in a 12 volt system, according to the condition of the battery, generator and voltage control unit, the system voltage can rise to over 14 volts, which means an increase in the wattage handled by the resistors. It is in consequence wise to err on the generous side in the interests of cool operation.

## THE RELAY

The relay for 12 volt systems may be almost any type with one make contact capable of carrying a minimum current of 5 amps, whilst the energising coil can be any resistance between 75 $\Omega$  and 200 $\Omega$ . Higher resistance coils are not advised as the relay operation tends to become sluggish, whilst lower resistance coils are inclined to overheat.

A P.O. 3000 relay with the spring set removed and a microswitch (stud type or lever-roller type) mounted on a small angle bracket so that the movement of the armature actuates the microswitch is an arrangement which has been tried and works well. So also has a P.O. 3000 relay with the spring set replaced by two specially prepared contacts. These were made with springs from two discarded moving contacts from contact-breaker sets after the contacts had been stoned to a smooth surface. The springs were then straightened, drilled and mounted. Tension to the required amount was attained by the stroking method.

Another possibility is one of the old single-coil cut-outs, as the contacts are rated at some 30 amps steady current. This has proved quite successful and is, indeed, the only relay which has been used in a 6 volt system where the current to be carried by the

2. As an aid to readers without access to suitable component retailers, Henry's Radio Ltd. have available 0.5 $\Omega$  wirewound resistors at 6 watts and 1 $\Omega$  wirewound resistors at 5/10 watts. If the 3 $\Omega$  resistors are difficult to obtain, seven 5 $\Omega$  5 watt wirewound resistors (also available from Henry's Radio Ltd.) in parallel give 0.71 $\Omega$ .—Editor.

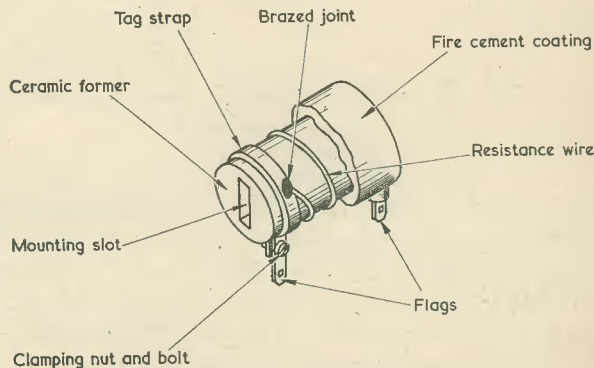

Fig. 3. An alternative method of resistor construction. Both this and the assembly of Fig. 2 have been fully tried and tested in practice

contacts is approximately 8.5 amps, assuming a resistor value of  $0.2\Omega$  at 15 watts with 36 watt bulbs.

A "Lucas" over-drive relay which is well suited for this application in a 12-volt system is currently available from R. E. Ralfe Electronics, 10 Chapel Street, Marylebone, London, N.W.1. This has a bathtub construction with mounting brackets, together with flags for snap-on connectors marked W1 and W2 for the coil winding, and C1 and C2 for the make contacts. This relay is easily attached by means of two self-tapping screws to any convenient part of the engine bay and is not affected by mounting position.

### CONCLUDING POINTS

In conclusion, it may be stated that the system described in this article needs no extra panel controls, and the existing headlamp on/off switch serves as a dim/bright switch on dipped headlights via the dip switch, which of course functions normally. Connections can usually be made via existing connectors; the one to the "D" terminal, if not accessible on the A.V.C. unit, can be made by means of a claw clip as used by suppressor capacitors direct to the "D" terminal of the dynamo itself.

It is hoped that readers may enjoy the benefits of the system as much as has the writer, in company with the friends whose cars he has similarly modified.

**N**OW THAT THE 10-METRE AMATEUR BAND IS PROVING livelier, converters and receivers for this band are receiving far more consideration than occurred previously. The band in question extends from 28 to 29.7MHz and not all receivers used by those interested in amateur radio activities are capable of being tuned around this region. Also, some of those that are, exhibit an inferior performance at these frequencies, this being usually true of types such as the familiar CR100 which are fitted with old and outdated valves. Receivers of this class can still do a good job on lower frequencies, however, and it is not unusual to operate them with an outboard converter for 10-metre working. Such a converter may use either valves or transistors.

### WHAT DOES A CONVERTER DO?

A converter is a frequency changing device which accepts signals of comparatively high frequency and then changes them to a much lower frequency that can be tuned in on a companion receiver which, itself, could not receive the original signals. As an example, a converter may be made to accept signals in the 10-metre amateur band and lower their frequency to say 6.5 MHz. If the new signals are then fed to the aerial input of a receiver tuned to 6.5MHz they will be amplified and demodulated in the usual way. Thus, signals will be heard which are normally not receivable by the receiver alone.

Although some converters are quite complex in design all employ the basic frequency changing process incorporated in the comparatively simple 2-transistor converter whose construction is described in this article. Circuit notes are, also, given later for an even simpler single transistor converter. It is hoped that these designs will whet the appetite and stimulate interest in "Ten".

### THE CIRCUIT

The theoretical circuit diagram of the 2-transistor converter is given in Fig. 1. Here, transistor TR1 does duty as r.f. amplifier-mixer, whilst the second transistor, TR2, operates as a tunable oscillator working on the low side of the signal input frequency. Contrary to popular belief it is not essential to tune both the oscillator and mixer stages simultaneously in converters designed for a particular amateur band. In consequence, coil L1 is adjusted to the required band centre, viz. around 29 MHz, and the oscillator coil L2 is manually tuned by VC1 over some 2MHz to produce the desired intermediate frequency of 6.5MHz. The oscillator can produce this if it tunes over either the range 21.5 to 23.2MHz or over 34.5 to 36.2MHz. Since a readily available oscillator coil exists for the lower of these two ranges this is the one selected. Such a coil requires an inductance value of about  $2.2\mu\text{H}$ . Input coil L1 is sufficiently damped by the aerial to accept signals over virtually the whole band (and only a section of it is normally required) but in order that optimum results can be obtained at any point its core is made adjustable from the panel; this control is designated "Trim".

Consider a signal at a frequency of 28.5MHz reaching L1 from the aerial. Transformer L4, L5 has been pre-tuned to 6.5MHz and its secondary winding is connected to a receiver which is also

# 2-TRANSISTOR CONVERTER FOR "TEN"

by

A. S. CARPENTER, G3TYJ

This simple converter is intended specifically for reception on the 10-metre amateur band, and it offers an output of the order of 6.5MHz for the following receiver. It is recommended that a grid-dip oscillator or signal generator be employed for tuned circuit alignment



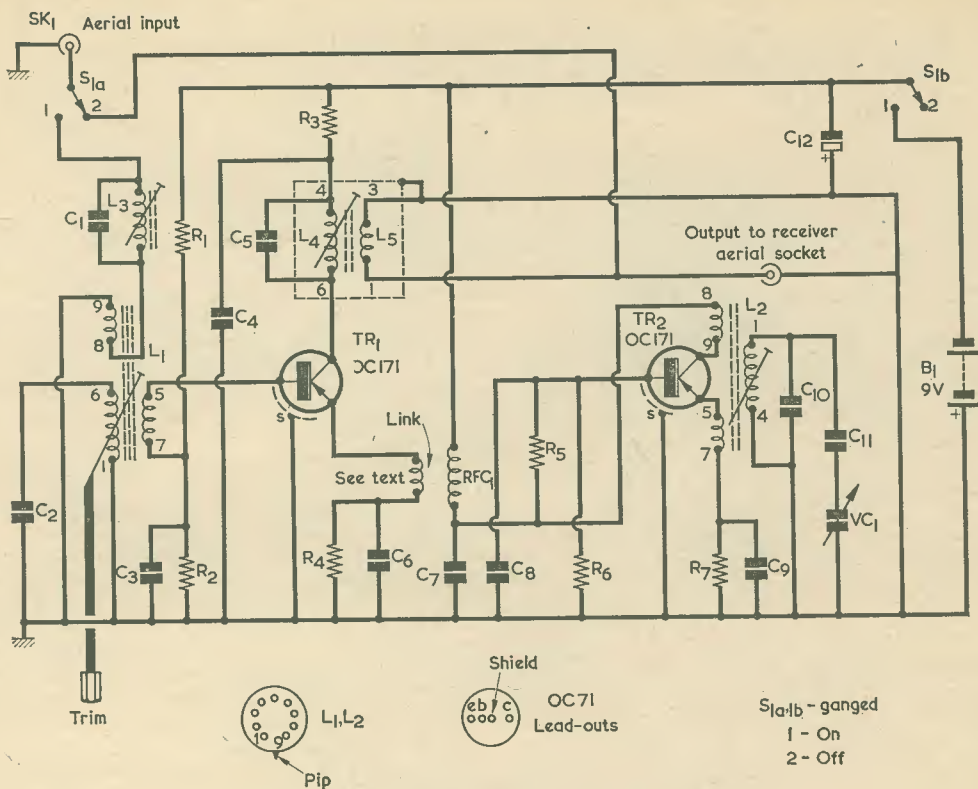

Fig. 1. The circuit of the 2-transistor 10 metre converter

**Resistors**

(All  $\frac{1}{4}$  watt 10%)

- R1 15k $\Omega$
- R2 2.2k $\Omega$
- R3 1k $\Omega$
- R4 1k $\Omega$
- R5 12k $\Omega$
- R6 2.2k $\Omega$
- R7 1k $\Omega$

**Capacitors**

- C1 50pF ceramic
- C2 50pF ceramic
- C3 10,00pF ceramic
- C4 0.04 $\mu$ F paper or plastic foil
- C5 50pF ceramic
- C6 10,000pF ceramic
- C7 5,000pF ceramic
- C8 0.04 $\mu$ F paper or plastic foil
- C9 5,000pF ceramic
- C10 10pF ceramic
- C11 15pF ceramic (see text)
- C12 100 $\mu$ F electrolytic, 10V wkg.
- VC1 20pF air-spaced variable trimmer, miniature (see text)

**Inductors**

- L1 Transistor Dual-Purpose Coil Range 5T, Blue (Denco)

**COMPONENTS**

- L2 Transistor Dual-Purpose Coil Range 4T, White (Denco)

- L3 See text
- L4,5 See text (Wound on Denco coil former type 5000 A/4PL with 6mm x 12.7mm grade 500 core and Denco screening can Ref. 1.)

- RFC1 2.5mH r.f. choke Type CH1 (Repanco)

**Transistors**

- TR1 OC171
- TR2 OC171

**Battery**

- B1 9-volt battery

**Socket and Plug**

- Coaxial socket (SK1)
- Coaxial plug

**Tagboard**

- 18-way Radiospares miniature (4.62 x 1.5in.)\*
- \* Radiospares components may only be obtained through retailers.

**Miscellaneous**

- Epicyclic reduction drive
- 3 knobs
- Aluminium for panel and brackets, etc.

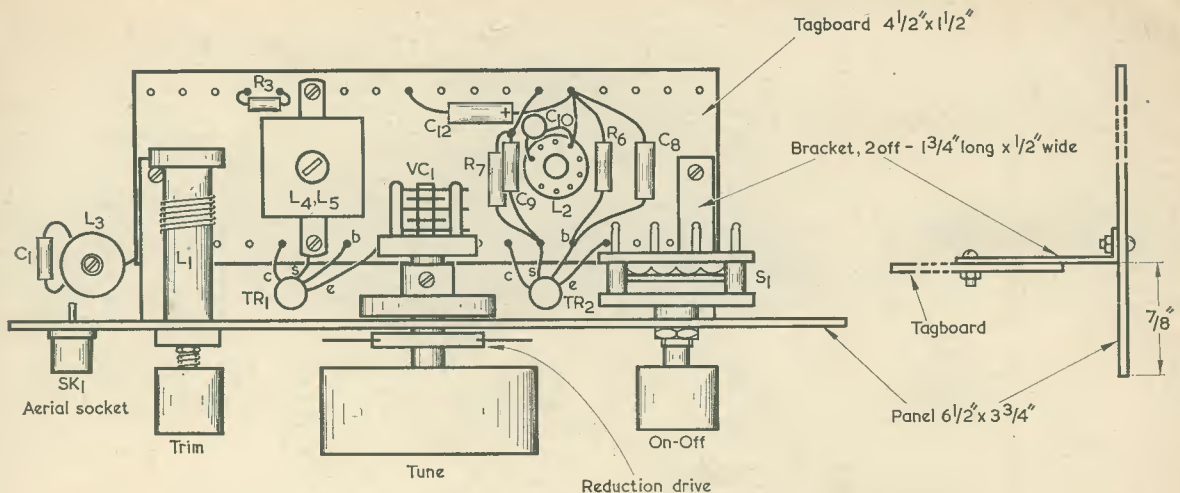

Fig. 2. Top view of prototype, showing layout and component connection points

tuned to this frequency. The signal is not received until the oscillator coil is tuned to 22.0MHz by means of VC1 whereupon, due to the frequency changing process in TR1 (28.5 minus 6.5 = 22.0 MHz) the aerial signal, now at 6.5MHz, passes through to the receiver. It is heard irrespective of the setting assigned to the 'Trim' control, which may then be adjusted for maximum received signal strength. If, whilst this is happening, an unwanted signal at 15.5MHz were to appear on the aerial and was able to reach TR1 it could also be converted to 6.5Mc/s (15.5 plus 6.5 = 22.0MHz). However, such unwanted signals are prevented from reaching TR1 due to the frequency trap given by L3 and C1 in the aerial input circuit.

Injection of the local oscillator signals into the r.f./mixer stage can be done in several ways, and the simple emitter inductive injection method shown in Fig. 1 is quite satisfactory. Here, a 2-turn link winding tightly coupled to the oscillator transistor

collector feed choke does the required duty. It might appear that oscillation amplitude following the bypass capacitor C7 would be too low for adequate oscillator injection but, in practice, the arrangement works very well. It is possible, also, that stray inductive and capacitive couplings contribute to the performance of the circuit.

Since the converter is not required for use continually it is convenient for the aerial to be 'fed through' direct to the receiver when other bands are to be used. The switching is accomplished by S1(a) which couples the aerial through to the output when the converter is out of action.

### CONSTRUCTION

The use of a miniature Radiospares 18-way tagboard secured to a metal panel measuring 3 3/4 x 6 1/2 in. was considered the simplest way of building the converter, and it lends itself more readily to changes

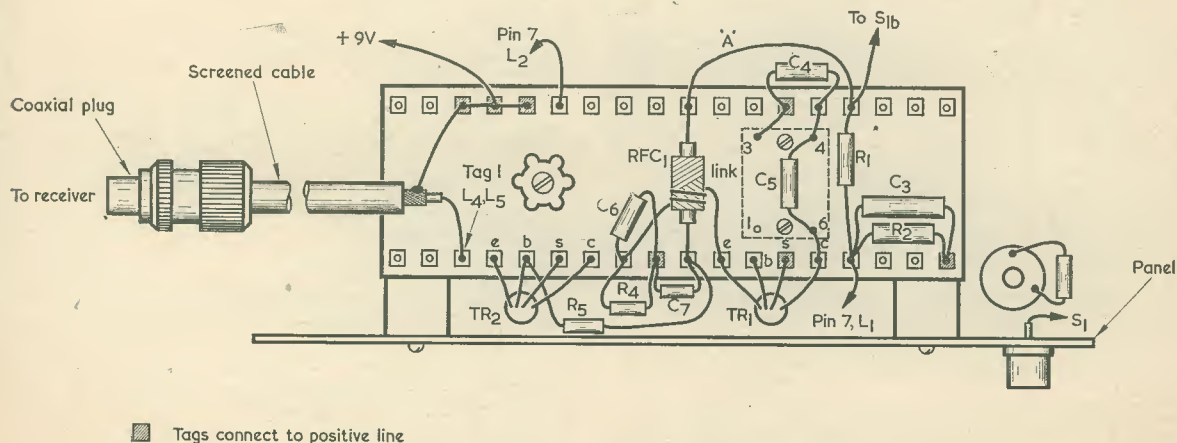

Fig. 3. Layout and connection points on the underside

than does Veroboard. The topside layout used in the author's prototype is shown in Fig. 2 and is self-explanatory. A simple epicyclic reduction drive aids tuning and its location is clearly indicated. Points to note are the orientation of the oscillator coil and the way in which the screening can lugs of L4, L5 are bent *outwards* so that the can may be removed easily if required. Coil L3 can be mounted in any way convenient to the builder; a pair of aluminium support brackets also have to be made. The underside layout is shown in Fig. 3 and is again self-explanatory. As may be seen, the tagboard is mounted such that its tags are on the underside.

The components on the front panel take up the positions indicated in Fig. 2. Control spindles should be on a horizontal line with the requisite clearance between control bodies and the upper side of the board. A simple bracket is required for VC1. The component used here by the writer was a surplus Cyldon air-spaced variable capacitor (part No. AD18/4/20) but readers may find this difficult to obtain. A suitable alternative is a 25pF Jackson Bros. type C804 variable capacitor. This is slightly larger in physical size than the component employed in the prototype and, if it is used, care should be taken to mount the tagboard relative to the front panel such that sufficient clearance is given between VC1 and L4, L5. The capacitor listed for C11 may still be employed when VC1 is 25pF, since C11 is, in any case, subject to adjustment during setting up.

It should be noted that not all the wiring is shown in Figs. 2 and 3, these diagrams being intended to indicate the tags to which individual components connect. Not shown are capacitors C2 and C11. C2 is mounted on the appropriate pins of L1 and C11 is fitted between pin 1 of L2 and the fixed vanes of VC1. Capacitors and resistors need not be positioned exactly as shown in Figs. 2 and 3, as the layouts have been expanded in the interests of clarity. In general, the capacitors and resistors should have their lead-outs as short as is reasonably possible. The transistors should be soldered into circuit last, after which all wiring should be carefully checked against Fig. 1.

A final point is that the wire marked 'A' in Fig. 3 is not fitted at this stage. This is because a current check is made during testing between the two tags bridged by this lead.

## COIL WINDING

Two of the coil assemblies are home-wound. Coil L3 consists of 12 turns of 30 s.w.g. enamelled copper wire closewound on a  $\frac{3}{8}$ in. diameter former fitted with a dust core. (A  $\frac{3}{8}$ in. former having a length of  $1\frac{1}{2}$ in. is available from Home Radio under Cat. No. CR9, together with a suitable dust core under Cat. No. CR10 and 4-way tag-ring under Cat. No. CR11. —Editor) In the L4, L5 assembly, the primary winding, L4, consists of 36 turns of 34 s.w.g. d.s.c. wire closewound and connected to tags 4 and 6. The secondary comprises 12 turns of similar wire, closewound over the end of the primary associated with tag 4 (i.e. the earthy end connecting to bypass capacitor C4). The earthy end of the secondary (connecting to tag 3) is over the earthy end of the primary. The windings are separated from each other by a layer of Sellotape. This assembly is wound on a Denco coil former type 5000 A/4PL fitted with

a dust core, and covered with a Denco aluminium screening can Ref. 1. The dust core is 6mm grade 500 12.7mm long, also available from Denco.

Coils L1 and L2 are ready made items. The threaded brass core stem of L1 projects through the panel, and it is fitted with a small collar to enable a control knob to be fitted.

## TESTING

Prior to hooking up the converter to the receiver with which it is to be used, a check of oscillator functioning should be made. To do this connect a testmeter set initially to read 0-10mA between the tags linked by lead 'A' in Fig. 3, with meter positive towards the r.f. choke. Switch on and note the current reading when, with a screwdriver, tags 5 and 7 of L2 are short-circuited. A decrease in current should be noted. If no current change is detected the circuit is not oscillating and R5 may require changing to a slightly lower value—say 10k $\Omega$ . Normally, however, no difficulty should be found. After this test, lead 'A' of Fig. 3 is wired in permanently.

If a grid-dip oscillator (g.d.o.) is available L1 can be pre-tuned to 29MHz by means of its core and L2 can be similarly adjusted to 22.5MHz, but with the vanes of VC1 set half enmeshed. Coil L3 can also be resonated with its core to 15.5MHz. (When a signal generator is used for alignment, coil L3 will be set to give maximum attenuation at the appropriate frequency.) The advantage given by using a g.d.o. for pre-alignment is that the various inductors can be adjusted fairly closely to their operating points with the converter switched off. Coil assembly L4, L5 can be adjusted similarly with its can removed, although re-fitting the can will necessitate a slight re-adjustment.

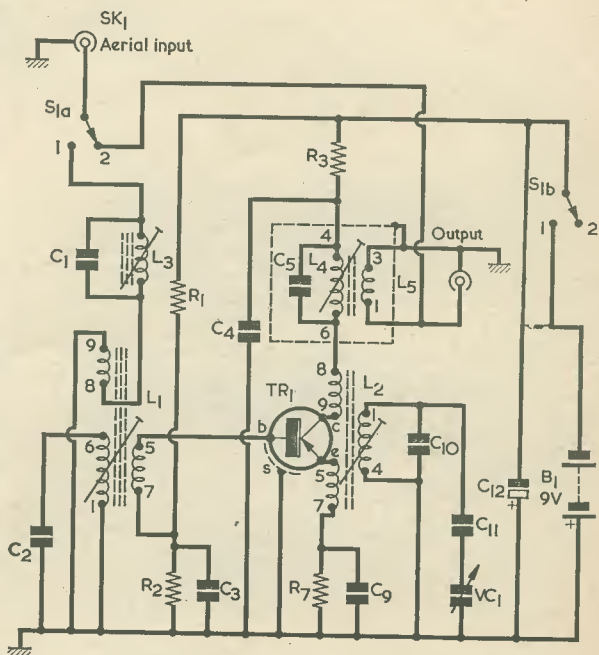

Fig. 4. A simpler circuit using a single transistor

## FINAL ADJUSTMENTS

The converter output is connected to the receiver with which it is to be used and the battery applied. With the receiver tuned to a quiet spot around 6.5MHz—the precise point is not important—the converter is switched on, whereupon the noise level should be heard to increase. If the current drain of the converter is checked it should be approximately 2mA.

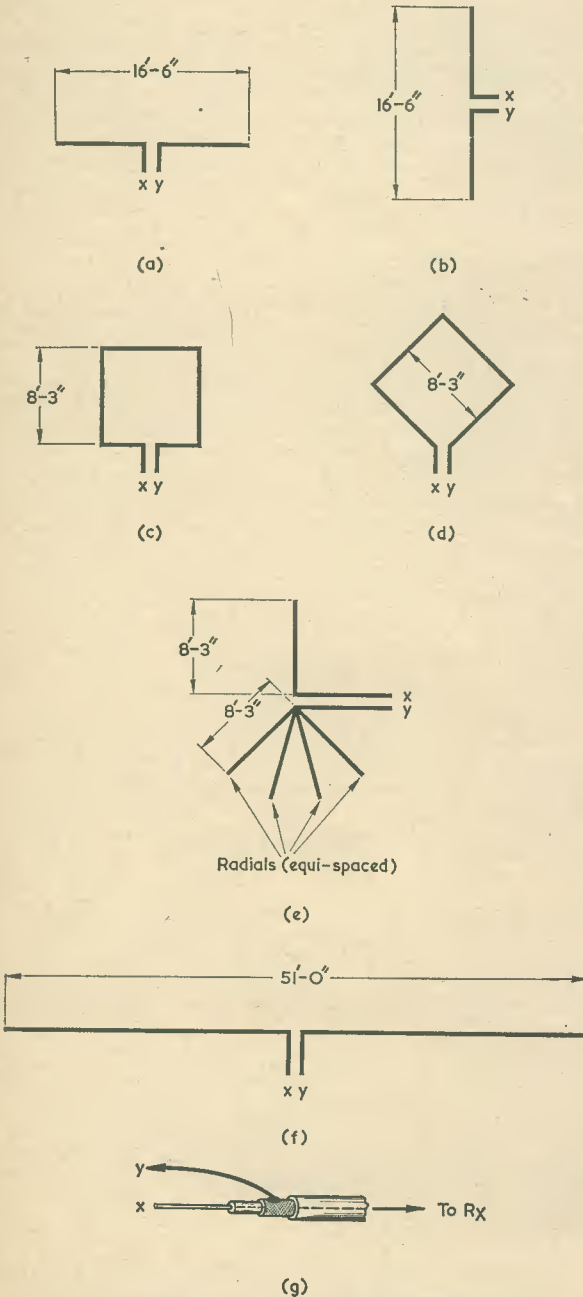

Fig. 5. Reception on 10 metres is improved if a resonant aerial system is employed. Some suitable aeriels are illustrated here

The core of L4, L5 is then adjusted for maximum noise level and the receiver gain controls retarded as required. If the aerial is now connected to the converter signals should be heard as VC1 is rotated. Readers not familiar with 'Ten' should note, however, that due to atmospheric conditions or even to lack of amateur activity the band is not always 'open' and some patience may be required; a good time to listen is at week-ends around midday. The converter may also not be quite 'on the band' and some minor difficulty may be found in initially locating this if no test equipment is available. The g.d.o. tuned to 28MHz and positioned nearby will prove useful, or a signal generator may provide the answer. However, for precise location of the band edge a crystal marker is much to be preferred.

The 28MHz band edge should coincide with the vanes of VC1 being almost fully engaged. If 30MHz coincides with the vanes of VC1 being almost fully disengaged all is well, but normally some adjustments to the core of L2 will be called for. Capacitor C11 may also need to be altered in value. Should it be found that VC1 affords too large a frequency swing, C11 should be made slightly smaller in value and the core of L2 reset. Conversely, insufficient tuning range is put right by increasing the value of C11 slightly.

When signals are coming through nicely it should be found possible to peak them by carefully adjusting the 'Trim' control; it may also be found beneficial at times to tune the receiver very slightly to one side during a transmission to lose interference.

## SINGLE TRANSISTOR CONVERTER

As was mentioned earlier, a single transistor converter is also feasible, and a suitable circuit is given in Fig. 4. Component values and designations are exactly as for the 2-transistor circuit already described. If desired, the dust core stem of L1 in the single transistor version may be similarly brought out to a panel 'Trim' control.

Alternative converter output frequencies from either version to suit a particular receiver can be arranged by retuning L2, L3 and L4, L5 but output frequencies lower than about 5MHz may not be suitable. For a 5MHz output the oscillator tuning range is required to be 23.0 to 24.7MHz. The new trap frequency for L3 is found, in MHz, from:

$$29 \text{ minus (twice output frequency)} = 19\text{MHz}$$

## AERIALS

Before concluding this article, a few words on aeriels suitable for 'Ten' may not be out of place.

Although many short wave listeners use but a random length of wire 'end connected' as an aerial, benefits will be obtained by the use of a resonant system. Resonant aeriels for 10 metres can be easily accommodated at most locations.

A simple half-way dipole is easy to construct and its overall length in feet is found from the familiar formula

$$L = \frac{468}{f} \text{ feet,}$$

where f is in MHz.

(Continued on page 230)  
THE RADIO CONSTRUCTOR

# HYBRID

# TRANSPORTABLE

# RECEIVER

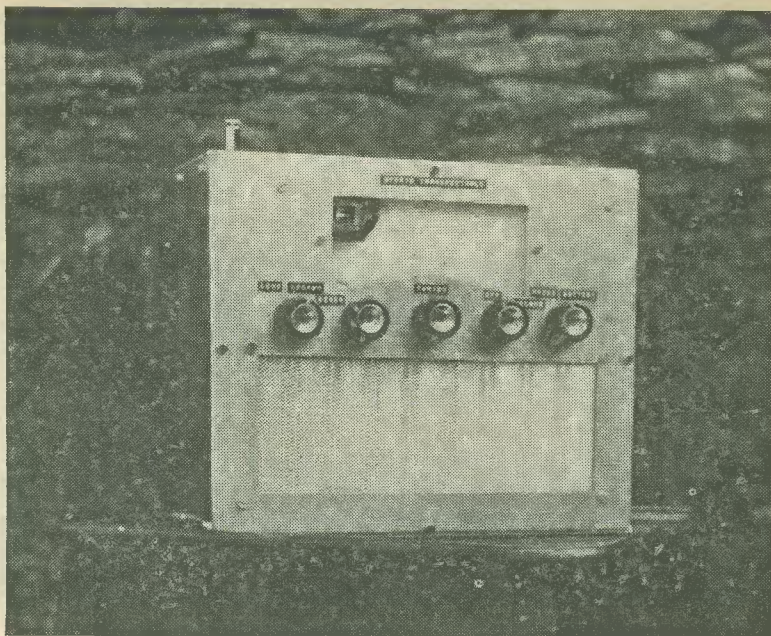

by

**SIR DOUGLAS HALL, K.C.M.G., M.A. (Oxon)**

**Another unusual and ingenious design from our popular contributor. This medium and long wave receiver uses only a single tuned circuit, together with two valves and three transistors, in a circuit which provides an extremely effective a.g.c. performance. Power may be obtained either from the mains or from a 12-volt car battery**

SOME TIME AGO THE AUTHOR PUBLISHED A DESIGN for a car radio, which used an unusual form of amplified a.g.c.\* The design which is now to be discussed borrows a number of features from the earlier circuit, though it is primarily intended as a transportable receiver for use off the mains. It can, however, be powered from a 12-volt car battery by means of a simple switching circuit. The present design shows how, provided a hybrid circuit is employed, effective a.g.c. can be obtained in a receiver having only one tuned circuit.

It is easy to obtain relatively good non-amplified a.g.c. using transistors only, and this will provide adequate results when a sensitive superheterodyne circuit is employed with considerable amplification before the a.g.c. rectifier. But for a.g.c. to work properly with a simple circuit it must be amplified; and if transistors alone are used there is the difficulty that a very small change in current passed by the amplifying transistor—such as may be brought about by quite a small change in ambient temperature—

can alter the current passed by the controlled transistor by a factor of many times more. Correction by negative feedback merely cancels out the advantage of amplifying the a.g.c. voltage. This is an instance where the extreme stability of the valve comes into its own. On the other hand, a transistor is more suitable as the controlled device, since a very small change in its base bias current has a large effect on its amplification factor.

The author does not claim that all signals heard on the receiver to be described will be held rock-steady. There will still be some which will disappear altogether. But blasting as signals are tuned in is avoided, and stations such as Luxembourg, which provides a good signal in many parts of the British Isles, will often be rendered steady and of good programme value.

## TWO R.F. STAGES

The author's Universal Car Radio design used two radio frequency stages, the second of which, a valve, was tuned at both input and output circuits. Reaction

\*Sir Douglas Hall, "Design For A Universal Car Radio", *The Radio Constructor*, April, 1969.

## COMPONENTS

### Resistors

(All fixed values  $\frac{1}{2}$  watt 10%. A 'moulded track' component is preferred for VR2.)

R1	8.2k $\Omega$
R2	27k $\Omega$
R3	10M $\Omega$
R4	1k $\Omega$
R5	47k $\Omega$
R6	1 $\Omega$
R7	1k $\Omega$
R8	100 $\Omega$
VR1	10k $\Omega$ potentiometer, preset
VR2	5k $\Omega$ potentiometer, log, with switch S3
VR3	25k $\Omega$ potentiometer, preset

### Capacitors

C1	220pF silver-mica
C2	0.1 $\mu$ F paper or plastic foil
C3	100pF silver-mica
C4	0.0033 $\mu$ F paper or plastic foil
C5	1,000pF ceramic
C6	0.01 $\mu$ F paper or plastic foil
C7	1,000 $\mu$ F electrolytic, 15V wkg.
C8	80 $\mu$ F electrolytic, 2.5V wkg.
C9	50 $\mu$ F electrolytic, 15V wkg.
C10	1,600 $\mu$ F electrolytic, 15V wkg.
C11	2,000 $\mu$ F electrolytic, 15V wkg.
VC1	365pF variable, single-gang type 01 (Jackson Bros.)
VC2	100pF variable, Dilecon (Jackson Bros.)

### Inductors

L1	See text
L2, 3, 4	Dual-range coil type DRR2 (Repanco)
L5	All-wave choke type QC1 (Osmor)
T1	A.F. transformer type LT44 (Eagle)
T2	Heater transformer, secondary 13 volts C.T. at 0.5 amp, Radiospares (Cat. No. TH5D, Home Radio)

### Semiconductors

TR1	2N4058
TR2	BC168B or BC168C
TR3	OC22
D1	OA202
D2	DD000 (Lucas)

### Valves

V1	EF97
V2	EF97

### Meter

M1	Level indicator type V103 (Eagle)
----	-----------------------------------

### Switches

S1	1-pole 2-way, rotary
S2	1-pole 2-way, rotary
S3	d.p.s.t., part of VR2

### Speaker

35 $\Omega$ , 7in. x 4in.

### Aerial

Telescopic aerial, 13-section 51 in. open type TA10(A) (Henry's Radio)

### Case

9in. x 11in. x 4in. with back (see text) Cat. No. CU31A and Cat. No. CU202 (Home Radio)

### Sockets

2 B7G valveholders  
Battery plug and socket, type P.360 (Bulgin) or similar

### Miscellaneous

Epicyclic drive type 4511/F (Jackson Bros.)  
5 knobs  
3-core mains lead  
Material for cabinet and panel (see text)  
2 3-way tagstrips  
1 2-way tagstrip

was provided, but many will have found that this control is employed more as a preset device than as a frequently adjusted control. In fact, there is sufficient sensitivity for the use of a variable control to be hardly necessary. With the present circuit there are still two radio frequency stages, but only one tuned circuit. Fairly critical adjustment of reaction becomes an important part of tuning in a station, and for this reason the receiver is not really suitable as a car radio unless it is pretuned to a local station, or there is a passenger in the car to operate it.

The use of a single tuned circuit has the advantage of simplicity in building and setting up, and makes the provision of two wavebands very easy. The lack of selectivity is not as serious as might be expected. Signal pick-up relies on nothing more than about 4ft. of aerial and a mains earth, and the design is such that advancing the reaction control automatically cuts down the gain of the first radio frequency stage, so that selectivity is enhanced to a far greater degree than is usually provided by regenera-

tion. This effect is most noticeable in areas where there are two stations providing powerful signals at frequencies close to each other.

If Fig. 1 is examined it will be seen that the incoming signal is passed to the emitter of TR1. C1 isolates the aerial from the power supply, and L1, which consists of 35 turns of 32 s.w.g. enamelled copper wire closewound on a 1in. length of  $\frac{3}{8}$ in. ferrite rod, prevents powerful short wave transmissions from causing cross modulation. VR1 sets the emitter bias for TR1 and it has a value which allows about ten times the current in TR1 to pass through it. Thus, the bias is held comparatively steady. The tuned circuit given by VC1 and L2, or by VC1 and L2 plus L3, is in the collector circuit of TR1, which operates in the common base mode. The same tuned circuit is at the input of V1, which offers virtually no damping, with the result that TR1 gives a large voltage amplification. TR1 is of a type which gives high gain at a small collector current. In this circuit its collector current never exceeds 130 $\mu$ A, and it

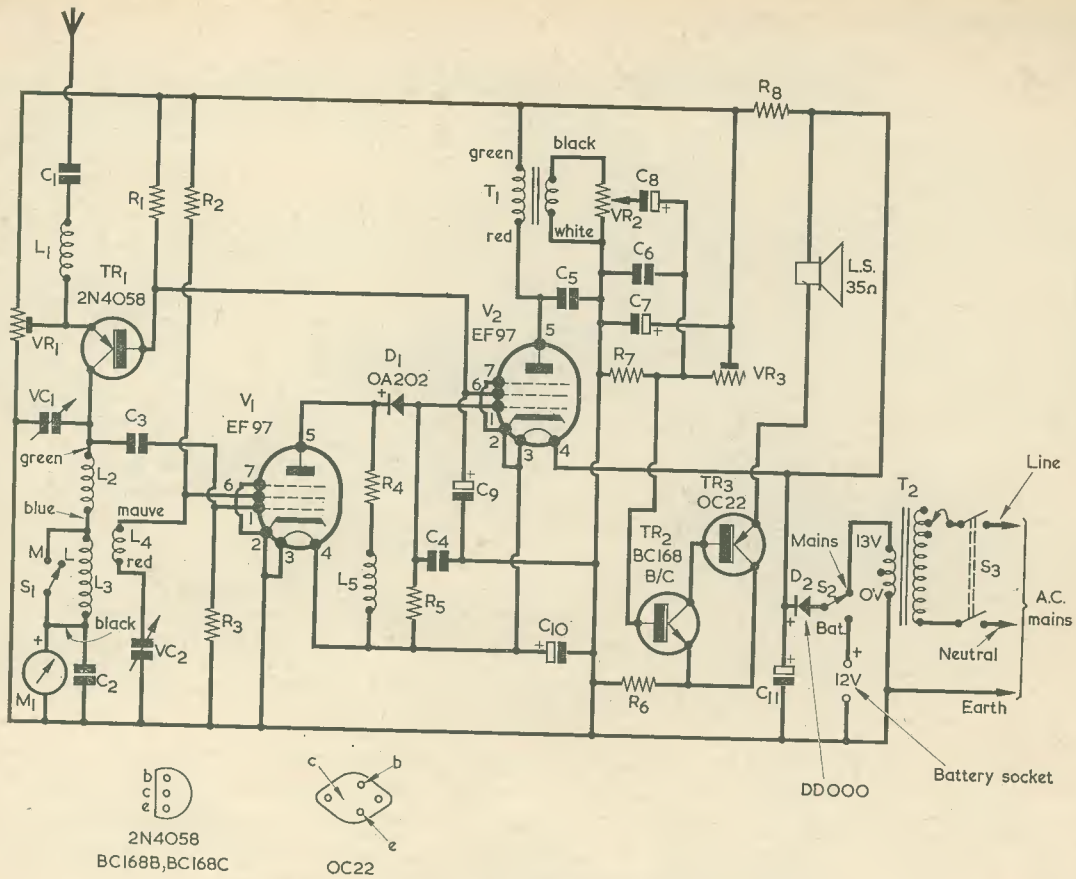

Fig. 1. The circuit of the hybrid transportable receiver

drops to nearly zero on the receipt of a powerful signal.

The output load for V1 consists of a 23mH choke in series with a resistor R4. V1 passes about 800 $\mu$ A and there is therefore a voltage drop of about 0.8 across L5 and R4. Across this load is the diode D1, a silicon device—not germanium and R5. A small forward current therefore passes through D1, whereupon the grid of V2, which is taken to the junction of D1 and R5, is made slightly negative of its cathode, so that it is suitably biased as a signal amplifier. Bias for the grid of V1 is obtained by grid current flowing due to the large-value grid resistor R3.

When a signal is received, the negative end of D1 will become more negative, and a small drop in current through V2 will take place. This will not be sufficient, even with a powerful incoming signal, to upset the functioning of V2 as an amplifier, but there will be a significant drop in the voltage across V2 screen-grid resistor, R1.

In fact V2, up to its screen-grid, acts as a d.c. triode amplifier. The drop in current through R1 will reduce the current passed by TR1, and hence its amplification factor. This effect will not be reduced by negative feedback due to resistance in the emitter circuit of TR1 because of the comparatively large steady current flowing through VR1 which has

already been mentioned. In practice it will be found that any reasonably good signal, brought up by reaction, will cause the current through TR1 to fall appreciably, and that powerful stations will almost cut TR1 off.

Readers may remember that although the general method of provision of a.g.c. was similar in the author's car radio receiver, yet in that circuit V2 acted as a leaky grid detector, with separate diodes providing the voltage for a.g.c. Also, the voltage given by the diodes was applied to the grid of the signal frequency amplifier, V1, and not to an audio frequency amplifier.

In addition to its operation as a d.c. amplifier in the present circuit, V2 also functions as a conventional audio frequency amplifier. Because of the rather unusual characteristics of the EF97 when used with a 6-volt supply (each valve receiving only about half the total voltage available because of direct coupling between them and the use of the heaters as a potential divider) the output impedance is very much lower than is normally the case with a pentode, and this enables transformer coupling to be used between V2 and TR2. With a normal pentode and a conventional supply, transformer coupling would result in a drastic loss of bass, unless a transformer is used having a very high primary inductance.

(Continued on page 231)

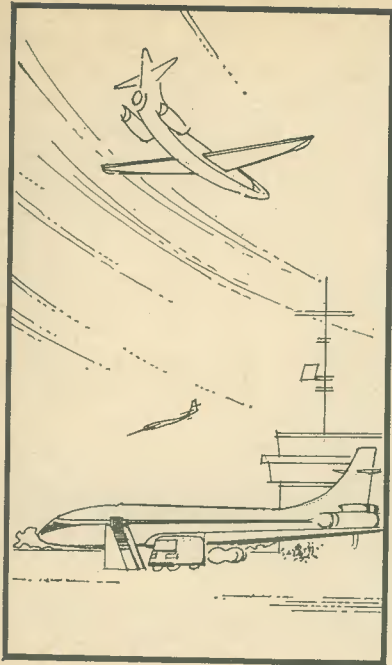

# THE "AIRLANE" 7-TRANSISTOR AIRCRAFT BAND RECEIVER

by

C. H. G. MILLS

Intended for the more advanced constructor who is capable of working from a circuit diagram and general layout details, this article describes a super-regenerative receiver designed expressly for reception on the v.h.f. aircraft band. Coverage is from 108 to 140MHz. There is no necessity for padding and tracking adjustments, since tuning is carried out by a single variable capacitor

THE "AIRLANE" RECEIVER TO BE DESCRIBED WAS originally conceived to satisfy the demand of a younger member of the family for a simple set with which to listen-in on the Aircraft Band. The completed receiver was found to perform very satisfactorily and was, if anything, more suitable for its particular purpose than some of the superhets that are available. Its construction should be within the capabilities (and the purse) of young aircraft enthusiasts and, with slight modifications to the tuned circuit, could also be used on the 144MHz Amateur Band.

Using a 30in. whip aerial, at a location only some 200 feet above sea-level in the Midlands, aircraft can regularly be heard at about 100 miles range, and some ground stations are regularly heard at good strength although some 50 to 70 miles distant. The feature of variable band-width particularly facilitates station searching, so important when the transmissions are relatively transient, and the broad-tuned r.f. stage, coupled with careful screening, mitigates the problem of radiation from the super-regenerative detector.

## THE DETECTOR

The choice of a self-quenching super-regenerative detector was dictated basically by the need for simplicity, but it does have certain positive advantages provided that it can be made stable and reliable. Extremely high sensitivity can be achieved using only one transistor and, although selectivity is inevitably not as good as with a superhet, it can be made quite adequate by keeping the quench frequency and the quench amplitude as low as is practicable. In fact, extremely high selectivity can make the task of searching for signals of short duration quite tedious. On the other hand, variable selectivity, giving a wide bandwidth for searching and adequately sharp tuning for adjacent channel rejection, can be achieved very simply by controlling the amplitude and frequency of the quench.

The super-regenerative detector also gives a level of amplitude limiting and thus exhibits some degree of a.g.c. action; some distortion of the signal is inevitable with this type of detector, but not such that intelligibility is impaired, and is of little consequence for the service for which the receiver is intended.

The transistor employed as the detector, TR2, is a Texas T1407, formerly 2N3983, an n.p.n. silicon planar device in encapsulated form, and with an  $f_t$  of 500 MHz. It is available from L.S.T. Electronic Com-



**Cover Feature**



ponents, Ltd. Much experimentation was carried out with various transistors in this stage, checking n.p.n. and p.n.p., silicon and germanium, and the particular type specified was found to be the most satisfactory. Using the T1407 no selection was found to be necessary, nor was any adjustment of the collector-emitter capacitance required to achieve oscillation. Since super-regenerative circuits have a reputation for being a little 'touchy' it is not recommended that an alternative type of transistor is used in this stage.

The circuit is basically a collector-emitter feedback oscillator, the tuned circuit consisting of L2, C5, and C6 in the collector circuit and positive feedback being applied by a small capacitor C8 connected between the emitter and collector. The r.f. choke L3 presents a high impedance at the frequency of oscillation, so that the feedback current flows into the emitter. Base bias is provided by the chain R4, VR1, and R5. By the correct choice of the time-constant of the emitter load, determined by VR2 and R6 in parallel with C9, the oscillator will be self quenched, the quench frequency and amplitude being adjustable by VR2. The audio signal appears at the junction of L3 and R6 and is fed to the a.f. pre-amplifier through C10.

The r.f. input is coupled to the detector at a tap close to the earthy end of L2 to avoid damping the tuned circuit. A padder capacitor C6 is provided in series with the tuning capacitor C5 to achieve the required coverage of 108—140MHz using a readily avail-

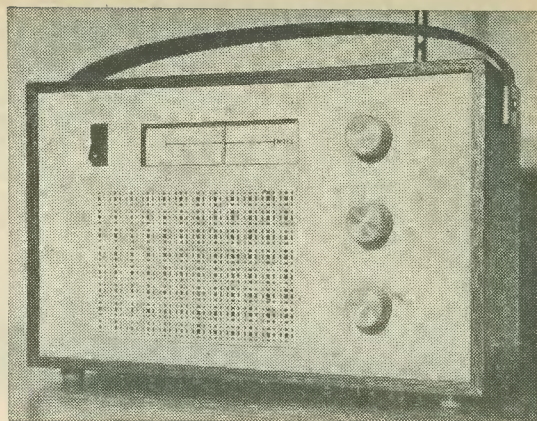

The exceptionally neat and symmetrical layout of the author's receiver is well demonstrated by this photograph. To the left of the tuning scale is on-off switch S1. The three controls to the right are (from top to bottom) tuning, regeneration and a.f. gain

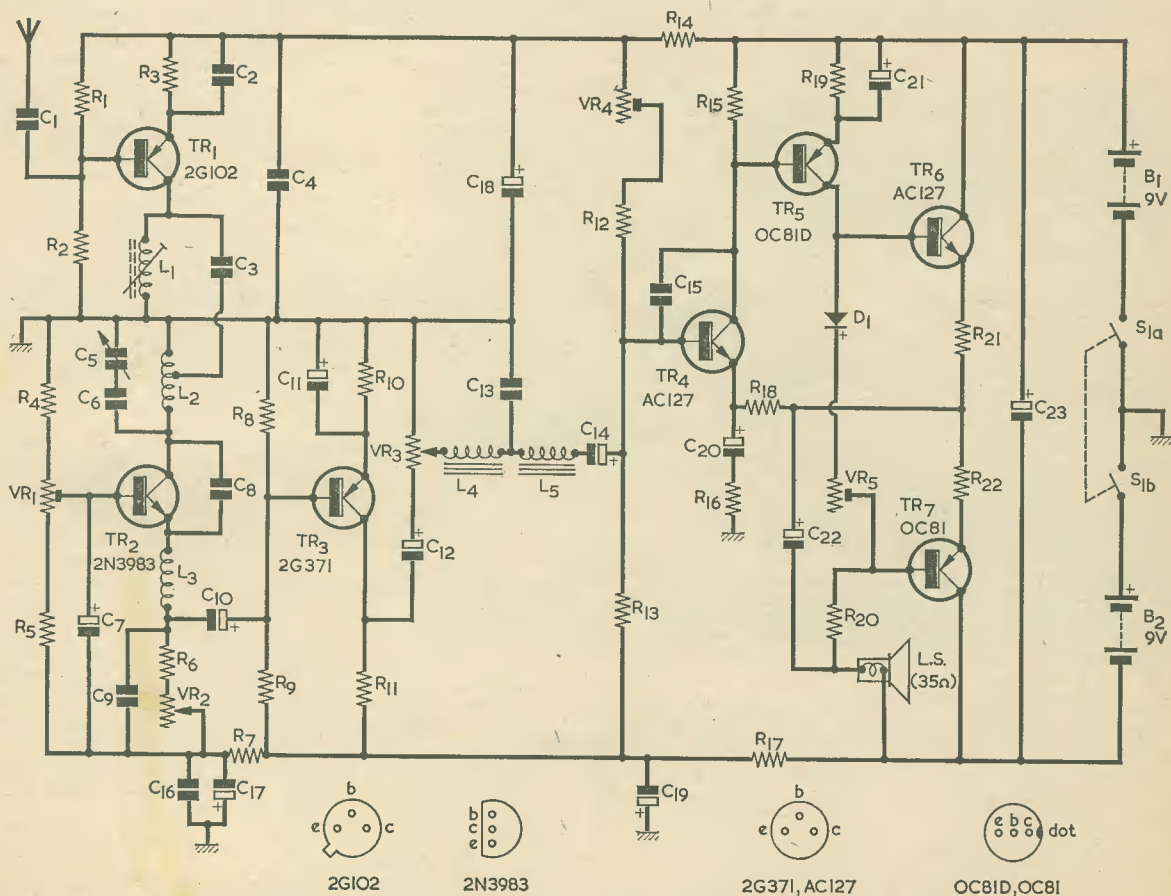

The complete circuit diagram for the v.h.f. aircraft band super-regenerative receiver

able tuning capacitor with integral slow-motion drive. C5 is, in fact, one gang of a two-gang unit currently used in many f.m. tuner kits.

The whole of the detector and the a.f. pre-amplifier circuit is contained within a screening box, which can conveniently be a metal socket outlet box, 3 by 3 by 1½ in. deep, as used in domestic electrical installations. The socket outlet box used by the author was an M.E.M. Type 7402.

## THE R.F. STAGE

Complete screening of the detector and the addition of an r.f. stage is essential in order to minimise the radiation from the detector, but this does not significantly improve the signal to noise ratio. Broad tuning is achieved by L1 in the emitter of a germanium p.n.p. transistor with an  $f_t$  of 180MHz. The choice of r.f. transistor is not critical, a Texas 2G102 was employed in the original circuit but suitable equivalents such as the Mullard AF102 should be equally satisfactory. (Check results initially with the AF102 shield lead-out not connected to chassis.—Editor.) Although unconventional, the p.n.p. r.f. stage feeding the n.p.n. detector has the advantage of having the common earth line at the cold end of both coils, this overcoming problems of stability that had been experienced with other experimental configurations. It is also particularly convenient to use this arrangement with a conventional complementary power amplifier having a centre-earthed power supply.

amplifier is attenuated by the gain control. A Texas 2G371 was employed in this stage, but any similar device could be substituted.

## LOW-PASS FILTER

In order to reduce the detector noise in the absence of a carrier, the a.f. response of the receiver is limited to about 4kHz by a simple T-section L-C filter comprising L4, C13 and L5. The inductors employed originally in this filter were Fortiphone 470 mH iron cored chokes, C13 having a value of 0.001 $\mu$ F. However, these chokes may be difficult for the home-constructor to obtain and the writer has since redesigned the filter using the primary windings of Radiospares transformers type T/T6 for L4 and L5. No connections are made to the secondaries. With these new inductors, C13 has the value of 0.005 $\mu$ F shown in the Components List. (It should be noted that Radiospares components may only be obtained through retailers). The filter given by L4, C13 and L5 is a refinement rather than a necessity, and although the reduced noise bandwidth is well worthwhile, the filter could be omitted or replaced by a single R-C top-cut circuit.

## OUTPUT STAGE

In the original receiver a conventional complementary power amplifier was incorporated, giving an output of 1 watt to drive a 35 ohm, 4in. circular loudspeaker.

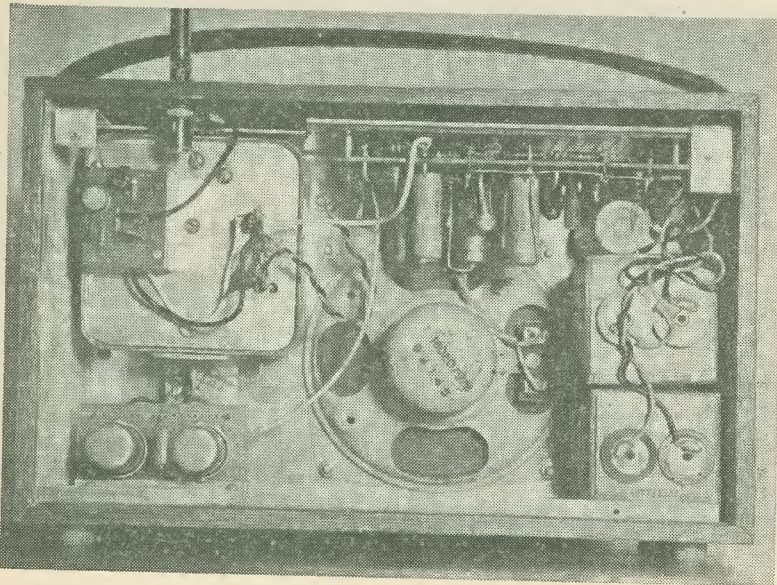

Rear view of the prototype receiver. At top left is the screened box containing the detector (TR2) and a.f. amplifier (TR3) stages. Secured, on the outside, to the back cover of the box is the r.f. amplifier (TR1) and a 3-way tag-strip for negative and positive supplies. A.F. gain control VR3 is mounted on a bracket fixed to the bottom edge of the screening box, the a.f. output from the latter passing through an adjacent hole in the bottom edge. L4 and L5 are at bottom left (the photograph shows the Fortiphone chokes used originally) whilst the power amplifier is at top right. External a.f. leads prior to the power amplifier are screened

## A.F. PRE-AMPLIFIER

The a.f. pre-amplifier stage, incorporating TR3, is conventional, being notable only because it is housed within the detector screening box, thus providing a compact front end with ample output voltage to drive any desired output stage. The a.f. gain control, VR3, is placed at the output of the pre-amplifier, rather than at its input, to allow the quench circuit of the detector to feed a constant impedance. This arrangement also ensures that any noise originating in the pre-

Additional top-cut is provided by feedback capacitor C15. This amplifier was described in more detail by T. Snowball in earlier issues of this journal.\*

The type of construction which was adopted for the front end results in a virtually self-contained unit that can be used to drive any type of output amplifier; a very compact unit has, for instance, been constructed by employing a miniature packaged power amplifier driving a 3in. speaker. There is, however, much to be

\* T. Snowball, "High Sensitivity Transistor V.H.F. Portable", *The Radio Constructor*, February and April 1967.

## COMPONENTS

### Resistors

(All fixed values  $\frac{1}{2}$  watt 10%)

R1	10k $\Omega$
R2	47k $\Omega$
R3	1k $\Omega$
R4	3.3k $\Omega$
R5	2.2k $\Omega$
R6	560 $\Omega$
R7	220 $\Omega$
R8	12k $\Omega$
R9	39k $\Omega$
R10	1k $\Omega$
R11	2.7k $\Omega$
R12	10k $\Omega$
R13	22k $\Omega$
R14	220 $\Omega$
R15	560 $\Omega$
R16	15 $\Omega$
R17	220 $\Omega$
R18	1.5k $\Omega$
R19	56 $\Omega$
R20	1.5k $\Omega$
R21	2.2 $\Omega$
R22	2.2 $\Omega$
VR1	10k $\Omega$ potentiometer, preset miniature
VR2	5k $\Omega$ potentiometer, linear
VR3	10k $\Omega$ potentiometer, log
VR4	10k $\Omega$ potentiometer, preset miniature
VR5	100 $\Omega$ potentiometer, preset miniature

### Capacitors

C1	0.001 $\mu$ F ceramic
C2	0.001 $\mu$ F ceramic
C3	0.001 $\mu$ F ceramic
C4	0.001 $\mu$ F ceramic
C5	One section of 15 + 15pF variable capacitor type 00 with slow motion drive (Henry's Radio)
C6	68pF ceramic
C7	10 $\mu$ F electrolytic, 6V wkg.
C8	4.7pF ceramic
C9	470pF ceramic
C10	2 $\mu$ F electrolytic, 6V wkg.
C11	50 $\mu$ F electrolytic, 6V wkg.
C12	2 $\mu$ F electrolytic, 9V wkg.
C13	0.005 $\mu$ F paper
C14	2 $\mu$ F electrolytic, 6V wkg.
C15	0.005 $\mu$ F ceramic

C16	0.001 $\mu$ F ceramic
C17	100 $\mu$ F electrolytic, 12V wkg.
C18	100 $\mu$ F electrolytic, 12V wkg.
C19	100 $\mu$ F electrolytic, 12V wkg.
C20	200 $\mu$ F electrolytic, 12V wkg.
C21	100 $\mu$ F electrolytic, 12V wkg.
C22	250 $\mu$ F electrolytic, 12V wkg.
C23	500 $\mu$ F electrolytic, 25V wkg.

### Inductors

L1	See Table and text
L2	See Table
L3	See Table
L4	Radiospares transformer type T/T6 (see text)
L5	Radiospares transformer type T/T6 (see text)

### Semiconductors

TR1	2G102 (or AF102)
TR2	2N3983 (TI407)
TR3	2G371
TR4	AC127
TR5	OC81D
TR6	AC127
TR7	OC81
D1	OA5

### Switch

S1	double pole rocker switch (or toggle if desired)
----	--

### Batteries

B1, B2	9-volt batteries type PP9 (Ever Ready)
--------	--

### Loudspeaker

35 $\Omega$	4in. round loudspeaker
-------------	------------------------

### Miscellaneous

18 s.w.g.	aluminium sheet
Plain	Veroboard with terminal pins
3	knobs
Outlet	socket box (see text)
Whip	aerial (see text)
Dial	drive components (see text)
Cabinet	(see text)
Battery	connector clips
Screened	wire, etc.

said for the larger version described in this article; it allows room for batteries of ample capacity as well as a relatively large speaker, and it permits a tuning scale of reasonable length in a cabinet of well balanced external appearance.

### CONSTRUCTIONAL DETAILS

A general view of the completed receiver is shown in the accompanying photograph. The cabinet measures  $9\frac{1}{2}$  by 6 by  $3\frac{3}{4}$ in. and is constructed from 5 mm plywood pinned and glued at the corners and finished in a wood-grain material

(e.g. Fablon). The front panel is of melamine laminate, drilled to take the control spindles, and with rectangular holes cut for the on-off switch, the tuning scale and the loudspeaker fret. The plastic loudspeaker fret is simply glued to the front panel with Araldite; a piece of thin Perspex is glued behind the chamfered opening for the scale; and the whole front panel is glued to wooden strips,  $\frac{1}{4}$ in. square and fixed to the inside of the cabinet such that the panel is recessed slightly from the sides of the cabinet. The back of the cabinet is simply made from thin ply-wood or hardboard covered with wood-grain material; the handle is cut from a leather strap and fixed with woodscrews and bent aluminium finish plates.

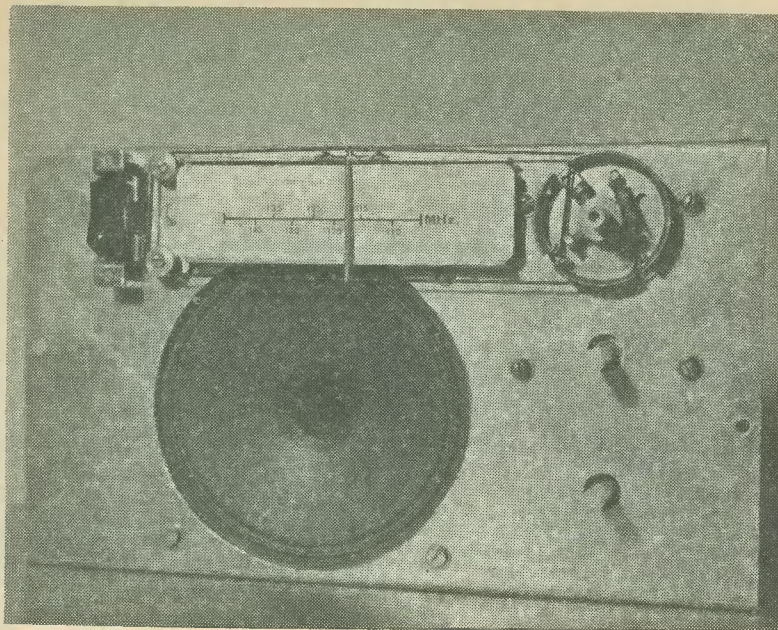

*The whole receiver is mounted on the aluminium sub-panel shown here. Switch S1, to the left, is a double-pole rocker component. The tuning drive drum is fitted over the rear section of the tuning capacitor shaft, this coupling directly to the moving vanes. The forward section of this shaft is coupled to the moving vanes by way of the integral slow motion drive of the capacitor*

The melamine laminate just referred to may be Wareite or Formica plain silver grey, and is available from most do-it-yourself shops. The plastic speaker grille was obtained from a local retailer, and appears to be generally available. Also, a suitable plastic grille in black, cream, grey or white is listed in the Home Radio catalogue under Cat. No. LS1A.

The aerial may be any whip aerial having a length of 30in. The writer used a TA11 telescopic aerial obtained from Henry's Radio. This is swivel jointed, with a maximum extended length of 36in.

It is not intended to give dimensioned drawings since constructors may wish to use components differing from those specified, and may need to vary the dimensions accordingly. Little difficulty should be experienced in the construction of a cabinet with a pleasing finish if the accompanying photographs are referred to.

Also illustrated is a rear view of the receiver with the back of the cabinet removed. The screening box housing the detector and the a.f. pre-amplifier can be seen in the top left of the picture, with the r.f. amplifier mounted on the rear of the screening box. The coils of the low pass filter can be seen at the bottom left, these being the Fortiphone chokes in round cans which were employed originally. The a.f. gain control is immediately behind these coils. At the top right of the cabinet is mounted the power amplifier and the batteries are housed to the right of the loud-speaker.

The whole receiver is mounted on a sub-panel of 18 s.w.g. aluminium sheet as illustrated. The appropriate photograph also shows the assembly of the tuning scale and pointer drive mechanism. The scale is cut from a scrap of white melamine laminate and measures 4 x 1in.; lines can be drawn with indian ink and figures and letters applied by means of pressure sensitive stencils or transfers. The drive-cord pulleys can conveniently be made from the wheels of miniature toy motor-cars, with the tyres removed. Suitable pulleys, as well as a drive drum, may also

be obtained from radio component sources, such as Home Radio.

A piece of 18 s.w.g. aluminium is bent into a shallow channel and screwed to the front of the sub-panel to house the scale. The top flange acts as a guide for a U-shaped runner bent from a piece of tin plate, to which a piece of 16 s.w.g. copper wire is soldered to form a pointer. The drive cable is fixed to a loop formed in the pointer wire above the guide, and the pointer proper is covered with red pvc sleeving.

The coils L1, L2 and L3 are home-wound. Winding details are given in the accompanying Table. It will be noted that 14/44 Litz is specified for L1, this being chosen for its mechanical, not electrical properties. The wire used by the author was taken from an old i.f. transformer. It is very flexible and makes the construction of L1 extremely simple, with the application of just a spot of wax to hold the winding in place. As an alternative, 36 s.w.g. tinned copper wire is perfectly satisfactory electrically, but is a little springy for a small diameter coil. Nevertheless, 36 s.w.g. wire could be used for L1 if the spares box does not yield a suitable Litz wire. A suitable coil former and core for L1 would be the Cat. No. CR26 and Cat. Z87 respectively, obtainable from Home Radio.

The socket outlet box, which forms the screening box for the detector stage, is first fitted with an 18 s.w.g. aluminium cover, cut such that it fits snugly in the box and rests on the four lugs which normally take the fixing screws of the socket outlet. 4BA clearance holes are drilled in the cover to mate with the tapped holes in the upper and lower lugs; the other two lugs are removed. The whole of the detector and a.f. pre-amplifier stages are built up on the cover plate as illustrated.

The tuning capacitor is first fitted to the cover plate by means of the three tapped holes in the rear of the capacitor frame;  $\frac{3}{8}$ in. spacers are employed on the 4BA fixing screws. Care must be taken in

positioning the tuning capacitor to ensure that the moving vanes do not foul, but just clear, the top of the screening box. A bracket, bent from 18 s.w.g. aluminium, is fixed to the base of the capacitor frame by means of the two 4BA tapped holes provided here, to carry the regeneration control VR2. Clearance holes are cut in the screening box to take the tuning and regeneration control shafts.

A small piece of plain Veroboard (i.e. without copper strips) is cut to fit around the regeneration control and secured to the cover plate with a small bracket; this board carries most of the detector components, viz: R4, R5, R6, VR1, L3 and C9. Connections are made with the aid of terminal pins in the Veroboard. VR1 should be mounted on the underside of the Veroboard and a hole cut in the screening box to allow screwdriver access for adjustment. The tuning coil L2 is soldered between the tuning capacitor frame and a small stand-off insulator; the latter carrying the collector lead of TR2 and one side of C6 and C8. The lead from the r.f. stage to the tap on the coil is carried through a grommet in the cover plate.

The a.f. amplifier stage is also housed within the screening box and is constructed on a small piece of plain Veroboard, mounted on the side of the tuning capacitor. Again, terminal pins are used as required. The gain control, VR3, is mounted on a bracket beneath the screening box and feeds the filter incorporating L4 and L5 which is mounted on the base of the cabinet.

The r.f. amplifier is constructed on a small piece of plain Veroboard, about 1½ by 1in. and, after completion, is mounted on the back of the detector unit. The method of construction needs no special mention since it is obvious from the various photographs. All r.f. leads should be kept as short as possible and the earthy end of components taken to one earth point. It is of particular importance to keep

TABLE  
COIL WINDING DETAILS

Coil	Turns	Wire	Former	Spacing or Length
L1	4	14/44 Litz (see text)	3/16in. former, with dust core (see text)	¼in. long
L2	5, tapped at 1½ turns from earthy end	16 s.w.g. tinned copper	Air cored, I.D. ¼in.	Turns spaced by wire diameter
L3	25	36 s.w.g. enamelled copper	¼in. former	Close-wound

the leads of the decoupling capacitors, C2 and C4, as short as possible. Terminal pins are omitted in view of the simplicity of the circuit.

The power amplifier is assembled, using terminal pins, on a plain piece of Veroboard measuring 4 by 1½in., so as to fit in the top of the aluminium sub-panel. The layout of this section of the receiver is in no way critical and is left to the discretion of the constructor. As mentioned earlier, a small commercial amplifier, with an input sensitivity of about 100mV, could be used in place of the amplifier shown in the circuit diagram.

#### ALIGNMENT PROCEDURE

If the power amplifier shown in the circuit diagram is used, it is recommended that C14 be initially disconnected and the power amplifier adjusted first.

Side view of the components on the cover plate, illustrating in particular the r.f. amplifier stage. Coil L1 is visible affixed to the underside of the Veroboard (facing the cover plate). The upper disc capacitor is C3 and the lower C2, with TR1 between. Note the lead from C3 to the tap in L2

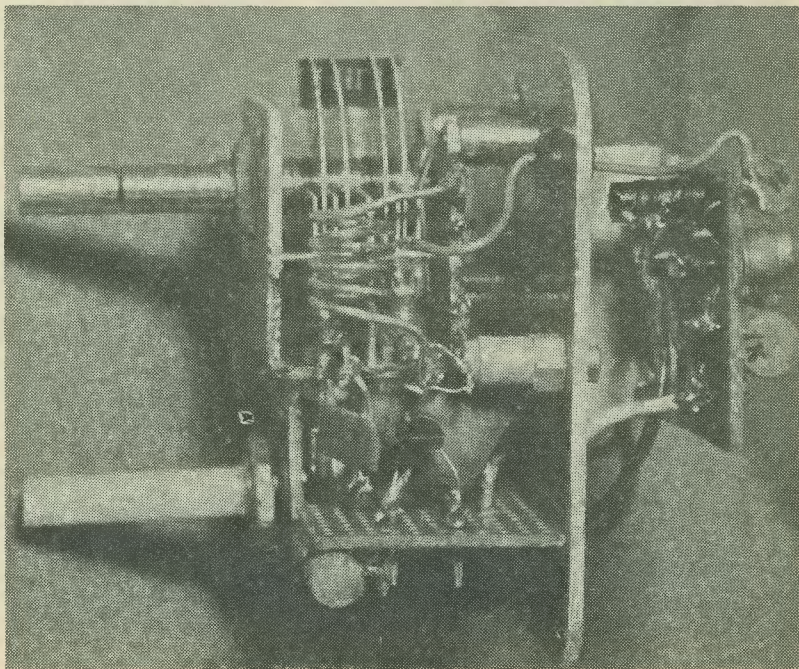

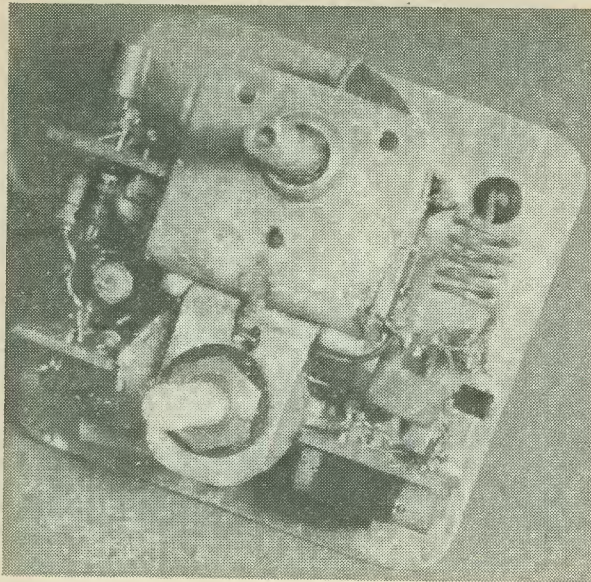

*This photograph shows the general layout employed in the screened box containing the detector and a.f. amplifier stages. Directly below the tuning capacitor is regeneration control VR2, this being straddled by a piece of plain Veroboard. At top right is coil L2, with TR2 and C6 below. Underneath the Veroboard is choke L3. A second piece of Veroboard, to the left of the tuning capacitor, carries the a.f. amplifier components. Connection is made to the front fixed vanes only of the tuning capacitor*

Check all connections, then connect a milliammeter in the collector circuit of TR6, and switch on. A current of not more than about 20mA should flow; if the current significantly exceeds this figure, switch off immediately and check for incorrect polarity of the battery supply and any other faults. Assuming a reasonable current flows in the output transistors, adjust VR4 until the voltage at the junction of R21 and R22 is exactly mid-way between the positive and negative supply rails, then adjust VR5 for a quiescent current of 5mA in the collector of TR6.

Reconnect C14 and connect the milliammeter in the negative supply line to the detector and a.f. amplifier stages. If the current exceeds 5mA, disconnect immediately and check wiring; if the current is less than 5mA, remove the meter and connect the supply line directly. Repeat the above procedure with the positive supply line to the r.f. amplifier.

Extend the aerial, set the tuning capacitor to a position in which the vanes are half engaged, set the regeneration control to its mid-position and advance the gain control slightly. Typical regeneration noise

should now be heard as a loud hissing. Adjust VR1, if necessary, to ensure that regeneration occurs over the whole of the range of the regeneration control. Now tune to the high frequency end of the scale (minimum capacitance in C5) and check that regeneration occurs at all settings of VR2. If it does not, the tapping on L2 should be adjusted slightly until satisfactory regeneration occurs over the whole of the tuning range at all settings of VR2.

Tune in a signal at about the centre of the tuning band and, with VR2 in the high-selectivity position, adjust the core of L1 for maximum signal strength; this adjustment is not critical.

Calibration of the tuning scale and alignment can, of course, be more conveniently carried out with a suitable signal generator, but the procedure outlined above will yield good results with patience. Patience is necessary in order to calibrate the scale which, without a signal generator, must be done by listening to an aircraft announce a change of frequency and retuning to the same aircraft on the new frequency.

## TWO TRANSISTOR CONVERTER FOR 'TEN'

*(Continued from page 220)*

For a frequency of 28MHz we find that the length required is approximately 16ft. 6in., and such a dipole is conveniently connected at its centre to 75Ω coaxial cable. This cable should leave the horizontal or vertical wire at right-angles, preferably for some 16ft.

Various types of aerial suited to the 10-metre band are shown in Fig. 5. Here, (a) and (b) are simple dipoles. The types shown at (c) and (d) are rather more 'gainy' and give a fair match to 75Ω cable. At (e) a ground plane type is shown, and here 50Ω cable is preferred, with not less than four radial

wires set at an angle of 45°. Type (f) is a harmonic type using three half-wave elements; it is also resonant at approximately 9.3MHz.

All the aeriels shown are easily hung from convenient supports. The method of connecting the coaxial cable to them is shown in Fig. 5(g).

## The RADIO CONSTRUCTOR

This magazine is published on the 1st of each month (allowing for weekends and public holidays). Copies are sent by post, rail and road to wholesalers in time for retailers to place copies on sale by the 1st of the month.

# HYBRID TRANSPORTABLE RECEIVER

(Continued from page 223)

## A.F. STAGES

A volume control, VR2, is connected across the secondary of T1, and the signal passes to TR2, a straightforward common emitter amplifier using a very high gain transistor. (Both TR1 and TR2 were obtained from Amatronix Ltd.) TR2 is directly coupled to a power transistor, TR3, this being connected as a common collector device with a 35Ω speaker in its emitter circuit. The collector current of TR2 is, of course, the same as the base current of TR3, and VR3 is adjusted so that TR3 passes a collector current of 170mA. But because TR3 is also a high amplification type the collector current of TR2 is unlikely to exceed 2mA, and may well be less. R6 provides adequate stabilisation and a little extra negative feedback for the signal, which is already subjected to heavy voltage feedback because of the common collector configuration of TR3. About half the power supply is dropped across the speaker,

leaving 6 volts or so for TR3. This, with 170mA passing, makes for a dissipation of about 1 watt, and an undistorted maximum output of about 500mW.

T2 is a heater transformer delivering a nominal 13 volts a.c. across its secondary. It is rated at 500mA and is required here to provide 475mA. Under these conditions a rectified voltage of about 12.5 will be found across C11. It has already been mentioned that it is a facet of the design that the series-connected heaters are used as a d.c. potential divider. For this reason it is necessary for the heaters to pass rectified currents, as Fig. 1 makes clear.

The coil unit L2, 3, 4, is designed for a 500pF tuning capacitor. In this case a 365pF capacitor is used and the inductance of the winding is increased a little by cementing in a small piece of ferrite at each end. Trial and error is necessary for this, and ½in. ferrite rod will be found suitable. Only a very small piece is required to make the tuning range on the medium waveband 190 to 550 metres, and to cover the long waveband equally suitably.

S1 is the simple wave change switch. S2 enables the receiver to be run from the mains or from a 12 volt car battery. When the latter source of power is used it will be necessary to turn S2 to the mains position in order to turn the receiver off. It will also be necessary to switch on S3 when the receiver is used with a car battery, as the switch is integral with the volume control. But it must be remembered

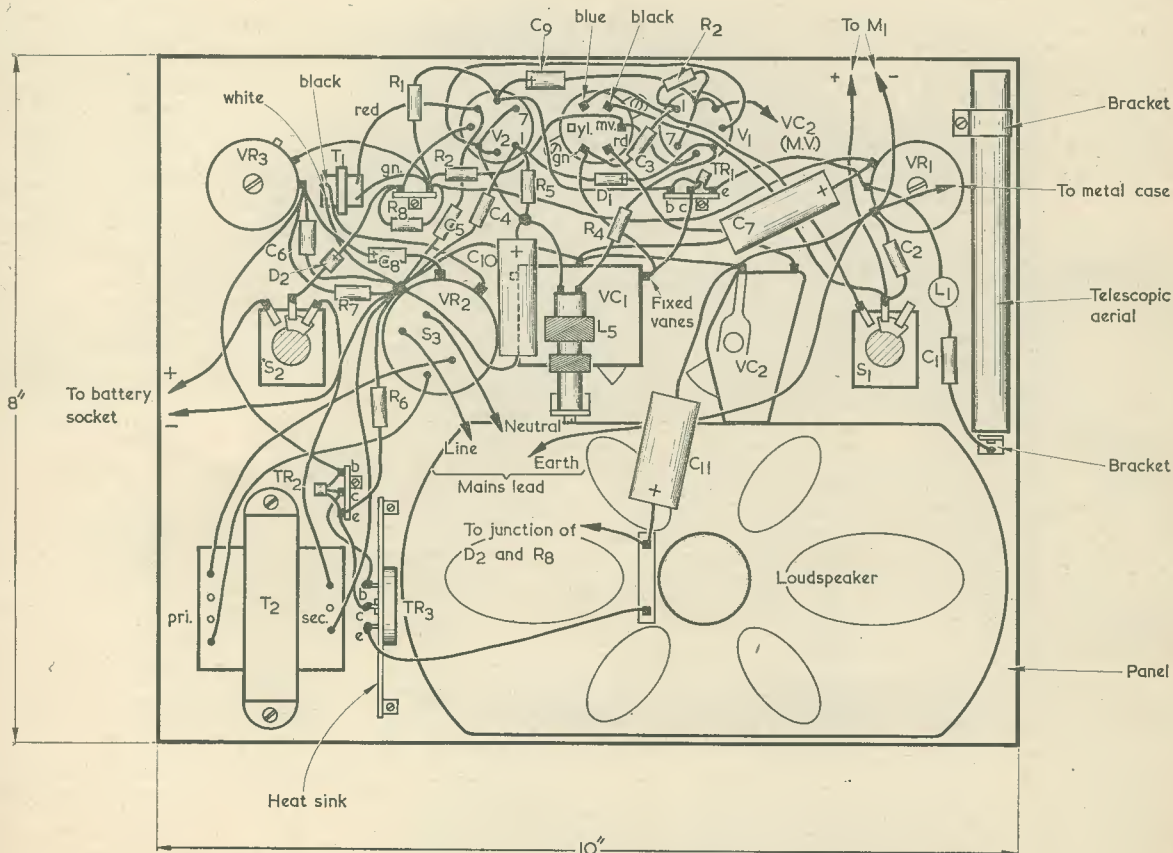

Fig. 2. Component layout and wiring. The two valveholders are shown turned through 90° to illustrate the wiring to their tags

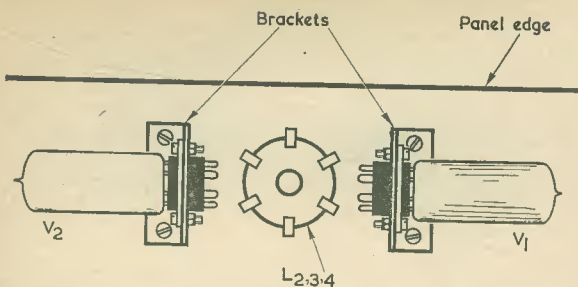

Fig. 3. How V1 and V2 are mounted to the panel

that if only S3 is switched off at the end of a programme, and despite the fact that no signals will be heard from the speaker, nearly 500mA will continue to flow from the battery!

As is shown in Fig. 1, the rectifier, D2, is in circuit both for mains and for battery operation. When S2 is set to the "Mains" position, D2 functions as a rectifier in conventional manner. When, however, S2 is set to the "Battery" position, D2 acts as a safety device and protects the receiver electrolytic capacitors by ensuring that no supply current flows if the battery should be inadvertently connected with incorrect polarity.

Meter M1 is used as a tuning indicator. It has a full-scale deflection of  $130\mu\text{A}$ , and TR1 is arranged, by means of the adjustment of VR1, to pass this current when no signal is being received and there is no a.g.c. voltage. The correct tuning point is indicated by the needle of M1 being at the lowest possible position. Adjustment of VC2, the reaction control, to increase regeneration causes the meter reading to fall due to the corresponding increase in a.g.c. voltage. Reaction is necessary with all fading signals to make the a.g.c. action as efficient as possible. It will be seen that the screen-grid of V1 provides the reaction feedback signal.

## CONSTRUCTION

All the components with the exception of the tuning indicator and the battery socket are mounted on a piece of  $\frac{1}{4}$ in. plywood measuring 10in. by 8in. The layout is shown in Fig. 2. VC1 should be mounted with its spindle half-way between the 8in. sides and 3in. from the top 10in. edge of the panel. The other four controls are mounted in a horizontal line at  $1\frac{1}{4}$ in. intervals, the horizontal line being  $\frac{1}{4}$ in. below the centre of VC1 spindle. (This allows clearance for a tuning pointer fitted later to VC1.) In most cases it is obvious from the diagram how the components should be fitted to the panel. T1, VR1 and VR3 should be held in position with suitable brackets or, as in the prototype, simply secured to the panel with adhesive. L1 is glued into a  $\frac{3}{8}$ in. hole drilled through the panel. It will be seen that two 3-way tagstrips and one 2-way tagstrip are used as anchoring points for TR1, TR2 and R8 respectively, together with the associated wiring. The correct mains voltage tap on T2 primary should be selected, in accordance with local mains voltage. Should the latter be between two indicated taps, the tap with the higher indication should be used. That is to say, for 240 volt mains, the 250 volt tap should be used.

In Fig. 2 the valveholders are shown turned through  $90^\circ$  in order to illustrate the wiring more clearly. In practice, they are each mounted on a bracket, and the valves take up the positions shown in Fig. 3. Both valveholders are oriented on their brackets so that pins 1 and 7 are nearest the panel.

The choke, L5, is provided with two pairs of tags. Two tags have the choke leads obviously soldered to them, and these are used for the circuit connections. No connections are made to the other pair of tags. One end of the choke is threaded 4BA, and the component is mounted on a bracket so as to lie over VC1. See Fig. 4. Be careful to see that the bracket is clear of the moving vanes of VC1 when these are open.

The yellow tag on the coil unit, L2, 3, 4, is not used. For setting-up purposes, the connection between R6 and TR2 emitter is left open. The lead from VR1 designated 'To Metal Case' in Fig. 2 should consist of a 6in. length of flexible wire suitable for mains wiring. Its other end is connected later.

TR3 should be mounted on a heat sink which may be made of 16 s.w.g. aluminium sheet and which need not be larger than about  $2\frac{1}{2}$ in. square. It is fixed to the panel by brackets, and there is no need for a mica washer to be employed. This heat sink is connected to the collector of TR3, and care must be taken to ensure that it does not touch the speaker frame or the live part of any other component.

It will be seen that a 3-core mains lead is employed, with one of the wires connecting to mains earth at the mains socket. *It is important that the receiver be used only with a 3-core mains lead which is fitted to a correctly wired 3-way plug, so that the receiver is always connected to a reliable mains earth when powered by the mains. Do not use a 2-core lead or obtain a mains supply from a 2-way socket.*

The tag positioning on S3 may vary with different components. Check through with a continuity tester or ohmmeter to identify the tags corresponding to each pole on the particular component employed before making any connections to them.

Fig. 2 shows a relatively large number of leads soldered to the earthy tag of VR2. This is the tag to which are connected C4, C5, etc. It will be helpful here to fit a small solder tag near the potentiometer tag, connect this to the potentiometer tag, and share the leads between these two tags. If the metal case

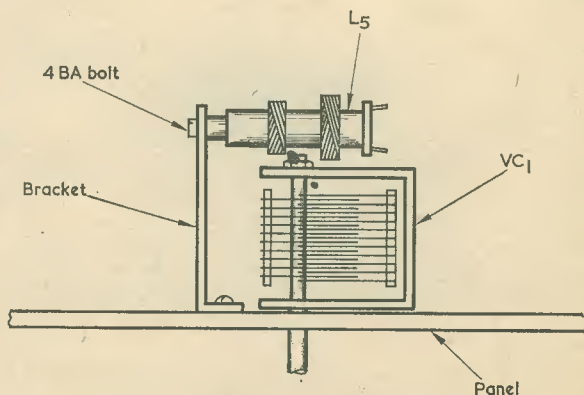

Fig. 4. L5 is positioned above VC1 on a small bracket



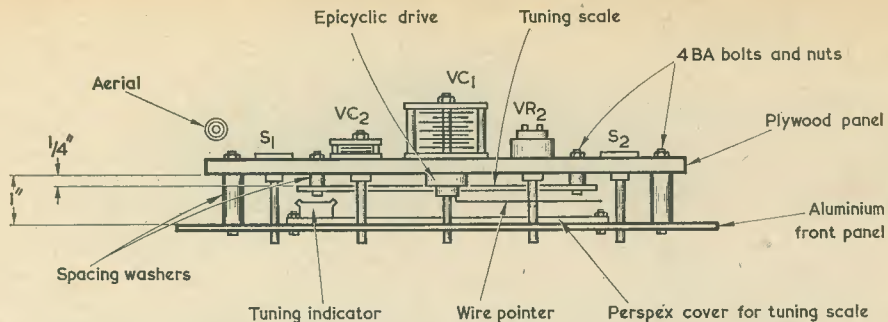

Fig. 5. Detail illustrating the manner in which the receiver panel, tuning scale and front panel of the cabinet are assembled together

of the potentiometer has a solder lug fitted, this may be employed as the extra tag instead, the potentiometer case then being earthed as well.

At this stage the battery socket and the tuning indicator should be wired up with short lengths of flex, to enable the receiver to be set up. The battery socket and indicator are not mounted in position yet.

First set VR1 to a half-way position and VR3 so that all its resistance is in circuit—fully clockwise as shown in Fig. 2. Select a suitable current range on a testmeter so that it is able to give a clear reading of 170mA and connect it between the emitter of TR2 and R6 (negative to R6). It will be recalled that the connection between these two components was left open during wiring. Adjust VR3 so that the meter gives a reading of 170mA when the receiver has been switched on for 10 minutes. Connect R6 to TR2 emitter, and then adjust VR1 until, with no signal being tuned in by the receiver, the tuning indicator needle is at, or close to, its maximum position. This is well over to the right. No other adjustments are

necessary except for the fitting of the small pieces of ferrite rod to the coil, which have already been mentioned.

### RECEIVER CASE

The prototype receiver was housed in an aluminium case. This is a Home Radio 'Universal Chassis' with a back panel. (A wooden cabinet cut to the same internal dimensions as the aluminium case could, of course, be used instead; whereupon the lead from VR1 marked 'To Metal Case' in Fig. 2 is not needed.) The plywood panel is fitted to the front panel of the case in the manner shown in Fig. 5, but first an epicyclic ball drive should be fitted to the spindle of VC1 and a scale, mounted with the aid of spacing washers of Paxolin or metal to the plywood panel. A tuning pointer made of wire is fixed to the epicyclic drive. The scale should now be calibrated. Next, the aluminium front panel is cut, with a fret saw, to give suitable apertures for the speaker and tuning scale,

*A view inside the receiver. As can be seen, the larger components are spread out comfortably and without crowding*

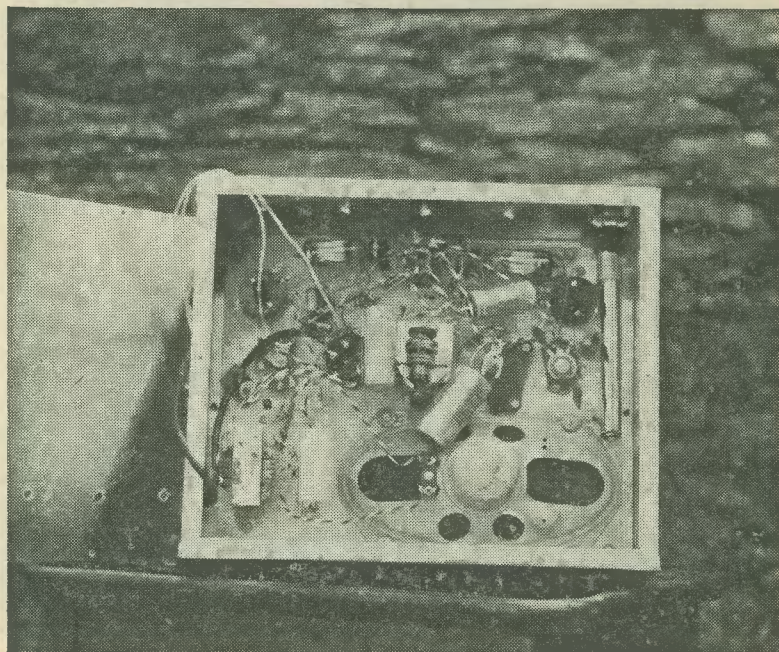

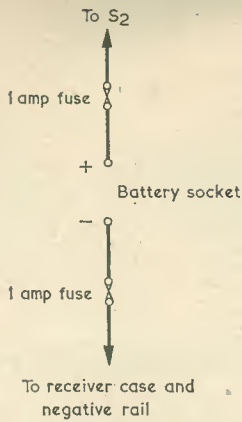

Fig. 6. If a metal case is used, two 1-amp fuses should be fitted for some applications

and for the spindles of the five controls. A piece of expanded metal speaker grille is bolted over the inside of the speaker aperture with its edges covered with plastic insulating tape or similar material, to prevent rattles. (With a wooden cabinet, use speaker fabric.) A piece of Perspex is cut to cover the inside of the scale aperture, and a  $\frac{3}{4}$ in. by  $\frac{1}{2}$ in. hole is cut in this, so as to appear at the top left hand corner of the tuning scale aperture. Meter M1 is mounted in this aperture, being pushed into position from behind. The Perspex is then bolted into place. The plywood panel is next bolted to the aluminium panel, again with the aid of spacing washers, so that each of the edges of the aluminium panel overlaps the adjacent edge of the plywood panel by  $\frac{1}{2}$ in.

Fig. 5 shows the assembly from the top as so far made up. The chassis sides are not fitted yet. Both the tuning scale and the aluminium panel are spaced off from the plywood panel by four spacing washers each, although only two of each appear in Fig. 5, the others being hidden below. One of the long sides of the case, which will later form the top, should have

four or five small holes drilled in it for ventilation. It also requires a hole, fitted with a grommet, for the telescopic aerial. The four sides are bolted together, using the nuts and bolts provided with the case kit, and the receiver assembly is fitted to these, the self-tapping screws provided passing through the front panel. Fit a solder tag to the case side adjacent to VR1 and connect this solder tag to the lead from VR1 marked, in Fig. 2, 'To Metal Case'. Shorten the lead as necessary, and ensure that all connections in the earthing circuit to the earth lead of the mains cord are soundly and reliably made.

The two large aluminium panels in the case kit are identical, and the one which has not yet been used, and which will be the back, has a hole drilled through it for the 3-core mains lead. This hole must be fitted with a rubber or p.v.c. grommet. The mains lead should be clamped internally to one of the case sides.

The back panel also has the battery socket fitted to it. A lead should be taken from the negative socket connection to a solder tag under one of the socket mounting nuts in order to connect the back panel to the negative line. The back panel should also have four or five holes drilled in it— $\frac{1}{4}$ in. is large enough—for ventilation. It can then be fitted to the case with the self-tapping screws provided. Panel-Signs transfers will make neat indications of the functions of the five controls.

When the receiver is operated from the mains an effective earth is automatically provided. But if it is run from a battery of which neither side is earthed, an external earth connection is required for adequate pick-up. Should it be intended to operate the receiver near a vehicle whilst running from the vehicle battery, insert two miniature 1 amp cartridge fuses immediately after the battery socket, as shown in Fig. 6. The fuse holders may be fitted to the receiver back. The metal case of the receiver should not be allowed to touch the vehicle metalwork in case of short-circuits, and the fuses will protect against excessive current flow in such an instance. (The fuses will not be required if a wooden case with no exposed metal common to the negative line is employed.) The body of the vehicle will provide an adequate counterpoise earth.

## CAN ANYONE HELP?

Requests for information are inserted in this feature free of charge, subject to space being available. Users of this service undertake to acknowledge all letters, etc., received and to reimburse all reasonable expenses incurred by correspondents. Circuits, manuals, service sheets, etc., lent by readers must be returned in good condition within a reasonable period of time.

**Philips Radio, Model L4X25T.**—G. E. Dobson, 7 Chingford Avenue, Thorntree Estate, Middlesbrough, Yorks. — manual, circuit or any information on this Australian-made transistor radio.

**Murphy TO.156 Receiver.**—F. Hossell, Victoria, Seychelles — manual, circuit or any information very urgently required.

**Siemens Alignment Tape A10.**—G. L. Page, 154 Chiltern Avenue, High Wycombe, Bucks. — loan, hire or sale of this tape, as used in setting up the Siemens Model 10, 11 and 12 tape recorders. Has any reader successfully overcome channel crosstalk when using mono?

**Murphy B40 Receiver.**—I. Simmonds, 20 Brownhill Road, Chandlers Ford, Eastleigh, Hants. — circuit diagram, manual or any other information — loan or purchase.

**Invicta TV model 5370.**—T. F. Jones, Flat 2, Block 2, Wychbury Court, Halesowen, Worcs. — manual or service sheets — loan or purchase.

**McMurdo Silver Communication Receiver.**—C. T. Dowson, 39 Victoria Street, Scarborough — service sheet, circuit or any information. Loan or purchase.

**Reception Set Type R209 Mk. II.**—T. Wallis, 1 Park View Terrace, Rawdon, Nr. Leeds, LS19 6ES — details of input and output voltages of vibrator required.



- 1** Household contents and personal possessions up to £600
- 2** All Risks cover on personal belongings up to £60
- 3** Personal accident insurance (road, rail and sea risks) - £3 per week
- 4** Loss of cash up to £20
- 5** Household removal cover up to £600
- 6** All Risks cover on sports equipment up to £30
- 7** Personal liability cover for the family up to £20,000
- 8** Cover on Radio, Television etc. for damage in the home up to £60
- 9** Holiday deposits cover up to £20

## Each £3 unit of Home Unit Insurance gives you protection up to the limit shown

This is the simplified insurance you have been waiting for. Not just cover on the contents of your home but a package of personal protection you and your family need. And it's how we save you so much money: just ONE policy to issue instead of nine!

(or 1/2 units after the first) up to a maximum of five. So simple. So easy. Apply to your Broker, Agent or local office of a General Accident company.

The Home Unit Policy can replace your existing insurances. And remember - as you buy more possessions just add more Home Units at any time.

# THE YORKSHIRE INSURANCE COMPANY LIMITED

Becket House, 36-37 Old Jewry, LONDON, E.C.2.

It pays to be protected by a **General Accident** company

Please send me further particulars of the Home Unit Insurance.

Name.....

Address.....

5304 JB



# UNDERSTANDING RADIO

## MEASURING INSTRUMENTS

$$f = \frac{1}{2\pi\sqrt{LC}}$$

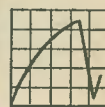

by W. G. Morley

IN LAST MONTH'S ISSUE WE COMPLETED OUR EXAMINATION of superhet receivers by dealing with ceramic intermediate frequency filters. We now turn our attention to quite a different subject, that of measuring instruments.

A very wide range of measuring instruments are employed in electronic work, these indicating the magnitude of the electrical quantity being measured in a variety of different ways. The most common method of indication is provided by an instrument incorporating a pointer, or "needle", moving across a graduated scale, and we shall commence by examining instruments of this type.

### POINTER INSTRUMENTS

Of the measuring instruments which incorporate a pointer the most frequently employed in electronic work is the moving-coil meter. There are, however, several other types of pointer instrument, and we shall initially consider these in this month's article since, unlike the moving-coil meter, they are each intended for quite simple measuring applications and only require a description of their basic operation. They also provide a useful introduction to the moving-coil meter, which we shall discuss in next month's issue.

Fig. 1 illustrates the *hot wire meter*, this being an instrument intended for the measurement of current. The hot wire meter was superseded many years ago by more modern and efficient current measuring instruments, but it is of interest because of its mode of operation and because it can be made up fairly easily by experimenters and students. The current to be measured by the meter flows through the wire connected between its terminals, whereupon the wire warms up and increases in length due to expansion. The amount of expansion is proportional to the temperature of the wire and, hence, the current which flows through it. A phosphor-bronze wire is attached to the centre of the heated wire, its other end being secured at the lower anchoring point. Attached, in turn, to the centre of the phosphor-bronze wire is a length of silk which passes round a small pulley on a pivot to which the pointer is attached. The whole system is kept under tension by the leaf spring, and a zero-adjust facility is provided by the screw indicated. To impart a high level of rotation to the spindle, both the heated and phosphor-bronze wires

need to be nearly straight. The metal used for the heated wire requires a high melting point and a high specific resistance (i.e. the wire should offer a relatively high value of resistance per unit length). Wire materials employed in these instruments have included platinum-silver and iridium-platinum.

No more need be said about the construction of the hot wire meter. It has, however, allowed the introduction of an important point which must always be considered when dealing with pointer instruments. In order that the hot wire meter may function, the current flowing through the heated wire must cause a voltage to be dropped across it, whereupon the instrument inevitably absorbs power from the circuit in which it is inserted. All pointer instruments cause power to be absorbed from the circuits to which they are connected, and the selection of an instrument for a specific measuring application is partly governed by the permissible amount of power which may be so absorbed.

Since the indication offered by the hot wire meter depends upon the heating of the wire, this instrument is capable of measuring alternating currents (includ-

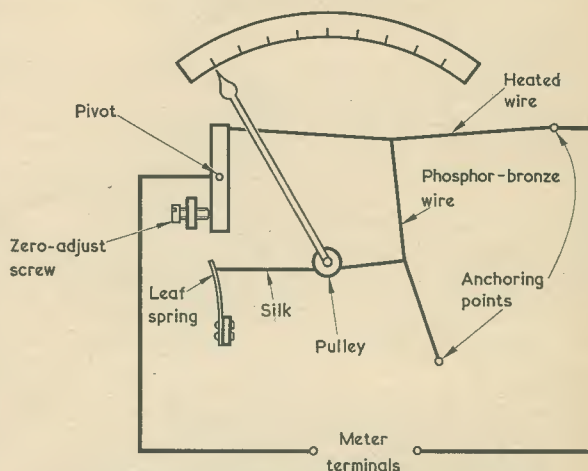
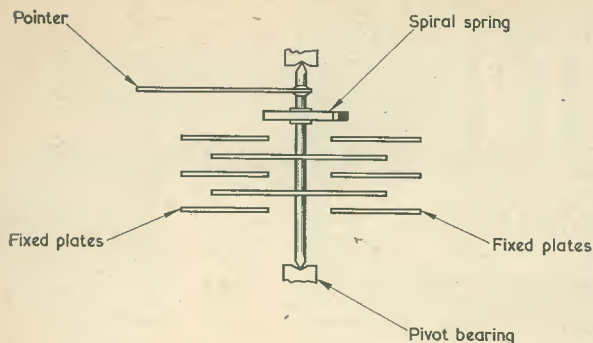
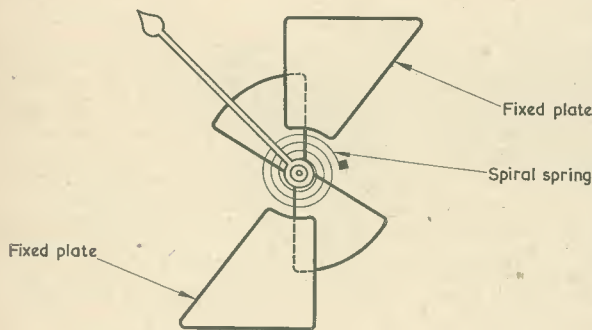

Fig. 1. Although superseded by modern current-reading instruments, the hot wire meter shown here is still of interest, and it offers an introduction to some basic factors concerning pointer instruments



(a)



(b)

Fig. 2. Illustrating the basic method of operation of the electrostatic voltmeter. A side view of a typical plate assembly appears in (a), whilst (b) gives a view from the pointer end of the pivot. The voltage to be measured is applied to the fixed and rotating plates

ing the lower radio frequencies) as well as direct currents. With alternating current, the reading given is the r.m.s. value of the current.

## ELECTROSTATIC VOLTMETER

Another type of pointer instrument is the *electrostatic voltmeter*, this being shown in basic form in Figs. 2(a) and (b). The electrostatic voltmeter has two sets of plates, one fixed and the other mounted on a pivot to which the pointer is attached. When no voltage is applied to the instrument, the pointer is held at the zero end of the scale by means of a spiral spring. (As we shall see later, it is more common to use two springs.) If a voltage is applied across the two plates the resulting electrostatic attraction between them causes the moving plates to become interleaved with the fixed plates, the degree to which the plates interleave depending upon the magnitude of the electrostatic attraction as it acts against the torque imparted by the spiral spring. The electrostatic attraction is proportional to the value of the applied voltage, with the result that the pointer gives a direct indication of this value. Since the mechanical force resulting from electrostatic attraction is small, the instrument is only capable of reliable operation with

high voltages. In general, electrostatic voltmeters are not usually employed for measuring voltages lower than 500. The instrument is of considerable value in television work, where cathode ray tube electrode potentials are of the order of 10 to 25kV.

The sensitivity of the electrostatic voltmeter increases as the spacing between the two sets of plates is reduced. This spacing must not, however, be too small or sparking will take place between the plates. The number of fixed and moving plates in a practical electrostatic voltmeter may differ from that in the example shown in Fig. 2, as also may their shape.

A considerable advantage with the electrostatic voltmeter is that the power it draws from the circuit to which it is connected is negligibly small. If it is used for measuring a direct voltage the only current which flows is an initial charge current to the effective capacitor formed by the two sets of plates. This factor is of great value for the television work just referred to, since television high voltages are frequently generated by circuits offering relatively low values of current, and their operation is unaffected by the connection of the voltmeter.

The electrostatic voltmeter may also be employed for measuring alternating voltages at low frequencies, since such voltages cause the same electrostatic attraction to appear between the two sets of plates on each half-cycle. In this case, a small current flows due to the capacitive reactance offered by the plates. At high frequencies—above 1MHz or so—current flow due to the reactance, and to insulation “losses”, is normally too high to allow the electrostatic voltmeter to be used.

## THERMOCOUPLE METER

The next type of meter to be considered takes advantage of what is described as a *thermocouple*, or *thermo-junction*. A thermocouple is formed at the junction of two dissimilar metals where, on the application of heat, a potential difference appears

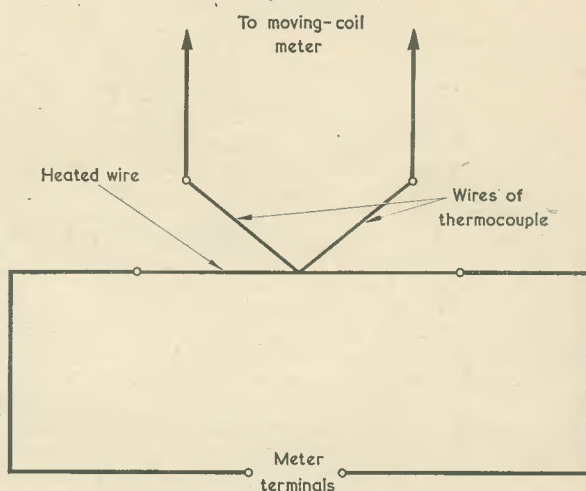
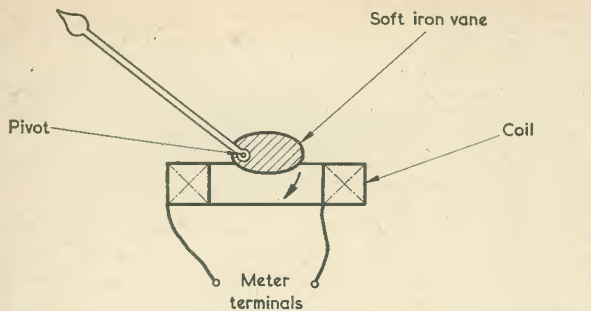
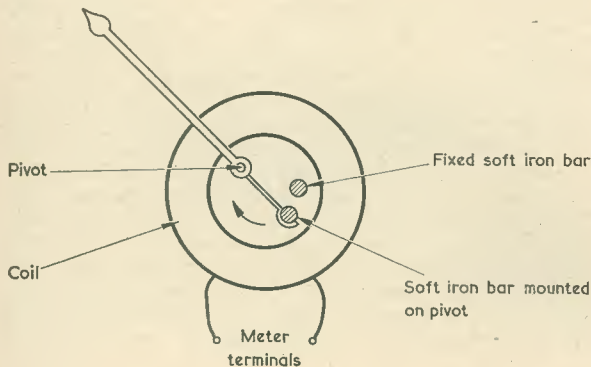

Fig. 3. In the thermocouple meter the current to be measured first heats a wire to which is welded a thermocouple junction. The resultant potential difference across the junction is then indicated by a moving-coil meter



(a)



(b)

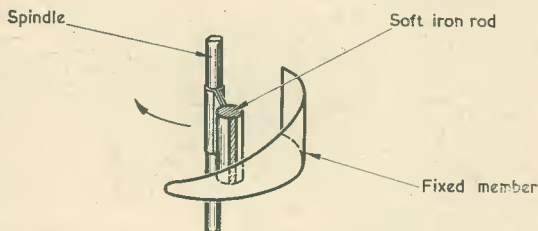

(c)

Fig. 4(a). Operating principle of the attraction moving-iron meter. In this diagram, and in (b) and (c) pivot springs are omitted for clarity

(b). A simple repulsion moving-iron meter

(c). Non-linearity in the repulsion moving-iron meter may be reduced by giving the fixed member a shape similar to that shown here. The diagram shows the soft iron rod deflected, in the direction of the arrow, by about two-thirds of full travel from the zero position

across the junction faces. In practice, the metals at the junction are usually in the form of wire. The appearance of the potential difference is particularly pronounced with some pairs of metals, such as iron and Eureka.<sup>1</sup>

1. "Eureka" is the trade-name for an alloy employed for resistance wire.

The *thermocouple meter* is shown in basic form in Fig. 3. It is intended for the measurement of current, the current flowing through a wire whose temperature increases accordingly. A thermocouple is welded to the centre of the heated wire. The two dissimilar metal wires of the thermocouple then connect to a sensitive moving-coil meter which gives an indication proportional to the potential difference, and hence the temperature, at the junction. The overall result is that the moving-coil meter indicates the magnitude of the current flowing through the heated wire.

The main function of the thermocouple meter is to measure current at radio frequencies. It provides

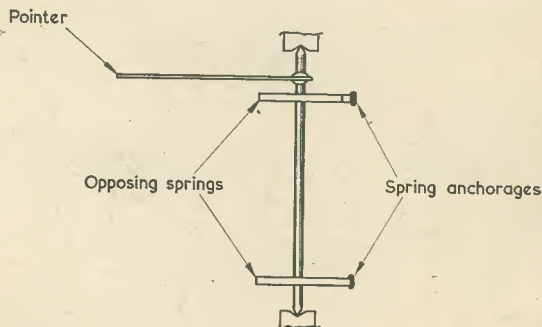

(a)

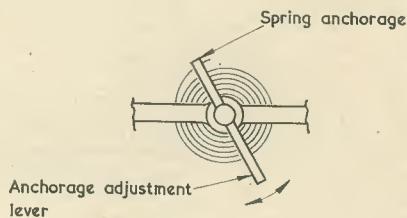

(b)

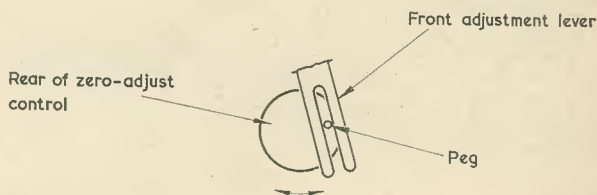

(c)

Fig. 5(a). It is usual to employ two spiral springs in a meter assembly, these offering opposing torques to the pivot. The pointer deflecting mechanism appears between the springs

(b). The spring anchorage position is adjustable, as shown here. The type of lever illustrated is fixed to the rear pivot bearing

(c). The front anchorage adjustment lever has a U-slot with which is engaged a peg on the rear of the zero-adjust control fitted to the meter case. Turning the control then varies the setting of the lever

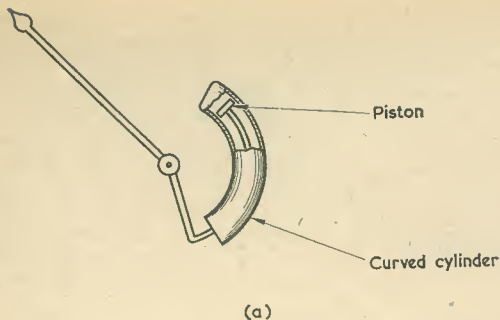

(a)

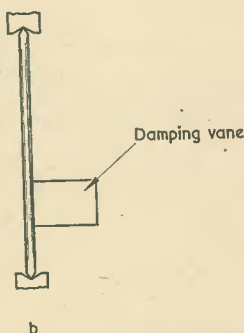

b

Fig. 6(a). A damping device in which air resistance causes braking of pointer movement

(b). A simpler form of damping is given by fitting a vane to the pivot

accurate indication at frequencies up to some 50MHz, above which it tends to be inaccurate due to "skin effect" in the heated wire through which the current passes.<sup>2</sup> Special heating element and thermocouple assemblies have, however, been produced in which the inaccuracies due to skin effect are reduced.

Since the readings given by a thermocouple meter depend on the heating and cooling of the wire through which the current passes, there is a slight delay before the meter pointer takes up any new position corresponding to a change in current. The meter is, in consequence, described as being *sluggish*. With

2. Because of eddy currents in the body of a wire, radio frequency currents flow nearer its outer surface or "skin", the effect becoming more pronounced as frequency increases.

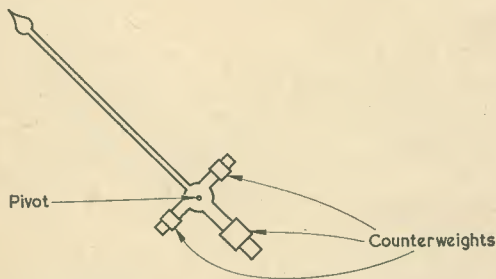

Fig. 7. Counterweights are added to the pivot and pointer assembly to counterbalance the weight of the pointer and any other parts fitted to the pivot

most practical instruments, the sluggishness is not sufficiently pronounced to represent any serious disadvantage. The scale of a thermocouple meter is not linear (i.e. it does not have equally spaced graduations from the zero point to the maximum point), and graduations are "cramped" at the low current end. The voltage dropped across the wire in the thermocouple meter need not be as great as in the case of a hot wire instrument, since it is only necessary that the wire length be sufficient to allow an increased temperature to appear at its centre. Thus, the power absorbed from the external circuit by the thermocouple meter is lower than with the hot wire meter.

## MOVING-IRON METER

Figs. 4(a) and (b) illustrate two types of *moving-iron meter*. The meter shown in Fig. 4(a) is an example of the *attraction* type. In this version the pointer is mounted on a pivot, as also is a vane of soft iron. When a current is passed through the coil the resulting magnetic field pulls the soft iron vane into the coil against the torque imparted by a spiral spring. For simplicity, this spring is omitted from the diagram. Also, the coil is shown in section, as though it were cut in half. As may be visualised, the vane is drawn further into the coil as coil current increases, whereupon the device is capable of indicating the magnitude of the current flowing in the coil. A basic disadvantage is that pointer deflection for a given change in current increases as the soft iron is

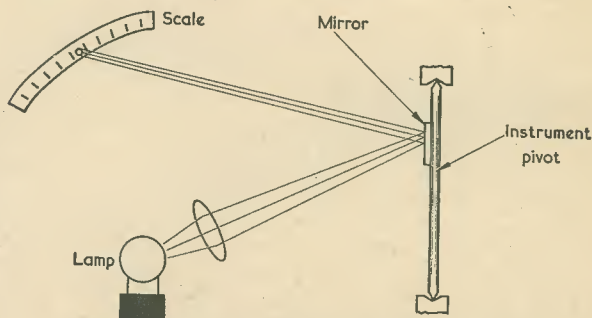

Fig. 8. What is effectively a long and weightless "pointer" may be obtained with the aid of a mirror secured to the instrument pivot

drawn more and more into the coil, with the result that the lower end of the scale becomes "cramped" and the higher end "opened out". Graduation spacing on the scale may be made more even by designing the vane so that the soft iron saturates at fairly low coil currents, whereupon the magnetic field due to the iron itself cannot increase further. At coil currents above the saturation level the scale then becomes nearly linear.

The second type of moving-iron meter is the *repulsion* version, a simple example of which is shown in Fig. 4(b). Affixed to the pivot of the instrument is a bar of soft iron, this being held close to a second, rigidly fixed, soft iron bar due to the torque imparted to the pivot by a spiral spring (not shown). Both bars are of the same size and they appear end-on in Fig. 4(b). When a current passes through the coil the two soft iron bars become magnetised. Both have the



same magnetic polarity, with the result that repulsion is set up between them, causing the bar secured to the pivot to move away from the fixed bar by a distance which depends upon the current in the coil. This distance varies approximately as the square of the coil current and so the scale of the meter is non-linear. The non-linearity may be considerably reduced by using a specially shaped fixed soft iron member, as shown in Fig. 4(c). When, with this design, current flows in the coil surrounding the two parts, the moving bar is deflected to a narrower section of the fixed curved member, where the magnetic field is weaker. Reasonable linearity can be achieved by suitably shaping the curved member. Fig. 4(c) shows a soft iron rod mounted on the spindle. The moving part may, alternatively, be a sheet of magnetic material bent to present a narrow flat surface to the fixed member.

Moving-iron meters can measure low frequency alternating currents as well as direct currents. They are relatively insensitive, and are only normally employed for measuring currents in circuits which can tolerate the consequent absorption of power. On the other hand, moving-iron meters are robust and have a simple mechanism which enables them to be produced at low cost. They lend themselves particularly well to such applications as the measurement of battery charging current and the like. Earlier moving-iron meters had a reputation for inaccuracy, but this is not true of modern instruments, which have adequate accuracy for the applications in which they are used.

## MECHANICAL DETAILS

We have not yet dealt with some of the mechanical details which are encountered in practical meter design, and we shall next turn to these. Of the meter types we have so far discussed, these details apply to the electrostatic voltmeter and to the moving-iron meter.

We have assumed, when dealing with these two meters, that the pointer is deflected against the torque imparted by a single spiral spring. In practice, it is preferable to employ two opposing spiral springs, as in Fig. 5(a) both springs applying equal torque to the pivot when the pointer is at the zero position. Since there are then two torques acting on the pivot for the zero setting rather than no torque at all, as would occur if only a single spring were employed, the effects of possible friction in the pivot bearings are overcome, and the pointer is able to return reliably to zero when the actuating current or voltage is removed. With two springs the torsional force exerted on the spindle increases in linear fashion as the spindle rotates, just as would occur if a single spring were employed. A further advantage of having two springs operating in opposite directions is that they automatically compensate for temperature variations. A normal spring material is phosphor-bronze,

which is non-magnetic and is thereby unaffected by magnetic fields either inside or outside the meter.

The end anchorages of the two springs are made adjustable, as in Fig. 5(b). The rear anchorage position is set up at the factory, whilst that at the front may be adjusted by the user over a small degree of rotation, thereby enabling a "zero-set" control to be obtained (see Fig. 5(c)).

It is desirable that the movement of the pivot and pointer of a meter be *damped*, so that the pointer settles down quickly to any new setting. Without suitable damping the pointer could oscillate around the setting for a considerable time before finally becoming stationary. The requisite damping may be achieved by mechanical means, typical examples being given in Figs. 6(a) and (b). In Fig. 6(a) a piston coupled to the pivot travels inside a curved cylinder, the dimensions being such that the edge of the piston does not touch the inside wall of the cylinder. The consequent air resistance imparts a braking action and provides the requisite damping. The assembly of Fig. 6(a) is referred to as a *dashpot*. A simpler approach is to fix a vane to the pivot, as in Fig. 6(b), the whole being mounted in a partially or completely enclosed chamber. The air resistance acting on the vane similarly imparts damping. Frequently, the mechanical damping system may be made integral with the construction of the meter. For instance, the moving soft iron bar in the repulsion moving-iron meters of Figs. 4(b) and (c) could be mounted on the outside edge of a damping vane.

It is desirable for the pointer and pivot assembly to be as light as possible in order that frictional losses may be kept to a minimum. Counterweights are normally added to the assembly, as in Fig. 7, to counterbalance the weight of the pointer and any other parts fixed to the pivot. These counterweights ensure that the pointer always takes up the same setting regardless of the position of the meter. Frictional losses are kept low by mounting the pivot between two steel or jewel bearings.

A "weightless pointer" may be obtained by fixing a mirror to the pivot of a meter. The general scheme is shown in Fig. 8. A beam of light is directed on to the mirror, is reflected and then becomes finally focussed as a spot or circle on a scale. The length of such a "pointer" can, of course, be as great as is required, and the technique is employed with laboratory instruments having a high sensitivity. Of the meters we have considered so far, the use of a mirror in this manner could not be justified with a moving-iron meter. On the other hand it has been employed with electrostatic voltmeters intended for work with television receivers.

## NEXT MONTH

In next month's issue we shall introduce the moving-coil meter.

---

## BUILD . . .

A 3-volt Neon Test Unit consisting of an oscillator applying a series of pulses to a step-up transformer and following rectifier giving an off-load output voltage well in excess of 200 from a supply battery of 3 volts only. See the December issue for details!

## TRANSISTORISED G.D.O.

Part 2 and conclusion of "Transistorised G.D.O. for the H.F. Bands" by R. J. Hulbert, G3SRY, will be published in the next issue.

# In your workshop



**“CLIMB EVERY MOUNTAIN!”**  
The sound of the song of the Mother Abbess, reproduced with great clarity and, apparently, quite considerable volume, reached Dick's ears as he hurried through the chill early morning air towards the lighted windows of the Workshop. It was obvious that, once more, Smithy had beaten him to it.

Dick hastened his step and the loudness of the music increased as he approached the Workshop door. As he opened the door the full volume of the sound enveloped him; and he listened appreciatively to what, to his ears, represented a more than adequately pleasant quality of reproduction. Whilst he hung up his raincoat on one of the hooks behind the door, the Workshop long-playing copy of “The Sound of Music”, only brought into use for checking the better class of record playing equipment, finally came to the end of its track.

“Gosh,” said Dick, impressed, “that sounded good.”

“It wasn't bad, was it?” replied Smithy proudly, as the pick-up rose from the record and returned to its rest.

The Serviceman leaned over and turned off a power supply unit on his bench.

“Not perhaps in the high fidelity class,” he added, “but certainly good enough to merit the name ‘high quality’.”

## LONG-TAILED PAIR

A puzzled expression suddenly appeared on Dick's face.

“So far as I can remember,” he said pensively, “the only record-player we've got in for repair is a

Readers may recall the long-tailed pair employing voltage amplifier valves which Smithy described in our last episode. We find, this month, that the Serviceman has fruitfully devoted his intervening time to the development and construction of a high quality amplifier. The push-pull output valves of this amplifier similarly function as a long-tailed pair, and they carry out their own phase splitting

rather cheap and nasty little effort. I didn't think you'd be able to get it to give as good an output as the music I've just been listening to.”

“I haven't,” grinned Smithy. “What you've been hearing is the output of an amplifier I built myself. I have, however, temporarily coupled this to the crystal pick-up of that little record-player in order to get an input signal.”

With rising interest, Dick walked over to Smithy's bench, whereupon that gentleman indicated to him a small chassis bearing three B9A valves, a speaker transformer of moderate size, a transistor mounted on a small heat sink, and very little else.

“This is the amplifier,” remarked Smithy proudly, “and it's a development from the long-tailed pair phase splitter using voltage amplifier valves we played around with when we had our last gen-session together. If you remember, the phase splitter had a circuit like this.”

Smithy scribbled a circuit on his note-pad. (Fig. 1).

“I remember that phase splitter very well,” replied Dick promptly. “In fact, we had quite a bit of fun plotting out the two anti-phase

anode voltages it gave when we took the input grid negative and positive of chassis.”

“It worked quite well, didn't it?” agreed Smithy. “Just to recap, the transistor in the common cathode circuit of the two triodes functions as a constant current device having a very high slope resistance, whereupon the valves give the same performance as they would with a high value physical resistor in their common cathode circuit, the resistor being returned to an auxiliary negative supply. But in our version there's no need for an auxiliary negative supply, which represents what is, to my mind, quite a considerable advantage.”

“I've been wondering since then,” said Dick, “whether the same constant current idea couldn't be used with two transistors instead of two valves.”

“It can be,” said Smithy. “And I would have mentioned this fact during our last session if I hadn't been rather preoccupied with the valve application and if I'd had a little more time at my disposal. With transistors, the basic long-tailed pair circuit is like this. Notice that it requires an auxiliary supply

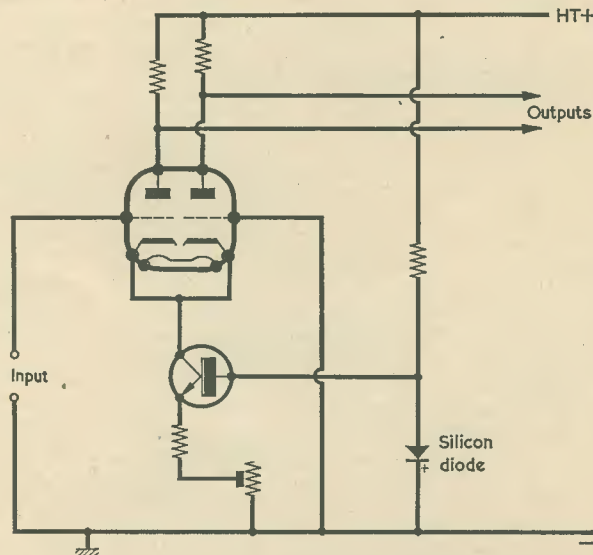

Fig. 1. The circuit of the constant current long-tailed pair using voltage amplifier triodes. Component types and values were discussed in last month's episode

line for the constant current transistor."

Once again, Smithy scribbled on his note-pad. (Fig. 2(a)).

"In practice, though," he continued, "you don't usually see this circuit employed as a phase splitter. It's more frequently used to provide what is known as a 'differential amplifier' and you'll meet modified versions of it in linear integrated circuits."

"What," asked Dick, "are 'linear integrated circuits'?"

"They're integrated circuits," explained Smithy, "which are intended to operate as amplifiers, as opposed to digital integrated circuits which have gates and flip-flops and such-like in them and are designed for logic functions in a computer. The differential amplifiers in linear integrated circuits normally allow two inputs to be applied."

Again, Smithy sketched out a circuit on his pad. (Fig. 2(b)).

"A differential amplifier of the type I've drawn here," he went on, "may be followed by several further amplifier stages which finally feed into a single output terminal. The output signal will be 180 degrees out of phase with a signal applied to one of the differential amplifier inputs, and exactly in phase with a signal applied to the other differential amplifier input. These inputs are, in consequence, known as the 'inverting input' and the 'non-inverting input' respectively."

"Fair enough," said Dick hastily. "I think I'll find things easier if we get a bit closer to home ground! Let's get back to this amplifier of yours."

"As you like," responded Smithy equably, reaching over and pulling a sheet of paper towards him. "So

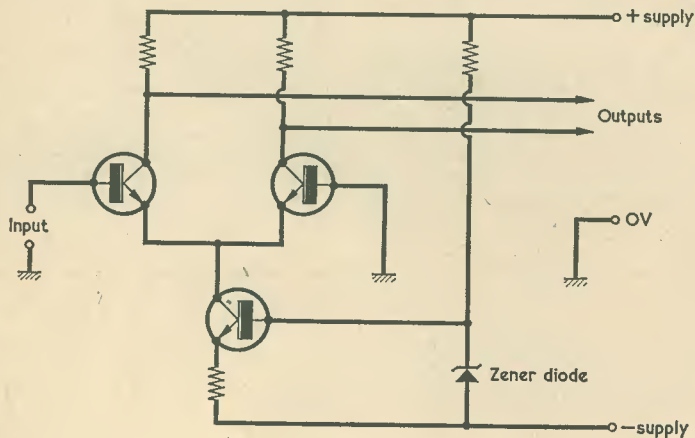

(a)

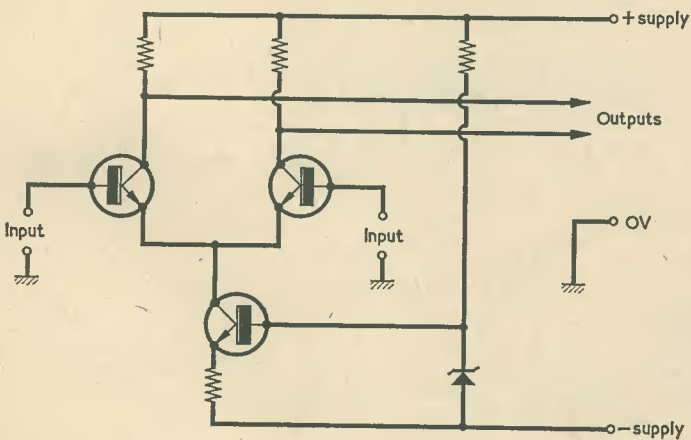

(b)

Fig. 2(a). Basic transistor version of the long-tailed pair with constant current transistor

(b). The long-tailed pair is very often used as a differential amplifier with inputs to both transistor bases

## Your Local Supplier

LONDON

Established 1910

### H. L. SMITH & CO. LTD.

*Comprehensive stocks of components by all leading makers.*

287-9 EDGWARE ROAD  
LONDON W.2

Tel: 01-723 5891

### THE MODERN BOOK CO.

*Largest selection of English & American radio and technical books in the country.*

19-21 PRAED STREET,  
LONDON, W.2

Tel: PADDington 4185/2926

### ST. HELEN'S RADIO

Hi-Fi Equipment  
Tape Recorders  
Radio Receivers  
Television

*SPECIALISTS IN RADIO & ELECTRONIC TEXTBOOKS*

ST. HELEN'S GARDENS  
LONDON W.10

Tel: 01-969 3657

HAMPSHIRE

### BOURNEMOUTH

LARGEST HI-FI AND  
RADIO COMPONENT  
STORE IN THE SOUTH

FORRESTERS NATIONAL  
RADIO SUPPLIES LTD.

70-72 Holdenhurst Road

Bournemouth

Telephone 25232



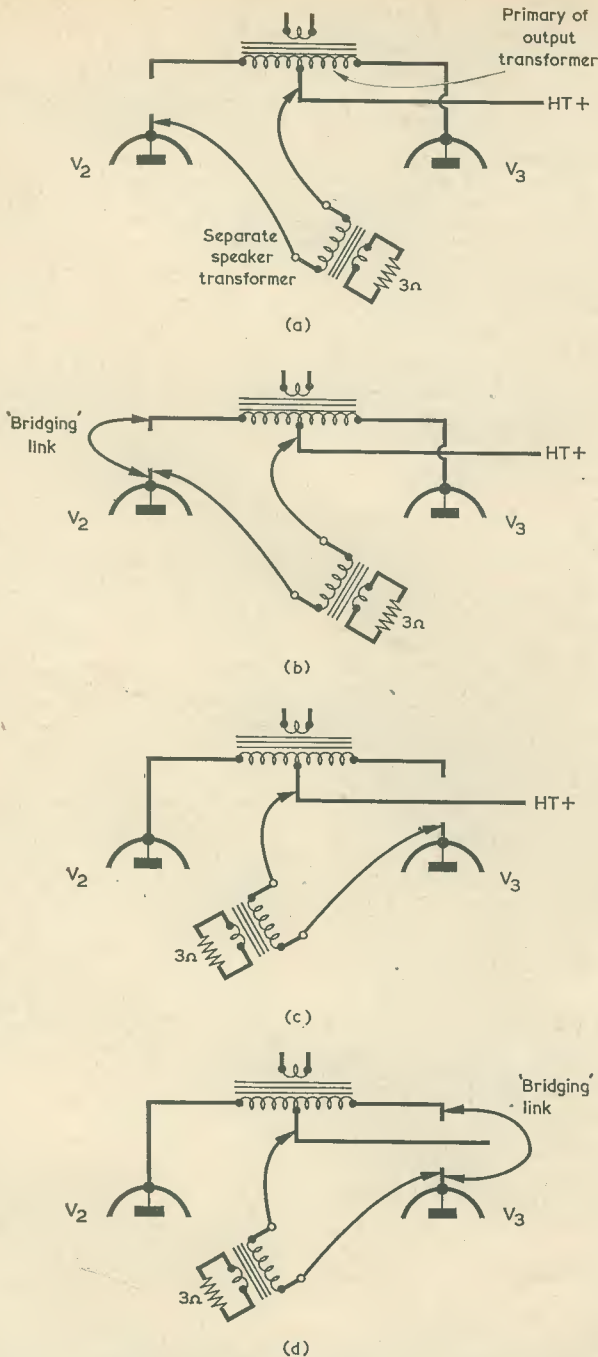

Fig. 4. Checking the performance of the individual output tetrodes in the amplifier. In (a) V3 provides an output on its own whilst, in (b), push-pull operation is temporarily restored. The process is repeated in (c) and (d) for V2

positive by, say, 4 volts, the distribution of current between the two valves causes their common cathodes to go positive by 2 volts. So, both tetrodes have an effective grid-to-cathode potential difference of 2 volts which is, of course, half the

full input voltage. The reason I inferred, earlier on, that this amplifier is not in the high fidelity category is that the grid voltage-anode current characteristics of the two output valves will not be perfectly linear nor quite identical, and so a

## Your Local Supplier

KENT

### EMSAC BASIC ANTENNA SYSTEMS

CN1 New this month! 144 MHz to 28MHz converter complete crystal, four valves. Requires 150v. D.C. and 6.3v. A.C. 200/-.

CN1K Kit for above 170/-  
GD1 A GSRV type multi-band dipole. 102 ft. top, 100 ft. feeder. Complete and ready to go! 68/-.

GV1 General purpose vertical, useful range 1.8MHz to 28MHz. Adjustable 7 ft. to 23 ft. 92/-.

TU2 Receiver antenna tuning unit. Amateur and SW broadcast bands 1.5 to 30 MHz. 90/-.

Send SAE for details. Open weekends. G31AR Carriage extra.

ELECTRONIC & MECHANICAL  
SUB-ASSEMBLY CO. LTD.

Highfield House, West Kingsdown, Kent.  
Tel: West Kingsdown 2344.

SURREY

### Portable Transistor Amplifier plus Dynamic Microphone

A self-contained fully portable mini p.a. system. Many uses — ideal for Parties, or as a Baby Alarm, Intercom.



Telephone or Record Player, Amplifier, etc. Attractive rexine covered cabinet, size 12 x 9 x 4in., with powerful 7 x 4in. speaker and four transistor one watt power amplifier plus dynamic microphone. Uses PP9 battery. Brand new in Makers' carton with full makers' guarantee. World famous make 90/- Post Full List 1/- Only 90/- Free

RADIO COMPONENT SPECIALISTS  
337 Whitehorse Road, West Croydon,  
Surrey. Phone 01-684-1665

SUSSEX

## E. JEFFRIES

For your new television set,  
tape recorder, transistor radio,  
and hi-fi equipment.

PHILIPS, ULTRA, INVICTA,  
DANSETTE, MASTERADIO, PERDIO,  
MARCONI, PHILCO, FIDELITY.

6A Albert Parade,  
Victoria Drive,  
EASTBOURNE SUSSEX

EIRE

## PEATS for PARTS

ELECTRONIC COMPONENTS  
RADIO & TELEVISION

For the convenience of IRISH  
enthusiasts we supply:

The Radio Constructor,  
Data Books and  
Panel-Signs Transfers

Also a postal service

Wm. B. PEAT & Co. Ltd.  
28 PARNELL STREET  
DUBLIN 1

small degree of non-linear distortion can be introduced in the output stage. In practice, and as you heard just now, the quality of the amplifier's output is still not to be sneezed at, though."

## PROTECTION CIRCUIT

"It sounded jolly good to me," said Dick stoutly, as he studied the amplifier circuit. "Incidentally, why do you use a zener diode to provide the transistor base voltage? In the previous circuit with the voltage amplifier you obtained the base voltage from a forward-biased silicon diode."

"I could have used the silicon diode here, too," said Smithy. "But this would have resulted in the transistor offering a constant current of 70mA for cathode potentials down to less than 1 volt."

"Does that matter?"

"In this instance, yes," replied Smithy. "Try and visualise what would happen if I'd used the silicon diode in the present circuit, and one of the output tetrodes was removed whilst the amplifier was switched on. The result would be that all the constant current would flow through the remaining tetrode, its cathode voltage automatically adjusting itself to the level which allowed this current to flow. I've used 6BW6's for the two tetrodes and, as these have a maximum cathode current rating of 65mA, a flow of 70mA in one of them would'nt, exactly, do it much good. So, instead of using a forward-biased silicon diode, I've employed a 7.5 volt zener diode to stabilise the transistor base voltage. In consequence, should one of the tetrodes be removed whilst the amplifier is switched on, the cathode of the remaining tetrode won't go lower than about 8 volts positive of chassis, because the transistor can't supply the full current at voltages lower than this. At the h.t. voltage I'm using here, which is approximately 225 volts, a cathode voltage of 8 corresponds to a cathode current of just about 60mA. The protection offered by the circuit isn't

perfect because anode dissipation is still right up on top line, but the circuit does at least prevent either of the tetrodes passing a full 70mA on its own."

"Does the protection circuit restrict output power?"

"It does, unfortunately," confessed Smithy. "Without it, each tetrode could theoretically have an anode current swing of some 35mA on either side of a standing current of about 35mA. Bearing in mind the relationship between anode current and cathode voltage it would appear that the swing is now restricted to a little less than 25mA on one side of the 35mA figure. The available power in practice is still, however, very noticeably in excess of that given by a single 6BW6 on its own."

## CHOICE OF TRANSISTOR

"What," asked Dick, changing the subject abruptly, "about the transistor used for providing the constant current?"

"Well," said Smithy, "this must, of course, be an n.p.n. type because the collector connects to a positive voltage. The normal common cathode voltage with both tetrodes plugged in is around 13 volts, which means that about 5.5 volts is dropped across the transistor. At a constant current of 70mA this corresponds to rather less than half a watt of dissipation. The AD161 is quite a suitable type. This is an n.p.n. transistor which is rated at a much higher dissipation than half a watt and its voltage and current ratings happen to fit in very nicely with circuit requirements. The AD161 is housed in a case intended for bolting to a heat sink, but this is only about two-thirds the size of a housing of the OC28 type. When I initially tried out the amplifier I operated the AD161 without any heat sink at all but I found that it got perceptibly warm. In the final design I bolted it to a heat sink which is insulated from chassis and which is about 1½ inches square. I'm confident that this is far larger than is actually needed!"

"I see," remarked Dick, "that you've used a 39kΩ resistor to feed the zener diode."

"That's right," agreed Smithy. "This provides a zener current of a little more than 5mA. The minimum gain of the AD161 is 80, so the maximum base current it needs to keep it happy for the present application is just slightly less than 1mA. With 5mA flowing in R9, there's stacks of current available for the transistor base."

"Another point," remarked Dick, "is that you've marked the preset pot, R8, as 1 watt."

"True enough," confirmed Smithy. "About 70mA flows in the emitter circuit and the components here have to be rated accordingly. You could, if you like, replace R7 and R8 with a single fixed resistor of the appropriate value after you've found the value required in R8. Incidentally, you may find it a little difficult to obtain a 1 watt component for R8, in which case you could, of course, use a 2 watt or 3 watt pot."

"There's another preset pot," said Dick. "It's the one you've shown as R5."

"That's in the negative feedback line," explained Smithy, "and you adjust it for the overall amplifier gain you require. R5 can be a skeleton pot, and it could also be replaced, after setting up, by a fixed resistor. In point of fact, the amplifier doesn't sound too bad without any feedback at all, whereupon both R5 and R4 could be omitted. The lower ends of R3 and C1 then connect direct to chassis."

"What about the output transformer?"

"Any push-pull output transformer rated around 8 watts or so and offering a primary anode-to-anode impedance of 8,000Ω will do. Whilst I was working out the transformer required I happened to note that Home Radio have just the right job. This is described as being suitable for two 6V6 valves in push-pull and, as you probably know, the 6BW6 is a scaled-down version of the old 6V6."

Dick digested this information, and it seemed that even his prodigious curiosity had at last been satisfied. But a further thought occurred to him.

"How," he asked suspiciously, "do you know that V3 is amplifying?"

"It's bound to be," replied Smithy. "In this circuit it can't do anything else."

"Yes," persisted Dick, "but how can you be absolutely certain?"

"I don't need to be certain," stated Smithy a little irritably, "I just know, that's all."

"You can't prove it, though."

"Why not?"

"Because," returned Dick triumphantly, "in an ordinary push-pull output stage fed by a phase splitter you can always pull out one

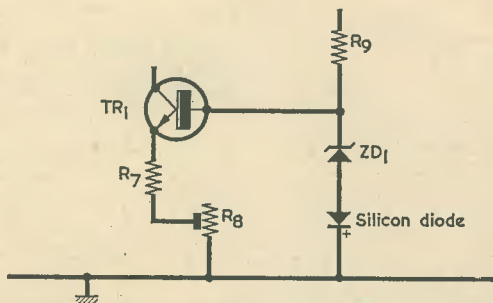

Fig. 5. If needed, a small increase in base voltage for TR1 may be achieved by inserting a forward-biased silicon diode in series with the zener diode

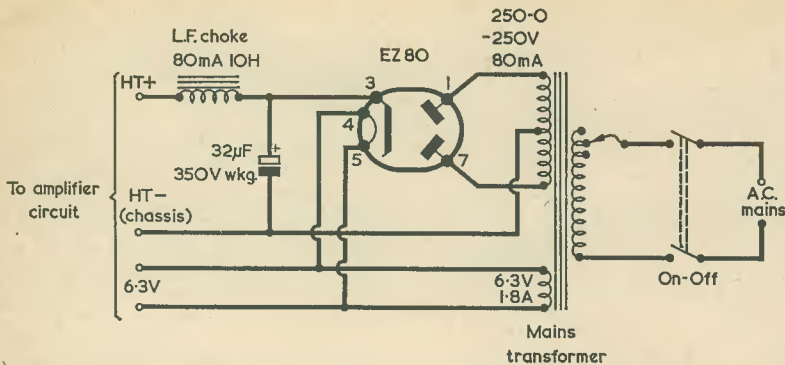

Fig. 6. The power supply is not critical and a typical circuit is given here. One side of the 6.3 volt supply connects to chassis in Fig. 3. All current figures given are minimum values

valve to see if the other is doing its whack, and then repeat the operation with the other valve. If, in your present circuit, you pull out the right hand tetrode, the left hand tetrode starts running at the safety current of 60mA. And if you pull out the left hand tetrode, the right hand tetrode goes to 60mA with no signal fed to it at all!"

"It so happens," said Smithy loftily, "that I carried out tests."

"What sort of tests?"

"If you must know," responded Smithy icily, "I took the control grid of the left hand tetrode negative and positive of chassis, and measured the resulting d.c. voltage drops across the two halves of the transformer primary. I got the same sort of results as we did with the voltage multiplier phase splitter we worked on during our last session."

"I suppose," said Dick doubtfully, "that should be a sufficient test."

"Dash it all," snorted Smithy, "you've got me worried now! The trouble is that, now you've raised the question, I can't help but feel that d.c. checks aren't the same as tests at audio frequency. However, we'll soon see whether this circuit really is functioning correctly at a.f."

Purposefully, Smithy switched on his soldering iron, then strode over to the spares cupboard. After some rummaging, he returned with a speaker transformer and a resistor.

"Right," he pronounced briskly.

"Well, the only simple way of checking whether the right hand tetrode is doing its stuff consists of giving the left hand tetrode an anode load which is separate from the existing output transformer primary. I've got a single-ended valve output transformer here, together with a 3Ω resistor. If I connect the 3Ω resistor across its secondary, the primary will then present a load roughly equivalent to one half of

the output transformer primary in the amplifier."

Smithy checked the temperature of his soldering iron and grunted with satisfaction. He quickly soldered the 3Ω resistor to the secondary tags of the speaker transformer he had taken from the spares cupboard. He next produced two short lengths of p.v.c. insulated wire and temporarily made up the test connections he had referred to. (Fig. 4(a)). He next adjusted R5 to insert maximum resistance. After this

he started the record player motor, placed the pick-up on the record, then switched on the power supply to which the amplifier was connected. After some moments, the loudspeaker reproduced the music from the record.

"The quality of reproduction," remarked Smithy, listening carefully, "seems to be about the sort of thing you'd expect from a single-ended 6BW6 with very little feedback. Let's turn the wick up a bit."

The Serviceman turned the volume control to its full setting. There was evidence of overloading on the louder bursts of music. Struck by a sudden thought, Smithy took a further piece of wire and bridged the anode of the left-hand tetrode to the output transformer tag from which he had just disconnected it. (Fig. 4(b)). The distortion due to overloading cleared and the quality of reproduction improved noticeably.

"Well, the right hand tetrode certainly seems to be doing its stuff," he remarked, switching off the amplifier power supply once more. "Just for interest let's repeat that exercise with the other tetrode."

Smithy returned the left hand tetrode anode circuit to its previous condition, disconnected the anode of the right hand tetrode from the amplifier transformer and inserted the separate speaker transformer primary. (Fig. 4(c)). He switched on

## Stella Nine Range Cases

Manufactured in Black, Grey, Lagoon or Blue Stelvetite and finished in Plastic-coated Steel, Morocco Finish with Aluminium end plates. Rubber feet are attached and there is a removable back plate. There is also a removable front panel in 18 s.w.g. Alloy.

Now all Aluminium surfaces are coated with a stripable plastic for protection during manufacture and transit. All edges are polished.

LIST OF PRICES AND SIZES which are made to fit Standard Alloy Chassis

Width	Depth	4" Height		6" Height		7½" Height	
		£	s. d.	£	s. d.	£	s. d.
6½"	3½"	12	6	15	0	18	0
6½"	4½"	13	6	18	0	1	0
8½"	3½"	15	0	1	0	1	0
8½"	6½"	1	0	1	6	1	11
10½"	7½"	1	8	1	15	6	18
12½"	3½"	1	1	0	1	6	11
12½"	5½"	1	8	0	1	4	0
12½"	8½"	1	16	0	2	3	0
14½"	3½"	1	5	0	1	11	6
14½"	9½"	2	3	0	2	15	9
16½"	6½"	1	18	6	2	6	3
16½"	10½"	2	10	0	3	5	0

Cases—Post 4s. 6d. per Order.  
Discounts available on quantities.

## CHASSIS in Aluminium, Standard Sizes, with Gusset Plates

Sizes to fit Cases		All 2½" Walls		s. d.	
s. d.	s. d.	s. d.	s. d.		
6"×3"	5 6	10"×7"	8 6	14"×3"	7 3
8"×4"	5 9	12"×3"	6 9	14"×9"	14 6
8"×3"	6 6	12"×5"	7 6	16"×6"	10 9
8"×6"	7 9	12"×8"	10 9	16"×10"	16 0

Chassis—Post 3s. 0d. per Order.  
Discounts available on quantities.

## E. R. NICHOLLS

MANUFACTURER OF ELECTRONIC INSTRUMENT CASES

(DEPT. R.C.) 46 LOWFIELD ROAD  
STOCKPORT - CHESHIRE

Tel: 061-480 2179

## NEW VHF KIT

Receives Television Sound, Ambulances, Aircraft, Radio 2, 3 and 4 on VHF etc.

This novel little set will give you endless hours of pleasure and can be built in one evening. The Kit comes with easy to follow instructions and circuit. Powered by 9v Battery. Complete with built-in Jack Plug Socket for use with Earphones or Amplifier.

ONLY 57/- P & P FREE UK ONLY

Postal Orders, Cheques to

Dept. R.C.3.,  
Galleon Trading Co.,  
298A Lodge Lane,  
Romford, Essex

## FANTASTIC SALE

1,000 of the following Amplifier Kits to clear -

	List Price	Sale Price	P.S.
5 watt amplifier	£3.15.0	£1.15.0	9v
7 watt amplifier	£6.15.0	£2.5.0	9v
10 watt amplifier	£8.19.0	£2.15.0	9v

If two are required deduct the following: 2 x 5 watt 5/-, 2 x 7 watt 7/6, 2 x 10 watt 10/-. Please add 2/6 P&P.

## M. GLEAVES AND BROTHER

28 WENNY ESTATE  
CHATTERIS  
CAMBS

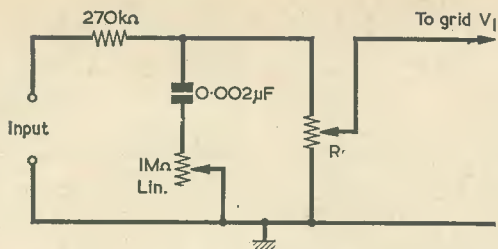

Fig. 7. A simple top cut tone control can be added in front of R1, as shown here

and checked the reproduction offered by the left hand tetrode on its own.

"So far as I can judge," he stated, "the left hand tetrode is giving exactly the same output on its own as the right hand one did. Let's try bridging *this* anode over to its proper tag."

Again, Smythy bridged over the connection (Fig. 4(d)), and again the distortion due to overloading cleared and the quality improved. With a satisfied smile, Smythy switched off the amplifier power supply, disconnected the separate speaker transformer and returned the anode lead of the right hand tetrode to its normal tag on the amplifier output transformer.

## AMPLIFIER CONSTRUCTION

"Well," he remarked, "that proves pretty adequately that both these tetrodes are feeding about the same level of signal into the amplifier output transformer."

"You've certainly convinced me," remarked Dick. "In fact I couldn't detect any difference whatsoever between the right hand tetrode on its own and the left hand tetrode on its own. By the way, it was quite impressive the way the sound quality improved when you bridged over the anode connections and returned to push-pull working."

"The improvement was noticeable wasn't it?" agreed Smythy. "Really, though, it's rather unfair to judge the output of a single-ended stage feeding into half the primary of a transformer designed for push-pull operation. A push-pull output transformer has interleaved laminations and these are rather liable to go towards saturation if the magnetising forces due to the standing primary currents aren't allowed to cancel out. On the other hand, a single-ended output transformer has butt-jointed laminations with a small gap to break the magnetic circuit, and is less affected by the magnetising force resulting from the standing primary current. However, that is by the way. The test we've just carried out constituted a *comparison* between the two output valves, and it

showed that they both offered the same performance when used on their own."

"It's certainly a ding-dong amplifier circuit," commented Dick enthusiastically. "I've got half a mind to knock one up for myself."

"Excellent," commended Smythy. "I think I should emphasise though that, due to the rather unusual circuitry employed, it's a wee bit on the experimental side."

"Are there any special points to watch out for?"

"Just one or two," replied Smythy. "The amplifier should be initially wired up without the negative feedback connection between R5 and the output transformer secondary. For setting up purposes, it's also necessary to insert a meter capable of reading up to 100mA into the h.t. circuit to the output valves at the point I've marked with a cross. Again, R8 should be initially set to insert full resistance into circuit. The next thing to do is to switch on, and then carefully reduce the resistance inserted by R8 until you get a meter reading between 70 and 75mA. The following test is to switch the amplifier off, then switch it on again with only one 6BW6 plugged in. If all is well, the current indicated by the meter should be around 60mA. If it is higher than about 63mA, you can slightly increase the voltage on the base of the transistor by inserting a forward-biased silicon diode between the zener diode and the chassis. (Fig. 5). If it is considerably lower than 60mA, you run a risk of reducing available current swing on the anodes when both tetrodes are plugged in. It might be advisable, then, to slightly increase the value of R9 so as to reduce the zener voltage a little. Small changes in the current passed by the single tetrode can, incidentally be obtained by choosing a requisite constant current between the 70 and 75mA values when both the tetrodes are plugged in."

Dick frowned.

"All this," he stated, "seems to be a bit fiddling."

"It isn't so bad in practice," replied Smythy, "and you'll probably find that you get approximately

60mA first go. The snag is that there are rather a lot of variables in the circuit which all need to be catered for. One of the main things to remember is that you should only run the amplifier for very short periods with one tetrode removed even if the current the remaining one passes is limited to 60mA. You want to bear in mind also that any change made to the voltage applied to the base of the transistor requires a corresponding adjustment in R8, and that the protection circuit only offers a limited degree of protection. The best general plan is to ensure that the amplifier is never switched on without both the output valves plugged in."

"Rightly-ho. Any other points?"

"Only the usual ones," said Smythy. "After you've got the amplifier set up, you then connect R5 to the output transformer secondary. If you get a howl when you switch on the power supply, you've got positive instead of negative feedback, and you must switch off again very quickly. After that you transpose the transformer secondary connections to R5 and to chassis, to make the feedback negative. This last check is best done with R5 at about mid-travel. Another thing is that you mustn't operate the amplifier without a speaker connected."

"What about the power supply?"

"That's not particularly critical," replied Smythy. "As you can see, I've used one of the Workshop power supply units myself. A suitable supply would include a mains transformer capable of offering 250-0-250 volts at 80mA or more, and this could operate with, say, an EZ80, a reservoir capacitor of 32μF and a smoothing choke capable of passing 80mA. (Fig. 6). The smoothing capacitor is provided by C3, which is already included in the amplifier circuit. This set-up should give you about 225 volts across C3. Incidentally, I wouldn't advise the use of h.t. voltages much higher than 225 volts."

"You haven't," Dick reminded him, "provided a tone control."

"You can add a top cut control in the input circuit quite easily," Smythy stated, taking up his pen and sketching a further circuit on his pad (Fig. 7). "Something like this will be perfectly adequate."

## FINAL PERFORMANCE

"That seems to cover everything," said Dick. "Let's have a final listen to that amplifier before we start work."

Once more Smythy switched on the amplifier power supply. After the valves had warmed up he turned the volume to a level which caused the Workshop to be comfortably saturated with the music from the loudspeaker.



# Radio Topics

## By Recorder

LET'S START, THIS MONTH, WITH what may turn out to be a minor, but very interesting, example of possible future "spin-off". As you know, "spin-off" is the term used to define the cases where minor technologies obtain benefits due to the developments involved in major projects. Thus, the American moon shots have provided spin-off, owing to the massive research they caused to be initiated into new materials and new electronic devices.

The spin-off example I now want to discuss arises from the design of a new video-data terminal introduced by Marconi-Elliott Computer Systems, Ltd. This terminal is intended to link, via standard Post Office data transmission systems, with any commercial computer. Available for less than £2,000, the terminal can be especially useful to non-specialist people in management activities who are involved with advanced computer systems.

Designated the *Videodata 4000*, the terminal is a self-contained desk-mounted unit with integral typewriter keyboard, data storage, character generation and data transmission interface, and it provides real time access to the remote computer. Incidentally, I gave a little glossary last month which covers the more esoteric terms in this description.

### HALL EFFECT KEYBOARD

What particularly caught my eye in the technical description of the *Videodata 4000* was a major innovation incorporated in its keyboard. This makes use of the Hall effect to eliminate completely any form of moving electrical contact. Each key is mounted on a sprung movement, with a carrier which holds a permanent magnet. As the key is de-

pressed, the magnet is moved down to enclose a slab of silicon within the magnetic field, the slab of silicon having an electric current passing through it at right angles to the magnetic field. As the field is applied, a Hall effect voltage is set up along the third orthogonal axis of the silicon. Two microcircuit amplifiers are built onto the same slab of silicon to amplify this control voltage, which can then be applied to the terminal as an input signal. It is stated that the keyboard provides a considerable improvement in reliability and ease of maintenance, and also offers a good "touch" for the operator.

This departure from standard keyboard practice makes me think immediately of electronic organs. The manuals of such organs have quite complicated and costly keying arrangements, a typical key switching assembly employing gold-plated contact wires together with a rhodium earthing bar against which non-depressed contact wires rest. Also, considerable care has to be taken in circuit design to prevent each note starting and ceasing too abruptly as the appropriate key contacts are made and broken. Some manufacturers have, indeed, produced graduated resistance switches which ensure that keying circuits are made and broken without any "clicks" or similar transients.

It seems possible that the Marconi-Elliott system offers as helpful an answer to the problem of electronic organ keying as it does to those of data transmission, and I predict that the electronic organ of the future may well incorporate manuals with Hall effect switching. So far as the amateur organ constructor is concerned - and there are, I know, quite a number of extremely keen British enthusiasts in this field - I don't at the time being know of any retail source for Hall effect devices. Nevertheless, it may well be worth while keeping an eye on manufacturers' surplus markets here, as such devices, when they do become available, could afford the basis of a considerable amount of useful experiment.

### NEATER HEATER JOINTS

Occasionally, the minor advantages of technology tends to creep up on some of us unnoticed.

That, at any event, is my view after a little experience I had recently with a new mains transformer I was wiring into circuit. This had lead-out wires instead of tags, and I was just about to start the laborious process of scraping the enamel off the heater secondary wires when a thought suddenly occurred to me. Might it not be possible that, in these enlightened days, the manufacturers of the

transformer had seen fit to use "solder-through" enamel?

It only took a few moments to check this by applying the soldering iron to the wire enamel, together with a length of rosin-cored solder. There was an initial splutter and then - lo and behold! - the wire tinned beautifully at the point where I applied the iron without any necessity for scraping at all. The makers of that transformer, bless their little laminations, had used "solder-through" enamel.

A brief survey on the common wire enamels might be helpful at this stage for those who have had no experience of "solder-through" enamels. For the majority of normal domestic radio applications there are three basic types of wire enamel, these being the oil-based or oleo-resinous enamel, the "synthetic" or vinyl acetal enamel, and the "solder-through" or polyurethane enamel. The oil-based enamel is, in general, the cheapest, but it is not as tough, physically, as the "synthetic" and polyurethane enamels. In many instances, the "synthetic" and polyurethane enamels are light brown in colour whilst the oil-based enamels are dark brown, and this fact can help in their identification.

If, in the future, you intend to wire a mains transformer into circuit, you may be able to save yourself quite a bit of trouble by initially testing to see whether the heater lead-out wires on your component are, like those on mine, similarly coated with polyurethane "solder-through" enamel. For this check you need a good hot iron, and it's advisable to rub its tip lightly against the enamel to start the operation quickly. With oil-based enamel, you'll just end up with a burnt length of enamel. If the enamel is "synthetic" the iron won't do anything to it at all except, perhaps, slightly char its surface. But, should the enamel be polyurethane, you'll find that the iron goes right through, enabling you to tin directly on to the copper underneath. The polyurethane has, in fact, a slight fluxing action.

There's only one possible snag. The process means that the iron is applied a little longer to the wire than would occur if the enamel had previously been scraped off. If, therefore, the manufacturer has fitted low-temperature p.v.c. sleeving over the heater lead-out wires, this is more liable to become softened during the soldering operation. It is advisable to keep the wire straight so that, even if the p.v.c. does soften for a short period, it does not peel away. The best plan is to first carry out the check and then get in some practice on the outermost lengths of the lead-outs before these are cut back to the length they will finally have when the transformer is installed.

# TV FAULT FINDING MANUAL for 405/625 LINES



**8/6**  
POSTAGE 8d.

**REVISED & ENLARGED**  
EDITED BY J. R. DAVIES  
**124 pages**

Over 100 illustrations, including 60 photographs of a television screen after the appropriate faults have been deliberately introduced.

Comprehensive Fault Finding Guide cross-referenced to methods of fault rectification described at greater length in the text.

# UNDERSTANDING TELEVISION

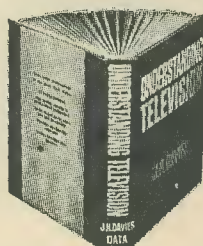

by  
J. R. DAVIES

Over 50 pages  
300 diagrams

**37/6** POSTAGE  
3/-

UNDERSTANDING TELEVISION deals with:

- Principles of 405 line reception
- Principles of 625 line reception
- Nature of the television signal
- Receiver tuner units
- A.F. and video amplifiers
- Deflector coil assemblies
- Automatic gain and contrast control
- Receiver aerials
- The cathode ray tube
- Receiver i.f. amplifiers
- Vertical and horizontal timebases
- Synchronising
- Power supply circuits
- Colour television
- **COLOUR TELEVISION – 80 page section deals comprehensively with this subject**

The reader is required to have only a basic knowledge of elementary radio principles. The treatment is non-mathematical throughout, and there is no necessity for any previous experience in television whatsoever. At the same time, UNDERSTANDING TELEVISION is of equal value to the established engineer because of the very extensive range it covers and the factual information it provides.

**To Data Publications Ltd., 57 Maida Vale, London, W.9**

Please supply the 4th revised edition of TV FAULT FINDING, Data Book No. 5.....

Please supply UNDERSTANDING TELEVISION, Data Book No. 17.....

I enclose cheque/crossed postal order for..... (Tick which book is required)

NAME.....

ADDRESS.....

(BLOCK LETTERS PLEASE)

# SMALL ADVERTISEMENTS

Rate: 9d. per word

Minimum charge 12/-

Box No. 2/- extra.

Advertisements must be prepaid and all copy must be received by the 4th of the month for insertion in the following month's issue. The Publishers cannot be held liable in any way for printing errors or omissions, nor can they accept responsibility for the *bona fides* of advertisers. (Replies to Box Numbers should be addressed to: Box No. —, *The Radio Constructor*, 57 Maida Vale, London, W.9.)

**BUILD IT in a DEWBOX** robust quality plastic cabinet. 2in. x 2½in. x any length. S.A.E. for details. D.E.W. Ltd., 254 Ringwood Road, Ferndown, Dorset. Write now—right now.

**SERVICE SHEETS.** Radio, Television, Transistors, Tape Recorders, Record Players (1925-1969). S.A.E. enquiries.—Hamilton Radio, 54 London Road, Bexhill, Sussex.

**UFO DETECTOR CIRCUITS.** Data, 10s. (refundable). Para-physical Laboratory (UFO Observatory), Downton, Wilts.

**FULLY TESTED TRANSISTORS.** T05 can, p.n.p. Germ. Similar to OC71, OC41, NKT 128, etc. Characteristics supplied. 30 for 10/-. P. & P. 1/-.—D. Huddart, 56 Mortlake Road, Ilford, Essex.

**BOOKS FOR SALE:** *Earth's Envelope*, Theo Lobsack 10/-. *Space Research & Exploration*, D. R. Bates 15/-. *Practical Yacht Racing*, Schiottz 15/-. *Yacht Racing*, Sturgess £1, *Faster Sailing*, Bavier 10/-. *The Story of Atomic Energy*, Soddy 7/6d., *Radioisotope Laboratory Techniques*, Faires 7/6d., *Atomic Medicine*, Behrens 15/-. *Medical Radiation Biology*, Ellinger £1, *Sunday Times & Life World Library Volumes: Brazil, S.E. Asia, Israel, Italy, Russia, Mexico, Greece, Africa, Germany, France, India, Britain, Japan, Scandinavia*, 12/6d. each, *Life Science Library: Wheels, Mathematics, Man & Space, Planets, Energy*, 12/6d. each, *The Colour of Canada*, £1, *Science Survey 3*, Vista Books £1, *Science Today & Tomorrow* 10/-. Box No. F364.

**MULLARD AMPLIFIERS.** 5/10 40s. 3/3 30s. 2/2 20s. Fully finished in perfect working order. Assorted components, 20s. the lot. S.A.E. for details. T. Gomes, 1 Abbey Street, Edinburgh.

**MUSICAL MIRACLES.** Send s.a.e. for details of Drum Sound Modules, versatile bass-pedal accompaniment unit, self-contained with unique effects. Kits for Waa-waa pedals 47/-. Also 50µA meters 25/- each. New. D.E.W. Ltd., 254 Ringwood Road, Ferndown, Dorset.

**WANTED:** "The Radio Constructor" May 1962 issue and November 1963. Good price offered. 7 Clarence Road, Harpenden, Herts.

**"MEDIUM WAVE NEWS"** Monthly during DX season.—Details from: K. Brownless, 7 The Avenue, Clifton, York.

**WORLD DX CLUB** covers all aspects of SWLing on Amateur and Broadcast Bands through its monthly bulletin "Contact". Membership costs 25s. a year. Enquiries to Secretary, WDXC, 17 Taunton Road, Bridgewater, Somerset.

**WANTED:** Complete volumes Nos. 1 to 12, *The Radio Constructor*. J. Dobson, 16 Launceston Drive, East Herrington, Sunderland, Co. Durham.

**PLASTIC CASES.** Non-brittle, easily drilled. 2½in. x 1½in. x 4in. 2/- each from: 16 Church Street, Bletchley, Bucks.

**FOR SALE:** Revspeed revolution counter £3. Box No. F378.

(Continued on page 253)

# BENTLEY ACOUSTIC CORPORATION LTD.

38 Chalcot Road, Chalk Farm,  
LONDON, N.W.1.  
01 - 722 9090

The Old Police Station  
Gloucester Road  
LITTLEHAMPTON, Sussex  
PHONE 6743

Please forward all mail orders to Littlehampton

5Z4G	6/9	ECC189	9/6	PC900	8/3	UABC80	5/9	ACY17	3/-	BY213	5/-
6AT6	4/-	ECF80	6/6	PCC84	6/-	UBC81	7/-	ACY18	3/8	GET573	7/6
6/30L2	12/6	ECF82	6/6	PCC85	6/6	UBF80	5/9	ACY19	3/9	OA70	3/-
6BW6	12/9	ECF86	9/-	PCC88	9/9	UBF89	6/9	ACY20	3/6	OA79	1/9
6BW7	11/-	ECF84	10/-	PCC89	9/6	UC92	5/6	ACY21	3/9	OA81	1/9
6F23	13/3	ECF81	5/9	PCC189	9/6	UCC84	8/-	AD140	7/6	OA90	2/6
6L6GT	7/9	ECF83	8/-	PCF80	6/6	UCC85	6/6	AD149	8/-	OA91	1/9
10P13	13/-	ECF84	7/-	PCF82	6/-	UCF80	8/3	AD162	9/-	OA95	1/9
20P4	18/6	ECL80	6/6	PCF84	8/-	UCH21	9/-	AF114	4/-	OA182	2/6
30C15	13/6	ECL82	6/-	PCF86	9/-	UCH42	9/9	AF115	4/3	OA200	1/-
30C17	12/6	ECL83	9/-	PCF801	7/2	UCH81	6/6	AF119	3/-	OA202	2/6
30C18	8/9	ECL86	8/-	PCF802	9/-	UCL82	7/-	AF125	3/6	OC22	5/-
30F5	13/6	EF22	12/6	PCL82	7/2	UCL83	10/-	AF139	13/-	OC23	5/-
30FL1	15/-	EF41	9/6	PCL83	9/6	UF41	9/6	AF180	9/6	OC24	5/-
30FL12	16/-	EF80	4/6	PCL84	7/6	UF80	6/9	BA102	9/-	OC25	5/-
30FL14	12/6	EF85	5/3	PCL85	8/3	UF85	6/9	BA115	2/8	OC26	5/-
30L15	13/9	EF86	6/-	PCL86	8/6	UF86	9/-	BA129	2/6	OC28	5/-
30L17	13/-	EF89	4/9	PEN45DD	12/-	UF89	6/3	BA130	2/2	OC30	5/-
30P4	12/-	EF91	3/3	PFL200	12/-	UL41	9/6	BC107	4/-	OC35	5/-
30P4MR	17/6	EF183	6/-	PL36	9/6	UL36	6/6	BC108	3/6	OC36	7/6
30P12	13/-	EF184	6/-	PL81	7/3	UM80	6/6	BC113	5/-	OC38	11/6
30P19	12/-	EH90	6/6	PL82	6/6	UY41	6/9	BC118	4/6	OC41	10/-
30P1L	15/-	EL33	12/-	PL83	6/6	UY85	5/6	BC105	5/-	OC44	2/6
30P1L3	15/-	EL41	9/3	PL84	6/3	2N404	6/-	BCY12	5/-	OC45	1/9
30P1L4	15/-	EL84	4/6	PL500	12/-	2N1756	10/-	BCY33	5/-	OC46	3/-
CL33	18/6	EL95	5/-	PL504	12/6	2N2147	17/-	BCY34	4/6	OC70	2/3
DY87	5/9	EM80	5/9	PL509	28/9	2N2297	4/6	BCY38	5/-	OC71	2/-
E88CC	12/-	EM81	6/9	PL802	15/-	2N2369	4/6	BCY39	4/6	OC72	2/6
EAB5C60	6/-	EM84	6/-	PY33	9/6	2N2613	7/9	BCZ11	3/6	OC74	2/6
EA42	8/9	EM85	11/-	PY81	5/3	2N3053	6/6	BD119	9/-	OC75	2/6
EB91	2/3	EM87	7/3	PY82	5/-	2N3121	50/-	BFY50	4/-	OC78	3/-
EBC41	8/6	EY51	6/9	PY83	5/6	2N3703	3/9	BFY51	4/-	OC78D	3/6
EBC81	6/3	EY87	6/-	PY88	6/-	2N3709	4/6	BFY52	4/6	OC81	2/6
EBF80	6/-	EZ40	7/3	PY800	6/6	2N3866	20/-	BF159	5/-	OC81D	2/6
EBF83	8/-	EZ80	4/3	PY801	6/6	2N3988	10/-	BF163	4/6	OC82	2/3
EBF89	6/3	EZ81	4/6	UY19	34/6	2S232	10/-	BF173	7/6	OC83	2/6
ECC92	6/6	HVR2	8/9	U25	13/-	AA119	3/-	BF180	6/-	OC84	3/-
ECC81	3/9	KTW62	10/-	U26	11/9	AA120	3/-	BY100	3/6	OC123	4/6
ECC82	4/6	PAEC80	7/3	U37	34/11	AC113	5/9	BY126	5/-	OC169	3/6
ECC83	4/6	PC86	9/6	U191	12/6	AC127	2/-	BY127	5/-	OC172	4/6
ECC84	5/6	PC88	9/6	U301	11/-	AC154	5/-	BYZ10	5/-	OC200	4/4
ECC85	5/-	PC95	8/3	U404	7/6	AC156	4/6	BYZ11	5/-	OC202	4/6
ECC88	7/-	PC97	8/6	U801	18/-	AC157	5/-	BYZ12	5/-	OC203	4/6

Terms of business: Cash with order only. No C.O.D. Post/Packing 6d. per item. Orders over £5 post free. All orders despatched same day as received by first class mail. Complete catalogue including transistor section and components with terms of business 10d. Any parcel insured against damage in transit for 6d. extra. Business hours 9 a.m.—5.30 p.m. Saturdays 9 a.m.—1 p.m.

## TECHNICAL TRAINING by ICS IN RADIO, TELEVISION AND ELECTRONIC ENGINEERING

First class opportunities in Radio and Electronics await the ICS trained man. Let ICS train YOU for a well-paid post in this expanding field.

ICS courses offer the keen, ambitious man the opportunity to acquire, quickly and easily, the specialized training so essential to success.

Diploma courses in Radio TV Engineering and Servicing Electronics, Computers, etc. Expert coaching for:

- \* C. & G. TELECOMMUNICATION TECHNICIANS CERTS.
- \* C. & G. ELECTRONIC SERVICING
- \* R.T.E.B. RADIO AND TV SERVICING CERTIFICATE
- \* RADIO AMATEURS EXAMINATION
- \* P.M.G. CERTIFICATES IN RADIO TELEGRAPHY

Examination Students Coached until Successful.

### NEW SELF-BUILD RADIO COURSES

Build your own 5-valve receiver, transistor portable, signal generator, multi-test meter and professional-type valve voltmeter—all under expert guidance.

POST THIS COUPON TODAY and find out how ICS can help YOU in your career. Full details of ICS courses in Radio, Television and Electronics will be sent to you by return mail.

MEMBER OF ASSOC. OF BRITISH CORRESPONDENCE COLLEGES.

### INTERNATIONAL CORRESPONDENCE SCHOOLS

Dept. 248, Intertext House, Stewarts Road, London, S.W.8.

NAME \_\_\_\_\_  
Block Capitals Please  
ADDRESS \_\_\_\_\_  
11.69

# DENCO (CLACTON) LIMITED

## 355-7-9 OLD ROAD, CLACTON-ON-SEA, ESSEX

Our components are chosen by Technical Authors and Constructors throughout the World for their performance and reliability, every coil being inspected twice, plus a final test and near spot-on alignment as a final check.

Our General Catalogue showing full product range	...	...	...	2s. 6d.
DTB4 Transistor & Valve circuitry for D.P. Coils	...	...	...	2s. 6d.
DTB9 Valve Type Coil Pack Application circuitry	...	...	...	2s. 6d.
MD.1 Decoder Circuitry for Stereo Reception	...	...	...	4s. 0d.

All post paid, but please enclose S.A.E. with all other requests in the interests of retaining lowest possible prices to actual consumers.

## THE MODERN BOOK CO

### TRANSISTOR, AUDIO AND RADIO CIRCUIT

For Radio Receivers, Radiograms, Record Players,  
Tape Record Players and Hi-Fi Equipment

**30s.**

A Mullard Publication

Postage 1s.

**Servicing with the Oscilloscope**  
by Gordon J. King. 28s. Postage 1s.

**Colour Television PAL System**  
by G. N. Patchett. 40s. Postage 1s.

**Audio Amplifiers**  
by DATA. 10s. 6d. Postage 6d.

**Television Engineers' Pocket Book**  
by J. P. Hawker. 21s. Postage 1s.

**Beginner's Guide to Radio Control**  
by Warring. 18s. 6d. Postage 1s.

**Electronics Pocket Book**  
by J. P. Hawker. 21s. Postage 1s.

**Mathematics for Radio and Electronics Technicians** by Fritz Bergtold. 50s.  
Postage 1s.

**Radio Servicing Problems**  
by W. A. L. Smith. 9s. Postage 6d.

**Amateur Radio Call Book 1970**  
by RSGB. 6s. 6d. Postage 6d.

**Basic Theory and Application of Transistors.** 17s. Postage 1s.

**The Hi-Fi and Tape Recorder Handbook**  
by Gordon J. King. 40s. Postage 1s.

**Transistor Manual**  
by General Electric Company. 21s. Postage 2s.

**Solution of Problems in Electronics and Telecommunications** by Henson. 38s.  
Postage 2s.

**Beginner's Guide to Colour Television**  
by Squires. 15s. Postage 1s.

We have the Finest Selection of English and American Radio Books in the Country

**19-21 PRAED STREET (Dept RC) LONDON W2**

Telephone PADdington 4185

## SMALL ADVERTISEMENTS

Continued from page 251

**JOIN THE INTERNATIONAL S.W. LEAGUE.** Free Services to members including Q.S.L. Bureau, Amateur and Broadcast Translation, Technical and Identification Dept.—both Broadcast and Fixed Stations, DX Certificates, contests and activities for the SWL and transmitting members. Monthly magazine, *Monitor*, containing articles of general interest to Broadcast and Amateur SWLs, Transmitter Section and League affairs, etc. League supplies such as badges, headed notepaper and envelopes, QSL cards, etc., are available at reasonable cost. Send for League particulars. Membership including monthly magazine, etc., 35s. per annum. Secretary ISWL, 60 White Street, Derby.

**FOR SALE:** Metal Rectifier, Radiospares Type REC22, 30/-. Push-pull Interstage transformer, Repanco Type TT4, 7/6d. Pair Mullard OC36 transistors, unused, 35/-. Heat sink to match, 10/-; 0-200mA meter, 2½ in. diam., flush mounting, 10/-; 0-40mA meter, 2 in. sq. f.m., 15/-; 50 assorted resistors, £1. 25 assorted capacitors, £1. Box No. F379.

**FOR SALE:** Four Mullard RG1-240A rectifier valves, with high voltage insulation filament transformer, suitable use in pairs. £5. Box No. G100.

**FOR SALE:** Lafayette HE-30 4-Band communications receiver. Condition as new. Complete with manual, etc. £22 10s. o.n.o. Jackson, 26 New North Road, Attleborough, Norfolk.

**FOR SALE:** 813 valve and socket. 50/-. Box No. G101.

**ASSORTED LOTS OF USED COMPONENTS.** Resistors 15/- for 50. Capacitors 10/- for 20. Box No. G102.

**INNOVATION IN DX CLUBS ANNOUNCED!** Formed in October, 1965, the Radio New York Worldwide Listeners Club now has 3,600 members in 86 countries! A unique club offering shortwave listeners monthly magazines containing listening tips and technical features, numbered wallet-sized membership cards and gold 8½ in. by 11 in. membership certificates. Multilingual report forms available for cost of postage. "We must be doing something right!" Find out . . . join now!" Send 7s. 2d. (crossed domestic money order) for one year's membership to: The Radio New York Worldwide Listeners Club, 485 Madison Avenue, New York 10022, U.S.A.

**LEARNKIT OSCILLOSCOPE.** Complete with teaching course and components, including radio kit, photo switching and many circuits. Cost £45. Sell £20. Telephone: 021-427-1180.

**2.5kV SOLID STATE POWER SUPPLY** for sale. As per description in *The Radio Constructor*, August 1966 issue. In cabinet 8 in. wide x 11 in. deep x 9½ in. high. Matsunaga Variac and 0-3000V d.c. meter. £25 o.n.o. Box No. G103.

**POSTAL ADVERTISING?** This is the Holborn Service, Mailing lists, addressing, enclosing, wrapping, facsimile letters, automatic typing, copy service, campaign planning, design and artwork, printing and stationery. Please ask for price list.—The Holborn Direct Mail Company, Capacity House, 2-6 Rothsay Street, Tower Bridge Road, London, S.E.1. Telephone: 01-407-1495.

**LARGEST SUPPLIERS OF SERVICE SHEETS:** TV, Radio, Tape, Recorders, Record Players, Transistors, Stereograms, Radiograms. Only 5/- each, plus s.a.e. Uncrossed P.O.'s please, returned if service sheets not available. We have the largest supplies of service sheets (strictly by return of post). Please state make and model number alternative. Mail order only. Please mention *The Radio Constructor* when answering this advert. Mr. C. Caranna, 71 Beaufort Park, London N.W.11.

**TOROIDS FOR SALE:** 550, 475, 500, 395, 480, 210, 185, 110, 92mH. 5/- each. Box No. G104.

(Continued on page 255)

# JACKSON

the big name in PRECISION components



Precision built radio components are an important contribution to the radio and communications industry. Be sure of the best and buy Jackson Precision Built Components.

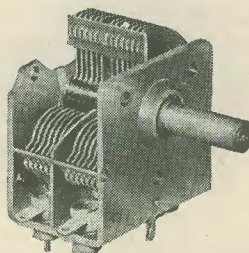

"00" Twin Gang 12/6 each

- \* THE gang for the transistor radio.
- \* Robust. Lightweight. Reliable.
- \* 2 gang 208/176 pF. The right capacitance for full cover.
- \* Fully screened. Fitted with Trimmers. Price 12s. 6d.

*It's reliable if it's made by JACKSON!*

**JACKSON BROS. (London) LIMITED**

Dept. RC KINGSWAY-WADDON, CROYDON, CR9 4DG  
Phone Croydon 2754-5 (01-688) Grams Walfilco, Croydon  
U.S. Office: M. Swedgal, 258 Broadway, N. York. N.Y. 10007

## FREE TO AMBITIOUS ENGINEERS

—THE LATEST EDITION OF ENGINEERING OPPORTUNITIES

Have you sent for your copy?

**ENGINEERING OPPORTUNITIES** is a highly informative 164 page guide to the best paid engineering posts. It tells you how you can quickly prepare at home for a recognised engineering qualification and outlines a wonderful range of modern Home Study Courses in all branches of Engineering. This unique book also gives full details of the Practical Radio & Electronic Courses administered by our Specialist Electronics Training Division — explains the benefits of our Appointments Dept. and shows you how to qualify for five years promotion in one year.

**"Satisfaction or refund of fee" terms**

Whatever your age or experience you cannot afford to miss reading this famous book. Send for your copy of "ENGINEERING OPPORTUNITIES" today — FREE.

**Practical Equipment including Tools**

The specialist Electronics Division of B.I.E.T. NOW offers you a real laboratory training at home with practical equipment. Basic Practice and Theoretical Courses for beginners in Radio, T.V., Electronics, etc. Ask for details.

**Which is your pet subject**

A.M.I.E.R.E. City & Guilds  Radio Amateur's Exam.  R.T.E.B. Certificate P.M.G. Certificate  Practical Radio  Radio & Television Servicing  Practical Electronics  Electronics Engineering  Automation

The B.I.E.T. is the leading institute of its kind in the world.

Please send  
Free Books and  
Full Information

**British Institute of  
Engineering Technology**

NAME .....

ADDRESS .....



Subject  
of interest..... Age.....

ALDERMASTON COURT, Dept. 480D. Aldermaston, Berks.

# NEW STYLE SELF-BINDER

for "The Radio Constructor"

The "CORDEX" Patent Self-Binding Case will keep your issues in mint condition. Copies can be inserted or removed with the greatest of ease. Rich maroon finish, gold lettering on spine.

Specially constructed Binding Cords are made from Super Linen of great strength, very hard twisted and twice doubled. They are attached to strong RUSTLESS Springs under tension, and the method adopted ensures PERMANENT RESILIENCE of the Cords. Any slack that may develop is immediately compensated for, and the Cords will always remain taut and strong. It is impossible to overstretch the springs, as a safety check-device is fitted to each.

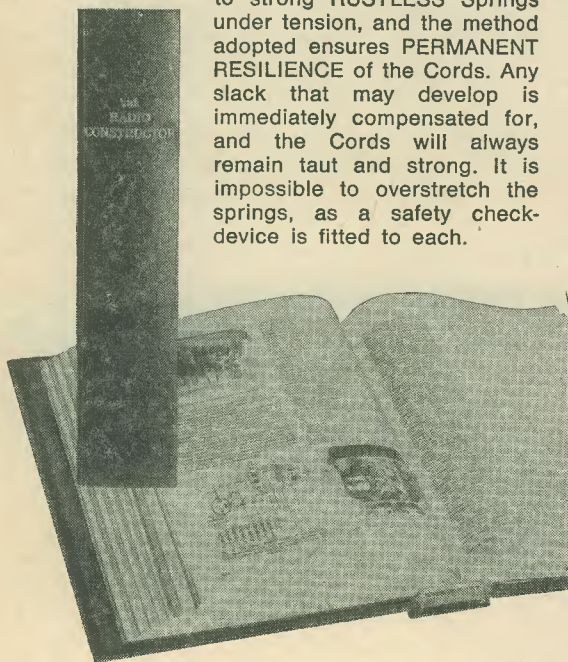

PRICE **14/-** Postage 1/6

Available only from:—

**Data Publications Ltd.**  
57 Maida Vale London W9

# RADIO CONTROL

THE NEWEST ELECTRONIC HOBBY

START WITH A SINGLE CHANNEL  
UNIT AT

TRANSMITTER

**£8**

(Kit)

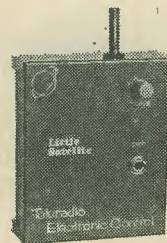

RECEIVER

**£4**

(Kit)

leading up to sophisticated  
DIGITAL CONTROL from £80

DETAILS FROM UK'S LARGEST R/C  
KIT SUPPLIERS

FULL CATALOGUE 3/6, post included

**TELERADIO ELECTRONICS**  
325 FORE STREET, EDMONTON  
LONDON N.9

# INTERNATIONAL SHORT WAVE LEAGUE



Membership 35s. 0d. per annum (U.S.A. \$5.00) including 12 monthly issues of *Monitor* — the League journal. Including free use of all Services, QSL Bureau, etc.

**THE LARGEST S.W.L. ORGANISATION  
IN THE WORLD**

For full details write to:

The Secretary,  
I.S.W.L.,

60 WHITE STREET, DERBY

## SMALL ADVERTISEMENTS

Continued from page 253

**ARE YOU A MOTORING ENTHUSIAST?** The Seven Fifty Motor Club caters for all types of motor sport—racing, rallies, hill climbs, etc. Monthly Bulletin free to members. For full details write to: The General Secretary, Colin Peck, "Dancer's End," St. Winifred's Road, Biggin Hill, Kent.

**IF YOU HAVE ENJOYED A HOLIDAY** on the Norfolk Broads, why not help to preserve these beautiful waterways. Join the Broads Society and play your part in determining Broadlands future. Further details from:—The Hon. Membership Secretary, The Broads Society, "Icknield", Hilly Plantation, Thorpe St. Andrew, Norwich, NOR 85S.

**RECITALS OF RECORDED MUSIC.** The second Saturday evening of each winter month. Next recital: November 8th, 1969, 8 p.m. Woodford Green United Free Church, Woodford Green, Essex. Bus routes 20, 20A, 38A and 179—alight at "The Castle" stop. Programme includes works by Mendelssohn, Vaughan Williams, Elgar and Dvorak.

**FOR SALE:** Taylor 88A Multimeter, 20k $\Omega$ /V, wood case, 74 ranges to 5,000 volts and 10 amp., a.c./d.c. Resistance to 50M $\Omega$ . £15. EICO 249 VTVM, 7 $\frac{1}{2}$ in. Meter, to 1,500V, a.c./d.c. Measures p-p Complex waves to 3MHz, measures resistance to 1,000M $\Omega$ . £18. Heathkit Millivoltmeter AV3U. £10. All with manuals and leads. Box No. G106.

**ESSEX GARDENERS.** Buy your bedding and rock plants, shrubs, etc., also cacti from May's Nurseries, 608 Rayleigh Road, Hutton, Brentwood, Essex. Callers only. Monday to Saturday.

**PROPERTIES** for sale and to let in London and suburbs. Apply to Maggs & Stephens, Estate Agents, 229 Maida Vale, London, W.9. MA1Da Vale 8123.

### SITUATIONS VACANT

**SMALL EXPANDING INSTRUMENT MANUFACTURERS** have a number of vacancies in production and testing for young men aged about 17 to 23. Applicants should be keen, intelligent and have some electronic knowledge. A good salary and prospects in a progressive company are offered to the right applicants. Write or phone: Melico, 32-34 Gordon House Road, London N.W.5. Telephone: 01-267 1348.

### HENRY'S RADIO LTD. 303 EDGWARE ROAD, LONDON, W.2

**HAVE THE FOLLOWING VACANCIES IN THEIR ORGANISATION ORGAN DEPARTMENT:** Young man interested in Electronic Musical Instruments with a good general knowledge of electronics required for this expanding Dept. Write, or Telephone 723-1008/9 Extn. 1 or 2.

**SALES ASSISTANT:** Young man with a good general knowledge of HIGH FIDELITY EQUIPMENT required for our retail HI-FI SALES DEPT. Please contact MR. STEVENS, Telephone 723-6963.

### W. E. C. LTD.

#### NEW QUALITY COMPONENTS

We stock Resistors, Capacitors, Cable, Wire, Fuse-holders, Lamps, Lampholders, Metal, Bakelite, Plugs, Sockets, Potentiometers, Semi-Conductors, Sleeveing, Switches, Hardware and Sundries.

SEND FOR OUR FREE CATALOGUE

#### HARDWARE KITS

50 - Assorted 6BA x  $\frac{1}{4}$ "  $\frac{1}{8}$ "  $\frac{1}{4}$ " with Nuts & Washers 4/9d per Kit  
50 - Assorted 4BA x  $\frac{1}{4}$ " and  $\frac{1}{8}$ " with Nuts & Washers 5/9d per Kit  
50 - Assorted 2BA x  $\frac{1}{4}$ " and  $\frac{1}{8}$ " with Nuts & Washers 7/3d per Kit  
State Cheesehead or Countersunk Head

#### IN FREE PLASTIC BOX

Packing and Postage 1/6d per Kit

W. E. C. LTD.

74 THE STREET, ASHTEAD, SURREY

# PLAIN-BACKED NEW STYLE SELF-BINDERS

for your other magazines

(max. format 7 $\frac{1}{2}$ " x 9 $\frac{1}{2}$ ")

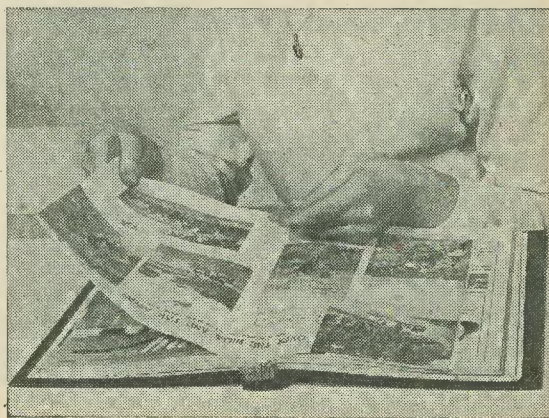

The "CORDEX" Patent Self-Binding Case will keep your copies in mint condition. Issues can be inserted or removed with the greatest of ease. Specially constructed Binding cords are made from Super Linen of great strength, very hard twisted and twice doubled. They are attached to strong RUSTLESS Springs under tension, and the method adopted ensures PERMANENT RESILIENCE of the Cords. Any slack that may develop is immediately compensated for, and the Cords will always remain taut and strong. It is impossible to overstretch the springs, as a safety check-device is fitted to each.

COLOURS: MAROON OR GREEN

(Please state choice)

PRICE **13/6** Postage 1/6

Available only from:—

**Data Publications Ltd.**  
57 Maida Vale London W9

# CHASSIS and CASES by



**H. L. SMITH & CO. LTD.**  
287/9 Edgware Road  
London W2  
TEL: 01-723 5891

## BLANK CHASSIS

FOUR-SIDED 16 SWG ALUMINIUM

Size	Price	Base	Size	Price	Base
6x4x2"	6/3	2/11	10x8x2 1/2"	12/-	5/6
7x4x1 1/2"	6/-	3/2	12x7x2 1/2"	12/-	5/11
7x5x2"	7/6	3/5	12x9x2 1/2"	13/9	7/-
8x4x2"	7/-	3/4	13x8x2 1/2"	13/9	6/11
8 1/2x5 1/2x2"	8/-	3/9	14x7x3"	14/6	6/6
9x7x2"	9/3	4/10	14x10x2 1/2"	16/-	8/7
10x4x2 1/2"	9/-	3/9	15x10x2 1/2"	16/6	9/1
12x4x2 1/2"	10/-	4/3	17x10x3"	19/6	10/1
12x5x3"	12/-	4/9			

## CASES ALUMINIUM, SILVER HAMMERED FINISH

Type	Size	Price	Type	Size	Price
N	8x6x2"*	18/-	W	12x7x7"	37/6
N	6x6x3"	17/6	W	15x9x8"	48/6
N	4x4x2"	11/-	Y	8x6x6"	29/-
U	4x4x4"	11/-	Y	12x7x7"	45/-
U	5 1/2x4 1/2x4 1/2"	17/-	Y	13x7x9"	50/6
U	8x6x6"	23/-	Y	15x9x7"	53/6
U	9 1/2x7 1/2x3 1/2"	24/-	Z	17x10x9"	72/6
U	15x9x9"	49/-	Z	19x10x8 1/2"	78/-
W	8x6x6"	23/-			*Height

Type N has removable bottom, Type U removable bottom or back, Type W removable front, Type Y all screwed construction, Type Z removable back and front. Plus p. & p.

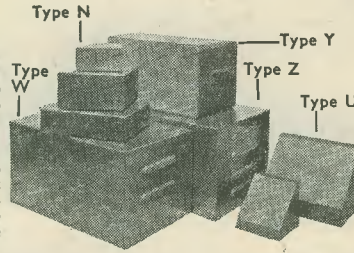

### TO FIT OUR CASES

7x5 1/2x1 1/2"	7/-	3/9	12x6 1/2x2"	10/9	5/11
7x5 1/2x2"	7/9	3/9	14x8 1/2x2"	13/6	7/11
11x6 1/2x1 1/2"	10/-	5/6	15 1/2x9 1/2x2 1/2"	17/-	9/6
11x6 1/2x2"	10/-	5/6	17 1/2x9 1/2x2 1/2"	18/6	10/6

Plus post & packing

PANELS: Any size up to 3ft. at 6/- sq.ft. 16 s.w.g. (18 s.w.g. 5/3). Plus postage and packing.

## THE WILSIC REVERBERATION UNIT KIT

Self-contained, 6 transistor, reverberation chamber to which microphones, instruments, tuners or tape recorders may be connected for added dimensional effect. The output is suitable for most amplifiers and the unit is especially suitable for use with electronic organs. A ready-built spring and transducer assembly is used (58/11 if bought separately). Complete, easy-to-build kit with constructional notes and circuits: £7.10.0. Pre-drilled and printed case 34/- extra. All parts available separately. Send 1/- for circuit and construction details.

### BUILD A WAH-WAH PEDAL

**SELECTIVE AMPLIFIER MODULE.** Basis of Wah-Wah Pedal. All components to build two transistor circuit including sockets, control, battery and clip, resistors, capacitors and veroboard. Full instructions provided. 30/- post free. Assembled and tested £2.

Send 1/- for our catalogue of components, testmeters, musical electronics & more details of the above items. Callers welcome.

### WILSIC ELECTRONICS LIMITED

6 Copley Road, Doncaster, Yorkshire

**YUKAN** SO PROFESSIONAL THE  
**SELF-SPRAY** YUKAN AEROSOL WAY-

Get these air drying **GREY HAMMER**  
**NOW!** OR **BLACK WRINKLE**  
**(CRACKLE) finishes**

Yukan Aerosol spraykit contains 16 ozs. fine quality, durable easy instant spray. No stove baking required. Hammers available in grey, blue, gold, bronze. Modern Eggshell Black Wrinkle (Crackle) all at 15/11 at our counter or 16/11, carriage paid, per push-button self-spray can. Also Durable, heat and water resistant Black Matt finish (12 ozs. self-spray cans only) 13/11 carriage paid.

**SPECIAL OFFER:** 1 can plus optional transferable snap-on trigger handle (value 5/-) for 18/11, carriage paid. Choice of 13 self-spray plain colours and primer (Motor car quality) also available.

Please enclose cheque or crossed P.O. for total amount direct to:  
**DEPT: N/6 YUKAN, 307A, EDGWARE ROAD, LONDON, W.2**  
We supply many Government Departments, Municipal Authorities, Institutes and Leading Industrial Organisations—We can supply you too.

Other Yukan Air Drying Aerosols, 16 ozs. at 16/11 carb. paid include:  
Zinc Chromate  
Clear Lacquer  
Metallics: Grey, Blue, Bronze and Gold.

Open all day Saturday. Closed Thursday afternoons.

Closed ALL DECEMBER for annual holiday

## DATA BOOK SERIES

- DB5 TV FAULT FINDING**  
124 pages. Price 8/6, postage 8d.
- DB6 THE RADIO AMATEUR OPERATOR'S HANDBOOK**  
64 pages. Price 6/-, postage 6d.
- DB15 TWENTY SUGGESTED CIRCUITS**  
48 pages. Price 3/6, postage 5d.
- DB16 RADIO CONTROL FOR MODELS**  
192 pages. Price 15/-, postage 1/-.
- DB17 UNDERSTANDING TELEVISION**  
512 pages. Price 37/6, postage 3/-
- DB18 AUDIO AMPLIFIERS**  
128 pages. Price 10/6, postage 8d.

I enclose Postal Order/Cheque for.....in payment for.....

NAME .....

ADDRESS .....

(Please use Block Capitals for both name and address)

Postal Orders should be crossed and made payable to Data Publications Ltd.

Overseas customers please pay by International Money Order

All publications are obtainable from your local bookseller.

**Data Publications Ltd., 57 Maida Vale, London W.9**



# RADIO CONSTRUCTORS DATA SHEET

# 32

## CUBE ROOTS OF NUMBERS

The Table lists cube roots, to 2 decimal places, of numbers from 1 to 100.

1	1.00	21	2.76	41	3.45	61	3.94	81	4.33
2	1.26	22	2.80	42	3.48	62	3.96	82	4.34
3	1.44	23	2.84	43	3.50	63	3.98	83	4.36
4	1.59	24	2.88	44	3.53	64	4.00	84	4.38
5	1.71	25	2.92	45	3.56	65	4.02	85	4.40
6	1.82	26	2.96	46	3.58	66	4.04	86	4.41
7	1.91	27	3.00	47	3.61	67	4.06	87	4.43
8	2.00	28	3.04	48	3.63	68	4.08	88	4.45
9	2.08	29	3.07	49	3.66	69	4.10	89	4.47
10	2.15	30	3.11	50	3.68	70	4.12	90	4.48
11	2.22	31	3.14	51	3.71	71	4.14	91	4.50
12	2.29	32	3.17	52	3.73	72	4.16	92	4.51
13	2.35	33	3.21	53	3.76	73	4.18	93	4.53
14	2.41	34	3.24	54	3.78	74	4.20	94	4.55
15	2.47	35	3.27	55	3.80	75	4.22	95	4.56
16	2.52	36	3.30	56	3.83	76	4.24	96	4.58
17	2.57	37	3.33	57	3.85	77	4.25	97	4.59
18	2.62	38	3.36	58	3.87	78	4.27	98	4.61
19	2.67	39	3.39	59	3.89	79	4.29	99	4.63
20	2.71	40	3.42	60	3.92	80	4.31	100	4.64

# HENRY'S RADIO LTD.

# ENGLAND'S LEADING COMPONENT AND EQUIPMENT CENTRES

## HENRY'S RADIO Fully Illustrated CATALOGUES

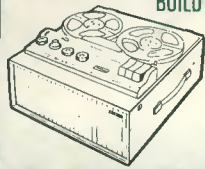

### BUILD A QUALITY 4 TRACK TAPE RECORDER

To get the best out of your MAGNAVOX DECK, you need a MARTIN RECORDAKIT. This comprises a special high quality 6 valve amplifier and pre-amplifier which comes to you assembled on it's printed circuit board - in fact everything for making a superb Tape Recorder. You need no experience or technical skill to bring this about. THE INSTRUCTIONS MANUAL MAKES BUILDING EASY, AND SUCCESS IS ASSURED. Kit comprises: Deck, Amplifier, Cabinet and speaker, with microphone, 7" 1200 ft. tape, and spare spool. ASK FOR BROCHURE 6. TODAY'S VALUE £60. PRICE 39gns. p.p. 22/6. NOTHING ELSE TO BUY

### SCOOP! STAAR RECORD PLAYER

Deck plays 33, 45, 78, R.P.M. records. 9 volt operated, with mono cartridge. BRAND NEW ... as illustrated.

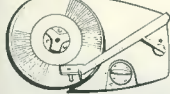

PRICE 59/6. p.p. 3/6. Send for leaflet No. 2.



### MULLARD 7 WATT AMPLIFIER

Portable Transistor Unit-ideal for Intercoms, Baby Alarms, Tele phone, Record Players or Guitar Practice. 9 Volt 5 transistors with volume control, output 3 ohms. Ideal for use with STAAR RECORD DECK. PRICE 45/- p.p. 2/6.

OTHER ITEMS. Suitable 7 x 4 inch. 3 ohm speaker 17/6 p.p. 1/6. Rexine covered cabinet 12 x 9 x 4 1/2 12/6 p.p. 2/6. P.P. 9 volt battery 3/9. Write for leaflet No. 2.

### GARRARD RECORD DECKS

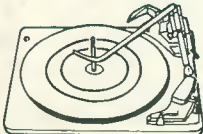

All the latest models BRAND NEW and guaranteed - TERRIFIC SAVINGS!

- \*2025 STEREO £ 719.6.
- \*2025TC DIAMOND, 9TAH.C. £ 919.6.
- \*3000 STEREO 9TAH.C. £ 919.6.
- \*SP 25 Mk.II £1119.6.
- \*SL 55 £1119.6.
- \*A70 Mk.II. £1210.0.
- \*AT 60 K.II. £1310.0.
- \*SL 65 £1414.0.
- AP 75 £19.0.
- 401 £28.7.6.
- SL 75 £29.0.0.
- SL 95 £36.0.0.
- GL 75 GOLDRING £33.0.0.
- GL 75 P £46.15.0.

ALSO IN STOCK - THORENS - Lenco - B.S.R Carriage/insurance 7/6 extra on any model. WB4 BASES £3.19.6. PERSPEX COVERS £3.10.0. \*Special offer base and cover available for these models at £4.15.0. Carriage 5/-. Complete range of Cartridges/Plinths/Covers. SEND FOR 8 PAGE BROCHURE 16/17 TODAY.

### BUILD YOURSELF A QUALITY RADIO

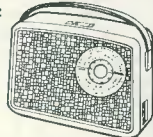

New printed circuit design with full power output. Fully tunable on both m.w./w. bands. 7 Mullard transistors, Fitted 5" speaker, Room Filling Power. Easy to build with terrific results. All local and continental stations. Complete detailed instructions. TOTAL COST £6.19.6. p.p. 4/6. Ask for Leaflet No. 1.

### TRANSISTORS DIODES RECTIFIERS

WE HAVE THE MOST COMPREHENSIVE STOCK IN GREAT BRITAIN. NEW 1969 LIST OF 1000 TYPES. SEND FOR FREE COPY TODAY (LIST 36) Whether you require one or 1000, devices can fulfil your order from stock! For quantity quotations telephone: (01) 723 0401 Ex. 4. or (01) 402 6823.

### HENELEC 5-5 STEREO AMPLIFIER

Excellent low priced British designed Stereo Amplifier for use with Record Decks, Mks., Tuners. 16 transistor mains operated. Output 5+5 watts for 8-15 ohm speakers. Black, silver and wood finish, size 13" x 3" x 6".

PRICE £13.10.0. p.p. 7/6. (Leaflet on request).

Complete Stereo System 5-5. Garrard 2025 stereo. 5-5 Amplifier, Plinth/Cover, Two 10 watt speakers with tweeters in polished cabinets.

Usual price £47.0.0. OUR PRICE £39.10.0. p.p. 20/-. ASK FOR BROCHURE 13



### SINCLAIR EQUIPMENT

The SINCLAIR IC-10 is the worlds first monolithic integrated circuit high fidelity power amplifier and pre-amplifier. The circuit itself has an output power of 10 watts, yet with an overall-size of 1 x 0.4 x 0.2 in.



- |                                    |          |                                    |      |
|------------------------------------|----------|------------------------------------|------|
| IC-10 Integrated Circuit Amplifier | 59/6     | OTHER TYPES OF INTEGRATED CIRCUITS |      |
| Stereo 60                          | 89/6     | G.E. PA246*                        | 52/6 |
| P25 Power Supply                   | £9.19.6. | RCA. CA3014                        | 29/6 |
| O16 Loud Speaker                   | £4.19.6. | RCA. CA3018                        | 22/6 |
| Z12 Amplifier                      | £8.19.6. | RCA. CA3020                        | 29/6 |
| P2.4 Power unit                    | 89/6     | RCA. CA3036                        | 18/6 |
| Stereo 25                          | £9.19.6. | Sinclair I.C.10.                   | 59/6 |
| Q14 Speaker system                 | £7.19.6. | G.E. PA230*                        | 22/6 |
|                                    |          | G.E. PA234*                        | 20/0 |
|                                    |          | G.E. PA237*                        | 37/6 |

All post paid, delivery from stock.

### BUILD THIS VHF FM TUNER

5 MULLARD TRANSISTORS. 300 kc/s BANDWIDTH. PRINTED CIRCUIT. HIGH FIDELITY REPRODUCTION MONO & STEREO. A popular VHF FM Tuner for quality and reception of mono and stereo. There is no doubt about it - VHF FM gives the REAL sound.

PARTS TOTAL COST £6.19.6. DECODER £5.19.6. ASK FOR LEAFLET No. 3. (FOR STEREO)

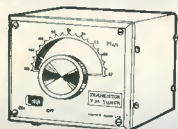

A ALL TYPES OF ELECTRONIC COMPONENTS TEST EQUIPMENT KITS BUILT UNITS

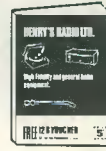

B HIGH FIDELITY & GENERAL AUDIO EQUIPMENT CATALOGUE

COMPREHENSIVE · CLEAR · CONCISE · CATALOGUES  
 A Over 300 pages fully detailed and illustrated with more than 6,000 stock items. Everything for amateur and professional use. Complete with 5 vouchers. 10/- value, for use with purchases.  
 ORDER AS CATALOGUE A PRICE 7/6. p.p. 2/-.  
 B New audio and high fidelity catalogue. 120 pages containing ideas and equipment for every application. Special low prices for all leading makes Plus 12/6 extra discount voucher.  
 ORDER AS CATALOGUE B PRICE 5/-. p.p. 1/-.  
**WHY NOT SEND AWAY TODAY!**

### AUDIO EQUIPMENT

Mono or Stereo Audio equipment developed from Dinsdale Mk.II - each unit or system will compare favourably with other professional equipment selling at much higher prices. COMPLETE SYSTEMS AND MIXERS from £11.12.6. to £38.17.6. (all units available separately).

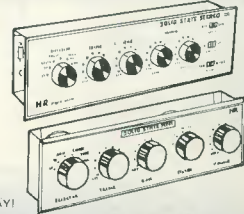

THE FINEST VALUE IN LOW COST HIGH FIDELITY - CHOOSE A SYSTEM TO SUIT YOUR NEEDS AND SAVE YOURSELF POUNDS.

SEND FOR BROCHURES No. 12/14 and 21 TODAY!

### HI-FI equipment to suit EVERY POCKET

HIGH FIDELITY AUDIO EQUIPMENT CATALOGUE 5/- p.p. 1/-

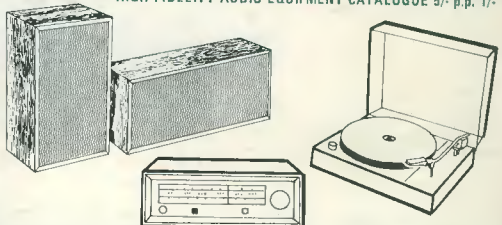

VISIT OUR NEW HI-FI CENTRE AT 309 EDGWARE ROAD, for all leading makes of - AMPLIFIERS, TUNERS, DECKS, SPEAKERS, MICROPHONES. TEST EQUIPMENT. ALL WITH DISCOUNTS - IT WILL PAY YOU TO PAY US A VISIT. AUDIO SYSTEMS £40 - £300 TO SUIT EVERY POCKET. DEFERRED TERMS AVAILABLE. SEND FOR ILLUSTRATED BROCHURE 16/17. TWO DEMONSTRATION ROOMS

### ELECTRONIC ORGANS

COMPLETE KITS FOR THE HOME CONSTRUCTOR

STAR FEATURES:  
 \*ALL TRANSISTOR PRINTED CIRCUIT DESIGNS.  
 \*BRITISH DESIGN. \*STEP BY STEP DETAILED INSTRUCTIONS. \*SAVES UP TO 50% ON COMMERCIAL EQUIVALENT. \*EVERYTHING SUPPLIED DOWN TO THE LAST ITEM. \*FULL AFTER SALES SERVICE & ADVICE. \*CREDIT SALE & H.P. TERMS AVAILABLE.

We are pleased to offer the choice of FOUR British designs from a single manual portable at £99 THE MAYFAIR for light or classical music - to a two manual five octave de-luxe model with OAK CONSOLE from £285 for the serious musician.

These kits are the result of years of research and design and offer the best that is essential to good organ designs, coupled with excellent value are within the reach of most pockets. No technical skill or knowledge is required in construction, with the aid of the STEP BY STEP illustrated manuals will produce an instrument that will be a delight to own and use and will give years of trouble free entertainment for the whole family.

SEND FOR ILLUSTRATED BROCHURES 9/10/11 TODAY! When in LONDON... CALL IN SEE, HEAR, PLAY FOR YOURSELF. Organ Demonstration Room 1st Floor. PRACTICAL ELECTRONICS ORGAN - ORGAN COMPONENTS

We are able to supply all items for this series, details on request.

START BUILDING FOR AS LITTLE AS £10. MODELS FROM £99 - £350.

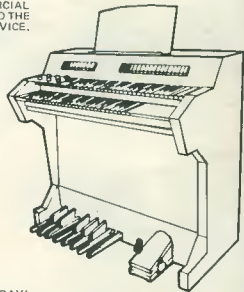

ILLUSTRATION of GROSVENOR ELECTRONIC ORGAN

Built models available from £124.

# HENRY'S RADIO LTD.

Mail Order Dept., Components, Organ Dept.  
 303 EDGWARE ROAD, LONDON W.2.  
 Telephone: 01-723 1008/9

High Fidelity and Equipment Centre  
 309 EDGWARE ROAD, LONDON W.2.  
 Telephone: 01-723 6963

OPEN MON-SAT 9am-6pm THURS. 9am-1pm