

THE

RADIO CONSTRUCTOR

Vol. 23 No. 3

OCTOBER 1969

THREE SHILLINGS

NE  PHYTE
AUDIO AMPLIFIER

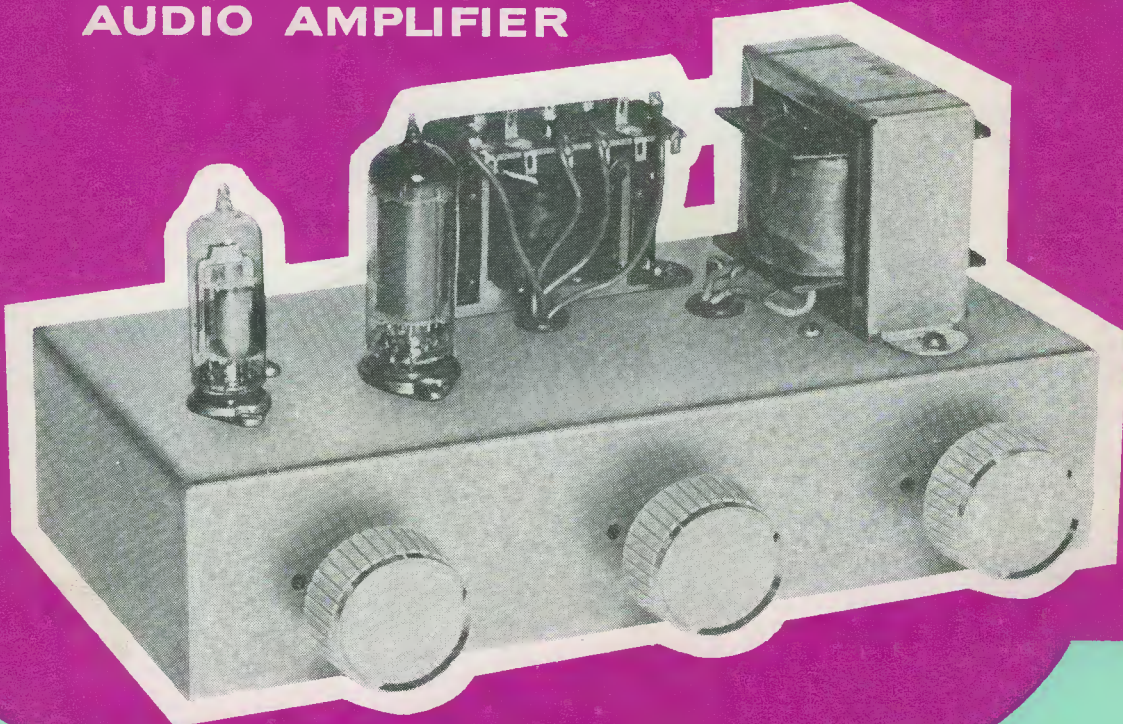

Special
IN THIS ISSUE

FREE INSIDE
Workshop Plans
for the above Amplifier

EXCLUSIVE
Motoring
Offer

L.S.T. ELECTRONIC COMPONENTS LTD.

SEMI-CONDUCTORS, BRAND NEW AND FULLY GUARANTEED

1N914	2/-	2N4155	8/6	BC212	10/4	OC19	5/7
1S13	3/-	2S018	12/6	BD121	19/6	OC20	33/-
1S120	2/-	2S024	25/-	BD123	23/6	OC22	13/-
1S130	2/6	2S034	15/6	BD124	17/6	OC23	13/6
1S131	2/6	AC107	14/6	BF152	13/6	OC24	10/-
1S132	2/6	AC126	6/6	BF167	6/6	OC25	4/8
1S301	4/-	AC127	7/6	BF172	7/6	OC26	4/8
1G302	3/9	AC128	4/-	BF181	7/6	OC28	12/-
1G315A	5/-	AC176	7/6	BF184	7/6	OC29	15/-
1G374	6/6	AC187	12/6	BF237	7/6	OC30	7/6
2G381	5/-	AC188	12/-	BFW58	7/6	OC35	9/6
2G371	3/-	AC177	5/6	BFW59	6/6	OC36	13/-
2N385A	15/-	AC189	12/6	BFW60	6/6	OC41	3/6
2N388A	15/-	AC191	4/4	BFX13	4/8	OC42	4/-
2N696	6/-	AC170	3/8	BFX29	8/5	OC44	3/-
2N697	6/-	AC171	4/-	BFY50	6/1	OC45	3/-
2N698	4/6	AC172	2/4	BFY51	6/-	OC71	3/6
2N705	3/-	AD140	15/-	BFY52	6/-	OC72	4/6
2N706A	6/6	AD149	11/8	BFY53	6/-	OC73	3/6
2N708	4/-	AD161	6/-	BSX20	3/3	OC75	5/6
2N711	7/6	AD162	6/-	BSX21	8/-	OC76	2/6
2N714A	7/6	AD170	12/6	BSY27	4/6	OC77	8/8
2N929	5/6	AF102	18/-	BTX39	600	OC80	3/6
2N930	6/6	AF104	4/4	BUY11	15/-	OC82	4/6
2N1131	9/6	AF115	4/4	BSY5A	3/4	OC8D	3/6
2N1132	7/6	AF116	4/4	BY100	5/-	OC83	4/6
2N1302	4/6	AF117	4/4	BYX10	4/9	OC84	4/6
2N1303	6/6	AF139	12/6	GEY27	4/6	OC123	3/6
2N1304	5/-	AF124	6/-	BYZ12	5/-	OC139	8/6
2N1305	5/-	AF127	4/6	BYZ13	5/-	OC140	12/6
2N1306	6/6	AF139	12/6	GET12	5/6	OC160	12/6
2N1307	6/6	AF186	11/6	GET103	4/6	OC170	4/6
2N1308	8/-	AF239	12/6	GET113	5/6	OC171	6/6
2N1309	9/6	AF212	11/6	GET121	5/6	OC200	10/6
2N1613	6/6	ASY26	5/8	GMO290	10/-	OC201	10/6
2N2147	17/-	ASY27	5/8	GMO378B	6/-	OC202	16/6
2N2148	12/6	ASY28	6/4	MA121	5/6	OC204	8/6
2N2160	14/-	ASY29	4/4	MAT121	5/6	OC204	8/6
2N2368	6/6	ASZ21	11/6	MPE102	9/6	OC205	9/6
2N2369	5/6	ASZ10	39/6	MPE103	9/6	OC206	10/6
2N2369A	7/6	BAA115	2/8	MPE104	9/6	OC207	7/6
2N2646	10/-	BA130	3/6	MPE105	9/6	ORP60	12/6
2N2696	6/6	BAY31	2/6	NKT16	10/5	ORP61	8/6
2N2924	5/-	BAY38	3/6	NKT17	10/5	ORP63	9/6
2N2925	5/6	BC107	2/9	NKT261	4/3	SK631	7/4
2N2926	2/6	BC108	2/9	NKT262	4/3	SK636	10/6
Green	2/-	BC109	2/9	NKT264	4/3	SK638	12/6
Yellow	2/-	BC113	5/6	NKT271	4/3	SZ20C	15/6
Orange	2/-	BC115	13/6	NKT272	4/3	SZC1	17/4
Red	2/-	BC115	13/6	NKT272	4/3	SZC2	17/4
2N3053	8/-	BC118	5/6	NKT275	3/6	P3A6A	6/6
2N3054	15/-	BC125	16/6	NKT276	2/6	V405A	9/3
2N3055	15/-	BC126	14/6	NKT281	5/6	EC401	5/6
2N3702	4/-	BC134	5/6	NKT403	16/-	EC102	4/8
2N3703	4/-	BC137	5/6	NKT405	15/6	EC116	18/6
2N3704	4/-	BC148	4/6	NKT713	5/6	C400	9/6
2N3705	4/-	BC149	6/6	NKT773	5/4	C221	45/9
2N3706	4/-	BC150	6/6	NKT774	5/4	C225	32/6
2N3707	4/-	BCY30	7/6	OAS	3/8	EA403	3/6
2N3708	3/-	BCY31	9/6	OA47	1/6	EB383	3/6
2N3709	3/-	BCY32	12/6	OA70	1/6	M1991	30/3
2N3710	4/-	BCY33	4/8	OA73	1/6	M1981	27/6
2N3711	4/-	BCY34	6/4	OA79	1/6	O4036	13/3
2N3819	8/-	BCY38	8/6	OA81	1/6	OC269	3/6
2N3820	23/6	BCY39	27/4	OA85	1/6	OAZ241	3/6
2N4058	7/-	BCY40	13/4	OA90	1/6	OAZ242	3/6
2N4059	6/6	BCY54	13/3	OA91	1/6	OAZ269	3/6
2N4060	6/-	BCY70	4/4	OA95	1/6	OAZ270	3/6
2N4061	6/-	BCY71	8/8	OA200	2/-	ST140	18/3
2N4062	6/-	BCY72	6/6	OA202	2/-	ST140	18/3
2N4254	9/6	BCY87	86/9	OA210	6/4	ST141	5/6

CHEAPEST EVER SOLID-STATE SALE

- BEST VALUE IN BRITAIN**
 40 Silicon Planar Transistors, TO-18 case, NPN & PNP mixed, Similar V405A, P3A6A, etc. Not tested or coded. Guaranteed minimum 50% good ... 10/-
- 40 Silicon Planar Transistors, TO-18 case, NPN type similar 2N706, BSY5A, etc. Not tested or coded. Guaranteed minimum 50% good ... 10/-
- 10 PNP Silicon Planars, Similar BSX40/2N2904/A, 3 Watts. 100 Mc/s. Fully tested. Uncoded ... 10/-
- 30 Silicon Planar Transistors, TO-18 case, NPN type similar BC107/B/9 range. Not tested or coded. Guaranteed minimum 50% good ... 10/-
- 30 Silicon Power Transistors similar to BUY11, TO-3 case. Not tested or coded. Gold plated cases ... 10/-
- 20 Germanium Transistors 3G371B, Case 5027. Fully tested to makers' specifications PNP. Equal to OC71 range. Not coded ... 10/-
- 25 Silicon NPN VHF Transistors, TO-18 case. Similar to BSY27, etc. Not tested or coded ... 10/-
- 20 Silicon Planar Transistors, Plastic type, NPN. Similar to 2N3705/7 range. Not tested or coded. Guaranteed minimum 50% good ... 10/-
- 20 Silicon Planar Transistors, Plastic type, PNP. Similar to 2N3702. Not tested or coded. Guaranteed minimum 50% good ... 10/-
- 16 Silicon Rectifiers, Top-Hat case, 750mA + @ 100 - 1000 pV. Guaranteed minimum 80% good ... 10/-
- 12 Silicon Avalanche Rectifiers, Top-Hat case 11 Amp @ up to 1200 pV. Guaranteed minimum 80% good ... 10/-
- 10 Silicon Epitaxial Planar Diodes—Sub-miniature, Type SD19. Pleasex. Exact substitute for 1N914, etc. 100% perfect. Not coded ... 10/-
- 30 Part made Top-Hat Rectifiers (top connection broken, but plenty room to solder) 750mA up to 800 pV. Guaranteed minimum 80% good ... 10/-
- 2G371B and SD19 are Manufacturers' tested devices. All other un-coded stock are given type numbers as a guide only. Money refunded if not satisfied.
- All above packs post free in UK.
EXPORT SPECIAL: 10% of the above SALE goods are reserved for export until August 1969.



DeCs Single "Dec" with accessories and project manual ... 2/96
 "DeC" kit contains two "DeCs", component tray, accessories, instruction book, all packed in attractive plastic box ... 6/96
 "4-DeC" kit contains four "DeCs", accessories, manual, etc. ... 11/76

BOOKS FROM STOCK

General Electric Transistor Manual, 640 pages of data & circuits 2/96
 RCA Transistor Manual, 554 pages, includes SCR circuits ... 28/-
 Designers' Guide to British Transistors. Excellent data book lists over 1,000 common types plus Computer-selected substitution chart 25/- (ADD 2/6 POST & PACKING FOR ALL BOOKS)

NEONS

Signal neons for many types of circuit, type "N". Price 1/6 each or 18/- dozen.

HEATSINKS

Suitable for 2 x OC35, etc. As used in commercial equipment. Type 10D ... 6/-

ALUMINIUM CHASSIS

6 x 4 x 2 1/2" with reinforced corners 6/9 each (P & P, 1/6). Alloy panel to fit 1/6. Panel on panel to fit 2/-. Many other sizes in stock up to 12 x 8 x 2 1/2" (see catalogue).

X-LINE

MODULES YOU CAN OPEN!

- X-161 2 Watt Amplifier 35/-
- X-461 Siren 35/-
- X-471 Burglar Alarm 35/-
- X-661 Metronome 30/-
- X-761 Morse Oscillator 20/-
- X-691 Lamp Flasher (Double) 30/-



Generous discounts to retailers given on all 'X-Line' products. Send for details now.

SILICON RECTIFIERS

PIV	200mA	750mA	2Amp	10Amp
50	6/-	1/6	2/3	1/6
100	9/6	1/6	2/3	4/6
200	1/3	2/6	2/9	5/-
400	—	2/6	4/-	8/-
600	—	3/-	4/6	9/6
800	3/-	3/9	5/-	11/3
1000	—	6/6	6/6	14/-

THYRISTORS—SCRs

PIV	1A	3A	10A	30A	100A
50	7/6	9/6	—	20/-	—
100	—	10/-	10/-	22/-	—
200	8/6	—	12/6	42/-	35/-
300	—	11/-	—	—	—
400	9/6	12/6	15/-	60/-	45/-
600	—	—	20/-	84/-	120/-
800	—	—	—	—	—

ZENER DIODES

± Watt 10% Tolerance—
 Voltages:

3.0	4.7	7.5	12	ALL
3.3	5.1	8.2	13	ONE
3.6	5.6	9.1	15	PRICE:
3.9	6.2	10	16	3/6
4.3	6.8	11	18	each

See 18 Panel on 1 Watt types. Full range 5 Watt also in stock.

BC107/8/9 NPN 2/9

2N3819 TEXAS FET 8/-

25+ 6/9 100+ 5/9

2N2646 UNI-JUNCTION 10/-

2N4871 UNIJUNCTION SIMILAR 2N2646 BEN 3000, ETC. 6/9

25+ 5/3 100+ 4/9

CRS3/40AF 5TC 400V 12/6

TD716 TUNNEL DIODE 12/-

D13T1 PROGRAMMABLE UNIJUNCTION TRANSISTOR 10/-

2N3055 115 WATT POWER SILICON NPN 15/-

2N2926 POPULAR PLANAR NPN 2/-

BF180 MULLARD UHF AMPLIFIER 6/-

25+ 4/11 100+ 3/9

LOGIC

- uL900 11/- 9/6 8/4
 - uL914 11/- 9/6 8/4
 - uL923 14/- 12/6 11/9
- Five Page Data and Circuits article ... 2/6
 Larger quantity prices (100+ and 1,000+) on application.

LINEAR AMP. IC'S

CA3020 1/2 Watt output 9 volt supply ... 30/6
 (Price includes free circuit for Guitar/PA Amplifier!!)

TAA263 Tiny Mullard linear only 17/6—data on request.

CA3012 Wide band with built-in regulation 27/6

CA3014 3 stage amp. with Darlingon output 32/6

SL701 Plessey lin. amp. for PE circuits 18/-

ULTRASONIC TRANSDUCERS

Operate at 40kc/s. Can be used for remote control systems without cables or electronic links. Type 1404 transducers can transmit and receive.
 FREE: Each pair our Complete transmitter and receiver circuit.
 PRICE £5.18.0 Pair (Sold only in pairs)



SOLAR CELLS

- B2M 0.2-0.4 volts @ 2mA Selenium type ... 12/6
- B3M 0.2-0.4 volts @ 11-21mA Selenium type ... 15/6
- SRM 0.3-0.4 volts @ 10-16mA Silicon ... 19/6
- S4M 0.3-0.4 volts @ 25-40mA Silicon ... 33/6

SOLAR DRIVE MOTOR

EP50A Runs from sunlight activity on 54M cells (above) 39/6

PHOTOCONDUCTIVE CELL

CS120 20v 0.4 Watts Dark Res 110k ohms Min. R @ 10FC = 7.2k
 R @ 100 FC = 800 ohms ... 19/8

SOLAR CELL KITS

- DD190 Contains 4 Selenium photocells and free 24-page handbook ... 9/11
- K-421 Super assortment of 7 cells, 3 Selenium, 2 Silicon and 2 Sulphide, plus 24-page manual ... 58/6

TRANSISTOR KITS

- DD180 Contains 2 Audio and 1 RF Transistor plus free manual ... 11/4
- DD184 Contains Audio, RF, and Power transistors, Silicon solar cell and germanium diode. With FREE manual ... 33/6

SILICON RECTIFIER KITS

- DD175 Contains 4 100 pV amp diodes ... 9/11
- DD176 Contains 2 200 pV amp diodes ... 5/11
- DD177 Contains 2 400 pV amp diodes ... 9/11

ALL INCLUDE FREE 24 PAGE MANUAL

ZENER DIODES

Available in the following voltages with a dissipation of 1 watt and tolerance on 10%. All supplied with free manual describing many interesting projects.
 3.9v, 4.7v, 5.6v, 6.8v, 8.2v, 10v, 12v, 15v, 18v, 22v, 27v
 ALL ONE PRICE ... 7/11

ZENER KIT

DD170 Bargain pack—contains 5 popular 1 Watt diodes plus free project manual ... 19/6

TRANSISTOR SUBSTITUTION

Our TRIO-IC to TRIO-C range are universal replacements for over 700 JEDEC (2N—) types. Prices in our FREE Catalogue.

COMPONENTS

RESISTORS 1 or 1/2 Watt 5% LOW noise CARBON FILM 10,

VALUE ALL THE WAY

INTEGRATED CIRCUITS
BI-PAK
MONOLITHIC DIGITAL CIRCUITS
(10 Lead TO-5)
BP305A, 6-Input AND gate, 9/6 each.
BP314A, 7-Input NOR gate, 9/6 each.
BP315A, Dual 3-Input NOR gate, 9/6 each.
BP316A, Dual 2-Input NOR gate (expandable), 9/6 each.
BP320A, J-K-Binary element, 11/6 each.
BP332A, Dual 3-Input OR gate, 9/6 each.

MONOLITHIC AMPLIFIERS
(TO-5 8 lead)
BP709C, Operational amplifier, 15/- each.
BP701C, Operational amplifier (with Zener output), 12/6 each.
BP702C, Operational amplifier (with direct output), 12/6 each.
BP501, Wide band amplifier, 18/- each.
BP521, Logarithmic wide band amp., 14/- each.
BP201C, General purpose amplifier (TO-5 8 lead) (voltage or current amp.), 12/6 each.
I.C. Operational Amplifier with Zener output. **Type 701C**, Ideal for P.E. Projects. 8 lead TO-5 case. Full data.

Our price 12/6 each 5 off 11/- each. Large Qty. Prices quoted for.

OTHER MONOLITHIC DEVICES
BP424, Zero voltage switch, 8/6 each.
This device is a monolithic I.C. that acts as a combined threshold detector and trigger circuit for controlling a triac. It is designed to pulse the gate of a thyristor at the point of zero supply voltage and therefore eliminate radio frequency interference when used with resistive loads.
D13D1 Silicon Unilateral switch 10/- each.
A Silicon Planar, monolithic integral circuit having thyristor electrical characteristics, but with an anode gate and a built-in "Zener" diode between gate and cathode. Full data and application circuits available on request.

FAIRCHILD (U.S.A.) RTUL MICROLOGIC INTEGRATED CIRCUITS
Epoxy case T8-5 lead temp. range 15°C. to 55°C. UL900, Buffer, 10/6 each.
UL914, Dual two-input gate, 10/6 each.
UL923 J-K-flip-flop, 14/- each.
Complete data and circuits for the Fairchild I.C.'s available in booklet form priced 1/6.

MULLARD I.C. AMPLIFIERS
TA A243, Operational amplifier, 70/- each.
TA A263, Linear AF amplifier, 18/6 each.
TA A293, General purpose amplifier, 21/- each.
CA3020 RCA (U.S.A.) LINEAR INTEGRATED CIRCUITS

Audio Power Amplifier, 30/- each.
Owing to the mass of I.C. printed matter often required by customers in connection with the I.C.'s themselves we ask you to help us in the cost of reproducing this literature by adding 2s. towards same. This is only necessary when a number of different sheets are required.

Sil. trans. suitable for P.E. Organ. Metal TO-18 Evt. ZTX300 1/- each. Any Qty.

ADI61 NPN
ADI62 PNP
MATCHED COMPLEMENTARY PAIRS OF GERMANIUM POWER TRANSISTORS.
For mains driven output stages of Amplifiers and Radio receivers. OUR LOWEST PRICE OF 12/6 PER PAIR.

HIGH POWER SILICON PLANAR TRANSISTORS.
TEXAS 25034 NPN TO-3.
VCB100 I.C. 4A 15M/cs
VCE100 Prot. 40W hFE(min.) 60 Price 15/- each

FREE
One 10/- Pack of your own choice free with orders valued £4 or over.

SEMI-CONDUCTOR HANDBOOK (VOLUME 2)
With introduction to basic circuits, registered transistor and diode types, full specifications. Eleven languages including English, Dutch, French, German, Swedish, Spanish and Italian. 240 pages of semiconductor information. Price 28/6. Money refunded if not fully satisfied.

NPN DIFFUSED SILICON PHOTO-DUO-DIODE TYPE IS701 (2N1275) for Tape Readout, high switching and measurement indicators. 50V, 250mW. OUR PRICE 10/- EACH, 50 OR OVER 8/6. EACH. FULL DETAILS.

SIL. G.P. DIODES
300mW 30 10/-
25PIV (Min.) 100 25/-
Sub-Min. 500 £5
Fully Tested 1,000 £9
Ideal for Organ Builders.

CADMIUM CELLS
ORP60 ORP61 8/- each
ORP12 8/6

FULL RANGE OF ZENER DIODES
VOLTAGE RANGE 18V.
400mW (DO-7 Case) 2/6 each
1-5W (Top-Hat) 3/6 each
10W (SO-10 Stud) 5/- each
All fully tested 5% tol. and marked state voltage required.

SILICON HIGH-VOLTAGE RECTIFIERS
10-Amp 3-K.V. (3000 P.I.V.) Stud Type with Flying Leads 16/- each

BRAND NEW TEXAS GERM. TRANSISTORS
Coded and Guaranteed

Pak No.	EQVT.	
T1	8 2G3710	OC71 .. 10/-
T2	8 2G374	OC75 .. 10/-
T3	8 2G3744A	OC81D .. 10/-
T4	8 2G381A	OC81 .. 10/-
T5	8 2G382T	OC82 .. 10/-
T6	8 2G344A	OC44 .. 10/-
T7	8 2G345A	OC45 .. 10/-
T8	8 2G378	OC78 .. 10/-
T9	8 2G399A	2N1302 .. 10/-
T10	8 2G417	AF17 .. 10/-

KING OF THE PAKS Unequaled Value and Quality

SUPER PAKS NEW BI-PAK UNTESTED SEMICONDUCTORS

Satisfaction GUARANTEED in Every Pak, or money back.

Pak No.	Description	Price
U1	120 Glass Sub-min. General Purpose Germanium Diodes	10/-
U2	60 Mixed Germanium Transistors AF/RF	10/-
U3	75 Germanium Gold Bonded Diodes sim. OA5, OA47	10/-
U4	40 Germanium Transistors like OC81, AC128	10/-
U5	60 200mA Sub-min. Sil. Diodes	10/-
U6	40 Silicon Planar Transistors NPN sim. BSY95A, 2N706	10/-
U7	16 Silicon Rectifiers Top-Hat 750mA up to 1,000V	10/-
U8	50 Sil. Planar Diodes 250mA OA/200/202	10/-
U9	20 Mixed Volts 1 watt Zener Diodes	10/-
U11	30 PNP Silicon Planar Transistors TO-5 sim. 2N1132	10/-
U13	30 PNP-NPN Sil. Transistors OC200 & 2S104	10/-
U14	150 Mixed Silicon and Germanium Diodes	10/-
U15	30 NPN Silicon Planar Transistors TO-5 sim. 2N697	10/-
U16	10 3-Amp Silicon Rectifiers Stud Type up to 1000 PIV	10/-
U17	30 Germanium PNP AF Transistors TO-5 like ACY 17-22	10/-
U18	8 6-Amp Silicon Rectifiers BYZ13 Type up to 600 PIV	10/-
U19	30 Silicon NPN Transistors like BC108	10/-
U20	12 1.5-Amp Silicon Rectifiers Top-Hat up to 1,000 PIV	10/-
U21	30 A.F. Germanium alloy Transistors 2G300 Series & OC71	10/-
U22	10 1-Amp Glass Min. Silicon Rectifiers High Volts	10/-
U23	30 Mad's like MAT Series PNP Transistors	10/-
U24	20 Germanium 1-Amp Rectifiers GJM up to 300 PIV	10/-
U25	25 300 Mc/s NPN Silicon Transistors 2N708, BSY27	10/-
U26	30 Fast Switching Silicon Diodes like IN914 Micro-min	10/-
U28	Experimenters' Assortment of Integrated Circuits, untested. Gates, Flip-Flops, Registers, etc., 8 Assorted Pieces	20/-
U29	10 1 amp SCR's TO-5 can up to 600 PIV CRS1/25-600	20/-
U30	15 Plastic Silicon Planar trans. NPN 2N2924-2N2926	10/-
U31	20 Sil. Planar NPN trans. low noise Amp 2N3707	10/-
U32	25 Zener diodes 400mW D07 case mixed Volts, 3-18	10/-
U33	15 Plastic case 1-amp Silicon Rectifiers IN-4000 series	10/-
U34	30 Sil. PNP alloy trans. TO-5 BCY26, 2S302/4	10/-
U35	25 Sil. Planar trans. PNP TO-18 2N2906	10/-
U36	25 Sil. Planar NPN trans. TO-5 BFY50/51/52	10/-
U37	30 Sil. alloy trans. SO-2 PNP, OC200 2S322	10/-
U38	20 Fast Switching Sil. trans. NPN 400Mc/s 2N3011	10/-
U39	30 RF Germ. PNP trans. 2N1303/5 TO-5	10/-
U40	10 Dual trans. 6 lead TO-5 2N2060	10/-
U41	30 RF Germ. trans. TO-1 OC45 NKT72	10/-
U42	10 VHF Germ. PNP trans. TO-1 NKT667 AF117	10/-

Code Nos. mentioned above are given as a guide to the type of device in the Pak. The devices themselves are normally unmarked.

QUALITY-TESTED PAKS

6 Matched Trans. OC44/45/81/81D	10/-
20 Red Spot AF Trans. PNP	10/-
16 White Spot RF Trans. PNP	10/-
5 Silicon Rects. 3 A. 100-400 PIV	10/-
2 10 A Silicon Rects. 100 PIV	10/-
2 OC1 140 Trans. NPN Switching	10/-
1 12 A SCR 100 PIV	10/-
3 Sil. Trans. 2S303 PNP	10/-
4 Zener Diodes 240mW 3-12V	10/-
3 200 Mc/s Sil. Trans. NPN BSY26/27	10/-
3 Zener Diodes 1W 33V 5% Tol.	10/-
4 High Current Trans. OC42 Eqvt.	10/-
2 Power Transistors 1 OC26 1 OC35	10/-
5 Silicon Rects., 400 PIV 250mA	10/-
4 OC75 Transistors	10/-
1 Power Trans. OC20 100V	10/-
10 OA202 Sil. Diodes Sub-min.	10/-
2 Low Noise Trans. NPN 2N929/30	10/-
1 Sil. Trans. NPN VCB 100 ZT86	10/-
8 OA81 Diodes	10/-
4 OC72 Transistors	10/-
4 OC77 Transistors	10/-
1 Sil. Rects. 400 PIV 500mA	10/-
5 GET884 Trans. Eqvt. OC44	10/-
5 GET883 Trans. Eqvt. OC45	10/-
2 2N708 Sil. Trans. 300Mc/s NPN	10/-
3 GT31 LF Low Noise Germ. Trans.	10/-
6 IN914 Sil. Diodes 7.8 PIV 75mA	10/-
8 OA95 Germ. Diodes Sub-min. IN69	10/-
3 NPN Germ. Trans. NKT773 Eqvt.	10/-
2 OC22 Power Trans. Germ.	10/-
2 OC25 Power Trans. Germ.	10/-
4 AC128 Trans. PNP High Gain	10/-
4 AC127/128 Comp. pair PNP/NPN	10/-
2 2N1307 PNP Switching Trans.	10/-
7 CG62H Germ. Diodes Eqvt. OA71	10/-
3 AF116 Type Trans.	10/-
12 Assorted Germ. Diodes Marked	10/-
4 AC126 Germ. PNP Trans.	10/-
1 Silicon Rects. 100 PIV 750mA	10/-
3 AF117 Trans.	10/-
7 OC81 Type Trans.	10/-
3 OC171 Trans.	10/-
5 2N2926 Sil. Epoxy Trans.	10/-
7 OC71 Type Trans.	10/-
2 2S701 Sil. Trans. Texas	10/-
3 12 Volt Zener 400mW	10/-
2 10 A 600 PIV Sil. Rects. 1545R	10/-
3 BC108 Sil. NPN High Gain Trans.	10/-
1 2N1910 NPN Sil. Trans. VCB 100	10/-
2 1000 PIV sil. Rect. 1.5 A R533 10 AF	10/-
3 BSY95A Sil. Trans. NPN 200Mc/s	10/-
3 OC200 Sil. Trans.	10/-
2 GET880 Low Noise Germ. Trans.	10/-
1 AF139 PNP High Freq. Trans.	10/-
3 NPN Trans. 1 ST141 & 2 ST140	10/-
4 Mad's 2 MAT100 & 2 MAT120	10/-
3 Mad's 2 MAT101 & 1 MAT121	10/-
OC44 Germ. Trans. AF	10/-
3 AC127 NPN Germ. Trans.	10/-
1 2N3906 Sil. PNP Trans. Motorola	10/-
1 Sil. Power Rects. BYZ13	15/-
1 Sil. Power Trans. NPN 100Mc/s. TK201A	15/-
6 Zener Diodes 3-15V Sub-min.	15/-
1 2N1132 PNP Epitaxial Planar Sil.	15/-
3 2N697 Epitaxial Planar Trans. Sil.	15/-
4 Germ. Power Trans. Eqvt. OC16	15/-
1 Unijunction Trans. 2N2646	15/-
2 Sil. Trans. 200Mc/s 60Vcb ZT83/84	15/-
1 Tunnel Diode AEXY11 1050 Mc/s	15/-
2 2N2712 Sil. Epoxy Planar HFE225	15/-
8 BY100 Type Sil. Rects.	20/-
25 Sil. and Germ. Trans. Mixed, all marked, New	30/-

PRINTED CIRCUITS

EX-COMPUTER
Packed with semiconductors and components. 10 boards give a guaranteed 30 trans. and 30 diodes. Our price 10 boards 10/- Plus 2/- P. & P.

GERM. RECTIFIERS SINGLE-PHASE BRIDGE, Mullard type. GEX541-B.P. Output Vics. 48V, Output I.C. 5A. List Price 58/-. OUR PRICE 12/6 EACH.

2N2060 NPN SIL. DUAL TRANS. CODE D1699 TEXAS.
OUR PRICE 5/- each.

120 VCB NIXIE DRIVER TRANSISTOR Sim. BSX21 & C407. 2N1893 FULLY TESTED AND CODED ND120. 1-24 3/6 each. TO-5 NPN 25 up 3/- each.

PLEASE NOTE. To avoid any further Increased Postal Charges to our Customers and enable us to keep our "By Return Postal service" which is second to none, we have re-organized and streamlined our Despatch Order Department and we now request you to send all your orders together with your remittance, direct to our Warehouse and Despatch Department, postal address: **BI-PAK SEMICONDUCTORS**, Despatch Dept., P.O. BOX 6, WARE, HERTS. Postage and packing still 1/- per order. Minimum order 10/-.

FET'S

2N 3819 10/-
2N 3820 25/-
MPF105 8/-
OC P71 Type. 8/6

UNIUNCTION

UT46. Eqvt. 2N2646, Eqvt. T1543. BEN3000
7/6 EACH
25-99 5/- 100 UP 4/-

TESTED SCR'S

PIV	1A	7A	16A	30A
25	7/6	8/6	10/6	30/-
50	7/6	8/6	10/6	35/-
100	8/6	10/6	15/6	45/-
200	12/6	15/6	20/6	55/-
300	15/6	20/6	25/6	
400	17/6	25/6	35/6	80/-
500	30/6	40/6	45/6	95/-
600		40/6	50/6	

SIL. RECTS. TESTED

PIV 750mA	3A	10A	30A
50	1/-	2/9	4/3 9/6
100	1/3	3/3	4/6 15/-
200	1/9	4/-	4/9 20/-
300	2/3	4/6	6/6 22/-
400	2/6	5/6	7/6 25/-
500	3/-	6/-	8/6 30/-
600	3/3	6/9	9/- 37/-
800	3/6	7/6	11/6 40/-
1000	5/-	9/3	12/6 50/-
1200	6/6	11/6	15/-

BI-PAK



500, Chesham House,
150 Regent Street,
LONDON, W.1.

KING OF THE PAKS BI-PAK GUARANTEE SATISFACTION OR MONEY BACK

AMATRONIX LTD.

396 Selsdon Road,
South Croydon,
Surrey, CR2 0DE

Mail Order Only. Prompt Service.
Orders over 10/- UK post paid.

GUARANTEED TRANSISTORS

AD161-2	15/-	GET693	1/3	2N3055	16/6
AF239	10/-	HK041	2/6	2N3707	4/-
B5000G	11/3	HK101	2/-	2N3794	3/-
BD121	18/-	HK601	2/6	2N3983	5/8
BC107B	3/-	IS44	1/4	2N4058	4/6
BC168B	2/3	MEM564C	16/-	2N4285	3/-
BC168C	2/3	SF115	3/-	2N4289	3/-
BC169C	2/6	TIS18	7/-	2N4291	3/-
BF167	5/3	TIS60M	4/8	2N4292	3/-
BF178	9/-	TIS61M	4/11	2SB187	2/-
BF224	4/-	2N706	2/7	2SB405	5/-
BFY51	4/-	2N2926G	2/6	2SD72	5/-
		40468A	7/6		

RECTIFIERS:

800piv, 500mA Si, IS557, 3/-; 50piv, 100mA, 1/-; Submin. Selenium Bridge, 30Vrms, 150mA dc, 3/6; Contact-cooled Sel. Bridge, 30Vrms, 700mA dc, 6/-; Silicon Bridge, 80Vrms, 1A dc, 10/-.

INTEGRATED CIRCUITS

CA3011, 18/-; CA3020, 28/-; TAA263, 16/8; TAA320, 15/-; TAB101, 21/-; PA234, 24/-.
ALL WITH DATA SHEETS.



MINI MAINS TRANSFORMERS

1 x 1 x 1 1/2 in., normal mains primaries.
Eagle MT6, 6-0-6V, 100mA, 13/6.
Eagle MT12, 12-0-12V, 50mA, 13/6.
Osmor MT9, 9-0-9V, 80mA, 12/6.
Supplied with Gen Sheet showing how 6-60V may be obtained.

MINI MAINS PACK (as shown). All parts, 17/6

COMPONENT KITS

NEW! In response to many requests, we have designed an amplifier circuit for use with low-impedance speakers. The new AX5 delivers 3W to 3Ω and uses the well-tried arrangement of the AX4, plus one extra stage for higher sensitivity and input impedance.

- * 3W rms to 3Ω. Higher loads usable
- * -3dB at 50Hz and 20kHz
- * 30mV in 300k for full output

The AX5 needs a 12V, 500mA supply and will work from up to 15V. Component Kit with Data Sheet 39/-.

AND ALSO OUR REGULAR PACKS—
RELIABLE AND EFFICIENT:

- AX2 Mini 9V Amplifier for any load. Still only 12/6.
- AX3 9V Amplifier, 800mW to 8Ω. Still only 22/6.
- AX4 18-24V Amplifier, up to 5W in 8Ω. 4W in 15Ω. Still only 30/-.
- AX9 TRF Receiver Kit (printed circuit). Still only 45/-.

CAPACITORS

Polystyrene, 160V, small, close tolerance.
6d. each: 12, 15, 39pF, ±1pF
9d. each: 56, 82, 150, 270, 390, 560, 680pF, ±2 1/2%
1/- each: 3300pF (.0033uF), 10,000pF (.01uF), ±2 1/2%
1/3 each: 22,000pF (.022uF, 22nF), ±2 1/2%
Min. Metallised Polyester, 250V:
.01uF, 8d.; 0.1uF, 10d.; 0.22uF, 1/-.
J. B. Tuning Capacitors: 300pF Dilemin, 10/-; 4-gang 3-17pF FM type, built-in slow motion drive, 17/-.

RESISTORS

Carbon Film, 1/2W, miniature, low noise.
10, 12, 15, 18, 22, 27, 33, 39, 47, 56, 68, 82Ω and so on to 10M. Tol. ±5% to 1M, 10% above 1M. All 3d. each.
Carbon Skeleton Presets. Submin., vertical, linear, 100mW, 50, 150, 500Ω and so on to 1.5M. Egen Type 467, 1/6 each.
Volume Control, 10K log. with d.p. switch and long aluminium spindle with flat. Standard size, Egen, 5/6 each.

R. F. CHOKES. Repanco: CH1, 2.5mH, 2/6; CH2, 5mH, 3/-; CH3, 7.5mH, 3/-; CH4, 10mH, 3/-; CH5, 1.5mH, 2/6. All small, ferrite-cored.

FERRITE RODS: 4in. or 4 1/2 in. x 3/4 in., wound for MW (300pF), 5/-; unwound, 2/-; oval, unwound, 2 x 1/2 x 1/4 in., with data, 2/6.

TRANSFORMERS, MINI. A.F.: Eagle LT700, 1200Ω c.t. to 3Ω, 200mW, 5/-; Repanco TT47 driver for single ended push-pull, 4.5 to (1) + (1), 6/-.

TELESCOPIC AERIAL: 7 1/2 in. opening to 47 in., 9/-.

BATTERY HOLDER BH2 for two 1.5V pen cells, with snap connector, 2/6.

EARPIECES, all 3.5mm plugged, crystal, 4/9; magnetic, 8Ω, 2/6; 50Ω, 3/-.

There's Something for Everyone in the New 1970

HEATHKIT CATALOGUE!

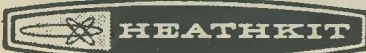

- GUITAR PRACTICE AMPLIFIER ● CAR RADIO
- ELECTRONIC METRONOME ● AMBASSADOR SPEAKERS
- AUTO-TUNE-UP METER ● DIY SPEAKER SETS
- AIRCRAFT MONITOR RECEIVER ● TOOL KITS
- TECHNICIANS LOW-COST VVM ● HI-FI 'COMPACTS'
- HAND HELD TACHOMETER ● SEVERN AM/FM RADIO
- DIY RADIOGRAM PACKS ● SW RECEIVERS

And many other models
too numerous to mention.

SAVE MONEY - BUY HEATHKITS.

Send for
the
FREE
CATALOGUE
Today!

TO DAYSTROM LTD., GLOUCESTER GL2-6EE

Please send me my copy of the
FREE HEATHKIT CATALOGUE

Name.....
Address.....

RC-10

DAYSTROM LTD., HEATHKIT DIVISION,
GLOUCESTER. GL2-6EE
Tel. Glos: 29451.

SINCLAIR IC-10

10 WATT MONOLITHIC INTEGRATED CIRCUIT AMPLIFIER AND PRE-AMP

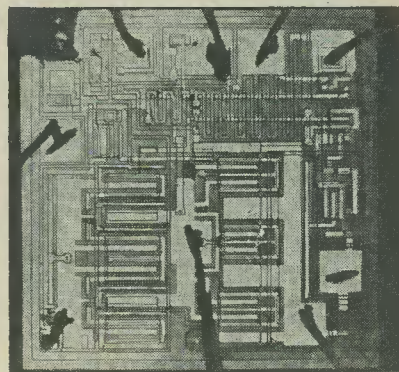
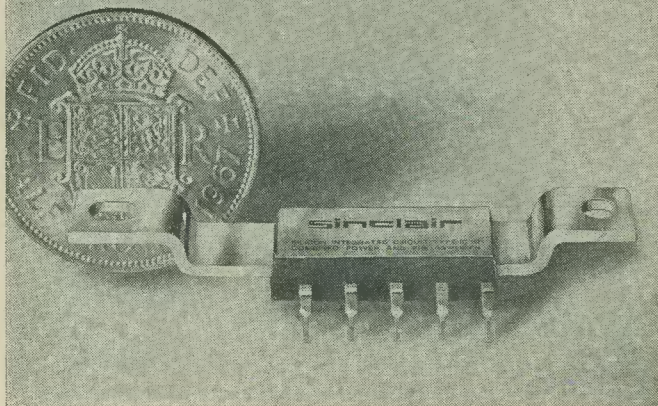

A 13 transistor circuit measuring only one twentieth of an inch square by one hundredth of an inch thick!

the world's most advanced high fidelity amplifier

The Sinclair IC-10 is the world's first monolithic integrated circuit high fidelity power amplifier and pre-amplifier. The circuit itself, a chip of silicon only a twentieth of an inch square by one hundredth of an inch thick, has an output power of 10 watts. It contains 13 transistors (including two power types), 2 diodes, 1 zenor diode and 18 resistors, formed simultaneously in the silicon by a series of diffusions. The chip is encapsulated in a solid plastic package which holds the metal heat sink and connecting pins. This exciting device is not only more rugged and reliable than any previous amplifier, it also has considerable performance advantages. The most important are complete freedom from thermal runaway due to the close thermal coupling between the output transistors and the bias diodes and very low level of distortion.

The IC-10 is primarily intended as a full performance high fidelity power and pre-amplifier, for which application it only requires the addition of the usual tone and volume controls and a battery or mains power supply. However, it is so designed that it may be used simply in many other applications including car radios, electronic organs, servo amplifiers (it is d.c. coupled throughout), etc. Once proven, the circuits can be produced with complete uniformity which enables us to give a 5-year guarantee on each IC-10, knowing that every unit will work as perfectly as the original and do so for a lifetime.

■ SPECIFICATIONS

Output: 10 Watts peak, 5 Watts R.M.S. continuous.
Frequency response: 5 Hz to 100 KHz ± 1 dB.
Total harmonic distortion: Less than 1% at full output.
Load impedance: 3 to 15 ohms.
Power gain: 110dB (100,000,000,000 times) total.
Supply voltage: 8 to 18 volts.
Size: 1 x 0.4 x 0.2 inches.
Sensitivity: 5mV.
Input impedance: Adjustable externally up to 2.5 M ohms.

■ CIRCUIT DESCRIPTION

The first three transistors are used in the pre-amp and the remaining 10 in the power amplifier. Class AB output is used with closely controlled quiescent current which is independent of temperature. Generous negative feedback is used round both sections and the amplifier is completely free from crossover distortion at all supply voltages, making battery operation eminently satisfactory.

■ APPLICATIONS

Each IC-10 is sold with a very comprehensive manual giving circuit and wiring diagrams for a large number of applications in addition to high fidelity. These include stabilised power supplies, oscillators, etc. The pre-amp section can be used as an R.F. or I.F. amplifier without any additional transistors.

SINCLAIR

IC.10

with IC-10
manual and
5-year guar-
antee
Post free

59/6

AUDIO & PHOTO-CINE FAIRS, OLYMPIA, STAND 95

SINCLAIR

SINCLAIR RADIONICS LIMITED

22 NEWMARKET RD, CAMBRIDGE Tel: 0223 52731

OCTOBER 1969

131

NEW

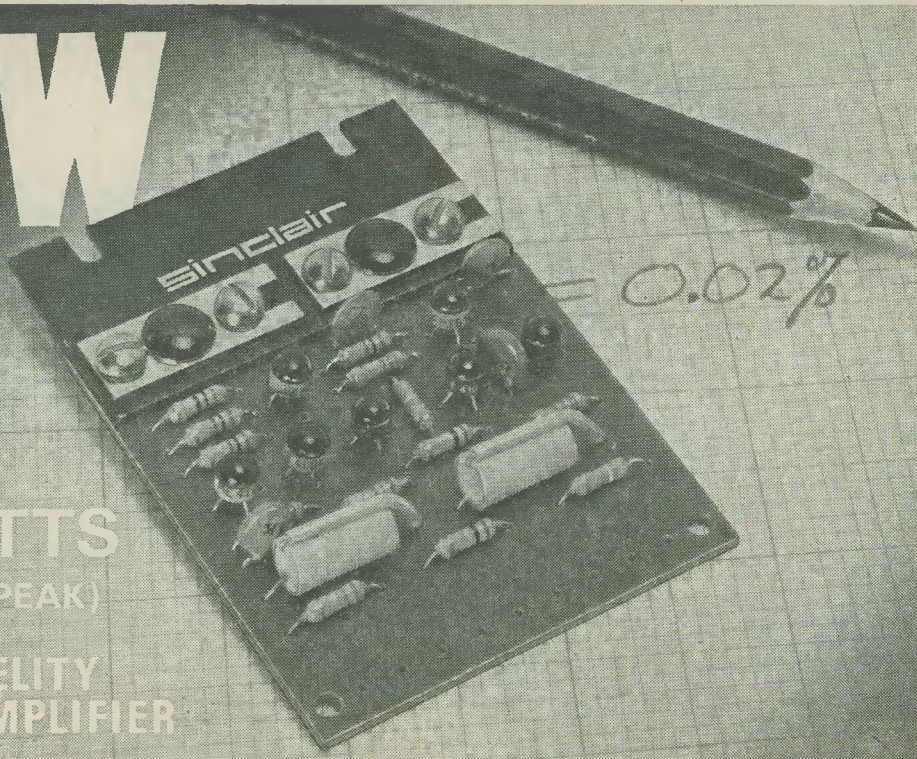

25 WATTS
(50 WATTS PEAK)

**HIGH-FIDELITY
POWER AMPLIFIER**

Z.30

**0.02% DISTORTION
AT FULL POWER**

■
**OPERATES IDEALLY
FROM 8 TO 35 VOLTS**

■
SIZE 3½ x 2¼ x ½ ins.

■
**FREQUENCY RESPONSE
FROM 20 Hz TO 30 kHz**

■
**USE IT FOR
HIGH FIDELITY, MUSIC
INSTRUMENTS, ECONOMY
RECORD PLAYER, P.A.,
INTERCOM, ETC.**

*Built, tested and
guaranteed, with
Z.30 manual*

89/6

**AT THE AUDIO &
PHOTO-CINE FAIRS
STAND 95**

THE WORLD'S LOWEST DISTORTION HIGH FIDELITY AMPLIFIER

For four years, the Sinclair Z.12 dominated the constructor world, being the best selling unit of its kind this side of the Atlantic. Excellent as it was, the new Sinclair Z.30 is still better. Half the size of the Z.12, it has more than twice the power, very much greater gain and a level of distortion 50 times lower. This incredible figure results from using over 60dB of negative feedback with a constant current load to the driver stage obtained by incorporating a two-transistor circuit in place of the more usual boot-strapping. 9 silicon epitaxial planar transistors are used to provide enormous power (up to 25 watts RMS continuous sine wave (50 watts peak)). The circuitry of this marvellous amplifier allows it to be operated from any voltage from 8 to 35 to perfection. At all output levels, distortion is only 0.02%. This puts true laboratory standards into the hands of every user of a Z.30. Two Z.30s and a new Stereo Sixty will make a stereo assembly of such perfection that it could not be bettered in its class no matter how much you spent. The Z.30 has an enormous variety of applications where quality, precision and reliability are essential, yet the Z.30 can also be used on its own to make an economy record player. Even so, this brilliant new Sinclair design costs not a penny more than its famous predecessor.

- Input Sensitivity—250 mV into 100 Kohms
- Signal to noise ratio—better than 70dB unweighted
- Class AB output
- Power requirements 8–35 volts from batteries or PZ.5
- Complete with manual of circuits and instructions

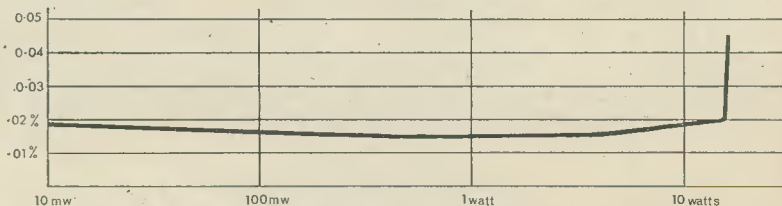

sinclair

SINCLAIR RADIONICS LIMITED

22 NEWMARKET ROAD, CAMBRIDGE Tel: 0223 52731

THE RADIO CONSTRUCTOR

NEW

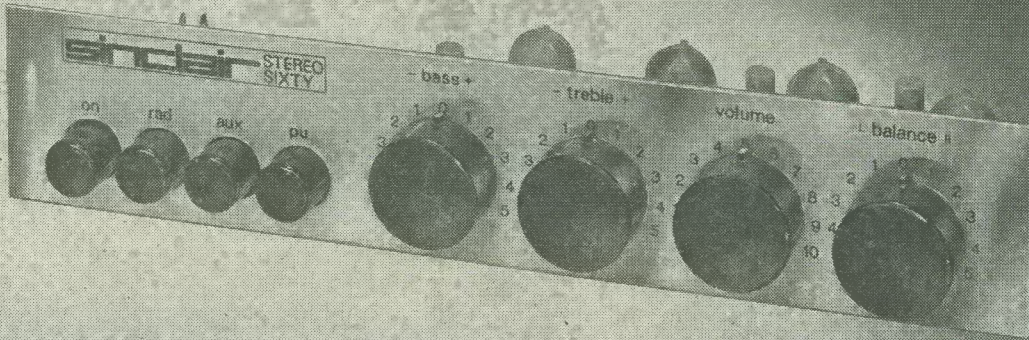

STEREO SIXTY

PRE-AMP & TONE CONTROL UNIT

This attractive and completely new unit is intended for use with two new Z.30 amplifiers to provide the finest possible standards of stereo reproduction. Four press buttons and four rotary controls are used to provide on-off, three input selectors and Volume, Bass cut/boost, Treble cut/boost and Stereo balance. The on-off button also switches the power amplifiers. The front panel in brushed aluminium is flush mounted to the cabinet front, it being necessary only to drill holes to accommodate the controls. Rear adjustable brackets hold the chassis tight to the cabinet. The very latest ganged rotary controls are used to afford compactness and extra long working life free from noise. *The Stereo-60 may also be used with 2 IC-10's or any other high performance amplifiers.*

STEREO SIXTY built, tested & guaranteed, with instructions

£9.19.6

Frequency range: Radio & Aux. 20-25,000 Hz \pm 1dB Pick-up corrected to within \pm 1dB for R.I.A.A. equalisation.
 Inputs: Radio, pick-up (magnetic, ceramic or crystal) Auxiliary.
 Overload factor: Greater than 20dB per channel on all inputs.
 Distortion: 0.03%.
 Signal to noise ratio: Better than 70dB unweighted.
 Controls: Press buttons for on-off, P.U., radio and aux.
Treble +15dB to -15dB at 10kHz. Bass +15dB to -15dB at 100Hz. Volume, Stereo Balance.
 Size: 8 $\frac{1}{2}$ " x 1 $\frac{1}{2}$ " x 4" from front to back, plus knobs.
 Finish: Brushed aluminium, black knobs and press buttons.

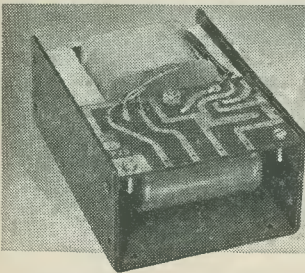

NEW

PZ.5 POWER SUPPLY UNIT

A new heavy duty mains power supply unit designed specially to drive two Z.30s and a Stereo Sixty. New compact design. For AC mains, 200-240V/50Hz. **£4.19.6**

AUDIO & PHOTO-CINE FAIRS, OLYMPIA - STAND 95

To: SINCLAIR RADIONICS LTD, 22 NEWMARKET RD, CAMBRIDGE

Please send

NAME.....

ADDRESS.....

For which I enclose cash/cheque/
money order

RC1069

YOUR SINCLAIR GUARANTEE

Should you not be completely satisfied with your purchase when you receive it from us, return the goods without delay and your money will be refunded in full, including cost of return postage, at once and without question. Full service facilities are available to all Sinclair customers.

sinclair

BOUND VOLUME No. 22 of "The Radio Constructor" FOR YOUR LIBRARY



Comprising
800 pages
plus index

AUGUST 1968
to JULY 1969

PRICE **35/-** - Postage 4/6

Special discount of 10/- for regular readers

Just cut the heading from each month's contents page, including title and month of issue, and this will be sufficient evidence of readership to qualify for the discount.

Thus regular readers will still retain their copies for workbench use, while having a splendid bound volume containing issues in mint condition.

PRICE 25/- Postage 4/6

Limited Number of Volume 21

(August 1967 to July 1968) still available

Price 35/- Postage 4/6

Available only from:-

Data Publications Ltd.
57 Maida Vale London W9

Now! A FAST EASY WAY TO LEARN BASIC RADIO AND ELECTRONICS



Build as you learn with the exciting new
TECHNATRON Outfit! No mathematics.
No soldering—but you learn the *practical* way.

Now you can learn basic Radio and Electronics at home—the fast, modern way. You can give yourself the essential technical 'know-how' sooner than you would have thought possible—read circuits, assemble standard components, experiment, build . . . and enjoy every moment of it. B.I.E.T.'s Simplified Study Method and the remarkable new TECHNATRON Self-Build Outfit take the mystery out of the subject—make learning *easy and interesting*.

Even if you don't know the first thing about Radio now, you'll build your own Radio set within a month or so!

and what's more, YOU'LL UNDERSTAND EXACTLY WHAT YOU ARE DOING. The Technatron Outfit contains everything you need, from tools to transistors . . . even a versatile Multimeter which we teach you how to use. You need only a little of your spare time, the cost is surprisingly low and the fee may be paid by convenient monthly instalments. You can use the equipment again and again—and it remains your own property.

You LEARN—but it's as fascinating as a hobby.

Among many other interesting experiments, the Radio set you build—and it's a good one—is really a bonus; this is first and last a *teaching* Course. But the training is as rewarding and interesting as any hobby. It could be the springboard for a career in Radio and Electronics or provide a great new, spare-time interest.

A 14-year-old could understand and benefit from this Course—but it teaches the real thing. Bite-size lessons—wonderfully clear and easy to understand, practical projects from a burglar-alarm to a sophisticated Radio set . . . here's your chance to master basic Radio and Electronics, even if you think you're a 'non-technical' type. And, if you want to carry on to more advanced work, B.I.E.T. has a fine range of Courses up to A.M.I.E.R.E. and City and Guilds standards.

Send now for free 164-page book. Like to know more about this intriguing new way to learn Radio and Electronics? Fill in the coupon and post it today. We'll send you full details and a 164-page book —'ENGINEERING OPPORTUNITIES'—Free and without any obligation.



BRITISH INSTITUTE OF ENGINEERING TECHNOLOGY

Dept. 370B, Aldermaston Court,
Aldermaston, Berkshire.

To: B.I.E.T., Dept. 370B, ALDERMASTON COURT,
ALDERMASTON, BERKS.

I would like to know more about your
Practical Radio & Electronics Course. Please
send me full details and FREE 164-page book.

name.....

address.....

.....age.....

POST
THIS
COUPON
NOW!

BI-PRE-PAK LIMITED

FULLY TESTED AND MARKED

AC107	3/-	OC170	3/-
AC126	2/6	OC171	4/-
AC127	2/6	OC200	3/6
AC128	2/6	OC201	7/-
AC176	5/-	2G301	2/6
ACY17	3/-	2G303	2/6
AF114	4/-	2N711	10/-
AF115	3/6	2N1302-3	4/-
AF116	3/6	2N1304-5	5/-
AC117	3/6	2N1306-7	6/-
AF186	10/-	2N1308-9	8/-
AF139	10/-	2N3844A	5/-
AF239	12/6	Power	
BFY50	4/-	Transistors	
BSY25	7/6	OC20	10/-
BSY26	3/-	OC23	10/-
BSY27	3/-	OC25	10/-
BSY28	3/-	OC26	5/-
BSY29	3/-	OC28	7/6
BSY95A	3/-	OC35	5/-
OC41	2/6	OC36	7/6
OC44	1/11	AD149	10/-
OC45	1/9	AUY10	30/-
OC71	2/6	2N3055	15/-
OC72	2/6	Diodes	
OC73	3/6	AAY42	2/-
OC81	2/6	OA95	2/-
OC81D	2/6	OA70	1/9
OC83	4/-	OA79	1/9
OC139	2/6	OA81	1/9
OC140	3/6	IN914	1/6

TRY OUR X PACKS FOR UNEQUALLED VALUE

XA PAK

Germanium PNP type transistors, equivalents to a large part of the OC range, i.e. 44, 45, 71, 72, 81, etc.

PRICE £5 PER 1,000

POST & PACKING 4/6 U.K.

XB PAK

Silicon TO-18 CAN type transistors NPN/PNP mixed lots, with equivalents to OC200-1, 2N706a, BSY27/29, BSY95A.

PRICE £4.5.0 PER 500 £8 PER 1,000

POST & PACKING 2/6 U.K.

XC PAK

Silicon diodes miniature glass types, finished black with polarity marked, equivalents to OA200, OA202, BAY31-39 and DK10, etc.

PRICE £4.10.0 PER 1,000

POST & PACKING 2/6 U.K.

ALL THE ABOVE UNTESTED PACKS HAVE AN AVERAGE OF 75% OR MORE GOOD SEMI-CONDUCTORS. FREE PACKS SUSPENDED WITH THESE ORDERS. ORDERS MUST NOT BE LESS THAN THE MINIMUM AMOUNTS QUOTED PER PACK.

NEW TESTED & GUARANTEED PAKS

B2	4	Photo Cells, Sun Batteries. .3 to .5V, .5 to 2mA.	10/-
B77	2	AD161-AD162 NPN/PNP Trans. Comp. output. Pair	10/-
B79	4	1N4007 Sil. Rec. Diodes. 1000 Piv. 1 amp Miniature.	10/-
B81	10	Reed Switches. Mixed types large and small.	10/-
B89	2	5SP5 Light Sensitive Cells. Light res. 400Ω. Dark 1MΩ.	10/-
B91	8	NKT163/164 PNP Germ. to -3. Equiv. to OC44, OC45.	10/-
B92	4	NPN Sil. Trans. A06=BSX 20, 2N2369, 500 MHz, 360 mW.	10/-
B93	5	GET113 Trans. equivalent to ACY17-21 PNP Germ.	10/-
B94	6	NPN Sil. Planar Epitaxial Trans. C54 similar to BSY38 or BC108.	10/-
B96	5	2N3136 PNP Sil. Trans. TO-18. HFE100-300. IC.600mA. 200 MHz.	10/-
B98	10	XB112 & XB102 equiv. to AC126, AC156, OC81/2, OC71/2, NKT271, etc.	10/-
B99	200	Capacitors. Electrolytics, Paper, Silver Mica, etc. Postage on this pak 2/6.	10/-
H4	250	Mixed Resistors. Post & packing 2/-.	10/-

FREE! Packs of your own choice up to the value of 10/- with orders over £4.

HUGE CLEARANCE OF UHF/VHF TUNER UNITS REJECTS Stocks Almost Exhausted! Place Your Orders NOW!!! Fantastic Transistor Value!

TU.2. Containing 2 AF186's & 2 AF178's PRICE 10/- each Unit
 TU.3. Containing 2 AF186's & 2 AF178's
 PLUS Waveband Slider Switch PRICE 12/6 each Unit

P & P 2/6 each Unit. All the Units have many other components, e.g. Capacitors, Resistors, Coils and Tuning Condensors, etc. Connection data supplied with all Tuner Units.

Return of the unbeatable P.1 Pak.

Now greater value than ever

Full of short lead semiconductors and electronic components, approx. 170. We guarantee at least 30 really high quality factory marked Transistors PNP and NPN, and a host of diodes and rectifiers. Mounted on printed circuit panels. Identification chart supplied to give some information on the transistors.

P.1 PLEASE ASK FOR PAK P.1 ONLY 10/-
 2/- P & P on this Pak.

MAKE A REV. COUNTER for your Car. The 'TACHO BLOCK'. This encapsulated block will turn any 0-1mA meter into a perfectly linear and accurate rev. counter for 20/- each any car. State 4 or 6 cylinder.

FREE CATALOGUE AND LISTS for:- ZENER DIODES TRANSISTORS, RECTIFIERS FULL PRE-PAK LISTS & SUBSTITUTION CHART

MINIMUM ORDER 10/- CASH WITH ORDER PLEASE. Add 1/- post and packing per order. OVERSEAS ADD EXTRA FOR AIRMAIL.

MULLARD DATA BOOK

Semiconductor & Valve Data & equivalents. 3/6 EACH
 Postage 6d.

NEW UNMARKED UNTESTED PAKS

B78	12	Integrated Circuits, Data & Circuits of types, supplied with orders.	10/-
B80	8	Dual Trans. Matched O/P pairs NPN. Sil. in TO-5 can.	10/-
B82	10	OC45, OC810 & OC81 Trans. Mullard glass type.	10/-
B83	200	Trans. Makers rejects. NPN/PNP. Sil. & Germ.	10/-
B84	100	Silicon Diodes DO-7 glass equiv. to OA200, OA202.	10/-
B66	150	High quality Germ. Diodes. Min. glass type.	10/-
B86	50	Sil. Diodes sub. min. IN914 & IN916 types.	10/-
B87	100	Germ. PNP Trans. equiv. to OC44, OC45, OC81, etc.	10/-
B88	50	Sil. Trans. NPN, PNP, equivalent to OC200/1, 2N706a, BSY95A, etc.	10/-
B60	10	7 Watt Zener Diodes. Mixed voltages.	10/-
H5	16	1 Amp. Plastic Diodes. 50-1000 Volts.	10/-
H6	40	250mW. Zener Diodes DO-7 min. Glass Type.	10/-

SPECIAL OFFER
 12 volt Stabilised Power Units
 Input 110-250V. AC
 Output 11-13V. Stabilised
 Brand new Makers surplus at the unrepeatable price of £5 each plus P & P 7/6



FREE! A WRITTEN GUARANTEE WITH ALL OUR TESTED SEMICONDUCTORS

BI-PRE-PAK LTD

DEPT. C, 222-224 WEST ROAD, WESTCLIFF-ON-SEA, ESSEX
 TELEPHONE: SOUTHEND (0702) 46344

There are Catalogues AND Catalogues!

Ours is THIS kind...

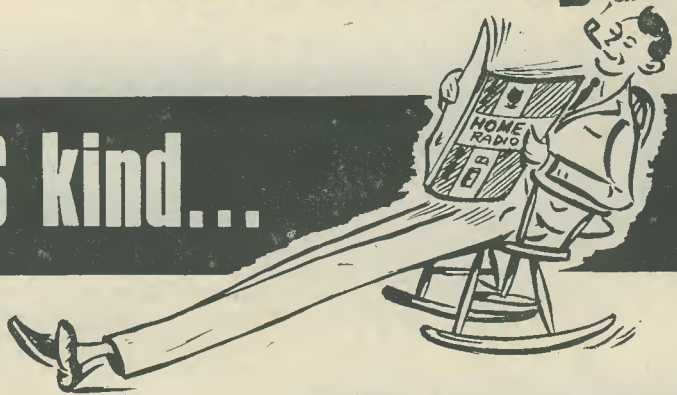

... the kind that's

INDEXED THOROUGHLY For instance "Aerials Telescopic" under "A" and "Telescopic Aerials" under "T".

PLANNED LOGICALLY Having over 8,000 items it needs to be! Components are listed alphabetically in logical sections.

ILLUSTRATED PROFUSELY Over 1,800 pictures. Some are photos some are drawings, but all clearly show the features you look for.

PRINTED CLEARLY No eyestrain here. Large easy-to-read type, on 330 sensible-size pages—9½" x 7¼" (ignore our artist's enthusiastic exaggeration!)

BOUND SECURELY This catalogue is bound to receive long and frequent use. Glossy laminated covers don't show fingerprints, don't tear easily.

PRICED REASONABLY Just 8/6d. plus 3/6d. for post, packing and insurance. Folk tell us it's worth twice the price! We quite agree.



Yes — the Home Radio Catalogue is a pleasure to buy and to use.

By the way, every Catalogue contains six Vouchers, each worth 1/- when used as directed, and we supply free a 30-page Price Supplement, a Bookmark giving electronic abbreviations and, of course, an Order Form.

POST THIS COUPON NOW
with cheque or P.O. for 12/-



The price of 12/- applies only to catalogues purchased by customers residing in the U.K.

Please write your Name and Address in block capitals

Name _____

Address _____



HOME RADIO (COMPONENTS) LTD., Dept. RC,
234-240 London Road, Mitcham, Surrey CR4 3HD.

THE Radio Constructor



Incorporating THE RADIO AMATEUR

OCTOBER 1969

Vol. 23 No. 3

CONTENTS

Published Monthly (1st of Month)
First Published 1947

Editorial and Advertising Offices
57 MAIDA VALE LONDON W9

Telephone 01-286 6141
Telegrams Databux, London

© Data Publications Ltd., 1969. Contents may only be reproduced after obtaining prior permission from the Editor. Short abstracts or references are allowable provided acknowledgement of source is given.

Annual Subscription 42s. (U.S.A. and Canada \$5) including postage. Remittances should be made payable to "Data Publications Ltd.". Overseas readers please pay by cheque or International Money Order.

Queries. We regret that we are unable to answer queries other than those arising from articles appearing in this magazine nor can we advise on modifications to equipment described. Queries should be submitted in writing and accompanied by a stamped addressed envelope for reply.

Correspondence should be addressed to the Editor, Advertising Manager, Subscription Manager or the Publishers as appropriate.

Opinions expressed by contributors are not necessarily those of the Editor or proprietors.

Production.—Letterpress.

Transistorised G.D.O. for the H.F. Bands	138
High Sensitivity Proximity Detector (Suggested Circuit No. 227)	142
News and Comment	146
"Cir-Kit" Personal Portable Superhet	148
Simple Colour Printer	155
"Neophyte" Audio Amplifier	160
Can Anyone Help?	167
New Life for "Midget" Receivers	168
Trade News	172
Ceramic Filters (Understanding Radio)	173
In Your Workshop	177
Radio Topics	184
Radio Constructor's Data Sheet No. 31 (Cubes of Numbers)	iii

Published in Great Britain by the Proprietors and Publishers, Data Publications Ltd, 57 Maida Vale, London, W.9.
The Radio Constructor is printed by Kent Paper Company Ltd, London and Ashford, Kent.

NOVEMBER ISSUE WILL BE PUBLISHED
ON NOVEMBER 1st

TRANSISTORISED G.D.O. FOR THE H.F. BANDS

(Part 1)

by

R. J. HULBERT, G3SRY

This small and efficient g.d.o. (grid-dip oscillator) covers 11 to 65 MHz in five overlapping ranges. Simple home-wound plug-in coils are employed, these operating without feedback windings. One of the many attractive features of this instrument is that it is self-powered and that no trailing mains lead is therefore required. The circuit, components and case are described this month, and the concluding instalment in next month's issue will deal with wiring up, coil winding and calibration

THE INSTRUMENT TO BE DESCRIBED WAS CONSTRUCTED to assist with the building of a solid state single sideband transmitter. Several items of test equipment were in use at that time, all of which were mains powered. The mains leads proved to be a nuisance, not to mention the problem of a shortage of sockets to which they could be connected. It was therefore decided that this particular instrument should be self-powered from an internal dry battery.

The accompanying photograph shows the prototype, from which the final design described in these two articles has been developed. Originally, a variable resistor was included in series with the meter, but since this was found to be entirely unnecessary it has been deleted. This enables the case to be shortened by two inches. The final design also incorporates a currently available meter, whereas the prototype employed an ex-W.D. type.

CIRCUIT DESCRIPTION

As may be seen from the circuit diagram of Fig. 1, the g.d.o. uses an n.p.n. silicon transistor in a simple Colpitts derived oscillator circuit. M1, in conjunction with D1, R5, C6, and C7, functions as a peak indicating r.f. voltmeter. The appropriate plug-in coil is tuned by a combination of fixed capacitors (C1, C4, and C5), and the variable capacitor VC1. The ratio of fixed to variable element is such that the frequency swing on each range is less than is normally found in instruments of this nature. This provides more open scales, which are easily read, and gives better accuracy. The present design provides a range of 11 to 65 MHz in five overlapping bands. The range may be extended both at the high and low frequency ends, but only by alteration of the values of C1, C4, and C5. The values given were found to

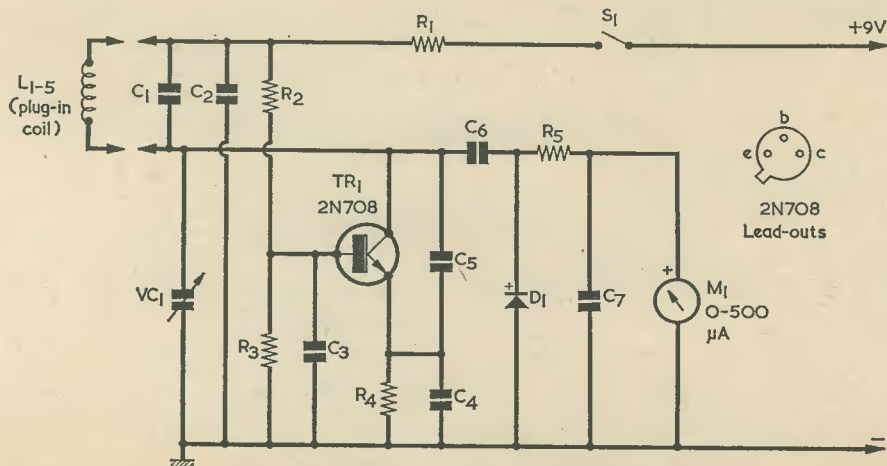

Fig. 1. Circuit diagram for the transistor g.d.o.

COMPONENTS

Resistors

(All $\frac{1}{4}$ watt 10%)

R1	100 Ω
R2	22k Ω
R3	10k Ω
R4	1k Ω
R5	10k Ω

Capacitors

C1	18pF silver mica or polystyrene
C2	0.1 μ F metallised film
C3	0.1 μ F metallised film
C4	100pF silver mica or polystyrene
C5	12pF silver mica or polystyrene
C6	5pF ceramic
C7	500pF ceramic
VC1	50pF variable (see text)

Semiconductors

TR1	2N708
D1	OA91 or CG62H

Switch

S1 d.p.d.t. slide switch (see text)

Meter

M1 0-500 μ A meter, type MR38P (Sew)

Miscellaneous

5 Denco polystyrene coil formers. B9A, 6 spills, green (Cat. No. CR24/Green—Home Radio)

1 Chassis, reinforced corners, 6in. x 3in. x 2 $\frac{1}{2}$ in. (Cat. No. CU221—Home Radio)

1 Radiospares 6-way miniature groupboard (Cat. No. BTS13—Home Radio)*

1 Knob (see text)

1B9A valveholder

18 s.w.g. aluminium sheet (for cover, brackets and clamp)

Matt white Formica laminate (for scale)

1/16in. Perspex sheet (for scale cover)

Battery clips

2 $\frac{1}{4}$ in. spacing pillars

Screws, nuts, etc.

*Radiospares components are available through retailers only.

be the best compromise over the range used. Since the battery drain is less than 2 mA, the battery fitted will power the instrument for a considerable period of time.

COMPONENTS

Almost all of the components are standard items, and easily obtainable. To avoid the possibility of disappointing results, the writer recommends adhering strictly to the types and values specified. The one possible exception is the variable capacitor, VC1. The capacitor used here has been in abundant supply in

years gone by, but is now not so easily obtained. It was used since it can be fastened to the panel by countersunk screws, and therefore does not interfere with the scale. If another variable capacitor is employed, this should be of a type secured by screws, and not by a single centre nut. In case of difficulty, the correct component may be obtained from SRY Electronics, 11 Rosedene Avenue, Croydon, CRO 3DN.

The knob fitted to VC1 in the writers' instrument is also a little non-standard since it has three holes tapped 6BA on its under surface. These provide a convenient means for mounting the scale cover, which

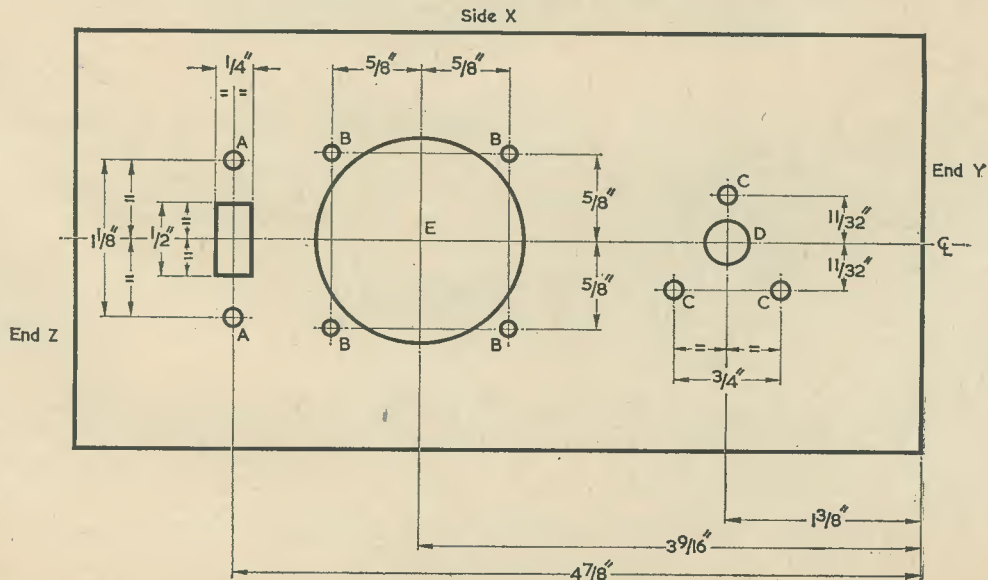

Fig. 2. Drilling details for the front panel

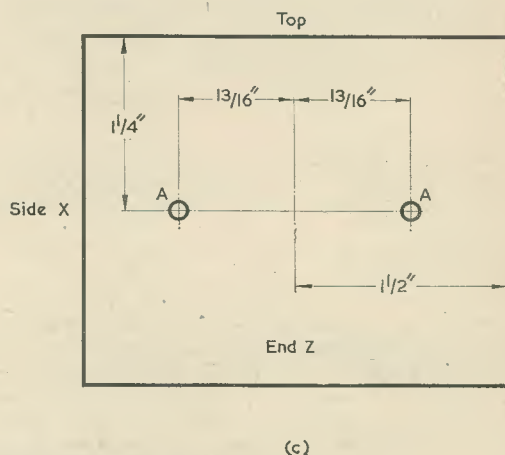
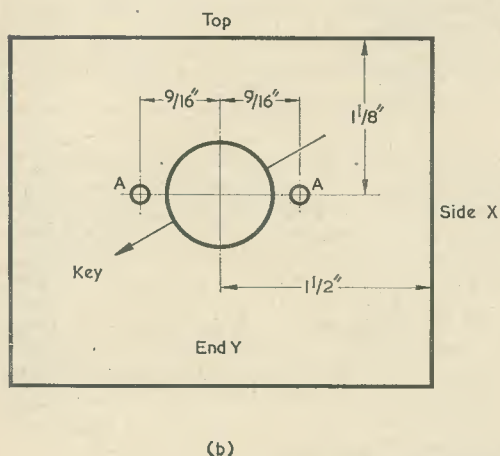
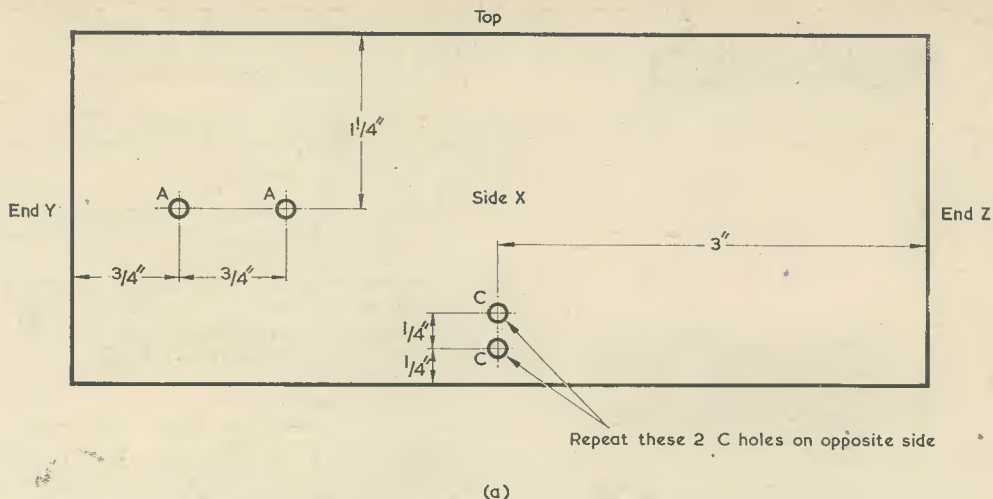

Fig. 3. The holes required in (a) the side panels, (b) the end to which the coil socket is fitted, and (c) the end to which the battery clamp is fitted

is secured to the knob. It is not essential to use a knob of this nature, as the scale cover can be mounted alternatively with Araldite general purpose adhesive, but the 6BA holes do make the assembly quicker and easier to carry out. The knob employed by the writer may also be obtained from SRY Electronics.

It will be noted in the Components List that 5 Denco coil formers are specified. These are required for the coils, whose assembly is described in Part 2, and they plug into the B9A valveholder which is also listed. The Formica laminate and Perspex sheet are (as is also described in Part 2) cut to form circles having a diameter of $2\frac{1}{2}$ in.

Two of the fixed capacitors are specified in the Components List as "metallised film". Capacitors of this type have the advantage of being small in physical size, and are available from Electronics and other suppliers.

PREPARING THE CASE

The g.d.o. is constructed within a standard 6 in. x

3 in. x $2\frac{1}{2}$ in. aluminium chassis with reinforced corners. The deck of the chassis forms the front panel, and it is drilled and cut out as shown in Fig. 2. It should be noted that the three holes marked C are for mounting the variable capacitor just referred to. Alternative hole positions may be required if a different type of capacitor is employed. The rectangular slot and the two A holes are for the on-off slide switch which, in the writer's instrument, was a standard d.p.d.t. component. Before drilling, the constructor should check that the dimensions given for the holes and slot are correct for the particular switch he is employing.

One side of the chassis has four holes drilled in it, these being indicated in Fig. 3(a). The two C holes in this side are repeated on the opposite side. These two sets of holes are intended for two bottom cover fixing brackets, as shown in Fig. 4(a). The two A holes in Fig. 3(a) are for the groupboard, which is spaced off by $\frac{1}{4}$ in. pillars.

The B9A valveholder is fitted at the chassis end nearer the tuning capacitor, and the holes required

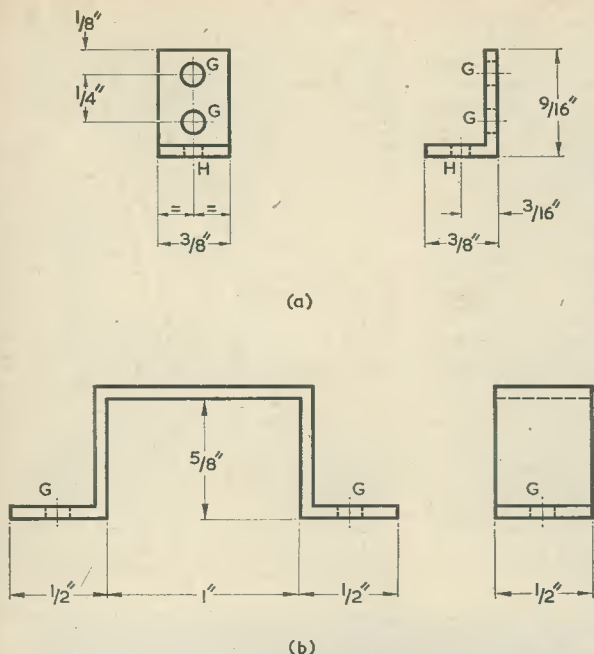

Fig. 4(a). Two bottom cover fixing brackets, made to the dimensions shown here, are required (b). Dimensions of the battery clamp. The hole positions are discussed in the text

TABLE I

Key To Hole Sizes (Figs. 2, 3 and 4)

Type	Drill or Dia.	Remarks
A	No. 32	8 holes for 6BA Mush. Hd. screws
B	No. 42	4 holes for meter mounting studs
C	No. 32 and Csk	7 holes for 6BA Csk. Hd. screws
D	5/16in. dia.	Clearance for VCI spindle
E	1½in. dia.	Clearance for meter body
F	¾in. dia.	Clearance for coil socket
G	No. 32	6 holes 6BA clear 2 holes to suit self-tapping screws
H	—	

are shown in Fig. 3(b). The arrow indicates the orientation of the valveholder and points in the direction of the gap between pins 1 and 9. The other end of the case has two A holes, as illustrated in Fig. 3(c).

The two bottom cover fixing brackets just mentioned are made up as in Fig. 4(a). A battery clamp,

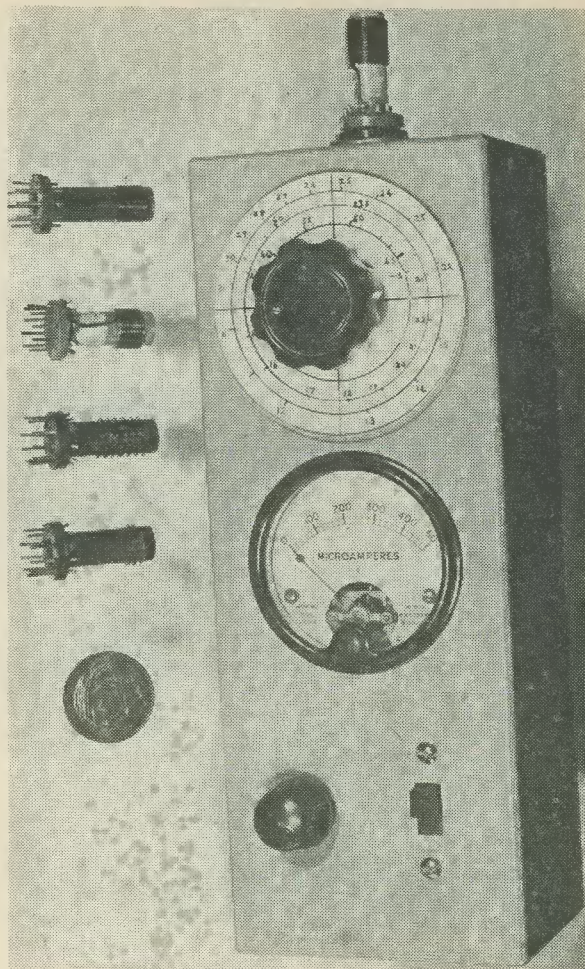

The original transistor g.d.o. constructed by the author. This had a variable resistor in series with the meter which was subsequently taken out of circuit

shown in Fig 4(b), is also required, the two holes in this being marked off from the two A holes drilled in Fig. 3(c). The two brackets and the battery clamp are made from 18 s.w.g. aluminium.

The accompanying Table I gives details of the holes identified in Figs. 2, 3 and 4.

A baseplate is next cut to fit neatly inside the chassis walls, and is secured by six self-tapping screws, four to the corner flanges and one to each of the brackets located half way along each side. Due to manufacturing tolerances in the chassis, it is not possible to provide a cutting size for the baseplate. This should be cut from 18 s.w.g. aluminium to dimensions measured from the actual chassis to be used.

(To be concluded)

TRANSISTOR SUPERHET FOR TOP BAND

The type designations of the intermediate frequency transformers for this receiver were omitted from the components list on page 756 of the July 1969 issue. IFT1 and IFT2 are Denco type IFT13 and IFT3 is a Denco type IFT14. The omission is regretted.

THIS MONTH'S SUGGESTED CIRCUIT article describes a proximity detector incorporating a crystal as a frequency selective device. The function of the detector is to switch on an external circuit if a pick-up wire or plate is approached by any person, and the design can be set up to provide a high level of sensitivity. The prototype operated when a person approached within 1 ft. of a vertical pick-up wire 4 ft. long, or when a hand was held 9 in. or less away from a flat pick-up metal plate measuring 3 by 9 ins. The effect which causes the detector to operate is the increase in capacitance to earth of the pick-up wire or plate when it is approached.

The device has a number of applications, these including the actuation of warning circuits to indicate the presence of intruders, and the operation of electrical equipment without the necessity of physically touching any switch, button or contact.

SUGGESTED CIRCUIT No. 227

HIGH SENSITIVITY PROXIMITY DETECTOR

by G. A. FRENCH

BASIC OPERATION

An important section of the proximity detector consists of an oscillating parallel tuned circuit. One end of this is connected to earth, whilst the other end is connected to the pick-up wire or plate. If, for any reason, the capacitance between earth and the pick-up wire or plate increases, the frequency of oscillation is reduced accordingly.

The output of the oscillator in which the tuned circuit appears is coupled via a crystal to a detector and d.c. amplifier which controls the external circuit by means of a relay. In the present design the relay is held normally in the energised condition, and it de-energises when the pick-up wire or plate is approached. For the more serious applications, therefore, the device offers an automatic fail-safe facility.

The full circuit of the proximity detector appears in Fig. 1. In this diagram the tuned circuit consists of

L1(a), C1 and C2, the upper ends of these components coupling to the "Proximity" terminal, to which the external pick-up wire or plate connects. The lower ends of the tuned circuit components connect to the chassis and metal screening case of the detector, and thence to earth. Positive feedback to coil L1(a) is provided by TR1, to whose base is connected the coupling coil L1(b).

The oscillator output voltage at the collector of TR1 is applied by way of the crystal to the diode detector circuit around D1. The crystal is intended to operate in the series resonant mode rather than in the parallel resonant mode encountered in crystal oscillators and the like. For this reason it was decided to choose a crystal which would normally be employed for series resonant operation, and the component selected is a 455kHz crystal intended for use in the AR88 receiver. This crystal is a component with wire lead-outs, and is available

Diode D1 appears in a shunt detector circuit, the requisite input series capacitance being provided by the crystal itself. The diode is connected such that the detected voltage is positive of the lower supply rail, and this voltage is applied by way of R6 and C6 to the base of TR2. R6 is given the rather high value of 100kΩ in order to reduce loading on the detector circuit. This high value is permissible because the combination of TR2 and TR3 offers an exceptionally high degree of d.c. gain, causing TR3 to be fully conductive for a base current in TR2 of only slightly more than 1μA. To enable this high degree of gain to be achieved, it is important that TR2 be the BC168C specified. (The BC168C is available from Amatronic Ltd.) Because TR2 is a silicon transistor, it remains cut off until its base-emitter voltage approaches about 0.4 volts. There is, in consequence, an automatic delay in the functioning of TR2 and TR3 for

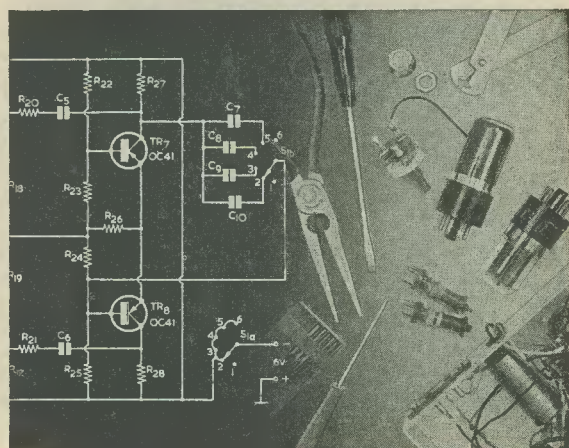

from Henry's Radio Ltd. The crystal offers minimum impedance at its series resonant frequency, whereupon maximum detected voltage appears across diode D1 when the oscillator output is at this frequency. Due to the sharply selective frequency characteristic of the crystal it requires only a very small subsequent change in oscillator frequency for the crystal to exhibit a relatively high impedance, thereby causing an abrupt drop in the detected voltage across D1. Sensitivity is controlled by the preset variable resistor R5, this being adjusted to present a resistive load to the crystal which enables it to offer optimum selectivity*

* Readers who are unfamiliar with the use of a quartz crystal in the series resonant mode are advised to consult "Understanding Radio" in the last August issue. "Understanding Radio" in the preceding July issue, it may be added, introduced the subject of quartz crystals in general, and dealt with the crystal in parallel resonant mode.—Editor.

detected voltages at TR2 base below this level. This voltage delay enhances the ability of the section incorporating TR2 and TR3 to differentiate between the conditions where the crystal is in the low impedance state (at series resonance) and where it is in the relatively high impedance state (off series resonance).

The emitter of TR3 connects to the coil of a relay, details of which are given later. The relay has a set of normally-closed contacts coupling to an external warning circuit which could consist, typically, of a bell and battery. Inserted between the positive supply line and the coil of the relay is a meter having an f.s.d. greater than the current passing through the relay coil when TR3 is hard on. This meter is required for setting-up purposes. Connected across the relay coil is the usual protective diode, its function being to prevent the appearance of a high-back-e.m.f. across

the coil when the energising current ceases.

We may now sum up the overall operation of the circuit in the following manner. The "Proximity" terminal is connected to a pick-up wire or plate, and the oscillator circuit around TR1 is adjusted to provide an output at the series resonant frequency of the crystal. The latter then exhibits a low impedance, allowing a high detected voltage to be applied to the combination of TR2 and TR3. TR3 is in consequence hard on, the relay is energised, and its normally-closed contacts are open. If, due to the proximity of a person, the capacitance to earth at the pick-up wire or plate becomes greater the frequency of the oscillator reduces, falling outside the low impedance series resonant range of the crystal. The crystal now exhibits a relatively high impedance, whereupon the detected voltage passed to TR2 and TR3 falls, and the relay de-energises. The relay contacts close, causing the external warning circuit to be actuated.

CHOICE OF OSCILLATOR FREQUENCY

It was initially intended to have the oscillator run at the crystal frequency of 455kHz, but it was found much more convenient in practice to have the oscillator run at 227.5 kHz, whereupon its second harmonic provides the necessary series resonant frequency of 455kHz. A considerable advantage offered by having an oscillator frequency of 227.5kHz is that it then becomes a very simple matter to bring the tuned circuit to correct frequency by taking advantage of the BBC2 radio signal on 200kHz. Without this aid, the initial setting-up of oscillator frequency becomes somewhat long and tedious.

The coil employed for L1 is a Denco Miniature Dual Purpose (Valve) Yellow Range 1 coil. This coil is normally employed with valves instead of transistors, but it functions very well in the present circuit. It is designed to cover the long wave band when tuned by a variable capacitor having a nominal value of 300pF. In the present application its coupling winding, L1(b), connects to the base of TR1. The coil plugs into a B9A valveholder and the numbers alongside the windings in Fig. 1 indicate the corresponding valveholder pins.

TUNING CAPACITANCE

In a proximity detector operating on the principles just outlined, an important design point centres around the tuning capacitance across the tuned wire circuit to which the pick-up wire or plate is connected. If this tuning capacitance is low, the increased capacitance due to proximity will cause a

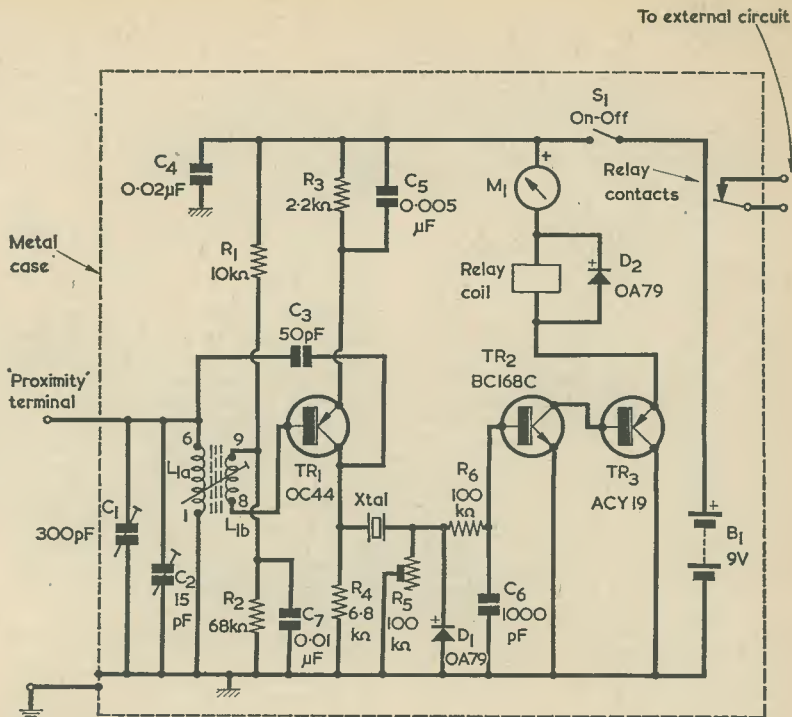

Relay, L₁, Xtal, M₁ - see text
All fixed resistors 1/4 watt 10%



OC44
Lead-outs



BC168C
Lead-outs



ACY19
Lead-outs

Fig. 1. The complete circuit of the proximity detector

greater shift in resonant frequency than if the tuning capacitance is high. It follows that, for the same frequency selective device, greater sensitivity is offered when a low tuning capacitance is employed. Opposed to this is the fact that a low tuning capacitance results in a tuned circuit which is more liable to drift due to changing stray capacitances and internal capacitances in the transistor. A high tuning capacitance tends to swamp the stray and internal transistor capacitances whereupon (provided it has a low temperature coefficient of capacitance) it reduces oscillator drift. With the present design the tuning capacitance, when properly set up, is of the order of 180pF; and it might be thought that this rather high value leans somewhat more towards the procurement of frequency stability than towards sensitivity. In practice, however, a tuning capacitance of this value is quite acceptable because of the exceptionally high selectivity offered by the crystal. It is doubtful if any significantly greater sensitivity could be achieved, whilst employing an inexpensive circuit with home-constructed components, by the use of a lower tuning capacitance.

In this context the choice of resonant frequency for the tuned circuit is of less importance, and indeed the resonant frequency depends mainly upon the capabilities of whatever frequency selective device is incorporated. In the present design tuned circuit resonant frequency is dictated by the crystal. The fact that the resonant frequency is at the relatively low figure of 227.5kHz offers the minor advantage that oscillator layout and wiring is not particularly critical.

COMPONENTS AND CONSTRUCTION

A number of the components employed in the circuit have yet to be discussed.

Although shown as a trimmer, C1 is actually a standard single-gang air-spaced variable tuning capacitor having a maximum value of around 300pF. C2 is also an air-spaced variable capacitor, and it should have a maximum value of about 15pF. A suitable component for C2 would be a Jackson Brothers variable capacitor type C804. The adjustment of C1 is extremely critical and it is for this reason that C2 is included, since the low value in C2 enables final tuning adjustments

to be made more easily. Although not essential, it may be found helpful to fit C1 with a simple epicyclic slow motion drive. If C1 were fitted with a reliable slow motion drive offering a reduction of 20:1 or more, C2 could be omitted.

Capacitor C3 must be a silver-mica component. Preset resistor R5 can be a small "skeleton" type.

The relay should be capable of energising at some 7 volts or less, and its coil resistance should be between 450 and 2,000Ω. In the prototype, the writer used a P.O. 3000 relay having a 500Ω coil and two sets of changeover contacts. Fig. 1 illustrates a single set of normally-closed contacts only, but the actual relay employed can, of course, have more contact sets than this if it meets the energising voltage requirement just mentioned.

The meter in the M1 position should have an f.s.d. slightly greater than the maximum current drawn by the relay coil. In the prototype the writer used a 0-20mA meter, which corresponded comfortably with the maximum current of around 18mA which could flow through the 500Ω coil of the relay.

Only a small number of components is employed in the circuit, and construction should not raise too many problems. In Fig. 1 the whole circuit is depicted as being housed in a screened metal case. Complete screening is not entirely essential, but it is strongly recommended if the unit is to be built up in permanent form. If it will facilitate battery replacement, the battery can, if desired, be positioned outside the screening case. There is no necessity to screen the oscillator section from the components following the crystal, but it is advisable to keep these sections separate from each other. The best plan here is to assemble the oscillator components in one group, and all components to the right of the crystal in a second group, the two being linked together by the crystal itself. Capacitor C4 should be included in the oscillator group.

When finally assembled, the spindles of C1 and C2 should protrude through the front panel of the metal case and be fitted with suitable pointer knobs. A cover over these knobs is desirable, to prevent accidental maladjustment. A hole should be provided through which a screwdriver can be inserted to adjust R5. Meter M1 and S1 are mounted on the front panel. The "Proximity" terminal should be positioned well away from the front panel to avoid hand-capacitance effects whilst the panel controls are being adjusted. Also, the internal wiring between this terminal and the oscillator tuned circuit should be kept short.

The circuit has to be initially checked and set up in the un-

screened condition. In consequence it is a good plan to mount the chassis and all components directly to the front panel of the screening case. This can then be finally fitted into the case for the last adjustments and for subsequent use.

SETTING UP

After the circuit has been assembled and the wiring carefully checked it may be tested and set up.

Initially set R5 to insert full resistance into circuit. Adjust the dust core of L1 so that about $\frac{3}{8}$ in. of the brass threaded stem protrudes from the former and secure it in position by passing a 6BA nut over it to act as a lock-nut. The position of the dust core is not important, and it is merely necessary to ensure that it is held in place securely. Set C2 to half-capacitance. No connection should be made to the "Proximity" terminal at this stage. The chassis of the unit should be connected to any convenient earth, such as a mains socket earth connection.

Connect the battery and switch on. If the oscillator is running satisfactorily, meter M1 should indicate full, or nearly full, relay coil current for most of the travel of C1, the reading probably dropping noticeably as C1 approaches full capacitance. This reading is due to the detection, by D1, of r.f. from the oscillator passing via the capacitance of the crystal holder.

Obtain a transistor radio with a ferrite rod aerial and tune this to the BBC2 radio programme on 200 kHz (1,500 metres). Hold the radio about 1 ft. away from L1 and swing C1 for a heterodyne beat with the received programme. If there are several heterodynes in the range of C1 the correct one is that which still continues to be indicated by the radio as the latter is moved away from L1. With the prototype, the heterodyne was evident with the receiver 4 ft. away from L1. The vanes of C1 should be about one-half to three-quarters enmeshed for this heterodyne.

Switch off the receiver. Reduce the resistance inserted into circuit by R5 until the needle of meter M1 is just slightly deflected forwards from its zero position. Reduce the capacitance of C1 *extremely* slowly, continually observing the meter. It is possible that the meter reading will increase gradually during this adjustment of C1, due to slightly increasing r.f. output from the oscillator. This gradual increase in meter reading should be ignored. At a precise setting of C1 the meter will suddenly swing over to full relay current and the relay will energise. Further reduce the resistance inserted by R5 until the meter indicates slightly less than full relay current. Attempt, so far as is

possible, to bring C1 to a position which once more gives maximum reading in the meter. This last adjustment of C1 will be found very critical. Mark on the front panel the position taken up by C1, as indicated by its pointer knob, then leave this component alone.

All further frequency adjustments are carried out by C2. It should now be possible, by adjustment of this capacitor, to take oscillator frequency right through the resonant response of the crystal, with full relay current near the centre of C2 travel and zero, or very low, relay current at either end of its travel.

The next process is to find the optimum value required in R5. As the resistance inserted into circuit by this resistor is reduced it will be found that the selectivity offered by the crystal increases, this selectivity being checked by swinging C2 throughout its range. However, too low a resistance in R5 produces an effect whereby the crystal exhibits its low impedance as the oscillator frequency approaches the crystal resonant frequency in one direction only. This effect is due to the fact that the crystal is coupled directly to the oscillator tuned circuit via C3. The final value required in R5 is that at which the resistance it inserts is just sufficiently high to prevent this last effect taking place. It will then be possible to obtain the same low impedance resonant response in the crystal regardless of the direction in which C2 is rotated. This condition can be confirmed by setting C2 to any position and switching S1 off. The same reading in M1 should be given as S1 is switched on again.

Finally set C2 to the centre of the settings at which M1 indicates full relay coil current. A finger close to or touching the insulation of the wire to the fixed vanes of C1 or C2 should cause the relay to de-energise. For ultra-high sensitivity increase the capacitance of C2 to the point where relay coil current is on the point of falling.

The adjustment procedure just outlined requires a number of critical adjustments, together with concentration on the part of the constructor. However, it does enable the optimum setting for R5 to be found, and this component should not require any further adjustment when the unit is housed in its case and the pick-up wire or plate connected. The procedure illustrates the advantage of using the 200kHz BBC2 signal to provide a starting point for oscillator adjustments. The heterodyne test with the BBC2 signal also checks oscillator functioning since, if a clear beat note is provided, the oscillator is operating correctly. In the unlikely event of oscillator squegging due to ex-

cessive feedback the beat note will have a harsh noisy background. Oscillator efficiency can be adjusted, incidentally, by increasing or decreasing the value of C5 as required, but it is doubtful if any change in the value of this component will be needed in practice.

The unit should next be fitted into its case and operation rechecked. The case will slightly alter the effective inductance of L1(a) and will also cause slight changes in stray wiring capacitances. Readjust C1 and C2 as before. The setting in C1 will be very close to that previously obtained, and there should be no need to touch R5. Next, connect the pick-up wire or plate to the "Proximity" terminal, keeping all the external capacitances to earth as low as possible. Keeping well away from the proximity wiring, finally adjust C1 and C2.

The proximity detector is then ready for use.

OSCILLATOR STABILITY

The current drawn from the 9-volt battery in the circuit of Fig. 1 consists of the energising current for the relay employed, together with approximately 1mA for the oscillator section. A standard PP9 battery should offer full terminal voltage for reasonably long periods at a current of this nature.

If the device is to be employed for very long periods it would be preferable to provide a mains power supply having a stabilised 9 volt output, since falling supply voltage could cause oscillator drift. Alternatively, an unstabilised 12

volt supply could be used, the oscillator supply being stabilised by a 9 volt Zener diode as shown in Fig. 2. Zener diode dissipation here is of the order of 90mW and the diode passes a standing current of about 10mA.

In Fig. 2, the relay section of the circuit runs directly from the 12 volt supply. Relay requirements are the same as with the 9 volt supply apart from the fact that relay energising voltage may now be about 10 volts or less. The meter in Fig. 2 should have an f.s.d. value slightly greater than relay energis-

ing current at 12 volts.

When very long term operation is envisaged it would also be helpful to replace C2 by an air-spaced ceramic variable capacitor fitted with a slow-motion drive and having a value of 50pF, and to replace C1 with a silver-mica fixed capacitor whose value, found by experiment, causes C2 to bring oscillator frequency to crystal resonance at around mid-travel. For very long term operation the unit should be positioned in a place where ambient temperature is reasonably constant.

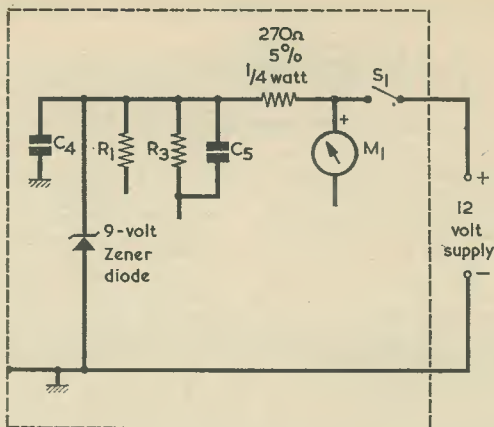

Fig. 2. For long-term operation from a 12 volt supply the oscillator section should have its supply stabilised by a zener diode having a nominal rating of approximately 9 volts. The relay section may run direct from the 12 volt supply

NEW CATALOGUE

Currently available is the 1969-70 catalogue of L.S.T. Electronic Components Ltd. This comprises 44 large pages listing a very wide range of semiconductor products by various manufacturers, including R.C.A., Mullard, SGS, Newmarket, Texas, General Electric, International Rectifier, Motorola, S.T.C. and Plessey. Also given in the catalogue are details of batch quantities of manufacturers' surplus semiconductor devices which may be purchased at very low prices. Further components listed are capacitors, resistors, potentiometers, nickel-cadmium cells, 40kHz transducers, chassis and hardware, reed relays, coils, transformers, meters, and many other items. The catalogue is available free and post free to readers of *The Radio Constructor* from L.S.T. Electronic Components Ltd., 7 Coptfold Road, Brentwood, Essex.



NEW BIB COMPACT TAPE HEAD CLEANING KIT



Bib Division of Multicore Solders Ltd., Hemel Hempstead, Herts, are introducing a new compact size J Bib Tape Head Maintenance Kit. The kit comprises a 30 c.c. bottle of anti-static, non-inflammable Bib cleaner, two each Bib applicator and polisher tools for applying the cleaner, or alcohol for removing oxide and dirt from the tape heads and all parts of the tape path. Ten double ended cotton wool tipped sticks may be used for the same purpose for recorders, to which easy access cannot be achieved with the Bib tools. They are used also for removing oxide from baseplates of recorders, scraps of tape, etc. A Hi-Fuster absorbent cloth is provided for cleaning the soiled tools and sticks and the exterior of tape recorders.

All these components are contained in a plastic wallet, which is packed in a polythene bag attached to an attractive header card for pegboard display. Full instructions for use in English are given on the back of the card, the inside of which contains these instructions in French and German. The recommended retail price is 9s. 9d., including 1s. 11d. purchase tax.

HOW TO TREAT YOUR TRANSISTOR

Transistor radios, fresh from the factory, were recently found to be faulty on arrival in the shops. Quite a mystery, for they had all passed their final tests at the makers. The explanation turned out to be that these radios had been packed in plastic bags. These bags, like almost any dry piece of plastics material, had become charged with static electricity. It so happened that when the static discharged itself it went through the aerial into the receiver and destroyed the first transistor.

A BBC reporter warning against this trouble, stated in a recent broadcast that similar disasters have been known to overtake car radios. Cars often pick up a static charge in dry weather. If you get out and then touch the radio aerial all you feel is a slight tingle, but the radio set loses a transistor. Fortunately, there is a simple remedy. It is to connect a miniature neon tube to the aerial circuit of the receiver. When a static discharge occurs, the neon lights up momentarily and absorbs the electrical energy.

ANOTHER NEW AUDIO LINE FROM EAGLE PRODUCTS

A new sub-miniature AM Tuner Chassis - an ideal addition to those installations which are FM only where the rest of the family might want to listen to stations only available on AM. Operates from a single 9 volt battery.

Specification:

Frequency coverage: 600-1500kHz.

Aerial: Ferrite rod.

List price: £4.18.10d. inc. tax. Model No. AMT 35.

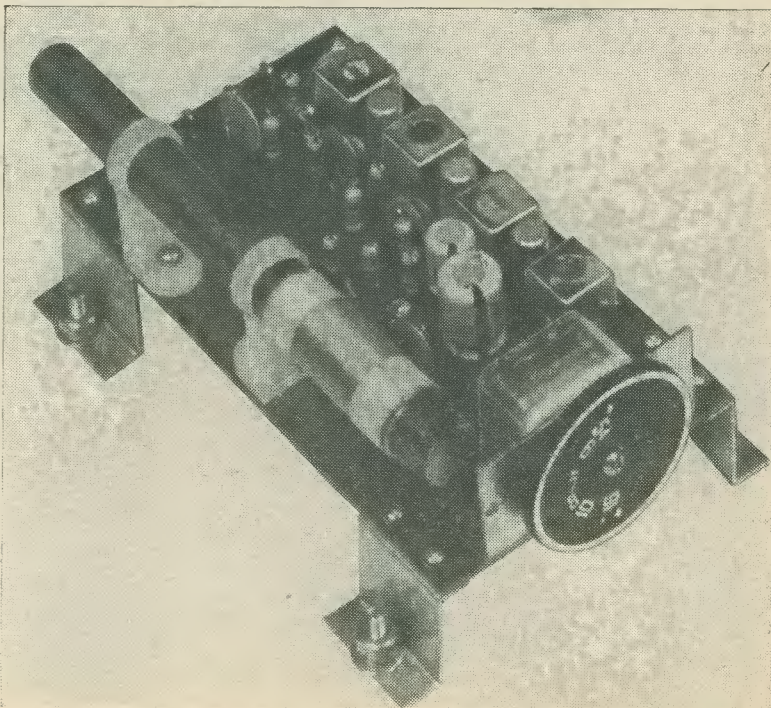

COMMENT

NEW INTERNATIONAL CALL AREAS AWARD

A number of transmitting amateurs have long wanted an international award that would stimulate skilful Dx operation. A number of meetings in London and Geneva were held which resulted in the formation of a new body—the International Dx Organisation (IDXO).

The award the new organisation will be promoting is called the International Call Areas Award (ICAA), and we hope at a later date to give details of the rules.

This new body is not intended to compete with existing organisations and it is perhaps a guarantee of this that the first chairman of the board of directors is Roy Stevens, G2BVN, a former president of the R.S.G.B.

COLOUR TV MANUFACTURERS' FEARS

TV Trade Associations have warned the Government that there is likely to be a very serious shortage of colour TV sets when colour is introduced on three channels later this year.

The fears of a shortage stem from the hire purchase and rental regulations and the manufacturers are anxious to receive early advice of any changes because it can take up to six months to alter the rate of production.

The difficulties of assessing the likely demand when BBC 1, BBC 2, and ITV all transmit colour are immense; possible revaluation of the Deutsche Mark, change in h.p. and rental regulations, strength of foreign competition can all profoundly affect demand for home produced receivers. Even leaving things as they are we have seen forecasts vary from just over 100,000 sets per year to as many as 300,000, all these forecasts being made by knowledgeable bodies.

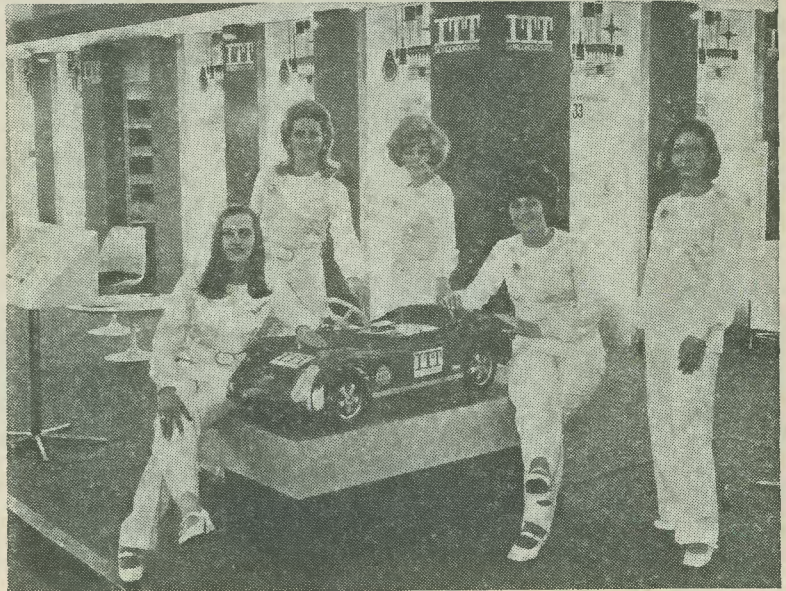

NOT JUST A PRETTY FACE!

An attraction at the 1969 Paris Components Salon was the ITT hostesses in their white silk trouser suits with silver leaf embroidery. Some visitors thought they were professional models. In fact, they are ITT secretaries, each with two or three language qualifications.

Left to right are: Ursula Jahn – ITT-Cannon, Paris; Annik Fiacre – ITT Components, Paris; Rita Franz – ITT Components, Nürnberg; Germaine Kehoe – STC, London; Lise Moreau – ITT Semiconductors, Paris.

The small car was used to demonstrate ITT's solid state electronics for the automobile industry.

MANAGEMENT AND ECONOMICS IN THE ELECTRONIC INDUSTRY SYMPOSIUM

The president of the Scottish Council (Development & Industry), Lord Polwarth, is to be president of the symposium on management and economics in the electronics industry to be held in Edinburgh from the 17th to 20th March 1970.

The Scottish Council, with which Lord Polwarth has been associated for many years, has played a leading role in the establishment of a thriving electronics industry in Scotland. Since 1945 this has grown from one major company to more than eighty firms employing nearly 40,000 people.

BBC RESEARCH SCHOLARSHIP 1969

The engineering division of the BBC maintains six research scholars at United Kingdom universities, and is awarding one scholarship this year. The scholarships are intended to provide the opportunity for selected honours graduates to work for a higher degree, the subject chosen for post-graduate study being within

those fields of physics or engineering which have an application to radio or television broadcasting.

Mr. P. A. Ratliff, who graduated with first class honours in electronic engineering from the University of Birmingham in June this year, has been awarded a three-year BBC Research Scholarship to undertake

research in the Department of Electronic and Electrical Engineering, University of Birmingham. The subject of Mr. Ratliff's study is 'an aerial system designed to combat multipath fading in VHF mobile communications, using existing AM receivers'.

"Cir-Kit" Personal Portable Superhet

by

J. HOSSACK

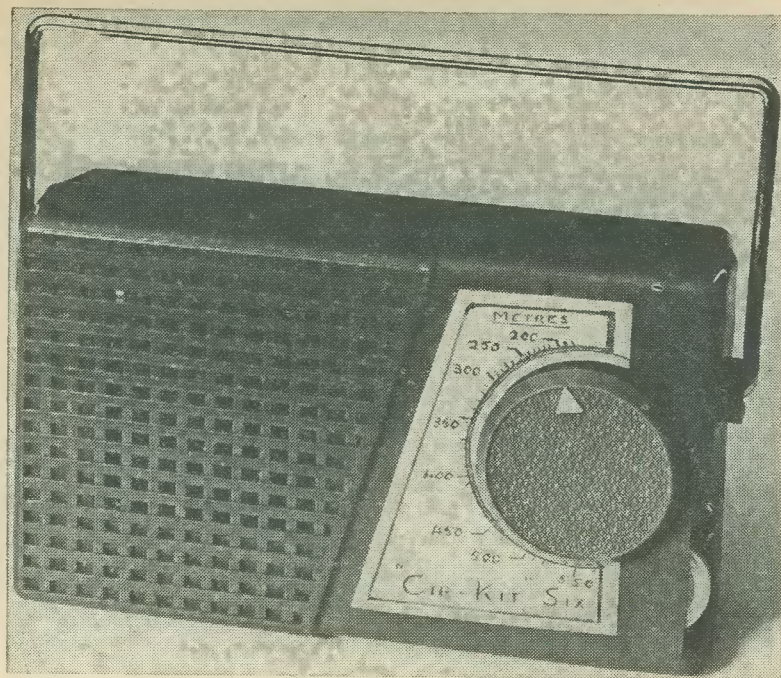

Intended for the more advanced constructor, this medium-wave personal portable offers a performance fully equal to that of similar commercially manufactured receivers. A particularly interesting feature is given by the use of "Cir-Kit" Instant Circuit Board

Editor's Note. — a few of the components employed in this receiver are imported or are manufacturer's surplus, and may not be available for as long a period as are standard British parts. We have been assured that adequate supplies of such components will be available when this article is published, but we cannot guarantee that they will continue to be available at later dates. Suggestions for alternative parts are given in the article, and these alternatives may require small changes in the layout or, even, in the "Cir-Kit" layout. Such changes will be well within the capabilities of the more experienced constructor who understands the principles involved.

BASIC DESIGN

THIS DESIGN, WHICH IS BASED ON A CONVENTIONAL six-transistor superhet circuit covering the medium-wave band, is built up on a printed circuit board using the popular "Cir-Kit" technique, and the complete receiver can be constructed for a very modest sum. Although not really suitable for the beginner, it can be built with confidence by any reader who has previously tackled one of the small transistor receivers available in kit form, and has the advantage of giving the constructor the satisfaction of making his own printed circuit board and building up his design from scratch.

For those readers who are not familiar with "Cir-Kit", it should be pointed out that this consists of a sheet of thin Paxolin board, with a roll of self-adhesive copper strip approximately $\frac{3}{32}$ in. wide, together with a further sheet of copper foil for making larger conducting areas. The latter are generally at

earth potential. It is important that these earthed areas are included in their entirety in any design project, since they provide an appreciable screening effect, and their omission, or replacement by copper strip alone, could result in instability. Attempts to design extremely small sub-miniature layouts with Cir-Kit present difficulties, due to the nature of the material, and the present design represents a reasonable compromise between small size and ease of construction. The author used "Cir-Kit" kit No. 3, which provides ample material for several receivers.

The cabinet employed by the author is that listed in the Components List. Three holes, tapped for 6BA bolts, retain the circuit board in position, and the corresponding clearance holes in the Cir-Kit board are shown, marked "x" in Fig. 2, which incidentally is viewed from the copper side of the board. A $2\frac{1}{2}$ in. speaker is held tightly under the board once the latter is bolted into position, and further clamping should be unnecessary. The ferrite rod and battery brackets are constructed from aluminium sheet. If a cabinet of different dimensions is used, the Cir-Kit board may have to be modified to suit, but note that a clearance of 1in. above the board and $\frac{3}{8}$ in. below will be required to accommodate the battery, speaker, and ferrite rod mountings with the cabinet lid in position.

THE CIRCUIT

As mentioned, the circuit, which is shown in Fig. 1, is based on a conventional superhet design, this consisting of mixer, two i.f. stages and a diode de-

ductor, these being followed by driver and push-pull output stages. The mixer stage uses an OC44 functioning as a self-mixing Reinartz oscillator. This takes the form of two small coils connected in emitter and collector circuits respectively, to which is tightly coupled a third, larger coil. Oscillation is maintained by feedback between the collector and emitter coils, while the third closely coupled coil, in conjunction with VC1(b), determines the oscillator frequency.

Two stages of i.f. amplification are employed, and the OC45 transistors used require a small amount of neutralisation, which is provided by C12 and C13. Details on mounting the i.f. transformers are given later. After detection by D1, the resulting a.f. signal is amplified by TR4 and fed to the output transistors, which consist of two OC81's in push-pull. The biasing arrangement for this stage is a little unusual, and was chosen to allow room for experimentation in the event of unmatched transistors being pressed into service for the sake of economy. In this case, an improvement in quality may be obtained by slightly altering the values of R16 and/or R17, keeping an eye on the total no-signal current while doing so. The aim is to achieve a current of around 8mA, rising to about 50 to 60mA on sound peaks, with a minimum of crossover distortion.

CONSTRUCTION

The "Cir-Kit" board is first of all cut and drilled, using Fig. 2, which is reproduced full-size, as a template for drilling and component-positioning. Before commencing the actual drilling, however, it is a wise

precaution to check the sizes of the i.f., driver and output transformers against Fig. 2 to ensure that the components on hand correspond with the indicated dimensions in all respects. (Also, the notes given later in this article concerning alternative components should be consulted.) Slight variations, of the order of $\frac{1}{8}$ to $\frac{1}{4}$ in., can occur with these parts, and it may be necessary to alter the "Cir-Kit" layout to allow for these small differences. Component holes are drilled with a No. 50 to 54 bit. The speaker hole can be easily cut out by drilling a series of $\frac{1}{8}$ in. holes round the inside circumference and tapping out the centre, smoothing up afterwards with a half-round file. If preferred this operation can, alternatively, be carried out with a fretsaw or small hacksaw. The hole for the tuning capacitor spindle is $\frac{1}{2}$ in. diameter, and the remaining fixing holes for ferrite rod brackets, etc., are all $\frac{1}{8}$ in. diameter.

Special care must be taken, as already mentioned, to ensure that the fixing holes for oscillator coil, i.f. and audio transformers, and the volume control, are in precisely the correct positions. A very slightly larger drill size (say No. 46) can be used with advantage in this case. The mounting of these components will also be simplified if the holes are slightly elongated to take the corresponding lugs on the component cans (a lady's nail file is a useful tool) which should pass easily, but not too loosely, through the board. Do not bend these lugs over at this stage. Note that the volume control must be inserted from the bottom (copper) side of the board, and that only one pole of the double-pole on-off switch will be connected. It is recommended that the connections

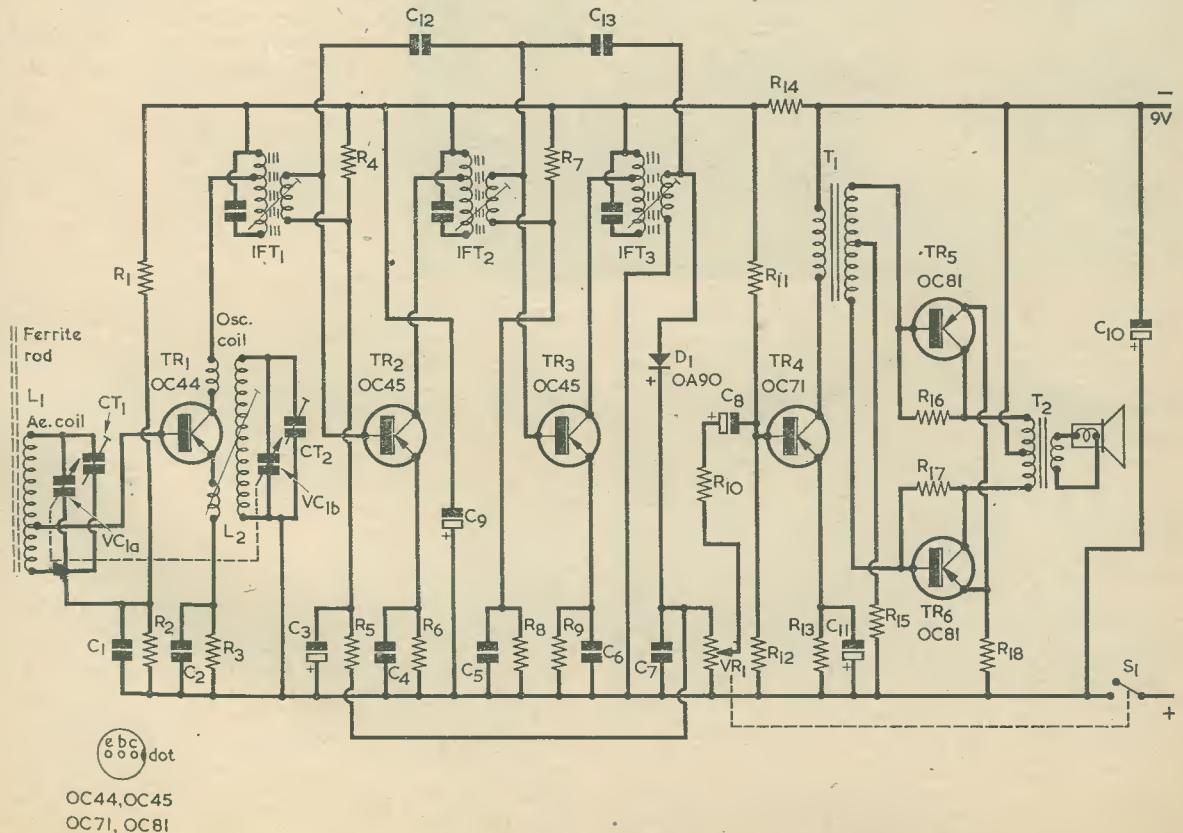
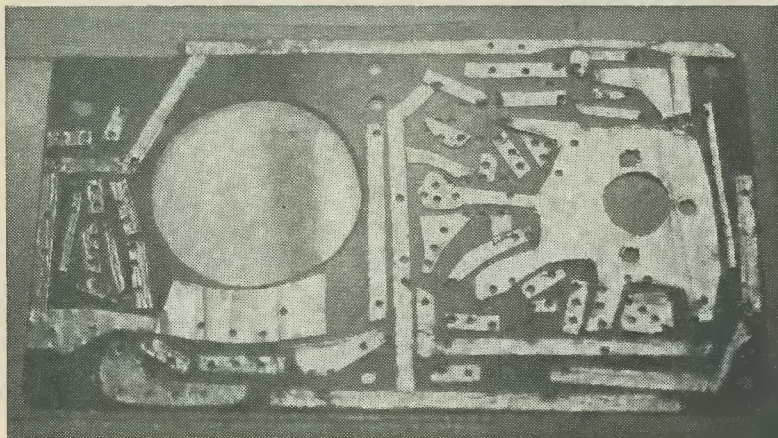

Fig. 1. The circuit of the personal portable superhet

to the particular control used are checked with a meter for correspondence with Fig. 2, since, if a different design of control is employed, it may be necessary to modify either the fixing hole points or the wiring.

After drilling has been completed, temporarily mount all the components just mentioned and, in addition, the tuning capacitor (which, incidentally, must be held by very short bolts to avoid fouling the moving vanes), and try fitting the board into its cabinet with the speaker in the position which it will finally occupy. Ensure that the tuning capacitor spindle is centrally positioned with respect to the cabinet opening, and that the board will screw fully into the cabinet with sufficient "grip" on the speaker to hold the latter firmly in position. If not, it may be necessary to bolt the speaker into position with screws inserted from the front of the cabinet, or, alternatively, to pad out with sponge rubber placed between the back of the speaker and the board. If sponge rubber is not used it will still be necessary to place an insulating ring of thin cardboard over the back of the speaker to prevent accidental contact of its metal frame to the "Cir-Kit" copper strips which are later fitted to the board.



The actual "Cir-Kit" copper layout before components are mounted

Having made these initial checks, remove all components from the board, and unroll a piece of "Cir-Kit" strip. With sharp scissors, cut this into the required lengths, following the plan of Fig. 2 and the photograph of the board underside. After removing the backing, press each length of copper firmly on to the underside of the board in the position shown. Next, cut the "lands" and the remaining irregular shapes from the large piece of copper sheeting supplied, and stick down similarly. If a mistake is made, the copper can be lifted and repositioned without loss of adhesion. Now, place a spot of solder on each overlap junction between strips and "lands", and between the strips themselves. If necessary, final trimming can be carried out with an old razor blade. The copper can then be pierced with a needle where it overlays each component hole, thus completing the preparation of the board. The final appearance should be similar to the photograph.

From this point onwards, construction follows normal printed circuit technique. Remount the tuning capacitor, volume control, and all transformers, bending back the lugs of the latter before soldering them into position. It is essential to ensure that the oscil-

lator coil and i.f. transformers are correctly oriented. The coil pack specified consists of the final i.f. transformer (code black), the two preceding i.f. transformers (code white) and the oscillator coil (code red). The last is the only one of the four possessing six connecting pins. The correct position of this coil on the board is achieved when the two terminals connected to the main tuned winding are positioned towards the right, viewing the board as in Fig. 2. The appropriate terminals are designated by a white spot on the base of the coil, next to one of the fixing lugs. The coil should therefore be mounted so that this spot faces right. If, because the spot is difficult to see or for any other reason, there is doubt, an ohmmeter check will locate the two terminals in question, the resistance being a few ohms. The other two windings (see theoretical circuit) will be found connected to the remaining pairs of terminals in the rows of three along both sides of the coil, each of these windings having a resistance of less than 1Ω .

The i.f. transformers are more easily oriented, since they possess only five pins and are therefore asymmetric. The first two (white coding) are mounted with the 3-pin side towards the top edge of the board, whilst the last i.f. transformer (black) has the 3-pin

array on the left. In cases of doubt, check back against the circuit diagram.

When soldering in the volume control, the connections may prove a little difficult of access, due to the fact that they are partially concealed by the control itself. The best plan is to leave a small gap (not more than $\frac{1}{16}$ in. as otherwise the control knob will foul the side of the cabinet after assembly) between it and the underside of the board, bending the lugs back on the top side of the board and placing a spot of solder on each lug to anchor the control in position. Then solder the leads to the copper strip below the board. If, due to the use of a non-miniature soldering bit, difficulty is anticipated in obtaining access for the latter operation, it is recommended that $\frac{1}{2}$ in. wire lengths be first of all affixed to the control points for subsequent connection to the Cir-kit strip itself.

Once the main components have been soldered in position and "wired" up, proceed to the smaller ones, such as resistors, capacitors, etc. Miniature fixed capacitors are used throughout, but, with a few exceptions, standard $\frac{1}{4}$ watt resistors were found to be sufficiently small, and gave a more "solid" appearance to the layout, besides being less expensive and

COMPONENTS

Resistors

(All fixed values $\frac{1}{4}$ watt 10%—see text concerning R15, R16, R17 and R18)

R1	39k Ω
R2	10k Ω
R3	3.3k Ω
R4	68k Ω
R5	10k Ω
R6	470 Ω
R7	22k Ω
R8	3.9k Ω
R9	1k Ω
R10	390 Ω
R11	56k Ω
R12	10k Ω
R13	470 Ω
R14	390 Ω
R15	47 Ω
R16	8.2k Ω
R17	8.2k Ω
R18	4.7 Ω
VR1	5k Ω pot., log, miniature edge, Radio-spares, with d.p.s.t. switch (Home Radio, Cat. No. TRC78)

Capacitors

(See text for details of fixed capacitors)

C1	0.022 μ F
C2	0.01 μ F
C3	8 μ F electrolytic, 6V wkg.
C4	0.047 μ F
C5	0.022 μ F
C6	0.047 μ F
C7	0.047 μ F
C8	4 μ F electrolytic, 6V wkg.
C9	50 μ F electrolytic, 9V wkg.
C10	50 μ F electrolytic, 9V wkg.
C11	50 μ F electrolytic, 6V wkg.
C12	47pF
C13	12pF
VC1	(a) (b) 165 + 70pF with trimmers, miniature air-spaced, complete with with knob (Henry's Radio)
CT1, CT2	Part of VC1 (a) (b)

Inductors

L1	Ferrite aerial, wound on ferrite rod 4in. x $\frac{5}{16}$ in. dia. (rod, Henry's Radio)
L2	} Set of four 10 mm superhet coils for 455kHz, Type C10 (Henry's Radio)
I.F.T.1	
I.F.T.2	
I.F.T.3	
T1	Sub-miniature driver transformer*
T2	Sub-miniature output transformer*

*T1 and T2 are available from Glasgow Electronic Services, 21 Old Dumbarton Road, Glasgow C.3.

Semiconductors

TR1	OC44
TR2	OC45
TR3	OC45
TR4	OC71
TR5	OC81
TR6	OC81
D1	OA90

Switch

S1	s.p.s.t., part of VR1
----	-----------------------

Loudspeaker

3/10 Ω loudspeaker, Eagle, 2 $\frac{1}{2}$ in. square (Henry's Radio)

Miscellaneous

"Cir-Kit" kit No. 3
 Small Radio Cabinet, with carrying handle, 5 $\frac{1}{4}$ in. x 3 $\frac{1}{4}$ in. x 1 $\frac{3}{4}$ in. (Electronics (Croydon) Ltd., 266 London Road, Croydon, Surrey)
 9-volt battery type PP3 (Ever Ready)
 Battery connector
 Aluminium for ferrite rod and battery brackets
 6BA screws, nuts, etc.

easier to handle than the usual miniature types. Some care is required when making connections to the "Cir-Kit" strip, particularly around the i.f. transformer tags, to ensure that solder does not run on to adjacent strips and form unwanted "bridges". If this does happen, the quickest procedure is merely to lift off one or both of the offending copper strips and replace with fresh "Cir-Kit". The usual precautions should be observed when soldering in the transistors and diode. However, as about 1in. of free space is available above the board with the cabinet lid on, at least $\frac{1}{2}$ in. wire ends may be left on each transistor, considerably reducing the risk of heat damage when soldering them into position. The polarity of the diode must be observed, the negative end being connected to the final i.f. transformer.

Fig. 2 shows that the tap and lower end of the aerial coil each connect to a group of two component holes, one being in the strip leading from TR1 base and the other at the junction of C1 and R2. The groups of two holes allow short lengths of tinned copper wire to be threaded through to the component side of the board and firmly anchored in place, for subsequent connection above the board to the aerial coil. About $\frac{1}{4}$ in. of wire above the board should be sufficient. Apart from battery and speaker connections, to which reference is made later, this completes the connections on the copper side of the board.

Referring now to the top side of the board, the ferrite rod is mounted on two aluminium brackets which hold it well clear of components. These

brackets must not completely encircle the rod or they will constitute a shorted run. A third bracket retains the PP3 battery in position. Holes for mounting these should already be drilled, provided Fig. 2 has been followed in detail. These brackets should be clearly seen in the photograph of the completed receiver. The type of aerial coil required will depend, to some extent, on the length of ferrite rod. With the 4in. by $\frac{1}{8}$ in. rod used by the author, 80 turns of 30 s.w.g. enamelled wire, tapped 4 turns from one end, provided excellent signal strength and sensitivity. The coil was wound with the turns side by side on a cardboard former which was made a sliding fit over the rod. A commercial coil can, of course, be used if desired. The three lead-out wires should be at least $2\frac{1}{2}$ in. long so that subsequent adjustment can be carried out during alignment. The method of connecting the coil will be clear from Fig. 2, but it should be noted that the end connection from the main portion must be soldered to the larger (165pF) section of the 2-gang tuning capacitor which, in the present design, corresponds with the tag closest to the printed circuit board.

The battery and speaker connections consist of thin plastic-covered flex soldered to the appropriate points on the board. The method of anchoring these leads is important. After stripping the plastic back for approximately $\frac{1}{8}$ in., the bare wire-end must be pushed through the appropriate hole *from the top of the board*, so that the plastic covering is flush with the Paxolin, and then held tightly in this position while it is soldered to the Cir-Kit strip below the hole. On no account must any connecting wires be soldered directly to the printed board, from below, as the adhesion between board and strip is insufficient to withstand the frequent strain imposed upon it during, for example, battery replacements.

COMPONENTS

Before proceeding further, some comments should be made concerning components.

If i.f. transformers other than those specified are obtained they should, of course, be the same size (nominally 10 by 10mm) as those used here. Generally, if a complete i.f. pack is purchased a note of the colour coding for the order of the individual transformers is included. As a guide, however, red

normally denotes the oscillator coil and black the final i.f. transformer, the position of the remaining i.f. transformers being unimportant. Oscillator coils suitable for the present circuit have 6 terminals. An alternative mixer circuit uses a tapped coil with 5 terminals, so it is well to check that the oscillator coil to be used is of the 6-terminal variety. An ohmmeter check will reveal the internal connections and, since the tuned winding has the highest resistance of the three, also enable the correct orientation of the oscillator coil on the board to be determined.

The audio transformers are usually coded green for driver and red for output transformer but, here again, a meter check will do no harm. The output transformer will be easily recognised by the very low resistance of its secondary, typically less than 1 Ω . Sub-miniature transformers, such as those specified in the Components List, should be used. These are Japanese-type transformers measuring $\frac{1}{8}$ in. between fixing lugs.

In case difficulty is experienced in obtaining the sub-miniature transformers, the standard "Eagle" LT44 and LT700 types can be used but, as these are slightly larger all round, some crowding of the components in the vicinity of the OC81's may occur. It will be unnecessary to alter the "Cir-Kit" design with the "Eagle" transformers since their leads, being flexible, will easily pass through the existing holes. As the fixing lugs are now $\frac{3}{4}$ in. apart, however, the spacing of their holes in the board must be increased accordingly. In addition, R15, R16, R17 and R18 should be changed to sub-miniature types, while C10 will have to be mounted in an upright position to allow the extra space required for T1. A good idea here is to route the negative lead of this capacitor through the T2 primary centre-tap hole, which goes, via the jumper wire, to the negative battery line. T2 itself may foul the battery unless care is taken to make the mounting for this as small as possible and, in fact, it may be possible to dispense with a battery holder altogether if a piece of sponge rubber or plastic is inserted to prevent the battery from moving around.

The fixed resistors have already been mentioned. The volume control should be the Radiospares type listed.

The 0.022 μ F capacitors used by the author are Radiospares miniature tubular polyester, 250 volt

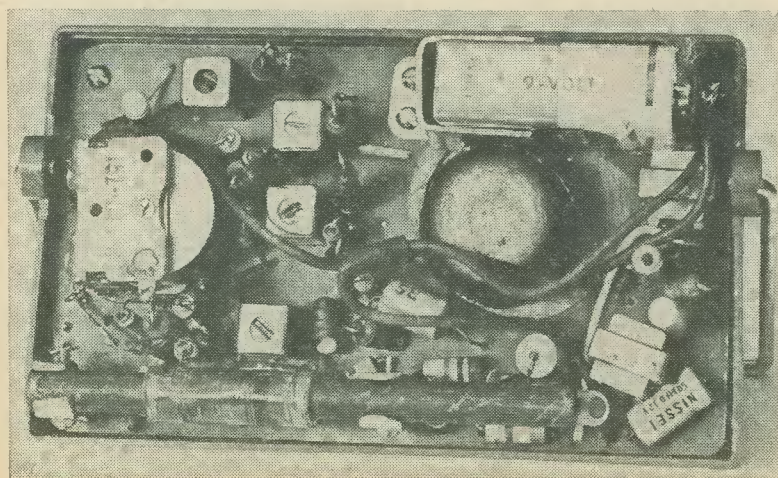

An internal view of the receiver with the rear cover removed

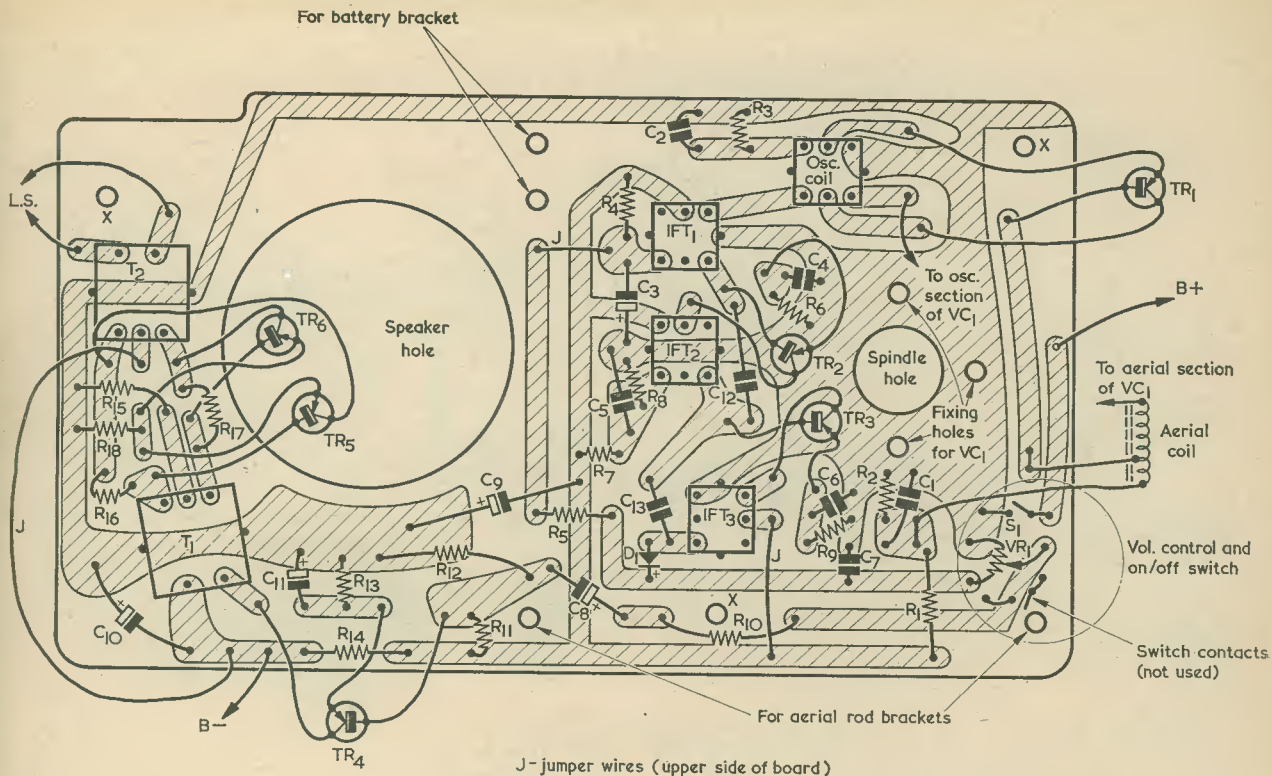

Fig. 2. The copper side of the board. This diagram is reproduced full size and may be employed as a template

working. These have a length of 0.45in. and a diameter of 0.16 to 0.2in. C2 could be a similar type in 500 volt working and having the same dimensions. Alternative capacitors should have similarly small dimensions, and it should be mentioned that Radiospares components may only be obtained through retailers. The electrolytic capacitors are all sub-miniature. The two neutralising capacitors, C12 and C13, are ceramic.

ALIGNMENT

When assembly of the board is complete, a final check should be made to ensure that all components have been inserted into their correct positions, and that all soldered joints are sound. Examine particularly the continuity through the i.f. transformers and connecting "Cir-Kit" strip; and the soldering of the latter to the "lands" and to each other.

Before connecting the battery, it is a wise precaution to measure the resistance across the battery connector with S1 on and a speaker connected. Typical values should be 250 and 2,500Ω in each direction respectively. If much lower values are found, a fault is almost certainly indicated. With a 9V supply, the approximate no-signal current should be 8 to 12mA. With the aerial coil about half-way along the rod, the local station should be audible at some point on the dial and, if so, trim the i.f. transformer cores carefully for maximum volume without instability.

If some instability is evident on peaking these transformers, it is probably an indication that the particular OC45's used are not being completely neutralised and, in this case, it may be necessary to replace C12 or C13 with slightly higher or lower values. If a signal generator is available, set the cores to 455 kHz initially, then stagger-tune the first and last ones slightly to increase band-width.

Assuming no signals are heard on rotating the tuning capacitor, but slight hiss is audible (indicating that the a.f. section, at least, is functioning), try moving the aerial coil towards one end of the ferrite rod, at the same time tuning slowly over the dial. Next, turn the oscillator core first inwards then outwards about half a turn, repeating these operations. If the set still appears to be dead it is probable that either a faulty connection or component is to blame, and it will be necessary to carry out a systematic check, preferably with a multi-meter and signal generator. As a general guide, the approximate values of voltage at the transistor electrodes, as measured with a Model 8 Avometer, are given in the accompanying Table.

Once the receiver is operational and the i.f. section aligned, the aerial and oscillator sections must be set to track correctly over the full tuning range. It is helpful, when making these adjustments, to appreciate the effects which each alteration will have on the tuning. Ideally, the aerial coil must tune from 1500 kHz to 550 kHz while the oscillator simultaneously

covers from 1955 to 1005 kHz, maintaining a constant i.f. difference over the full medium wave range. It should be relatively easy to set the oscillator core and the ferrite rod coil to bring in a station at the high frequency end of the band, with maximum volume, but adjustments may now be required to the ferrite coil as the tuning is rotated towards the low frequency end. *Decide, first of all, in which direction this coil has to be moved* to obtain maximum sensitivity as the frequency is decreased with the tuning capacitor. If the coil has to be pushed further on to the rod, this capacitor is not causing a sufficiently rapid decrease in frequency, and the remedy is to return to a signal at the high frequency end of the band, turn the tuning capacitor compression trimmer for the aerial gang slightly anti-clockwise, and compensate by moving the ferrite coil further on to the rod until volume is restored. Now try a station at the low frequency end and again note if the aerial coil has to be moved. If the aerial coil requires pushing away from the centre of the rod, reverse the above sequence. Repeat these operations until perfect tracking is achieved. Note that the settings of the oscillator core and oscillator trimmer will similarly alter the tracking but, in addition, station position will also be affected, and it may be necessary to adjust these two trimming elements first of all until correct station position, combined with full band coverage, is obtained.

Once the alignment has been completed, the receiver can be mounted inside its cabinet and a suitably marked dial glued in position. The set is then complete and ready for use.

TABLE

Voltages to positive line, as measured with Avometer No. 8, on 10 and 2.5 volt ranges, as applicable. (No-signal conditions and 9 volt supply applied to receiver.)

Transistor	Base	Emitter	Collector
TR1	1.35V	1.3V	7.2V
TR2	0.7V	0.6V	7.2V
TR3	1.0V	0.85V	7.2V
TR4	0.8V	0.7V	8.4V
TR5	0.25V	0.05V	8.6V
TR6	0.25V	0.05V	8.6V

WANSTEAD & WOODFORD RADIO SOCIETY

Would all who are interested in re-establishing the Wanstead and Woodford Radio Society to again be an active group forwarding radio/electronic hobbies in the London E.11/E.18 areas, please contact Ken Smith, G3JIX, at 82 Granville Road, E.17, or at The Electronics Laboratory, The University, Canterbury, Kent.



IF YOU'RE BUYING A HOUSE

Mortgage Protection

is the best Policy for you

If you're buying your house with the help of a Building Society or a private loan, a "Yorkshire" Mortgage Protection Policy will take care of your outstanding payment in the event of your premature death. And, if you wish, you can arrange a Protection "Plus" Policy, which gives you a substantial cash return at the end of the mortgage term. It costs so little yet means so much to your dependants. Leave them a home not a mortgage!

Please send for further details, without any obligation, of course.

THE YORKSHIRE INSURANCE COMPANY LTD

Chief Offices: Rougier Street, YORK
and Becket House, 36-37 Old Jewry, LONDON E.C.2

Please send me further particulars of the
"Yorkshire" Mortgage Protection Policy

Name.....

Address.....

J/B

SIMPLE COLOUR PRINTER

by

A. KYPRIOTIS

The successful printing of colour photographs requires a considerable degree of skill and experience if the resultant prints are to have correct colour balance and density. This article describes an inexpensive electronic device which automatically regulates exposure time for three enlarger filters

AUTOMATIC COLOUR PRINTERS ARE USUALLY EXPENSIVE high-class instruments which are difficult to obtain by the amateur or the small-scale professional photographer. This fact directed the author's efforts in designing a really inexpensive but quite reliable instrument suitable for users in this class.

The colour printing equipment to be described need cost no more than a few pounds, and it gives about 80% acceptable prints from a wide variety of colour negatives of the same make. Its chief disadvantage is low production rate.

DESIGN CONSIDERATIONS

Between additive and subtractive methods (Ref. 1) of colour printing, the first was selected because it uses only three filters and therefore requires quite a simple mechanical assembly for filter changing. With this method three separate exposures are made, these being through a 100% blue, green and red filter respectively for a suitable period of time each.

A light-sensitive device is employed to measure the amount of light passed by a specific negative for each filter. A number of light-sensitive devices are available but most are expensive, require high voltages or have to be employed in complicated circuits. However, one light-sensitive device, the light dependent resistor (or photoconductive cell), does not suffer from these disadvantages. It has a high sensitivity to white light, a very low price, and requires no high voltages or complicated circuits. An excellent black and white printer using a light dependent resistor has been described by J. L. Linsey Hood (Ref. 2) and this gave the present author the idea of developing a similar instrument for colour prints. In the black and white printer design, an l.d.r. is used to measure the light scattered from the surface of the printing paper and to control, by way of a simple integrating circuit, the exposure time. The process may be summarised by stating that a starting switch turns on the enlarger lamp and at the same time enables a capacitor to charge via the l.d.r. When the capacitor voltage increases over a certain value it actuates a relay by way of a transistor amplifier circuit, and the relay contacts then switch the enlarger lamp off. Since the resistance of an l.d.r. reduces as the brightness of its illumination increases, it follows that exposure time varies inversely as the average brightness of the image on the printing paper.

Returning to the present design, it has to be pointed out that the use of an l.d.r. as a colour sensing element presents a lot of problems due to its low speed at low light intensities, its low sensitivity to blue and green light, and its temperature dependence. These disadvantages have, however, been compensated to some extent in the design.

Low speed has been compensated for by sacrificing full automation and by making the instrument operational in two steps. First, ordinary white paper is inserted on the easel in place of the printing paper and, with the negative in place, the light value for each filter colour is "memorised" by setting up a separate variable resistor to balance a bridge incorporating the l.d.r. The variable resistors are next switched to a timer circuit and the printing paper is fitted. The timer circuit is then activated so that the enlarger lamp is lit for a period controlled by the variable resistor setting for each filter.

Of course, this procedure slows down production rate and this is the main disadvantage of the instrument.

The low sensitivity to blue and green light has been taken up by choosing suitable component values for the measuring circuits corresponding to the appropriate filters. These component values were selected after examining the performance of an l.d.r. under real printing conditions, the results being given in the accompanying table. The measure-

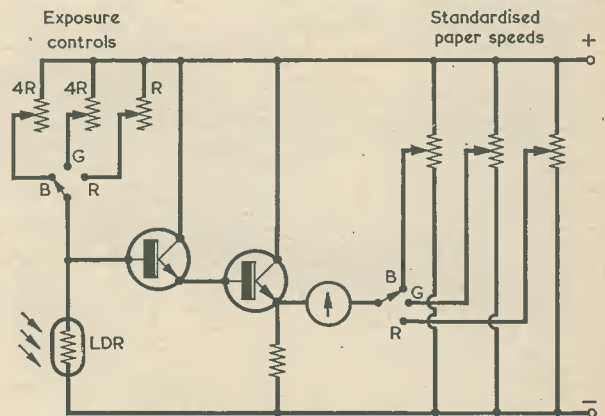

Fig. 1. The basic bridge circuit in which the l.d.r. appears during the "measure" operation

ments shown in the table were made with reflected light from a square white surface measuring 9 by 9 cm. The l.d.r. was placed at a distance of about 15 cm. from the surface. The light was integrated by a lens of 8 mm. diameter and 3 mm. focal length and focussed on a 4 by 4 mm. area of the l.d.r. The l.d.r. resistance values shown are mean values for a number of negatives considered as representative of their class. The l.d.r. was a Philips LDR03 (Ref. 3)¹. It should be mentioned that the filters referred to in the table are not exactly the correct ones. The recommended ones are Kodak Wratten No. 70 Red, No. 99 Green and No. 98 Blue, or Agfa No. 45 Red, No. 54L Green and No. 552 Blue.

Temperature stabilisation for the l.d.r. was achieved by mounting it on a large piece of brass and ensuring that only low voltages were applied to it.

negatives, sufficient control will be provided by the three lower value variable resistors, R3, R4 and R5. R6, R7 and R8 are useful when dealing with negatives which deviate considerably from the average. The two transistors of Fig. 1 are shown as TR1 and TR2, and the three paper speed potentiometers as R14, R16 and R18. The meter is the centre-zero component M1, this being protected against excessive current by the two diodes D1 and D2 connected across it.

S2(a) to S2(e) constitute the colour selection switch, and it will be seen that section S2(e) connects to three solenoids. These solenoids actuate the filters in the manner shown in Fig. 3. The assembly of Fig. 3 is positioned 2 to 3 cm. below the enlarger lens system.

The supply to the main part of the circuit is stabilised at 18 volts by the zener diodes D3 and

TABLE
L.D.R. Resistance
L.D.R. : Philips LDR03.
Enlarger lamp : Philips Photocrescenta 150W.
Filters : Gevaert Red L 599, Green U 525, Blue U 438.

Filter	Without negative (kΩ)	Normal negative (kΩ)	Very dense negative (kΩ)	Maximum variation (kΩ)
Red	50	250	400	350
Green	200	1,000	1,500	1,300
Blue	300	1,200	1,700	1,400

CIRCUIT DESCRIPTION

Three bridge circuits are used for red, green and blue, these appearing in the basic form illustrated in Fig. 1. Since l.d.r. sensitivity for blue and green is lower than it is for red, the variable resistors in the l.d.r. side of the bridge for these two colours have four times the value of that employed for red. This simple arrangement proved quite satisfactory for compensation of l.d.r. and enlarger lamp spectral response inequalities. Variations in the brightness of a single colour are easily detected, particularly if the paper speed controls are adjusted near their centre positions. These controls are given by the three potentiometers on the right, and these are set up to accommodate the speed of the printing paper employed. Because the current in the l.d.r. section of the bridge is low, this arm of the bridge is coupled to the meter by two transistor emitter followers in cascade. (The two emitter followers also provide the required base current for the relay switching transistor, this being the main reason for their presence in the circuit.)

The full circuit diagram appears in Fig. 2. The timer section is similar to that described by J. L. Linsey Hood but has been somewhat simplified by the omission of a transistor, this being possible owing to the use of a relay which needed only 4mA to energise and because the l.d.r. used here is more sensitive.

The three variable resistors shown at the left of Fig. 1 appear in Fig. 2 as R3 to R8. For many

D4. These diodes also ensure that the emitter of TR3 is maintained at 8 volts positive of the lower supply rail. The relay coil A/1 appears in the collector circuit of TR3. Its contact set A1 controls the enlarger lamp and it should be noted that this contact set is closed when the relay is de-energised.

Switch S1(a) to S1(c) controls the two modes of the equipment. The setting "M" stands for "Measure" and the setting "E" for "Exposure". S4 is a s.p.d.t. push-button, whilst S3 switches the filter solenoids on and off. S3 is normally switched off when preliminary adjustments in the enlarger, such as positioning of the negative, etc., are being carried out.

The equipment is operated, with a typical negative, in the following manner. Without printing paper fitted, S3 is switched off and the negative set up. S1 should be in position "M" and S2 in position "R" (or "B" if it is intended to start in the sequence blue - green - red). S3 is next switched on, whereupon the red filter is selected by S2(e). S2(a) switches in variable resistors R5 and R8, and these are set up to give a zero reading in the meter. S2 is next switched to "G", and R4 and R7 similarly adjusted. S2 is finally set to "B", whereupon R3 and R6 are set up. The three sets of variable resistors now hold the required information concerning the brightness of the negative at the three filter colours.

S1 is now set to "E", causing the arm of S2(a) to connect to C1 via S4 and S2(b). However, C1 has already been fully charged to the 18 volt supply by way of R11, and so the arm of S2(a) also takes up this potential. The potential is also applied, by way of emitter followers TR1 and TR2, and S1(c),

¹ The LDR03 is available from Henry's Radio, Ltd. An equivalent is the ORP12.—Editor.

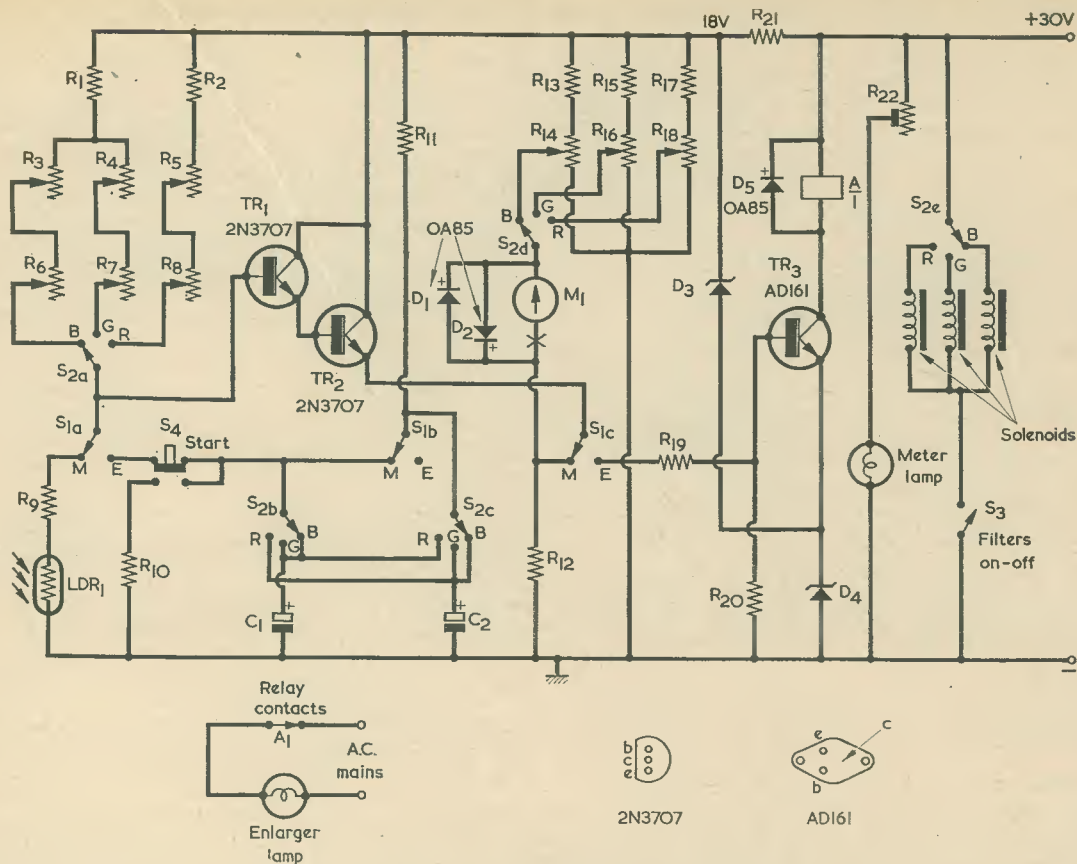

Fig. 2. Complete circuit of the automatic colour printer equipment

to R19. In consequence, TR3 conducts. The relay energises and its contacts open, extinguishing the enlarger lamp. The printing paper is now fitted.

The Start button S4 is next pressed, whereupon it discharges C1 via R10. When the button is released it applies the discharged capacitor to the arm of S2(a), whose potential drops to zero. So also does the potential applied to the base of TR3, whereupon this transistor becomes non-conductive and the relay de-energises. The relay contacts close and the enlarger lamp is switched on.

As soon as the Start button was released, C1 commenced to charge via the variable resistors selected by S2(a). The potential at the arm of S2(a) goes positive, as also does that at the base of TR3. When this potential exceeds that on its emitter by a sufficient amount, TR3 conducts, energises the relay and turns off the enlarger lamp.

S2 is next to "G" and the Start button pressed again, whereupon the process is repeated once more. S2 is set to "R" and the Start button finally pressed, allowing the timing action to occur once more. This time, however, the timing capacitor is C2 instead of C1. The exposures are now all complete, the length of each having depended on the settings given to variable resistors R3 to R8 during the "Measure" operation.

Some further points need to be discussed. C2 is switched in when S2(b) selects "R" because the

variable resistors in the red l.d.r. bridge arm have a quarter of the value of those in the green and blue arms. Since C2 has four times the capacitance of C1 the same range of time constants is available. In practice, the maximum exposure time for each colour is about 10 seconds. It is necessary for both C1 and C2 to be maintained in the charged condition whilst S1 is in the "M" position as, otherwise, they may cause the relay to de-energise for a short period (and thereby turn on the enlarger lamp)

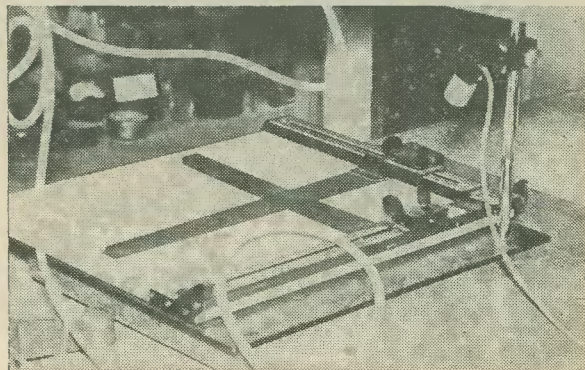

The measuring head, incorporating the l.d.r., in position ready for use

when S1 is set to "E" or when, subsequently, C2 is switched in after C1.

Another point not yet mentioned is concerned with R22. This is connected in series with a meter lamp and is adjusted so that the meter can be read under darkroom conditions without producing excessive light.

PAPER SPEED ADJUSTMENTS

Paper speed adjustments are given by R14, R16 and R18.

Here, a good normal negative with, as far as is possible, equal amounts of red, green and blue in it is necessary. This negative must be kept as a standard for other negatives of the same make. Some trial prints should be made in order to find the right exposure times for every colour of the standard, these exposure times being set up by means of R3 to R8. R14, R16 and R18 are ignored at this stage. When the l.d.r. variable resistors have been correctly adjusted for the standard, S1 is set to "M" and R14, R16 and R18 adjusted in turn for zero indication in the meter.

If it is found that the paper speed controls are not roughly in their central positions, the process is repeated after having increased or decreased the light intensity as necessary by means of the iris of the enlarger lens.

COMPONENTS

Most of the components are standard types. All

the variable resistors and potentiometers are panel mounted. If difficulty is experienced in obtaining a suitable push-button for S4, a spring-biased toggle switch may be employed instead.

D3 and D4 have nominal zener voltages of 10 and 8 volts respectively. D3 should be capable of dissipating some 240mW and D4 (according to relay coil resistance) up to about 300mW.²

TR1 and TR2 are silicon n.p.n. transistors with a maximum collector voltage rating in excess of 18 volts and an hfe greater than 100. A wide range of transistors can satisfy these requirements, a suitable example being the 2N3707. TR3 may be a germanium transistor capable of meeting the collector voltage and current and reverse base-emitter voltage figures imposed by the circuit, and a suitable type would be the AD161. This is used well within its dissipation figure and does not need to be mounted on a heat sink. Other transistors meeting the general requirements in the circuit could alternatively be employed.

The relay used in the prototype is not generally available but a suitable alternative should not be difficult to obtain. Coil resistance should not be less than 1kΩ.³

The meter used in the prototype is a 200-0-200μA centre-zero instrument. If difficulty is experienced

² Suitable zener diodes, with more than adequate dissipation in hand, are the ZL10 and ZL8 available from Henry's Radio, Ltd.—Editor.

³ A Post Office type 3000 relay with 1,000Ω coil and a single set of high voltage twin platinum break contacts would be satisfactory. Post Office type 3000 relays are available from L. Wilkinson (Croydon) Ltd., Longley House, Longley Road, West Croydon, Surrey.—Editor.

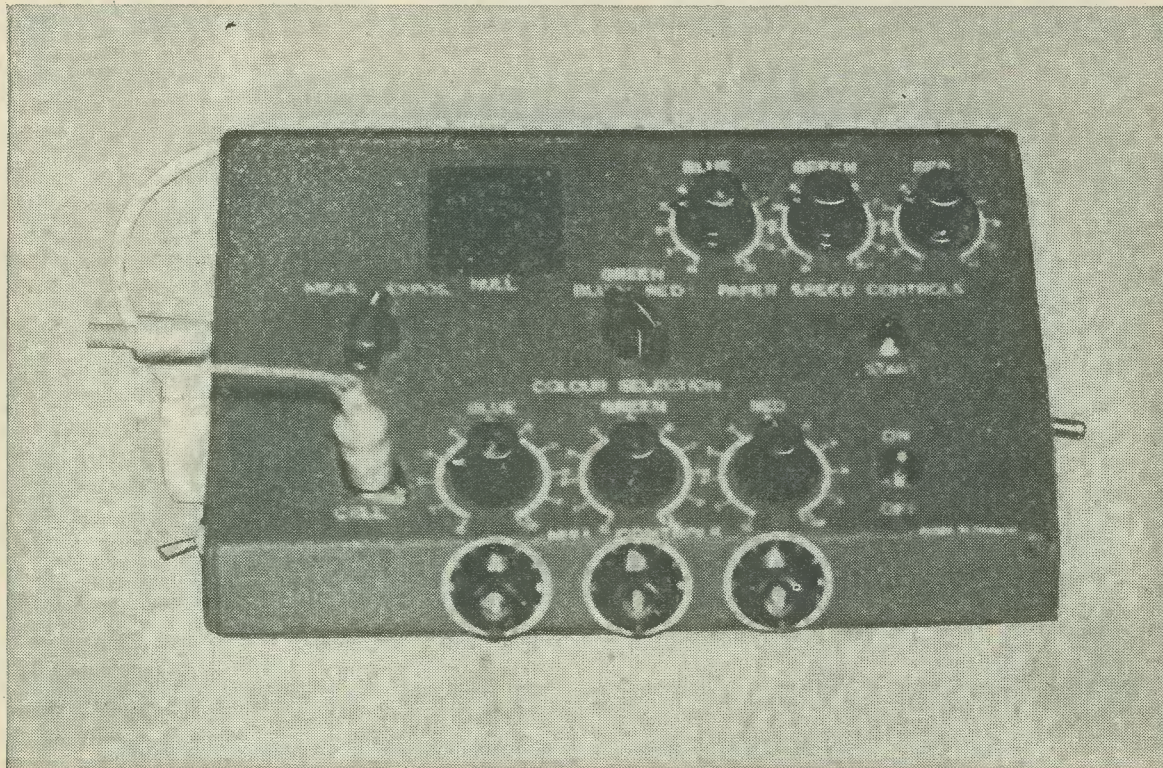

The prototype instrument. The upper three controls are those for paper speed control, and immediately below these are S1, S2 and S4. At the bottom of the sloping panel are a socket for the measuring head, R3, R4, R5 and S3; whilst R6, R7 and R8 are mounted on the front apron

COMPONENTS

Resistors:

(All fixed values $\frac{1}{2}$ watt 5%)

R1	56k Ω
R2	12k Ω
R3	200k Ω potentiometer, linear
R4	200k Ω potentiometer, linear
R5	50k Ω potentiometer, linear
R6	2M Ω potentiometer, linear
R7	2M Ω potentiometer, linear
R8	500k Ω potentiometer, linear
R9	2.7k Ω
R10	100 Ω
R11	56k Ω
R12	22k Ω
R13	2.2k Ω
R14	20k Ω potentiometer, linear
R15	2.2k Ω
R16	20k Ω potentiometer, linear
R17	2.2k Ω
R18	20k Ω potentiometer, linear
R19	470 Ω
R20	56k Ω
R21	560 Ω
R22	Preset potentiometer (see text)

Capacitors:

C1	3 μ F electrolytic, 25V wkg.
C2	12 μ F electrolytic, 25V wkg.

Semiconductors:

TR1	2N3707 (see text)
TR2	2N3707 (see text)
TR3	AD161 (see text)
D1	OA85
D2	OA85
D3	10V zener diode (see text)
D4	8V zener diode (see text)
D5	OA85

Meter:

M1	200-0-200 μ A centre zero meter (see text)
----	---------------------------------------------------

Switches:

S1	3-pole 2-way, rotary
S2	5-pole 3-way, rotary
S3	s.p.s.t., toggle
S4	s.p.d.t., press button

Photoconductive Cell:

LDR1	Cell type LDR03
------	-----------------

Miscellaneous:

Relay with single break contact set (see text)
 Meter lamp (see text)
 3 solenoids (see text)
 Knobs, as required
 Hardware for measuring head and filter unit
 Plugs and sockets, as required

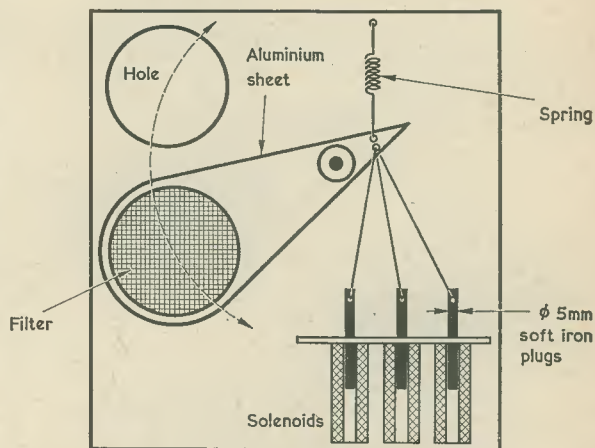
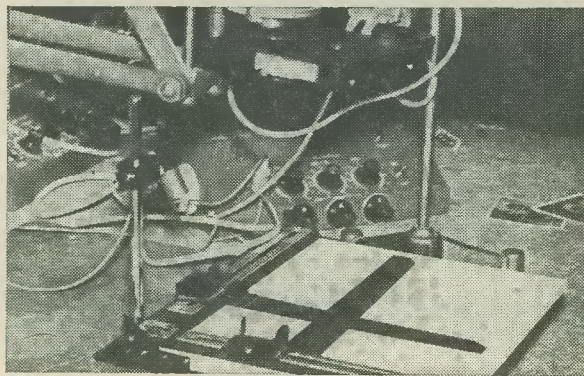

Fig. 3. The filters are selected by solenoids, as shown here

In the filter system shown in Fig. 3, three gelatine filters were fixed to three thin aluminium sheets cut to the shape shown. Each solenoid consists of 6,000 turns of 40 s.w.g. enamelled wire.

The power supply for the equipment should be capable of offering 30 volts d.c. at some 150mA plus the current drawn by the meter lamp.

All the components are fitted in a metal case which *must* be connected to a reliable mains earth. Apart from other reasons this precaution is necessary because the relay contacts switch a mains circuit. Suitable sockets are provided for connection to the l.d.r., the solenoids and the enlarger lamp circuit.



The filter unit of Fig. 3, positioned just below the enlarger lens assembly

The measuring head incorporating the l.d.r. is shown in one of the accompanying photographs. It is positioned at a distance of about 15 cm. for a 9 by 9 cm. enlargement. The l.d.r. is mounted on a brass block measuring 2 by 2 by 6 cm., this having been suitably machined to take the l.d.r. contour. The lens assembly is that described earlier.

(Continued on page 185)

in obtaining a similar meter, a 100-0-100 μ A movement may be incorporated instead. With the more sensitive meter it may be necessary to insert a fixed resistor of some 500 Ω to 2k Ω at the point marked in Fig. 2 with a cross to ensure that D1 and D2 limit needle movement within f.s.d. The meter is provided with a small lamp and it is left to the constructor to choose a suitable type, to select the required value for R22 and to devise the manner in which the lamp is mounted.

NEOPHYTE AUDIO AMPLIFIER

by

R. J. CABORN

AN A.F. AMPLIFIER IS ALWAYS AN ATTRACTIVE ITEM of equipment as it not only lends itself to domestic entertainment requirements but can also be used for experimental or servicing work in the workshop. Although designed primarily for entertainment purposes, the "Neophyte" amplifier offers many more serious functions as well. An interesting departure from normal practice is the inclusion of a switch in the negative feedback loop. When this switch is opened, the amplifier offers increased gain without, of course, the benefits of distortion reduction which are imparted by feedback. With the negative feedback switch closed, the amplifier is mainly intended for monaural reproduction from a crystal gramophone pick-up. It may also accept inputs of about the same amplitude from radio tuner units and other a.f. signal sources.

It was decided to present the article describing this amplifier in a different manner to the usual form. The reader will find that the drilling and wiring diagrams are published in a special pull-out section in the centre of the magazine. If desired, the constructor may remove these diagrams and keep them directly in front of him on the bench as he proceeds with construction. There is, then, no necessity to turn the pages of the magazine to consult the drawings whilst following instructions contained in the text.

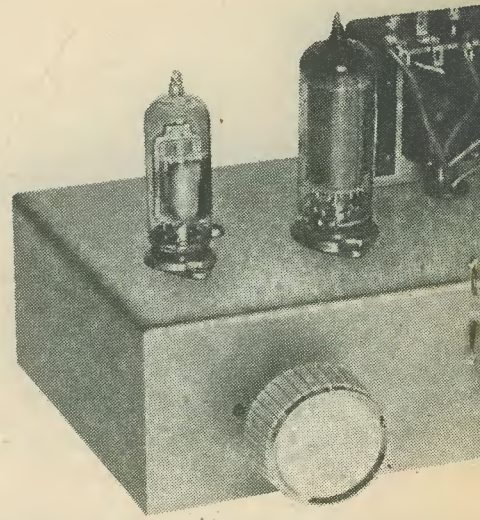

Designed for ease of assembly, this amp is simple for the beginner to follow and controls are provided, and an unusual negative feedback loop. To assist in diagrams are published in the spec

THE CIRCUIT

The circuit of the amplifier appears in the accompanying diagram. Signal input is applied to jack socket J1 and then passes to the bass tone control network given by C1, VR1 and R1. The bass control network is followed by volume control VR2, the

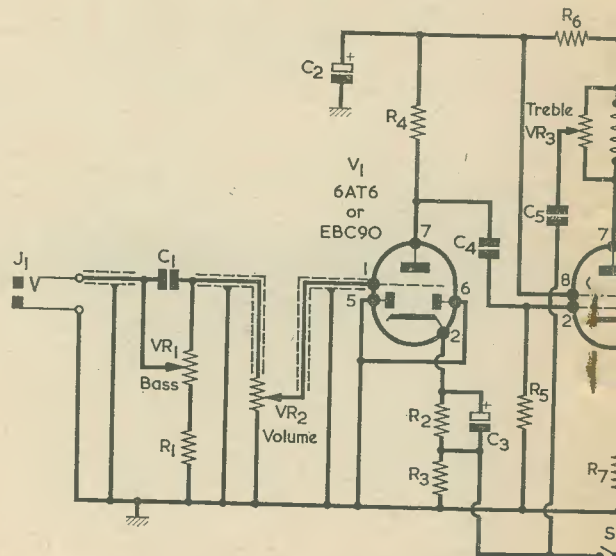

The complete circuit of the "Neophyte" 5-watt by a single contact-coo

THE RADIO CONSTRUCTOR



Cover Feature

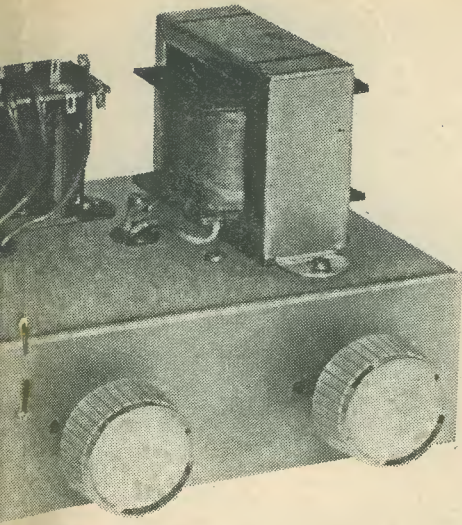

amplifier employs a reliable circuit which is easy to build and understand. Treble and bass tone control features are the inclusion of a switched feedback loop. In construction, the drilling and wiring are simple. This is a special removable section of this issue.

The slider of which couples to the grid of V1 triode. All the input circuitry is at high impedance, and is suitable for the direct connection of a crystal pick-up. The interconnecting wires inside the amplifier are screened in order to suppress mains hum.

V1 is a double diode triode, the two diodes of which are unused and are connected to chassis. The

amplified signal at the anode of V1 couples to the control grid of V2 by way of C4 and grid resistor R5. V2 is a beam tetrode type 6BW6. This is the B9A version of the octal 6V6, the latter being a valve which has acquired well-earned popularity over a considerable period because of its ability to provide a low-distortion a.f. signal in non-critical single-valve output stages.

The anode signal from the 6BW6 is applied to the primary of output transformer T1, this having a ratio suitable for coupling to a 3Ω loudspeaker. The treble tone control, VR3, is connected across the primary of T1 and its function is to apply a selected proportion of the anode signal to C5, and thence to the cathode of V1. This represents a negative feedback loop, the value of C5 being such that the signal level fed back increases with frequency. Thus, the circuit causes less amplification to be given to the higher audio frequencies, and provides a variable control of treble attenuation.

Another negative feedback connection is taken from the secondary of T1 and applied, via R8 and S1, to the cathode of V1. The addition of S1 is a novel feature in an amplifier of this nature, and it increases the versatility of the design at the cost of only one component, this being the switch itself. If, for any reason, a higher degree of gain is required than would be available with feedback applied, S1 is opened. The amplifier then offers increased gain, but without the reduction in distortion imparted by the feedback. The tone control offered by VR3 is still available when S1 is opened.

The power supply employs a mains transformer offering complete isolation from the mains. An extremely economical combination is provided by the use of a contact-cooled bridge rectifier (D1 to D4) in conjunction with a transformer having a single untapped 230 volt h.t. secondary. The transformer employed does not have a centre-tapped 6.3 volt heater winding and it would be normal practice to have one side of the heater supply circuit connected to chassis. However, due to the facts that V1 grid is at high impedance and that the circuit may be built by newcomers to the hobby, it was decided to provide an effective centre-tap into the heater supply by means of the two equal-valve resistors, R10 and R11, their junction being connected to chassis. This eliminates a possible cause of hum before construction is even commenced and, for the cost of two resistors, the extra precaution was considered worthwhile. In the amplifier, as built, the connections to the heaters of V1 and V2 are carried out with twisted wiring.

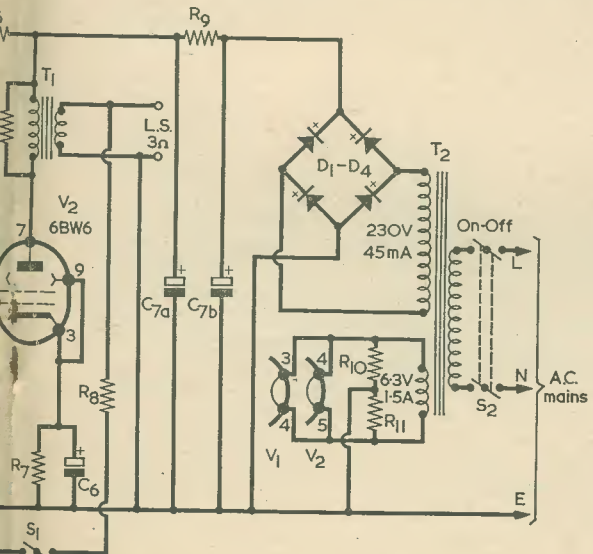

10-watt amplifier. Rectifiers D1 to D4 are provided in a contact-cooled bridge rectifier

OCTOBER 1969

COMPONENTS

The components required for the amplifier are specified in the accompanying Components List, and a few words are required concerning some of these.

It will be noted that the electrolytic capacitors have their manufacture and type, or a retail catalogue number, quoted. The reader is strongly advised to obtain the types specified, as alternative components of the same capacitance and rating may prove to be

bulkier in size. This point applies in particular to C7AB, which has to fit between two tagstrips.

The output transformer quoted is a type intended for operation at 5 watts, as is available from the 6BW6 in the circuit employed here, and it would be unwise to attempt to use a smaller component. The transformer is listed in the Home Radio range of economically priced output transformers, with manufacturers "as available". In consequence, the tag positioning of the specific transformer obtained by the constructor may vary from that in the transformer used for the prototype. The constructor should initially satisfy himself concerning the tags to which the primary and secondary windings connect: if no other indication is provided, it will usually be found that the secondary leads from the winding to the tags consist of the enamelled wire employed in the winding itself, whilst the primary leads from the winding are p.v.c. covered. Also, the secondary will have a very low resistance, whilst the primary will have a resistance of the order of 300Ω.

The mains transformer should have an indication as to which of its leads connect to the primary (or transformer "input") and which to the 230 volt h.t. secondary. It is usual practice for the h.t. secondary leads to be covered with red insulation. The transformer used in the prototype had no mains primary tappings. Should such tappings be provided, the constructor should select the tap appropriate to the local mains voltage, tape up the remaining primary leads separately and tuck them out of the way in any convenient manner so that there is no risk of their short-circuiting to chassis or to any other component. The 6.3 volt heater winding lead-outs will consist of the enamelled copper wire with which the heater secondary is wound.

The dimensions given in the chassis drilling diagram apply only to the two transformers specified.

The tagstrips quoted are Lektrokit types, these being 5-way with the centre-tag earthed (i.e. the centre tag is used also for mounting the tagstrip to the chassis). The four non-earthly tags have anchoring points at the upper and lower ends, and this fact is of assistance during wiring. The tagstrips are not sold singly, and it is necessary to purchase them in packets of twelve. Thus, some tagstrips will be left over for other projects after the amplifier has been built.

The three controls, VR1, VR2 and VR3/S2, will be supplied with spindles which are probably too long for most requirements. The spindles should be cut to the desired final length with a hacksaw before fitting the controls to the chassis.

A further point is concerned with the fact that a short length of single screened wire is required for connections inside the amplifier. Television aerial coaxial cable *could* be used here, but it is rather bulky for the present purpose. A neater job will result if the constructor uses the much thinner type of screened flexible cable which is intended for a.f. wiring.

The mains lead must be a 3-core type of suitable length, and it should be terminated in a 3-way mains plug with earth connection. It is preferable to use a mains lead having a p.v.c. outer sheath rather than one with a woven fabric covering, since the former is easier to handle. As is described later, a small cable clamp has to be made up to anchor the mains lead inside the chassis.

PREPARING THE CHASSIS

Drilling dimensions for the chassis are given on the first sheet of the pull-out section. The chassis material is 16 s.w.g. aluminium.

The upper drawing shows the view looking down on the top of the chassis. The $\frac{5}{16}$ in. and $\frac{3}{16}$ in. holes are for the B7G valveholder (V1) and B9A valveholder (V2) respectively. When these holes have been cut out, use the valveholders themselves as templates for marking out the two 6BA clear mounting holes (indicated as "A") required for each valveholder.

The three $\frac{3}{16}$ in. holes are intended for rubber or p.v.c. grommets. The drawing indicates, also, the mounting holes which will be used by T1 and T2.

The centre diagram shows the front apron as viewed when looking at the front of the chassis. Three holes for the controls are required here, as indicated. The $\frac{1}{4}$ in. holes alongside the bush-mounting holes are intended for the locating lugs of these controls.

The lower diagram illustrates the rear apron as seen when observing the chassis from the rear. Two sets of holes on the rear apron have to be marked out with the aid of the components themselves. First, take up the rectifier obtained for D1-D4, centralise it on the line between X and X', then mark out the two 6BA clear holes required for mounting along the central horizontal line. Secondly, initially drill the two $\frac{1}{8}$ in. holes at the centre of the rear apron. Then, take up the 2-way terminal board, hold it against the apron in its final position and, ensuring that its internal tags and screws do not short-circuit against the edges of the two $\frac{1}{8}$ in. holes, mark out its 4BA clear mounting holes. The $\frac{3}{16}$ in. hole in the rear apron is for a grommet, and the remaining two holes for the jack socket and switch S1.

When drilling is complete, clean up the chassis and remove all burrs, etc. Ensure that the locating lugs of the three front panel controls fit comfortably into their $\frac{1}{4}$ in. holes. Check, in particular, that there are no burrs or other projections on the holes for D1-D4 which would prevent this component from making good thermal contact to the chassis. No components are mounted at this stage.

WIRING AND ASSEMBLY

The next process consists of wiring and assembly, and the constructor should work from the wiring and layout diagram on the centre sheets of the pull-out section. Here, the front and rear aprons are shown "opened-out" for convenience of illustration. Note that the tags of the tagstrips are numbered 1 to 20 to facilitate identification. The upper anchoring points for the tags (i.e. those furthest away from the chassis) are assumed, in the diagram, to project on the opposite side of the Paxolin strip to the mounting lug. (In practice, both anchoring points are on the same side of the strip.)

In the assembly steps which will next be given, soldering at a particular tag should only be carried out when stated. This avoids the rather undesirable practice of adding a lead to a tag which is already soldered up. All soldered connections must be made with the aid of resin-cored solder, such as is manufactured by Multicore Solders Ltd. On *no* account attempt to use a paste or liquid flux.

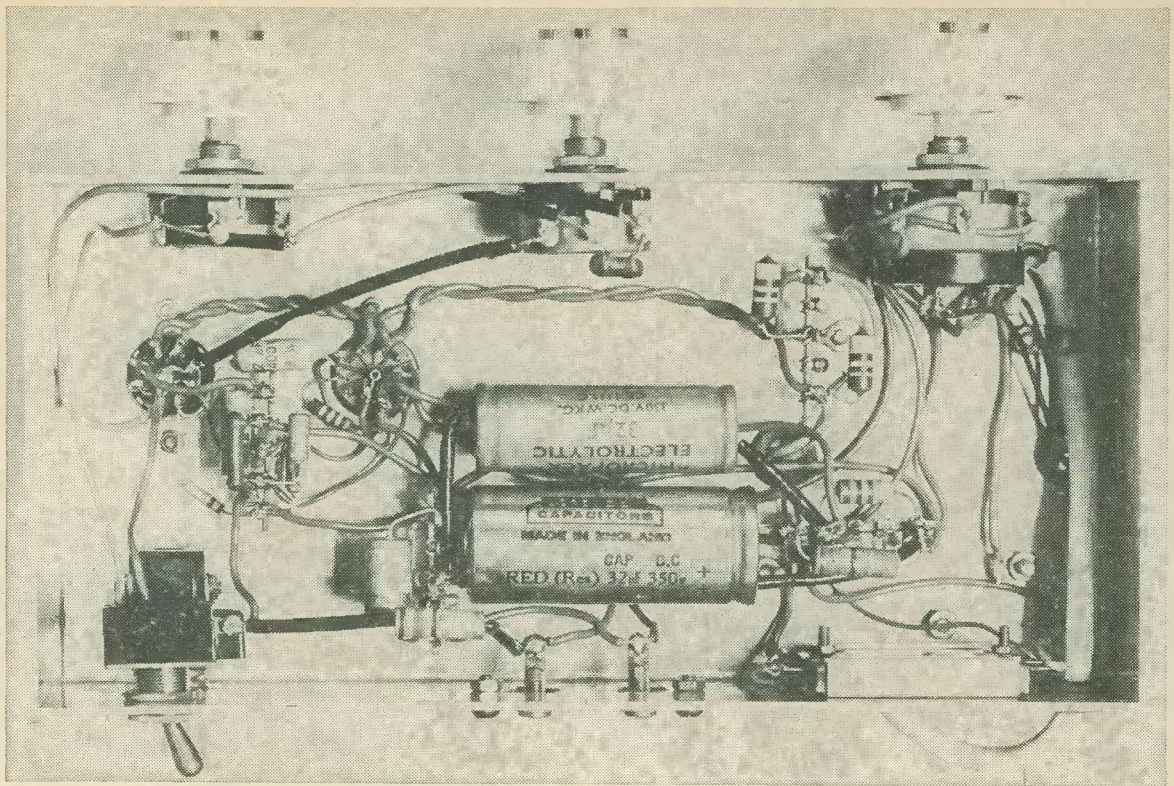

Photo 3. The layout under the chassis. Although compact, there is no crowding of components

1. Mount tagstrips 1-5, 6-10 and 16-20 with 4BA nuts and bolts, so that they take up the positions shown in the wiring diagram. Be careful to ensure correct orientation.

2. Mount V1 and V2 valveholders with 6BA nuts and bolts, orientating these so that pins 3 and 4 of V1 valveholder, and pins 4 and 5 of V2 valveholder, are nearest the front apron.

3. Fit all four grommets to the top surface and rear apron.

4. Take up the mains lead and strip back its outer sheath for 3½ in. Pass the stripped end through the rear hole intended for it. Fabricate a simple cable clamp from an oddment of metal (quite an adequate clamp may be made by suitably bending a centre lug taken from one of the unused tagstrips) and clamp the cable as illustrated in the diagram, using a 4BA nut and bolt. If there is any risk of the cable sheath chafing against the clamp, wrap p.v.c. insulating tape around it.

5. Fit a 4BA chassis tag, as shown, and solder the earth mains wire (green and yellow striped with the new mains lead coding system) to this.

6. Mount the mains transformer, T2, with 4BA nuts and bolts, fitting plain washers under the bolt heads. The four secondary lead-outs pass through the grommet adjacent to tagstrip 1-5, and the primary lead-outs pass through the grommet over which the mains lead passes. If the primary has voltage taps, deal with these as described earlier.

7. Shortening as necessary, connect the 6.3 volt

secondary leads from T2 to tag 1 (lower) and tag 5 (lower). Take care to ensure that the enamel on the transformer leads has been removed and that the copper underneath is properly tinned. Solder at tag 1 (lower) and tag 5 (lower). It does not matter which secondary lead connects to which tag.

8. Using two wires twisted together, connect pins 3 and 4 of V1 to pins 4 and 5 of V2. Again using two wires twisted together, connect pins 4 and 5 of V2 to tag 1 (upper) and tag 5 (upper). Solder the four connections made at V1 and V2.

9. Connect R10 (150Ω) between tag 1 (upper) and tag 3 (upper). Connect R11 (150Ω) between tag 5 (upper) and tag 3 (upper). Solder at tags 1, 3 and 5 (all upper).

10. Fit VR3/S2 to the front apron. With an ohmmeter or any simple continuity tester identify the tags of the switch sections which correspond to the switch poles, as the tag positions with some switches may differ from those shown in the diagram.

11. Shortening as necessary, connect the line and neutral wires from the mains lead to one side each of the two switch poles. (With the new coding system, brown is live and blue is neutral). Shortening as necessary, connect the two primary leads of the mains transformer to the other sides of the two switch poles. It does not matter which primary lead connects to which switch pole. Solder all four connections at S2.

12. Mount the rectifier D1 to D4, with its flat side against the chassis inside surface, using ½ in. 6BA bolts and fitting shakeproof washers both under the

bolt heads and under the nuts. The rectifier lugs should take up the positions shown in the diagram.

13. Shortening as necessary, connect the 230 volt h.t. secondary leads from T2 to the two a.c. tags (marked with a "sine wave") of the rectifier. Solder these two connections. It may be found convenient to pull a few inches of the mains lead inside the chassis and keep it out of the way whilst soldering the tag adjacent to it. It does not matter which secondary lead connects to which rectifier tag.

14. Connect a wire between the negative tag (marked -) of the rectifier and tag 8 (upper). Connect a wire between the positive tag (marked +) of the rectifier and tag 10 (lower). Solder all these four connections.

15. Connect R6 (2.2k Ω) between tag 9 (upper) and tag 6 (upper). Connect R9 (270 Ω 2 watts) between tag 10 (upper) and tag 6 (upper).

16. Connect R4 (220k Ω) between pin 7 of V1 and tag 20 (lower). Connect a wire between tag 20 (lower) and tag 9 (lower). Solder at tag 20 (lower) and tag 9 (lower).

17. Connect C4 (0.02 μ F) between pin 7 of V1 and pin 2 of V2, so that it takes up the position shown in the wiring diagram. Similarly connect R5 (680k Ω) between pin 2 of V2 and V2 centre spigot. Connect a wire between V2 centre spigot and tag 18 (upper). Solder at pin 7 of V1, pin 2 of V2 and V2 centre spigot.

18. In this step and step 20, the components C3, C5, R2 and R3 are wired into circuit. For illustration these are shown further away from tagstrip 16-20 than they need be. The constructor should wire these components so that they are neatly parallel with the strip and close to it. Connect C5 (0.0022 μ F) between tag 17 (upper) and tag 19 (upper). Connect R3 (270 Ω $\frac{1}{2}$ watt) between tag 18 (upper) and tag 19 (upper). Connect a wire between V1 centre spigot and tag 18 (upper). Solder at tag 17 (upper) and tag 18 (upper).

19. Connect a wire between tag 17 (lower) and the centre tag of VR3, the wire following the route shown in the diagram. Solder both these connections.

20. Connect R2 (2.7k Ω) between tag 19 (lower) and tag 16 (lower). Connect C3 (25 μ F) between tag 19 (lower) and tag 16 (lower) with its positive end to tag 16. Solder at tag 19 (lower) and tag 16 (lower).

21. Connect a wire between pin 2 of V1 and tag 16 (upper). Solder both connections.

22. Using bare tinned copper wire, connect V1 centre spigot to pin 6 of V1 and thence to pin 5 of V1. Solder at pin 6 only.

23. Connect a wire between tag 20 (upper) and pin 8 of V2. Solder both these connections.

24. Connect a wire between pin 7 of V2 and the right hand tag of VR3 (see diagram). Solder at the tag of VR3.

25. Mount the output transformer T1 with 4BA nuts and bolts, so that its tags point inwards. Fit plain washers under the screw heads. This operation also incurs fitting tagstrip 11-15, which is secured under one of the mountings nuts for T1. Note the required orientation in tagstrip 11-15.

26. Connect together pin 3 of V2 and pin 9 of V2. (The wire used here should be normal insulated connecting wire and not bare, as was used for the inter-pin connections at V1). Connect a wire between pin 9 of V2 and tag 11 (lower). Solder at pins 3 and 9 of V2 and at tag 11 (lower).

27. Connect a wire between tag 13 (upper) and tag 15 (lower).

28. Connect R7 (270 Ω 2 watts) between tag 11 (upper) and tag 15 (upper). Connect C6 (50 μ F) between tag 11 (upper) and tag 15 (upper), with its positive end to tag 11. C6 may be mounted above R7, and not alongside as is shown, for purposes of illustration, in the diagram. Solder at tag 11 (upper) and tag 15 (upper).

29. Connect a wire between tag 6 (lower) and the left hand tag (see diagram) of VR3. Connect a wire between tag 6 (lower) and one primary tag (it does not matter which) of T1. This wire passes through the grommet adjacent to T1. Solder at the VR3 tag, at tag 6 (lower) and the T1 primary tag.

30. Connect a wire between the remaining primary tag of T1 and pin 7 of V2, passing it through the grommet. Solder at the T1 primary tag and at pin 7 of V2.

31. Mount the 2-way terminal board, using 4BA nuts and bolts.

32. Connect a wire between one tag of the terminal board and one secondary tag of T1 (it does not matter which). Connect a wire between the remaining tag of the terminal board and the remaining secondary tag of T1. Both wires pass through the grommet. Make temporary solder joints at the secondary tags of T1 as it may be necessary to transpose these two connections later.

33. Connect a wire between the right hand tag of the terminal board (see diagram) and tag 15 (lower). Solder at the terminal board tag and at tag 15 (lower).

34. Mount jack socket J1, with its tags projecting away from the underside of the chassis.

35. Connect a wire between the centre spigot of V1 and the tag of J1 which connects to the jack plug sleeve contact.

36. Take up the screened wire and connect one end to the tags of jack socket J1. The braiding connects to the jack plug sleeve contact and the centre conductor to the jack plug tip contact. Solder at both tags of the jack socket.

37. Mount VR2 and VR1.

38. Run the screened wire fitted in Step 36 over the route shown in the diagram and connect its centre conductor to the centre tag of VR1. No connection is made to the braiding at this end. To reduce the risk of short-circuits to whatever braiding may be exposed, it is of advantage to fit a short length of suitable sleeving over the end of the screened wire.

39. Connect the centre conductor of a further length of screened wire to the right hand tag of VR1 (see diagram). Again, no connection is made to the braiding, and, again, a short length of sleeving is advisable.

40. Connect C1 (300pF) between the centre and right hand tags of VR1. The body of this capacitor should be close to these two tags. Solder at the two tags of VR1.

41. Terminate the other end of the screened wire fitted in Step 39 so that its centre conductor connects to the right hand tag (see diagram) of VR2 and its braiding connects to the left hand tag of VR2. Fit sleeving over the braiding between the screened lead end and the left hand tag of VR2. Solder at the right hand tag of VR2.

42. Connect a further length of screened wire to

COMPONENTS

Resistors

(All fixed values $\frac{1}{2}$ watt 10% unless otherwise stated)

R1	1M Ω
R2	2.7k Ω
R3	270 Ω
R4	220k Ω
R5	680k Ω
R6	2.2k Ω
R7	270 Ω 2 watts
R8	2.7k Ω
R9	270 Ω 2 watts
R10	150 Ω 5%
R11	150 Ω 5%
VR1	2M Ω potentiometer, linear
VR2	1M Ω potentiometer, log
VR3	50k Ω potentiometer, linear, with S2

Capacitors

C1	300 μ F, ceramic or silver-mica
C2	32 μ F, electrolytic, 350V wkg., T.C.C. type No. CE111LC (Home Radio Cat. No. 2CK25)
C3	25 μ F, electrolytic, 6.4V Max., Mullard miniature
C4	0.02 μ F, paper or plastic foil, 350V wkg.
C5	0.0022 μ F, paper or plastic foil, 500V wkg.
C6	50 μ F, electrolytic, 25V Max., Mullard miniature
C7A,B	32 + 32 μ F, electrolytic, 350V wkg., Hunts wire-ended (Home Radio Cat. No. 2DJ22)

Transformers

T1	Output transformer, 5000 Ω to 3.75 Ω , 5 watts. (Home Radio Cat. No. TO44)
T2	Mains transformer, secondaries 230V 45mA and 6.3V 1.5A. Osmabet (Home Radio Cat. No. TM26A)

Valves

V1	6AT6 or EBC90
V2	6BW6

Rectifier

D1 - D4	Contact cooled bridge rectifier, 250V 75mA
---------	--------------------------------------------

Switch

S1	s.p.s.t. toggle
S2	d.p.s.t. part of VR3

Jack Socket

J1	Jack socket, Igranic type P71 (Home Radio Cat. No. JH5)
----	---------------------------------------------------------

Valveholders

1	B7G moulded valveholder with centre spigot
1	B9A moulded valveholder with centre spigot

Chassis

9 x 4 $\frac{1}{2}$ x 2 in., 16 s.w.g. aluminium chassis (H. L. Smith & Co. Ltd.)

Miscellaneous

4	5-way tagstrips, Lektrokit Part No. LK-2231 (Home Radio Cat. No. LK-2231)
1	2-way terminal board with captive screws (Home Radio Cat. No. Z101D)
3	knobs, 1 $\frac{1}{4}$ in. diameter (H. L. Smith & Co. Ltd.)
4	grommets, to fit $\frac{3}{8}$ in. holes
2	ft. single screened wire
3	-core mains lead
1	4BA solder tag
1	cable clamp (home constructed)
11	4BA bolts, cheese or round head, $\frac{3}{8}$ in.
11	4BA nuts
4	4BA plain washers
4	6BA bolts, cheese or round head, $\frac{1}{2}$ in.
2	6BA bolts, cheese or round head, $\frac{3}{8}$ in.
6	6BA nuts
4	6BA shakeproof washers
	Connecting wire, sleeving, etc.

VR2, with its centre conductor to VR2 centre tag and its braiding to VR2 left hand tag. Solder at the centre and left hand tags of VR2.

43. Following the route shown in the diagram, terminate this third screened wire at V1 valveholder, with the centre conductor connected to pin 1 of V1 and the braiding to V1 centre spigot. Solder at pin 1 of V1 and V1 centre spigot.

44. The next component to fit is R1 (1M Ω), and it is important that its body be positioned close to the tag of VR1 to which it connects. This necessitates extending one of its lead-outs by soldering a further length of tinned copper wire to it. After extending the lead-out, connect the short wire end of R1 to the left hand tag of VR1 (see diagram) so that the body

is close to the tag. Covering with sleeving as required, connect the extended end of R1 to pin 5 of V1. Solder at the left hand tag of VR1 and pin 5 of V1.

45. The main wiring is now complete and the constructor should next turn to the final wiring diagram given on the fourth sheet of the pull-out section. First fit switch S1. If this has a metal case, ensure that there is no risk of this case short-circuiting to the jack socket connection. There will be more than adequate clearance if a normal switch is used.

46. Connect a wire between the lower tag of S1 and tag 19 (upper). Solder at both connections.

47. Fitting sleeving over its lead-outs, connect R8 (2.7k Ω) between the left hand tag of the terminal

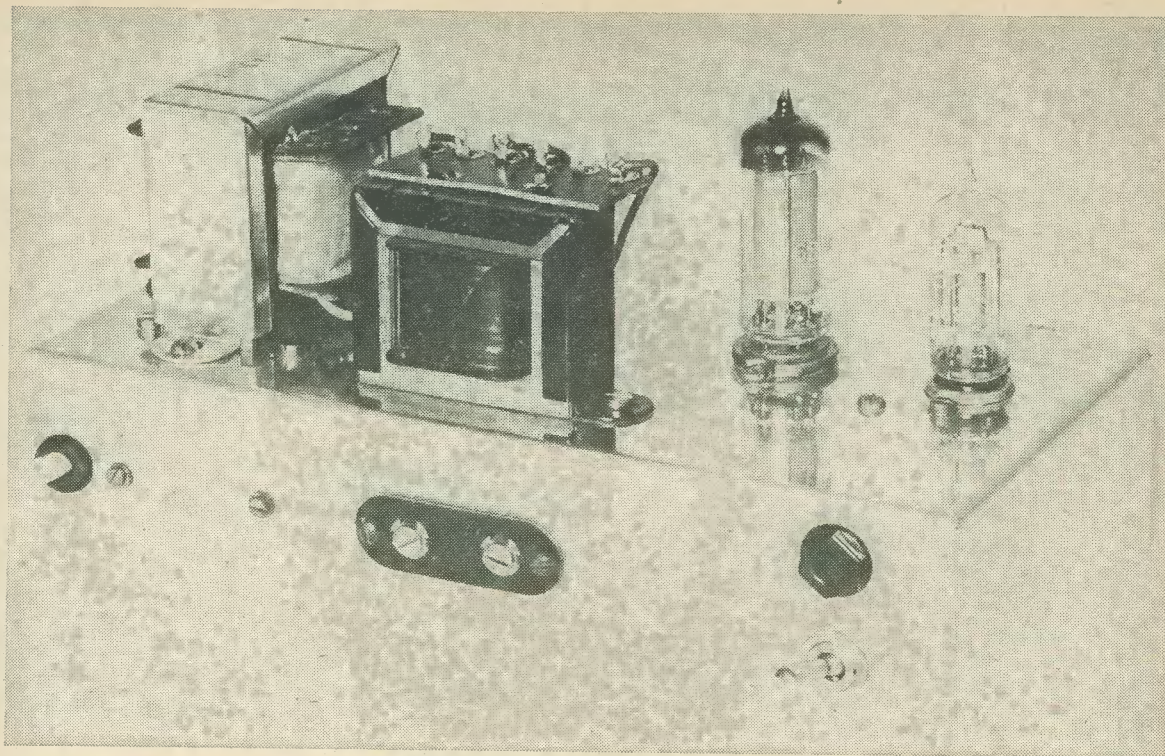

Photo 2. Rear view of the amplifier, illustrating the 2-way terminal board, switch S1 and the input jack socket

board and the remaining tag of S1. Solder at both connections.

48. Position C7AB ($32 + 32\mu\text{F}$) so that its red and yellow lead-outs take up the positions shown in the diagram, then connect the red positive lead-out to tag 10 (upper). Connect the common negative lead-out to tag 13 (upper) and, fitting sleeving over this last lead, the yellow positive lead-out to tag 6 (upper). Solder at tag 10 (upper) and tag 6 (upper).

49. Following the layout shown in the diagram, and fitting sleeving over both its lead-outs, connect the negative lead-out of C2 ($32\mu\text{F}$) to tag 13 (upper) and its positive lead-out to tag 9 (upper). Solder at both tags.

50. Fit knobs to VR1, VR2 and VR3. Insert the two valves.

51. Fit a suitable mains plug to the 3-way mains lead, taking care to ensure that the earth wire connecting to the amplifier chassis connects also to the earth pin of the plug.

TESTING

The assembly of the amplifier is now complete and it has next to be tested.

Two points have now to be mentioned so far as testing and subsequent use are concerned. First, the amplifier should not be operated without a speaker connected to it. This is because excessively high a.f. voltages may appear in the anode circuit of V2 if there is no load across the secondary of T1 and, if switch S1 happens to be open. Second, some form of supporting block should be used at the V1 end

of the chassis if this is inverted on the bench. Without such a support the chassis will rest on the top of V2, with consequent risk of damage to this valve.

The first step in testing is to visually check all wiring for poor joints, short-circuits between tags and any other obvious faults. Remove any excess blobs of solder which may have fallen into the chassis. If an ohmmeter is available check the resistance between the h.t. positive supply and chassis by connecting the meter between chassis and tags 10, 9 and 6 successively. The resistance should be well above $20\text{k}\Omega$, the meter needle giving an initial kick due to the h.t. electrolytic capacitors charging.

The next task is to check whether the negative feedback is in correct phase. Connect a loudspeaker to the terminal board, close S1 and plug the amplifier supply lead into the mains. Switch on by means of VR3/S2, maintaining a grip on its control knob. If, as the valves achieve emitting temperature a howl or similar oscillation becomes audible from the speaker, switch off *immediately*. Reverse the connections at T2 secondary and switch on again. This time there should be no oscillation, indicating that the feedback is truly negative. When satisfied that the connections at T2 secondary tags are correct, they should be soldered up permanently.

The amplifier may now be checked finally with a suitable signal source such as a crystal pick-up. It should be found that all the controls work satisfactorily and that gain increases when S2 is opened.

Some final operating points need to be dealt with. With S2 closed there should be, at worst, a very low hum level with no input and VR2 at maximum set-

ting. Hum level in the prototype under these conditions was negligibly low. The tags of VR1 and VR2 are very prone to capacitive hum pick-up and care should be taken to keep mains wiring away from these circuit points. Some potentiometers on the home-constructor market have metal covers which are not, by reason of the potentiometer construction, automatically connected to chassis by way of the mounting bush. The use of such potentiometers for V1 or V2 may cause the appearance of hum. If a potentiometer of this type is employed for VR2, the metal cover may, if necessary, be earthed by connecting it via a short bare wire to the left hand tag (see the wiring diagram) of this component. If a similar potentiometer is used for VR1, earth its cover to the cover of VR2 by means of a short insulated wire.

Input signals must, of course, be applied by way of screened wire. *Never attempt to obtain an input*

signal from an item of equipment whose chassis is connected to one side of the mains.

It should be remembered that the primary tags of the speaker transformer above the chassis are at h.t. positive potential. If there is a risk of these tags being touched when the amplifier is in use, the amplifier should be housed in a suitable cabinet. Ventilation is required at the rear of such a cabinet for the heat dissipated by V2 and the rear chassis apron area in contact with D1-D4.

It is recommended that a speaker of some 8 in. diameter be used with the amplifier, this being housed in a large cabinet to ensure a good bass response. Very small speakers should be avoided. Such speakers may even be damaged if the full output of the amplifier is fed to them.

The assembly and operating instructions are now concluded. The "Neophyte" 5-watt a.f. amplifier is complete and ready for use.

HOME RADIO — CREDIT ACCOUNT SCHEME

Home Radio (Components) Ltd., 240 London Road, Mitcham, Surrey, CR4 3HD., now have a credit account scheme which, in effect, brings 8,000 components as far away from the customer as the nearest telephone. Some of the advantages are:—

- (1) The facility to order by phone at any hour of the day or night (including Sunday) obviously a great saving in time, where an item is wanted in a hurry.
- (2) No worry about finding a stamp when ordering by post, because order forms and prepaid envelopes are provided.
- (3) No worry about buying a postal order, signing a cheque, or registering the letter.
- (4) One cheque, postal order, or money order only required each month to settle the account. This in itself could show quite a saving, as the average cost of a cheque is about 1/- (one shilling).
- (5) A new catalogue sent free each year while the account is in force.
- (6) No minimum invoice charge (normally on credit accounts there is a minimum invoice charge of 30/-).

How it works — the customer decides the monthly credit required to the nearest £10. Fill in a simple form and send to Home Radio with deposit, this being half the amount of the credit required. Goods may then be ordered up to three-quarters of the amount selected for credit. After the first month goods may be purchased up to the full amount of credit.

With each parcel of goods, an invoice is enclosed and, at the end of the month, a statement is sent showing the total amount outstanding. This must be settled by the 10th of the month following receipt of goods. The amount owing is not deductible from the deposit — this being held as long as the agreement remains in force. The deposit is returnable (less any final deductions) when the agreement is terminated by giving 30 days notice in writing.

By taking part in this scheme, the customer is not committed in any way to making purchases in excess of normal requirements over any period of time — £10 credit could be exchanged for goods over one month or several years if required.

CAN ANYONE HELP?

Requests for information are inserted in this feature free of charge, subject to space being available. Users of this service undertake to acknowledge all letters, etc., received and to reimburse all reasonable expenses incurred by correspondents. Circuits, manuals, service sheets, etc., lent by readers must be returned in good condition within a reasonable period of time.

Ferguson Transistor Receiver 'Flight 3132'. — I. Millar, 23 Fouracres, Brimsdown, Enfield, Middx. — loan or purchase of circuit diagram.

Wavemeter Class D No. 2.—R. J. Pratt, 61 Avonmead, Greenmeadow, Swindon, Wilts — loan or purchase of circuit or manual.

Philips Mitcham Instrument Type GM3152-15.—G. Wade, Knowle Orchard, Churchill, Nr. Bristol—any information.

Signal Generator Type 106.—R. Mohamed, 368 Attercliff Common, Carbrooke, Sheffield 9—loan or

purchase of charts, operating instructions or any other information.

36 Set P.S. Unit.—G. Corris, 43 Brookside Crescent, Upton, Wirral, Cheshire—Mk. I unit, Cat. No. ZA11688, Serial No. RGD167. Also R.F. Unit Mk. I, Cat. No. ZA11689, Serial No. BD1482. Circuits diagrams or any other data.

Oscilloscope No. 11.—E. E. Ogilvie, 88 Haslemere Road, Thornton Heath, Surrey, CR4 7BE—purchase of manual, handbook or circuit for the Oscilloscope No. 11 A. A. Predictor Mk. I O.S. 1879 G.A. Reg. No. ACL564.

NEW LIFE FOR "MIDGET RECEIVERS"

by

PAUL DEWHURST

A phenomenon of the early post-war years was the appearance of a large number of commercially manufactured t.r.f. medium and long wave receivers. These sets are capable, after modification, of providing a good performance even in today's crowded broadcast bands, and our contributor describes his experiences in this direction. Of particular interest is the use of an infinite impedance detector in the modified receiver. The final circuit described here can also, of course, be made up as a home-constructed receiver in its own right

THE WRITER WAS RECENTLY PRESENTED WITH AN old receiver, made during the early 1950's and of the type then known as "midget", with a request that he make it suitable for reasonable interference-free good-quality reception of the B.B.C. a.m. programmes, as far as this was possible with present-day crowding on the medium wave band. It was also asked that the set be made capable of operating with only a few feet of wire as aerial.

ORIGINAL DESIGN

The set in question was a four-valve t.r.f. consisting of a 12K7GT r.f. amplifier, a 12J7GT leaky-grid detector, a 35L6GT output valve, and a 35Z4GT rectifier. The heaters were run in series with a line-cord across the mains, and naturally there was no isolation from the mains, meaning that the chassis could under certain conditions become live. The set tuned medium and long waves, and the aerial consisted of 25 feet of plastic covered wire which resonated the primary coil of the aerial transformer at the low-frequency end of the medium waveband, so as to increase the sensitivity of the receiver at the higher wavelengths.

The set was tried out, and sensitivity was more than adequate, reception of some of the more powerful Continental stations being possible during daylight. The quality and selectivity, however, left much to be desired.

The quality was poor because the grid detector fed the output valve. This detector had to be operated at too high an input to give reasonable quality, since it had to ensure that there was enough a.f. signal for the final valve. A grid detector is only capable of giving reasonable quality when operated at a low level, and it overloads very easily. At the same time, the selectivity was poor because the grid detector damped its tuned circuit excessively. The lack of selectivity was not quite so bad at full volume, for the volume control was of the r.f. variety and was

so arranged that the r.f. valve almost went into oscillation at the full volume setting. As the volume setting was decreased, on the other hand, not only was there less gain from the r.f. valve, but also the primary of the aerial transformer was gradually short-circuited to chassis. Thus, as the volume control was turned down the selectivity became worse, so that if one were listening to a fairly powerful station with another fairly powerful one adjacent, interference could only be avoided by turning up the control until the volume was far too great.

These disadvantages, together with the horrid and dangerous line-cord and the fact that the chassis was not isolated from the mains, made the set useless in the author's opinion, and obviously a completely different approach was necessary if the set was to be made usable under modern conditions.

FIRST EXPERIMENTS

The first thing to be done was to fit a small mains transformer with 6.3 volt and 250 volt secondaries. Room was made for this component by removing the rectifier valve and using a small metal rectifier instead. The heaters were then wired in parallel and 6.3 volt valves substituted, namely 6K7GT, 6J7GT, and 6V6GT. The set was now safe, and worked just the same as before. The selectivity and quality problem remained, however. So the detector, the 6J7GT, was rewired as an anode-bend detector, which type does not load the tuned circuit feeding it and does not therefore impair the selectivity of that circuit.

The set was now much better (many sets using this circuit were in fact made at that time), the selectivity being markedly increased. But the r.f. gain control was still a nuisance, and had to be operated to prevent overloading of the detector stage. It was felt that an audio gain control after the detector, as employed in the normal domestic superhet, would be more satisfactory. When tuning the set with only an r.f. gain control, it was found that one had to have a hand on

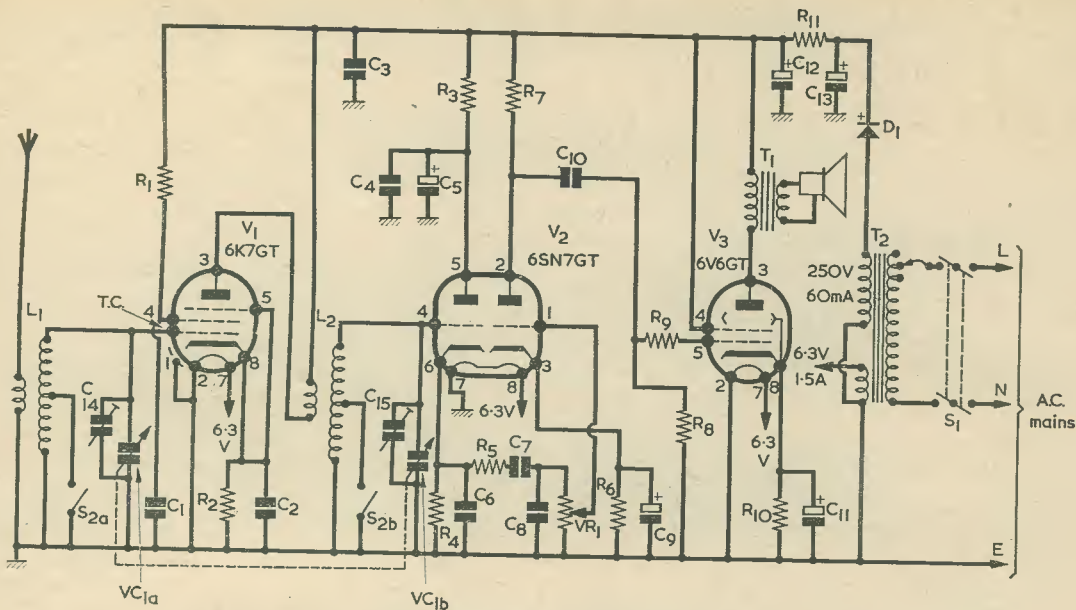

The circuit of the modified receiver, As may be seen, this incorporates an infinite impedance detector

the control all the time to prevent "blasting" from powerful stations. This was especially true when trying to find a weak station, since the control then had to be turned well up. This effect is not nearly so apparent when using an audio gain control, even if

a.g.c. is not applied to the r.f. stages. Unfortunately, the anode-bend detector overloads fairly easily, precluding the use of a fixed-gain r.f. stage.

The most obvious choice for a non-overloading detector is the diode, and so a 6Q7GT double-diode-

COMPONENTS

Resistors:

(All fixed values $\frac{1}{2}$ watt 10% unless otherwise stated)

R1	47k Ω
R2	330 Ω
R3	27k Ω
R4	150k Ω
R5	22k Ω
R6	1k Ω
R7	150k Ω
R8	470k Ω
R9	10k Ω
R10	250k Ω 1 watt
R11	1k Ω 3 watts
VR1	500k Ω potentiometer, log, with switch S1

Capacitors:

C1	0.01 μ F paper or plastic foil
C2	0.01 μ F paper or plastic foil
C3	0.1 μ F paper or plastic foil
C4	0.1 μ F paper or plastic foil
C5	8 μ F electrolytic, 350V wkg.
C6	250pF silver-mica or ceramic
C7	0.01 μ F paper or plastic foil
C8	250pF silver-mica or ceramic
C9	25 μ F electrolytic, 6V wkg.
C10	0.01 μ F paper or plastic foil

C11	25 μ F electrolytic, 25V wkg.
C12	16 μ F electrolytic, 350V wkg.
C13	16 μ F electrolytic, 350V wkg.
C14	50pF trimmer
C15	50pF trimmer
VC1	(a)(b) 500 + 500 pF, twin gang, variable.

Inductors:

L1, L2	Dual range coils, aerial coil and r.f. transformer (see text)
T1	Output transformer, 40:1, primary rating 50mA minimum
T2	Mains transformer, secondaries: 250V at 60mA and 6.3V at 1.5A

Valves:

V1	6K7GT
V2	6SN7GT
V3	6V6GT

Rectifier

D1	Metal rectifier or silicon diode, 250V at 60mA
----	------------------------------------------------

Switch:

S1	d.p.d.t., ganged with VR1
S2	(a)(b) d.p.s.t. wavechange switch

Speaker:

3 Ω	speaker
------------	---------

triode was substituted, using one of the diodes as detector and the triode section as audio amplifier. The r.f. gain control was dispensed with and an audio gain control substituted, this being inserted between the diode and the triode. Results were now extremely good from a quality point of view, being much better than with either the grid detector or the anode-bend detector, and there was no overloading (it is difficult to overload the diode detector). However, the selectivity was back to the level given with the grid detector. What was required, obviously, was a detector which had the good non-overloading characteristics of the diode together with the high input impedance of the anode-bend detector.

The author had previously been experimenting with the "infinite impedance" or cathode follower detector as the second detector in superhets for amateur bands intended particularly for the reception of s.s.b.—which requires that the detector be as linear as possible—using half a 6SN7GT as the detector with the other half as b.f.o. Results had been extremely good, with very high signal handling capabilities together with a very high input impedance. It seemed that this detector circuit was a "natural" for the set being modified, for the triode used before as a b.f.o. could be employed as an audio amplifier, thus making sure that no extra valves would be involved even though in effect an extra stage was to be included. The cathode follower detector has all the characteristics required: it is practically impossible to overload; it has a high input impedance, and therefore gives good selectivity; and it offers good quality because of the high degree of negative feedback at audio frequencies. The circuit was tried in the original set, and immediately results exceeded all expectations. The selectivity was good, sensitivity more than adequate, and the quality was surprising, especially considering the small loudspeaker being used. There was no sign of any overloading and so the set was operated in the way one operates a normal superhet, just using the tuning and audio gain controls, together with the wavechange switch of course.

FINAL CIRCUIT

Being completely satisfied with the circuit, the set was "tidied up" somewhat, and the final circuit was that shown in the accompanying diagram. From this it will be seen that the first valve, a 6K7GT, is operated as a fixed-gain r.f. amplifier, after which the 6SN7GT performs the dual office of cathode follower detector and audio amplifier. This in turn feeds the 6V6GT output valve. The original coils were retained for convenience, though more modern dust cored components would certainly give better results. The tuning capacitor, output transformer, loudspeaker, and valveholders were the only other items used from the original set as it was thought wise to use new

capacitors and resistors as far as possible. The metal rectifier was a selenium one taken from an old set but the obvious modern component here would be one of the silicon rectifiers, such as the BY100, which would be both smaller and more efficient. The mains transformer can be any one small enough which will give 250 volts at about 60mA and 6.3 volts at 1.5 amps.¹ The mains supply is preferably taken from a 3-pin plug via a 3-core flex, with the chassis of the receiver connected to the earthing pin of the plug.

The only alignment necessary is to adjust the trimmers at the high frequency end of the medium wave band. If dust cored coils are used the cores should be adjusted at the low frequency end (i.e. with the tuning capacitor vanes well enmeshed).

It is thought that there must be many similar small receivers around which could be converted in the above way, thus giving them a new lease of life. The cost of conversion is small, and the valves required are all in the two to three-shilling category. Such a receiver would be excellent for a second set.

Obviously, there is nothing to prevent anyone from building the set from scratch, in which case one might just as well use modern valves. Just to check that the circuit was suitable for these valves, it was tried using an EF183 as r.f. amplifier, ECC82 as cathode follower detector and audio amplifier, with an EL84 for the output valve. This receiver was found so sensitive that it was possible to receive all the B.B.C.'s programmes with only a ferrite rod aerial, which improved the selectivity, of course. All the component values were the same as with the original conversion except for the screen-grid and cathode resistors of the EF183 (39 k Ω and 120 Ω respectively), the cathode resistor of the audio amplifier section of the ECC82 (680 Ω), and the cathode resistor of the EL84 (150 Ω). Careful screening between the grid and anode circuits of the EF183 was found necessary and between the two tuned circuits due to the extremely high gain of the r.f. amplifier.²

It is felt that the circuit is sufficiently "different" to be of interest to constructors. Whilst it is not a world-beater so far as Dx reception is concerned, it was certainly with mixed feelings that the writer found, on connecting a decent sized loudspeaker to the output of the original conversion, that the quality of music from Radio 3 was quite a lot better than is given by the large superhet in a huge wooden cabinet which had previously been the writer's pride and joy!

¹ A midget transformer with secondaries rated at 250 volts, 60mA, and 6.3 volts 2A, is available from R.S.C. Hi-Fi Centres, Ltd., 102-106 Henconner Lane, Bramley, Leeds 13.—Editor.

² Suitable dual range coils for a home-constructed version would be Denco type C2 and C3 (Home Radio Cat. Nos. C04 and C05) the reaction winding on the C3 coil being ignored. The output transformer for either the EL84 or 6V6 should have a ratio of approximately 40:1 for matching into a 3 Ω speaker, and a primary capable of passing 50mA.—Editor.

NEW EMI LOUDSPEAKER SYSTEMS AT AUDIO FAIR

In addition to a full range of their nine well-known loudspeaker systems EMI will exhibit two new systems on Stand 56 at the International Audio Fair to be held in the National Hall, Olympia from 16th to 22nd October 1969. These are systems 215 and 315.

The 315 system consists of a new 15in. round bass loudspeaker with a rigid die-cast chassis, capable of handling 35 watts with a bass resonance of 20 Hz; two new 5in. round mid-range high-flux loudspeakers with specially designed pvc suspension; two new moulded chassis high-frequency units with the advantage of low magnetic leakage; a switch plate and a crossover network.

The 215 system consists of a new 14in. by 9in. bass loudspeaker with a rigid die-cast chassis and 2in. pole piece, capable of handling 30 watts; two of the 5in. mid-range loudspeakers and one of the high frequency units used in the 315 system; a switch plate and a crossover network.

RADIO CONSTRUCTOR

SPECIAL EXCLUSIVE OFFER

★ ROOF RACK

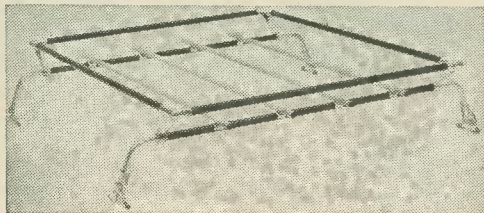

The Classic – a really new and handsomely designed roof rack. Made with high quality steel tubing and alloy castings. A fully collapsible model requiring only four bolts and four wing nuts supplied for its complete and rapid assembly. The framework is covered with a durable P.V.C. and the rack stands on the very latest type of gutter mountings. These mountings have very wide feet for maximum stability and are fixed to the car roof gutters via isolating polythene sleeves to prevent rusting. Carrying platform of 40" x 34" wide. List Price 99/6. **OUR PRICE 65/-** plus carriage 8/6

★ ESTATE CAR CONVERSION KIT

This converts the saloon kit into an estate car kit. Carrying platform becomes 75" x 34" wide.

List Price 99/6. **OUR PRICE 65/-** plus carriage 8/6

If roof rack and conversion kit ordered together – carriage free

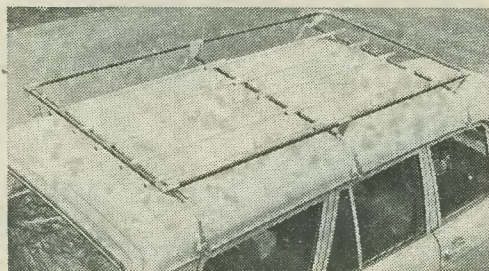

★ HEAD REST

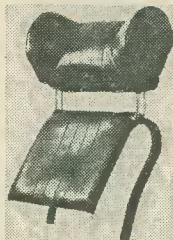

For comfort and safety! Latest Finnish design. Suitable for all types of seating. Upholstered in first quality foam and covered in extremely durable P.V.C. Fully and easily adjustable for the widest range of height and angle. Available in black or red. List Price 59/6 **OUR PRICE 39/6** plus p. & p. 6/-

★ MASERATI AIR HORNS

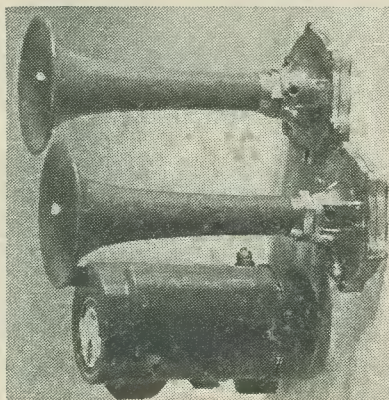

TS Sprint. Ideal for Motorway or Continental driving. Will fit under the bonnet of any car. Available in 6, 12 or 24 volts. This unit incorporates a new extra powerful compressor, which is only available with Maserati Air Horns. Extra tough red plastic trumpets, both 6½" long, base diameter of each 3". Compressor height 4½", diameter 2½". Total weight, including box, 4¼ lbs. Complete with relay, tubing, securing nuts and bolts and fixing instructions. List Price 5 gns. **OUR PRICE 69/6** plus p. & p. 6/-

The above car accessories are first grade, high quality, and are covered by a **SEVEN-DAY MONEY BACK GUARANTEE**

Please send the following:—
(Please tick where applicable)

- Classic Roof Rack Head Rest
 Estate Car Conversion Kit Maserati Air Horns

Model and year of car..... Please state voltage required.....

I enclose cheque/crossed postal order for.....

Name

Address

BLOCK CAPITALS PLEASE

Please make remittances payable to our distributors:— **IVORYET LTD.** and send to:
RADIO CONSTRUCTOR SPECIAL OFFER, 57 MAIDA VALE, LONDON W.9

NEW SINCLAIR PRODUCTS AT THE AUDIO FAIR

Sinclair Radionics Limited will be exhibiting a new range of high fidelity modules and a new loudspeaker, the Q.16. The new module range uses silicon epitaxial planar transistors throughout and includes the Z.30 amplifier which provides up to 25 watts continuous sine wave output power. This amplifier is claimed to have a lower distortion than any other amplifier on the market.

The Stereo 60 pre-amplifier and control unit is designed to drive two Z.30 modules and uses push-button controls for input selection. The volume,

balance, bass and treble controls are rotary and the front panel is in solid aluminium.

Two power supplies are available to power the Stereo 60 and two Z.30's. The first of these, the PZ.5, is recommended for the majority of domestic applications. The PZ.6 is intended for use where the absolute maximum output power is required.

The new loudspeaker, the Q.16, is based on the Sinclair Q.14. The Q.16 is completely new in appearance, however, being finished in black cloth with a solid teak surround. The retail price is £8 19s. 6d.

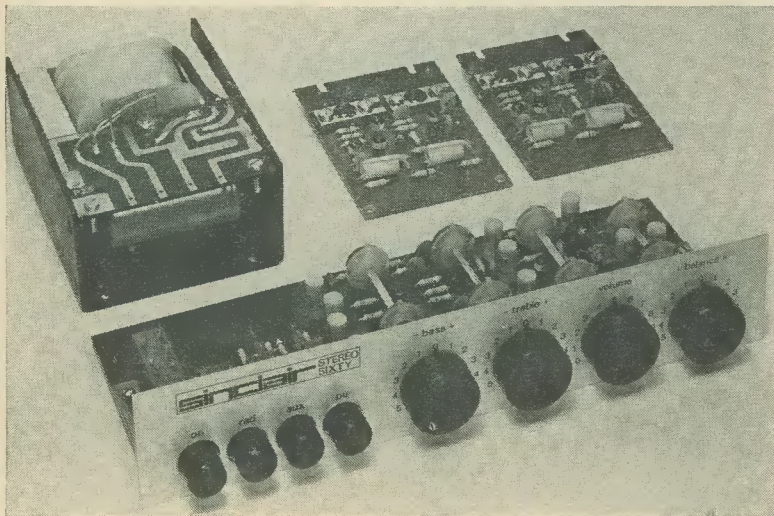

A complete stereo assembly. The Stereo 60 pre-amplifier is in the foreground, with a PZ5 power supply and two Z.30 amplifier modules behind.

MANUFACTURER'S SPECIFICATIONS

Z-30

Power output: 15 watts continuous sine wave (30 watts peak) into 8 ohms from a 35 volt supply.
25 watts continuous sine wave (50 watts peak) into 3 ohms from a 30 volt supply.

Frequency response: 20 to 300,000 Hz \pm 1dB.

Distortion: 0.02% total harmonic distortion at full output into 8 Ω and at all lower output powers.

Size: 3 x 2.2 x 0.5in.; 7.6 x 5.6 x 1.25 cms.

Input Impedance: 100k Ω .

Damping factor: Greater than 500.

Operating voltage: 8 to 35 volts.

Notes: Sensitivity is sufficient for operation directly from a ceramic or crystal Cartridge.

Recommended price: 89s. 6d.

STEREO 60

Controls: Mains and 3 inputs on push-buttons.
Rotary controls for volume, balance, bass and treble.

Sensitivity: Up to 3mV on all inputs.

Equalisation: To within \pm 1dB of R.I.A.A.

Signal to noise ratio: Better than 70dB.

Size: 8.15 x 3.4 x 1.6in.; 20.3 x 8.6 x 4.1 cms.

Recommended price: £9 19s. 6d.

PZ.5. 30 volt unswitched power supply.

Price 99s. 6d.

PZ.6. 35 volt 1.4 amp stabilised power supply.

Sufficient to drive two Z.30's and stereo-60 to give

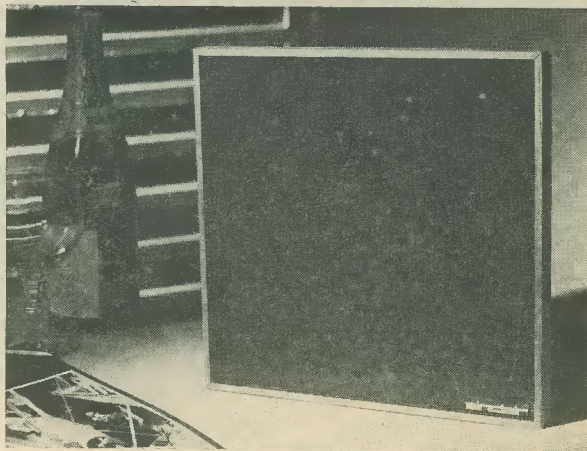

The new Sinclair Q.16 loudspeaker. This is finished in black cloth with a solid teak surround.

15 watts continuous sine wave on both channels at the same time.

Price £7 19s. 6d.

Size: (PZ5 and PZ6) 3.95 x 2.85 x 1.9in.;

10 x 7.25 x 4.8 cms.

UNDERSTANDING RADIO

CERAMIC I.F. FILTERS

$$f = \frac{1}{2\pi\sqrt{LC}}$$



by W. G. Morley

IN LAST MONTH'S ARTICLE IN THIS SERIES, WE CONTINUED our examination of circuit devices which are capable of improving the selectivity of the i.f. amplifier of a superhet, and we discussed the Q-multiplier. As we saw, the Q-multiplier incorporates a normal tuned circuit whose effective Q is increased to a very high level by means of carefully controlled regeneration. The Q-multiplier tuned circuit may then be coupled to a receiver i.f. amplifier in such a manner that it offers a very sharp response curve either for the acceptance or for the rejection of signals.

The Q-multiplier is normally employed by amateur transmitting enthusiasts and short wave listeners, and its basic function is to improve the selectivity of an existing superhet receiver. It is nearly always assembled in the form of a separate "add-on" unit, being coupled to the receiver i.f. amplifier by way of a length of screened cable.

We now turn our attention to another frequency selective device which may also be incorporated in the i.f. amplifier of a superhet. In this instance, however, the function of the device is not that of improving the selectivity given by an amplifier employing standard i.f. transformers. It is, instead, designed to *replace* such transformers by offering a comparable performance in terms of frequency response and gain. This performance, it should be added, is only intended to be adequate for the requirements of an a.m. domestic receiver.

The device to be discussed is designed for operation in transistor circuits rather than in valve circuits. We have not dealt with the transistor in detail in this series, but it will be assumed for the purpose of the present article that the reader has sufficient knowledge of this subject to be able to recognise and comprehend the working of a simple common emitter transistor amplifier stage. In this mode of operation the input signal is applied to the base of the transistor, whilst the amplified output signal appears at the collector. The emitter is common to both input and output circuits. The common emitter circuit, it may be added, is that which is most frequently employed in transistor signal amplifiers. Also, it is that which is most closely similar to the standard valve amplifier circuit.

CERAMIC I.F. FILTERS

The frequency selective device now to be discussed is the *ceramic i.f. filter*. Like the quartz crystal, the ceramic i.f. filter takes advantage of the properties of a piezoelectric material, and the knowledge we have acquired in recent articles concerning series resonance and parallel resonance in the quartz crystal will be of assistance to us when considering its operation.

A number of synthetic piezoelectric materials have been introduced over the last three decades, the first of these being a ceramic, barium titanate. Another synthetic piezoelectric material, lead titanate zirconate, appeared later and this has been employed in ceramic i.f. filters. Since these piezoelectric materials are in the form of ceramic, it is possible for them to be made up to different shapes and dimensions far more readily than the naturally

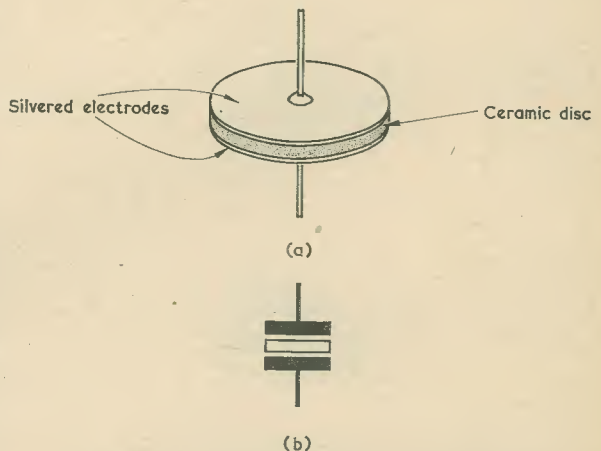

Fig. 1 (a). The construction of a two-electrode ceramic i.f. filter. For purposes of illustration, the silvered electrodes are shown with exaggerated thickness

(b). Circuit symbol for the two-electrode filter

occurring crystalline quartz. One of the manufacturing processes in the preparation of the piezoelectric ceramics consists of applying a high electric voltage across two opposite faces. This process is referred to as "polarisation", and it enables the material to afterwards exhibit its piezoelectric properties.

The simplest type of ceramic i.f. filter is illustrated, together with its circuit symbol, in Figs. 1(a) and (b). It consists basically of a circular disc of piezoelectric ceramic with electrodes, to which external connections may be made, on either side. Each electrode is provided by a layer of silvering deposited over all, or very nearly all, of the ceramic surface. The construction resembles that of a quartz crystal in its housing, and the filter functions in a similar manner. Like the quartz crystal it exhibits mechanical resonance when a signal at the resonant frequency is applied to its two electrodes. Also like the quartz crystal, it offers a series resonant frequency (at which its electrical impedance is low) and a parallel resonant frequency (at which its electrical impedance is high). Yet again like the quartz crystal, the parallel resonant frequency is slightly higher than the series resonant frequency.

On the other hand, the two-terminal ceramic filter of Fig. 1(a) does not present as high an effective Q as does the quartz crystal. Nevertheless, it is still capable of offering a degree of selectivity which makes it attractive for use, together with other ceramic filters and/or i.f. tuned circuits, in the i.f. amplifier of a domestic a.m. radio receiver. In this application advantage is taken of its low impedance at series resonant frequency, this impedance being typically less than 20Ω .

A three-terminal ceramic filter is illustrated in Fig. 2(a). Again, a disc of piezoelectric ceramic material is employed. One surface of the disc is covered with a single silvered electrode whilst the other has two silvered electrodes, these consisting of a central circular section and an outside concentric ring. These

two electrodes are referred to as the *dot* and *ring* electrodes respectively. The single electrode on the other side of the disc is described as the *common* or *base* electrode. The circuit symbol for the three-terminal filter is given in Fig. 2(b).

The input signal to the three-terminal ceramic filter is applied between the dot electrode and the common electrode, the output signal being taken from the ring electrode and the common electrode. At the appropriate frequency the disc exhibits mechanical resonance due to the piezoelectric properties of the material of which it is made, whereupon it is capable of passing a band of frequencies at or near this resonant frequency.

The selectivity offered by the three-terminal filter is affected both by the external impedance to which the ring electrode is coupled and by the impedance of the input signal source coupled to the dot electrode. A further complicating factor is that an impedance transformation occurs in the filter itself, the ratio between its input and output impedances depending upon the relative areas of the dot electrode and the ring electrode.

Due to the large number of varying factors involved, the three-terminal filter cannot be resolved into an equivalent circuit which is as simple as that for a quartz crystal. Indeed, some three-terminal filters are manufactured to function at a specific series resonance frequency (whereupon the transfer of energy from input to output electrodes is dependent upon the operation of the crystal in its series resonant mode) whilst others are manufactured for a specific parallel resonant frequency. In the latter case, the performance of the filter approaches that of a network having a parallel resonant circuit across the input and output, with series impedance in either one or both of the input and output circuit paths.

A range of practical ceramic i.f. filters has been available in the U.K. over recent years, these being marketed by the Brush Clevite Company, Ltd. They are available to home-constructors through component retailers and are intended for use in domestic transistor radio receivers at a number of intermediate frequencies, these including 455kHz, 465kHz and 470kHz.

Three of the Brush Clevite range, types TF-O1A (455kHz), TF-O1B (465kHz) and TF-O1D (470kHz), are two-terminal devices similar to that shown in Fig. 1(a). They are fitted in housings whose dimensions, excluding tags, are slightly smaller than 0.3 by 0.4 in. These devices are series resonant at their nominal frequencies.

A further three, types TO-O1A (455kHz), TO-O1B (465kHz) and TO-O1D (470kHz), are three-terminal devices in which the ceramic elements are manufactured to exhibit a series resonance at the nominal frequencies. Another three, TO-O2A (455kHz), TO-O2B (465kHz) and TO-O2D (470kHz) are also three-terminal devices, and are intended to operate at the parallel resonance of the piezoelectric material. All the filters with the TO prefix appear in housings measuring some 0.65 by 0.75 in., excluding tags.

In passing, it should be mentioned that the terms "resonant" and "anti-resonant" are sometimes employed in references to piezoelectric frequency selective devices. These terms correspond to "series resonant" and "parallel resonant" respectively. This point is mentioned here as the reader may encounter the alternative terms in literature dealing with

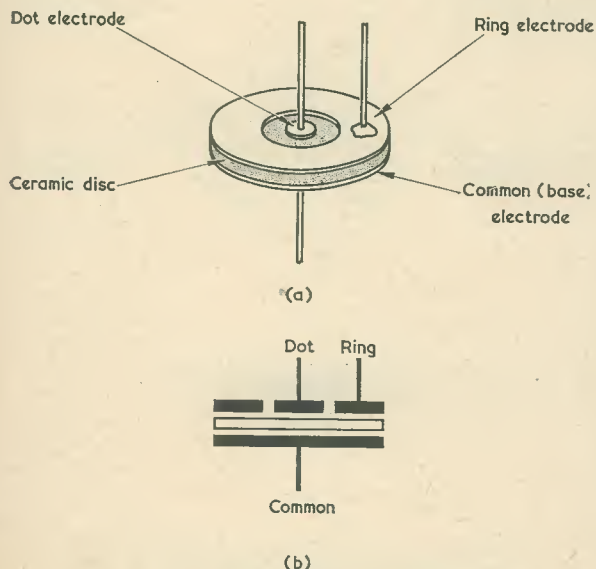

Fig. 2(a). The three-electrode filter
(b). The circuit symbol employed for the three-electrode filter

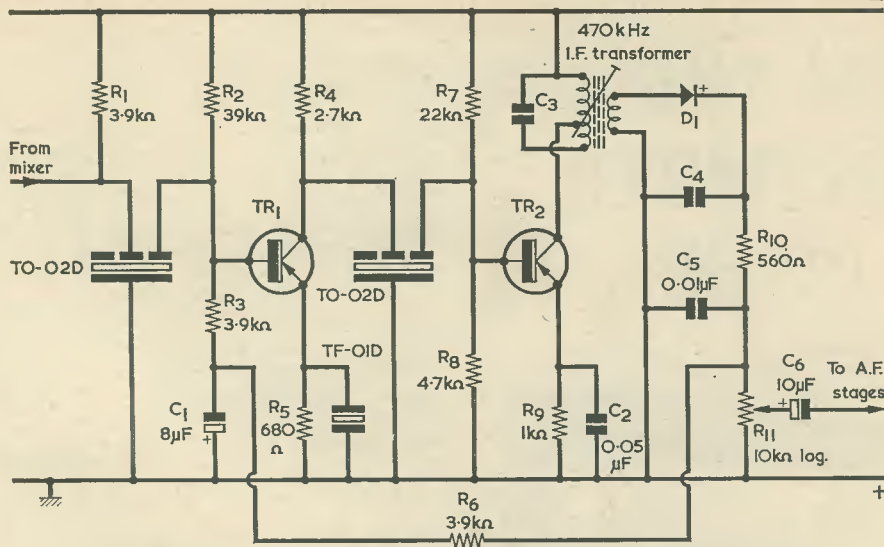

Fig. 3. A practical 470kHz i.f. amplifier employing ceramic filters. Note the low resistance and high capacitance values which reflect the low impedances at which transistors operate. C3 and C4 are housed in the i.f. transformer can. The receiver circuits in which this i.f. amplifier appears are powered by a 9 volt battery.

ceramic i.f. filters. A further point of terminology concerns the fact that the Brush Clevite i.f. filters are referred to as "Transfilters".

As already mentioned, the two-terminal filters with the TF prefix are series resonant at their nominal frequencies. These frequencies are the fundamental frequencies for the piezoelectric discs employed. Unfortunately, it is rather difficult to manufacture three-terminal filters using discs which are similarly resonant at about 460kHz, because the relatively small size of the disc raises problems in processing and handling. In consequence, the three-terminal filters employ larger discs with a fundamental frequency around 180kHz, these having an overtone response at the nominal filter frequencies in the 455 to 470kHz range.¹

The three-terminal devices offer a response at the fundamental frequency in addition to the overtone frequency. In consequence, it is undesirable to employ them on their own in an i.f. amplifier, since such an amplifier would amplify at the fundamental frequency as well as at the required overtone frequency. It is necessary to have some means of suppressing the amplifier response at the fundamental frequency, and a suitable solution consists of including in the amplifier a single i.f. transformer of conventional type tuned to the required intermediate frequency. This provides adequate rejection of the fundamental frequency, whereupon all the remaining frequency selective components in the i.f. amplifier can be of the ceramic filter type. It is preferable for the conventional i.f. transformer to be fitted immediately after the frequency changer stage since the

risk of cross-modulation between the two sets of frequencies in later stages is then eliminated. However, practical receiver designs have been produced in which the conventional i.f. transformer appears at the end of the i.f. amplifier. A measure of suppression of the fundamental frequency may, incidentally, be provided by incorporating one or more two-terminal filters in the i.f. amplifier design. A further point which is of significance here is that, in a medium and long wave receiver having an accurately aligned high-Q aerial tuned circuit (as is possible with a ferrite rod aerial) there will be, in any case, an appreciable level of rejection to aerial signals which could cause the fundamental filter frequency to appear after the frequency changer.

A practical 470kHz i.f. amplifier incorporating ceramic filters is shown in Fig. 3, this being part of a successful home-constructor design for a medium and long wave receiver.² This circuit is very helpful in illustrating the simplicity imparted by ceramic i.f. filters. The overall i.f. gain and response curve of the amplifier is commensurate with that of an amplifier using the same transistor types and conventional i.f. transformers.

In Fig. 3 an i.f. output from the collector of the mixer transistor is applied to the dot electrode of the first ceramic filter, the ring electrode of which then couples to the base of the following i.f. transistor, TR1. The collector of TR1 next couples via a second three-terminal filter to the base of TR2. A conventional i.f. transformer follows, this feeding into a detector diode D1, the a.f. output from which is passed to the a.f. amplifier stages of the receiver via volume control R11 and C6. The two ceramic filters, in company with the i.f. transformer, allow the

1. It is possible to make a quartz crystal or similar piezoelectric device exhibit mechanical resonance at a frequency which is approximately a multiple of its fundamental frequency. The term "overtone", rather than "harmonic", is preferred in this instance, because the higher frequencies are not an exact multiple of the fundamental frequency.

2. "The 'Good Companion' Mk. II Transfilter Portable", *The Radio Constructor*, August, 1962. The component suffix numbers given in Fig. 3 differ from those in the circuit originally published.

IN THE NOVEMBER ISSUE

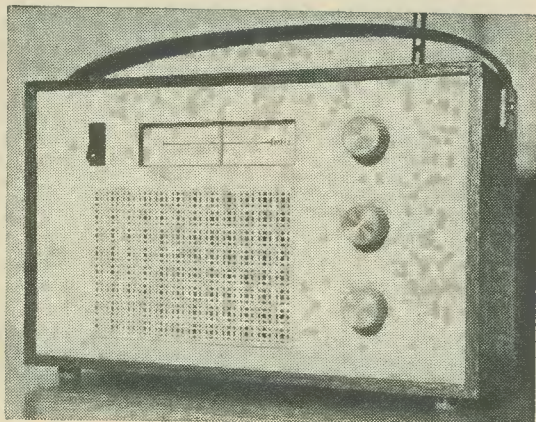

The "Airlane" 7-Transistor Aircraft Band Receiver

A super-regenerative design having a frequency coverage from 108 to 140MHz (approx). With slight modification the receiver can also be used on the 144MHz amateur band.

Two-Transistor Converter for 'Ten'

A simple transistor converter for the 10 metre amateur band having an output at 6.5MHz. Aerial designs are also featured.

Suppressed-Zero Voltmeter

Showing how a 0-5mA meter may be employed as a car battery voltmeter for 12-volt systems—an added attraction being that full scale range extends from some 10 to 16 volts only.

Also . . .

Data Sheet 32

and many other supporting features

on Sale NOVEMBER 1st

desired band of frequencies to pass to the detector.

A little additional selectivity is required for the circuit to be comparable with one using standard i.f. transformers and this is provided by the two-terminal filter connected across R5, in the emitter circuit of TR1. Normally a bypass capacitor similar to that connected across R9 would appear across R5, this offering negligible reactance at intermediate frequencies and thereby preventing degeneration of gain in the transistor. In this respect, the capacitor would function in the same manner as the normal bypass capacitor which is connected across the cathode bias resistor of a valve. The two-terminal filter connected across R5 takes the place of the bypass capacitor, and it offers a high impedance for frequencies removed from its resonant frequency, and a low impedance for frequencies close to or at its resonant frequency. Thus, the gain offered by TR2 is significantly reduced, due to degeneration, for all frequencies except those close to or at the resonant frequency of the filter, and the overall selectivity offered by the i.f. amplifier is enhanced.

Since no direct current flows through the ceramic i.f. filters, it is possible to connect their electrodes direct to the appropriate input and output circuit points, regardless of the direct potentials existing at such points. No blocking capacitors are needed.

It has been necessary to use a transistor circuit to demonstrate a practical application of ceramic i.f. filters, because these filters are expressly designed to function at the low impedances which appear in such circuits. Included in the diagram for completeness are the components R6 and C1, these appearing in a simple a.g.c. circuit. When signal strength at the detector diode increases, the voltage at the upper end of R11 goes positive with relation to the lower supply line. The increasing positive voltage is then passed to the base of TR1 via R6 and R3, TR1 being of a type whose gain decreases as its base is made more positive. C1 is merely an a.g.c. bypass capacitor.

NEXT MONTH

In next month's issue, we shall turn to a new subject, and shall commence to examine measuring instruments.

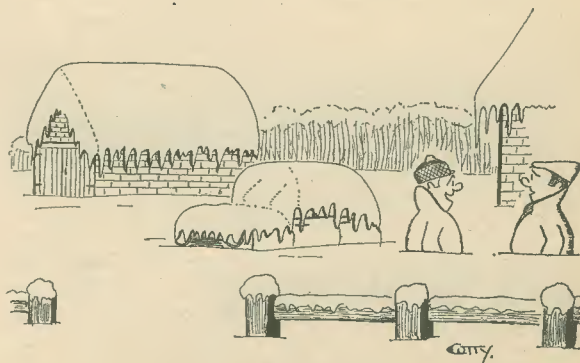

" . . . I see your windscreen wipers have gone solid-state!"

THE RADIO CONSTRUCTOR

In your workshop-shop



SMITHY PICKED UP HIS SCREWDRIVER and applied it to the surface of the tea in his disreputable tin mug. Deftly, he flicked out a floating tea leaf, returned the screwdriver to his bench, then regarded the contents of the mug abstractedly.

"Anything wrong?"

Smithy directed an absent-minded eye at his assistant.

"What?"

"I asked," repeated Dick, "if anything was wrong."

Smithy looked surprised.

"Why, no," he replied. "So far as I'm concerned, everything's fine."

He turned his attention away from his assistant and once more contemplated the surface of his tea.

An exasperated expression appeared on Dick's face.

"What is it," asked Dick, "that you're looking for? A smiling face?"

Once more the Serviceman roused himself and gazed at his assistant.

"What's this," he asked perplexedly, "about smiling faces?"

"If," remarked Dick, sarcastically, "you look at a glass of Guinness for long enough you're supposed to see a smiling face on the top. I was just wondering if you are trying to do the same with your tea."

CONSTANT CURRENT DEVICES

"You have a mind," returned Smithy dispassionately, "that moves along strange and devious paths."

"Perhaps it does," snorted Dick. "But at least it doesn't cause me to completely withdraw myself from my fellow-men as you've been doing ever since tea-break started."

This month we find Smithy in enquiring mood. Aided as always by his able assistant Dick, we follow a series of experiments instigated by the Serviceman, these culminating in the appearance of a novel and unusual phase-splitting circuit which offers quite a number of significant practical advantages

"Oh, it's *that* which has been worrying you, is it?" said Smithy. "Well, seeing that I have about as much privacy in this Workshop as a goldfish in its bowl, I suppose you're now expecting me to tell you what it is I've been thinking about."

"That," replied Dick graciously, "is up to you, of course."

Smithy's air of preoccupation suddenly vanished. It was obvious that he had come to a decision.

"Right," he pronounced briskly. "I shall now proceed to satisfy your curiosity. What's been taking up my thoughts since our tea-break started has been the fact that nobody these days seems to take account of all the things you can do with constant current devices."

"Constant current devices?"

"Constant current devices," repeated Smithy gravely. "Of which perhaps the easiest to set up is given by a common or garden transistor in grounded base. If you come over here I'll start off by giving you some gen on why a grounded base transistor gives a constant current."

Dick walked over to Smithy's bench, whilst that worthy drew his notepad towards him.

"Now," said Smithy, "the transistor amplifier stages we most frequently encounter employ the transistor, not in the grounded base, but in the grounded emitter mode. If we have an n.p.n. transistor in grounded emitter, its emitter couples to the negative supply rail and the input signal is applied to its base. The bias current flowing into the base is from a d.c. source of the same polarity as the collector supply. I'll show you what I mean with the aid of batteries so that you can see the polarities more clearly."

Smithy drew out a circuit (Fig. 1(a)) whilst Dick looked on.

"That circuit," remarked Dick, "seems nice and obvious to me."

"Good," said Smithy. "If we next draw a series of collector current-collector voltage curves for the transistor in grounded emitter we then get something like this. (Fig. 1(b)). Each curve is drawn for a different base current. Now, the straight sections of these curves have what is known as a 'slope resistance'. If, following the 50 μ A curve in my sketch, for instance, I change the collector voltage from eight to four volts, the change in collector current along the curve is only about a

milliamp. (Fig. 1(c)). Thus, a change of four volts causes a change in current of 1mA, which corresponds to a slope resistance of 4k Ω . Got it?"

"I think so," replied Dick a little dubiously. "At any event, keep at it!"

"Right-ho," said Smithy obligingly. "Now, at six volts along our 50 μ A curve the actual collector current drawn by the transistor is about 4mA, and these two figures correspond to an actual resistance of 1.5k Ω . Which is quite a lot lower than the 4k Ω of the slope resistance."

"My impression," said Dick frowning, "of what you're driving at is that, so far as a battery supplying the transistor is concerned, the transistor is no different, at six volts, from a 1.5k Ω resistor. At the same time though, so far as a varying voltage at the collector is concerned, the transistor acts like a 4k Ω resistor."

"You're right first time," confirmed Smithy. "For the present discussion you don't need to worry any more about this slope resistance business except to remember the obvious fact that, as the current-voltage curve becomes nearer to horizontal, the slope resistance goes up."

Smithy pulled his pad towards him again.

"After having introduced the slope resistance concept," he said, "I will now turn to the transistor in grounded base, which has been the real subject of my recent thoughts. Here it is, complete with batteries for collector supply and for bias. (Fig. 2(a)). In this case, however, the bias goes to the emitter, and it comes from a battery terminal of opposite polarity to that which supplies the collector: Once again, I've assumed an n.p.n. transistor."

Smithy indicated the transistor with his pencil.

"As you can see," he continued, "the grounded base transistor really has the same sort of supply potentials as does the grounded emitter. As before, the collector goes to a positive supply. We now bias the emitter negative of the base which, so far as potentials are concerned, is pretty well the same as biasing the base positive of the emitter. However, the collector current is now drawn from the negative ter-

minal of the collector supply battery via the base of the transistor instead of via the emitter, and this has a very marked effect on the collector current-collector voltage curves. These now appear like this." Smithy sketched out a further set

of curves on his pad. (Fig. 2(b)). "Stap me," exclaimed Dick. "The straight bits of these curves are practically horizontal." "They are indeed," confirmed Smithy. "In fact, a grounded base transistor offers an almost fantastic

performance in this respect. The collector current-collector voltage curves are so near to being horizontal that it's almost impossible to measure any change in collector current over quite wide changes in collector voltage. The current is as near as dammit to being constant, whereupon we refer to the grounded base transistor as being an exceptionally efficient 'constant current device'. I don't want to go on any further with this theoretical stuff except to remark on one point. Since the straight parts of these grounded base curves are very nearly horizontal, they correspond to an extremely high slope resistance. In practice, this slope resistance can be of the order of $20k\Omega$ to $200k\Omega$."

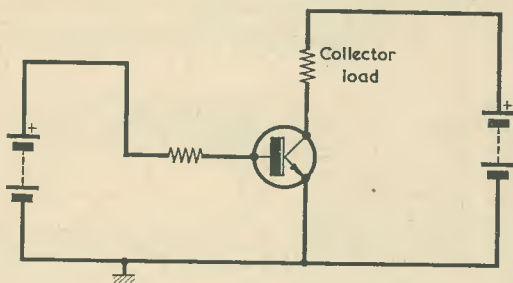

(a)

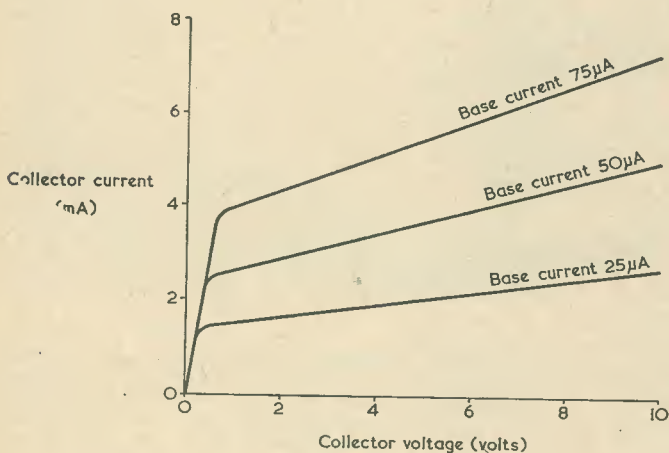

(b)

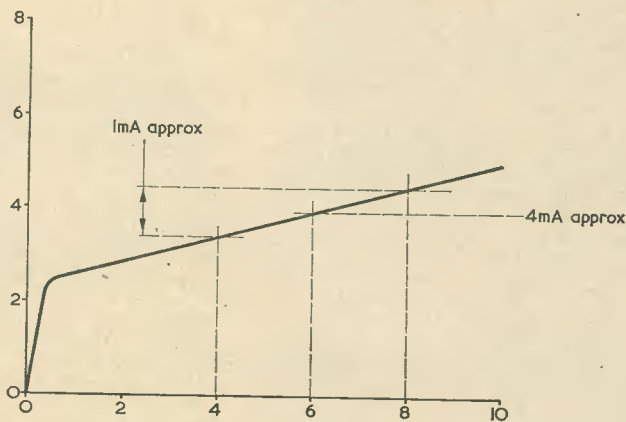

(c)

Fig. 1(a). Collector supply and base bias polarities for an n.p.n. transistor in grounded emitter
 (b). A typical family of collector current-collector voltage curves for a grounded emitter transistor
 (c). Illustrating the concept of 'slope resistance'. The curve shown here is the central curve of (b)

INITIAL EXPERIMENT

Dick frowned. "All this," he remarked critically, "is really quite interesting, but I don't see why it should have caused you to go into a state of limbo like you did just now."

"I was undertaking," explained Smithy, "a little bit of cogitation. I wasn't thinking about constant current devices in themselves, but of constant current device applications. Before you so rudely interrupted my train of thought I'd just about finished working out in my mind a gadget using a constant current transistor which could prove to be quite impressive."

"What sort of gadget is that?"

"I shan't tell you yet," replied Smithy cagily. "Over the years, I've become too cautious to start committing myself on things which are based only on theory. I like to check them out in practice first!"

"Are you," asked Dick interestedly, "going to check this idea out in practice, too?"

"I am," replied Smithy decisively. "What's more, if you feel like wieldign the odd soldering iron for me, you can join me in this little enterprise as well."

"That would be fine," exclaimed Dick eagerly. "It will make a very pleasant change from ordinary servicing."

"Then we'll get started right now," stated Smithy. "I first of all want to carry out an initial experiment, after which we'll get down to the main thing. So, Dick, could you hunt around and see if you can find an odd chassis somewhere on which we can temporarily mount a few components? It needn't be anything special, just a bit of metal which will take several tagstrips, a couple of pots and a B9A valveholder. There's bound to be something knocking around with a few holes of convenient size in it. In the meantime, I'll dream up a little circuit for you."

The Workshop fell into silence, broken only by the clanking of metal upon metal as Dick sorted through a miscellaneous collection of oddments contained in one of the many mysterious cardboard cartons stored under his bench. There was a sudden triumphant cry.

"I've found something here," Dick called out, "which should be just the job. It's got a couple of B9A holes in it and there are stacks of holes in it for pots and tag-strips as well."

"Excellent," pronounced Smithy, putting down his pen. "And I've just finished the circuit for our first experiment. Here it is."

Dick looked distrustfully at Smithy's diagram. (Fig. 3).

"I don't get it," he remarked eventually. "Is that transistor in grounded base or is it in grounded emitter?"

"It's in grounded base," replied Smithy. "The $2.2k\Omega$ resistor from the positive supply line causes a forward current of some 5 to 6mA to pass through the silicon diode, which means that the upper terminal of the diode is always about 0.5 volts positive of the negative supply line. In consequence, that upper terminal can be looked upon as a point of fixed potential. We then vary the emitter current by adjusting the 500Ω preset potentiometer."

"What's the 50Ω resistor for?"
 "It's merely a limiter resistor," explained Smithy. "It prevents excessive current flowing if you should accidentally set the 500Ω pot to too low a resistance. By the way, please use new batteries for the 12V supply. I want the actual supply voltage to be rather higher than 12 volts."
 "All right," said Dick. "What

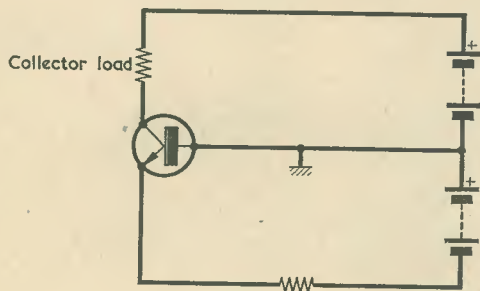

(a)

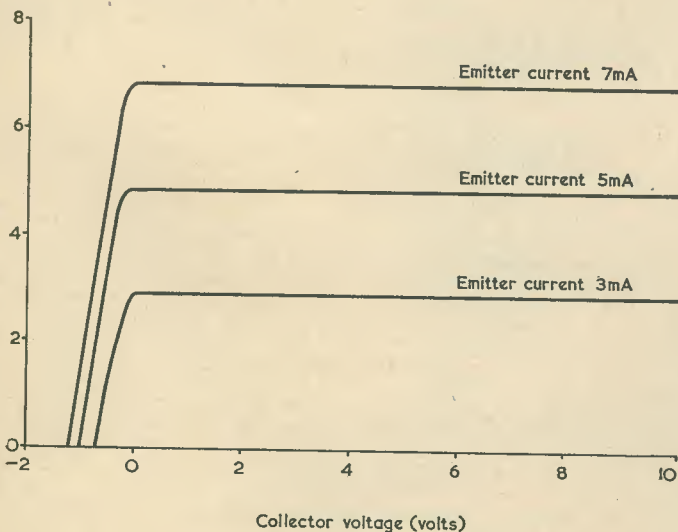

(b)

Fig. 2(a). An n.p.n. transistor in grounded base has the collector supply and emitter bias polarities shown here
 (b). Typical collector current-collector voltage curves for a grounded base transistor. These incidentally reflect the fact that current gain in grounded base is always less than unity

Your Local Supplier

LONDON

Established 1910

H. L. SMITH & CO. LTD.

Comprehensive stocks of components by all leading makers.

287-9 EDGWARE ROAD
 LONDON W.2

Tel: 01-723 5891

THE MODERN BOOK CO.

Largest selection of English & American radio and technical books in the country.

19-21 PRAED STREET,
 LONDON, W.2

Tel: PADDington 4185/2926

ST. HELEN'S RADIO

Hi-Fi Equipment
 Tape Recorders
 Radio Receivers
 Television

SPECIALISTS IN RADIO & ELECTRONIC TEXTBOOKS

ST. HELEN'S GARDENS
 LONDON W.10

Tel: 01-969 3657

HAMPSHIRE

BOURNEMOUTH

LARGEST HI-FI AND RADIO COMPONENT STORE IN THE SOUTH

FORRESTERS NATIONAL RADIO SUPPLIES LTD.

70-72 Holdenhurst Road
 Bournemouth
 Telephone 25232

Your Local Supplier

KENT

EMSAC BASIC ANTENNA SYSTEMS

CN1 New this month! 144 MHz to 28MHz converter complete crystal, four valves. Requires 150v. D.C. and 6.3v. AC. 200/-.

CN1K Kit for above 170/-

GD1 A G5RV type multi-band dipole. 102 ft. top, 100 ft. feeder. Complete and ready to go! 68/-.

GV1 General purpose vertical, usefull range 1.8MHz to 28MHz. Adjustable 7 ft. to 23 ft. 92/-.

TU2 Receiver antenna tuning unit. Amateur and SW broadcast bands 1.5 to 30 MHz. 90/-.

Send SAE for details. Open weekends.

G31AR Carriage extra.

ELECTRONIC & MECHANICAL

SUB-ASSEMBLY CO. LTD.

Highfield House, West Kingsdown, Kent.
Tel: West Kingsdown 2344.

SURREY

Portable Transistor Amplifier plus Dynamic Microphone

A self-contained fully portable mini p.a. system. Many uses — ideal for Parties, or as a Baby Alarm, Intercom, Telephone or Record Player, Amplifier, etc. Attractive rexine covered cabinet, size 12 x 9 x 4in., with powerful 7 x 4in. speaker and four transistor one watt power amplifier plus dynamic microphone. Uses PP9 battery. Brand new in Makers' carton with full makers' guarantee. World famous make 90/- Post Full List 1/- Only 90/- Free

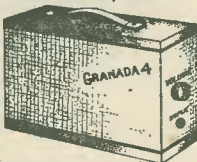

RADIO COMPONENT SPECIALISTS
337 Whitehorse Road, West Croydon, Surrey.
Phone 01-684-1665

SUSSEX

E. JEFFRIES

For your new television set, tape recorder, transistor radio, and hi-fi equipment.

PHILIPS, ULTRA, INVICTA, DANSETTE, MASTERADIO, PERDIO, MARCONI, PHILCO, FIDELITY.

6A Albert Parade,
Victoria Drive,
EASTBOURNE SUSSEX

EIRE

PEATS for PARTS

**ELECTRONIC COMPONENTS
RADIO & TELEVISION**

For the convenience of IRISH enthusiasts we supply:

The Radio Constructor,
Data Books and
Panel-Signs Transfers

Also a postal service

Wm. B. PEAT & Co. Ltd.
28 PARNELL STREET
DUBLIN 1

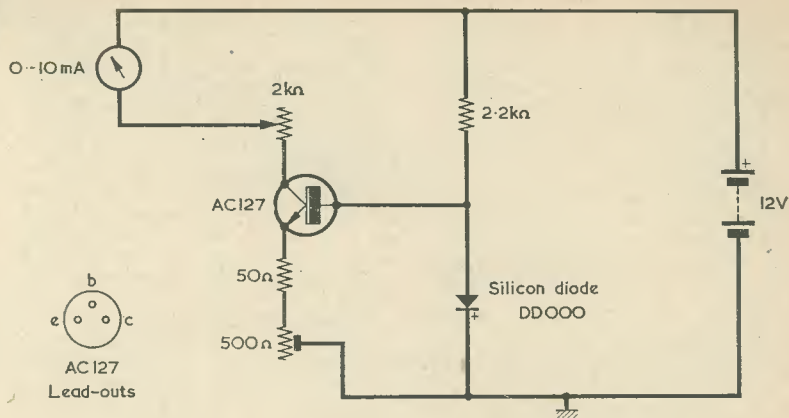

Fig. 3. The first experimental circuit checked by Smithy

about this 10mA meter you've put in the collector circuit? Have we got any 10mA meters in stock?"

"Just use your testmeter switched to its 10mA range," replied Smithy. "Remember, I only want this circuit made up in lash-up form, and you don't need to bother about layout or anything like that. Incidentally, so far as the semiconductors are concerned, the silicon diode isn't critical, and one of those little Lucas DD000 types would be perfectly adequate here. I've decided to use a germanium transistor rather than a silicon one because a germanium transistor requires a lower emitter-base voltage to become conductive, and that enables me to use a single silicon diode for the fixed potential at the base. An AC127 will do fine, and we've got plenty of them in the spares cupboard."

Dick soon found the components required for the circuit, after which he immediately settled to work on its assembly.

"All finished, Smithy," he called out after five minutes. "I haven't connected the 12 volt supply yet, though."

"Fair enough," responded Smithy, as he walked over to Dick's bench and inspected his assistant's handiwork. "You'd better start off by setting both pots to insert maximum resistance. Then connect the battery and slowly reduce the resistance inserted by the 500Ω pot until the meter reads 6mA."

"No sooner asked," replied Dick cheerfully, "than carried out! I'm adjusting the 500Ω pot now. And I'm getting that 6mA reading just as you ask."

"Good," said Smithy. "Next reduce the resistance inserted by the 2kΩ pot."

Carefully watching the meter, Dick slowly turned the spindle of the 2kΩ potentiometer. The meter reading remained unaltered. Unbelievably, Dick continued rotating the spindle until, eventually, the

potentiometer inserted zero resistance.

"Corluvaduk, Smithy," he remarked incredulously. "That meter needle's stayed at 6mA all the time!"

"I told you," chuckled Smithy, "that a grounded base transistor was a constant current device. You've now confirmed that fact for yourself! Well, I'm very pleased with the results so far because they mean that an essential part of my final circuit will be all right. I'd better make another check, though. Just borrow the testmeter off my own bench, switch it to an appropriate voltage range and couple it between the collector of the transistor and chassis. Then adjust the 2kΩ pot over its range whilst the 6mA current is flowing, and see what the maximum and minimum collector voltages are."

Smithy watched patiently whilst Dick set about this task.

"The collector voltage," announced Dick, ranges from 0.7 to just a little more than 12.5 volts."

LONG-TAILED PAIR

"Excellent," pronounced Smithy. "The 0.7 volts, incidentally, will be given by the 0.5 volts dropped across the silicon diode plus 0.2 volts in the collector-base junction of the transistor. And you get a maximum voltage slightly above 12.5 volts because, as I asked you to do, you used new batteries. The current would have fallen below 6mA if there were more than 2kΩ in the collector circuit because 6mA can't flow through a resistance higher than 2kΩ at a voltage of 12. Anyway, we have now confirmed that our AC127 transistor offers a steady 6mA for all collector voltages from 0.7 to more than 12 volts. We now carry on to my main experiment."

Dick glanced at the Workshop clock. Its hands indicated that tea-

break had ended more than 20 minutes ago.

"Shouldn't we," he asked a little anxiously, "be doing a spot of official work by now?"

"Nonsense," boomed Smithy. "Just for once we're going to use this Workshop as a research establishment."

A gleam came into the Serviceman's eye.

"I've often wondered," he continued, an unconscious note of wistfulness tingeing his voice, "what my life would have been like if I'd spent it designing sets instead of repairing them. At any event, I'm jolly well going to check out *this* particular idea of mine. And until I've done just that, blow the servicing!"

Followed by an astonished Dick, Smithy returned to his bench and proceeded to draw out a further circuit. (Fig. 4).

"Now this," he said, "is what is known as a 'long-tailed pair', and it forms what is perhaps the simplest phase splitter going. You put an input signal into the grid of the left hand triode whereupon its cathode current increases or decreases in sympathy with the signal voltage, thereby changing the cathode voltage of the right hand triode. If the left hand grid goes positive so also do the two cathodes, and the effect in the right hand triode is the same as if its grid went negative. The output signals at the anodes are out of phase and, provided the common cathode resistor has a high enough value, are virtually equal in amplitude. The triodes have similar characteristics, of course, and each offers half the gain it would give if employed on its own in a standard voltage amplifier circuit."

"That long-tailed pair," commented Dick, "is something I learned about ages ago. It may well be a very simple phase splitter, as you say, but I haven't seen it used very often in practice."

"That's because," replied Smithy, "to get a high enough value of resistance in the common cathode resistor you need the auxiliary negative supply I've shown, and an auxiliary negative supply is something of a nuisance in a practical design. You *can*, mind you, use the circuit without the auxiliary supply by biasing the two grids at a point positive of chassis, but this tends to introduce complications. If all goes well, that constant current transistor of ours will enable both the grids to be biased at chassis potential and an auxiliary h.t. negative supply won't be required."

Smithy turned to his pad yet again to sketch out a further circuit. (Fig. 5).

"This," he announced proudly, "is the circuit for our final experiment, and it represents what seems to me to be the phase splitter to end all phase splitters! The ECC82 appears in a long-tailed pair configuration but, instead of a high value resistor coupling the cathodes to an auxiliary negative supply, we now have our constant current transistor coupling the cathodes to the standard h.t. negative line. We know that, so far as change in collector voltage is concerned, the slope resistance offered by a transistor in grounded base is very high. Looked at in that light alone, the transistor in this circuit offers the requisite high resistance for a long-tailed pair. And we also know, from experiment, that our AC127 offers a con-

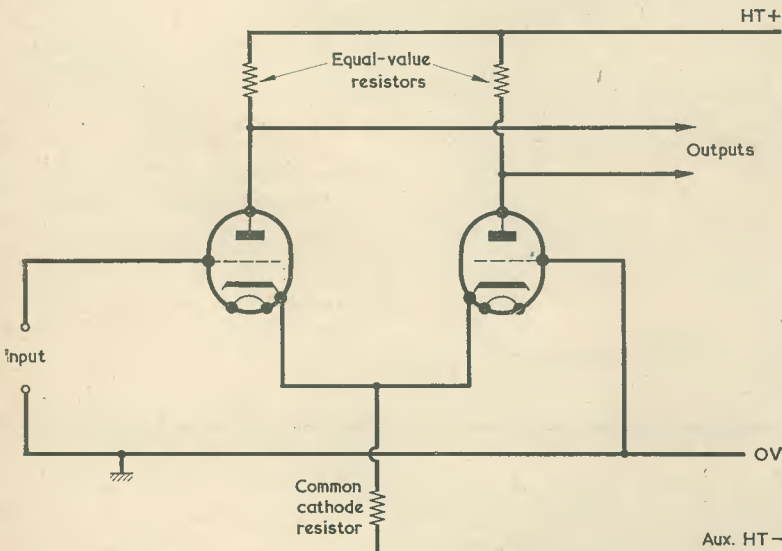

Fig. 4. The basic long-tailed pair, using triode valves. The auxiliary h.t. negative supply is negative of chassis

Stella Nine Range Cases

Manufactured in Black, Grey, Lagoon or Blue Stelvetite and finished in Plastic-coated Steel, Morocco Finish with Aluminium end plates. Rubber feet are attached and there is a removable back plate. There is also a removable front panel in 18 s.w.g. Alloy.

Now all Aluminium surfaces are coated with a stripable plastic for protection during manufacture and transit. All edges are polished.

LIST OF PRICES AND SIZES
which are made to fit Standard Alloy Chassis

Width	Depth	4" Height		6" Height		7 1/2" Height	
		£ s. d.	£ s. d.	£ s. d.	£ s. d.	£ s. d.	£ s. d.
6 1/2"	3 7/8"	12	6	15	0	18	0
6 1/2"	4 3/8"	13	6	18	0	1	0
8 1/2"	3 3/8"	15	0	0	0	1	0
8 1/2"	6 3/8"	1	1	0	1	6	6
10 1/2"	7 3/8"	1	8	6	1	5	6
12 1/2"	3 3/8"	1	1	0	1	6	6
12 1/2"	5 3/8"	1	8	0	1	4	0
12 1/2"	8 3/8"	1	16	0	2	3	0
14 1/2"	3 3/8"	1	5	0	1	11	6
14 1/2"	9 3/8"	2	3	0	2	15	9
16 1/2"	6 3/8"	1	18	6	2	6	3
16 1/2"	10 3/8"	2	10	0	3	5	0

Cases—Post 4s. 6d. per Order.
Discounts available on quantities.

CHASSIS in Aluminium, Standard Sizes, with Gasket Plates

Sizes to fit Cases All 2 1/2" Walls

s. d.		s. d.		s. d.	
6" x 3"	5 6	10" x 7"	8 6	14" x 3"	7 3
6" x 4"	5 9	12" x 3"	6 9	14" x 9"	14 6
8" x 3"	6 6	12" x 5"	7 6	16" x 6"	10 9
8" x 6"	7 9	12" x 8"	10 9	16" x 10"	16 0

Chassis—Post 3s. 0d. per Order.
Discounts available on quantities.

E. R. NICHOLLS

MANUFACTURER OF ELECTRONIC INSTRUMENT CASES

(DEPT. R.C.) 46 LOWFIELD ROAD
STOCKPORT - CHESHIRE

Tel: 061-480 2179

NEW VHF KIT

Receives Television Sound, Ambulances, Aircraft, Radio 2, 3 and 4 on VHF etc.

This novel little set will give you endless hours of pleasure and can be built in one evening. The Kit comes with easy to follow instructions and circuit. Powered by 9v Battery. Complete with built-in Jack Plug Socket for use with Earphones or Amplifier.

ONLY 57/- P & P FREE UK ONLY

Postal Orders, Cheques to

Dept. R.C.2.,
Galleon Trading Co.,
298A Lodge Lane,
Romford, Essex

FANTASTIC SALE

1,000 of the following Amplifier Kits to clear —

	List Price	Sale Price	P.S.
5 watt amplifier	£3.15.0	£1.15.0	9v
7 watt amplifier	£6.15.0	£2.5.0	9v
10 watt amplifier	£8.19.0	£2.15.0	9v

If two are required deduct the following: 2 x 5 watt 5/-. 2 x 7 watt 7/6, 2 x 10 watt 10/-. Please add 2/6 P&P.

M. GLEAVES AND BROTHER

28 WENNY ESTATE
CHATTERIS
CAMBS

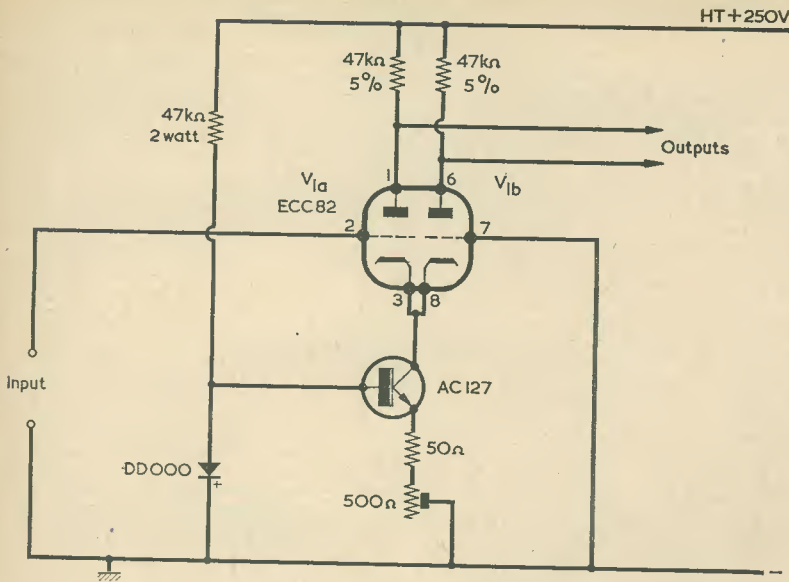

Fig. 5. Smythy's constant current long-tailed pair phase splitter circuit

stant current of 6mA for all voltages from 0.7 to greater than 12. If we set up the AC127 in this circuit for a constant current of about the same value those two triodes *must* share that current between them. So they *must* then function as a true phase splitter."

Dick looked impressed. "You certainly," he remarked, "appear to have been doing some heavy thinking on this circuit. Incidentally, why are you now feeding the silicon diode via a 47kΩ resistor?"

"The grounded base circuit here," said Smythy in reply, "is essentially the same as the previous one with the 12 volt supply. But as we're now using the much higher supply voltage associated with valves, a larger value of resistance is needed to draw the necessary forward current through the diode. In the present circuit the diode passes just about the same forward current as it did in the 12 volt one. Now, what I want you to do next is to wire up this circuit on that chassis you've been using. Some of the previous components and wiring won't need to be altered for the new circuit. You can get an ECC82 out of the cupboard, and we've got an old power supply unit knocking around from which you can take 250 volts h.t. and a 6.3 volt heater supply."

As Dick rushed away enthusiastically to make up the new circuit, Smythy walked over to the bookshelf, picked out the Workshop copy of the Mullard Maintenance Manual and opened it at "ECC82".

After briefly studying its contents he rummaged around in the cupboard under his bench and produced a spare multi-testmeter.

"I've nearly got this circuit finished," called out Dick, as he worked feverishly with his soldering iron.

Several minutes later Dick announced that the experimental circuit was complete. Smythy examined the wiring carefully.

"That's fine," he commended. "Now the Mullard gen I've just been looking up states that, with 250 volts h.t. and a 47kΩ anode load, each triode of an ECC82 gives a voltage gain of 13.5 at a cathode current of 3mA, and with a cathode

bias resistor of 1.2kΩ. Under these conditions, therefore, the cathode bias voltage is 3.6 volts. The first thing to do with this circuit is to connect the grid of the left hand triode, which I've identified as V1(a), to chassis, and to adjust the 500Ω preset pot till the two cathodes are 3.6 volts above chassis. The total current in the two triodes should then be about 6mA, so that the 500Ω pot will require pretty well the same setting as it had in the 12 volt circuit."

PROOF OF THE PUDDING

Quickly, Dick coupled his test-meter between the cathodes and chassis, connected V1(a) grid to chassis, switched on the supply unit and waited for the ECC82 to warm up. As Smythy had predicted, the 500Ω potentiometer needed very little adjustment. Dick switched off the supply and looked expectantly at the Serviceman.

"We're on the last stage now," pronounced Smythy. "And that consists of finding out whether this darned thing works or not! Couple a voltmeter between each of the anodes and chassis, and add an input supply which will enable the grid of V1(a) to swing positive and negative of chassis. You can do this by first connecting two 6 volt batteries in series with their junction to chassis, and then connecting a pot of around 20kΩ across them with its slider to V1(a) grid." (Fig. 6).

"How do I know the voltage that will be going to that grid?"

"With the aid of this spare multi-testmeter I've unearthed for you," replied Smythy, handing his assistant the instrument. "You'll have to change its leads over, of course, when the input goes from positive to negative and vice-versa. Our ordinary bench meters will do for the anode voltages. Since they're both of the same make and type,

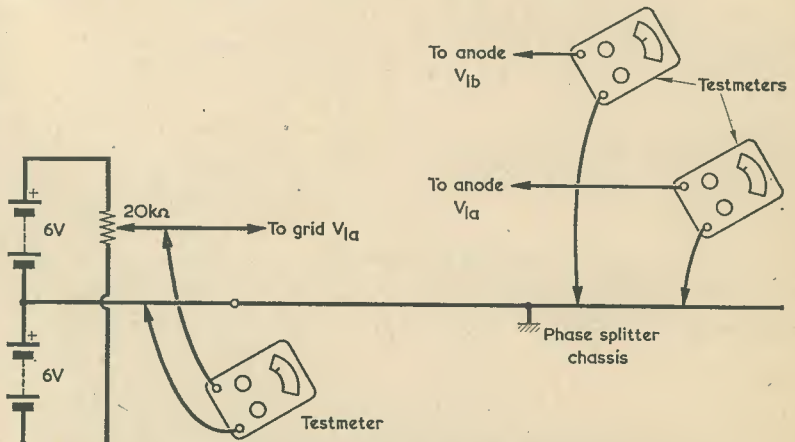

Fig. 6. Smythy brought into use a battery of testmeters for his final performance check of the phase splitter circuit

they'll offer the same loading on the circuit."

"This is becoming really interesting," remarked Dick. "Especially having all these meters in use."

"It is getting rather exciting," admitted Smithy, his usual phlegmatic manner deserting him as the moment of truth approached. "So let's get those extra bits wired up without too much delay."

It was not long before Dick had coupled up the additional components. As he completed the last connection, a suddenly impatient Smithy moved over and switched on the power supply. As he waited for the ECC82 to warm up, Smithy unclipped the meter monitoring the input voltage and set the 20kΩ input potentiometer to mid-travel.

Several seconds later the needles of the two anode voltmeters started to rise, both steadying after a moment at about 120 volts. With a shaking hand Smithy turned the spindle of the input potentiometer.

One anode voltmeter needle went up. The other anode voltmeter needle went down.

The elated Serviceman turned the input potentiometer in the opposite direction.

The first anode voltmeter needle went down. The second went up.

"That's it!" exclaimed Smithy jubilantly. "The circuit works exactly as I thought it would!"

"It certainly seems to be acting as a phase splitter," remarked Dick cautiously. "But are you completely sure that the two outputs have equal amplitude?"

"Well," said Smithy, "the needle swings of both meters certainly looked equal. However, we'll check that point by drawing anode voltage-grid voltage curves for these two triodes. I've got a spot of graph paper in the cupboard, so what you can do is to adjust that input pot in half-volt steps on either side of chassis potential up to, say, 5 volts each way. At the same time, call out the corresponding anode voltages."

SATISFACTION ASSURED

For the next quarter of an hour the Workshop did, indeed, take upon itself the rarified atmosphere

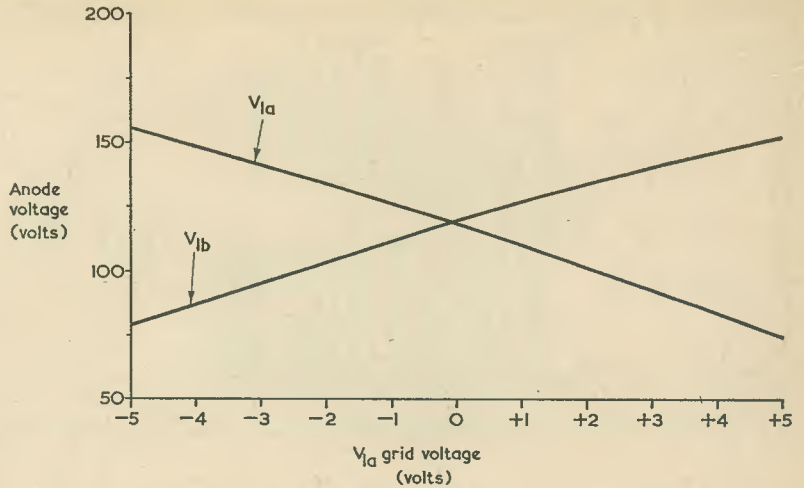

Fig. 7. Curves showing anode voltage of V1(a) and V1(b) of Fig. 5, plotted against V1(a) grid voltage

of your actual Research and Development laboratory. Dick busied himself with his meters whilst Smithy plotted the readings on his graph paper. After the last reading had been taken, Smithy drew two lines through the points he had plotted and gazed at them with considerable satisfaction (Fig. 7).

"There you are, Dick," he said to his assistant, who had joined him after announcing the final reading. "Within experimental error, these two curves are almost exact mirror images of each other. So that circuit really does function as a high performance phase splitter. I see that for a grid voltage swing of 10 volts we get a change in anode voltage of about 70 volts, which means that each of those ECC83 triodes is giving a voltage gain of 7. Which ties in very nicely with basic theory, because this figure of 7 is just about half of the gain given by an ECC83 triode under normal voltage amplifier conditions."

Dick looked once more at the phase splitter circuit with the constant current transistor in the common cathode circuit.

"Do you know, Smithy," he re-

marked admiringly. "You really have produced something today."

"As this circuit stands," stated Smithy, "it is of main use for a.f. amplifiers and things like that. But there are a lot of other potential applications I've got in the back of my mind for this constant current long-tailed pair arrangement, and I'm going to look into these at a future date. For the moment, though, I'm satisfied. I suppose we'd better now cease these experiments and get down to a bit of the set repairing we're paid to do."

"Smithy," commended Dick warmly, "your talents are wasted here. I reckon you're a genius, mate."

Smithy acknowledged this praise with a modest dusting of the finger nails on the lapels of his overall jacket. Then, doffing his R and D cap and donning the more accustomed headgear of a service engineer, the Great Man turned back to the little transistor radio he had been working on before tea-break, and continued with the replacement of its noisy volume control.

DAYSTROM AT AUDIO FAIR

Daystrom Ltd., Gloucester will be exhibiting the latest Heathkit Hi-Fi stereo amplifiers, tuner-amplifiers, F.M. tuners, stereo 'compacts', loudspeakers, etc. A selection of these will be on demonstration in the Audio Studio on their stand.

New models this year include two stereo 'compacts' models AD-17 and AD-27. The AD-17 comprises a BSR MA65 turntable with Shure M44-MB magnetic cartridge and a 10 watt (rms) per channel stereo amplifier all mounted on a teak or walnut plinth. The AD-27 is similar but uses the MA70 turntable and includes an FM stereo tuner. In this case the 'plinth' is better described as a small cabinet. It has a 'roller shutter' lid and is available in teak or walnut.

A new loudspeaker has been added to the Heathkit range. The 'Ambassador' is a first class hi-fi loudspeaker. The cabinet comes ready assembled and finished in teak or walnut to match other current Heathkit equipment. It uses three loudspeaker units - a 12in. bass unit, a 5in. mid range and a small tweeter.

Radio Topics

By Recorder

SOME STORIES, EVEN THOSE CONCERNED with electronic matters, have a sting in the tail. There is a particularly noxious sting at the end of the story which I am now about to relate and which deals with, of all things, the fitting of mobile radios to a city's buses.

As mentioned in News and Comment last month, by the time these notes appear, 37 of the Corporation buses in Coventry will be fitted with mobile radio installations to enable their drivers to keep in constant touch with a new traffic control centre in the centre of the city.

BUS INSTALLATION

The installation for each bus consists of the G.E.C. high power v.h.f. frequency modulated transmitter-receiver type RC/600. This equipment is fully transistorised except for the 20 watt power output and driving stages in the transmitter, which use "quick-heat" valves. The transmitter with its power supplies is housed in a single unit, mounted under one of the bus seats. The receiver and system controls are in a small unit, mounted in the driver's cab. The receiver itself can be withdrawn from its mounting and carried by the driver to keep him in touch with the base if he should have to leave his cab for any reason. The RC/600 provides an extremely flexible communication system, capable of working throughout the whole area of operations of the Coventry bus service.

The bus systems are augmented by eleven G.E.C. "Courier" v.h.f. pocket transceivers, these being employed by inspectors patrolling the routes and also by the management.

Why has all this equipment been installed? One of the reasons is that the communication system keeps the drivers in touch with the transport centre and enables them to increase overall efficiency by reporting breakdowns, accidents and traffic jams.

But that isn't the main reason. The main reason is that the bus installations provide a measure of protection for drivers against attack by the hooligans and thugs who infest so many of our cities these days. The question of driver protection is particularly important with the newer "pay-as-you-enter" buses, where the driver is completely on his own. It is anticipated also that the radios will enable vandalism to be reduced. So, yet again, we see public expenditure and time being spent in the fight against hoodlums and drop-outs.

I said that this story had a sting in its tail.

PROGRAM PATTERN

Computers, in the intervals when they are not engaged in sending me a final reminder for the gas bill a fortnight after I've paid it, certainly seem to be very productive machines. They are not, however, directly responsible for the many colourful new terms which have now been added to our language by those who design, build and tend them. Such terms can be a little confusing when first encountered, and so I have compiled a short glossary of those which tend to appear most frequently in articles and news items devoted to computer technicalities. Some readers will, of course, be already familiar with these terms, but the definitions which follow may be helpful to others.

Alphanumerical system. A system which handles both alphabetical characters (i.e. letters) and numbers.

Bit. Short for "binary digit", e.g. 1 or 0.

Buffer store. An item of equipment which by means of data storage, enables a computer to be coupled to an input or output device when their operating speeds differ.

Data. The facts and/or figures fed to a computer or produced by a computer.

Data processing. The operations which process data for further use, for future reference or for revision of existing information.

Digital computer. A computer which processes figures directly (as opposed to an analogue computer which deals with quantities).

Hardware. The computer and its peripheral electrical, electronic and mechanical equipment.

Interface. An interface appears at the point of coupling between two equipments having different functions.

On line working. Applied to a computer coupled directly to data producing equipment, sometimes via a buffer store.

Peripheral equipment. The items of equipment coupled to, and operating with, the computer.

Program. A sequence of instructions which controls the processes carried out by a computer.

Real time working. Applied to a computer which deals with external events at the same time as they occur.

Software. The program.

Store. An item of equipment which can retain information for later retrieval. May also be referred to as a "memory".

Word. A sequence of binary digits processed as one group.

NEAT FINISH FOR PANELS

I am indebted to a reader, Mr. W. L. Brunson of Wallasey, Cheshire, for details of a very neat and convenient method of providing a protective finish for metal panels. Basically, the idea consists of applying a thin transparent adhesive film over the panel surface. The film employed is known as "Coverlon", is made by the manufacturers of "Fablom", and should be available at any good stationer's and, in particular, at any branch of W. H. Smith and Sons. The cost of "Coverlon" is only a few shillings for a piece measuring 13 by 36in., and it can be obtained in vari-

THE RADIO CONSTRUCTOR

ous colour tints or in neutral.

The panel to which the film is applied must first have its holes drilled, and it must be free from all blemishes since any marks will show through on the finished job. It must also be clean and well burnished, a requirement which is easily met with the aid of fine grade steel wool.

When applying the film to the panel, the main thing to bear in mind is to press and work from the centre, so as to ensure that no air bubbles are formed. The film must be well rubbed down. Overhanging film at edges and corners can be removed with a fine file or the abrasive side of a match box. Small holes can be pushed through with a match stick.

The film gives the finished panel an extremely attractive appearance, and further advantages are that it may be applied quickly, easily and cleanly, without all the fuss and mess which accompanies a painting job. Panel-Sign transfers can be affixed either under or over the film and impart a "professional" look to the completed panel. "Coverlon" is tough and durable, and it adheres very firmly to the surface to which it has been applied.

Mr. Brunson says that he has used the film on the panels of quite a lot of home-constructed equipment, and his friends have been extremely impressed by the results obtained. This is certainly an excellent idea to my mind, and my thanks are due to Mr. Brunson for passing along the details.

SWITCH RATINGS

Some years ago, whilst doing a little servicing work on a valve communications receiver, I bumped into a little resistor whose function puzzled me for a few minutes. This

receiver had a wafer function switch which, on certain of its positions, short-circuited the a.g.c. line to chassis. The short-circuit was taken to a point along the a.g.c. line which was by-passed to chassis by a $0.1\mu\text{F}$ capacitor, and the receiver designer had seen fit to insert a 150Ω resistor between the switch and the capacitor.

After a while, light suddenly dawned on me. Without that resistor in series the switch would, of course, be applying a dead short across the $0.1\mu\text{F}$ capacitor whenever a.g.c. was switched out. The capacitor could, typically, be charged to some 15 volts and there would then be a small surge current when the switch contacts closed. The short-circuit surge current from a $0.1\mu\text{F}$ capacitor charged to 15 volts is hardly in the epoch-making bracket, but the set-designer had presumably considered it of sufficient importance to merit the inclusion of a series limiter resistor, with consequent increase in the useful life of the switch.

Which brings me to a topic that is not always fully appreciated by newcomers to radio, this concerning the current and voltage ratings quoted by switch manufacturers for their products. The current rating is, normally, either the maximum current which can be interrupted by the switch or the maximum current which can flow at the instant of closing, whichever is the greater. Usually, the current a switch can carry *after* it has closed and *before* it opens is significantly greater than the rated current. If current rating figures are exceeded the useful contact life of the switch will almost certainly be shortened.

The voltage rating of a switch is governed by the distance of contact separation, the rate at which the con-

tacts separate, and the insulation employed in the switch.

The switch ratings quoted are normally for resistive loads. A capacitive load (like that a.g.c. capacitor in the communications set) causes a heavy initial current to flow when the switch closes. An inductive load can cause flashing across the switch contacts when they open, this being due to the high back-e.m.f. produced when the current in an inductor suddenly ceases. Both these points require attention when a switching circuit is being worked out for capacitive or inductive loads.

Some purely resistive loads can be a little tricky, too. The best example here is given by the common or garden electric light bulb, whose filament has a much lower resistance when cold than when it has reached full temperature. The switch employed to turn the lamp on and off should be capable of switching on the current which flows in the *cold* lamp resistance.

Finally, a point about d.c. and a.c. ratings. These are normally specified with switches which are slow-acting or which have small contact separation when open, the a.c. ratings being higher than the d.c. ratings. This is because the arc which is formed when a d.c. circuit is broken stays maintained until contact separation is too great to sustain it. An a.c. arc, on the other hand, tends to cease when the voltage drops to zero on each half-cycle.

CHEERS FOR NOW

I see that I've once more come to the end of my allotted space so I'll say cheerio for the time being.

See you next month!

A SIMPLE COLOUR PRINTER

(Continued from page 159)

CONCLUSIONS

About 1,000 prints were made with the prototype model from a wide variety of negatives of the same make. The success percentage was about 80%. The instrument was simultaneously correcting both optical density and colour balance. Manual corrections were only necessary with negatives varying considerably from normal. The production rate achieved was about 40 prints per hour.

Enlargements made with the instrument have mainly been 9 by 9 cm. from 6 by 6 cm. negatives, together with a small number of 7 by 10cm from 35 mm. negatives. With the present instrument enlargements up to 13 by 18 cm. are feasible, but the larger size requires a 250 watt enlarger lamp to ensure that sufficient light is passed to the measuring head. This head should be shifted higher for these larger prints.

OCTOBER 1969

ACKNOWLEDGEMENTS

The author wishes to express his sincere thanks to Mr. Evangelos Rigopoulos for his invaluable assistance during design and construction of the instrument.

Also, thanks are due to Dr. K. Georgopoulos for helpful discussions on colour photography and Dr. D. Bersis for instructions in constructing the lens.

REFERENCES

1. J. H. Coote, F.R.P.S., F.B.K.S., "Colour Prints", Focal Press, Ltd.
2. J. L. Linsey Hood, "A Simple Automatic Photographic Enlarger Timer", *Electronic Engineering*, July, 1966.
3. Phillips Data Handbook "Components and Materials" part II, November, 1967.

THE RADIO CONSTRUCTOR

"CIR-KIT 6" RECEIVER

DESCRIBED IN
THIS MONTH'S
ISSUE

IS BASED ON PEAK SOUND
"Cir-kit"

The world's most versatile
circuit building medium

Once more a famous technical journal specifies Peak Sound "Cir-Kit" as the basis for its circuitry. This marvellously adaptable medium enables you to wire up a circuit board more quickly, more economically and with greater flexibility than any other system. "Cir-Kit" comprises almost 100% pure copper strip backed by a specially powerful heat-resistant adhesive and is extremely easy to lay and solder to. It is particularly valuable to experimenters and as *Radio Constructor* shows, it could not be bettered in a design such as this attractive receiver.

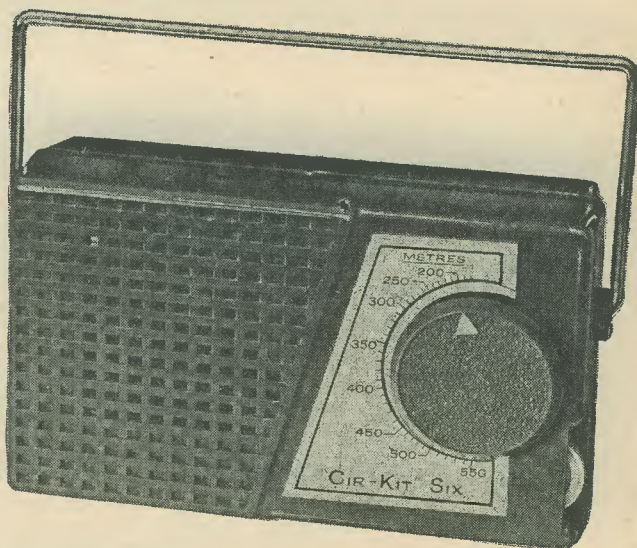

PEAK SOUND "Cir-Kit" Kit No. 3 as specified for the R.C. "Cir-Kit 6" Receiver comprises mounting board, 6" x 4" "Cir-Kit" sheet and 15ft. of "Cir-Kit" adhesive copper strip — sufficient for a great variety of circuits and designs, with instructions.

12/6

Postage & packing in U.K. please add 1/-

"Cir-Kit" in spool form 5ft. x $\frac{1}{8}$ " 2/-

Other Peak Sound designs

P.W.12-12 STEREO AMPLIFIER

Integrated stereo amp. described in P.W. With Peak Sound "Cir-Kit", amplifier modules, etc., you can build it complete including cabinet for approximately **£24.0.0**

PA.12-15 POWER AMPLIFIER

Power amp. module, 12 watts into 15 ohms; in kit **£3.19.6**
Built module **£5.19.0**

PA.25-15 POWER AMPLIFIER

25 watt de-luxe power amp., 25 watts into 15 ohms.
Built module **£11.15.0**

SCU.400 PRE-AMP/CONTROL

De-luxe pre-amp/control unit for Peak Sound power amps.
Built module **£15.15.0**

ES.10-15 BAXANDALL SPEAKER

Designed by P. J. Baxandall and described in *Wireless World*.
Peak Sound approved part. inc. P.T. **£11.5.0**

GO TO YOUR DEALER for Peak Sound products. Leaflets on request.

TRADE ENQUIRIES INVITED.

PEAK SOUND (HARROW) LTD., 32 ST. JUDES ROAD, ENGLEFIELD GREEN,
EGHAM, SURREY

Telephone: EGHAM 5316

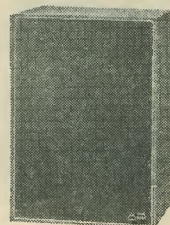

SMALL ADVERTISEMENTS

Rate: 9d. per word

Minimum charge 12/-

Box No. 2/- extra.

Advertisements must be prepaid and all copy must be received by the 4th of the month for insertion in the following month's issue. The Publishers cannot be held liable in any way for printing errors or omissions, nor can they accept responsibility for the *bona fides* of advertisers. (Replies to Box Numbers should be addressed to: Box No. —, *The Radio Constructor*, 57 Maida Vale, London, W.9.)

BUILD IT in a **DEWBOX** robust quality plastic cabinet. 2in. x 2½in. x any length. S.A.E. for details. D.E.W. Ltd., 254 Ringwood Road, Ferndown, Dorset. Write now—right now.

SERVICE SHEETS. Radio, Television, Transistors, Tape Recorders, Record Players (1925-1969). S.A.E. enquiries.—Hamilton Radio, 54 London Road, Bexhill, Sussex.

UFO DETECTOR CIRCUITS. Data, 10s. (refundable). Para-physical Laboratory (UFO Observatory), Downton, Wilts.

FULLY TESTED TRANSISTORS. T05 can, p.n.p. Germ. Similar to OC71, OC41, NKT 128, etc. Characteristics supplied. 30 for 10/- P. & P. 1/-.—D. Huddart, 56 Mortlake Road, Ilford, Essex.

BOOKS FOR SALE: *Earth's Envelope*, Theo Lobsack 10/-, *Space Research & Exploration*, D. R. Bates 15/-, *Practical Yacht Racing*, Schiottz 15/-, *Yacht Racing*, Sturgess £1, *Faster Sailing*, Bavier 10/-, *The Story of Atomic Energy*, Soddy 7/6d., *Radioisotope Laboratory Techniques*, Faïres 7/6d., *Atomic Medicine*, Behrens 15/-, *Medical Radiation Biology*, Ellinger £1, *Sunday Times & Life World Library Volumes: Brazil, S.E. Asia, Israel, Italy, Russia, Mexico, Greece, Africa, Germany, France, India, Britain, Japan, Scandinavia*, 12/6d. each, *Life Science Library: Wheels, Mathematics, Man & Space, Planets, Energy*, 12/6d. each, *The Colour of Canada*, £1, *Science Survey 3*, Vista Books £1, *Science Today & Tomorrow* 10/- Box No. F364.

MULLARD AMPLIFIERS. 5/10 40s. 3/3 30s. 2/2 20s. Fully finished in perfect working order. Assorted components, 20s. the lot. S.A.E. for details. T. Gomes, 1 Abbey Street, Edinburgh.

JOIN THE INTERNATIONAL S.W. LEAGUE. Free Services to members including Q.S.L. Bureau, Amateur and Broadcast Translation, Technical and Identification Dept.—both Broadcast and Fixed Stations, DX Certificates, contests and activities for the SWL and transmitting members. Monthly magazine, *Monitor*, containing articles of general interest to Broadcast and Amateur SWLs, Transmitter Section and League affairs, etc. League supplies such as badges, headed notepaper and envelopes, QSL cards, etc., are available at reasonable cost. Send for League particulars. Membership including monthly magazine, etc., 35s. per annum. Secretary ISWL, 60 White Street, Derby.

PLASTIC CASES. Non-brittle, easily drilled. 2½in. x 1½in. x 4in. 2/- each from: 16 Church Street, Bletchley, Bucks.

FOR SALE: Disposing of small collection of 78 r.p.m. records. Classical, semi-classical and light music (some musicals). Many collectors' items. S.A.E. for list. Box No. F369.

MUSICAL MIRACLES. Send s.a.e. for details of Drum Sound Modules, versatile bass-pedal accompaniment unit, self-contained with unique effects. Kits for Waa-waa pedals 47/-. Also 50µA meters 25/- each. New. D.E.W. Ltd., 254 Ringwood Road, Ferndown, Dorset.

Continued on page 189

BENTLEY ACOUSTIC CORPORATION LTD.

38 Chalcot Road, Chalk Farm,
LONDON, N.W.1.
01 - 722 9090

The Old Police Station
Gloucester Road
LITTLEHAMPTON, Sussex
PHONE 6743

Please forward all mail orders to Littlehampton

5Z4G	6/9	ECC189	9/6	PC900	8/3	UABC80	5/9	ACY17	3/-	BYZ13	5/6
6AT6	4/-	ECF80	6/6	PC884	6/-	UBC81	7/-	ACY18	3/8	GET573	7/6
6/30L2	12/6	ECF82	6/6	PC885	6/6	UBF80	5/9	ACY19	3/9	CA70	3/-
6BW6	11/-	ECH42	10/-	PC889	9/9	UBF89	6/9	ACY20	3/6	CA79	1/9
6F23	13/3	ECH81	5/9	PC8189	9/6	UCC84	8/-	AD140	7/6	OA90	2/6
6L6GT	7/9	ECH83	8/-	PCF80	6/6	UCC85	6/6	AD149	8/-	OA91	1/9
10P13	13/-	ECH84	7/-	PCF82	6/-	UCF80	8/3	AD162	9/-	OA95	1/9
20P4	18/6	ECF80	6/6	PCF84	8/-	UCH21	9/-	AF114	4/-	OA182	2/6
30C15	13/6	ECF86	6/-	PCF86	9/6	UF86	9/-	BA129	2/6	OC28	5/-
30C17	12/6	ECL86	6/-	PCF801	7/-	UCH81	6/6	AF119	3/-	OC202	2/-
30C18	8/9	ECL86	8/-	PCF802	9/-	UCL82	7/-	AF125	3/6	OC22	5/-
30F5	13/6	EF22	12/6	PCL82	7/-	UCL83	10/-	AF139	13/-	OC23	5/-
30FL1	15/-	EF41	9/6	PCL83	9/-	UF41	9/6	AF180	9/6	OC24	5/-
30FL12	16/-	EF80	4/6	PCL84	7/6	UF80	6/9	BA102	9/-	OC25	5/-
30FL14	12/6	EF85	5/3	PCL85	8/3	UF85	6/9	BA115	2/8	OC26	5/-
30L15	13/9	EF86	6/-	PCL86	8/6	UF86	9/-	BA129	2/6	OC28	5/-
30P7	13/-	EF89	4/9	PEN45DD	12/-	UF89	6/3	BA130	2/-	OC30	5/-
30P4	12/-	EF91	3/3	PFL200	12/-	UL41	9/6	BC107	4/-	OC35	5/-
30P4M2	17/6	EF183	6/-	PL36	9/6	UL84	6/6	BC108	3/6	OC36	7/6
30P12	13/-	EF184	6/-	PL81	7/3	UM80	6/6	BC113	5/6	OC38	11/6
30P19	12/-	EH90	6/6	PL82	6/6	UY41	6/9	BC118	4/6	OC41	10/-
30PL1	15/-	EL33	12/-	PL83	6/6	UY85	6/6	BC119	5/6	OC42	11/-
30PL13	8/5	EL41	9/3	PL84	6/3	2N404	6/3	BCY12	5/6	OC45	1/9
30PL14	15/-	EL84	4/6	PL500	12/-	2N1756	10/-	BCY33	5/6	OC46	3/6
CL33	18/6	EL95	5/-	PL504	12/6	2N2147	17/-	BCY34	4/6	OC70	2/3
DY87	5/9	EM80	5/9	PL509	28/9	2N2297	4/6	BCY38	5/6	OC71	2/-
EB8CC	12/-	EM81	6/9	PL802	15/-	2N2369	4/3	BCY39	4/6	OC72	2/6
EABCB80	6/-	EM84	6/-	PY33	9/6	2N2613	7/9	BCZ11	3/6	OC74	2/6
EAP92	6/6	EM85	11/-	PY81	5/3	2N2053	6/6	BD119	9/-	OC75	2/6
EB91	2/3	EM87	7/3	Y82	5/-	2N3121	5/9	BFY50	4/-	OC78	3/6
EBC41	8/6	EY51	6/9	PY83	5/6	2N3703	3/9	BFY51	4/-	OC78D	3/6
EBC81	5/9	EY87	6/-	PY88	6/3	2N3709	4/-	BFY52	4/6	OC81	2/-
EBF80	6/-	EZ40	7/3	PY800	6/6	2N3866	20/-	BFY59	5/-	OC81D	2/-
EBF83	8/-	EZ80	4/3	PY801	6/6	2N3988	10/-	BFY63	4/-	OC82	2/3
EBF89	6/3	EZ81	4/6	U19	34/6	25323	10/-	BFY73	7/6	OC83	2/-
EC92	6/6	HVR2	8/9	U25	13/-	AA119	3/-	BFY80	6/-	OC84	3/6
ECC81	3/9	KTW62	10/-	U26	11/9	AA120	3/-	BY100	3/6	OC123	4/6
ECC82	4/6	PABC80	7/3	U37	34/11	AC113	5/-	BY126	5/-	OC169	3/6
ECC83	4/6	PC86	9/6	U191	12/6	AC127	2/-	BY127	5/-	OC172	4/6
ECC84	5/6	PC88	9/6	U301	11/-	AC154	5/-	BYZ10	5/-	OC200	4/4
ECC85	5/-	PC95	8/3	U404	7/6	AC156	4/-	BYZ11	5/-	OC202	4/6
ECC88	7/-	PC97	8/6	U801	18/-	AC157	5/6	BYZ12	5/-	OC203	4/6

Terms of business: Cash with order only. No C.O.D. Post/Packing 6d. per item. Orders over £5 post free. All orders despatched same day as received by first class mail. Complete catalogue including transistor section and components with terms of business 10d. Any parcel insured against damage in transit for 6d. extra. Business hours 9 a.m.—5.30 p.m. Saturdays 9 a.m.—1 p.m.

TECHNICAL TRAINING by ICS IN RADIO, TELEVISION AND ELECTRONIC ENGINEERING

First class opportunities in Radio and Electronics await the ICS trained man. Let ICS train YOU for a well-paid post in this expanding field.

ICS courses offer the keen, ambitious man the opportunity to acquire, quickly and easily, the specialized training so essential to success.

Diploma courses in Radio TV Engineering and Servicing Electronics, Computers, etc. Expert coaching for:

- * C. & G. TELECOMMUNICATION TECHNICIANS CERTS.
- * C. & G. ELECTRONIC SERVICING
- * R.T.E.B. RADIO AND TV SERVICING CERTIFICATE
- * RADIO AMATEURS EXAMINATION
- * P.M.G. CERTIFICATES IN RADIO TELEGRAPHY

Examination Students Coached until Successful.

NEW SELF-BUILD RADIO COURSES

Build your own 5-valve receiver, transistor portable, signal generator, multi-test meter and professional-type valve voltmeter—all under expert guidance.

POST THIS COUPON TODAY and find out how ICS can help YOU in your career. Full details of ICS courses in Radio, Television and Electronics will be sent to you by return mail.

MEMBER OF ASSOC. OF BRITISH CORRESPONDENCE COLLEGES.

INTERNATIONAL CORRESPONDENCE SCHOOLS

Dept. 248, Intertext House, Stewarts Road, London, S.W.8.

NAME

Block Capitals Please

ADDRESS

10.69

NEW STYLE SELF-BINDER

for "The Radio Constructor"

The "CORDEX" Patent Self-Binding Case will keep your issues in mint condition. Copies can be inserted or removed with the greatest of ease. Rich maroon finish, gold lettering on spine.

Specially constructed Binding Cords are made from Super Linen of great strength, very hard twisted and twice doubled. They are attached to strong RUSTLESS Springs under tension, and the method adopted ensures PERMANENT RESILIENCE of the Cords. Any slack that may develop is immediately compensated for, and the Cords will always remain taut and strong. It is impossible to overstretch the springs, as a safety check-device is fitted to each.

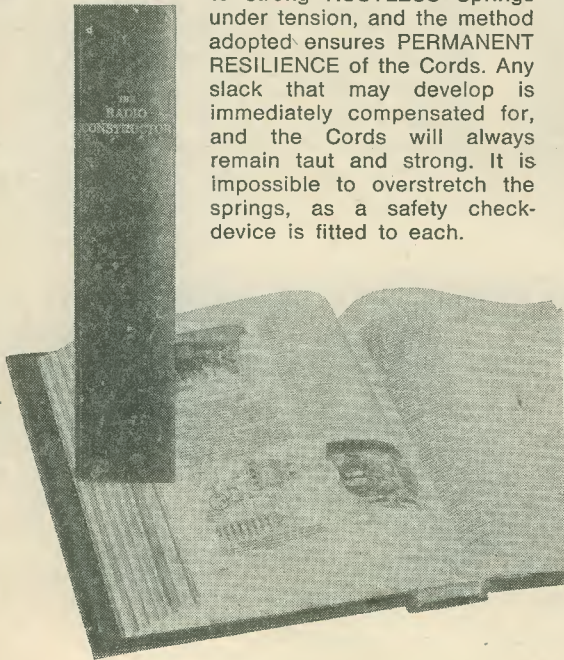

PRICE **14/-** Postage 1/6

Available only from:—

Data Publications Ltd.
57 Maida Vale London W9

JACKSON 
the big name in PRECISION components

The Latest Transmitter Capacitor Type TX 5

Variable Capacitor

Ceramic insulation. End area $2\frac{3}{4} \times 2\frac{3}{4}$ ". Heavy gauge aluminium vanes with radiused edges.

.128" air gap up to 150pF.
.064" air gap up to 500pF.
.036" air gap up to 1000pF.

Designed for use in radio transmitting and power oscillators. Split stator models also available to order.

Write for details



JACKSON BROS. (London) LIMITED
Dept. RC, KINGSWAY-WADDON, CROYDON, CR9 4DG
Phone Croydon 2754-5 (01-688). Grams Walfilco, Croydon. U.S. Office: M. Swedgal, 258 Broadway, N. York. N.Y. 10007.

INTERNATIONAL SHORT WAVE LEAGUE



Membership 35s. 0d. per annum (U.S.A. \$5.00) including 12 monthly issues of *Monitor* — the League journal. Including free use of all Services, QSL Bureau, etc.

**THE LARGEST S.W.L. ORGANISATION
IN THE WORLD**

For full details write to:

**The Secretary,
I.S.W.L.,
60 WHITE STREET, DERBY**

SMALL ADVERTISEMENTS

Continued from page 187

POSTAL ADVERTISING? This is the Holborn Service, Mailing lists, addressing, enclosing, wrapping, facsimile letters, automatic typing, copy service, campaign planning, design and artwork, printing and stationery. Please ask for price list.—The Holborn Direct Mail Company, Capacity House, 2-6 Rothsay Street, Tower Bridge Road, London, S.E.1. Telephone: 01-407-1495.

LARGEST SUPPLIERS OF SERVICE SHEETS: TV, Radio, Tape, Recorders, Record Players, Transistors, Stereograms, Radiograms. Only 5/- each, plus s.a.e. Uncrossed P.O.'s please, returned if service sheets not available. We have the largest supplies of service sheets (strictly by return of post). Please state make and model number alternative. Mail order only. Please mention *The Radio Constructor* when answering this advert. Mr. C. Caranna, 71 Beaufort Park, London N.W.11.

MAGAZINES FOR SALE: *Wireless World* July to September 1965 inc., March, July and September 1966, 1967-January & February, May, June, August and September. *Radio Constructor* January 1966 to March 1968 inclusive. *Practical Wireless* 1964 February to April inc., June, 1965-March to September inc. plus November & December; 1966-January to April inc. *Practical Television* 1965-January, April, July & August; 1966-January to July inc., plus September & October. *Short Wave Magazine* 1965-March, July, September to December inc.; 1966-January to November inc. *R.S.G.B. Bulletin* 1965-January, March, June, August, September, November & December; 1966-January to September inc., plus November. *Hi-Fi News* 1965-May, August to October inc., November & December; 1966-January to October inc. *Amateur Tape Recording* 1965-May, August, September, October & December; 1966-January to April inc., June to August inc.; 1967-April May, June to September inc. What offers? Will sell in lots or separately. Can be collected in London. Box No. F370.

WANTED: "The Radio Constructor" May 1962 issue and November 1963. Good price offered. 7 Clarence Road, Harpenden, Herts.

"MEDIUM WAVE NEWS" Monthly during DX season.—Details from: K. Brownless, 7 The Avenue, Clifton, York.

WORLD DX CLUB covers all aspects of SWling on Amateur and Broadcast Bands through its monthly bulletin "Contact". Membership costs 25s. a year. Enquiries to Secretary, WDXC, 17 Taunton Road, Bridgewater, Somerset.

FOR SALE: Revspeed revolution counter £3. Box No. F378.

FOR SALE: Metal Rectifier, Radiospares Type REC22, 30/-. Push-pull Interstage transformer, Repanco Type TT4, 7/6d. Pair Mullard OC36 transistors, unused, 35/-. Heat sink to match, 10/-. 0-200mA meter, 2½in. diam., flush mounting, 10/-. 0-40mA meter, 2in. sq. f.m., 15/-. 50 assorted resistors, £1. 25 assorted capacitors, £1. Box No. F379.

INNOVATION IN DX CLUBS ANNOUNCED! Formed in October, 1965, the Radio New York Worldwide Listeners Club now has 3,600 members in 86 countries! A unique club offering shortwave listeners monthly magazines containing listening tips and technical features, numbered wallet-sized membership cards and gold 8½in. by 11in. membership certificates. Multi-lingual report forms available for cost of postage. "We must be doing something right!" Find out . . . join now!" Send 7s. 2d. (crossed domestic money order) for one year's membership to: The Radio New York Worldwide Listeners Club, 485 Madison Avenue, New York 10022, U.S.A. *Continued on page 190*

The "NEOPHYTE" AMPLIFIER

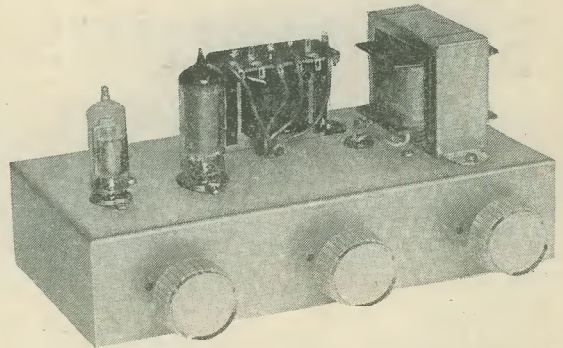

TELERADIO new Hi Fi dept are stocking all parts to build this interesting project.

Full details on request to
TELERADIO ELECTRONICS
325-7 Fore St., Edmonton, London N9

FREE TO AMBITIOUS ENGINEERS

—THE LATEST EDITION OF ENGINEERING OPPORTUNITIES

Have you sent for your copy?

ENGINEERING OPPORTUNITIES is a highly informative 164 page guide to the best paid engineering posts. It tells you how you can quickly prepare at home for a recognised engineering qualification and outlines a wonderful range of modern Home Study Courses in all branches of Engineering. This unique book also gives full details of the Practical Radio & Electronic Courses administered by our Specialist Electronics Training Division — explains the benefits of our Appointments Dept. and shows you how to qualify for five years promotion in one year.

"Satisfaction or refund of fee" terms

Whatever your age or experience you cannot afford to miss reading this famous book. Send for your copy of "ENGINEERING OPPORTUNITIES" today — FREE.

Practical Equipment including Tools

The specialist Electronics Division of B.I.E.T. NOW offers you a real laboratory training at home with practical equipment. Basic Practice and Theoretical Courses for beginners in Radio, T.V., Electronics, etc. Ask for details.

Which is your pet subject

A.M.I.E.R.E. City & Guilds Radio Amateur's Exam. R.T.E.B. Certificate P.M.G. Certificate Practical Radio Radio & Television Servicing Practical Electronics Electronics Engineering Automation

The B.I.E.T. is the leading institute of its kind in the world.

Please send
Free Books and
Full Information

**British Institute of
Engineering Technology**

NAME

ADDRESS



Subject
of interest..... Age.....

ALDERMASTON COURT, Dept. 480D. Aldermaston, Berks.

PLAIN-BACKED NEW STYLE SELF-BINDERS

for your other magazines
(max. format 7½" x 9½")

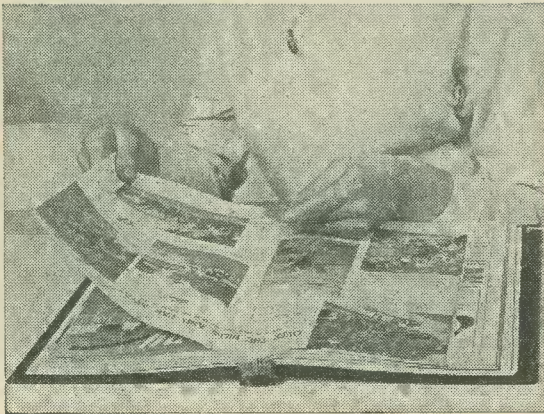

The "CORDEX" Patent Self-Binding Case will keep your copies in mint condition. Issues can be inserted or removed with the greatest of ease. Specially constructed Binding cords are made from Super Linen of great strength, very hard twisted and twice doubled. They are attached to strong RUSTLESS Springs under tension, and the method adopted ensures PERMANENT RESILIENCE of the Cords. Any slack that may develop is immediately compensated for, and the Cords will always remain taut and strong. It is impossible to overstretch the springs, as a safety check-device is fitted to each.

COLOURS: MAROON OR GREEN
(Please state choice)

PRICE 13/6 Postage 1/6

Available only from:-

Data Publications Ltd.
57 Maida Vale London W9

SMALL ADVERTISEMENTS

Continued from page 189

FOR SALE: Four Mullard RG1-240A rectifier valves, with high voltage insulation filament transformer, suitable use in pairs. £5. Box No. G100.

FOR SALE: Lafayette HE-30 4-Band communications receiver. Condition as new. Complete with manual, etc. £22 10s. o.n.o. Jackson, 26 New North Road, Attleborough, Norfolk.

FOR SALE: 813 valve and socket. 50/-. Box No. G101.

ASSORTED LOTS OF USED COMPONENTS. Resistors 15/- for 50. Capacitors 10/- for 20. Box No. G102.

LEARNAKIT OSCILLOSCOPE. Complete with teaching course and components, including radio kit, photo switching and many circuits. Cost £45. Sell £20. Telephone: 021-427-1180.

2.5kV SOLID STATE POWER SUPPLY for sale. As per description in *The Radio Constructor*, August 1966 issue. In cabinet 8in. wide x 11in. deep x 9½in. high. Matsunaga Variac and 0-3000V d.c. meter. £25 o.n.o. Box No. G103.

4 WATT GRAM AMPLIFIERS. Volume and tone controls. New and boxed. Fully guaranteed. Immediate delivery. Only 65/- post paid.—D. H. Electronics, 23 Wyle Cop, Shrewsbury, Shropshire.

TOROIDS FOR SALE: 550, 475, 500, 395, 480, 210, 185, 110, 92mH. 5/- each. Box No. G104.

38 SET power supply. L.F. unit. Two 12 x 6 way connectors wanted. — P. Smithson, 1 Orlando Street, Bootle 20, Lancs.

FOR SALE: Heathkit 012U 5in. oscilloscope, £30. S3U Trace doubler £10. Alignment generator HFW1 with 1.5 and 6Mc/s crystals (aligned by Heathkit) £35. Grid dip meter GD1U 350kc/s to 250Mc/s, £6. Q meter QM1, £9. All with leads and manuals. Box No. G105.

IF YOU HAVE ENJOYED A HOLIDAY on the Norfolk Broads, why not help to preserve these beautiful waterways. Join the Broads Society and play your part in determining Broadlands future. Further details from:—The Hon. Membership Secretary, The Broads Society, "Icknield", Hilly Plantation, Thorpe St. Andrew, Norwich, NOR 85S.

FOR SALE: 110 used valves. 4-9 pins. £7 o.n.o. Telephone: 01-467-5091.

ESSEX GARDENERS. Buy your bedding and rock plants, shrubs, etc., also cacti from May's Nurseries, 608 Rayleigh Road, Hutton, Brentwood, Essex. Callers only. Monday to Saturday.

FOR SALE: 77 copies *The Radio Constructor*, 1954-1963, complete volumes 8, 9 & 11. 17 copies *Practical Wireless*, 1962-1963. Offers? D. J. Norris, 7 Sawtry Close, Carshalton, Surrey.

PROPERTIES for sale and to let in London and suburbs. Apply to Maggs & Stephens, Estate Agents, 229 Maida Vale, London, W.9. MAIda Vale 8123.

W. E. C. LTD.

NEW QUALITY COMPONENTS

We stock Resistors, Capacitors, Cable, Wire, Fuseholders, Lamps, Lampholders, Metal, Bakelite, Plugs, Sockets, Potentiometers, Semi-Conductors, Sleeving, Switches, Hardware and Sundries.

Send for our FREE Catalogue

★
WHY NOT ORDER YOUR COMPONENTS FOR THE NEOPHYTE 5 WATT AMPLIFIER FROM US?

★
SPECIAL HARDWARE KIT for the NEOPHYTE 5 - 14/- Post Free
Includes all Wire, Knobs, Tag Strips, etc., and a FREE plastic box for Screws.

★
W. E. C. LTD.
74 The Street, Ashted, Surrey

DENCO (CLACTON) LIMITED

355-7-9 OLD ROAD, CLACTON-ON-SEA, ESSEX

Our components are chosen by Technical Authors and Constructors throughout the World for their performance and reliability, every coil being inspected twice, plus a final test and near spot-on alignment as a final check.

Our General Catalogue showing full product range	2s. 6d.
DTB4 Transistor & Valve circuitry for D.P. Coils	2s. 6d.
DTB9 Valve Type Coil Pack Application circuitry	2s. 6d.
MD.1 Decoder Circuitry for Stereo Reception	4s. 0d.

All post paid, but please enclose S.A.E. with all other requests in the interests of retaining lowest possible prices to actual consumers.

THE MODERN BOOK CO

The Hi-Fi and Tape Recorder Handbook by G. J. King. 40s. *Postage 2s.*

Servicing With The Oscilloscope by G. J. King. 28s. *Postage 1s.*

Solid State Hobby Circuits Manual by R.C.A. 17s. 6d. *Postage 1s.*

Transistors For Technical Colleges by L. Barnes. 25s. *Postage 1s.*

Beginner's Guide to Radio Control by R. H. Warring. 18s. 6d. *Postage 1s.*

TV Fault Finding 405 625 Lines by J. R. Davies. 8s. 6d. *Postage 6d.*

Colour Television Pal System by G. N. Patchett. 40s. *Postage 1s.*

Electronics & Radio An Introduction by M. Nelkon & H. I. Humphreys. 30s. *Postage 1s. 6d.*

World Radio TV Handbook 1969. 42s. *Postage 1s.*

Radio Communication Handbook by R.S.G.B. 63s. *Postage 4s. 6d.*

Practical Integrated Circuits by A. J. McEvoy. 18s. *Postage 1s.*

Television Engineers' Pocket Book by J. P. Hawker. 21s. *Postage 1s.*

Electronics Made Simple by Henry Jacobowitz. 15s. *Postage 1s.*

Electronics in Photography by Byron G. Wels. 30s. *Postage 1s.*

Electronic Computers Made Simple by Henry Jacobowitz. 10s. *Postage 1s.*

Record Changers How They Work by Louis M. Dezettel. 28s. *Postage 1s.*

Novel Electronic Circuits by John Potter Shields. 28s. *Postage 1s.*

VHF-UHF Manual by G. R. Jessop. 21s. *Postage 1s.*

Rapid Servicing of Transistor Equipment by Gordon J. King. 30s. *Postage 1s.*

Hi-Fi in The Home by John Crabbe. 40s. *Postage 1s. 6d.*

We have the Finest Selection of English and American Radio Books in the Country

19-21 PRAED STREET (Dept RC) LONDON W2

Telephone PADdington 4185

CHASSIS and CASES by



H. L. SMITH & CO. LTD.
287/9 Edgware Road
London W2
TEL: 01-723 5891

BLANK CHASSIS

FOUR-SIDED 16 SWG ALUMINIUM

Size	Price	Base	Size	Price	Base
6x4x2"	6/3	2/11	10x8x2 1/2"	12/-	5/6
7x4x1 1/2"	6/-	3/2	12x7x2 1/2"	12/-	5/11
7x5x2"	7/6	3/5	12x9x2 1/2"	13/9	7/-
8x4x2"	7/-	3/4	13x8x2 1/2"	13/9	6/11
8 1/2 x 5 1/2 x 2"	8/-	3/9	14x7x3"	14/6	6/6
9x7x2"	9/3	4/10	14x10x2 1/2"	16/-	8/7
10x4x2 1/2"	9/-	3/9	15x10x2 1/2"	16/6	9/1
12x4x2 1/2"	10/-	4/3	17x10x3"	19/6	10/1
12x5x3"	12/-	4/9			

CASES ALUMINIUM, SILVER HAMMERED FINISH

Type	Size	Price	Type	Size	Price
N	8x6x2"	18/-	W	12x7x7"	37/6
N	6x6x3"	17/6	W	15x9x8"	48/6
N	4x4x2"	11/-	Y	8x6x6"	29/-
U	4x4x4"	11/-	Y	12x7x7"	45/-
U	5 1/2 x 4 1/2 x 4 1/2"	17/-	Y	13x7x9"	50/6
U	8x6x6"	23/-	Y	15x9x7"	53/6
U	9 1/2 x 7 1/2 x 3 1/2"	24/-	Z	17x10x9"	72/6
U	15x9x9"	49/-	Z	19x10x8 1/2"	78/-
W	8x6x6"	23/-			

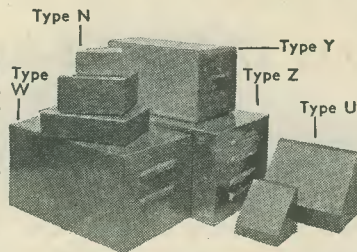

Type N has removable bottom, Type U removable bottom or back, Type W removable front, Type Y all screwed construction, Type Z removable back and front. Plus p. & d.

TO FIT OUR CASES

7x5 1/2 x 1 1/2"	7/-	3/9	12x6 1/2 x 2"	10/9	5/11
7x5 1/2 x 2"	7/9	3/9	14x8 1/2 x 2"	13/6	7/11
11x6 1/2 x 1 1/2"	10/-	5/6	15 1/2 x 9 1/2 x 2 1/2"	17/-	9/6
11x6 1/2 x 2"	10/-	5/6	17 1/2 x 9 1/2 x 2 1/2"	18/6	10/6

Plus post & packing
PANELS: Any size up to 3ft. at 6/- sq.ft. 16 s.w.g. (18 s.w.g. 5/3). Plus postage and packing.

MOTORISED UNI-SELECTOR

8 BANKS 25 POSITIONS 75Ω

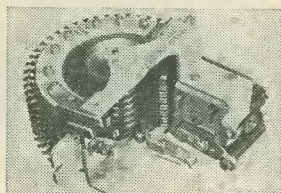

£5 each

P. & P. 4/6

SENT BY RETURN POST

11 FRINDSBURY ROAD, ROCHESTER, KENT

THE WILSIC REVERBERATION UNIT KIT

Self-contained, 6 transistor, reverberation chamber to which microphones, instruments, tuners or tape recorders may be connected for added dimensional effect. The output is suitable for most amplifiers and the unit is especially suitable for use with electronic organs. A ready-built spring and transducer assembly is used (58/11 if bought separately).

Complete, easy-to-build kit with constructional notes and circuits: £7.10.0. Pre-drilled and printed case 34/- extra. All parts available separately. Send 1/- for circuit and construction details.

THE WILSIC SIGNAL INJECTOR

Miniature transistorised square wave signal injector, ready for use, only 19/6 including battery. P. & P. 1/6.



Send 1/- for our catalogue of components, testmeters, musical electronics & more details of the above items. Callers welcome.

WILSIC ELECTRONICS LIMITED

6 Copley Road, Doncaster, Yorkshire

DATA BOOK SERIES

- DB5 TV FAULT FINDING**
124 pages. Price 8/6, postage 8d.
- DB6 THE RADIO AMATEUR OPERATOR'S HANDBOOK**
64 pages. Price 6/-, postage 6d.
- DB15 TWENTY SUGGESTED CIRCUITS**
48 pages. Price 3/6, postage 5d.
- DB16 RADIO CONTROL FOR MODELS**
192 pages. Price 15/-, postage 1/-.
- DB17 UNDERSTANDING TELEVISION**
512 pages. Price 37/6, postage 3/-
- DB18 AUDIO AMPLIFIERS**
128 pages. Price 10/6, postage 8d.

I enclose Postal Order/Cheque for..... in payment for.....

NAME

ADDRESS

(Please use Block Capitals for both name and address)

Postal Orders should be crossed and made payable to Data Publications Ltd.

Overseas customers please pay by International Money Order

All publications are obtainable from your local bookseller

Data Publications Ltd., 57 Maida Vale, London W9

CUBES OF NUMBERS

The Table lists cubes of numbers from 1 to 100.

1	1	1	21	9,261	41	68,921	61	226,981	81	531,441
2	8	22	22	10,648	42	74,088	62	238,328	82	551,368
3	27	23	23	12,167	43	79,507	63	250,047	83	571,787
4	64	24	24	13,824	44	85,184	64	262,144	84	592,704
5	125	25	25	15,625	45	91,125	65	274,625	85	614,125
6	216	26	26	17,576	46	97,336	66	287,496	86	636,056
7	343	27	27	19,683	47	103,823	67	300,763	87	658,503
8	512	28	28	21,952	48	110,592	68	314,432	88	681,472
9	729	29	29	24,389	49	117,649	69	328,509	89	704,969
10	1,000	30	30	27,000	50	125,000	70	343,000	90	729,000
11	1,331	31	31	29,791	51	132,651	71	357,911	91	753,571
12	1,728	32	32	32,768	52	140,608	72	373,248	92	778,688
13	2,197	33	33	35,937	53	148,877	73	389,017	93	804,357
14	2,744	34	34	39,304	54	157,464	74	405,224	94	830,584
15	3,375	35	35	42,875	55	166,375	75	421,875	95	857,375
16	4,096	36	36	46,656	56	175,616	76	438,976	96	884,736
17	4,913	37	37	50,653	57	185,193	77	456,533	97	912,673
18	5,832	38	38	54,872	58	195,112	78	474,552	98	941,192
19	6,859	39	39	59,319	59	205,379	79	493,039	99	970,299
20	8,000	40	40	64,000	60	216,000	80	512,000	100	1,000,000

ENGLANDS LEADING COMPONENT & EQUIPMENT CENTRES

SOLID STATE-HIGH FIDELITY AUDIO EQUIPMENT

Mono or Stereo Audio. Equipment developed from Dinsdale Mk.II—each unit or system will compare favourably with other professional equipment selling at much higher prices.

COMPLETE SYSTEMS FROM **£15.5.0**

THE FINEST VALUE IN HIGH FIDELITY—CHOOSE A SYSTEM TO SUIT YOUR NEEDS AND SAVE POUNDS

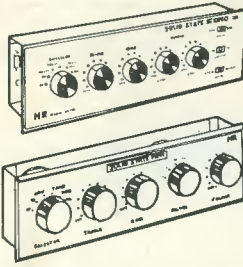

All units available separately.

SEND FOR FREE BROCHURE (No. 21) TODAY! DEMONSTRATIONS DAILY AT '303' EDGWARE ROAD

INTEGRATED TRANSISTOR AMPLIFIERS

MA66 12 WATTS STEREO

We are pleased to offer two new designs with the choice of either mono or stereo systems. These BRITISH DESIGNED UNITS favour the user in so many ways—with fantastic power and quality with far greater adaptability, with freedom for battery or mains operation.

For complete listening satisfaction choose either the—

MA7 MONO
£8.10.0

OR THE STEREO
POST PACKING 5/-
EITHER MODEL

MA66
£16.10.0

OPTIONAL MAINS UNIT
PS20 62/6d, p.p. 4/-

Illustrated leaflets 12 and 14 FREE on request.



DO IT YOURSELF MW/LW PORTABLE

New printed circuit design with full power output. Fully tunable on both mw/lw bands, 7 transistors plus diodes, push-pull circuit. Fitted 5 inch speaker, large ferrite aerial and Mullard transistors. Easy to build with terrific results. All local and Continental stations. **TOTAL COST £6.19.6.** P.P. 4/6 TO BUILD Send for Brochure 1

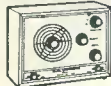

NEW MODELS NOMBREX

TRANSISTORISED Test Equipment

MODEL	£	s.	d.	No.
294 R.F. Gen.	21	0	0	35
294 Xtal R.F. Gen.	29	10	0	35
30 Audio Generator	19	10	0	24
31 R.F. Generator	12	10	0	25
32 C.R. Bridge	10	10	0	26
33 Inductance Bridge	20	0	0	28

ELECTRONIC ORGANS KITS TO BUILD YOURSELF AND COMPLETE UNITS

Acclaimed by everyone

The MAYFAIR

A completely new development in portable electronic musical instruments and a new field for the home constructor. The 'MAYFAIR' produces a multitude of the most pleasing sounds with a wide range of tone colours suitable for classic or popular music. The organ is fully polyphonic, the 16 transistors include 165 transistors, printed circuits panel, special fully sprung and depth of touch adjustable attractive vinyl covered cabinet with carry handle. A complete detailed and illustrated construction manual is provided with circuits and full parts list. All items may be purchased separately. All parts supplied are fully guaranteed. Full after sales service.

Delivered terms available
COMPLETE KIT
Deposit £29.19.0
12 monthly payments of
£7. Total £113.19.0
BUILT AND TESTED
Deposit £36.9.0 and
12 monthly payments of
£9. Total £144.8.0



THE MAYFAIR 99 GNS BROCHURE 9

The GROSVENOR

is designed for the more ambitious musician and has a much wider range than most commercial organs. It comprises two four-octave (49-note) keyboards and a thirteen-note pedal board. It has four pitches (i.e. 8H, 4H, 2H, 1H) on the upper or solo keyboard, three pitches (i.e. 16H, 8H, 4H) on the lower or accompaniment keyboard, two pitches (i.e. 16H, 8H) on the pedal board. Variable sustain on the solo keyboard and variable vibrato on both keyboards. It has 15 voices in the solo tone-forming unit, 10 voices in the accompaniment tone-forming unit and 4 voices in the pedal tone-forming unit. All components and kit sections are available separately including the Oak Console at £65.18.0.



THE GROSVENOR KITS FROM £220 terms available BROCHURE 9B

PRACTICAL ELECTRONICS - ELECTRONIC ORGAN KIT

We are able to supply Parts as described in this series. Details on request.
ORGAN COMPONENTS: COMPLETE RANGE IN STOCK - 48 AND 51 NOTE KEYBOARDS - 2 TO 5 AMP GLO CONTACTS COLDS AND CHOKES - REVERBERATION SPRINGS AND UNITS - STOP TAPS AND ASSEMBLIES - PEDAL BOARDS - BROMIUM AND GLO CLAD WIRE, ALSO PRINTED CIRCUITS ETC. COMPLETE RANGES FOR TRANSISTORISED ORGANS. ASK FOR PRICE LISTS WITH DETAILS. LEAFLET 9B
ALL ENQUIRIES TO: ORGAN DEPT. - MR. ELVINS

BUILD A QUALITY TAPE RECORDER

To get the best out of your MAGNAVOX DECK, you need a MARTIN RECORDAKIT. This comprises a special high quality 9 valve amplifier and pre-amplifier which comes to you assembled on its printed circuit board—in fact everything needed down to the last screw FOR MAKING A SUPERB TAPE RECORDER, which, when built, will compare favourably with instruments costing twice as much, yet you need no experience or technical skill to bring this about. THE INSTRUCTIONS MANUAL MAKES BUILDING EASY AND SUCCESS ASSURED

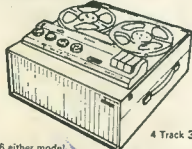

4 Track 39 gns.

P.P. 22/6 either model. Kit comprises: Deck, Amplifier, Cabinet and speaker, with MICROPHONE 7 in 1, 200 ft. tape, spare spool. ALL UNITS AVAILABLE SEPARATELY. Today's Value £60. ASK FOR BROCHURE 6.

VHF FM SUPERHET TUNER MKII

5-MULLARD TRANSISTORS & 4 DIODES - 300 Kc/s BANDWIDTH - PRINTED CIRCUIT CONSTRUCTION - HIGH FIDELITY REPRODUCTION MONO AND STEREO. A popular VHF FM Tuner now used throughout the country for quality reception of monophonic and, with the decoder stereophonic broadcasts. There is no doubt about it—VHF FM gives the real sound. Excellent stability, economically priced. PARTS TOTAL COST £6.19.6. DECODER £5.19.6. (CABINET 20/- EXTRA) ASK FOR LEAFLET 3.

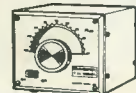

NEW - MALLORY LONG LIFE MERCURY BATTERIES 50% OFF LIST PRICES

*RM12 1.35 volts 3600 mAh OUR PRICE 5/- each Pack of 6 Size 2 1/2 dia.
*RM625 10.35 volts 350 mAh OUR PRICE 10/- each Pack of 6 Size 2 1/2 dia.
These cells are ideal for any application where SMALL SIZE HIGH CAPACITY and LONG LIFE are required. QUANTITIES AVAILABLE.

TRANSISTORS - SEMICONDUCTORS

COMPLETELY NEW 1969 LIST OF 1000 types. Send for your FREE COPY TODAY. (list 36)
S.C.R.'s from 5/-
Field Effect Transistors from 7/6
Power Transistors from 5/-
Diodes and Rectifiers from 1/6

GARRARD RECORD DECKS

BRAND NEW
All below list price £ s d
2025 Mono/Stereo GKS 25 8 0
3000LM Mono/Stereo 9 16 6
9 TAHC 9 16 6
AT60 Mk II 13 0 0
AP75 19 0 0
SL65 11 19 6
SL65 14 14 0
SL75 29 0 0
SL95 35 0 0
A70 Mk II 12 12 0
B.S.R. UA25 Mono 5 19 6
MA65 9 19 6
MA70 12 12 0
MA75 15 6 0
401 Garrard 28 10 0



Hi-Fi equipment to suit EVERY POCKET

VISIT OUR NEW HI-FI CENTRE at 303 EDGWARE ROAD AND SAVE UP TO £40 ON SEPARATE UNITS OR THE SYSTEM OF YOUR CHOICE for all leading makes

- AMPLIFIERS
- TUNERS
- DECKS
- SPEAKERS
- MICROPHONES
- TEST EQUIPMENT
- HEADPHONES
- CARTRIDGES, etc.

All with Terrific Savings It will PAY YOU to pay us a VISIT!

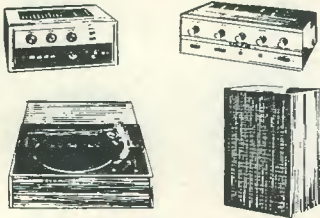

COMPLETE SYSTEMS FROM £46 - Saves £12.10.0! Send for new 8-page illustrated Hi-Fi list 16/17.

Fully Illustrated CATALOGUE

COMPLETELY NEW 9th EDITION (1969)
The most COMPREHENSIVE—CONCISE—CLEAR COMPONENTS CATALOGUE

Complete with 10/- worth discount vouchers FREE WITH EVERY COPY
* 32 pages of transistors and semi-conductor devices, valves and crystals.
* 210 pages of components and equipment.
* 70 pages of microphones, decks and Hi-Fi equipment.

6,500 ITEMS
320 BIG PAGES

Send today 7/6 Post etc 2/-

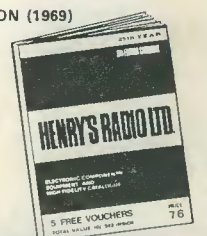

HENRY'S RADIO LTD



OPEN MON.-SAT. 9 a.m.-6 p.m. THURS. 9 a.m.-1 p.m.

303 Edgware Road, London, W.2. Mail Order Dept. all types of Components, Organ Dept. (01) 723-1008/9 309 Edgware Road, London, W.2. High Fidelity Sales, P.A. and Test Equipment, Record Decks (01) 723-6963