

THE Radio Constructor

RADIO
TELEVISION
AUDIO
ELECTRONICS

VOLUME 17 NUMBER 7
A DATA PUBLICATION
PRICE TWO SHILLINGS

February 1964

TRANSISTOR Portable Four

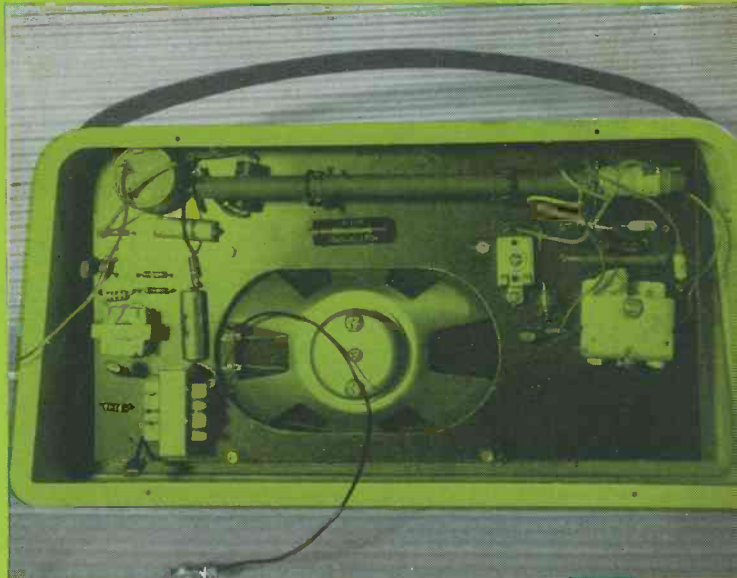

Interchangeable
Oscilloscope



One Valve
Receiver



Expanded Range
Mains Voltmeter



Printed Circuits
Made Easy



Mullard CIRCUITS FOR AUDIO AMPLIFIERS

PRICE 8/6



— A BOOK EVERY ENTHUSIAST WILL WANT!

This Mullard publication is a practical manual for every audio enthusiast. In addition to describing twelve of the most popular Mullard circuits, it has introductory chapters on many of the theoretical and practical aspects of high quality sound reproduction.

Whether you are interested in disc or tape, monaural or stereo, you will find that "Circuits for Audio Amplifiers" gives you just the sort of information you need.

This informative book costs only 8s. 6d. (U.K. Price). The demand for it is high, so get your copy now from your local radio dealer.

MULLARD LTD · DEPT. C · MULLARD HOUSE · TORRINGTON PLACE · LONDON W.C.1

EXCEL in

RADIO AND ELECTRONICS

AS A CAREER OR AS A FASCINATING HOBBY...

THERE IS AN ICS COURSE FOR YOU!

PRACTICAL INSTRUCTION!

By taking an ICS specialised home study course you gain a sound theoretical and practical knowledge of valve and transistor circuits and servicing work while building your own 5-valve receiver, transistor portable (or a.f. amplifier), signal generator and multi-test meter. *All under expert tuition!*

ICS Construction Courses have been specially written and designed by experienced radio engineers to enable YOU to learn easily and quickly, in your own home, in your own time.

ICS training will take you from basic principles to advanced applications of various circuits, all made up from the kits supplied.

With the ICS Complete Radio and Electronics Construction Course you get SIX kits, including testing instruments, tools and first class components. And, what is most important, a personal library of Instruction Manuals.

If you are making a career in the Radio Industry, you will be interested in the wide range of examination and specialist diploma courses offered by ICS. These include:

Radio and Television Engineering, Industrial Television, Radio and Television Servicing, Colour Television, Electronic Technicians, Servomechanisms, Radio-Electronic Telemetry, Instrumentation, Principles of Automation, Calculus for Electronics, Digital and Analogue Computers.

Specialised coaching for Grad.Brit.I.R.E., City and Guilds Telecommunication Technician's Cert., Radio and TV Servicing Cert. (R.T.E.B.), P.M.G. Certs. and Radio Amateur's Exam.

Examination students coached until successful

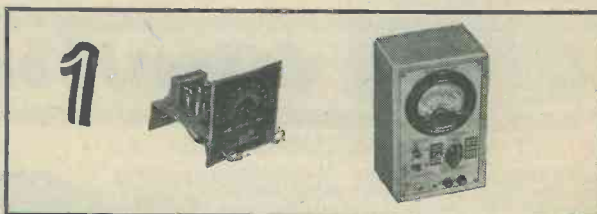

Assembly and use of signal generator and multi-test meter (especially valuable in servicing work).

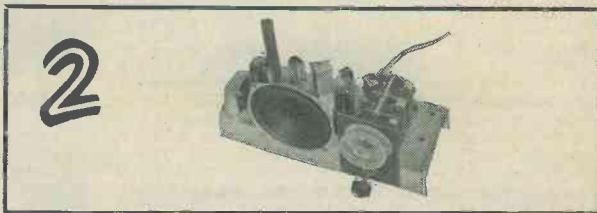

Construction of 5-valve 2-waveband AC/DC superheterodyne receiver, and a number of instructional experiments, using testing instruments.

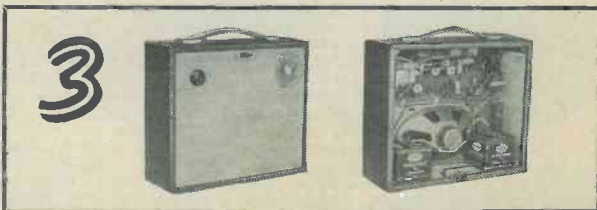

Construction of 6-transistor (with semiconductor diode) 2-waveband portable, and a number of instructional experiments, including a.f. amplifier with microphone pre-amplifier.

For full details
of ICS Radio and
Electronics Courses
post coupon
TODAY

ICS (DEPT. 248) INTERTEXT HOUSE
PARKGATE ROAD, LONDON, S.W.11

NAME

AGE

ADDRESS

2.64

INTERNATIONAL CORRESPONDENCE SCHOOLS

Member of the Association of British Correspondence Colleges

HI-FI AMPLIFIERS

TUNERS

RECORD PLAYERS

S-33



S-99



GL-58



HA-12



HI-FI 6W STEREO AMPLIFIER. Model S-33. 3 watts per channel 0.3% distortion at 2.5W/chnl., 20dB N.F.B. Inputs for Radio (or Tape) and Gram, Stereo or Monaural, ganged controls. Sensitivity 200mV. **£13.76**

DE LUXE STEREO AMPLIFIER. Model S-33H. De luxe version of the S-33 with two-tone grey perspex panel, and higher sensitivity necessary to accept the Decca Deram pick-up. **£15.176**

HI-FI STEREO AMPLIFIER. Model S-99. 18W output. Ganged controls. Stereo/Mono gram., radio and tape inputs. Push-button selection. Printed circuit construction. **£27.196**

POWER SUPPLY UNIT. Model MGP-1. Input 100/120V, 200/250V. 40-60 c/s. Output 6.3V, 2.5A A.C. 200, 250, 270V, 120mA max. D.C. **£5.26**

A wide range of American Audio equipment available. See Direct Mail order scheme below.

GOLDRING Lenco TRANSCRIPTION PLAYER. Model GL-58. With G-60 pick-up arm and Ronette 105 cartridge. **£18.19.2**

GARRARD AUTO/RECORD PLAYER. Model AT-6. With R 105 cartridge. **£13.12.1** With Decca Deram pick-up **£14.6.1**

SUGDEN MOTOR UNIT "CONNOISSEUR CRAFTSMAN" Heavy duty motor operating at 33½ and 45 r.p.m. Very heavy 12" turntable. Virtually no rumble. **£16.6.6**

HI-FI MONO AMPLIFIER. Model MA-5. A general purpose 5W Amplifier, with inputs for Gram., Radio. Presentation similar to S-33. **£10.19.6**

HI-FI MONO AMPLIFIER. Model MA-12. 12W output, wide freq. range, low distortion. **£11.18.0**



Enjoy Yourself and Save Money

TEST INSTRUMENTS

CAPACITANCE METER. Model CM-1U. Direct-reading 4½" scale. Full-scale ranges 0-100µF, 0-1,000µF 0-0.01µF and 0-0.1µF. **£15.15.0**

VALVE VOLTMETER. Model V-7A. 7 voltage ranges d.c. volts to 1,500. A.C. to 1,500 r.m.s. and 4,000 peak to peak. Resistance 0.1Ω to 1,000MΩ with internal battery. D.C. input impedance 11MΩ. dB measurement, has centre-zero scale. Complete with test prods, lead and standardising battery. **£13.18.6**

MULTIMETER. Model MM-1U. Ranges 0-1.5V to 1,500V A.C. and D.C.; 150µA to 15A D.C.; 0.2Ω to 20MΩ. 4½" 50µA meter. **£12.18.0**

R.F. SIGNAL GENERATOR. Model RF-1U. Up to 100 Mc/s fundamental and 200 Mc/s on harmonics and up to 100mV output on all bands. **£13.8.0**

AUDIO WATTMETER. Model AW-1U. Up to 25W continuous, 50W intermittent. **£17.5.0**

AUDIO VALVE MILLIVOLTMETER. Model AV-3U. 1mV-300V A.C. f.s.d. 10 c/s to 400 kc/s. **£16.10.0**

AUDIO SINE-SQUARE WAVE GENERATOR. Model AO-1U. Covers 20 c/s to 150 kc/s and square waves to 50 kc/s in four ranges. Maximum output 10V, distortion less than 1%. **£14.15.0**

5" OSCILLOSCOPE. Model O-12U. Has wide-band amplifiers, essential for TV servicing, FM alignment, etc. Vertical frequency response 3 c/s to over 5 Mc/s, without extra switching T/B covers 10 c/s to 500 kc/s in 5 ranges. **£35.10.0**

2½" SERVICE 'SCOPE. Model OS-1. Light, compact portable for service engineers. Dim. 5" x 8" x 14½" long. Wt. 10½ lb. **£21.18.0**

ELECTRONIC SWITCH. Model S-3U (Oscilloscope Trace Doubler). Enables a single beam oscilloscope to give simultaneous traces of two separate and independent signals. Switching rates approx. 150, 500, 1,500, 5,000 and 15,000 c/s. Sig. freq. response 0-100 kc/s. ±1dB. Separate gain controls and sync. output. Sig. input range 0.1-1.8V r.m.s. **£12.18.0**

AUDIO SIGNAL GENERATOR. Model AG-9U. 10 c/s to 100 kc/s, switch selected. Distortion less than 0.1%, 10V sine wave output metered in volts and dB's. **£22.10.0**

RESISTANCE/CAPACITANCE BRIDGE. Model C-3U. Measures capacity 10pF to 1,000µF, resistance 100Ω to 5MΩ and power factor. 5-450V test voltages. With safety switch. **£10.10.0**



V-7A



RF-1U



O-12U



S-3U



C-3U

A RANGE OF

250 AMERICAN HEATHKIT MODELS

Now obtainable for direct delivery from U.S. plant to your U.K. address. *Illustrated catalogue* and full details of mail order scheme can be obtained from us for the nominal charge of 1/- post paid.

TRANSISTOR RADIOS

LATEST MODEL! "OXFORD" LUXURY PORTABLE. Model UXR-2. Specially designed for use as a domestic, car or personal portable receiver. Many features, including solid leather case. **£14.18.0**

TRANSISTOR PORTABLE. Model UXR-1. Pre-aligned I.F. transformers, printed circuit. Covers L.W. and M.W. Has 7" x 4" loudspeaker. Real hide case. **£12.11.0**

TRANSISTOR PORTABLE RECEIVER. Model RSW-1. In a handsome leather case, it has retractable whip aerial and socket for car radio use. Covers Med., Trawler and two S wave bands. **£19.17.6**

JUNIOR TRANSISTOR RADIO. Model UJR-1. Single transistor set. Excellent introduction to radio. **£2.7.6**



UXR-2



UXR-1



UJR-1

FOR THE MUSICIAN



PA-1

PA AMPLIFIER PA-1. The ideal compact unit for VOCALISTS, INSTRUMENTALISTS, RECORDS, with 50W (100W pk output), 2 Heavy Duty Speakers. Variable TREMOLO. Elegant modern cabinet. Send for full specification. **£54.15.0**

Legs optional extra 17/6 set of 4.

ELECTRONIC ORGAN

(fully transistorised)

Ideal for Soloists, Home use, Groups. Full 20 WATTS VOLUME. Matching bench **£14.10.0** extra. **£187.10.0**

Money-back Guarantee

Daystrom Limited unconditionally guarantees that each Heathkit product assembled in accordance with our easy-to-understand instruction manual must meet our published specifications for performance or the purchase price will be cheerfully refunded.

TAPE DECKS

CONTROL UNITS

TAPE AMPLIFIERS



COLLARO



D-83



FM-4



AM/FM

COLLARO "STUDIO" TAPE DECK. The finest buy in its price range. Operating speeds: 1½", 3¼" and 7¼" p.s. Two tracks "wow" and "flutter" not greater than 0.15% at 7¼" p.s. **£17.10.0**

TRUVOX D83/2 & D83/4 TAPE DECKS. High quality mono/stereo tape decks.

D83/2, 2 track, **£31.10.0** D83/4, 4 track, **£29.8.0**

HI-FI AM/FM TUNER. Model AFM-1. Available in two units which, for your convenience, are sold separately. Tuning heart (AFM-T1—£4.13.6 incl. P.T.) and I.F. amplifier (AFM-A1—£21.16.6). Printed circuit board, 8 valves. Covers L.W., M.W., S.W., and F.M. Built-in power supply. Total **£26.10.0**

HI-FI FM TUNER. Model FM-4U. Also available in two units. R.F. tuning unit (£2.15.0 incl. P.T.) with I.F. output of 10.7 Mc/s, and amplifier unit, with power supply and valves (£13.3.0). Total **£15.18.0**

TAPE RECORDING/PLAYBACK AMPLIFIER. Thermometer type recording indicators, press-button speed compensation and input selection. Mono Model TA-1M, **£19.18.0** Stereo Model TA-1S, **£25.10.0**

MONO CONTROL UNIT. Model UMC-1. Designed to work with the MA-12 or similar amplifier requiring 0.25V or less for full output. 5 inputs. Baxandall type controls. **£8.12.6**

STEREO CONTROL UNIT. Model USC-1. Push-button selection, accurately matched ganged controls to ±1dB. Negative feedback, rumble and variable low-pass filters. Printed circuit boards. **£19.10.0**

Building these Heathkit models



SPEAKER SYSTEMS

HI-FI SPEAKER SYSTEM. Model SSU-1. Ducted-port bass reflex cabinet "in the white". Two speakers. Vertical or horizontal models with legs **£11.12.0** without legs **£10.17.6**.

THE "COTSWOLD". This is an acoustically designed enclosure 26" x 23" x 15¼" housing a 12" bass speaker with 2" speech coil, elliptical middle speaker together with a pressure unit to cover the full frequency range of 32-20,000 c/s. Capable of doing justice to the finest programme source, its polar distribution makes it ideal for really Hi-Fi Stereo.

COTSWOLD "MFS" SYSTEM. Specially developed to give best possible results in small rooms. This minimum floor space model is based on standard Cotswold. Size: 36" high x 16¼" wide x 14¼" deep. Either Model **£23.4.0**



SSU-1



MFS

HI-FI EQUIPMENT CABINETS



"GLOUCESTER"

A wide range of equipment cabinets are available to meet the differing needs of enthusiasts. Designed for max. operating convenience or for where room space is an overriding consideration this range includes kits, ready assembled cabinets or fully finished cabinets, and has at least one model to suit your requirements. Send for full details.

Other models from our wide range include

TELEPHONE AMPLIFIER TTA-1 **£7.9.6**

TRANSISTOR INTERCOM. X1R-1U (remote) **£4.7.6**

X1-1U (master) **£10.19.6**

ELECTRONIC WORKSHOP EW-1. Makes over 21 experiments. The ideal present for the youngster. **£7.13.6**

All models also available assembled

Deferred Terms over **£10**

Send coupon for **FREE** illustrated British catalogue of Heathkit range to:

DAYSTROM LTD DEPT. RC.2 GLOUCESTER

AMATEUR EQUIPMENT



SB-10U



DX-40U

SINGLE SIDEBAND ADAPTOR. Model SB-10U. May be used with most A.M. transmitters. Less than 3W R.F. input power required for 10W output. Operation on 80, 40, 20, 15 and 10m bands on U.S.B., L.S.B. or D.S.B. **£39.5.0**

AMATEUR TRANSMITTER. Model DX-40U. Covers all amateur bands from 80 to 10 metres; crystal controlled. Power input 75W C.W., 60W peak controlled carrier phone. Output 40W to aerial. Provision for V.F.O. Filters minimise TV interference. **£33.19.0**

New Model **RG-1**

COMMUNICATIONS TYPE RECEIVER.

A high performance, low cost receiver for the discriminating listener. Frequency coverage: 600 kc/s - 1.5 Mc/s and 1.7 Mc/s - 32 Mc/s. Send for full specification. **£39.16.0**

VARIABLE FREQUENCY OSCILLATOR. Model VF-1U. Calibrated, 160-10 m. Fundamentals on 160 and 40m. Ideal for our DX-40U and similar transmitters. **£12.10.0**

AMATEUR BANDS RECEIVER. Model RA-1. To cover all the Amateur Bands from 160-10 metres. Many special features, including: half-lattice crystal filter; 8 valves; signal strength "S" meter; tuned R.F. Amplifier Stage. Send for spec. **£39.6.6**

THE "MOHICAN" GENERAL COVERAGE RECEIVER. Model GC-1U. With 4 piezo-electric transmitters, variable tuned B.F.O. and Zener diode stabiliser, this is an excellent fully transistorised general purpose receiver for Amateur and Short wave listeners. Printed circuit boards, telescopic whip antenna, tuning meter and large slide-rule dial, 10 transistors. **£39.17.6**

AMATEUR TRANSMITTER. Model DX-100U. The world's most popular, compact and completely self-contained Amateur Transmitter. Covers all amateur bands: 160-10 m. 150W d.c. input. Careful design has achieved the stability and high performance for which the DX-100U is noted and no less than 35 disc ceramic capacitors reduce TVI to a minimum. **£79.10.0**

A wide range of American amateur equipment. See Mail Order Scheme.



RA-1



RG-1

Without obligation please send me **FREE BRITISH HEATHKIT CATALOGUE**

(Tick here)

FULL DETAILS OF MODEL(S)
(Please write in BLOCK CAPITALS)

NAME

ADDRESS

DEPT. RC.2

LASKY'S RADIO

FOR THE FINEST RANGE OF TRANSISTOR RECEIVERS

We consider our construction parcels to be the finest value on the home constructor market. If on receipt you feel not competent to build the set, you may return it as received within 7 days, when the sum paid will be refunded, less postage.

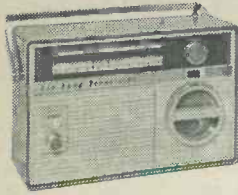

THE SKYROVER

Controls: Waveband Selector, Volume Control with On/Off Switch, Tuning Control. In plastic cabinet, size 10" x 6 1/2" x 3 1/2", with metal trim and carrying handle.

Can be built for
£10.19.6

P. and P. 5/- extra

THE SKYROVER DE LUXE

Tone Control circuit is incorporated, with separate Tone Control in addition to Volume Control, Tuning Control and Waveband Selector. In a wood cabinet, size 11 1/2" x 6 1/2" x 3", covered with a washable material, with plastic trim and carrying handle. Also car aerial socket fitted.

Can be built for **£12.19.6** P. and P. 5/- extra

READY BUILT BARGAINS

BOY'S TRANSISTOR RADIO. Ready built, 2-transistor pocket radio. In attractive plastic case. Size only 4" x 2 1/2" x 1". Fitted with 2 1/2" loudspeaker. Socket for personal-earpiece and telescopic aerial. Works from single PP3-type battery. Fully tunable over full Medium waveband. Supplied complete with earpiece, telescopic aerial, carrying purse and 9 volt battery. Ideal Birthday Present.

LASKY'S PRICE 42/-
with all accessories. Post Free.

6-Transistor Pocket Radio. Fully built. 4" x 2 1/2" x 1", with 2 1/2" speaker. Uses single PP3-type battery. Supplied complete with personal-earpiece and leather case. Tunable over full Medium waveband. **LASKY'S PRICE 79/6** complete with all accessories. Post Free.

TRANSFILTERS by BRUSH CRYSTAL CO.

TO-01B 465 kc/s ± 2 kc/s
TO-01D 470 kc/s ± 2 kc/s
TO-02B 465 kc/s ± 1 kc/s
TO-02D 470 kc/s ± 1 kc/s
TF-01D 465 kc/s ± 2 kc/s
TF-01D 470 kc/s ± 2 kc/s

6/6 each
P. & P. 6d.



TAPE DECK MOTORS
Motors for the Collaro Studio Deck — new and unused. 200-250V A.C. Take-up, re-wind and capstan. Listed at £2.5s. each. **LASKY'S PRICE 14/11** each. P. & P. 2/6. Set of three 35/- P. & P. 6/-.

DISTLER MINIATURE MOTORS
6 volt battery operated. P. & P. 2/6 **7/11**

THE SKYROVER and the SKYROVER DE LUXE

GENERAL SPECIFICATION. 7 transistor plus 2 diode superhet, 6 waveband portable receiver. Operating from four 1.5V torch batteries. The SKYROVER and SKYROVER DE LUXE cover the full medium waveband and short waveband 31-94 M, and also 4 separate switched band-spread ranges, 13 M, 16 M, 19 M and 25 M, with band-spread tuning for accurate station selection. The coil pack and tuning heart is completely factory assembled, wired and tested. The remaining assembly can be completed in under three hours from our easy to follow, stage by stage instructions.

SPECIFICATION: Superhet, 470 kc/s. All Mullard transistors and diode. Uses 4 U2 batteries. 5" Ceramic Magnet P.M. Speaker. Easy to read Dial Scale, Band-spread Tuning. 500mW Output. Telescopic Aerial and Ferrite Rod Aerial.

WAVEBAND COVERAGE: 180-576 M, 31-94 M, and band-spread on 13, 16, 19 and 25 metre bands.

All components available separately. Data for each receiver, 2/6 extra, refunded if you purchase the parcel. Four U2 batteries, 2/8 extra. Four leak-proof batteries, 3/4 extra.



LOOK!—LASKY'S NEW SCOOP! The "Sixteen" Multirange METER KIT

This outstanding meter was featured by *Practical Wireless* in the January 1964 issue. Lasky's are now able to offer the complete kit of parts as specified by the designer. The "Sixteen" Multirange offers the home constructor and serviceman an instrument that will meet most of his requirements for voltage, current and resistance measurement. There are 16 switched ranges: 9 for voltage measurement, 4 current ranges and 3 resistance ranges. All British components are used throughout. The instrument case is supplied with the meter movement built-in. The two scales are clearly printed in black on white and are very easy to read.

RANGE SPECIFICATION
D.C. volts: 0-2.5-25-50-250-500 at 20,000Ω/V.
A.C. volts: 0-25-50-250-500 at 1,000Ω/V.
D.C. current: 0-50mA, 0-2.5-50-250mA.
Resistance: 0-2,000Ω, 0-200kΩ, 0-20MΩ.
Basic movement: 40mA f.s.d. moving coil. With universal shunt full scale deflection current is 50mA.
Size/finish: Black plastic case 3 1/2" x 5 1/2" x 1 1/2".
Controls: 12 position range switch; separate slide switch for A.C. v. d.c.—D.C. ohms; ohms zero adjustment pot. meter; meter zero.
External connections: Two 4mm sockets for test lead plus.

Power requirements: One 15V and one 1.5V batteries. Complete with all parts and full construction details.
This offer is exclusive to Lasky's!
LASKY'S PRICE £5.19.6 P. & P. 5/-
Data and circuit available separately 5/-, refunded if all parts bought.

REALISTIC SEVEN

★ 7-transistor Superhet. ★ 350 milliwatt output into 4" high flux speaker. ★ All components mounted on a single printed circuit board, size 5 1/2" x 5 1/2" in one complete assembly.

★ Plastic cabinet with carrying handle, size 7" x 10" x 3 1/2", in Red/Grey, Blue/Grey or all Grey. ★ Easy to read Dial. ★ External socket for car aerial. ★ I.F. frequency 470 kc/s. ★ Ferrite rod internal aerial. Operates from PP9 or similar battery. ★ Full comprehensive data supplied with each receiver. ★ All coils and I.F.s, fully wound ready for immediate assembly.

An Outstanding Receiver. **LASKY'S PRICE** for the complete parcel including Transistors, Cabinet, Speaker, etc.: **£5.19.6**

P. and P. 4/6
PP9 Battery, 3/9. Data and instructions separately, 2/6. Refunded if you purchase the parcel.



REALISTIC 'Seven' De Luxe

By popular request a de luxe version of the well-proven Realistic "Seven" now available. With the same electrical specification as standard model—PLUS A SUPERIOR WOOD CABINET in CONTEMPORARY STYLING, covered in attractive washable material, with superchrome trim and carrying handle. Also a full vision circular dial, externally mounted to further enhance the pleasant styling. ALL FOR ONLY **£1 EXTRA**

P. & P. as for std. model

THE SPRITE

CAN BE BUILT FOR **79/6** P. and P. 3/6 extra



★ Six-Transistor Superhet Miniature Personal Pocket Radio
★ Long and medium wavebands
★ Ferrite Rod Aerial
★ I.F. Freq. 470 kc/s
★ 3" speaker

★ Printed circuit 2 1/2" x 2"
★ In Plastic Case. Size 4" x 2 1/2" x 1 1/2".

In order to ensure perfect results, the SPRITE is supplied to you with R.F. and L.F. stages. Driver and output stages ready built with all components mounted on the printed circuit. The SPRITE pre-assembled, plus cabinet, speaker and all components for final construction, can be built for 79/6. Postage and package 3/6 extra. Data and instructions separately 2/6. Refunded if parcel is purchased. Real calf leather case, wrist strap, personal earphone and case for earphone and battery, 12/6 the lot extra. Make no mistake, this is a SUPERHET receiver of genuine commercial quality. It is not a regenerative circuit.

TRANSISTORS

All New and Guaranteed
GET.51, GET.55, GET.56—2/6; 837A, 874P—3/6; OC.45, OC.71, OC.81D—4/6; OC.44, OC.70, OC.76, OC.81 (matched pair 10/6)—5/6; AF.117, OC.72, OC.75, OC.170, OC.171, OC.200—6/6; OC.25, OC.42, OC.43, OC.73, OC.82D—7/6; OCP.71—9/6; OC.28, OC.201, OC.204—15/-; OC.205, OC.206—19/6.

33 TOTENHAM COURT ROAD • W1
2 mins. Oxford St. Nearest Station: Goodge St.
MUSEum 2605
Tottenham Ct. Rd. & Edgware Rd. addresses open all day Sat. Close 1 Thur.

207 EDGWARE ROAD • W2
Few yards from Praed St.
PADDington 3271/2
Please address all Mail Orders to Dept. W at above Edgware Road address

152/3 FLEET STREET • EC4
(ELECTRONICS Fleet St. Ltd.) FLEET 2833.
Open all day Thurs. Closed 1 p.m. Sat.

**NOW! ANOTHER PURCHASE of the year's keenest
TAPE RECORDER BARGAIN!**



A 24 gns. Tape Recorder offered at the bargain price of only 15 gns. plus 10/- Carr. Supplied in 3 Units already wired and tested. A modern Circuit for quality recording from Mike, Gram or Radio, using latest B.S.R. Twin Track Monardeck Type TD2. Magic Eye recording Indicator, Ext. spkr., switch, super-impose and straight-through amplifier facilities, etc.
Valve line-up—EF86, ECL82, EM84, EZ80 and Silicon Diode.

- 2 tone Cabinet and 8" x 5" Speaker. Size 14" x 10 1/2" x 7 1/2" **£3.10.0** + 5/- carr.
- Wired Amplifier complete with 4 valves, Front Panel, Knobs **£5.12.6** + 3/6 carr.
- B.S.R. Monardeck Type T.D.2 **£7. 7.0** + 4/6 carr.
- Accessories—Mike, Spare Reel Tape, Screened Lead, Plugs, etc. **£1. 1.0** + 2/- carr.
- COMPLETE KIT** comprising items above **15 gns.** + 10/- carr.

Leaflet, Circuit and Instruction 2/- post free

New Boxed	VALVES	Reduced Bargain Prices	Electrolytics All Types New Stk.	TUBULAR	CAN TYPES		
1T4	3/6	ECC83 7/-	PCC84 8/-	25/25V	1/9	8+8/450V	4/6
1R5	1/6	ECL82 10/-	PCF80 8/-	50/12V	1/9	16+16/450V	5/6
1S5	6/-	ECL80 9/-	PCL83 10/6	50/50V	2/-	32+32/275V	4/6
3S4	7/-	EF80 7/6	PCL84 10/-	100/25V	2/-	50+50/350V	6/6
3V4	7/-	EF86 8/6	PL81 9/6	8/450V	2/3	60+250/	
DAF96 8/-	EL84 7/-	PL82 9/-	4/350V	2/3	275V	12/6	
DF96 8/-	EY51 9/-	PL83 8/-	16+16/450V	5/6	100+300/		
DK96 8/-	EY86 9/-	PY32 10/6	32+32/450V	6/6	275V	12/6	
DL96 8/-	EZ81 7/-	PY81 8/-	1000/25V	3/9	2000+4000/		
ECC81 7/-	GZ32 9/6	PY82 7/-			6V	3/6	
ECC82 7/-	EM84 8/6	U25 10/6			Ersin Multicore Solder 60/40 4d.		
					per yard. Cartons 2/6, etc.		

NEW BRITISH RECORDING TAPE

Famous Mfr. Bulk Purchase—Genuine recommended Tape Bargain. Uncond. Guar. Fitted Leader & Stop Foils (except 3").
Standard (PVC base) Long Play (PVC base) D'ble Play (Mylar base)
3" 150ft. ... 3/9 225ft. ... 4/9 300ft. ... 6/6
5" 600ft. ... 11/6 900ft. ... 15/- 1,200ft. ... 25/-
5 1/2" 850ft. ... 14/6 1,200ft. ... 17/6 1,800ft. ... 32/6
7" 1,300ft. ... 17/6 1,800ft. ... 22/6 2,400ft. ... 42/6
Post and Packing—3" Reels 6d. Each additional Reel 3d. 4" to 7" Reels 1/- Each additional Reel 6d.
EMPTY TAPE REELS (Plastic): 3" 1/3; 5" 2/-; 5 1/2" 2/-; 7" 2/3.
PLASTIC REEL CONTAINERS (Cassettes): 5" 1/9; 5 1/2" 2/-; 7" 2/3

Jack Plugs. Standard 2 1/2" Igranite Type, 2/6. Screened Ditto, 3/3. Miniature scr. 1 1/2", 2/3. Sub-min. 1/3.
Jack Sockets. Open Igranite Moulded Type, 3/6. Closed Ditto, 4/- Miniature Closed Type, 1/6. Sub-min. (deaf aid) ditto, 1/6. Stereo Jack Sockets, 3/6. Stereo Jack Plugs, 3/6.
Phono Plugs, 9d. Phono Sockets (open), 9d. Ditto (closed), 1/- Twin Phono Sockets (open), 1/3.
Grandig Continental. 3 p. or 5 p. plug, 3/6. Sockets, 1/6.

Soldering Irons. Mains 200/220V or 230/250V. Solon 25 watt Inst., 22/6. Spare Elements, 4/6. Bits, 1/- 65 watt, 27/6 etc.
Alumin. Chassis. 18g. Plain Undrilled, folded 4 sides, 2" deep, 6" x 4", 4/6, 8" x 6", 5/9, 10" x 7", 6/9, 12" x 6", 7/6, 12" x 8", 8/- etc.
Alumin. Sheet. 18g. 6" x 6", 1/- 6" x 9", 1/6, 6" x 12", 2/-, 12" x 12", 4/6 etc.

RECORD PLAYER CABINETS

Contemporary style, rexine covered cabinet in two-tone maroon and cream. Size 15 1/2" x 14 1/2" x 8 1/2", fitted with all accessories including baffle board and Vinair fret. Space available for all modern amplifiers and auto-changers, etc. Uncut record player mounting board 14 1/2" x 12 1/2" supplied Cabinet Price 59/6. Carr. and Ins. 5/-.

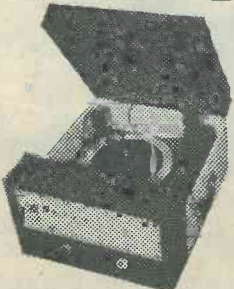

2-VALVE 2 WATT AMPLIFIER
EZ80 and Twin stage ECL82 with vol. and neg. feedback tone control. A.C. 200/250V with knobs, etc., ready wired to fit above cabinet. £2.17.6. P. & P. 1/6. 7" x 4" Speaker and trans, 22/- P. & P. 2/-.

COMPLETE R/PLAYER KIT. As ill. inc. BSR UA14 Unit. New Bargain Price Now Only £11.10.0, 7/6 carr.

Now Available! De luxe Record Player Kit

Based on Mullard's 3-watt amplifier with printed circuit and Bass Boost and Treble Controls and 8" x 5" High Flux Speaker and Garrard Auto-Slim Unit. Cabinet size, 17 1/2" x 16" x 8". Send for full details; 3d. stamp.

Complete Kit **£13.19.6** carr. 10/-

Volume Controls—5K-2 Meg-ohms, 3" Spindles Morganite Midget Type. 1 1/2" diam. Guar. 1 year. LOG or LIN ratios less 5V. 3/- DP. Sw. 4/6. Twin Stereo less 5V. 6/6. D.P. Sw. 9/6 (100 kc. to 2 Meg. only). 1/2 Meg. VOL. Controls. D.P. Sw. 1/2" flatted spindle. Famous Mfrs. 4 for 10/- post free.

COAX 80 OHM CABLE
High grade low loss Cellular air spaced Polythene—1/2" diameter. Stranded cond. Famous mfrs. Now only 6d. per yard. Bargain
Prices—Special lengths:
20 yds. 9/- P. & P. 1/6.
40 yds. 17/6 P. & P. 2/-.
60 yds. 25/- P. & P. 3/-.
Coax Plugs 1/- Sockets 1/-.
Couplers 1/3. Outlet Boxes 4/6.

Condensers—5/Mica all values 2pF to 1,000pF 6d. Ditto Ceramic 9d. each, .005, .01 and .1, etc. 1/- Paper Tubular 450V .001 mfd to .01 mfd and .1/350V 9V. .02-.1 mfd 1/-, .25 mfd 1/6, .5 mfd 1/9.

Close Tol. S/Micas—10% 5pF-500pF 8d. 600-5,000pF 1/- 1% 2pF-100pF 9d. 100pF-500pF 11d. 575pF-5,000pF 1/6.
Resistors—Full Range 10 ohms-10 megohms 20%; 1/2 and 1/4 W 3d., ditto 10% 4d., 1/2 W 5d., (Midget type modern rating) 1W 6d., 2W 9d. Hi-Stab 5% 1/2 W 100 ohms 1 megohm 6d. Other values 9d. 1% 1/2 W 1/6. W/W Resistors 25 ohms to 10K 5W 1/3, 10W 1/6, 15W 2/- Pre-set T/V Pots. W/W 25 ohms-50K 3/- 50K-2 Meg. (Carbon) 3/-.

TRANSISTOR BARGAINS
Brand New—BVA 1st Grade

OC44	8/6	OC70	5/6
OC45	8/6	OC71	6/-
OC81D	7/6	GEX34	2/9
2/OC81	15/6	OA70	2/9
GET114	6/6	OA81	2/9
OC72	7/6	GEX13	2/9
AF117	9/6		

Speakers P.M.—3 ohms 2 1/2" E.M.I. 15/6. Goodmans 3 1/2" 16/6. 5" Rola 15/6. 6" Elac 16/6. 7" x 4" Goodmans 15/6. 8" Rola 19/6. 10" R. x A. 25/- 9" x 6" Goodmans 22/6. E.M.I. Tweeter 22/6.

Speaker Fret—Expanded gilt anodised metal 1/2" x 1/2" diamond mesh, 4/6 sq. ft., multiples of 6" cut. Max. size, 4ft. x 3ft. 47/6. Carr. extra.

Brand New Mfrs. surplus list grade. 1 OC44 & 2 OC45, 15/6. 1 OC81D & 2 OC81, 15/- All above and OA81, 32/6, post free.

TYGAN FRET (contemp. pat.) 12" x 12" 2/-, 12" x 18" 3/-, 12" x 24" 4/-, 18" x 18" 4/6, etc.

BONDACOUNT Speaker Cabinet Acoustic Wadding, 12" wide, any length cut 1/6 per ft. 4/- per yd.

ENAMELLED COPPER WIRE—1/8 reels, 14g-20g, 2/6; 22g-28g, 3/-; 36g-38g, 4/3; 39g-40g, 4/6, etc.

TINNED COPPER WIRE—16-22g. 2/6 1/2 lb.

PVC CONNECTING WIRE—10 colours (or chassis wiring, etc.)—Single or stranded conductor, per yd., 2d. Sleeving, 1mm. and 2mm., 2d. yd., etc.

KNOBs—Modern Continental types: Brown or Ivory with Gold Ring, 1" dia., 9d. each; 1 1/2", 1/- each; Brown or Ivory with Gold Centre, 1" dia., 10d. each; 1 1/2" dia., 1/3 each. LARGE SELECTION AVAILABLE.

TRANSISTOR COMPONENTS

Midget I.F.—465 kc/s 1/2" diam. 5/6
Ditto Coil—1/2" diam. M/W. 5/3
Osc. coil M. & L.W. 5/9
Midget Driver Trans. 3.5:1 6/9
Ditto O/Put Push-pull 3 ohms 6/9
Elect. Condensers—Midget Type 15V 1mfd-50mfd, ca. 1/9. 100mfd. 2/-.
Ferrite Aerial—M. & L. W. with car aerial coupling coil, 9/3.

Condensers—150V. wkg. .01 mfd. to .04 mfd., 9d. .05 mfd., 1 mfd., 1/-, .25 mfd., 1/3. 5 mfd., 1/6, etc.
Tuning Condensers. I.B. "000" 208+176pF, 8/6. Ditto with trimmers, 9/6. 365pF single, 7/6. Sub-min. 1/2" DILEMIN 100pF, 300pF, 500pF, 7/-.

Midget Vol. Control with edge control knob, 5kΩ with switch, 4/9, ditto less switch, 3/9.

Speakers P.M.—2" Plessey 75 ohms, 15/6. 2 1/2" Continental 8 ohms, 13/6. 7" x 4" Plessey 35 ohm, 23/6.

Ear Plug Phones—Min. Continental type, 3ft. lead, jack plug and socket. High Imp. 8/- Low Imp., 7/6. High sensitivity M/coil 8-10 ohms, 12/6.

JASON FM TUNER UNITS

Designer-approved kit of parts:
FMT1, 5 gns. 4 valves, 20/-
FMT2, £7. 5 valves, 35/-
JTV MERCURY 10 gns.
3 valves, 22/6.
JTM2 £13.19.6. 4 valves, 28/6.
NEW JASON FM HANDBOOK, 2/6. 48 hr. Alignment Service 7/6. P. & P. 2/6.

TRIMMERS, Ceramic (Compression Type)—30pF, 50pF, 70pF, 9d.; 100pF, 150pF, 1/3; 250pF, 1/6; 600pF, 1/9.

METAL RECTIFIERS—STC Types—RM1, 4/9; RM2, 5/6; RM3, 7/6; RM4, 16/-; RM5, 21/-; RM4B, 17/6.

**MULLARD "3-3" HI-FI AMPLIFIER
3 VALVES 3 WATT**

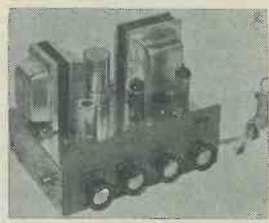

3 ohm and 15 ohm Output.
A really first-class Amplifier giving Hi-Fi quality at a reasonable cost. Mullard's latest circuit. Valve line-up: EF86, EL84, EZ81. Extra H.T. and L.T. available for Tuner Unit addition. This is the ideal companion Amplifier for FM tuner units.

TECHNICAL SPECIFICATION—Freq. Response: ± 1dB, 40 c/s-25 kc/s. Tone controls, max. treble cut 12dB at 10 kc/s. Max. Bass Boost 14dB at 80 c/s sensitivity: 100MV for 3W output. Output Power (at 400 c/s); 3W at 1% total harmonic distortion. Hum and Noise Level: At least 70dB below 3W.

COMPLETE KIT (incl. valves, all components, wiring diagram and special quality sectional Output Trans.) BARGAIN PRICE £6.19.6 carr. 4/6. Complete wired and tested, 8 gns. Wired power O/P socket and additional smoothing for Tuner Unit, 10/6 extra.

Bronze Escutcheon Panel, Printed Vol., Treble, Bass, On-Off, supplied with each kit. Recommended Speakers—R. & A. 12" with tweeter 42/6, WBHF10-12 £47.6, Goodmans Axiette £55.0, Axiom 10 £65.0, Audiom 51 £8.10.0. Carr. extra.

Send for detailed bargain lists, 3d. stamp. We manufacture all types Radio Mains Transf. Chokes, Quality O/P Trans., etc. Enquiries invited for Specials, Prototypes for small production runs. Quotation by return.

RADIO COMPONENT SPECIALISTS

70 Brigstock Rd., Thornton Heath, Surrey THO 2188 Hds; 9 a.m. — 6 p.m., 1 p.m. Wed. Terms C.W.O. or C.O.D. Post and Packing up to 1/2 lb 9d., 1 lb., 1/3 3lb., 2/3 5 lb., 2/9 8 lb. 3/6.



THE SMALLEST

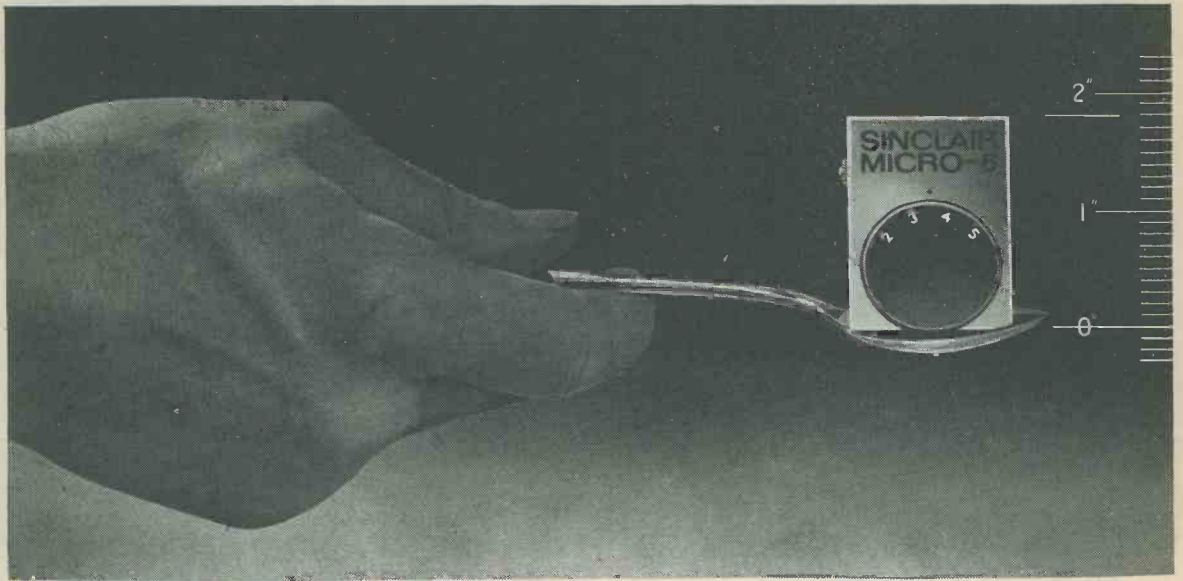

A teaspoonful of power!

TECHNICAL SPECIFICATION

Two stages of R.F. amplification with double diode detector followed by three stages of audio amplification. The application of negative feedback to all A.F. stages ensures ultra-linear amplification, while amplified A.G.C. applied to the first R.F. stage provides fade-free reception from distant stations such as Luxembourg. Sensitivity is actually superior to that of conventional radios many times larger. The Micro-Six tunes over the entire medium waveband with increased coverage at the high frequency end to provide improved separation of Continental stations. The set switches on automatically when the high-impedance featherweight earpiece is plugged into the specially designed micro socket. Quality of reproduction is exceptionally good.

**CHASSIS VIEW
GREATLY ENLARGED**

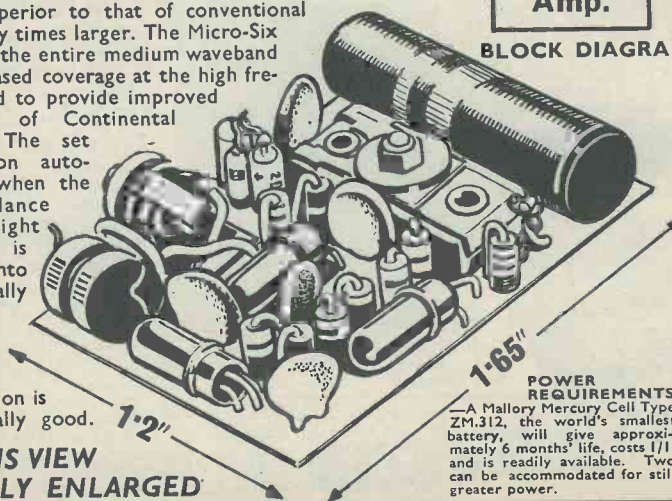

POWER REQUIREMENTS
—A Mallory Mercury Cell Type ZM.312, the world's smallest battery, will give approximately 6 months' life, costs 1/11 and is readily available. Two can be accommodated for still greater power.

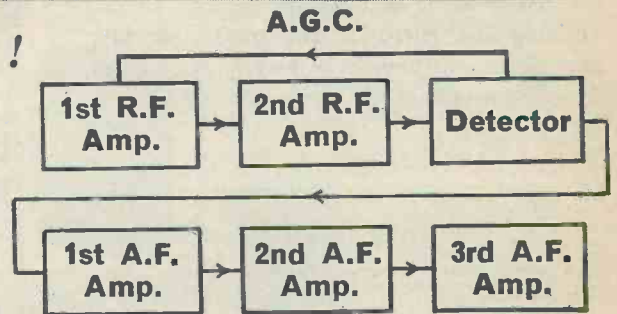

BLOCK DIAGRAM OF THE SINCLAIR MICRO-6

**SIX-STAGE SENSITIVITY
BETTER THAN MANY SUPERHETS**

**UNIQUE CIRCUITRY GIVES
IMMENSE POWER AND QUALITY**

**PLAYS IN ANY CAR, TRAIN,
BUS, PLANE**

**SELF-CONTAINED AERIAL
AND BATTERIES**

SET IN THE WORLD

A fantastic development in micro-miniaturisation

Just look at the remarkable specification of this latest Sinclair micro-electronic design—and then look at its size— $1\frac{4}{5}$ " x $1\frac{3}{10}$ " x $\frac{1}{2}$ ". It is almost unbelievable that a set with these tested and proven standards of performance can be contained within a case considerably smaller than a matchbox. Yet it gives superb results from stations all over the medium waveband with a power and sensitivity placing it years ahead of anything even the Japanese have produced. This is a professionally styled set brilliantly designed by the Sinclair research team to incorporate all the important circuit features of a de-luxe receiver. You will find building the Micro-Six the most absorbing experience you have ever had in electronics. So send for your Micro-Six today, and you will have for your pride and pleasure the smallest and most efficient receiver of its kind in the world.

SINCLAIR GUARANTEE

Should you not be completely satisfied with your purchase (although we are confident that you will be delighted) the full purchase price will be refunded instantly and without question.

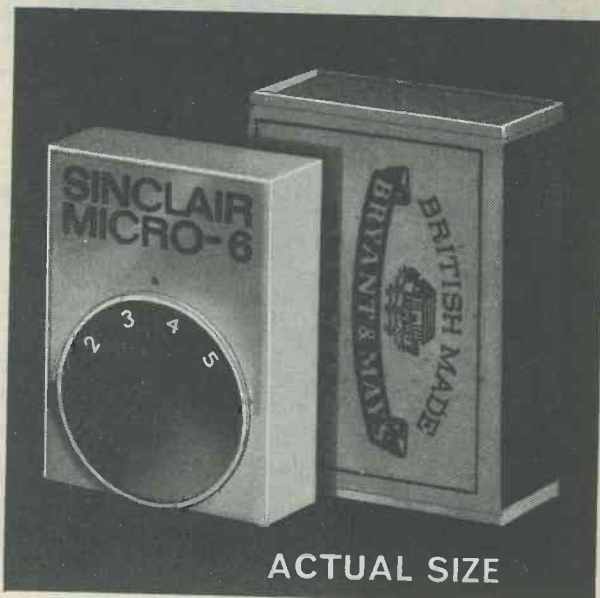

ACTUAL SIZE

ONLY $1\frac{4}{5}$ " x $1\frac{3}{10}$ " x $\frac{1}{2}$ "

ALL YOU NEED TO BUILD THIS AMAZING RECEIVER

All parts necessary to build this wonderful receiver, including MAT transistors, diodes, micro-miniature components, printed circuit board, special ferrite-rod aerial, elegant case and knurled dial and featherweight hi-fi quality earpiece together with well presented instructions come only to

59/6

MALLORY MERCURY CELL, TYPE ZM.312—EACH 1/11.
FULL SERVICE FACILITIES AVAILABLE TO ALL SINCLAIR CUSTOMERS

SINCLAIR MICRO-6

IMPORTANT NOTICE

The Sinclair Micro-Six is an ultra-small precision designed instrument. As such, previous experience in transistor building will be found helpful. It is imperative that a modern miniature soldering iron be used when building the set.

★ MORE SINCLAIR DESIGNS ON NEXT PAGE

SINCLAIR RADIONICS LTD
69 HISTON ROAD · CAMBRIDGE

If you do not wish to cut coupon, mention "Radio Constructor" when ordering.

To SINCLAIR RADIONICS LTD., 69 HISTON ROAD, CAMBRIDGE

Please send parts for building.....Micro-6 Receiver(s) and
.....Mallory Cells Type ZM.312 at 1/11 each for which I
enclose £.....s....d.

NAME.....

ADDRESS.....

RC.2..... **A**

MORE SINCLAIR DESIGNS FOR TRANSISTOR ENTHUSIASTS

Sinclair 'SLIMLINE'

THE EASY-TO-BUILD MICRO-RECEIVER THAT GIVES YOU EUROPE IN THE PALM OF YOUR HAND

This set is delightfully easy to build. For POWER, SELECTIVITY and QUALITY it has no equal in its class. Yet it is actually smaller than a standard packet of 20 cigarettes! Such exciting standards are due entirely to exclusively developed Sinclair circuitry, and it costs so very little to build this wonderful receiver. It gives you Home, Light and Third Programmes as well as many other stations with amazing ease, playing even in cars and trains. For a brand new concept in radio listening, BUILD A SLIMLINE NOW—when a complete beginner is assured of complete success.

All parts including MAT transistors, blue and gold case, featherweight high quality earpiece, ferrite rod aerial and instructions come to

49'6

Size:

$2\frac{1}{8}'' \times 1\frac{1}{8}'' \times \frac{3}{4}''$



SINCLAIR MICRO-AMP

Makes an ideal broadband R.F. Amplifier and is smaller than a 3d. piece. Frequency response from 30 to 50,000 c/s ± 1 dB, and power gain of 60dB (1,000,000 times). It can be used as a sub-miniature hi-fi amplifier with an output suitable for any earpiece or even loudspeaker. Also makes an invaluable tool in the hands of the keen experimenter.

With MATs, micro-miniature quality components and micro-printed circuit, and instructions for building and using with pick-ups, micro-radio receivers and transmitters, microphones, etc.

Now widely used throughout the Electronics Industry



*** OUTPERFORMS AMPLIFIERS 20 TIMES LARGER * 40dB GAIN AT 1 Mc * 30-50,000 c/s ± 1 dB.**

Build it for only **28'6**

SINCLAIR TR.5 $\frac{1}{2}$ WATT AMPLIFIER WITH PRE-AMP STAGE

CIRCUIT—5 matched transistors and temperature compensating diode in a transformerless complementary-symmetry configuration.

POWER OUTPUT—500 mW into 15 ohms.

SENSITIVITY—0.5mV.

POWER GAIN—80dB (100 million times).

FREQUENCY—50 c/s to 20 kc/s ± 3 dB.

SIZE— $2\frac{1}{2}'' \times 1\frac{1}{4}'' \times \frac{3}{8}''$.

POWER REQUIREMENTS—9V.

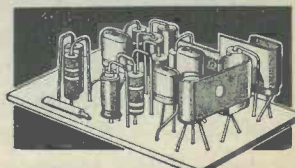

Will produce a perfectly clean half watt of audio power even from very low output tape heads, pick-ups and microphones. ready built with instructions and unconditionally guaranteed.

READY BUILT AND TESTED 59'6

USEFUL BOOKS FOR CONSTRUCTORS

GENERAL "22 Tested Circuits Using Micro Alloy Transistors. Post free **5/6**

SHORT WAVES "Tested Short Wave Receivers Using MATs." Post Free **5/6**

S.W. & COMMUNICATIONS "Tested Superhet Circuits for Short wave and Com- munication Receivers, using MATs." Post free **6/6**

SINCLAIR QUALITY TRANSISTORS

MICRO-ALLOY TRANSISTORS (MATs) for extremely high power gains. MAT 100 High gain low level, 7/9. MAT 101 Extra high gain, low level, 8/6. MAT 120 High gain, medium and high level, 7/9. MAT 121 Extra high gain, medium and high level, 8/6. ADT.140 FOR V.H.F. and U.H.F. Suitable for F.M., T.V., V.H.F. and U.H.F. freq. Typical alpha cut-off of 400 Mc/s, 15/-.

To SINCLAIR RADIONICS LTD., 69 HISTON ROAD, CAMBRIDGE

Please send.....

..... for which I enclose £.....s.....d.

NAME.....

ADDRESS.....

B

TRACE FAULTS THE MODERN WAY WITH A SINCLAIR MICRO-INJECTOR

Provides a simple, highly efficient and economical way to trace faults in valve and transistor audio and radio equipment of all kinds. Two Micro-Alloy Transistors (MATs) are used in this precision sub-miniature instrument which generates and injects a signal into any part of the equipment to be tested, at a frequency from 1 kc/s to 30 Mc/s. The 6d. standard battery which it uses will last for about 6 months. Making the Sinclair Micro-Injector is extremely easy with the help of the instructions provided. In neat, well-made plastic case. Parts, including case, come to

27'6

Ready built and Tested **32'6**

$1\frac{4}{5}'' \times 1\frac{3}{10}'' \times \frac{1}{2}''$



SEE ALSO THE TWO PRECEDING PAGES ALL ITEMS GUARANTEED • FULL SERVICE FACILITIES

SINCLAIR RADIONICS LTD

69 HISTON ROAD • CAMBRIDGE

* If you do not wish to cut out coupon, mention "Radio Constructor" when ordering

RETURN-OF-POST SERVICE

We offer a really efficient Mail Order Service on all items stocked. All cash orders are dealt with on the day of receipt.
 ★ Hire purchase orders are subject to slight delay but this is kept to the absolute minimum.

● ILLUSTRATED LISTS

Illustrated lists are available on LOUDSPEAKERS, TAPE DECKS, TEST GEAR, GRAMOPHONE EQUIPMENT, AMPLIFIERS. Any will be sent free upon request.

● AMPLIFIER KITS

We have full stocks of all components for the Mullard 510, Mullard 3-3, Mullard 2 and 3 Valve Pre-amp, Mullard Stereo, Mullard Mixer. Fully detailed list on any of these sent upon request.
 Instruction Manual: All Mullard Audio Circuits in "Circuits for Audio Amplifiers", 9/5. Post Free.

● MARTIN AUDIO KITS

A range of high quality transistor amplifying equipment is now being produced by MARTIN ELECTRONICS.
 Included are 3 and 10 watt Amplifiers, Pre-amplifiers, Mixer and Input Switching Units. Please write for full details.

● STEREO COMPONENTS

Morganite ganged potentiometers as specified for the Mullard circuits.
 ★ Log/Anti-Log, 500k, 1 meg., 2 meg. ★ Log/Log, 50k, 250k, 1 meg., 2 meg. ★ Lin/Lin 250k, 500k, 1 meg., 2 meg. All 10/6 each. Postage extra.

● TRANSISTORS

MULLARD. Current production types, not rejects. All in makers' boxes. Postage 3d. on each.
 AF114, 11/-; AF115, 10/6; AF116, 10/-; AF117, 9/6; OC44, 8/3; OC45, 8/-; OC70 and OC71, 6/6; OC72, 8/-; OC72 Matched Pairs, 16/-; OC78, 8/-; OC81, 8/-; OC170, 8/6; OC171, 9/- . Any other Mullard type obtained promptly. Ask for quotation.

● NEW MULLARD CONDENSERS

Mullard Miniature Foil and Polyester condensers as used in the latest TV and Transistor sets.

Miniature Foil. 30 volt working for Transistor sets. .01mfd, 7½d.; .022mfd, 9d.; .047mfd, 9d.; .1mfd, 11d.

Polyester Tubular Capacitors. Moulded outer case designed to withstand accidental contact with the soldering iron. Tolerance 10%. 125V range: .01mfd, .022mfd, .047mfd, all 9d. each; .1mfd, 1/2; .22mfd, 1/3; .47mfd, 1/6; 1mfd, 3/-.

400V range: .001mfd, .0022mfd, .0047mfd, .01mfd, .022mfd, all 9d. each. .047mfd, 1/2; .1mfd, 1/3; .22mfd, 1/6; .47mfd, 2/5. Postage extra.

● MINIATURE ELECTROLYTIC CONDENSERS

Latest miniature types by Mullard and Radio Spares.

RADIO SPARES. All 15V, 2mfd, 4mfd, 5mfd, 8mfd, 10mfd, 16mfd, 32mfd, 50mfd, 100mfd, all 2/3 each. Postage extra.

MULLARD. 2mfd, 10V, 1/9; 4mfd, 4V, 1/9; 10mfd, 16V, 1/8; 16mfd, 10V, 1/8; 25mfd, 4V, 1/8; 25mfd, 25V, 1/3; 32mfd, 2.5V, 1/8; 32mfd, 40V, 1/8.

● "SYNCHROTAPE" RECORDING TAPE

Low-priced British tape, all reels fitted with leaders.
 Standard Play: 600ft (5"), 13/6; 850ft (5½"), 17/-; 1,200ft (7"), 21/-.
 Long Play: 900ft (5"), 17/-; 1,200ft (5½"), 20/-; 1,800ft (7"), 30/- . Post free.

● TAPE RECORDING EQUIPMENT

TAPE DECKS

	Cash Price	Deposit	Hire Purchase Mthly Pmts.
ALL CARRIAGE FREE			
COLLARO STUDIO. Latest model. Two track. Bradmatic Heads	£10.19.6	£2. 3.6	12 of 16/4
Four Track, Marriott Heads	£17.17.0	£3.12.0	12 of 26/2

MARTIN TAPE AMPLIFIER KITS

Tape Amplifiers
 For Collaro 8311-V 2-Track £11.11.0; 8311-4-V 4-Track £12.12.0.

Tape Pre-Amplifiers
 For Collaro 8312-CP 2-Track £8.8.0; 8312-4-CP 4-Track £9.9.0.

Drop through assembly for mounting 8312 Pre-Amp under Collaro Deck, £1.11.6.

Carrying Cases with speaker. For Collaro Deck and 8311 Amplifier £5.5.0.

H.P. TERMS available on decks, amp. and cases. Ask for quote.

MULLARD TAPE PRE-AMPLIFIER KIT

We stock complete kits and all separate components for the Mullard Tape Pre-Amplifier. Fully detailed list available.

● LOUDSPEAKERS

GOODMANS: Axiette 8", £5.5.7; Axiom 10", £6.5.11; Axiom 201 12", £10.17.4; Axiom 301 12", £15.4.6; Audiom 51 Bass 12", £9.2.8;

Audiom 61 Bass £14.7.8; Trebax Tweeter, £6.10.2; XO5000 Crossover Unit, £2.0.11.

WHITELEY: HF1016 10", £7.0.0; HF1012 10", £4.7.6; HF816 8", £6.0.0; T816 8", £5.13.6; T10 Tweeter, £4.8.3; T359 Tweeter, £1.10.6;

CX3000 Crossover Unit, £1.11.6; CX1500 Crossover Unit, £2.0.0. H.P. Terms available on all speakers.

● TERMS OF BUSINESS

Cash with order or C.O.D. We charge C.O.D. orders as follows: Up to £5, minimum of 4/2.

Over £5 and under £10, 2/8. Over £10, no charge. Postage extra on CASH orders under £5 except where stated. Postage extra on overseas orders irrespective of price.

● ARMSTRONG EQUIPMENT

	Cash Price	Deposit	Hire Purchase Mthly Pmts.
TUNER AMPLIFIERS			
Model 227 Stereo	£48.15.0	£9.15.0	12 of £3.11.6
Model 227M Mono	£33.18.0	£6.18.0	12 of £2. 9.6
Model 226 De Luxe Stereo	£56. 0.0	£11. 0.0	12 of £4. 2.6
Stereo 55 Stereo	£29.18.0	£5.18.0	12 of £2. 4.0
RADIOGRAM CHASSIS			
Model AF208 AM/FM	£21. 4.0	£4. 4.0	12 of £1.11.2
TUNERS			
Model T48 FM	£20. 8.0	£4. 2.0	12 of £1. 9.11
Model ST3 Mk2 AM/FM	£25.12.0	£5. 2.0	12 of £1.17.11

Makers literature available on any item

● JASON F.M. TUNERS

We stock all parts needed for the construction of these excellent tuners. All parts can be supplied separately but we can offer attractive reductions in price if all items are purchased at same time as follows:

FMT1	£6.12.6	FMT2 (less power)	£7.15.0
FMT2 (with power)	£9.12.6	FMT3 (less power)	£9. 9.6
FMT3 (with power)	£11.7.6	Mercury 2	£10.14.6
ITV/2	£14.12.6		

Hire Purchase Terms available. Ask for list.

● P.W. STRAND, MAYFAIR & SAVOY UNITS

We stock parts for the P.W. Strand Amplifier, Mayfair Pre-Amplifier and Savoy FM Tuner. Detailed price lists are available.

● LATEST TEST METERS

	Cash Price	Deposit	Hire Purchase Mthly Pmts.
AVO Model 8, Mark II	£24. 0.0	£4.16.0	12 of £1.5. 2
AVO Model 7, Mark II	£21. 0.0	£4. 4.0	12 of £1.10.10
AVO Multiminor Mark 4	£9.10.0	£1.18.0	12 of 14/4
T.M.K. TP10	£3.19.6	£1. 3.6	3 of £1. 2. 0
T.M.K. TP55	£5.19.6	£1.15.6	3 of £1.11. 4
T.M.K. Model 500	£8.19.6	£1.15.6	12 of 13/8
TAYLOR MODEL 127A	£10.10.0	£2. 2.0	12 of 15/8

Full details of any of the above supplied free on request.
 The AVO models 7 and 8 are both latest models from current production —not to be confused with Government surplus.

● OUTPUT TRANSFORMERS

GILSON: W0696A, W0696B, 50/6, post 2/6. W0710, 55/6, post 2/6. W0892, 62/3, post 2/9. W0767, 27/-, post 1/6. W01796A, 57/6, post 2/6. W01932, 84/-, post 3/-.
 PARTRIDGE: P3667, 75/-, post 2/9. P4131, 75/-, post 2/9.
 PARMEKO: P2629, 47/6; P2642, 45/-; P2643, 47/6. All plus post 2/9; P2641, 29/6, post 2/-; P2928, 17/-, post 2/-; P2932, 41/-, post 2/6.

● MAINS TRANSFORMERS

GILSON: W0741A, 63/-, post 4/-; W0839, 48/9, post 2/9; W01328, 58/6, post 3/6; W01288, 58/-, post 3/6; W01566, 80/-, post 4/6; W01341, Choke, 36/-, post 2/-.
 PARMEKO: P2631, 35/-, post 2/9; P2630, 54/9, post 3/3; P2644, 76/6, post 4/-; P2930, 41/-, post 3/-; P2931, 56/9, post 3/3.

● GRAMOPHONE EQUIPMENT

ALL LATEST MODELS

	Cash Price	Deposit	Hire Purchase Mthly Pmts.
ALL POST FREE RECORD CHANGERS			
GARRARD AUTOSLIM			
(Mono PU)	£7. 2.6	£1. 8.6	12 of 11/2
GARRARD AUTOSLIM De-luxe AT6 (Mono PU)			
	£11. 9.0	£2. 6.0	12 of 16/11
GARRARD AUTOSLIM AT6 (Stereo/Mono PU)			
	£12. 5.4	£2. 9.4	12 of 18/-
B.S.R. UA14 (TC8 Mono PU)			
	£6.19.6	£1. 7.6	12 of 11/-
B.S.R. UA14 Monarch (TC8 Stereo/LP/78)			
	£7.19.6	£1.11.6	12 of 12/4
B.S.R. UA16 (TC8 Mono PU)			
	£7.19.6	£1.11.6	12 of 12/4
B.S.R. UA16 (TC8 Stereo/LP/78)			
	£8.19.6	£1.15.6	12 of 13/8
SINGLE RECORD PLAYERS			
B.S.R. TU12 (TC8 Mono PU)			
	£3.17.6	£1 4.6.	3 of £1.1.0
B.S.R. GU7 (TC8 Mono PU)			
	£4.18.8	£1. 8.8	3 of £1.6.8
GARRARD SRP10 (Mono PU)			
	£5.9.11	£1.12.11	3 of £1.9.0
TRANSCRIPTION UNITS			
GARRARD 4HF (GC8 PU)			
	£16.12.6	£3. 6.6	12 of £14.5
PHILIPS AG1016 (S/M PU)			
	£12.12.0	£2.10.0	12 of 18/6

Many of the above can be supplied for stereo working. See our Gramophone Equipment List for details.

PHILIPS AG1016 (S/M PU) ... £12.12.0 ... £2.10.0 ... 12 of 18/6

PHILIPS AG1016 (S/M PU) ... £12.12.0 ... £2.10.0 ... 12 of 18/6

PHILIPS AG1016 (S/M PU) ... £12.12.0 ... £2.10.0 ... 12 of 18/6

PHILIPS AG1016 (S/M PU) ... £12.12.0 ... £2.10.0 ... 12 of 18/6

PHILIPS AG1016 (S/M PU) ... £12.12.0 ... £2.10.0 ... 12 of 18/6

PHILIPS AG1016 (S/M PU) ... £12.12.0 ... £2.10.0 ... 12 of 18/6

PHILIPS AG1016 (S/M PU) ... £12.12.0 ... £2.10.0 ... 12 of 18/6

PHILIPS AG1016 (S/M PU) ... £12.12.0 ... £2.10.0 ... 12 of 18/6

PHILIPS AG1016 (S/M PU) ... £12.12.0 ... £2.10.0 ... 12 of 18/6

PHILIPS AG1016 (S/M PU) ... £12.12.0 ... £2.10.0 ... 12 of 18/6

PHILIPS AG1016 (S/M PU) ... £12.12.0 ... £2.10.0 ... 12 of 18/6

PHILIPS AG1016 (S/M PU) ... £12.12.0 ... £2.10.0 ... 12 of 18/6

PHILIPS AG1016 (S/M PU) ... £12.12.0 ... £2.10.0 ... 12 of 18/6

PHILIPS AG1016 (S/M PU) ... £12.12.0 ... £2.10.0 ... 12 of 18/6

PHILIPS AG1016 (S/M PU) ... £12.12.0 ... £2.10.0 ... 12 of 18/6

WATTS RADIO

(MAIL ORDER) LTD.
 54 CHURCH STREET WEYBRIDGE SURREY
 Telephone Weybridge 47556
 Please note: Postal business only from *his address
 (Callers welcome by appointment)

● HIRE PURCHASE TERMS

are available on any item. Repayments may be spread over 3, 6 or 12 months. Details as follows: 3 months; Dep. 6/- in the £. Service charge 5% but min. charge of 10/- 6 months; Dep. 5/- in the £. Service charge 7½% but min. charge of 15/- 12 months; Dep. 4/- in the £. Service charge 10% but min. charge 20/-.

TIME IS MONEY!

With today's high labour costs, this old saying is particularly true. What has this to do with catalogues? A catalogue that lists all the components you are likely to need — over 5,000 — and indexes them fully and accurately must save you many hours of searching. With our well-known by-return Mail Order Service we save you even more time. Most of the items we sell are at standard prices. We don't give stamps, but by saving you time we save you money!

If you are unconverted send the coupon today, together with 2/6, plus 1/6 postage and packing. You may find it the best investment you ever made.

SHOP HOURS FROM 1st MARCH 1964

Mon. ... 9-5.30

Tues. ... 9-5.30

WED. CLOSED ALL DAY

Thur. ... 9-5.30

Fri. ... 9-6.30

Sat. ... 9-5.30

PLEASE WRITE YOUR NAME AND ADDRESS IN BLOCK CAPITALS

NAME

ADDRESS

HOME RADIO LTD., Dept. RC, 187 London Rd., Mitcham, Surrey

BARGAIN WHILE STOCKS LAST

BASIC COMPONENTS FOR AN F.M. KIT, CONSISTING OF THE FOLLOWING:—

- One 10 pf. 2 gang with 3:1 reduction drive
- Two I.F. coils
- One P.D. coil
- Two High Quality Diodes

All for **15/6** post paid

THE GANG ALONE IS WORTH THE MONEY!

CAR SUPPRESSOR SETS

Consisting of:—

- Four Plug suppressors
- One Condenser for coil

5/- plus 1/6 Postage

500 pF. 2 gang
CONDENSERS

3/6 plus 1/6 P & P

16 M.F. DUBILIER
Electrolytic Condensers

350 Volts

Working Size 2" x 1"

Price for 6, **3/9** plus 1/6 postage

HOME RADIO of MITCHAM

DEPT. RC, 187 London Road, Mitcham, Surrey. (Phone MIT 3282)

THE Radio Constructor



Incorporating THE RADIO AMATEUR

FEBRUARY 1964

Vol. 17, No. 7
Published Monthly
(1st of month)

*Editorial and
Advertising Offices*
57 MAIDA VALE LONDON W9

Telephone
CUNningham 6141
(2 lines)

Telegrams
Databux, London

First Published
1947

The Six-Point-Three 1-Valve Receiver, by Michael J. Dunn	444
Trade Review—Sinclair Micro-6 Receiver	449
Suggested Circuits No. 159: Expanded Range Mains Voltmeter, by G. A. French	450
An Interchangeable Oscilloscope, Part 1, by J. Hillman	454
Printed Circuits Made Easy, by C. Morgan	459
Kit Review—The Heathkit Aerial Tower Model HT-1 and Model HT1-G	460
Can Anyone Help?	461
News and Comment	462
Understanding Radio, Part 30, by W. G. Morley	463
C-Cores for the Constructor, by P. Crawley	468
In Your Workshop	472
Transistor Portable-4, by F. G. Rayer, Assoc. Brit. I.R.E.	480
Transistorised Television Circuits, Part 4, by Gordon J. King, Assoc. Brit. I.R.E., M.T.S., M.I.P.R.E.	485
Transistorised Home-built Closed Circuit TV, Part 2, by R. Murray-Shelley and T. Ian Mitchell	489
Radio Topics, by Recorder	493

© Data Publications Ltd., 1964. Contents may only be reproduced after obtaining prior permission from the Editor. Short abstracts or references are allowable provided acknowledgement of source is given.

Annual Subscription 30s. (U.S.A. and Canada \$4.50) including postage. Remittances should be made payable to "Data Publications Ltd". Overseas readers please pay by cheque or International Money Order.

The "Six-Point-Three"

1-Valve Receiver

By MICHAEL J. DUNN

There is considerable fascination in investigating the circuits which were employed in the earlier days of radio. In this article our contributor resuscitates an unusual circuit of the twenties, and brings it up to date in the form of a particularly attractive receiver employing modern components.

THE "SIX-POINT-THREE" IS THE NAME THE WRITER has given to a somewhat unusual receiver which he evolved after a series of experiments on an old circuit from the early twenties—the "Unidyne".

In the early days of broadcasting, signals were weak and fairly widely spaced on the dial. Components, although most carefully made, were by modern standards large and very inefficient. At the same time, bright emitter valves demanded a heavy filament current, which had to be provided by large capacity accumulators, usually of from four to six volts. Selectivity was not a very serious problem,

but sensitivity was all-important and hard to obtain with coils of low Q and triode valves whose slopes were rated in $\mu\text{A/V}$ rather than mA/V . Today the position is reversed with high-gain circuits, and the medium wave band is completely overcrowded. The result is that the erstwhile thrill of searching for faint and distant sounds in the headphones has been replaced by the experience of receiving closely spaced and fiercely strong signals mixed with shrill whistles and even worse cacophonous noises!

The "Unidyne"

The early twenties was the era of "-dyne" circuits, nearly all of which attempted to obtain the maximum of sensitivity whilst at the same time trying to economise on components and power supplies—both expensive items for the amateur constructor. Around 1923 Keith Rogers and G. V. Dowding produced the "Unidyne" circuit in an attempt—which must be regarded as successful—to do without the h.t. battery.¹ The circuit is shown in Fig. 1 and it will be seen that there are some unusual features about it, not the least of which is that of obtaining the h.t. supply from the positive l.t. lead. The heart of the circuit is the Thorpe K4 valve which has two grids, and which is one of the earliest examples of what was then called a four-electrode valve and today a tetrode. Contemporary with it and possibly even preceding it in date, the Marconi-Osram Company produced a four-electrode valve which was used in an entirely different context. Neither this, nor the K4, functioned in the same way as the screened grid "h.f." amplifier, also first introduced by the same firm in 1926-7. These valves are shown in photographs A, B, C and D.

To understand the way in which the K4 valve was designed to operate, it is necessary briefly to consider some elementary valve theory. When a

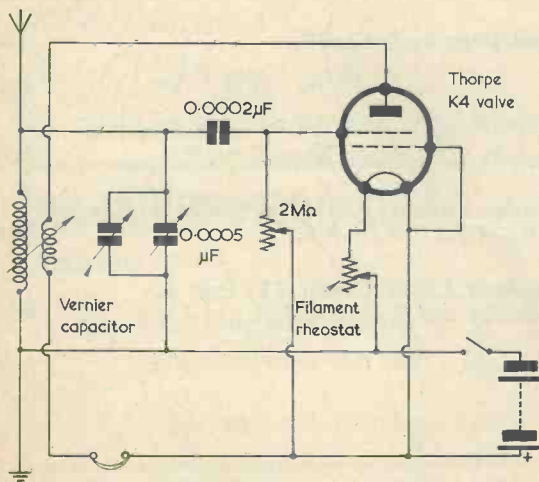

Fig. 1. The Unidyne detector circuit. The only deviation from the original is that parallel tuning is shown. In the original the tuning capacitance is inserted in series with the aerial and the tuned coil. Note that the G_1 is connected direct to l.t. positive, the signal being applied to G_2

¹ Harmsworth's Wireless Encyclopedia (circa 1923), pp. 2146-2152 inclusive.

filament is raised to incandescence in a vacuum, electrons are emitted from the surface and form a cloud which is known as the space charge. This, consisting as it does of negatively charged particles which repel each other, prevents further emission from the heated filament. If, however, the anode is given a positive charge, the cloud of electrons is drawn towards it and current flows through the valve; but this charge must be above a certain threshold before it can dispel the space charge, which otherwise inhibits the passage of current for very low values of anode potential. The designers of the K4 contended that if it were possible to dispel the space charge around the filament, the valve could be made to function with a very low anode voltage. To achieve this they introduced an extra grid between the control grid and the filament, which in the Unidyne circuit was connected direct to the l.t. positive terminal. The idea was that this positive potential near the cathode would neutralise the space charge and sufficiently lower the resistance of the valve so that it would operate with the anode connected (via the reaction coil and phones) to the l.t. positive line. The control grid was also returned to l.t. positive via a $2M\Omega$ variable grid leak. All the electrodes were, therefore, at positive potential with respect to the cathode. In the original Unidyne circuit a second K4 valve was employed, transformer-coupled, working under similar conditions, as a "low-frequency" (audio) amplifier and loudspeaker results were claimed for the two-valve set.

Reconstruction

During some efforts to collect museum pieces, the writer was fortunate enough to come across two specimens of the K4 valve at a shilling each "brand new and boxed"! With these and other contemporary components, a complete reconstruction of the original circuit was made. It was found to work very well, though it is only fair to mention that present-day radio signals are very much more powerful than they were in 1923. Having demonstrated that the circuit could function satisfactorily with original components, the writer decided to conduct experiments to find out what results, if any, could be obtained using more modern valves and components, especially in view of the vastly improved thermionic emission of present-day valves and the far higher Q of modern coils. To this end an experimental circuit was constructed using a litz-wound dual range coil and capacitance controlled reaction. By incorporating a reversal switch, arrangements were provided for the immediate comparison of the effects of reversing the functions of G_1 and G_2 for every valve tested. In the original Unidyne circuit, the source of l.t. to light the bright emitter tungsten filament of the valve was a 4-6V accumulator, the current being controlled by a rheostat. For the purposes of the experiments, therefore, it was considered legitimate to have an h.t. supply of up to 6V, whatever the actual filament or heater rating of the valve under test. A large number and variety of valves were subjected to testing, including the K4 itself, battery output pen-

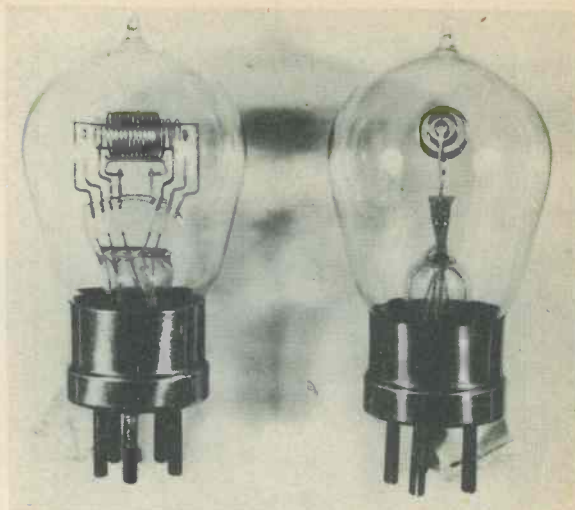

The Thorpe K4 valve. Two views at right angles showing the four electrodes

todes with 2V and 1.5V filaments, output tetrodes and pentodes with indirectly heated cathodes, and also various r.f. amplifiers.

With modern components and using G_2 as control grid, the K4 worked very well; it could be made to oscillate readily and gave a good audible signal.

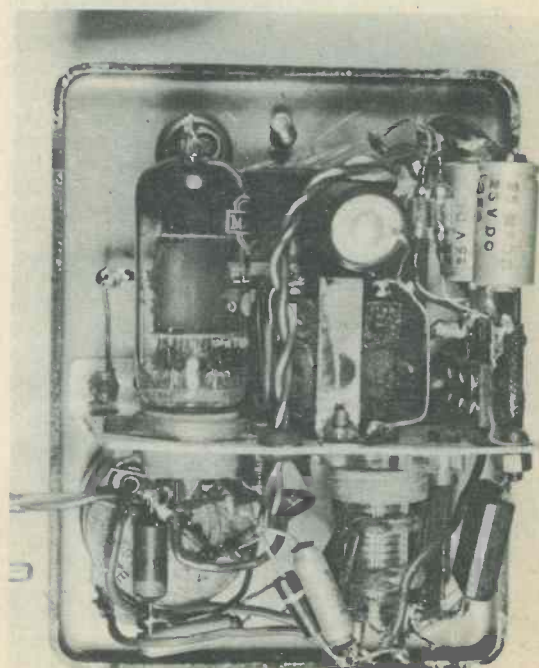

Inside view of the "Six-Point-Three". This illustration and other photograph should be compared with Figs. 5 (a) and (b)

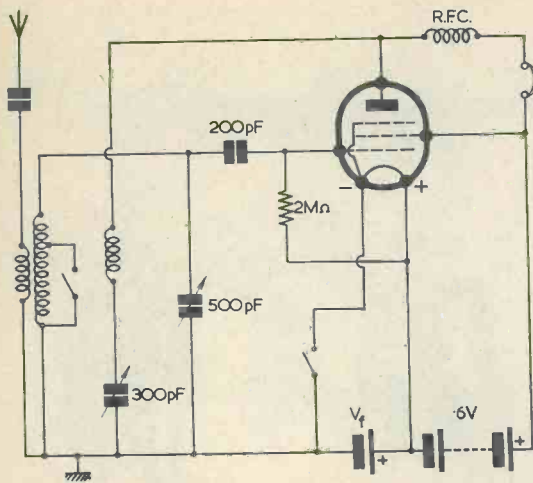
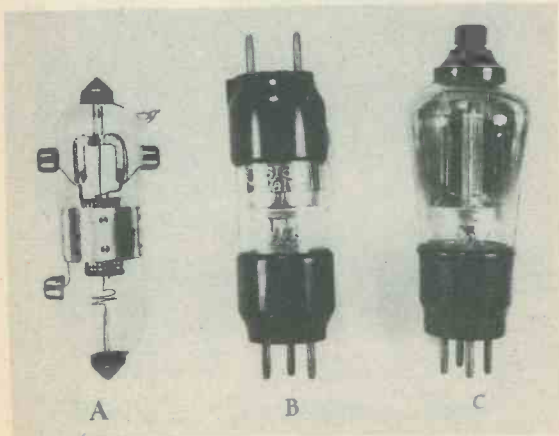

Fig. 2. Practical circuit using a battery output pentode

With more modern valves results were very disappointing, except that the Mullard PM22A gave a tolerable performance. It was, however, with the functions of G_1/G_2 reversed that most of the valves that had performed so badly, or not at all, came to life. The readings taken during the experiments showed that the current taken by the priming grid was much greater for G_1 than for G_2 , as one would expect, due to the great proximity of the former to the cathode. Using G_2 as priming grid, good results were obtained with readings of around $200\mu A$ whereas, using G_1 , readings of 5mA or more were observed and performance was either poor or non-existent. Obviously most of I_k was going to G_1 , which was contributing nothing to the signal component of the electron flow. Curiously enough, this is the very situation which obtains in the original Unidyne circuit, but the K4 valve gives a very poor



- (a) A very early four electrode valve by Marconi-Osram.
- (b) The first true screened grid valve by the same company (1926-26)
- (c) The once-familiar screened grid valve of the thirties

account of itself with a reversal of the functions of its two grids as originally designed.

From these experiments it was established that many pentodes and tetrodes of modern type are capable of working well as detectors under conditions of very low anode potential. Performance was found to be best and I_k minimum when G_2 is used as the priming grid. It was also made evident that r.f. amplifiers were not suitable in this context, best results being obtained from output and power types of valve, the larger the better.

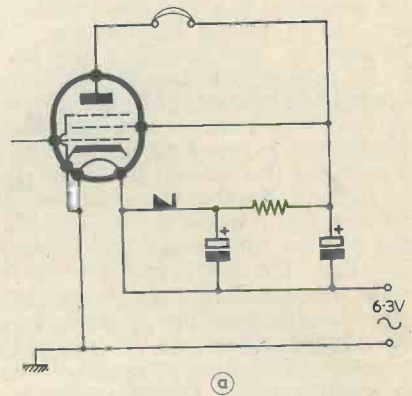
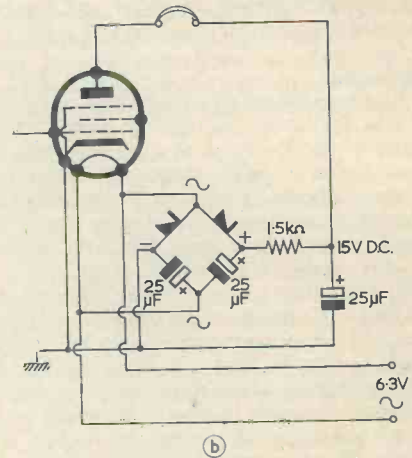

Fig. 3 (a). Half-wave rectification of the a.c. heater supply



(b). The voltage doubling circuit which was employed in the prototype. The components used are discussed in the text

Practical Circuits

Two practical circuits were developed as a result of these experiments: one for use with directly heated battery valves, the other with indirectly heated mains types. With the former, either a 2V accumulator of a 1.5V dry cell is used to supply the filament current (according to the valve's require-

ments) and, for the h.t., dry batteries delivering 4.5 to 9V were employed. For 2V operation, by far the best valve was found to be the Pen220A (VT51) and, for 1.5V operation, any of the B7G output pentodes, such as 1S4, 3S4, 3V4 or their equivalents were satisfactory.

The battery circuit is shown in Fig. 2. In this diagram the dual range coil may be any high-Q component, such as the Repanco DRR2. The r.f. choke may be a Repanco CH1 (2.5mH) or equivalent, whilst the headphones are high impedance, at 2,000Ω per coil.

Over a quarter of a century ago, the originators of the Unidyne circuit had, as their object, the elimination of the h.t. battery as a separate entity and the utilisation of the l.t. supply in its place. It is with the then unheard-of indirectly heated mains valves that the modern counterpart of the Unidyne is a realistic possibility. The first and obvious thing to do is to rectify and smooth the 6.3V supply to the heater and use this as h.t. This gives quite good results with valves such as the 6V6, but it is only a short step further to use a voltage doubling circuit. This gives nearly 15 available volts, together with a very marked improvement in performance. These two stages in the development of the h.t. are shown in Figs. 3 (a) and (b). The power pack is very simple and can easily be kept down to very small dimensions. For valves of a type such as the 6V6, the total current demand is in the region of 400μA only, so that cheap surplus germanium diodes can be used as rectifiers,² and the electrolytic capacitors can be the smallest available versions with values from 8μF upwards. The actual capacitance is not critical and the writer employed midget capacitors of 25μF, 25V wkg. Fig. 7 shows a practical arrange-

² Although the rectifier p.i.v. in the circuit of Fig. 3 (b) is only 18, this still exceeds the ratings for diodes of the OA70 class.—EDITOR.

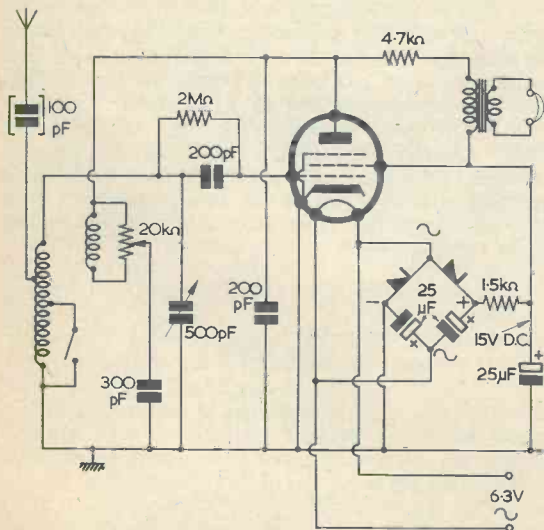
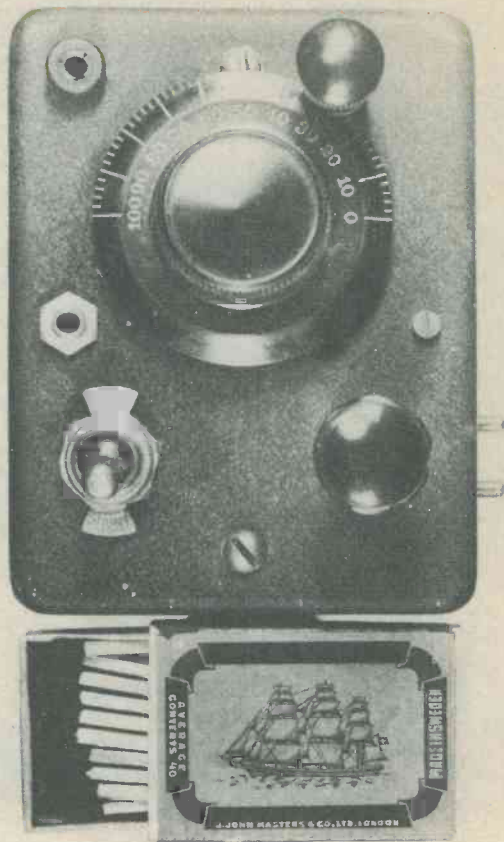

Fig. 4. Complete circuit of a practical mains-operated one valve receiver. Note that neither of the heater supply leads should be connected to chassis



The front panel of the "Six-Point-Three"

ment on a group board. Alternatively, of course, the components can be wired straight in from point to point.

The circuit of a complete one valve set is shown in Fig. 4. Except for keeping the grid circuit connections short, the layout will present no problems. The 6.3V a.c. is obtained from the mains through a suitable step-down transformer, the heater current depending on the valve used. Heater current will range from 0.15A for a 6G6 or 6AK6 to 0.9A for a 6L6 or even 1.27A for a KT66. Most constructors should have no difficulty in finding a suitable transformer amongst their spares or in obtaining one at low cost. As with Fig. 2, the dual range coil may be any high-Q type, such as the Repanco DRR2.³

Experiments were also carried out in an endeavour to use a second valve as an audio amplifier, as in the original circuit, with a very low anode potential. A 6V6 provided enough volume to drive a loud-speaker, but distortion was considerable. The characteristics of the valve were plotted working on

³ Results with either Fig. 2 or Fig. 4 should be reasonably similar if an aerial coupling coil (Fig. 2) or an aerial tap (Fig. 4) is used. The method of connecting the aerial into the circuit will depend upon the connections offered by the coil employed.—EDITOR.

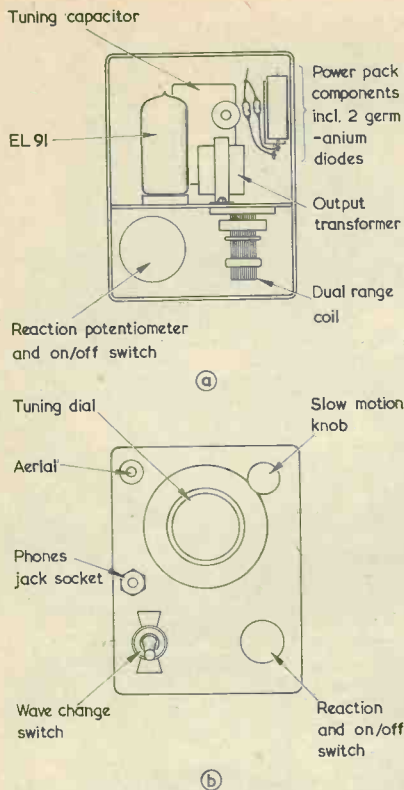

Fig. 5 (a). Rear view of the one valve receiver
(b). The front panel layout

15V h.t., and it was found that not only was there no straight part of the slope between zero grid volts and cut-off, but that this section of the characteristic was so short that it allowed very little swing of grid potential without running into grid current in one direction and cut-off in the other. Because of this, no further attempt was made to construct a two valve set.

Choice of Valves

The size of the one valve version will, of course, depend on the choice of valve and other components. Almost any output tetrode or pentode will perform well and, if the constructor wants maximum results rather than miniaturisation, a 6L6 or KT66 is recommended. However, a 6V6GT works excellently and, in the B7G range, the 6AQ5 has similar characteristics and is very much smaller. Also in the miniature range are the 6AK6 and 6AM5 (EL91), both entirely suitable. Using the latter valve, the writer made a very small and compact receiver as shown in the two photographs. This was fitted into a small (ex-Government) aluminium case measuring approximately 4 x 3 x 2in, the entire set being constructed on the front panel. The EL91 heater is rated at 6.3V and a modest

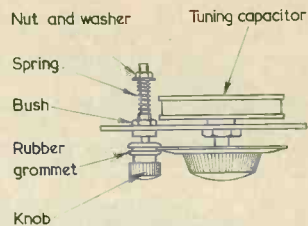

Fig. 6. Detail showing the slow-motion drive devised for the receiver

0.2A; the h.t. current (at 15V) is only about 300 μ A so that the power consumption is negligible. As will be seen, no particular effort has been made at miniaturisation (except possibly in the power pack) and standard components have been used. The circuit shows no real departure from the conventional leaky grid detector except that a potentiometer is used to provide exceptionally smooth reaction and this is ganged to the on/off switch.

For the output circuit, a small microphone transformer is used having a ratio of 80:1. This was a surplus item which had a high impedance primary winding. (In this circuit the secondary now, of course, becomes the primary.) Any good output transformer having a ratio of 50:1 or more should be satisfactory, but best results will be obtained when the primary impedance is high. The high impedance winding is in the anode circuit, the secondary feeding into a pair of low-impedance 150 Ω Government surplus phones which connect to the set by a miniature jack and socket. Excellent results were also obtained with two low-impedance hearing aid phones of 30 Ω each wired in series. A single 30 Ω phone could also be used.

The only power supply to the set is 6.3V a.c. and this is conveniently obtained from the mains with a transformer adaptor having a bayonet fitting to plug into any standard electric light socket. The writer obtained his from Woolworths for 3s. 6d., the unit being described as "Transformer adaptor unit for MULTUM workshop models. 200/250V, a.c. only. Output 6V, 0.5A". A 2-pin 2A plug is mounted on the set and the l.t. flex from the adaptor terminates with a female 2A flex connector. Both the plug and the connector are also obtainable from Woolworths.⁴

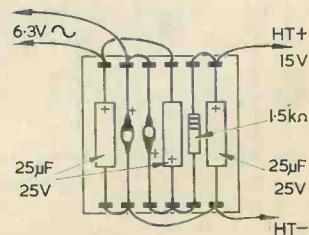

Fig. 7. A suggested layout for the voltage doubling components of Fig. 3 (b)

In most areas a short aerial will be sufficient, optimum results being obtained if the set can be earthed. If a long aerial is found necessary, a series capacitor of from 100 to 300pF is recommended to preserve selectivity. In spite of the very limited power supply, it will be found that a large number of Continental stations can be received on this set at good listening volume.

Fig. 6 shows the writer's method of providing a slow-motion dial by using the remains of an old "push-pull" switch. Construction is simplicity itself and the drive has, of course, a wider application than the set in question so that the idea may be of general use to readers.

As the power supply required is only 6.3V, it makes this type of set absolutely ideal for use by a child's bedside, obviating the necessity of having to renew batteries. Although deriving its power from the mains it is completely safe, even if inquisitive little fingers get inside while the set

⁴ It is essential to ensure that the 6.3 volt supply is fully and reliably isolated from the mains.—EDITOR.

is switched on! At the request of a friend, a large version was made for him to install and give to his small son as a Christmas present. The transformer providing the 6.3 volt supply was mounted in a place of safety outside the bedroom and, as with a bell transformer, was left permanently connected across the mains. The cable carrying the low tension current terminated at a 2-pin 2A socket by the bedside, into which the receiver can be plugged. The set employed a 6V6G and all the components were quite large. The luxury of an illuminated dial was provided, much to the delight of the youngster who used it, as this is a refinement not practical in a set using dry batteries.

The "Six-Point-Three" can be described as an "All-mains Miniature" and for those who still enjoy the intimacy of listening-in with headphones (or who prefer their children to do so!) it will be found to give endless listening with no problems of power supply and a current consumption which will scarcely register on the domestic supply meter!

trade review . . .

Sinclair Produce the World's Smallest Radio for the Constructor

SINCLAIR RADIONICS LTD., OF CAMBRIDGE, HAVE produced a self-contained transistor radio measuring a mere $1\frac{4}{5} \times 1\frac{3}{10} \times \frac{1}{2}$ in the "Micro-Six" as it is called, is considered to be well in advance of anything even the Japanese have produced. It is very much smaller than a box of matches, for example.

The Micro-Six is a complete six-stage transistor receiver with amplified a.g.c. applied to the first r.f. stage to ensure fade-free reception of foreign stations such as Luxembourg. Negative feedback is applied to all a.f. stages for complete linearity and the sensitivity is as good as that of conventional 6-transistor superhets many times larger. The Micro-Six has its own tiny internal ferrite rod aerial, making external aerial connections unnecessary. Tuning covers the entire medium waveband with increased coverage given to the high-frequency end of the band to improve separation of Continental stations.

Primarily, this remarkable little set is intended for use with an earpiece, and the quality of reproduction obtained is superb. However, the output power is quite sufficient to drive a large loudspeaker with good volume. The set functions very well in cars, buses, trains, etc., and tests have already shown it to operate in steel-frame buildings where other receivers have failed to work at all. This set is powered by a minute mercury cell, readily



available all over the country, which will last about six months under average conditions.

The Sinclair Micro-Six is a set which will appeal particularly to constructors who already have experience of transistors. All parts, including elegant case and dial, earpiece, printed circuit board, Micro-Alloy Transistors (M.A.Ts) and all micro-miniature components together with building instructions are available immediately from Sinclair Radionics Ltd., 69 Histon Road, Cambridge, at a total cost of 59s. 6d. post free.

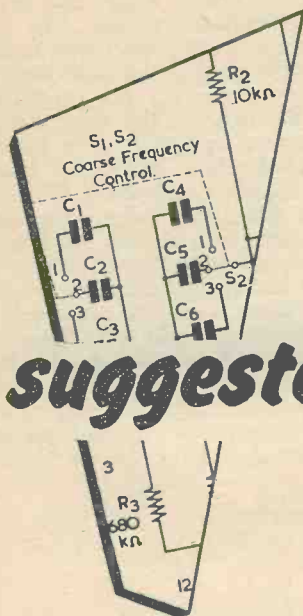

suggested circuits

No. 159 Expanded Range Mains Voltmeter

AT THIS TIME OF THE YEAR we tend to experience exceptionally high voltage drops or cuts in the public electricity supply owing to heavy demands by heating and similar equipment. These voltage drops can be a considerable nuisance when radio and electronic work is being carried out, as they cause equipment to work under incorrect supply conditions. A typical instance is given in the service workshop, where a low voltage mains supply can prohibit the final setting-up of television receivers or may even lead an unsuspecting engineer to look for a fault which would be non-existent under normal supply conditions.

To counteract this effect, it is very helpful to have a voltmeter connected permanently across the mains supply in order to monitor supply voltage at periods when excessive drops or cuts are imminent. Such a voltmeter can, then, always be consulted whilst working on equipment whose performance may be seriously affected by low mains voltages.

A conventional voltmeter with a linear scale is not always the best instrument for this application, since the variation in needle deflection for low mains voltage changes represents only a small percentage of full-scale deflection. Thus, a drop from, say, 250 to 200 volts causes a needle deflection of only one-fifth of the higher reading,

and this is not immediately obvious when the meter is observed from a distance. A better choice would be given by a meter which offers a wide deflection over the range to be measured, as small changes in voltage can then be much more readily noted.

This month's article gives details of two circuits which achieve this end, and which may be made up with components which are relatively inexpensive, if not already available in the spares box. This last point is of significance here, as there is little point in using costly components in a device which is normally required only for several months out of the year. Prototypes were made up for both the circuits, and that which gave the better results is dealt with first. The second circuit is included since the principle involved is of interest, but it necessitates more experimental work on the part of the constructor.

The First Circuit

The first circuit is illustrated in Fig. 1. In this diagram the a.c. mains voltage to be measured is applied to the outside terminals of a centre-tapped mains transformer winding. The voltage across this winding is applied to the full-wave rectifier circuit given by D_1 and D_2 , the rectified voltage appearing at the junction of their cathodes. There is no reservoir capacitor and, as measured by a

moving coil voltmeter, the rectified potential will be equal to $\frac{1}{1.11}$ of the r.m.s. voltage across each half of the transformer winding. For mains inputs of 200 to 250 volts, the rectified potential will then be of the order of 100 volts. The rectified voltage is applied to two potential dividers, one consisting of R_1 and the zener diode D_3 , and the other consisting of R_3 and R_4 . Approximately 10mA flows through each potential divider.

The voltage dropped across the zener diode is nearly constant for all mains potentials to be encountered, whilst the potential at the junction of R_3 and R_4 is proportional to the a.c. mains voltage applied to the transformer winding. The circuit is initially set up by adjusting the value of R_4 such that, at the lowest a.c. voltage to be measured, the voltage dropped across R_4 is equal to that dropped across D_3 , whereupon the meter gives a zero reading. The highest mains voltage to be measured is then applied to the transformer winding, and the value of R_2 adjusted until the meter gives full-scale deflection. As a result of the setting-up operation, the meter now gives readings only over the range between the lowest and highest a.c. voltages to be measured.

A numerical example may assist in explaining the process. Let us assume that the device is to be used

The circuits presented in this series have been designed by G. A. French, specially for the enthusiast who needs only the circuit and essential data

at a location where the nominal mains voltage is 240, and that it is required to indicate voltages in the range 200 to 250. Let us also assume that the zener diode, D_3 , drops a constant potential of 6 volts. Initially, a resistor of around $1k\Omega$ is fitted in the R_2 position, and an input voltage of 200 is applied. The value of R_4 is then adjusted until the voltage dropped across D_3 . This condition will be indicated by a zero reading in the meter, and the voltage drop across R_4 will now be 6 volts.

Let us next increase the input voltage to 250. In the potential divider R_3R_4 (and assuming that the meter is disconnected) the voltage drop across R_4 will be increased by a factor of $\frac{250}{200}$, giving a figure of

7.5. But this ignores the current which is now drawn through R_3 by the meter, and so the voltage will, in fact, be slightly lower. However, the actual value does not concern us here, as all we now need to do is to adjust the value of R_2 until the meter reads full-scale deflection, whereupon it draws an extra milliamp through R_3 in addition to the current (of the order of 10mA) which is drawn by R_4 . Thus, the meter now gives full-scale deflection at 250 volts input. The adjustment in R_2 will not effect the setting of R_4 which gave zero reading at 200 volts input because, at that voltage, the meter drew no extra current through R_3 .

As may be seen, the steps just described provide a device which gives a meter reading of zero at 200 volts and full-scale deflection at 250 volts. Small changes in mains voltage are, therefore, presented in a much more obvious manner than if a conventional voltmeter were employed.

Further Points

The practical operation of the circuit of Fig. 1 was checked with the aid of a prototype. The results obtained with this are shown in Table I, and are illustrated graphically in Fig. 2. It was decided to use the arbitrary range 190 to 250 volts for the experiment and, as may be seen, these figures correspond to zero and f.s.d. meter readings respectively. However, the circuit could have been set up just as readily to give a narrower range of readings, extending say from 210 to 250 volts.

It will be noticed from Table I that the voltage across the zener diode is not constant at all input

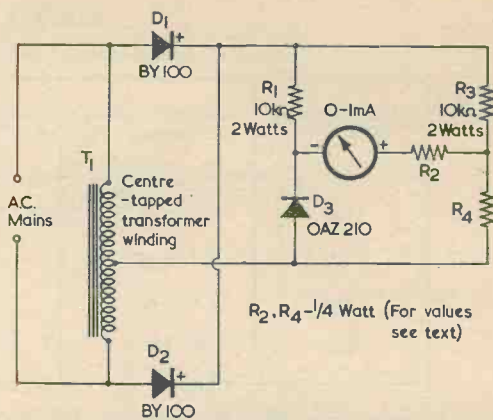

Fig. 1. The circuit of an expanded-scale voltmeter employing direct rectification from the mains

voltages, and that it varies from 6.05 to 6.2 according to input voltage and, hence, the current through R_1 . The small change in zener voltage is not of great consequence here, as it is automatically allowed for during the setting up of R_2 and R_4 . It should be added that the zener current of around 10mA brings the diode on to the flatter section of its zener voltage/current curve, and that the resulting voltage is sufficiently constant for the present application. The OAZ-210 specified has a spread of $\pm 15\%$, giving zener voltages, at 1mA, of 5.3 to 7.2. Thus, total dissipation in an upper limit diode is only of the order of 72mW, which is well within the permissible figures for operation without a cooling clip or heat sink.

The spread of zener diode voltage makes it difficult to specify values for R_2 and R_4 . These values should,

therefore, be found empirically after the particular diode to be used has been connected into circuit. For operation over the range 200 to 250 volts, R_4 will need a value lying between some 560Ω and $1k\Omega$, whilst R_2 will need a value of the order of $1k\Omega$. The values required may be found by using variable resistors which are replaced, when the correct value has been found, by fixed components. If this course is adopted, care should be taken to see that good contact exists between the slider and track of the variable resistor connected temporarily in the R_4 position. Should there be a momentary open-circuit in R_4 , excess current may flow through the meter. It would be possible to specify the values of R_2 and R_4 somewhat more closely if an OAZ203 were used in place of the OAZ210, since the OAZ203 has a spread of

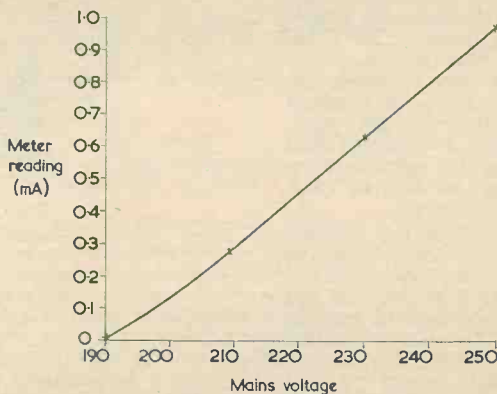

Fig. 2. A typical mains voltage/meter reading curve for the circuit of Fig. 1

TABLE I

Meter and voltage readings with the circuit of Fig. 1

Mains Voltage	Meter Reading (mA)	Rectified Voltage	Zener Voltage
190	0	86	6.05
209	0.28	93	6.15
230	0.63	102	6.2
250	1.0	112	6.2

±5% (5.8 to 6.6 zener volts at 1mA), but the OAZ203 is more expensive than the OAZ210 and its use would still necessitate final adjustments to R₂ and R₄.

Diodes type BY100 (with a maximum p.i.v. of 800) are shown in the D₁ and D₂ positions. However, the maximum peak inverse voltage on each diode is only 353 volts (assuming a maximum mains voltage of 250) and silicon diodes with lower p.i.v. ratings could be employed instead. A suitable choice would be the OA210 with a maximum p.i.v. of 400. Selenium rectifiers of suitable ratings should also be satisfactory, although the writer has not checked these in practice. It is interesting to note, incidentally, that the rectified voltages listed in Table 1 correspond with what is theoretically expected from a full-wave rectifier.

The centre-tapped mains transformer winding, shown in Fig. 1 as T₁, may be obtained from several sources. The writer understands that there are, for instance, several small mains transformers in the component market with centre-tapped primaries, and these would be an excellent choice for the present circuit. Alternatively, a 200-0-200 or 250-0-250 volt h.t. secondary winding could also be employed. The remaining transformer windings would, of course, be left open-circuit, although a pleasing effect might be given by using a spare heater winding to feed a pilot lamp if it was so desired.

Several a.c. voltages are required for setting up and calibration and a choice of three would be available by tapping into the 210, 230 and 250 volt primary taps of another transformer. The input voltage should be monitored by an a.c. voltmeter whilst setting up and taking calibration points. Small changes in input voltage (up to some 10 volts or so) can be obtained

by inserting resistance in series with the input of T₁ of Fig. 1. The meter may be calibrated after setting up, and three calibration points should prove to be an adequate minimum. It will be noted that the calibration curve obtained with the prototype, and shown in Fig. 2, is very nearly a straight line.

A point which should also be raised is that, at a.c. input voltages below the lowest to be measured, the meter needle will be deflected in the reverse direction. When a narrow range of voltages is to be indicated, this effect may conceivably result in excessive meter currents which are not immediately obvious from the deflection of the needle. Such currents may be obviated by inserting a germanium diode in series with the meter, but it should be noted that such a diode will result in a non-linear scale. (Alternatively, a suitable diode could be connected in shunt with the meter to by-pass some of the excess reverse current).

The Second Circuit

The second circuit checked by the

writer is shown in Fig. 3. This will be dealt with more briefly here, because it is more difficult to put into operation.

Fig. 3 shows the component values employed in a prototype made up by the writer, these being intended for rough guidance only. The mains voltage to be measured is applied to a bell transformer having a nominal secondary voltage of 8. This voltage is rectified by the four diodes D₁ to D₄, the rectified voltage being applied to zener diode D₅ via R₁, and via R₂ and the meter. R₁ maintains a minimum zener current of about 0.8mA, and the meter, in conjunction with R₂, measures the voltage difference between the rectified voltage and the zener voltage. A meter reading/mains voltage curve is given in Fig. 4, whilst the appropriate voltage readings are shown in Table II.

There are two difficulties with the circuit of Fig. 3. The first of these is given by the relatively poor regulation of the rectified voltage given by D₁ to D₄. OA79's were used in the prototype and, in company with other germanium diodes, they exhibit a fairly high

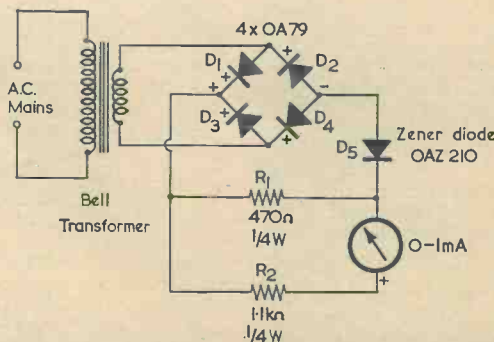

Fig. 3 An alternative circuit, which will be of interest to the experimenter. The components and values shown are intended for guidance only, and are those employed in an experimental prototype. The bell transformer has a nominal secondary voltage of 8.

TABLE II
Meter and voltage readings with the circuit of Fig. 3.

Mains Voltage	Meter Reading(mA)	A.C. Secondary Voltage	Rectified Voltage	Zener Voltage
175	0.23	6.2	5.2	4.8
190	0.31	6.6	5.4	4.9
207	0.41	7.1	5.7	5.1
230	0.63	7.8	6.1	5.4
250	0.88	8.55	6.55	5.4

forward resistance which detracts from the range expansion effect. Because of the high forward resistance it is desirable to operate the zener diode at currents of the order of 0.8 to 3mA only, and these correspond to a curved section of the zener voltage/current characteristic. There is, in consequence, a further lowering of the range expansion effect.

OA79's were employed in the bridge circuit because suitable bridge rectifiers at the voltages and currents involved do not appear to be readily available on the home-constructor market. If a bridge rectifier having considerably lower forward resistance were employed instead of the OA79's there should be a significant improvement in results. The value of R_1 should then be adjusted so that some 5 to 15mA zener current flows over the range of voltages to be measured, thereby bringing the zener diode on to a flatter part of its characteristic. The improved regulation would also assist in scale expansion.

The second disadvantage with the circuit of Fig. 3 is that it depends upon the actual zener voltage,

within its spread, of the diode selected. If the actual zener voltage is high, it may even be necessary to employ a mains transformer with a higher nominal secondary voltage to drive the circuit!

Despite these two difficulties, the circuit of Fig. 3 can, in the

hands of an experimenter who understands the principles involved, offer results which are nearly as good as those given by the Fig. 1 arrangement. Amongst other things, the circuit of Fig. 3 has the advantage that it may be made up in a smaller space than that of Fig. 1.

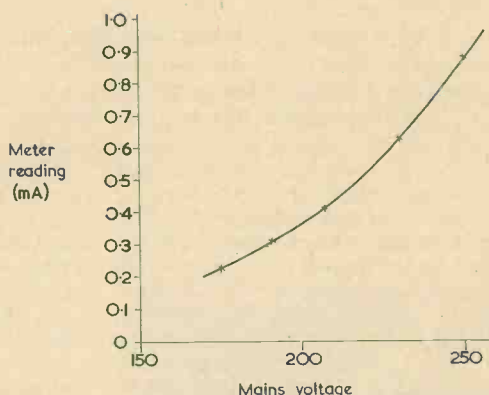

Fig. 4. The mains voltage/meter reading curve obtained with the prototype of Fig. 3

Marconi Aerials for BBC 2

The Marconi Company has been awarded a contract by the B.B.C. for the supply and installation of u.h.f. aerials at Sutton Coldfield, for coverage of the Birmingham area, and at Wenvoe, for coverage of the South Wales area. This major contract follows one received last year for aerial equipment installed in the London area.

These new aerials will be the first of their kind to be introduced in this country. They will consist of a number of fibreglass cylinders with the dipole aerials mounted on panels attached to the inside. In this way the cylinders not only provide excellent weather protection but will also act as the supporting structure. The whole assembly measuring 5 feet in diameter and having a length of 43 feet (32 feet for the Wenvoe installation) will be attached to the top of the existing 750 foot masts.

Although, at the moment, only intended for radiation of B.B.C. 2 programmes, an additional feature of these aerials is that they can radiate up to four programmes simultaneously. This will enable future additional programmes to be added without disturbance to the aerial system.

An Interchangeable Oscilloscope

PART I

by J. Hillman

This is the first of a three-part series describing an ambitious oscilloscope which is built in separate units. The basic units are introduced in this instalment, their full circuit diagrams being given when their construction is described. This month's article deals also with the first of the sections, this being the cathode ray tube unit.—Editor.

HAVING BUILT AND SERVICED SEVERAL OSCILLOSCOPES it was found that most of these were difficult to get at in order to replace components. Also it was difficult, when fault finding, to isolate the different sections in order to pin down the fault. It was felt that if an oscilloscope could be made up in self-contained units not only would it be easier to service but it would, in addition, be easy to alter any section to suit different requirements. The particular collection of units described here is intended for TV servicing but other units can be used to make up any type of oscilloscope.

Description of the Basic Units

The basic c.r.t. unit consists of the cathode ray tube, which can be either a 3BP1 or a VCR139A, or their equivalents, a beam switch for switching off the trace without switching off the oscilloscope, brightness, focus and two shift controls and, finally, two output sockets for direct connection to the X and Y plates of the tube.

The power pack consists of a full wave rectifier delivering 350 volts at 80mA, with heater supplies for the various units, and e.h.t. for the c.r.t. unit. The power supplies are fed out via octal plugs and sockets at the back of the power supply unit.

The X timebase unit, which provides the horizontal trace, consists of the familiar transitron oscillator and offers 5 c/s to 60 kc/s in five ranges. The range is selected with a coarse frequency switch and adjusted with a fine frequency control. Provision is made for either a linear or non-linear trace by means of a selector switch, and this trace is then amplified. By means of a gain control the trace can be expanded as desired. An EF80 valve is used

for the oscillator and a 12AT7 is used for linearity and amplification. There is provision for three types of sync signals, internal, external and 50 c/s, and these are selected by means of the sync switch. Before being fed to the oscillator the sync signal is first amplified by one half of a 12AT7 valve, the amount of sync being controlled by the sync

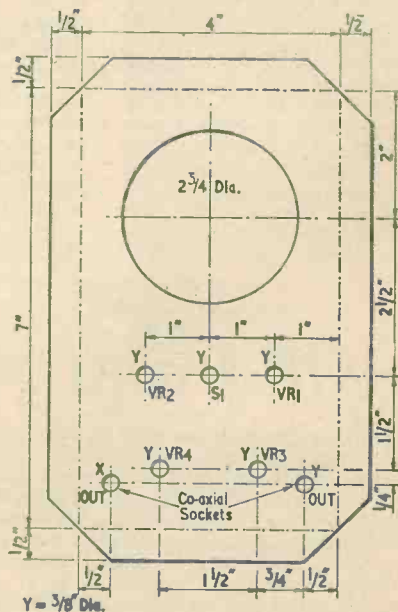
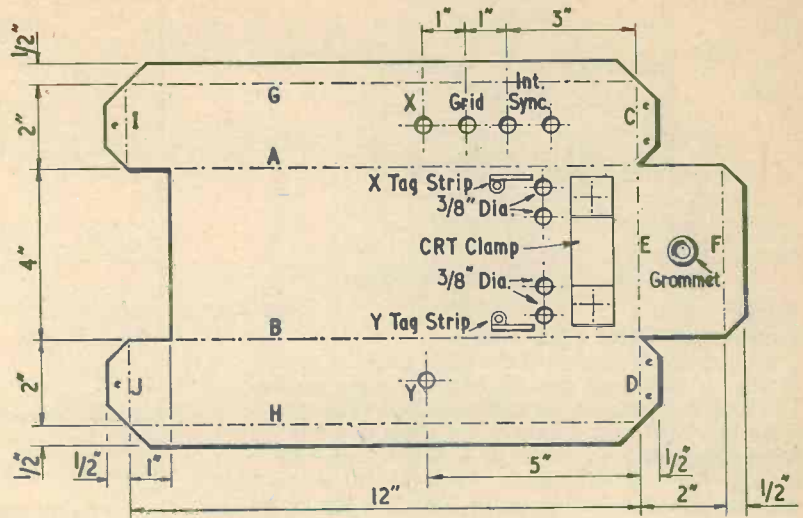

Fig. 1. The front panel of the c.r.t. unit

Fig. 2. The c.r.t. unit chassis



control. Beam blanking is obtained by means of a diode and a pre-set control.

The Y amplifier has a frequency compensated attenuator in the input circuit giving four steps of attenuation without altering the shape of the trace. In the first position, X1, the signal is at maximum; in the next position, X2, it is halved; at X5 it is reduced to one-fifth; and, at X10 to one-tenth. Provision is also made for switching the signal direct to the c.r.t., thus bypassing the amplifier but leaving the attenuator still in circuit. Two valves are used in the amplifier, both being type 12AU7. The first half of the first 12AU7 is used as a cathode follower. The other half of this valve is the first stage of the amplifier proper, and its anode load is arranged so that either high or low amplification is obtained by means of a selector switch. A coil is included in series with the anode load to improve high frequency amplification. Two further stages of amplification are given by the two halves of another 12AU7, one of these stages being similarly switched to high or low amplification. Provision is also made for testing line output transformers by means of "ringing" them and so producing a trace

which will be damped if the transformer has a shorted turn. This also applies to scan coils, and linearity and width coils, since a shorted turn in any of these will result in a damped trace. An internal standard peak-to-peak voltage calibrator is incorporated so that the voltage of any trace can be measured.

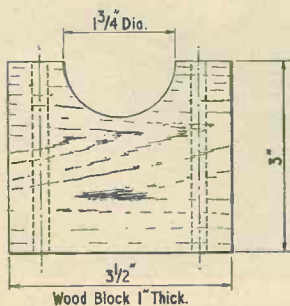

Fig. 3. The c.r.t. mounting clamp



The c.r.t. unit complete with cover

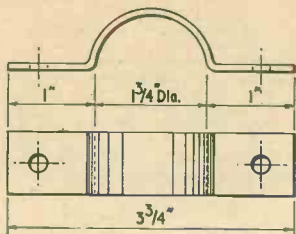

Fig. 4. The c.r.t. metal securing bracket

Construction of the CRT Unit

First mark out and drill the front panel as shown in Fig. 1, and bend the $\frac{1}{2}$ in edges at right angles. The hole for the c.r.t., as marked— $2\frac{1}{2}$ in diameter—is for the 3BP1 and should be satisfactory for other tubes although it would be as well to check before actually cutting the hole. The chassis is next marked out and drilled as in Fig. 2. The holes

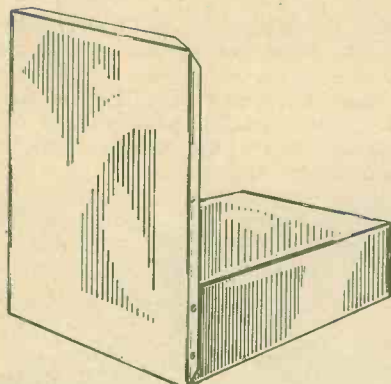

Fig. 5. How the front panel and chassis are assembled

marked "X", "Grid", "Int. Sync", and "Y Amp" are for insulated wander plug sockets, and should be drilled $\frac{1}{2}$ in. The grommet hole is $\frac{3}{8}$ in. The sides should now be bent in the following order—A, B, C, D, E, F, G, H, I and J, the back then being drilled so that it may be bolted to the sides with 6BA nuts and bolts. The front panel is next placed in position as in Fig. 5 and holes drilled through the edges to secure the front panel to the chassis. The $1\frac{1}{2}$ in space cut out of the chassis is to allow clearance for the potentiometers. At this stage paint the front panel with black crackle paint or any

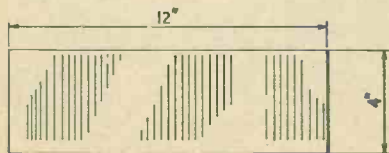

Fig. 6. The baseplate

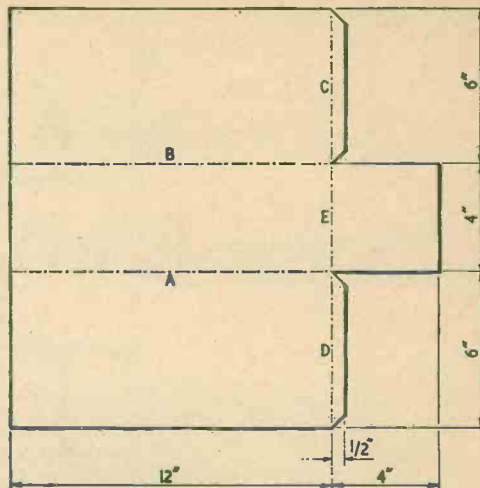
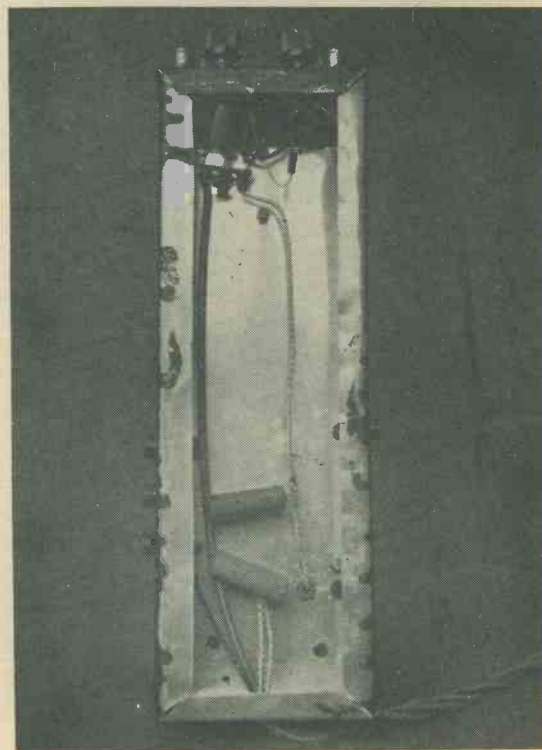

Fig. 7. The cover for the c.r.t. unit

alternative finish chosen. A wood block is now cut and shaped as shown in Fig. 3 and a metal bracket made up as shown in Fig. 4. Two holes to take 4BA threaded rod are drilled in the metal bracket and the c.r.t. is temporarily placed so that its base rests in the wood block. The metal clamp is placed over



Below-chassis view of the c.r.t. unit showing the lead to the power plug passing through the rear of the chassis

Components List
(Fig. 8 for 3BP1)

Resistors (all $\frac{1}{2}$ watt 10%)

- R₁ 2.7M Ω
- R₂ 1M Ω
- R₃ 3.9M Ω
- R₄ 2.7M Ω
- R₅ 470k Ω
- R₆ 470k Ω
- R₇ 470k Ω
- R₈ 47k Ω

Capacitors

- C₁ 0.01 μ F 500V working
- C₂ 0.01 μ F 500V working
- C₃ 0.01 μ F 500V working
- C₄ 0.1 μ F 500V working
- C₅ 0.005 μ F 2kV working

Potentiometers

- VR₁ 2M Ω
- VR₂ 2M Ω
- VR₃ 2M Ω
- VR₄ 250k Ω

Switch

- S₁ Toggle s.p.d.t.

Miscellaneous

- 2 Coaxial sockets
- 4 Insulated wander plug sockets
- 2 Tagstrips 2-way
- 1 Tagstrip 7-way
- 1 Tagstrip 3-way
- 1 Octal plug
- Threaded 4BA rod

Components List
(Fig. 8 for VCR139A)

Resistors (all $\frac{1}{2}$ watt 10%)

- R₁ 2.7M Ω
- R₂ 470k Ω
- R₃ 470k Ω
- R₄ 2.7M Ω
- R₅ 470k Ω (interchanged with VR₃)
- R₆ 100k Ω
- R₇ 150k Ω
- R₈ 47k Ω

Capacitors

As for 3BP1

Switch

As for 3BP1

Potentiometers

- VR₁ 2M Ω
- VR₂ 2M Ω
- VR₃ 1M Ω
- VR₄ 100k Ω

Miscellaneous

As for 3BP1

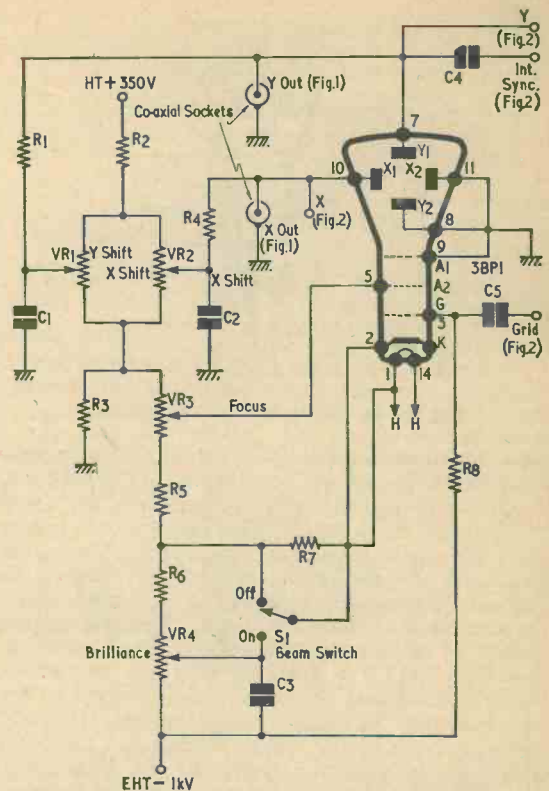

Fig. 8. The c.r.t. unit circuit diagram. E.H.T., heater, h.t. and chassis leads are brought out to the octal plug shown in Fig. 10

it and the holes marked off on to the wood block. The c.r.t. is then removed and the wood block drilled to take 4BA threaded rod. Next glue thin felt strips to the inside of the curved portions of the wood block and the metal clamp so that they will hold the c.r.t. firmly without damage. With the block and clamp placed temporarily in position around the c.r.t., place the c.r.t. face against the front panel and ensure that, with the wood block resting on the chassis, this is central in the opening. If it is not, then adjust the wood block. Having positioned the c.r.t. face correctly, mark round it and remove the c.r.t. Cut out a thick strip of felt to conform to the marking and stick this to the front panel for the c.r.t. face to rest in once finally in position. Now place the c.r.t. temporarily in position and mark and drill out two holes in the chassis to take the block. Finally, secure the c.r.t. by passing the threaded rod through the metal clamp, wood block and chassis, securing with suitable nuts. The rods and nuts should preferably be of brass and not steel or any other magnetic material. If a mu-metal screen is available with the c.r.t. then this should be fitted.

Two two-way tagstrips are next fitted about $\frac{1}{2}$ in from the edge of the chassis and near the wood

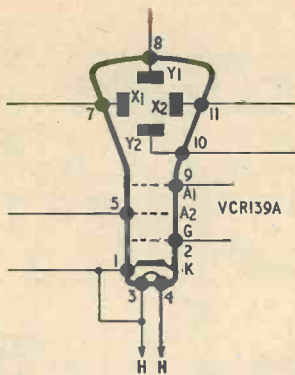

Fig. 9. Pin connections for the VCR139A

block as shown in Fig. 2. Four rubber grommets are fitted to the four $\frac{3}{8}$ in holes shown in this diagram. A seven-way tagstrip is next secured to the wood block above the grommet holes and the c.r.t. holder leads are anchored to this component. Mount the remainder of the panel components shown in Fig. 1. A three-way tagstrip is mounted under the chassis near the front panel. The grid lead is connected to this tagstrip and R_8 fitted across it. (See Fig. 8.) C_5 is mounted with one end at the "Grid" socket and the other end connected to the wire that runs to the seven-way tagstrip. One end of C_4 connects to the "Sync" socket and the other end goes through the chassis to the Y tagstrip. (See Fig. 2.) Special heavy insulation wire is required for the e.h.t. lead to C_3 and VR_4 but the remainder of the wiring is composed of colour coded single leads, these being twisted together after they emerge from the rubber grommet at the rear of the chassis.

When wiring up, pins 2, 3 and 5 of the c.r.t.,

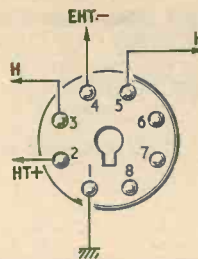

Fig. 10. Connections to the c.r.t. unit power plug

assuming a 3BP1, are taken to the tagstrip on the wood block, whilst pin 7 goes to the Y tagstrip (Fig. 2) and pin 10 to the X tagstrip. The heater leads 1 and 14 are brought down near the tagstrip, the lead from pin 1 connecting to the same tag as the lead from pin 2. The two heater leads then carry on down to the chassis and out through the back to the power plug.

The next step is to mark out and cut the baseplate (Fig. 6) and the cover (Fig. 7). Bend the cover in the following order—A, B, C, D, and E, bolting the back to the sides with 6BA bolts and nuts. Do not fit the cover until the unit is performing satisfactorily, for the c.r.t. will have to be turned until the trace is horizontal before finally tightening the c.r.t. clamp.

Fig. 8 provides a complete circuit diagram for the c.r.t. unit, whilst Fig. 9 illustrates the alternative pin connections required with the VCR139A. The power plug pinning is shown in Fig. 10, the leads to this plug, which should be about 3 feet long, travelling through the rear of the c.r.t. unit chassis. Note that, when the VCR139A is used, R_5 and VR_3 are interchanged in the circuit.

(To be continued)

BBC-2 TRADE TEST TRANSMISSION FROM CRYSTAL PALACE

Trade test transmissions on 625 lines u.h.f. from the B.B.C.'s London television station at Crystal Palace commenced on 4th January, 1964. These are to assist the radio trade in the installation of receivers and aerials for reception of the second programme, B.B.C. 2, which starts in London on 20th April, 1964. The test transmissions are on Channel 33 (vision 567.25 Mc/s; sound 573.25 Mc/s) with horizontal polarisation and take place each weekday as follows: Mondays to Fridays, 9 a.m. to 1 p.m., 2 p.m. to 8 p.m.; Saturdays, 9 a.m. to 8 p.m.

The nominal effective radiated power will be 500kW when the installation of the new transmitting aerial is completed about the beginning of March. Until then the effective power is expected to be approximately half this figure. Every effort will be made to maintain continuity of transmission, but there may be interruptions and variations in power during the installation period.

The test transmissions will consist of periods of Test Card, with 400 c/s tone or music, alternating with periods of film.

These films have been carefully chosen for their high technical quality to ensure that the best possible pictures are transmitted during the test transmissions. Their showing has been scheduled so that they not only allow the television supplier to show his customers something more interesting than just the familiar test card but also to give some entertainment to viewers who have already equipped themselves to receive 625 line u.h.f.

During the morning and afternoon, they consist of documentary and travel films. These have been drawn not only from the B.B.C.'s own extensive film resources but also from the libraries of industrial combines. Some of the latter will be receiving their first broadcast.

Each day's transmission ends with a showing of a full-length feature film. There are two on Saturdays, when the test card will not be shown in the afternoon.

The pattern of the test transmissions will be reviewed from time to time in consultation with the industry and in the light of experience gained.

Full details will be published week by week in *Radio Times*.

Printed Circuits Made Easy

C. MORGAN

Our contributor describes an unusual method of making printed circuits in which the copper is plated on to a thin carbon pattern superimposed on an insulating board. The process is experimental, and it affords an interesting field of investigation for the amateur who seeks to try something new. It should be noted that a dilute solution of sulphuric acid is required, and that adequate safeguards must, of course, be observed with regard to its handling and storage

IN THE PROCESS TO BE DESCRIBED, A printed circuit is produced by plating copper on to an insulating board such as Paxolin, the copper pattern having been previously marked out on the board by means of carbon powder.

Preparing the Board

The board is initially prepared by drawing the outlines of the proposed copper areas with a soft lead pencil. Where components have to be soldered into circuit, the areas should be made wide enough to accept a solder joint. This may sometimes necessitate drawing round sections at the points of connection, when the printed copper "lines" are relatively narrow. The areas enclosed in the outlines drawn by the pencil are then scribed over a number of times, the scribe marks forming a key for the copper which is to be later plated on.

It is next necessary to obtain some carbon powder, and this can be provided by a run-down torch battery. The powder should not be sticky and it should be mixed, with turpentine, to a consistency which allows it to just flow evenly from a small water-painting brush. If the powder is too sticky the carbon rod from the battery may be scraped in

with the turpentine. The carbon composition is applied over the areas to be plated as evenly as possible, the secret being to apply a little at a time.

When painting is complete, the board should be left flat in a warm place until dry. This part of the process should on no account be hurried. When completely dry, the painted areas should show continuity as measured by a testmeter set to a high resistance (say $1M\Omega$) range. If there are any breaks in the carbon paths, these may be bridged by drawing a soft lead pencil over each break several times.

Plating Process

A non-metallic bath is required for the plating process, and this should be capable of holding the circuit board vertically in addition to a copper rod. The plating supply required should have a potential of 1 to 1.5 volts d.c., with a current capability of about 1 amp. This could conveniently be provided by a battery on charge.

The bath is filled to the requisite depth with dilute sulphuric acid (about 40 parts water to 1 part acid) and the solution is initially prepared by placing in it two copper rods connected to the plating supply.

After a few minutes the acid will change to a green colour, indicating the presence of copper sulphate. The copper rods are then removed.

The printed circuit is next immersed in the solution, with its carbon areas connected to the negative side of the plating supply. A copper rod is also inserted, this being connected to the positive terminal of the supply. Bubbles rising from the copper rod will then indicate that the process is working. Two to three hours will be required for sufficient copper to be deposited, and the board may be removed after this time to check the thickness of the plating. If this is insufficient, the plating process may be continued for several hours more. The process should not be hurried by increasing the plating voltage, as this will cause the deposited copper to be spongy and non-regular.

After plating is complete, the board should be washed under running water until all traces of acid have disappeared, and then dried. When completely dry, the deposited copper may be given a gentle polish with a metal polish.

Alternative Methods

Since the process just described is essentially a plating operation, insulating materials other than Paxolin may be employed. Possible materials are Perspex, plybond or even wood.

An alternative method of preparing the board consists of rubbing its surface initially with a fairly coarse sandpaper. This allows the initial pencil lines and carbon deposit to be more deeply ingrained.

With complicated patterns it may prove helpful to join the areas to be plated by pencil lines (preferably drawn over smooth, unroughened, sections of the board) so that a multiplicity of connections to carbon areas for plating is avoided. The interconnecting lines can be removed after plating.

When the board has been completed and all components soldered into place, the copper side should be given a coating of shellac, or similar varnish, in order to protect the insulating surface.

HYDROFOIL FOR HONG KONG

The Marconi International Marine Co. Ltd. has received an order to supply communications equipment to the hydrofoil *Coloane*, probably the first of its kind to be used for commercial purposes in the British Commonwealth.

The *Coloane* is capable of carrying 68 passengers at a speed of about 40 miles an hour, and will be engaged on a service between Hong Kong and Macao, a distance of some 35 miles. This 56 ton vessel was built in Italy by Rodrigues of Messina for The Shun Tak Shipping Co. Ltd. of Hong Kong.

The *Coloane* will be fitted with a Marconi Marine "Salvor II" medium frequency transmitter, and a "Kestrel" receiver. The installation of the communications equipment is to be carried out by technicians from the Hong Kong Depot of The Marconi International Marine Company.

Kit Review

The Heathkit Aerial Tower Model HT-1 and Model HTI-G

THE HEATHKIT AERIAL TOWER IS FULLY SELF-supporting and has been specially designed for communal TV installations, long distance TV reception, communications and amateur radio applications. The height of the tower is 32ft and it will carry a 2in diameter aerial mast up to 15ft above the tower itself. Being a fully engineered, robust, rigid and safe tower, designed by specialist engineers to comply with BSS 499/1959, it is better and safer than a chimney mounting for single or multiple aerial arrays.

The tower stands on an easily laid concrete base or suitable roof (tower weight is 240lb) and no support wires are necessary.

The illustration shown here shows the aerial tower in the process of erection and it may be erected in a few hours by two completely unskilled persons, the tower adequately supporting the weight for climbing and subsequent aerial adjustment, etc. Easily followed step-by-step illustrated instructions are supplied with each tower.

The tower itself is supplied either fully galvanised or, at a lower cost, in red oxide finish, *all* nuts and bolts being electro-galvanised.

Accessories may be obtained for mounting a 2in mast (up to 20ft in length) and aerial rotor mountings and drives are also available.

The tower will be found ideal for fringe-area TV reception, especially for the new Bands IV and V 625 line and colour transmissions. An extensive range of Bands I, III, IV and V aerials are available for mounting atop the tower.

Model HT-1 (red oxide finish) retails at £29 15s. whilst Model HTI-G (heavily hot-dip galvanised) is priced at £35 15s., both prices including carriage in England, Scotland and Wales.

Mounting the tower is effected by clamps on to a concrete base (details of this are given in the Instruction Manual supplied) or to a suitable roof. In the latter case, however, a surveyor's or architect's advice should be sought prior to mounting. Rag bolts are provided. The size of the tower at the base is 3ft square whilst the top is 11½in square.

Erection

No special tools are required for the erection of this tower. in fact only two spanners are necessary.

The erection will be facilitated with an assistant and a 20ft ladder (not essential but recommended) and such a ladder may be hired for a modest sum from most builder's merchants.

The tower is built up, piece by piece, in simple and easy-to-follow steps, the tower being climbed as assembly proceeds (see illustration), each section providing a platform from which to continue the assembly of the mast.

Local planning permission to erect this mast will probably be necessary and for this purpose scale drawings are available free.

Quotations for erection within 100 miles of



The Heathkit Aerial Tower in process of erection

Gloucester will be given if required although at greater distances it will almost certainly be more economically effected by a local builder's scaffolding erector.

Accessories

These should be ordered with the tower and they include a pair of mast clamps for mounting a 2in aluminium mast (galvanised) £1 15s., (red oxide) £1 10s. per pair carriage paid; clamp-on rotor plates for mounting a 2in mast which may be rotated

(complete with nylon bearing bushes and mast collar) per pair (galvanised) £4 4s., (red oxide) £3 15s. carriage paid.

Electrically controlled aerial rotators complete with angle-of-rotation indication from the ground are also available—details on request from Daystrom Ltd. Hand rotation from the ground may easily be arranged by using the rotor plates and fitting a 3/4in or 1in iron or copper pipe to the inside of the aerial mast and extending this down to the ground.

CAN ANYONE HELP?

Requests for information are inserted in this feature free of charge, subject to space being available. Users of this service undertake to acknowledge all letters, etc., received and to reimburse all reasonable expenses incurred by correspondents. Circuits, manuals, service sheets, etc., lent by readers must be returned in good condition within a reasonable period of time.

A.C. Bridge.—K. Bartram, 157 Middlebridge Street, Romsey, Hants, has obtained this instrument, made by Victoria Instrument Co., Model BH/1001. The dial is missing and no other details are available. Can any reader supply any information and full details of calibration, etc.

* * *

The Radio Constructor.—W. L. Brunson, 56 Greenwood Lane, Wallasey, Cheshire, requests the loan or purchase of the May 1955 issue (Full-Tone Amplifier).

* * *

Smith's Radiomobile Car Radio.—R. A. Ward, 21 Woodfield Drive, East Barnet, Herts, requires loan of service information and circuit diagram

of this car radio (model No. 4260) control unit, amplifier and power pack Type A ref. No. 46028B. Material can be duplicated and returned at once.

* * *

R1155 Receiver.—C. Bussell, 18A York Road, Northampton, wishes to know the precise full-mesh capacity of the main tuning capacitor. Would also like to offer the service manual for the T1154 series free to any reader to whom it would be useful.

* * *

The Radio Constructor.—A. A. Visualingam, 10 Manson Place, London, S.W.7., would like to obtain a copy of the November 1961 issue in order that he may construct the Oxford Tachometer described in that edition.

STC to make EIMAC UHF Klystrons at Paignton

Standard Telephones and Cables Limited is to manufacture the Eimac range of high performance u.h.f. television klystrons at its Paignton, Devon, plant, as the result of an agreement signed between Eitel McCullough Inc. and the International Telephone and Telegraph Corporation (I.T.T.). S.T.C. is a British associate of I.T.T.

Initial production at Paignton for the U.K. and export markets will concentrate on Types 4KM 100 LA, 4KM 100 LF and 4KM 100 LH. These klystrons operate in frequency bands from 470 to 890 Mc/s with power outputs of 25kW.

In addition, S.T.C. will soon start the production of other Eimac klystrons in the same frequency bands but with power outputs of 12.5 and 50kW.

Eimac high power klystrons are in service in u.h.f. television transmitters throughout the U.S.A. where their adoption is becoming widespread to give increased power output, signal strength and u.h.f. TV coverage.

STC-Eimac klystrons, manufactured by S.T.C. Valve Division will now be available to assist the expansion of the 625-line TV service in the United Kingdom as planned by the B.B.C. and the I.T.A.

NEWS AND COMMENT . .

Poor Man's Telstar

Last October, in Geneva, an international conference on Space Communications was held. Some 65 countries were represented, and the delegates deliberated on the allocation of radio frequency bands for satellite communications.

A decision at the conference of particular interest to radio amateurs was that they may operate space radio communications systems in the 144-146 Mc/s band. This band is, of course, an exclusively amateur one, and this decision therefore indicates official approval for amateur participation in space radio communication research, already so ably carried out by those responsible for the OSCAR (Orbital Satellite Carrying Amateur Radio) projects.

As many of our readers will know, there have so far been two such OSCAR Satellites, the amateur radio equipment in each enabling results of real scientific value to be achieved. The first two OSCARs were American sponsored but now a European one is planned to be built in Europe under the guidance of the International Amateur Radio Club in Geneva, with the backing of the I.A.R.U.—International Amateur Radio Union. A further American project is also planned, which will be OSCAR III, and this is due for launching very shortly. It is a more sophisticated unit than its predecessors; it will be transistorised and will contain a converter for receiving signals on 144 Mc/s and re-transmitting them on 146 Mc/s. This converter can be shut down to conserve power by a command signal from the earth. OSCAR III will also radiate a beacon signal for tracking purposes.

The orbit of OSCAR III will enable it to be used by radio amateurs in Europe and U.S.A. for intercommunication in much the same way as TELSTAR is used professionally. Amateurs desirous of participating in this project will need high gain 2 metre steerable aerials and about 250 watt 2 metre transmitters.

Colour TV Prospects

In the House of Commons on 18th December last, Mr. Dudley Smith, the M.P. for Brentford and Chiswick, asked the P.M.G. what

progress was being made in establishing a colour television service in this country.

Mr. Bevins, in his reply, pointed out that a choice has to be made between three systems and that it was highly desirable that European countries should have the same system. He stated that soon after the meeting of his Television Advisory Committee in January, he hoped to receive their advice on the policy to be followed.

His reply concluded with the categorical statement that by 1965 we shall have colour TV at prices people will be able to afford.

This statement contrasts with the widely expressed fears of delays, in the awaited decision on a European standard, by the European Broadcasting Union.

Electrical Interference

We normally think of this subject as affecting radio or television apparatus, but it can also be a serious embarrassment to professional musicians. Professor James Denny of Leeds University, President of the Incorporated Society of Musicians, dealt with this matter at a recent conference.

He referred to "the emission by lighting, heating or air conditioning plants of audible pitched notes in places like concert halls where silence is essential to comfort and concentration".

It does seem extraordinary that the more advanced civilisation becomes the more difficult it is to enjoy a simple thing like silence.

Understanding Television

We have now added another title to our Data Book Series—*Understanding Television* by J. R. Davies, DB 17. This book contains all the articles under the foregoing title which proved so popular in this magazine, revised and brought up to date as necessary, plus the recently concluded "Introduction to Colour Television" series.

Regular readers of *The Radio Constructor* will already know the outstanding merit of the original series and many will be glad to have the information available in book form.

Understanding Television fully deals with the principles of both 625 and 405 line reception, is most comprehensive and can be under-

stood by readers who have only a basic knowledge of elementary radio principles. The book will be of equal value to the established engineer by virtue of the very extensive range it covers in its 500 pages. The book can be obtained through your bookseller, price 37s. 6d. per copy, or direct from us, postage 2s. Full details and order form will appear in our March issue.

Nottingham Playhouse

This controversial theatre, opened by the Earl of Snowdon on 11th December, 1963, has, of course, many first class features one of which is a dual-channel sound effects system which enables the sounds to be "moved" around the 750 seat auditorium.

Forming part of the overall sound system installed by Standard Telephones and Cables Limited, this dual-channel sound amplification system can also be used for stereophonic reproduction over the eight auditorium loudspeakers.

Another part of the STC sound system relays the stage programme to 27 loudspeakers in dressing rooms and the theatre workshops.

In addition, the producer and key theatre personnel in lighting control and in the flies are provided with a loudspeaker intercom system. By pressing a "talk" switch any one person may speak to all others connected to the system, to pass vital cues and rehearsal instructions. This is in addition to the 25-line internal telephone system also installed by STC in the theatre.

The foyer, staircases and bars are also served by loudspeakers; these can be used for announcements from the stage manager's control unit or for music relayed from the sound effects console.

Tailpiece

The Christmas Eve edition of *The Daily Telegraph* reported that an attempt had been made to smuggle a transistor radio, complete with battery, into Aylesbury Prison inside a chicken!

Reports that it was a part of a plan to establish radio contact with accomplices outside the prison were dismissed as groundless. The prisoner, who was on remand, was reprimanded and the set confiscated; no other action was taken according to the report.



The thirtieth in a series of articles which, starting from first principles, describes the basic theory and practice of radio

part 30

understanding radio



By W. G. MORLEY

IN LAST MONTH'S ISSUE WE CONCLUDED OUR EXAMINATION of the basic elements of radio, having dealt with the theoretical and practical aspects of resistance, capacitance and inductance, together with their behaviour in combination. We now carry on to a new subject: sound and sound reproducing devices.

Radio Reproduction

It is the function of radio equipment to cause information transmitted at one point to be reproduced at another without relying upon (except in a few isolated instances) any wires or other conductors between the two points. The information may be reproduced at the receiving end in a number of forms, of which the most common is sound. The reproduction of sound enables us to hear a speaker's voice, the music of an orchestra, or the dots and dashes of the morse code.

In order that the electrical signals picked up by a radio receiver can be converted into sound, they must be fed to a sound reproducing device. We shall be discussing such devices very shortly, but it is first of all necessary for us to examine the nature of sound itself.

Sound

Sound is the impression, perceived through the ear, which results from variations in air pressure. The term is also applied to the pressure variations themselves. These variations may occur at any frequency to which the ear is sensitive. With human beings, the audible range can be considered to extend from some 30 to 20,000 c/s, although the range for a particular person may, in practice, be lower than this. A commonly encountered instance of decreased range is the inability to hear the higher audible frequencies due to age. Small animals are capable

of hearing frequencies above the range for humans, and a well-known example of this effect occurs with the "silent" or *supersonic* dog whistle. Such a whistle sets the air about it in vibration at a frequency outside the human audible range, but the vibrations are audible to the dog. (The term "supersonic" refers to frequencies above the audible range for human beings.)

Sound consists of a succession of compressions and rarefactions in the air, and these could be represented in the manner shown in Fig. 187 (a). At the left-hand side of this diagram we have a source of sound and, for the purpose of demonstration, we assume that the disturbances in air pressure travel in a straight line to the right. An observer situated some distance away from the source of sound would then find that the air pressure about him was continually increasing and decreasing. Fig. 187 (a) shows, also, a complete cycle of the air pressure variation. This cycle starts and ends at two instants when the air is at normal pressure, and it encloses one compression and one rarefaction. The number of cycles which pass the observer in one second (which is equal to the number of cycles generated by the sound source) then defines the frequency of the sound.

Because the observer of Fig. 187 (a) experiences a continuing succession of alternate compressions and rarefactions, he is perceiving an *alternating quantity*. However, this alternating quantity takes up rather a different form from the alternating quantities we have examined up to now, the latter having been represented in the manner shown in Fig. 187 (b). Two rough analogies may be of assistance at this stage. It could be said that the alternating quantity of Fig. 187 (b) is rather like the waves which travel along the surface of a pond when it is disturbed at one point. On the other hand, the

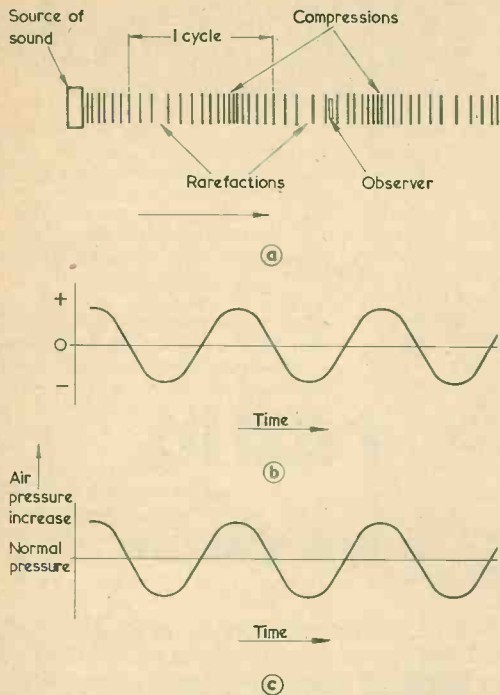

Fig. 187 (a). A sound wave in air consists of a succession of compressions and rarefactions
 (b). An electrical alternating quantity may be depicted by the familiar waveform shown here
 (c). By showing air pressure variations on the vertical axis of a graph, a sound wave may be represented in a similar manner

alternating quantity of Fig. 187 (a) is rather like the behaviour of loosely coupled railway waggons. When a railway locomotive suddenly pushes a line of goods waggons to which it is coupled, the push (a compression) travels all the way down the line, to be followed by a pulling-apart (a rarefaction) which also travels all the way down the line. Alternatively, we may draw the disturbances in air pressure which are experienced by our observer in the form of a graph, the vertical axis being dimensioned in terms of pressure. This we do in Fig. 187 (c), whereupon we obtain a waveform which represents an alternating quantity in a manner with which we are more familiar.

The succession of alternate compressions and rarefactions of Fig. 187 (a) constitutes a *sound wave*. In practice, a sound wave would not travel along the narrow straight path shown in this diagram. Instead, it would spread out as in Fig. 188, the amount of spread depending on the device producing the sound, the frequency, and other factors.

A sound wave cannot exist without the presence of a physical medium between the source of sound and the ear. In our normal experience the physical medium is air. An elementary experiment carried out in most school physics classes consists of suspending an electric bell in a bell jar. The jar is then

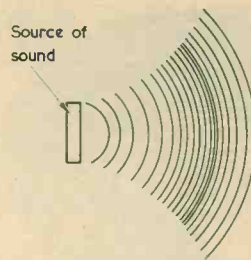

Fig. 188. A sound wave does not, in practice, follow the path shown in Fig. 187 (a). Instead, it tends to spread out

slowly evacuated, whereupon the sound of the bell becomes fainter and fainter until it is eventually inaudible. The sound generated by the bell cannot be heard outside the bell jar because, in the absence of air, there can be no successive compressions and rarefactions to carry it.

Sound may be defined in terms of its loudness (the intensity of the compressions and rarefactions) and its frequency (the number of compressions and rarefactions which occur in one second). We state that a musical note is "higher" than another when it has a higher frequency. The musician also refers to the "highness" or "lowness" of a note, but he would much more probably employ the term *pitch*, instead of frequency, to define this attribute. Pitch is derived from the *sensation* which enables a note to be ascribed its position between "high" and "low" on the musical scale, and it is primarily dependent on frequency. At low frequencies, below about 1,000 c/s or so, the pitch of a sound may appear to fall slightly when its loudness decreases, and so the two terms, pitch and frequency, do not correspond to exactly the same thing. The apparent change in pitch just mentioned is, incidentally, a purely physiological effect, and is not of any importance so far as ordinary radio work is concerned.

The speed of sound in air at normal pressure is approximately 700 miles per hour, or slightly more than 1,000 ft per second. We may, therefore, find the wavelength of a sound (i.e. the distance between two equivalent points in successive cycles) by using the equation:*

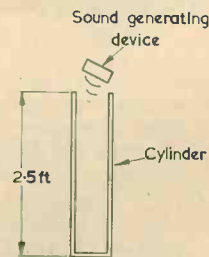

Fig. 189. A simple illustration of resonance. The air in the cylinder goes into a condition of resonance at a frequency near 200 c/s

$$\text{Frequency} = \frac{\text{Speed}}{\text{Wavelength}}$$

Rearranging the equation, we get:

$$\text{Wavelength} = \frac{\text{Speed}}{\text{Frequency}}$$

We may thus see that, with a speed of approximately 1,000 ft per second, the wavelength of a sound at 1,000 c/s is about 1 ft. Similarly, the wavelength of a sound at 200 c/s is about 5 ft.

Resonance

It is possible for air to be set into a condition of resonance by enclosing it in a container and agitating it at a particular frequency. A simple example is shown in Fig. 189, wherein we have a cylinder which is closed at one end and which has a length of 2.5ft. At the top of the cylinder we mount a sound generating device which sets the air in vibration (i.e. generates a sound) at any frequency we desire. We will find that, as we cause the frequency to approach 200 c/s, the sound we hear gradually becomes louder, until it reaches a peak at a frequency which is close to 200 c/s. The peak occurs because the air in the cylinder has been set in resonance. At the frequency at which resonance occurs, each compression from the sound reproducing device passes to the bottom of the cylinder at the speed of sound. At the bottom, it is reflected upwards again, with the result that it has travelled over 5ft. However, the wavelength of sound at 200 c/s is approximately 5ft, and so the emerging compression will appear at the open end of the tube at the same time as the sound reproducing device is generating a further compression. The emergent compression will then augment the compression from the device, thereby producing an increase in the loudness of the sound. Rarefactions will also pass down the cylinder, to be reflected upwards in the same manner. When the length of the cylinder and the frequency of the sound are such that the initial and reflected compressions and rarefactions at the open end of the cylinder are exactly in phase, the air in the cylinder is at resonance, and there is a very noticeable increase in the loudness of the sound.

The effect just described represents a very simple example of sound resonance. Resonance at one sound frequency or another is always possible when air is enclosed, and this fact has an important bearing on the design of sound reproducing equipment. Resonance can occur even when the air is only partly enclosed, a typical example being given by an open organ pipe, the note of which depends almost entirely upon the dimensions of the pipe. However, the question of sound resonances with enclosed or semi-enclosed volumes of air is a complex one requiring especial study, and we need do no more at present than to recognise the fact that such resonances can occur.

Sound waves may also result from mechanical resonance, as occurs when the string of a violin is

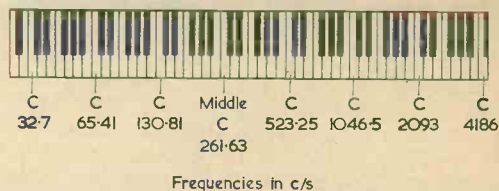

Fig. 190. The piano keyboard. The frequencies shown are those which correspond to concert pitch

set in vibration by being bowed or plucked. The resonant frequency of the string can be raised by increasing its tension, or by shortening the length which is allowed to vibrate. Percussive instruments such as the xylophone employ solid objects which produce a sound at their own resonant frequency when struck. The existence of mechanical resonance is of importance with sound reproducing devices, and has to be taken into account during their design.

Whilst musical instruments produce sound at selected resonant frequencies they also produce a number of *harmonics* or *overtones*, these consisting of sound at frequencies which are a multiple of the basic, or *fundamental frequency*. The harmonics are almost always lower in strength than the fundamental frequency and different instruments generate a different number of harmonics. A flute, for instance, normally produces a fundamental frequency with very little harmonic content, whereas a violin produces a fundamental with a relatively large number of harmonics. In general, the characteristic "tone quality" of an instrument is given by the number and strength of harmonics which accompany the fundamental.

The Octave

Fig. 190 illustrates a piano keyboard, showing the

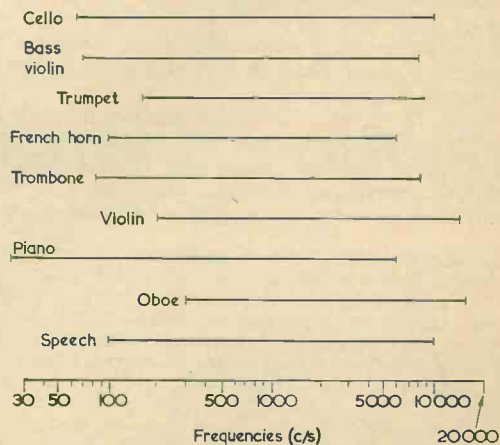

Fig. 191. The approximate ranges of frequencies covered by the fundamentals and harmonics given by familiar musical instruments. Also shown is the approximate range covered by the human voice

* See "Understanding Radio", Part 19, March 1963 issue.

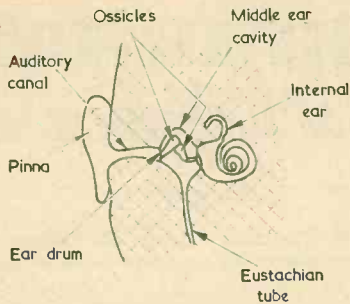

Fig. 192. A simplified diagram, illustrating the basic operation of the human ear

frequencies which correspond to the individual C's. It will be noted that the C above Middle C has a frequency which is twice that of Middle C. This 1:2 frequency relationship holds good for all other adjacent C's on the keyboard, any C having half the frequency of the C which appears an octave above. Thus, any note which is an octave above another note has twice the frequency of that note.

Musical instruments cover different sections within the range of frequencies which are audible to the human ear. An approximate idea of the frequencies covered by typical instruments can be gained from Fig. 191. Also included in this diagram is the approximate range occupied by human speech.

A sound which is of importance in radio work is the *transient*. A transient sound is one which builds up to a short-lived peak very quickly, if not virtually instantaneously. Typical instances are given by the clashing of cymbals or the beating of a drum. Transient sounds contain a very large number of frequencies, and can be difficult to reproduce truthfully by electro-mechanical means.

The Ear

A short description of the human ear will not be out of place here, as it will provide an insight into the means by which we perceive sound, whether this be from a natural source or reproduced by means of electrical equipment.

Fig. 192 shows a simplified section through the ear, indicating the various parts which assist in the sensation of hearing. The pinna, outside the head, tends to concentrate external variations in air pressure, causing these to be applied to the auditory

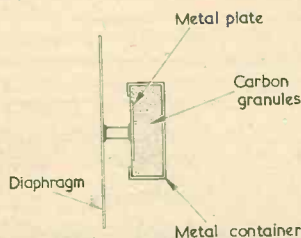

Fig. 193. A simple example of the carbon microphone. The metal container holding the granules is secured to the body of the microphone

canal and, thence, to the ear drum. The ear drum is a thin membrane whose centre moves back and forth in sympathy with the compressions and rarefactions which impinge on it. In consequence, it vibrates at the frequency of the sound passing along the auditory canal. The pinna and auditory canal up to the ear drum constitute the outer ear.

Behind the ear drum is the middle ear, this consisting of a cavity containing air at atmospheric pressure. In the absence of sound the ear drum is at rest, because it has air at the same pressure on both sides of it. When there are changes in external atmospheric pressure, these are catered for by the Eustachian tube which couples the middle ear to the pharynx lying behind the nose, and which opens during swallowing or similar actions. Readers who have experienced quickly changing variations in external air pressure, as occur for instance when ascending or descending in an aircraft, will be aware that discomfort in the ears can be relieved by swallowing or otherwise causing the Eustachian tube to be opened. The pressures on either side of the ear drum then become equal again, and the discomfort is relieved.

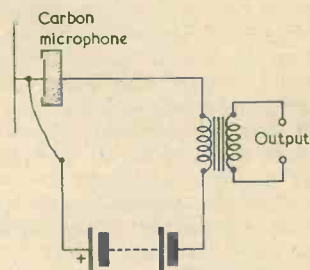

Fig. 194. Using the carbon microphone to convert sound waves into equivalent electrical signals

The vibrations at the centre of the ear drum are transmitted to a second diaphragm by way of the ossicles. The ossicles consist of three small bones, the first two of which function rather as a pair of levers coupled together on a common pivot. However, the position of the effective pivot and the degree of coupling vary according to the intensity of the sound actuating the ear drum, with the result that loud sounds are transmitted at lower efficiency by the two bones than are quiet sounds. The third bone of the ossicles forms part of the second diaphragm.

The second diaphragm couples to the internal ear, which contains the end-organs of the auditory nerve. These end-organs react to the frequencies and intensities of the vibrations transmitted via the ossicles, and the auditory nerve finally passes this information on to the brain.

Because of the presence of the external pinna, sound waves from the front of the head are channelled into the auditory canal more readily than are

sound waves from the rear. Thus, it is possible to obtain a very rudimentary idea of the direction from which a sound is coming with the single ear only. When two ears are employed the direction from which a sound emanates may be judged more accurately because, due to the shielding effect of the head, the ear closer to the sound is affected by stronger variations in air pressure. Also, since the sound reaching the more distant ear has to travel a greater distance, it has a different *phase* to that which is received by the closer ear. All these points assist us in judging the approximate position of a source of sound.

The Carbon Microphone

Sound reproducing devices, as used in radio work, convert electrical signals to sound signals. Before entering into a full discussion on how such devices operate, it will be helpful to briefly examine an example of the manner in which the original sound waves are, first of all, converted to electrical signals. This will then give us a better understanding of the signals which the sound reproducing devices have to deal with.

A simple instrument for converting sound waves into electrical signals is the *carbon microphone*, and it functions on a principle which is very easy to understand.

A typical carbon microphone is illustrated, in section, in Fig. 193. In this diagram we have a diaphragm which is mechanically coupled to a metal plate forming one wall of a metal container. This container is loosely packed with small particles of carbon, which are described as *carbon granules*. The plate is held in place by a flexible insulating surround, with the results that it is free to move back and forth in sympathy with the diaphragm,

and that it is electrically insulated from the container. A flexible wire is connected to the plate, which next appears in the circuit shown in Fig. 194. In this diagram, we may see that a circuit is completed from the left-hand terminal of the battery, through the carbon granules between the plate and the metal container, through the primary of the iron-cored transformer, and back to the right-hand terminal of the battery. In consequence, a current flows through the circuit, including the carbon granules.

If a sound wave reaches the diaphragm, this moves backwards and forwards in sympathy with the compressions and rarefactions of the air. When it moves backwards the carbon granules become more compressed, and the resistance which they offer drops. Thus, an increased current flows through the primary of the transformer. When the diaphragm moves forward, the carbon granules suffer less compression. The resistance they offer increases, and the current in the transformer primary decreases. We have, therefore, the case where the current in the transformer primary increases and decreases in sympathy with the compressions and rarefactions of the original sound waves, with the result that these increases and decreases in current provide an electrical replica of the sound. The increases and decreases in current constitute an alternating quantity superimposed on the direct current supplied by the battery, and they induce an alternating voltage in the secondary of the transformer which then corresponds to the original sound.

Next Month

In next month's article we shall continue with our discussion on sound reproduction, carrying on to the headphone and the loudspeaker.

CLOSED-CIRCUIT TV

to help speed Mersey Tunnel Traffic

Traffic in Liverpool's Mersey Tunnel is now so heavy that closed-circuit television is to be used to help speed the flow of vehicles. The Mersey Tunnel Joint Committee has commissioned E.M.I. Electronics Ltd. to install a system of cameras at key points in the Tunnel and its approach roads. Several of the cameras are now being installed.

On-the-spot tests, carried out earlier this year before the Committee, have proved the value of television for observing traffic movements and anticipating where delays are likely to occur. A battery of TV receivers will be housed in the traffic inspector's office at the Kingsway end of the Tunnel, until a permanent traffic control building is completed.

Some of the cameras will be sited at vantage points on the approaches on each side of the River Mersey. This will enable them to command views of all the roads feeding the entrances and warn the traffic controller of impending build-ups from any direction. Other cameras will observe conditions at the underground junctions and the remaining cameras will be positioned in the central section of the Tunnel.

All cameras used will be E.M.I. Type 6 minicameras, to facilitate unobtrusive siting. The cameras in outdoor positions will be fitted with remotely-controlled zoom lenses and pan and tilt facilities. They will be enclosed in all-weather housings equipped with windscreen wipers and thermostatically-controlled heating. So the traffic controller will be able to see long shots or close-up views in all directions, whatever the weather.

Excellent pictures have already been obtained from cameras in the Tunnel, despite the difficult visibility conditions.

C-Cores



for the Constructor

P. CRAWLEY

What is a C-core? How does it differ from a conventional core? How can the amateur constructor make full use of its remarkable properties?

THE CONVENTIONAL TRANSFORMER LAMINATION is punched from material whose magnetic properties are virtually unaffected by the direction of the applied magnetising force. A C-core on the other hand utilises the latest grain oriented steel, with its vastly improved magnetic properties, along the direction of rolling. Across the direction of rolling the magnetic characteristics are very similar to conventional laminations. Grain oriented steel is cold rolled by a process which the manufacturers are unable to divulge

due to an agreement with the patent holders. It is known, however, that this process consists of a series of carefully controlled annealing operations between cold rolling passes.

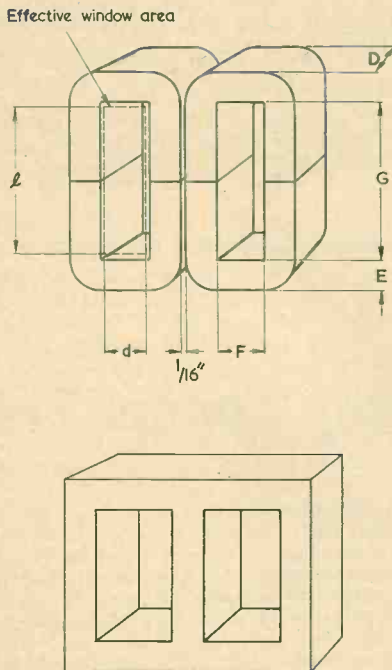
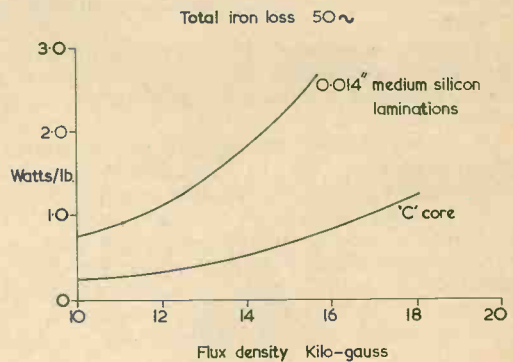
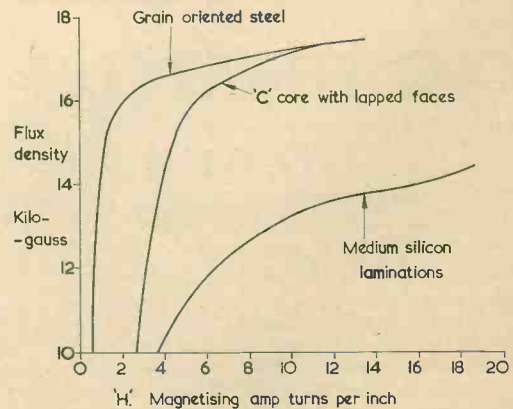

Fig. 1. Illustrating two types of transformer cores which are of approximately the same rating, that below being of a standard core having a similar VA rating to the C-core above



(a)



(b)

Figs. 2 (a), (b). Showing that, for an equivalent magnetising force and total iron loss, it is possible to work the C-core at approximately 1.4 times the flux density in an equivalent standard laminated core

TABLE I
C-Core Data
Single Loops

TYPE NO.	E.	F.	G.	D.	l.	d.	Effective window area	Core area x 0.95	Product of effective window area and 0.95 x the core area (Aw. Ac.)	Total iron loss at 17.5 kilo-gauss	Total magnetising amp turns at 17.5 kilo-gauss	Price per loop (new)
H.W.R.												
10/8	5/16"	3/8"	1 1/2"	1 1/2"	1 1/8"	1 3/8"	0.53	0.15	0.080	0.22	45	6/9
10/12	5/16"	3/8"	1 1/2"	1 1/2"	1 1/8"	1 3/8"	0.53	0.22	0.117	0.33	45	8/4
10/16	5/16"	3/8"	1 1/2"	1 1/2"	1 1/8"	1 3/8"	0.53	0.30	0.160	0.44	45	9/9
10/24	5/16"	3/8"	1 1/2"	1 1/2"	1 1/8"	1 3/8"	0.53	0.45	0.239	0.66	45	12/9
30/8	3/8"	3/8"	2"	1 3/8"	1 1/8"	1 7/8"	0.97	0.18	0.175	0.34	59	8/6
30/12	3/8"	3/8"	2"	1 3/8"	1 1/8"	1 7/8"	0.97	0.27	0.262	0.52	59	10/9
30/16	3/8"	3/8"	2"	1 3/8"	1 1/8"	1 7/8"	0.97	0.36	0.350	0.68	59	13/0
30/20	3/8"	3/8"	2"	1 3/8"	1 1/8"	1 7/8"	0.97	0.45	0.437	0.86	59	15/2
40/12	3/8"	3/8"	2 1/4"	3/4"	2"	3/8"	1.25	0.27	0.338	0.56	63	11/3
40/16	3/8"	3/8"	2 1/4"	1"	2"	3/8"	1.25	0.36	0.450	0.75	63	13/10
40/20	3/8"	3/8"	2 1/4"	1 1/4"	2"	3/8"	1.25	0.45	0.563	0.94	63	16/7
40/24	3/8"	3/8"	2 1/4"	1 1/2"	2"	3/8"	1.25	0.54	0.675	1.12	63	18/11
50/14	1/2"	7/8"	2 1/2"	7/8"	2 1/4"	3/4"	1.69	0.42	0.710	1.02	75	17/7
50/18	1/2"	7/8"	2 1/2"	1 3/8"	2 1/4"	3/4"	1.69	0.54	0.910	1.31	75	21/6
50/24	1/2"	7/8"	2 1/2"	1 3/8"	2 1/4"	3/4"	1.69	0.72	1.210	1.75	75	26/10
50/32	1/2"	7/8"	2 1/2"	2"	2 1/4"	3/4"	1.69	0.92	1.600	2.33	75	34/2

A C-core consists of a long strip of this material wound tightly on a convenient former, which sets up a high stress in the steel. Because this is detrimental to the magnetic properties it is necessary to carefully anneal the wound core in an inert atmosphere. An epoxy resin is then used to impregnate the core and bond all the individual laminations into a solid insulated mass. The core is next slit into two halves and the mating faces ground and lapped to provide a low reluctance joint.

C-cores are made in a great variety of shapes and sizes from a fraction of an ounce to several hundred-weight, or even tons in special cases. However, the amateur has only a limited range in which he is likely to be interested and therefore this article deals with sixteen of the smaller cores only. Fig. 1 illustrates two types of transformer cores which are of approximately the same rating.

Magnetic Advantage

The magnetic advantage of a C-core over a conventional core is clearly illustrated in Figs. 2 (a) and (b), which show that, for an equivalent magnetising force and total iron loss, it is possible to work the C-core at approximately 1.4 times the flux density in an equivalent standard laminated core.

At what flux density should a C-core be worked? This depends entirely on the application; for instance a transformer for a power pack, charging set or any other instance where the quality of the

waveform need not be 100% pure, can be quite safely worked at 17.5 kilo-gauss. Should a pure wave be essential, as for instance in a transformer used to supply the power to an instrument test bench, then somewhere in the region of 10-13 kilo-gauss would be suitable. However, if an instrument transformer is contemplated, it will be necessary to reduce this to below 5 kilo-gauss depending on the accuracy required.

Mating faces

An important point to note with C-cores is that the mating faces are exceptionally flat and clean. With some second-hand cores which the amateur might be likely to use, renovation may be necessary, and this can be carried out in the following manner. Hold one half core by suitable wooden clamps in a vice with the joint faces just proud of the jaws. Next, smear a trace of very fine valve grinding paste on these surfaces before placing the other half of the core on top of the first. Ensure that the identification marks line up and then, with a firm oscillatory action, carefully lap the two surfaces together. When a good flat finish has been obtained remove all trace of paste and grease with a good solvent such as lighter fuel. By this method, and with care and patience, it is possible to reduce the magnetising current required by the core to a very low value—suitable, in fact, for saturable reactors.

TABLE II
Copper Wire Data

S.W.G.	Diameter of bare wire	Resistance per yard (approx.)	Amps at 100 per sq. inch	Winding Factor K
17	0.056	0.0097	2.5	1.45
18	0.048	0.0133	1.8	1.45
19	0.040	0.0191	1.3	1.45
20	0.036	0.0236	1.0	1.45
21	0.032	0.0300	0.80	1.45
22	0.028	0.0390	0.62	1.45
23	0.024	0.053	0.45	1.45
24	0.022	0.063	0.38	1.50
25	0.020	0.076	0.31	1.50
26	0.018	0.094	0.25	1.50
27	0.0164	0.114	0.21	1.50
28	0.0148	0.140	0.17	1.50
29	0.0136	0.165	0.15	1.55
30	0.0124	0.199	0.12	1.55
31	0.0116	0.227	0.11	1.60
32	0.0108	0.262	0.092	1.65
33	0.010	0.306	0.079	1.70
34	0.0092	0.361	0.067	1.75
35	0.0084	0.433	0.055	1.75
36	0.0076	0.529	0.045	1.80
37	0.0068	0.661	0.036	1.90
38	0.0060	0.849	0.028	1.95
39	0.0052	1.13	0.021	2.05
40	0.0048	1.33	0.018	2.15

NOTE: The winding factor K is for hand-wound coils with 0.001in insulation paper between layers. This factor is intended as a guide and may vary by about 10% depending on the actual wire used and the skill of the individual.

VA Rating

Magnetic cores are said to have a certain VA rating and this, for a given core size, will depend mainly on the four following variables: (a) the working flux density in kilo-gauss, (b) the frequency of the supply to which it will be connected, (c) the current density in the conductors, and (d) a winding factor depending on the size of conductor used. (See Table II.)

We have already discussed the working flux density, and the frequency is fixed for us in this country by the Central Electricity Generating Board at 50 c/s (give or take a half cycle depending on the demand). The current density, on the other hand, is governed by the particular application. For continuous use this density should not exceed 2500 amps per sq. in. of conductor and in fact, 2,000 amps would probably be a good all-round safe value. For intermittent use a higher density is allowable, up to a maximum of about 5,000 amps per sq. in.; whilst, for an ultra-cool core, this current density may be limited to 1,000 amps per sq. in. with the flux density at 10 kilo-gauss. Coils wound on a hand winding machine take a little while to wind but are as good as automatic layer-wound coils if made with care. However, they are inclined to take up a little more room.

Table II gives the effective factor to allow when hand winding coils which are hand guided and insulated between layers by 0.001in insulating paper. It will be noticed that this factor gradually increases as the diameter of the conductor decreases,

due to the fact that the insulation is taking up a higher proportion of the total available winding area.

Calculation of required core size

Firstly, note down what is known and what is required for the given transformer as detailed below.

(a) The primary voltage V_p , normally the mains supply voltage, (b) the supply frequency f , (c) the working flux density in kilo-gauss B , (d) the conductors' nominal current density D , (e) the secondary voltages V_{s1} , V_{s2} , . . . etc., and (f) the secondary currents I_{s1} , I_{s2} , . . . etc.

From (e) and (f) calculate the total secondary volt amps ($V_{s1}I_{s1} + V_{s2}I_{s2}$. . . , etc.). Allowing a 90% efficiency, the primary current (not taking into account the magnetising current) is obtained by dividing the total secondary volt-amps by 0.9 of the primary volts. Or (considering magnetising current

$$I_p = \frac{\text{Total sec. volt-amps} \times 1.1}{V_p} \times (1 + 0.005H)$$

where H is the mag. amp turns per inch (See Fig. 2 (b)). Table II is now used to obtain the appropriate wire diameter for each of the windings and also the equivalent winding factors, K_p , K_{s1} , K_{s2} . . . , etc.

It is convenient to express a magnetic core relative to another in terms of the product of the window area and core cross-sectional area, i.e., $A_w.A_c$. (See Table I.) The total $A_w.A_c$ required for a

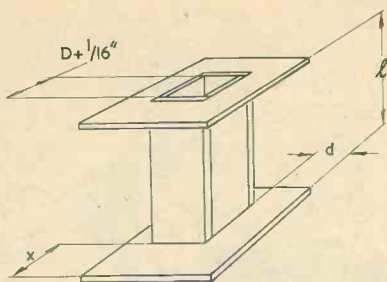

Fig. 3. Bobbin construction

given transformer is given by:

$$Aw. Ac. = \frac{4940 (V_p. I_p. K_p + V_{s1}. I_{s1}. K_{s1} + V_{s2}. I_{s2}. K_{s2}, \dots, \text{etc})}{DfB}$$

This allows an efficiency of 90%.

Single Loop

It is usual to use two cores together as illustrated in Fig. 1 rather than a single loop on its own. However, if the power required is only small it is quite feasible to do this. From Table I choose a core of the appropriate calculated Aw.Ac. value but note that these values are for single loops. If a double loop is used then the core area should be doubled. At the same time, the window area and the total magnetising amp-turns remain the same as for a single loop, thus Aw.Ac. is doubled.

Knowing the effective core area we can now calculate the primary turns per volt, which is given by

$$\frac{N_p}{V_p} = \frac{3500}{fBAC}. \text{ Where Ac. is in sq. in.}$$

The secondary turns per volt is equal to $1.1 \times$ the primary turns per volt to allow for the 90% efficiency.

We now come to the bobbin. Here, the two dimensions "1" and "d" shown in Fig. 3 are important, and should not exceed the values given in Table I. Two cheeks are required, of Bakelite or similar insulating material. Dimension "x" can be any suitable value over "d" and the ends of the windings should be brought out on this face through small drill holes. The bobbin tube is best made from four strips of similar material to the cheeks, these being butt jointed together. The whole

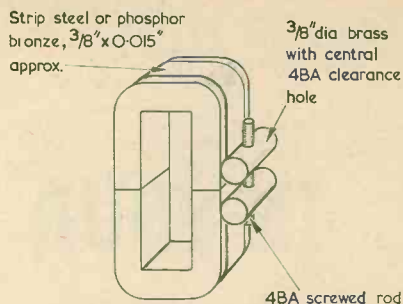

Fig. 4. Method of clamping C-cores

assembly should then be stuck with a resin glue, after first cleaning with lighter fuel. When using double loops the internal dimensions of the bobbin tube should be $(2E + \frac{3}{8} \text{\"})$ by $(D + \frac{1}{8} \text{\"})$. (See Table I.)

Clamping

When the bobbin has been wound it may be impregnated with any good insulating varnish, after which the cores are clamped together around it. The normal method of clamping is with a special banding tool that can be adjusted to various tensions. This is not possible for the amateur, but the alternative shown in Fig. 4 is quite satisfactory, and is often used professionally where a core has interchangeable bobbins. The clamp is made from a length of $\frac{3}{8}$ in. diameter brass rod and a $\frac{3}{8}$ in. wide strip of steel or phosphor bronze about 0.015 in. thick. Wrap the end of the strip around a piece of $\frac{1}{8}$ in. material about three times so that, when it is placed on the $\frac{3}{8}$ in. brass it grips it tightly. Use a fairly long piece of brass and push the strip flush with one end. Then heat the rod about one inch away from the strip in order that it is not burnt, apply resin flux, and allow some solder to flash all through the strip. When cool, saw off and file flat. Check the length of strip needed to go completely round the core, and repeat the operation for the other end of the strip. Next, drill cross holes of $\frac{3}{8}$ in. diameter, as shown, so that the rod pulls squarely on the band. Insert a length of 4BA brass studding through the two holes and place two nuts on each end. Finally, tighten up as tight as possible and lock the two nuts together for a permanent job; then make a terminal board to suit your fancy and your transformer is complete.

Record Housing Introduces Teak

Record Housing, Brook Road, London, N.22, have announced that they are now manufacturing most of their hi-fi cabinets and record storage units with a teak finish, as well as the standard medium walnut and mahogany. This is following the trend towards teak and will enable enthusiasts with teak domestic furniture to have their equipment in the same finish.

Among the cabinets which are made in teak are the new "Lowlines" which since their introduction last September have captured the imagination of hi-fi fans.

IN YOUR WORKSHOP



This month Smithy the Serviceman, aided as always by his able assistant, Dick, embarks on an examination of the switching circuits employed in valve a.m.-f.m. sound receivers.

A H!" With a gesture of triumph Dick removed the prods of his testmeter from the chassis in front of him. Reaching round, he picked up his soldering iron and a pair of taper-nosed pliers. Gently, he applied the iron to a wavechange switch tag carrying one lead from a small paper capacitor. As he carefully disengaged the capacitor lead with his pliers, Dick released his pent-up breath.

"Pho-o-o-o!"

After several seconds' manipulation, the capacitor lead was finally released, and Dick gave voice to his satisfaction.

"Ah-ha!"

Faulty Receiver

Fascinated by the noises reaching his ears, Smithy turned round and watched his assistant at work. Dick next applied his test prods to the capacitor and gazed at the meter scale.

"Oh!"

Dick's cry of dismay touched one of the few remaining soft spots which existed in Smithy's case-hardened soul. Silently, he padded over to his assistant and peered over his shoulder.

"What's the trouble?" he remarked into Dick's ear.

The effect on his engrossed assistant was galvanic. Dick's head pivoted sharply round at this sudden

intrusion into his preoccupation, to find Smithy's face confronting him at a distance of slightly less than one inch. With a yelp of shock at this completely unexpected apparition, Dick dropped his test prods and reared over backwards whereupon, toppling over his stool, he fell to the floor with a heavy thud. From this vantage point he gazed up malevolently at the Serviceman.

"What on earth," he asked bitterly, "did you do that for? I thought it was a man from Outer Space or something!"

"I was only trying to help," said Smithy aggrievedly. "There's surely no need to jump through the ceiling just because someone asks you a question!"

Dick picked himself up and carried out a careful examination for broken bones and other damage.

"It's a good thing for you," he growled eventually, and with a discernible note of regret in his voice, "that I didn't do myself an injury just then. I'd have jolly well sued you if I had."

Smithy shrugged his shoulders.

"Not to worry," he replied equably, "the insurance company would have paid!"

Dick grunted an indeterminate answer and glanced at the chassis lying on his bench.

"Dash it all," he complained. "I've forgotten where I'd got to with that set, now."

"It was because of that set I came over," said Smithy. "I thought you wanted a bit of help with it."

"I do, actually," admitted Dick reluctantly. "It's an a.m.-f.m. job that won't work on f.m. I'd just about come to an end of ideas for fixing it when you sneaked up on me and started shouting down my ear-hole."

"There shouldn't be much trouble with an a.m.-f.m. set," pronounced Smithy, ignoring his assistant's final comment. "They're pretty simple once you've got the hang of them."

"That's what I've found myself," admitted Dick, "but the sets I've repaired up to the present haven't had a snag in the a.m.-f.m. switching circuits. This one has, and it's got me completely foxed. To tell you the truth, I'm not too certain how these a.m.-f.m. switching circuits operate, anyway."

Smithy bent down and picked up Dick's stool.

"It wouldn't be a bad idea," he remarked, "if we devoted the next hour or so to a short course on a.m.-f.m. switching. We have to service quite a lot of valve a.m.-f.m. sets these days, and if you don't know the basic manner in which they operate you can waste a considerable amount of time in chasing the faults they suffer from."

Dick's face indicated acquiescence to this suggestion, and Smithy carried over his own stool together with

a note pad from his bench. He then sat down beside his assistant.

"The first thing you have to remember with valve a.m.-f.m. sets," he pronounced, "is that they really comprise two separate receivers which operate under widely different principles. When you're on a.m., you have a receiver which works with medium and long wave signals, whereupon you start off with a conventional frequency changer of the triode-heptode variety. This is followed by an i.f. amplifier working at 470 kc/s or thereabouts. The i.f. amplifier next feeds into a diode a.m. detector, an a.g.c. voltage being taken off, also, at this point. The detected a.m. is finally passed to the audio amplifier and, thence, to the speaker. The whole arrangement can be drawn up in block form like this."

Smithy quickly sketched out a diagram on his note pad. (Fig. 1 (a).)

"When we start to work with f.m. signals," he continued, "we need to employ quite a different scheme of things in the receiver. To begin with the aerial signals are now in Band II, which ranges from 87.5 to 100 Mc/s. Band II lies, of course, between the television Bands I and III, and so it would be quite out of the question to expect a medium and long wave triode-heptode to work efficiently at frequencies as high as these. In consequence we have to rely, instead, on techniques which are rather reminiscent of those we encounter in TV tuners. The result is that we couple our aerial direct to a tuner unit, just as we do in a TV set. (Fig. 1 (b).) Practically all a.m.-f.m. receivers have these tuners, which consist of a separate sub-assembly incorporating an r.f. amplifier followed by a mixer. All the tuners give an i.f. output at 10.7 Mc/s.

"This i.f. signal is next fed to a 10.7 Mc/s i.f. amplifier, the last stage of which should, preferably, incorporate an amplitude limiting valve. The output of the i.f. amplifier is then applied to a frequency discriminator which, in practical a.m.-f.m. receivers, is of the ratio type. The a.f. from the ratio discriminator finally passes to the a.f. amplifier and the speaker."

Differences of Operation

Smithy put his pencil down on the bench and turned round to his assistant.

"There you are, then," he announced. "You've got an a.m. receiver with a frequency changer of the triode-heptode type, a 470 kc/s i.f. amplifier, a diode detector, and an a.f. amplifier and speaker. And

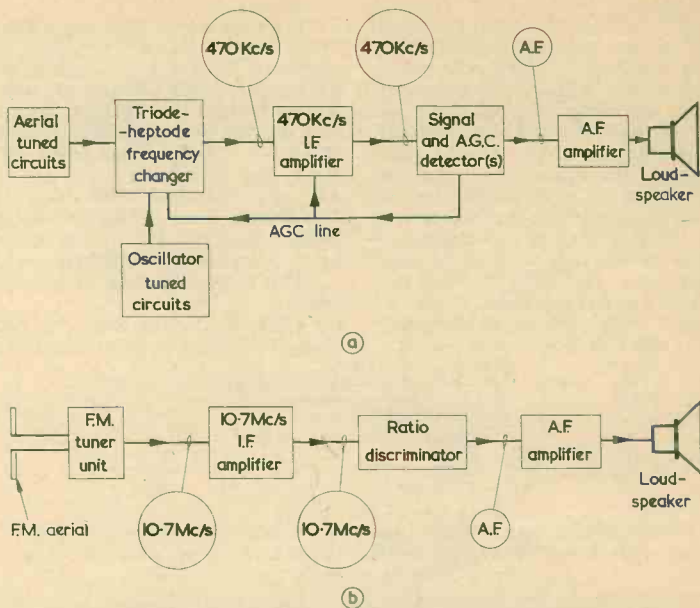

Fig 1 (a). Block diagram showing the basic stages in the a.m. section of a valve a.m.-f.m. receiver. No aerial is shown because the aerial tuned circuits will normally consist of a ferrite rod assembly
(b). The basic stages in the f.m. section of the receiver. The final stage in the i.f. amplifier should, preferably, be an amplitude limiter

you've got an f.m. receiver which requires a tuner unit capable of operating at Band II frequencies, a 10.7 Mc/s i.f. amplifier incorporating preferably an a.m. limiting valve, and a ratio discriminator. After which you have the a.f. amplifier and the speaker. The problem which confronts the designer of an a.m.-f.m. receiver is that of combining the two circuits so that, consistent with the minimum amount of switching, the maximum number of components can be made common to the two types of receiver. How would you set about such a problem?"

Dick studied Smithy's block diagrams for the a.m. and the f.m. receiver.

"Well," he remarked after a moment, "you could start off by having the a.f. amplifier and the speaker common to the two types of receiver."

"Right," agreed Smithy. "What's next?"

"Is there any chance of using a common detector circuit?" asked Dick. "I seem to remember hearing somewhere that, if you disconnect the stabilising capacitor in a ratio discriminator circuit, that circuit will detect amplitude modulation as well."

"What you heard," replied Smithy, "is true enough, but the effect isn't

used in any commercial a.m.-f.m. receiver I've seen myself. In practice, this part of an a.m.-f.m. receiver uses separate detectors: a diode detector for a.m. and a ratio discriminator for f.m. Most receivers have the various diodes required by these two circuits packed into a single valve, so the extra components required for the two separate detector stages are not so many after all."

"Fair enough," said Dick. "Working back from the speaker, I presume that the i.f. stages come next. In this case I know, from my experience with handling these receivers, that the a.m. i.f. amplifier valve is also used for f.m."

"That's quite correct," agreed Smithy. "Whereupon we arrive at the part of the set which is probably the most difficult to assimilate. It is possible to obtain amplification both at 470 kc/s and at 10.7 Mc/s by connecting the appropriate i.f. transformer windings in series. For the moment I'll just illustrate two possible arrangements which can appear between two i.f. amplifier valves. (Fig. 2.) In both cases the sets of windings, with their parallel tuning capacitors, are in series, as you can see. In one instance the 470 kc/s windings are below the 10.7 Mc/s windings and, in the other, the 10.7 Mc/s windings are below the 470 kc/s

windings. From the basic technical point of view it doesn't matter which set of windings is below the other; and you will find, in practice, that the i.f. amplifiers of some a.m.-f.m. receivers have the 470 kc/s windings below whilst, in others, the 10.7 Mc/s windings are below. Because the frequencies are widely separated, it is possible to work on the assumption that the reactance of the capacitors across the 470 kc/s windings is negligibly low at 10.7 Mc/s, and that the reactance of the few turns of wire in the 10.7 Mc/s windings is negligibly low at 470 kc/s."

"With the result," chimed in Dick, "that if you inject 470 kc/s into the amplifier, the 470 kc/s windings will act as a standard 470 kc/s i.f. transformer because the 10.7 Mc/s windings are nearly a dead short at that frequency. Also, if you inject 10.7 Mc/s, the 10.7 Mc/s windings will act as a standard 10.7 Mc/s i.f. transformer because the capacitors across the 470 kc/s winding are nearly a dead short at that frequency."

"You've got the idea," confirmed Smithy.

"That part," said Dick, "is easy enough. What I don't understand is

why the i.f. amplifier doesn't respond to unwanted signals at 470 kc/s when you're on f.m., and why it doesn't respond to unwanted signals at 10.7 Mc/s when you're on a.m."

"Don't worry about that little problem for the moment," said Smithy. "As I shall be showing you shortly, there is a simple and rudimentary form of overall switching which prevents the wrong i.f. appearing after the i.f. amplifier."

He turned round and once more glanced expectantly at his assistant.

"We have already," he remarked, "seen that we can use a common a.f. amplifier and speaker in our a.m.-f.m. set, and that the a.m. detector and f.m. discriminator are kept separate. We have also seen that, by this dodge of connecting two sets of windings in series, we can use a single valve for i.f. amplification either at 10.7 Mc/s or at 470 kc/s. Continuing back towards the aerial, what else can you think of in the way of common components for f.m. and a.m.?"

Dick scratched his head.

"I'm a bit flummoxed here," he confessed. "You've got to have a special tuner unit for f.m., and you've got to have a frequency changer of the triode-heptode type for a.m. I can only guess that you keep the f.m. tuner unit and the triode-heptode separate, and feed their outputs into a common i.f. amplifier."

"You haven't been looking very closely at your a.m.-f.m. service manuals," accused Smithy. "If you had, you'd have seen what is actually done in practice in this particular department. What happens with all standard receivers, whatever their make, is that the triode-heptode functions in a conventional manner on a.m., and that the h.t. supply to the f.m. tuner is cut off. On f.m., the h.t. supply is applied to the tuner unit, whilst that to the triode oscillator of the triode-heptode is cut off. The 10.7 Mc/s i.f. output from the f.m. tuner unit is then fed to the signal grid of the heptode section. This amplifies the 10.7 Mc/s signal, and functions as a 10.7 Mc/s i.f. amplifier."

Circuit Details

"Blimey," said Dick impressed. "That's a knobby way of going about things! All you waste on f.m., then, is the triode of the triode-heptode."

"That's right," confirmed Smithy. "But don't forget that the f.m. tuner unit is out of use on a.m., and so the components in this unit are similarly wasted so far as medium and long waves are concerned. Nevertheless, the arrangement offers what

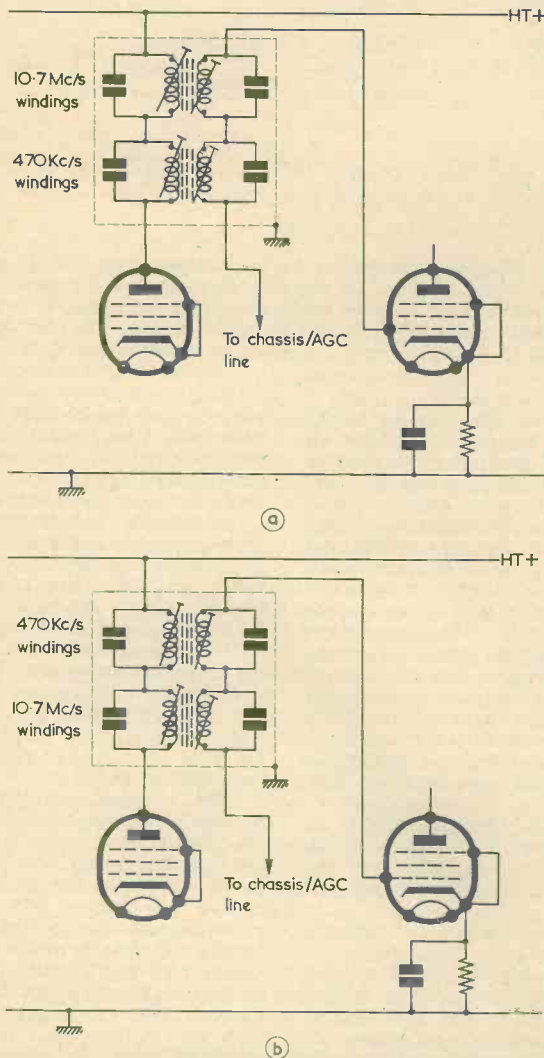

Fig. 2 (a). An i.f. amplifier may operate either at 470 kc/s or 10.7 Mc/s if the tuned windings are connected in series as shown here. The two sets of windings are fitted in a single can
(b). The same results are possible if the 10.7 Mc/s windings appear below the 470 kc/s windings

is probably the most economical manner of combining a.m. and f.m. techniques at this part of the receiver which has been devised up to the present."

Smithy tore the top sheet from the note pad.

"We've worked our way," he announced, "back from the loudspeaker in discussing the common components which can be used for both a.m. and f.m. I propose, now, to reverse the process and work forward from the aerial, examining some of the typical switching circuits which you'll encounter. Fortunately, nearly all a.m.-f.m. sets, regardless of make, employ the same basic switching principles, and it's possible to generalise on the circuits employed to quite a considerable extent. In the circuits I'm going to show you, I'll assume that we have a four-way wavechange switch, this giving f.m., medium waves, long waves, and gram. O.K.?"

"Sure," confirmed Dick. "Fire away!"

"Right," said Smithy, applying himself once more to his pad. "I'll start off with the switching circuits around the f.m. tuner unit and the a.m. frequency changer. What you will find, in most sets, is four switch sections here and I'm numbering these S₁ to S₄ in my sketch (Fig. 3). Switch S₁ is the one we have already discussed. When it's set to f.m. it applies h.t. to the f.m. tuner unit, and when it's set to medium or long waves it applies h.t. to the triode oscillator and the tuner unit. You may find in some receivers that a high value resistor allows a small amount of h.t. current to flow to the f.m. tuner unit when it's switched off. However, this is much too low to allow the unit to operate, and the resistor is in circuit merely to prevent cathode poisoning in the valves."

"S₂ is the next switch I want you to look at. This switches the inputs to the signal grid of the triode-heptode. On f.m. this grid is switched to the 10.7 Mc/s i.f. output of the f.m. tuner unit. On medium and long waves the grid is connected to the medium and long wave aerial tuned coils, which will probably be on a ferrite aerial rod. On gram, the grid is switched to a blank contact or, say, to chassis, according to the ideas of the designer. S₃ and S₄ are purely for selecting medium and long wave tuned circuits in the a.m. aerial and oscillator sections."

"You haven't," objected Dick, "shown any circuit around S₃ and S₄."

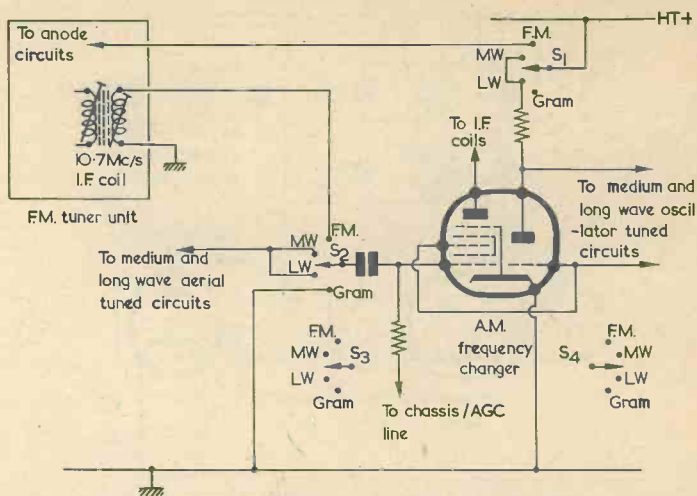

Fig. 2. A skeleton circuit showing typical a.m.-f.m. switching arrangements around the a.m. frequency changer. The valve employed here is normally an ECH81 or UCH81

"That's because," replied Smithy, "they have no effect on the a.m.-f.m. switching proper. Also, different manufacturers employ quite different circuits for medium and long wave selection, and so it isn't possible to give anything approaching a typical circuit here."

"Do you find any variations on the circuits you've shown for S₁ and S₂?"

"You'll find a few," said Smithy, "but pretty well all sets follow the basic pattern I've just given. In some receivers you'll find that S₂ enters into the medium and long wave switching circuits as well as selecting the 10.7 Mc/s output from the tuner unit. In a small proportion of the earlier sets, you may even find no switching at the heptode signal grid at all, both the a.m. aerial tuned circuits and the 10.7 Mc/s i.f. coil in the tuner unit being coupled permanently to the grid via low value capacitors. You may, also, occasionally encounter a different method of killing the triode oscillator on f.m., this being done, say, by shorting its grid to chassis instead of breaking the h.t. supply. Finally, there are some sets that use the triode oscillator as an a.f. amplifier on f.m., but this is an unusual departure from the general trend, which is along the lines I have just indicated."

"What," asked Dick, "about a.g.c.?"

"A.G.C. systems vary quite a bit," replied Smithy. "In some sets, a.g.c. is applied to the triode-heptode by way of a grid capacitor and leak, as I've shown, but in others it may be

applied via the a.m. aerial tuned circuits. You don't need a.g.c. with this valve on f.m., so what you usually find is that either the a.g.c. line is shorted to chassis on f.m., or that the signal grid of the frequency changer is at chassis potential by way of the 10.7 Mc/s coil in the f.m. tuner unit. It's difficult to generalise here, however."

"Okey-doke," said Dick. "What's next on the list?"

"The circuit," replied Smithy, "between the frequency changer heptode anode and the grid of the i.f. amplifier. This uses the two sets of windings in series which we've already discussed. Quite a few sets introduce switching at this point, and I'll indicate the particular switch employed as S₅. In some sets you'll find that the 470 kc/s windings are below the 10.7 Mc/s windings, and that the primary of the 10.7 Mc/s windings is shorted out on medium and long waves. (Fig. 4 (a).) Or you'll find that the 10.7 Mc/s windings are below, with the 10.7 Mc/s primary still being shorted out on medium and long waves. You may encounter a few other permutations and combinations on this short-circuiting idea, and in some of these the 470 kc/s primary may be shorted on f.m. An alternative approach is to switch secondaries (Fig. 4 (b)) and this has the further advantage of enabling the grid of the i.f. amplifier to be returned to the a.g.c. line on medium and long waves, and to chassis on f.m. I should add that there are quite a few sets which have no switching at all in this part of the

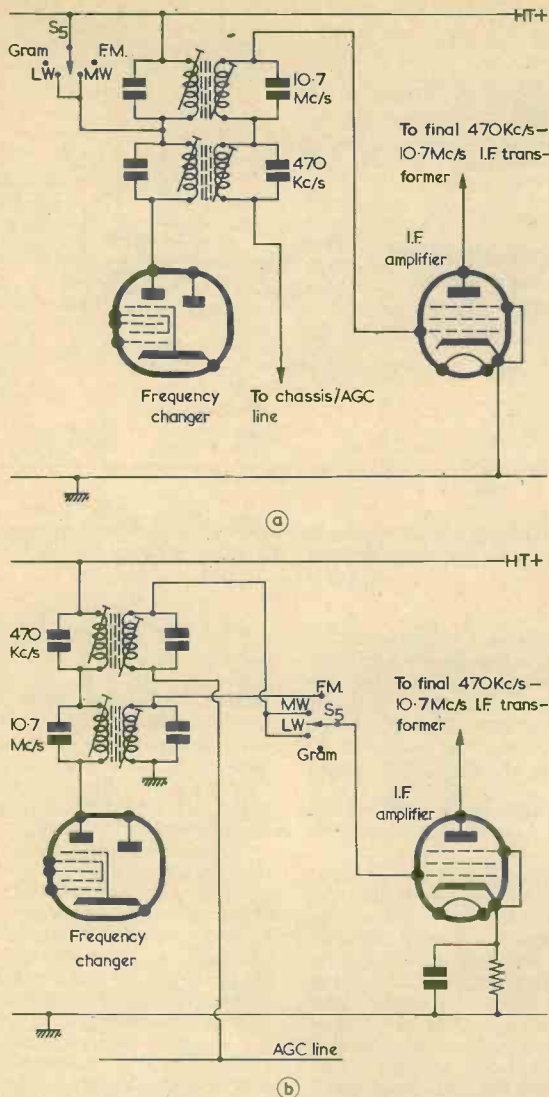

Fig. 4. A number of a.m.-f.m. receivers employ switching circuits around the first combined i.f. transformer. In (a), the 10.7 Mc/s primary is short-circuited when receiving medium and long waves whilst, in (b), the switch selects the 10.7 Mc/s or 470 kc/s secondary as required. (On gram, the pentode grid could be connected to chassis)

circuit. Both the 470 kc/s windings and the 10.7 Mc/s windings are in circuit all the time."

Dick gazed at Smithy's diagrams and scratched his chin thoughtfully.

"I must admit," he said, after a moment, "that these various circuits don't seem all that complicated, after all. Once you pick up the basic idea, the variations seem to become quite reasonable."

"They aren't all that difficult," agreed Smithy. "The first thing to

remember is that you have a double i.f. transformer between the heptode section of the frequency changer and the i.f. amplifier valve. All you then have to bear in mind is that some manufacturers fit simple and obvious a.m.-f.m. switching circuits to this double i.f. transformer, whilst others do not."

Detector Circuits

"I suppose," said Dick reluctantly, "that we must now pass on to the

a.m. detector and the f.m. discriminator."

Smithy raised an eyebrow. "You sound," he remarked, "as though this is going to be the hardest part of the set."

"I'm quite certain it's going to be," replied Dick, with conviction. "That's the bit which looks most complicated whenever I take a shift at the service manuals!"

"The detector and discriminator section may look a little complex," conceded Smithy, "but that's only because it's usual to use a triode-diode-triode such as the EABC80 or the UABC80. With all these diodes knocking about, you tend to get a number of lines crossing each other in the circuit diagram."

"I'll say you do," remarked Dick warmly. "Clapham Junction isn't in it!"

"Then I had better set your mind at rest," commented Smithy. "Because, in actual fact, the detector and discriminator part is pretty well the easiest of the lot. This is because there isn't any switching at all of 470 kc/s and 10.7 Mc/s windings as we have encountered up to date. The primaries for the 470 kc/s and 10.7 Mc/s windings are simply connected in series between the anode of the i.f. amplifier and the h.t. positive line, and that's all there is to it. In some sets, the 10.7 Mc/s windings are below and in others the 470 kc/s windings are below. Which represents the only complication you're ever liable to find."

"Dash it all," protested Dick, "that's only the primaries! What about the secondaries?"

"These," replied Smithy, "feed into the a.m. detector or f.m. discriminator, as applicable. However, before I embark on a full detector and discriminator circuit, I think I had better first deal with the separate detector and discriminator circuits on their own. To start with, let's take a look at the a.m. detector (Fig. 5 (a)). As you can see, this employs the regulation diode and diode load which we have met so often in a.m. superhets in the past. As you know, also, we can obtain a negative-going a.g.c. voltage from the diode load. Next, let's look at a ratio discriminator (Fig. 5 (b)). The basic type I've shown here is that which you'll find in pretty well all the a.m.-f.m. sets you're likely to bump into, although you might encounter some slight modifications here and there. An occasional modification is to insert a little resistance in series with the stabilising capacitor circuit (Fig. 5 (c)) as this assists the discriminator to give good a.m. limiting action. With a ratio discriminator, the

things to look out for are two diodes connected to the secondary of the 10.7 Mc/s discriminator transformer in such a manner that, when a signal is present, they cause the electrolytic stabilising capacitor to be charged with correct polarity. The stabilising capacitor is, by the way, usually of the order of 2 to 5 μ F in value."

"I notice," said Dick, "that the positive end of the stabilising capacitor is connected to chassis."

"That's right," confirmed Smithy. "And that is what you'll meet in most sets. Occasionally, you'll find that the resistor across the stabilising capacitor is split into two, with the centre-tap going to chassis (Fig. 5 (d)). Nevertheless, this circuit works in just the same manner as the others."

"Where does the a.f. come from?"

"From the tertiary winding," said Smithy. "And don't forget that all that 'tertiary' means is 'third'. It is usual to insert a low value resistor between the tertiary winding and the first i.f. filter capacitor (Fig. 5 (b)) since this further assists in a.m. limiting. The value of this resistor is fairly critical and it normally lies somewhere between 100 Ω and 250 Ω , according to the set. Indeed, you may even find that a pre-set pot, with a value of 500 Ω or so, is inserted at this point, whereupon you adjust it for maximum a.m. rejection."

"Fair enough," said Dick. "I'm a little surprised, though, to find that these ratio discriminator circuits are so fussy with regard to a.m. limiting. I thought ratio discriminators automatically gave a.m. limiting because of the stabilising capacitor."

"They will always give you fairly good limiting," replied Smithy, "but you can often improve that limiting very considerably if you play around with the resistor values in the stabilising and tertiary winding circuits. By the way, an important point to remember is that the ratio discriminator gives optimum limiting at one frequency only, and that this frequency need not necessarily be at the centre of the straight part of the discriminator curve. (Fig. 6.) You can notice this effect on some sets if you tune in an f.m. signal in the presence of heavy impulsive interference. If the discriminator circuit isn't exactly spot-on, you will sometimes find that the tuning point which gives maximum interference suppression is noticeably displaced from that which corresponds to correct tuning. Unless the effect is serious I wouldn't count it as a fault, incidentally, and most of the customers wouldn't notice it, anyway."

"What happens," said Dick, returning to the previous subject,

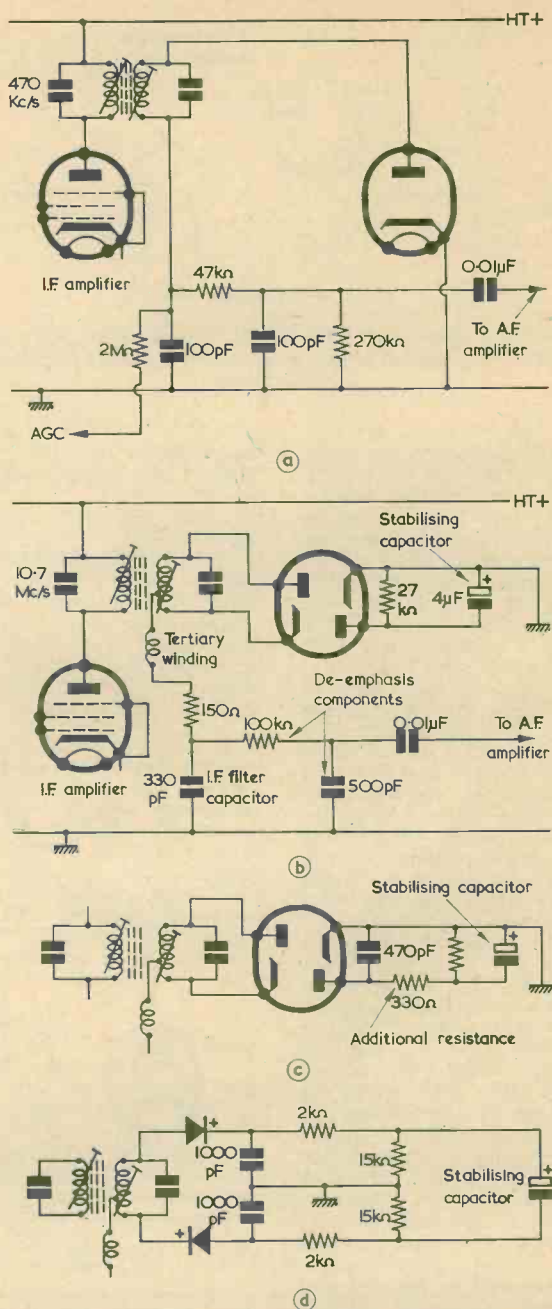

Fig. 5 (a). A typical a.m. diode detector. Representative component values are given here and, also, in (b), (c) and (d)
 (b). The basic ratio discriminator circuit, as employed in a.m.-f.m. receivers
 (c). Occasionally, additional resistance is inserted in the stabilising circuit to improve a.m. limiting. The 470pF capacitor completes the r.f. circuit after the diodes
 (d). In some receivers the resistor across the stabilising capacitor is centre-tapped, as shown here. With this circuit neither of the diode cathodes can be at chassis potential, as would be required with valves such as the EABC80, and so it is common to employ germanium diodes

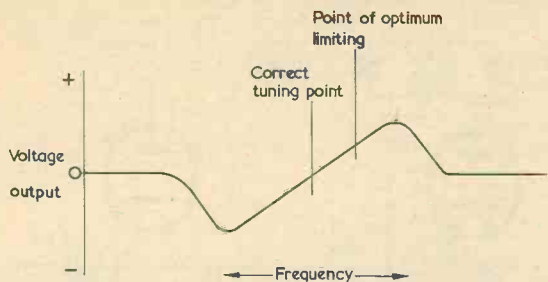

Fig. 6. The frequency at which a ratio discriminator circuit provides optimum limiting may not exactly coincide with the centre frequency of its characteristic

"after the i.f. filter capacitor which follows the tertiary winding?"

"After this point," said Smithy, "you bump into the de-emphasis circuit. The function of the de-emphasis circuit is to knock off the 50 μ S pre-emphasis which the B.B.C. puts on its f.m. transmissions. The de-emphasis circuit consists of a resistor and a capacitor, and these carry out the secondary function of giving i.f. filtering as well. To operate correctly, the de-emphasis resistor and capacitor should have a time constant of 50 μ S, such as would be given by a 100k Ω resistor and a 500pF capacitor, but you won't find the correct time constant in all the sets you work with. Quite a few receivers use a de-emphasis circuit that is a lot lower than 50 μ S. Which only goes to prove, I suppose, what an imperfect world we live in!"

"I should imagine," commented Dick, "that you would get a little extra top if you used a de-emphasis circuit with a lower time constant."

"That's true enough," agreed Smithy. "Whereupon you can kill it later on with a top-cut tone control in the a.f. stages! I mustn't be too critical, though, because in some sets the time constant may be increased if the a.f. from the de-emphasis network passes into screened cable with a high self-capacitance. Anyway, let's get back to our combined a.m. detector and f.m. discriminator circuit."

Smithy returned to his pad and sketched out a further circuit. (Fig. 7.)

"Here we are," he said. "Now, this is the complete gubbins which exists between the i.f. valve and the a.f. amplifier volume control. As you can see, there is no intermediate frequency switching at all. All that you do is to switch the volume control to the a.f. output of the a.m. detector on medium and long waves, and to the a.f. output of the f.m.

discriminator on f.m. And what, might I ask, could be simpler than that?"

"It certainly looks easy enough," agreed Dick.

"It is easy," said Smithy. "You usually have an EABC80 or a UABC80 in this part of the receiver and, as I said earlier, this valve has three diodes. Two of the diodes are on the common cathode of the valve, whilst the third diode has a separate cathode. The result is that two

diodes become immediately available for the ratio discriminator. The fact that one of these diodes is on the common cathode, which has to be at chassis potential, explains also why the stabilising capacitor has to have its positive end connected to chassis. You may recall that this is a point we referred to a few moments ago. By the way, the common cathode also serves a triode in the valve as well, which then functions as the voltage amplifier for the a.f. stages. Quite useful bottles, these triple-diode-triodes!"

"Any variations on the circuit you've just drawn up?"

"You'll find a few small differences in practice," remarked Smithy, "but nothing that's terribly serious. The discriminator circuit may, for instance, vary slightly in the ways we've just discussed. Sometimes you'll find that the set uses a double-diode-pentode, such as the EBF89, for the i.f. amplifier and a.m. detector, together with a double-diode such as the EB91 for the f.m. discriminator. Or you may find an EBF89 with two germanium diodes in the f.m. discriminator circuit. Most set designers, however, favour the EABC80 or UABC80."

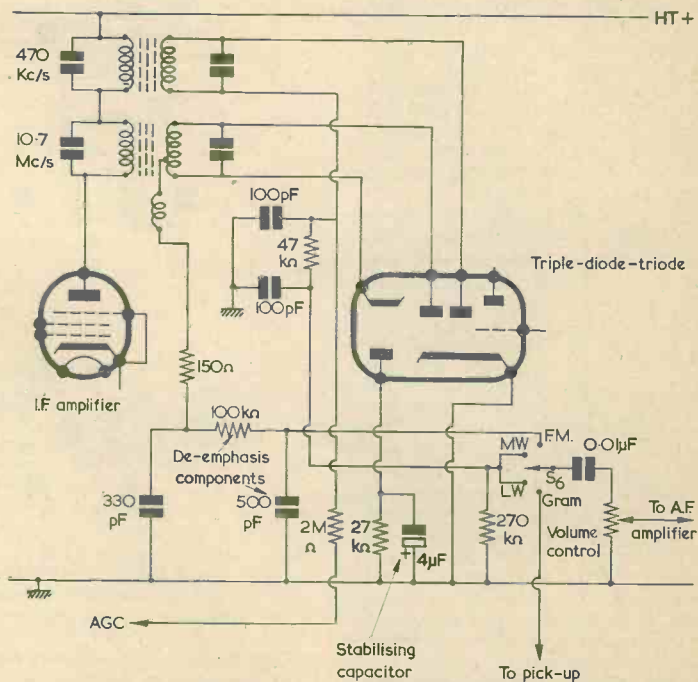

Fig. 7. The a.m. detector of Fig. 5 (a) and the f.m. discriminator of Fig. 5 (b) combined in a single circuit. The triple-diode-triode may be an EABC80 or UABC80. In some receivers the 470 kc/s windings are below the 10.7 Mc/s windings

Overall Switching Circuits

"We seem," remarked Dick, with some surprise, "to have cleared up all the a.m.-f.m. switching circuits which are used in these receivers."

"We have," confirmed Smithy, "apart for a minor exception which I'll deal with in a minute. Summing up what we've seen up to now we can say that, when we go from a.m. to f.m., we do four basic things. First of all, we break the h.t. to the triode oscillator of the frequency changer and apply it to the f.m. tuner unit. Secondly, we switch the signal grid of the frequency changer heptode section from the a.m. aerial tuned circuits to the 10.7 Mc/s i.f. output of the tuner. Third, we operate—in most sets—a switching circuit which affects the first combined i.f. transformer in the receiver. There are a number of variations to this particular switching circuit but it can, typically, take a short off the 10.7 Mc/s windings. Fourthly and lastly, we switch the input to the audio amplifier stages from the a.m. detector to the f.m. discriminator."

"Well, it all seems very clear to me," commented Dick. "I can now understand why the switching, although it is still pretty rudimentary, is quite capable of preventing 10.7 Mc/s breakthrough in the i.f. stages when you're on medium and long waves, and vice versa."

"Good!" said Smithy briskly. "The switching provides, in fact, quite an adequate safeguard against such breakthrough."

"What's the minor exception you referred to just now?"

"It's given," replied Smithy, "by a further switching circuit which may be fitted and which affects the a.g.c. voltage developed by the a.m. detector, or the operating conditions of the i.f. amplifier valve. In a fairly typical case this switching circuit may short the a.g.c. line to chassis when you turn to f.m. If the i.f. amplifier valve has a grid capacitor and leak, it will then tend to function as a limiter. Unfortunately, it's im-

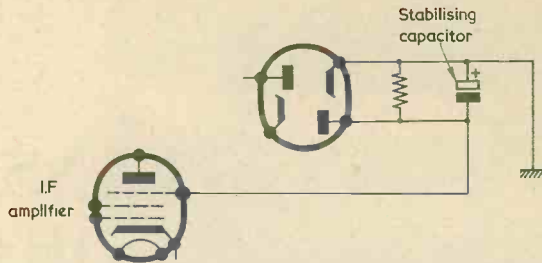

Fig. 8. With some receivers the negative voltage developed across the stabilising capacitor is applied to the suppressor grid of the i.f. amplifier valve

possible to lay down any hard-and-fast rules here, because there is a wide variance between sets of different makes so far as a.g.c. switching circuits are concerned. Another point is that, on f.m., you may occasionally find that a switch causes the screen grid voltage of the i.f. amplifier valve to be reduced, thereby making it function more as a limiter. By the way, an interesting wheeze which is used quite a bit consists of returning the suppressor grid of the i.f. amplifier to the negative end of the stabilising capacitor (Fig. 8). With strong signals you can get a voltage of the order of 20 or more across this capacitor, and this then becomes applied to the i.f. amplifier suppressor grid. It causes the standing anode current of the valve to be reduced, whereupon the circuit tends to give a certain amount of automatic gain control. The negative voltage could also enable the i.f. amplifier valve to work more as a limiter when f.m. signals are present."

Back to Normal

With an air of finality, Smithy picked up his pad and pencil.

"And that," he remarked, "completes our discussion for today!"

"Right-ho," said Dick serenely. "I must say that you've given me some really useful gen to carry on

with here. I'm not half as worried about the switching circuits in this set as I was before."

As Smithy returned to his bench and continued with his own work, Dick re-applied himself enthusiastically to the receiver on his bench. Such was the value of Smithy's tuition that only fifteen minutes elapsed before the characteristic sound given by an f.m. radio when it is being tuned in to a station gave evidence that Dick had at last located his fault. Smithy turned round, to see Dick gazing enraptured at the receiver which, at full volume, was now giving forth a stentorian rendition from "Music While You Work."

Always the first to offer congratulations for honest achievement, Smithy walked across to Dick's bench and leaned over his assistant's shoulder. The Serviceman cupped his hands together and applied them to Dick's ear.

"Well done!" he bellowed, against the racket from the receiver's overloaded loudspeaker.

The effect on Dick was galvanic. His head swung round, to find Smithy's face confronting him at a distance of slightly less than one inch. He gave a yelp of shock at this unexpected apparition and, toppling over his stool . . .

But this is where we came in.

LONDON SESSIONS BEING TAPE-RECORDED

After experiments in the Divorce Courts, the Treasury's Organisation and Methods Division are making experimental tape recordings of the proceedings at London Sessions. A system using professional tape recording equipment has been engineered by E.M.I. Electronics Ltd.

Six microphones are so positioned in the court that all the proceedings can be recorded. They are used by the Judge, clerk of the peace, witnesses, defendant, foreman of the jury and counsel. The microphones are connected to a control console where the microphone outputs are mixed and pass to an RE301 remotely-controlled tape recorder. Limiter amplifiers and corrections networks are installed in the console to obtain a clear recording of the spoken words by reducing extraneous noises, such as the slamming of doors and the sounds of traffic outside the building.

Recording levels are pre-set to court conditions and the engineer need only operate a switch to start the recording system, when proceedings begin. EMITAPE type 100 on 8 $\frac{1}{2}$ in tape reels is used.

The experiment will show whether tape recorders offer a practical means of recording court proceedings.

Cover Feature

TRANSISTOR PORTABLE 4

By F. G. Rayer, Assoc. Brit. I.R.E.

THE T.R.F. TYPE OF RECEIVER REQUIRES FEW components compared with a superhet, and it uses a circuit which is easy to build and test. For maximum efficiency from the four transistors fitted, the receiver described here has fully controllable regeneration, whilst the usual type of push-pull output stage provided offers good volume with economical running.

The circuit is shown in Fig. 1. L_1 is the tuned winding of the ferrite rod aerial, coupling to TR_1 being provided by L_2 . L_1 and L_2 are windings on a standard medium wave aerial such as is used in

superhet and other receivers. Regeneration is obtained by trimmer CT_1 and L_3 . CT_1 is initially adjusted, and the $25k\Omega$ potentiometer VR_1 then serves as regeneration and volume control, the on/off switch S_1 being incorporated in the control. R.F. is taken via C_2 to the diodes, and the audio signal passes through L_2 , is amplified by TR_1 , and is taken from R_1 via C_4 . TR_1 thus acts both as r.f. and a.f. amplifier.

TR_2 is the second a.f. amplifier and driver. TR_3 and TR_4 are two matched output transistors driven by T_1 , operating the speaker by way of the output

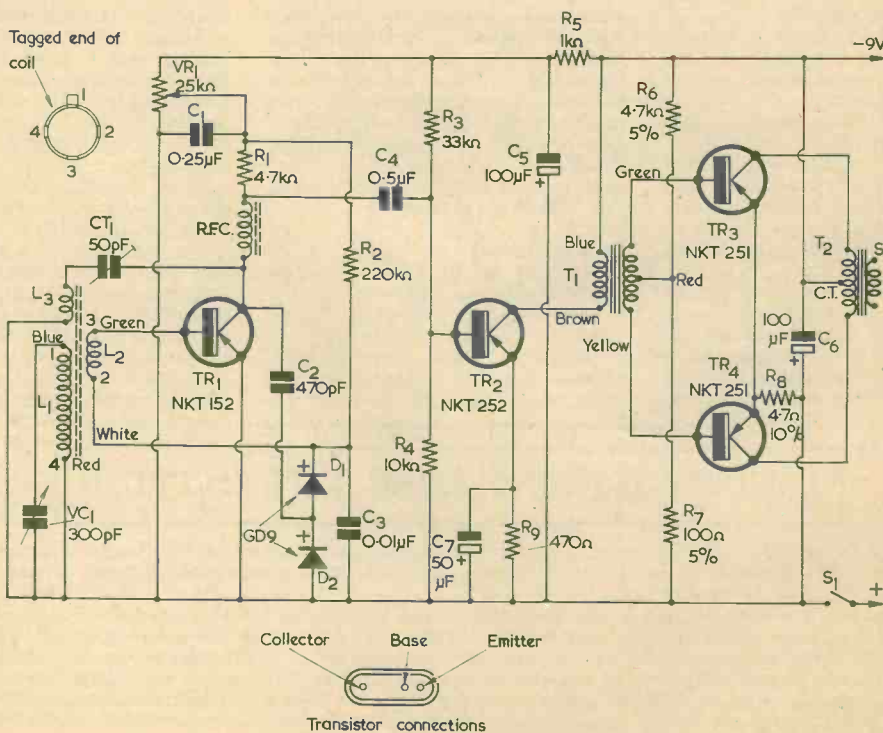

Fig. 1. The circuit of the receiver

transformer T₂. Any 9 volt battery is suitable. The non-miniature type of battery, or two 4.5 volt flashlamp batteries in series, will have a long working life.

The receiver is designed to fit a ready made cabinet which is obtainable at moderate cost, and it uses a 7×4in speaker, which is capable of good volume.

Paxolin Panel

The receiver is built complete on a Paxolin panel measuring approximately 10½×5½in. An opening approximately 3×5in is required for the speaker magnet and frame. This can be cut out with a fretsaw, or by means of a washer type cutter (two 1½in radius holes overlapping). Alternatively, small holes may be drilled until the central piece can be removed, whereupon the opening can then be cleaned up with a flat and half-round file.

Two ⅜in holes are required, ⅝in from the panel top and 8½in apart, for the tuning wheels, which project through slots in the cabinet top. The horizontal drive specified has a long metal bracket with

Components List

Resistors

(All fixed resistors ¼ watt 20% unless otherwise stated)

R ₁	4.7kΩ
R ₂	220kΩ
R ₃	33kΩ
R ₄	10kΩ
R ₅	1kΩ
R ₆	4.7kΩ 5%
R ₇	100Ω 5%
R ₈	4.7Ω 10%
R ₉	470Ω
VR ₁	25kΩ pot with switch S ₁

Capacitors

C ₁	0.25μF paper
C ₂	470pF mica
C ₃	0.01μF paper
C ₄	0.5μF paper
C ₅	100μF electrolytic 12V wkg.
C ₆	100μF electrolytic 12V wkg.
C ₇	50μF electrolytic 6V wkg.
VC ₁	variable approx. 300pF (see text)
CT ₁	50pF trimmer mica

Inductors

r.f.c.	Miniature r.f. choke (4.5mH). Osmor Radio
L ₁ , L ₂	(See text). Ferrite rod aerial QFR1, medium wave. Osmor Radio
T ₁	Driver transformer QXD1. Osmor Radio
T ₂	Non-miniature output transformer QXO2. Osmor Radio

Miscellaneous

Cabinet and horizontal drive, complete, with wheel knobs. Osmore Radio
 Speaker, 7×4in elliptical. 3Ω impedance
 Paxolin panel, 10½×5½×⅛in
 Hardboard panel, 7½×4¼×⅛in
 9 volt battery (see text)
 Connecting wire, battery clips, etc.

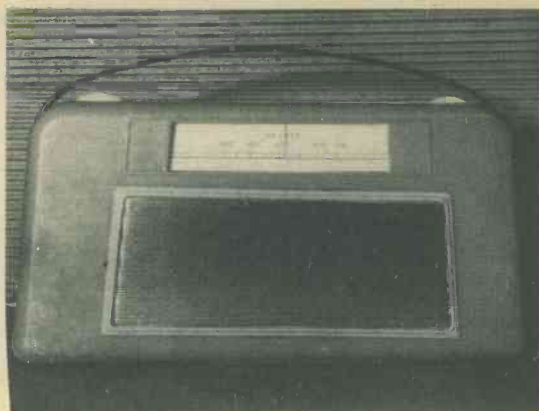

Front view of the completed Transistor Portable 4 receiver

the necessary holes, so it is in fact only necessary to drill the Paxolin to match this bracket. The bracket is held by a bolt near VR₁, and by the cord drive spindle bush. As shown in Fig. 4 (b), the driving cord passes round the tuning spindle, horizontally along the bracket, round a small pulley, back along the bracket, then over a further pulley, and finally round the drum fitted to the tuning capacitor spindle.

Small holes required for components, etc., will be seen in Figs. 2 and 3, and these should be drilled before mounting any parts. A ⅛in drill is suitable for the wire ends of resistors, etc. There is plenty of free space.

Speaker Fitting

A piece of ⅛in hardboard 7½in×4¼in has an oval aperture cut to match the speaker cone. The hardboard is then bolted to the speaker, using four countersunk 4BA or 6BA bolts 1½in long. An extra nut is run on each bolt, to provide spacing, and the bolts are passed through the holes marked S in Fig. 2. Further nuts are then locked on.

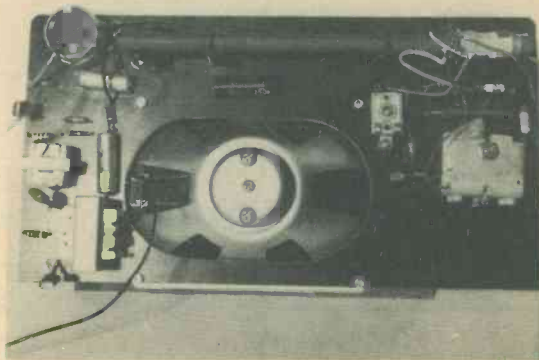

Internal view of the chassis assembly

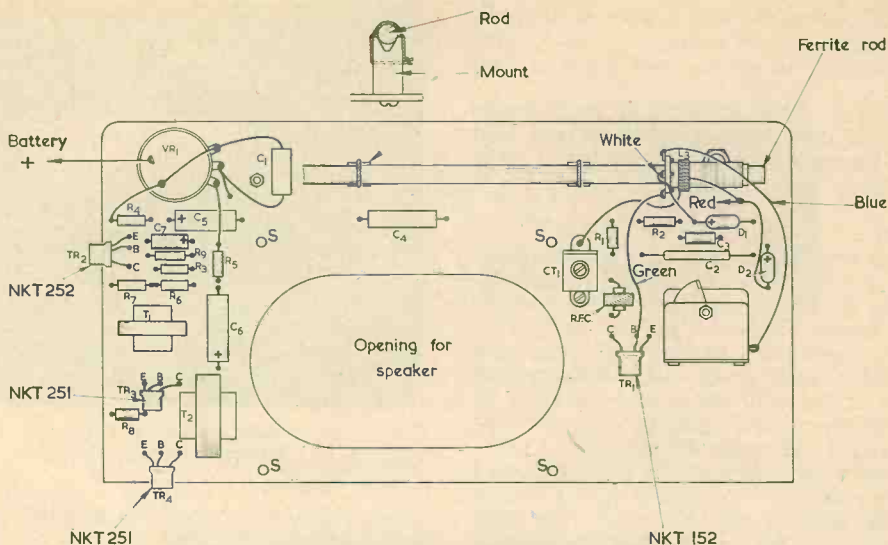

Fig. 2. Component layout and wiring at the back of the receiver panel

A check can be made that the panel, with speaker, VR₁, and tuning drive, fits correctly in the case, and the control wheels can be positioned so that they project correctly without fouling the cabinet.

Four countersunk screws, driven through holes provided in the cabinet front, and into the hard-board, hold the speaker baffle, etc., in position. A grille fits the cabinet front and conceals these items.

The receiver can be removed by taking out these four screws. Alternatively, the receiver panel may be released by removing the four 6BA or 4BA nuts, the speaker then remaining in the cabinet. This is convenient if flexible leads several inches long are provided from T₂ to the speaker.

When wiring the receiver, the speaker is connected last, and is not fitted until construction is otherwise completed.

Wiring

VC₁ is specified as being approximately 300pF. A 300pF solid dielectric capacitor was tried here, and gave reasonably good results. An air spaced component is preferable, however, and a 350pF capacitor was tried, and also the 208pF section of a two-gang capacitor. The 208pF was found sufficient for full coverage (200–550m). This particular component was a Jackson type 00 two-gang capacitor, with capacitances of 208 and 176pF. The capacitor actually used must have a spindle at least ½ in long.

All the small parts are mounted by passing their wire ends through the holes. Both diodes, together with C₅, C₆ and C₇, must be fitted with the polarity shown in Fig. 2. Resistors and other capacitors may be fitted either way round.

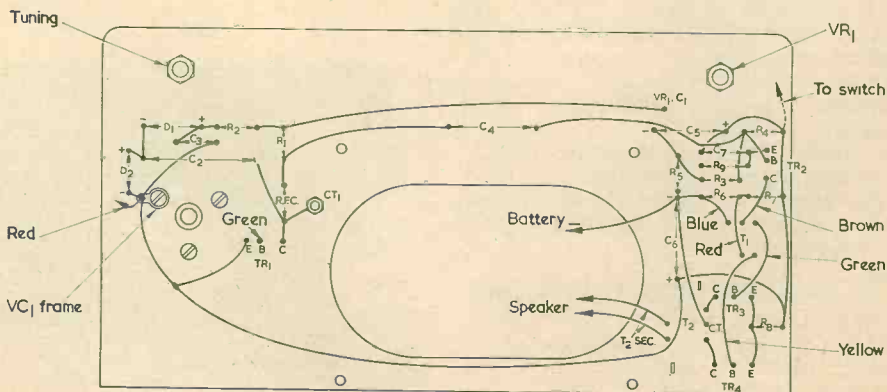

Fig. 3. The complementary wiring on the front of the panel

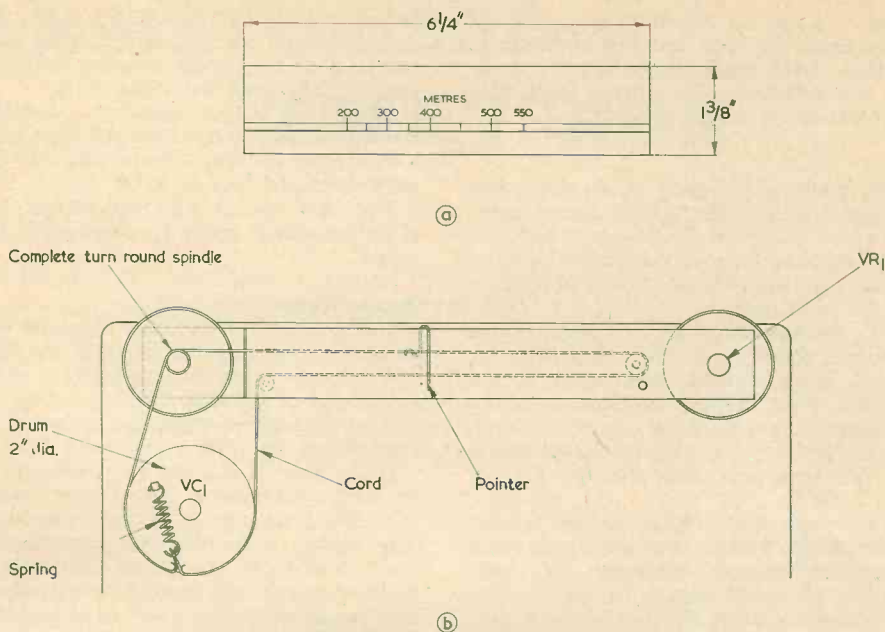

Fig. 4 (a). The tuning scale given with the prototype
 (b). Detail of the tuning drive assembly

Transistor leads can be left reasonably long. Pieces of 1mm sleeving $\frac{1}{2}$ in long can be placed on the transistor leads before passing the wires through their appropriate holes.

T₁ is held by its five projecting leads, which emerge as illustrated in Fig. 3. T₂ has five leads and two lugs. The lugs pass through slots made by drilling $\frac{1}{8}$ th holes, and they are twisted or bent over to secure the transformer.

The ferrite rod is fitted to two mounts, cut as in Fig. 2. These can be made from wood, and held with wood screws. Alternatively, they can be made from ebonite or similar insulating material, and tapped, if a 4BA or 6BA tap is available. Elastic, or string, holds the ferrite rod in place. Metal brackets are not used. As space is available, an 8in rod can be used, and this gives a slight increase in signal strength, compared with a 5in rod.

Fig. 1 shows tag connections for the aerial listed, and will allow wiring to other aerials to be identified. Tags 1 and 4 are the tuned winding, tag 4 being earthed (i.e. connected to the positive line). Tags 2 and 3 are the base coupling winding. Short lengths of thin coloured flex may be soldered to the tags, to agree with Fig. 1, as this will simplify wiring up as in Fig. 2.

L₃ is of 30 s.w.g. silk covered or similar wire, and consists of 15 turns wound on top of L₁, near L₂. See Fig. 2. One end of L₃ goes to earth (positive line) and the other end to trimmer CT₁. If first tests show that regeneration is not obtained, disconnect both ends of L₃, reverse them, and re-

connect. If regeneration is unsatisfactory, whichever way L₃ is connected, then the connections to L₂ may need reversing.

Wiring on the front of the panel is shown in Fig. 3. Transistor wires are left almost full length, and are soldered quickly employing a heat shunt. All leads are covered with 1mm sleeving.

Trimmer CT₁ is held by a 6BA bolt and is wired to the r.f. choke, C₂, and TR₁ collector, as in Fig. 3. The metal frame of VC₁, or the moving plates, is wired to the earth line.

Figs. 1 and 3 show how the coloured leads of T₁

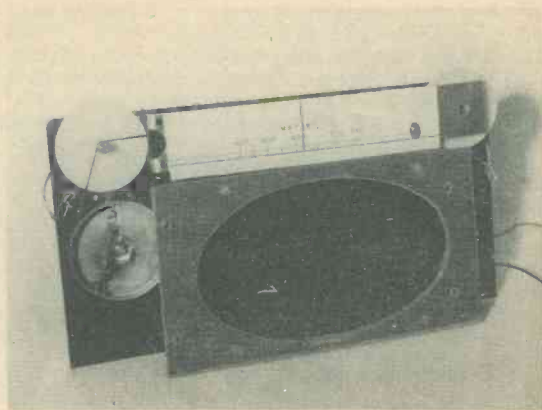

Showing tuning scale and speaker assembly

are connected. T_2 has no colour coding, but the centre tap can easily be seen and this connects to battery negative. Each remaining primary connection goes to one collector. The output leads then pass from the secondary to the speaker.

Transistors

For proper results, TR_1 must be in first class condition. Two new transistors were found satisfactory. A surplus transistor of low cost, listed as being suitable, resulted in a very high background hiss and erratic regeneration, which was obtainable over part of the band only.

If preferred, the first stage may be tested alone by wiring phones from C_4 to the earth line, the remaining parts being omitted. Oscillation should commence when VR_1 is near maximum. If no oscillation is obtained, reverse L_3 as described above. If necessary, screw down CT_1 slightly. If oscillation begins with VR_1 very near zero, unscrew CT_1 or remove turns from L_3 .

In general, no particular difficulty should arise in obtaining correct regeneration over the whole band. But for maximum possible efficiency, CT_1 (and possibly L_3) will probably need some adjustment, to suit the transistor actually fitted.

An OC71 and similar transistors provide an alternative for TR_2 .

The output stage should draw about 2 to 4mA with no signal, peaking up to 10 to 25mA or so at good volume. Alternatives to the transistors shown are OC72's or similar. The values of R_6 , R_7 and R_8 must suit the transistors fitted. Published circuits will show values for OC72's or other transistors, and 5% resistors are generally used to obtain correct operation. The adjustment of operating conditions in this stage is very easily carried out, if necessary.

If the output pair draws almost zero current with

no signal, and reproduction is distorted, the base voltage should be made a little more negative. This can be done by slightly reducing the value of R_6 , or slightly increasing the value of R_7 .

Should the output pair draw more than 4mA or so with no signal, the base voltage should be made a trifle more positive. That is, R_6 may be increased, or R_7 reduced (say to 82Ω).

For best results with economical running, the same comments apply to any output stage of this type.

Tuning Range

Fig. 4 (a) shows the scale obtained with a 208pF capacitor. Moving the winding on the ferrite rod will influence coverage, especially at the high wavelength end of the scale.

Two methods of obtaining reception of the Light Programme on 1500 metres were tried, as follows:

(1) L_1 may be shunted with sufficient capacitance to reach 1500 metres. A 1000pF mica capacitor, with 500pF trimmer in parallel, was found suitable. The actual value depends considerably on the position of L_1 on the ferrite rod. VC_1 then merely acts as a manual trimmer. The capacitance required may be found with a few fixed capacitors and a $2 \times 500\text{pF}$ gang capacitor, or similar means. Volume was sufficient in an area where the 1500 metre transmitter provides good signal strength. An on/off type switch brings the extra capacitance across L_1 when wanted.

(2) A long wave winding, with its own base and regeneration windings, was fitted on the other end of the rod. A 3-pole 2-way switch is then required. The circuits from T_1 to L_3 , VC_1 to L_1 , and base to L_2 were all switched, with the long wave tuned winding short-circuited when the switch is in the m.w. position. Very good l.w. results were obtained.

£1 MILLION TV aerials contracts for



First two aerial contracts for extending the B.B.C. 2 television programme beyond the London area have now been placed by the British Broadcasting Corporation with E.M.I. Electronics Ltd.

These aerials, which will be erected on Independent Television Authority's masts at Emley Moor, near Huddersfield, and Winter Hill, near Bolton, will serve the main population centres of Yorkshire and Lancashire. Both are designed for two-channel working, to transmit B.B.C. 2 and, in due course, B.B.C. 1 programmes of u.h.f. Each contract calls for the supply and erection of an aerial and feeder system.

Combined value of the two contracts is nearly £130,000. This brings the total value of orders recently placed by the B.B.C. and I.T.A. with E.M.I. for aerials and masts to nearly a million pounds.

At Emley Moor, an aerial consisting of 48 u.h.f. aerial panels will occupy the top 64ft space of a new 1,250ft mast to be erected at the I.T.A. transmitting station. The aerial will be enclosed in a 9ft diameter cylinder of glass-fibre-reinforced plastics for protection against the weather and to facilitate all-the-year-round maintenance. Two independent halves of the aerial—each of which continues to operate if a fault develops in the other—will each be fed by a 6½in diameter semi-flexible transmission line from the transmitters. The aerial, which will be horizontally polarised, will transmit on Channels 44 and 51. It will have an effective radiated power of 1,000kW, directional over an arc of 220° , with reduced power in other directions.

In many respects, the aerial at Winter Hill will be similar but for Channels 55 and 62. It will occupy the top 64ft of a 1,000ft triangular mast to be erected at the I.T.A. transmitting station. The aerial will be omnidirectional, with an effective radiated power of 500kW.

Both aerials are scheduled for completion during the summer of 1965.

TRANSISTORISED TELEVISION CIRCUITS

PART 4 By Gordon J. King,
Assoc.Brit.I.R.E., M.T.S., M.I.P.R.E.

In the first three articles of this six-part series, our contributor dealt with tuners, sound and vision i.f. amplifiers, audio and video amplifiers, and a.g.c. and contrast control circuits. The present article carries on to the line timebase and a.f.c. stages.

THIS MONTH'S ARTICLE STARTS WITH A DISCUSSION of the line timebase circuits. In valve circuits the line output stage caters for high voltages, medium value currents and a booster circuit for enhancing the overall efficiency of the stage. In transistor circuits, we must start off with the low voltage of the power supply and from this derive high value currents and a boost voltage which, in effect, can be applied in parallel with the supply source, thereby returning power back to the battery. This latter operation is rather like using a battery-operated electric motor for working a piece of machinery, to which is coupled a dynamo for putting some of the electrical energy back into the battery.

It will be understood that once the line timebase is in action it is a relatively simple matter to obtain voltages considerably higher than that of the supply for working other parts of the set, such as the video amplifier (see Part 3), the picture tube biasing and the vertical oscillator. This technique is, in fact, adopted, as we shall see later.

Line Oscillator

In Fig. 10 is shown the line timebase and tube biasing circuits of the Pye T11. A good point to commence the discussion is the line oscillator, TR₃₂, using an OC72 transistor. This stage is a transistorised version of the well-known valve blocking oscillator. The stage oscillates by virtue of the magnetic coupling between the base and collector circuits given by two of the windings on the blocking oscillator transformer T₁₄. The resulting line waveforms at the base and collector of TR₃₂ are shown on the circuit. It will be noted that the waveform has a peak-to-peak value of only 4.5 volts at the base, which is raised to 20 volts at the collector.

At the start of the "switched-off" period of the oscillator, high peak voltages are produced by the primary inductance of the blocking oscillator transformer (a sort of back e.m.f. effect) and, unless

these are suppressed, the transistor would not last very long. Suppression is achieved by the "horizontal damper" diode D₃₃. This is pushed hard into conduction when the peak voltages occur and they are thus "damped" or bypassed through R₁₀₄.

The line oscillator waveform is developed for application to a "horizontal driver" transistor across a third winding on T₁₄. It will be seen from the waveform at the base of the driver TR₃₄ that the third winding gives a step-down and, in fact, matches to the low base impedance of TR₃₄.

Driver

The driver does two major operations: (i) it amplifies the line signal to a relatively high power value which is required for working the line amplifier or output stage, and (ii) it avoids having the line oscillator work excessively hard, thereby ensuring that the oscillator is operated under conditions of good thermal stability; a feature which is not compatible with large power drive.

There is another rather important aspect of the matter, and that is "switching". A transistor differs from a valve in that it is affected by "hole storage" effects. Such effects in the line output transistor(s) tend to detract from the switching action, making it slower than is desirable.

An ideal line amplifier should represent an instantaneous electronic switch. With a valve, for instance, anode current can be switched on by removing a negative cut-off bias, and this is almost instantaneous. Conversely, anode current can be switched off by turning on a cut-off bias, whereupon the anode current drops almost instantaneously to zero.

With a transistor, however, when the forward current in the base-emitter junction is removed (the same as turning on the cut-off bias in the case of a valve) the collector current does not fall instantaneously to zero, because an excess hole storage charge remains which tries to retain the collector current. It does this, in fact, until the charge is

exhausted. The hole storage problem enters into all high speed transistor switching considerations.

Fortunately, the effects of hole storage can be considerably minimised in the line amplifier by applying considerable power input both during the scan period, when the stage is "switched-on", and during the retrace, when the stage is "switched-off". High power to secure the switching-off effect sweeps away the holes very rapidly and provides a very fast switching action. This "switching power", then, in the Pye TT1 is facilitated by the horizontal driver stage.

The driver transistor collector is loaded by the primary of the line amplifier driver transformer T₁₅, which features two secondary windings for supplying power to the base circuits of the two output transistors, TR₃₅ and TR₃₆.

Some transistorised television receivers use a single transistor as the line amplifier, and transistors capable of withstanding the high peak voltages are available and being improved upon.

Line Amplifier

The two series-connected transistors in the Pye line amplifier share the flyback voltage pulse developed across the inductance of the line scanning coils. These coils (which themselves are connected in parallel with each other), L₁₄ and L₁₅ are connected in series with the collector of the line amplifier direct (one side going to the negative line and the other side to the collector of TR₃₅).

The primary winding of the line output transformer, T₁₆, serves purely as a shunt for the d.c. component of the deflection current. The tapped top winding is the primary in shunt with L₁₄ and L₁₅. The next winding down is the e.h.t. overwind, and the next the heater winding for the e.h.t. rectifier valve. The last winding, designated A-B, provides a pulse phase-test voltage for the automatic frequency-control (a.f.c.) line synchronising circuit (see later).

A brief run-over of the operation of the line output stage would be instructive at this time. Towards the end of the scanning stroke the collector current in the output transistors rises to a maximum, and a large quantity of holes accumulate at the base. The retrace drive from the driver stage pushes the output pair hard into reverse base-emitter conduction which quickly eliminates the holes.

During the retrace (i.e. flyback), the inductive collector load resonates with stray and circuit capacitances, and the usual half-cycle of oscillation occurs. The current through the inductance of the scanning coils reverses in polarity towards the end of the retrace, and a positive voltage appears at the "anode" end (i.e. the end marked "negative") of the efficiency diode D₃₈.

The diode thus conducts, and remains conducting for the first part of the scanning stroke, when the drive waveform changes to provide forward base current for the output transistors. It will be seen that the efficiency diode is connected between the chassis (supply positive) and the negative line, via

the top winding on T₁₆, thus power is fed back into the circuit.

In effect, the first part of the line scan is provided by power from the efficiency diode and the second part by conduction of the output transistors. This is rather similar to the normal operation of a valve line output/booster diode stage.

Stepped-up Voltages

Now, the pulses at the collector of the output stage are further rectified by the "vertical oscillator h.t. rectifier", D₃₇, and the "video amplifier h.t. rectifier", D₃₉. Rectified d.c. in the former circuit is applied to R₁₀₉ and the reservoir C₉₄ and fed to the vertical oscillator, while in the latter circuit the d.c. voltage is applied to R₁₁₀ (with C₉₈ as the

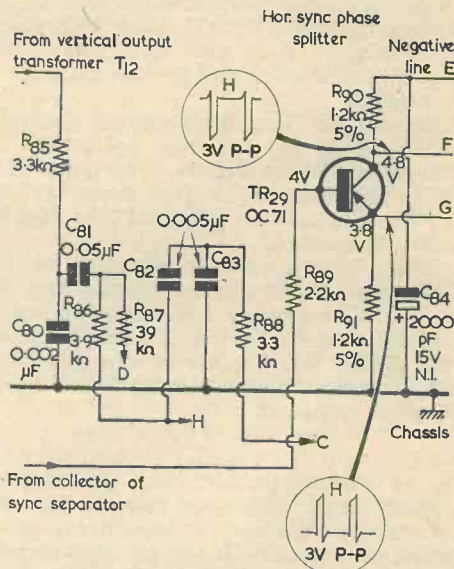

Fig. 11. The horizontal sync phase splitter stage which, driven from the sync separator stage (see next article), feeds sync pulses to the discriminator circuit in Fig. 10

reservoir, and C₉₉ as the smoothing capacitor). These supplies are negative relative to chassis and are thus suitable for direct application to the collector circuits of the associated transistors.

A positive source of voltage is produced by the "brightness" diode, D₄₀. Here, the d.c. is developed in the "cathode" circuit. A still further d.c. supply higher than the supply voltage is obtained from the "c.r.t. h.t. rectifier", D₄₂, the voltage pulses in this case being obtained from a tap on the e.h.t. overwind on T₁₆.

Thus we have a +60 volt supply for the brightness control circuit, in conjunction with a balancing rectifier D₄₀, and two -60 volt supplies. One of the latter is used for the video amplifier power supply (see Fig. 9, Part 3), and the other for the vertical oscillator.

The positive supply from D₄₂ is connected to the

picture tube first anode via R₁₁₄ and R₁₁₆. C₁₀₂ is the reservoir capacitor. The negative 60 volt supply for the vertical oscillator is also taken to one end of the focus control, R₁₁₅, with the other end of the control going to the positive supply from D₄₂. This gives a wide range of potential variation for the focus electrode.

Tube Bias

Since the grid of the picture tube is connected to the -60 volt collector circuit of the video amplifier transistor, it follows that the tube cathode must be adjustable over a voltage range from about +50 to -25 to provide sufficient variation of grid-to-cathode bias for control of brightness.

This is achieved by connecting one side of the brightness control circuit to the -60 volt supply to the video amplifier and the other side to the positive potential derived from D₄₀, the "brightness" rectifier. Resistors R₁₁₁ and R₁₁₃ "pad" the brightness control so as to give the correct range of voltage variation.

The tube cathode "brightness control" potential is filtered by C₁₀₀ and fed from point "D" on Fig. 10 to point "D" on Fig. 11. The potential is thus fed through R₈₇ and R₈₆ to point "H" on Fig. 11. This ties up with point "H" on Fig. 10, which is the tube cathode.

This rather long journey is necessary so that vertical timebase pulses can be injected into the cathode circuit to give flyback line suppression. The pulses fed through C₈₁ (Fig. 11) and developed across the divider R₈₅-C₈₀ are positive-going and thus push the tube into beam-current cut-off during the vertical retace period.

Line A.F.C.

In Fig. 11 is shown the horizontal synchronising phase splitter stage. This stage receives line sync signals at its base from the sync separator stage (to be described next month). It will be noted that the collector and emitter load resistors for TR₂₉ have equal values, so that the line sync signals to the base give equal amplitude signals of opposing phase at the collector and emitter, as shown by the accompanying waveforms.

The two equal antiphase sync pulses are applied in the correct "polarity sense" to the reference sync input terminals of an a.f.c. bridge discriminator made up of two OA81 crystal diodes, D_{30A} and D_{30B} (Fig. 10). Note that the circuit of Fig. 11 ties to that of Fig. 10 at points "E", "F" and "G", with "E" being the negative line.

The discriminator is also fed with pulse "phase-test" voltages from the winding terminated "A-B" on the line output transformer T₁₆. Note that "A" goes to the discriminator through R₉₇ and that "B" connects to the horizontal hold control, R₉₄.

The discriminator produces an output voltage at the junction of R₉₆ and R₉₈ whose amplitude and polarity are governed by the phase difference between the point of zero datum-level in the flyback pulse across "A-B" and the sync pulses. This output is filtered in an "anti-hunt" network comprising C₉₀,

R₈₉ and R₁₀₀, and it is then applied to the base of the "a.f.c. amplifier", TR₃₁.

The operation of this circuit is very interesting, and is as follows. The collector of TR₃₁ is energised from the negative line through the two primary windings on the "control" transformer T₁₃. The permeability of the core of the control transformer alters in accordance with the amount of collector current flowing in the two primary windings.

On this same core is wound a third winding which is in the feedback base circuit of the line oscillator transistor, TR₃₂. This winding acts as a stabilising device on the one hand and as a control device on the other. It will be understood, of course, that the inductance of the winding determines the repetition frequency of the line oscillator, and that the inductance can be altered by varying the permeability of the core upon which it is wound.

Since the core permeability is controllable by the collector current of the sync amplifier, and the collector current is governed by the phasing of the sync and reference pulses in the discriminator, it follows that line lock is achievable by these channels.

The line hold control is connected in series with the phase-test voltage from the line output transformer to the discriminator, and thus serves to adjust the initial bias on the a.g.c. amplifier and hence the operating frequency of the line blocking oscillator. Should the timebase speed tend to go out of step with the sync pulses, a correcting voltage is produced by the discriminator which alters the collector current of the a.f.c. amplifier and, hence, the permeability of the core material of T₁₃. The frequency is thus pulled back into step.

This method of a.f.c. is particularly suited to a transistor blocking oscillator, since the frequency control is not determined primarily by the resistance of the circuit. It is therefore less susceptible to temperature effects in the oscillator transistor.

The a.f.c. amplifier transistor is a silicon type which further minimises thermal variations of the circuit.

Note that the pulse fed to point "A" (Fig. 10) is also fed to point "C" in Fig. 11, and from point "C" to point "H", which is the tube cathode. Thus, line pulses are also fed to the tube cathode to mask any picture shift due to the small delay in the line amplifier transistors caused by hole storage effects previously described. Picture shift is also avoided by the use of an auto-phase control circuit, similar to the Pye a.f.c. circuit. Next month we will see how the problem is tackled by other makers.

Filter Networks

During the line retrace period quite a disturbance, current-wise, occurs in the circuits. The resulting pulses are prevented from getting into vulnerable signal sections of the circuit by various filter networks, of which R₉₂ and L₁₂ is one.

The picture tube has all the characteristics of the type of tube used in valve receivers. Ion trap and picture centring magnets are employed, as also is a line linearity sleeve, consisting of a closed-circuit loop on the tube neck beneath the scanning coils.

(To be continued)

TRANSISTORISED HOME BUILT CLOSED CIRCUIT TV

Part 2—R. Murray-Shelley
and T. Ian Mitchell

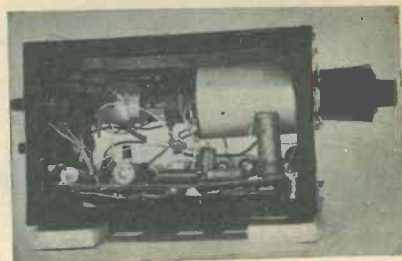

The second in a series of four articles describing the construction and operation of an amateur-built closed circuit television camera. The camera, which is fully transistorised, provides an r.f. output at any channel in Band I and it may, in consequence, be used in conjunction with a conventional domestic television receiver.

THE CAMERA TO BE DESCRIBED IS QUITE STRAIGHT-forward in its construction, operation and setting up procedure and is capable of giving results which are comparable with those obtainable from more costly commercial equipment.

The Circuit

The complete camera circuit, excluding the power pack, is shown in Fig. 6, and is a modification of one developed by the manufacturers of the inductors and the other main components employed. The focus and deflection coils can be supplied as a complete unit, together with the target connector for the Vidicon tube, by the D.T.V. Group, who will also supply the necessary line oscillator coil and inductor required in the line timebase circuit.

The camera consists essentially of six parts. These are:

- (1) The Vidicon tube and associated components.
- (2) The video pre-amplifier and amplifier.
- (3) A simple r.f. oscillator capable of being tuned to any channel in Band I.
- (4) The vertical timebase circuit.
- (5) The line timebase oscillator and pulse shaping circuit.
- (6) A blanking pulse mixer and amplifier.

The circuit is fully transistorised, a total of 13 transistors and 6 diodes being used. All the circuitry is contained within the camera head itself and the whole equipment can be made quite compact.

The varying potential produced across the target load resistor R_1 is passed via C_1 to the video pre-amplifier TR_1 . The transistors used in the video amplifier are all type OC170, and these enable an amplifier having the necessary bandwidth and stability to be produced. As stated last month the Vidicon tube is essentially a high impedance device, and hence it is necessary to raise the input

impedance of the amplifier to avoid serious mismatch. This is done by making use of negative feedback. A negative feedback loop is taken from the collector of TR_3 , via R_{46} and C_5 to the amplifier input. Besides raising the input impedance, this feedback also has the effect of linearising the gain of the amplifier. Our tests have shown that the response of the circuit is satisfactory up to 3 Mc/s.

The output from the video amplifier is taken via C_6 to the base of TR_4 . This is an emitter-follower stage which is also used to mix the sync and video signals. These sync pulses are derived from the line and vertical timebase circuits and they are fed to the base of TR_4 via the two diodes D_1 and D_2 . These are crystal diodes, their function being to reduce the loading on TR_4 during the line scan periods.

Since the camera is to be used with domestic receivers, it is necessary that the output be in the form of a modulated radio frequency signal. Accordingly the composite waveform, which consists of the video (positive-going) the sync pulses and the blanking pulses derived from the Vidicon, is used to amplitude modulate the output of a simple r.f. oscillator.

TR_5 acts as a grounded base r.f. oscillator with a frequency coverage of about 45 to 75 Mc/s. The exact frequency of oscillation is determined by the setting of C_{13} .

Since the video amplifier is not a d.c. amplifier, d.c. restoration of the signal is required before it can be used to modulate the oscillator. This is accomplished by the action of D_3 , R_{18} and C_9 . The output from the oscillator is transferred inductively into the coil L_3 . The diode D_3 is normally held biased in the forward direction. In this condition maximum r.f. can pass via C_8 to the output socket. As the signal tends to go negative the diode D_3 starts to cut off, the impedance

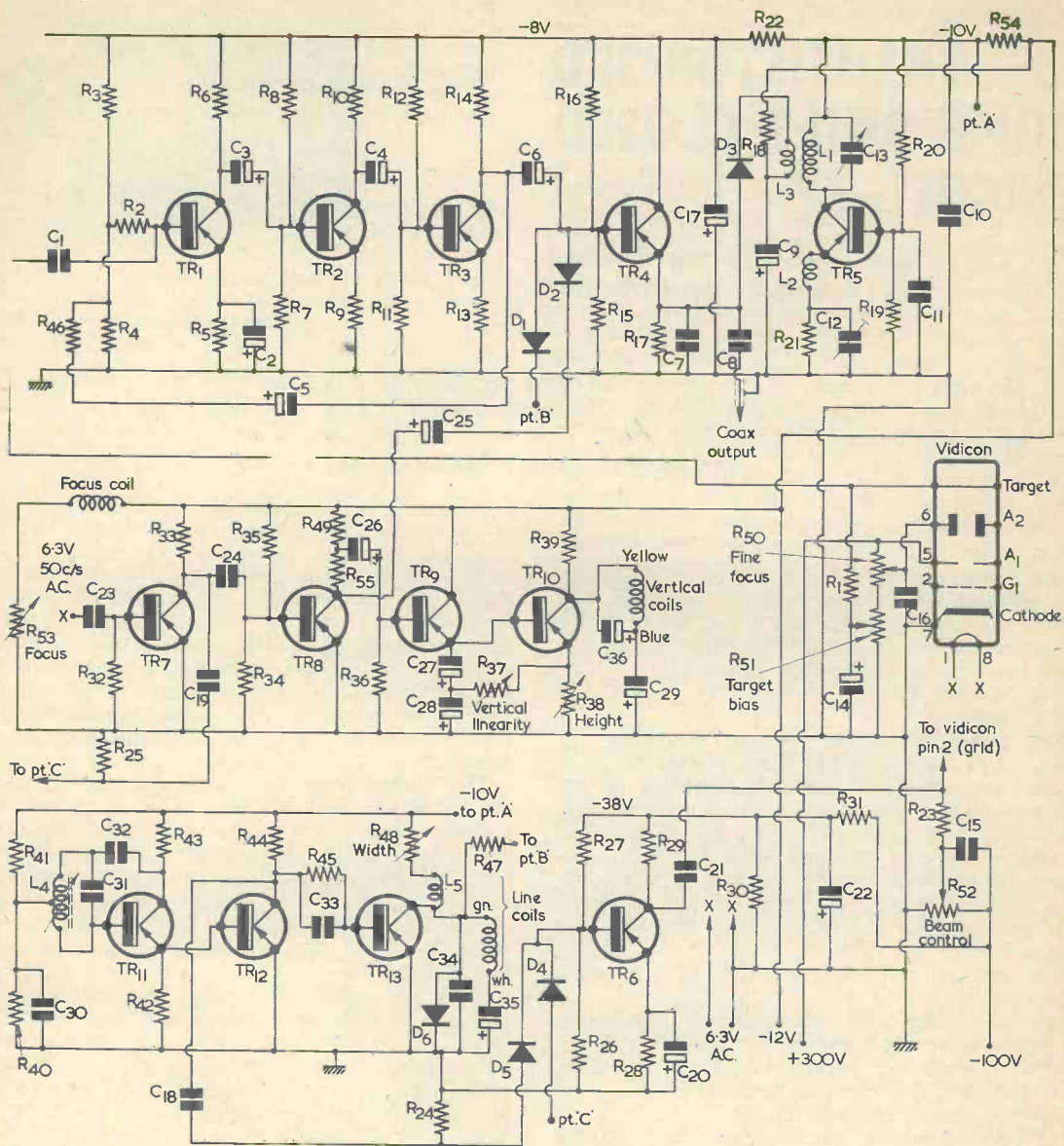

Fig. 6. The circuit of the camera head

of the device rising. This is accentuated by the non-linear characteristic of the diode at these low voltages. As a result less r.f. can pass to the output and hence the oscillator output is amplitude modulated by the composite signal.

The Timebases

The line timebase incorporated in this design is of the free-running type. As was discussed last month the pictures produced by the unit are, therefore, of the random interlaced form. This

is not such a disadvantage as it appears to be at first sight.

Let us consider first the line timebase. The function of this circuit is to produce suitable pulses at (in a 405 line system) a repetition frequency of 10,125 c/s. These are then used to deflect the scanning beam in the Vidicon and to produce the scanning lines. Further, the line timebase generates sync pulses which initiate the line timebase flyback in the receiver and so keep the two line scans absolutely in step with one another.

Components List (Fig. 6)

Resistors

All resistors $\frac{1}{2}$ watt rating, 10% tolerance unless otherwise stated.

R ₁	470k Ω	R ₂₉	22k Ω
R ₂	47k Ω	R ₃₀	47k Ω
R ₃	33k Ω	R ₃₁	22k Ω
R ₄	12k Ω	R ₃₂	470k Ω
R ₅	1k Ω	R ₃₃	22k Ω
R ₆	1.8k Ω	R ₃₄	12k Ω
R ₇	10k Ω	R ₃₅	22k Ω
R ₈	68k Ω	R ₃₆	39k Ω
R ₉	330 Ω	R ₃₇	5k pre-set pot.
R ₁₀	1.8k Ω	R ₃₈	200 Ω pre-set
R ₁₁	10k Ω	R ₃₉	330 Ω
R ₁₂	68k Ω	R ₄₀	47k Ω
R ₁₃	330 Ω	R ₄₁	470k Ω
R ₁₄	1.8k Ω	R ₄₂	150 Ω
R ₁₅	10k Ω	R ₄₃	4.7k Ω
R ₁₆	68k Ω	R ₄₄	1k Ω
R ₁₇	330 Ω	R ₄₅	1k Ω
R ₁₈	22k Ω	R ₄₆	47k Ω
R ₁₉	10k Ω	R ₄₇	68k Ω
R ₂₀	27k Ω	R ₄₈	500 Ω pre-set
R ₂₁	1.8k Ω	R ₄₉	2.2k Ω
R ₂₂	150 Ω	R ₅₀	100k Ω pot.
R ₂₃	470k Ω	R ₅₁	50k Ω pot.
R ₂₄	47k Ω	R ₅₂	500k Ω pot.
R ₂₅	100k Ω	R ₅₃	100 Ω pre-set.
R ₂₆	33k Ω	R ₅₄	47 Ω
R ₂₇	100k Ω	R ₅₅	2.2k Ω
R ₂₈	2.2k Ω		

Inductors

L₁, L₂, L₃, see text

Capacitors

C ₁	0.04 μ F, see text
C ₂	100 μ F 9V elec.
C ₃	16 μ F " "
C ₄	16 μ F " "
C ₅	16 μ F " "
C ₆	16 μ F " "
C ₇	300pF ceramic, see text
C ₈	30pF ceramic, see text
C ₉	100 μ F 15V elec.
C ₁₀	5,000pF ceramic
C ₁₁	5,000pF ceramic
C ₁₂	250pF trimmer (postage stamp)
C ₁₃	500pF trimmer—mica
C ₁₄	4 μ F 150V elec.
C ₁₅	0.1 μ F 150V paper
C ₁₆	0.1 μ F 500V paper
C ₁₇	250 μ F 15V elec.
C ₁₈	0.01 μ F 150V paper
C ₁₉	0.5 μ F paper
C ₂₀	25 μ F 25V elec.
C ₂₁	0.5 μ F paper
C ₂₂	8 μ F 150V elec.
C ₂₃	1 μ F paper
C ₂₄	0.04 μ F 150V paper
C ₂₅	16 μ F 15V elec.

C ₂₆	16 μ F 15V elec.
C ₂₇	2 μ F 15V elec.
C ₂₈	2 μ F 15V elec.
C ₂₉	500 μ F 15V elec.
C ₃₀	0.01 μ F ceramic
C ₃₁	5,000pF silver mica, close tolerance
C ₃₂	0.01 μ F paper
C ₃₃	0.01 μ F paper
C ₃₄	0.01 μ F paper
C ₃₅	16 μ F 15V elec.
C ₃₆	2 μ F 15V elec.

Transistors

TR ₁	OC170
TR ₂	OC170
TR ₃	OC170
TR ₄	OC170
TR ₅	OC170
TR ₆	OC83
TR ₇	OC71
TR ₈	OC71
TR ₉	OC71
TR ₁₀	OC83
TR ₁₁	OC44
TR ₁₂	OC44
TR ₁₃	OC83

Transistors

Diodes

D ₁	OA81
D ₂	OA81
D ₃	OA70
D ₄	OA81
D ₅	OA81
D ₆	OA5

Some of the output from the line timebase is also, after suitable treatment, used to blank off the Vidicon beam in the flyback period between successive line scans.

As can be seen from Fig. 7, the line waveform obtained with this circuit appears rather more as a square wave than the more usual sawtooth—nevertheless the effect is quite satisfactory. TR₁₁ acts as a conventional oscillator, the frequency of oscillation being controlled by adjusting the inductance of the coil L₄ which is slugged for this purpose. The nominal frequency coverage of the oscillator is from 10.125 kc/s to 15.625 kc/s, allowing for operation on either 405 or 625 line systems. In practice, however, it may be necessary to reduce the value of the resonant capacitor C₃₁ to achieve the higher frequency.

The exact frequency to which the oscillator is tuned is not particularly critical so long as it can be followed by the line timebase oscillator in the receiver. The line timebase should, however, be reasonably stable.

The output taken from the emitter of TR₁₁ is direct coupled to TR₁₂. Line blanking pulses

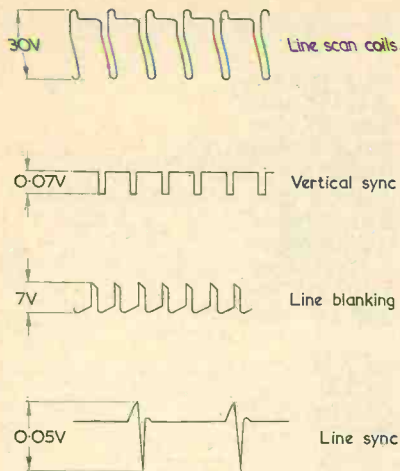

Fig. 7. Sync, line scan and line blanking waveforms. Waveform amplitudes may vary with control settings

are taken via C_{18} from the collector of this stage. Some pulse forming is provided by the combination C_{33} and R_{45} , which feed the output stage. This stage uses a small power transistor type OC83. Pulse shaping is carried out by the combination of C_{34} and D_6 and the inductor present in the collector circuit. The variable resistor R_{48} serves to control the amplitude of the line output and, hence, the width of the resultant picture. Notice the seeming anomaly that underscanning of the Vidicon target produces an overscanned picture in the monitors. Line sync pulses are taken from the collector of TR_{13} .

Vertical Timebase

It is the normal practice in camera equipment of this type to employ a vertical oscillator whose frequency is locked to that of the mains supply. In this case no oscillator as such is used, its place being taken by the injection of a 50 c/s sine wave derived directly from the mains. This sinusoidal input is applied to the base of TR_7 , where it is rectified and amplified. Vertical blanking pulses are taken from the collector of this transistor and fed via C_{19} and D_4 to the blanking pulse mixer TR_6 . The shape of the vertical blanking waveform is shown in Fig. 8. Further amplification and pulse forming is provided by TR_8 and TR_9 . Vertical



Fig. 8. The vertical blanking waveform



Fig. 9. The vertical scan waveform

sync pulses are taken from the collector of TR_8 . The output stage again uses an OC83 transistor (TR_{10}). R_{37} and R_{38} are respectively the vertical linearity and height controls. The purpose of the linearity control is to ensure that the velocity of the downward motion of the scanning spot is constant throughout its travel. Lack of vertical linearity is characterised by distortions in the height of objects when they are moved from one part of the field of view to another. Fig. 9 shows the vertical waveform as it is seen at the vertical deflection coils. The vertical blanking width is of about 14 lines duration.

Components

The method of construction which has been adopted in this equipment, and which will be described later, is made somewhat easier if miniature components are used where possible. There is little point, however, in using miniature resistors, the normal $\frac{1}{4}$ or $\frac{1}{2}$ watt rating components are quite suitable. The writers used resistors of 10% tolerance throughout their equipment. If "surplus" parts are to be used, it is suggested that they be carefully checked before they are included. The use of high stability, low noise, cracked carbon resistors in the video amplifier would definitely be an advantage and would help to keep the signal to noise ratio of this part of the circuit to a suitable level. "Surplus" transistors, particularly for such sections of the circuit as the video amplifier, are not to be recommended, since the characteristics of these specimens may be too far removed from those required.

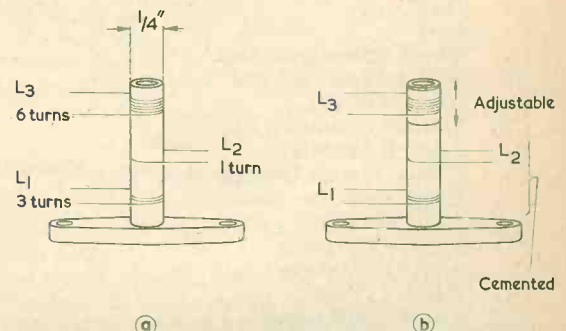

Fig. 10 (a). The construction of the L_1 , L_2 , L_3 coil assembly. All coils are wound on a $\frac{1}{4}$ inch air-cored former with 32 s.w.g. wire. L_1 and L_2 are sealed with cement, whilst L_3 is adjustable, as described in the text

(b). The manner in which L_3 is adjusted along the former. Moving L_3 varies modulation depth

The variable resistors R₃₇, R₃₈, R₄₈ and R₅₃ need only be of the pre-set type. The electrostatic focus (fine focus) control, R₅₀, the target bias control, R₅₁, and the beam control, R₅₂, should all be standard miniature potentiometers.

The capacitors, which are mostly electrolytic, should for preference be new components with low leakage characteristics. C₁ should if possible be a ceramic component (Two 0.02 μ F ceramics in parallel are suitable). The coil assembly L₁, L₂, and L₃ can be readily home-made. Fig. 10 gives details of this assembly. The coils are wound on a standard $\frac{1}{4}$ in diameter former. The coil L₃ is wound between two layers of cellulose tape in such a manner that it can be slid closer to or farther away from the tuning coil L₁ and the feedback coil L₂. This facility enables the depth of modulation of the output signal to be adjusted. This adjustment is rather critical since too little modulation causes clipping of the peak white parts of the picture. Overmodulation, on the other hand can cause a loss of vertical hold on some receivers. Undermodulation also affects the line and vertical hold on the monitor.

The Vidicon tube used in this camera is the E.M.I. type 10667M. This is obtainable from the D.T.V. Group. Some notes on the handling of this tube might be in order. When handling the tube, care should be taken to keep the tube upright with the end window vertical. This is because there may be small particles inside the tube which might damage the photoconductive coating if they were to come sharply into contact with it.*

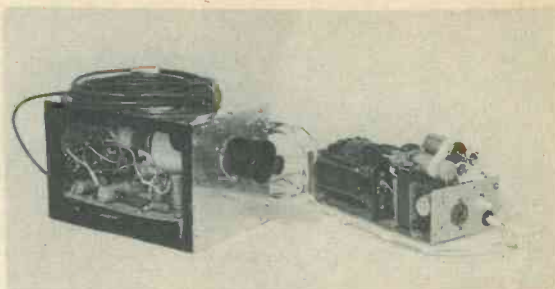

The complete camera equipment, with the power supply alongside the camera head. The latter connects to the television receiver aerial socket via the coaxial cable shown

Special Components

All the following components are available from D.T.V. Group, 126 Hamilton Road, West Norwood, London, S.E.27.

Deflection coils, focus coils, target connector assembly, line oscillator coil L₄ and inductor L₅, complete, as "Beukit No. 1".

Vidicon type 10667M.

13 transistors, 6 diodes, and vidicon base, complete, as "Beukit No. 3".

The Vidicon tube is fitted with an unusual type of base. This is known as a "Small button Ditetra 8 pin" base, and is also obtainable from the D.T.V. Group.

* Maximum ratings for the 10667 (all potentials relative to cathode) are: modular G₁ (pin 2) 0 to -150 volts; limiter G₂ (pin 5) 500 volts; wall anode G₃ (pin 6) 500 volts. Do not use pins 3 and 4 and the short index pin.—EDITOR.

RADIO TOPICS . . . by Recorder

READERS WHO FOLLOWED THE series "An Introduction to Colour Television" (which ran in our June to December issues last year) will have noticed that, so far as colour demodulation was concerned, we concentrated mainly on the R.C.A. XZ system.

To hand is the December issue of our American contemporary *Radio-Electronics*, and it is interesting to see that, in a review of 1964 colour receivers, no fewer than 9 out of 11 manufacturers are listed as using the XZ system. These comprise Admiral, Curtis Mathes, General Electric, Heath, Magnavox, Motorola, Packard-Bell, Philco, and, of course, R.C.A. The makers which use alter-

native circuits are Zenith and the Japanese firm Toshiba. Zenith uses high level demodulation with "switch tubes" as it always has done, the demodulator circuits feeding direct into the grids of the three-colour c.r.t.¹ Toshiba demodulate at low level on the R-Y, B-Y and G-Y axes, applying the outputs to three separate amplifiers employing a common

¹ A "switch tube" circuit—not necessarily that employed by Zenith—may consist of triodes gated by having -(R-Y), -(B-Y), and -(G-Y) reference phases applied to their grids and the chrominance subcarrier applied to their anodes. The triodes conduct for short instants on positive reference phase peaks and offer anode signals which, after passing through low-pass filters, are proportional to the corresponding positive colour-difference signals.

cathode resistor. These then feed the grids of the c.r.t. Flyback blanking is applied to the common cathodes of the amplifiers.

It cannot, of course, be denied that some of the American set makers using the XZ system are sharing a common basic chassis. Nevertheless, it is still worthwhile noting that the system we gave most space to in our introductory series is that chosen by 82 per cent of the only manufacturers in the world for 1964.

Converting for B.B.C.2

Several readers have written to us raising the question of converting 405 line television receivers for reception of B.B.C.2 programmes on u.h.f. and 625 lines. As this is a subject of considerable interest at the moment, I would like to pass on what information I can at the time of writing.

The first thing I feel should be pointed out is that a receiver conversion from 405 to 625 lines is not a job to be undertaken too lightly if good and reliable results are to be achieved. I appreciate that quite a

few TV Dx enthusiasts (whose exploits have, incidentally, been reported in earlier issues of this magazine) obtain 625 line reception from the Continent by the simple processes of reversing the vision detector diode to cater for the negative vision modulation and of speeding up the line timebase oscillator to cater for the increased line frequency. If it is as easy as this to obtain 625 line reception, where do the snags come in?

The answer is that the simple modifications which enable a receiver to pick up 625 line Dx signals are not really good enough if reproduction of worth-while entertainment value is to be obtained from B.B.C.2. Firstly, the 625 line picture can only have the resolution resulting from the relatively narrow bandwidth 405 line i.f. strip and, perhaps, the existing video amplifier. Secondly, the simple TV Dx modifications do not provide reception of the sound channel. Thirdly, the line output stage and line output transformer are operating at incorrect frequency and may possibly be working outside their proper limits for voltage or current. Fourthly, the TV Dx modifications do not cater for reception on Bands IV and V. None of these four points are by any means unsurmountable, but they do emphasise my remark that a conversion for B.B.C.2 is not one which should be too lightly embarked upon. There are quite a few pitfalls for the unwary!

I haven't carried out an actual modification for B.B.C.2 myself, but I can still foresee many of the problems involved. In consequence I would like to offer some tips which may be of help to experimenters. There are, naturally, many different models and makes of 405 line receiver which are potentially capable of modification, and so the notes which follow can only be of a general nature. No guarantee of successful results can be given and the work involved should only be tackled by someone who understands the principles involved. An attempt to convert a commercially-made 405 line set to B.B.C.2 is *not* a job for the beginner.

To see what is involved, let us now briefly examine the four points just raised. The first is concerned with the relatively narrow bandwidth of the 405 line i.f. strip and, possibly, the video amplifier. An experienced engineer or amateur could, with luck, widen the bandwidth of a 405 line i.f. strip to give reasonable results on 625 lines. Some 405 line video amplifiers have peaking chokes which

raise the response at 3 Mc/s. These may need attention.

The second point is concerned with the sound channel, and this raises a major difficulty. The sound channel on B.B.C.2 is frequency modulated and is 6 Mc/s *above* the vision carrier. On Bands I and III, the sound carrier is *below* the vision carrier, whereupon the output of the receiver tuner unit consists of the "standard" intermediate frequencies of 34.65 Mc/s vision and 38.15 Mc/s sound. On Bands IV and V the corresponding i.f.'s are, typically, 39.5 Mc/s vision and 33.5 Mc/s sound. The method employed by set manufacturers for reproduction of B.B.C.2 sound is to take a 6 Mc/s intercarrier signal from the vision detector, apply it to a 6 Mc/s amplifier and detect it with a 6 Mc/s ratio discriminator. If this course is adopted by the amateur, quite a few extra components and valves are required. A possible alternative scheme for the amateur might consist of bringing the existing 38.15 Mc/s sound i.f. strip down to some 33.5 Mc/s and, say, fitting an additional limiter stage feeding into a ratio discriminator with a home-wound 33.5 Mc/s ratio discriminator coil.

The third point has to do with conditions in the line output stage when its operating frequency is raised from 10,125 c/s (405 lines) to 15,625 c/s (625 lines). This is an increase in frequency of over 50 per cent and will almost certainly result in the line output stage running under incorrect conditions.

Fourthly and finally, there is the question of the tuner. No manufacturers' surplus tuners for Bands IV and V have, at the time of writing, appeared on the home-constructor market (possibly because set makers are chasing up every tuner they can lay their hands on!) However, such tuners may appear fairly soon if there is a demand for them from amateur experimenters.

This brief discussion of the four major points should help to emphasise just what has to be done in a conversion to B.B.C.2. It is quite obvious that a lot of circuit changes and additions are required. This being realised, let us next consider the sort of 405 line set which should be most easy to modify. It is possible to divide such sets, here, into two categories: those employing printed circuits and those employing conventional wiring. Personally, I would not look forward very much to carrying out the changes required in a printed circuit set. A printed circuit receiver doesn't offer the flexibility needed for experiment and

modification. Also, it is usually housed in a small cabinet, whereupon the cramped layout leaves no room for the additional components and stages which may be required. A conventionally wired chassis would, on the other hand, be much easier to modify and, as these sets were usually housed in relatively large cabinets, there should be a reasonable amount of spare space for additional bits and pieces as well.

The risk that 625 line operation may cause the line output stage to be overrun also has a bearing on the choice of set for modification. Whilst it is impossible to be specific it is fairly safe to say that, so far as overrunning is concerned, there is probably more leeway in hand with a line output stage feeding a 70° or 90° deflection yoke than one feeding a 110° yoke (provided that one does not select one of the very early 70° receivers). However, don't blame me if you decide to run either a 70° or 90° line output stage at 15,625 c/s, and find that it goes up in smoke!

The most likely contender for an amateur 625 line conversion would, therefore, appear to be a conventionally wired receiver with 70° or 90° deflection. Sets of this nature are rather venerable these days but, as we all know, they are still capable of giving perfectly good pictures when they are correctly set up and are working properly. Since the trade-in value of these receivers is very low, the possibility of their conversion for B.B.C.2 is by no means unattractive. I hardly need to add that such a conversion should not be commenced unless the experimenter has a service manual or service sheet giving the full circuit for the set. Also, the receiver should be in good working order on 405 lines before commencing the modification.

I assume that the conversion will be to 625 lines only, and not to a 405-625 switchable receiver. The latter is by no means impossible—but it will be a lot harder.

Detailed Changes

Let us now return to our four basic points and reconsider them in greater detail.

The first was concerned with widening the i.f. and video amplifier pass-band of the existing 405 line receiver. The vision bandwidth of the B.B.C.2 signal is 5.5 Mc/s with a vestigial bandwidth of 1.25 Mc/s, and so there is quite a bit of widening to do! It may prove impossible to satisfactorily broaden the response of some i.f. strips, and this is a job which should not, in any case, be tackled without at least a signal

generator and output-reading meter, such as a voltmeter across the vision diode load or video amplifier anode load. Preferably, a wobulator and oscilloscope should be used. It may be necessary, with some i.f. strips, to fit one or more damping resistors across the coils. The existing 38.15 Mc/s sound traps will have to be taken out of circuit, or detuned to the edge of the new response. Widening the response will, of course, reduce i.f. gain.

The video detector at the end of the i.f. strip has to be reversed to respond to the negative modulation, and this diode will almost certainly be incarcerated in a screen or coil can. The output of the vision detector will now have picture information going positive, as occurred previously with the 405 line signal, but all video voltages will be negative of chassis where, previously, they were all positive of chassis. Video amplifier cathode bias has, in consequence, to be reduced to bring the signal within its grid base.

The anode of the video amplifier couples usually to the cathode of the c.r.t. and the sync separator grid, and in most cases these circuits should function reasonably well without any changes. So, also, should any mean level a.g.c. circuit which is run from the sync separator grid. Gated a.g.c. circuits may not, however, operate so well, and they may need changing to mean level or putting out of action. For optimum results it may be necessary to change the value of the video amplifier cathode bypass capacitor, and peaking chokes may need to be damped by parallel resistors. Occasionally, 3.5 Mc/s sound rejectors appear in the video amplifier, and these will need to be taken out of circuit.

The second point, reproduction of the sound channel, has already been dealt with in some detail. This will require either the construction of a 6 Mc/s intercarrier strip or modifica-

tions to the existing 38.15 Mc/s sound i.f. amplifier. The 6 Mc/s intercarrier signal can be taken off the video detector load via a capacitor of some 5pF, and it needs very efficient limiting because it is heavily amplitude modulated by the vision signal. Limiting need not be so efficient if the sound channel is obtained from a modified 38.15 Mc/s i.f. amplifier, as the latter obtains its input from the tuner or a first common i.f. stage.

The line output stage comes next, and the major risk involved here is the possibility of overrunning due to the increased line frequency. Care should be taken to ensure that e.h.t. voltage at 625 line frequency does not exceed the rated figures for the c.r.t. and that boosted h.t. does not rise unduly. Many line output transformers intended for 405 line working have fixed capacitors across part of the windings. Operation at 625 lines may be enhanced by experimentally reducing the value of such capacitors. Types capable of handling the pulse voltages involved should be employed. If the line output stage cannot run reliably at the increased frequency the possible results may be voltage breakdown in the transformer or deflection yoke, breakdown of the line output or booster valve, or overheating of the line output transformer core. The line output stage should be run for at least three to four hours at the increased frequency to ensure that the new conditions are safe. Care should also be taken to see that the e.h.t. rectifier filament runs at approximately the correct temperature. This can be confirmed fairly accurately by visual check of its appearance when heated.

The increase in line frequency required for 625 lines may be obtained by modifying the line sawtooth generator. The line hold control should be identified, together with the capacitor in the associated CR

circuit. Usually, the line hold control has a series fixed resistor, and the increased frequency may be obtained by slightly reducing the value of that resistor. In some instances the value of the capacitor in the associated CR circuit may need to be reduced also.

It is with a sense of some relief that I say that the vertical oscillator and output stage need no changes at all. They run at the same frequency on 625 lines!

The fourth and final point has to do with the need for a u.h.f. tuner. All British set makers appear to be using the basic PC88 and PC86 u.h.f. tuner which was described in "In Your Workshop" way back in our June and September 1962 issues. The type currently favoured has a tuned aerial input circuit² in order to overcome the second channel problems liable to arise from the transmitter channel spacing adopted in this country. An amateur-designed u.h.f. tuner could, of course, be used and some constructors may like to try their hand at this.

Final Words

In these comments I have attempted to pass on a few hints to show what is involved in general when carrying out a TV conversion for reception of B.B.C.2. Whilst this is not a job for the inexperienced person, it still offers a very interesting field for the experimenter *provided that he understands fully the principles involved in the modification*. There is a risk of component failure due to the increased line frequency and this has to be faced and accepted.

I have no doubt that quite a few experimenters will be having a go at conversions of this nature. Provided these are successful I would be interested in receiving brief details for possible inclusion in these columns.

² Fig. 6 (b), page 111, of the September 1962 issue.

Queries. We regret that we are unable to answer queries other than those arising from articles appearing in this magazine nor can we advise on modifications to equipment described. Queries should be submitted in writing.

Correspondence should be addressed to the Editor, Advertising Manager or the Publishers, as appropriate.

Opinions expressed by contributors are not necessarily those of the Editor or proprietors.

Contributions on constructional matters are invited, especially when they describe the building of particular items of equipment. Articles should be written on one side of the sheet only and should preferably be typewritten, diagrams being on separate sheets. Whether handwritten or typewritten, lines should be double-spaced. Diagrams need not be large or perfectly drawn, as our draughtsmen will re-draw in most cases, but all relevant information should be included. Photographs should be clear and accompanied by negatives. Details of topical ideas and techniques are also welcomed and, if the contributor so wishes, will be re-written by our staff into article form. All contributions must be accompanied by a stamped addressed envelope for reply or return, and should bear the sender's name and address. Payment is made for all material published.

Production.—Letterpress/contact litho.

JACKSON



the big name in **PRECISION** components

Precision built radio components are an important contribution to the radio and communications industry. Be sure of the best and buy Jackson Precision Built Components

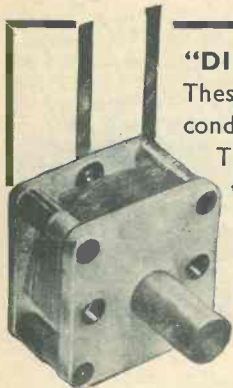

"DILEMIN" CONDENSERS

These miniature solid dielectric condensers are only $\frac{7}{8}$ " square.

The $\frac{1}{4}$ " dia. spindle projects $\frac{1}{2}$ " from the front plate. Low loss construction provides Power Factor better than .001.

JACKSON BROS. (LONDON) LTD.
Dept. R.C., KINGSWAY-WADDON, CROYDON, SURREY
Phone: Croydon 2754-5 Grams: Walfilco, Souphone, London

THE MOSLEY COMMANDO II SSB TX

AS REVIEWED LAST MONTH £140
FULL LITERATURE ON REQUEST

Antennas by Mosley include:

	£	s.	d.
TA31 JR 3 BAND DIPOLE	8	10	0
TA32 JR 3 BAND BEAM	17	10	0
TA33 JR 3 BAND BEAM	24	15	0
V3JR 3 BAND VERTICAL	7	10	0
Y46 4 BAND VERTICAL	14	0	0
TW3X 3 BAND VERTICAL	9	0	0
TD3 3 BAND DIPOLE KIT	5	10	0
SWL-7 7 COMMERCIAL BANDS	7	0	0
RD5 4 BAND DIPOLE KIT	8	0	0
POWERMASTER BEAMS FOR 10, 15 & 20 METRES FROM	13	10	0

CM1 RX XTAL CONTROLLED FRONT END, COVERS 10, 15, 20, 40, 80	66	0	0
CV160B TOP BAND CONVERTER VALVE OR TRANSISTOR	7	10	0
FAMOUS Q MULTIPLIER, COMPARE THE PRICE NOT A KIT }	4	15	0

Send now for all literature on above items from

Mosley Electronics Ltd.

40 Valley Road, New Cotessey, Norwich
NOR N 26K

FREE THIS BOOK WILL INTEREST YOU!

LEARNING the PRACTICAL WAY

Radiostructor EQUIPMENT-COURSES

FOR ... Your Career
... Your Own Business
... An Absorbing Hobby

A NEW-PRACTICAL WAY of UNDERSTANDING

RADIO · TELEVISION · ELECTRONICS

Including: Transistors; VHF/FM; Hi-Fi Equipment; Computers; Servo-Mechs. Test Instruments; Photo-electrics; Nucleonics; etc.

Radiostructor—an organisation specialising in electronic training systems—offers a new self-instructional method using specially designed equipment on a "do-it-yourself" basis. You learn by building actual equipment with the big kits of components which we send you. You advance by simple steps, performing a whole series of interesting and instructive experiments—with no complicated mathematics! Instructional manuals employ the latest techniques for showing the full story of electronics in a practical and interesting way—in fact, you really have fun whilst learning!

RADIOSTRUCTOR

LEADS THE WORLD
IN ELECTRONICS TRAINING

POST NOW

To RADIOSTRUCTOR (Dept. G149), READING, BERKS.
Please send brochure, without obligation, to:

*Name _____

*Address _____

(We do not employ representatives) *Block Caps Please 2/64

THE NEW RADIO AND TELEVISION

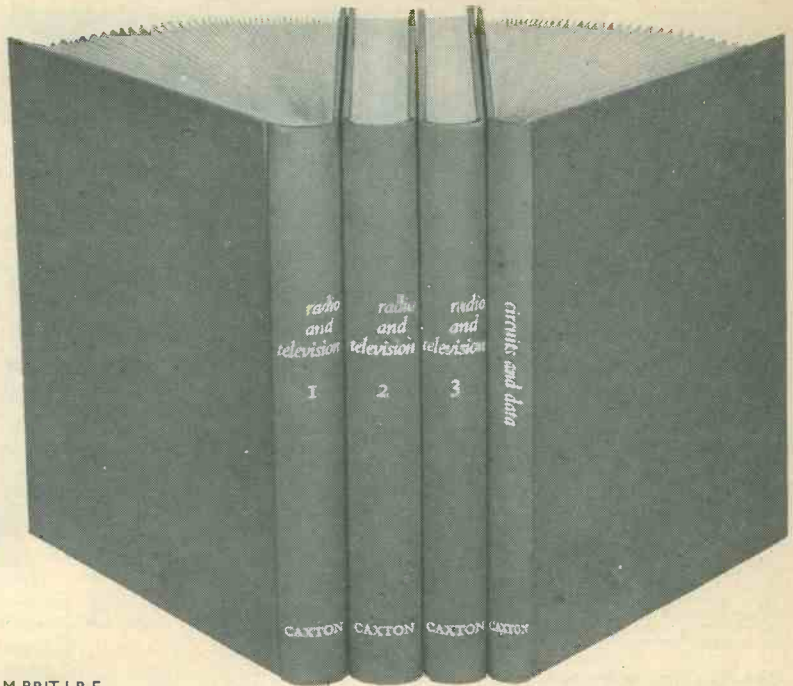

by C. A. QUARRINGTON, A.M.BRIT.I.R.E.

RADIO AND TELEVISION is the most up-to-date work which deals with the principles, design considerations, applications, component parts, maintenance, adjustment and repair of radio and television. Essential for every radio and television engineer and enthusiast, these four magnificent volumes have been designed to meet the needs of all connected with this branch of engineering. By mastering everything in this work and using it for reference, you can join the ranks of men who are sought after because they know the trade from A to Z.

FREE INFORMATION BUREAU. To every purchaser we offer a free postal information service to keep him in touch with what is happening today, what happened yesterday, and even what may happen tomorrow.

SOME OF THE CONTENTS

Waves in free space - Inductance - Capacitance - The tuned circuit - Detection - R.F. pentode - R.F. amplifier - The superheterodyne - Frequency changing stage - A.G.C. and tuning indicators - R.F. coils, screens and switches - Output stage - Press-button tuning - Combined A.M. and F.M. receivers - Transistors and diodes - Power supply and decoupling - High fidelity and stereo reproduction - Microphones and pre-amplification - Tape recording - Car radio - Low-power transmission - Video signal - Waveform generator - Synchronising circuits - Automatic gain control - Vision detection and amplification - Interference limiters - Colour television - Aerials - Fault diagnosis - Workshop equipment - Voltage and current testing - Testing basic components - Instability and motor-boating - Mains hum and background noise - Tracing distortion - Radio receiver alignment - Blank screen - Poor interlacing, television - Pattern on screen - Television receiver alignment - Projection television.

SEND NOW FOR FULL INFORMATION

To THE CAXTON PUBLISHING CO. LTD.,
Dept. 73/26, Gatehouse Industrial Estate, Aylesbury, Bucks

Please send me full information about "Radio and Television"

NAME

ADDRESS

RT 73/26

and now

MARTIN AUDIOKITS

A NEW AND VERSATILE BUILDING TECHNIQUE IN TRANSISTORISED HI-FI

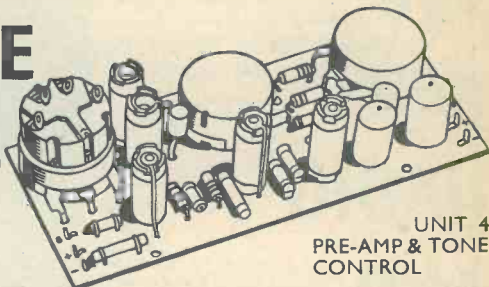

UNIT 4
PRE-AMP & TONE
CONTROL

FOR TAPE ENTHUSIASTS

MARTIN RECORDAKITS enable you to build a complete quality recorder or pre-amp for use between deck and hi-fi installation. These kits have won untainted praise in the technical press for their value, design and efficiency.

With these kits, you can build a transistorised hi-fi assembly and then enlarge it by adding further Martin Audiokits. At the same time, you go on using the equipment with which you started. Should you change to a quite different type of pick-up, for example, you can match your existing Audiokit to it instantly and thereby save pounds. If you choose to convert to stereo, you can double the entire system quite simply whilst retaining much of the original material. Connections are standardised throughout, using printed circuit boards for which front enclosures plates are available according to the combination of units selected. Kits are complete down to the last detail and include modern style knobs, full instructions, etc.

- UNIT 1 5 stage matching input selector .. £2. 7.6.
- UNIT 2 Pre-amp and master volume control £1.17.6.
- UNIT 3 3-Channel mixer £3.19.6.
- Plug-in adaptors for same, each 8.6.
- UNIT 4 Combined pre-amp and tone controls £3. 2.6.
- UNIT 5 10 watt amplifier £5.12.6.
- UNIT 6 Mains power supply unit .. £2.12.6.

TRADE ENQUIRIES INVITED

MARTIN ELECTRONICS LTD

154-155 HIGH STREET,
BRENTFORD, MIDDLESEX
Telephone ISL 5885/1161

MARTIN ELECTRONICS

Details of your Audiokits please

Details of your Recordakits please

Name

Address

SUPERHET RADIO CHASSIS

These well-made chassis were made for the Government for Forces entertainment with 6K8, 6K7, 6Q7, 6V6. Choke smoothing slow-motion tuning, printed scale, 200-550 metres. Brand new, complete with valves & 6 volt power pack. Cabinet with 8" speaker to fit. Complete in maker's cartons. 79/11 P. & P. 5/-



WIRELESS SET NO. 38 ASV

A lightweight walkie-talkie with transmitting range 5 to 10 miles and frequency coverage 7.4 to 9 Mc/s. Operates from 3 and 120V external dry batteries. Large, clearly numbered tuning control with tuning lock. In good condition, ONLY 39/6. Plus 5/- P&P.



TEST SET TYPE 46

Will radiate a continuous note. Range 1,250 kc/s-23,500 kc/s (12-240 m.). 5 switched bands. Contains VR21 valve and a precision slow motion tuning unit enclosed in grey metal case, rod aerial base on side, good condition. Power requirements 2V, 90-120V. Battery space provided. 49/6 P. & P. 5/-

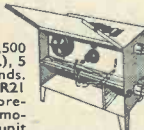

COMPONENTS

- SMOOTHING CHOKES.** 100mA, 10-20H, resistance 450Ω. Sturdy metal case. P. & P. 2/6 4/11
- SMOOTHING CONDENSERS.** T.C.C. metal enclosed block condenser, 4", 2 1/2", 1 1/2", with terminals. 8mF, 350V working. Suitable for cross-over units. P. & P. 1/6 3/11
- MAINS TRANSFORMER.** Mains standard primary 250-0-250V 80mA, 6.3V at 4A, 5V at 2A. Both tapped at 4V. P. & P. 2/6 Each 18/11 As above 350-0-350V sec. P. & P. 2/6 19/11
- FILAMENT TRANSFORMERS.** 250-25V 50 c/s primaries. 6.3V at 2A. P. & P. 1/3 6/11
- PAXOLIN TAG STRIPS** (14 tags). Double way. P. & P. 6d. Each 1/3
- 7-WAY TAG STRIP.** P. & P. 1/3 Each 9d.
- PANEL MOUNTING FUSE HOLDERS.** Beautifully made, plastic sturdy construction. P. & P. 6d. Each 2/11
- ELECTROLYTIC CONDENSERS.** .05μF T.C.C. 500V working. P. & P. 3d. Each 1/-
- OCTAL MOULDED VALVE-HOLDERS.** 6d., 3 for 1/3; 807 valveholders, 9d., 3 for 2/-; 87G valveholder, ceramic moulded with screening skirt, 9d., 3 for 2/-. P. & P. on each 3d.
- CONDENSERS.** Variable condenser solid dielectric, .0005μF. P. & P. 9d. 3/3

- TRIMMERS.** .750pF max. P. & P. 3d. 9d.
- CONDENSERS.** 50μF electrolytic reversible, 12V working. P. & P. 3d. 1/3
- 1μF CONDENSERS.** 130V working. Suitable as suppressors. 1/11 P. & P. 9d. 470pF, 10 tolerance, 500V working, 7d. P. & P. 3d.

ELECTRONIC CONSTRUCTION KITS

8 Radio Circuits including Morse practice set. (No soldering necessary). 49/11 Past free. All components & headphone provided.

NO. 19 TRANSMITTER-RECEIVER

Trans/Receiver covers 2-8 Mc/s (150-37 metres in two bands). Has an intercom. amplifier. Designed for 12 and 24 volts operation. Uses a 6-valve superhet receiver, i.f. being 465 kc/s, and a 6-valve transmitter designed for voice and c.w. operation. Incorporates test and tuning meter for voltages, aerial loading and current tests. Panel controls: frequency tuning, p.a. tuning, gain control, MCW, CW, R/T switch. Het-tone netting. Off-on quench aerial. 1 AVC, LT-HT-drives test. ONLY 47/6. P. & P. 5/- Instruction handbook 3/6

PERSONAL CALLERS WELCOME AT OUR NEW BRANCH BELOW:



SONA ELECTRONIC CO (DEPT RC3)
BRIGGATE HOUSE, 13 ALBION PLACE, LEEDS, 1 TEL: 34703

TERMS: Cash with order. 5/- extra on C.O.D. Orders

TRANSISTOR SALE

- Mullard OC44 (P. & P. 3d.) 3/11
- Mullard OC45 (P. & P. 3d.) 3/11
- Mullard OC71 (P. & P. 3d.) 2/11
- Mullard OA90 (P. & P. 3d.) 1/11
- Ediswan XD202 Germanium diodes (P. & P. 3d.) 1/11
- Transistor Holder, 3-pin (P. & P. 3d.) 11d. each

MICRO-ALLOY TRANSISTORS

- Mat 100.....7/9
 - Mat 101.....8/6
 - Mat 120.....8/6
 - Mat 121.....7/9
 - Mat 122.....8/6
- Above MATs postage paid.
Ferrite Slab Aerials, suitable for transistor sets 3/- P. & P. 6d.

R.F. FIELD INDICATORS

Designed for checking the radiation from a transmitting antenna. The sensitivity can be controlled by adjustment of panel control, the antenna length or by increasing distance from the radiator. Frequency range 1-250 Mc/s, 200mA D.C. 69/6. Complete with instruction book.

VERNIER DIAL

Precision vernier dials with approx. 8 to 1 ratio. Surface mounting. Accurately centred metal insert for 1/2" shaft. Reads counter clockwise 0-1 in 180°. Model T.501, 1 1/2" dia. 12/6
Model T.502, 2" dia. 14/-
Model T.503, 3" dia. 16/-

HOOVER ROTARY TRANSFORMERS

12V input, 500V output at 65mA or 6V input, 250V output at 75mA
PRICE 9/11 P. & P. 3/6



SMALL ADVERTISEMENTS

Rate: 9d. per word.

Minimum charge 12/-.
 Box No. 2/- extra.

Advertisements must be prepaid and all copy must be received by the 4th of the month for insertion in the following month's issue. The Publishers cannot be held liable in any way for printing errors or omissions, nor can they accept responsibility for the bona fides of advertisers. (Replies to Box numbers should be addressed to: Box No. —, The Radio Constructor, 57 Maida Vale, London, W.9.)

DIRECT TV REPLACEMENTS LTD. Largest stockists of TV components in the U.K. Line output transformers, Frame output transformers, Deflector coils for most makes. Official sole suppliers for many set makers. Same day despatch service. Terms C.O.D. or C.W.O. Send S.A.E. for quotes. Day and night telephone: Gipsy Hill 6166.—126 Hamilton Road, West Norwood, London, S.E.27.

METALWORK. All types cabinets, chassis, racks, etc., to your specifications.—Philpott's Metalworks Ltd., Chapman Street, Loughborough.

THE INCORPORATED PRACTITIONERS IN RADIO AND ELECTRONICS (I.P.R.E.) LTD. Membership conditions booklet 1s. Sample copy of I.P.R.E. Official Journal 2s. post free.—Dept. D, Secretary, 32 Kidmore Road, Caversham, Reading, Berkshire.

SERVICE SHEETS for all makes Radio/TV, 1925-1963. Prices from 1s. with free fault-finding guide. Catalogue 6,000 models, 1s. 6d. S.A.E. enquiries. All types of modern/obsolete valves. Books. Components. S.A.E. lists.—Hamilton Radio, 13 Western Road, St. Leonards, Sussex.

CATALOGUE No. 15. Government surplus electrical and radio equipment. Hundreds of items at bargain prices for the experimenter and research engineer, 2s. 6d. post free. Catalogue cost refunded on purchase of 50s.—Arthur Sallis Radio Control Ltd., 93 North Road, Brighton.

S.E.S. SERVICE SHEETS for all TV, Radio, including transistors, tape recorders, echo units, amplifiers, record players, autochangers, etc. Also various domestic appliances. List 1s. S.A.E. Mail order only.—Sun Electrical Services, 38 St. George's Road, Hastings.

IF YOU ARE a self employed TV Service Engineer wishing to increase your profits by at least 25% and receive free technical information, send s.a.e. for details to—Box No. F194.

FIND TV SET TROUBLES IN MINUTES from that great book *The Principles of TV Receiver Servicing*, 10s. 6d., all book houses and radio wholesalers. If not in stock, from—Dept. D, Secretary, 32 Kidmore Road, Caversham, Reading, Berkshire.

continued on page 501

BENTLEY ACOUSTIC CORPORATION LTD

38 CHALCOT ROAD CHALK FARM LONDON NW1
 THE VALVE SPECIALISTS Telephone PRIMROSE 9090
 ALL GOODS LISTED BELOW IN STOCK

OA2	4/6	7B6	12/6	BL63	10/6	EL85	7/-	PY88	8/-	MIDGET	250
OB2	6/-	7B7	7/-	CCH35	12/6	EL86	7/6	PY800	6/6	SILICON	volt at 1
OZ4GT	4/3	7C5	10/-	CL33	11/6	EL91	2/6	PY801	6/6	RECTIFIERS	amp. No larger
IA4GT	8/-	7C5	5/9	Y331	5/9	EL95	5/6	R10	34/11	Mullard	than a
IC5	6/3	7H7	5/9	DAF96	5/9	EL360	27/-	R18	10/6	BY100	shirt button!
IG6	6/-	7R7	12/6	DF66	15/-	EL220	16/4	R19	7/-		7/6 each
IHS5T	8/-	7Y4	5/-	DF96	5/9	EL880	20/5	T41	9/-	Output 250	
IL4	2/3	98W6	9/6	DF97	10/-	EM4	17/9	TDD4	8/3	amp. No larger	
ILDS	4/3	10C1	9/3	DH76	3/6	EM71	13/6	TH41	13/-	than a	
ILN5	4/6	10C2	12/3	DK40	18/8	EM80	6/3	TH233	6/9	shirt button!	
IN5GT	8/6	10D2	10/6	DK92	6/9	EM81	7/-	TP2620	17/6		
IR5	4/-	10F1	10/-	DK96	6/3	EM84	6/9	TY86F	11/8		
IS4	5/-	10LD11	9/-	DL68	15/-	EM85	8/-	U12/14	7/6	TRANSIS-	
IS5	3/6	10P13	8/3	DL96	5/9	EM87	15/2	U16	8/9	TORS &	
IT4	2/3	10P14	11/6	DLS10	10/6	EN31	45/-	U18/20	6/6	DIODES	
IU4	5/9	12A6	2/3	DH70	5/-	EY51	5/9	U19	48/6		
IU5	5/3	12AC6	8/6	DY86	7/-	EY81	7/3	U22	6/-	AA129	4/6
2D21	5/6	12AD6	9/6	E80F	24/-	EY83	9/3	U24	12/6	AC107	14/6
2X2	3/-	12AE6	8/-	E83F	24/-	EY84	10/6	U25	8/6	AC127	9/6
3A4	3/9	12AH8	9/-	E88CC	10/-	EY86	5/9	U26	7/6	AD140	25/-
3A5	6/9	12AT6	4/6	E180F	19/6	EY88	8/9	U31	7/-	AF102	27/6
3B7	5/9	12AV5	3/6	EABC80	5/6	EZ40	3/3	U33	13/6	AF173	11/-
3D6	4/-	12AV6	6/6	EAC91	3/3	EZ41	6/-	U35	16/6	AF115	10/6
3Q4	5/3	12BA6	5/9	EAF42	6/9	EZ80	4/-	U37	23/3	AF116	10/-
3Q5	7/-	12BE6	4/9	EB41	4/9	EZ81	4/-	U45	15/6	AF117	5/6
3S4	4/9	12BH7	6/9	EB91	2/3	EZ32	7/6	U76	4/9	AF118	20/-
3V4	5/6	121GT	7/3	EB41	6/6	EZ33	17/6	U107	17/6	AF127	9/6
3R4GY	1/2	12CA5	10/-	EB51	6/2	EZ34	10/-	U131	9/6	BYZ1	11/6
5T4	7/-	12K7GT	3/6	EBF80	5/6	EZ37	17/6	U282	13/6	AF100	7/9
5U4G	4/6	12K8GT	9/-	EBF83	7/3	HABC80	9/9	U301	11/3	MAT101	8/6
5V4G	7/6	12Q7GT	3/6	EBF89	6/3	HL2	7/6	U329	9/6	MAT120	7/9
5Y3GT	4/3	12SA7	6/9	EBL21	8/-	HL41DD	8/6	U403	9/9	MAT121	8/6
5Z3	8/-	12SC7	4/-	EC70	4/9	HL42DD	8/6	U404	6/-	OA5	6/-
5Z4G	7/3	12SK7	3/-	EC81	27/6	HL309	25/-	U801	16/3	OA10	8/-
6A8G	6/6	12R27	8/9	EC92	6/6	EZ37	17/6	U282	13/6	AF100	7/9
6AG5	2/9	19AQ5	7/6	ECC32	4/-	HVR2A	8/9	UABC80	5/6	OA73	3/-
6AK5	5/-	19H1	6/-	ECC34	21/7	KT33C	4/-	UAF42	7/6	OA79	3/-
6AT5	5/9	20D1	10/-	ECC35	5/9	KT36	29/11	UBC41	6/3	OA81	3/-
6AT6	3/9	20F2	11/6	ECC40	7/-	KT41	7/6	UBC81	6/3	OA85	3/-
6AU6	5/3	20L1	12/6	ECC81	3/6	KT44	5/-	UCF80	5/9	OA86	4/-
6AV6	5/6	20P1	6/6	ECC82	4/6	KT61	6/9	UBF89	6/9	OA90	3/-
6B8G	2/6	20P3	12/-	ECC83	4/6	KT66	13/6	UCF92	6/9	OA91	3/-
6BA6	4/6	20P4	13/6	ECC84	5/9	KT88	28/-	UCC84	9/-	OA95	3/6
6BE6	4/9	20P5	12/3	ECC85	6/3	LP12	9/6	UCC85	6/6	OA120	9/6

We require for prompt cash settlement all types of valves, loose or boxed, but must be new. Send list of types available for offer by return.

6BH6	5/3	25A6G	7/6	ECC88	10/-	MHL4	7/6	UCF80	8/9	OA211	13/6
6B16	5/6	25L6GT	6/-	ECC189	10/6	MKT4	17/6	UCH21	8/6	OC16W335	6/6
6BQ7A	7/6	25Z4G	6/6	ECC804	16/4	MU14	4/6	UCH42	7/-	OC19	25/-
6BR7	8/6	25Z5	7/3	ECF80	6/-	N37	23/3	UCH81	6/6	OC22	23/6
6BR8	9/3	27SU	23/3	ECF82	6/3	N38	26/-	UCL82	7/9	OC23	57/-
6BW6	6/9	28D7	6/9	ECF86	11/6	N39	15/-	UCL83	8/6	OC25	12/-
6BW7	5/6	30C15	9/-	ECH21	10/-	PABC80	6/9	UF41	6/9	OC26	25/-
6C5	4/-	30C18	10/6	ECH35	6/3	PC86	10/6	UF42	5/-	OC28	12/6
6C9	10/9	30F5	5/9	ECH42	6/6	PC88	14/7	UF80	6/6	OC29	25/6
6CD6G	18/-	30FL1	9/3	ECH81	5/9	PC95	11/8	UF85	7/-	OC35	18/-
6CH6	5/-	30FL12	11/-	ECH83	6/6	PC97	7/9	UF86	8/6	OC36	21/6
6D3	9/6	30L15	9/3	ECH84	9/6	PC84	5/6	UF89	6/-	OC41	8/-
6E2	3/-	30P4	12/3	EL90	6/6	PC86	8/6	UL41	6/9	OC42	8/6
6E5	9/6	30P12	7/6	ECL82	7/-	PCC88	10/6	UL44	23/3	OC43	12/6
6F1	9/6	30P19	12/3	ECL83	9/9	PCC89	7/6	UL46	8/6	OC44	8/3
6F6G	3/9	30PL1	8/6	ECL86	8/9	PCC189	10/6	UL84	6/-	OC44PM11	1/-
6F13	4/9	30PL3	9/6	EF22	6/9	PCF80	5/6	UM14	15/2	OC45	8/-
6F23	9/-	30PL14	12/6	EF36	3/3	PCF82	6/3	UM134	16/10	OC45PM10	10/6
6F24	9/6	30P4	12/3	EF37A	5/6	PCF84	8/6	UL41	8/6	OC63	22/6
6F33	3/6	35L6GT	6/9	EF39	3/9	PCF86	7/9	URIC	6/6	OC66	25/-
6J5G	3/-	35W4	4/9	EF40	8/3	PL82	6/6	U06	9/-	OC70	6/6
6J6	3/-	35Z3	16/4	EF41	6/9	PCL83	7/9	U08	11/6	OC71	3/6
6J7G	4/6	35Z4GT	4/9	EF42	4/9	PCL84	7/-	U09	5/6	OC72	8/-
6K7G	1/3	35Z5GT	5/9	EF73	5/-	PCL85	7/6	Y1N	10/9	OC73	16/-
6K8G	3/3	35C5	6/6	EF80	4/-	PCL86	8/9	Y21	8/-	OC74	8/-
6K25	12/-	30L6GT	6/3	EF83	9/9	PCL88	12/6	U41	4/6	OC75	8/-
6L1	10/-	52KU	14/6	EF85	4/9	PEN46	4/3	Y85	5/-	OC76	8/6
6L6G	6/6	72	6/6	EF86	6/9	PEN383	11/6	VP4	14/6	OC77	12/-
6L7GT	4/6	78	4/9	EF89	4/3	PL33	9/-	VP48	20/5	OC78	8/-
6L18	10/-	80	5/3	EF91	3/-	PL36	8/-	VP13C	7/-	OC81	4/-
6LD20	5/6	85A2	8/6	EF92	2/6	PL38	16/-	VP23	2/6	OC81D	4/-
6N7GT	11/-	90AG	6/6	EF97	11/6	PL81	6/9	VP133	9/9	OC82	10/-
6P28	11/6	90AV	6/6	EF98	10/-	PL82	5/3	VR105	5/6	OC83	6/6
6Q7G	4/6	90CG	42/-	EF183	7/9	PL83	5/3	VR150	5/-	OC84	8/-
6R7G	5/9	90CV	42/-	EF184	7/9	PL84	5/6	W76	3/6	OC139	12/-
6S17	5/-	90C1	16/-	EK32	6/-	PM84	9/3	W81M	5/9	OC140	19/-
6SN7	4/-	150B2	16/6	EL32	3/6	PX4	9/-	X41	15/-	OC170	8/6
6U4GT	8/6	183BT	34/11	EL33	3/9	PX25	8/6	X61	6/6	OC71	9/-
6U5G	5/-	5763	7/6	EL34	9/6	PY31	6/6	X65	5/6	OC200	10/6
6U7G	7/-	AC6PEN	4/9	EL38	12/-	PY32	8/6	X76M	9/-	OC201	29/-
6V6G	3/9	AC/TP	18/-	EL41	7/3	PY33	8/9	X78	26/-	OC203	14/-
6V6GT	5/6	AZ1	5/9	EL42	7/6	PY80	5/-	X79	20/6	OCPT71	17/6
6X4	3/9	AZ31	6/6	EL81	8/3	PY81	5/-	XH(1.5)	6/6	TS2	12/6
6X5	4/6	AZ41	6/9	EL82	6/9	PY82	4/9	Y63	5/-	TS3	13/6
6/30L2	8/-	B36	4/9	EL84	4/9	PY83	5/9	Z66	8/-	XA103	11/-

All goods new and first grade only, subject to makers' full guarantee. We do not sell second-hand goods, manufacturers' rejects or seconds (as described as "new and tested"), nor items from second-hand equipment. Complete catalogue of over 1,000 valves, also resistors, condensers, metal rectifiers, microphones, loudspeakers, etc., with terms of business, 6d.

Terms of business: Cash with order or C.O.D. only. Post 6d. per item. Orders over £3 post free. C.O.D. 3/6 extra. All orders despatched same day. C.O.D. orders by telephone accepted for immediate despatch until 3.30 p.m. Any parcel insured against damage in transit for 6d. extra. We are open for personal shoppers 8.30-5.30. Sats. 8.30 a.m.-1 p.m.

THE MODERN BOOK CO

Understanding Television. By J. R. Davies. 37s. 6d. Postage 1s. 6d.

Radio and Line Transmission. By G. L. Danielson and R. S. Walker. Vol. 1, 21s. Vol. 2, 22s. 6d. Postage 1s. each.

A Beginner's Guide to Radio. By F. J. Camm. 7s. 6d. Postage 6d.

The Radio Amateur Operator's Handbook. A Data Publication. 4s. 6d. Postage 6d.

Magnetic Recording Handbook. By R. E. B. Hickman. 27s. 6d. Postage 1s.

Cabinet Handbook. By G. A. Briggs. 7s. 6d. Postage 6d.

Service Valve Equivalents. An R.S.G.B. Publication. 3s. Postage 6d.

Electronics Experiments and Projects. By L. Buckwalter. 25s. Postage 9d.

Frequency Divider Organs. By A. Douglas. 25s. Postage 1s.

How to Build Tiny Electronic Circuits. By M. Moses. 30s. Postage 1s.

Understanding Amateur Radio. By A.R.R.L. 18s. Postage 1s. 3d.

Getting Started With Transistors. By L. E. Garner, Jr. 28s. Postage 1s.

Modern Tape Recording and Hi-Fi. By K. Peters. 30s. Postage 1s.

Radio Valve Data, 7th Ed. Compiled by "WW" 6s. Postage 10d.

Tape Recording Year Book, 1964. 7s. 6d. Postage 6d.

Amateur Radio Call Book, 1964. By R.S.G.B. 4s. 6d. Postage 6d.

We have the Finest Selection of British and American Radio Books in the Country

19-21 PRAED STREET (Dept RC) LONDON W2

Complete Catalogue 1s.

Telephone PADdington 4185

LATEST HIGH QUALITY COMPONENTS FROM THE MAXI-Q RANGE . . .

TESTED AND TRIED OVER 5 FREQUENCY RANGES

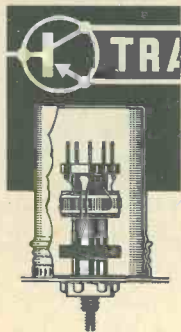

TRANSISTOR

DUAL PURPOSE COILS

Coils for transistor superhets or converters, with or without an R.F. stage and using 465 kc/s or 1.6 Mc/s I.F.

- ★ Noval B9A Based for Plug-in application—Screw threaded for Chassis application.
- ★ Formers moulded in low-loss polystyrene for best results.
- ★ Each coil is packed in an aluminium container which may be used as a screening can.
- ★ Brass threaded adjustable iron-dust cores.

The following colour code identifies the coils:

BLUE—Aerial coil with base input winding.

YELLOW—Interstage R.F. coil with couplings.

RED—Oscillator coil for 465 kc/s I.F.

WHITE—Oscillator coil for 1.6 Mc/s I.F.

PRICE 4/9 each.

Coverages: Range 1T—15/4 Mc/s; 2T—.515/1.545 Mc/s; 3T—1.67/5.3 Mc/s; 4T—5/15 Mc/s; 5T—10.5/31.5 Mc/s.

Full technical details now included in Technical Bulletin DTB.4—1/6d.

I.F.T.13 Miniature 465 kc/s I.F. Transformer . . . 7/6d. each

GENERAL CATALOGUE covering full range of components send 1/6d. in stamps.

I.F.T.14 Miniature 465 kc/s Last I.F. Transformer 7/6d. each

PLEASE SEND S.A.E. WITH ALL OTHER ENQUIRIES.

I.F.T.16 Miniature 1.6 Mc/s I.F. Transformer . . . 6/6d. each

I.F.T.17 Miniature 1.6 Mc/s Last I.F. Transformer 6/6d. each

DENCO (GLACTON) LTD (DEPT. R.C.) 357/9 Old Road Clacton-on-Sea Essex

SMALL ADVERTISEMENTS

continued from page 499

PROFESSIONAL HAMMER FINISH for your instrument panels, brackets, etc. A really beautiful effect, easily applied by brush. Air dries in 20 minutes. 2½oz tin 3s. 6d., post free. Pewter, green or blue. Trade enquiries invited.—Finnigan Speciality Paints, 5 Stanley Square, Stalybridge, Cheshire.

FOR DISCERNING ENTHUSIASTS. Prompt service. New quality components. Post free over 10s. otherwise 6d. please. C.W.O. R53 thermistors 21s. Mullard semiconductors including industrial range, e.g. GET880 (low noise) 10s. 6d.; OC83 6s.; OC139 (n.p.n.) 12s.; OC200 (silicon) 10s. 6d. Zener diodes from 7s. Mullard miniature electrolytic capacitors 1s. 5d. to 1s. 11d. each. Miniature foil: 30V 0.01μF 7½d.; 0.022μF and 0.047μF 9d.; 0.1μF 11d. Texas and R.C.A. semiconductors available to order—some in stock. For W.W. 3 watt amplifier: 2N215 19s. 9d.; 2N217 7s. 3d.; 2N647 12s.; 2N1184 25s. 6d.; 1N2326 5s. 6d.; set of 7 90s. Printed circuit board, materials and instructions. Erie 1/10 watt 10% resistors 9d. each. Please send s.a.e. for list.—J. Williams & Co., 208 Hagley Road, Birmingham 16.

FOR SALE. R1155B. Virtually rebuilt and fully mains modified. Superb working condition. Speaker included. Offers?—Box No. F195.

FOR SALE. Newnes *Radio and Television Servicing*, 9 volumes, pre-1955–1963, £12. Also hi-fi transistor amplifier, pre-amplifier and power supply. 10 watts into 3 ohms. 0.25% distortion, 45 c/s–20 kc/s, £10.—S.A.E. to Warrington, 12 St. Alphege Court, Colindale Lane, London, N.W.9.

FOR SALE. Bound volumes *The Radio Constructor* Nos. 10, 11, 12, 13, 14 and 15. Unbound Vol. 16 and up to December 1963. Offers?—Box No. F196.

FOR SALE. Class "D" wavemeters with instructions, phones and spares, £5. Precision signal generators 445-485 kc/s, ideal s.s.b. work, £8. Cossor 1059 double beam oscilloscope, £32. All carriage paid. Other equipment s.a.e. for details.—G3LMR, 112 Groby Road, Glenfield, Leicester.

WANTED in South-west London. Electro/mechanical engineer with small lathe, etc., to assist development specialised servo mechanism.—Box No. F197.

WANTED. 9.5mm cine film projector in working order. Would exchange Philips 3 speed record player, 4 watt amplifier and 8in speaker for same.—Box No. F198.

FOR SALE. Quantity of new accumulators. Varley type VPT 9/17. 2 volt, 11 amps. hrs. at 1 hr. rate. Willard Radio-20-2, 2 volt, 5s. each, plus carriage.—Box No. F199.

FOR SALE. Valves: 6B8, 6SK7, at 2s. 6AG5, 6AT6, 6J6, 1625, at 4s. 6AK6, 6BW6, DAF91, DK91, DL92, EB91, EF92, EL41, EL91, 12AT7, at 5s. EF40, 6AS7, 6BR7, KT66, at 9s. QVO4/7, 5B/254M, at 14s.—Box No. F200.

continued on page 503

OSMOR

PRICE LISTS & INFORMATION ON

Various Designs in

Practical | Radio | Wireless | R.S.G.B.
Wireless | Constructor | World | Bulletin

SEND 6d. POSTAGE FOR



CIRCUITS

OSMOR LTD

418 BRIGHTON ROAD
S. CROYDON SURREY
Telephone CRO 5148

20 SUGGESTED CIRCUITS

by G. A. FRENCH

No. 15 in our Data Book Series. This book contains the first 20 circuits to be published in the very popular series of the same name appearing in *The Radio Constructor*.

The contents include: simple and inexpensive two-valve capacity bridge, short wave re-generation preselector, one-valve speech operated switching circuit, transformer ratio analyser, series noise limiter, receiver remote mains on-off control, and many others; covering subjects ranging from electronic laboratory equipment to a simple 2-Stage Gram Amplifier.

PRICE 3s. 6d. Postage 4d. 48 pages

Available from your usual supplier, or direct from

DATA PUBLICATIONS LTD
57 Maida Vale London W9

NOW AVAILABLE . . .

PANEL SIGNS TRANSFERS

NEW SERIES

Set 3 Wording—WHITE

Wording for Receivers, Amplifiers, Transmitters, Test Equipment and other Radio Apparatus. Six sheets, over 1,000 words and symbols. 4s 6d. Postage 3d.

Set 4 Wording—BLACK

Wording and symbols as in Set 3. 4s 6d. Postage 3d.

Height of all wording approximately $\frac{3}{32}$ in.

Radio Constructor

PANEL SIGNS
PERMANENT PAINT TRANSFERS

SET 3 WHITE WORDING

Six sheets containing more than 1,000 words and symbols: Amplifiers, Transmitters, Test Equipment, etc. Full instructions for use on back of envelope. 4/6

Radio Constructor

PANEL SIGNS
PERMANENT PAINT TRANSFERS

4 BLACK WORDING

Six sheets containing more than 1,000 words and symbols: Amplifiers, Transmitters, Test Equipment, etc. Full instructions for use on back of envelope. 4/6

Old Series

PS1 and PS2 of the old series have been superseded by the above.

To: Data Publications Limited, 57 Maida Vale, London, W.9

Please supply PS3, PS4, PS5, PS6, at 4s 6d each, postage 3d.

NAME

ADDRESS

(BLOCK LETTERS PLEASE)

Radio Constructor

PANEL SIGNS
PERMANENT PAINT TRANSFERS

SET 5 DIALS

Six sheets containing one large and two medium scales, large horizontal tuning scale, frequencies, 12 control panels (white markings on black background). Full instructions for use on back of envelope. 4/6

Radio Constructor

PANEL SIGNS
PERMANENT PAINT TRANSFERS

6 DIALS

Six sheets containing one large and two medium scales, large horizontal tuning scale, frequencies, 12 control panels (white markings on clear background). Full instructions for use on back of envelope. 4/6

Set 5 DIALS

Six sheets containing one large and two medium Scales, horizontal Tuning Scale, Control Panels (switches, potentiometers and variable capacitors) having white markings on a clear background. 4s 6d. Postage 3d.

Set 6 DIALS

As in Set 5, but the control panels have white markings on a black background. 4s 6d. Postage 3d.

An Exciting New Project!



BUILD a complete TRANSISTORISED C.C.T.V. CAMERA!

Buy it and build it in easy stages with the famous BEUKITS—Kit No. 1 £18.17.6. Spec., principles of vidicon tube, scanning assembly and optical system diagram. Kit No. 2 £16.10.0. Printed circuit board and assoc. components, circuit, diagram, layout instructions and Manual. Kit No. 3 £8.0.0. All transistors and semi-conductors. Kit No. 4 £6.0.0. All metal work. Plus 7/6 P. & P. for each kit. (Kits cannot be split. Inst. Manual cannot be supplied separately).

...and get the most out of it
with a genuine

BEUKIT!

Kit, less Vidicon
and lens
**ONLY
£48**
p. & p. 7/6

THE RADIO CONSTRUCTOR TV Camera is based on the BEULAH design and these are the officially recommended components. Also available factory assembled and tested, with vidicon, less lens, 69 gns.; or with lens and vidicon, 79 gns. Free literature from:

BEULAH ELECTRONICS DEPT. R.C., 126 HAMILTON ROAD,
WEST NORWOOD, LONDON, S.E.27. Telephone GIP 6166 (PBX)

SMALL ADVERTISEMENTS

continued from page 501

JOIN THE INTERNATIONAL S.W. LEAGUE. Free Services to members including Q.S.L. Bureau. Amateur and Broadcast Translation. Technical and Identification Dept.—both Broadcast and Fixed Stations, DX Certificates, contests and activities for the SWL and transmitting members. Monthly magazine, *Monitor*, containing articles of general interest to Broadcast and Amateur SWLs, Transmitter Section and League affairs, etc. League supplies such as badges, headed notepaper and envelopes. QSL cards, etc., are available at reasonable cost. Send for League particulars. Membership including monthly magazine, etc., 21s. per annum.—Secretary, ISWL, 12 Gladwell Road, London, N.8.

THE INTERNATIONAL HAM HOP CLUB is a non-profit-making organisation open to RADIO AMATEURS AND SHORT WAVE LISTENERS. OBJECT: to improve international relationships through an organised system of hospitality. MEMBERS offer overnight hospitality to visiting members, subscription 10s. per annum. ASSOCIATE MEMBERS invite radio amateurs to visit their stations. Associate membership 5s. per annum. FAMILY EXCHANGE holidays arranged, also FRIENDSHIP LINKS between radio clubs. The Club's official journal is free to both Full and Associate Members.—Hon. Gen. Secretary: G. A. Partridge, G3CED, 17 Ethel Road, Broadstairs, Kent.

SPEAKERS BY GOODMAN'S, ELAC, PLESSEY, etc.

4" square	12/-	P & P 1/6
5" round	12/-	1/6
7" x 4" elliptical	13/6	1/6
8" x 5" elliptical	16/6	2/-
10" x 6" elliptical	23/6	2/6

18G STEEL CASES

Finished in superior quality hammer grey with aluminium removable panel on face.

Sloping Front:		
4" x 4" x 4"	10/6	
8" x 5" x 5"	16/-	
12" x 6" x 6"	25/6	

Rectangular Small		
4" x 4" x 2 1/2"	8/6	
6" x 4" x 3"	10/-	
8" x 6" x 3"	12/6	

Rectangular Standard		
10" x 7" x 7"	27/6	
12" x 7" x 7"	34/-	
14" x 7" x 7"	37/6	
14" x 8" x 9"	47/6	
16" x 8" x 9"	52/6	
16" x 8" x 11"	57/6	
19" x 8" x 11"	64/-	
19" x 10" x 11"	66/-	

Postage and Packing extra

OUR FAMOUS READPACKS!

- No. 1 100 resistors 1/4w. to 5w. 10 ohm to 50 meg.
 - No. 2 25 condensers 1pF to 1,000pF 5% to 20%
 - No. 3 20 condensers 1,000pF to 0.01 mfd
 - No. 4 12 condensers 0.01 mfd. to 0.1 mfd
 - No. 5 25 Hi-Stab resistors 1, 2 & 5% 10Ω-25 meg.
 - No. 6 10 w/w Resistors 6 ohm-82K ohm
 - No. 7 4 Carbon controls volume, tone, etc.
- All at 8/6 each POST FREE!

SWITCHES for MULLARD circuits to specification and "Mullard approved".

TR2 2V Pre-Amp	...	12/9
TR3 3V Pre-Amp	...	12/9
TR4 3V Pre-Amp Lo/Pass Filt	...	10/9
TR5 3V Pre-Amp Hi-Pass Filt	...	8/4
TR6 3V Tape Amp Rec/Play...	...	16/6
TR7 3V Tape Amp Eqz	...	7/4
TR8 Tape Pre-Amp Rec/Play	...	16/6
TR9 Tape Pre-Amp Eqz	...	7/4
TR10 Stereo Pre-Amp Selector	...	18/6
TR11 Stereo Pre-Amp Ch/E	...	9/6
TR12 Stereo Pre-Amp Stereo-Mono	...	9/6

P & P 1/- per switch

TELE-RADIO (1943) LTD

189 EDGWARE ROAD, LONDON, W2
PADdington 4455

YOUR CAREER IN RADIO?

Big opportunities and big money await the qualified man in every field of Electronics today—both in the U.K. and throughout the world. We offer the finest home study training for all subjects in radio, television, etc., especially for the CITY & GUILDS EXAMS. (Technicians' Certificates); the Grad. Brit. I.R.E. Exam.; the RADIO AMATEUR'S LICENCE; P.M.G. Certificates; the R.T.E.B. Servicing Certificates; etc. Also courses in Television; Transistors; Radar; Computers; Servo-mechanisms; Mathematics and Practical Transistor Radio course with equipment. We have OVER 20 YEARS' experience in teaching radio subjects and an unbroken record of exam. successes. We are the only privately run British home study Institute specialising in electronic subjects only. Fullest details will be gladly sent without any obligation.

SEND FOR FREE BROCHURE TO:
BRITISH NATIONAL RADIO SCHOOL
DEPT 4, RADIO HOUSE · READING · BERKSHIRE

PANL BLACK CRACKLE PAINT

Give your metalwork a really professional finish.
Easily applied by brush. Air drying.

Available by post from
THE BRUCE MILLER CO. LTD
249 COASTAL CHAMBERS
BUCKINGHAM PALACE ROAD SW1

4/- per 1/2 pint can which includes application instructions, postage and packing

CHASSIS and CASES by



287/9 Edgware Road
London W2
TELEPHONE
PADDINGTON 5891/7595

BLANK CHASSIS—Same Day Service

Of over 20 different forms made up to YOUR SIZE. Order EXACT SIZE you require to nearest 1/16th. (Maximum length 35", depth 4").
Specials dealt with promptly.

SEND FOR ILLUSTRATED LEAFLETS

or order straight away, working out total area of material required and referring to table below which is for four-sided chassis in 18 s.w.g. (for 16 s.w.g. add 1/6th).
48 sq. in. 4/- 176 sq. in. 8/- 304 sq. in. 12/-
80 sq. in. 5/- 208 sq. in. 9/- 336 sq. in. 13/-
112 sq. in. 6/- 240 sq. in. 10/- 368 sq. in. 14/-
144 sq. in. 7/- 272 sq. in. 11/- and pro rata
P. & P. 2/6 P. & P. 2/9 P. & P. 3/-

Discounts for quantities. Finishes arranged for quantities of 25 or over.

FLANGES (1/2" or 3/4"), 6d. per bend.
STRENGTHENED CORNERS, 1/- each corner.
PANELS

Any size up to 3ft x 4/6 sq. ft. 18 s.w.g. (16 s.w.g. 5/3). Plus postage and packing (orders over £2 Post Free).

CASES

ALUMINIUM, SILVER HAMMERED FINISH

Type	Size	Price	Type	Size	Price
U	4 x 4 x 4"	9/6	Y	8 x 6 x 6"	25/-
U	5 1/2 x 4 1/2 x 4 1/2"	14/6	Y	12 x 7 x 7"	39/-
U	8 x 6 x 6"	20/-	Y	13 x 7 x 9"	44/-
U	15 x 9 x 9"	42/6	Y	15 x 9 x 7"	46/-
W	8 x 6 x 6"	19/6	Z	17 x 10 x 9"	63/-
W	12 x 7 x 7"	32/6	Z	19 x 10 x 8 1/2"	67/6
W	15 x 9 x 8"	42/-			

Type W

Type Y

Type Z

Type U

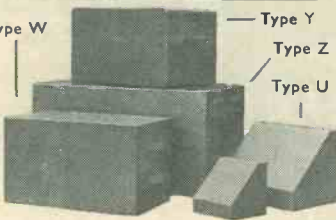

Type Z has removable back and front panels.
Type Y all-screwed construction.

The thrills of VHF Amateur Radio can now be yours for as low as 39/6!—complete kit (by post 2/6 extra)—tuneable range, 70-150 Mc/s. Write today for interesting literature, s.a.e. please. If a newcomer to Short-Wave radio, ask for a free copy of world-famous "Globe-King" S.W. kits and other receivers. Home and Overseas Sales.

Johnsons (Radio) St. Martin's Gate Worcester

BRASS · COPPER · DURAL · ALUMINIUM · BRONZE STAINLESS STEEL

ROD, BAR, SHEET, TUBE, STRIP, WIRE. 3,000 STANDARD STOCK SIZES
No Quantity too small List on application

H. ROLLET & CO LTD
HOWIE ST. LONDON SW11 BATTERSEA 7872
Also at Liverpool, Birmingham, Manchester, Leeds, Glasgow

Quality Components **FOR CONSTRUCTORS**
capacitors, resistors, coils, valves, transistors, controls, chassis, transformers, speakers, pick-ups, cartridges, stylii, and all types of components in stock.

CATALOGUE AVAILABLE ON REQUEST

J. T. FILMER 82 DARTFORD ROAD
DARTFORD KENT
Telephone Dartford 24057



ELECTRONIC ORGAN KIT
For home entertainment, or musical group. Transistor, battery operated, self-contained loudspeaker, two octave. No musical knowledge needed to play. Can be connected to power amplifier if required for a band, etc.
Complete Kit of Parts **79/6** Plus 2/6 p. & p.
Size 12 in. long x 6 in. deep x 3 in. high.
S.A.E. for price of Tremolo parts.

M.D.C. (Sonics) · 43 Rushall Manor Road · Walsall · Staffs

KING TELEBOOSTER

LOWEST NOISE dual band amplifier currently available. SPECIFICALLY DESIGNED for simultaneous boosting on any two channels in Bands I and III. (FM-Booster also available). HIGH RELIABILITY transistorised printed circuit insert. SELF CONTAINED in plastic case 3 1/2" x 3 3/4" x 2". Just plug between aerial and set and switch on. No mains connections. GUARANTEED effectively to boost transmitter power at the set, eliminating entirely or reducing significantly snowy TV pictures in fringe areas.

SPECIFICATIONS

Gain: Typically 18dB Band I and 14dB Band III
Noise Figure: Typically 4dB Band III
Channels: Any one in Band I plus any one in Band III
Power Requirements: 9V at approximately 1 1/4mA (internal PP3 battery)
Price: 75/6 with battery. (P. & P. 2/6 extra).
Please state B.B.C. and I.T.V. channels required.

From: **GORDON J. KING LTD** 6 New Road Brixham Devon
Telephone Brixham 2304

MORSE CODE

Train by the well-known
CANDLER System
of world-wide reputation

YOU TOO CAN BECOME A SKILLED OPERATOR

Learn in your spare time and combine pleasure with success

Special course for Amateur Transmitting Licence. Also courses for Operators

Send 3d. stamp for details: **The CANDLER SYSTEM CO**
Dept. RC, 52b ABINGDON ROAD, LONDON, W.8
Candler System Co., Denver, Colorado, U.S.A.

THE RADIO CONSTRUCTOR

BOUND VOLUMES

VOLUME 16 AUGUST 1962 to JULY 1963

PRICE £1. 10. 0. Postage 2s. 9d.

Where all issues are returned: Price £1. Postage 2s. 9d.

ALSO AVAILABLE

Volume 13, August 1959 to July 1960 £1. 5. 0. postage 2s. 3d.

Volume 14, August 1960 to July 1961 £1. 5. 0. postage 2s. 3d.

We regret Volume 15 is now sold out

DATA PUBLICATIONS LTD 57 MAIDA VALE LONDON W9

TRANSISTORS, CRYSTALS, VALVES, COMPONENTS & EQUIPMENT

FOR THE AMATEUR & PROFESSIONAL—TRADE SUPPLIED—QUOTATIONS BY RETURN

ALL LINES PREVIOUSLY ADVERTISED STILL AVAILABLE FROM STOCK

★ Stethoscope Headsets Mono Crystal or Magnetic, 10/6 Stereo Magnetic, 27/6.
★ New fully retractable car radio aerial, tamper proof (usually 55/-) 35/-, p.p. 1/6.

★ Transistor insulation tester, £17.10.0.

★ Recording tape, Best American and Canadian quality. 5" 600', 12/6; 5" 900', 15/-; 7" 1,200', 18/6. 7" 1,800', 25/-; 2,400' 7", 27/6.

★ 10 watt horn tweeter, 29/6, p.p. 1/6.

★ Portable oscilloscope, £16.10.0.

★ Transistor portable baby alarm, £5.10.0.

★ Signal Injector transistorised, 39/6.

★ High output telephone amplifier, £5.10.0.

★ 4-transistor 1 watt 3Ω 9 volt amplifier kit, 52/6. Built 59/6.

★ 5-transistor 350mW 9 volt 15Ω amplifier, 57/6

★ Large range of TSL pre-built FM units in stock. Also AM and AM/FM units.

★ Panel meters. 50mA, 39/6; 50μA 32/6; 1mA, 5mA, 300 volt, 27/6 each. New miniature types, clear plastic or black moulded fronts—Brand new and boxed.

★ 5 hole chassis punch kit, 49/6, p.p. 1/6.



MULTI-METERS

Multi-range test meters featuring easy to read scales and provided with full operating instructions, lead and batteries. Suitable for amateurs, designers, repair shops, all domestic uses. Full details and specifications in our catalogue.

- ★ PT34, 1kΩ/volt ... £2. 5.0
- ★ M1, 2kΩ/volt ... £2. 9.6
- ★ THL33, 2kΩ/volt (illus.) ... £3.15.0
- ★ EP10K, 10kΩ/volt ... £4. 9.6
- ★ PT1-2, 20kΩ/volt ... £5. 5.0
- ★ TP55, 20kΩ/volt ... £5.19.6
- ★ EP30K, 30kΩ/volt ... £6.19.6
- ★ 500, 30kΩ/volt ... £8.19.6
- ★ EP50K, 50kΩ/volt ... £9.19.6

Crystal Contact Microphone, 12/6. P.P. 9d.
2K, 1/2-track Tape Head, 15/-, P.P. 9d.
Telephone Recording Attachment, 12/6. P.P. 9d.
4-channel Transistor Mixer Unit, 59/6.
Tape Jack Radio Tuner, 29/-, P.P. 1/-.

RUN YOUR RADIO OR AMPLIFIER FROM MAINS BATTERY ELIMINATORS AND CHARGERS

1. For PP3 or equivalent 9 volt Pocket Radio Battery, 18/6. P.P. 1/-.
2. For PP4, PP7, PP9, 9 volt Portable Radio and Equipment. Supplies up to 300mA, 49/6. P.P. 2/-.
3. De Luxe version of No. 1, also charges PP3 type batteries, 24/-, P.P. 1/-.

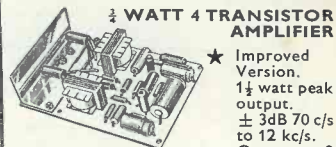

★ Improved Version. 1 1/2 watt peak output. ± 3dB 70 c/s to 12 kc/s. Output to 3 ohm speaker 9 volt operated.

Built and Tested 59/6 OR Kit of Parts 52/6
P.P. 1/6 P.P. 1/6

Details on request.

NEW 8 PAGE TRANSISTOR, RECTIFIER VALVE AND CRYSTAL CATALOGUE 1/- POST FREE
★ PRICE REDUCTIONS — NEW TYPES ALL BRAND NEW STOCKS

TAPE RECORDERS

- ★ COLLARO STUDIO 2-TRACK DECK, £10.19.6. P. & P. 5/-.
 - ★ 4-TRACK DECK, £13.19.6 P. & P. 5/-.
 - ★ CABINET with SPEAKER for above, 5 gns. P. & P. 2/-.
 - ★ RECORD/PLAY AMPLIFIER KITS, 2 track, 11 gns. 4 track, 12 gns.
- Leaflets on Request.

MAINS DECKS

- ★ GARRARD AUTOSLIM, 4 speed changer, £6.10.0.
 - ★ PLUG IN HEAD VERSION, £6.19.6.
 - ★ Stereo Version, £7.10.0.
 - ★ GARRARD AT6 STEREO £10.19.6. Mono £10.10.0.
 - ★ B.S.R. UA14 4 speed, £5.19.6.
 - ★ GARRARD SRP10 or BSR GU7—4-Speed Single Player, £5.5.0.
- All complete with cartridge

BATTERY DECKS

- ★ STAR 45 r.p.m., 39/6. P. & P. 2/6.
 - ★ GARRARD 45 r.p.m., 35/-, P. & P. 2/-.
 - ★ STAR 45 and 33 r.p.m., 92/6.
 - ★ B.S.R. GU7 4 speed, 5 gns. P. & P. 2/6.
- All decks fitted Crystal pick-ups.

MICROPHONES

- Acos 60 Stick Microphone ... 27/6
 - Acos 39-1 Stick Microphone ... 32/6
 - Acos 40 Desk Microphone ... 15/-
 - Acos 45 Hand Microphone ... 25/-
 - Lapel/Hand Microphone ... 12/6
 - DF1 50k with stand ... 52/6
 - DM304 50k or 50 ohm ... 5 gns
 - DM17HL 50k or 50 ohm ... 7 gns
 - 100C Stick with Stand ... 39/6
 - BM3 Stick with Stand ... 52/6
 - Lapel/Hand Magnetic ... 12/6
- Post and Packing 1/6 any type.



★ **NOMBREX ALL TRANSISTOR SIGNAL GENERATOR.** 150 kc/s to 350 Mc/s. AF, RF Mod., etc., £7.18.6, with leads, batt., etc.

★ **NOMBREX TRANSISTORISED RESISTANCE CAPACITANCE BRIDGE.** 1pF to 100 mfd., 1 ohm to 100 meg., leakage test, visual null indicator, £7.2.3, with batt.

★ **NOMBREX AUDIO GENERATOR.** 10 to 100,000 c/s. Sine/square, £15.2.3, with battery.
Post and Packing 2/6 any type.

★ **NOMBREX TRANSISTOR POWER SUPPLY UNIT.** 1 to 15 volts D.C. up to 0.1 amp. 230/250V, A.C. mains, £5.17.6.

★ DETAILED LEAFLETS ON REQUEST ★

MONO/STEREO AMPLIFIERS



Complete with full function pre-amplifiers and controls.
★ SA80 4+4 watts ... £9.10.0
★ SA150 7+7 watts ... £16.10.0
★ SA300 15+15 watts ... £32.10.0

Each amplifier completely self-contained and designed for Mono and Stereo output. Supplied complete with full manual. Leaflets on any type on request.

HI-FI SPEAKERS

- 12" 15 ohms, 12,000 G. ... 35/-
 - 8" 15/16 ohm (8A7) ... 78/6
 - 12" 15/16 ohm (CR30AE) ... 10 gns
- BRAND NEW—GUARANTEED

★ TRANSISTOR POCKET RADIOS

Ready to use complete with Battery, Leather Case, Earphone. P.&P. 2/- any type

- 6-Transistor Zephyr 79/6
- 6-Transistor De Luxe 85/-
- 7-Transistor Zephyr 89/6

7-Transistor M/L/SW—3 waveband £13.19.6
6-Transistor MW/LW £5.19.6.

HENRY'S RADIO LTD

PADDINGTON 1008/9
303 EDGWARE RD., LONDON W2
Open Monday to Sat. 9-6, Thurs. 1 o'clock

PLEASE TURN TO BACK PAGE

SUBSTITUTION BOXES

★ Capacitor Box. Provides 9 standard values from 0.001 to 0.22 mfd. at 600 volt working, 29/6.
★ Resistor Box. Provides 24 standard values at 1 watt. 15 ohms to 10 meg., 37/6.
Each box fully calibrated with insulated leads. Invaluable for service and design.

100 Kc/s QUARTZ CRYSTALS

- 2 Pin: OCTAL or 3 Pin 15/- ea.
 - 500 kc/s 2 Pin ... 15/-
 - 455 kc/s (AR88) ... 12/6
 - 5,000 kc/s 2 Pin ... 10/-
 - 10 Mc/s 2 Pin ... 15/-
 - 27.255 Mc/s ... 15/-
 - HC6U 18 Mc/s to 46 Mc/s 7/6
- 80 frequencies 0.005% Acc.
Over 800 frequencies in stock for all uses.

FIELD STRENGTH METER

Measures transmitter carrier waves from 1 Mc/s to 200 Mc/s in 5 switched fully adjustable ranges. Contains 200μA meter for carrier level and earphone for modulation. Requires no connection to transmitter. Self-contained, ready for use, 69/6, post free.

DEAC Rechargeable Batteries
(a) 18V. 100mA/H 4" x 1" diam. Brand new, sleeved, 30/-
(b) 3.9V 450mA/H. 1 1/2" x 1 1/2" in diam. 12/6 p.p. 1/6. Easily split into any multiple of 1.2 volt. Brand new.

7-TRANSISTOR RECORD/PLAYER /RADIOGRAM AMPLIFIER

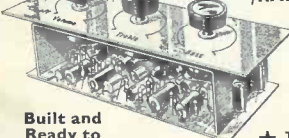

- ★ 4 watt peak output.
- ★ Full Treble and Bass boost and cut.
- ★ 40 c/s to 20 kc/s ± 3dB.
- ★ Inputs for Pick-ups, Radio Tuners, Microphone, Mixers, etc.

★ TWO VERSIONS AVAILABLE

- 12/18 volt for 15 ohm speakers (mains unit now reduced to 60/- extra).
- 9/12 volt for 3 ohm speakers (mains unit 49/6 extra).
- ★ Size only 6" x 2 1/2" x 2".
- ★ Ideal for mains or battery, portable or domestic record player, grams, etc.
- ★ Booklet Free on Request ★

Built and Ready to Use
£5.19.6
P.P. 2/-
(Complete with full descriptive Booklet)

Call for demonstration.

Published in Great Britain by the Proprietors and Publishers Data Publications Ltd. 57 Maida Vale London W9

Printed by A. Quick & Co. (Printers) Ltd. Oxford Road Clacton-on-Sea England

Obtainable abroad through the following Collects Subscription Service Continental Publishers & Distributors Ltd. William Dawson & Sons Ltd. Australia and New Zealand Gordon & Gotch Ltd. Electronics Publications (Australia) South Africa Central News Agency Holland "Radio Electronica"

We can supply from stock most of the components and items specified on circuits published in this and other magazines and radio books. Let us quote for your circuit.

HENRY'S RADIO LTD

303 EDGWARE ROAD LONDON W2
 PADdington 1008/9
 Open Monday to Sat. 9-6. Thurs. 1 o'clock

LATEST CATALOGUE

68 PAGES, 10" x 7 1/2"
 Includes new Transistor, Crystal, Valve, Rectifier Catalogue.
 Fully detailed and illustrated 2/- post free

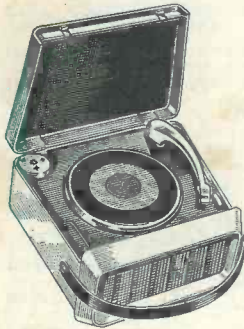

"MINI-GRAM" TRANSISTOR PORTABLE RECORD PLAYER

- ★ Ready Built 4-transistor 1 watt amplifier with elliptical speaker and volume control. 35/- P.P. 2/-.
- ★ 9 volt 45 r.p.m. turntable with Crystal pick-up. 39/6 P.P. 2/6.
- ★ Two-tone moulded case with handle, 5/- P.P. 2/-

Sold as three pre-built units with less than 30 minutes interconnection work. Originally sold at more than double the price. A superb record player, fully portable—the ideal gift for teenager or adult.

OR TOTAL COST **79/6** P.P. 5/-

(Battery 3/9 extra)



'THE CONTESSA'

★ COMBINED PORTABLE AND CAR RADIO ★
 AMAZING SENSITIVITY AND SELECTIVITY ON MEDIUM AND LONG WAVEBANDS

- ★ The easiest Superhet Radio to build on the market. Features clearly-marked printed circuit and packaged components with full illustrated building instructions. Full tuning of medium and long wave bands with unbeatable sensitivity and selectivity. Excellent tone and volume with over 600mW push-pull output.
- ★ Clearly marked horizontal station dial with slow motion tuning. Two colour Blue or Beige cabinets with Gold handles, grilles and fittings. Size 10 3/4" x 7 1/2" x 3 3/8", includes car aerial socket, recording sockets.
- ★ 6 Mullard Transistors and 2 Diodes

TOTAL COST OF ALL PARTS **£9.19.6** P.P. 3/6

All parts sold separately — Guaranteed the Best Obtainable
 ★ Attractive Appearance Quality Performance ★
UNBEATABLE FOR QUALITY AND VALUE
 Fully Detailed and Illustrated Leaflet on request

10 WATT TRANSISTOR HI-FI AMPLIFIER AND PREAMPLIFIER

NEW LOW PRICES

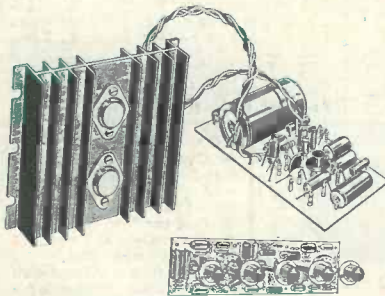

- ★ AVAILABLE IN KIT FORM OR PREBUILT PANELS
- ★ LOW NOISE
- ★ LOW POWER REQUIREMENTS
- ★ MONO OR STEREO

Circuits and details FREE on Request

PERFORMANCE EQUIVALENT TO VALVE AMPLIFIERS OF FOUR TIMES THE PRICE AND MANY TIMES THE SIZE

- ★ Power output 10 watts at 400 c/s. Second harmonic distortion 0.1%. Total harmonic distortion 0.25% at 10 watts. Signal to noise ratio at 10 watts 70 dB. Overall response within 3 dB 40 c/s to 20 kc/s.
- ★ 6-Transistor 10 watt power amplifier. 0.25 ohm output impedance for 3 ohms. 24 volt supply, 300mA average for 10 watts. 100mV into 33 k.ohm sensitivity.
 Built **£5.10.0** P.P. 2/6 or Kit 99/6 P.P. 2/6 (Mains Unit 69/6 P.P. 2/6)
- ★ As above but 10 watts for 15 ohms speakers. 40 volt supply, 150mA average for 10 watts.
 Built **£5.19.6** P.P. 2/6 or Kit **£5.10.0** P.P. 2/6 (Mains Unit 69/6 P.P. 2/6)
- ★ Full function pre-amplifier on printed circuit. Size 9" x 2 1/2". Features 6 position input selector for microphones, tuners, tape, pick-ups—treble and bass controls + 12dB at 50 c/s and 12 kc/s—14dB at 50 c/s and 12 kc/s. Four-position filter and volume controls. 1.5mV input sensitivity. ● Front Panel 8/6 extra ●
 Built **£5.10.0** P.P. 2/- or Kit 99/6 P.P. 2/-

★ CALL FOR DEMONSTRATION—ANY TIME ★

FM TUNER First Again!

See Dec. Edition of Radio Constructor

- ★ 5-Transistor
- ★ 4 Diodes
- ★ Full coverage 87 to 105 Mc/s
- ★ AFC and AVC
- ★ Pre-aligned I.F.T.s.

Printed circuit design of high sensitivity and quality. Output for valve or transistor amplifiers. Size 3 1/2 x 2 1/4 x 4". Simplified building instructions. All parts sold separately.

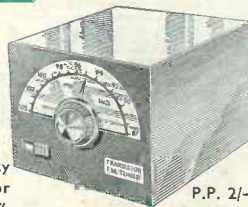

P.P. 2/-
 TOTAL COST **£7.19.6**
 (Cabinet Assembly 20/- extra)

TO BUILD YOURSELF

- | | | |
|--------------------------------------|---|------------------|
| PLEASE
TURN
TO
NEXT
PAGE | ★ Miniranger | £2.9.6 P.P. 1/6 |
| | ★ Quintet M/LW | £3.19.6 P.P. 2/- |
| | ★ Repanco DC/AC Invertor | £3.2.6 P.P. 2/6 |
| | ★ Sinclair Slimline | £2.9.6 P.P. 1/6 |
| | ★ PW-6 Pocket Superhet | £7.19.6 P.P. 2/- |
| | ★ PW Celeste Portable | £9.15.0 |
| | ★ PW Spinette Record Player | £10.19.6 |
| | All TSL, Bernards, Repanco, Sinclair, Osmor, Ardent, etc., components and books in stock. Quotations by return. | |

BOAC VHF Pocket Receivers

- ★ Features 5 transistors (V6/8R—OC44) 2-OA91 diodes VHF detector, OA10 rectifier.
- ★ 1K ohm Stethoscope headset.
- ★ 3.9 volt 450mA/H rechargeable deac cells.
- ★ Moulded case with aerial/strap.
- ★ Full circuit and details.
- ★ Deac separately 12/6, P.P. 1/6.
- ★ Headset separately 15/-, P.P. 1/-.
- ★ Unit without above cell and phone 12/6, P.P. 1/6.



★ Complete with circuit, **35/-** P.P. 2/-.

Ideal for experimental receivers, personnel locators, etc.

4-WAVEBAND COMMUNICATIONS RECEIVER RX60 or SR40

550 kc/s—30 mc/s.—BFO—AVC—'S' meter—noise limiter—Bandspread—Telescopic aerial, etc. Brand new. Detailed leaflet on request. **£24.15.0**

- ★ De Luxe version, 9 valve Superhet, 2 RF Stages, etc. **£42.0.0**
- Leaflets on request ●