

# THE Radio Constructor

RADIO  
TELEVISION  
AUDIO  
ELECTRONICS

VOLUME 16 NUMBER 3  
A DATA PUBLICATION  
PRICE TWO SHILLINGS

**October 1962**

**"Progressive"  
Transistor  
Superhet**

*Also featured*

Electronic Timer with Fast  
Relay Operation

Electrolytic Conditioner  
and Insulation Tester

Car Power Pack for  
Transistor Radios



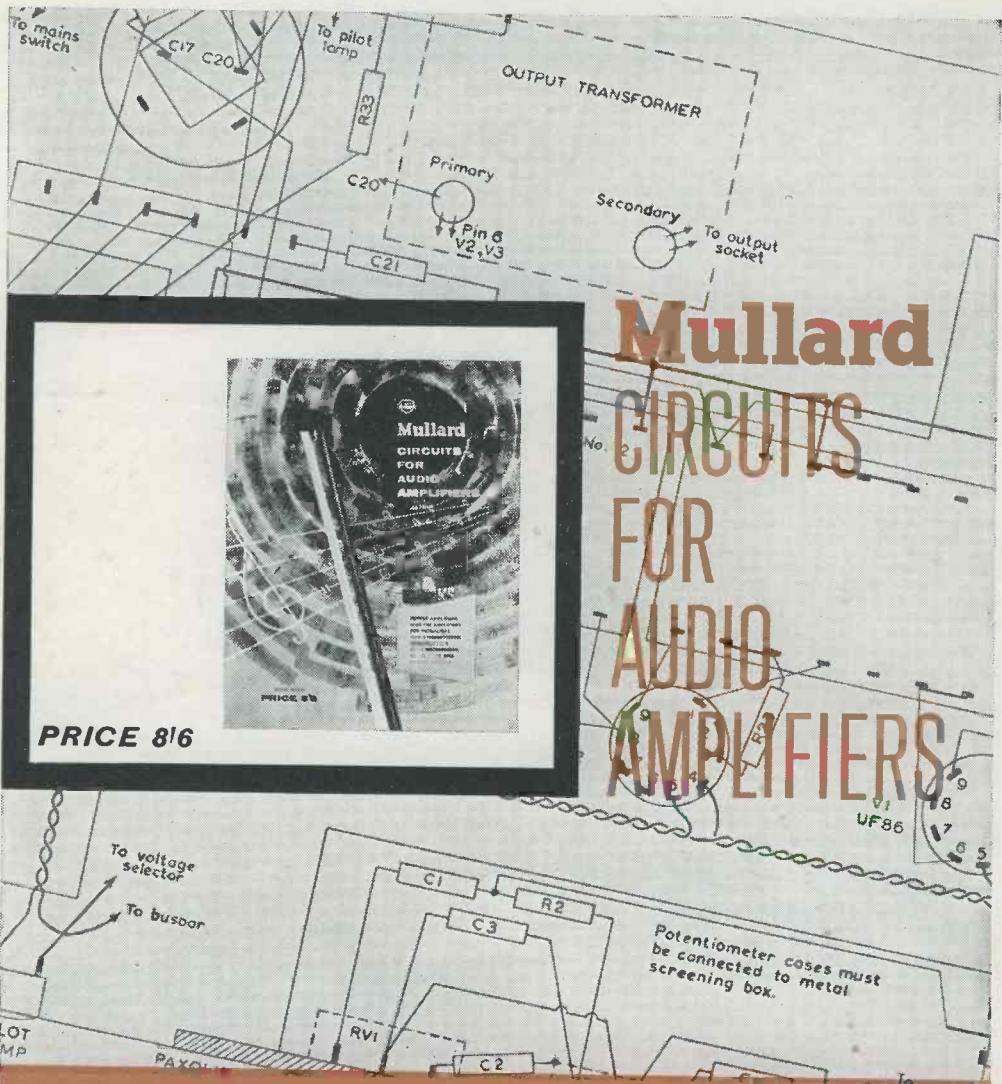

# Mullard CIRCUITS FOR AUDIO AMPLIFIERS



PRICE 8/6

**— A BOOK EVERY ENTHUSIAST WILL WANT!**

This Mullard publication is a practical manual for every audio enthusiast. In addition to describing twelve of the most popular Mullard circuits, it has introductory chapters on many of the theoretical and practical aspects of high quality sound reproduction.

Whether you are interested in disc or tape, monaural or stereo, you will find that "Circuits for Audio Amplifiers" gives you just the sort of information you need.

This informative book costs only 8s. 6d. (U.K. Price). The demand for it is high, so get your copy now from your local radio dealer.

**MULLARD LIMITED · MULLARD HOUSE · TORRINGTON PLACE · LONDON W.C.1**

MVM 3597



# PUSH BUTTON TUNING

## FOR FM RECEIVERS WITH STC TRIPLE CRYSTALS

FM radio is by nature a "local station" service and variable tuning is unnecessary. Switched tuning, instead of variable tuning by dials, is a saving and an attraction to the user.

The STC quartz crystal assembly Type 4434 comprises a trio of quartz elements mounted in a single B7G based glass envelope. The three elements each work on their 5th overtone at 10.7 Mc/s below the radiated frequencies of the three FM transmissions in each area of the United Kingdom. Improved manufacturing techniques and quantity production of crystal units designed specifically for FM application enables STC to offer the units at less than a quarter of the normal cost.



HERMETICALLY SEALED  
B7G STC 4434

STC TYPE	BBC TRANSMITTERS	STC TRIPLE CRYSTAL FREQUENCIES (Mc/s)		
		LIGHT	THIRD	HOME
4434/A	Wrotham	78.4	80.6	82.8
4434/B	Peterborough, Divis and Thrumster	79.4	81.6	83.8
4434/C	Rosemarkie and Llanddona	78.9	81.1	83.3
4434/D	North Hessary Tor	77.4	79.6	81.8
4434/E	Sutton Coldfield	77.6	79.8	82.0
4434/F	Pentop Pike and Rowridge	77.8	80.0	82.2
4434/G	Meldrum and Blaen Plwyf	78.0	80.2	82.4
4434/H	Holme Moss and Orkney	78.6	80.8	83.0
4434/J	Douglas	77.7	79.9	82.1
4434/K	Kirk o' Shotts	79.2	81.4	83.6
4434/L	Llangollen	78.2	80.4	82.6
4434/M	Norwich	79.0	81.2	83.4
4434/P	Les Platons	80.4	83.75	86.4
4434/Q	Oxford	78.8	81.0	83.2
4434/R	Dover	79.3	81.7	83.7
4434/S	Wenvoe	79.25	86.1	81.425 West

The list price of all the above items is £3 15 0 each. For local oscillator circuit diagram and further information ask for leaflet MQ/104.



**Standard Telephones and Cables Limited**

COMPONENTS GROUP

QUARTZ CRYSTAL DIVISION: HARLOW · ESSEX · HARLOW 24212

## SUPERB COMMUNICATION RECEIVERS

**AMERICAN AR88D RECEIVERS.** Fresh release of these renowned sets. 14 valves, 6 wavebands, covering 500 kc/s-32 Mc/s. Incorporate every possible refinement and have internal A.C. mains pack for nominal 115/230V. Thoroughly reconditioned, immaculate in appearance, and in perfect working order. **ONLY £35** (add carriage 30/- and 50/- deposit on returnable transit case). S.A.E. brings illustrated leaflet.

**MARCONI CR. 100/8 COMMUNICATIONS RECEIVER.** Covers 60 kc/s to 30 Mc/s. Complete with all valves, maker's instruction manual, and internal A.C. power unit for 200/250 volts. **BRAND NEW IN ORIGINAL TRANSIT CASES.** Aerial tested before despatch. **ONLY £35** (carr. etc., 40/-). S.A.E. for full details.

## TEST METERS FOR EVERY PURPOSE & POCKET

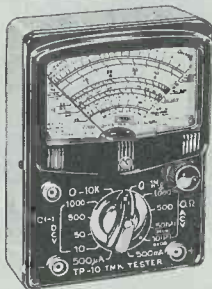

**2,000 O.P.V. MODEL TP-10.** Reads A.C. and D.C. volts up to 1,000; D.C. Current to 500mA; resistance to 1 Meg; Capacitance to 1µF; Decibels from -20 to +36; Output jack for Audio Measurements. Size 3½" x 5" x 1¼". **£3.19.6**

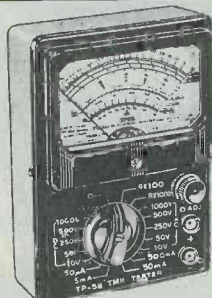

**20,000 O.P.V. MODEL TP-5S.** Reads Voltage up to 1,000; D.C. at 20,000 ohms per volt and A.C. at 10,000 o.p.v.; D.C. Current to 500mA; Resistance to 10 Meg.; Capacitance to 0.1µF; Decibels from -20 to +36. Size 3½" x 5¼" x 1¼". **£5.19.6**

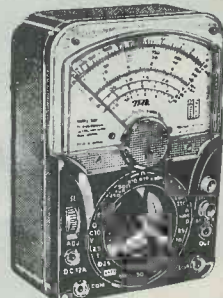

**30,000 O.P.V. MODEL 500.** Volts to 1,000; D.C. at 30,000 o.p.v.; A.C. at 20,000; 12 Amps D.C. Current; 60 Meg. Resistance; -20 to +56 Decibels; Internal buzzer short circuit warning. Size 3½" x 6½" x 2¼". **£8.19.6**

All new stock, with leads, prods & internal batteries. 6 mths. guar. backed by full service facilities. Details S.A.E.

**AMPLIFIER TYPE A1413.** Ex-R.A.F. For normal A.C. mains use. 5Z4 rectification with 6V6 output. Input and output jack sockets, gain control, fully fused. 600 ohms output transformer, easily changed for 3 ohms type. Standard rack mounting size 19" x 7" x 6". Used, good condition. **ONLY 59/6** (carriage, etc., 10/6).

**POWER UNITS TYPE 234.** Primary 200/250V 50 cycles. Outputs o 250V 100mA and 6.3V 4A. Fitted double smoothing. For normal rack mounting (or bench use) having grey front panel size 19" x 7". Fitted input and output voltmeter, 79/6, or model less meter, 59/6 (carriage either type 10/6).

**12 VOLT ALTERNATOR DYNAMOTORS.** Deliver 220 volts at 100mA. Size 5½" x 3½" diameter. Ideal for running Electric Shaver, etc., from car battery. **ONLY 32/6** (post 2/6).

**AVOMETER MODEL 7 LEATHER CASES,** fitted with carrying handle and long strap. **BRAND NEW. ONLY 32/6** (post 2/6).

### PCR COMMUNICATION RECEIVERS

Manufactured by Pye and Philips. One of the Army's most versatile and sensitive sets. RF stage and 2 of IF, using 6 British I.O. type valves. Large 180 degrees. Illuminated and Calibrated Dial. Flywheel tuning with locking device. Aerial trimmer. Tone and volume controls. Band switch from panel jacks for speaker or phones. In black metal case, size 17" L x 8" H x 10" D. Model PCR covers 6-18 Mc/s, 200-550 metres and 850-2,000 metres and has internal 5" speaker. **£6.19.6.** Model PCR2 has similar L & M waveband coverage. Short wave 6-22 Mc/s, but no speaker. Used but excellent condition, **£5.19.6.** Every receiver aerial tested before despatch. Add 10/6 carr. all models. Designed to operate from bulky EXTERNAL power supply, but any set can be fitted with **BRAND NEW COMPONENTS INTERNAL PACK** for 200/250V a.c. at extra cost of **£2.**

S.A.E. FOR ILLUSTRATED LEAFLET

### "P.W." 6 TRANSISTOR PERSONAL RECEIVER



Designed by the technical staff of Practical Wireless: easy to build, using printed circuit and 1st grade Matched Transistors and Diode. Full Medium and Long Wave coverage to internal speakers. All parts sold separately (new components only) enabling you to buy as required, and full detailed price list will be sent on request. Constructional details 1/6. Newly designed OSMOR Cabinet and reduced price. **TOTAL COST INCLUDING BATTERY AND CABINET NOW £7.19.6.** S.A.E. for 7 transistor version.

BATTERY AND CABINET NOW £7.19.6. S.A.E. for 7 transistor version.

### THE "GOOD COMPANION" Mk. II Using transistors, the latest manufacturing technique to save alignment difficulty.

As described in "THE RADIO CONSTRUCTOR", August issue  
**THE FINEST COMBINED PORTABLE and CAR RADIO  
YET DESIGNED FOR THE HOME CONSTRUCTOR**

★ 750mW output.

★ 6 transistors and 2 diodes.

★ Full Medium and Long Wave coverage.

★ Quality speaker.

★ Brilliantly styled 2-tone cabinet, size 11" x 8" x 3".

★ Very fine tuning with calibrated dial.

★ Latest printed circuit. ★ Internal high gain aerial with car aerial socket. Easy to follow construction data (available separately 3/6). All parts sold separately and full illustrated details will be sent on request.

Total Cost **£9.19.6**

With alternative luxury cabinet using 7" x 4" speaker, **£10.19.6.** Either type, plus 5/- post and ins. (Battery 3/6 extra.)

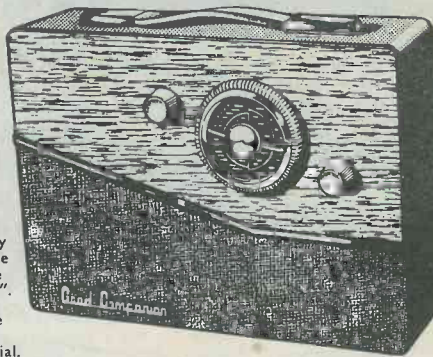

### "POCKET 4" TRANSISTOR RECEIVER

Uses miniature speaker, proper tuning condenser, and volume control. Built-in aerial makes unit efficient and portable. Ideal for the beginner. Full medium wave coverage. All components and case for only **42/6** (p. & p. 2/6). Ten-page constructional book free with parts or separately 1/6. S.A.E. for parts price list.

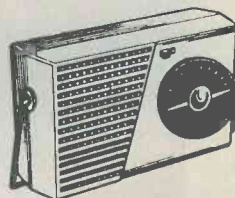

# HARRIS ELECTRONICS (LONDON) LTD

(DEPT. M)  
**138 GRAY'S INN ROAD LONDON WC1**

Telephone **TERminus 7937**

Please include carriage costs on ALL items.  
(Open until 1 p.m. Saturdays.) We are 2 mins. from High Holborn (Chancery Lane Station) and 5 mins. by bus from King's Cross.

**TECHNICAL**

**TRAINING**

*in radio*

*television*

*and*

*electronic*

*engineering*

*with*



The decision is **YOURS**. To be a success in your chosen career; to qualify for the highest paid job . . . to control a profitable business of your own. ICS home-study courses put your plans on a practical basis; teach you theory and practice; give you the knowledge and experience to take you, at your own pace, to the top.

*Choose the RIGHT course.*

**RADIO & TELEVISION ENGINEERING . INDUSTRIAL TELEVISION . RADIO AND TV SERVICING . RADIO SERVICE AND SALES . ELECTRONICS . COMPUTERS AND PROGRAMMING**

ICS provides thorough coaching for professional examinations:

AM BRIT. IRE, City and Guilds Telecommunications.

C. & G. Radio and TV Servicing, C. & G. Radio Amateurs.

P.M.G. Certificates in Radiotelegraphy.

**LEARN AS YOU BUILD**

*Practical Radio Course*

Gain a sound up-to-professional-standards knowledge of Radio and Television as you build YOUR own 4 valve T R F and 5 valve superhet radio receivers, signal generator and high-quality multimeter. At the end of the course you have three pieces of permanent and practical equipment and a fund of personal knowledge and skill . . . ICS Practical Radio courses open a new world to the keen radio amateur.



**THERE ARE ICS COURSES TO MEET YOUR NEEDS AT EVERY STAGE OF YOUR CAREER.**

Post this coupon today: In return you will receive the FREE 60-page ICS Prospectus listing technical examinations and their appropriate ICS courses PLUS details of over 150 specialised subjects.

*Other ICS courses include:*

MECHANICAL, MOTOR, FIRE, CHEMICAL, ELECTRICAL AND CIVIL ENGINEERING, ETC. SELLING AND MANAGEMENT, ARCHITECTURE, WOODWORKING, FARMING, GARDENING, ART, PHOTOGRAPHY.

**Please state subject in which you are interested on coupon.**

**INTERNATIONAL CORRESPONDENCE SCHOOLS**

(Dept. 248) Intertext House Parkgate Road London SW11

NAME.....

ADDRESS.....

OCCUPATION..... AGE.....

SUBJECT..... 10.62

# Heathkit

DAYSTROM



SB-10U



DX-40U



GD-1U



O-12U



S-3U



C-3U



AG-9U

**SINGLE SIDEBAND ADAPTOR, Model SB-10U.** May be used with most A.M. transmitters. Less than 3w R.F. input power required for 10w output. Operation on 80, 40, 20, 15 and 10m bands on U.S.B., L.S.B. or D.S.B. **£39.50**

**AMATEUR TRANSMITTER, Model DX-40U.** Covers all amateur bands from 80 to 10 metres; crystal controlled. Power input 75W C.W., 60W peak controlled carrier phone. Output 40W to aerial. Provision for V.F.O. Filters minimise TV interference. **£33.19.0**

**GRID-DIP METER, Model GD-1U.** Functions as oscillator or absorption wave meter. With plug-in coils for continuous frequency coverage from 1.8 Mc/s to 250 Mc/s. **£10.19.6**

Three Additional Plug-in Coils Model 34-1U extend coverage down to 350 kc/s. With dial correlation curves. **17/6**

**TRANSISTORISED VERSION, Model XGD-1.** Similar to GD-1U. Fully transistorised with a frequency range of 1.8 to 45 Mc/s. **£10.18.6**

**5" OSCILLOSCOPE, Model O-12U.** Has wide-band amplifiers, essential for TV servicing, FM alignment, etc. Vertical frequency response 3 c/s to over 5 Mc/s, without extra switching T/B covers 10 c/s to 500 kc/s in 5 ranges. **£38.10.0**

**2½in. SERVICE 'SCOPE, Model OS-1.** Light, compact portable for service engineers. Dim. 5" x 8" x 14½" long. Wt. 10½lb. **£19.19.0**

**ELECTRONIC SWITCH, Model S-3U (Oscilloscope Trace Doubler.)** Enables a single beam oscilloscope to give simultaneous traces of two separate and independent signals. Switching rates approx. 150, 500, 1,500, 5,000 and 15,000 c/s. Sig. freq. response 0-100 kc/s. +1dB. Separate gain controls and sync. output. Sig. input range 0.1-1.8V r.m.s. **£11.15.6**

**RESISTANCE CAPACITANCE BRIDGE Model C-3U.** Measures capacity 10pF to 1,000µF, resistance 100Ω to 5MΩ and power factor. 5-450V test voltages. With safety switch. **£9.5.0**

**AUDIO SIGNAL GENERATOR, Model AG-9U.** 10 c/s to 100 kc/s, switch selected. Distortion less than 0.1%, 10V sine wave output metered in volts and dB's. **£21.9.6**

**TRANSISTOR INTERCOM, Models XI-1U & XIR-1U.** The master unit uses a 4-transistor amplifier, constructed on a printed circuit board, and an internal 9V battery. Remote stations use a similar battery for call only. Up to five remote units can be ordered for each master.

XIR-1U (remote) **£4.7.6**

XI-1U (master) **£10.19.6**

**SUGDEN MOTOR UNIT "CON-NOISSEUR CRAFTSMAN."** Heavy duty motor operating at 3½ and 45 r.p.m. Very heavy 12" turntable. Virtually no rumble. **£18.3.6**

**AMATEUR TRANSMITTER, Model DX-100U.** The world's most popular, compact and completely self-contained Amateur Transmitter. Covers all amateur bands: 160-10 m. 150W d.c. input. Careful design has achieved the stability and high performance for which the DX-100U is noted and no less than 35 disc ceramic capacitors reduce TVI to a minimum. **£74.19.0**

**VARIABLE FREQUENCY OSCILLATOR, Model VF-1U.** Calibrated 160-10 m. Fundamentals on 160 and 40 m. Ideal for our DX-40U and similar transmitters. **£11.17.6**

**BALUN COIL UNIT, Model B-1U.** Will match unbalanced co-axial lines to balanced lines of either 75 or 300Ω impedance. **£4.15.6**

**THE "MOHICAN" GENERAL COVERAGE RECEIVER, Model GC-1U.** With 4 piezo-electric transistors, variable tuned B.F.O. and Zener diode stabiliser, this is an excellent fully transistorised general purpose receiver for Amateur and Short wave listeners. Printed circuit boards, telescopic whip antenna, tuning meter and large slide-rule dial, 10 transistors. **£39.17.6**



DX-100U



VF-1U



GC-1U

## THE BEST QUALITY

**4-WAVEBAND TRANSISTORISED PORTABLE RECEIVER, Model RSW-1.** This model possesses Medium, Trawler and two Short-wave bands and is midway between the domestic broadcasting and professional general communications receiver. Ideal and inexpensive for those who wish to listen to world broadcasts, shipping and aviation communications. It is not the set to buy if you wish only to enjoy domestic broadcasting. In a handsome leather case, it has retractable whip aerial and socket for car radio use. **£22.8.0**

**TRANSISTOR PORTABLE RADIO, Model UXR-1.** Pre-aligned I.F. transformers, printed circuit and a 7" x 4" high-flux speaker. Real hide case. **£14.3.0**

**HI-FI AM/FM TUNER, Model AFM-1.** Available in two units which, for your convenience, are sold separately: Tuning heart (AFM-T1—£5.5.6 incl. P.T.) and I.F. amplifier (AFM-A1—£20.13.0). Printed circuit board, 8 valves. Built-in power supply. Total **£25.18.6**

**HI-FI FM TUNER, Model FM-4U.** Also available in two units as above: R.F. tuning unit (£3.2.0 incl. P.T.) with I.F. output of 10.7 Mc/s, and amplifier unit, with power supply and valves (£12.6.0). Total **£15.8.0**

**POWER SUPPLY UNIT, Model MGP-1.** Input 100/120V 200/250V, 40-60 c/s. Output 6.3V, 2.5A A.C.: 200, 250, 270V, 120mA max. D.C. **£5.2.6**



RSW-1



UXR-1



AM/FM TUNER



FM TUNER

### MONEY-SAVING "PACKAGED DEALS"

For the benefit of customers wishing to purchase several units of their Hi-Fi equipment at the same time, useful price reductions are offered. Such "Packaged Deals" may include RECORD PLAYERS and TAPE DECKS of your preference, not necessarily featured in our catalogue. Two money-saving examples are given here and quotations for your own special requirements will gladly be sent on request.

GL-58 Transcription Unit	£19.12.6	TA-1M	£19. 2.6
S-33 Stereo Amp.	£13. 7.6	Collaro "STUDIO"	£17.10.0
Twin SSU-1 Speakers (Bookcase Type)	£22.10.0	USC-1	£19.10.0
		MA-12	£11. 9.6
	£55.10.0		£67.12.0
	<b>Packaged £53.4.0</b>		<b>Packaged £63.15.0</b>

All models directly available from the makers:

**DAYSTROM Ltd GLOUCESTER**



"GLOUCESTER"



GL-58

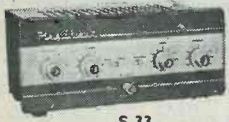

S-33

**HI-FI EQUIPMENT CABINETS.** Our four equipment cabinets meet a wide variety of tastes and requirements: the "CHEPSTOW" was designed for those who have little floor space, the contemporary "MALVERN" for the Tape and Gram enthusiast, and the "GLOUCESTER" Mk. I and II for those with traditional tastes. All parts are pre-cut and drilled for easy assembly, and left "in the white".

Prices from **£11.12.6** to **£18.10.0**

**TRANSCRIPTION RECORD PLAYER (STEREO).** Manufactured by Goldring-Lenco. This 4-speed unit is fitted with a G60 pick-up arm. Infinitely variable speed adjustment from 33½ to 80 r.p.m. Fixed speed of 16 r.p.m. Its balanced turntable (3½ lb) reduces rumble, wow and flutter to very low level. The unique lowering device fitted provides absolutely safe means of placing pick-up on record **£19.12.6**

**6W STEREO AMPLIFIER, Model S-33.** 3 watts per channel, 0.3% distortion at 2.5 w/chnl., 20dB N.F.B. Inputs for Radio (or Tape) and Gram., Stereo or Monoaural, ganged controls. Sensitivity 100mV. **£13.7.6**

## AT LOWEST PRICES



Truvox D83

**TRUVOX D83 & D84 TAPE DECKS.** High quality mono/stereo tape decks. D83, 2 track, for highest fidelity. **£31.10.0**

D84 (identical presentation), 4-track, for most economical use of tape. **£29.8.0**



"STUDIO"

**COLLARO "STUDIO" TAPE DECK.** The finest buy in its price range. Operating speeds: 1½, 3½ and 7½ i.p.s. Two tracks. "Wow" and "flutter" not greater than 0.15% at 7½ i.p.s. Long Term Speed Stability better than 0.5%. **£17.10.0**

**HI-FI STEREO/MONO PRE-AMPLIFIER, Model USP-1.** Extremely versatile unit. Gain may be preset over a wide range. Input 2mV-20mV. Output 20mV-2V. **£7.7.6**

**HI-FI SINGLE CHANNEL AMPLIFIER, Model MA-12.** 12W output, wide freq. range, low distortion. **£11.9.6**

### TAPE RECORDING AND REPLAY HI-FI AMPLIFIER

Mono model **TA-1M**, Stereo model **TA-1S**. For use with most tape decks. Thermometer type recording indicators, press-button speed compensation and input printed circuit construction.



TA-1S



USC-1

- TA-1M ... £19. 2.6
  - TA-1M & Collaro STUDIO ... £30.10.0
  - TA-1M & TRUVOX D83 ... £47. 2.6
  - TA-1M & TRUVOX D84 ... £45. 5.0
  - TA-1S ... £24.10.0
  - TA-1S & STUDIO ... £35.14.0
  - TA-1S & TRUVOX D83 ... £52. 6.0
  - TA-1S & TRUVOX D84 ... £50. 9.6
- STEREO CONTROL UNIT, Model USC-1.** Push-button selection, accurately matched ganged controls to ±1dB. Negative feedback, rumble and variable low-pass filters. Printed circuit boards. **£19.10.0**

## FINEST ELECTRONIC KITS IN THE WORLD

**VALVE VOLTMETER, Model V-7A.** 7 voltage ranges d.c. volts to 1,500 a.c. to 1,500 r.m.s. and 4,000 peak to peak. Resistance 0.1Ω to 1,000MΩ with internal battery. D.C. input impedance 11MΩ. dB measurement has centre-zero scale. Complete with test prods, lead and standardising battery. **£13.18.6**



V-7A

**MULTIMETER, Model MM-1U.** Ranges 0-1.5V to 1,500V A.C. and D.C.; 150µA to 15A D.C.; 0.2Ω to 20MΩ. 4½" 50µA meter. **£12.10.0**

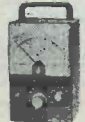

MM-1U

**R.F. SIGNAL GENERATOR, Model RF-1U.** Up to 100 Mc/s fundamental and 200 Mc/s on harmonics and up to 100mV output on all bands. **£12.15.6**



RF-1U

**AUDIO WATTMETER, Model AW-1U.** Up to 25W continuous, 50W intermittent. **£15.15.0**

**AUDIO VALVE MILLIVOLTMETER, Model AV-3U.** 1mV-300v A.C. 10 c/s to 400 kc/s. **£14.17.6**

**AUDIO SINE-SQUARE WAVE GENERATOR, Model AO-1U.** Covers 20 c/s to 150 kc/s and square waves to 50 kc/s in four ranges. Maximum output 10V, distortion less than 1%. **£13.15.0**

**CAPACITANCE METER, Model CM-1U.** Direct-reading 4½" scale. Full-scale ranges 0-100µµF, 0-1,000µµF, 0-0.01µF and 0-0.1µF. **£15.15.0**

**HI-FI SPEAKER SYSTEM, Model SSU-1.** Ducted-port bass reflex cabinet "in the white". Twin speakers. With legs **£11.19.6** **£11.5.0**

**HEATHKIT ELECTRONIC WORKSHOP, Model EW-1.** This educational kit will teach and amuse your children. It can make 21 exciting experiments including transistor radios, burglar alarm, radio or TV silencer, intercom., etc. **£7.18.0**

**JUNIOR TRANSISTOR RADIO, Model UJR-1.** Single transistor set. Excellent introduction to radio. An instructive present. **£2.13.6**

**HI-FI STEREO AMPLIFIER, Model S-99.** 18W output. Ganged controls. Stereo/mono gram., radio and tape recorder inputs. Push-button selection. Printed circuit construction. **£27.19.6**

**THE "COTSWOLD".** This is an acoustically designed enclosure 26" x 23" x 15½" housing a 12" bass speaker with 2" speech coil, elliptical middle speaker together with a pressure unit to cover the full frequency range of 32-20,000 c/s. Capable of doing justice to the finest programme source, its polar distribution makes it ideal for really Hi-Fi Stereo. Delivered complete with speakers, crossover unit, level control, Tygan grille cloth, etc. All parts pre-cut and drilled for ease of assembly and left "in the white" for finish to personal taste. **£23.4.0**



THE "COTSWOLD"

Prices include free delivery U.K. Deferred terms available over £10

★ SEND THIS COUPON NOW FOR FURTHER INFORMATION  
(Please write in BLOCK CAPITALS)

NAME \_\_\_\_\_  
ADDRESS \_\_\_\_\_

Without obligation please send me **BRITISH HEATHKIT CATALOGUE** (Tick here)

FULL DETAILS OF MODEL(S) \_\_\_\_\_

**DAYSTROM LTD DEPT RC10 GLOUCESTER ENGLAND**

A member of the Daystrom Group, manufacturers of the **WORLD'S LARGEST-SELLING ELECTRONIC KITS**







# STERN'S MULLARD DESIGNS

Designed by MULLARD—presented by STERN'S strictly to specification

## MULLARD "5-10" MAIN AMPLIFIER

For use with the MULLARD 2-valve pre-amplifier with which undistorted power output of up to 10 watts is obtained. We supply SPECIFIED COMPONENTS and NEW MULLARD VALVES, including PARMEKO MAINS TRANSFORMER and choice of the latest Ultra-Linear PARMEKO or the PARTRIDGE Output Transformer.

COMPLETE KIT OF PARTS (PARMEKO Output Trans) **£10.10.0**

Alternatively we supply ASSEMBLED and TESTED. **£11.10.0**

INCORPORATING PARTRIDGE OUTPUT TRANSFORMER, £1.6.0 EXTRA.



## MULLARD'S PRE-AMPLIFIER TONE CONTROL UNIT

Employing two EF86 valves, and designed to operate with the MULLARD MAIN AMPLIFIERS, but also perfectly suitable for other makes.

PRICE COMPLETE KIT OF PARTS **£6.6.0**

ASSEMBLED AND TESTED **£8.0.0**

Supplied strictly to MULLARD'S SPECIFICATION and incorporating:

- Equalisation for the latest R.I.A.A. characteristics.
- Input for Crystal Pick-ups, and variable reluctance magnetic types.
- Input (a) Direct from High Imp. Tape Head. (b) From a Tape Amplifier or Pre-Amplifier.
- Sensitive Microphone Channel. • Wide range BASS and TREBLE Controls.



## THE MULLARD "510/RC" AMPLIFIER

The popular and very successful complete "5-10" incorporating Control Unit providing up to 10 watts high quality reproduction. Only Specified Components and new MULLARD VALVES are supplied including PARMEKO MAINS TRANSFORMERS and choice of the latest PARMEKO or PARTRIDGE ULTRA-Linear Output Transformers.

KIT OF PARTS **£11.10.0** OR ASSEMBLED AND TESTED **£13.10.0**

H.P. Dep. £2.6.0 12 months at 17/- Dep. £2.14.0 12 months at 19/10 ABOVE incorporating PARTRIDGE OUTPUT TRANS. £1.6.0 extra

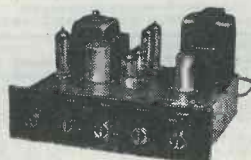

## THE MULLARD "33/RC"

THE IDEAL AMPLIFIER FOR A SMALL HIGH QUALITY INSTALLATION PROVIDING EXCELLENT REPRODUCTION OF UP TO 3 WATTS OUTPUT

COMPLETE KIT OF PARTS **£7.10.0** OR ASSEMBLED AND TESTED **£8.19.6**

(plus 6/6 carriage and insurance) H.P. Terms: Deposit £2.0.0 and 8 months at £10.0. Complete to MULLARD'S SPECIFICATION including Mullard valves and a PARMEKO OUTPUT TRANSFORMER.

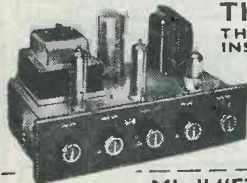

## Mk. II "Fidelity" FM TUNING UNIT

An attractively presented Unit incorporating KIT OF PARTS **£10.0.0**

MULLARD PERMEABILITY TUNING HEART PARTS AND corresponding Mullard valve line-up. **ASSEMBLED AND TESTED £14.5.0**

Very suitable to operate with our Mullard. **Deposit £2.17.0. 12 months of £1.0.11.**



## A BULK PURCHASE ENABLES US TO OFFER



PRICE ONLY **£19.19.0**

THE "TUDOR" AM/FM TUNING UNIT A SELF POWERED HIGH FIDELITY TUNER OF OUTSTANDING DESIGN, PROVIDES FULL COVERAGE of the VHF/FM TRANSMISSIONS and also the LONG and MEDIUM WAVE BANDS.

Deposit £4.0.0 and 12 months £19.4

Provides full coverage of the VHF/FM band (87-108 Mc/s) and also the LONG and MEDIUM Wavebands. Incorporates Multiplex outlet socket for stereophonic purposes (when adopted) and separate controls for tuning FM and AM bands. Operates perfectly with the STERN-MULLARD AMPLIFIERS and contains matching FRONT PANEL in Black/Gold or White/Black. Also operates equally well with any Amplifier requiring input of 100 to 350 mVolts.

## THE "TUDOR" STEREO AMPLIFIER



For Only **£18.18.0**

Deposit **£3.16.0**

12 months **£17.8**

A self contained Amplifier designed to provide high quality stereophonic and monophonic reproduction. Each channel provides a rated output of 6 watts and for monophonic operation approx. 12 watts is produced. Separate BASS and TREBLE CONTROLS, DESCRIPTIVE LEAFLET IS AVAILABLE.

## PRICE REDUCTIONS

(a) The KIT OF PARTS to build both the "5-10" Main Amplifier and the 2-valve PRE-AMP CONTROL UNIT H.P. Dep. **£37.0** and 12 months at **£15.15.0**

(b) The "5-10" and the 2-stage PRE AMP both ASSEMBLED and TESTED H.P. Dep. **£18.18.0** and 12 months at **£17.8** With Partridge Output Transformer **£1.6.0** extra.

## RECORD PLAYERS

The Standard GARRARD "AUTO-SLIM" 4-speed Autochanger with Crystal Pick-up..... **£8.10.0**

COLLARO "JUNIOR" 4-SPEED SINGLE RECORD PLAYER with separate Crystal Pick-up..... **£3.15.0**

Carriage and Insurance 5/- Above Pick-up separately for **£1.6.6**

GARRARD "AUTOSLIM DE-LUXE" 4-speed Autochanger incorporates transcription Pick-up Arm..... **£12.14.6**

The NEW COLLARO C60 4-speed Autochanger unit with Studio "O" Pick-up..... **£7.19.6**

B.S.R. MODEL UA14. A 4-speed mixer Autochanger with Crystal Pick-up..... **£7.19.6**

GARRARD MODEL TA/Mk. II 4-speed Player fitted high output Crystal Pick-up..... **£8.10.0**

PHILIPS MODEL AG1016 A 4-speed Player which can be operated both manually and automatically. Suitable for Mono or Stereo operation..... **£13.13.0**

Carriage and Insurance on each above 5/- extra.

## MULLARD FOUR CHANNEL MIXING UNIT

Self powered. Cathode follower output. Operates Two inputs for MICROPHONES. One input for CRYSTAL PICK-UP and a fourth for RADIO or TAPE



Complete Kit of Parts **£8.8.0**

Assembled and Tested **£10.0.0**

TERMS: Deposit £2 and 12 months at 15/- Alternatively MODEL I.L. provides for one microphone input matched for moving coil or Ribbon Mike. **£1.17.0** extra.

## THE "MONO-GRAM" AMPLIFIER

A small Amplifier capable of genuine high quality performance. It incorporates the new MULLARD ECL86 Valve, separate BASS and TREBLE CONTROLS and when driven by the standard Crystal Pick-up a

power output of 3 watts is achieved without distortion. The "MONO-GRAM" is ideally suited to incorporate in Portable Record Players. A specially designed case finished in two tone Rexine is available and this will accommodate both the Amplifier and matching 8" x 5" P.M. Loudspeaker.

PRICE AMPLIFIER ONLY **£4.14.6** (Carr. and Ins. 5/- extra.)

PORTABLE CASE **£4.0.0** 8" x 5" LOUDSPEAKER **£1.0.0**

COMBINED PRICE (3 Units) **£9.10.0** also available as a kit of parts, price on application.

## THE "TRUVOX" TOUCH

With the New "SERIES 60" RECORDERS TWO MODELS ARE AVAILABLE

R62. Twin Track Recorder with speeds of 12 and 33 i.p.s.

R64. Four Track Recorder with speeds of 33 and 7 1/2 i.p.s.

PRICE FOR EACH MODEL **£40.19.0**

Deposit **£8.4.0**, 12 months of **£30.1.**

They offer full MIXING, MONITORING and SUPERIMPOSING facilities. There is an AUTOMATIC STOP, a REV COUNTER and a storage compartment for 7 in. spools tape.

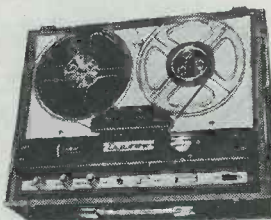

DESCRIPTIVE LEAFLETS READILY AVAILABLE

# STERN RADIO PREMIER RADIO

MAIL ORDERS and all POSTAL ENQUIRIES to

THE RADIO CONSTRUCTOR

# Stereophonic Sound by Stern's

## THE "STP-1" STEREO TAPE PREAMPLIFIER

● BRENNELL Mk. V TAPE DECK  
Incorporating similar 1/2-TRACK MINI-FLUX  
TAPE HEADS.

- PUSH-PULL OSCILLATOR CIRCUIT
- 4-SPEED EQUALISATION
- FERROXCUBE OSCILLATOR TRANSFORMER
- SENSITIVE METER FOR SIGNAL LEVEL
- SEPARATE GAIN CONTROLS IN EACH CHANNEL
- MULLARD VALVES

- (a) The BRENNELL Mk V 1/2 TRACK DECK with complete KIT to build the STP-1 ..... **£61.00**  
Deposit £12.4.0, 12 months of £4.9.6.
- (b) The COLLARO "STUDIO" 1/2 TRACK DECK with complete KIT to build the STP-1 ..... **£39.00**  
Deposit £7.16.0, 12 months of £2.17.3.



### COMBINED PRICE SCHEDULE

## DESIGNED TO OPERATE WITH

COLLARO "STUDIO" TAPE DECK  
Incorporating the latest 1/2-TRACK  
TAPE HEADS.

OVERALL SIZE CASE 13 1/2 x 3in.  
FRONT PANEL (Choice of Black or  
White) 14 x 3 1/2in.

### PRICES INCLUDES SEPARATE POWER SUPPLY UNITS

KIT OF PARTS **£22.0.0** ASSEMBLED AND TESTED **£28.0.0**

Deposit £4.8.0 12 months of £1.12.3

Deposit £5.12.0 12 months of £2.1.1

- (a) The BRENNELL Mk V 1/2 TRACK DECK with the STP-1 assembled and matched to the Deck ..... **£67.0.0**  
Deposit £13.8.0, 12 months of £4.18.3.
- (b) The COLLARO "STUDIO" 1/2 TRACK DECK with the STP-1 assembled and matched to the Deck ..... **£45.0.0**  
Deposit £9.0.0, 12 months of £3.6.0.

THE MULLARD "10 plus 10" AMPLIFIER (described below) with the STP-1 PREAMPLIFIER and one of the TAPE DECKS provide a complete STEREOPHONIC INSTALLATION.

Details are readily available.

## MULLARDS "10 PLUS 10"

### STEREO AMPLIFIER

A high fidelity design based on the famous Mullard "10 plus 10". Provides up to 10 watts (per channel) Superb reproduction. Frequency response flat to within 3 db from c/s. to 50 Kc/s. at 50Mw. Total Harmonic Distortion at 10 watts 0.1%.

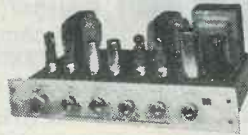

- (a) ASSEMBLED COMPLETE AMPLIFIER, including CONTROL UNIT (as illustrated) ..... **£21.0.0**  
Deposit £4.4.0, 12 months at £1.10.10

- (b) A complete KIT OF PARTS ..... **£18.10.0**  
Deposit £3.14.0, 12 months at £1.7.2

We also supply the assembled MAIN AMPLIFIER only (excludes control unit) for operation with our DUAL CHANNEL PREAMPLIFIER, this provides for a more versatile or elaborate installation and would be essential if a low output Magnetic Pick-Up, such as the Decca, is to be used.

- (a) THE ASSEMBLED MAIN AMPLIFIER with the ASSEMBLED DUAL CHANNEL PREAMPLIFIER ..... **£30.0.0**  
Deposit £6.0.0, 12 months at £2.4.0.

- (b) A complete KIT OF PARTS for both Units ..... **£26.0.0**  
Deposit £5.4.0, 12 months at £1.18.2

Illustrated and Descriptive Brochure available. Please enclose S.A.E.

## STEREOPHONIC RECORD PLAYER UNITS MICROPHONES AND TWIN LOUSPEAKERS ARE AVAILABLE FROM STOCK

## DUAL CHANNEL AMPLIFIER

A four valve design both STEREO-  
PHONIC or MONAURAL operation.  
It is designed primarily to operate with  
our range of MULLARD MAIN AM-  
PLIFIERS but will also operate equally  
well with any make of Amplifiers requiring  
an input of 250 mV/mts.



COMPLETE KIT **£12.10.0** ASSEMBLED AND TESTED **£15.0.0**  
H.P. £2.10.0 & 12 mths. at 18/4. H.P. £3.0.0 & 12 mths. at £1.2.0

## THE "TWIN THREE" STEREO AMPLIFIER

OFFERED ASSEMBLED **£7.15.0**  
AND TESTED for  
(Carr. & Ins. 7/6 extra)



Based on a recent design by MULLARD LTD., the "TWIN THREE" is ideally suited for use in PORTABLE RECORD PLAYERS for which purpose we offer a specially designed Portable Case it incorporates MULLARD ECL 86 Valves, separate BASS and TREBLE CONTROLS and produces excellent reproduction of up to 3 watts per channel. Frequency response is 40 c/s to 30 Kc/s, size is only 11 1/2in. x 3in. x 5in.

To construct a STEREO PORTABLE RECORD PLAYER we offer—  
The assembled AMPLIFIER with two ROLA 8in. x 5in. LOUSPEAKERS  
and the PORTABLE CASE for £14 (Carr. and Ins. 10/- extra) Deposit £2/16/-  
12 months of £1.0.6.

SUITABLE RECORD PLAYERS ARE AVAILABLE FROM £8.14.0.

## HF/TR3 TAPE AMPLIFIER

(Mullard Type "A" design)

A very high quality Amplifier in-  
corporating 3-speed treble equalisa-  
tion, by the latest FERROXCUBE POT  
CORE INDUCTOR FOR COLLARO-  
TRUVOX-BRENNELL WEARITE Tape  
Decks, has GILSEN Output Trans-  
former. Includes separate Power  
Supply Unit.

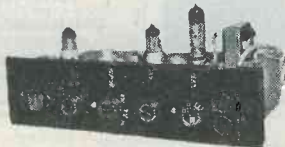

KIT OF PARTS **£13.13.0** ASSEMBLED AND TESTED **£17.0.0**  
Deposit £2.15.0 12 months at £1.0.0 Deposit £3.8.0 12 months at £1.4.11

## ADD "HI-FI" TAPE RECORDING TO YOUR EXISTING AUDIO INSTALLATION WITH STERN'S-MULLARD TYPE "C" TAPE PREAMPLIFIER—ERASE UNIT

INCORPORATING THE NEW  
FERROXCUBE POT. CORE  
PUSH-PULL OSCILLATOR  
and 3-SPEED TREBLE EQUAL-  
ISATION by means of the latest  
FERROXCUBE POT CORE  
INDUCTOR.



PRICES . . . INCLUDING SEPARATE SMALL POWER SUPPLY UNIT  
COMPLETE KIT **£14.0.0** ASSEMBLED AND TESTED **£17.0.0**  
OF PARTS  
Deposit £2.16.0 12 months £1.0.6. Deposit £3.8.0, 12 months of £1.4.11.  
ALSO AVAILABLE EXCLUDING POWER SUPPLY UNIT FOR  
**£11.15.0** and **£14.10.0** respectively. (Carr. and Ins. 5/- extra)

**109, FLEET ST., LONDON, E.C.4.**  
TELEPHONE FLEET ST., 5812-3  
**23, TOTTENHAM COURT RD., LONDON W.1.**  
TELEPHONE MUSEUM 3451  
**7-9 TUDOR PLACE, TOTTENHAM COURT RD.,**  
LONDON, W.1. TELEPHONE MUSEUM 6128/9

## SPECIAL "COMBINED ORDER" PRICES

For Constructors with their own cabinet—WE OFFER—

- (a) COMPLETE KIT to build the HF/TR3 Amplifier together with the COLLARO "STUDIO" DECK  
Deposit £5.4.0, 12 monthly payments of £1.18.2 ..... **£26.0.0**
- (b) As above but with the HF/TR3 supplied ASSEMBLED and TESTED  
Deposit £5.18.0, 12 monthly payments of £2.3.4 ..... **£29.10.0**
- (c) COMPLETE KIT to build the HF/TR3 AMPLIFIER with the BRENNELL Mk. V TAPE DECK ..... **£42.0.0**  
Deposit £8.8.0, 12 monthly payments of £3.1.7
- (d) As above but with HF/TR3 supplied ASSEMBLED and TESTED ..... **£45.10.0**  
Deposit £9.2.0, 12 monthly payments of £3.6.9
- (e) THE ASSEMBLED AND TESTED HF/TR3 AMPLIFIER with the WEARITE MODEL 4A DECK, incorporates Wearite Head Lift Transformer etc. .... **£60.10.0**  
Deposit £12.12.0, 12 monthly payments of £4.8.9.
- (a) The COLLARO "Studio" Deck with the Model "C" Preamplifier and POWER SUPPLY UNIT ASSEMBLED AND TESTED ..... **£29.10.0**  
Deposit £5.18.0, 12 monthly payments of £2.3.3
- (b) As above but the TYPE "C" Unit and POWER UNIT supplied as COMPLETE KIT OF PARTS  
Deposit £5.6.0, 12 monthly payments of £1.18.10 ..... **£26.10.0**
- (c) The BRENNELL Mk. V Deck with the Model "C" PREAMPLIFIER and POWER UNIT, ASSEMBLED and TESTED ..... **£46.0.0**  
Deposit £9.4.0 and 12 months at £3.7.6
- (d) As above but the Model "C" PREAMPLIFIER and POWER UNIT supplied as a COMPLETE KIT OF PARTS ..... **£43.0.0**  
Deposit £8.12.0, 12 monthly payments of £3.3.1
- (e) The WEARITE MODEL "A" DECK with ASSEMBLED and TESTED Model "C" PREAMPLIFIER and POWER UNIT incorporating WEARITE HEAD LIFT TRANSFORMER, Etc. .... **£60.10.0**  
Deposit £12.2.0 and 12 months at £4.8.9

(Carriage and Insurance on each above is 10/- extra.)

# FREE

inside **PRACTICAL  
TELEVISION**

# TELEVISION DATA CHART

WITH GREAT NEW SERIES

**COMPLETE COURSE ON  
PRINCIPLES & PRACTICE  
OF TELEVISION**

#### DATA SHEET INCLUDES:

Maps showing all TV stations  
—lists of BBC and ITA stations,  
with frequency, polarisation,  
channel number and estimated  
radiated power—circuits of attenu-  
ators—interference suppression  
devices—aerials for channels 1-13—  
—tables of channels, bands, TV  
standards, decibels, power ratios  
—television check points—con-  
denser and resistor colour codes  
—comprehensive block diagram  
of TV receiver.

#### SERIES INCLUDES:

Bands and channels—tuners—  
UHF channels—UHF propaga-  
tion—line standards—bandwidths  
—possible future of television  
—VHF and UHF aerials—servic-  
ing—techniques of fault analysis  
—receiver adjustment—communal  
TV systems—recent developments  
—remote control of receivers—  
problems of 625-line television.

DOUBLE-SIDED  
SIZE 22" x 16"  
(value 7/6)

**DATA CHART**

TABLE 3

**OUT  
NOW**

**Practical** OCTOBER 2/-  
**TELEVISION**

Britain's **MOST Popular Portable**  
**The "GOOD COMPANION Mk. 2"**  
**CAR RADIO & PORTABLE**  
**USING LATEST CERAMIC TRANSFILTERS**

One of the finest of its kind available. The design is the combined efforts of our technicians and of those of several of the leading manufacturers in the country, and the resulting set has a performance as good as if not superior to those selling at £20 and more. It has the eight transistor set performance. Features include American Philco R.F. transistors and Mullard A.F. transistors—Q.P.P. output giving 750mW—full coverage on Medium and Long—very fine tuning arrangement—excellent reception of difficult stations like 208—variable feed-back control—full tonal qualities—really superior looking cabinet size 11" x 8" x 3" approximately—car aerial attachment—several months operation from battery costing only 3/6.

Circuit employs six transistors and two diodes. It incorporates all latest refinements. The transistors are set, so no I.F. alignment is necessary. Anyone who can solder competently can make this set. The instructions are fully comprehensive with plenty of illustrations. Service is available in the unlikely event of your getting into difficulties. All components fully guaranteed.

Price of all components for Mk. 2 **£9.19.6** Post and Insurance 5/-  
 circuit and Standard Cabinet Battery 3/6 extra

The Good Companion was fully described in August issue, pages 54-59

**AGENTS**

wanted to build up our Companion Receivers. Send addressed envelope for full particulars to Eastbourne.

**The "TREMENDO COMPANION"**

If you don't mind the battery consumption being a little higher and you want really big output then order the "Tremendo". This has an undistorted output of almost 1 1/2 watts and is probably the most powerful home constructor set available today. Complete building cost of this is £10.15.0, which includes the transfilter (Mk. II circuit) batteries cost 3/6 (two required).



**DE-LUXE CABINET 20/- extra**



**STANDARD CABINET**

**The "POCKET COMPANION"**

"A jolly fine set, but deserving a better case"

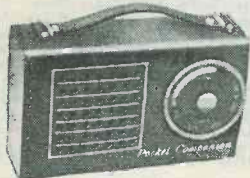

This is a comment which many constructors have voiced and therefore we now offer a De-Luxe version of the Pocket Companion. This uses a solid hide case of very pleasant red with gold lettering and our Pocket Companion now has the 15-guinea look.

The most up-to-date Superhet portable of its type, it uses a transfilter in conjunction with output transistors. Complete building costs with plastic case £6.15.0 or with solid hide case, £7.15.0.

Philco R.F. transistors and Mullard building costs with plastic case £6.15.0 or with solid hide case, £7.15.0.

If you have already built and want to change your case, then return the plastic case with a postal order for £1, or if you wish to retain the plastic case then send 26/- plus 1/6. Post and insurance for the hide case only.

**LAST OF THESE BRAYHEAD TURRET TUNERS**



complete with Band 1 and Band 3 coils. New but removed from unused equipment. Less valves 15/- each, or with valves 25/- each. Post 2/6. Knobs 3/6 extra.

**MINIATURE MICROPHONE**

American made. Dynamic type, real bargain at 2/6, plus 6d. postage.



**BE THE BEST DAD IN THE WORLD**

What a thrill for your boy to receive a present like this!



**ONLY £6.19.6**

Completely transistorised tape recorder with full

**ROMANTICA 7**



Cheaper than you can possibly make it, we offer a completely made up transistor Pocket Superhet. Uses all first-grade miniature parts and is complete with leather case, earphone and battery. 535-1.065 kc/s. sensitivity, 300 microvolts/M, output 150 m.w. ferrite slab aerial. Size approximately 4 1/4" x 2 1/4" x 1 1/4". Price £6.19.6. Post and Ins. 3/-.



**CABINET AND PICK-UP**

Cabinet for battery record player. Size approx. 9" x 11" x 5" allows for 7" x 4" speaker and amplifier.

Nicely covered two tone. Must have cost at least £2 to make. New and perfect. Offered whilst stocks last, 19/6, plus 4/6 post and insurance.

**COSMOCORD PICK-UP**

As illustrated with cartridge and headrest. Ready, new and perfect. Suitable for 45 or 33 records. Price 9/6, plus 2/6 post and insurance.

**TRANSFILTERS:** These ceramic devices save alignment problems and improve performance. Use instead of I.F. transformer. Complete with circuit 8/6 each

range of accessories. Suitable for work or play—study or relaxation—office or home—outdoors or indoors. Weight 2 1/2 lb and only 9" x 6" x 3" (approx). Supplied as completely wired sub-assemblies; just link these together—only 10 connections to make. Three transistor amplifier with centre switch-forward stop-rewind with microphone input record play-volume control, etc. Complete in most modern carrying case in two-tone and with microphone, reel of tape and spare reel. Nothing else to buy. Order this bargain now as it won't be available for Xmas. Only £6.19.6 plus post and ins. 5/- or secure with a small deposit.

**ELECTRONIC PRECISION EQUIPMENT LTD**

★ Orders received by post are despatched from our warehouse, Dept. 34, 66 Grove Road, Eastbourne, and to save time, please post your order to this address. Please include enough for postage. Callers, however, should use one of the following addresses: **John Bull**  
 520 High Street North 42-46 Windmill Hill 266 London Road 29 Stroud Green Road 246 High Street  
 Manor Park, E.12 Ruislip, Middx. Croydon Finsbury Park, N.4 Harlesden, N.W.10

# HOME RADIO OF MITCHAM

Dept. AC, 187 London Road,  
Mitcham, Surrey. MIT 3282  
Shop Hours: 9.0 to 6.0 p.m.  
(Weds. 1.0 p.m.)



## NOMBREX SIGNAL GENERATOR

Completely portable self-contained transistor Signal Generator covering 200 kc/s to 220 Mc/s in eight ranges. Built to highest standards and representing the best value in test equipment in the world. Output modulated or CW, and accuracy better than 2%. Audio output at 1 kc/s available. Weighs under 2 lb and only 6½" x 4½". Complete with battery £7.12.0, post and packing 3/6.

## EDDYSTONE 870A SHORT WAVE RECEIVER

Compact size, light weight, attractive styling, and high grade engineering make this the ideal dual-purpose Domestic and Short Wave Receiver. Full long and medium wave plus three short wavebands covering 12.5 to 40 metres, 40 to 90 metres, 90 to 220 metres. Gear driven full width dial with vernier logging scale. Built-in speaker. Will operate on any voltage AC/DC 110 to 250 volts. Full specification on request. PRICE £32.2.0, post paid U.K. Export price for overseas customers £24 plus 25/- postage.

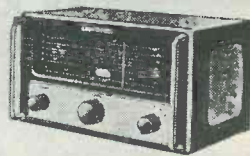

## POCKET TRANSISTOR RADIO



**EXPORT PRICE**  
£6.16.6  
post 3/6

The PERDIO MINI 66 is a little gem of a set that slips easily into pocket or handbag. 6 transistors and covers full Medium wave plus Long wave Light programme. Size only 2½" x 4½" x 1½" and weighs only 9 oz. Complete ready to use with self-contained ferrite rod aerial and high efficiency speaker. BRAND NEW and boxed, and the best set in this size that we have tried. Ideal present for a special girl friend. Cheaper than buying a kit of parts. **PRICE ONLY 8½ gns.** Leather case and personal phone 21/- extra.

## ANTEX PRECISION IRON



A wonderful Miniature Iron for the radio constructor. Five different sizes of interchangeable bits are available to allow for any type of work from normal wiring to sub-miniature transistor assembly. All voltages from 6 to 240 in stock. Illustrated leaflet on request. Iron with one standard bit 29/6 post paid. Additional bits 3/6 each. **PLEASE STATE VOLTAGE REQUIRED.**

## WE ARE ACTUAL STOCKISTS FOR THE FAMOUS HEATHKITS

## ARMSTRONG CHASSIS

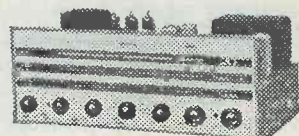

We carry the full range of ARMSTRONG radio chassis, tuners, amplifiers and tape pre-amplifiers, including: **AF208.** An economical chassis of traditional Armstrong quality with 5 watts output, full VHF and medium bands, separate tone controls, facilities for pick-up, tape, etc. PRICE £22.18.0, carriage 3/6. **JUBILEE Mk. 2.** A high fidelity chassis with 8 watts push-pull output and covering full VHF and medium and long wavebands. Automatic tuning on the FM. Separate tone controls for bass and treble, facilities for pick-up, tape, etc. PRICE £30.12.0, carriage 3/6. **STEREO 55.** Provides 5 watts each channel. Full coverage of VHF and medium wavebands. Separate tone controls and inputs for stereo or mono pick-ups, tape, etc. PRICE £32.15.0, carriage 3/6. **STEREO 12 Mk. 2.** The last word in compact stereo high fidelity combined radio, pre-amplifier, and amplifier, 8 watts push-pull output on each channel, full coverage VHF and medium and long wavebands, automatic tuning on FM, separate full range bass and treble controls, ferrite rod aerial for AM bands, and a host of other features. Everything you want on one compact chassis. PRICE £43.10.0, carriage 3/6.

## GOODMANS HI-FI SPEAKERS

We are main stockists for Goodmans Speakers and accessories, including the new models, as follows:

- AXIETTE 8.** 6 watts 15 ohms 8" die-cast chassis with new FERObA 11 high flux magnet. PRICE £5.5.0, post 1/6.
- AXIOM 10.** 10 watts 15 ohms 10" die-cast chassis with new FERObA 11 high flux magnet. PRICE £5.16.8, post 1/6.
- AXIOM 201.** 15 watts 15 ohms 12" twin diaphragm unit giving smooth response from 30 to 16,000 cycles. Powerful FERObA 11 magnet and rigid die-cast chassis. Aluminium voice coil and special plastic treated suspension. Equally suitable for mono or stereo. PRICE £9.15.0, post 2/6.
- AXIOM 301.** The most advanced 12" twin diaphragm speaker ever produced. Similar appearance and specification to the 201 but will handle up to 20 watts. PRICE £14, post 2/6.



## NEW MULLARD 10 WATT AMPLIFIER

Printed circuit panels for the remarkable ECL86 Amplifier are now available from stock, price 12/6, post 6d. Trade enquiries invited.

## HI-FI ENTHUSIASTS

Have you tried CEIBALINE? This is the new super sound-absorbent material with self-adhesive backing for lining hi-fi speaker enclosures. Really wonderful results and clean and easy to use. PRICE 2/6 per sq. foot, plus 1/6 post on order.

## AERIALS

For the really serious long distance Short wave listener the MOSLEY "Wavetrapp" dipoles offer superb performance. Two models available: **RD5** for the main amateur bands 10, 15, 20, 40 and 80 metres, PRICE £8. **SWL7** for broadcast bands 11, 13, 16, 19, 25, 31 and 49 metres, PRICE £7. 3d. stamp for leaflets. Please add 1/6 post to order.

**2 metre arrays.** The Aerialite **SPO80XU** is an excellent 8-element array designed for the 2 metre amateur band. Delivery from stock PRICE £3.19.0 plus 10/- carriage.

**WE ALSO STOCK THE MOSLEY VERTICAL AND TWO AND THREE ELEMENT BEAMS.**

## PYE MOZART COMPACT HI-FI

If you are interested in the best high fidelity, but space is at a premium we can recommend the **PYE MOZART** range of compact units.

**HFT108** FM tuner with automatic tuning, 22 gns.

**HFT113** FM plus medium wave coverage, 27½ gns.

**HF10** 10 watts hi-fi amplifier with built-in controls, 22 gns.

**HFS20** 9 watts per channel with full range pre-amplifier control unit which can be mounted separately if desired, £35.

Neat smart cabinets for shelf mounting the above are available. Leaflets on request.



## STILL THE BEST SHORT WAVERS. "GLOBE KING"

Never mind the weather, travel round the world from your own fireside. Short wave radio is a fascinating hobby; you can start today with the

**GLOBE KING 100/A**, an amazing little one-valve battery set that gives really long distance PARTS with three plug-in coils £3.19.6, post 1/6. model in metal cabinet with built-in speaker. **MODEL 300A.** Two-stage mains version in metal bandspread tuning, etc. PRICE OF KIT £10, post 2/6.

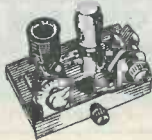

## LEKTROKIT

We carry the full range of the LEKTROKIT chassis construction system components and we can offer by-return service to schools, laboratories, research depts., etc. Write in on official heading for full details.

## TRANSISTORS & DIODES

**BRAND NEW BOXED MULLARD TRANSISTORS.** OC44 9/-, OC45 9/3, OC70 6/6, OC71 6/6, OC72 8/-, OC78 8/-, OC81 8/-, OC170 9/6, OC171 10/6, AF114 11/-, AF115 10/6, AF116 10/-, AF117 9/6, many other types available from stock. Add 6d. post to order. **BY100 Silicon Diodes** 17/6, OA70 3/-, OA81 3/-, OA79 3/-, OAZ202 Zener Diode 9/6, OAZ203 Zener Diode 10/6, OAZ204/5/6 9/6.

reception at minimum cost. **KIT OF MODEL 200A.** Two-valve battery PRICE OF KIT £9.0.0, post 2/6. cabinet with built-in speaker and

# THE Radio Constructor

Incorporating THE RADIO AMATEUR

## OCTOBER 1962

Vol. 16, No. 3

Published Monthly

Annual Subscription 29/-  
(including postage)

Editorial and  
Advertising Offices

57 MAIDA VALE LONDON W9

Telephone  
CUNningham 6141  
(2 lines)

Telegrams  
Databux, London

Suggested Circuits No. 143: Electronic Timer with Fast Relay Operation, by G. A. French	166
Photo-Sensitive Car Parking Light Actuator, by M. J. T. Smith	169
Can Anyone Help ?	171
An Oxo Tin Alignment Aid, by A. S. Carpenter	172
Peak Performance Control	177
Electrolytic Conditioner and Insulation Tester, by C. L. Jones, B.Sc.(Hons.), Grad.Inst.P.	178
Understanding Radio, Part 14, by W. G. Morley	182
Simple TV Armchair Control, by K. V. R. Bowerman	187
In Your Workshop	191
Car Power Pack for Transistor Radios, by S. Smith	198
News and Comment	199
The "Progressive" Transistor Superhet, Part 1, by A. A. Baines	200
Transistor Stabilised Power Supply Unit, by K. Berry	206
The "Realistic-7" Portable Transistor Receiver, described by E. Govier	208
A Transistorised Electronic Organ, Part 3, by S. Astley	213
Radio Topics, by Recorder	219
The 1962 National Radio Show	222
Trade Review, "Adamin" C15L Precision Micro Soldering Instrument	223

© Data Publications Ltd, 1962

CONTENTS may only be reproduced after obtaining prior permission from the Editor. Short abstracts or references are allowable provided acknowledgment of source is given.

CONTRIBUTIONS on constructional matters are invited, especially when they describe the construction of particular items of equipment. Articles should be written on one side of the sheet only and should preferably be typewritten, diagrams being on separate sheets. Whether hand-written or typewritten, lines should be double spaced. Diagrams need not be large or perfectly drawn, as our draughtsmen will redraw in most cases, but all relevant information should be included. Photographs should be clear and accompanied by negatives. Details of topical ideas and techniques are also welcomed and, if the contributor so wishes, will be re-written by our staff into article form. All contributions must be accompanied by a stamped addressed envelope for reply or return, and should bear the sender's name and address. Payment is made for all material published.

OPINIONS expressed by contributors are not necessarily those of the Editor or the proprietors.

TRADE NEWS. Manufacturers, publishers, etc., are invited to submit samples or information of new products for review in this section.

TECHNICAL QUERIES must be submitted in writing. We regret that we are unable to answer queries, other than those arising from articles appearing in this magazine; nor can we advise on modifications to the equipment described in these articles.

CORRESPONDENCE should be addressed to the Editor, Advertising Manager, Subscription Manager or the Publishers, as appropriate.

REMITTANCES should be made payable to "DATA PUBLICATIONS LTD."

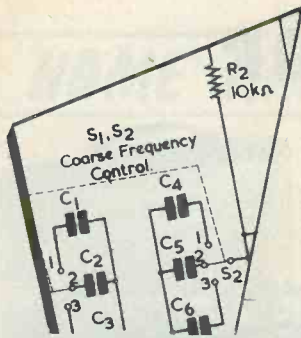

## suggested circuits



The circuits presented in this series have been designed by G. A. FRENCH, specially for the enthusiast who needs only the circuit and essential data

### No. 143 Electronic Timer with Fast Relay Operation

THE CONVENTIONAL ELECTRONIC timer employs, in its basic timing circuit, a capacitor which either discharges into a resistor, or charges up via a resistor. When the voltage across the capacitor reaches a certain pre-determined level a relay operates, thereby switching off the controlled equipment and terminating the timing period. The length of the timing period may be set up in advance by selecting suitable values of capacitance and resistance in the basic timing circuit.

A disadvantage with many common electronic timer circuits is that the current flowing through the relay coil varies at a relatively slow rate near the end of the timing period. In consequence, it is necessary for the relay to energise, or de-energise, at the same current in each timing period if the length of the latter is to be accurately maintained. In practice, this is frequently impossible to achieve because a number of mechanical factors govern the energising or de-energising currents of normal relays, and these factors cannot be reliably controlled. A better approach consists of designing the relay-energising circuit such that relay current changes rapidly near the end of the timing cycle. Shifts in relay energising or de-energising currents then have proportionally less effect on the overall timing period, and this can be held to a more accurate figure.

This month's Suggested Circuit is for an electronic timer which offers rapid de-energising of a standard Post Office relay at the end of the timing cycle, and which should therefore offer good long-term accuracy. Tests with the prototype indicate that the de-energising current falls over a 2:1 ratio during approximately 1% of the overall timing period, and over a 10:1 ratio during approximately 3% of the overall timing period. This is a much faster rate of change than occurs in most conventional timers, and is achieved with very few additional components.

The circuit has the disadvantage that a 6 volt battery is required for voltage delay. However, the current drawn from this battery is very low and its life should be nearly as long as its shelf life. By a slight rearrangement of the circuit, the 6 volt delay may also be provided by an external supply.

The circuit described offers continually varying timing periods from 1 to 25 seconds. Longer periods, up to some ten minutes or so, are possible if additional capacitance is shunted across the capacitor in the basic timing circuit.

#### Transistor Currents

Before describing the action of the circuit, it will be helpful to briefly consider some of the factors applicable to an electronic timer employing transistors.

It is conventional to control the relay in a transistorised electronic timer by means of a transistor connected as an earthed emitter amplifier. The timing CR circuit may then be coupled to its base. It is important to note, however, that the timing CR circuit must be capable of feeding sufficient current to the base to energise the relay at the end of the timing period, or to keep it energised during the timing period, according to the mode of circuit operation used.

It was decided, with the present device, to employ a P.O. type 3000 relay having a 500Ω coil in conjunction with an OC72 transistor. The writer has used these components in a number of previous circuits described in this series; and they represent an excellent combination in that they allow a robust standard relay to be controlled by a readily available transistor. The energising current for the 500Ω relay (with two sets of contacts) is approximately 14mA. Speaking in very approximate terms, one could assume a current gain of 50 times in the OC72 which controls it, whereupon the base current corresponding to relay energising is of the order of 0.28mA.

In the timing CR circuit, it is desirable to employ as much resistance as possible for the longer timing periods in order to keep the complementary capacitance low, and thereby save expenditure on components. The timing capacitor is



almost inevitably an electrolytic component having leakage resistance, whereupon the maximum practicable resistance value in the CR circuit becomes limited to some 200k $\Omega$  or so. In the instance described in the preceding paragraph, the CR circuit would be called upon to provide a current of at least 0.28mA. Such a current, in combination with resistance of the order of 200k $\Omega$ , argues a CR energising voltage in excess of 56, which is much higher than that employed for powering normal transistor circuits. An alternative method of obtaining the base current would consist of using a lower energising voltage together with lower resistance values in the timing CR circuit but, as we have already noted, this increases the complementary capacitance and raises costs.

The simplest solution consists of adding a second transistor before that which controls the relay. Again assuming a current gain figure of 50, the 0.28mA base current previously required now drops to some 5 $\mu$ A, and this can be readily supplied by a CR circuit incorporating a resistance of 200k $\Omega$ . The circuit described this month employs a second transistor preceding that which controls the relay.

A further advantage of employing a second transistor is that the increased sensitivity which results allows the overall circuit to exhibit a relatively fast relay operation at the end of the timing period.

#### The Circuit

The circuit of the timer appears in Fig. 1. In this diagram we have the 500 $\Omega$  relay connected in the collector circuit of TR<sub>2</sub>, the base of this transistor being directly coupled to the collector of TR<sub>1</sub>. When TR<sub>1</sub> is biased "off", sufficient current flows in the base-emitter junction of TR<sub>2</sub> to cause the relay to energise. When TR<sub>1</sub> passes current, TR<sub>2</sub> base-emitter current falls and the relay de-energises. Thus, the relay is energised when TR<sub>1</sub> is "off" and is de-energised when TR<sub>1</sub> passes current.

Let us examine circuit operation by assuming initially that S<sub>1</sub> is in the "reset" position. Under this condition, C<sub>1</sub> is discharged via R<sub>1</sub>, and the base of TR<sub>1</sub> is coupled to the negative supply line via R<sub>4</sub>, the 6 volt battery, R<sub>3</sub> and R<sub>2</sub>. The 6 volt battery is in series-opposition to the 12 volt supply, with the result that TR<sub>1</sub> base connects effectively to a 6 volt source of e.m.f. via R<sub>2</sub>, R<sub>3</sub> and R<sub>4</sub>. Thus, base current in TR<sub>1</sub> lies between 28 and 300 $\mu$ A according to the setting of R<sub>3</sub>. TR<sub>1</sub> passes sufficient collector current at these base

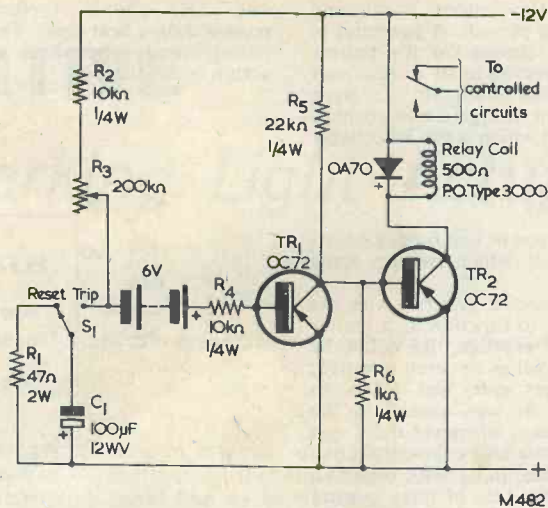

Fig. 1. The circuit of the electronic timer

currents for the relay to remain de-energised.

When S<sub>1</sub> is thrown to "trip", capacitor C<sub>1</sub> is connected to the negative terminal of the 6 volt battery. Initially, C<sub>1</sub> has zero charge, with the result that a positive bias of 6 volts is applied to the left-hand end of R<sub>4</sub>. TR<sub>1</sub> is biased "off" in consequence and the relay energises, its contacts completing the circuit to the controlled equipment.

C<sub>1</sub> now commences to charge, via R<sub>2</sub> and R<sub>3</sub>. After a time the potential across its plates rises to 6 volts, and zero volts bias appears at the left-hand end of R<sub>4</sub>. The charge in C<sub>1</sub> continues to increase, whereupon TR<sub>1</sub> commences to pass current and causes the relay to de-energise. The

relay contacts then break the circuit to the controlled equipment and the timing period is at an end.

At any time subsequent to the end of the timing period, S<sub>1</sub> may be returned to the "reset" condition. The base of TR<sub>1</sub> then couples to the negative supply line as before, and the relay remains de-energised. At the same time C<sub>1</sub> is rapidly discharged via R<sub>1</sub> and becomes ready for the next cycle.

It will be noted that, due to the 6 volt battery, TR<sub>1</sub> is held cut-off over most of the timing period, and that this transistor passes a rapidly increasing current when the potential across C<sub>1</sub> rises above 6 volts. It is the delaying action provided by the 6 volt battery which allows the rapid

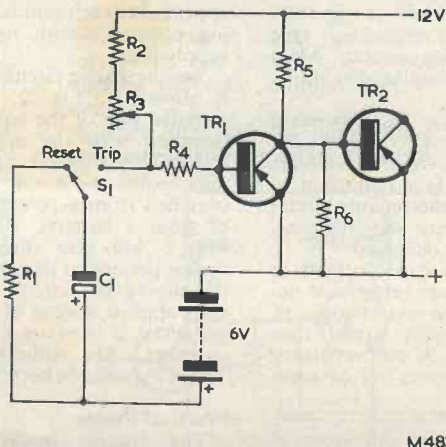

Fig. 2. An alternative arrangement which allows one terminal of the 6 volt battery to be made common with the positive supply line

change in relay current at the end of the timing period. A potential of 6 volts was chosen for the battery as this corresponds to a relatively well advanced point in the basic timing circuit charge curve (voltage against time) which is still reasonably steep.

### Further Points

There are one or two further points in the circuit which require some explanation.

$R_4$  is connected in series with the base of  $TR_1$  to function as a limiter resistor. In practice,  $R_4$  could be reduced in value or even omitted, provided that care was taken to ensure that  $S_1$  was always in the "reset" position whenever the 6 volt battery was changed or re-connected. A lower value in  $R_1$  may cause an increase in the rate of relay current change at the end of the cycle. The writer has not, however, carried out any checks with a resistor other than  $10k\Omega$  in the  $R_4$  position.

A  $100\mu F$  component is specified for  $C_1$  and, in the prototype, this gave timing periods ranging from less than 1 second to greater than 25 seconds according to the setting of  $R_3$ . Longer timing periods may be obtained by increasing the value of  $C_1$ . Should, for instance, a  $500\mu F$  component be connected across  $C_1$ , timing periods would be some 6 times longer. If desired, different values of capacitance could be switched into the  $C_1$  position, thereby offering more than one timing range.

$R_2$  is a limiter resistor and has a value which causes the minimum timing period to be slightly less than one second.  $R_1$  is included in circuit to prevent excessive current flow when  $C_1$  is discharged.

An OC72 is shown in the  $TR_1$  position, but the transistor type required here is not critical. Most p.n.p. alternatives should offer equivalent performance.

A crystal diode is connected across the relay coil to prevent the formation of high reverse voltages on de-energising. It is important to ensure that it is connected into circuit with correct polarity as, otherwise,  $TR_2$  may become damaged.

The relay specified is available to the home-constructor.<sup>1</sup> It should not have more than two sets of contacts, as energising current would then become excessive. A coil resistance lower than  $500\Omega$  must not be used,

and  $TR_2$  should preferably be mounted on a heat sink. The 12 volt power supply should be regulated within  $\pm 2$  volts.

It is desirable to employ components having high leakage resistance in the  $C_1$  position, and this point may normally be ensured by

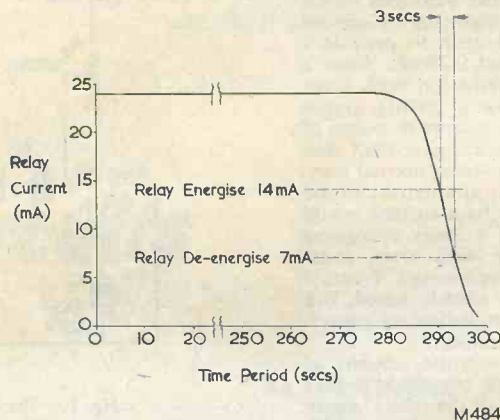

Fig. 3. Curve obtained with the prototype, illustrating the rapid fall of relay energising current at the end of the timing period

It might be thought that the 6 volt battery of Fig. 1 could be replaced by a 6 volt zener diode, since this would offer a low impedance when the voltage on the upper plate of  $C_1$  was 6 volts negative of the base of  $TR_1$ . However, the base current is too low to bring a zener diode on to the level part of its characteristic, and the rate of change of relay de-energising would be much lower with the diode than with the battery. This point was confirmed in practice by the writer.

### Alternative Circuit

In Fig. 1, the 6 volt battery appears between points having varying potentials with respect to the supply lines.

An alternative circuit arrangement is shown in Fig. 2, wherein the negative side of the battery is made common with the positive supply line. This method of connection may enable the 6 volt supply to be obtained from a power unit instead of from a battery. The circuit of Fig. 2 will give slightly different timing periods to that of Fig. 1 since the timing CR circuit now has 18 volts applied instead of 12. Also  $C_1$  will need a working voltage of 18 or more. The collector circuit of  $TR_2$  is the same in both Figs. 1 and 2.

### Practical Points

The circuit should give little trouble in practice due to its simplicity of operation.

using new capacitors of reliable manufacture. If the capacitor employed has been in stock for some time it would be advisable to have several preliminary runs to ensure that it is fully formed before commencing calibration of  $R_3$ .

### Results with the Prototype

It was found that the prototype behaved reliably, giving consistent timing periods for all settings of  $R_3$ .

The curve in Fig. 3 shows relay energising current against time with the prototype, and was obtained by shunting a  $2,000\mu F$  capacitor across  $C_1$  and adjusting  $R_3$  for a period around 5 minutes. As may be seen, energising current remains constant for the first 275 seconds and falls rapidly between 283 and 297 seconds. The relay employed by the writer energised at 14mA and de-energised at 7mA; and these currents are marked in, as a point of interest, in Fig. 3. They are spaced apart by 3 seconds on the falling part of the curve. Currents of 20mA and 2mA appear at the 287 and 297 second points respectively.

A large value capacitor was employed to obtain the curve of Fig. 3 in order that the falling de-energising current could be observed and plotted. The curve should retain approximately the same shape and proportions for lower values of capacitance in the timing circuit.

<sup>1</sup> A suitable relay, fitted with two sets of changeover contacts may be obtained from H. L. Smith & Co. Ltd., 287 Edgware Road, London W.2.

# PHOTO-SENSITIVE

## Car Parking Light Actuator

By M. J. T. SMITH

In which the author describes a regenerative circuit which effectively speeds relay operation

FOLLOWING THE VISIT BY AN OFFICER OF THE LAW to a friend of the writer concerning the lack of a parking light on his car, it was decided to develop an automatic device for actuating the parking light.

The device had to be simple, reliable in operation, and capable of being constructed from components that were readily available. Reference was made to the "Liton" described in earlier issues of the *Radio Constructor*,\* but as few of the parts were to hand, it was decided to use a photo-transistor for the photo-sensitive device. The relay to hand was of 1,700+1,700 $\Omega$  resistance, a Siemens H96E.

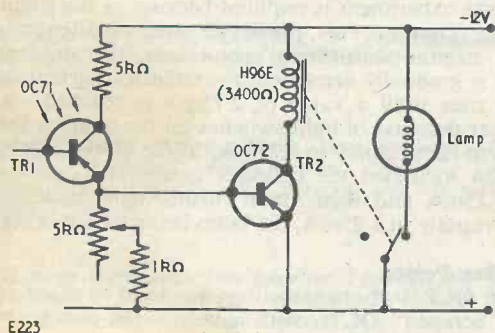

Fig. 1. The initial circuit investigated

The circuit of Fig. 1 was initially set up, using an OC71 with its black protective paint removed for TR<sub>1</sub>, and an OC72 for TR<sub>2</sub>. The circuit worked to a limited extent, and was in fact used for some time. However, various criticisms arose. It was thought that a current rise in TR<sub>2</sub> as darkness approached was desirable, and the circuit of Fig. 2 was tried.

After operation for some time, the actual switching operation was observed one night, and it immediately became apparent that because the rate of change of ambient lighting was very low the relay armature moved extremely slowly also, this encouraging the contacts to arc, although the standard 12 volt 2.2 watt lamp was being used. As reliability

was an essential qualification for the device, some method of making the switching action far more rapid had to be devised.

One way of doing this would have been to increase the number of transistors and hence the d.c. gain, but this was ruled out on the grounds of complexity and thermal stability.

The relay used is of single changeover design, allowing the back contact to be utilised for regenerative switching. The final circuit, Fig. 3, was then evolved.

### Circuit Operation

Consider "light" conditions, in Fig. 3, with the d.c. bias to TR<sub>2</sub> set by the potentiometer to a level such that the relay is de-energised. If the ambient light now decreases the photo-transistor TR<sub>1</sub> increases in resistance and the base bias to TR<sub>2</sub> increases. At a certain level the relay armature just moves away from the back contact. This operation is very slow because of the low rate of change of light. However, as soon as the armature moves from the back contact, the right hand end of R<sub>5</sub> is disconnected from the positive supply line, thus increasing the bias to TR<sub>2</sub> which immediately makes the armature move smartly to the "make" contact. When contact is made, the bias is increased a little further by the removal of the bias on TR<sub>1</sub>, thus making the relay change over in a very positive manner.

When the ambient light rises, the condition is reached when the relay armature starts to move

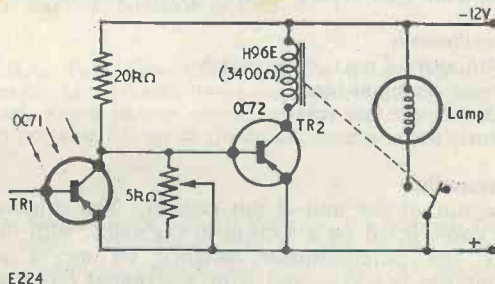

Fig. 2. An alternative circuit which causes TR<sub>2</sub> current to rise with increasing darkness

\* "The 'Liton', A Photo-Electric Parking Light Switch", described by J. M. Ankers, *The Radio Constructor*, April, May 1960.

away from the "make" contact. The bias to TR<sub>1</sub> via R<sub>3</sub> is then restored, and the armature moves rapidly to the back contact because of the decrease of bias to TR<sub>2</sub>. When it arrives, the bias on TR<sub>2</sub> is still further decreased and the armature moves with a very positive action.

There is a certain amount of backlash, but it was considered preferable to the arcing that would otherwise occur at the contacts. Alteration of the amount of switched bias will lessen the backlash effect but will also lead to deterioration of the switching speed, and a compromise must be made.

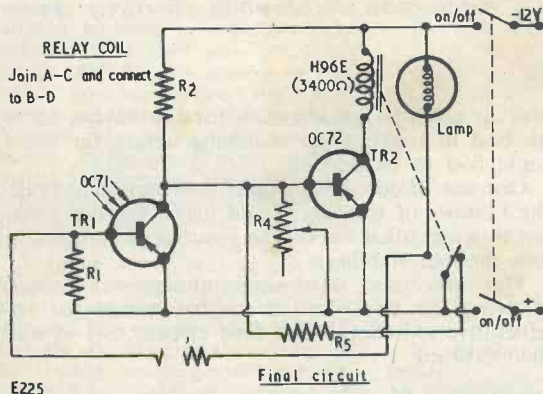

Fig. 3. The final circuit. Regenerative action causes quick energising and de-energising of the relay

#### Components List (Fig. 3)

Resistors (all fixed values, ¼ watt)

- R<sub>1</sub> 220kΩ
- R<sub>2</sub> 20kΩ
- R<sub>3</sub> 10MΩ
- R<sub>4</sub> 5kΩ pot, wirewound or carbon
- R<sub>5</sub> 6.8kΩ

Transistors

- TR<sub>1</sub> OC71 (see text)
- TR<sub>2</sub> OC72

Relay

Siemens type H96E, 1,700+1,700Ω (see text)

Miscellaneous

- Miniature d.p.s.t. slide-switch
- 3-way terminal block
- Plastic case (see text)
- Nuts, bolts, etc.

Construction

Layout of the unit is not critical. The original was constructed on a section of tagboard, with the relay and potentiometer fastened by means of aluminium brackets, and with a terminal block at one end for connections to the 12 volt supply and the lamp.

A later version was constructed in a small plastic soap box obtained very cheaply from the chemist—but other methods of construction will soon suggest themselves.

The photo-sensitive transistor was arranged to protrude through a small hole in the lid. An OC71 was scraped with a razor blade to remove the black paint.

The potentiometer in the original was wirewound, but a carbon component will do just as well.

A small slide-switch was incorporated. This was of Japanese origin and of extremely small size. It was incorporated to enable the unit to be switched off if the car was used during the day. Otherwise the unit tended to operate when passing under bridges!

#### Setting Up

The prototype was used on the shelf at the rear of the car where the photo-sensitive transistor could "look" out of the rear window. The shelf was slightly lower than the window, and hence the unit was unaffected by the headlights of approaching cars.

The 12 volt supply and 12 volt 2.2 watt lamp are connected up and the switch put to "on". The potentiometer is then slowly rotated from the short-circuited position, until the relay just goes over with the photo transistor covered up. Upon removal of the covering the relay should drop out smartly, switching off the lamp.

Some experiment is required because of the slight backlash but, once set, the device needs no attention.

If, starting with "light" conditions, the ambient light is gradually decreased, the collector current of TR<sub>2</sub> rises until a value of 2.75mA is reached. A further decrease of light switches on the lamp as the current rises rapidly to 3.25mA. If the ambient light is now increased the collector current falls slowly to 1.75mA and then, upon further light increase, falls rapidly to 1.25mA, the lamp being switched off.

#### Further Points

An OCP71 photo-transistor was tried in place of the "scraped" OC71, with a very slight change in performance in this application.

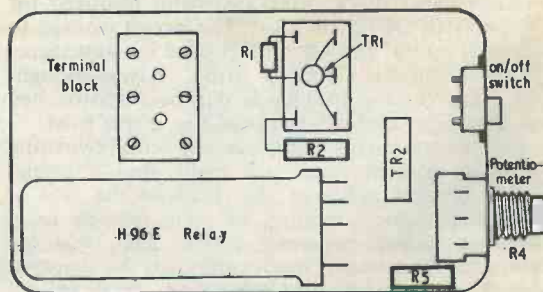

Fig. 4. The general layout employed by the writer

If operation of other devices is required, or of devices consuming more current than 500mA, a secondary relay must be used. Its coil should be for operation from 12 volts and the coil should be connected in place of the existing lamp, a switch being arranged to select either the lamp or relay.

Numerous applications other than actuating of car parking lights will be apparent, as the level at which switching occurs is controlled to a certain extent by the potentiometer.

The unit has been in operation for some time with

no trouble, and the car has been left for a period of many days with complete confidence. Consumption is low, 300 $\mu$ A when light and 3.5mA when dark.

The Siemens H96E relay is a sealed unit, this being an advantage in winter when the atmosphere in cars is far from dry. It is available from Service Trading Company, 47-49 High Street, Kingston-upon-Thames. The coil terminals should be wired as shown in Fig. 3, and the overall coil resistance checked before connecting up to avoid damage to TR<sub>2</sub>.

## CAN ANYONE HELP?

*Requests for information are inserted in this feature free of charge, subject to space being available. Users of this service undertake to acknowledge all letters, etc., received and to reimburse all reasonable expenses incurred by correspondents. Circuits, manuals, service sheets, etc., lent by readers must be returned in good condition within a reasonable period of time*

**Test Set Models AN/UPM-1, AN/UPM-1B.**—A. Redman, 46 Tukes Avenue, Bridgemaury, Gosport, Hants, requires the circuit diagrams, or any other information, of the above American units—purchase or loan.

\* \* \*

**Eddystone 358X Receiver.**—R. Everitt, "Ferndale", Colchester Road, Ardleigh, Colchester, Essex, would like to obtain the manual and also information on where to obtain coil ranges A and E.

\* \* \*

**Oscilloscope Circuit.**—G. Ning, 28 Withington Road, Speke, Liverpool 24, wishes to obtain such a circuit built around the VCR138A tube.

\* \* \*

**Harting HM8 Stereo 4-Track Tape Recorder.**—R. J. Dark, "Bankers", Bucks Cross, Bideford, Devon, urgently requires the circuit diagram and any servicing data.

\* \* \*

**Marconi Communications Receiver Type AD108.**—B. J. Newman, "Meadowlad", Aldington, Ashford, Kent, would like to obtain the handbook.

\* \* \*

**R1155B.**—C. Nicholson, 60 Lodge Lane, Collier Row, Romford, Essex, requires the manual and also any information on modifications to improve selectivity.

\* \* \*

**Portable Amplifier for Piano.**—A. R. Davies, 12 Danescourt Road, Birkenhead, would like to contact a reader who has successfully used a portable amplifier for use with a piano regarding the most suitable equipment.

\* \* \*

**DST100 Mk. III Communications Receiver.**—J. Sharples, 11 Parsonage Road, Blackburn, Lancs, wishes to obtain the service manual, circuit, etc.

\* \* \*

**Hallicrafters SX17.**—B. Watson, 38 Hyde Road, Roade, Northampton, would like to borrow or purchase the handbook or circuit.

**R3647.**—H. J. Duggan, 13 Regina Drive, Leeds 7, wishes to purchase or borrow manual, circuit or information both on this unit and the tuner 10A/147.

\* \* \*

**Hallicrafters SX24.**—J. Walker, 40 Devon Street, Beswick, Manchester 12, requires the lining-up details and, if possible, to purchase or borrow the manual or circuit diagram.

\* \* \*

**TR1986 Transmitter/Receiver.**—R. Hughes, 18 Bexley Drive, Little Hulton, Walkden, Lancs, wishes to purchase the service sheet or manual.

\* \* \*

**Unit Indicator Type 97.**—C. W. Austin, 135 Shaftesbury Avenue, Kenton, Harrow, Middlesex, requires information, circuit diagram and any conversion data for use as an oscilloscope.

\* \* \*

**R1392D VHF Receiver.**—P. Walters, 112 Windsor Avenue, Penn, Wolverhampton, would like to obtain the circuit diagram and details of any conversions.

\* \* \*

**R107 Receiver.**—R. B. Simpson, 38 Meadowbank Road, Fareham, Hants, wishes to obtain the service manual for this receiver; purchase or borrow.

\* \* \*

**U.S.A. Twin Tube CRT Indicator BC-1151-B.**—A. J. Bevan, 11 Parkside, Hepscoth, Morpeth, Northumberland, would like to obtain circuits, etc., to convert to (a) portable TV set or (b) an oscilloscope. All expenses met.

\* \* \*

**Car Radio Circuit.**—S. M. Badham, 115 Narbeth Drive, Aylesbury, Bucks, would like to obtain circuit data and component information with an all-transistor layout, no ferrite aerial but direct coupling of car aerial, 12V supply and between half and one watt output. Willing to purchase and refund postages, etc.

# An OXO Tin Alignment Aid

By A. S. CARPENTER

*Apart from the inexpensive "chassis" employed for the unit described here, further points of interest are given by the use of a transitron r.f. oscillator and the fact that a.f. and r.f. oscillators are combined in a single heptode valve*

**R**ECIPE: TAKE ONE OXO TIN—AND, IN IT, construct a simple, single valve signal generator that can be used to test and align a.m. receivers.

Two oscillators are employed in the unit, one generating radio frequencies, and the other audio frequencies. The a.f. generator is made to modulate its radio frequency counterpart in normal fashion. Oscillators are not usually good neighbours and are preferably boxed in metal; for this purpose we use the tin.

When a great deal of constructional or repair work is usually carried out, the purchase of a good quality signal generator might be justifiable; but the expense is hardly worthwhile for the occasional hobbyist who has little work for it to do. A simple arrangement is then usually sufficient and the

generator described here comes into this category.

Two ranges provide frequency coverage as follows: Range 1, 500–1,600 kc/s; Range 2, 180–600 kc/s.

Most superhet and t.r.f. receivers can, therefore, be easily aligned, for the ranges embrace the conventional a.m. broadcast intermediate frequency of 465 kc/s in addition to the medium waveband and a large part of the long.

## The Circuit

The circuit of Fig. 1 shows that a single valve is utilised and is a 6A8G, a type normally used for frequency changing in a superhet receiver. The r.f. oscillator is based on the transitron circuit, coils  $L_1$  and  $L_2$  in conjunction with  $C_2$  providing the frequency coverage detailed above. The control

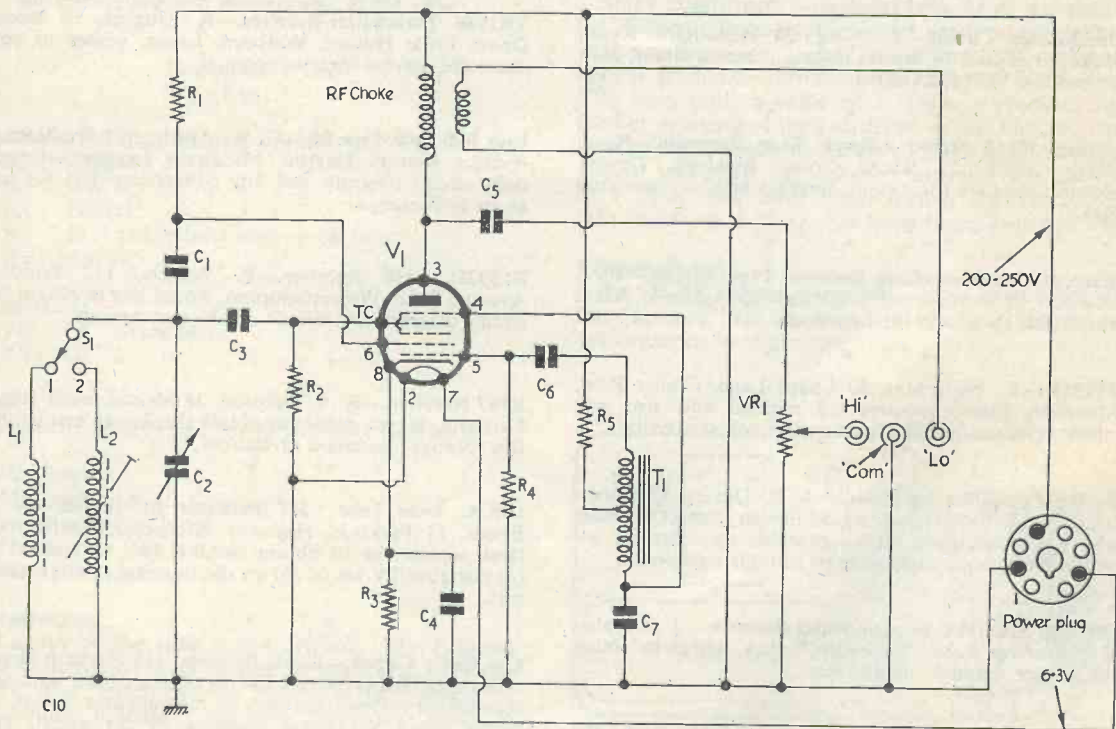

Fig. 1. The circuit of the alignment aid

spindle of  $C_2$  is fitted with a pointer which travels over a scale calibrated in terms of frequency. Audio signals are provided by grids 1, 3 and 5 of the valve, these acting as the elements of a triode valve in conjunction with the transformer  $T_1$  and associated circuitry. Both oscillators are grid leak biased, the bias being dependent upon oscillations being present. Absence of oscillation can give rise to high currents, therefore a small safety bias is included and consists of  $R_3$  and  $C_4$ .

Modulated r.f. appears at the anode of the valve, where it is applied to the choke and passed via  $C_5$  to  $VR_1$ , so that the required level may be taken from the slider. This high impedance point is not entirely suitable for application to, say, the aerial coil of a broadcast receiver where a relatively low impedance obtains, so an alternative low impedance output is provided by a small secondary winding on the r.f. choke.

The transformer used for  $T_1$  is, in the prototype, a vintage tapped model and might therefore not be generally available. Use of the primary winding of a discarded output transformer is possible but

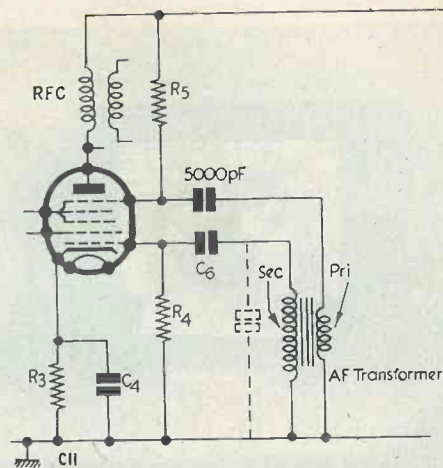

Fig. 2. The modifications required to the audio oscillator to permit use of a transformer

### Components List

(Fig. 1)

#### Resistors. (All fixed resistors $\frac{1}{4}W$ )

$R_1$	22k $\Omega$
$R_2$	56k $\Omega$
$R_3$	200 $\Omega$
$R_4$	100k $\Omega$
$R_5$	68k $\Omega$
$VR_1$	50k $\Omega$ Potentiometer (carbon track)

#### Capacitors

$C_1$	0.01 $\mu F$ ceramic or paper
$C_2$	500pF (nominal) variable
$C_3$	200pF ceramic or mica
$C_4$	0.01 $\mu F$ ceramic or paper
$C_5$	0.01 $\mu F$ ceramic or paper
$C_6$	0.01 $\mu F$ ceramic or paper
$C_7$	5,000pF ceramic or mica (see text)

#### Chassis

Oxo tin

#### Coils

$L_1$	Medium-wave coil
$L_2$	Long-wave coil (dust cored)
$T_1$	See text
	R.F. choke (see text)

#### Valve

6A8G

#### Switch

Miniature rotary 2-pole 2-way (see text).

#### Miscellaneous

Valveholder I.O., screw terminals (3), pointer knobs (3), cable (3-core), hardware, etc. Power plug (if required).

adequate inductance is necessary and, in cases of doubt, the revised circuit shown in Fig. 2 should be adopted. This has been tried and found highly satisfactory. However, the transformer used for the test was too large physically to fit the space available and this point should be borne in mind when the transformer is chosen. If the circuit of Fig. 2 is used the transformer should be a small *intervalve* type, ratio 3 : 1 or 4 : 1. The connections to it must be correctly phased or oscillation will not result, so that it is not unlikely that at the setting-up stage reversal of either the primary or secondary connections will be necessary.<sup>1</sup> The capacitor shown in broken lines across the secondary winding is used to tune the audio note to a suitably pleasing tone and its value must be found empirically starting with a 5,000pF. Capacitor  $C_7$ , Fig. 1, performs a similar function. The values of other components in Fig. 2 should agree with those specified for Fig. 1.

#### Powering the Generator

The generator is powered by an external supply unit offering 6.3 volts a.c. at 0.3A and 200–250 volts h.t. at some 10mA. Both voltages must be isolated from the mains supply, and a suitable power unit has been described in a previous article.<sup>2</sup> The octal power plug of Fig. 1 is intended to fit to the output socket of the power unit previously described. Other isolated supply units can, of course, be used.

#### Constructional Notes

The layout of the prototype generator is shown in Fig. 3. The whole unit is built on the lid of the tin, the carcass merely being used for screening.

<sup>1</sup> It may be found that better results with some a.f. transformers are obtained if the primary (the winding with the smaller number of turns) is connected in the  $g_1$  circuit of Fig. 2 instead of the secondary.—*Editor*.

<sup>2</sup> "A Small Power Supply Unit", by A. S. Carpenter, *The Radio Constructor*, August 1962.

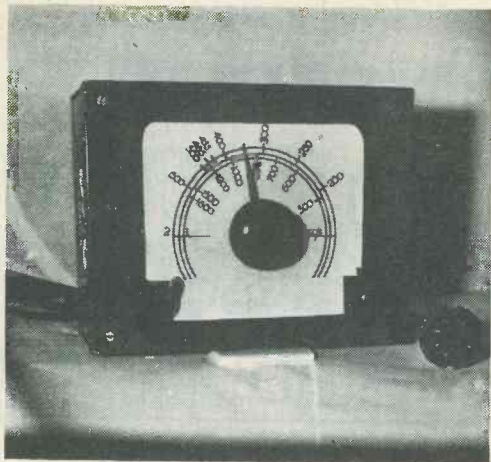

Panel view of the completed unit

The lid is not thick enough to carry the weight unsupported so a rectangle of hardboard, cut smaller than the width and breadth by  $\frac{1}{4}$  in, is used. This strengthening panel allows a  $\frac{1}{4}$  in space all round so that the lid is flush when fitted; 6BA nuts and bolts retain the panel at each corner and the controls also assist in this. In Fig. 3 the valve base is shown removed from its proper position to illustrate the pin connections more clearly.

The main holes are drilled as shown in Fig. 4, and these are easily made if a small bodkin is used in association with a small circular file. Care is necessary or the lid may become unduly distorted; its edges are also extremely sharp!

A simple bracket as shown in Fig. 5 is required to retain the valveholder.

Since the purpose of the choke is primarily to provide a reasonably high impedance to r.f., an inexpensive commercial type ("all wave" pattern) is

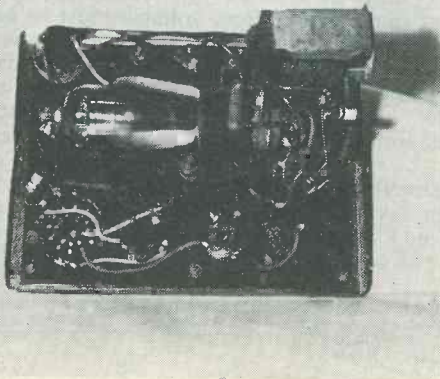

Rear-panel view and layout

suitable. Alternatively, a simple home-made component may be used, and this can comprise a  $\frac{1}{4}$  in diameter coil former (iron cored type) on to which as many turns as possible of fine enamelled copper wire (say 40 s.w.g.) are wound in three or four sections slightly spaced from each other.<sup>3</sup> Winding can be rapidly accomplished by fitting the coil former to the chuck of a hand drill, wire being speedily taken from the reel as the hand drill is operated. The low impedance output winding can comprise of 20 to 30 turns of 36 s.w.g. d.c.c. copper wire, close or pile wound as convenient, on or between sections of the main winding. Care should be taken to ensure that primary to secondary insulation resistance is high, as a d.c. leakage could prove disastrous due to the secondary being effectively at chassis potential. On completion a dust-ion core should be fitted.

It is desirable to fit an h.t. feed point, and a stand-off insulator is fitted at the valveholder for this purpose.<sup>4</sup>

When mounting the output terminals check with an ohmmeter to ensure that the two "Lo" and "Hi" terminals are isolated from chassis. Check also that the assembly can be placed in position in the tin easily without the sides fouling any components on connections, and thereby causing short-circuits. If any doubt exists, insulate the interior. The type of switch employed for  $S_1$  is not important and that used in the prototype consisted of a miniature 3-pole, 4-way type, some of the spare tags being used as wiring anchors for  $C_3$  and  $R_2$ . Capacitors should be miniature, or congestion will inevitably result. A small single-gang air or solid dielectric type is suitable for  $C_2$ .

Any small medium-wave coil can be used for  $L_1$ , whilst  $L_2$  requires an iron cored long-wave type. The reason for using a cored coil will become clear later. The r.f. oscillator uses only the main (tuned) winding on each coil.

No troubles should be experienced during wiring, and operation should be satisfactory provided component values are adhered to reasonably closely. Single valve circuits of this nature are apt to be more temperamental than those employing separate valves or sections thereof for the two functions described. It was found that the values of  $R_5$  and  $C_7$  affected not only the audio oscillator but also affected the r.f. section as well. For example, with  $R_5$  decreased in value and/or  $C_7$  increased, better audio oscillator performance resulted, but there was restricted r.f. coverage. With  $R_5$  at  $18k\Omega$  r.f. oscillations could only be obtained at the high frequency end of the scale with  $L_1$  in use. If any trouble occurs in this respect a milliammeter, switched to read 0-10mA, should be inserted between the anode (pin 3) of the valve and the choke, and  $R_5$  adjusted for highest obtainable current (assuming that both oscillators are functioning).

<sup>3</sup> A maximum of some 700 or 800 turns should be adequate in practice.—Editor.

<sup>4</sup> Pin 1 of the valveholder (NC) could also be used as an h.t. anchor point.—Editor.



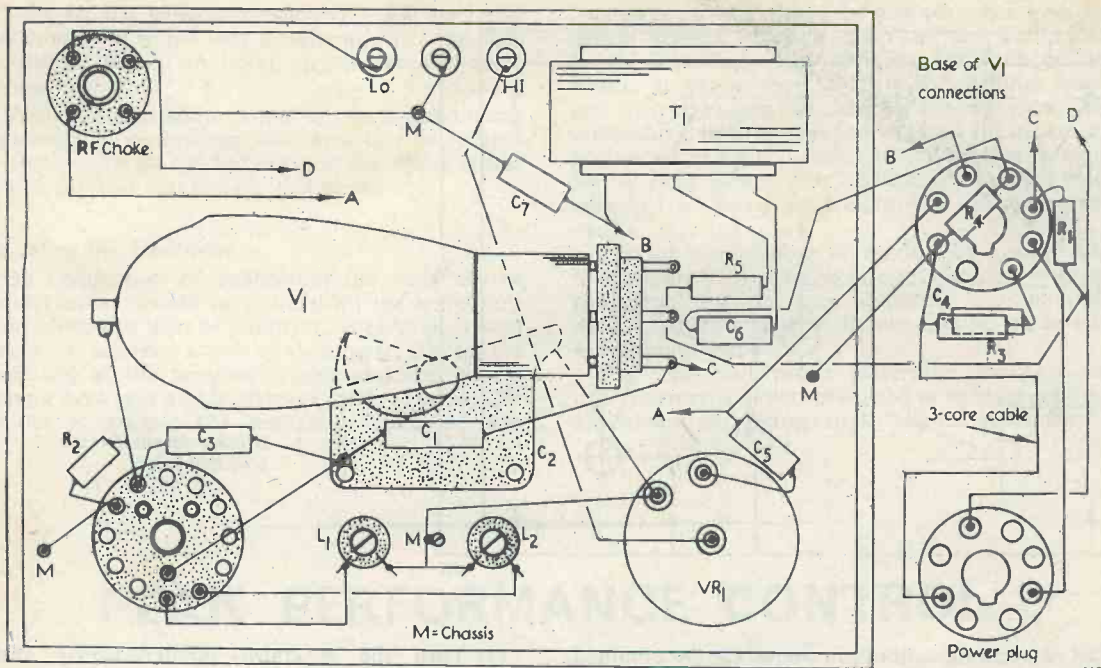

c12

Fig. 3. Layout and wiring. The valveholder is shown flat to illustrate the underside wiring. The position of coil and choke tags may differ from those shown here

**Testing**

A pair of high impedance headphones may be connected to the "Com" and "Hi" terminals on completion. The audio note can then easily be heard if VR<sub>1</sub> is suitably adjusted. If the revised circuitry of Fig. 2 is in use and no note is heard, switch off and reverse the connections to either the primary or secondary of the a.f. transformer. Try again and if no note is now audible switch off and insert a meter in the valve anode circuit as described in the preceding paragraph. Switch on again and watch the meter needle carefully. As the valve warms up this should swing upwards rapidly, then stop suddenly as oscillation causes bias to be applied. If the needle does not stop but shows increasing current switch off and inspect the wiring. A reading of 2 to 4mA is satisfactory. Oscillation can be checked by quickly short-circuiting the resistors R<sub>2</sub> and R<sub>4</sub> in turn, whereupon the current reading in the meter should increase. The tests should be carried out at several settings of C<sub>2</sub> and on both ranges to ensure that complete frequency coverage is being given. If, after this, no note is heard try tuning the a.f. transformer as described earlier.

When all is in order the lid may be fitted back on the tin and the power leads led out through a grommetted hole in the side. The lid should only be fitted temporarily at this stage. The output may then be fed into a broadcast band receiver after a rectangle of white card 4½in x 3in has been tem-

porarily fixed with Sellotape to act as a scale and a pointer fitted to C<sub>2</sub>. The generator and receiver are easily connected by means of TV coaxial cable, the screening being connected to the "Com" terminal on the generator and to the earth socket on the set.

**Calibration**

Range 1 may be calibrated using broadcast stations as check points and a list of BBC wavelengths and frequencies is given in the Table.

Frequency kc/s	Wavelength metres	Transmitter
1546	194	Third Programme
1457	206	West
1214	247	Light Programme
1151	261	N. Ireland, N.E. England
1088	276	Midland
1052	285	West
908	330	London
881	341	Wales
809	371	Scotland
692	434	North
647	464	Third Programme
200	1500	Light Programme

On Range 2 more difficulty is likely to be experienced since few beginners will possess useful ancillary test apparatus. However, with care quite

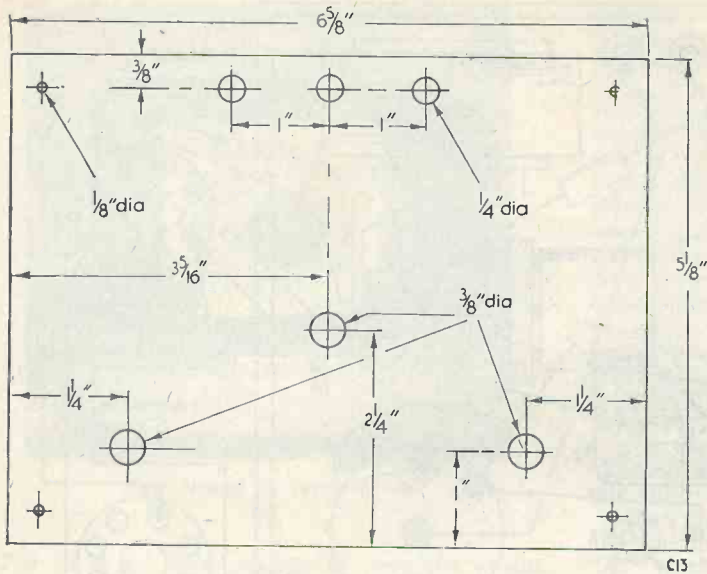

Fig. 4. Drilling details for the principal holes

a lot of accurate calibration points can be obtained using the 200 kc/s Light programme transmission, and by making use of harmonics. A method of working is outlined as follows:

- (1) Calibrate and mark Range 1 scale using transmissions as fully as possible with the aid of a broadcast receiver.
- (2) Switch the receiver to the long-wave and the generator to Range 2. Tune receiver dial to the Light programme (200 kc/s) and tune the generator until its a.f. note is heard in the speaker. Note the position of the generator-pointer and by adjusting the dust core of  $L_2$  (or even removing it entirely) make it necessary for the pointer to be almost at the right-hand end of the scale (vanes of  $C_2$  almost fully enmeshed). Mark "200" on Range 2 scale.
- (3) Leave generator as set, switch receiver to medium-wave and tune around 500 metres (600 kc/s) until the generator harmonic note is heard.
- (4) Leave receiver so tuned. Switch the generator to Range 1 and tune it until the fundamental 600 kc/s note is heard. The vanes of  $C_2$  should be nearly fully enmeshed; judge from the existing calibration. Mark "600" on Range 1 scale.
- (5) Leave the generator set and tune the receiver towards the higher frequency end of its scale until the generator harmonic is heard again at 250 metres (1,200 kc/s).
- (6) Leave receiver so tuned. Tune the generator until 1,200 kc/s fundamental is heard and mark the Range 1 scale "1,200".
- (7) Leave the receiver set, switch the generator to Range 2, and set its pointer to 200 kc/s (already marked) whereupon the 6th harmonic should be heard.
- (8) Turn the generator pointer slowly anti-clockwise until the next harmonic (5th) is heard. Mark Range 2 scale "240".
- (9) Turn the generator pointer anti-clockwise again until the 4th harmonic is heard. Mark scale "300".
- (10) Repeat until 3rd harmonic is heard and mark "400".
- (11) Repeat until 2nd harmonic is heard and mark "600".

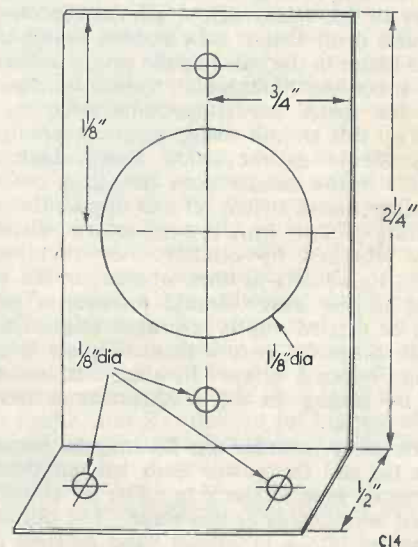

Fig. 5. Details of the valveholder mounting bracket

Now set the generator pointer to 300 kc/s and switch receiver to the long waveband, when the note should be heard at 1,000 metres receiver scale setting.

Various intermediate points can be located using harmonics. For instance, 440 kc/s can be located by listening to its 2nd harmonic at the Wales Home service receiver dial setting, and so on.

### Finalising the Generator

On completion of calibration the ends of the pointer travel should be marked on the temporary scale which can then be removed. A piece of Bristol board or suitable white cord is next cut to the same size as the temporary scale and arcs drawn using a bow pen and indian ink before the spindle cut-out is made. The temporary scale is next

located accurately above the new scale and a sewing needle passed through both at the calibration points including those depicting ends of pointer travel. It is now easy to fill in the readings neatly and correctly using the old scale for reference. The centre may then be snipped out and the new scale positioned and glued firmly to the generator, using Bostik clear adhesive or similar, the pointer being arranged to locate accurately with the end travel marks.

The lid should now be made secure and, since it is essential for it to be in direct contact with the carcass of the tin, spot soldering may be used. Alternatively, a reliable fixture can be made with self-tapping screws.

The unit will prove extremely useful to the experimenter, newly constructed or existing receivers and tuners, etc., being rapidly aligned as required.

## PEAK PERFORMANCE CONTROL

Transistor receivers having Class B output stages tend to suffer from cross-over distortion when battery voltage or ambient temperature falls. This is because these conditions can cause base current in the output transistors to drop to too low a value.

A circuit device which overcomes this difficulty has been introduced by Pye Ltd., and is described as "Peak Performance Control". In this circuit the two fixed resistors which normally supply bias to the driver transformer centre-tap are replaced by a variable resistor and a transistor connected as a diode, as illustrated in the accompanying diagram. The diode is connected so that it conducts.

When battery voltage falls the current through the diode drops, causing its forward resistance to

increase. Thus, the nominal base bias is substantially maintained. The diode also counteracts the effects of extreme ambient temperatures. At high ambient temperatures the output transistors pass increased current. So also does the diode, thereby reducing base bias and reducing collector current in the output transistors. A similar effect, in the reverse direction, occurs at low ambient temperatures. This time, however, the diode also prevents the onset of distortion due to low quiescent currents.

The P.P.C. circuit is now fitted to Pye Q8 and Q9 transistor receivers. In some instances, the variable resistor may be replaced by a fixed component, this being used in conjunction with a selected diode. It is claimed that the circuit gives an increase of 20% in battery life, as well as overcoming shortcomings in performance at extreme ambient temperatures.

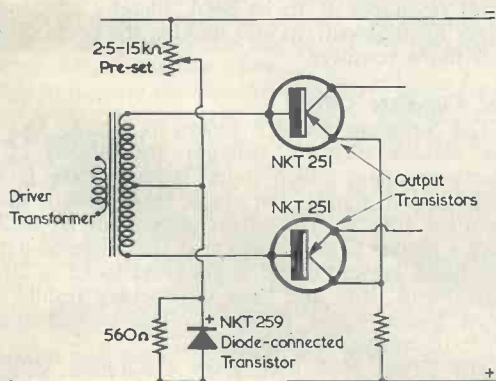

M527

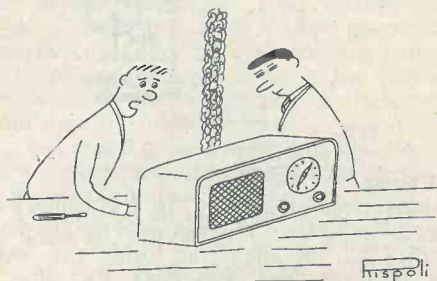

"It's behaving more like a superhet than a superhet!"

# Electrolytic Conditioner and Insulation Tester

By C. L. JONES

B.SC.(HONS.) GRAD.INST.P.

**E**LECTROLYTIC CAPACITORS CAN DETERIORATE when stored due to the dielectric becoming punctured. They can, however, be reformed by passing a small d.c. current through them: care must be taken not to subject the capacitors to voltages greater than their "working voltage", and also to avoid excessive current being passed through them.

The main purpose of the unit described in this article is to provide a means of reconditioning electrolytic capacitors which have been stored for some time. The addition of a capacitor and one or two resistors enables insulation tests to be carried out also.

Attention is drawn to the following points of the circuit described.

- (i) A neon lamp is used to indicate when the electrolytic capacitors are reformed, even though their working voltage may be as low as 12V.
- (ii) The actual leakage current can be monitored by connecting a 10V meter across the terminals provided. This avoids "tying up" an expensive meter in a piece of equipment which will only be used intermittently.
- (iii) The crocodile clips may be short-circuited without harming the circuit or power supply.
- (iv) A power pack is needed to run the instrument as described, but a small conventional h.t. unit can be built in if required.

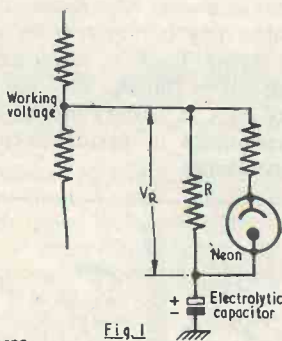

## Basic Circuit

The basic circuit is seen in Fig. 1 in which a high resistance,  $R$ , is placed in series with the electrolytic capacitor. As the dielectric forms the leakage current decreases as, also, does  $V_R$ ; thus the voltage applied to the capacitor is slowly built up to the working voltage.

The neon is used to indicate when the dielectric is reformed. If  $V_R$  is greater than the striking voltage,  $V_S$ , of the neon (in this case 76V) it glows. When  $V_R$  drops below that required to keep up the discharge,  $V_E$ , it extinguishes. Since  $V_R$  is proportional to the leakage current,  $R$  can be chosen such that the neon extinguishes when the dielectric is sufficiently well formed.

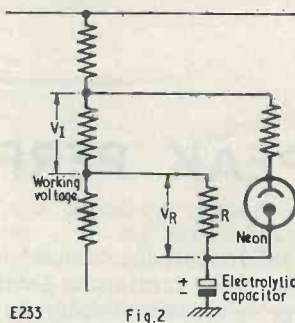

The circuit has to be modified when the working voltage is less than  $V_S$ . In this case, the neon is biased (Fig. 2) by connecting it to a voltage higher than the working voltage. Thus when  $V_1 + V_R$  is greater than  $V_S$  the neon strikes, and when  $V_1 + V_R$  is less than  $V_E$  it extinguishes. This circuit enables the neon to be used for electrolytic capacitors whose voltage is equal to, or greater than 12V, but  $V_S - V_E$  being approximately 10V this scheme does not work for 6V working components.

In the complete unit, the bias arrangement has been used for components with working voltages of 150V and lower; this enables lower values of the series resistance  $R$  to be used, thereby allowing a larger forming current and making the neon indication more sensitive.

## The Complete Circuit

The complete circuit is shown in Fig. 3. In this, the various working voltages are tapped off a resistance chain which is fed from a 350V power pack. As it stands, the chain takes about 40mA from the source. The values chosen for  $R_1$  to  $R_{13}$  were a matter of convenience as they were to hand. The bleed current could easily be reduced to 20. or even 15mA, and still give satisfactory results, by using higher value resistors. The correct ratios must, of course, be maintained.

The power pack used gives a nominal 350V at 100mA, and it was found to give 375V at the bleed current.  $R_1$  was chosen to bring the voltage across

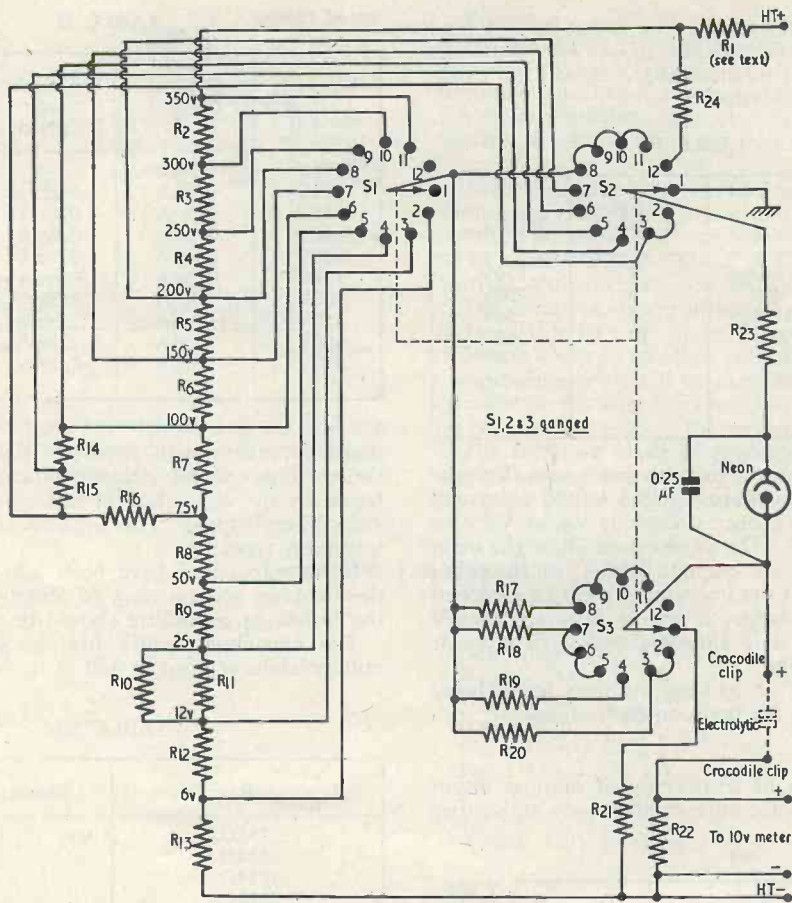

Fig. 3

E234

the chain to 350V, so that the value of this resistor will depend on the h.t. unit used.

There is no reason why any power pack of sufficient capacity cannot be used. If its output is less than 350V, the appropriate resistors can be omitted from the resistance chain. The instrument would be of considerable use even if its maximum voltage were limited to 250V.

R<sub>17</sub> to R<sub>20</sub> are the resistors which are switched in series with the electrolytic capacitor. The wafer S<sub>1</sub> can be omitted if a separate resistor is used for each position, 2 to 11, of the switch.

R<sub>22</sub> is a 1kΩ resistor wired in series with the electrolytic capacitor, every mA passing through it producing a potential difference of 1 volt across it. This p.d. can be monitored on a 0-10V meter if an accurate value of the leakage current is required. On no range does the current through R<sub>22</sub> exceed 10mA, even with the clips short-circuited, so that no harm can possibly befall the 10V meter. An error of about 10% is introduced by placing a 1,000 o.p.v. instrument on its 10V range across R<sub>22</sub>, but greater accuracy is hardly warranted.

Once the electrolytic capacitor is formed the switch must be returned to the Discharge position, and enough time allowed to elapse before the component is removed for the charge to leak away. If this routine is not strictly adhered to, unpleasant shocks may be felt from the charged capacitor or the clips.

It may be felt desirable to use insulated terminals instead of crocodile clips. This certainly reduces the risk of shock but, since a large proportion of electrolytic capacitors have solder tags instead of leads, it reduces the convenience of the instrument. If the switch is always returned to the Discharge position then all should be well.

R<sub>14</sub>, R<sub>15</sub> and R<sub>16</sub> need some explanation. Their purpose is to provide the correct bias for the neon when switch positions 2, 3 and 4 are in use. If the neon is connected to the 100V point, once it has struck it will not extinguish; whilst if it is connected to the 75V point it will not strike in the first place. No difficulty should be encountered with the 25V position, but tolerance on components may be enough to upset the correct functioning on the 12V

range and  $R_{16}$  may have to be found by trial and error. If the neon will not strike with the leads shorted,  $R_{16}$  must be increased, if it will not extinguish,  $R_{16}$  must be reduced.

TABLE I

Switch Position	Function	Switch Position	Function
1	Discharge	7	150V
2		8	200V
3		9	250V
4		10	300V
5		11	350V
6		100V	Insulation test

The 6V range cannot possibly work with this type of circuit, as the voltage applied to the neon will not drop below  $V_E$  once it exceeds  $V_S$ , as  $V_S - V_E$  is greater than 6V. The values used allow the neon to light if the leakage exceeds 0.5mA; on the other hand, once it is lit the instrument must be switched to another range before it will go out. On the 6V range, therefore, it is almost essential to monitor the leakage current.

Table II gives the leakage currents for lighting and extinguishing the neon on each range.

#### Use

There seems to be a diversity of opinion about the allowable leakage current and some authorities

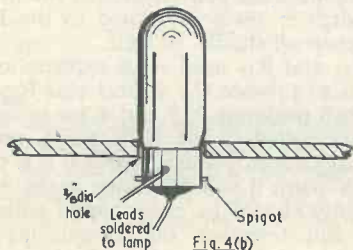
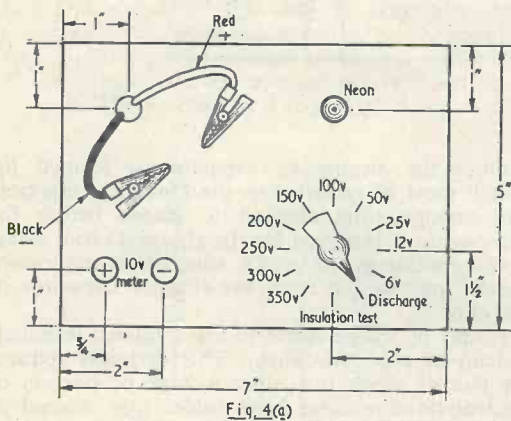

TABLE II

Working Voltage	Striking Current	Extinguishing Current	Maximum Current Croc. clips shorted
6V	0.5mA	—	2.0mA
12V	2.7mA	0.25mA	3.3mA
25V	1.2mA	0.4mA	2.6mA
50V	0.9mA	0.6mA	2.4mA
100V	0.8mA	0.6mA	4.7mA
150V	0.7mA	0.6mA	7.0mA
200V	1.1mA	1.0mA	4.2mA
250V	1.1mA	1.0mA	5.3mA
300V	1.1mA	1.0mA	6.6mA
350V	1.1mA	1.0mA	7.8mA

quote a maximum of 1mA per 10 $\mu$ F. This seems rather high, as all electrolytic capacitors so far tested by the writer have a leakage much less than 1mA when formed. This includes some 60+100 $\mu$ F television types.

If the capacitors have been idle for some time the forming process may be lengthy. In any case the following procedure should be adopted.

The capacitor should first be subjected to a voltage about a third to half of its working voltage.

TABLE III

Leakage Resistance	Flashes Per Minute
1M $\Omega$	186
5M $\Omega$	136
10M $\Omega$	80
20M $\Omega$	68
30M $\Omega$	60
40M $\Omega$	48
50M $\Omega$	36

When the neon goes out the switch may be turned to the next range, and so on until the working voltage is reached. The process can often be accelerated by switching back and forth to the higher voltage (not larger than the working voltage). Old components which have not been used for some time may be rather stubborn and take some time to reform, these should be discharged and the process repeated several times.

It is a good idea to reform stocks of electrolytic capacitors every few months.

#### Insulation Tests

When the switch is turned to the Insulation Test position, the neon is switched to 350V through  $R_{24}$ . The 0.25 $\mu$ F capacitor changes up through  $R_{24}$ ,  $R_{23}$  and any leakage resistance placed across the crocodile clips. The flashing of the neon indicates the extent of the leakage, as given in Table III.  $R_{24}$  is chosen to give a reasonable flashing rate for a leakage resistance as low as 1M $\Omega$ .

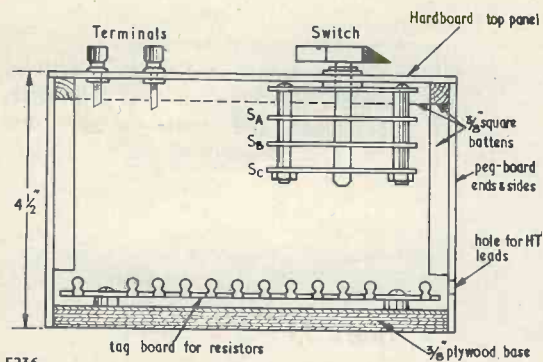

### Constructional Details

The layout is in no way critical, and the unit can be built into any convenient box. If a container has to be made, however, the constructor may find the following details useful.

The base is made of  $\frac{3}{8}$  in plywood, pegboard ends being pinned and glued on with impact adhesive. The top panel (Fig. 4 (a)) carries the switch, terminals and neon, and is fastened to the ends by  $\frac{3}{8}$  in square battens. The ends and top also carry battens to enable the long side to be screwed on. (Fig. 5.)

A  $\frac{3}{8}$  in diameter hole is drilled in the panel for the neon lamp (Fig. 4 (b)) and a knife cut may have to be made on one side of the hole to allow the spigots to be eased through. Once in place the neon is a tight fit, and wires may be soldered directly to it.

The components are mounted on two tag boards screwed side by side on to the base, and a hole is drilled in one end to allow entry of the h.t. leads.

No difficulty should be experienced in wiring the circuit with the long sides removed, they are screwed on for ease of removal for servicing.

The sides are made of pegboard to allow plenty of ventilation, as a considerable amount of heat is generated in the potentiometer chain.

### Components List (Fig. 3)

#### Resistors

R <sub>1</sub>	See text
R <sub>2</sub>	} 1.2k $\Omega$ 5% 2W
R <sub>3</sub>	
R <sub>4</sub>	
R <sub>5</sub>	
R <sub>6</sub>	
R <sub>7</sub>	
R <sub>8</sub>	
R <sub>9</sub>	} 620 $\Omega$ 5% 2W
R <sub>10</sub>	
R <sub>11</sub>	
R <sub>12</sub>	} 150 $\Omega$ 5% 1W
R <sub>13</sub>	
R <sub>14</sub>	
R <sub>15</sub>	
R <sub>16</sub>	
R <sub>17</sub>	70k $\Omega$ 5% 2W

R <sub>18</sub>	20k $\Omega$ 5% 5W
R <sub>19</sub>	8.2k $\Omega$ 5% 1W
R <sub>20</sub>	2.2k $\Omega$ 5% 1W
R <sub>21</sub>	6.8k $\Omega$ 20% 1W
R <sub>22</sub>	1k $\Omega$ 5% 1W
R <sub>23</sub>	100k $\Omega$ 20% 1W
R <sub>24</sub>	3.6k $\Omega$ 5% $\frac{1}{2}$ W

#### Capacitor

0.25 $\mu$ F 350V working

#### Switch

S<sub>1, 2, 3</sub> Yaxley type: 3 wafers each 1-pole, 12-way

#### Neon

G.E.C. Miniature Neon Indicator Lamp Type LNI with M.C.C. cap. (M.O. Valve Co. Ltd.)

## London Studio Has World Radio Programmes Taped

News flashed across Europe to London before breakfast is edited, recorded and transmitted by direct line to New York. A commentator can speak to any part of the world using G.P.O. cables or short wave transmitters at Berne.

The organisation behind this network is Stagesound Ltd., whose well-equipped studios overlook London's Covent Garden.

Following a recent delivery by E.M.I. Electronics Ltd. of 15 RE301 tape recorders, over 50 E.M.I. machines are now involved in these operations, which consume three-quarters of a million feet of Emitape every week.

Originally supplying London theatres with tailored sound effects, Stagesound now records radio programmes in 63 languages for transmission throughout the world. Many of the programmes are transmitted direct from the studios by G.P.O. private lines or short wave radio to overseas networks. In other instances edited tapes are delivered to radio stations at home and abroad.

Broadcasts of important events like royal weddings and major sporting fixtures are often transmitted live to the United States, France and Belgium.

Stagesound supplies a regular programme service to New York for the R.K.O. Network and Mutual Broadcasting Service, and for some 2 $\frac{1}{2}$  years has been responsible for all news sent over the air from Europe direct to these two stations.

All programmes from this country for Europe No. 1, a Continental commercial radio station, are supplied by Stagesound Ltd.

A multi-tape copying channel that uses 17 E.M.I. tape recorders makes copies of either monaural or stereo tapes at any speed and produces up to 500 copy tapes per day. The two master machines are E.M.I. type TR90 recorders having various head set-ups so that they are capable of replaying tapes of full track, top track, bottom track or stereo recordings. Two machines are used so that two tracks of unrelated recordings can be transferred to the copy tapes.

A control unit is provided to control the level and frequency characteristics of the copy tapes. The desk feeds 15 E.M.I. RE301 tape recorders for copying purposes. These are often kept running for weeks without respite.

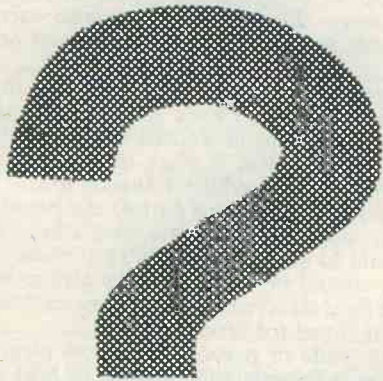

# understanding radio

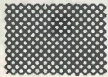

The fourteenth in a series of articles which, starting from first principles, describes the basic theory and practice of radio

part 14

By W. G. MORLEY

**I**N LAST MONTH'S ISSUE WE UNDERTOOK A PRELIMINARY examination of practical inductors, and dealt also with inductor symbols and inductors in parallel and series. We shall now carry on to time constant, after which we shall introduce the subject of alternating current.

## Time Constant

Up to the present we have considered the functioning of circuits which contain resistance only, capacitance only, or inductance only. We shall now carry on to consider some circuits which contain resistance and capacitance, and resistance and inductance.

As we know, if a capacitor is connected to a battery or a similar source of e.m.f. it becomes charged. Let us now examine what happens if we connect a resistor in series with the capacitor, as we do in Fig. 77 (a). In this diagram the capacitor is initially in the discharged condition, and the circuit is interrupted by a key which is shown in the open position.

At the instant of pressing the key, the voltage across the capacitor (i.e. that on its plates) is zero, because the capacitor is discharged. The initial current which flows is then that which the applied e.m.f. would cause to pass through the resistor on its own (the capacitor being considered short-circuited). However, as soon as the capacitor commences to charge, a voltage appears across it. This causes the voltage across the resistor to become reduced, whereupon less charging current flows through it. The process carries on continuously, the charging current through the resistor reducing

as the voltage across the capacitor increases. In theory, the voltage across the capacitor never becomes equal to that of the applied e.m.f., but in practice it becomes sufficiently close after a period of time for the difference to be negligible.

Fig. 77 (b) illustrates the curve relating the voltage across the capacitor to time. The zero point of the graph indicates the instant when the key of Fig. 77 (a) is depressed, and the voltage across the capacitor increases rapidly immediately after this point. The rate of increase of voltage continually reduces as voltage increases, becoming very small indeed as the voltage approaches that of the applied e.m.f.

As is to be expected, the capacitor will charge more slowly if the value of the series resistance increases. It will also charge more slowly if the capacitance increases, and these two facts can be combined into the equation

$$T = CR$$

where C is the capacitance in farads and R is the resistance in ohms. T is the *time constant* of the circuit and defines the time, in seconds, taken for the voltage across the capacitor to rise to 63% of the applied e.m.f. The use of the 63% figure enables time constant to be evaluated very conveniently in farads and ohms, as is illustrated by the formula. Since the farad is a large unit it is usually simpler, with radio calculations, to express time constant as the product of capacitance in microfarads and resistance in megohms. As we are multiplying one unit by a million and dividing the other by a million, the result is the same as working with farads and ohms.

A few examples may illustrate how time constant



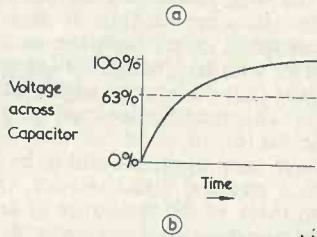
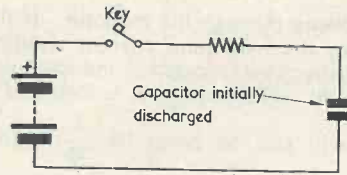

M478

Fig. 77 (a). Charging a capacitor via a resistor  
(b). Curve showing the rise of voltage across the capacitor. Time constant defines the time taken for the voltage to rise to 63% of that applied

may be evaluated with commonly met components. Let us assume that the capacitor of Fig. 77 (a) has a value of  $2\mu\text{F}$  and that the resistor has a value of  $10\text{M}\Omega$ . The time constant will then be given by

$$\begin{aligned} T &= CR \\ &= 2 \times 10 \\ &= 20 \text{ seconds.} \end{aligned}$$

The voltage across the capacitor will, therefore, rise to 63% of the applied e.m.f. 20 seconds after the key has been closed.

To take a further example, let us assume that the capacitor has a value of  $5\mu\text{F}$  and the resistor a value of  $200\text{k}\Omega$  (or  $0.2\text{M}\Omega$ ). Then:

$$\begin{aligned} T &= CR \\ &= 5 \times 0.2 \\ &= 1 \text{ second.} \end{aligned}$$

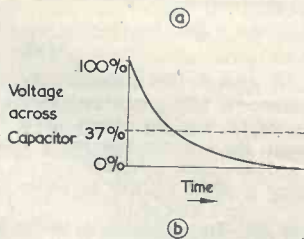
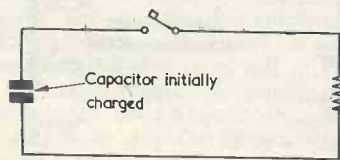

M479

Fig. 78 (a). Discharging a capacitor through a resistor  
(b). The voltage discharge curve of the capacitor. Time constant defines the time taken for the voltage to fall to 37% of its initial value

If we have a capacitor of  $1\mu\text{F}$  and a resistor of  $1\text{M}\Omega$ , the time constant will also be 1 second, as it will be with  $2\mu\text{F}$  and  $500\text{k}\Omega$ ,  $10\mu\text{F}$  and  $100\text{k}\Omega$ , and so on. Because the same time constant is given with different individual values in the capacitor-resistor circuit, such circuits are sometimes defined in terms of time constant only. If circuit requirements merely dictated the use of a capacitor-resistor combination having a time constant of 1 second, any of the combinations we have just mentioned would work equally well. (It is usual, incidentally, to refer to the capacitor-resistor combination as a *CR circuit*.)

In Fig. 78 (a) we see the effect of discharging a capacitor via a resistor. The capacitor is initially charged and, when the key is pressed, commences to discharge through the resistor. The discharge current flowing through the resistor will be at its maximum at the instant of closing the key, and will

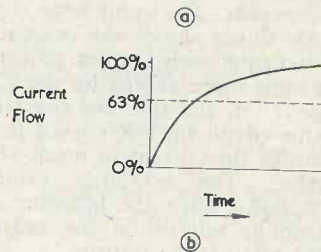
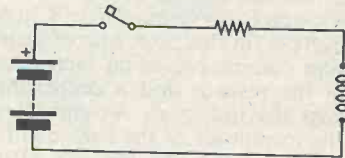

M480

Fig. 79 (a). Coupling an inductor to a source of e.m.f. via a resistor  
(b). The rise in current follows the curve shown here. The time constant is the time taken for the current to reach 63% of its maximum value

then decrease as the voltage across the capacitor falls. In theory, the capacitor never becomes fully discharged but, in practice, the voltage across its plates falls to a negligibly low value after a period of time has elapsed. The curve for voltage across the capacitor with reference to time is given in Fig. 78 (b) and it may be noted that this is the reverse, so far as voltage is concerned, of that shown in Fig. 77 (b). When the capacitor discharges into a resistor, the time constant defines the time taken for the voltage across its plates to fall to 37% of its initial value. This corresponds to a *loss* of voltage of 63%, whereas the previous case corresponded to a *gain* of voltage of 63%.

Circuits employing inductance and resistance exhibit properties similar to those of the CR circuit. In Fig. 79 (a) we have an inductor connected in series with a resistor, the pair being applied to a battery or similar source of e.m.f. by way of a key.

This time we do not examine the voltage appearing across the inductor (as we did with the capacitor) but the current which flows through it.

At the instant of closing the key, a current is caused to flow through the inductor. However, the latter immediately sets up a back e.m.f. which opposes the flow of current. In consequence the current does not rise to its maximum value immediately, but rises at a slow rate instead. Actually, the process is rather complicated if considered in greater detail, and it is not quite as simple to grasp as is the case with the CR circuit. It may help if it is noted that the back e.m.f. increases as rate of current change in the inductor increases, and that the back e.m.f. cannot be greater than the voltage applied to the coil via the resistor. At the instant of closing the key there is zero current flowing through the coil and the voltage dropped across the resistor is zero also, thereby allowing the back e.m.f. to approach the full voltage of the source of e.m.f. A high back e.m.f. corresponds to a high rate of change of current (in this case, rate of increase), but the increasing current causes an increasing voltage drop across the resistor and a decreasing applied voltage across the inductor. As current increases, therefore, the magnitude of the back e.m.f. becomes more and more limited and the rate of change of current decreases also. The result is the curve given in Fig. 79 (b), which shows the current flowing through the inductor with respect to time. This curve has the same shape as that for the CR circuit shown in Fig. 77 (b), and the time constant of the inductor-resistor circuit (or *LR circuit*) is equal to the time taken for the current to reach 63% of its maximum value. This maximum value is the current which flows when the inductor offers no further opposition, whereupon the only limiting factor to current flow is the resistor.

As is to be expected, the time constant of an LR circuit increases as the value of the inductor increases. At the same time, the time constant *decreases* as the value of the resistor increases. This may seem a little surprising at first, but it may prove helpful to remember that we are talking in terms of 63% of the maximum current which can flow, and the maximum current which can flow decreases as resistance increases.

The time constant of an LR circuit is given by:

$$T = \frac{L}{R}$$

where T is the time constant in seconds, L is inductance in henrys, and R is resistance in ohms. Henrys are units frequently encountered in radio work and no great advantage is gained by using sub-multiples as we did in the previous case with microfarads and megohms.

Since inductors are wound with wire they must always possess a certain amount of resistance in addition to their inductance. Some inductors have many turns of fine wire and it is not at all unusual for these to have resistances of the order of hundreds or thousands of ohms. In Fig. 79 (a) we showed a resistor which limited the maximum value of the

current flowing through the inductor. If there were no resistor, the maximum current would then be limited by the resistance of the inductor itself. The circuit would still function as before and the time

constant will still be given by  $\frac{L}{R}$ ; however, R

would now be the resistance, in ohms, of the *inductor itself*. Because of this, it is possible to depict the resistance of an inductor as a physical resistor in series with it. In Fig. 80 (a) we have an inductor of 10H (i.e. 10 henrys) which has a resistance of 100Ω. This may be depicted in the manner shown in Fig. 80 (b), in which we now assume the inductor to have zero resistance and to be connected in series with a physical 100Ω resistor. It is quite permissible to think of the resistance of an inductor as a physical resistor in series with it, and this method of presentation can often be of assistance when carrying out calculations.

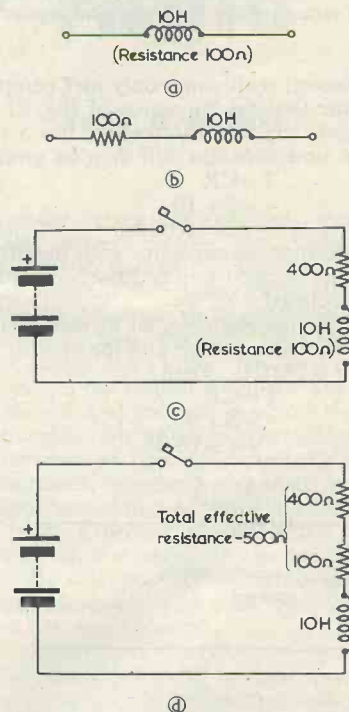

M481

Fig. 80 (a). A typical 10H inductor may have a resistance of 100Ω, as shown here

(b). The resistance may be shown as a physical resistor in series, the inductor now being assumed to have zero resistance

(c). Connecting a 400Ω resistor in series with the inductor of (a)

(d). The total effective resistance in series with the inductor is 500Ω when its own resistance is added

Let us now find the time constant of our 10H coil with its 100Ω resistance.

$$T = \frac{L}{R}$$

$$= \frac{10}{100}$$

$$= 0.1 \text{ second.}$$

In Fig. 80 (c) we connect a physical 400Ω resistor in series with our 10H inductor, giving us a circuit similar to that of Fig. 79 (a). However, the inductor itself still has its own resistance of 100Ω and we should show this in series also, giving us a total resistance of 400 plus 100Ω, as in Fig. 80 (d). In this case

$$T = \frac{10}{500}$$

$$= 0.02 \text{ second.}$$

Therefore, the time constant is now 0.02 seconds; as would be given by a 10H inductor with zero resistance in series with a 500Ω resistor.

Before concluding the present discussion it should be mentioned that the behaviour of the inductor in Fig. 79 (a) will be very different from that of the capacitor of Fig. 77 (a) when the key in the circuit is opened. In the latter case the capacitor will merely remain charged when the key is opened, and no further action will take place. The inductor, on the other hand, will have had a magnetic field established about it, and this will collapse when the key is opened. This collapse will be much quicker than the initial build-up of the field when the key was originally closed. Since the lines of magnetic force in the collapsing field cut the turns of the coil more quickly, a voltage is induced in the coil which is greater than that of the battery. This voltage may be so high that sparking occurs at the contacts of the key.

### Alternating Current

Up to now we have considered component applications and circuits in which electromotive force is obtained from a source of supply having the same characteristics as a cell or battery. The current we obtain from such sources of supply has constant polarity, one terminal of the source always remaining negative and the other always remaining positive. We refer to the current so obtained as a *direct current*, in order to differentiate it from another type of current which we shall now consider.

If we have a rectangular loop of wire positioned in a magnetic field, as in Fig. 81, a voltage will appear across its terminals when it is rotated over a small part of a revolution. This voltage is induced in the loop because its sections are cutting lines of magnetic force. It will be noted that we have provided the loop of wire with an arrangement of sliding contacts which enables the connections to the terminals to be retained during rotation.

In order to study the effect of the loop more closely, it will prove helpful to show a cross-section through its conductors and the magnetic field, as

in Fig. 82 (a), which corresponds to Fig. 81. In Fig. 82 (a) the left-hand conductor is designated A, and the right-hand conductor B, for purposes of identification.

Let us next turn the loop of Fig. 82 (a) through 180° so that conductor A is now at the right, and conductor B is at the left. (See Fig. 82 (b).) If we once more rotate the loop through a small part of a circle, we will again obtain a voltage at the terminals. However, each conductor of the loop is now passing through the field with opposite direction to that given in Fig. 82 (a). In consequence, the polarity of the voltage obtained at the terminals is reversed.

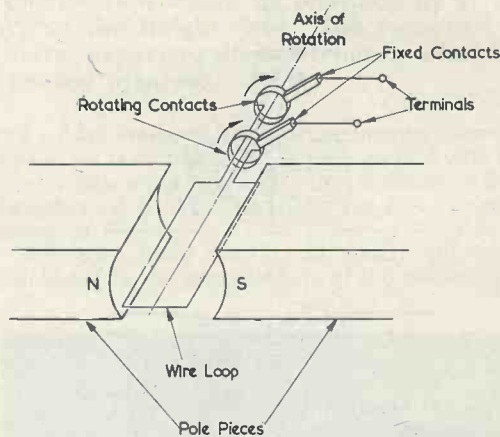

M506

Fig. 81. A loop of wire, free to rotate in a magnetic field, generates a voltage

In Fig. 82 (c) we see another relationship. In this case the loop is mid-way between the two previous positions. If the loop is made to rotate over a small part of a circle as before, we will now find that, because of the relative positions of loop and field, it cuts very few lines of force. In consequence, a smaller voltage appears at the terminals. Indeed, at the instant when the loop passes through the exact position shown in Fig. 82 (c) it cuts no lines of force at all because its conductors are travelling in the same direction as the lines of force. At this instant, therefore, the voltage at the terminals is zero. A similar effect occurs when the loop is rotated through 180°, as at Fig. 82 (d).

Instead of moving the loop over small parts of a complete circle, let us now commence to rotate it so that it is continually revolving in the field, and examine the voltage presented at the terminals. At the instant when the loop has the position shown in Fig. 82 (c) zero voltage appears at the terminals. Immediately after this instant a voltage appears and this increases until we reach the position shown in Fig. 82 (a), in which the loop is cutting the maximum number of lines. After this point the voltage

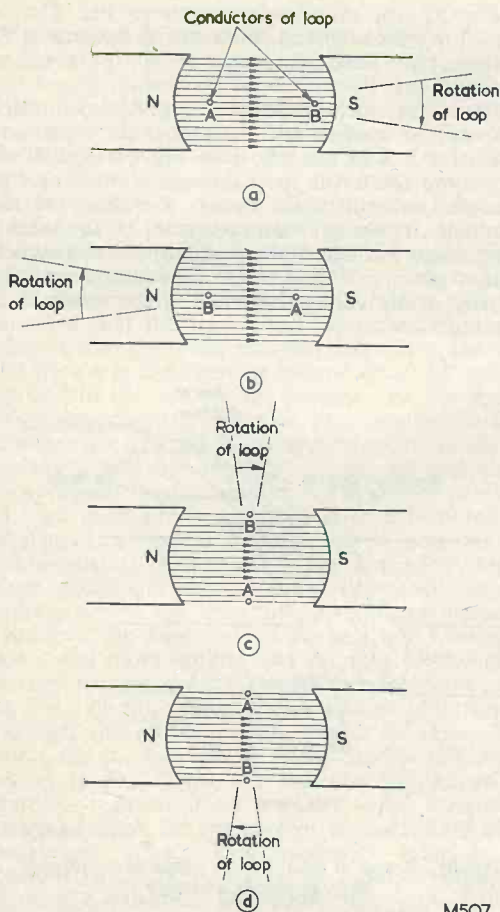

M507

Fig. 82. Cross-sections through the assembly of Fig. 81, showing different positions of the loop in the field

commences to fall until, at the instant corresponding to Fig. 82 (d), it becomes zero again. Immediately after this instant the voltage at the terminals com-

mences to rise again, but with *opposite polarity* because each conductor of the loop is passing through the field with opposite direction. As before, the voltage at the terminals increases again, reaching a maximum when the loop has the position shown in Fig. 82 (b), and dropping to zero when the loop has the position shown in Fig. 82 (c). After this last position the polarity of the voltage at the terminals reverses once more and the operation commences to repeat itself.

The arrangement depicted in Figs. 81 and 82 is an elementary form of *generator*.<sup>1</sup> If an external conductor were connected across the terminals, current would flow in it, this being at a maximum when the voltage generated is at a maximum, and at zero when the voltage generated is at zero. Immediately after the instant of zero current the direction of current flow in the external conductor would reverse, because the polarity of the voltage generated has similarly reversed. A current whose direction continually reverses in this manner is known as an *alternating current*.

The term "alternating current" is very frequently abbreviated to "a.c.", the latter being employed as an adjective also. Thus, the elementary generator we have considered could be described as an "a.c. generator". The voltage provided by our generator can be referred to as an *alternating voltage*. However, the abbreviation "a.c." is so widely employed as an adjective that the term "a.c. voltage" is often encountered instead, despite the conflicting meaning of the words and abbreviations employed. An alternative, frequently met, is "a.c. potential". The abbreviation "d.c."—for "direct current"—is similarly applied to components, equipment and units such as voltage.

#### Next Month

In next month's issue we shall continue with the subject of alternating current, dealing with waveform and reactance.

<sup>1</sup> In the contact arrangement shown in Fig. 81 the two fixed contacts could then be described as *brushes*, and the rotating circular conductors against which they bear as *slip-rings*.

## Closed-Circuit TV Aids Prehistoric Shaft Excavations Near Stonehenge

That most modern of supervisory tools—closed circuit television—is being employed to save time and improve all-round control during archaeological excavations at the prehistoric Wilsford Shaft, near Stonehenge.

Excavations have already reached a depth of almost 100 feet in this shaft, which is quite unlike any other discovered in this country. It is 6 feet in diameter, vertical and extremely well engineered.

A closed-circuit TV camera situated at the bottom of the shaft and a television receiver in a hut at ground level—both supplied by E.M.I. Electronics Ltd.—enable visual contact to be maintained at all times between the one or two operators who can work in the limited area at the base of the shaft and the remainder of the team above ground.

Use of this equipment saves communication time—the round trip to the bottom of the shaft and back takes fifteen minutes—and enables the supervisor to make limited decisions, based on immediate appreciation of the difficulties of any new situation, without descending the shaft. It is also possible to take immediate photographs from the TV receiver screen of any finds which are in inaccessible positions and cannot therefore be quickly removed.

Middle Bronze Age urns and a shale ring discovered during the excavations suggest a possible date for the shaft of around 1500 B.C. Marks on the walls suggest that they were dug with antler picks and bronze axes, which were the tools widely used at that time.

This is the first time that closed-circuit TV has been used in this way in the United Kingdom. Paul Ashbee, who is supervising the excavations on behalf of the Ministry of Works Inspectorate of Ancient Monuments, first thought of using this technique at the Wilsford Shaft when he heard about the "bloodless" archaeological methods used in the Etruscan Tombs, which were photographed by rotating cameras inserted through small holes bored in the ceilings, without any human being entering the tombs.

Commenting on future prospects for this technique, Mr. Ashbee said, "Closed-circuit television will undoubtedly take its place among the modern scientific aids to the study of man's prehistoric past".

# Simple TV Armchair Control

By K. V. R. Bowerman

This article describes a simple but very effective method of obtaining remote control of a television receiver. It must be emphasised that the circuit arrangement is such that the remote control leads may either be at mains potential or at the h.t. positive potential of the receiver. In consequence, care must be taken to ensure that there is no risk of shock and that the wiring and control unit have adequate insulation. In the author's version a B9A socket is used for connection to the 6-way cable at the remote point. A safer termination would be provided by a more robust plug and socket assembly such as the Bulgin P466. The remote control should only be installed by the more experienced constructor who appreciates the shock hazard involved

THE WRITER HAS A SOMEWHAT ANCIENT 16IN TV receiver which he is loath to replace because the picture quality on the rebuilt 70° tube seems, to his prejudiced eye, superior to that obtained on present 110° jobs. Furthermore, the sound quality is (for a t.v. set) really excellent. Originally B.B.C.-only, the set was converted by means of a turret tuner into a two-channel receiver about three years ago. Since then a remote volume control (of an admittedly crude nature) was added as shown in Fig. 1. This conferred immense benefits, and it was not long before we began to hanker after a remote control for channel changing as well.

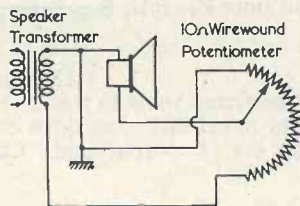

M502

Fig. 1. The volume control circuit

All sorts of elaborate devices to achieve this were thought out, but they were eventually discarded on the grounds either of complexity or expense. Recently, however, an advertisement was noticed for 13-channel tuners, salvaged from equipment, less valves, at 12s. 6d.! This produced an idea and, as a result, a remote channel changing system of exceptional simplicity exists. Not only is the change from B.B.C. to I.T.V. or vice versa absolutely instantaneous, but it is also completely silent in action.

The remote unit itself is illustrated herewith. As may be seen, this has a slide switch, a volume control

and a neon indicator, the latter serving to show that the t.v. set is switched on. A later version with two neon indicators is now used. One lights on B.B.C., the other on I.T.V. The wiring for this version is shown in Fig. 2.

The writer fitted the 12s. 6d. tuner with valves, installed it in the opposite side of the cabinet from

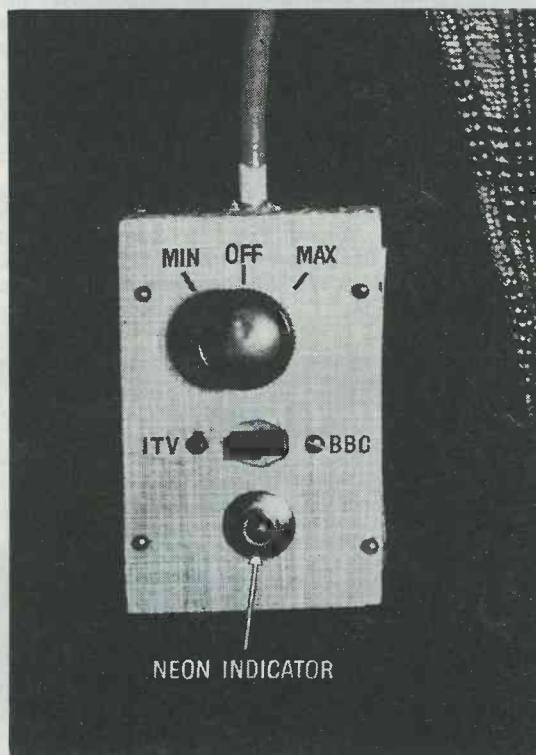

The remote control unit. That shown here has a single neon indicator. The later version employed two indicators

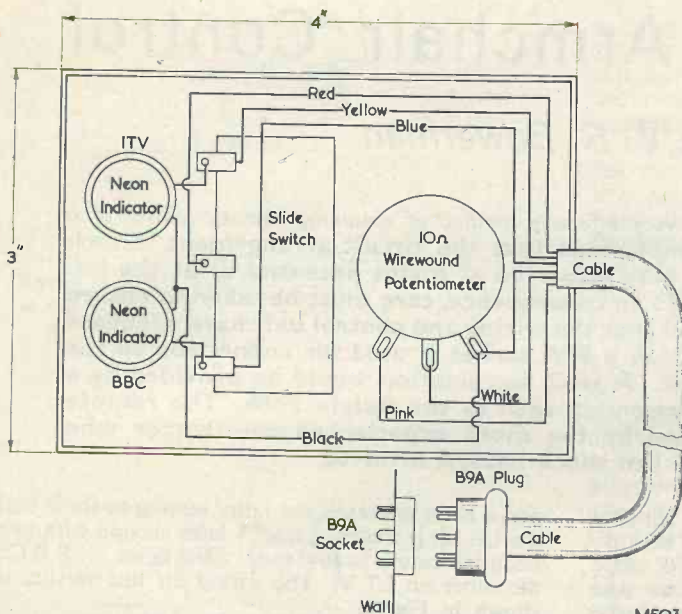

Fig. 2. Wiring and layout of the control unit

M503

the original tuner (being an old receiver, there is room for this), and adjusted one tuner to Channel 1 and the other to Channel 9. The outputs were then combined and a two-way switch in the h.t. line was arranged so that h.t. is fed only to the tuner adjusted to the channel required. Extending the two-way switch line to the remote point gave us all the facilities required.

#### Combining the I.F. Outfits

One problem which had to be solved was the combining of the i.f. outputs from the two tuners. Luckily, both tuners have a nominal output impedance of  $56\Omega$ , and it was therefore an easy matter to devise a resistive combining network, as shown in Fig. 3.

The figure of  $18\Omega$  is arrived at in the following manner. Where the nominal impedance of all fed

(or feeding) elements is the same,  $R = \frac{Z(n-1)}{n+1}$  ohms

where  $Z$  is the nominal impedance in ohms and  $n$  the number of fed (or feeding) elements. In this instance, we have two tuners feeding one t.v.

receiver, and since  $Z = 56\Omega$ ,  $R = \frac{56(2-1)}{2+1}$  ohms

$$= 18.7 \text{ ohms}$$

The nearest preferred value to this is 18 ohms.

It should be noted that some types of turret tuner have h.t. on the i.f. output lead. Check this by

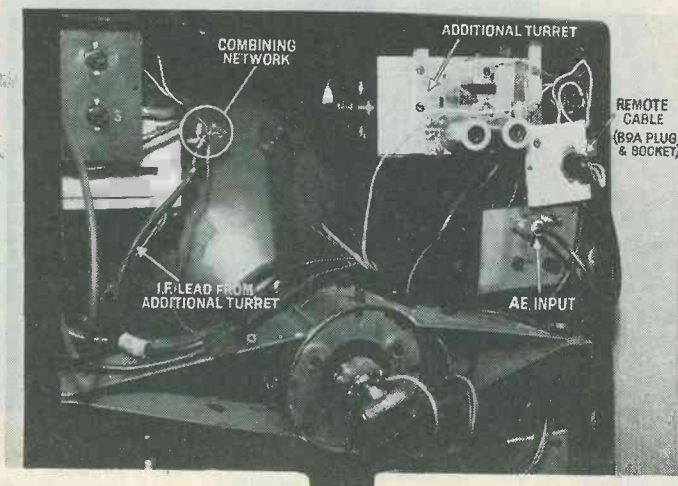

The additional tuner and wiring fitted in the receiver

means of a meter. If h.t. is present, insert a 1,000pF capacitor (ceramic) in the i.f. line before wiring into the combining network.<sup>1</sup>

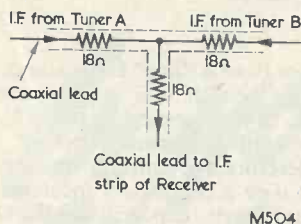

Fig. 3. Combining the i.f. outputs

### Installation

Leave the existing turret tuner where it is and, if possible, use its connecting panel as a tagboard. Unsolder the h.t. line, and the centre conductor of the coaxial i.f. output lead. Fix the additional turret so that the channel switch and fine tuner are accessible. Take the h.t. and i.f. lines of the additional tuner, the multiple cable from the remote point, and the additional resistors and solder as shown in Fig. 4. The i.f. combining network of three 18Ω resistors can be "hung" on the i.f. tag of the original tuner. (See illustration.) Now wire the diplexer with two short lengths of coaxial cable terminating in coaxial plugs, one for I.T.V. and one for B.B.C. Wire the existing aerial downlead to the input of the diplexer. Next screw the diplexer to some convenient point and plug in the output leads to their respective tuners.

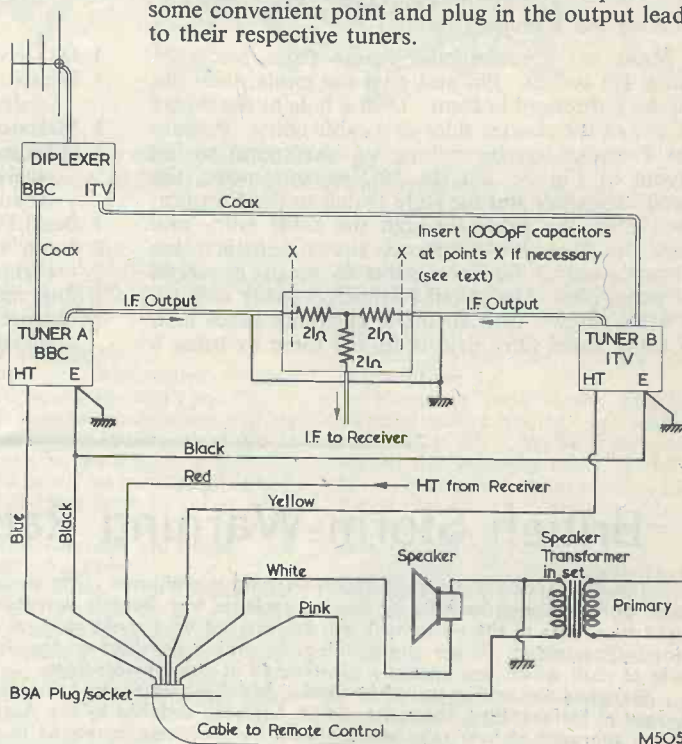

Fig. 4. Wiring at the receiver.

### Wiring

Wiring to the remote point is carried out by multicore cable and B9A plugs and sockets. It was found convenient to fix the cable to the skirting board and terminate it with a B9A socket on the wall near the required operating point (the arm-chair). The remote unit is then plugged into this point by means of a B9A plug on the end of about 4 feet of cable.<sup>2</sup>

<sup>1</sup> The tuner employed in an arrangement of this nature should have a transformer-type coil in the i.f. output circuit, i.e. a coil with a tuned primary and a low impedance secondary. Some tuners have single winding i.f. coils for use in a pi-filter network and these could not be readily used in the present application. Also, of course, the intermediate frequency from the additional tuner should be the same as that employed in the receiver.—*Editor*.

<sup>2</sup> See remarks concerning safety in the Introduction.—*Editor*.

It should be noted that if the existing turret tuner has a.g.c. applied to it, the additional tuner will not be so controlled. This does not matter in areas of good signal strength as the sensitivity control of the additional tuner can be set for optimum performance.

The heater supply for the additional tuner depends upon several factors. In the present instance, both tuners were of the parallel heater type, and the additional tuner heaters were connected across the receiver 6.3V supply. If the receiver has a series heater chain it would probably be preferable to run the heaters of the second tuner from an additional mains transformer. A heater supply is fed to both tuners when the receiver is switched on.

### Setting Up

On the t.v. receiver, turn the Contrast and Brilliance controls to their normal settings and set the volume control to about three-quarters of maximum volume. Switch on and let the equipment warm up. Set the remote switch to the I.T.V. position and turn the remote volume control to maximum. Use the original turret for Band III. On this, adjust the fine tuner for optimum performance on I.T.V. Next turn the remote switch to B.B.C. Adjust the fine tuner of the second tuner for optimum performance, reducing gain if necessary (by means of the sensitivity control) until volume and contrast match that of the I.T.V. signal. Adjust the remote volume control to taste—and that is all.

### Making the Remote Unit

Make up a rectangular frame from pieces of  $1\text{in} \times \frac{1}{2}\text{in}$  batten. Pin and glue the joints, then pin on the hardboard bottom. Drill a hole at the centre of one of the shorter sides as a cable entry. Prepare the Formica top by drilling to correspond to the layout of Fig. 3. Fit the  $10\Omega$  potentiometer, the neon indicators and the slide switch to the Formica, then push the cable through the cable entry and wire up the components as shown. Attach the Formica top to the frame either by means of screws or panel pins. Unbacked Formica is easily split so, if using screws, drill adequate clearance holes first. If using panel pins, drill holes for these by using a

spare panel pin as a drill bit. (Snip off the head of the pin and insert the blunt end into the drill chuck.) The neon indicators are a "push fit"; no other fixing should be necessary.

### Precautions

Most t.v. sets have a "live" chassis and, on most, one side of the speech coil is connected to the chassis. Also, in this instance, the h.t. potential appears on the leads to the remote point. It is very important, therefore, to ensure that the remote switching unit is in a completely insulated case and that any metal parts exposed to the hand are completely isolated from the circuit. The points in the Introduction should also be observed.

### Components List

- 3  $18\Omega$   $\frac{1}{4}$  watt resistors
- 1 Wirewound  $10\Omega$  potentiometer with "off" position (slider off track). (Clyne Radio Ltd.)
- 1 Miniature slide-switch, 1-pole, 2-way
- 1 Salvaged turret tuner (i.f. and heaters to suit receiver). (D. & B. Television, 131A Kingston Road, South Wimbledon, London, S.W.19)
- 1 Band I/III diplexer (Clyne Radio Ltd.)
- 2 Neon indicators (internal series resistors) with chromium collars (Clyne Radio Ltd.)
- 1 Plug and socket assembly
- Multicore cable, coaxial cable, coaxial plugs, sockets, etc., etc.

## British Storm-Warning Radar For Australia

The first specially designed storm-warning surveillance radar to cover the inhabited areas of the north-eastern coast of Australia threatened by tropical cyclones was recently despatched to Liverpool for shipment. Weighing over eight tons, part of the equipment will be installed on a rocky spur on Saddle Mountain, 2,000 feet above sea level, in North Queensland. Power and buildings have been provided on the site, connected with the main highway by over a mile of road which was specially constructed at considerable cost.

Designed and manufactured by Cossor Radar & Electronics Ltd., Harlow, Essex, to a specification of the Australian Bureau of Meteorology, the radar, which has been ordered by the Australian Commonwealth Government, will warn of the approach of hurricane winds arising from cyclone formation in the Coral Sea. Such short term warning is of great value in helping to minimise hurricane damage which on occasion may occur along the coastal region of Queensland, the area of which state alone is over seven times that of the United Kingdom.

Data from the radar on Saddle Mountain will be received via a microwave radio link to the other portions of the equipment installed at Cairns Airport, seven miles away. Trees on the hills have been cleared to establish a line of sight from mountain to airport. The radar, which has a nominal range of 240 miles, will enable meteorologists to observe the positions and tracks of storm centres, including cyclones, whose characteristic cloud patterns can be seen on a plan position indicator (p.p.i.) display. Iso-echo facilities will enable the densities of clouds and precipitation to be assessed.

The radar will operate in the "S" (10cm) band and will normally be controlled remotely from Cairns Airport via a v.h.f. link. The 800kW transmitter operates at a fixed pulse repetition frequency of 300 pulses per second with a pulse width of 2 microseconds. The aerial consists of a fixed dipole mounted at the focus of an 8ft diameter dish, giving a  $2.6^\circ$  beamwidth. Aerial elevation is adjustable from the airport in  $2^\circ$  steps between  $0-16^\circ$ . The azimuthal rotational information from the radar scanner is converted into a series of coded pulses which, after mixing with the video and transmitter trigger information, is decoded and applied to the remote p.p.i. The Saddle Mountain installation is completed by a monitor display and an automatically operated  $\text{CO}_2$  fire prevention system.

The remote display at Cairns Airport consists of a 12in p.p.i. which incorporates iso-echo facilities. Four display ranges are available, the maximum being 240 miles, the shortest 30 miles. Other facilities include a north marker and a reflection plotter. This latter device enables information such as markers to be superimposed on the display without introducing parallax errors. Permanent records of display data can be obtained, either as single shots or time lapse sequences, by a magazine loaded 16mm camera.



# In your Workshop

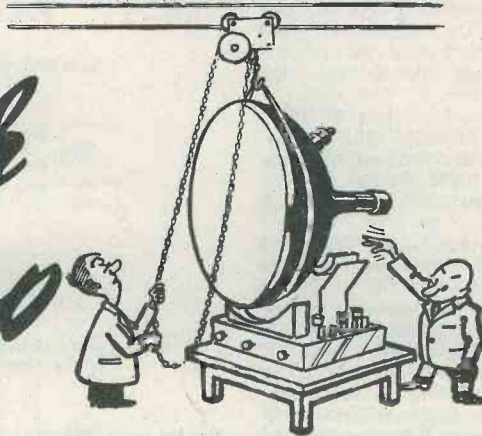

This month, Smithy the Serviceman, aided by his able assistant Dick, finds time to discuss the major differences in design between 625 and 405 line television receivers

"I'M RUINED," WAILED DICK.  
"Ruined!"

"At your tender age?" queried Smithy unsympathetically.

Dick gulped at his tea with the air of a bankrupt having his last fling before the bailiffs move in.

"Yes, ruined," repeated Dick bitterly. "I can no longer follow the profession to which I have dedicated my life."

Smithy looked puzzled.

"What profession is that?"

"Service engineering, of course."

"Oh I see," said Smithy.

There was silence for a moment.

"Aren't you interested in what I'm about to say?" queried Dick.

"Not really," replied Smithy unhelpfully. "But don't let me stop you."

"Right," said Dick. "As I was saying, I'm ruined. From now on, I shall be delegated to the backwash of human affairs, whilst other service engineers, younger in age and keener of eye than I am, will overtake me and grasp my humble wage from my threadbare pocket."

"The correct word there is 'relegate'," Smithy pointed out, "not 'delegate'."

But Dick had now got firmly into his stride.

"Here am I," he continued, his voice quivering with self-pity, "an honest working lad, labouring through every hour of the day, carrying back-breaking loads from the rack to the bench. And back again, after I have spent the flower of my youth in their repair—and what for?"

"I don't know," said Smithy.

"What do you do it for?"

"Just a crust," replied Dick, bleakly. "I do it all for just a crust."

## Dick's Trouble

"Dear me," commented Smithy. "You do carry on, don't you?"

Dick slouched despondently in his seat, an almost visible black cloud hanging over his head.

"And now," he concluded, abjectly, "that crust is to be taken away from me!"

Smithy decided to cheer his assistant up a little.

"Surely things aren't quite that bad," he remarked brightly. "For instance, don't forget that I got you a new testmeter last week. 20,000 ohms per volt it was, too."

"That's true," admitted Dick grudgingly.

"Then what's biting you?"

"What's biting me," said Dick indignantly, "is that, after I've spent all my working life genning up on 405 line television, they go and change the standard! Why can't they leave things alone?"

Dick's further comments were lost in a raucous and uncontrollable guffaw from Smithy.

"Am I really to understand," laughed the Serviceman, wiping his eyes, "that all this carry-on is because we're going over to 625 lines?"

"Of course it is. Blimey, I've only just got used to 405 lines!"

"Well, all that the 625 standard means is that you'll get a few more lines in the picture."

"Come off it, Smithy," said Dick disgustedly. "You know there's more to it than that. There's negative vision modulation, intercarrier sound, different sync pulses, and all sorts of horrible jazz like that. It's just too much for me."

"Nonsense," said Smithy, briskly. "You're letting yourself get scared off, that's all. We've only just started our morning break, so let's have a little natter about some of the things that are troubling you. How about the negative modulation business, for instance?"

"All right, Smithy," said Dick happily, settling himself down more comfortably. "Let's start off with that."

Smithy cast a doubtful glance at his assistant.

"You seemed to have cheered up remarkably quickly," he observed suspiciously. "Anyway, let's get down to the subject in hand."

"Now, the 405 line system," continued the Serviceman, "has positive modulation of the vision carrier, which means that transmitter output increases as the brightness of the transmitted scene increases. If you look at the 405 line waveform (Fig. 1) you'll see that white level—which we often refer to as 'peak white'—corresponds to 100% transmitter output. Blanking level, which is the level of the front and back porches of the line sync pulse, is at 30% of white level, whilst synchronising level, which is given at the sync pulse tips, is less than 3% of white level."

"I see," remarked Dick. "It

sounds as though the transmitter could theoretically go off the air when it's transmitting sync pulses." "It could, theoretically," agreed Smyth, "and it would still meet the tolerances laid down for the signal."

"Isn't there a black level?"

"There is, indeed," said Smyth. "This appears at 5% above blanking level, and it is the level corresponding to fully black parts of the scene being transmitted."

"Well, all that," said Dick, "is nice and easy. What about the 625 line waveform?"

"It's much the same," replied Smyth, "except, of course, that it's upside down, since the sense of vision modulation is negative. The result is that white level now corresponds to *minimum* transmitter output. However, before going into any further details on the waveform, I think I'd better tell you that we have, first of all, to consider the three main 625 line standards."

"Do you mean to say," said Dick aghast, "that there's more than one 625-line standard?"

"That's right," grinned Smyth.

"Blimey," groaned Dick. "625 lines gets complicated even before we start discussing its waveform!"

"I shouldn't worry yourself too much about it," chuckled Smyth. "The differences between the standards aren't all that great. The two main 625 line standards in use at the time being are the Western European standard and the Eastern European standard. The Western European standard, which is also used in Australia, has a video bandwidth of 5 Mc/s. (Fig. 2.) The Eastern European standard, which operates in Russia and the satellite countries, has a video bandwidth of 6 Mc/s. Both of these standards have a vestigial, or 'suppressed', sideband of 0.75 Mc/s. The sound carrier is on the opposite side to the vestigial sideband and, with the Western European system, is 5.5 Mc/s higher than the vision carrier. With the Eastern European system, it is 6.5 Mc/s higher."

"That seems simple enough," said Dick reluctantly. "Do both systems have f.m. sound?"

"Oh yes," replied Smyth. "They both have f.m. sound. And both sound channels have a maximum deviation of  $\pm 50$  kc/s and a pre-emphasis of 50  $\mu$ s. They are therefore the same, apart from their spacing to the vision carrier."

"What's the third 625 line standard?"

"That's the one proposed by the Television Advisory Committee in

this country," replied Smyth. "The T.A.C. reported in 1960, and its recommendations went into the Pilkington Committee which approved them in general. The T.A.C. recommended a 625 line system with a 5.5 Mc/s video bandwidth, the vestigial sideband being 1.25 Mc/s wide. In this case the sound carrier is 6 Mc/s higher than the vision carrier. Otherwise, the T.A.C. system has no major differences to the other two standards."

"So it looks," said Dick, "as though all these standards are the same, apart from the spacing between sound and vision carriers, the video bandwidth, and the size of the vestigial sideband."

"You've got it," said Smyth. "There are slight differences between the sync signal dimensions for the Western and Eastern European standards, but they are pretty negligible."

"In other words," put in Dick, "you could, therefore, tune in an Eastern European signal on a Western European receiver and vice versa."

Smyth hesitated.

"Well, that's not exactly true," he said. "You'd get a picture in either case, but you probably wouldn't get sound. If the receiver had inter-carrier sound, it would only respond to the standard it was designed for."

"But, dash it all," protested Dick. "It was only recently that I was reading in the newspapers about the people in East Berlin picking up West Berlin transmissions."

"That's a special case," said Smyth. "Both Eastern Germany and Western Germany use the Western European standard."

Dick frowned.

"I see," he remarked at length. "These discrepancies are a bit of a nuisance, aren't they?"

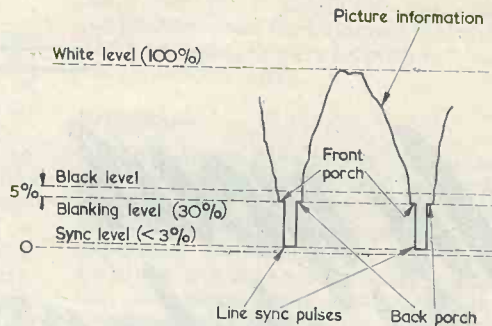

M508

Fig. 1. The line waveform of the 405 line standard, showing the dimensions of the sync pulse and black level relative to full amplitude

"They are, rather," agreed Smyth. "Anyway, the fact that all 625 line pictures are on a common standard is something to be thankful for."

"Why can't a set with intercarrier sound pick up the alternative standard?"

"I'll be coming to that shortly," said Smyth patiently. "But, in the meantime, I am attacked by a raging thirst which must be assuaged at all costs."

#### Negative Modulation Waveform

Obediently, Dick picked up Smyth's empty cup and busied himself at the Workshop sink. Smyth took the replenished cup from his assistant and drank deeply.

"Second today," he remarked with considerable satisfaction.

"You do enjoy your tea, don't you?" remarked Dick chattily.

"Tea is like money," remarked Smyth. "It's one of the best social lubricants that man has devised. Where were we?"

"We dealt with the 405 line waveform," said Dick helpfully. "After which you filled me in on the different 625 line standards."

"I do wish you wouldn't use phrases like 'filled me in,'" complained Smyth. "They're quite inappropriate in a serious discussion of this nature."

Dick sighed. The Serviceman had a tendency to veer every now and again. Dick decided to set him firmly back on course again.

"What does the 625 line waveform look like?" he asked directly.

"I was just about to come to that," said Smyth irritably, "but you keep putting me off! Now, the 625 line waveform (Fig. 3) is, as I said just now, upside-down as compared with the 405 line waveform. Synchronising level corresponds to maximum transmitter output and,

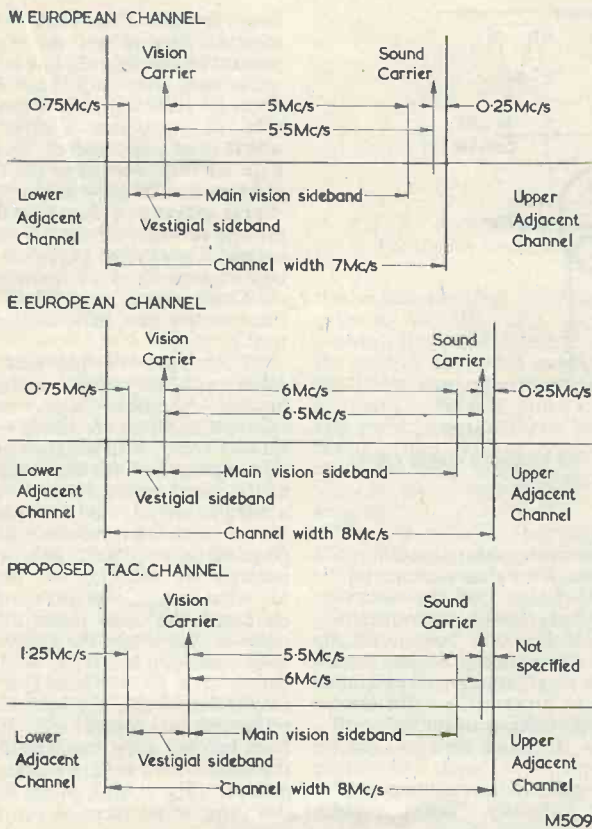

Fig. 2. The carrier and sidebands in the Western European, Eastern European, and proposed T.A.C. 625 line channels

M509

using the Western European figures, blanking level corresponds to 72.5 to 77.5% of maximum. Peak white is 10 to 12.5% of maximum signal, and black level is 3 to 6.5% below blanking level."

"There's something queer here," remarked Dick.

"What's that?"

"With the 405 line waveform," said Dick, "the signal went down to less than 3% on sync pulse tips, and could even disappear altogether without going out of tolerance. With the 625 line waveform, minimum signal corresponds to peak white, and it's not allowed to go lower than 10%."

"That's right."

"Then why," asked Dick, "can't the 625 line waveform go down to zero like the 405 line waveform does?"

"Because," replied Smithy, "you wouldn't be able to operate inter-carrier receivers if it did."

"Now we're back to this inter-carrier business again," grumbled

Dick. "I knew that 625 lines would be beyond me!"

"Don't give up all hope yet," grinned Smithy. "It'll soon become clear. Let's get back to our 625 line waveform. Our next exercise is to consider how we can detect this and present it to the cathode ray tube and so reproduce a picture."

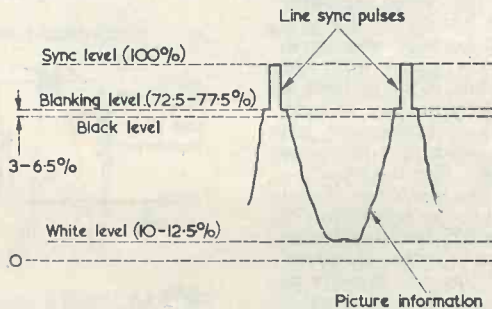

M510

Fig. 3. Line waveform dimensions of the Western European 625 line standard

"The detection bit's easy," said Dick scornfully, "you just reverse the video detector. That's what all the TV Dx boys have been doing when they've modified 405 line sets to pick up Continental transmissions."

"Up to a point that's fair enough," said Smithy, "but you have to go a wee bit further than that if your going to do the job completely. I've been looking at a number of negative modulation receiver circuits recently, and I've noticed that the use of a single video amplifier valve feeding into the cathode of the c.r.t., which is pretty well standard practice nowadays with 405 line receivers, is very nearly as popular with 625 line sets as well. So, let's assume that, after we've reversed the video detector, we apply it to a single video amplifier valve." (Fig. 4.)

"Okeydoke," said Dick agreeably, "let's try that."

"We shall want to use d.c. couplings all the way between the video detector and the tube," continued Smithy, "if we're going to make a good job of things. Picture information on the cathode of the tube needs to be negative-going, which means that picture information on the signal passed to the grid of the video amplifier has to be positive-going. O.K.?"

"Sure."

"The arrangement looks the same," said Smithy, "as that given with a similar 405 line version having the video diode the other way round. However, it isn't!"

"Hey?"

"There's one important difference," grinned Smithy. "Let's look more closely at the two detector circuits and assume that the video diode load is returned to chassis in each case. With the 405 line arrangement (Fig. 5 (a)) the signal goes more and more positive of chassis as signal strength increases. So we

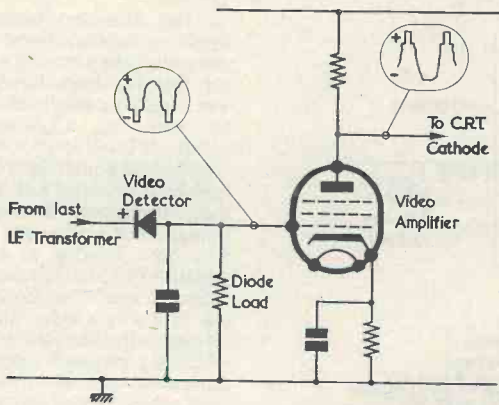

MS11

Fig. 4. As in 405 line receivers, many 625 line sets employ a single video amplifier feeding the cathode of the c.r.t.

choose, as video amplifier, a valve whose grid base is wide enough to accommodate the range of voltages in the signal, and we bias its cathode so that it's just positive of the maximum signal passed to it. Which corresponds to peak white, of course."

"I understand that," said Dick, "and it seems that we're following straightforward amplifier practice."

"So we are," agreed Smiethy. "Now, with the 625 line arrangement (Fig. 5 (b)) we have the diode reversed, whereupon the signal across the diode load still has picture information going positive. However, the strongest signal now corresponds to the sync pulse tips and these are negative of chassis. So is all the rest of the signal. Peak white is the most positive part of the waveform, but even this is negative of chassis."

"I see what you mean," said Dick frowning. "But what difference does it make to receiver design?"

"It means that you've got to alter the bias for the video amplifier valve," replied Smiethy. "Its grid base must still be wide enough to accommodate the signal from the video detector but, if the cathode is to be only slightly positive of peak white potential, this electrode has to be brought down very nearly to chassis potential. Got the idea?"

"I see what you mean now," said Dick. "You get the same sort of signal from the 625 line detector as from the 405 line detector. However, all the 625 line signal is negative of chassis, and all the 405 line signal is positive of chassis. You want the grid base of the valve to accommodate the signal and so, with the 625 line arrangement, you bring the

cathode down to chassis potential."

"Very nearly to chassis potential," corrected Smiethy. "If the cathode were fully at chassis potential the valve would have no bias at all if the signal disappeared. So you have to insert a small amount of cathode resistance to prevent the valve from cooking up if the transmitter is off the air or if you've switched to a dead channel."

"That's quite an interesting point," said Dick judiciously, "but I would

have thought that video amplifier cathode bias is not the most important feature of a 625 line receiver."

"It may not be," said Smiethy, "but, by referring to it, I have been able to introduce another point which is of importance. One attribute of 405 line receivers is that contrast can be adjusted by the very simple process of changing the bias on one or more of the i.f. amplifier valves. Usually, we pop the contrast control into the a.g.c. network."

"That's right," said Dick. "And the circuits get jolly complicated, too!"

"Then you will find that life is easier with 625 lines," commented Smiethy, "because a.g.c. network contrast controls are never used, so far as I know, with negative modulation receivers. Let's first of all look at the video detector waveform with a 405 line signal, the i.f. stages being biased back to give low contrast. (Fig. 6 (a).) Then, let's increase contrast by reducing i.f. bias and see what results. When contrast is increased the sync pulse tips stay more or less where they were, black level comes up a bit and white level comes up a lot. Which is a pretty easy effect for the average television set-owner to control for himself. Next let's see what happens if we do the same with a negative modulation picture. (Fig. 6 (b).) What happens this time, as we increase contrast, is

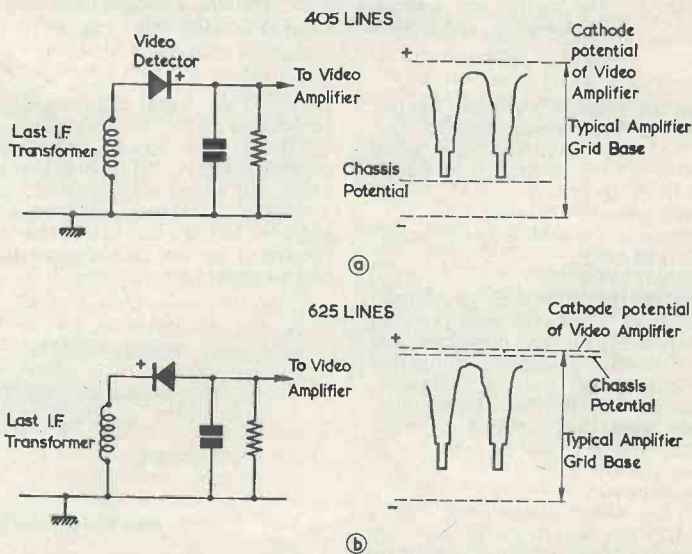

MS12

Fig. 5 (a). With a conventional 405 line detector, all the rectified signal is positive of chassis  
(b). Whilst the 625 line signal gives a signal with the same polarity, this signal is now entirely negative of chassis. The video amplifier cathode bias has to be reduced in consequence

that the white level actually *drops* a tiny bit whilst the black level drops a lot. You're still getting increased contrast but the effect is confusing and is not so easy for the set-owner to control."

"Well, I'm dashed," said Dick. "That's certainly quite an effect!"

"I thought you'd be interested," replied Smithy. "Anyway, the result is that negative modulation receivers always, so far as I am aware, have the contrast control *following* the video detector. A typical method consists of having a potentiometer control the screen grid voltage of the video amplifier. Alternatively, you may find a potentiometer which handles the video signal just like a volume control, it being specially designed to ensure that the higher video frequencies are not lost due to stray capacitances. (Fig. 7.) A low-value capacitor between the hot end of the track and a tap also reduces high frequency attenuation. Such a pot could well form the video amplifier anode load."

"Up to now," said Dick, "we've been assuming that the video circuits employ d.c. coupling throughout. Is this always the case?"

"Not in practice," replied Smithy. "Several of the circuits I've seen use a.c. couplings. You may, for instance, find a capacitor between

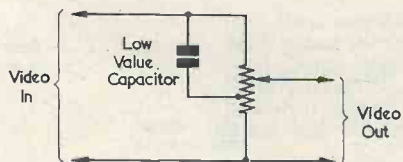

M514

Fig. 7. A contrast control encountered in negative modulation receivers. The control functions in the same basic manner as an a.f. volume control

the video amplifier anode and the cathode of the c.r.t. or, even, between the video detector load and the grid of the video amplifier. In the latter case, the video amplifier can have a grid leak down to chassis and conventional cathode bias. The cathode bias resistor may even be made variable, whereupon it functions as the contrast control for the receiver."

"It will certainly be nice," said Dick, "to have contrast controls as simple as that! But what you've just said raises another point. If you've got an a.c. coupling in the video circuits, won't the effect on the picture be just the same as when you have a similar coupling in 405 line receivers?"

"So far as I can visualise," said Smithy, guardedly, "it will be exactly the same."

"In which case," continued Dick, "what harm would result if you applied a contrast control to the a.g.c. network after all? The effect would be no worse than if you did the same thing with a 405 line set having an a.c. coupling."

"That's true enough," confessed Smithy. "But in actual practice it doesn't seem to be done. I think personally that putting a.c. couplings into *any* set is a naughty thing to do; and that it is *especially* naughty with 625 line sets, because the 625 line system allows the d.c. component of the signal to be retained so easily."

#### Gated A.G.C.

"We seem to be getting into deep waters here," said Dick hastily. "And I don't want to get out of my depth at this early stage. Can we have a natter about a.g.c. circuits?" "One moment," said Smithy. "Could you fill my cup again, please?"

"Are 625 line a.g.c. circuits complicated?"

"We could be out in the desert," complained Smithy bitterly, "shrivelling away in the sand. And you'd *still* be asking questions!"

"I'm only asking about a.g.c. circuits," persisted Dick. "Are they the same as with 405 line sets?"

Smithy drew a deep breath.

"Tea!" he yelled.

Dick jumped, and directed his thoughts to the irate Serviceman.

"Is your cup empty already?" he asked innocently.

"Empty?" exploded Smithy. "It's *arid*! It's a wonder that the glaze hasn't eroded away!"

Hastily, Dick got up, re-filled the Serviceman's cup, and hurried back from the sink with his precious cargo of life-saving fluid. Smithy gulped greedily and gradually returned to his former self. Dick watched him interestedly.

"You ought to try injecting it into you," he remarked, "with a hypodermic syringe."

"With a syringe?"

"That's right," said Dick. "Give yourself a fix, like. I saw a film once in which there was a chap who

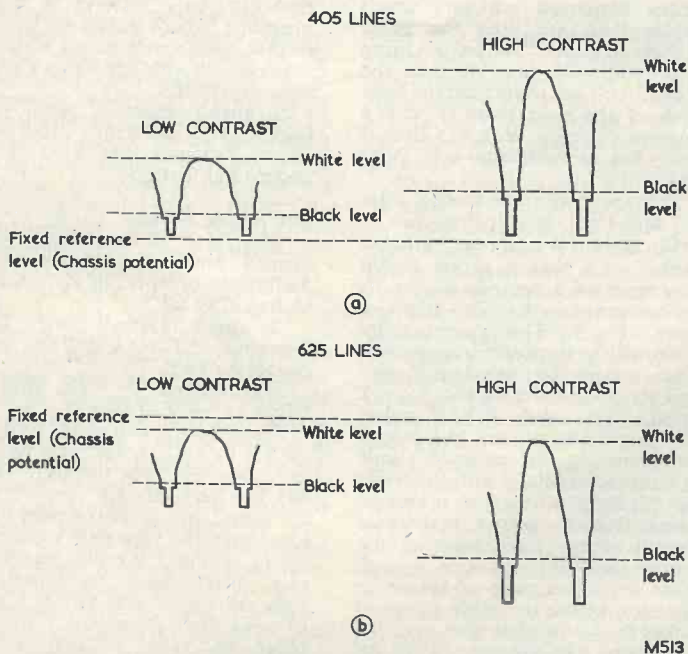

M513

Fig. 6 (a). Waveforms at the 405 line video diode for different contrast levels, as obtained by varying i.f. bias  
(b). When contrast is adjusted by varying i.f. bias, the 625 line detector gives the effect shown here

carried on just like you until he'd had a fix. I bet that if I hadn't filled your cup just then you'd have started convulsions. This chap did."

"I think," said Smithy frowning, "we'll get back to 625 line a.g.c. circuits."

"This chap was a lot younger than you though," said Dick reflectively, "and quite a bit thinner as well."

"You asked me just now," said Smithy firmly, "whether 625 line a.g.c. circuits were the same as with 405 lines."

"Another thing about this chap

Dick caught Smithy's eye and stopped abruptly.

"A.G.C. circuits in 625 line receivers," continued Smithy resolutely, "are, in general, simpler than those in 405 line sets. We've already seen that the rectified voltage following the video detector is negative of chassis. What is also important is that the most negative part of the waveform is given by the sync pulse tips, which have a constant amplitude relative to signal strength. So, all you need to do is to take the negative voltage from the diode load, pass it through an RC filter to smooth it out, and you have an a.g.c. voltage ready-made." (Fig. 8.)

"Well, that's knobby," said Dick. "You couldn't have things much simpler than that!"

"The circuit," Smithy carried on, "has the further advantage that the a.g.c. voltage generated is truly proportional to signal strength. With simple 405 line a.g.c. circuits it is usual to take an a.g.c. voltage from the grid of the sync separator, this giving you a 'mean level' a.g.c. system. The snag with such a system is that a.g.c. voltage increases when the brightness of the transmitted scene increases, and the effect is as though you'd lost part of the d.c. component of the picture. You don't get this trouble with the 625 line arrangement, because the a.g.c. voltage is proportional to sync pulse amplitude."

"It's certainly a dead easy circuit arrangement," said Dick. "Are there any snags with it?"

"There is one major short-coming," said Smithy.

Dick groaned.

"There would be! Nothing in this 625 line business seems to be as simple as it looks at first sight. What's the snag, Smithy?"

"The snag," replied Smithy, "is that the circuit is wide open to interference. If an interference pulse having an amplitude higher than that of the signal appears at the

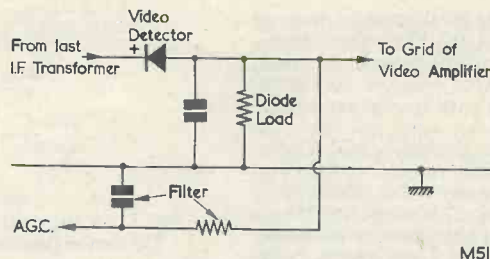

Fig. 8. A simple a.g.c. circuit, possible with the 625 line system

video detector, it causes a higher a.g.c. voltage to be generated. A series of such pulses could push the sensitivity of a set right down and not only could you have the interference but you would also lose your picture as well. Despite this, the circuit is used in some of the cheaper negative modulation receivers and seems to be satisfactory enough, particularly if such sets are operated in areas with good signal strength. And, of course, the snag may be overcome by using gated a.g.c."

An expression of intense dejection crossed Dick's face.

"Gated a.g.c.," he remarked unhappily. "I should have known it!"

"Cheer up," said Smithy. "The circuits employed are very much simpler than are used for gated a.g.c. on 405 lines. The complicating factor with 405 lines is that the gating circuit has to sort out the back porch of the sync pulse to find a reference voltage. With 625 lines it merely has to work from sync pulse tips."

"Perhaps it won't be so bad, after all," said Dick, brightening up.

"I'm certain it won't be," grinned Smithy. "A typical gating circuit can consist of a pentode having its grid connected to the video amplifier anode. (Fig. 9.) The video amplifier anode will have positive-going sync pulses, and so the pentode grid goes similarly positive during each flyback period. You apply flyback pulses from a winding on the line output transformer to the pentode anode via a series capacitor, with the result that the capacitor receives a charge, during flyback, whose magnitude depends upon how positive the pentode grid is. Between flyback pulses the upper plate of the series capacitor is close to chassis potential so that the lower plate goes negative of chassis. The average voltage on the lower plate is then filtered off and applied to the a.g.c. circuits as a potential negative of chassis. When signal strength increases, the

sync pulses tips at the video amplifier anode go positive, the series capacitor gets a greater charge, and the average voltage on its lower plate goes further negative of chassis. And so you have an a.g.c. loop set up."

"Blimey," said Dick, impressed, "you rattled off that description of circuit operation pretty smartly, didn't you?"

"I didn't want to spend too long on it," confessed Smithy, "because we've already fully discussed a similar circuit earlier this year.<sup>1</sup> Anyway, the pentode functions as an amplifier, and gives us our negative a.g.c. voltage. The important point about the circuit is that the series capacitor only receives a charge when line flyback pulses are present, so that interference pulses which do not coincide with line flyback pulses have no effect."

"I shan't grumble here," said Dick. "This is the only gated a.g.c. circuit I've ever met which I can understand first go!"

#### Intercarrier Sound

"I'm glad about that," commented Smithy. "Maybe you're finding the prospect of 625 lines not so bad after all."

"I don't know," said Dick, frowning. "There's still this intercarrier business."

"Intercarrier?" said Smithy. "That's a piece of cake!"

"Well, how does it work, then?"

"Let us once more," said Smithy, in reply, "get back to basic. With 405 line receivers we amplify both the sound and vision carriers in the tuner unit and then pass them on to the i.f. section. We then handle the two intermediate frequencies as separate sound and vision signals, splitting them immediately after the tuner or, more usually, after a common i.f. amplifier stage. The vision i.f. is then handled by the

<sup>1</sup> "In Your Workshop", page 598, March 1962 issue.

vision i.f. strip, and the sound i.f. by the sound i.f. strip. We could do the same sort of thing with the sound and vision i.f.'s of a 625 line signal but, in practical 625 line receivers, the intercarrier system is employed instead. With the intercarrier system both the sound and vision i.f.'s pass through a single i.f. strip right up to the video detector. Since the video detector is an extremely non-linear device it functions as a mixer as well. The result is that across its load resistor appears not only the detected video signal but a second signal given by the beat between the vision and sound i.f. carriers. The vision and sound carriers are spaced apart by 5.5 Mc/s in the Western European 625 line system and so, if our receiver were designed for this system, the beat frequency at the video detector would similarly be 5.5 Mc/s.

"What happens if the tuner oscillator frequency varies?"

"You will still," said Smyth, "get a 5.5 Mc/s beat. As picked up by the receiver aerial, the two carriers are 5.5 Mc/s apart. Whatever the frequency of the tuner oscillator, the two resulting i.f.'s will still be unavoidably spaced by 5.5 Mc/s."

"I see," commented Dick. "So it's impossible for an off-tune oscillator to change the beat frequency at the video detector."

"That's right," said Smyth. "Now, this beat is known as the intercarrier frequency and it is amplitude modulated by the vision signal and frequency modulated by the sound signal. So we next feed it to a tuned amplifier working, in the Western European instance, at 5.5 Mc/s, and finally pass it to an f.m. discriminator. The a.f. output of the discriminator is then amplified and fed to a loudspeaker."

"That's cute," said Dick. "You save all the valves needed in a separate sound i.f. amplifier."

"You don't save all that many valves," admitted Smyth, "because, due to the very heavy amplitude modulation of the intercarrier signal, you need some form of limiting in the intercarrier amplifier. A typical intercarrier amplifier would have one straight amplifier valve and one limiter valve, although I've seen some circuits which use a limiter valve only. You would need two or three valves, probably, if you had a separate sound i.f. strip. However, the circuit has the advantage that the discriminator can be designed for a specific frequency and be really efficient as a result. If a separate sound i.f. strip were employed, the discriminator would have to have a

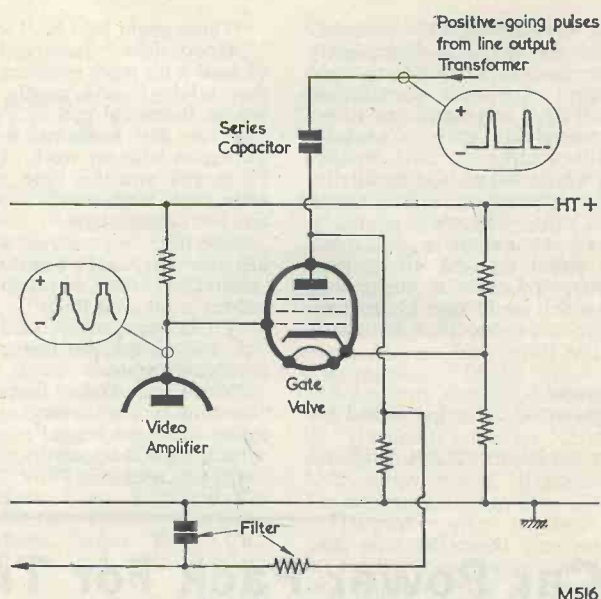

Fig. 9. The 625 line system allows simple gated a.g.c. circuits to be employed. The positive-going pulses in the circuit shown here may be obtained from a separate winding on the line output transformer, and could have an amplitude around 500 volts. The series capacitor would have a value of some 500pF. The cathode of the gate valve is returned to a potential positive of sync pulse tips

wide overall response to ease fine tuning adjustments, and to allow for tuner unit oscillator drift. None of these things are required with an intercarrier discriminator, because the frequency applied to it is always spot-on."

"What sort of discriminator would be used?"

"Ratio detectors are most common," said Smyth, "and this is partly because they have efficient a.m. limiting qualities of their own."

"Where do you take out the intercarrier frequency?"

"Usually," replied Smyth, "immediately after the vision detector. A simple tuned circuit resonant at intercarrier frequency picks it out here and applies it to the grid of the first intercarrier amplifier. A further tuned circuit, just like you have in a 465 kc/s i.f. amplifier, may then pass it to the limiter if a two-valve intercarrier amplifier is employed. The intercarrier frequency can also be taken from the anode of the video amplifier, but this is not a common practice. It is more usual, instead, to fit a parallel rejector circuit in series with the grid of the video amplifier in order to keep the intercarrier frequency out. Otherwise there is a risk of cross-modulation

in the video amplifier between video and intercarrier frequencies. There is usually a further parallel rejector circuit between the anode of the video amplifier and the cathode of the c.r.t."

"What harm can the intercarrier frequency do," asked Dick, "if it gets to the c.r.t., anyway?"

"It could modulate the picture," said Smyth, "and cause a fine grain to appear along the lines. Don't forget that sync separator and gated a.g.c. circuits are also taken from the anode of the video amplifier, and it might well be advisable to keep the intercarrier frequency out of these circuits, too."

"I see," said Dick. "Incidentally, I also see why you said earlier that a Western European receiver couldn't pick up the sound of an Eastern European transmission. All the intercarrier circuits in the receiver have to be re-tuned from 5.5. to 6.5 Mc/s."

"You've got it," said Smyth. "And you may also realise now why peak white on the 625 line standard isn't allowed to go below 10% of full amplitude. If it went too low you would have a harder job limiting out the resultant increased amplitude modulation."

"The 405 line signal," remarked Dick thoughtfully, "can theoretically go down to zero amplitude on sync pulse tips. I wonder what would happen if a 625 line signal went down to zero amplitude on peak whites."

"If that happened," said Smithy, "there would be no vision carrier, and the intercarrier signal would cease to exist. The result would be the same as switching the intercarrier signal on and off at field frequency, and there is no limiting circuit which could possibly remove the amplitude modulation on a signal like that!"

#### The Future

Smithy stood up and stretched his legs.

"Any tea left in the pot, lad?" he asked.

"There might be a bit," said Dick. "Good show," remarked Smithy. "I need a bit more moisture after all that talking! As usual, I notice you've flannelled me into spending half the day nattering instead of getting on with my work. However, I'll forgive you this time, especially after your impassioned demonstration at the beginning."

"I've been very worried about this 625 line business," admitted Dick, "although I must admit that I was putting it on a bit then!"

"I'll say you were," said Smithy. A wicked thought came into the Serviceman's head.

"You know, Dick," he continued, "the time to start worrying is when colour television starts."

Dick's jaw dropped. "Colour television?"

"Of course," said Smithy. "It's only a few years off now. I can hardly wait for the time when you have to de-gauss a picture tube."

"De-gauss a tube?"

"Or carry out dynamic convergence adjustments."

"Take it easy, Smithy, please!"

"Or," continued Smithy remorselessly, "tackle the purity magnets."

"Have I got to learn all this?"

"Of course you have," said Smithy, "and stacks more besides. Wait till you start chasing the colour sub-carrier through the i.f. stages. That'll give you something to really think about!"

"This is where I came in," wailed Dick. "Smithy, I'm just ruined!"

## Car Power Pack For Transistor Radios

By S. SMITH

**I**DEALLY, A RADIO FOR USE IN A CAR SHOULD BE specially designed for the job, with screening, a socket for the aerial, and a proper power pack. However, there must be many like the author who have not yet invested in a car radio, and who wish to use instead an ordinary pocket-size transistor set. These sets will work in cars, although some trial may be necessary to find the best site to avoid interference from the ignition system and unwanted screening of the incoming signal. These difficulties are not hard to overcome and it is a pity, then, to be using the internal dry batteries of the set when ample power is available from the electrical system of the car.

The really miniature power pack described here is intended to supply 6V with adequate current and low output impedance when connected to, say, the fascia sockets used for cigarette lighters and the like.

The accompanying circuit shows that the power pack consists merely of a zener diode in series with a limiting resistor across the input (i.e. the car battery). A constant voltage, namely 6V in the case of the Mullard OAZ203, appears across the zener diode, this becoming the power output for the transistor receiver. The dynamic impedance of the OAZ203 is only about  $2\Omega$  when a current of 20mA or more is flowing through it, and so the output to the set has this very satisfactory low impedance.

The limiting resistor must be sufficiently large to prevent excessive current flowing through the zener diode if there is no load (e.g. the set is switched off), even if the car battery is fully charged and is thus producing about 14 volts; but it must not be so large as to prevent an adequate current from flowing at 6 volts through the set, even if the car battery is down to its nominal 12 volts. The design is based on a typical average consumption by the set of up

to 30mA, with a car battery voltage of 12 volts minimum and 15 volts maximum, and maximum zener current in the OAZ203 of 50mA.

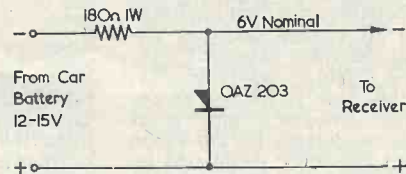

M517

It might be thought that one important fact has been overlooked, namely the peak requirements of the set. The peak current drawn by a typical transistor set can be of the order of 100-150mA under conditions of maximum signal and volume, and the circuit will not supply this. But every commercial set of quality has a very high value capacitor between the h.t. rail and chassis, and this is quite sufficient for supplying the required peaks of current. If such a capacitor is not fitted in the particular set being served by this circuit, then a  $100\mu\text{F}$  12 w.v. component should be connected across the zener diode.

*Note:* The zener diode in this power pack is operated at maximum permissible current when the receiver is switched off and the car battery voltage is 15. In consequence it would be advisable to ensure that the  $180\Omega$  resistor does not have a value lower than this figure and that the zener diode is provided with a cooling clip. Further protection would be given by leaving the receiver permanently switched on, the supply being turned on or off at the 12-15 volt input terminals.—*Editor.*



# NEWS and COMMENT . . .

## Publication Date

As announced elsewhere in this magazine, *The Radio Constructor*, for the November issue only, will be on sale on Monday 29th October, three days earlier than usual.

We receive enquiries, from time to time, as to the exact day of sale of this magazine. The publication date is the first of each month, except where that day falls on a Sunday, when it is the preceding day.

## Radio Call System

Motoring readers who have had a mechanical breakdown far from home will learn with interest, and possibly envy, that on the central part of the Los Angeles freeway network there will soon be in use what is claimed to be the world's first radio operated emergency call-box system.

Eighty call-boxes are to be placed at quarter mile intervals on four major freeway links radiating from the centre of the city. To summon help a motorist will simply have to press a button which sends a radio signal to police headquarters and tells a dispatcher where to direct a patrol unit.

The call-boxes have no external wiring of any kind. Power is provided by silicon solar cells which convert sunlight into electricity to charge batteries. Five minutes of sunlight recharges the energy used in one emergency call, and the batteries have enough reserve capacity to function normally for as long as three months without any solar recharging.

Unfortunately in this country the batteries would nearly always be, like the weather—washed out!

## R.S.G.B. Exhibition

This annual exhibition, as announced in our pages last month, is in future to be called the International Radio Communications Exhibition and this year is to be held in the Seymour Hall, near Marble Arch, from Wednesday 31st October to Saturday 3rd November, 10 a.m. to 9 p.m. daily, admission 3s.

Amongst items of especial interest there will be a communication satellite display and, for the first time, Japanese equipment showing the latest amplifiers and a wide range of microphones and transistors. Hi-Fi and loudspeaker components will

also be on view. New low noise u.h.f. valves and converters will be demonstrated. Aerials and extending and tilting masts of new designs for v.h.f. and u.h.f. will be demonstrated.

The armed services and the Post Office Engineering Department will again be there. Commercial firms exhibiting will include J. Beam Ltd., Daystrom Ltd., K.W. Electronics, Electronique Ltd., Enthoven Solders Ltd., Iliffe Press Ltd., Minimitter Ltd., M-O Valve Co. Ltd., Philpotts Metalworkers Ltd., Relda Radio Ltd., Short Wave Magazine Ltd., S.V.S. Masts, Selray Book Co., Webbs Radio Ltd. and Withers Electronics.

## A Deaf-aid Telephone

A new handset designed for telephone users who suffer from defective hearing has been developed by Telecommunications Division of Associated Electrical Industries Ltd. for use with any telephone system employing A.E.I. Centenary Neophone telephone instruments.

The deaf-aid handset, an injection moulding in impact resisting thermoplastic material, embodies a special transistorised printed wiring amplifier fitted in the earpiece. An inconspicuous volume control, fitted to the amplifier, projects through a small slot in the case of the handset so that it can be conveniently adjusted by either hand. The minimum setting of the volume control gives a level of reception equal to that of a standard instrument, and at the maximum position a substantially uniform gain of 20 dB is achieved over the frequency range 300–3,000 c/s.

The single-stage amplifier derives its supply voltage from the line so that the deaf-aid handset can be incorporated in an existing Centenary Neophone unit simply by connecting its cord. The new unit requires negligible maintenance and an amplifier can easily be replaced on the spot.

The deaf-aid handset weighs 8½ ounces complete with cord, 1½ ounces more than the standard handset.

The deaf-aid handset will shortly be available from Telephone Apparatus Department, A.E.I. Telecommunications Division, Woolwich, London, S.E.18.

## Communications Satellites

The launching of the Telstar satellite and its successful use for transatlantic television broadcasts has inaugurated the first stage of communication by the use of satellites.

In anticipation of this, the British Interplanetary Society held a meeting of an international group of scientists engaged in work with communications satellites. The eleven participants, four from England and seven from the United States, reviewed the work being done by such organisations as Bell Telephone Laboratories, Space Technology Laboratories, General Electric Missile and Space Vehicle Department, de Havilland Aircraft Company, British Aircraft Corporation, and U.S. Army Signal Research and Development Laboratory.

The papers given by these scientists, who presented their material in terminology understandable to any engineer, have just been published in *Communications Satellites*, by Academic Press, and is available from the publishers at Berkeley Square House, London, W.1, price 42s.

## Latest Dish for Marconi's

"Rolled out" recently at Marconi's mechanical engineering works at Felling was a 30ft diameter experimental dish reflector, believed to be the first produced in Great Britain, designed to operate at wavelengths down to 3cm. It is now undergoing an intensive programme of load and deflection tests.

Several completely new production techniques had to be devised in order to ensure a sufficiently high degree of precision and this very large dish has been manufactured with a measured surface accuracy of better than 20 thousandths of an inch standard deviation. Accurate reflectors of this type working at these high frequencies are likely to find increasing use in the field of satellite tracking.

## "Radio Watch"—Wavelength Refused

The *Daily Telegraph* has reported a hold up in the plans to market a watch, operated by radio signals and needing no winding or repairs, due to the refusal of the P.M.G. to grant a wavelength on which to broadcast the time.

The basis of the invention is the transmission continuously on tape from a master clock. The "watch" would convert the signals received into audible or visible time indication. The inventor is Mr. H. Roberts of Fleetwood.

**Cover Feature**

# THE "PROGRESSIVE" TRANSISTOR SUPERHET — Part 1

By A. A. BAINES

This series of two articles describes what are, in effect, four superhet receivers of varying performance, all of which may be assembled on the same circuit board and with the same basic layout. The term "progressive" arises from the fact that it is possible to commence by constructing the simplest version first, and to modify this later to the more advanced circuits. Alternatively, any model out of the four described can be built without passing through the intermediate versions

THE AUTHOR'S ORIGINAL REQUIREMENT WAS FOR A small medium wave transistor superhet receiver that, whilst not being "pocket" size, was still

small enough to be transportable in a weekend case or the glove compartment of a car. The first version of the completed receiver was little larger

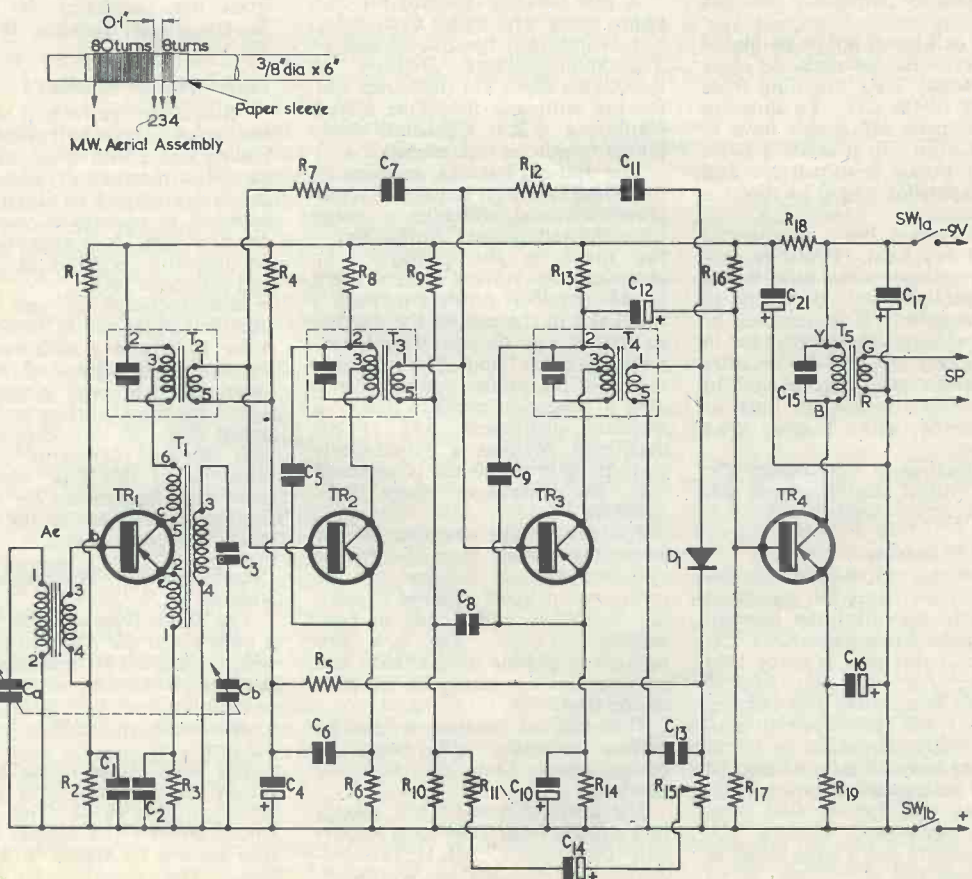

M518

than the cabinet needed to hold a 6 x 4in speaker and it incorporated a home made aerial rod assembly.

This was quite successful but the desire for more reliable Light programme reception caused the fitment of a dual band aerial and the necessary switching.

Following this, there occurred a succession of modifications and additions to the basic circuit with a view to either improving reception or increasing output. Both of these were, in general, achieved.

However, by this time, chaos had superseded confusion inside the cabinet and there was no internal accommodation even for the battery, so it was decided to go back to the beginning and draw up a cabinet that would take the final circuit and a 7 x 4in speaker whilst still meeting the original requirements regarding portability.

Again, the receiver would be built progressively but this time the circuit board would be, from the beginning, of a form to suit the final circuit.

As to the circuits used these will now be described and detailed in their four stages. A certain amount of permutation of various features is permissible and this point will also be discussed.

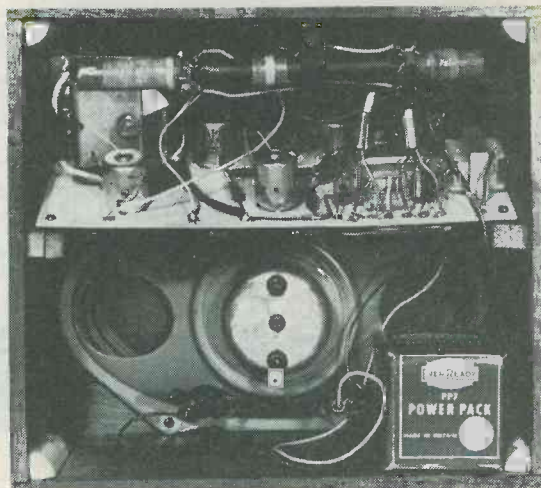

Rear cabinet view of the completed receiver

## COMPONENTS LIST

### Circuit A (Fig. 1)

#### Resistors (all $\frac{1}{4}W \pm 10\%$ )

R <sub>1</sub>	56k $\Omega$
R <sub>2</sub>	10k $\Omega$
R <sub>3</sub>	3.9k $\Omega$
R <sub>4</sub>	56k $\Omega$
R <sub>5</sub>	8.2k $\Omega$
R <sub>6</sub>	680 $\Omega$
R <sub>7</sub> *	1.2k $\Omega$
R <sub>8</sub>	2.7k $\Omega$
R <sub>9</sub>	22k $\Omega$
R <sub>10</sub>	4.7k $\Omega$
R <sub>11</sub>	1k $\Omega$
R <sub>12</sub> *	3.9k $\Omega$
R <sub>13</sub>	1k $\Omega$
R <sub>14</sub>	470 $\Omega$
R <sub>15</sub>	5k $\Omega$ pot.
R <sub>16</sub>	33k $\Omega$
R <sub>17</sub>	10k $\Omega$
R <sub>18</sub>	560 $\Omega$
R <sub>19</sub>	150 $\Omega$

#### Capacitors

C<sub>a</sub>-C<sub>b</sub> Jackson "00" twin gang with trimmers  
(C<sub>1a</sub> and C<sub>1b</sub>)

C <sub>1</sub>	0.1 $\mu F$
C <sub>2</sub>	0.01 $\mu F$
C <sub>3</sub>	215pF $\pm 3\%$ or 220pF $\pm 1\%$
C <sub>4</sub>	10 $\mu F$ 6 w.v. electrolytic
C <sub>5</sub>	0.04 $\mu F$
C <sub>6</sub>	0.04 $\mu F$
C <sub>7</sub> *	56pF $\pm 2\%$
C <sub>8</sub>	0.01 $\mu F$
C <sub>9</sub>	0.04 $\mu F$

C <sub>10</sub>	50 $\mu F$ 6 w.v. electrolytic
C <sub>11</sub> *	18pF $\pm 2\%$
C <sub>12</sub>	8 $\mu F$ 6 w.v. electrolytic
C <sub>13</sub>	0.01 $\mu F$
C <sub>14</sub>	8 $\mu F$ 6 w.v. electrolytic
C <sub>15</sub>	0.01 $\mu F$
C <sub>16</sub>	100 $\mu F$ 6 w.v. electrolytic
C <sub>17</sub>	50 $\mu F$ 12 w.v. electrolytic
C <sub>21</sub>	100 $\mu F$ 12 w.v. electrolytic

\* These components may not be needed (see text).

#### Miscellaneous

Ae	See text
T <sub>1</sub>	Weymouth P.50/1
T <sub>2</sub>	Weymouth P.50/2
T <sub>3</sub>	Weymouth P.50/2
T <sub>4</sub>	Weymouth P.50/3
T <sub>5</sub>	Ardente D.3058
D <sub>1</sub>	OA81
Sw. 1 (a) (b)	2 pole on/off (on R <sub>15</sub> )
TR <sub>1</sub>	OC44
TR <sub>2</sub>	OC45
TR <sub>3</sub>	OC45
TR <sub>4</sub>	OC72
Speaker	7 x 4in 3 $\Omega$
	7 x 3in Paxolin board
	Knobs, speaker grille, etc.
	Epicyclic reduction drive
	Battery—Grid bias, PP4, PP7 (see text)

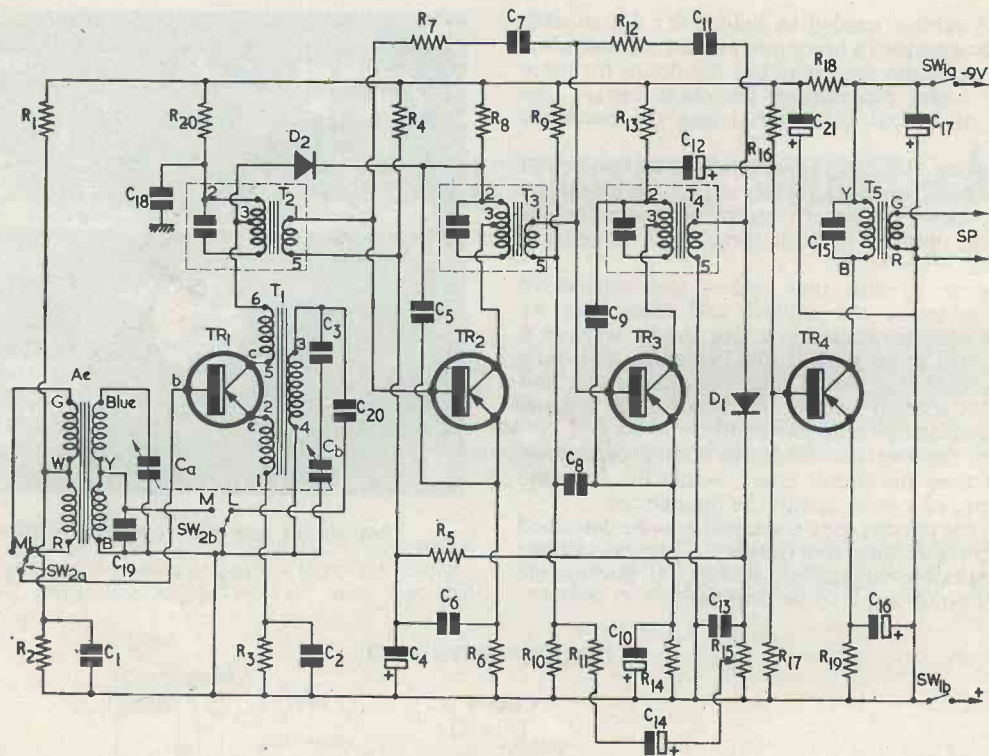

Fig. 2. Circuit B

M519

### Circuit B (Fig. 2)

As for Circuit A, plus:

- R<sub>20</sub> 1.5kΩ ± 10%
- Ae Weymouth type RA2W
- C<sub>18</sub> 0.01μF
- C<sub>19</sub> 150pF ± 3%
- C<sub>20</sub> 175pF ± 3% or 180pF ± 1%
- D<sub>2</sub> OA81
- SW<sub>2</sub> (a), (b) 2 pole, 2 way, with switch

### Circuit A

This is a straightforward four transistor superhet circuit (Fig. 1) with a home made medium wave winding on a 6 x 3/8 in diameter ferrite rod feeding into a self-oscillating frequency changer TR<sub>1</sub>.<sup>1</sup> The first i.f. transformer T<sub>2</sub> in the collector circuit of TR<sub>1</sub> feeds into the base of transistor TR<sub>2</sub> and the amplified signal is fed to the second i.f. transformer and thence to transistor TR<sub>3</sub>.

TR<sub>3</sub> is arranged in a reflex circuit so that the a.f. signal, after being passed via T<sub>4</sub> to diode D<sub>1</sub>, is

developed across the volume control R<sub>15</sub> and is returned to the base of TR<sub>3</sub> through the coupling capacitor C<sub>14</sub> and the secondary winding of T<sub>3</sub>. Capacitors C<sub>8</sub> and C<sub>9</sub> bypass the intermediate frequencies in the emitter and collector respectively of TR<sub>3</sub>. TR<sub>3</sub> is therefore operating as both an i.f. and a.f. amplifier and thus giving a degree of additional gain.

The d.c. component developed from D<sub>1</sub> is fed as a.g.c. voltage to TR<sub>2</sub> via R<sub>5</sub>.

The audio voltage from C<sub>12</sub> passes to the output transistor TR<sub>4</sub> and, after amplification, to the loudspeaker by means of output transformer T<sub>5</sub>.

Components R<sub>7</sub>, C<sub>7</sub>, R<sub>12</sub> and C<sub>11</sub> are for neutralisation and may not be essential. They could be omitted and only incorporated into the completed

<sup>1</sup> In the original, the 8 turn coupling coil on the ferrite rod employed 32 s.w.g. enamelled wire, whilst the 80 turn coil was wound with litz wire taken from a discarded i.f. transformer. However, enamelled wire of a similar gauge—28 to 36 s.w.g.—would be suitable. The wire gauge is not over-critical as the number of turns can be re-adjusted to compensate and give the range desired.

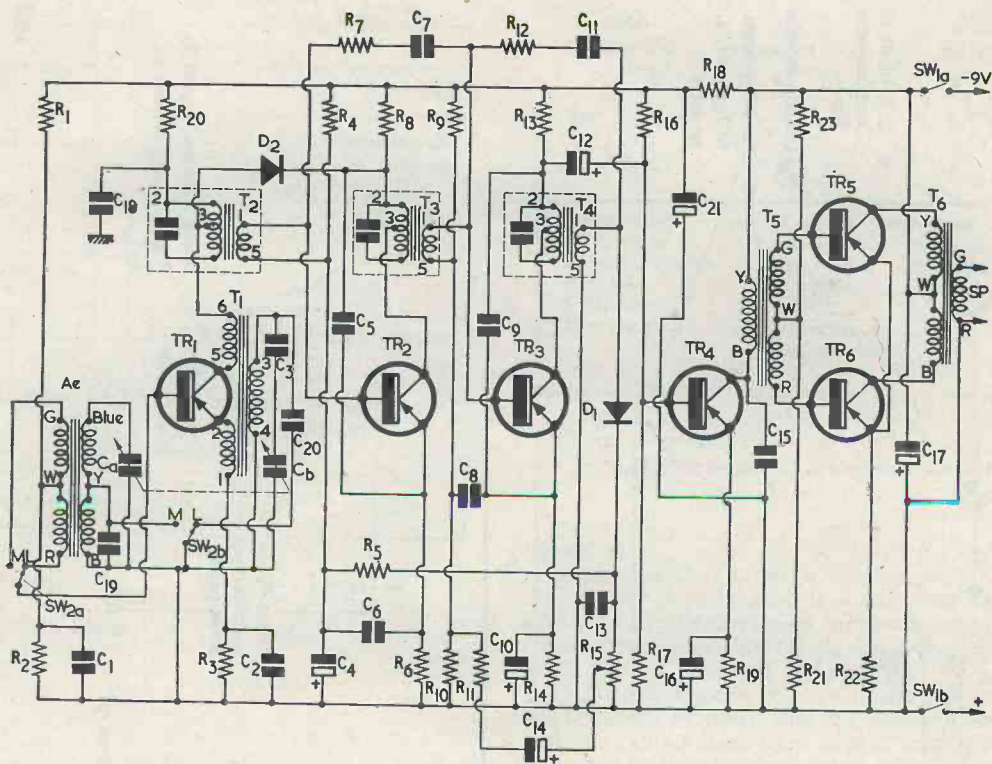

Fig. 3. Circuits C and D

M520

### Circuit C

(Fig. 3)

As for Circuit B, plus:

R<sub>19</sub> 1kΩ (was 150)

R<sub>21</sub> 220Ω

R<sub>22</sub> 4.7Ω

R<sub>23</sub> 6.8kΩ

All resistors ¼W ±10%

T<sub>5</sub> Ardente D.3034 (was D.3058)

T<sub>6</sub> Ardente D.3035

TR<sub>4</sub> OC71 (was OC72)

TR<sub>5</sub> OC72 } Matched pair

TR<sub>6</sub> OC72 }

### Circuit D

(Fig. 3)

As for Circuit C, except:

R<sub>21</sub> 82Ω ±5%

R<sub>23</sub> 4.7kΩ ±5%

T<sub>5</sub> Ardente D.3053

T<sub>6</sub> Ardente D.3027

TR<sub>4</sub> OC81D

TR<sub>5</sub> OC81 } Matched pair

TR<sub>6</sub> OC81 }

receiver if oscillation indicates that they are necessary.

### Circuit B

This is shown in Fig. 2, and is similar to Circuit A with the addition of a dual waveband ferrite rod assembly with associated switching, and a further a.g.c. circuit between transistors TR<sub>1</sub> and TR<sub>2</sub>.

Fig. 2 shows a commercial aerial rod unit, but those keen on experimenting can wind their own long wave coils on the rod assembly used for Circuit A. An aerial winding of 200 turns with a coupling coil of 40 turns would be suitable as a basis for trial, the coil unit being made up as the

medium wave unit and assembled on the free end of the ferrite rod. The aerial winding could employ litz wire or 36-40 s.w.g. single copper. The coupling coil would be of similar or slightly heavier gauge.

Diode D<sub>2</sub> assists the a.g.c. operation by functioning as a variable damping element which, under normal conditions, is biased off by the battery voltage. When a strong signal is received, however, D<sub>2</sub> starts to conduct and its low resistance damps the primary of T<sub>2</sub>, thus additionally attenuating the signal. This feature is particularly useful if the receiver is to be used in situations where the prevailing signal strength is subject to strong fluctuations.

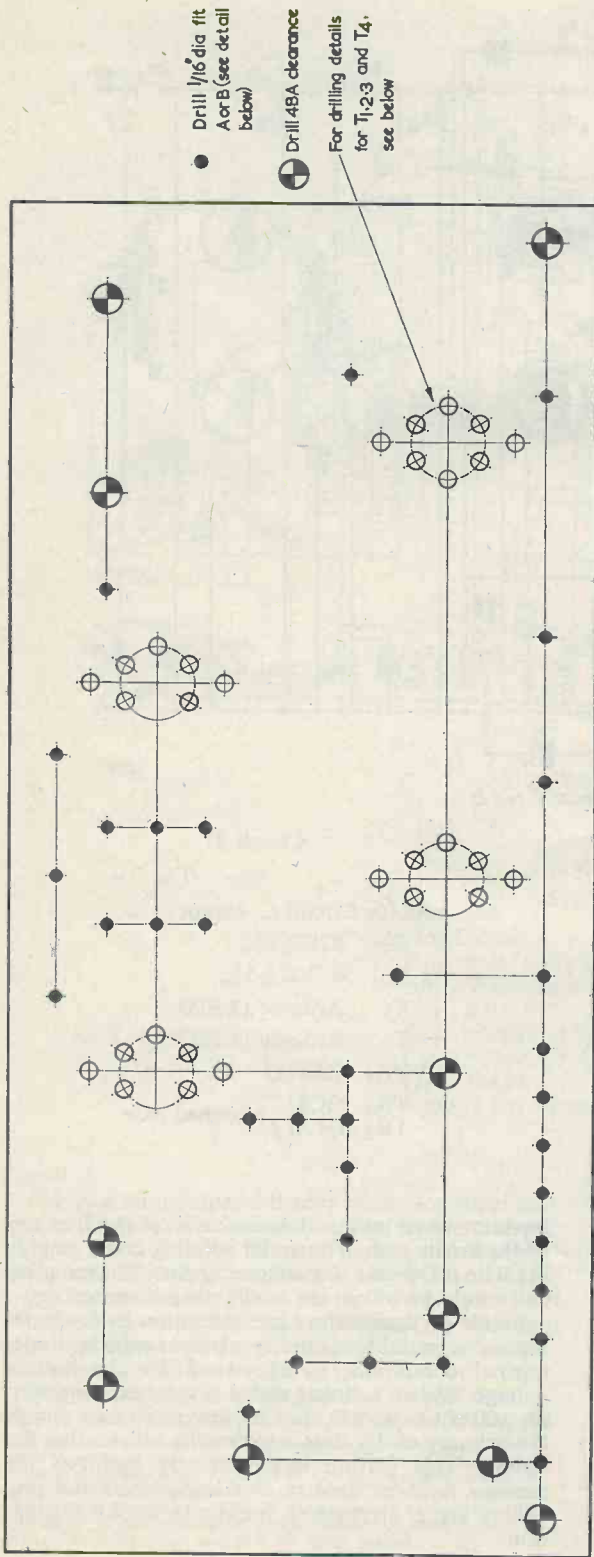

Drilling details: Scale full size: Material  $1/16$ " Plexiglas etc.

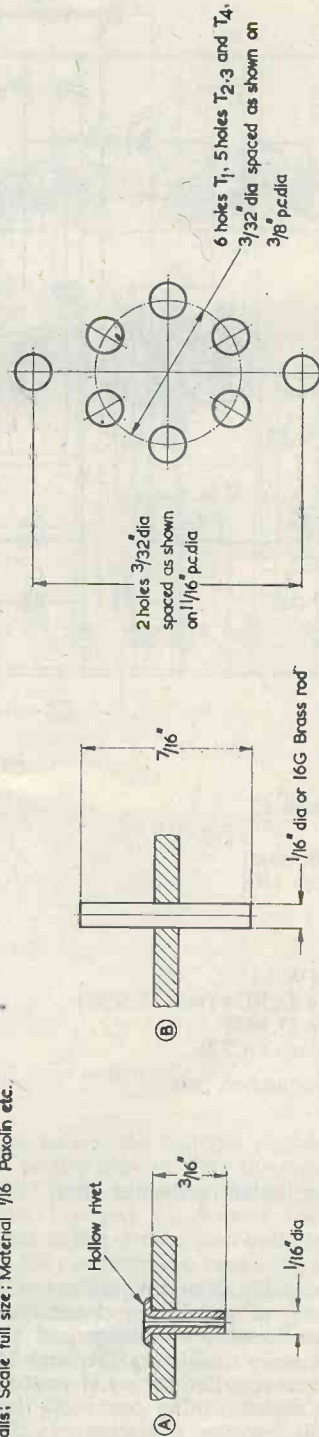
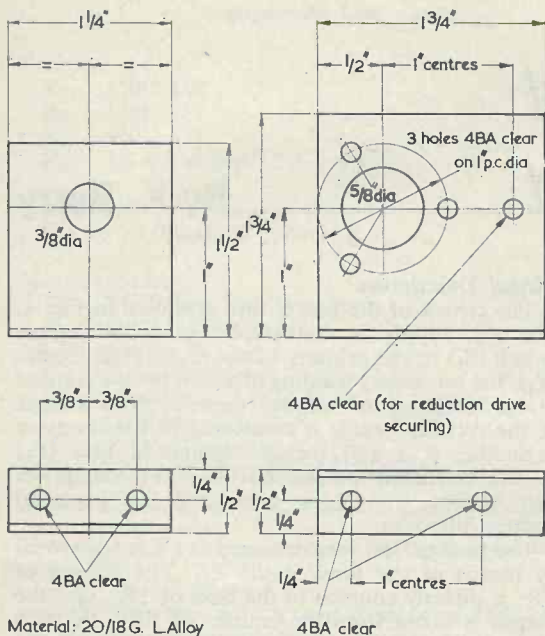

Fig. 4. The circuit board (underneath view). The board is reproduced full scale and dimensions may be taken directly



Material: 20/18 G. L Alloy

M522

Fig. 5. Bracket details

The output from Circuits A or B is not very high and the receiver as such is really only suitable for quiet listening regions such as a bedroom, so the next modification was to step up the output.

### Circuit C

This circuit, shown in Fig. 3, retains identical r.f. and i.f. stages as in the previous circuit but the output stage has been altered by changing TR<sub>4</sub> into a driver a.f. stage and by the addition of TR<sub>5</sub> and TR<sub>6</sub> to form a push-pull output stage.

This modification results in a much greater output volume, now in the order of 250 milliwatts and the range of the receiver is much enhanced.

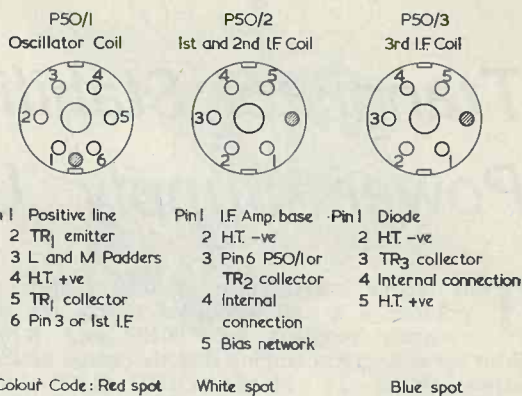

M523

Fig. 6. Oscillator and I.F. transformer pin details

### Circuit D

If more output power is desired, say for when the receiver is to be used in a car, then some 500 milliwatts is obtainable by substituting the OC81 series of transistors for TR<sub>4, 5</sub> and <sub>6</sub>, in place of the OC71 and OC72's used in Circuit C.

The circuit diagram remains unchanged as Fig. 3, but it should be noted that the resistors associated with the output stage have altered values, and that only these altered values must be used with the OC81 transistors. This fact is important and the correct values of the resistors are given in the components list.

The general description of the circuits is now complete and the constructor can choose to build them progressively as described or choose one particular circuit to complete, depending upon requirements, cash and kindred conditions.

As already mentioned, some "variations on a theme" may be permitted; for instance, a home made aerial assembly may be retained for any circuit, or the second a.g.c. stage introduced in Circuit B may be utilised in Circuit A—or omitted from any circuit. The choice is wide and foolproof, provided the correct and necessary components associated with a certain stage are retained.

## "THE RADIO CONSTRUCTOR"

### NOVEMBER ISSUE

The November issue of the magazine will be published on **Monday, 29th October**. Future issues however will continue to be published on the 1st of each month.

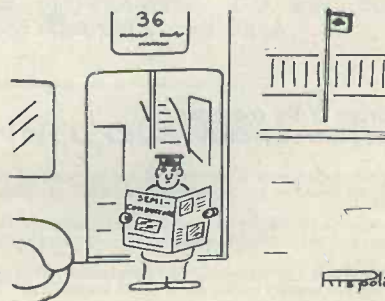

# Transistor Stabilised Power Supply Unit

By K. Berry

**T**HIS POWER SUPPLY UNIT WAS DEVELOPED TO produce a 6 volt smoothed supply for the ex-Army receivers type R109 and R209. Both these receivers employ directly heated battery valves (R109—2V Mazda Octal, R209—1.4V B7G) and consequently require a smooth ripple-free supply for satisfactory operation. The simplest way to operate these receivers from an a.c. supply is to run them from a trickle-charged 6 volt accumulator. However, whilst this is the simplest method, it is rather tedious and messy, involving as it does the presence of a battery and its corrosive electrolyte. It was to overcome these objections that the power supply unit described here was developed.

Although designed to power the receivers R109 and R209, this unit can also be used for any other purpose requiring a smooth 6 volt supply at currents of up to 2 amperes.

## Performance

Input Voltage	240 volts r.m.s.
Output Voltage	6.6 volts d.c. (No load)
"    "	6.1 volts d.c. (Full load)
Output Impedance	0.25 ohms
Ripple Voltage	15 millivolts Peak

## Circuit Description

The circuit of the power unit is shown in Fig. 1. The a.c. supply is connected via a double-pole switch ( $S_1$ ) to the primary of the mains transformer ( $T_1$ ), the secondary winding of which feeds a rectifier bridge ( $MR_{1-4}$ ) of silicon diodes. The output of the rectifier bridge is connected to the reservoir capacitor, ( $C_1$ ) and thence through a fuse ( $F_1$ ) to the transistor output circuit. This comprises two power transistors connected as cascaded emitter followers.

The base of  $TR_1$  is maintained at a fixed potential by means of the zener diode  $Z_1$ . The emitter of  $TR_1$  is directly coupled to the base of  $TR_2$ , and the output is taken from the emitter of  $TR_2$ . A pilot lamp ( $LP_1$ ) provides a d.c. path for the emitter of  $TR_2$  when no external load is connected. A resistor ( $R_4$ ) is connected in series with the collector of  $TR_2$  in order to restrict the power dissipated in  $TR_2$ .

## Design Considerations

A few points covering the design of this unit will be considered here. The choice of cascaded emitter followers as opposed to a series control transistor and error amplifier was made on the

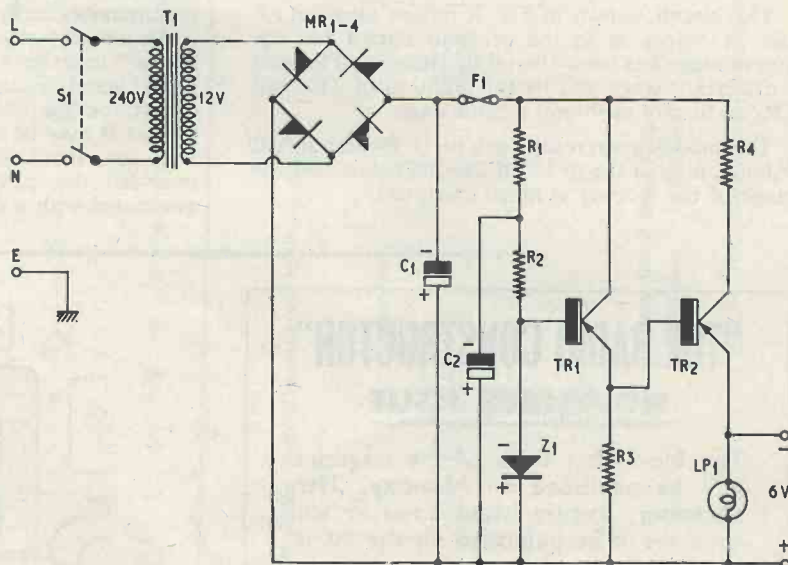

Fig. 1. Circuit of the transistor stabilised power supply unit



## Components List

### Resistors

- R<sub>1</sub> 150Ω ¼W  
 R<sub>2</sub> 150Ω ¼W  
 R<sub>3</sub> 680Ω ¼W  
 R<sub>4</sub> 1Ω 4W wirewound

### Capacitors

- C<sub>1</sub>, C<sub>2</sub> 3,000μF 25 volts wkg.

### Miscellaneous

- T<sub>1</sub> 240 input, 12V 2A output  
 Z<sub>1</sub> OAZ204 (Mullard)  
 LP<sub>1</sub> 6 volt, .06 amp  
 F<sub>1</sub> 2 amp fuselink  
 MR<sub>1-4</sub> SJ052-A (A.E.I.)  
 GEX541 (G.E.C.)\*  
 ZR20 (Ferranti)  
 TR<sub>1</sub>, TR<sub>2</sub> OC28 or OC35 (Mullard)†

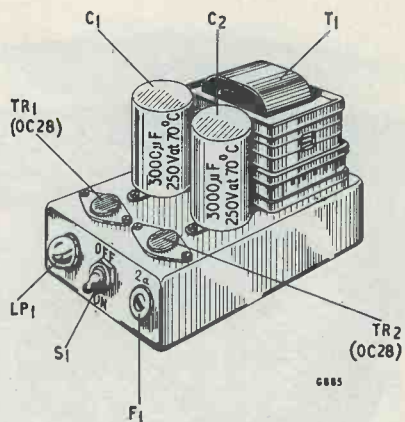

Fig. 2. General view of the completed unit

\* No heat sink required.

† Mica washer and two insulating bushes (per transistor) available under Mullard Code No. 56201.

grounds that this gave a unit capable of fulfilling the requirements at minimum expense.

The need for a transformer secondary voltage of 12 volts when an output voltage of only 6 volts is required may be explained by the fact that, at full load, it is necessary to ensure that the instantaneous voltage across the reservoir capacitor (C<sub>1</sub>) does not fall below about 9 volts, and the transformer used in the prototype unit gave only a choice of 9 or 12 volts output.

No specific surge limiting circuit has been fitted to the rectifier bridge since the diodes are operating well below their rated maximum peak-inverse voltage (P.I.V.).

Although TR<sub>1</sub> could be a transistor with a lower maximum collector dissipation than TR<sub>2</sub>, the same type transistor has been specified. This was done on the grounds of uniformity and also because when used at low (relative to I<sub>c</sub> max) collector currents, the gain of the transistor is much higher than it is at high currents.

### Components and Construction

No difficulties should be experienced in the construction or operation of this unit. The prototype unit was made, as shown in Fig. 2, on an "Eddy-stone" die-cast box which was of size 7½in by 4½in by 2in. This box forms the heat sink for the power

transistors. They are insulated from the chassis by means of a thin mica washer and insulated bushes obtainable with the transistors. The chassis surface to which the transistors are bolted should be flat and free from burrs.

Several types of diode are listed for MR<sub>1-4</sub>, and the choice is left to the constructor. The type with an asterisk against it does not require a heat sink and this simplifies construction. This list is by no means exhaustive and there are probably many other suitable diodes.

The use of silicon diodes (such as the GEX541) which can be used without a heat sink, enables a considerable saving in volume to be made over a selenium rectifier; furthermore, the voltage drop with a silicon diode is much smaller. It must be stressed however, that owing to the low internal resistance of silicon diodes very heavy currents can flow under fault conditions, and accordingly it is essential that the fuse (F<sub>1</sub>) is fitted.

The zener diode used, OAZ204, has a voltage tolerance of about ±0.4 volts, thus the output voltage may vary from unit to unit by as much as 0.8 volts. This can be adjusted, within small limits, by varying the current through the zener diode. If R<sub>1</sub> is increased, the output voltage will decrease and vice-versa. The zener current in the diode must not exceed 50mA.

## TV COMES TO THE CHANNEL ISLANDS

Smallest television station in the British Isles—at St. Helier, Jersey—went on the air on Saturday 1st September. It is expected that programmes will immediately reach 28,000 of the 34,000 homes in the six main islands. There will also be 2,000 television receivers in hotels for the use of the many visitors to the islands.

Channel Television, contractor for the new station, placed the major contract for the principal items of studio equipment with E.M.I. Electronics Ltd. These comprised two studio vidicon cameras, vision and sound mixing equipment, two telecine machines and the master control room system.

In view of the small size of the station, many items of equipment have been designed for operation by a minimum staff. For example, joystick control of the camera channels enables them to be operated from the master control room instead of from the studio control room.

# The "Realistic-7" Portable Transistor Receiver

*Described by E. Govier*

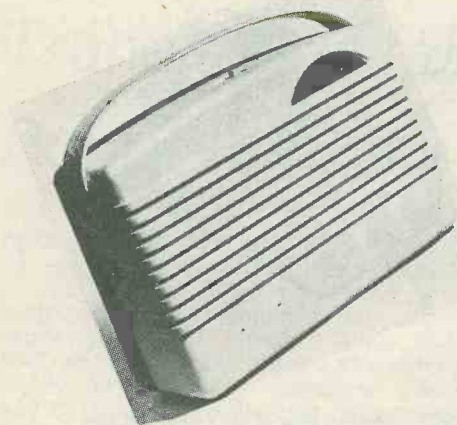

**T**HE "REALISTIC-7" IS A SEVEN TRANSISTOR BATTERY operated portable receiver covering the full medium and long wavebands. Ideally suited for construction by the home hobbyist, for whom it has been specifically designed, it is fitted with an internal ferrite rod aerial, fully employed on both bands, and an external socket for use when the receiver is employed as a car radio.

From the heading illustration shown herewith it will be seen that the two-tone moulded plastic cabinet is of pleasing appearance. Complete with carrying handle, the dimensions are 7in high, 10in wide and 3½in deep, the weight being some 3¼lb.

The coverage of the receiver is 190 to 570 metres (1,570 to 525 kc/s) medium wave, and 1,090 to 1,940 metres (275 to 155 kc/s) long wave. The controls consist of the volume control with combined on/off switch situated at the right-hand side of the cabinet, the wavechange switch at the top, and the tuning control. The upper arc of the dial is visible from the front.

## Circuit

The circuit is shown in Fig. 1.  $L_1$ ,  $L_2$  are the medium wave windings on the ferrite rod, being tuned by  $CV_1$  with  $CT_2$  in parallel.  $L_3$  is the long wave winding and is tuned by  $CV_1$   $CT_2$ , with  $C_1$  and  $CT_1$  in parallel.  $L_4$  is the car radio aerial coupling winding.  $TR_1$ , a Mullard OC44, operates as a self-oscillating mixer, feedback being effected by the central winding of the oscillator coil. On long waves this winding is tuned by the parallel combination of  $CT_3$ ,  $C_4$ ,  $CV_2$  and  $CT_4$ , whilst on medium waves only  $CV_2$  and  $CT_4$  are brought into circuit. Coupling to the base of  $TR_2$ , the first i.f. stage (470 kc/s) is effected via the i.f. transformer  $IFT_1$ . The emitter of  $TR_2$  (Mullard OC45) is coupled to the positive supply line via  $R_5$ ,  $C_8$ . The i.f. output from  $TR_2$  is coupled, via  $IFT_2$ , to the base of  $TR_3$  (Mullard OC45), the output across the

secondary winding of  $IFT_3$  being applied to diode  $D_1$  (Mullard OA70).

The detected a.f. voltage appears across the diode load  $RV$  (volume control), the required voltage being tapped off by the slider and applied, through  $R_{12}$ ,  $R_{13}$  and  $C_{16}$ , to the base of  $TR_4$  (Mullard OC71).

The amplified a.f. voltage is then passed direct to the base of  $TR_5$  (Mullard OC81) from the collector of  $TR_4$ . Bias, together with a degree of feedback, is applied to the base of this latter transistor via  $R_{16}$ . The output from the collector of the driver transistor  $TR_5$  is next applied to the primary winding of the driver transformer, and from the secondaries of this component to the bases of the push-pull output stage  $TR_6$  and  $TR_7$  (Mullard OC81's). Audio output is of the order of 350mW.

The loudspeaker is a 4in circular permanent magnet type, with high flux density and an impedance of 25Ω.

The battery specified is a Vidor T.6009, or the equivalents EverReady PP.9, Drydex DT.9—all of which are 9V types. Current consumption is 25 to 35mA at a reasonable listening level.

## Construction—Practical Hints

Dealing with the transistors, the lead-out wires should not be bent at a point less than 1.5mm from the seal and, when the lead-outs are being soldered into circuit, a heat shunt should be interposed between the point of soldering and the transistor itself. A pair of fine-nosed pliers serves admirably as a heat shunt.

A base or emitter circuit component should never be disconnected or shunted, by a low resistance for instance, or by using a milliammeter when the receiver is working. When making current measurements, first switch off the receiver, break the circuit at the point where the reading is to be taken, insert the milliammeter, switch on, take the current reading,

Internal view of the completed receiver

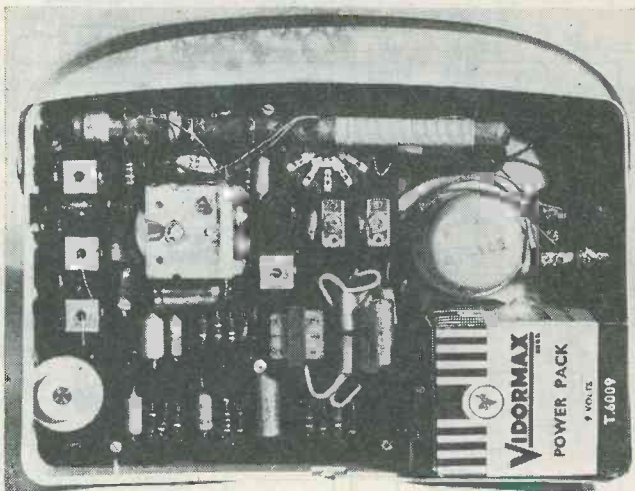

switch off and re-connect the circuit. The polarity of the supply should never, at any time, be reversed.

Ohmmeters set on ranges which incorporate batteries having a greater potential than 1.5V should not be used. When mains or battery operated test instruments are employed, connect them to the circuit only via an isolating capacitor.

#### Printed Circuits

Blistering of the laminated board will occur at about 200°C and, since this can lead to breaks in the printed circuit, care should be taken, when fitting components into circuit, not to excessively prolong the application of the soldering iron. A low temperature type of iron with a small bit and low temperature solder is recommended when working with printed circuits.

The removal of a capacitor or resistor from the board requires some consideration with reference to the length of the connecting leads. If these leads are of sufficient length, snip them with a pair of sidecutters close to the component, leaving enough lead protruding through the board to allow the replacement component to be soldered to it. Should the component leads be too short for the above treatment, snip them off as close as possible to the board, leaving only the ends soldered to the printed circuit wiring. Apply the iron, the board being component side uppermost, so that the lead ends fall clear when the board is tapped. Connecting leads of components should always be tinned prior to soldering to the board in order to reduce the period of time that the iron is applied.

#### Assembly Instructions

The printed panel is supplied ready drilled, cleaned, and with a layer of surfacing protecting material which permits easy soldering. Prepare the components for soldering by inserting them into the correct holes in the printed circuit board and cutting the lead-out wires to suitable lengths. All components except transistors and capacitor C<sub>20</sub> should

lay flat on the board. Transistor leads should be kept as long as possible, and never shorter than  $\frac{3}{16}$ in. TR<sub>6</sub> and TR<sub>7</sub> lead-out wires should *not* be shortened.

#### Sequence of Assembly

1. Fit all resistors except the volume control.
2. Fit all capacitors and trimmers except the tuning capacitor. C<sub>20</sub> is  $\frac{1}{2}$ in above the top of the board. Note the polarity of C<sub>6</sub>, C<sub>18</sub>, C<sub>19</sub> and C<sub>20</sub>.
3. Fit i.f. transformers and the oscillator coil. The latter is colour coded red/mauve. The first i.f. transformer is coded white/red, the second white/red, and the third white/blue. The i.f. transformers should be so positioned that the colour code spots face the tuning capacitor. The oscillator coil should be positioned such that the colour spot faces away from the tuning capacitor. Pin X is left unsoldered. All metal can lugs must be soldered.
4. Fit driver transformer T<sub>1</sub> with colour code spot facing R<sub>14</sub>.
5. Fit diode D<sub>1</sub> with positive end (red) facing C<sub>18</sub>.
6. Fit the transistors. Keep wires as long as possible, not less than  $\frac{3}{16}$ in, and do not shorten TR<sub>6</sub> and TR<sub>7</sub> leads in any event. Sleeve all lead-outs on TR<sub>6</sub> and TR<sub>7</sub>, and similarly deal with the centre lead-out on the remainder of the transistors. The red spot in each case denotes the collector. The arrow on the printed circuit board points to the collector.

After connecting both TR<sub>6</sub> and TR<sub>7</sub>, the special heat sinks supplied should be slipped over the metal cans of the transistors and screwed to the board with self-tapping screws beneath C<sub>20</sub>.

7. Fit the tuning capacitor. Pass the spindle through the printed circuit board and secure with three 4BA screws. Solder a short length of p.v.c. insulated wire from the fixed vane tag of the front gang to point "E" on the printed circuit, and likewise from the rear gang to point "L".

8. Fit the volume control and wavechange switch. Pass the shaft of the wavechange switch through the printed circuit board and secure with a Spire clip.

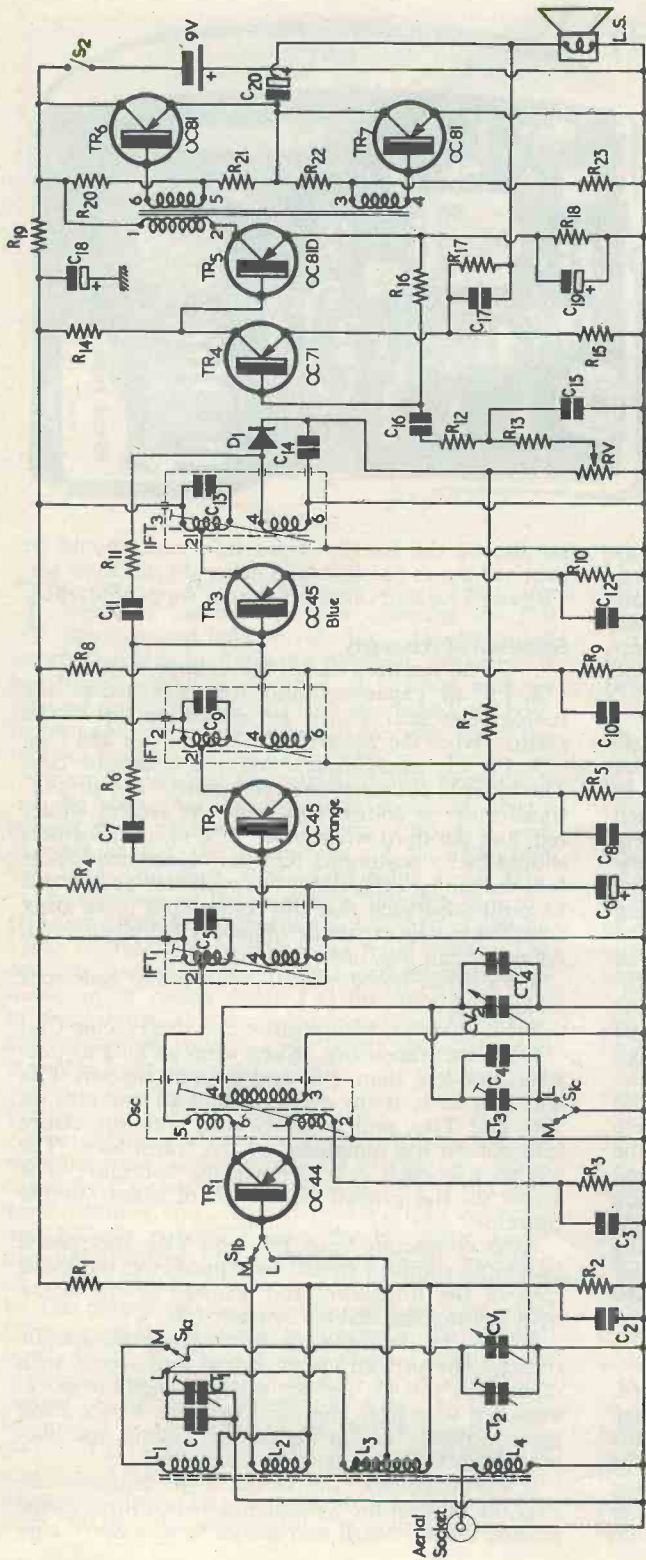

Fig. 1. Circuit diagram of the receiver

M500

Resistors (10% ± watt)

- R1 39kΩ
- R2 10kΩ
- R3 3.9kΩ
- R4 56kΩ
- R5 680Ω
- R6 1.2kΩ
- R7 8.2kΩ
- R8 22kΩ
- R9 4.7kΩ
- R10 820Ω
- R11 3.9kΩ
- R12 2.2kΩ
- R13 1kΩ
- R14 8.2kΩ
- R15 1kΩ
- R16 33kΩ
- R17 100kΩ
- R18 820Ω
- R19 560Ω
- R20 2.7kΩ
- R21 100Ω
- R22 2.7kΩ
- R23 100Ω
- \*C5 250pF 5%
- †C6 12μF 50 w.v., 125 w.v.
- C7 56pF ±1pF, 125 w.v.
- C8 0.1μF 10%, 125 w.v.
- \*C9 250pF
- C10 0.047μF 10%, 125 w.v.
- C11 18pF ±1pF, 125 w.v.
- C12 0.1μF 10%, 125 w.v.
- \*C13 250pF
- C14 0.01μF 10%, 125 w.v.
- C15 0.047μF 10%, 125 w.v.
- C16 0.022μF 10%, 125 w.v.
- C17 100pF 10%, 125 w.v.
- †C18 100μF, 12 w.v.
- †C19 100μF, 12 w.v.
- †C20 200pF 5%, 125 w.v.

Capacitors

- C1 10pF ±1pF, 125 w.v.
- C2 0.1μF 10%, 125 w.v.
- C3 0.01μF 10%, 125 w.v.
- C4 200pF 5%, 125 w.v.

Components List

- CT1, CT3 3—40pF trimmers
- CT2, CT4 On tuning capacitor
- CV1, CV2 Tuning capacitor
- † Electrolytic capacitors

Cabinet  
Lasky's Radio Ltd.

Printed Circuit Board  
Lasky's Radio Ltd.

Semiconductors  
TR1 Mullard OC44  
TR2 Mullard OC45

- TR3 Mullard OC45
- TR4 Mullard OC71
- TR5 Mullard OC81
- TR6 Mullard OC81
- TR7 Mullard OC81
- D1 Mullard OA70

Inductors  
Lasky's Radio Ltd.

Speaker  
5in 25Ω Lasky's Radio Ltd.

Driver Transformer  
T1 Lasky's Radio Ltd.

Miscellaneous  
Wavechange switch, knobs, volume control,  
etc., etc. (Lasky's Radio Ltd.)

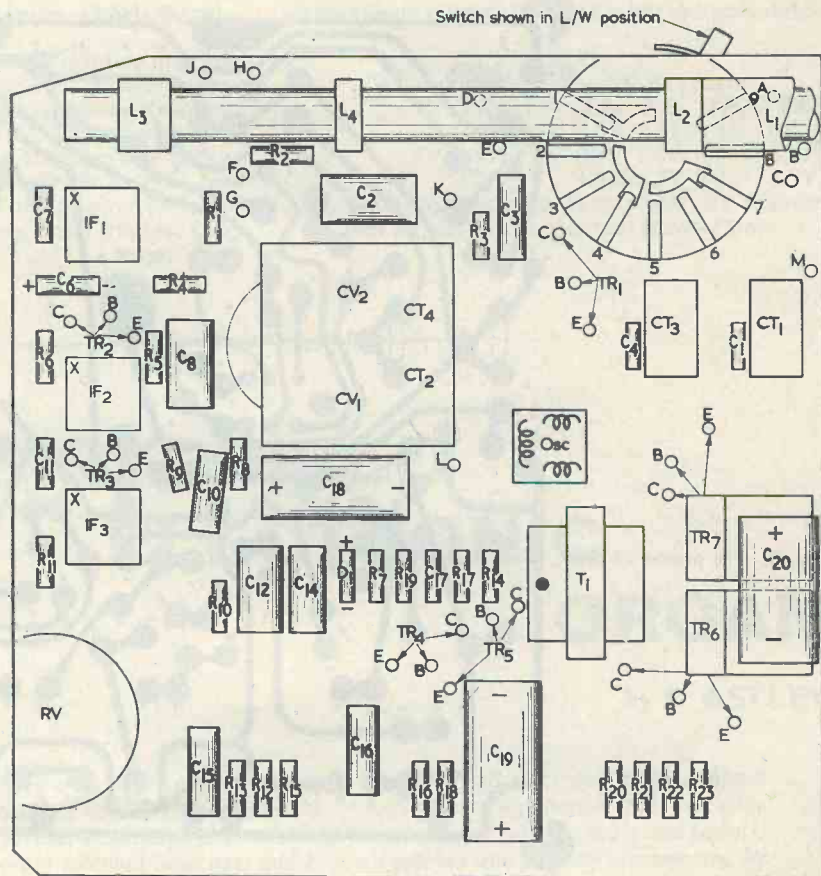

Fig. 2. Showing the layout of the components on the printed circuit board

M501

The wafer can then be passed over the shaft and soldered into position. The volume control can be soldered into position as shown in Fig. 2. Tag 3 of the wavechange switch should be left unsoldered.

9. The aerial rod should now be mounted in its brackets and the coils fitted as shown in Fig. 2. L<sub>1</sub> and L<sub>2</sub> are fitted together; L<sub>3</sub> has three tags, and L<sub>4</sub> is a single pile wound coil with two connections. Connect these coils as follows: L<sub>1</sub> start to point "F", finish to point "A". L<sub>2</sub> start to point "F", finish to point "C". (L<sub>1</sub> and L<sub>2</sub> start together. L<sub>2</sub> is the shorter of the two coils and ends after approximately six turns. L<sub>1</sub> ends at the extreme end of the former.) L<sub>3</sub>, tag 1 to point "G", tag 2 to point "K", tag 3 to point "J". (With the tags facing the constructor, L<sub>3</sub> tags are numbered clockwise from the gap—1, 2 and 3.) L<sub>4</sub> start to point "H", finish to point "D". (The start of L<sub>4</sub> is that of the inner wire and the end is the outer wire.)

10. Fit the battery leads. Use 9in lengths of red and black p.v.c. insulated wire. Solder the black lead to the point marked "9V—" on the printed circuit and the red lead to the point marked "9V+". (see Fig. 3.) Pass the wires up and down through

the two adjacent holes on the board in order to secure them in position. Solder the battery snap socket to the red wire and the plug to the black wire.

11. Fit the car aerial socket. Solder a 6in length of p.v.c. insulated wire from point "M" to the outer casing of the socket, and another from point "B" to the centre tag of the socket.

12. Secure the loudspeaker into the cabinet beneath the fixing lugs and position with its solder tags beneath the car aerial socket. Connect the speaker, with p.v.c. insulated wire, to the points marked "LS" on the printed circuit board. Push-fit the dial over the tuning capacitor spindle, ensuring that the flats on the dial shaft and capacitor spindle mate together.

The battery may now be connected and the receiver switched on and tested (see "Alignment Procedure"). Secure the aerial coils to the ferrite rod, after adjustment, with wax.

13. Fitting to the cabinet. The complete printed circuit assembly can now be eased into the cabinet, allowing the volume control and wavechange switch lever to clear their respective holes. Secure with

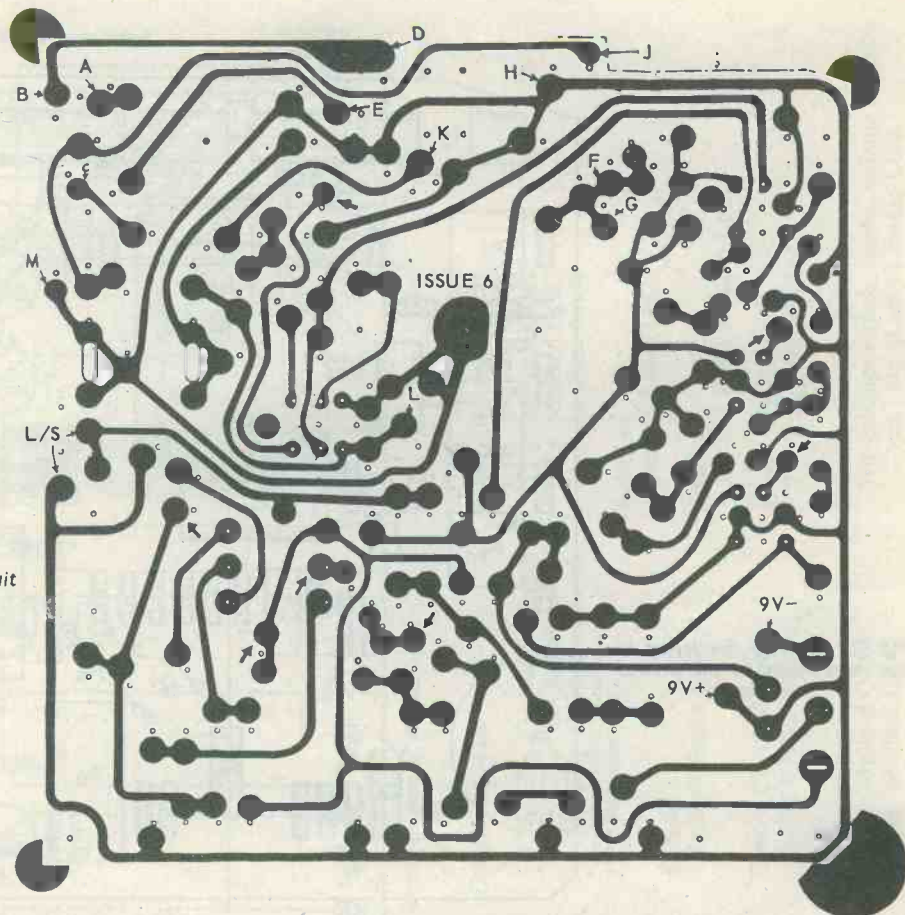

Fig. 3. The printed circuit

four self-tapping screws through the printed circuit board into the moulded pillars.

The battery is housed at the side of the speaker, no retaining clip being required. The cabinet back is secured by two  $1\frac{1}{2}$  in self-tapping screws into the Spire clips fitted to the front half of the cabinet.

#### Alignment Procedure

All the i.f. transformers and oscillator coil are supplied pre-aligned, but they may require some peaking. For correct alignment it is preferable to use a modulated signal generator having a frequency coverage of 155 kc/s to 1,570 kc/s and an output meter of  $25\Omega$  impedance, or a voltmeter capable of reading 0-2V a.c. across the speech coil. A non-ferrous trimming tool suitable for adjusting the i.f. and oscillator coils is also required.

The aerial and oscillator circuits must be aligned with the set fitted into the cabinet. I.F. alignment may be carried out either with the board in or out of the cabinet.

Before alignment, set the volume control to maximum and use the lowest signal volume from the generator consistent with reasonable output from the set; say 50mW, or 1V a.c. across the speech coil. This will avoid a.g.c. action.

Switch the receiver to the medium wave position and close the tuning capacitor vanes. Set the signal generator to 470 kc/s and connect to the base of the mixer transistor TR<sub>1</sub> via a blocking capacitor.

Align each i.f. transformer for maximum output with either the output meter connected in place of the speaker or with the voltmeter connected across the speaker.

For r.f. alignment the signal generator should be loosely coupled to the receiver by a loop of insulated wire placed at a convenient distance from the set. Maximum pick-up will be obtained with the loop at right angles to the ferrite rod.

Set the wavechange switch to the medium waveband and the signal generator to 525 kc/s with the receiver tuning capacitor closed, and adjust the oscillator coil for maximum output.

With the receiver still on the medium waveband, set the generator to 1,570 kc/s with the receiver gang fully open, and adjust the oscillator trimmer CT<sub>4</sub> for maximum output. Repeat these two operations.

Still switched to the medium waveband, set the generator to 600 kc/s and the receiver to 500 metres, adjusting the medium wave aerial coil for maximum output. Set the generator to 1,300 kc/s and the receiver to 230 metres, and adjust the medium wave

aerial trimmer CT<sub>2</sub> for maximum signal output. Repeat these two operations.

Set the receiver to the long wave position and the generator to 155 kc/s. With the receiver gang closed, adjust the long wave oscillator trimmer CT<sub>3</sub> for maximum output. Set the generator to 180 kc/s and the receiver to 1,670 metres and adjust the long wave aerial coil for maximum output. Set the generator to 270 kc/s and the receiver to 1,110 metres and adjust the long wave aerial trimmer CT<sub>1</sub>

for maximum output. Repeat the last two operations.

TABLE  
WORKING VOLTAGES—9V BATTERY

	TR <sub>1</sub>	TR <sub>2</sub>	TR <sub>3</sub>	TR <sub>4</sub>	TR <sub>5</sub>	TR <sub>6</sub>	TR <sub>7</sub>
Emitter	1.5V	0.7V	0.9V	0.6V	1.3V	4.5V	0V
Base	1.4V	0.8V	1.0V	0.7V	1.4V	4.65V	0.15V
Collector	7V	7V	7V	1.4V	8.5V	9V	4.5V

Above voltages are approximate and are negative with respect to the common positive line.

# A TRANSISTORISED ELECTRONIC ORGAN

Part 3

By S. ASTLEY

*This is the third in a series of four articles describing a transistorised electronic organ. Apart from the fact that transistors are employed, thereby reducing heat dissipation and assembly time, the organ has the further advantage that it is fully polyphonic on both manuals and pedals, that it employs no elaborate solenoid switches, and that all pitches and voicing are selected by electronic means*

## The Pedals

THE RANGE OF THE PEDAL BOARD IS OPTIONAL. Some prefer a full R.C.O. pedal board which is concave and radiating, with a range from C<sup>1</sup> to F#<sup>3</sup>. An alternative is a "stub" pedal board which, as the name implies, consists actually of short stubby keys protruding from the case. A stub pedal board usually covers one octave only, C<sup>1</sup> to C<sup>2</sup>, and is positioned on the left hand side of the console.

Whichever type of pedal board is decided upon, it is preferably made detachable in most domestic installations. The pedal board may then be coupled into the main instrument by means of a multi-way plug and socket.<sup>1</sup> Alternatively, as we shall see shortly, the contacts may be retained in the organ console.

In the writer's instrument, the pedal board has two buses (16ft and 8ft), so only two pairs of contacts are required for each pedal. It is not essential to use a rhodium earthing bar with the pedal board, and this can be omitted, if desired.

The pairs of contacts are normally open, and those coupling to the generator isolating resistors need not, in this instance, be short-circuited to earth when the pedal is at rest.



The stop tray viewed from the side. The pre-amplifiers are mounted at the rear

<sup>1</sup> See end of article for stockist of suitable plug and socket.

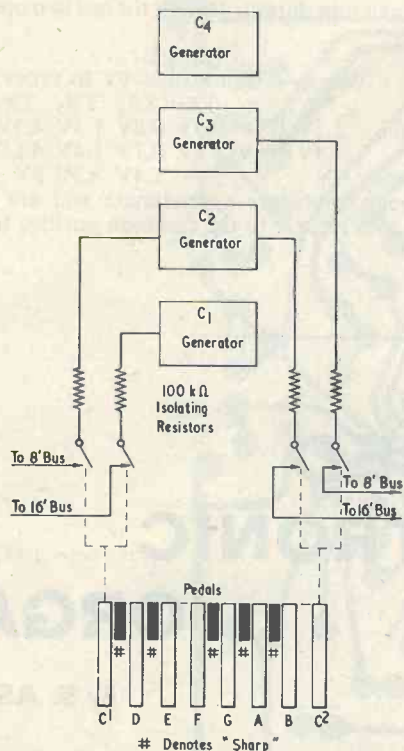

Fig. 20. The circuits switched by the C1 and C2 pedals

Fig. 20 illustrates the pedal contacts for C1 and C2. When C1 pedal is depressed, C1 generator couples to the 16ft bus and C2 generator couples to the 8ft bus. When C2 pedal is depressed, C2 generator couples to the 16ft bus and C3 generator couples to the 8ft bus. The routing of other generator outputs may be ascertained from Table 2 (published with Part 1 of this series).

Two methods of mounting the pedal contacts are illustrated in Fig. 21. In one instance the contacts

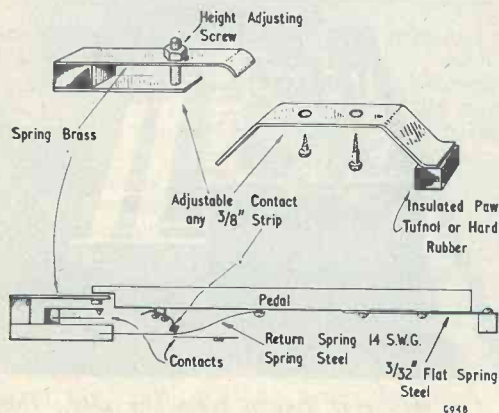

Fig. 21. Details of pedal contacts

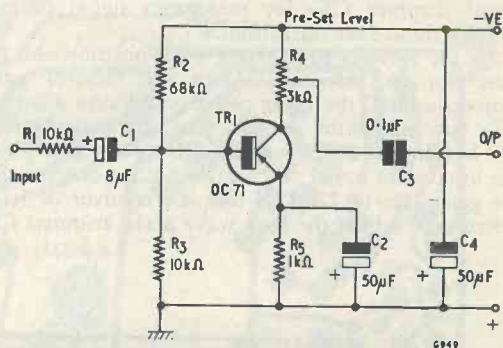

Fig. 22. A single-transistor pre-amplifier, which may be employed to make up losses sustained in filters, etc.

**Components List (Fig. 22)**

- R1 10kΩ ¼W
- R2 68kΩ ¼W
- R3 10kΩ ¼W
- R4 3kΩ potentiometer
- R5 1kΩ ¼W
- C1 8μF 6 w.v. electrolytic
- C2 50μF 6 w.v. electrolytic
- C3 50μF 12 w.v. electrolytic
- TR1 OC71

are below the pedal and are actuated by an adjustable contact arm fitted with an insulating paw made of Tufnol or hard rubber. In the second instance the contacts are operated by the inner edge of the pedal, this bearing against a piece of spring brass mounted on the floor of the main instrument case. In the second example the pedal board can still be made detachable. Since the contacts are now in the console, the latter may be permanently wired into the main circuit and there is no need for the multi-way plug and socket referred to above.

**Pre-Amplifiers and Stop Tray**

Dependent on the number of stops used it will be necessary to boost the outputs from the 8ft and 4ft buses. A suitable pre-amplifier circuit is illustrated in Fig. 22 and this may be inserted between the buses and filters as required. (It should be noted that the pre-amplifiers referred to here are not the pre-amplifiers shown in Fig. 3 of Part 1.)

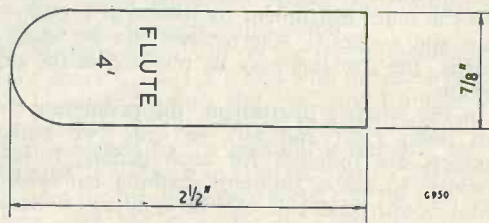

Fig. 23. A typical stop tab



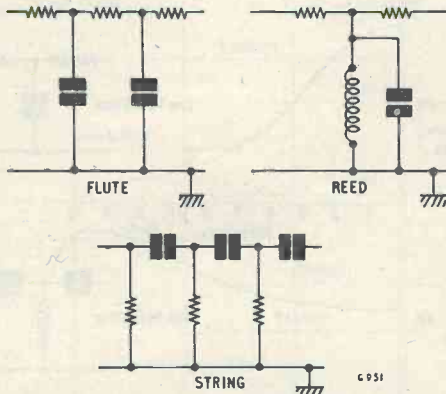

Fig. 24. The basic filters required for flute, string and reed tones

The pre-amplifiers, stop switches and filters are contained in a mild steel tray 3ft long by 1ft wide and 2½ in deep. Cables from the keyboard buses are screened and lead to a 12-way Jones plug situated on the tray. The stop switches may be made, and they are all mostly 1-pole except for couplers and Diapason which may be 2-pole. The writer used telephone key switches. Flats were filed on the knobs of these switches, white Perspex tabs then being cemented with Araldite to the knobs.<sup>2</sup> The tabs may be made or bought, a typical example being illustrated in Fig. 23.

### Filters

Filters are of three types to simulate the tones required. Differentiation, integration, and tuned filters are employed, as shown in Fig. 24. A specimen layout for the Solo manual is given in Fig. 25, but the general layout is left to the builder's own tastes. The reader may like to study the stop system employed in the Baldwin organ.<sup>3</sup> This is most adaptable for this instrument's waveform.

The potentiometers shown in Fig. 25 are pre-set and are adjusted to suit the individual stop levels.

<sup>2</sup> A supplier for suitable Perspex is given at the end of this article.

<sup>3</sup> *Electronic Musical Instruments*, by Richard Dorf, Schober Organ Co., New York. (Available from The Modern Book Co., 19-21 Praed Street, London W.2.)

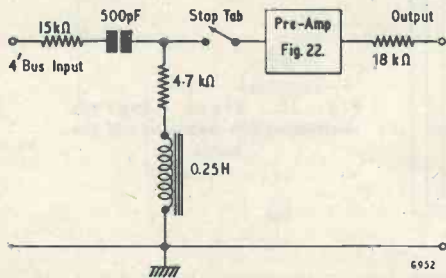

Fig. 25. A specimen stop and filter layout for the Solo manual

Any of the stops, such as the Trumpet, may be boosted still further by means of the pre-amplifier of Fig. 22. The latter is so economical (not needing valves) that it can be inserted at any point where necessary.

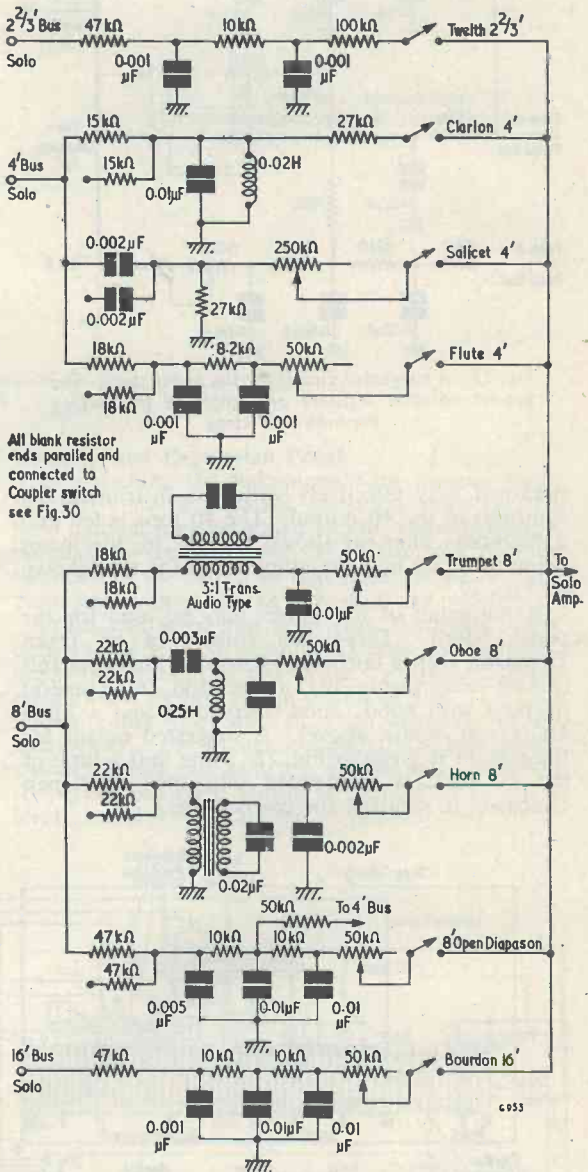

Fig. 26. The filter used for synthesis of the Fifteenth 2ft tone

It will be noted that a small amount of 4ft signal is fed into the 8ft Diapason stop circuit of Fig. 25. This helps to give the correct diapason (pipe organ) tone.

A 2ft stop, usually known as a Fifteenth 2ft, is

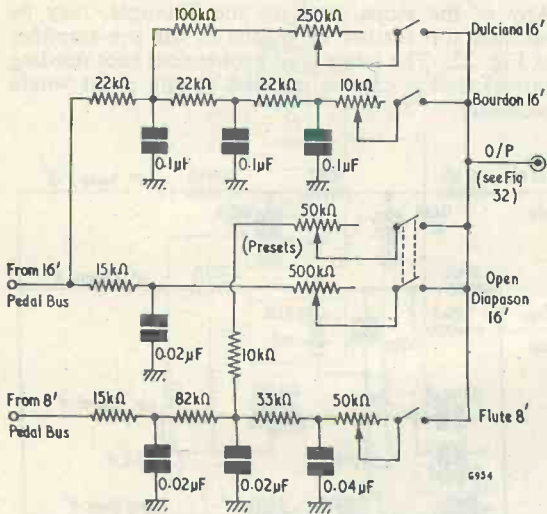

Fig. 27. A suggested circuit for the pedal stops. The pre-set variable resistors are employed for voicing the individual stops

obtained very effectively with this instrument by synthesis of the 4ft output. The 4ft tone is fed into a high-pass filter, as shown in Fig. 26, the losses being made up by a pre-amplifier of the type shown in Fig. 22.

A minimum of four stops may be used for the pedal board. These can consist of an Open Diapason 16ft (a fairly heavy stop), a Dulciana 16ft (a soft accompaniment), a Bourdon 16ft (general purpose with good round deep tone) and a Flute 8ft (a soft octave above). A suggested circuit for these stops is given in Fig. 27. Note that a little of the 8ft tone is introduced into the 16ft Open Diapason to simulate the correct tone.

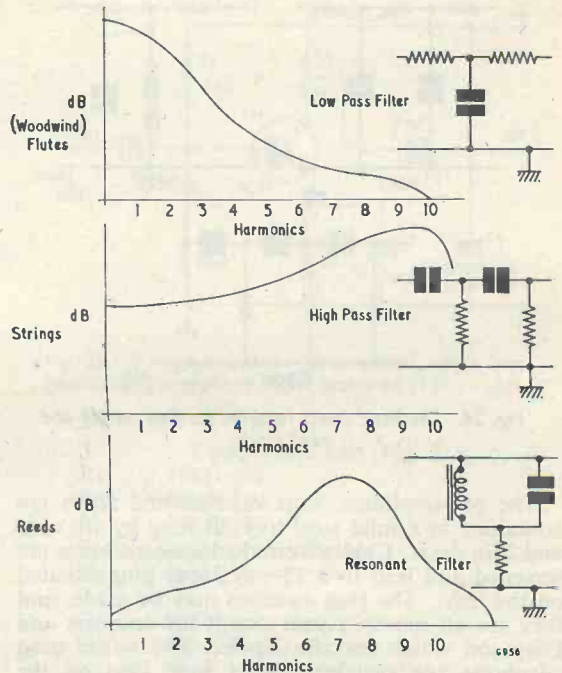

Fig. 29. Harmonic content of flute, string and reed tones

Fig. 3 (published in Part 1) shows the busbar routing between the manuals and pedal board and the stop tray. The information given in that diagram is augmented by Fig. 28 which illustrates also the transistor pre-amplifiers and the 2ft filters.

When designing filters it may be found helpful to think in terms of the *formant range*, or frequency response, of various orchestral instruments. In the present instrument tone colours are formed by a subtractive process from an initial signal which is

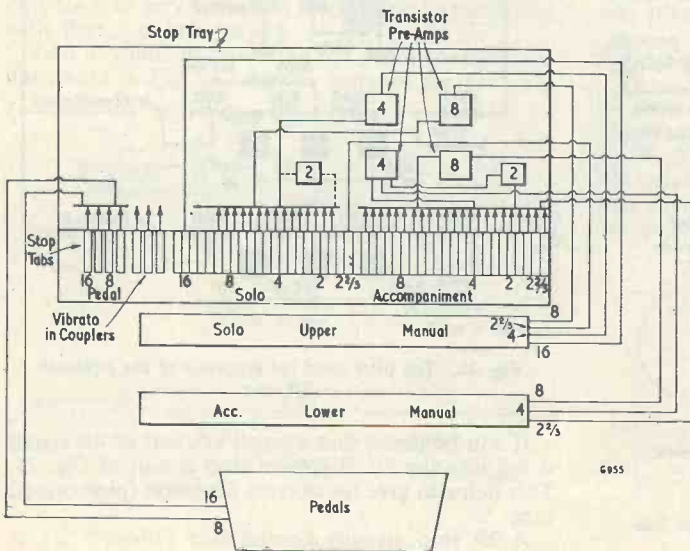

Fig. 28. Block diagram illustrating the disposition of the buses

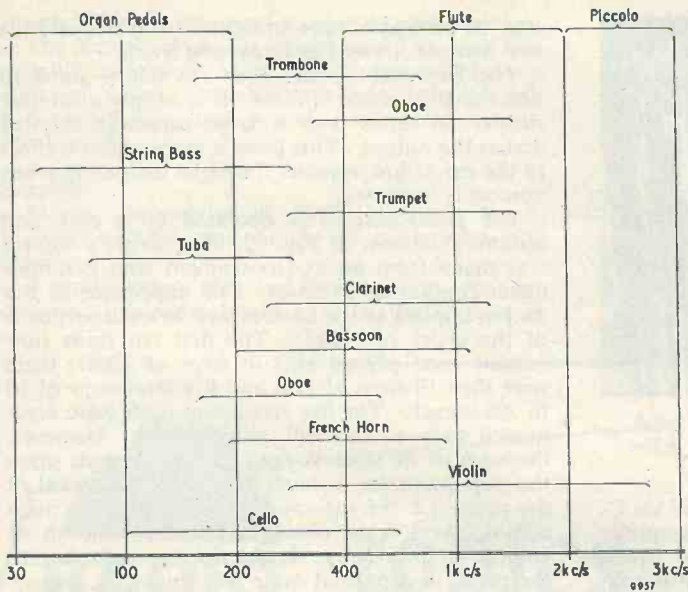

Fig. 30. The approximate frequency spectrum of various orchestral instruments

rich in harmonics. Fig. 29 illustrates the approximate harmonic content of woodwind, strings and reeds, together with the filter circuits which are needed to simulate these. Such filter circuits can, if desired, be used in combination with each other to obtain more complex effects. Fig. 30 gives the frequency range of particular orchestral instruments, and this information may be employed, for filter design, in conjunction with the curves of Fig. 29.

The constructor is advised to take some tapes of a good pipe organ when designing filters. If these are played back through the organ amplifier system it is possible to obtain a good comparison between the pipes and the electronically generated tones.

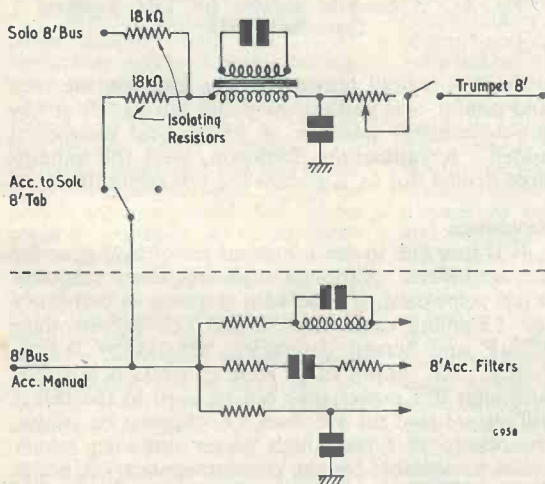

Fig. 31. Switching the Accompaniment buses through isolating resistors so that Solo stops may be added to the Accompaniment manual

### Couplers and Expression Pedal

By switching the Accompaniment manual buses through suitable isolating resistors, stops on the Solo manual may be added to the Accompaniment manual, as shown in Fig. 31. This idea may be extended to the pedals so that stops on the Accompaniment manual may be played on the pedals.

From the filter and stop tray there are three outputs (see Fig. 3), these being Solo, Accompaniment and Pedal. In the writer's instrument these outputs are applied to the circuit of Fig. 32 which allows either the Solo or both manuals to be connected to the Expression pedal via the selector switch. When this switch is in the upper position the Accompaniment output is coupled to its 50kΩ level control R<sub>1</sub> and, thence, to pre-amplifier No. 2.

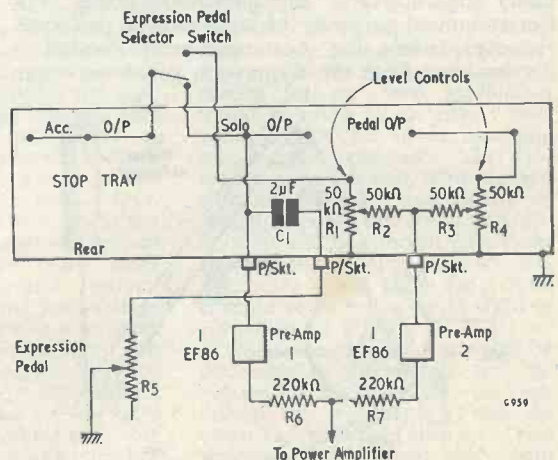
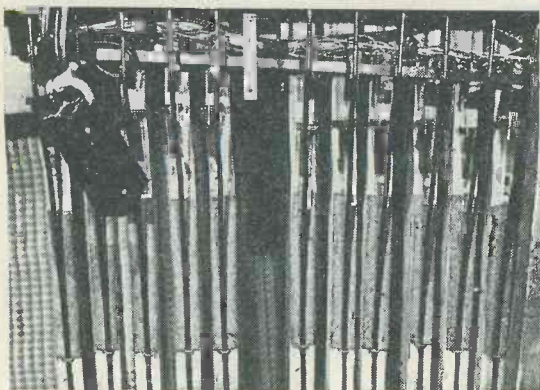

Fig. 32. The Expression pedal and selector switch circuit



Underside view of the pedals. The Standard R.C.O. pedal was cut in half and dowelled to allow convenient re-assembly

At the same time, the Solo output is coupled via  $C_1$  to the Expression pedal and is fed to pre-amplifier No. 1. When the Expression pedal selector switch is in the lower position the Accompaniment output is commoned with the Solo output and both are applied to the Expression pedal circuit and to pre-amplifier No. 1. The switch does not affect the pedal board output, which is always applied to pre-amplifier No. 2 via level control  $R_4$ .

It should be noted that the pre-amplifiers of Fig. 32, together with the Expression pedal selector switch, correspond to the similarly identified items in Fig. 3. Each pre-amplifier employs an EF86 with conventional a.f. circuitry, the outputs being combined by way of  $R_6$  and  $R_7$  and passed to the main power amplifier.

The scheme shown in Fig. 32 is optional. It has the advantage of enabling either the Solo manual, or both manuals, to be controlled by the Expression pedal. Two separate pre-amplifiers are required because, with only one, the whole organ would be under the control of the Expression pedal. For Entertainment purposes the latter may be preferred. However, when the Accompaniment manual is disconnected from the Expression pedal the organ

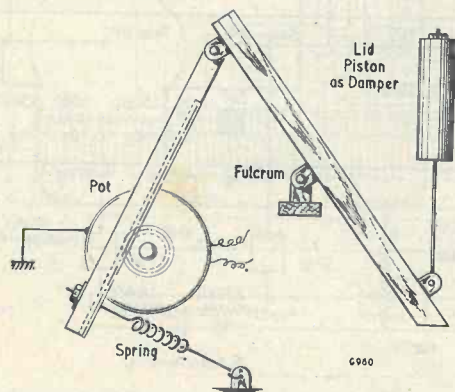

Fig. 33. Mechanical details of the Expression pedal

may be used as a more 'straight instrument, and the two manuals treated as Great and Swell.

The Expression pedal does not follow standard practice for volume control. It is simply a variable resistor in series with a large capacitor shunted across the output. This gives a more realistic effect to the ear at low volume, the highs increasing when volume is increased.

The pedal control is operated by a rack and pinion, as shown in Fig. 32. The writer's control was made from an ex-Government stud potentiometer containing 30 studs. The impedance of the output applied to the control and series capacitor is of the order of  $100k\Omega$ . The first ten studs (low volume end) offered  $1k\Omega$  in steps of  $100\Omega$ ; there were then 10 steps of  $1k\Omega$  and five final steps of 10 to  $20k\Omega$  each. The five remaining studs were commoned over at the full volume end. However, the number of studs is optional. It depends upon the potentiometer to hand and, also, the travel of the pedal, i.e. the rack and pinion ratio. The main consideration is to obtain a smooth build-up of volume. Full volume should not be realised until the pedal is depressed quite two-thirds.

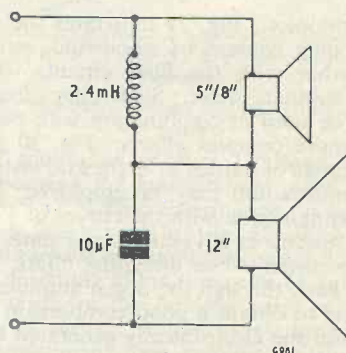

Fig. 34. A crossover network for  $15\Omega$  speakers. Crossover is at  $1kc$

So that a light tension can be kept on the rack and pinion, and so that the pedal can be left at any pre-determined position, a mechanical damper is added. A radiogram lid-piston, with the exhaust hole drilled out to  $\frac{3}{8}$  in does the job admirably.

### Amplifiers

It is possible to use a normal set of hi-fi gear for the amplifiers. Although high frequency response is not important, a good bass response is extremely so. Coupling capacitors should not be less than  $0.25\mu F$  and screen decouplers should be 0.1 to  $0.25\mu F$ . An output of at least 15 watts is advised. Although this power may not be used to the full it will ensure that no overload, i.e. clipping on peaks, can occur. A typical high power amplifier which would be suitable for the present application is the Cooper-Smith Magnum<sup>4</sup>. A sensitivity of approxi-

<sup>4</sup> See "The Cooper-Smith Magnum 20 Watt Power Amplifier", *The Radio Constructor*, February and March 1961.

mately 100mV is required for the main pre-amplifiers.

The ideal loudspeaker would be a 15in unit in a suitable enclosure. Most constructors will have a 12in unit which, with a suitable crossover filter and a 5 to 8in unit, will provide satisfactory results. See Fig. 34.

#### Suppliers

Messrs. Teleservice of 56/58 Highland Road, Southsea, Hants., will supply all components for the organ.

A multi-contact plug and socket (Jones type) for coupling the pedal board case to the console is

available from G. W. Smith & Co. (Radio) Ltd., 3-34 Lisle Street, London, W.C.2.

A retail source for Perspex is L. Glazer & Son Ltd., 275 Neasden Lane, London, N.W.10. The tabs may also be available from the organ component suppliers listed in Part 1 of this series.

#### Next Month

In next month's issue, the concluding article in this series will cover the vibrato and C<sup>1</sup> generator, and the reverberation unit. Additional facilities will also be discussed.



By **RECORDER**

**A** HAM FRIEND OF MINE ASKED me a few weeks ago to help him out with the design of a power supply circuit for a new transmitter which he was planning. The outputs required from the circuit were to be 750 volts h.t. at 100mA and 350 volts h.t. at 120mA, plus various heater voltages. An important point was that the power supply components must occupy as small a space as possible with, if this could be arranged, all mains transformer primary and secondary windings on a single former. Also, my friend wanted to know whether we could use silicon rectifiers instead of valve rectifiers and thereby save space. Transformer winding capacity was available, and so there were no worries about using non-standard mains transformers.

I am not a ham myself, and most of the power supplies I play around with are of the domestic radio and television category. In consequence I found that investigating the much higher voltages and currents required

for transmitter work was quite a new and fascinating experience. The interest was further increased here, because we were aiming also at low overall dimensions.

#### Valve Rectifiers

Having established our requirements, we first of all dug out the valve and semi-conductor books to see what would best meet our needs from the points of view of space considerations and cost. After a lot of head-scratching, we found that valve instead of silicon rectifiers won the day for both the high and low h.t. voltages specified. In the case of the high voltage supply, the high peak inverse voltage existing here would necessitate our using a multiple silicon rectifier (in which a number of rectifiers are in series) and this could be fairly bulky. Also, the multiple rectifier unit would not be generally available and would almost certainly be much more expensive than a valve rectifier. When we tackled the low voltage circuit we found that silicon rectifiers could replace a valve rectifier, with some saving of space, but that the cost would be quite a little higher. Although we finalised on the valve rectifier, we still examined a number of silicon rectifier circuits for the low voltage supply, and I shall refer to these afterwards. Our valve version is shown in Fig. 1.

Reverting to the 750 volt supply, by far the best valve appeared to be the Brimar 5R4GY. This is a full-wave rectifier on an octal base whose maximum height, excluding pins, is 4½in, and whose maximum diameter is 2⅞in. The same size, indeed, as a glass 6L6. The 5R4GY will work up to 1,000 volts r.m.s. input per anode for 175mA rectified output, and 750 volts r.m.s. input for 300mA rectified output. Also, there seems to be no delayed h.t. switching requirement with this valve when used with choke input. A further check on the ratings for the 5R4GY showed that the voltage and current needed for our own application would be given by an r.m.s. input voltage of 850 per anode, assuming zero supply resistance. In consequence, we felt that, if we worked with an 890-0-890 volt input, we should be pretty safe so far as losses in choke and transformer resistances were concerned. The extra 40 volts per anode would allow for a total effective series resistance of 400Ω at 100mA.

To save space, we felt it would be preferable to incorporate the low voltage h.t. secondary into the high voltage h.t. secondary. From the centre-tap we would then have two windings which would carry both high and low voltage rectifier currents up to the anode potential for the low voltage rectifier, after

which two windings using thinner wire would carry on for the high voltage rectifier. This idea can be seen in Fig. 1.

Our next query was: could we get the heater windings on the same transformer? The snag here is that it is necessary to be able to switch h.t. separately from heater supplies in a transmitter. A little thought soon showed us that it would be quite impossible to switch h.t. in the secondary circuit of the transformer because of the very high voltages which exist here. One possibility which presented itself consisted of switching the 750 volt circuit only, this to be done by inserting switches in series with the secondary winding at the points indicated by the letter P in Fig. 1. We soon realised that such switches would have to withstand the peak voltages existing across the sections outside the points marked P. If the switches were opened, the 5R4GY cathode would assume chassis potential and these peak voltages would then appear at the switch contacts on alternate half-cycles. We couldn't, in any event, locate in our catalogues any panel-mounting toggle switches rated above 250 volts! So we decided that we would require two transformers, one having the combined h.t. secondary, and the other having the various heater windings. The transmitter h.t. switch would then break the primary supply to the h.t. transformer. Since the second transformer had only to provide heater voltages, it could be quite a small component.

### Low Voltage

Having gone so far, we next decided to concentrate on the low voltage rectifier. This had to give 350 volts at 120mA. A nice modest requirement, with which I am more familiar! Having discarded the silicon rectifier idea during our initial investigation, we plumped for the Mullard EZ81, which is quite a small valve on a B9A base. With a capacitor input of  $8\mu\text{F}$ , this valve requires 340-0-340 volts to give 350 volts at 120mA on the cathode. We decided to make the input voltage 365-0-365, thereby allowing 25 volts drop in the smoothing choke. At 120mA, this voltage is dropped by 200 $\Omega$ . Our voltage figures assumed limiting resistors around 240 $\Omega$  in each anode circuit (Mullard specify 230 $\Omega$  for 350-0-350 volt input), and so we kept our eye mainly on losses in the choke and less on losses in the mains transformer. When the transformer was wound, we intended to measure the

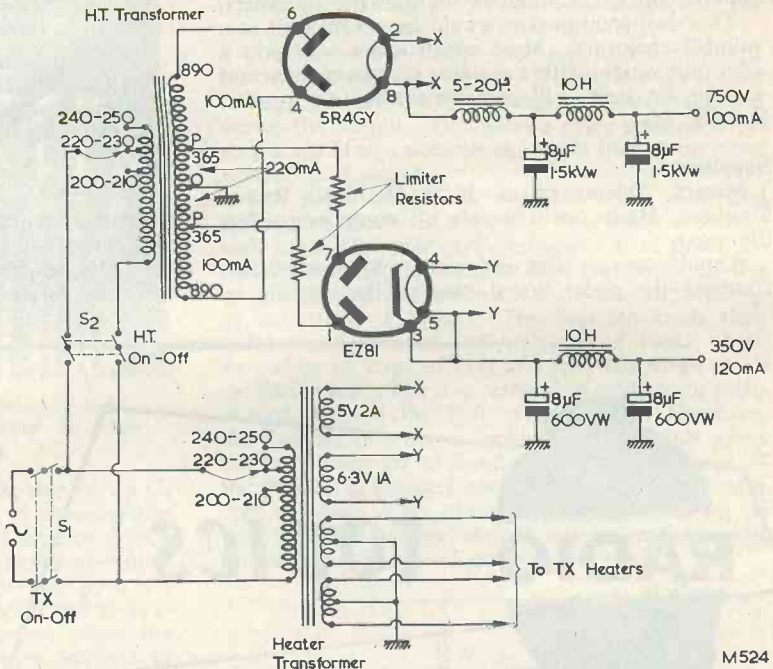

Fig. 1. The basic h.t. supply circuit described by Recorder. The diagram does not include bleeder resistors (to discharge the reservoir and smoothing capacitors when the h.t. switch is open) nor input fuses. Choke inductance figures are approximate. A swinging choke could follow the 5R4GY

resistance between the zero and 365 volt points on the secondary, and count this as part of the limiting resistance. We would then subtract this resistance from 240 $\Omega$ , and fit actual resistors equal to the difference to make the overall resistance equal to 240 $\Omega$ . This would not take into account primary resistance and transformer losses reflected into the secondary, and the total effective limiting resistance would be higher than that calculated. Nevertheless, we felt that we were on the safe side, especially as we were using a 365-0-365 volt secondary with its additional 25 volts per anode.

The working voltage of the smoothing capacitors in the high voltage circuit should have a value which is preferably at least the peak voltage of the applied a.c. With 890 volts, this is 1.26kV. Components having a working voltage of 1.5kV seem to be called for here. The reservoir and smoothing capacitors in the low voltage circuit require a similar rating, and 365 volts r.m.s. gives us a peak voltage of 516. A working voltage of 600 would be best here. It is possible, in many applications, to operate the EZ81

with its heater at chassis potential, but the limiting cathode-heater potential is 500 volts only. It would, therefore, be unwise to have the heater at chassis potential in the present instance, because of the peak voltage of 516. In consequence, the EZ81 would need to have a separate heater winding, its cathode and heater being strapped.

The final circuit we evolved is that shown in Fig. 1, and this takes up all the points discussed up to now. It should be noted that the h.t. secondary winding up to the 365 volt taps is rated at 220mA because it has to carry both h.t. currents. After these taps it is rated at the 100mA required for the 750 volt supply. The heater winding for the 5R4GY provides 5 volts at 2 amps, and should have insulation adequate for 1.5kV. The EZ81 heater winding gives 6.3 volts at 1 amp, and requires insulation adequate for 600 volts. The remaining two windings feed the heaters of valves in the transmitter circuit proper, and may be at chassis potential.

We haven't tried this circuit out in practice yet, but there seems to be no reason why it shouldn't function

satisfactorily. In use, it would be preferable, when switching on the transmitter from cold, to close  $S_1$  first and allow the transmitter heaters to warm up before closing  $S_2$  and applying h.t. This is merely a precautionary measure, and it ensures that the smoothing capacitors and h.t. decoupling capacitors in the transmitter circuits are not subjected to higher than normal voltages during warm-up. However, since there is no delay requirement with the 5R4GY when using choke input, and since the smoothing and reservoir capacitors are rated at peak voltage, no harm should result if both  $S_1$  and  $S_2$  are accidentally switched on together from cold.

### Silicon Rectifiers

Although we felt that the cost of silicon rectifiers precluded their use in the power supply circuit, we nevertheless looked into the question of using such components. The snag with silicon rectifiers is their relatively low peak inverse voltage ratings. If two silicon rectifiers were to replace the 5R4GY of Fig. 1, each would be subjected to a p.i.v. of 2,517 volts. Such a p.i.v. would necessitate the use of multiple diode rectifiers which would be expensive and, perhaps, somewhat bulky.

feeds the rectifier. This section, wound with heavier wire, could also form part of the 890-0-890 volt winding. The 200 volt tap offers a p.i.v. of 566 volts, which is comfortably inside the 800 volt rating for the BY100. Due to the inductive nature of the transformer there may, however, be some nasty switching surges every now and again, and it might be advisable to pop in a fuse between the rectifier and the reservoir capacitor in case the rectifier breaks

former winding) is required and the circuit should, theoretically, offer about 350 volts at 120mA. However, it is advisable to retain a tap at 170 volts or so, as shown, in case the 350 volt figure isn't realised in practice. If an output lower than 350 volts is given, then the input can be stepped up by using the 170 volt tap.

Both Figs. 2 and 3 have the advantage that the silicon rectifiers can be wired into circuit like resistors. They must, however, be mounted at a cool point in the chassis, the maximum ambient temperature rating being 70°C. A disadvantage is that they require larger electrolytic capacitors than the EZ81, because of their half-wave rectifying action. Also, they replace a valve which is readily available at low cost.

Another alternative scheme could employ four BY100's in a bridge circuit. This has the advantage of full-wave rectification, with low-value electrolytic capacitors. Also the p.i.v. on each rectifier is only 1.414 times the applied a.c. The snag is that four rectifiers are required to replace the single EZ81. Yet another scheme would consist of directly replacing the EZ81 with two silicon rectifiers capable of withstanding the p.i.v. of 1,032 which would result from this method of connection. Possible silicon rectifiers for this application are the Texas Instruments 1N1130, 1N1131, 1N2886 or 1N2887. All of these have peak inverse voltage ratings of 1,500.

The silicon diode circuits shown in Figs. 2 and 3 are suggestions only. They have not been tried out in practice, but they may offer food for thought to the ham who is keen on trying something new in his power supply.

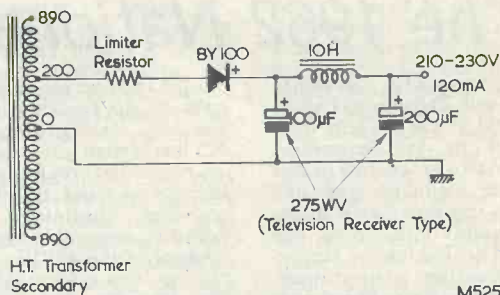

Fig. 2. A low voltage supply may be achieved as shown here. The smoothing and reservoir capacitors have a working voltage slightly lower than peak voltage, and should be of the type employed in television power supply circuits

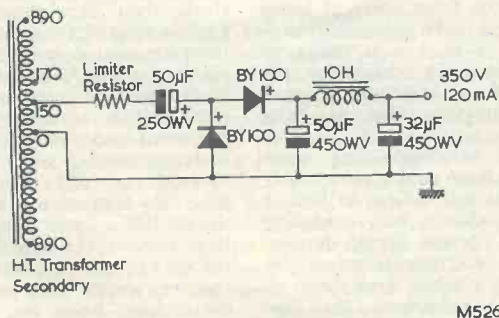

Fig. 3. An experimental voltage doubler supply

The 350 volt circuit looked more promising. If it had been permissible to use a lower h.t. voltage than 350, we could have employed a Mullard BY100 in the circuit shown in Fig. 2. This is similar to a television power supply circuit. The large reservoir capacitance and small forward resistance of the rectifier would result in an output, at 120mA, between some 200 and 220 volts d.c. A minimum limiting resistor value of 10Ω would seem safe, and this might be partly, or wholly, provided by the section of the secondary winding which

down. Television power supply practice is to connect a 1,000pF 300 a.c. working volt capacitor across the silicon rectifier to reduce transients, and this may prove helpful here also. Incidentally, the maximum transient peak rating for the BY100 is 1.25kV.

Fig. 3 shows a voltage doubler circuit employing two BY100's. If these are fed from the 150 volt secondary tap as shown, each suffers a p.i.v. of 424, which is well within limits. A limiting resistance of some 10Ω (which may be in the trans-

# The 1962 National Radio Show

THE TWENTY-NINTH NATIONAL Radio and Television Exhibition, held at Earls Court from 22nd August to 1st September, differed from last year's Show in that the television manufacturing and retail industry can now face a future free from doubts concerning line standards. The Pilkington Report and the subsequent Government White Paper have clearly shown that 625 line transmissions will eventually supersede our present 405 line standard, and manufacturers have been quick to develop, and get into production, receivers capable of resolving both 405 and 625 line signals.

## Television Receivers

Basically, there are two approaches to the 405/625 line problem. One consists of manufacturing receivers which are, in themselves, 405-v.h.f./625-u.h.f. and which contain all the circuitry needed to change from one standard to the other by means of a switch. However, such models may need the addition of a u.h.f. tuner at a later date. The second approach is provided by the convertible receiver which is at present 405-v.h.f. only, but which has space available for the addition of new 625 line circuitry and a u.h.f. tuner when the 625 line facility is required. In consequence, the choice is left to the customer, who can either buy a switchable receiver which (apart perhaps from the u.h.f. tuner) is already capable of receiving the new transmissions, or he can buy a convertible receiver at slightly lower cost and pay for the additional 625 line components when they are needed.

In general, the additional circuitry needed by convertible receivers will consist of vision and sound i.f. strips (the latter being probably intercarrier) together with the reversed video diode for negative modulation vision signals and the demodulator needed for f.m. sound signals. Many convertible sets have line timebase circuits which are already capable of running at either 405 or 625 lines and it would appear that a common sync separator can handle both signals. At least one add-on 625 line unit, however, incorporates a flywheel sync circuit.

A number of stands showed 405 and 625 line pictures side by side in order to give some idea of the increased resolution given by the new standard. It was difficult to compare the two systems because each carried a different programme,

but the increase in vertical resolution given by the greater number of lines was very obviously apparent. The 625 line system gives a small increase in horizontal resolution and this, bearing in mind the different programmes presented, was quite definitely noticeable also. That old bugbear of the 405 line system—line pairing—was evident with a few 405 line receivers, but seemed to be completely absent in the 625 line pictures.

The development of 625 line receivers may well have been the major preoccupation of manufacturers' research teams over the preceding twelve months as there were few other design changes from last year's models. Many receivers, including those manufactured by Ekco, Ferranti, Ferguson, K.B. and Philco, now employ tubes which have the protective window bonded to the face of the tube. These have the advantage of obviating a dust trap, and they reduce internal reflections and simplify tube mounting problems. Remote control by light beam or supersonic signals using devices similar to those employed in last year's models were exhibited, as were automatic contrast/brilliance controls operating from ambient room lighting level. An unusual introduction by K.B. was a range of television receivers which, by the addition of a microphone and adaptors, function also as baby alarms.

Television warm-up time when switching on from cold is notoriously lengthy, most sets taking, at best, a minute to achieve full operating temperature. A new circuit, demonstrated to set manufacturers by Mullard, can cut this time down to less than 15 seconds. The new circuit requires no extra components in the receiver, but merely needs an on-off switch with three positions instead of two. The extra position—Standby—causes the high voltages in the set to be switched off and the heaters to run at half-power. The receiver is initially switched on at the beginning of a day's viewing, after which it may be set to Standby at intervals as required, it being completely switched off at the end of the day. If used fully, the use of the Standby condition would add about a penny a day to the viewer's electricity bill!

A new portable transistorised receiver was introduced by Perdio and has the extremely light weight of 20 lb. This set, the "Portorama",

has dimensions of  $13\frac{1}{2} \times 10\frac{1}{2} \times 10\frac{1}{2}$  in, and employs a  $8\frac{1}{2}$  in 90° Mullard tube. Sensitivity on Band I is  $10\mu\text{V}$ , and on Band III is  $20\mu\text{V}$ . The receiver may operate either from 200–250 a.c. mains or from its own internal Venner silver cadmium batteries. Space is available for two batteries, these giving more than 8 hours viewing on one charge. Alternatively, a single battery giving 4 hours viewing can be used. The batteries may be re-charged by plugging the receiver into the mains, the process of re-charging taking approximately  $1\frac{1}{2}$  times longer than the previous discharge time. An interesting sidelight on the battery situation is that whilst each battery (guaranteed for a year but liable to last considerably longer) costs  $9\frac{1}{2}$  guineas new, Messrs. Venner give a trade-in allowance of £2 on an old battery, this representing the reclaim value of the silver it contains. The "Portorama" may also be run from a 12 volt car battery. The receiver is 405 lines, convertible to 625 lines.

## Television Avenue

Television Avenue was re-introduced at the Show in order to allow leading manufacturers to demonstrate their capabilities in colour. Considering that colour television receivers are in everyday domestic use in the U.S.A. and Japan it was, to the writer's mind, rather a pity that British versions had to be presented under artificial conditions of exaggerated gloom. The receivers operated on 625 lines from programmes transmitted by line from the B.B.C. Lime Grove studios, these employing a modified N.T.S.C. colour system. Obviously, the receivers shown were not for sale to the public, since the final colour system to be employed in the U.K. has not yet been decided. However, they did illustrate the fact that acceptable colour television could commence as soon as 625 line transmissions became available. All receivers shown had good registration with hardly any detectable fringing but there were, in some cases, noticeable differences in hue presentation when one receiver was compared with a neighbour manufactured by a rival firm. At the time of the writer's visit the test programme consisted of a film showing the building of Coventry Cathedral, and it was impossible to assess the truthfulness of the colours shown when the picture was composed mainly of stained glass designs. The



writer judged presentation by checking flesh colour when individual people appeared on the screen.

#### Audio Products

A mains operated transistor table radio was introduced by Pye, this operating on v.h.f., s.w., m.w. and l.w. Output is 3 watts to an 8 x 5in speaker, and the set can run for three months on a pennyworth of mains current.

Fidelity presented the "Duet" record player, which has an additional microphone connection and amplifier, thereby allowing audio from an external source to be mixed with the gram signal. In addition to microphone, the external inputs may consist of electric guitar, tape recorder, or radio, etc. Separate volume controls for gram and the additional channel are provided.

The "3102-Tune-Time" transistor receiver was exhibited by Ferguson. This incorporates a jewelled watch movement which can switch on the receiver at a pre-selected time. The watch switching facility is given by

setting the receiver to Alarm. If, with this setting, the receiver is switched off, an a.f. tone is generated when the watch contacts close, the tone being provided by coupling the secondary of the output transformer back to the base of the driver transistor.

Roberts Radio have, in past exhibitions, shown portable receivers in jewel-studded and solid gold cabinets. At the present exhibition, this company contented themselves with including a receiver in their range which was covered with swansdown. And very cuddly it looked, too.

Introduced by Daystrom at the Exhibition was the Heathkit Telephone Amplifier type TTA1. This comprises a specially shaped case designed to accommodate a telephone handset removed from its rest, and which contains a three-stage transistor amplifier. An inductive pick-up positioned close to the earphone connects to the input of the amplifier, thereby allowing the received telephone conversation to

be reproduced at loudspeaker level. The handset microphone nests into a depression in the case, resulting in a measure of concentration of the sound waves passed to the instrument. With the aid of this amplifier unit, a telephone may be operated without the necessity of holding the handset to the ear.

At the start of the Radio Show, the B.B.C. announced that a series of experimental stereophonic test transmissions would commence on 28th August from Wrotham on 91.3 Mc/s. Projected times of transmission are: midnight Tuesday-00.25 Wednesday; 10.50-11.10 Wednesday morning; midnight Wednesday-00.25 Thursday; and 10.50 to 11.10 Saturday morning. The Zenith-GE system developed in the U.S.A. will be used, employing a 38 kc/s sub-carrier for the A-B signal and a 19 kc/s pilot signal. The main carrier will be modulated by the A+B signal. The Zenith-GE system was described in "Radio Topics" in *The Radio Constructor* for October 1961.

## Trade Review . . .

### "Adamin" Model C15L Precision Micro Soldering Instrument

These superb instruments have been specifically developed to speed the production of miniature electronic circuits, to facilitate fine instrument assembly and for numerous other fine soldering operations.

The construction of most other types of soldering instruments, with the element and its casing behind and outside the bit, has certain advantages in respect of temperature regulation and heat capacity, but has the disadvantages of greater bulk and heat radiation from the element which can cause damage to adjacent wiring and components in confined spaces. It also necessitates a greater power input for a given bit temperature.

The Adamin overcomes these difficulties by having its element inside the actual bit. Heat loss from the shaft is negligible and the distance of the bit from the handle is reduced.

The Adamin range is extremely comprehensive, the models being divided into three groups according to their element construction. Group A (letter A prefixes list number) elements for 6V operation only; Group B (letter B prefixes list number) supplied for voltages of 6, 12, 20 and 24 volts, fixed or replaceable bits, fully insulated elements, and Group C (letter C prefixes list number) in which range are the recently introduced Adamin models suitable for 50V working and above, these including the new mains voltage instruments, which represent a major step forward in design, and bring the advantages of this range within the reach of those who prefer to operate them directly from the a.c. mains supply.

The C15L 15 watt instrument may be obtained for operation at the following voltages: 50, 110, 200, 230 or 240. A maximum temperature of some 375° Centigrade is obtainable in under four minutes, the bit having a working face of  $\frac{3}{16}$  in diameter.

The overall length of the instrument is 7in and it is fitted with a fully insulated element. The model tested by us attained the melting point of 60/40 solder (180°C.) in exactly one minute.

The element is securely mounted inside the stainless steel shaft of the instrument, this minimising the risk of damage or displacement due to mechanical shock. The bit occupies a position directly over the element, making the most effective use of the heat produced, and allowing higher than normal bit temperatures to be used without over-running the element, which considerably extends its life. Element units are easily removable from the handle if replacement becomes necessary.

The C15L is fitted with a special replaceable alloy copper bit having the highest possible thermal capacity, conductivity and efficiency, together with improved resistance to corrosion, scaling and erosion. These bits are heavily nickel plated for longer life.

The Adamin handle is made from an extremely tough and durable plastic material and will not fracture if dropped. The handle will not roll if laid on a flat surface. A nylon cord-grip screw is provided and a spring-steel clip makes the instrument easy to park.

Full details of the Adamin range of precision micro soldering instruments may be obtained from Light Soldering Developments Ltd., 28 Sydenham Road, Croydon, Surrey.

# LASKY'S RADIO

**LONDON'S LARGEST STOCKS OF  
EQUIPMENT AND COMPONENTS**  
SPEEDY MAIL ORDER SERVICE

Lasky's for All Types of Pocket and Personal Transistor Radios

## BUILD IT YOURSELF . . . REALISTIC SEVEN

The finest receiver at present available for home construction. Fully tunable long and medium wavebands. Uses 7 Mullard Transistors: OC44, 2 OC45s, OC71, OC81D and 2 OC81s, plus Crystal Diode OA70.



### STAR FEATURES ★ ★ ★ ★ ★

★ 7 Transistor Superhet. ★ 350 milliwatt output into 4" high flux speaker. ★ All components mounted on a single printed circuit board, size 5½" x 5½", in one complete assembly. ★ Plastic cabinet with carrying handle, size 7" x 10" x 3½", in choice of colours: red/grey, blue/grey, all grey. ★ Easy to read dial. ★ External socket for car aerial. ★ IF frequency 470 kc/s. ★ Ferrite Rod internal aerial ★ Operates from PP9 or similar battery. ★ Full comprehensive data supplied with each Receiver. ★ All coils and IFs, etc., fully wound ready for immediate assembly.

An Outstanding Receiver. Lasky's price for the complete parcel including Transistors, Cabinet, Speaker, etc., and Full Construction Data. All components available separately. Battery 3/9 (included free with complete parcel). Data and instructions separately, 2/6, refunded if you purchase the parcel.

Postage and Packing 4/6.

# £6.19.6

### THE NEW "ALBERTA 5" Mark II

Now using printed circuit and supplied with miniature earphone for personal listening at no extra cost. Push-pull 200 milliwatts output, 5 transistors and one diode, 2½" moving coil speaker, ferrite rod aerial. Med. and long wave. Smart plastic case, 5¾" x

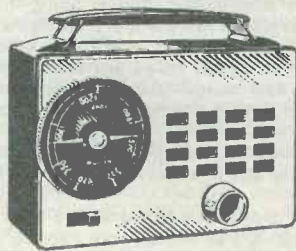

3½" x 1½" overall. **CAN BE BUILT FOR 59/6.** Post 3/6. Circuit diagram and data 1/6 (free with parcel).

### THE BETA TWO

A 2-transistor plus 2 diode personal receiver for home construction. Uses printed circuit and ferrite rod aerial. Personal earphone gives clear reception for private listening. Tunes over full medium waveband. Uses same cabinet as our Alberta 5 receiver. Illustrated on left, size 5¾" x 3½" x 1½" overall. All components available separately. **CAN BE BUILT FOR 21/-.** Postage 2/6 extra. Including personal earphone, cabinet, etc. Circuit diagram and step-by-step instructions 1/6. (Free with parcel.)

**33 TOTTENHAM COURT ROAD W1**

2 mins. Oxford Street. Nearest Station Gooch Street. MUSEum 2605

**207 EDGWARE ROAD W2**

Few yards from Praed Street

PADDington 3271/2

Both addresses open all day Saturday. Close 1 p.m. Thursday

PLEASE ADDRESS ALL MAIL ORDERS TO DEPT. W AT ABOVE EDGWARE ROAD ADDRESS



# MINISSETS LTD Hatherley Mews London E17

## THE IMPERIA

An easy-to-build 6-Transistor Portable Superhet which can be built by the constructor. Pre-assembled circuit board for easy construction. All components are new. 5" speaker giving good tone and output. Attractive case of exclusive design 8½" x 5½" x 2½" with gold-plated grille. Specially designed matching coil for use in car. Only first grade fully guaranteed matched transistors and diodes are used. Anyone can build this set for **£7.17.0**

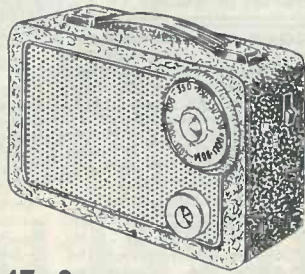

Everything supplied except soldering iron. P. & P. 3/- Full instructions 1/6 (free with order).

## 6-Stage Transistor Pocket Portable

Can be built for **£4.19.6** P.P. 2/6  
 ★ Completely self contained, no aerial or earth required.  
 ★ Push-pull output, 250 milliwatts.  
 ★ 3" high flux speaker  
 ★ Pre-assembled circuit board with simple instructions ensuring easy construction  
 ★ High Q Ferrite Rod Aerial  
 ★ After-sales service  
 ★ Can be supplied with long-wave 6/- extra

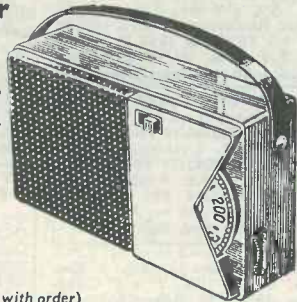

Full instructions, price list 1/6 (Free with order)

## 3-Transistor Radio (plus 2 diodes)

Total building **70/-** P.P. 2/6

- ★ Pre-assembled circuit board, ensuring easy construction
- ★ Full medium-wave coverage
- ★ Attractive case 5½" x 3" x 1½"
- ★ All components including transistors are brand new and direct from manufacturers
- ★ Ferrite Rod aerial coil, no external aerial or earth required
- ★ 2½" high flux speaker direct from manufacturer
- ★ After-sales service

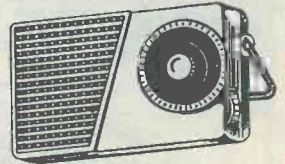

Send 1/6 for instructions, circuit and price list

## THE RIETI

6-Stage super sensitive Transistor Portable. Easy to build. All components first grade. A real portable transistor radio, covering Medium wave reception. 5" speaker, high Q ferrite aerial especially designed. Pre-assembled circuit board enables the complete set to be assembled and tested before placing in case. Attractive case 8½" x 5½" x 2½" with gold-plated grille. Total build costs **£5.2.6** P. & P. 3/-

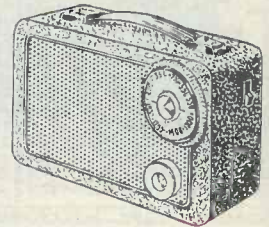

Medium and Long wave 8/- extra. Full instructions 1/6 (free with order).

# Premier RADIO

23 Tottenham Court Road London W1 Telephone MUSEUM 3451/2 and 309 Edgware Road London W2 Telephone PADDDINGTON 6963

## 6-TRANSISTOR POCKET SUPERHET



MAY BE BUILT FOR **£7.19.6**

plus 3/6 P. & P.  
 PP4 Battery 2/6 extra

Star Features: ★ 6 first grade transistors and one diode. ★ Simple to follow printed circuit. ★ Internal Ferrite rod aerial. ★ Provision for car radio aerial. ★ Full medium & long waveband coverage. ★ Attractive rexine covered cabinet size 7" x 4½" x 2½". ★ Simple point to point instr. supplied.

## The "Petite" PORTABLE



MAY BE BUILT FOR **£7.0.0** plus 5/- P. & P.

Batteries extra  
 HT 10/- (Type B126) or equiv.  
 LT 1/6 (Type AD35) or equiv.

- ★ Size only 8" x 8" x 4½"
- ★ Instruction book 1/6

Battery Eliminator, available in component form price 37/6 plus 2/- P. & P.

## WE HAVE BEEN APPOINTED STOCKISTS FOR FULL RANGE OF STERN'S RADIO (Fleet Street)

Famous Mullard Designs such as Type 'C' Tape Pre-amplifier and Erase Unit, including separate Power Supply. Complete Kit of Parts ..... £14. 0. 0 or Completely assembled and tested ..... £17. 0. 0 Also available Less Power Supply at £11.15.0 and £14.10.0 respectively. Stern's Model HF/TR3 Mk.2. Tape Amplifier Complete Kit of Parts ..... £13.14. 0 or Completely assembled and tested ..... £17. 0. 0 Complete Mullard 5-10 Amplifier with Pre-amplifier on same Chassis Complete Kit with Parmeko O/P and Mains Transformers ..... £11.10. 0 Completely assembled and tested ..... £13.10. 0 Complete Mullard 3-3 Amplifier Kit ..... £7.10. 0 Completely assembled and tested ..... £8.19. 6 P. & P. 6/6

Mullard 10-10 Stereo Power Amplifier based on the famous Mullard 5-10 Complete Kit of Parts ..... £18.10. 0 Completely assembled and tested ..... £21. 0. 0

(Control Unit on Main Chassis) Also available with separate dual-channel Pre-amp. Complete Kit for Power Amp. & Pre-amp ..... £26. 0. 0

Complete assembled and tested ..... £30. 0. 0 All components used in these kits are of the highest possible standard and strictly to circuit specifications.

Full descriptive literature available on these products and Circuit Diagrams may be purchased separately.

## TRANSISTOR SUPERHET RADIO

May be built for

**£8.19.6**

Plus 2/6 P. & P.

PP11 Battery extra at 5/6

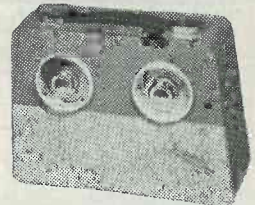

Using 6 Transistors and one Diode and internal Ferrite Rod Aerial, with provision for Car Radio Aerial. Full medium and long waveband coverage and 6 x 4 High Flux Speaker. When constructed the Receiver is housed in an attractive two tone case, size 10½" x 7½" x 3½".



## THE "MID-FI" A NEW DESIGN 4½W AMPLIFIER KIT

MAY BE BUILT FOR **95/-** plus 3/- P. & P.

A new circuit for the home constructor requiring a good quality med. powered amplifier for reproduction of records or f.m. broadcasts. Technical spec.: sep. bass and treble controls. Valves: EF86, EL84, EZ80. Voltage adjustment for a.c. mains from 200/250V, 3 or 15/2 imp. Neg. feedback. Size 7" x 5" x 2", overall ht. 5". Silver hammered finished chassis.



# FREE TO AMBITIOUS ENGINEERS

— THE LATEST EDITION OF ENGINEERING OPPORTUNITIES

## Have you sent for your copy?

**ENGINEERING OPPORTUNITIES** is a highly informative 156-page guide to the best paid engineering posts. It tells you how you can quickly prepare at home for a recognised engineering qualification and outlines a wonderful range of modern Home Study Courses in all branches of Engineering. This unique book also gives full details of the Practical Radio & Electronics Courses, administered by our Specialist Electronics Training Division—the *B.I.E.T. School of Electronics*, explains the benefits of our Employment Dept. and shows you how to qualify for five years promotion in one year.

We definitely Guarantee

**"NO PASS — NO FEE"**

Whatever your age and experience you cannot afford to miss reading this famous book. If you are earning less than £25 a week send for your copy of "ENGINEERING OPPORTUNITIES" today—FREE.

**BRITISH INSTITUTE OF ENGINEERING TECHNOLOGY** (Incorporating *E.M.I. Institutes*)  
(Dept. SE/23), 29 Wright's Lane, London, W.8

**THE B.I.E.T. IS THE LEADING ORGANISATION OF ITS KIND IN THE WORLD**

### WHICH IS YOUR PET SUBJECT?

Mechanical Eng.,  
Electrical Eng.,  
Civil Engineering,  
Radio Engineering,  
Automobile Eng.,  
Aeronautical Eng.,  
Production Eng.,  
Building, Plastics,  
Draughtsmanship,  
Television, etc.

### GET SOME LETTERS AFTER YOUR NAME!

A.M.I. Mech. E.  
A.M.I.C.E.  
A.M.I. Prod. E.  
A.M.I.M.I.  
L.I.O.B.  
A.F.R. Ae.S.  
B.Sc.  
A.M. Brit. I.R.E.  
City & Guilds  
Gen. Cert. of Education  
Etc., etc.

### PRACTICAL EQUIPMENT

Basic Practical and Theoretical Courses for beginners in Radio, T.V., Electronics, Etc., A.M. Brit. I.R.E. City & Guilds Radio Amateurs' Exam. R.T.E.B. Certificate P.M.G. Certificate Practical Radio Radio & Television Servicing Practical Electronics Electronics Engineering Automation

### INCLUDING TOOLS!

The specialist Electronics Division of *B.I.E.T. (Incorporating E.M.I. Institutes)* NOW offers you a real laboratory training at home with practical equipment. Ask for details.

### B.I.E.T. SCHOOL OF ELECTRONICS



### POST COUPON NOW!

Please send me your FREE 156-page "ENGINEERING OPPORTUNITIES"  
(Write if you prefer not to cut page)

NAME .....

ADDRESS .....

SUBJECT OR EXAM THAT INTERESTS ME .....

# PANDORA

THE NEW

TRANSISTOR 6

Designed By

Mel Electronic  
**ONLY £6.19.6.**

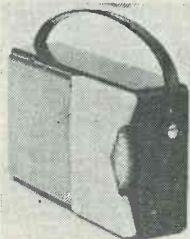

USING NEW HIGH GRADE PARTS

FULL AFTER SALES SERVICE

### MEDIUM WAVE, LONG WAVE/LIGHT PROGRAMME

Obtainable from your local stockist or in case of difficulty DIRECT FROM

- 6 TRANSISTORS + DIODE
- SUPERHET CIRCUIT
- AUTOMATIC WAVECHANGE
- 500mW PUSH PULL OUTPUT
- PRE-TINNED PRINTED BOARD
- EXCELLENT RESULTS

### TOTAL BUILDING COST

SEND S.A.E. ONLY FOR FREE DETAILS and Information on other Transistor designs

## 1/2 WATT 3-TRANSISTOR AMPLIFIER

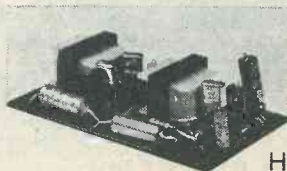

- 1/2 Watt Peak Output
- Output to 3Ω Speaker
- 9 Volts Operated
- Push-pull Output Stage

A PRINTED CIRCUIT HIGH GAIN AMPLIFIER

Size 3 1/2 x 2 x 3/4 in.

Price 45/- P. & P. 1/6

Using two Newmarket transistors (NKT251 and NKT252). Ideal for intercomm. or as record player amplifier.

## 2 WATT 4-TRANSISTOR AMPLIFIER

with Two Drivers and Push-Pull Stage

Size 4 x 2 3/4 x 3/4 in.

Ready Built 62/6 P. & P. 1/6

MEL ELECTRONIC CO. R/O 240 HIGH STREET BECKENHAM KENT

## SMALL ADVERTISEMENTS

continued from page 227

### TRADE

**PANL**, recognised for many years as the unique one-coat black crackle finish. Brush applied, no baking. Available by post in eighth-pint cans at 3s. 9d. from G. A. Miller, 255 Nether Street, London, N.3.

**THE INCORPORATED PRACTITIONERS IN RADIO AND ELECTRONICS (I.P.R.E.) LTD.** Membership conditions booklet 1s. Sample copy of I.P.R.E. Official Journal 2s. post free. —Secretary, 20 Fairfield Road, London, N.8.

**SERVICE SHEETS (1930-1962)** from 1s. Catalogue 6,000 models. 1s. 6d. S.A.E. enquiries.—Hamilton Radio, 13 Western Road, St. Leonards, Sussex.

**"MEDIUM WAVE NEWS."** Monthly during DX season.—Details from B. J. C. Brown, 196 Abbey Street, Derby.

**METALWORK.** All types cabinets, chassis, racks, etc., to your specifications.—Philpott's Metalworks Ltd., Chapman Street, Loughborough.

**RADIO AMATEUR COURSE.** A postal course for those wishing to take the Amateur Examination. A sound basic training in radio communication. Very reasonable terms. Send for brochure.—Premier School of Radio, BCM/Wireless, London, W.C.1.

**AMPLIFIERS AND FEEDERS.** Covers the construction of direct-coupled amplifiers and an assortment of radio feeders. Price 3s. 6d.—High Fidelity Co., 18 Melville Road, Birmingham 16.

**PRIVATE TUITION** given in G.C.E. ordinary level mathematics (London area). Terms reasonable.—Box No. F154.

**ELECTRONIC ORGAN.** A 6d. air-letter to us gets you full information about obtaining very detailed constructional data.—The Electronic Organ Company (Australia), 11 Cadow Street, Pymble, N.S.W., Australia. We will reply by air.

**FIND TV SET TROUBLES IN MINUTES** from that great book *The Principles of TV Receiver Servicing*, 10s. 6d., all book houses and radio wholesalers. If not in stock, from Secretary, I.P.R.E., 20 Fairfield Road, London, N.8.

**JOIN THE INTERNATIONAL S.W. LEAGUE.** Free Services to members including Q.S.L. Bureau, Amateur and Broadcast Translation, Technical and Identification Dept.—both Broadcast and Fixed Stations, DX Certificates, contests and activities for the SWL and transmitting members. Monthly magazine, "MONITOR", containing articles of general interest to Broadcast and Amateur SWLs, Transmitter Section and League affairs, etc. League supplies such as badges, headed notepaper and envelopes, QSL cards, etc., are available at reasonable cost. Send for League particulars. Membership including monthly magazine, etc., 21s. per annum.—Secretary ISWL, 12 Gladwell Road, London, N.8.

continued on page 231

## AMAZING RESULTS

### FROM THE "OLIVER" 5 STAGE TRANSISTOR RECEIVER

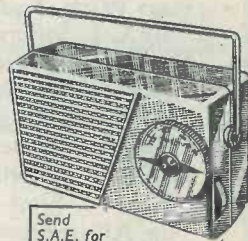

A highly sensitive receiver using top grade transistors and components. Fully tunable over medium and long waves.

- Can be built in 1 hour
- High flux moving coil speaker
- Built-in ferrite rod aerial
- Specially designed coils for maximum signal strength
- Volume on/off control
- Eyletted circuit board
- Easy to follow building plans

Send S.A.E. for **FREE** Layout plans and parts lists

Total Building Costs **ONLY**

**65/-** Plus P. & P. 2/6

### EXPLORE THE WORLD ON THIS 1-VALVE SHORT WAVE RADIO



Total Building Costs only

**35/-**

P. & P. 2/-

- ★ Receives speech and music from all over the world.
- ★ Construction price includes valve and one coil covering 40-100 metres.
- ★ Can be extended to cover 10-100 metres.
- ★ Can be converted to 2 or 3 valve.

Send 2/- for wiring diagram and components price list.

**R.C.S. PRODUCTS (Radio) LTD**  
11 Oliver Road • London • E17 (Mail Order Only)

## MINIATURE COILS & TRANSFORMERS FOR TRANSISTOR RADIOS



3 IFS & Osc. 22/- set  
Driver & Output 16/3 pair

ALL WINDINGS UNCONDITIONALLY  
GUARANTEED

WE ARE THE ACTUAL MANUFACTURERS  
**OSMOR LTD** 418 BRIGHTON ROAD  
S. CROYDON SURREY

## THE MODERN BOOK CO

**Fun With Radio-Controlled Models.**  
By E. L. Safford, Jr. 25s. Postage 1s.

**Newnes Radio Engineer's Pocket Book.** 10s. 6d. Postage 6d.

**Electronic Organ Handbook.** By H. Emerson Anderson. 40s. Postage 1s.

**Radio & Television Test Instruments.**  
By G. J. King. 25s. Postage 1s. 3d.

**The All-in-One Tape Recorder Book.**  
By J. M. Lloyd. 12s. 6d. Postage 6d.

**Tunnel Diode Manual.** By G.E.C. 8s. Postage 6d.

**Transistor Manual.** By G.E.C. New Ed. 16s. Postage 1s. 2d.

**Radio Valve Data.** 7th Ed. Compiled by "W.W." 6s. Postage 10d.

**Mullard Transistor Radios.** Circuitry and Servicing. 5s. Postage 6d.

**Basic Radio Course.** By J. T. Frye. 32s. Postage 1s.

**The Radio Amateur Operator's Handbook.** A Data Pub. 3s 6d. Postage 6d.

**Amateur Radio Call Book.** By R.S.G.B. 1962. 4s. 6d. Postage 6d.

**Radio Amateurs' Examination—Manual.** An R.S.G.B. Pub. 5s. Postage 6d.

**Cabinet Handbook.** By G. A. Briggs. 7s. 6d. Postage 9d.

**Elementary Telecommunications Examination Guide.** By W. T. Perkins. 17s. 6d. Postage 9d.

**Telecommunications.** Principles and Practice. By W. T. Perkins. 21s. Postage 9d.

We have the **Finest Selection of British and American Radio Books in the Country**  
Complete catalogue 1s.

**19-21 PRAED STREET (Dept RC) LONDON W2**

Telephone PADddington 4185

## FREE! EARN



There's plenty of room at the top for technically trained men—room for YOU if you want quick promotion or a better-paid, more interesting career. N.I.E. can quickly give you a guaranteed spare-time Postal Training, in the comfort of your own home, and open up a whole new world of opportunity for you.

## MORE

Find out, as thousands of others have done, how easy it is to learn at home with N.I.E. Send for *Success in Engineering*—120 pages of information—and details of pay-winning Courses in Radio/T.V., Electrical and other branches of engineering, building, etc. Get your copy today—FREE!

## SOON

Radio & Electronic Eng.	Grad. Brit. I.R.E.
Radio/TV Servicing	A.M.I. Mech. E.
R.T.E.B. Cert.	A.I.O.B.
Rad. Amateurs' Exam	A.R.I.C.S.
Telecomms. (C & G)	A.M.I.M.I.
	A.M.I. Struct. E.
	M.R.S.H.
	A.I.Q.S.

N.I.E. Guarantees—  
"Success—or no Fee"

### POST COUPON NOW!

■ Please send me a FREE copy of "Success in Engineering".

■ NAME .....

■ ADDRESS .....

■ Subject or exam of interest .....

■ **NATIONAL INSTITUTE OF ENGINEERING**  
■ (Dept. 445) 148-150 Holborn London EC1

**THE GATEWAY TO BETTER LIVING**

## The AMATEUR RADIO HANDBOOK

Third Edition

Contents include Fundamentals, Valves, Semiconductors, H.F. Receivers, V.H.F./U.H.F. Receivers, H.F. Transmitters, V.H.F./U.H.F. Transmitters, Keying and Break-in, Modulation, Single Sideband, Frequency Modulation, Propagation, H.F. Aerials, V.H.F. Aerials, Noise, Mobile Equipment, Power Supplies, Interference, Measurements, Operating Technique and Station Layout, the R.S.G.B. and General Data.

Bound in maroon linson buckram, 544 pages  
700 diagrams and 100 half-tones

PRICE 34/- (Postage and packing 2/6)  
(\$5.50 post paid U.S.A. and Canada)

Obtainable from leading booksellers or:  
(Dept. R.C.1.)

**RADIO SOCIETY OF GREAT BRITAIN**  
28 Little Russell Street London W.C.1



## SMALL ADVERTISEMENTS

continued from page 229

TRADE—continued

**BEST MAKES RECORDING TAPE.** Trade supplied. Special BULK discounts.—Kendall & Mousley Ltd., 18 Melville Road, Birmingham 16.

**THE INTERNATIONAL HAM HOP CLUB** is a non-profit making organisation open to RADIO AMATEURS AND SHORT WAVE LISTENERS. OBJECT: To improve international relationships through an organised system of hospitality. MEMBERS offer overnight hospitality to visiting members, subscription 10s. per annum. ASSOCIATE MEMBERS invite radio amateurs to visit their stations. Associate membership 5s. per annum. FAMILY EXCHANGE holidays arranged, also FRIENDSHIP LINKS between radio clubs. The Club's official journal is free to both Full and Associate members.—Hon. Gen. Secretary: G. A. Partridge, G3CED, 17 Ethel Road, Broadstairs, Kent.

**WANTED.** Instruction Book for oscilloscope type 13a Serial No. HF. 4229 No. 10s/831. Manufactured by Hartley Electromotives Ltd., Shrewsbury.—Messrs. Durrant, 320 Cauldwell Hall Road, Ipswich.

**COMPONENT BARGAINS.** New useful constructor's parcels. Containing: 6 droppers, 6 rectifiers, 6 coils, 12 trimmers, 12 knobs, 24 tagstrips, 6 valveholders, 2 switches, 4 pots, 2 Sw 2 amp sockets, 6 yds. sleeving, 250 sleeves and grommets, 48 springs, 2 socket panels, 24 resistors, 24 condensers, 48 rubber and felt washers, 24 condenser clips, etc. 4 handles, 2 diodes, 2 pointers, 8 anti-vib. mounts, 12 top caps, 24 self-tap screws, 24 ft. Prestic, 6 ft. felt, 2 coil formers, 2 Paxolin strips, 2 printed circuits. (600 parts,—Value exceeds £12). Only 37s. 6d. plus 3s. 9d. p. & p. Or Half quantity for only 19s. 6d. plus 2s. 9d. p. & p. 3 parcels sent post free. Similar parcels but used and soiled components for half price plus p. & p. Catalogue sent with goods.—Albatross Engineering Company, High Street, Gosberton, Spalding, Lincs.

**TRANSISTORS.** Marked and tested packets of 10. Unmarked but tested packets of 16. Unmarked and untested packets of 40. Duds suitable as diodes—packets of 80. All packets £1 each. Any 2 packets, 37s. 6d. C.W.O.—K. R. Whiston, Dept. TRC, New Mills, Stockport.

### SPECIAL OFFER

**MINIATURE 6-TRANSISTOR SUPERHET** Chassis 3½" x 2½" x 1". All components mounted on printed-circuit board. Long and medium waves: 200 mW. Push-pull output: 2" moving-coil speaker. Earpiece socket fitted. Each set complete with battery and guaranteed working perfectly. Supplied without case: £5.12.6 P. & P. 3/- extra.

**SAVOY ELECTRONICS (Sales) LTD**  
15 Maiden Lane, WC2 Temple Bar 5484

### G2ACC offers you . . .

- A 56 page illustrated catalogue No. 12
- Your buying guide for short wave, broadcast and transmitting components. 9d. post free (refundable on first order). U.K. and H.M. Forces anywhere.

**SOUTHERN RADIO AND ELECTRICAL SUPPLIES**  
SORAD WORKS REDLYNCH SALISBURY WILTS Telephone Downton 207

## R. COOPER G8BX RADIO OF CROYDON

32 South End Croydon Surrey CRO 9186

### ★ VALVES New Tested and Guaranteed

1R5	6/6	6K8GT	8/6	DAF96	8/-	ECC85	8/6	PL82	10/6
1S5	6/6	6Q7G	7/6	DCC90	11/6	ECC82	7/6	PY81	8/-
1T4	4/6	6SL7GT	8/6	DF91	4/6	ECH81	10/6	PY82	7/-
354	6/9	6V6G	7/6	DF96	8/-	ECH42	8/6	PCC84	9/6
3V4	7/6	6X4	7/6	DH76	8/6	ECL80	9/6	PCF80	9/-
5U4G	6/-	12A7	6/-	DH77	7/6	EF41	8/6	PCF82	11/-
5Y3GT	7/6	12AU7	6/-	DK91	6/6	EF80	8/-	PCL82	7/6
5Z4G	9/-	12AX7	7/6	DK92	7/6	EF86	9/6	PCL83	12/6
6AK6	6/6	12BH7	10/6	DK96	8/-	EF91	4/-	PCL84	8/6
6AL5	4/6	12K7GT	8/6	DL92	6/9	EL41	9/-	U76	8/6
6AM6	4/-	12K8GT	13/6	DL94	7/6	EL84	8/-	UBC41	10/-
6AT6	7/6	12Q7GT	6/6	DL96	8/-	EY51	7/6	UCH42	10/6
6BA6	8/6	25A6G	10/6	EB91	4/6	EZ40	6/6	UF41	10/-
6BE6	7/6	25L6GT	9/-	EBC41	9/6	EZ80	6/6	UL41	8/-
6BR7	10/6	35Z4GT	8/6	ECC81	6/6	EZ81	7/-	UY41	8/-
6BW6	8/6	35L6GT	9/6	ECC82	6/-	GZ32	10/6	W76	8/6
6J7GT	8/6	5763	10/6	ECC83	7/6	KT66	15/-		
6K7G	7/6	DAF91	6/6	ECC84	7/6	PL81	12/6		

**MATCHED PAIRS.** EL84, 17/-; EL85, 25/-; 6V6G, 17/-; 6BW6, 18/-; KT33C, 19/6; 807, 14/6 pair; KT66, 32/6.

#### SETS OF VALVES

DK96, DF96, DAF96, DL96	" REGENT "	29/6	per set
DK91, DF91, DAF91, DL92, or DL94		21/-	per set
1R5, 1T4, 1S5, 354, or 3V4		21/-	per set
6K8, 6K7, 6Q7, 6V6, 5Z4, " G " Types		27/6	per set
12K8, 12K7, 12Q7, 35L6, 35Z4, " GT " Types		35/-	per set
ECH42, EF41, EB41, EL41, EZ40		37/6	per set
UCH42, UF41, UBC41, UL41, UY41		35/-	per set

**Rotary Switches.** 1P, 3W, 1P, 4W, 1P, 8W, 2P, 2W, 2P, 3W, 2P, 4W, 3P, 2W, 3P, 3W, 4P, 2W, 4P, 3W, 3/-, 2P, 5W, 2 Bank, 2P, 6W, 2 Bank 5/6.

**Instrument Switches Push to Test:** 3/6. Toggle Switches, S.P.S.T. 2/-; S.P.D.T., 2/6; D.P.S.T., 3/6; D.P.D.T., 4/-.

**Volume Controls.** Midget Long Spindle 1/-, 5K to 2M, Non-Switch 3/-; D.P. Switch 4/6; Min. Edge Type 3/6; D.P.S. 5/6.

**Pre-Set Controls.** 3W w.w. to 30K 4W Carbon 50K to 2M 3/-; Wire Wound Long Spindle 1/2 4W, 50Ω to 100K 6/-.

**Block Capacitors.** .004 2kV 2/9; .05 4kV 2/6; .5 2.5 kV Nitrogol 4/3; 1 MFD 350V, T.C.C. 1/6; 2 MFD. 350V, Nitrogol 3/-; 4 MFD. 350V, Nitrogol 4/3; 4 MFD. 1,000V, T.C.C. 4/6; 4 MFD. 100V, T.C.C. 2/-; 4 MFD. 500V, Dubilier 4/9; 4 MFD. 600V, Nitrogol 5/6; 4 MFD. 750V, Nitrogol 6/6; 8 M.F.D. 600V. Dubilier 6/-.

S.A.E. FOR ALL ENQUIRIES.

## SMITH'S of Edgware Road BLANK CHASSIS

Precision made in our own works from commercial quality half-hard Aluminium. Two, three or four sided.

### SAME DAY SERVICE

of over 20 different forms made up to YOUR SIZE. Order EXACT size you require to nearest 1/16" (maximum length 35", depth 4").

SPECIALS DEALT WITH PROMPTLY

### SEND FOR ILLUSTRATED LEAFLET

Or order straight away, working out total area of material required and referring to table below, which is for four-sided chassis in 18 s.w.g. (for 16 s.w.g. add 3/4 ch)

48 sq. in.	4/-	176 sq. in.	8/-	304 sq. in.	12/-
80 sq. in.	5/-	208 sq. in.	9/-	336 sq. in.	13/-
112 sq. in.	6/-	240 sq. in.	10/-	368 sq. in.	14/-
144 sq. in.	7/-	272 sq. in.	11/-	and pro rata	
	P. & P. 2/6		P. & P. 2/9		P. & P. 3/-

Discount for quantities. Trade enquiries invited. Spray finish arranged for quantities of 25 or over.

**FLANGES** (1/4", 3/8" or 1/2") 6d. per bend.

**STRENGTHENED CORNERS,** 1/- each corner. **PANELS.** The same material can be supplied for panels, screens, etc. Any size up to 3ft (18 s.w.g.) at 4/6 sq. ft. (16 s.w.g. 5/3). P. & P., up to 72 sq. in. 1/3, 108 sq. in. 2/-, 144 sq. in. 2/6, 432 sq. in. 2/9, 576 sq. in. 3/3.

## H. L. SMITH & CO. LTD

287/289 EDGWARE ROAD LONDON W2  
Telephone PAD 5891/7595

The thrills of VHF can now be yours for only 39/6d, complete kit! Tunable 150-100 Mc/s, simplified construction, write today for leaflet. Also, if a newcomer to Amateur Radio, ask for free copy of the world famous "Globe-King" kits and receivers, stamp please to cover postage:

Johnsons (Radio) St. Martin's Gate Worcester

**H.A.C. THE ORIGINAL SUPPLIERS OF SHORT-WAVE KITS**

One valve Super Sensitive All-dry Short-wave Receiver, Model "K". Complete kit including valve and chassis, 77/-. (Other S.W. kits from 25/-) Before ordering call and inspect a demonstration receiver, or send stamped envelope for full specification, catalogue and order form.

H.A.C. SHORT-WAVE PRODUCTS (DEPT. R)  
44 OLD BOND STREET LONDON W1

What about that 12 w.p.m.

**Morse Code Test?**

You can only reach the goal by keen listening and constant practice with a Morse Key. The amount of "hard labour" involved depends on the method of training.

**The CANDLER System**

will help you as it has helped thousands of others over many years, and give you a sound basis. It turns a difficult task into a pleasurable pursuit.

Send 3d. stamp for details of our Special Course for Amateur Transmitting Licence

**The CANDLER System Co.**

Dept. RC, 52b ABINGDON ROAD, LONDON, W8

Candler System Co., Denver, Colorado, U.S.A.

**SURPLUS RADIO SUPPLIES**

2 LAING'S CORNER MITCHAM SURREY

SEND 2/6 FOR OUR CATALOGUE OF 400 BARGAINS

(2/- REFUNDED ON FIRST ORDER OVER 10/-)

**New Boxed Meters by Sangamo Weston**

50 microamps full scale deflection. Limited quantity

19/6. P. & P. 2/6

RADIO SOCIETY OF GREAT BRITAIN

**INTERNATIONAL RADIO COMMUNICATIONS EXHIBITION**

Wednesday-Saturday - 31st October-3rd November  
10 am to 9 pm ADMISSION 3/-

AT

SEYMOUR HALL SEYMOUR PLACE  
MARBLE ARCH LONDON W1

**BRASS · COPPER · DURAL · ALUMINIUM · BRONZE**  
ROD, BAR, SHEET, TUBE, STRIP, WIRE.  
3,000 STANDARD STOCK SIZES.

No Quantity too small

List on application

**H. ROLLET & CO LTD**

6 CHESHAM PLACE SW1

BELgravia 4300

Also at Liverpool, Birmingham, Manchester, Leeds

**Quality Components FOR CONSTRUCTORS**

capacitors, resistors, coils, valves, transistors, controls, chassis, transformers, speakers, pick-ups, cartridges, stylis, and all types of components in stock.

PRICE LISTS AVAILABLE ON REQUEST

**J. T. FILMER**

82 DARTFORD ROAD  
DARTFORD KENT  
Telephone Dartford 24057

**PORTABLE TRANSISTOR KIT £5.17.6 (post. 3/6).**

Medium and Long Waves, no aerial required, no difficult aligning, simple to follow instructions.

If you have been disappointed with other Kits, try ours. We were amongst the first to advertise Transistor circuits and we can recommend this set with confidence.

**POCKET KIT** with personal earphone 65/- (post 2/-)

Red Spot Transistors 2/3, White Spots 2/3, Yell./Gr. 3/-, Mullard OC71 6/-; OC72, 7/6; OC44, 7/6; OC45, 7/6; Sets of 6 for superhets Mullard 40/-; our selection 30/-, Newmarket V15/10P, 15/-, Silicon Rectifiers 70 p.v. 1/2 amp. 3/3; 400 p.v. 1/2 amp. 3/9. Sub-min. Electrolytics 2, 4, 8, 10, 16, 32, 50µf 2/-; 100µf, 2/9; 250, 500, 1,000µf, 3/3. Transistor Holders 1/-; Super Coax. 75 ohms 6d. yd. Tannoy Mike 3/6 (post 2/-); Crystal Inserts new 7/6. Gorer Units—the amazing 1 watt amplifier 92/6; I.F.A. Amplifier (460 Kc/s pre-aligned), 92/6; 3 waveband converter 90/3; Manual No. 167 describing and circuits, 2/9 post free.

Terms: C.W.O. Post extra, excess refunded. Send 10d. stamps for Transistor Notes.

**MOORE'S EXPERIMENTAL SUPPLIES Dept. C**  
8 & 10 GRANVILLE STREET SHEFFIELD 2 Telephone 27461

**"LITON" Photoelectric Construction Manual**

2nd edition coming out shortly

10 interesting PHOTOELECTRIC PROJECTS fully described with building plans and circuit diagrams which can be easily made by amateurs from standard components. Hints on the use of photocells and phototransistors. A mine of practical information for the experimenter. All units available built and tested, or in kit form.

1. Battery burglar alarm kit, 65/-
2. Mains burglar alarm
3. Light saver
4. Customer announcer
5. Simple garage door opener
6. Photoelectric counter. Price (2 to 6) Kit £4.12.6. Built £5.10.0.
7. Long range infra-red mains alarm
8. "MIRA" miniature infra-red battery alarm. Total consumption 0.2 watt.
9. Motorised garage door opener
10. Door opener with electronic lock

If you are interested in electronics or electro-mechanical gadgets send 1/- stamp for this 24-page profusely illustrated publication to:

"ST. JOHN'S RADIO" 3 Jews Row London SW18

**The SAVOY SUPER-3 3-TRANSISTOR POCKET RADIO**



with miniature loudspeaker

**NO SOLDERING NO DRILLING**

**47/-** 3 transistors and 2 diodes. Full medium wave coverage. Battery 1/- Size 4 1/4" x 2 1/8" x 1 1/4". Full P.P. 2/- ex. instructions provided.

All parts sold separately

or—**SAVOY-4** with 4 transistors and 2 diodes, in a 5 stage reflex circuit. Size 5 1/2" x 3" x 1 1/2" **75/-** Battery 2/3 P.P. 2/9 ex.

**SAVOY ELECTRONICS LTD** 15 Maiden Lane Strand London WC2 (Back of Adelphi Theatre)



**MODEL PT 34**  
1,000 ohms per volt A.C./D.C.  
49/6 Fully Guaranteed

0/10/50/250/500/1,000 volts A.C./D.C.  
0/1/100/500 mA D.C. Resistance 0/100k ohm. Ideal pocket sized multi-tester for all radio and domestic work. Size 3 3/8" x 2 3/8" x 1 1/2"

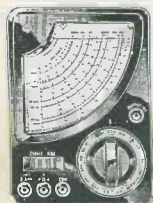

**MODEL ITI (200 H)**  
20,000 ohms per volt.  
Size 4 1/2" x 3 1/2" x 1 1/8"  
£5.5.0

With Test Leads, Battery and Instructions.

6 Ranges D.C. voltage to 2 1/2 kV.  
5 Ranges A.C. voltage to 1 kV.  
3 Ranges D.C. current to 250 mA.  
Resistance to 6 megs.  
Capacity and dB ranges.



**MODEL TH-L33**  
2,000 ohms per volt AC/DC.  
Size 5" x 3 1/2" x 1 1/2".  
79/6 Fully Guaranteed

with test leads, battery and instructions.

0/10/50/250/500/1,000 volts D.C.,  
0/10/50/250/500/1,000 volts A.C.,  
0/500µA/10/250mA., D.C.  
3 ranges resistance 0/10K/100K/1 Meg.  
Capacity and dB ranges. Large scale.

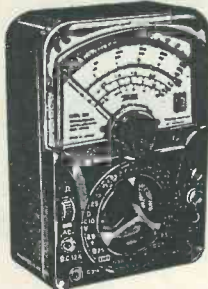

**MODEL 500**  
30,000 ohms per volt multi-meter  
Size 6 1/2" x 4 1/2" x 2 1/4".  
£8.19.6  
FULLY GUARANTEED

8 Ranges D.C. volts to 1 kV.  
7 Ranges A.C. volts or 1 kV.  
5 Ranges D.C. current to 12 amps.  
3 Range resistance to 60 meg.  
Short circuit, Buzz test. Output meter, dB, etc., etc. With Leads, Batteries and Instructions.

### AVO MODEL 7

Limited quantity offer of these well known multimeters. Reconditioned and fully guaranteed with test leads and batteries.

£11.0.0 P.P. 5/-.

Leather case, 25/- extra.

### TRANSISTORS

COMPLETE NEW RANGE OF 1ST GRADE A.E.I. TRANSISTORS, DIODES, MATCHED SETS, NPNS, POWER H.F., ETC. NOW IN STOCK. NEW VERY LOW PRICES.

SPECIAL REDUCTIONS FOR MATCHED SETS

Latest list on request



### LIGHTWEIGHT HEADPHONES

★ 2,000 ohms, 12/6  
★ 4,000 ohms, 14/6  
P.P. 1/-.  
BRAND NEW

### MINIATURE PANEL METERS

0/50µA (DC) 39/6  
0/500µA (DC) 32/6  
0/1mA (DC) 27/6  
0/5mA (DC) 27/6  
0/300 volts (DC) 27/6  
Brand New Boxed

### TAPE RECORDER MOTOR

Miniature 4 1/2-9 volt motor with built-in governor. 12/6  
BRAND NEW

### TRANSISTOR PORTABLE WIDE RANGE GENERATOR

Covers 200 kc/s to 220 Mc/s in 8 ranges. A.F., R.F., I.F. outputs modulated R.F., etc.

£7.10.0 P.P. 3/6

FULL LEAFLET ON REQUEST

### TRANSISTOR INTERCOMM.

2-way Intercomm. Housed in attractive moulded cabinets. 2-way calling and talking. Complete with cable and battery in presentation boxes. 89/6 P.P. 1/6.

De-luxe version, more powerful. Ideal for office or works, 8 gns. P.P. 2/-.

### SPEAKER UNIT

Tubular extension unit to give 5-times volume output when plugged into earphone socket of any pocket radio. Ideal for home or car use. 52/6 P.P. 1/6.

### CONTACT MICROPHONE

Crystal microphone for guitar use. Matches any valve amplifier.

12/6 P.P. 9d.

### TELEPHONE COIL

For recording or amplifying telephone conversations. Matches any recorder. No connections to phone.

12/6 P.P. 9d.

### 3/4 WATT 4 TRANSISTOR AMPLIFIER

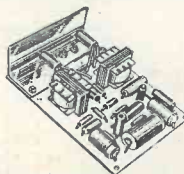

● 1 watt peak output.  
± 3dB 70cs to 12 kc/s.  
Output to 3 ohms speaker.  
9 volt operated.  
Details on request

Built and Tested 59/6 P.P. 1/6

OR Kit of Parts 52/6 P.P. 1/6

A printed circuit high gain amplifier size 4" x 2 3/8" x 3/8" using Mullard OC71/OC81D and 2-OC81 Transistors. Ideal for Intercomm., Record Player, Tuner Amplifier or any application requiring a quality and reliable amplifier.

### ALL-TRANSISTOR

### ★ TIME SAVER ★ OFFICE OR HOME TELEPHONE PICK-UP AMPLIFIER

★ No more "holding on" wasting time waiting for your call to come through. When it does the amplifier can be switched off if required. No connections, just press the pick-up coil to back of phone as below. Fully guaranteed. Housed in attractive Gold Finish Cabinet.

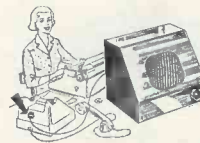

BUILT, TESTED, READY TO USE

£5.10.0

P.P. 2/6

### TRANSISTOR BABY-ALARM

Similar in appearance to above. Very sensitive, £5.10.0. P.P. 2/6

### 4 TRANSISTOR PUSH-PULL AUDIO MODEL PK-243 AMPLIFIER

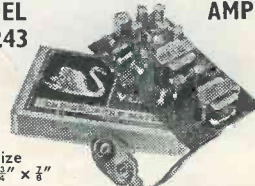

Size 3" x 1 1/2" x 7/8"

A ready-built, miniature 250mW push-pull amplifier incorporating input and output transformers, 4 transistors, 9 volt battery snap cord, speaker and volume connection leads. Ideal for use with record players, intercoms, hearing aids, tape recorders, etc. Complete with full instructions and circuit diagram.

PRICE 52/6 P.P. 1/6.

SUITABLE 2 1/2" SPEAKER, 16/6

### CRYSTAL MICROPHONES

ACOS 39-1. Stick Microphone with screened cable and stand (list 5 gns.), 32/6. P.P. 1/6.  
ACOS 40. Desk Microphone with screened cable and built-in stand (list 50/-), 15/- P.P. 1/6.  
ACOS 45. Hand Microphone with screened lead, very sensitive, 25/- P.P. 1/6.  
100 C. Stick Microphone with muting switch and screened cable, detachable desk stand, cord and neck, 39/6. P.P. 1/6.  
MC 24. Stick Microphone with muting switch and cable, 25/- P.P. 1/6.  
LAPEL. Miniature Mic. With clip. Ideal for recording, 15/- P.P. 1/-.

### BATTERY RECORD PLAYER



★ 6-7 1/2 volt Garrard turntable with crystal pick-up. Plays 45 r.p.m. Ideal for above amplifier.

55/- P.P. 1/6.

★ PORTABLE RECORD PLAYER CABINET for above player and amp., 17/6. for 7" x 4" speaker. P.P. 1/6.

### Henry's Radio Ltd

PADDINGTON 1008/9  
5 HARROW ROAD LONDON W2

Open Mon. to Sat. 6-9, Thurs. 1 o'clock  
Send 1/- stamp for Illustrated Price List

Please Turn Page

Published in Great Britain by the Proprietors and Publishers Data Publications Ltd. 57 Maida Vale London W9

Printed by A. Quick & Co. (Printers) Ltd. Oxford Road Clacton-on-Sea England

Obtainable abroad through the following Collets Subscription Service Continental Publishers & Distributors Ltd. William Dawson & Sons Ltd. Australia and New Zealand Gordon & Gotch Ltd. Electronics Publications (Australia) South Africa Central News Agency Holland "Radio Electronica" Registered for transmission by Magazine Post to Canada (including Newfoundland)

# The fabulous 'Contessa' Mk. III

★ combined portable and car radio ★

- NOW** WITH 600mW MELLOWTONE OUTPUT ON MEDIUM AND LONG WAVES
- NOW** FITTED HORIZONTAL TUNING SCALE WITH ALL STATIONS CLEARLY MARKED
- NOW** SUPPLIED WITH SIX MULLARD TRANSISTORS AND TWO DIODES
- NOW** FITTED RECORDING SOCKET AND CAR AERIAL SOCKET
- NOW** SUPPLIED WITH TWO-TONE BEIGE OR TWO-TONE BLUE CABINET WITH GOLD FITTINGS

**GUARANTEED THE VERY BEST OBTAINABLE**

- All parts sold separately ●

The New "CONTESSA" 6-Transistor Portable Superhet Radio. Features simple printed circuit construction and fully illustrated building instructions, with all parts clearly marked and identified. Fitted with 8" Ferrite aerial. Double IFTs and the latest in components and design. Full tuning of both Medium and Long Wave bands with unbeatable selectivity and sensitivity. Clearly marked station dial and room-filling "MELLOWTONE" push-pull output are standard features.



**OVERALL SIZE**  
10½" x 7½" x 3½"

- Detailed Leaflet on Request ●

**TOTAL COST**  
**£10.19.6** P.P. 3/6

★ ALL THESE EXTRA FEATURES AT NO EXTRA COST ★  
**COMPONENTS ARE OUR SPECIALITY—QUOTATIONS BY REQUEST**

## "TRANSFIVE" PORTABLE RADIO



Medium and Long Wave Portable  
8½" x 6½" x 3½"  
**£5.19.6**  
P.P. 2/6

300m/w.  
A simple to build 5-Transistor and Diode, Printed Circuit, Medium and Long Wave Portable. Features 5" speaker, Car aerial socket, Mullard transistors and carded components. Building plans free on request. THE IDEAL PORTABLE.  
Leaflet on request.  
Full after-sales service and guarantee.

## "QUINET" MEDIUM AND LONG WAVE POCKET RADIO

PUSH-PULL SPEAKER OUTPUT  
Size  
5½" x 3" x 1½"  
Red or Blue with Gold trim

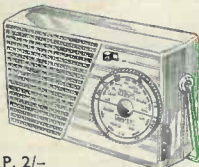

**Total Cost**  
**99/6** P.P. 2/-

A 5-Transistor and Diode Medium and Long Wave Printed Circuit Loudspeaker Radio. Features Mullard transistors and plainly marked printed circuit with carded components. Excellent results with full station separation guaranteed. Including Radio Luxembourg. Push-pull output up to 200mW. Fitted phone/recording socket and car aerial socket.  
Leaflet on request

Full after-sales service and guarantee.

PLEASE TURN PAGE

**Henry's Radio Ltd**

PADDINGTON 100B/9

5 HARROW ROAD LONDON W2  
Open Monday to Sat. 9-6. Thurs. 1 o'clock  
Send 1/- Stamps for Illustrated Price Lists

## "CAPRI" POCKET SIX. 6-TRANSISTOR MEDIUM AND LONG WAVE POCKET SUPERHET RADIO

★ SIZE 4½" x 2½" x 1½" REALLY POCKET SIZE ★

The most compact 6-transistor and diode radio with speaker available to the home constructor. Features the latest in miniature components and circuitry. Supplied with Mullard transistors and two-tone moulded cabinets in red/white or blue/white with gold fittings. All components are supplied in packets and clearly identified. A printed circuit is used with fully illustrated building instructions. Push-pull output coupled with a sensitive and selective circuit make the "CAPRI" hard to beat. Fitted Earphone/Record socket.

- FULL AFTER-SALES SERVICE AND GUARANTEE
- ALL PARTS SOLD SEPARATELY—DETAILED LEAFLET ON REQUEST

★ DESIGNED BY EXPERTS FOR THE HOME CONSTRUCTOR ★

**TOTAL COST** **£6.19.6** P.P. 2/-



## IT'S TINY BUT POWERFUL "MINIRANGER"

PERSONAL M.W. RADIO  
3-TRANSISTOR, 2-DIODE

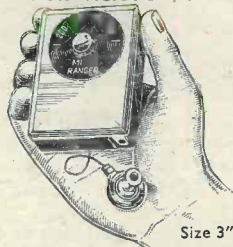

Size 3" x 2" x ¾"

The smallest printed circuit transistor radio available for home construction. Full coverage of Medium waves and top band without any aerial or earth. Fitted calibrated dial, volume control and 9 volt battery. All stations including Radio Luxembourg are received with amazing clarity. Pre-tinned printed circuit clearly marked with component details.

- Simple to Build ●
- Guaranteed Amazing Results

**TOTAL COST OF ALL PARTS** **59/6** P.P. 1/6

- Designed for your top jacket pocket ●
- Circuit Diagram Free on Request

## "PW TROUBADOUR" 7-TRANSISTOR

Medium and Long Wave Superhet Radio

Size  
5½" x 3½" x 2"



**£8.10.0** P.P. 2/-

Modified version of previously advertised "PW" Superhet. Now with new style Two Tone Cabinet. First grade components and transistors. Printed circuit. Features matched set of 6 Transistors. New 2½" quality speaker and new illustrated building instructions.

"PW6" TRANSISTOR POCKET SUPERHET ALWAYS AVAILABLE AT £7.19.6 S.A.E.

## "RANGER 3"

Size 4½" x 3" x 1½"

A Three-Transistor Two Diode Personal Radio for Medium Waves and Amateur top band and shipping. Quality output on personal phone. Fitted air spaced tuner, vol. control. No aerial or earth. Luxembourg guaranteed.



**59/6** P.P. 1/6