

THE Radio Constructor

RADIO
TELEVISION
AUDIO
ELECTRONICS

VOLUME 15 NUMBER 12
A DATA PUBLICATION
PRICE TWO SHILLINGS

July 1962

"Highwayman" Transistorised Car Radio

- Experimental Remote Control with Capacitive "Memory"
- 2-Valve Stereo Amplifier
- Transistorised Single Sideband Transmitter
- The Nomotron
- Test Instruments Need Testing
- Certification of High Fidelity Amplifiers

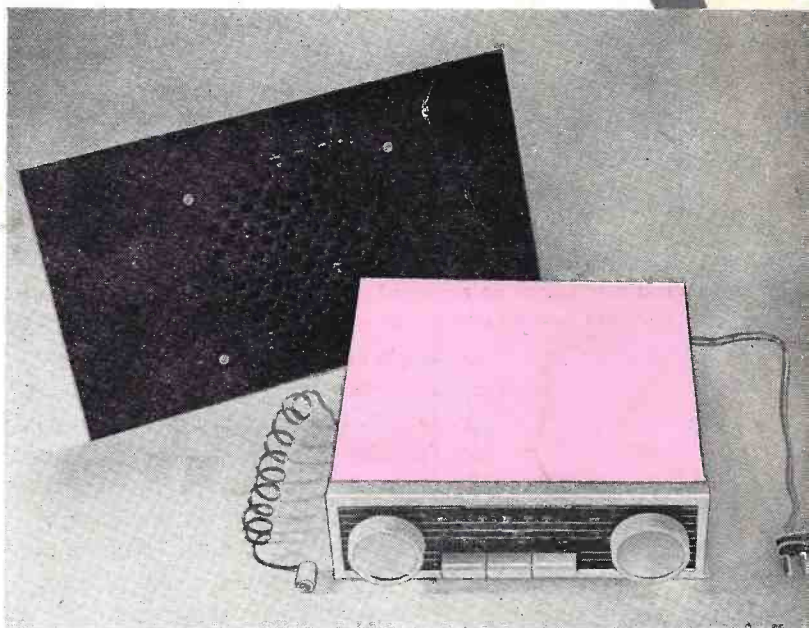

Announcing —

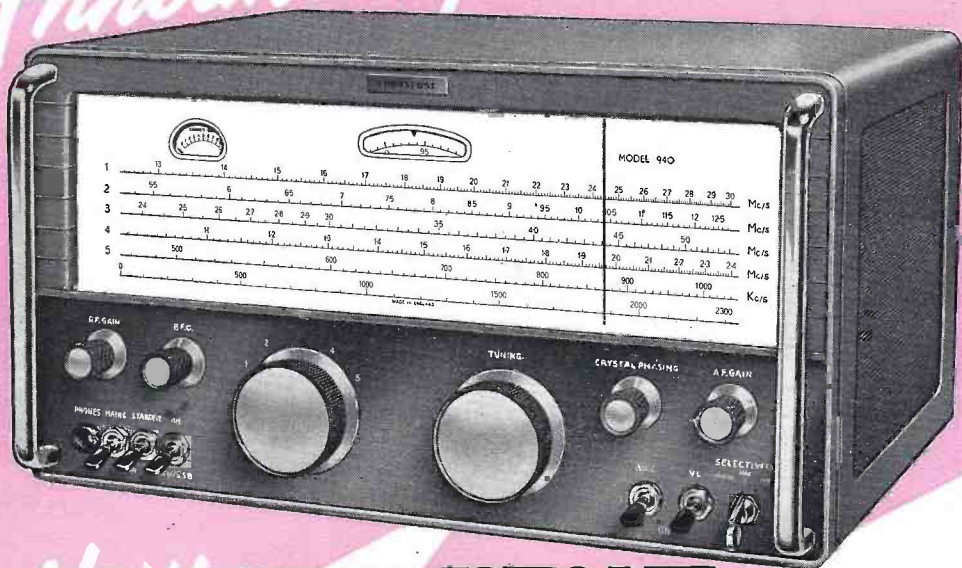

the NEW EDDYSTONE '940'

H.F. COMMUNICATIONS RECEIVER

This new Eddystone receiver has been produced for the Professional and serious Amateur. It has a large number of attractive features that will be highly appreciated in operational working including:

- ★ Single conversion superhet covering 480 kc/s to 30 Mc/s in 5 switched bands
 - ★ 2 R.F. stages and 2 I.F. stages including phased crystal filter
 - ★ 1st R.F. is of cascode type resulting in excellent noise and cross modulation figures
 - ★ Precision gear drive, flywheel loaded, and an adequate degree of mechanical bandspread
 - ★ High selectivity and excellent signal-to-noise ratio
 - ★ A high degree of frequency stability
 - ★ Suitable for C.W., A.M., SSB reception
 - ★ Push-pull output stage with excellent quality of reproduction
 - ★ Modern styling in two-tone grey finish, with the alternative of rack mounting fittings suitable for 19in rack
- Suitable for operation from 110/125 and 200/250 volts, 40/60 cycle with built-in power and stabiliser

£125



STRATTON & CO. LTD · BIRMINGHAM 31 · ENGLAND

CLYNE RADIO LTD.



18 TOTTENHAM COURT ROAD, W.1
162 HOLLOWAY ROAD, LONDON, N.7
9 CAMBERWELL CHURCH STREET, S.E.5

All post orders etc. to 162 HOLLOWAY ROAD, LONDON, N.7

THE
COMPONENT
SPECIALISTS

MUSEum 5929/0095
NORth 6295/6/7
RODney 2875

NEW! NEW! "THE AIR KING"

A New Six transistor, luxury portable with the new "SLIM LINE" look. To build yourself, with printed circuit chassis for reliability and simplicity in construction. May be used as Car Radio, with full MEDIUM wave and LONG wave coverage. Look at these features!

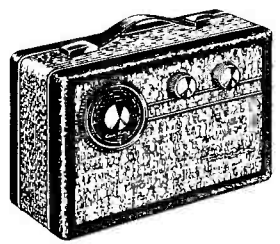

★ 500 milliwatt output to high flux 7" x 4" in. high fidelity loudspeaker. ★ Six selected Mullard Transistors in latest super sensitive circuit, plus germanium diode. ★ Compact size—only 9" x 3½ x 6¼ in. (high). ★ Attractive three tone cabinet, Black, Dark Grey, and Silver Grey, with gilt control knobs and all gilt fittings. ★ Coax socket for car aerial. ★ Brand New guaranteed components. ★ Push-pull output. ★ Automatic volume control. ★ Long life battery. ★ Super sensitive internal ferrite rod aerial.

Special inclusive price for all required components. **£7.19.6** Plus P. & P. 4/-

Nothing more to buy — Cabinet included!

Alignment service available. Full assembly details and individually priced parts list, all of which are available separately, price 1/6 post free.

THE "CRUSADER"

Our new four transistor plus diode portable with big set quality!

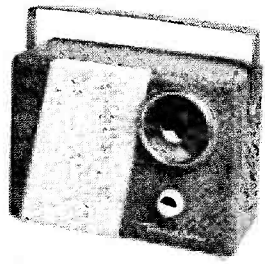

★ Full Medium Wave coverage.
★ Completely self contained.

- ★ Five inch P.M. Speaker.
- ★ Genuine high grade Mullard or Ediswan Transistors.
- ★ New components throughout.
- ★ Attractive two-tone blue/grey Vynide-covered cabinet size 8 x 5½ x 3½ in. with adjustable carrying handle.
- ★ Eyeletted chassis simplifies construction.
- ★ Longer life with larger size PP7 battery.

★ **SPECIAL FEATURES** ★
SUPPLIED WITH JACK SOCKET FOR DIRECT CONNECTION TO CRYSTAL MICROPHONE FOR USE AS **BABY ALARM WITHOUT ANY MODIFICATION!** ALSO FOR DIRECT CONNECTION TO CRYSTAL PICK-UP FOR USE AS A **GRAMOPHONE AMPLIFIER!** SUPPLIED COMPLETE WITH RECESSED SOCKET FOR DIRECT CONNECTION TO **CAR AERIAL!**

All required components including full instructions, solder, battery, etc. at special inclusive price of **ONLY 95/-** Plus 3/- P. & P.

All parts available separately *itemised parts list and full assembly instructions* 1/6 post free.

NEW! NEW! The "COURTESAN"

Our New 3 transistor plus 2 diode pocket receiver with full Medium and Long Wave Coverage.

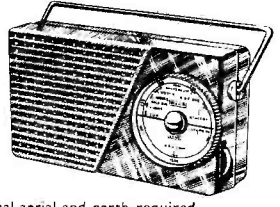

- ★ No external aerial and earth required.
- ★ Latest 2½"—75 ohm speaker.
- ★ First grade Mullard transistors.
- ★ Condenser tuning.
- ★ Volume control with on/off switch.
- ★ Easy assembly on pre-tagged circuit board.
- ★ Attractive red polystyrene cabinet, measures 5½ x 3½ x 1½", chrome handle, attractive gold and black dial.
- ★ Luxembourg, Hilversum, etc., guaranteed in reception areas.

ONLY 63/- Plus 2 6 P. & P.

All parts available separately. *Itemised parts list and full assembly instructions* 1 6, post free.

INEXPENSIVE TEST GEAR

Two Ideal Pocket Instruments for Amateur or Student

MODEL TI1
Size only 3½" x 2½" x 1½"
Meter
Size 1½" x 1½"
Sensitivity 285 microamps
— 1000 ohms per volt AC DC
DC Current 1.25, 250 ma.
DC and AC volts 10, 50, 250, 1,000 v.
Resistance 50 ohm—100 K Battery 1.5 v.-U12. Complete with test prods, battery and full instructions.

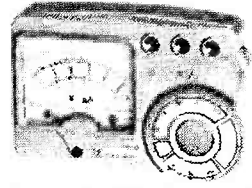

Outstanding Value at **57/-** Plus 2 6 P. & P.

MODEL TK.50

Size 5" x 3½" x 1½" 1000 ohms per volt. AC, DC DC Current 1-250 ma DC and AC volts 10, 250-500 and 1000 v.
Resistance 0-10K, 0-100K.



Complete with test prods, battery and full instructions. Outstanding buy at **63/-** Plus 2 6 P. & P.

Also available Model 500, 30,000 o.p.v., **£8.19.6**. 10 per cent deposit H.P.!

The "HIGHWAYMAN"

A Quality Car Radio to Build Yourself at an economical price!

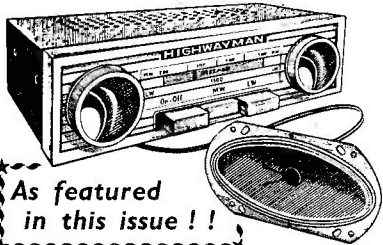

As featured in this issue!!

All parts available separately, but if purchased at one time, the whole will be supplied at a special inclusive price of **£10.19.6** Plus 4/- P. & P.

Parts list and comprehensive instruction booklet 2/6, post free. (Deducted from cost if complete parcel purchased later.)

Look at these features:—

- ★ Attractive styling.
- ★ Push-pull output.
- ★ 3 latest Mullard transistors plus valves type EBF 83 and ECH 83.
- ★ No Buzz. High output and sensitivity.
- ★ Printed circuit (newest type), 7" x 4"
- ★ High flux p.m. speaker.
- ★ Medium and Long Waves.
- ★ Push Buttons for fingertip control.
- ★ Extremely low Battery consumption (less than ½ amp).
- ★ Easy to fit any make car (Positive earth only).
- ★ 12 volt operation.
- ★ Compact size measures only 7" x 7" x 2" deep.
- ★ Easy assembly, supplied with dial and drive already mounted.

The "CLYMAX"

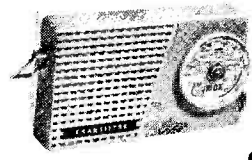

At last a 6-transistor pocket superhet for Medium and Long Wave at a price you can afford. All required component **ONLY**

ONLY £6.16.6

Nothing more to buy!

- ★ Completely self contained. No external aerial or earth required. ★ Full medium wave coverage, plus switched Light programme on Long Wave.
- ★ Push-pull output—250 milli-watts. ★ Matched set of latest type Mullard transistors. ★ Genuine 3 in. P.M. Speaker. ★ High-Q Coils. ★ Ferrite rod aerial with high selectivity. ★ Size: 5½" x 3½" x 1½". Two-tone cabinet. ★ Precision etched printed circuit with components references clearly marked. Alignment service available. All Parts available separately. Full assembly instructions and individually priced parts list, 2 - post free.

FREE TO AMBITIOUS ENGINEERS

— THE LATEST EDITION OF ENGINEERING OPPORTUNITIES

Have you sent for your copy?
ENGINEERING OPPORTUNITIES is a highly informative 156-page guide to the best paid engineering posts. It tells you how you can quickly prepare at home for a recognised engineering qualification and outlines a wonderful range of modern Home Study Courses in all branches of Engineering. This unique book also gives full details of the Practical Radio & Electronics Courses, administered by our Specialist Electronics Training Division—the *B.I.E.T. School of Electronics*, explains the benefits of our Employment Dept. and shows you how to qualify for five years promotion in one year.

We definitely Guarantee
“NO PASS — NO FEE”

Whatever your age and experience you cannot afford to miss reading this famous book. If you are earning less than £25 a week send for your copy of “ENGINEERING OPPORTUNITIES” today—FREE.

BRITISH INSTITUTE OF ENGINEERING TECHNOLOGY (Incorporating *E.M.I. Institutes*)
 (Dept. SE/23), 29 Wright's Lane, London, W.8

THE B.I.E.T. IS THE LEADING ORGANISATION OF ITS KIND IN THE WORLD

WHICH IS YOUR PET SUBJECT ?

Mechanical Eng.,
 Electrical Eng.,
 Civil Engineering,
 Radio Engineering,
 Automobile Eng.,
 Aeronautical Eng.,
 Production Eng.,
 Building, Plastics,
 Draughtsmanship,
 Television, etc.

GET SOME LETTERS AFTER YOUR NAME !

A.M.I.Mech.E.
 A.M.I.C.E.
 A.M.I.Prod.E.
 A.M.I.M.I.
 I.I.O.B.
 A.F.R.Ae.S.
 B.Sc.
 A.M.Brit.I.R.E.
 City & Guilds
 Gen. Cert. of Education
 Etc., etc.

PRACTICAL EQUIPMENT

Basic Practical and Theoretic Courses for beginners in Radio, T.V., Electronics, Etc., A.M.Brit.I.R.E. City & Guilds Radio Amateurs' Exam. R.T.E.B. Certificate P.M.G. Certificate Practical Radio Radio & Television Servicing Practical Electronics Electronics Engineering Automation

INCLUDING TOOLS!

The specialist Electronics Division of *B.I.E.T. (Incorporating E.M.I. Institutes)* NOW offers you a real laboratory training at home with practical equipment. Ask for details.

B.I.E.T. SCHOOL OF ELECTRONICS



POST COUPON NOW !





Please send me your FREE 156-page “ENGINEERING OPPORTUNITIES” (Write if you prefer not to cut page)

NAME.....

ADDRESS.....

SUBJECT OR EXAM THAT INTERESTS ME.....

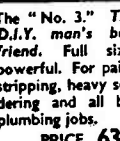
With a VALTOCK AUTOMATIC BLOWLAMP

 <p>The “2000.” Ideal for model makers, hobbyists and service engineers for fine delicate work, soft soldering, glass bending, etc. PRICE 14/7</p>	 <p>The “Major.” A larger version of the “2000” fitted with flame shield to give large flame: for most big soldering jobs about the house. PRICE 30/-</p>
 <p>The “No. 3.” The D.I.Y. man's best friend. Full size, powerful. For paint stripping, heavy soldering and all big plumbing jobs. PRICE 63/-</p>	 <p>Soldering Iron attachment. Fits the “Major” and “2000”. Gives you a soldering iron anywhere—away from electrical supplies. PRICE 5/-</p>

YOU CAN DO SO MANY JOBS SO WELL



and the **SLOTGRIP torsion Screwdriver**
 POSITIVELY GRIPS SCREWS ON THE END OF ITS BLADE

	<p>For putting screws in awkward places. Automatic action. Push—it grips. Pull—it's released. PRICE 5" 7/6 10" 12/-</p>
---	---

Get them at your local hardware shop or send to us for name of nearest stockist

VALTOCK LTD. Regency House 1-4 Warwick St. London W1 Telephone GERrard 1667



slip goes a submarine...

... and AVO is linked with atomic propulsion

A giant man-made whale slides into the water for the first time. The nuclear powered H.M.S. Dreadnought begins a new era in atomic propulsion. Avo electronic testing equipment is playing an important part in the construction and servicing of H.M.S. Dreadnought and in the development of other ships like her.



AVOMETER MODEL 8
 TRANSISTOR ANALYSER
 VALVE CHARACTERISTIC METER MK. IV
 SIGNAL GENERATOR TYPE 378 A

For further information please write to:

AVO LTD AVOCET HOUSE · 92-96 VAUXHALL BRIDGE ROAD ·
 Telephone: VICTORIA 3404 (12 lines) M. LONDON S.W.1 LONDON S.W.1.
 Telegrams: AVOCET, LONDON S.W.1

"A Jolly Fine Set but deserving a better case"



This is a comment which many constructors have voiced and therefore we now offer a **De-Luxe** version of the **Pocket Companion**. This uses a solid hide case of very pleasant red with gold lettering and our Pocket Companion now has the 15-guinea look. The most up-to-date Superhet portable of its type, it uses a transistor in conjunction with Philco R.F. transistors and Mullard output transistors. Complete building costs with plastic case £6.15.0, or with solid hide case, £7.15.0.

If you have already built and want to change your case, then return the plastic case with a postal order for £1, or if you wish to retain the plastic case then send 26/- plus 1/6, Post and Ins. for the hide case only.

AGENTS WANTED TO BUILD OUR COMPANION PORTABLES, SEND S.A.E. FOR FULL DETAILS

Introducing the J.B. Range of Transistors

Try these, you will be very pleased—

JB1. All wave mixer (replaces OC45, etc.).....	6/6
JB3. I.F. Amplifier (replaces OC44, etc.).....	4/6
JB4. A.F. Driver (replaces OC81D, etc.).....	5/-
JB6. Output matched pair (replaces OC81, etc.).....	13/-
Special offer set of six matched for superhet...	25/-
Special offer set of four matched for Amplifier (1 watt).....	17/-

ELECTRONIC PRECISION EQUIPMENT LTD

★ Orders received by post are despatched from our warehouse, Dept. 34, 66 Grove Road, Eastbourne, and to save time, please post your order to this address. Please include enough for postage. Callers, however, should use one of the following addresses:

John Bull

520 High Street North 42-46 Windmill Hill 266 London Road 29 Stroud Green Road 246 High Street
Manor Park, E.12 Ruislip, Middx. Croydon Finsbury Park, N.4 Harlesden, N.W.10

Portable Transistor Tape Recorder

Weight 2½ lbs and only 9" x 6" x 3" (approx). For office or home, outdoors or indoors.

at only
£6.19.6



You'll be really thrilled at its performance. Superior to many selling at £12 to £15. Supplied as completely wired sub-assemblies; just link these together—only 10 connections to make. Three transistor amplifier with centre switch-forward stop-rewind with microphone input record play-volume control, etc. Complete in most modern carrying case in two-tone and with microphone reel of tape and spare reel. Nothing else to buy. Do not miss this bargain! **Only £6.19.6.** plus Post and Ins. 5/-.

The "Good Companion" Mk. II

USING TRANSISTORS

In the "de-luxe" cabinet as illustrated it costs £10.19.6 to build—but what a set! Scan these pages: you will find nothing to compare with its specification. It uses transistors instead of I.F. transformers, has variable feedback as well as all the usual features, A.V.C., Push-pull output, Ferrite Aerial, Slow Motion Tuning, etc., etc., and is a very powerful Medium & Long Wave set, conservatively rated at 750mW. Every component used is by a famous maker, such as American Philco MADT R.F. transistors—Mullard A.F. transistors—Jackson Brothers' tuning condensers—Rola-Celestion loudspeaker—Dubilier—T.C.C.—Morganite resistors and controls. Also full after sales service available. **You will definitely be doing the right thing if you buy a Good Companion.**

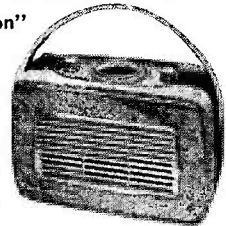

Adjustable Thermostat

Suitable for Industrial or domestic purposes, such as controlling furnace oven, immersion heater, etc. Can also be used as a flamelstat or fire alarm. Made by Sunvic these are approximately 17" long and adjustable over a range 0 to 550°F. The contacts are rated at 15 amps., 230 volts, and the adjustment spindle, which comes to the top, can be fitted with a flexible drive for remote control or just a pointer knob for local control. Listed at £3 or £4 each, these are offered at only 12/6 plus 2/6 postage and insurance.

Premier RADIO

23 Tottenham Court Road London W1 Telephone MUSEum 3451/2 and 309 Edgware Road London W2 Telephone PADdington 6963

6-TRANSISTOR POCKET SUPERHET

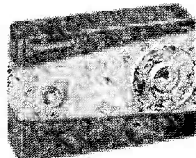

MAY BE BUILT FOR
£7.19.6

plus 3/6 P. & P.
PP4 Battery 2/6 extra

Star Features: ★ 6 first grade transistors and one diode. ★ Simple to follow printed circuit. ★ Internal Ferrite rod aerial. ★ Provision for car radio aerial. ★ Full medium & long waveband coverage. ★ Attractive rexine covered cabinet size 7" x 4½" x 2½". ★ Simple point to point instr. supplied.

The "Petite" PORTABLE



MAY BE BUILT FOR **£7.0.0** plus 5/- P. & P.

Batteries extra
HT 10/- (Type B126) or equiv.
LT 1/6 (Type AD35) or equiv.

★ Size only 8" x 8" x 4½"
★ Instruction book 1/6

Battery Eliminator, available in component form price 37.6 plus 2/- P. & P.

WE HAVE BEEN APPOINTED STOCKISTS FOR FULL RANGE OF STERN'S RADIO (Fleet Street)

Famous Mullard Designs such as Type 'C' Tape Pre-amplifier and Erase Unit, including separate Power Supply. Complete Kit of Parts £14.0.0 or Completely assembled and tested £17.0.0

Also available Less Power Supply at £11.15.0 and £14.10.0 respectively.

Stern's Model HF TR3 Mk.2. Tape Amplifier Complete Kit of Parts £13.14.0 or Completely assembled and tested £17.0.0

Complete Mullard 5-10 Amplifier with Pre-amplifier on same Chassis Complete Kit with Parmeko O P and Mains Transformers £11.10.0 Completely assembled and tested £13.10.0

Complete Mullard 3-3 Amplifier Kit £7.10.0 Completely assembled and tested £8.19.6

Mullard 10-10 Stereo Power Amplifier based on the famous Mullard 5-10 Complete Kit of Parts £18.10.0 Completely assembled and tested £21.0.0

(Control Unit on Main Chassis) Also available with separate dual-channel Pre-amp Complete Kit for Power Amp. & Pre-amp £26.0.0

Complete assembled and tested £30.0.0 All components used in these kits are of the highest possible standard and strictly to circuit specifications.

Full descriptive literature available on these products and Circuit Diagrams may be purchased separately.

TRANSISTOR SUPERHET RADIO

May be built for

£8.19.6

Plus 2/6 P. & P.

PP11 Battery extra at 5/6

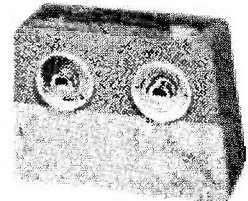

Using 6 Transistors and one Diode and internal Ferrite Rod Aerial, with provision for Car Radio Aerial. Full medium and long waveband coverage and 6 x 4 High Flux Speaker. When constructed the Receiver is housed in an attractive two tone case, size 10½" x 7½" x 3½".

THE "MID-FI" A NEW DESIGN

4½W AMPLIFIER KIT MAY BE BUILT FOR **95/-** plus 3/- P. & P.



A new circuit for the home constructor requiring a good quality med. powered amplifier for reproduction of records or f.m. broadcasts. Technical spec.: sep. bass and treble controls. Valves: EF86, EL84, EZ80. Voltage adjustment for a.c. mains from 200/250V, 3 or 15Ω imp. Neg. feedback. Size 7" x 5" x 2", overall ht. 5". Silver hammered finished chassis.

SUPERB COMMUNICATION RECEIVERS

AMERICAN AR88D RECEIVERS. Fresh release of these renowned sets. 14 valves, 6 wavebands, covering 500 kc/s-32 Mc/s. Incorporate every possible refinement and have internal A.C. mains pack for nominal 115/230V. Thoroughly reconditioned, immaculate in appearance, and in perfect working order. **ONLY £35** (add carriage 30/- and 50/- deposit on returnable transit case). S.A.E. brings illustrated leaflet.

MARCONI CR. 100/8 COMMUNICATIONS RECEIVER. Covers 60 kc/s to 30 Mc/s. Complete with all valves, maker's instruction manual and internal A.C. power unit for 200/250 volts. **BRAND NEW IN ORIGINAL TRANSIT CASES.** Aerial tested before despatch. **ONLY £35** (carr. etc., 40/-). S.A.E. for full details.

TEST METERS FOR EVERY PURPOSE & POCKET

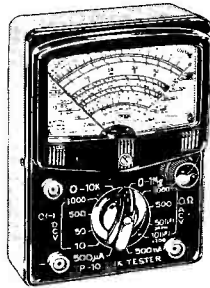

2,000 O.P.V. MODEL TP-10. Reads A.C. and D.C. volts up to 1,000; D.C. Current to 500mA; resistance to 1 Meg; Capacitance to 1µF; Decibels from -20 to +36; Output jack for Audio Measurements. Size 3½" x 5" x 1½". **£3.19.6**

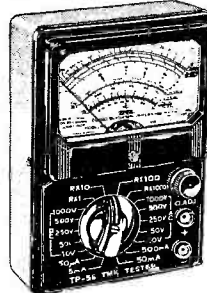

20,000 O.P.V. MODEL TP-55. Reads Voltage up to 1,000; D.C. at 20,000 ohms per volt and A.C. at 10,000 o.p.v.; D.C. Current to 500mA; Resistance to 10 Meg.; Capacitance to 0.1µF; Decibels from -20 to +36. Size 3½" x 5¼" x 1½". **£5.19.6**

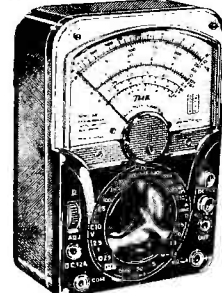

30,000 O.P.V. MODEL 500. Volts to 1,000; D.C. at 30,000 o.p.v.; A.C. at 20,000; 12 Amps D.C. Current; 60 Meg. Resistance; -20 to +56 Decibels; Internal buzzer short circuit warning. Size 3½" x 6½" x 2½". **£8.19.6**

All new stock, with leads, prods & internal batteries. 6 mths. guar. backed by full service facilities. Details S.A.E.

AMPLIFIER TYPE A1413. Ex-R.A.F. For normal A.C. mains use. 5Z4 rectification with 6V6 output. Input and output jack sockets. gain control, fully fused. 600 ohms output transformer, easily changed for 3 ohms type. Standard rack mounting size 19" x 7" x 6". Used, good condition. **ONLY 59/6** (carriage, etc., 10/6).

AMERICAN HALLICRAFTERS 6 VOLT VIBRATOR PACK. Output 300 volts D.C. at 170mA. Designed to run Communications Receivers from 6 volt car battery. Size 6½" x 6½" x 7½". Complete with 2 valves 6X5 and instructions, in maker's cartons. **BRAND NEW AND UNUSED.** **ONLY 29/6** (carr., etc., 3/6).

12 VOLT AMERICAN DYNAMOTORS. Deliver 220-volts at 100mA. Size 5½" x 3½" diameter. Ideal for running Electric Shaver, etc., from car battery. **ONLY 32/6** (post 2/6).

B.C. 221 FREQUENCY METERS. The famous American crystal controlled, portable frequency measuring standard. Coverage 125 kc/s-20 Mc/s. With original calibration book. Perfect order. Illustrated details on request. **ONLY £16.**

PCR COMMUNICATION RECEIVERS

Manufactured by Pye and Philips. One of the Army's most versatile and sensitive sets. RF stage and 2 of IF, using 6 British I.O. type valves. Large 180 degrees. Illuminated and Calibrated Dial. Flywheel tuning with locking device. Aerial trimmer. Tone and volume controls. Band switch from panel jacks for speaker or phones. In black metal case, size 17" L x 8" H x 10" D. Model PCR covers 6-18 Mc/s, 200-550 metres and 850-2,000 metres and has internal 5" speaker. REME reconditioned as new. **£6.19.6.** Model PCR2 has similar L & M waveband coverage. Short wave 6-22 Mc/s, but no speaker. Used but excellent condition, **£5.19.6.** Every receiver aerial tested before despatch. Add 10/6 carr. all models. Designed to operate from bulky EXTERNAL power supply, but any set can be fitted with **BRAND NEW COMPONENTS INTERNAL PACK** for 200/250V a.c. at extra cost of **£2.**

S.A.E. FOR ILLUSTRATED LEAFLET

"P.W." 6 TRANSISTOR PERSONAL RECEIVER

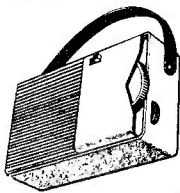

Designed by the technical staff of Practical Wireless: easy to build, using printed circuit and 1st grade Matched Transistors and Diode. Full Medium and Long Wave coverage to internal speakers. All parts sold separately (new components only) enabling you to buy as required, and full detailed price list will be sent on request. Constructional details 1/6. Newly designed OSMOR Cabinet and reduced price. **TOTAL COST INCLUDING BATTERY AND CABINET NOW £8.10.0.** S.A.E. for 7 transistor version.

BATTERY AND CABINET NOW £8.10.0. S.A.E. for 7 transistor version.

THE "GOOD COMPANION" Mk. II

Using transfilters, the latest manufacturing technique to save alignment difficulty.

THE FINEST COMBINED PORTABLE and CAR RADIO YET DESIGNED FOR THE HOME CONSTRUCTOR

★ 750mW output.

★ 6 transistors and 2 diodes.

★ Full Medium and Long Wave coverage.

★ Quality speaker.

★ Brilliantly styled 2-tone cabinet, size 11" x 8" x 3".

★ Very fine tuning with calibrated dial.

★ Latest printed circuit. ★ Internal high gain aerial with car aerial socket. Easy to follow construction data (available separately 3/6).

All parts sold separately and full illustrated details will be sent on request.

Total Cost **£9.19.6**

With alternative luxury cabinet using 7" x 4" speaker, **£10.19.6.** Either type, plus 5/- post and ins. (Battery 3/6 extra.)

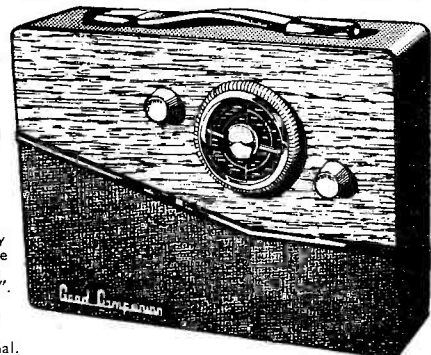

"POCKET 4" TRANSISTOR RECEIVER

Uses miniature speaker, proper tuning condenser, and volume control. Built-in aerial makes unit efficient and portable. Ideal for the beginner. Full medium wave coverage. All components and case for only 42/6 (p. & p. 2/6). Ten-page constructional book free with parts or separately 1/6. S.A.E. for parts price list.

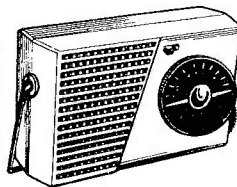

HARRIS ELECTRONICS (LONDON) LTD

(DEPT. M)
138 GRAY'S INN ROAD LONDON WC1

Telephone TERminus 7937

Please include carriage costs on ALL items.
(Open until 1 p.m. Saturdays.) We are 2 mins. from High Holborn (Chancery Lane Station) and 5 mins. by bus from King's Cross.

Heathkit

DAYSTROM



SB-10U



DX-40U



GD-1U



O-12U



S-3U



C-3U



AG-9U

SINGLE SIDEBAND ADAPTOR. Model SB-10U. May be used with most A.M. transmitters. Less than 3w R.F. input power required for 10w output. Operation on 80, 40, 20, 15 and 10m bands on U.S.B., L.S.B. or D.S.B. **£37.60**

AMATEUR TRANSMITTER. Model DX-40U. Covers all amateur bands from 80 to 10 metres; crystal controlled. Power input 75W C.W., 60W peak controlled carrier phone. Output 40W to aerial. Provision for V.F.O. Filters minimise TV interference. **£32.10.0**

GRID-DIP METER. Model GD-1U. Functions as oscillator or absorption wave meter. With plug-in coils for continuous frequency coverage from 1.8 Mc/s to 250 Mc/s. **£10.9.6**

Three Additional Plug-in Coils Model 34-1U extend coverage down to 350 kc/s. With dial correlation curves. **15/-**

TRANSISTORISED VERSION. Model XGD-1. Similar to GD-1U. Fully transistorised with a frequency range of 1.8 to 45 Mc/s. **£10.8.6**

5" OSCILLOSCOPE. Model O-12U. Has wide-band amplifiers, essential for TV servicing, FM alignment, etc. Vertical frequency response 3 c/s to over 5 Mc/s, without extra switching T/B covers 10 c/s to 500 kc/s in 5 ranges. **£36.10.0**

2 1/2 in. SERVICE 'SCOPE. Model OS-1. Light, compact portable for service engineers. Dim. 5" x 8" x 1 1/4" long. Wt. 10 1/2 lb. **£19.10.0**

ELECTRONIC SWITCH. Model S-3U (Oscilloscope Trace Doubler.) Enables a single beam oscilloscope to give simultaneous traces of two separate and independent signals. Switching rates approx. 150, 500, 1,500, 5,000 and 15,000 c/s. Sig. freq. response 0-100 kc/s. +1dB. Separate gain controls and sync. output. Sig. input range 0.1-1.8V r.m.s. **£10.15.6**

RESISTANCE CAPACITANCE BRIDGE Model C-3U. Measures capacity 10pF to 1,000µF, resistance 100Ω to 5MΩ and power factor. 5-450V test voltages. With safety switch. **£8.6.6**

AUDIO SIGNAL GENERATOR. Model AG-9U. 10 c/s to 100 kc/s, switch selected. Distortion less than 0.1%, 10V sine wave output metered in volts and dB. **£19.19.6**

TRANSISTOR INTERCOM. Models XI-1U & XIR-1U. The master unit uses a 4-transistor amplifier, constructed on a printed circuit board, and an internal 9V battery. Remote stations use a similar battery for call only. Up to five remote units can be ordered for each master.

XIR-1U (remote) **£4.3.0**

XI-1U (master) **£10.15.6**

SUGDEN MOTOR UNIT "CONNOISSEUR CRAFTSMAN." Heavy duty motor operating at 33 1/2 and 45 r.p.m. Very heavy 12" turntable. Virtually no rumble. **£18.3.6**

AMATEUR TRANSMITTER. Model DX-100U. The world's most popular, compact and completely self-contained Amateur Transmitter. Covers all amateur bands: 160-10 m. 150W d.c. input. Careful design has achieved the stability and high performance for which the DX-100U is noted and no less than 35 disc ceramic capacitors reduce TVI to a minimum. **£71.10.0**



DX-100U

VARIABLE FREQUENCY OSCILLATOR. Model VF-1U. Calibrated 160-10 m. Fundamentals on 160 and 40 m. Ideal for our DX-40U and similar transmitters. **£11.2.0**



VF-1U

BALUN COIL UNIT. Model B-1U. Will match unbalanced co-axial lines to balanced lines of either 75 or 300Ω impedance. **£4.9.6**

THE "MOHICAN" GENERAL COVERAGE RECEIVER. Model GC-1U. With 4 piezo-electric transistors, variable tuned B.F.O. and Zener diode stabiliser, this is an excellent fully transistorised general purpose receiver for Amateur and Short wave listeners. Printed circuit boards, telescopic whip antenna, tuning meter and large slide-rule dial, 10 transistors. **£38.15.0**



GC-1U

THE BEST QUALITY

4-WAYBAND TRANSISTORISED PORTABLE RECEIVER. Model RSW-1. This model possesses Medium, Trawler and two Short-wave bands and is midway between the domestic broadcasting and professional general communications receiver. Ideal and inexpensive for those who wish to listen to world broadcasts, shipping and aviation communications. It is not the set to buy if you wish only to enjoy domestic broadcasting. In a handsome leather case, it has retractable whip aerial and socket for car radio use. **£21.6.0**



RSW-1

TRANSISTOR PORTABLE RADIO. Model UXR-1. Pre-aligned I.F. transformers, printed circuit and a 7" x 4" high-flux speaker. Real hide case. **£14.3.0**



UXR-1

HI-FI AM/FM TUNER. Model AFM-1. Available in two units which, for your convenience, are sold separately: Tuning heart (AFM-T1—£5.5.6 incl. P.T.) and I.F. amplifier (AFM-A1—£19.8.0). Printed circuit board, 8 valves. Built-in power supply. Total **£24.13.6**



AM/FM TUNER

HI-FI FM TUNER. Model FM-4U. Also available in two units as above: R.F. tuning unit (£3.2.0 incl. P.T.) with I.F. output of 10.7 Mc/s, and amplifier unit, with power supply and valves (£11.11.0). Total **£14.13.0**



FM TUNER

POWER SUPPLY UNIT. Model MGP-1. Input 100/120V 200/250V, 40-60 c/s. Output 6.3V, 2.5A A.C.: 200, 250, 270V, 120mA max. D.C. **£4.16.6**

MONEY-SAVING "PACKAGED DEALS"

For the benefit of customers wishing to purchase several units of their Hi-Fi equipment at the same time, useful price reductions are offered. Such "Packaged Deals" may include RECORD PLAYERS and TAPE DECKS of your preference, not necessarily featured in our catalogue. Two money-saving examples are given here and quotations for your own special requirements will gladly be sent on request.

GL-58 Transcription Unit	£19.12.6	TA-1M	£18. 2.6
S-33 Stereo Amp.	£12. 8.6	Collaro "STUDIO"	£17.10.0
Twin SSU-1 Speakers (Bookcase Type)	£21. 8.0	USC-1	£18.18.6
		MA-12	£10.19.6
	£53. 9.0		£65.10.6
	Packaged £50.12.0		Packaged £59.10.0

All models directly available from the makers:

DAYSTROM Ltd GLOUCESTER



HI-FI EQUIPMENT CABINETS. Our four equipment cabinets meet a wide variety of tastes and requirements: the "CHEPSTOV" was designed for those who have little floor space, the contemporary "MALVERN" for the Tape and Gram. enthusiast, and the "GLOUCESTER" Mk. I and II for those with traditional tastes. All parts are pre-cut and drilled for easy assembly, and left "in the white".

Prices from **£11.12.6** to **£18.10.0**

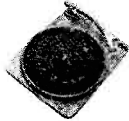

GL-58



S-33

TRANSCRIPTION RECORD PLAYER (STEREO). Manufactured by Goldring-Lenco. This 4-speed unit is fitted with a G60 pick-up arm. Infinitely variable speed adjustment from 33½ to 80 r.p.m. Fixed speed of 16 r.p.m. Its balanced turntable (3½ lb) reduces rumble, wow and flutter to very low level. The unique lowering device fitted provides absolutely safe means of placing pick-up on record **£19.12.6**

6W STEREO AMPLIFIER, Model S-33. 3 watts per channel, 0.3% distortion at 2.5 w/chnl., 20dB N.F.B. Inputs for Radio (or Tape) and Gram., Stereo or Monaural, ganged controls. Sensitivity 100mV. **£12.8.6**

FINEST ELECTRONIC KITS IN THE WORLD

VALVE VOLTMETER, Model V-7A 7 voltage ranges d.c. volts to 1,500 a.c. to 1,500 r.m.s. and 4,000 peak to peak. Resistance 0.1Ω to 1,000MΩ with internal battery. D.C. input impedance 11mΩ. dB measurement has centre-zero scale. Complete with test prods, lead and standardising battery. **£13.0.0**



V-7A

MULTIMETER, Model MM-1U. Ranges 0-1.5V to 1,500V A.C. and D.C.; 150μA to 15A D.C.; 0.2Ω to 20MΩ. 4½" 50μA meter. **£11.18.6**



MM-1U

R.F. SIGNAL GENERATOR, Model RF-1U. Up to 100 Mc/s fundamental and 200 Mc/s on harmonics and up to 100mV output on all bands. **£11.18.0**



RF-1U

AUDIO WATTMETER, Model AW-1U. Up to 25W continuous, 50W intermittent. **£14.14.0**

AUDIO VALVE MILLIVOLTMETER, Model AV-3U. 1mV-300v A.C. 10 c/s to 400 kc/s. **£13.18.6**

AUDIO SINE-SQUARE WAVE GENERATOR, Model AO-1U. Covers 20 c/s to 150 kc/s and square waves to 50 kc/s in four ranges. Maximum output 10V, distortion less than 1%. **£12.18.6**



CM-1U

CAPACITANCE METER, Model CM-1U. Direct-reading 4½" scale. Full-scale ranges 0-100μF, 0-1,000μF, 0-0.01μF and 0-0.1μF. **£14.15.0**

HI-FI SPEAKER SYSTEM, Model SSU-1. Ducted-port bass reflex cabinet "in the white". Twin speakers. With legs **£11.15.0** **£10.14.0**



SSU-1

HEATHKIT ELECTRONIC WORKSHOP, Model EW-1. This educational kit will teach and amuse your children. It can make 21 exciting experiments including transistor radios, burglar alarm, radio or TV silencer, intercom., etc. **£7.18.0**

JUNIOR TRANSISTOR RADIO, Model UJR-1. Single transistor set. Excellent introduction to radio. An instructive present. **£2.13.6**

HI-FI STEREO AMPLIFIER, Model S-99. 18W output. Ganged controls. Stereo/mono gram., radio and tape recorder inputs. Push-button selection. Printed circuit construction. **£26.19.0**



S-99

THE "COTSWOLD". This is an acoustically designed enclosure 26" x 23" x 15½" housing a 12" bass speaker with 2" speech coil, elliptical middle speaker together with a pressure unit to cover the full frequency range of 32-20,000 c/s. Capable of doing justice to the finest programme source, its polar distribution makes it ideal for really Hi-Fi Stereo. Delivered complete with speakers, crossover unit, level control, Tygan grille cloth, etc. All parts pre-cut and drilled for ease of assembly and left "in the white" for finish to personal taste. **£21.19.0**

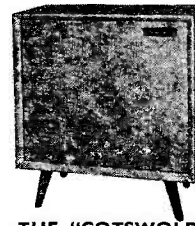

THE "COTSWOLD"

AT LOWEST PRICES

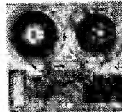

Truvox D83

TRUVOX D83 & D84 TAPE DECKS. High quality mono/stereo tape decks. D83, 2 track, for highest fidelity. **£31.10.0**

D84 (identical presentation), 4-track, for most economical use of tape. **£29.8.0**

COLLARO "STUDIO" TAPE DECK. The finest buy in its price range. Operating speeds: 1½, 3½ and 7½ i.p.s. Two tracks. "Wow" and "flutter" not greater than 0.15% at 7½ i.p.s. Long Term Speed Stability better than 0.5%. **£17.10.0**



"STUDIO"

HI-FI STEREO/MONO PRE-AMPLIFIER, Model USP-1. Extremely versatile unit. Gain may be preset over a wide range. Input 2mV-20mV. Output 20mV-2V **£6.17.6**

HI-FI SINGLE CHANNEL AMPLIFIER, Model MA-12. 12W output, wide freq. range, low distortion. **£10.19.6**

TAPE RECORDING AND REPLAY HI-FI AMPLIFIER

Mono model **TA-1M**, Stereo model **TA-1S**. For use with most tape decks. Thermometer type recording indicators, press-button speed compensation and input selection, 3-position bias level and printed circuit construction.



TA-1S

TA-1M **£18. 2.6**
TA-1M & Collaro STUDIO **£30.10.0**
TA-1M & TRUVOX D83 **£47. 2.6**
TA-1M & TRUVOX D84 **£45. 5.0**
TA-1S **£23. 6.0**
TA-1S & STUDIO **£35.14.0**
TA-1S & TRUVOX D83 **£52. 6.0**
TA-1S & TRUVOX D84 **£50. 9.6**



USC-1

STEREO CONTROL UNIT, Model USC-1. Push-button selection, accurately matched ganged controls to ±1dB. Negative feedback, rumble and variable low-pass filters. Printed circuit boards. **£18.18.6**

All prices include free delivery U.K.—Deferred terms available over £10

★ SEND THIS COUPON NOW FOR FURTHER INFORMATION

(Please write in BLOCK CAPITALS)

NAME

ADDRESS

Without obligation please send me

BRITISH HEATHKIT CATALOGUE.....

(Tick here)

FULL DETAILS OF MODEL(S).....

DAYSTROM LTD DEPT RC7 GLOUCESTER . ENGLAND

A member of the Daystrom Group, manufacturers of the WORLD'S LARGEST-SELLING ELECTRONIC KITS

ARMSTRONG AF 208 AM/FM RADIOGRAM CHASSIS

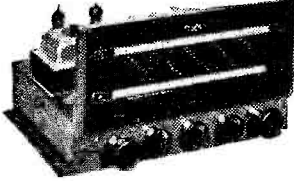

★ Full VHF Band (87-108 Mc/s.) and Medium Band, 187-570M. ★ 7 Valves ★ 5 Watts Output ★ 15dB Negative Feedback ★ Separate wide range Bass and Treble Controls ★ 2 Compensated Pick-up Inputs ★ Frequency Response 30-22,000 c.p.s. ★ 2dB ★ Tape Record and Playback Facilities ★ Continental Reception of Good Programme Value ★ For 3, 7½ and 15 ohm speakers. Send S.A.E. for leaflet.

Price **£22.18.0** Carr. Free

LATEST "E.M.I." 4 SPEED SINGLE RECORD PLAYER

Acos Hi-Fi Pick-up for LP, and/or 78, 7", 10" and 12" records. Silent motor, heavy turntable, auto stop. Completely assembled on base plate. **£6.5.0** post free

SINGLE PLAYER BARGAIN

Ready built complete with B.S.R. TU9 4-speed Gram Pick-up unit. Handsome portable case. 3-watt amplifier with 2 valves and speaker.

Our Price **£8. 19. 6.**

SUMMER SALE PRICES

New boxed VALVES 90-day Guarantee

0Z4	5/-	6K7G	5/-	E8BC80	8/-	PCL82	10/-
1R5	6/-	6K9G	5/-	E8B91	4/-	PCL84	10/-
1S5	6/-	6L6G	8/-	E8C41	8/-	PL81	10/-
1T4	3/-	6N7M	5/-	E8C81	8/-	PL83	8/-
2X2	2/-	6Q7G	6/-	E8F80	9/-	PY80	7/-
3S4	7/-	6SN7	5/-	E8H42	9/-	PY81	8/-
3V4	7/-	6V6G	5/-	E8H81	9/-	PY82	7/-
3Q5	7/-	6X4	5/-	E8F85	5/-	PY83	8/-
5U4	6/-	6X5	6/-	E8F89	8/-	PO25	7/-
5Y3	6/-	12A7T	6/-	E8L32	5/-	SP41	3/-
5Z4	9/-	12A07	6/-	E8L84	7/-	SP51	3/-
6AC7	4/-	12AX7	7/-	EY51	9/-	U22	7/-
6AM6	4/-	12BH7	7/-	EY86	9/-	UBC41	8/-
6AT6	6/-	12K7	5/-	EZ40	7/-	UBC81	9/-
6BA6	7/-	12K8	14/-	EZ80	7/-	UBF89	9/-
6BE6	5/-	12Q7	5/-	EZ81	7/-	UCH81	9/-
6BW6	7/-	25Y5G	9/-	E1148	1/-	UCL82	10/-
6C4	5/-	35L6	9/-	HABC80	10/-	UCL83	12/-
6D6	5/-	35Z4	5/-	HVR2A	5/-	UF89	9/-
6G6	4/-	807	5/-	KT33C	8/-	UL41	9/-
6H6	3/-	954	2/-	KT76	8/-	UY41	7/-
6I5	5/-	DAF96	8/-	MU14	7/-	UY85	7/-
6J6	5/-	DF96	8/-	PCC84	8/-	UR9	7/-
6J7G	6/-	DK96	8/-	PCF80	8/-	VR150	7/-
6K6	5/-	DL96	8/-	PCF82	8/-	WB81	6/-

SETS OF VALVES

DK96, DF96, DAF96, DL96 8/- each or 29/6 set.
1R5, 1T4, 1S5, 3S4 or 3V4 Set of four 19/6

NEW ELECTROLYTICS FAMOUS MAKES

TUBULAR	TUBULAR	FAMOUS MAKES CAN TYPES
1/350v.	2/-	50/350v. 5/6
2/350v.	2/3	100/25v. 3/-
4/450v.	2/3	100/270v. 5/6
8/450v.	2/3	250/25v. 3/-
16/450v.	3/8	500/12v. 3/6
32/450v.	3/8	32+32/350v. 5/-
25/25v.	1/9	32+32/450v. 5/-
50/25v.	2/-	8+16/450v. 3/9
100/25v.	2/-	32+32+32/350v. 7/-
		16+16/450v. 4/3
		64+120/350v. 11/6
		32+32/350v. 4/6
		100+200/275v. 12/6

QUALITY 2-STAGE HI-FI AMPLIFIER

A.C. only, 200-250V Valves ECL82 and EZ80. 3 watt quality output. Mullard tone circuits, bass boost, treble and volume controls. Separate engraved front-panel with de-luxe finish. Heavy duty output transformer 3 ohm. Shrouded mains transformer. Stove enamelled chassis size 6in. x 5in. x 3in. Bargain price **£4.10.0**. Circuit supplied.

COMPLETE RADIO CHASSIS

£4.19.6 post free

4 Mullard valves, 5" speaker, frame aerial. 4 pre-set stations. 1 long, 3 med. wave. Superhet Circuit. Size 9" x 6" x 5½" high. Tested ready for use. 200/250V A.C.-D.C. Mains. Brand New

DE LUXE MODEL

As above but with illuminated dial. Fully tunable over medium wave 200-550 M and long wave 1,000-2,000 M.

Bargain Price **£5.19.6**

MAINS TRANSFORMERS

200/250 AC Post 2/- each

STANDARD 250-0-250, 80 mA., 6.3 v. tapped 4 v. 4 a., Rectifier 6.3 v. 1 a. tapped 5 v. 2 a. and 4 v. 2 a.	22/6
Ditto 350-0-350	29/6
MINIATURE, 200 v. 20 mA., 6.3 v. 1 a. 10/6-	
MIDGET, 220 v. 45 mA., 6.3 v. 2 a.	15/6
SMALL, 220-0-220 v. 50 mA., 6.3 v. 2 a.	17/6
STANDARD, 250-0-250 65 mA., 6.3 v. 3.5 a.	17/6
HEATER TRANS., 6.3 v. 1½ a.	7/6
Ditto 6.3 v. 3 a.	10/6
Ditto 1.4, 2, 3, 4, 5, 6.3 v. 1½ a.	8/6
MULLARD "510" OSRAM 19121, 300-0-300, 120 mA., 6.3 v. 4 a. c.t., 6.3 v. 2 a. tapped 5 v.	38/6
GENERAL PURPOSE LOW VOLT. AGE. Outputs 3, 4, 5, 6, 8, 9, 10, 12, 15, 18, 24 and 30 v. at 2 a.	22/6
AUTO. TRANS. 150 v., 0, 10, 120, 200, 220, 250 v.	22/6
AUTO. TRANS. 500 v., 0, 115, 200, 230, 250 v.	82/6

O.P. TRANSFORMERS. Heavy duty 50 mA. 4/6. Miniature 3V4, etc., 5/9. Small, pentode, 4/6. Multi-ratio push-pull, 7/6. Multi-ratio push-pull 10 w., 15/6. Goodmans heavy duty 10/20 w. 6K push-pull, 30/-; Estone ultra-linear OT/ML 10 w. 45/-; L.F. CHOKES 15/10 H. 60/65 mA. 5/-; 10 H. 85 mA. 10/6; 10 H. 120 mA. 12/6; 10 H. 150 mA. 14/-

TELEVISION REPLACEMENTS

Line Output Transformers from 45/- each, NEW Stock and other timebase components. Most makes available. S.A.E. with all enquiries

FULL WAVE BRIDGE CHARGER RECTIFIERS. 2, 6 or 12 v. 1½ a., 8/9; 2 a., 11/3; 4 a., 17/6. Free charger circuit.

CHARGER TRANSFORMERS. Tapped input 200/250 v. for charging at 2, 6 or 12 v. 1½ a.; 15/6; 2 a., 17/6; 4 a., 22/6.

4 AMP. CAR BATTERY CHARGER with amp. meter Leads, Fuse Case, etc., for 6 v. or 12 v., 69/6.

BOOKS (List S.A.E.)

40 Circuits for Germanium Diodes	3/-
"W.W" Radio Valve Data	6/-
High Fidelity Speaker Enclosures	5/-
Valve and TV Tube Equivalents	9/6
TV Fault Finding	5/-
Quality Amplifiers	4/6
Radio Valve Guide. Books 1, 2, 3 or 4.	5/- each
Transistor Superhet Receivers	7/6
Practical Radio Inside Out	3/6
Master Colour Code	1/6

TINNED COPPER WIRE 16 to 22 swg. ½ lb. 3/-
COPPER ENAMEL WIRE ½ lb. 16 to 22 s.w.g. 2/9, 24 to 30 s.w.g. 3/6, 32 to 40 s.w.g. 4/6

CRYSTAL MIKE INSERT

Precision engineered. Size only 1½" dia. x 1"

ACOS STICK MIKE 39-1 ... 35/-

T.S.L. DE LUXE STICK MIKE ... 25/-

SPEAKER FRET. Gold cloth, 17in. x 25in., 5/-; 25in. x 35in., 10/-; TYGAN, various colours, 52in. wide, from 10/- ft.; 26in. wide from 5/- ft. Samples S.A.E. Expanding Metal, Gold, 12in. x 12in., 6/-

BAKER SELHURST LOUSPEAKERS



12" Baker 15W Stalwart 3 or 15Ω, 45-13,000 c.p.s. 90/-

12" Stereo 12W, 35-16,000 c.p.s. Foam suspension £6.17.6

12" Baker Ultra Twelve, 20 c.p.s. to 25 kc/s £17.10.0

15" Auditorium, Bass Mk II 35W 20 c.p.s. to 12 kc/s. £18

LOUDSPEAKERS P.M. 3 OHM. 2½in. 3in. 4in. 19/6; 5in. Rola, 17/6; 7in. x 4in., 18/6; 4in. Hi-Fi Tweeter, 25/-; 8in. Plessey, 19/6; 6in. Goodmans, 18/6; 10in. R.A., 30/-; 12in. Plessey, 30/-; 10in. x 6in. E.M.I. 27/6; E.M.I. 13½" x 8" 45/-; Stentorian HF1012 10in., 95/-; HF1016, £8. 12in. R.A. 15Ω45/-

CRYSTAL DIODES. G.E.C., 2/-; GEX34, 4/-; OA81, OA70, 3/-; Crystal Coils HAX, 3/-; DRR2, 4/-; CRYSTAL SET BOOKLET 1/-

H.R. HEADPHONES, 4,000 ohms, brand new, 15/-; Low resistance phones, 7/6 pair; SWITCH CLEANER FLUID, squirt spout, 4/6 tin.

C.R.T. BOOSTER TRANSFORMERS

For Cathode Ray Tubes having heater cathode short circuit and for C.R. Tubes with falling emission, full instructions supplied.

TYPE A. LOW LEAKAGE WINDINGS. OPTIONAL 25% and 50% BOOST ON SECONDARY: 2 V. OR 4 V. OR 6.3 V. OR 10.2 V. OR 13.3 V. WITH MAINS PRIMARIES. 10/6.

TWIN GANG CONDENSERS. Transistor 208 pF and 176 pF, with trimmers and screen, 12/6 each; 365 pF, miniature, 1½in. x 1½in. x 1½in., 10/-; 500 pF standard with trimmers, 9/-; midget, 7/6; midget with trimmers, 9/-

SHORT WAVE. Single 10pF, 25pF, 50pF, 75pF, 100 pF, 160 pF, 5 each.

TUNING AND REACTION CONDENSERS. 100 pF, 300 pF, 500 pF, 3/6 each, solid dielectric. CONDENSERS. 0.001 mfd. 7kV T.C.C., 5/6; ditto 20 kV., 9/6; 0.1 mfd. 7 kV., 9/6; 100 pF to 500 pF Micas, 6d.; Tubular 500 v. 0.001 to 0.05, 9d.; 0.1, 1/-; 0.25, 1/6; 0.1/350 v., 9d.; 0.5/500 v., 1/9; 0.01/2,000 v., 1/9

CERAMIC CONDENSERS. 500 v. 0.3 pF to 0.01 mfd., 9d. 0.1/30v., 1/3.

SILVER MICA. 10% 5 pF to 500 pF, 1/-; 600 pF to 3,000 pF, 1/3; close tolerance (plus or minus 1 pF), 1.5 pF to 47 pF, 1/6; ditto 1% 50 pF to 815 pF, 1/9; 1,000 pF to 5,000 pF, 2/-

465 Kc/s. SIGNAL GENERATOR. Total cost 15/-; Uses B.F.O. Unit ZA 30038 ready made. POCKET SIZE 2½in. x 4½in. x 1½in. Slight modifications required, full instructions supplied. Battery 8/6 extra 69 v. + 1½ v. Details S.A.E.

WAVECHANGE SWITCHES

2 p. 2-way, or 2 p. 6-way, long spindle ...	3/6
3 p. 2-way or 1 p. 12-way, long spindle ...	3/6
4 p. 2 way or 4 p. 3-way, long spindle ...	3/6
8 p. 4-way 2 waffer, long spindle ...	6/6
Wavechange "MAKITS". Wafers available: 1 p. 12 waffer, 2 p. 6 waffer, 3 p. 4 waffer, 4 p. 3 waffer, 6 p. 2 waffer, 1 waffer, 8/6; 2 waffer, 12/6; 3 waffer, 16/-; Additional wafers up to 14, 3/6 each extra.	
TOGGLE SWITCHES, s.p., 2/-; d.p., 3/6; d.p.d.t., 4/-; Rotary Toggles, s.p., 3/6, d.p., 4/6.	
JACKS. English open-circuit 2/6, closed-circuit 4/6, Grundig-type 3-pin 1/3	
JACK-PLUGS. English 3/-, Screened 4/-, Grundig 3-pin 3/6.	

JASON F.M. TUNER COIL SET, 29/-

H.F. coil, aerial coil, oscillator coil, two i.f. transformers 10.7 Mc/s., detector transformer and heater choke. Circuit and component book using four 6AM6, 2/6. Complete Jason FMTI kit, Jason chassis with calibrated dial, components and 4 valves, £6.5.0.

VALVEHOLDERS. Pax. int. oct., 4d. EA50, 6d. B12A, CRT, 1/3. Eng. and Amer. 4, 5, 6, and 7 pin, 1/-; MOULDED MAZDA and int. Oct., 6d.; B7G, B8A, B8G, B9A, 9d. B7G with can, 1/6. B9A with can, 1/8. Camic, EF50, B7G, B9A, Int. Oct., 1/-; B7G, B9A cans, 1/- each.

RADIO COMPONENT

Our written guarantee with every purchase. Buses 133 or 68 pass door. S.R. Stn. Selhurst

VOLUME CONTROLS

Long spindles. Midget 5K ohms to 2 Meg.
No. sw. D.P. Sw 3/-
Linear or Log Tracks.

80 ohm CABLE Coax

Semi-air spaced 1/2 in. Stranded core, 6d. yd. 40 yds. 17/6; 60 yds. 25/-
Fringe Quality. Air Spaced 1/4 yd.

EXTENSION SPKR. CONTROL 10 Ohm 3/-

TELESCOPIC CHROME AERIALS 13in. extending to 43in. 8/6 each.

RESISTORS. Preferred values. 10 ohms to 10 meg. 1/2 w. 4d.; 1 w. 4d.; 1 w. 6d.; 1 1/2 w. 8d.; 2 w. 1/-

HIGH STABILITY. 1/2 w. 1%, 2/- Preferred values. 10 ohms to 10 meg. Dicto 5%, 10 ohms to 5 meg. 9d.

5 watt WIRE-WOUND RESISTORS 1/6
10 watt 25 ohms-10,000 ohms (1/3)
15 watt 12/-
12.5K to 50K 10 w 3/-

I.F. TRANSFORMERS 7/6 pair
465 kc/s Slug Tuning Miniature Can. 2in. x 1in. x 1in. High Q and good band width. Data sheet supplied.

WIRE-WOUND Pots.

3 WATT. Pre-set Min. TV Type. All values 10 ohms to 25K, 3/- ea.; 30K, 50K, 4/-; Carbon 30K to 2 meg. 3/-
TRIPLEXERS, Bands I, II, III, 12/6
COAXIAL PLUGS, 1/-; PANEL SOCKETS, 1/-
LEAD SOCKET 2/-; OUTLET BOXES, 4/6
BALANCED TWIN FEEDER, 6d. yd., 80 or 300 ohms
TWIN SCREENED FEEDER, 1/6 yd., 80 ohms.
TRIMMERS. Ceramic 30, 50, 70 pF. 9d.; 100 pF. 150 pF. 1/3; 250 pF. 1/6; 600 pF. 750 pF. 1/9; Philips, 10 pF. 30 pF. 1/- each.

WIRE-WOUND

4 WATT POTS. Long Spindle, Values, 50 ohms to 50K, 6/6; 100K, 7/6

1962 RADIOGRAM CHASSIS



Three Wavebands S.W. 16 m.-50 m. M.W. 200 m.-500 m. L.W. 800 m.-2,000 m.
Five Valves Latest Mullard ECH81, EF89, EBC81, EL84, EZ80

12-month Guarantee. A.C. 200-250V, 4-way switch, Short-Medium-Long-Gram, A.C.C. and Negative Feedback, 4.2 watts. Chassis 13 1/2" x 5 1/2" x 2 1/2". Glass dial size 10" x 4 1/2", horizontal or vertical. Two Pilot Lamps. Four Knobs, Walnut or Ivory. Aligned and calibrated. Chassis isolated from mains.

BRAND NEW £9.10.0 Carr. 4/6
Matched Speakers 8" 17/6; 10" 25/-; 12" 30/-

BLACK CRACKLE PAINT. Air drying, 3/- tin.
NEON MAINS TESTER SCREWDRIVER, 5/-
SOLDER RADIOGRADE, 4d. yd., 1/2 lb. 5/-

HIGH GAIN TV PRE-AMPLIFIERS

BAND I B.C.
Tuneable channels 1 to 5. Gain 18 dB. ECC84 valve. Kit price 29/6 or 49/6 with power pack. Details 6d. (PCC84 valves if preferred.)
BAND III I.T.A.—Same prices
Tuneable channels 8 to 13. Gain 17 dB.

PAXOLIN PANELS, 1/2 in. x 10 in. x 8 in., 2/-

MINIATURE CONTACT COOLED RECTIFIERS. 250 v. 50 mA, 7/6; 250 v. 60 mA, 8/6; 250 v. 85 mA, 9/6. 200 mA, 21/-; 300 mA, 27/6. Full Wave Bridge 250V, 75mA, 10/-; 120mA, 13/-
SELENIUM RECT. 300 v. 85 mA, 5/-
COILS. Wearite "P" type, 3/- each. Osamor Midget "Q" type, adj. dust core from 4/- each. All ranges.
TELETRON D.W.R. L & Med. T.R.F. with reaction, 4/-; Med. only DR, 3/6.
FERRITE ROD AERIALS. M.W., 8/9; M. & L., 12/6.
FERRITE ROD AERIALS. L & M. for transistor circuits, 10/- each. FERRITE RODS 8in. x 1/2 in., 3/-; 8in. x 3/8 in., 3/-; 6in. x 3/8 in., 3/-

ALUMINIUM CHASSIS. 18 s.w.g. Plain, undrilled. 4 sides, riveted corners. Lattice fixing holes, 2 1/2 in. sides. 7in. x 4in., 4/6; 9in. x 7in., 5/9; 11in. x 7in., 6/9; 13in. x 9in., 8/6; 14in. x 11in., 10/6; 15in. x 14in., 12/6; 18in. x 16in. x 3in., 16/6.
ALUMINIUM PANELS. 18 s.w.g., 12in. 12in. 4/6; 14in. x 9in., 4/-; 12in. x 8in., 3/-; 10in. x 7in., 2/3. 8in. x 6in., 2/-

H.F. CHOKES, 2/6. Osamor QCI 6/9.
T.R.F. COILS A/HF, 7/- pair; HAX, 3/-, DRR2, 4/-
ALADDIN FORMERS and cores. 1in. 8d., 1in. 10d.
0.3in. FORMERS 5937 or 8 and cans TV1 or 2, 1in. sq. x 2 1/2 in. or 1in. sq. x 1 1/2 in., 2/- with cores.
SLOW MOTION DRIVES. Epicyclic ratio 6-1, 2/3.
SOLON IRON, 25 w., 200 v. or 230 v. 24/-
PRECISION Sub-miniature Iron, 200 or 240 v, 29/6:

4 TRANSISTOR PUSH-PULL AUDIO AMPLIFIER

Size 3 x 1 1/2 x 7/8
A ready built miniature push-pull amplifier with input and output transformers, 4 transistors. Ideal for use with record players, intercoms, etc. Complete with full instructions and circuit.
PRICE 52/6 9v Batt. 2/3. 2 1/2" SPEAKER 15/-

MAINS DROPPERS. Midget. With adj. sliders:

0.3A, 1,000 ohms 5/-; 0.2A 1,200 ohms, 5/-; 0.1A 2,000 ohms, 5/-
LINE CORD. 0.3 A 60 ohms per foot, 0.2 A 100 ohms per foot, 2-way, 1/- per foot; 3-way 1/- per foot.
MIKE TRANS. 50:1, 3/9.
P.V.C. CONN. WIRE, 8 colours, 2d. yd.
SLEEVEING, 1 or 2 mm, 2d.; 4 mm, 3d.; 6 mm, 5d. yd.

AMERICAN "BRAND FIVE" PLASTIC RECORDING TAPE

Double Play 7" reel, 2,400 ft.	60/-	Spare Plastic Reels
5" reel, 1,200 ft.	37/6	
Long Play 7" reel, 1,800 ft.	35/-	3" 1/6
5 1/2" reel, 1,200 ft.	23/6	4" 2/-
5" reel, 900 ft.	18/6	5" 2/-
Standard 7" reel, 1,200 ft.	25/-	5 1/2" 2/-
5" reel, 600 ft.	16/-	7" 2/6

"Instant" Bulk Tape Eraser and Head Defluxer, 200/250V A.C. 27/6. Leaflet S.A.E.

QMAX CHASSIS CUTTER

The cutter consists of four parts: a die, a punch, an Allen screw and key.
1 1/2" 14/6, 1 1/4" 14/9, 1 1/8" 15/6, 1 1/2" 15/9, 1" 17/6, 1 1/8" 17/6, 1 1/4" 20/-, 1 1/2" 20/6, 1 1/8" 22/6, 2" 34/3, 2 1/2" 37/9, 2 1/4" 44/3, 1" square 31/6, 1 1/2" square 28/-

"REGENT" 4 VALVE "96" RANGE VALVES

Kit Price £6.6.0
carr. 4/-



PRINTED CIRCUIT BATTERY PORTABLE KIT

Medium and long wave. 7 x 4 in. Speaker. Printed Circuit. Components clearly identified with assembly instructions. Ferrite Aerial. Resine covered cabinet. Size 12 in. x 8 in. x 4 in. Batteries used B125 (L5512) and AD35 (L5040), 10/9 extra. Instructions 9d. (Free with kit).

MONARCH RECORD PLAYER



BUILD IT YOURSELF using 4-SPEED BSR MONARCH AUTOCHANGER READY BUILT 3W AMPLIFIER, HANDSOME PORTABLE CASE, HIGH FLUX LOUDSPEAKER. FULL INSTRUCTIONS
Total Price £12.10.0
Carr. and ins. 5/-

RECORD PLAYER BARGAINS

4 Speed Autochangers: POST 2/- each
BSR, U.A.14.....£7.10.0
BSR, U.A.12 Stereo/Monaural.....£8.5.0
Garrard Autostim Changer.....£7.9.0
Garrard 209 Changer.....£9.9.0
4 Speed Single Players:
Garrard TA Mk. II.....£8.0.0
Garrard 4 HF Transcription.....£17.19.6
All Sapphire Stylus available from 6/-
All Crystal Cartridges available from 21/-
AUTOCHANGER ACCESSORIES
Amplifier player cabinets with cut boards, 63/-
2-valve amplifier and 6 1/2" speaker for above, ready mounted on baffle, 12in. x 7in., 3in. deep, Wired and tested ready for use. £4.15.0

ARDENTE TRANSISTOR TRANSFORMERS

D3035, 7.3 CT:1 Push Pull to 3 ohms for OC72, 9/6.
3034, 1.75:1 CT. Push Pull Driver for OC72, 9/6.
D3058, 11.5:1 Output to 3 ohms for OC72, etc., 9/6.
D167, 18:2:1 Output to 3 ohms for OC72 etc., 12/-
D239, 4.5:1 Driver, 1in. x 1in. x 1in., 10/-
D240, 8.5:1 Driver, 1in. x 1in. x 1in., 10/-
ARDENTE TRANSISTOR VOLUME CONTROLS. Type VC1543, 5K with switch, dia. 9in., 8/-
Type VC1760, 5K with switch, dia. 7in., 10/6.
DEAF AID EARPIECE Xtal or magnetic 7/6.

WEYRAD COILS AND TRANSFORMERS FOR A 2-WAVE TRANSISTOR SUPERHET WITH PRINTED CIRCUIT AND FERRITE ROD AERIAL

Long and Medium Wave Aerial—RA2W. On 6in. rod, 7/8 in. diameter, 208 pF. tuning, 12/6.
Oscillator Coil P50/1AC. Medium wave. For 176 pF. tuning, 5/4. Car aerial coil 1/-
1st and 2nd I.F. Transformer—P50/2CC. 470 kc/s. 1/2 in. diameter by 1/2 in. high, 5/7.
3rd I.F. Transformer—P50/3CC. to feed diode detector, 6/-
24-Fixed resistors 10/6.
Driver Transformer—LFD72, 1 1/2 in. x 1in. x 1 1/2 in., 9/6. 16-Fixed condensers 21/-
Printed Circuit—PCAL. Size 2 1/2 in. x 8 1/2 in. Ready drilled and printed with component positions, 9/6. Jackson 00 gang 12/6.
35 ohm Speakers, 7in. x 4in., 25/-; 3in., 19/6.
Wavechange Switch 3/6. Volume Control 4/6.
Set of 6 Mullard Transistors and diode, 42/6.
These components are approved by transistor makers and performance is guaranteed.
Constructor's Booklet with full details, 2/-

NEW MULLARD TRANSISTORS

Audio OC71 ... 6/6 R.F. OC44 ... 8/9
OC72 ... 7/6 OC45 ... 8/6
Sub-miniature Electrolytics (15 V.) 1 mfd. 2 mfd., 4 mfd., 5 mfd., 8 mfd., 16 mfd., 25 mfd., 30 mfd., 50 mfd., 100 mfd., 2/6.
Diodes OA71, OA81, 3/-; GEX 34 4/-

B.B.C. 2 Transistor, M.W. and L.W. Radio Kit, 22/6. Earpiece, 7/6. Battery 2/3.

6 TRANSISTOR RADIO MED. & LONG WAVE KIT
First-class components to make a 6-transistor 2-waveband superhet chassis. Ideal for portable or table radio. All parts including BVA transistors ferrite aerial, printed circuit, 8 1/2 in. x 2 1/2 in., but EXCLUDING speaker and cabinet. Simple instructions, 1/6 (Free with kit). 35 ohm 7in. x 4in. Speaker 25/- extra. £45.0

SPECIALISTS

337 WHITEHORSE ROAD
WEST CROYDON Telephone THO 1665

P. & P. charge 1/-, over £3 post free. C.O.D. 2/- (Export welcome. Send remittance and extra postage)

HOME RADIO OF MITCHAM

187 London Road,
Mitcham, Surrey. MIT 3282
Shop Hours: 9.0 to 6.0 p.m.
(Weds. 1.0 p.m.)

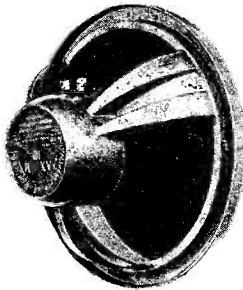

TWO NEW GOODMANS SPEAKERS

AXIETTE 8"

6 watts 15 ohms die-cast chassis with latest FEROPA 11 high-flux magnet. Price now £5.4.6. post 1/6.

AXIOM 10"

10 watts 15 ohms 10" die-cast chassis with new FEROPA 11 high-flux magnet. Price now £5.16.8 post 1/6.

HI-FI ENTHUSIASTS

Have you tried CEIBALINE? This is the new super sound-absorbent material with self-adhesive backing designed for internal lining the inside surfaces of loudspeaker enclosures. Easily cut to shape with scissors. PRICE 2/6 sq. ft. Please add 1/6 postage to order.

BUILD A MARTIN RECORDAKIT

It is easy to build a quality tape recorder with one of these completely trouble-free kits. The high quality amplifiers are already assembled and wired on to printed circuit boards, and a few simple tools are all that is required to build. Send 3d. stamp for fully illustrated leaflet.

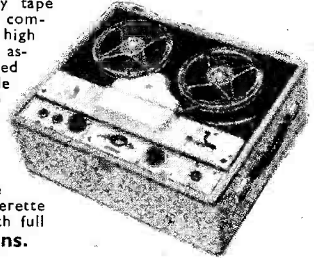

RECORDAKIT "A"

Four-track BSR deck complete with amplifier, two-tone leatherette covered case and speaker with full instructions. PRICE 24 gns.

RECORDAKIT "B" Two-track BSR deck complete with amplifier, two-tone leatherette covered cabinet and speaker with full instructions. PRICE 21 gns.

RECORDAKIT "C" Two-track 3-speed Collaro Studio tape deck complete with high quality amplifier, two-tone leatherette covered case and hi-fi 9" x 5" speaker with full instructions. PRICE £29.18.0

SPEAKER AND EQUIPMENT CABINETS

WB STENTORIAN CABINETS. We stock the full range of these beautifully made and finished cabinets including the new contemporary "Prelude" models. Fully illustrated leaflet will be sent on receipt of 3d. stamp. These cabinets are supplied packed flat and can be completely assembled in a few minutes with only a screwdriver.

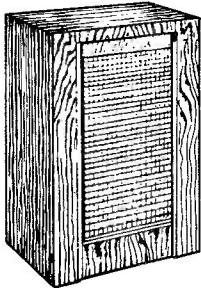

BASS REFLEX CONSOLE

Designed to provide the utmost quality from any 10" or 12" unit with provision for tweeter if desired. Size 32" x 22" x 16". Finished in polished walnut and complete with speaker covering.

PRICE £10.10.0
part carriage 3/6

JUNIOR HI-FI CONSOLE

Accommodates most makes of tape deck or record player, amplifier, pre-amp. and tuner. Also provides ample storage space in compartment at bottom for tape or records. Motor board and front panel are blank ready for cutting. Size 33" x 20" x 16". Finished in polished walnut.

PRICE £12.12.0
part carriage 3/6

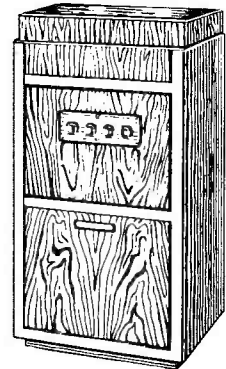

ALSO IN STOCK. Prelude Bass reflex console 12 gns. Prelude Bass reflex corner console 14 gns. Prelude Bass reflex corner console 11 gns. Prelude Hi-Fi table equipment cabinet 10 gns. (Legs 30/- extra.) Senior Bass reflex corner console 12 gns. Junior Bass reflex corner console 10 gns. Also CABINETS by HEATHKITS and RECORD HOUSING.

WE ARE ACTUAL STOCKISTS FOR

HEATHKITS

SOME MODELS NOW ON DEMONSTRATION

EDDYSTONE RECEIVERS

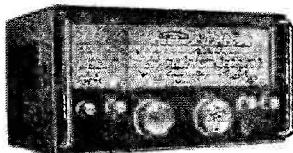

Full range of EDDYSTONE communications receivers and components in stock. **MODEL 870A.** Compact high performance set, ideal for travellers. PRICE £32.2.0 **MODEL 840C.** Full communications receiver. 8 valves including R.F. stage. PRICE £58.

MODEL 940. The last word in high performance long range receivers. 13 valves. PRICE £125.0.0.

898 SLOW MOTION DIAL

Without doubt the finest dial assembly available. Essential for really high grade receivers. Tuners, test gear, transmitters, etc. Precision cut Swiss gears give velvet smooth 110 to 1 reduction drive and vernier scale gives exact logging positions. Size 9 1/2" x 5 3/4". Complete with knob and fittings. PRICE £3.11.4 post 1/6 (Overseas post 7/6)

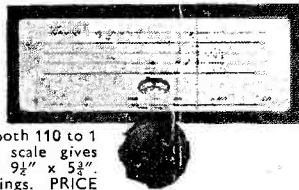

NOMBREX SIGNAL GENERATOR

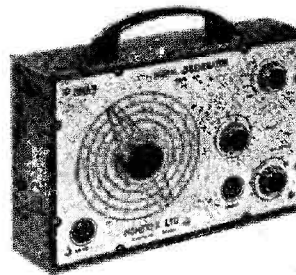

Completely portable transistor signal generator covering 200 kc/s to 220 Mc/s in 8 ranges. Built to highest standards with quality components and the best value in test equipment in the world. Accuracy on all ranges better than 2%. R.F. output modulated or unmodulated. Audio output of 1 kc/s. Weighs under 2lb. Size only 6 1/2" x 4 1/2". An essential instrument for all engineers and constructors. PRICE £7.12.0 complete with battery. Post and packing 3/6

SUPER CATALOGUE!

166 pages
600 illustrations
5000 items
2/6 post 9d.

METERS

A fortunate purchase enables us to offer a limited number of high grade meter movements at very competitive prices. 50 micro-amp moving coil 900 ohms meter made by Sangamo Weston, size 3" x 2 1/4" x 1 1/8". PRICE 19/6 post 1/6. 100 micro-amp 3" dia. panel mounting moving coil meter, scaled 0-100, made by Sangamo Weston. PRICE 30/- post 1/6

THE **Radio Constructor**

Incorporating **THE RADIO AMATEUR**

JULY 1962

Vol. 15, No. 11
Published Monthly
Annual Subscription 29/-
(including postage)

*Editorial and
Advertising Offices*
57 MAIDA VALE LONDON W9

Telephone
CUNningham 6141
(2 lines)

Telegrams
Databux, London

Suggested Circuits No. 140: Experimental Remote Control with Capacitive "Memory", by G. A. French	884
Can Anyone Help ?	888
Precautions in the Use of Voltage Stabilisers, by J. B. Dance, M.Sc.	889
2-Valve Stereo Amplifier, by B. W. Hollinshead	890
Why is F.M. Better ?	892
Transistorised Single Sideband Transmitter, by R. J. Barrett, GW3DFF	893
Understanding Radio, Part 11, by W. G. Morley	897
The Nomotron, by J. Anderson	904
News and Comment	907
In Your Workshop	908
Test Instruments Need Testing, by G. A. W. Partridge	914
Book Review	915
The "Highwayman" Transistorised Car Radio, described by E. Govier	916
Certification of High Fidelity Amplifiers	925
A Family Radiogram, Part 2, by A. S. Carpenter	927
Radio Topics, by Recorder	935

© Data Publications Ltd, 1962

CONTENTS may only be reproduced after obtaining prior permission from the Editor. Short abstracts or references are allowable provided acknowledgment of source is given.

CONTRIBUTIONS on constructional matters are invited, especially when they describe the construction of particular items of equipment. Articles should be written on one side of the sheet only and should preferably be typewritten, diagrams being on separate sheets. Whether hand-written or typewritten, lines should be double spaced. Diagrams need not be large or perfectly drawn, as our draughtsmen will redraw in most cases, but all relevant information should be included. Photographs should be clear and accompanied by negatives. Details of topical ideas and techniques are also welcomed and, if the contributor so wishes, will be re-written by our staff into article form. All contributions must be accompanied by a stamped addressed envelope for reply or return, and should bear the sender's name and address. Payment is made for all material published.

OPINIONS expressed by contributors are not necessarily those of the Editor or the proprietors.

TRADE NEWS. Manufacturers, publishers, etc., are invited to submit samples or information of new products for review in this section.

TECHNICAL QUERIES must be submitted in writing. We regret that we are unable to answer queries, other than those arising from articles appearing in this magazine; nor can we advise on modifications to the equipment described in these articles.

CORRESPONDENCE should be addressed to the Editor, Advertising Manager, Subscription Manager or the Publishers, as appropriate.

REMITTANCES should be made payable to "DATA PUBLICATIONS LTD."

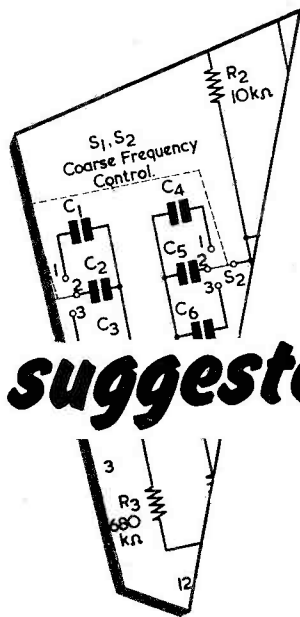

suggested circuits

No. 140 Experimental Remote Control with Capacitive "Memory"

IN LAST MONTH'S ISSUE, SUGGESTED Circuits No. 139 dealt with control circuits employing light dependent resistors as sensing elements. It was pointed out that a typical L.D.R., the ORP12, is capable of operating a relay directly, and that an attractive application would consist of having one or more L.D.R.s mounted on the front of a television receiver each controlling its own relay. With suitable ancillary circuitry, the control of contrast, brilliance or volume could then be achieved by illuminating the appropriate L.D.R.s with a reasonably powerful torch from a distance of 6ft or so.

The writer has since experimented with circuits capable of translating the control signals from the L.D.R. relays into a form suitable for operating television receiver circuits. The results of these experiments are described in the present article, which discusses a device capable of remotely controlling brilliance and contrast (in receivers where contrast control is given by a varying voltage positive of chassis) by means of torch-illuminated L.D.R.s. Other applications for the device are quite feasible, but the present article refers only to that for television receivers.

It should be emphasised that the circuits discussed this month are of a definitely experimental nature and that they take advantage of characteristics in the "memory" component (a high-value electrolytic capacitor)

which is not covered in the normal specifications for a component of this nature. This means that by no means all capacitors of the type employed by the writer could be guaranteed to work satisfactorily. Because of this point, the circuits described should be attempted only by the more experienced constructor who fully understands the principles involved. Also, the methods discussed for coupling the control circuit into a television receiver are illustrative only, and should be put into practice only by a constructor conversant with television functioning.

A "Memory"

Television contrast and brilliance controls employ potentiometers to enable continuously variable adjustments to be made. On the other hand, the only information available from an L.D.R.-controlled relay is either that it is "on" or that it is "off". The immediate problem in a torch-operated L.D.R. remote control system consists, therefore, of translating the information from the controlled relays into a continuously variable form.

A simple solution consists of employing two L.D.R.s and relays, these connecting to an electric motor such that, when one L.D.R. is illuminated the motor rotates in one direction, and when the other L.D.R. is illuminated the motor rotates in the reverse direction.

The circuits presented in this series have been designed by G. A. FRENCH, specially for the enthusiast who needs only the circuit and essential data

When neither L.D.R. is illuminated the motor is at rest. The motor is then coupled, via a reduction gear, to the brilliance or contrast potentiometer. To operate the system, the appropriate L.D.R. is illuminated, the illumination ceasing when the motor has rotated the potentiometer to the desired new position. Despite its apparent clumsiness, a system of this nature is not at all unattractive, particularly when it is remembered that there are a considerable number of low-cost imported d.c. motors on the market at present which are quite capable of carrying out the job.* An arrangement of this type could also be used for volume control, or for the adjustment of any other potentiometer.

Another mechanical solution would be given by a step-by-step motor, this advancing the controlled potentiometer by one step each time the appropriate L.D.R. is illuminated. In this case the individual steps should preferably be small and the motor would need to be reversible. Such a system is not, at first sight, attractive.

The writer felt that an electronic means of controlling contrast or brilliance would be of interest. Two L.D.R.s and relays would be re-

* A typical motor capable of running from 1.5 or 3 volts is, for instance, available from M.R. Supplies Ltd., 68 New Oxford Street, London, W.C.1, at 5s. retail. See "Suggested Circuits No. 128. An Experimental Remote Control Servo System", *The Radio Constructor*, July 1961.

quired, as with the motor, these varying the condition of an electronic component which functioned as a "memory". In practice the component would be a capacitor, whereupon one L.D.R.-controlled relay could increase its charge, whilst the other would decrease its charge. When neither L.D.R. was illuminated the capacitor would retain the charge last imparted to it. The voltage across the plates of the capacitor could then be used to control the brilliance and contrast circuits of the television receiver.

The Capacitor

It was considered that the device employing the capacitor would only be of practical use if the capacitor could hold its charge within close limits over a period of an hour. This infers a large capacitance and a very large leakage resistance, especially when it is remembered that the time constant of a CR circuit (microfarads multiplied by megohms) defines the time taken for the voltage across the capacitor to drop to 37% of its initial value and that the slope of the discharge curve is greatest immediately after the applied charging voltage has been removed. The present application requires, over the period of an hour, a discharge in the capacitor much smaller than that represented by the time constant figure.

A polystyrene component would appear to be a good choice for the capacitor because of its very high leakage resistance. However, it was intended that the capacitor be employed in conjunction with normally available valves and other components, and leakage in the latter would still necessitate a high value in the capacitor. A polystyrene capacitor having the requisite high value would be very expensive, and it was decided to investigate an electrolytic component instead.

Fig. 1 illustrates the leakage current for varying values of applied e.m.f. for the capacitor employed by the writer. The capacitor was a Plessey component, type CE7036, and had a value of $2,000\mu\text{F}$ with a working voltage of 12. As it had been in store for a considerable time since manufacture, it was initially formed for an hour by connecting it to a 12 volt supply via a $10\text{k}\Omega$ resistor. The readings for the curve of Fig. 1 were then taken.

At 12 volts applied e.m.f., leakage current was $200\mu\text{A}$, this dropping to $60\mu\text{A}$ at 9 volts, and $10\mu\text{A}$ at 6 volts. Leakage current at 3 volts was less than $0.5\mu\text{A}$ and was negligibly small at 1.5 volts. A current of $0.5\mu\text{A}$ at

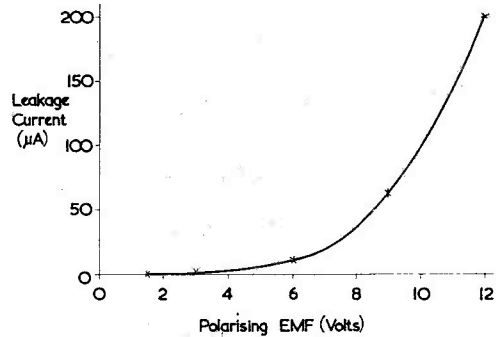

Fig. 1. Leakage current in the $2,000\mu\text{F}$ capacitor checked by the writer

3 volts indicates a leakage resistance of $6\text{M}\Omega$ and a consequent time constant (for $2,000\mu\text{F}$) of 12,000 seconds. This was sufficiently encouraging for a more practical arrangement to be tried out.

The capacitor was connected up in the C_1 position of Fig. 2, its positive plate coupling to the grid of the cathode follower $V_{1(a)}$. The voltage on the cathode of $V_{1(a)}$ is applied to the grid of $V_{1(b)}$ via R_3 , the latter being included to limit grid current should $V_{1(a)}$ cathode go positive of chassis. A 12AT7 was employed in the circuit since this valve has a relatively short grid base and should in consequence give large variations in anode current for small changes in grid voltage. An h.t. voltage of 200 was employed, thereby simulating conditions in a television receiver, and an additional

45 volts negative for the cathode follower was provided by a battery.

The 9 volt tapping into the battery for the negative plate of C_1 was decided upon after initial checks. It was intended to operate the capacitor with voltages across its plates ranging from zero to 3 volts; whilst, with the particular 12AT7 employed, the cathode of $V_{1(a)}$ was 4 volts positive of its grid. The 9 volt tapping would then result in a range of voltages on the cathode of $V_{1(a)}$ covering 5 to 2 volts negative of chassis according to the charge in C_1 . These voltages would be applied to the grid of $V_{1(b)}$ and give corresponding changes in anode current.

The results obtained with the circuit of Fig. 2 are illustrated in Fig. 3, which shows the anode current in $V_{1(b)}$ over an hour and a half for differing charges in C_1 . The curves

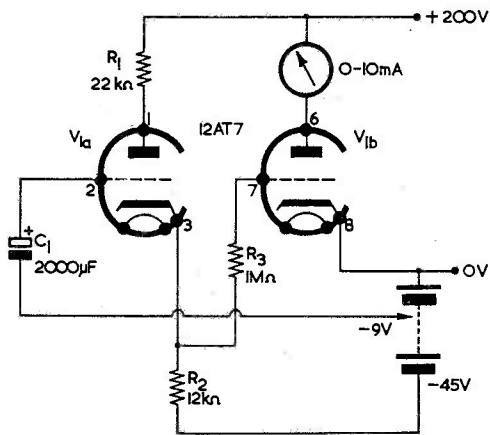

Fig. 2. An experimental "memory" circuit

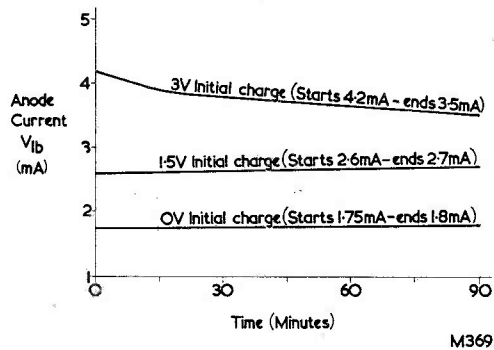

Fig. 3. Results obtained with the circuit of Fig. 2

were obtained by initially charging C_1 to 3 volts and 1.5 volts, and by discharging it completely. Anode current readings were then taken from time to time and the curves drawn. Results with the initial 3 volt charge are obviously unsatisfactory since, at the end of the period, anode current has dropped from 4.2 to 3.5mA. On the other hand, the only change in anode current for

the 1.5 volt initial charge condition is an increase from 2.6 to 2.7mA, and for the initially discharged condition is an increase of 1.75 to 1.8mA. This is satisfactory for all practical requirements and infers that, in this particular case, the $2,000\mu\text{F}$ capacitor could function as a reliable "memory" over periods of an hour or more for voltages ranging from zero to 1.5. In practice

it would probably be possible to get reliable results up to 2 volts, but no readings were taken for this voltage. The reason for the slight increase in anode current over the zero and 1.5 volt periods is not known; although it may have been due to reverse grid current in the valve or to a gradual increase in emission in $V_{1(b)}$.

The circuit of Fig. 2 would appear to offer a practical arrangement wherein television receiver functions may be controlled by the near-constant potential appearing across C_1 . As will be readily understood, this point can only be claimed with the particular electrolytic capacitor used by the writer. Other high-value capacitors may have even lower leakage currents than those found here and may allow the capacitor to function reliably over a wider range of voltages. Alternatively, capacitors may be encountered whose leakage currents are higher, and which would be quite useless for the present purpose. It can be suggested, nevertheless, that at least some capacitors having values of the order of $2,000\mu\text{F}$ or more should give results as good as those experienced by the writer.

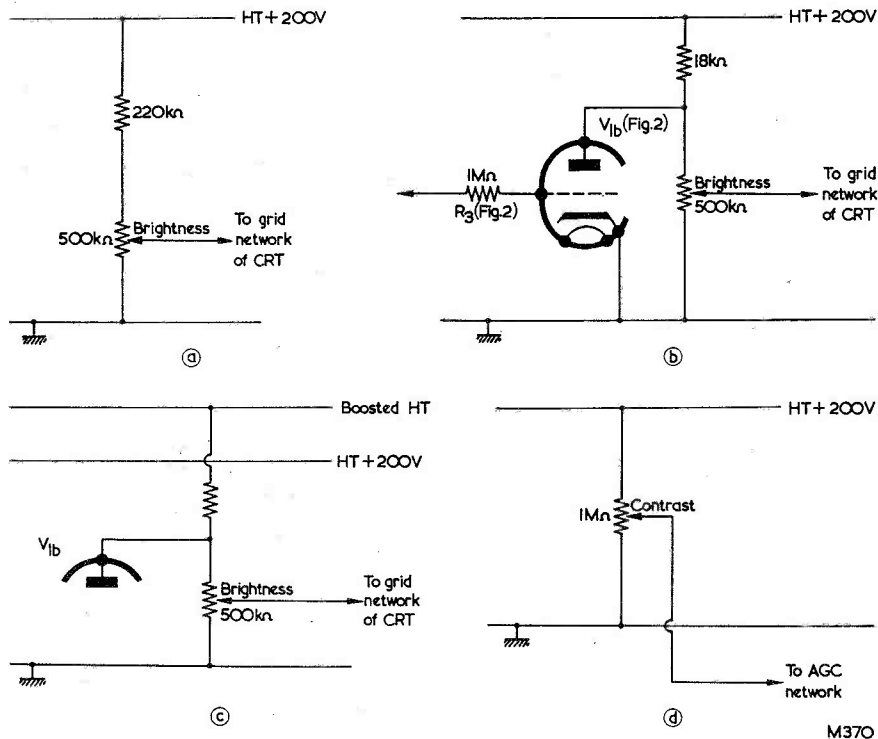

Fig. 4. (a). A typical brightness control circuit

- (b). A suggested modification which allows brightness to be controlled by the charge on C_1 of Fig. 2
- (c). A greater range of brightness control may be achieved by returning the upper resistor to the boosted h.t. line
- (d). A commonly encountered contrast control circuit which may similarly be modified for remote control

In the circuits which follow, it is assumed that the range of control available is that given by a capacitor having the same characteristics as that discussed up to now.

Television Control Circuits

The manner in which a circuit similar to that of Fig. 2 may be connected into the control circuits of a television receiver depends to a considerable extent upon the form the latter take. Nevertheless, some suggestions are now given which may be acted upon by the more experienced constructor. An anode current ratio of 1 : 1.5 in $V_{1(b)}$ will be assumed (i.e. 1.8 to 2.7mA, as in Fig. 3), although a much greater current ratio for the same change in grid voltage could be given by using sharp cut-off valves such as the 6BH6 in the $V_{1(b)}$ position.

Fig. 4 (a) illustrates a typical brightness control circuit in a television receiver. A potential of some 140 volts appears at the upper end of the potentiometer, and 0.3mA flows through both this and the fixed resistor. Control of brilliance could then be obtained by adding $V_{1(b)}$ in the manner shown in Fig. 4 (b). Assuming a control current range of, say, 3 to 4.5mA in $V_{1(b)}$, and an 18k Ω resistor in place of the 220k Ω component, the upper end of the potentiometer can then be varied through some 27 volts. A much wider range of control would be given by returning the upper resistor (with an increased value) to the boosted h.t. line, as in Fig. 4 (c). Care should be taken to ensure that these circuits do not allow excessive positive voltages to be applied to the grid of the cathode ray tube.

Fig. 4 (d) shows a contrast control circuit frequently encountered in current television receivers. The potentiometer passes a varying positive voltage to the a.g.c. network, the a.g.c. line being prevented from going positive of chassis by a clamp diode. By inserting a fixed resistor in series with the upper terminal of the potentiometer, either the control arrangement of Fig. 4 (b) or (c) could be employed.

The Supply Circuit

The circuit of Fig. 2 has the disadvantage that a 45 volt battery is used, and this is obviously undesirable in a practical arrangement. There is a second disadvantage also, this being given by the fact that if the 200 volt supply is switched off before the 45 volt supply the cathode of $V_{1(a)}$ goes negative of chassis and causes C_1 to be discharged via the cathode-grid diode of this valve. The same can happen if, after the

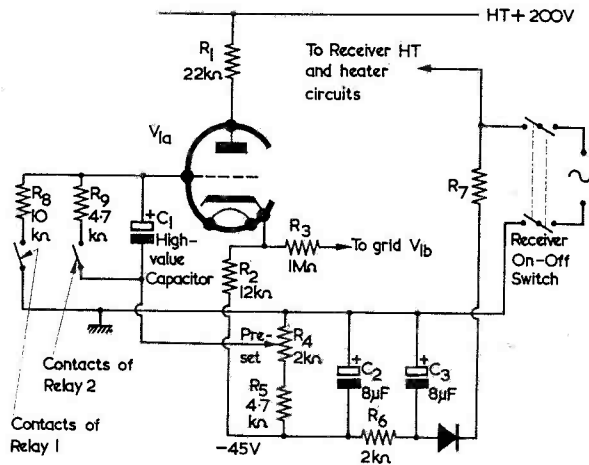

M371

Fig. 5. A suggested power supply circuit for C_1 and $V_{1(a)}$. Relays 1 and 2 are controlled by light dependent resistors

valve heaters have warmed up, the 200 volt supply is applied after the 45 volt supply. Apart from possible damage to the capacitor resulting from the reverse voltage applied to it, there is the nuisance value that this effect causes the capacitor to lose the charge it held before switching off, and that the charge has to be re-set to the requisite level by the appropriate L.D.R. control when the receiver is switched on again.

A suggested power supply circuit for C_1 and $V_{1(a)}$ suitable for television receivers employing selenium

or silicon h.t. rectifiers is shown in Fig. 5. An auxiliary power supply provides 45 volts negative of chassis and, since the current it provides is only of the order of 10mA, it can have low value smoothing capacitors. In consequence, its voltage should decay at a quicker rate than that of the main h.t. supply when the receiver is switched off. There should be little risk of discharging C_1 after switching on because both the 200 and 45 volt supplies appear before the valves warm up. The value of R_7 in the diagram is found empirically, 2kn, and is that which allows a

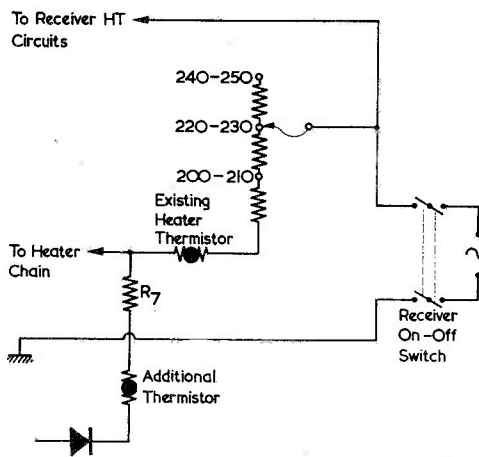

M372

Fig. 6. A simple method of delaying the appearance of the 45 volt supply after switching on

rectified voltage of 45 to appear across C_2 .

The negative plate of C_1 is now returned to the slider of the pre-set potentiometer R_4 instead of to a fixed tap in the battery. R_4 is set up such that $V_{1(b)}$ anode current varies over the desired range corresponding to the range of usable voltages across C_1 .

C_1 is charged and discharged by Relay 1 and Relay 2 respectively. When the contacts of Relay 1 are closed, the positive plate of C_1 is coupled to chassis via R_8 . When Relay 2 is closed it is discharged via R_9 . R_8 is given a higher value than R_9 since the charging voltage available will normally be greater than 3 volts (it depends on the setting of R_4) and it is desirable to make charge and discharge rates approximately the same.

With receivers having thermionic valve h.t. rectifiers it is necessary to

ensure that C_1 does not discharge due to the appearance of the 45 volt supply before the h.t. supply. There are several thermal devices which can delay the appearance of the 45 volt supply, and any of these can be employed. A simple solution would consist of a thermistor in series with R_7 of Fig. 5, further delay being obtained by taking the a.c. supply after the heater thermistor, as in Fig. 6.

Conclusion

In conclusion, it must be reiterated that the circuits described in this month's article are entirely of an experimental nature and that they are best attempted by the more experienced constructor who understands the principles involved. The circuit of Fig. 2 and the curves of Fig. 3 are the result of practical experimental work by the author.

The most important component

is, obviously, the high value electrolytic capacitor C_1 and it would be pointless to attempt any further work until the leakage current of the particular component chosen by the constructor has been initially measured and found satisfactory. It would also be very desirable to employ the capacitor in an experimental set-up such as that of Fig. 2 before trying it in a working circuit. It is interesting to note that leakage current in the sample checked was satisfactorily low at a small fraction of the working voltage, and this could indicate that a greater range of operating voltages would be given by a capacitor with a higher working voltage. It has to be re-stated also that all electrolytic capacitors will not exhibit the low leakage currents encountered in the writer's sample and that some selection may be necessary before a suitable component is found.

CAN ANYONE HELP?

Requests for information are inserted in this feature free of charge, subject to space being available. Users of this service undertake to acknowledge all letters, etc., received and to reimburse all reasonable expenses incurred by correspondents. Circuits, manuals, service sheets, etc., lent by readers must be returned in good condition within a reasonable period of time

3FP7 Tube.—P. Booth, 38 West Street, Farnham, Surrey, is in urgent need of information in respect of working voltages and the base connections for this tube.

* * *

RF Unit Type 26.—S. Jesson, 181 Kings Acre Road, Hereford, would like to obtain the circuit diagram of this unit.

* * *

"S" Band Signal Generator.—P. W. Fairlamb, 93 Beach Road, Cleveleys, Blackpool, Lancs., would like to obtain the manual for this equipment. The case is marked with the legend G210-AP53920B and it is believed that this is an ex-Admiralty unit.

* * *

Monitor Type 33.—J. H. Cater, 30 Junction Road, Blackburn, Victoria, Australia, is seeking for the circuit of this ex-Air Ministry unit. Marked 10T/564, it has a VCR138 tube and it is hoped to convert the unit into a c.r.o. Willing to pay for photostat copies.

* * *

"The Radio Constructor", April 1950.—N. Whitelegg, 4 Laverdene Road, Totley, Sheffield, urgently requires this issue of the magazine which contained an article on conversion of the R1155 receiver.

* * *

Analogue or Digital Computers.—G. R. Gaiger, 132 Westbourne Street, Hove 3, Sussex, requires to purchase or borrow and relevant data, especially circuitry (with component values) of any home-built or designed computers either transistor, or preferably valve-operated types.

Indicator Unit 277.—D. Scarlett, 26 Queens Avenue, London, N.20, wishes to obtain any information regarding the circuit and power supply requirements of this unit and any information on the conversion into a portable oscilloscope.

* * *

R109 Receiver.—R. J. Sayers, 120 Birmingham Road, Redditch, Worcs., would like to obtain the manual for this receiver.

* * *

Crystal Calibrator No. 10.—C. D. Hawkins, 67 Warwick Road, London, N.11, requires to borrow or purchase the circuit, and any other details, of this unit.

* * *

Test Set No. 74A.—R. D. Green, 767 Woodbridge Road, Ipswich, Suffolk, wishes to convert this unit into an oscilloscope. Can anyone provide a circuit diagram of the unit and any details of the conversion.

* * *

MCR1 Receiver.—J. E. Loades, G3OTL, 17 Manor Park Road, West Wickham, Kent, urgently requires to borrow the manual or circuit of this receiver.

* * *

"The Radio Constructor".—K. R. Goodley, 3 Highland Road, Parkstone, Dorset, urgently requires to purchase copies of the magazine dated April to September (inc.) 1948, condition not important provided they are reasonable copies.

* * *

Emerson TV Model No. 1183 Series J.—F. J. Brooks, 26 Ennismore Road, Stanley, Liverpool 13, would like to purchase or borrow the circuit of this receiver.

Precautions

IN THE USE OF VOLTAGE STABILISERS

By J. B. DANCE, M.Sc.

MANY AMATEUR CONSTRUCTORS USE VOLTAGE stabiliser tubes without having studied the manufacturer's operating recommendations and may not therefore obtain satisfactory performance or tube life. Some manufacturers publish general operating recommendations applying to all their stabiliser tubes separately from the data sheets for specific tubes; it is important that all this information is studied.

Ignition

A value is normally quoted for the maximum ignition voltage of each type of tube. The supply voltage should not be less than this value if reliable ignition is to be obtained after switching on the apparatus. In absolute darkness some considerable delay may occur before ignition takes place.

Burning Current

The component values should be chosen so that the current passing through the stabiliser tube always lies between the maximum and minimum values quoted for that particular tube. If the current is too low the tube voltage will not be stable, whilst an excessive current will lead to a large heat dissipation and possible loss of stability and/or damage to the tube.

It is, however, permissible to operate most stabiliser tubes for periods of up to about ten seconds with a current of two or three times the normal maximum rated current whilst indirectly heated valves in the associated equipment warm up.

The so-called "Reference tubes" provide a very stable source of voltage and should be operated at the preferred operating current quoted by the manufacturer, as such an operating point has maximum stability over life and is free from any discontinuities. If the current is changed from the preferred value during the life of the tube and is then returned back to it, the good initial voltage stability may never be regained.

Burning Voltage Spread

The burning voltage of normal stabiliser tubes of a specified type varies by about $\pm 3\%$ from tube to tube about the nominal mean value.

Temperature

The temperature coefficient of the burning voltage can be about 2 to 10 millivolts per degree C.

according to type, but the temperature of the tube normally becomes reasonably constant after approximately three minutes.

Alternating Voltage

If the voltage supply to the tube contains an alternating component or if the stabilised current taken from the circuit varies at a fairly high frequency some alternating voltage will be present in the stabilised output. This effect will be worse at higher frequencies, as the internal impedance of the tubes increase with frequency. Generally it is advisable to connect a capacitor across the stabiliser tube if alternating voltages are likely to appear across it. This capacitor should not be too large or relaxation oscillations may occur and large initial currents would pass immediately after ignition. Values of less than $1\mu\text{F}$ are generally suitable.

Series Operation

Voltage stabiliser tubes should not be operated in parallel, as under such conditions it would be impossible to ensure that each of the tubes passed a suitable current.

Stabiliser tubes may, however, be operated in series in order to obtain a larger stabilised voltage than that obtainable from any single tube, but if the series connected tubes are not all of the same type, care must be taken to ensure that the common burning current will always fall within the ratings of all the tubes.

Resistors (of value about $220\text{k}\Omega$) may be connected across some of the stabilisers in series in order to facilitate the striking of the tubes. It is not always necessary to provide a supply voltage as great as the sum of all the ignition voltages of the various tubes. (The ignition voltage of a tube is considerably greater than the normal burning voltage.)

Polarity

There is no objection to the use of a voltage stabiliser tube under such conditions that the anode becomes negative with respect to the cathode provided that no reverse current passes. This condition can be satisfied by ensuring that the maximum reverse voltage ever applied to the tube is less than nine-tenths of the normal burning voltage. The passage of reverse current may reduce the life and/or stability of a tube.

A toggle switch was employed as a mains on/off switch to avoid altering control settings, but a switch ganged with one of the potentiometers could similarly be used if desired.

Construction

The prototype was built on a 16 s.w.g. aluminium chassis measuring 8 x 4½ in with two 1½ in sides. See Fig. 2. Using the specified components, this chassis was just large enough, but different components to those used with the prototype would possibly entail changes with respect to chassis dimensions.

Figs. 2 and 3 show the component layout both above and below the chassis. The mains transformer is of the drop-through type and a cut-out was made in the chassis to suit. Constructors who use other mains transformers can mount their components in the most convenient manner.

To avoid hum, all chassis connections were made to a 16 s.w.g. copper busbar earthed at the input sockets only, this extending around the chassis and terminating at VR₁ as in Fig. 3. Two V-shaped bends are made in the busbar so that it may be soldered to the centre spigots of the valveholders. No hum in the audio output should be experienced when using this method of earthing.

The final wiring is quite conventional, the components being suspended in the wiring. Signal-

carrying connections in the input circuit were made with screened leads, these being reliably earthed at each end. Two small loudspeaker sockets were mounted on aluminium brackets, as shown, on top of the chassis, and the leads from the output transformer secondaries soldered directly to them. Fig. 4 shows the socket mounting.

If the mains transformer has primary tappings, as in the writer's

case, these can be taken to a tagstrip suitably arranged below the chassis and the appropriate connections made. To change taps requires re-soldering but as this is probably a rare occurrence it entails no undue inconvenience.

Care must be taken to see that all burrs are removed from holes drilled in the chassis, particularly those holding the rectifier. This last point ensures that there is a large area in contact with the aluminium to ensure good heat dissipation.

Setting Up

No difficulty should be experienced in setting up. The feedback resistors between the anodes of the ECL80s can be adjusted, if desired, to suit the constructor, and may lie between 380kΩ and 2MΩ. Also the tone correction capacitor C₃ may be experimented with, although the value specified appears to work admirably.

The completed amplifier was fitted in a shelf-mounted cabinet with a panel of ⅜ in mahogany faced plywood.

For those who require it, enough spare power—0.4A at 6.3V and 15mA at 200V—is available if a mains transformer of the specified rating is used, and this should be sufficient to power a simple AM tuner of the r.f. pentode/germanium diode type, or a similar unit.

Although most constructors will have their own ideas for a suitable housing for the amplifier, details of the writer's shelf-mounting cabinet

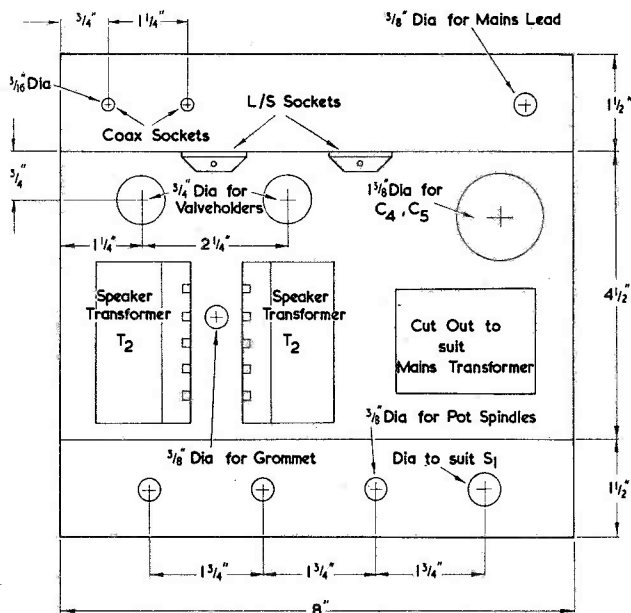

Fig. 2. Above-chassis layout

M357

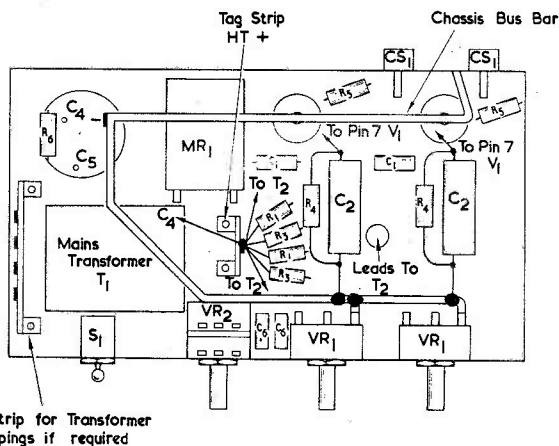

Fig. 3. Below-chassis layout showing components for both channels

M358

are given for those who consider that it will suit their requirements.

The Cabinet

The cabinet was made up from $\frac{3}{8}$ in faced chipboard which is comparatively cheap to buy and easy to work and which, when suitably finished and polished, makes a pleasing case for the unit. The chipboard is cut to size, four panels being required. After cutting, the edges of the panels with the exception of those which face the rear of the cabinet are bevelled at 45° , care being taken during this operation to ensure a good fit without unsightly gaps. When all panels are a good fit they are glued together, checked with a square and further held with panel pins. The heads of the pins should be punched below the surface and the holes filled with plastic wood.

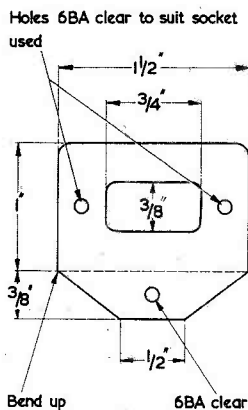

Fig. 4. The loudspeaker mounting socket, of which two are required. The material is 18 s.w.g. aluminium

The bevelled front edges of the cabinet reveal the chipboard surfaces and these should be filled with several coats of grain filler, rubbing down with fine sandpaper between each coat until a smooth surface is obtained. These edges can then be stained or painted a contrasting colour to the rest of the case.

A cut-out measuring 5 in by $1\frac{1}{2}$ in is made in the top of the case to allow the heat from the valves to escape. Similarly a cut-out is made in the $\frac{3}{8}$ in rear panel so that cooling air can flow right through the unit. Both these openings are covered by wire gauze or expanded metal. The rear panel, in which holes are made to allow the coaxial input sockets to protrude through, is held in position by six small wood screws and the finished unit gives quite a pleasing appearance.

WHY IS ~~~~~ f.m. ~~~~~ BETTER?

IT IS A COMMONLY BELIEVED FALLACY THAT BETTER reproduction can be obtained from f.m. transmissions than from a.m. transmissions because the maximum audio frequency transmitted by the f.m. stations is greater. In actual fact the pass bands of the B.B.C. transmitters themselves are level from about 30 c/s to 15 kc/s to within ± 1 dB. This applies to f.m., medium and long-wave a.m., television sound and also to the short-wave a.m. transmissions to other countries.

In practice the upper audio frequency transmitted is limited by the signal available from the Post Office land lines. Where the Post Office land lines are less than about 20 miles in length, the upper frequency limit of 15 kc/s will actually be transmitted, but where the land lines are about 200 miles or so in length, the maximum frequency transmitted will be about 10 kc/s. If a programme originates in the North of Scotland or in Northern Ireland and is transmitted from London, the uppermost transmitted frequency may be of the order of 8 kc/s. These figures apply to all f.m. and a.m. transmissions.

Conventional medium-wave a.m. receivers do not have a level pass band which is broad enough to accept audio frequencies up to 15 kc/s. It is, in fact, almost always necessary to use a fairly

narrow pass band at medium-wave frequencies in order to prevent adjacent channel interference. If one is close to the transmitter, it should be possible to obtain a good high frequency response from medium-wave transmissions by means of a specially designed receiver, as a wide pass band can be used if there is no danger of interference.

With f.m. receivers the situation is different, as there is no interference from foreign stations, and the full frequency response of the transmitted signal can be obtained from a well designed receiver. In addition less noise (except car ignition noise) is present at v.h.f. The use of f.m. also reduces the effect of any noise pulses which are received.

High fidelity is also possible from television sound, but the average television receiver is not designed to provide high quality sound.

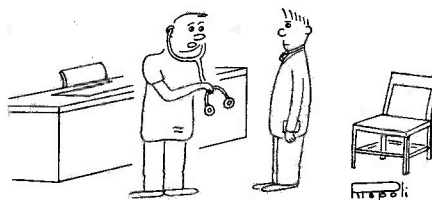

"Oh, don't worry sir, these are stereophonic!"

A Transistorised Single Sideband Transmitter

By R. J. BARRETT, GW3DFF

IT IS BECOMING INCREASINGLY OBVIOUS THAT transistors are coming into favour in amateur radio circles, both in receivers and low power transmitters. Their advantages regarding power supply and weight cannot be overlooked, and most progressive amateurs will have tried at least one or two circuits using them. Any keen listeners to the amateur bands will have noticed how popular single sideband transmission is becoming. This article describes an experimental single sideband transistorised transmitter which is relatively simple to construct and performs very well in spite of its modest power output and power supply requirements. It is assumed that anyone building this equipment will have had some experience with transistors, and that the usual precautions regarding soldering, etc., will be observed.

For experimental work using transistors the writer would recommend the "breadboard" method of construction. A piece of softwood about $\frac{1}{2}$ in thick is used for the board, and has panel pins driven in to support the transistors and components. Wiring may be fabricated by stretching 16 s.w.g. tinned copper wire between the pins. Small capacitors and resistors may then be soldered directly to the pins or on the wire as required. Most transistor components are very small and light in weight and are self supporting. Major modifications can be carried out on this "breadboard", and odd components can be used up if necessary. Yet, if carefully constructed, the finished job can look quite neat and presentable.

General Circuit Description

The transmitter was designed for use in the 160 metre amateur band. In Fig. 1 TR₁ is a crystal oscillator with its collector circuit tuned to the crystal frequency, which in the writer's case is 1,875 kc/s. L₁ and L₂ provide the necessary 90° r.f. phase shift. The output is passed through a double balanced modulator which consists of four diodes so arranged that the signal is cancelled out in L₃. TR₂ and TR₃ are r.f. amplifiers working in class AB. These are supplied with a small amount of bias so that advantage may be taken of the full gain of the transistor at the very low signal levels at which they operate. TR₄ is a class B output stage, its input peaking to 50mW. The audio unit (Fig. 2) consists of two OC71 audio amplifiers transformer coupled

into a 90° phase shift network. The output is balanced and split and taken to relatively high input impedance grounded emitter stages. These in turn are transformer coupled to the balanced modulator at points XX and YY. The unit was designed to work from a low impedance moving coil microphone.

Crystal Oscillator

In Fig. 1 the coil L_{1b} supplies the required feedback to enable the circuit to oscillate. If oscillations are not obtained as the slug in L₁ is adjusted its connections should be reversed. When oscillating the collector current of TR₁ should be approximately 5mA. Coils L₁ and L₂ should be mounted parallel to each other and separated by about 1½ diameters. It is preferable that the whole oscillator be screened, as radiation from it can beat with the final s.s.b. signal and make it difficult to monitor on the station receiver.

Balanced Modulator

This should be constructed using a symmetrical layout, and all earthing points marked with an asterisk should be short and taken to a common point. The diodes should be checked for forward and back resistances with a resistance meter, and the forward resistances (the lower readings) should agree within 10%. The radio frequency choke should be placed at right-angles to L₃ in order to minimise coupling between these components.

R.F. Amplifiers

Careful screening is important between each r.f. amplifier, or instability will result. Both TR₂ and TR₃ draw approximately 1mA standing current, rising with modulation. TR₄ will draw little or no standing current, but its input will peak to 5mA with full modulation. The writer does not consider it necessary to leave meters permanently connected to check the currents flowing through these transistors, but should it be desired to do so a 10mA meter could be conveniently connected at points MM on the circuit diagram.

The Audio Section

The first part of this unit (Fig. 2) consists of two grounded emitter OC71 transistors in the usual RC configuration. TR₅ and TR₆ have collector currents of 1 and 1.5mA respectively. The audio signal is

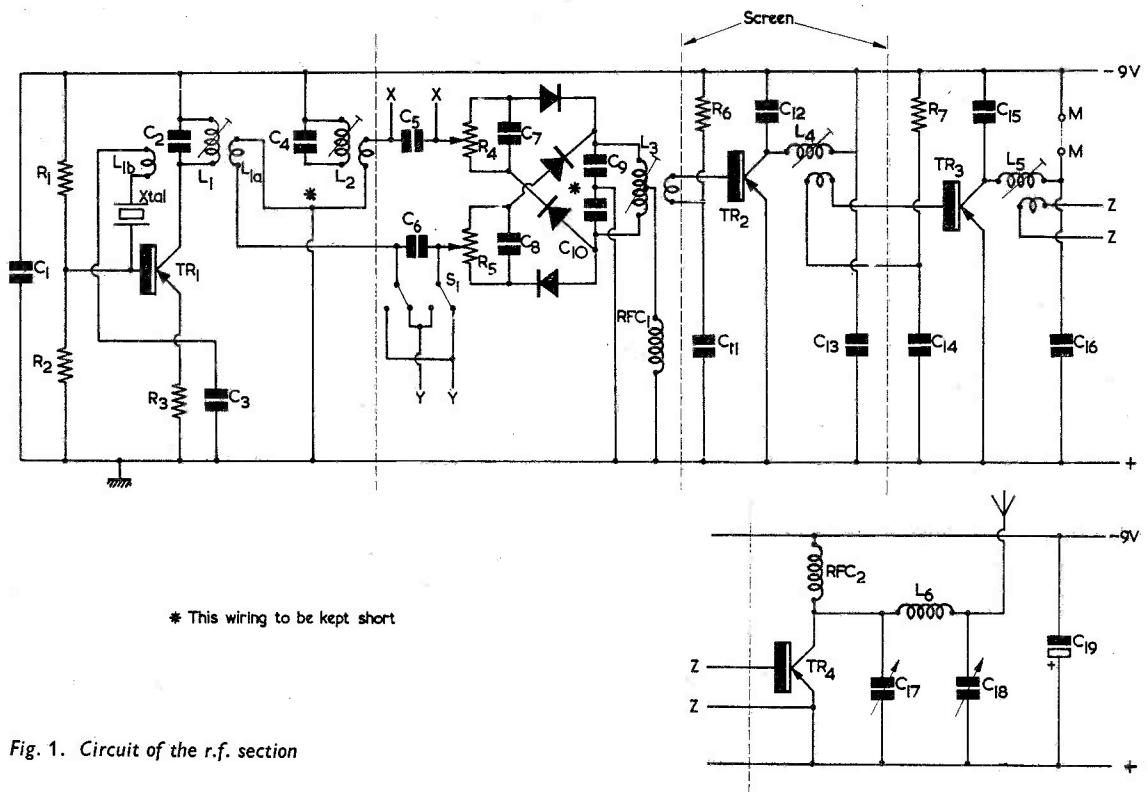

Fig. 1. Circuit of the r.f. section

M412

Components List (Figs. 1 and 2)

Resistors (all $\frac{1}{4}$ watt, 10% unless otherwise stated)

- R₁ 15k Ω
- R₂ 4.7k Ω
- R₃ 470 Ω
- R₄ 1k Ω potentiometer, carbon, linear
- R₅ 1k Ω potentiometer, carbon, linear
- R₆ 220k Ω
- R₇ 220k Ω
- R₈ 10k Ω potentiometer, carbon, log
- R₉ 62k Ω
- R₁₀ 10k Ω
- R₁₁ 3.9k Ω
- R₁₂ 1k Ω
- R₁₃ 39k Ω
- R₁₄ 10k Ω
- R₁₅ 1k Ω
- R₁₆ 100k Ω
- R₁₇ 15k Ω
- R₁₈ 15k Ω
- R₁₉ 100k Ω
- R₂₀ 50k Ω
- R₂₁ 50k Ω

Close tolerance. Values to be as accurate as possible

- R₂₂ 500k Ω potentiometer, carbon, linear
- R₂₃ 500k Ω
- R₂₄ 680k Ω
- R₂₅ 330k Ω
- R₂₆ 150k Ω
- R₂₇ 150k Ω
- R₂₈ 39k Ω 5%
- R₂₉ 10k Ω 5%
- R₃₀ 10k Ω 5%
- R₃₁ 39k Ω 5%
- R₃₂ 1k Ω 5%
- R₃₃ 1k Ω 5%

Capacitors

- C₁ 0.01 μ F
- C₂ 200pF
- C₃ 0.01 μ F
- C₄ 200pF
- C₅ 0.001 μ F
- C₆ 0.001 μ F
- C₇ 0.005 μ F
- C₈ 0.005 μ F

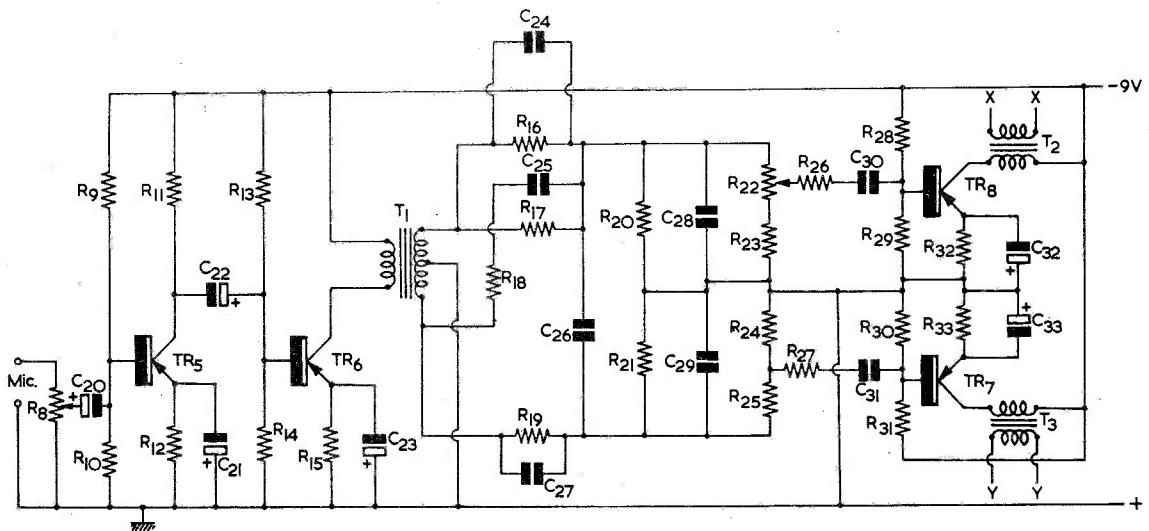

Fig. 2. Audio unit of the transmitter

M413

- C₉ 0.002 μ F
 - C₁₀ 0.002 μ F
 - C₁₁ 0.002 μ F
 - C₁₂ 200pF
 - C₁₃ 0.01 μ F
 - C₁₄ 0.002 μ F
 - C₁₅ 200pF
 - C₁₆ 0.01 μ F
 - C₁₇ 300pF variable
 - C₁₈ 600pF variable
 - C₁₉ 50 μ F 12 w.v. electrolytic
 - C₂₀ 8 μ F 6 w.v. electrolytic
 - C₂₁ 25 μ F 6 w.v. electrolytic
 - C₂₂ 8 μ F 12 w.v. electrolytic
 - C₂₃ 25 μ F 12 w.v. electrolytic
 - C₂₄ 0.00105 μ F
 - C₂₅ 0.0063 μ F
 - C₂₆ 0.0285 μ F
 - C₂₇ 0.00475 μ F
 - C₂₈ 0.0021 μ F
 - C₂₉ 0.0095 μ F
 - C₃₀ 1 μ F
 - C₃₁ 1 μ F
 - C₃₂ 25 μ F 6 w.v. electrolytic
 - C₃₃ 25 μ F 6 w.v. electrolytic
- } Close tolerance. To be as accurate as possible

Semiconductors

- TR_{1, 2, 3, 4} Mullard OC44, Mazda XA112
- TR_{5, 6, 7, 8} Mullard OC71, Mazda XB113
- D_{1, 2, 3, 4} Mullard OA81

Switch

- S₁ 2-pole, 2-way, toggle

Transformers

- T_{1, 2, 3} Radiospares type TT1 driver transformers, ratio 1:1. These transformers have centre-tap secondaries. In order to preserve the 1:1 ratio, only half of the secondary is used on T₂ and T₃

Chokes

- RFC_{1, 2} 2.5mH radio frequency chokes

Coils

- See Coil Winding table

transformer coupled to a Dome phase shift network. The components in this network must be selected with care and it is suggested that access be gained to a good resistance-capacitance bridge. Components can be selected from standard good quality supplies, or resource may be made to the junk box providing the components therein are in good condition. Checking a number of components of similar values should reveal that the manufacturer's limits are sufficiently wide to include one exactly of the value required. For instance, for the 0.0021 μ F

capacitor a number of 0.002 μ F components should be checked until one of the required value is found. It is preferable that the phase shift components be mounted on a Paxolin panel, and the whole panel can then be fitted inside a large i.f. transformer can. In order to ensure that both signals taken from the phase shift network are of equal amplitude, arrangements are made for the outputs to appear across potential dividers, one of which, R₂₂, is variable. TR₇ and TR₈ are high impedance input audio amplifiers. They have collector currents of approxi-

mately 1mA and their output transformers should be mounted at least 2in apart to eliminate stray coupling between them. The toggle switch connected to points YY (Fig. 1) is to provide selection of upper or lower sideband at will. Should it be required to use one sideband permanently this switch may be left out.

Adjustment

After the wiring has been carefully checked a crystal should be plugged in and the slug in L_1 adjusted until oscillations are obtained. This may be checked on a receiver or with an absorption wavemeter held close to L_1 . L_3 , L_4 , L_5 , and L_6 should then all be tuned for maximum output, the signal being checked on a receiver for any roughness that would indicate instability. L_6 is tuned by C_{17} and C_{18} . The two $1k\Omega$ balance potentiometers, R_4 and R_5 , should next be adjusted for minimum output. The carrier should now have been reduced to a very low value.

Inject an audio tone of about 1,000 c/s into the microphone socket. Advance the gain control, R_8 , and check the a.c. voltage on the collectors of TR_7 and TR_8 with a valve voltmeter or oscilloscope. If they are not equal adjust R_{22} until they are. Listening to the signal or checking it with an oscilloscope will probably give a modulated signal. L_2 should now be adjusted until the modulation is minimised. While it may not be possible to eliminate the modulation entirely it will be possible to reduce it to a satisfactory low level. Conditions that will prevent this are incorrect r.f. phasing, (readjust L_1 and L_2), lack of carrier suppression (readjust balance potentiometers R_4 and R_5), or lack of audio balance (readjust R_{22}). An oscilloscope will prove a most valuable piece of equipment when dealing with

single sideband units, and the experimenter is strongly advised to use one for testing purposes. An absorption wavemeter can be placed near L_6 and it will be noted that only with modulation applied is any indication given. The signal may finally be checked on the station receiver for sideband suppression and carrier suppression.

Results Obtained

In spite of the very low power output of this transmitter, S9, reports have been obtained from stations up to 10 miles distant, when using an aerial approximately 200ft long. Once the signal has been located and correctly tuned, stations have reported excellent readability even through heavy interference. The total power consumption is of the order of 180mW. A grid bias battery is used in the writer's case. It is hoped in the future to build a higher powered p.a. stage when a suitable transistor becomes available to the author.

Coil Winding Table

Coils L_1 , L_2 , L_3 , L_4 and L_5 are wound on $\frac{7}{16}$ in Aladdin slug tuned formers.

L_1 . 50 turns of 28 s.w.g. enamel copper close wound.

L_{1A} , L_{1B} . 5 turns of 26 s.w.g. plastic covered wire wound over earthy end of L_1 .

L_2 , L_4 and L_5 . 50 turns of 28 s.w.g. enamel copper close wound with 5 turn link of 26 s.w.g. plastic covered over earthy end.

L_3 . 28 turns of 28 s.w.g. enamel copper centre tapped with 4 turn link over centre of 26 s.w.g. plastic covered.

L_6 . 65 turns of 19 s.w.g. enamel copper on $1\frac{1}{8}$ in diameter former.

Tadic Helps London University to Study the Skies

Equipment has now been installed at University College, London, by E.M.I. Electronics Ltd. for use in the analysis of data obtained from Skylark high-altitude research rockets. This information concerns ultra-violet radiation and soft X-rays from the sun, stars and space, and the conditions of ionisation in the upper atmosphere—its temperature, concentration and character.

Known as TADIC, the Telemetry Analogue-to-Digital Information Converter, it is the first fully transistorised equipment of its kind in this country. It will process data in 10 hours which would take three people, working manually, three weeks to process.

Skylark firings take place in Australia, and the telemetered information is recorded on magnetic tape, on coded frequencies in the range 35–65 kc/s. TADIC is used to convert this analogue tape recording into a form in which it can be analysed on a digital computer.

The magnetic tape is first replayed into a frequency discriminator, to produce a voltage output of the same form as the time division multiplexed input to the telemetry transmitter. This waveform is fed to a fast analogue-to-digital converter and the digital output recorded on a secondary magnetic tape.

At the same time as data are replayed from one track, time of flight to millisecond accuracy is replayed from another. This time is digitised and recorded on the secondary magnetic tape at periodic intervals.

At present, the computer being used by University College requires a punched paper tape input. It is therefore necessary to replay the digital magnetic tape on TADIC at a reduced speed, to produce another recording on punched paper tape.



understanding radio

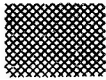

The eleventh in a series of articles which, starting from first principles, describes the basic theory and practice of radio

part 11

By W. G. MORLEY

IN LAST MONTH'S CONTRIBUTION IN THIS SERIES WE completed our discussion of practical fixed capacitors, covering ceramic and electrolytic components. We also listed the colour codes employed for indicating capacitor value, tolerance and temperature coefficient. We shall now carry on to practical variable capacitors.

Variable Capacitors

Many circuits require a capacitor whose value may be varied by means of a simple control. This need is met by variable capacitors.

We have already seen¹ that the value of a capacitor may be altered either by varying the area of overlap of the two plates or by varying the distance between them. Either of these methods can be utilised in the design of a variable capacitor. However, variable capacitors capable of being manually controlled by means of a knob almost invariably rely on varying areas of overlap, and we shall consider these first.

Fig. 48 illustrates the basic variable capacitor construction. In Fig. 48 (a) a set of semi-circular plates is fitted to a spindle which is free to rotate. As the spindle is turned these plates enmesh to a greater or lesser degree with the stationary plates. The two sets of plates are insulated from each other, with the result that a capacitance appears between them which varies as the spindle is rotated. Minimum capacitance is given when the rotating plates have the position illustrated in Fig. 48 (b), and maximum capacitance is given when the rotating plates are as shown in Fig. 48 (c).

In the construction shown in Fig. 48 (a) the rotating plates would be connected to the metal frame of the capacitor by means of a spring contact pressing against the spindle (this providing a more

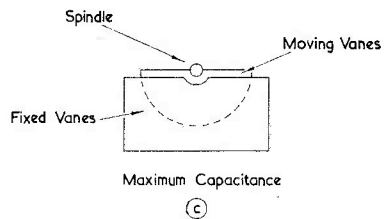
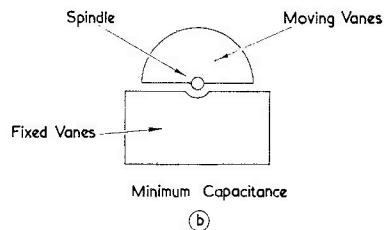
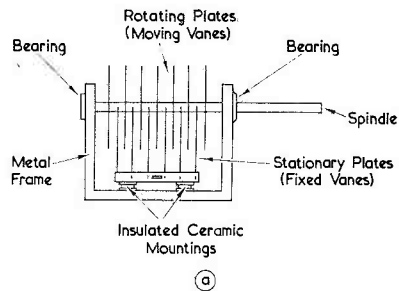

M394

Fig. 48 (a). The basic variable capacitor
(b). Minimum capacitance setting
(c). Maximum capacitance setting

¹ In "Understanding Radio", Part 8, April 1962 issue.

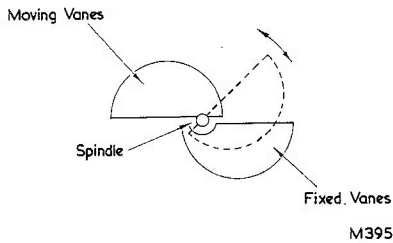

Fig. 49. Vane shapes similar to that shown here are frequently employed in practical variable capacitors

reliable contact than would be provided through the spindle bearings). Such a method of assembly is very common, and results in the rotating plates having the same potential as any metal panel or chassis to which the capacitor is fitted, unless some form of insulated mounting is employed. Normally, circuit requirements are such that this connection to chassis is acceptable. In practice, the rotating plates are referred to as the *moving vanes*, or *rotor vanes*, and the stationary plates as the *fixed vanes*, or *stator vanes*. Frequently, the word *plates* is used instead of *vanes*.

According to circuit requirements, practical variable capacitors may consist of almost endless variations on the basic design of Fig. 48. If larger maximum capacitances are required, a greater number of fixed and moving vanes will be employed in the construction. If lower capacitances are required fewer vanes are fitted, and a very low value component may have one moving and one fixed vane only. A greater maximum capacitance will be given if the spacing between fixed and moving vanes is reduced, and modern miniaturised variable

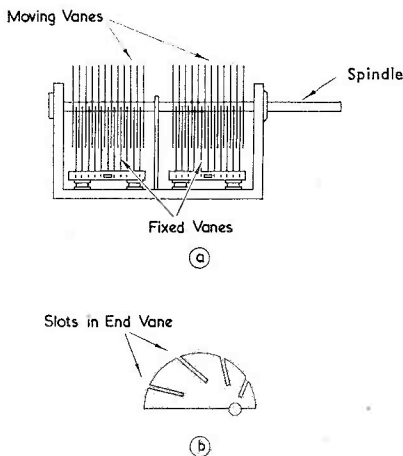

Fig. 50 (a). The two-gang capacitor
(b). Slotted end vanes allow the sections of a gang capacitor to have nearly equal capacitance throughout the range of adjustment

capacitors have very small spacing between vanes, care having been taken in design to ensure that the vanes and mountings are sufficiently rigid to ensure that correct spacing is maintained for all settings of the spindle. It is worth pointing out, incidentally, that variable capacitors of this type should always be handled with the moving vanes fully enmeshed with the fixed vanes. Otherwise, one or more of the moving vanes can be accidentally bent out of position and will short-circuit to the fixed vanes when the vanes are enmeshed.

Most modern applications do not require a variable capacitor with semi-circular vanes, as is shown in Fig. 48. A more usual shape would be similar to that illustrated in Fig. 49. In Fig. 48, increase in capacitance is approximately proportional to spindle rotation whereas, in Fig. 49, the initial increase in capacitance is more gradual. The vane shape employed in practice depends upon the function for which the variable capacitor is intended, and the graph given by drawing capacitance change against spindle rotation is described as the *characteristic* or *law* of the capacitor. Radio receivers employ variable capacitors for tuning purposes, and these are given a characteristic which enables the receiver scale to be graduated fairly evenly in units of wavelength.

It is frequently necessary for two or more variable capacitors to be operated from one spindle, and a typical arrangement is illustrated in Fig. 50 (a). Here, two variable capacitors are *ganged*, and the component is known as a *two-gang* capacitor. *Three-gang* and *four-gang* variable capacitors may be made up in a similar manner. It is desirable, in some instances, to ensure that the capacitors of a gang component all have almost exactly the same capacitance throughout the rotation of the spindle. The rotor end vanes are usually slotted, as in Fig. 50 (b), to allow adjustments to be made when this degree of accuracy is required. The sectors between the slots may be bent out to reduce capacitance over the corresponding angle of spindle rotation.

Many two-gang tuning capacitors intended for medium-wave, or for medium and long-wave, receivers are made with one of the sections lower in maximum capacitance value than the other.

Figs. 51 (a) and (b) show two alternative vane arrangements which may be encountered in single variable capacitors (i.e. not ganged components). In Fig. 51 (a) two sets of fixed vanes are so arranged that, as the spindle rotates, the capacitance of one half of the variable capacitor increases and that of the other half decreases. This component is known as a *differential capacitor*. Another vane combination is illustrated in Fig. 51 (b), wherein the two sets of fixed vanes are insulated from each other. This is described as a *butterfly capacitor*, the name deriving from the shape of the moving vanes.

The capacitors we have considered up to now are sometimes referred to as "air-spaced" to differentiate them from the *solid dielectric variable capacitor* illustrated in Fig. 52. The latter has fixed and moving vanes made of thin brass, these being

separated from each other by thin sheets of insulating material. The insulating sheets prevent the sets of vanes from short-circuiting, and the close spacing and thin vanes enable a very compact assembly to be constructed. Also, since there is no necessity to accurately position the vanes during manufacture, the component is cheaper (especially on the component retail market) than its air-spaced equivalent. Unfortunately, the dielectric used is not as efficient as air for many radio requirements and variable capacitors of this nature are more frequently used by the home-constructor than by the commercial set-maker. The re-set accuracy (i.e. the ability to present the same capacitance when returned to a previous setting) of solid dielectric capacitors is not high and they are rarely employed in ganged assemblies.

Pre-Set Variable Capacitors—The Trimmer

Pre-set variable capacitors, or *trimmers*, are used very often in radio circuits. They consist of variable capacitors which are required to be adjusted occasionally only and which do not, therefore, form part of the manually operated controls of the equipment in which they are used. According to their design and construction, trimmers are adjusted by screwdrivers or by special *trimming tools*. Trimmers are normally required to have lower maximum capacitances than variable capacitors, and they do not have to withstand continual adjustment or to present specific characteristics as does the variable capacitor. In consequence, trimmers can be made considerably smaller in size and simpler in design than variable capacitors.

Trimmers function by varying the area of overlap between plates, as with the variable capacitor, or by varying the distance between plates. We shall examine the latter type of operation first.

In Fig. 53 (a) we see a pre-set variable capacitor in which the distance between two flat circular plates is adjusted by a threaded spindle attached to one of the plates. Rotating the spindle varies the distance between the plates. Components of this type are normally employed in amateur transmitters to provide very small pre-set values of capacitance in applications where a high voltage appears between the plates. Such a component is much larger in size than the trimmers employed in radio equipment, but it illustrates the simplest manner in which capacitance may be pre-set by a varying distance between plates.

A very commonly encountered trimmer is shown in Fig. 53 (b). This has a fixed plate and a moving plate separated by a thin sheet of mica and the distance between the two is varied by adjusting the screw. The moving plate is made of springy material which opposes the pressure exerted by the screw. It also has a slightly curved surface which can be flattened out by the screw when the latter is set for maximum capacitance. Two solder tags integral with the plates are provided, and the latter are eyeletted in position on an inexpensive ceramic base. Typical dimensions for the component are 0.75in long by 0.6in wide. Trimmers of this type are

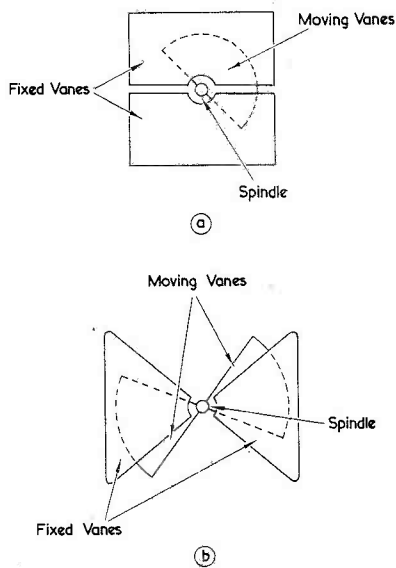

M397

Fig. 51 (a). The vane layout of the differential capacitor
(b). The butterfly variable capacitor

usually known as *mica trimmers* or as *postage stamp trimmers*. Sometimes, two or three such trimmers are mounted on a single base of insulating material.

Alternative constructions to that of Fig. 53 (b) may employ a Paxolin base or may have a metal base which also acts as the fixed plate. These alternatives function in the same basic manner.

The mica trimmer offers only a small change in capacitance when the adjusting screw is initially adjusted from the minimum capacitance position. The rate of change of capacitance rises steeply when the moving plate closely approaches the fixed plate, being at a maximum when the adjusting screw finally flattens out the moving plate. This varying rate of change of capacitance is not a disadvantage for most trimmer applications. Despite its simple construction, the long term stability of the postage stamp trimmer is quite good, and is certainly

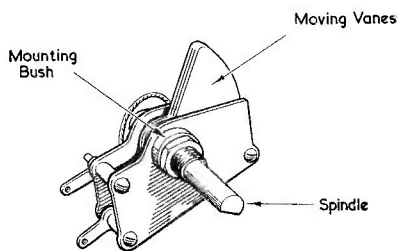

M398

Fig. 52. A typical solid dielectric variable capacitor

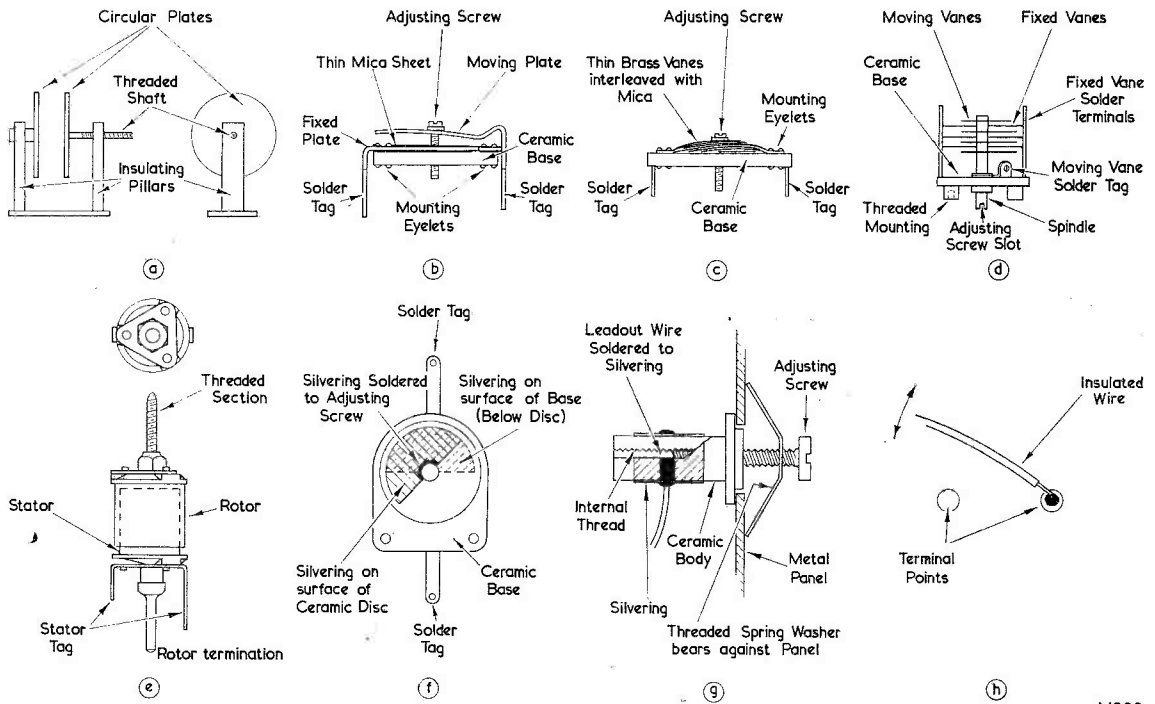

M399

Fig. 53 (a). A pre-set variable capacitor, frequently employed in amateur transmitting equipment
 (b). The mica trimmer
 (c). The compression trimmer
 (d). An air-spaced trimmer
 (e). The Philips, or Mullard, concentric trimmer
 (f). A ceramic disc trimmer
 (g). A tubular ceramic trimmer, mounted on a metal panel. Part of the ceramic is shown cut away to illustrate the internal thread
 (h). The "gimmick wire"

adequate for such requirements as tuning circuit adjustments in medium and long-wave receivers. Capacitance is most liable to shift with time when the trimmer is set very near the minimum or maximum capacitance positions. In the first case a low degree of friction is applied to the adjusting screw which may then shift due to mechanical shock; and in the second case there may be capacitance drifts due to flexing of the heavily stressed moving plate. It is always desirable to employ mica trimmers in such a manner that the desired capacitance is not close to the minimum or maximum capacitance settings.

Typical maximum capacitances for mica trimmers range between 40 and 100pF.

Fig. 53 (c) illustrates a *compression trimmer*. This is similar to the postage stamp trimmer with the exception that there are several sets of plates, together with interposed sheets of mica. The adjusting screw compresses the plates together as it is rotated, and thereby increases capacitance. Trimmers of this nature have high values of minimum capacitance and a typical component would

offer a range of some 100 to 400pF. The long term stability of a compression trimmer is not quite as good as that of a postage stamp trimmer. Compression trimmers are not encountered frequently at the present, but they have given reliable service in the past in the tuning circuits of medium and long-wave receivers.

A typical instance of a trimmer which functions by varying the area of overlap between two plates is shown in Fig. 53 (d). As may be seen, this is a scaled-down version of a normal variable capacitor. By means of a spring washer, or similar device, friction is applied to the rotor spindle to maintain it in position after adjustment.

Fig. 53 (e) illustrates an alternative form of trimmer. This is the *Mullard*, or *Philips concentric trimmer*. The trimmer employs two concentric metal tubes, the lower one in the diagram (the stator) extending inside the upper. As the upper tube (or rotor) is turned it travels up or down the threaded section, with the result that the area of overlap between the two tubes, and hence the capacitance, is varied. Higher values of maximum

capacitance may be given by adding further sets of concentric tubes inside the two outer tubes. Connection to the stator is obtained by means of two solder tags, whilst connection to the rotor is given via the threaded section. The latter extends through a ceramic sleeve in the body of the trimmer, appearing at the bottom as a plain conductor to which connection may be made. The rotor is maintained in a concentric position relative to the stator by means of a sleeve which fits closely over the ceramic sleeve in the body of the trimmer. The construction offers a wide range of capacitances, typical values for a single component being from 4pF or less minimum to 60pF or more maximum, or from 2pF or less minimum to 8pF or more maximum. A trimming tool, fitting over the hexagonal section at the top of the rotor, is required.

Another type of trimmer is shown in Fig. 53(f). In this, a ceramic disc free to rotate upon a ceramic base is fitted with an adjusting screw. Fired over 180° of the surface of the disc is a layer of silvering which is soldered to the adjusting screw. A similarly shaped area of silvering is fired over the ceramic base of the trimmer. As may be seen, rotating the disc causes the overlap between the two silvered areas to be varied, and the device functions, in consequence, as a trimmer. Connections to the two silvered layers are made via solder tags, that for the rotor silvering coupling to the adjusting screw.

An alternative ceramic trimmer is illustrated in Fig. 53(g). This employs a ceramic tube, on the outside of which is fired a layer of silvering. The inside of the tube is threaded and accepts a metal screw, maximum capacitance being given when the screw is fully inserted in the ceramic tube. A specially-shaped threaded spring washer is fitted to the screw and this not only provides a means of

mounting but also offers a connection to the screw, together with a degree of friction to maintain it in the required position. Connection to the outside silvering on the ceramic tube is achieved by soldering on a lead-out wire. The small size, ingenious design and inexpensive construction of this particular type of trimmer has caused it to be widely employed in television tuner units, in which only low values of trimming capacitance are required. A typical range for such a trimmer is of the order of 0.5 to 5pF, although maximum capacitances up to some 30pF are available.

The trimmers of Figs. 53(d), (e), (f) and (g) have a higher long-term stability than those of Figs. 53(b) and (c) and have better temperature coefficient characteristics. If desired, the trimmers of Figs. 53(f) and (g) can employ ceramic having a specific temperature coefficient, whereupon the component may offer a degree of "temperature compensation".

Although not exactly a trimmer in the true sense of the word, the arrangement shown in Fig. 53(h) should be included here for the sake of completeness. It consists, quite simply, of a piece of insulated wire which is bent closer to, or further away from, another conductor. In consequence, it offers a varying capacitance which can be adjusted up to a maximum of some 1 to 2pF. This device is quite often employed in commercial receiving equipment and is sometimes referred to as a "gimmick wire". A strip of malleable metal may sometimes be employed instead of the wire.

Capacitor Symbols

The circuit symbol for a fixed capacitor is shown in Fig. 54(a). Each parallel line in the symbol represents a plate. An electrolytic capacitor is

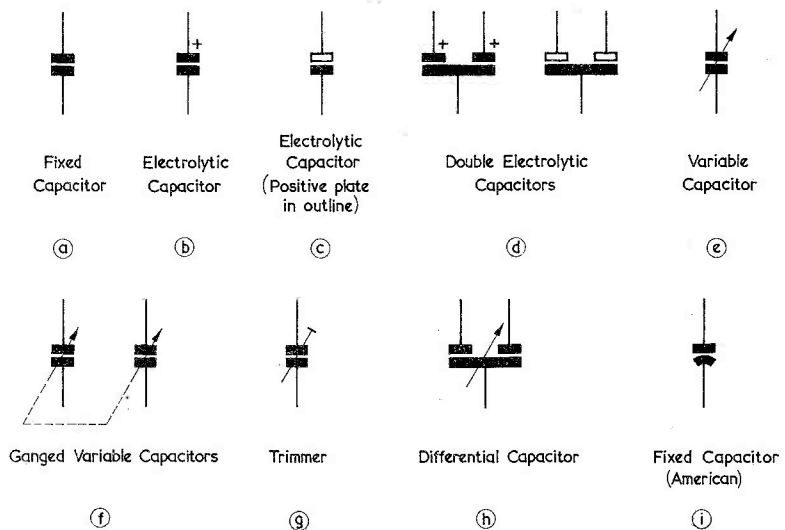

Fig. 54. Symbols for different types of capacitor. These are discussed in the text

shown as in Fig. 54 (b) in which the positive plate is indicated by the plus sign, or as in Fig. 54 (c) in which the positive plate is shown in outline only. Sometimes the plus sign may be added to this symbol as well. If an electrolytic component has two capacitors inside the one can, these may be shown as in one of the combined symbols of Fig. 54 (d).

A variable capacitor is depicted as shown in Fig. 54 (e), the arrow indicating variable. If two variable capacitors are ganged together, the capacitors are drawn in separate parts of the circuit and the two arrows are linked together by a dashed line, as in Fig. 54 (f). A trimmer is depicted as in Fig. 54 (g), the T-shaped symbol indicating "pre-set". A differential variable capacitor is shown as in Fig. 54 (h), the rotor vanes being represented by the long line.

In American circuits it is common practice to show one of the plates in the symbol curved, as in Fig. 54 (i). In circuits where such a connection is applicable, the curved plate is usually that which is at chassis potential, whilst with variable capacitors it represents the rotor. Apart from the use of the curved plate, American capacitor symbols are the same as those shown here, with the exception that electrolytic capacitors normally employ the Fig. 54 (b) presentation and not that illustrated in Fig. 54 (c).

Individual capacitors in a circuit diagram are normally identified by the letter C and a number suffix: e.g. C₁, C₂, etc. The letter C may be applied to fixed capacitors, variable capacitors, and trimmers alike. Occasionally, variable capacitors may be identified by the letters VC and a suffix number.

Capacitors in Parallel and Series

When we considered multi-plate capacitors² we saw that capacitance increased as additional plates were added to the assembly. In effect, single capacitors appeared between adjacent plates, and

² In "Understanding Radio", Part 8.

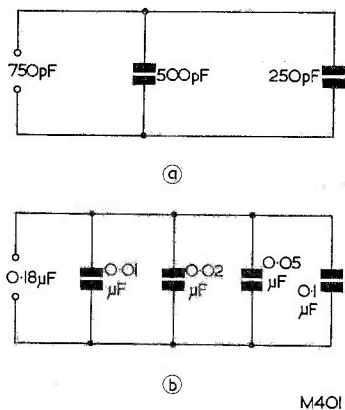

Fig. 55. Capacitors in parallel offer a total capacitance equal to the sum of the individual capacitances

the total capacitance of the assembly was equal to the sum of these individual capacitances.

This concept is helpful here, since it illustrates the fact that when two or more capacitors are connected together in parallel the total capacitance is equal to the sum of the individual capacitances. In Fig. 55 (a) we have a 500pF and a 250pF capacitor connected in parallel. The total capacitance is 750pF. In Fig. 55 (b) there are four capacitors in parallel, these having values of 0.01µF, 0.02µF, 0.05µF and 0.1µF. The total capacitance is their sum, i.e. 0.18µF.

When two equal value capacitors are connected together in series, the total capacitance at the outside terminals is half that of either capacitance. This effect is fairly easy to appreciate; and it may prove helpful to assume that both capacitors have exactly the same type and thickness of dielectric. When the two are in series, twice the thickness of dielectric then appears between the outside plates and a consequent halving of capacitance is not difficult to visualise. If a third capacitor of equal value were connected in series, the total capacitance becomes one third of each individual capacitance, and the same reasoning can be applied here again.

The effect of connecting capacitors in series is similar to that of connecting resistors in parallel and the total capacitance is represented by the formula:

$$\frac{1}{C} = \frac{1}{C_1} + \frac{1}{C_2} + \frac{1}{C_3} + \dots$$

where C represents the total capacitance and C₁, C₂, C₃, etc., the individual capacitances.

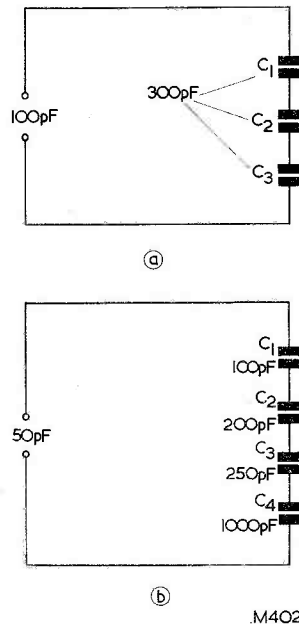

Fig. 56 (a). Three 300pF capacitors in series offer a total capacitance of 100pF
(b). Four capacitors with different values connected in series

Fig. 56 (a) shows three 300pF capacitors in series. From our formula we get:

$$\frac{1}{C} = \frac{1}{300} + \frac{1}{300} + \frac{1}{300}$$

$$= \frac{3}{300}$$

$$\therefore C = \frac{300}{3}$$

$$= 100\text{pF.}$$

As we would expect, the total capacitance is a third of the individual equal capacitances.

In Fig. 56 (b) we have four capacitors in series, these having values of 100pF, 200pF, 250pF and 1,000pF. The total capacitance is given by:

$$\frac{1}{C} = \frac{1}{100} + \frac{1}{200} + \frac{1}{250} + \frac{1}{1,000}$$

$$= \frac{10+5+4+1}{1,000}$$

$$= \frac{20}{1,000}$$

$$\therefore C = \frac{1,000}{20}$$

$$= 50\text{pF.}$$

The total capacitance is 50pF.

If only two capacitors are connected in series, the formula may be simplified to:

$$C = \frac{C_1 C_2}{C_1 + C_2}$$

When capacitors are connected in series, it is important to ensure that the working voltage of any single capacitor is not exceeded. If the voltage applied to the capacitors is lower than the working voltage of any single capacitor no difficulty on this count exists.

To take an example, Fig. 57 (a) illustrates two equal value electrolytic capacitors in series coupled to a source of e.m.f. Each capacitor has a working voltage of 350, and the source voltage is 600. The source voltage will very probably not divide equally between the two capacitors since their leakage resistances will almost certainly be dissimilar. Let us assume that the leakage resistance of the upper capacitor, C_1 , is $1\text{M}\Omega$ and that of the lower capacitor C_2 , is $200\text{k}\Omega$. We can add these resistances to the diagram as physical resistors to see what action they perform, and this we do in Fig. 57 (b), wherein the capacitors themselves are now assumed to have an infinite leakage resistance. As, is at once apparent, a potential divider circuit is given, with

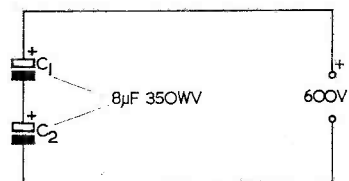

(a)

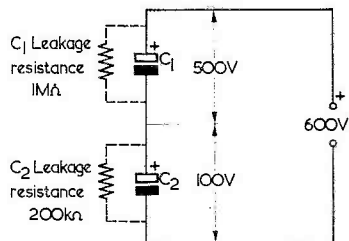

(b)

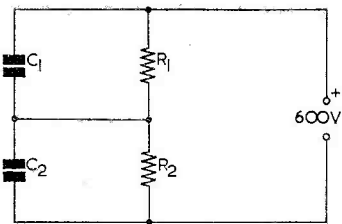

$$R_1 = R_2 = 27\text{k}\Omega \text{ or less}$$

(c)

M403

Fig. 57 (a) and (b). It is unwise to connect capacitors as shown in (a) because different leakage resistance may cause excessive voltage to appear across one of them

(c). Additional resistors ensure a more equal voltage distribution

one sixth of the supply voltage appearing across C_2 and five-sixths across C_1 . The result of this may be quite catastrophic because, if C_1 breaks down due to the 500 volts applied across its plates, it will function as a short-circuit and cause the full 600 volts to be applied to C_2 ; which will then break down in its turn!

This risk may be overcome by connecting equal value physical resistors across C_1 and C_2 as in Fig. 57 (c). These resistors should have a value significantly lower than the lowest leakage resistance and, in this instance, could conveniently be $27\text{k}\Omega$ or less. Such resistors ensure that each capacitor has approximately half the source voltage applied across its plates, and they thereby obviate the risk of breakdown.

We employed electrolytic capacitors in the illustration just given, because these represent an instance of series capacitor connection which is often encountered in practice. Other types of

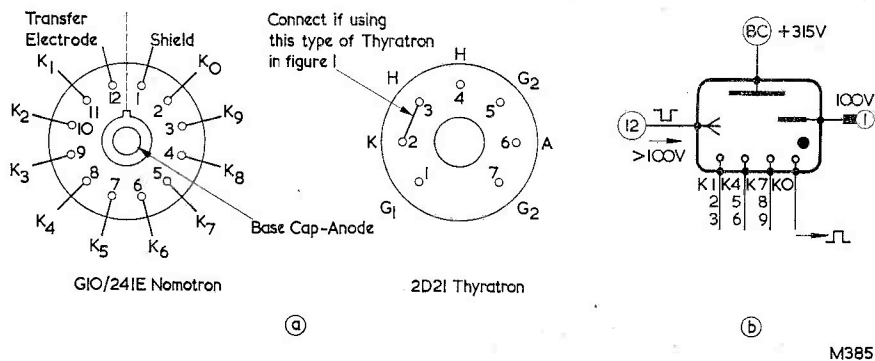

Fig. 4. (a) Pin layout of the Nomotron and the thyatron and (b) the Nomotron symbol

The Q6/4 rectifiers in Figs. 1 and 2 (a) are obsolete, although they may be available in surplus equipment employing Nomotrons (as, also, may

the Q3/5 and the G55/1K). A rectifier capable of passing several mA with a P.I.V. of some 300volts should prove adequate in place of the Q6/4.

Montreal—Vancouver Communications Microwave Network

Construction of a \$36 million general communications microwave network between Montreal and Vancouver has been announced by Donald Gordon, President, Canadian National and N. R. Crump, Chairman and President, Canadian Pacific.

The technical planning of the 3,000-mile network has already been completed and actual construction began this summer. It is scheduled to be ready for service by the end of 1963. The line will be owned and operated jointly, with Canadian Pacific Telecommunications responsible for administration and operating between Montreal and Melville, Sask., and Canadian National Telecommunications taking similar responsibility between Melville and Vancouver.

The new system is being built to provide high-quality, high-capacity circuits for use by Canadian business and to meet national defence requirements. For strategic defence reasons, the route of the new line will be generally well away from existing communications facilities spanning the country. Spur lines or "drop outs" from the main system will feed major centres across Canada.

The line will be tied to existing CN-CP microwave and UHF radio circuits servicing the Atlantic provinces, central Canada, the Yukon, the North-West Territories, and Vancouver Island as well as landline circuits operated by the two companies elsewhere in Canada.

Primary use of the network will be for commercial and business communications—telex, teletype circuits, data processing, facsimile transmission, telemetering, cable and message traffic and allied fields. Necessity for the line is based on the rapidly growing market for these services. Present facilities are not able to keep pace with the expanding communications field. Railway communications for CPR and CNR will also be handled.

RCA Victor Company of Canada Limited, Montreal, has been awarded a \$12 million contract for manufacture and installation of electronic equipment. Specifications call for microwave gear of an advanced design to give high-speed, high-quality transmission necessary for newer commercial telecommunications equipment and business data processing systems planned by manufacturers for the future. Although not intended initially for television transmission, the network will be built to a standard capable of carrying black and white or colour television signals.

The system will follow a route north from Montreal with "drop outs" leading to Ottawa, Toronto, North Bay and Fort William, Ontario. The line will then swing north of Winnipeg and Regina, although connected to both prairie centres, pass close to Saskatoon and Edmonton with connectors, and then drop down to Vancouver.

A basic purpose behind the route which takes the line away from major centres, is to bypass built-up areas which might be affected in the event of hostilities. In this way, while a Canadian city might be destroyed or damaged in the event of an attack, the main cross-country network would continue in operation to other points.

Some 136 microwave relay towers will be built to complete the system. Initial survey of the planned route has been completed.

Initially, the microwave network will consist of two channels, each capable of providing 600 voice circuits. Provision has been made in the design and engineering, however, for additional channels to be superimposed on the system as needed.

Special attention has been given to the network to provide automatic remote control, monitoring and warnings systems. In areas where accessibility to towers will be difficult because of their location, radio equipment and power facilities capable of operating unattended for long periods have been specified.

NEWS and COMMENT

TV Telephone

A Special Correspondent of *The Times* recently wrote a very interesting article on the prospects for a visual telephone.

The National Research Development Corporation have, for some years, been financing a project which it is hoped will soon be tried out commercially. According to the article, the technique allows highly complicated signals representing television, etc., normally requiring a wide information channel, to be carried over more conventional circuits.

Dr. Colin Cherry of the Imperial College of Science and Technology, London University, is leading a small team of scientists in this work. He has stated that it is not science fiction any longer to imagine a conference or board room meeting of the future with some form of remote visual contact.

The above project gives point to the views of Mr. Sol Cornberg, an American, who is a believer in education by machine. (This is an over-simplification, of course.) In a recent interview on B.B.C. television Mr. Cornberg argued from the premise that, as the birth rate continues to outstrip the supply of teachers, the solution is "to assist the educator to multiply himself" and to feed information for students into a number of mechanical devices.

Well, we shall "see".

Guide to British Electronic Valve Industry

A guide to the structure of the British electronic valve and semiconductor industry, published recently in booklet form, broadly classifies 48 types of valves, tubes and other devices and gives the names of the firms which make each type mentioned.

In a brief historical foreword it is stated that British production of electronic valves and tubes exceeds 90 million annually while the current annual rate of manufacture of semiconductor devices in the United Kingdom is of the order of 32 million transistors, 28 million diodes and five million rectifiers (including selenium). Exports have been growing steadily and direct exports of valves for industrial purposes alone have multiplied more than three times over the last four years.

There is a reminder in the 800-word history that the thermionic valve, patented in 1904, resulted from research by a British scientist Sir Ambrose Fleming, and that the magnetron, which revolutionised radar, and travelling wave tubes were invented in the U.K.

Primarily intended as a brief for British Commercial Attaches and Information Officers abroad, the booklet is published by the British Radio Valve Manufacturers' Association (B.V.A.) and the Electronic Valve and Semiconductor Manufacturers' Association (V.A.S.C.A.) and is available post free from the secretary, B.V.A., Mappin House, 156 Oxford Street, London, W.1.

The B.V.A., formed in 1926, is concerned solely with entertainment types of valves and television cathode ray tubes, V.A.S.C.A. being responsible for all industrial valves and tubes and semiconductor devices. Each association is autonomous, but they share the same secretariat and offices and work closely together in all matters involving liaison with government departments, allied trade associations and international bodies.

Bird Watching

With the development of high power microwave radars, and their passage into operational use for both civil and military purposes, the phenomenon of radar "angels" has become a common occurrence.

To explain them, The Institution of Electrical Engineers' Electronics and Communications Section invited Dr. E. Eastwood, Director of Research, Marconi's Wireless Telegraph Co. Ltd., to take as his subject "Radar Observations on Bird Migration" at the Section's Annual Lecture.

A radar angel is a signal displayed upon the Plan Position Indicator (P.P.I.) of the radar station, which does not correspond to the echoes received from aircraft, from clouds or from hills and trees. For a long time the origin of such radar angels was in doubt, but it is now known that the majority of angels can be attributed to reflection from birds.

Bird effects can constitute an operational hazard in high power radars, and allowance has to be made for them in their design. On the other hand, radars can be designed as an ornithological tool

for the study of bird migration, detecting and recording the echoes from moving birds.

At the Marconi experimental radar station, situated on Bushy Hill in Essex, film records have been obtained of the periodic changes which take place in the pattern of bird movement around the south-east corner of England. These studies have not only materially assisted the radar development work of the laboratory, but they have also revealed a number of exciting new facts concerned with bird migration.

The Television Society's Silver Medal Award for 1961

Mr. Richard Cawston, Documentary Film Producer, B.B.C. Television, was presented with the Society's 1961 award at the Annual Dinner of The Television Society held at The Dorchester Hotel, at which many TV celebrities were present.

The Society's Silver Medal is awarded for outstanding artistic achievement in television during the year. It is intended that this medal should acknowledge the work done by an author, actor, producer, or any other member of the television staff in promoting the entertainment, artistic or educational side of television programmes.

Mr. Cawston has been making films with the B.B.C. Television Service since 1947. In the early days of the B.B.C. Film Unit at Alexandra Palace first he was a Film Editor. From 1950 until 1954 he was producer of the original Television Newsreel, being responsible for nearly 700 editions, including all the B.B.C.'s Coronation Newsreels. Since 1955 he has been with Television Talks Department, producing documentary films: during the past few years he has written and produced some of the B.B.C.'s most ambitious and successful projects in this field.

Electric Power from a Kerosene Lamp

A thermo-electric generator, developed in America to run radios in areas not served with electricity, operates by means of a kerosene lamp. This practical, inexpensive device was made for the government of Mexico by the Minnesota Mining and Manufacturing Company, and is being used in rural schools to receive educational television programmes. One pint of kerosene keeps the generator going for 24 hours. The device is expected to be useful on boats, in weather stations and at mining and lumber camps, as it also provides small amounts of light and heat.

IN YOUR WORKSHOP



This month, Smithy the Serviceman, aided by his able assistant, Dick, settles down to the pleasurable task of discussing the latest batch of hints received from readers.

"DO YOU KNOW, SMITHY," SAID Dick, "this is one of those really nice times". Smithy settled himself more comfortably.

"I must admit," he said reflectively, "that it is quite pleasant."

"Here we are," continued Dick, "at the end of the week. And we don't have to get up early tomorrow morning, either."

"You don't get up early," observed Smithy, "on any morning."

"What is more," said Dick, ignoring the Serviceman's comment, "we've cleared out the entire Workshop so far as sets are concerned. And we've given the place a thorough cleaning."

The pair sat, resting from their labours, and looked around the unusually neat and tidy Workshop. Evidence of the recent cleaning activities referred to by Dick was given by the golden motes of dust dancing in the slanting rays of the late afternoon sunlight. Had A. E. Housman observed this tranquil scene of Service Manager and Staff taking their ease he may well have written:

*There sit the careless people
That call their souls their own;
There by their work they loiter,
How idle and alone.*

Readers' Hints

It was the Staff who first broke the silence.

"Smithy."

The Serviceman turned a relaxed eye upon his assistant.

"Hullo."

"How much longer to packing-up time?"

"About half an hour or so," grunted Smithy. "Why, do you want to nip off early?"

"No, it's not that," replied Dick. "I thought that this would be an ideal time to go through the latest batch of hints from readers. We haven't had a hint session for quite a while, you know."

Smithy brightened.

"That's true enough," he remarked, "it will finish the day off perfectly."

He rose, walked over to his bench and extracted a sheaf of letters from a drawer. Dick waited expectantly.

"Here we are," said Smithy,

settling himself back on his seat again, and examining a letter he had chosen. "Let's start right away. Now, the first hint has to do with tape recorders. When you're re-winding tape, it can often happen that you let the end of the tape run through without switching off the re-wind motor. The result is that the spool revolves at high speed, and you have a loose free end banging away at everything within reach. The end of the tape may be ruined because of this, and other damage can be caused elsewhere."

"That's true enough," observed Dick. "I've noticed the effect on some recorders myself."

"The cure," said Smithy, showing his assistant a sketch enclosed with

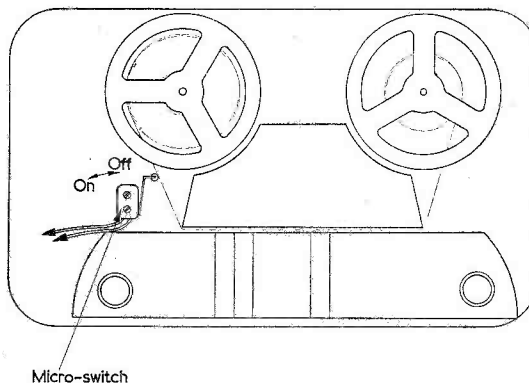

Fig. 1. A micro-switch fitted to a tape recorder can be used to switch off the motor when the tape is finally wound on to one of the spools

the letter (Fig. 1), "is to fit a micro-switch between the head cover and the spool. When the tape is under tension, this switch closes and allows the mains supply to be fed to the motor. When the tape is not under tension the switch opens and cuts off the motor. This idea can, incidentally, be adapted to cover other cases in which the tape may be subjected to stress. As, for instance, may happen if it is threaded loosely, and becomes subject to snatch when the spools take up the slack. I might add that it is possible to obtain micro-switches with a roller at the end of the arm which would be excellent for this application. A typical example would be the Bulgin micro-switches type S510/RP or S510/RSS. The first has a Tufnol roller and the second a stainless steel roller. The tape would, of course, run along this roller."

"That's a neat dodge," remarked Dick. "I can visualise other uses for a micro-switch working from tape tension. It could be used to cut playback or record amplification until the tape was under correct tension, and things like that."

"That seems possible," commented Smithy. "And you've just given a typical example of how one bright idea can spark off other bright ideas. Let's have a look at the next hint."

Smithy selected another letter.

"This one," he continued, "deals with waxed capacitors. Our correspondent says 'I strip my scrap sets and find that the waxed capacitors are usually covered with dust. This makes reading the values difficult. After some thought I hit upon the idea of putting paraffin on the affected component. Because paraffin has such a low surface tension it passes right through the dust and starts melting away the offending layer of wax. I tried this, and after a few seconds I rubbed over the surface with a dry rag; and to my satisfaction I found the component looking brand-new. At first the new surface appeared rather sticky but this vanished before any further dust could adhere.'"

"That's useful," remarked Dick. "I usually try to make the values on such capacitors decipherable by lightly passing a soldering iron barrel over them. But that's a process which tends to cause damage if you aren't careful."

Fuses

"True enough," replied Smithy. "Now there's another hint here which is not exactly new, but which is still worth mentioning because of its simplicity and advantages. The idea is, quite simply, to use 2.5 volt

0.3 amp torch bulbs instead of fuses in low current circuits such as are given by h.t. supplies and the like. There are quite a few advantages to using bulbs in this manner. Firstly, they are easy to replace. Secondly, they are very easily obtainable. Thirdly, they cost about half the normal price for fuses. Fourthly, they give a visual warning of overload before they blow. And, fifthly, by using parallel combinations, most fusing values from 300mA upwards can be obtained."

"Torch bulbs are certainly cheap enough in the chain stores," commented Dick, "and, for people who aren't near radio component shops, are a jolly sight easier to obtain than fuses. Under these conditions, it's easier also to get torch bulb holders than fuse holders. As you say, using torch bulbs as fuses is not exactly a new idea, but it's certainly very attractive when you consider *all* the advantages."

"I've got another one on fuses here," said Smithy, who had been looking through his sheaf of letters. "And it describes a cheap and efficient way of inserting a cartridge fuse in a chassis. What you do is to fit a valve grid-cap clip on each end of the fuse and then wire it into circuit like a resistor. The fuse can be fitted at any accessible point, including below the chassis if the associated receiver has a removable base board. If it blows, a new one can easily be clipped in place."

"That is a knobby idea," said Dick enthusiastically. "Have you got any more hints on fuses?"

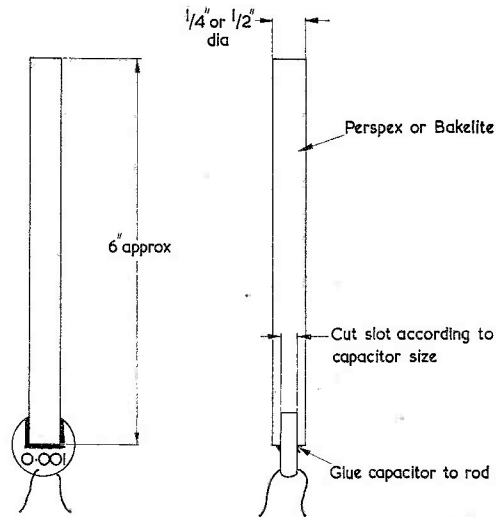

M374

Fig. 2. A simple testing device for checking decoupling capacitors

Testing Decoupling Capacitors

"Not for the time being," replied Smithy. "The next hint has to do with capacitors. Actually, this letter discusses two hints. The first describes a simple but very useful tool for checking decoupling capacitors in heater chains, i.e. circuits and tuner units. The tool consists of a 1,000pF disc ceramic capacitor fitted to a slot at the end of a Perspex or Bakelite rod. (Fig. 2). If you suspect an open-circuit decoupling capacitor you simply apply the tool so that the test capacitor leads bridge the connections to the suspect component. The tool is quick and easy to use and, since the test capacitor leads are short, it does not introduce excessive lead lengths into the decoupling circuit. Also, you can bend the test capacitor leads to any shape you like, and this is particularly useful if the circuit to be bridged is awkwardly placed. As you can see, the cost of the tool is pretty negligible."

"That," pronounced Dick, "is a gadget I can use myself. I'll knock one up first thing on Monday. What's the second hint?"

"The second hint," said Smithy, "will be appreciated mainly by the service engineer who can obtain the essential component required. This consists of a high pulse voltage ceramic capacitor of the type you encounter in t.v. line output stages. It needs to have a value around 220pF, and its central lead is coupled to a flexible wire terminated in a crocodile clip. (Fig. 3). You

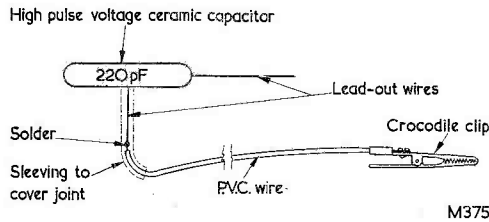

Fig. 3. A high pulse voltage ceramic capacitor may be employed to feed an output from the line timebase to the a.f. circuits of a television receiver.

employ this device for checking line speed in television receivers by clipping the crocodile clip to the sound output grid and using the remaining lead-out wire of the capacitor as a probe. The latter can be applied anywhere around the line oscillator stage. This arrangement gives a quick check as to whether the line speed is right or wrong, as the speed is reproduced by the speaker as a whistle of corresponding frequency. If the whistle is high the speed is too fast, and if it is low the speed is too slow."

"The device would be especially useful," said Dick thoughtfully, "if you suspected the line output stage and wanted to see if you were getting the right frequency at the line output grid."

"Very true," agreed Smithy. "Also, you occasionally get the case where there appears to be drive at the line output grid but the e.h.t. rectifier heater isn't quite warm enough to give you adequate e.h.t. A drive whose frequency is too low could give you that effect, and the test device we're discussing would soon inform you of the fact. Incidentally, I would suggest that a good place to apply the capacitor initially would be at the line output grid itself. This would minimise the effect of adding extra capacitance to the timebase circuit."

"I've thought of another use," put in Dick. "If you have a set which won't resolve a picture you can use the tester to check that the line oscillator is both running and syncing. When there is reliable sync the note from the speaker will hold steady at correct line frequency over a wide range of travel of the hold control. You will then hear it break off above and below line frequency as the control passes outside the sync range. Also, if you aren't getting a drive on your line output grid, you can work back to the line

oscillator just as though you had a signal tracer."

Smithy chuckled.

"You certainly seem to be full of ideas this afternoon," he said. "These hints seem to be giving you something to think about!"

"They are," agreed Dick. "Any more?"

Transistor Mounting

"Stacks," replied Smithy. "The next one is rather unusual. It describes a method of mounting transistors without soldering. (Fig. 4). Instead of being soldered the leads are terminated in brass eyelets which can be mounted on a piece of stiff card or Paxolin. The eyelets are available in the form of a do-it-yourself kit manufactured by Alexandra Products and retailed at Woolworths. The inside diameter of the eyelets is quite large, and you can easily pass a 4BA bolt through them. The method of connection is quick and safe, since heat is never applied to the transistor. The eyelets could fit over small bolts on a chassis or, alternatively, bolts fitted to the eyelets could be employed as terminals. Again, solder tags may be fitted to the bolts.

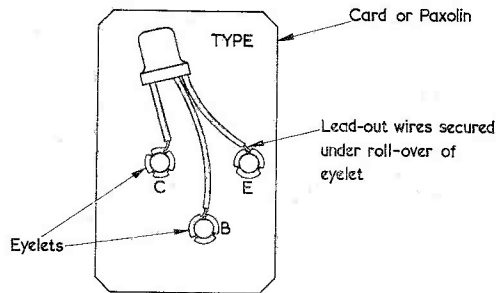

Fig. 4. Mounting a transistor to a sheet of card or Paxolin

Another point about the scheme is that the transistor type can be marked on the card together with any other remarks. Also, the eyelets connecting to the collector, base and emitter can be similarly marked."

Dick looked thoughtful.

"It strikes me," he said after a while, "that mounting transistors in this manner could be rather useful in training schools and places like that where transistors are connected up into a number of different experimental rigs. The transistors would stand up to a considerable amount of handling because there is no strain on the lead-out wires, and the emitter, base and collector would also be obviously connected to the appropriate parts of the circuit for visual demonstrations."

"You've got a point there," remarked Smithy. "Anyway, we must proceed! I have here no less than four hints from one of our readers. We've already discussed the difficulties of deciphering the values of dirty wax-covered capacitors. The first of the present four hints concerns the same problem, but this time it's with wax-covered resistors. Sometimes the wax on these resistors gets sufficiently dirty to make it difficult to read the colour code. The hint suggests that such components may be cleaned by gently rubbing with a small amount of Dura-Glit "Magic" wadding. Just a little application causes the resistor to become spotlessly clean without removing any painted colour-coding. Also, a piece of the wadding will last a considerable time if it is put back into the tin after use."

"Well, that's a new idea for a well-known product," remarked Dick. "I used to use Dura-Glit when I was in the Boys' Brigade!"

"You were in the Boys' Brigade?"

"Of course I was," replied Dick, incensed. "What is more, we had a band and played at the local football pitch. People used to throw orange peel at us."

"There are facets in your background," remarked Smithy, "that astound me sometimes."

"I thought you'd be interested," said Dick cheerfully. "What's the second hint in that group of four?"

"It has to do with twisting wire for a.c. heater circuits," replied Smithy. "The idea is not exactly new but it is worth airing again here. The two wires to be twisted should be single strand and p.v.c. insulated. They should also have the same length. The first two or three inches is twisted together by hand, and this section is then secured in a vice. The other ends are tightly held in the chuck of a hand-brace. The wires are held taut, and the drill handle turned so as to twist them together. When a resistance against the rotation is felt the handle is released, whereupon it will turn back on itself for a second or so. A few more twists are put into the wire, jerking it once or twice to relieve strains. When the wire is released it will be found that it is twisted evenly and tightly, the copper conductors and p.v.c. insulation both having taken up the strain imparted to them. When you have wire as tightly twisted as this, the resultant a.c. field in a high-gain amplifier should be noticeably lower than is given with the more loosely twisted wires which are usually employed."

"I like that idea," said Dick. "Especially the point about the tightly twisted wire having a reduced a.c. field."

"The third hint," continued Smithy, "concerns outdoor shacks and workshops. Some people often paint the walls with black bituminous paint because it is cheap, looks fairly tidy, and offers protection. Unfortunately, it tends to stain anything brought into contact with it and, if it is painted over with ordinary flat or gloss paint, it tends to come through and leave dark oily patches. The present hint is, quite simply, to paint the inside walls of the shack with aluminium paint, allow this to dry, and then put on any other covering that may be required. The aluminium paint is a good thermal insulator and looks quite presentable, even if left on its own. On its own, it also brightens the place up and saves electric light since it acts as a reflector. Our reader has painted the walls and ceiling of

his own shack with aluminium paint and says that it looks very good."

"Well, that's a novel idea," remarked Dick. "What's the fourth hint is this group?"

"It's a tip," replied Smithy, "for renovating french-polished or varnished cabinets which have become dirty and dull. They can be cleaned with the aid of a mixture containing equal parts, by volume, of pure linseed oil and pure turpentine. Emphasis must be placed on the word 'pure' and no substitutes must be used. The mixture should be applied exceedingly sparingly to the cabinet with a soft cloth or, preferably, a camel hair brush. It is next left for two or three minutes and then polished off with a soft cloth. The dirt comes off on to the cloth and the cabinet attains a deep, long-lasting shine."

"The polish can be made for only a few pence and will last for a long time. It takes about one half teaspoonful to do a large TV cabinet."

"I must make a note of that mixture," commented Dick. "I wonder if it would work with cellulose or polyester finished cabinets."

"Probably not," said Smithy. "I would, incidentally, advise anyone using this idea to get a little practice in first. Also, I would state that the polish should be tried out on an odd corner of any cabinet you handle before attacking large surfaces, and that it might be advisable to keep it away from transparent tuning scales."

"Modifying Surplus Equipment

Smithy looked at the Workshop clock and started.

"Aren't you going out tonight?" he asked.

"Who, me?"

"Yes, you," said Smithy. "It's packing-up time, you know."

Normally, the speed with which Dick left the Workshop in the evening was only exceeded by the speed with which he arrived in the morning.

"I'm in no hurry," said Dick airily. "Besides, these hints are interesting."

Smithy raised an incredulous eyebrow.

"Am I to understand that you have no extra-mural activities to entice you from the Workshop?"

"I don't get you," said Dick, puzzled. "You mean, should I be painting walls or something?"

"By 'extra-mural,'" explained Smithy, "I mean 'out-of-doors'. A young lad like you should be

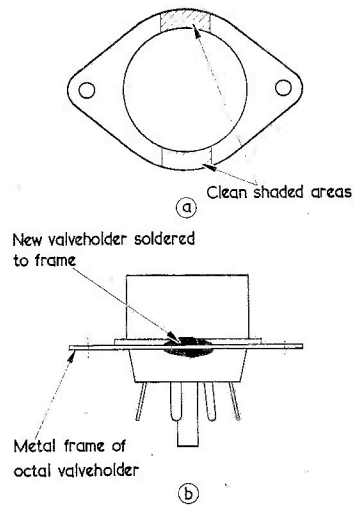

M377

Fig. 5. Replacing octal valveholders by B7G or B9A types. If the Amphenol insulation is broken away from the octal valveholder, the metal frame shown in (a) is left. The new valveholder may then be wired and soldered to this frame, as in (b)

out in the open on a lovely evening like this."

"Oh, I've got nothing special to do," said Dick, carelessly. "Let's hear a few more hints."

"As you like," said Smithy. "Well, it so happens that the next letter also includes four hints. The first of these had to do with modifying American surplus equipment."

"That sounds interesting," remarked Dick. "Fire away!"

"One of the difficulties," began Smithy, "of modifying American surplus equipment is that of replacing octal valveholders with the more modern B7G or B9A types. In the method suggested here, the original valveholder is removed from the chassis and its Amphenol insulation broken away, leaving a metal frame. (Fig. 5 (a)). The portions shown shaded in the sketch are cleaned up with a file, as also are the areas around the bolt-holes on the replacement valveholder. The latter is then placed over the metal frame and secured to it with 26 s.w.g. bare wire. The new valveholder is then soldered to the metal frame, employing enough solder to cover the wire at the joint. (Fig. 5 (b)). The whole assembly is finally fitted to the chassis, the metal frame taking up the same position as it had

before. The new valveholder will be found rigidly mounted, and the complete operation takes only two minutes, which is much quicker than the time needed for drilling out ordinary mounting plates. This idea has, incidentally, also been used for converting from B9G, UX5, UX6, UX7 and MO valveholders to B7G, B8G and B9A."

"That's a very useful wheeze," commented Dick. "And it should certainly prove to be a time-saver."

"Well, the second hint," remarked Smithy, "is a time-delayer! It seems that a time delay mechanism was required which would give approximately 40 seconds delay for a mercury vapour rectifier. A thermal delay was not available, and so a PY81 boosted h.t. diode was pressed into service instead. (Fig. 6). The PY81 was used

this letter is quite a simple idea and is, again, partly applicable to surplus equipment. It concerns crackle black finishes. When these have become dull and dirty they can be rejuvenated by first washing with soap suds, rinsing, and drying, and by then rubbing in a fine oil. The oil should be applied sparingly, and the excess wiped off. Transformer oil is ideal for this application."

"I should imagine," said Dick, "that a detergent would be just as good as the soap suds for the original cleaning."

"I would think so,"

"In which case," said Dick, triumphantly, "you could end up with a finish which is 'blacker than black'."

Smithy sighed.

"The fourth hint," he continued,

feet or so, and then look back again at the chassis. Not only is this tiring but there is quite a little risk involved if a test prod slips whilst you're looking up. Also, your hands may stray and result in your getting a shock. The suggested solution to this problem consists of covering the working surface with $\frac{1}{4}$ in Perspex or glass implosion guards, and putting the requisite circuit diagram underneath. The result is that the circuit, the chassis and the testmeter all come into the same field of vision, and are all approximately the same distance from the eye."

Demagnetising Screwdrivers

"There are certainly some good ideas going today," remarked Dick. "Have you any more hints?"

"Plenty," replied Smithy, rummaging through his sheaf of letters. "We next have a letter with two simple hints. The first concerns screwdrivers, pliers and other metal tools. As you know, these tools frequently get magnetised in radio work owing to the fact that they come into contact with speaker magnets and things like that. When magnetised they tend to be a nuisance, especially when doing close work, because steel washers and other parts become attracted to them. Such tools can, however, be demagnetised quite easily by placing them on top of a mains transformer for some time. I presume it would be advisable also to draw them slowly out of the transformer field before switching the latter off. Our correspondent says that the bigger the transformer the better."

"The second tip is another cabinet-cleaning idea. Only, in this case, it's plastic cabinets. It is possible to get rid of shallow scratches in plastic cabinets quite

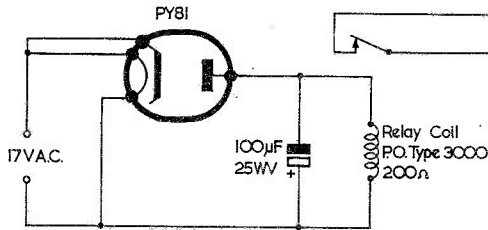

M378

Fig. 6. A simple time delay circuit

because of its long warm-up time, this being 45 seconds in the prototype. Operation is, of course, quite straightforward. The 17 volt supply is fed to the PY81 at the same time as the heater supply for the mercury vapour rectifier is switched on. When the PY81 has reached emitting temperature, a rectified d.c. potential appears across the 100µF electrolytic capacitor and causes the relay to energize. The contacts of the relay then complete the h.t. circuit to the mercury vapour rectifier. The electrolytic capacitor prevents relay buzz, particularly if the PY81 is low-emission; and the prototype functioned satisfactorily with a PY81 which was so worn-out that it wouldn't function in a television receiver."

"Time delay circuits are always of interest," commented Dick. "This appears to be one of the simplest I've encountered to date. Inexpensive, too, considering that you can employ valves which would otherwise be chucked out."

"It is," agreed Smithy, "a neat arrangement. The third hint in

completely ignoring Dick's remark, "has to do with service sheets. It is often difficult to refer to service sheets or circuit diagrams whilst working on a set. If, for instance, you are chasing an open-circuit heater you may often have to look away from the chassis, refocus your eyes on a circuit propped up against the wall at a distance of some three

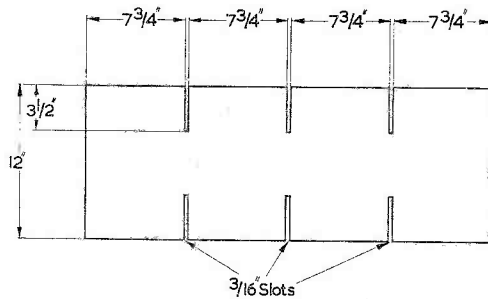

M379

Fig. 7. The dimensions of a typical example of foil lined cardboard referred to in the text

easily, by rubbing on a small quantity of Brasso with a piece of cloth. Brasso is slightly abrasive and soon brings the surface up to an even finish."

"First Dura-Glit and now Brasso," commented Dick. "It's like the Sergeant-Major's reunion dinner! I bet the next hint will tell us how to build an Oxometer."

Smithy was temporarily off his guard.

"What's an Oxometer?"

"A device," replied Dick promptly, "for measuring bull-shine!"

Smithy grinned.

"O.K.," he chuckled. "I fell for that one. I think I should add that the Brasso tip might not be applicable to all plastic cabinets. Some of these are sprayed a different colour to the plastic of which they're made, and too much abrasion could then remove the outer coat of paint. Also, I would, as always, advise keeping cleaning materials away from transparent tuning scales."

"Any more hints on cabinet finishes?" asked Dick.

"Yes," replied Smithy. "There's quite a nice one here. This points out that front panels for equipment such as audio amplifiers, recording amplifiers and tuner units can be given an original and pleasing finish by making them from 18 s.w.g. aluminium bonded to a woodgrain Formica panel. Evo-Stik 528 or any similar impact adhesive is ideal for this job. Our reader is fortunate enough in having access to an engraving machine and so he is able to engrave all necessary lettering. On the other hand, a really professional finish can be given with Panel Signs transfers. If white knobs are used, the whole effect is very pleasing indeed."

Screening

"We seem," remarked Dick, "to have covered a pretty wide range in this session."

"We have, indeed," replied Smithy. "However, one aspect we haven't touched on is screening, and I have a hint here which can be of particular interest to the audio man or the experimenter. Frequently, the underside of a home-built a.f. amplifier is not screened. This deficiency can be made good, either temporarily as an experiment or permanently, by the use of foil-lined cardboard. Foil-lined cardboard can be obtained free of charge from many photographic dealers, because it is used for despatching batches of flash-bulbs. If the box is opened out carefully, you can obtain a large area of the cardboard, a typical example measur-

ing approximately 12in by 31½in. (Fig. 7). The whole area of a sheet of this nature could be employed, or you could cut out four sections measuring 12in by 7¾in. The cardboard backing is quite tough and strong, and the foil is aluminium. Material of this nature represents a good way, also, of providing inexpensive screening inside the cabinet of a TV or radio set."

"The foil-lined cardboard could also be bent very easily into any particular shape you wanted," remarked Dick. "Which is another advantage."

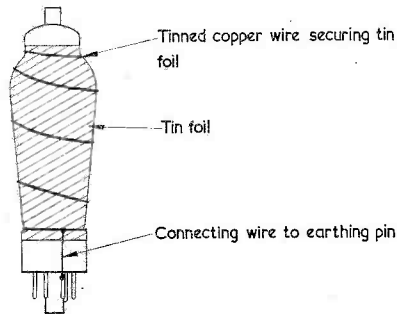

M380

Fig. 8. Screening a valve whose metallising has broken away from its earthing connection

"That's true enough," replied Smithy. "Another tip on screening comes from a different reader, and it applies to metallised valves of the EF9 and EF39 variety. You only meet these valves in old a.m. receivers but they're still doing yeoman service, nevertheless. A common fault is that their metallising becomes disconnected from the earthing contact, whereupon you are liable to get crackles and instability. When the valve concerned is the i.f. amplifier, instability is almost inevitable. The receivers in which these valves are fitted are pretty venerable and don't merit an expensive repair. In practice, the valve can be fixed by the simple expedient of wrapping tin foil around the bulb and holding it in place with several turns of tinned copper wire. (Fig. 8). Run the tinned copper wire down to the earthing pin or contact at the base and the valve once more becomes reliably screened. Whereupon, it will probably give another twenty to thirty years of good service!"

"They certainly seemed to make valves to last in those days," remarked Dick. "I had a set only the other day with side-contact valves, and they were still working

merrily away despite the bashing they've had over the years."

"My own memories of side-contact valves," remarked Smithy nostalgically, "seems to consist of pulling out the glass section and leaving the base stuck in the valve-holder! Still, let's carry on to the next hint. Which must, also, I'm afraid, be the last in this present session."

"This hint," continued Smithy, "describes a simple device for starting screws in awkward places. (Fig. 9). It consists of a length of ⅜in metal rod having a slot at one end into which two strips of

spring steel are fitted. These strips are taken from an old clock spring. If the bottom of the rod is put in a vice, the slot can be squeezed down on to the springs, whereupon they are held very securely. The projecting springs are opened out slightly, with the result that they grip the internal sides of the slot in the screw."

Going Home

With an air of finality, Smithy took up his letters and returned them to the drawer in his bench.

"Is that the lot?" asked Dick.

"It is for now," replied Smithy. "But there are still quite a few outstanding. We shall have to have another hint session pretty soon, I'm thinking."

"Good show," said Dick. "They always make a pleasant break from ordinary servicing."

By now, the dust in the Workshop had settled, and the evening sun shone clearly across the benches and the test equipment. The pair leisurely made their departure and wandered off to their separate homes through the quiet air. Their day was over. We have already put words into the mouth of A. E. Housman and we can now only

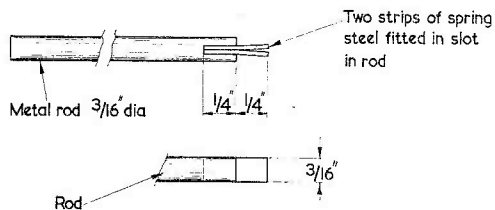

M381

Fig. 9. A useful tool for starting screws in difficult positions. The two strips of spring steel grip the inside edges of the screw slot

conclude this particular episode by saying that, even in a moment of acute aberration, Thomas Gray could never have perpetrated the following:

*The curfew tolls the knell of parting day,
The lowing herd wind slowly o'er the lea;
Whilst Smithy homeward plods his weary way,
Leaving the world to darkness, for his tea.*

The hints described in this month's episode of "In Your Workshop" were contributed (in the order in which they appear) by P. S. Anderson, B. Slight, D. M-Evans, D. Watson, B. M. Jeffery, K. Summersgill, D. J. Pratt, D. Powell, J. D. F. Hewson, R. D. Raby, N. L. Cowell, N. O'Riordan and J. Greenway.

Further hints for this feature are welcomed, and payment is made for all that are published.—Editor

Test Instruments Need Testing

By G. A. W. PARTRIDGE

ELECTRICAL MEASURING INSTRUMENTS such as voltmeters, ammeters, and universal meters, tend to become inaccurate after years of faithful service. It is therefore a great help if these instruments can be checked now and again, even if only to satisfy one's self that they are maintaining a reasonable margin of accuracy.

The checking circuits described here are simple but, with good components, extremely efficient.

Fig. 1 shows the volt-box circuit connected to a voltmeter under test. There are ten instrument-type one-watt resistors connected in series, and their values are:

- A=1,000Ω
- B=3,000Ω
- C=4,000Ω
- D=7,000Ω
- E=15,000Ω
- F=30,000Ω
- G=65,000Ω
- H=125,000Ω
- I=250,000Ω
- J=500,000Ω

Resistor A is connected to a morse key, a 0-1 milliammeter,

and a Weston Standard Cell* which has a very accurate p.d. of 1.0183 volts when *no current* is being drawn from it. The voltmeter under test, along with a suitable d.c. supply (either from a power-pack or batteries) is connected to say, the 500 volt tap and the voltage adjusted so that the voltmeter indicates this value by the rheostat. The key is quickly pressed and released. If the milliammeter needle moves the rheostat is again adjusted and the key "touched". This procedure continues until there is no movement of the milliammeter needle, thus indicating balance. The voltage applied to the voltmeter is now 500 (accurate to about 1%). The voltmeter reading is then checked for any discrepancy. Various points on the voltmeter scale on different ranges can be checked in this manner by selecting suitable taps.

* A suitable Weston Standard Cell is available from Doran Instrument Company Ltd., Stroud, Gloucester. Instrument resistors are available through trade channels, although it should be pointed out that these may be expensive if purchased new.—Editor

A complete volt-box is shown in Fig. 2. The resistors are mounted inside the box which can be made of stiff cardboard.

Testing a milliammeter is just as simple. The circuit in Fig. 3 shows that the same principle is used.

The resistor values are:

- A=2Ω
- B=2Ω
- C=6Ω
- D=90Ω
- E=900Ω

Again, they are mounted in a box which is, this time, known as an amp-box.

In Fig. 3 the milliammeter is being tested on the 10mA tap. The rheostat is adjusted until 10mA is indicated with the Standard Cell circuit open. Now the key is

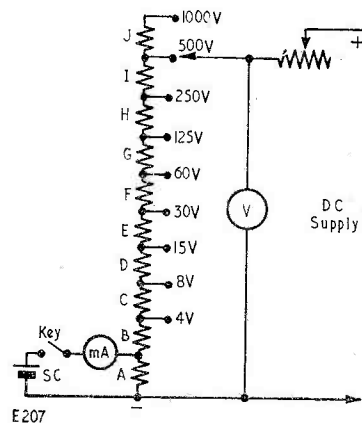
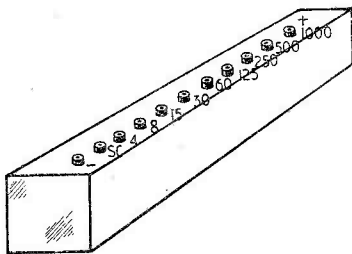

Fig. 1. Testing a voltmeter



E208

Fig. 2. The volt-box

quickly pressed and released while the rheostat is again adjusted until there is no movement noted on the 0-1 milliammeter. The current flowing through the milliammeter under test is now 10mA. Similar tests can also be carried out on the 1, 100, 250, and 500mA taps depending, of course, upon the range of the instrument under test.

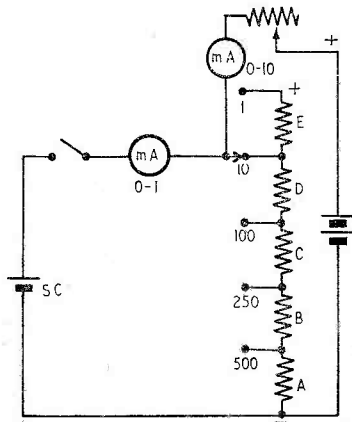

F209

Fig. 3. Testing a milliammeter

It is also possible to test a.c. instruments but, in this case, a dynamometer voltmeter is necessary.

This meter operates with equal accuracy on d.c. as well as on a.c. It is tested with the volt-box as a d.c. instrument and then connected to an a.c. meter under test as shown in Fig. 4. The readings are checked by comparison.

A.C. millimeters can be tested with the same dynamometer voltmeter but the current readings have to be checked by Ohm's Law:

$$I = \frac{E}{R}$$

To take an example let us assume that the milliammeter reads from 0 to 500mA, and that the dynamometer voltmeter reads up to 150 volts. First, we calculate the load resistor R. See Fig. 5. The milliammeter internal resistance is neglected for the present.

$$R = \frac{E}{I}$$

$$= \frac{150}{0.5}$$

$$= 300\Omega$$

Therefore a load resistance, R, of 300Ω is required. It must also be able to pass half an ampere (500mA).

The milliammeter is now checked in the following manner:

Say the milliammeter has a resistance of 2Ω. The total resistance will then equal 300+2=302Ω.

The rheostat is adjusted until the dynamometer voltmeter reads exactly 150 volts.

$$\text{Now } I = \frac{E}{R}$$

$$= \frac{150}{302}$$

$$= 0.497\text{A or } 497\text{mA.}$$

This should be the reading on the milliammeter. Other readings can be taken and calculated at

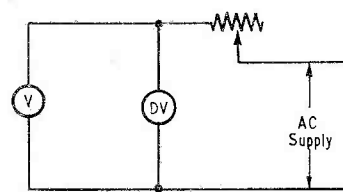

E210

Fig. 4. Testing an a.c. voltmeter

say, 125, 100, 75, 50 volts, and so on.

Finally, a few points which need to be remembered. Keep the Standard Cell in a cool dry

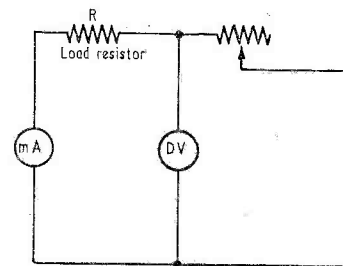

E211

Fig. 5. Testing an a.c. milliammeter

place, and never allow current to be drawn from it for more than a fraction of a second at a time. *When working from the mains remember that all connections are live. A resistor does not reduce the possibility of shock, nor does a low voltage reading in a voltmeter.*

All connections must be made as tight as possible, and the resistors used must be suitable for test instruments. The 0-1 milliammeter acts as a galvanometer. If a centre zero instrument can be obtained, so much the better.

BOOK REVIEW . . .

TAPE RECORDING FOR EVERYONE, by F. C. Judd, A.Inst.E. 134 pages, 5½in by 8½in. Published by Blackie and Son, Ltd. Price 10s. 6d.

Mr. F. C. Judd is well-known amongst tape recording enthusiasts, not only on account of his articles and publications but also because of his lively approach to allied subjects including, in particular, the composition and recording of *Musique Concrète*. In consequence, one can expect this book to be of considerable value to anyone interested in tape recording. And one is not disappointed.

The book covers all aspects of tape recording, and will be especially useful for the non-professional. A number of electronic devices and circuits are described, and their methods of operation are clearly explained.

After dealing with the basic theory of tape recording, the book reviews the range of machines currently available, giving succinct details of performance and price. A helpful chapter describes how a recorder may be assessed both in terms of performance and manufacturers' specifications. Details are given of practical recording and editing, together with accessories such as pre-amplifiers, mixers, radio tuners and telephone pick-up coils. Special recording techniques both for normal programme work and synthetic music are described, and a further chapter covers attenuators, volume indicators and distortion. There is also a glossary of technical terms, and a list of clubs and associations.

Cover Feature

The 'Highwayman' Transistorised Car Radio

Described by E. GOVIER

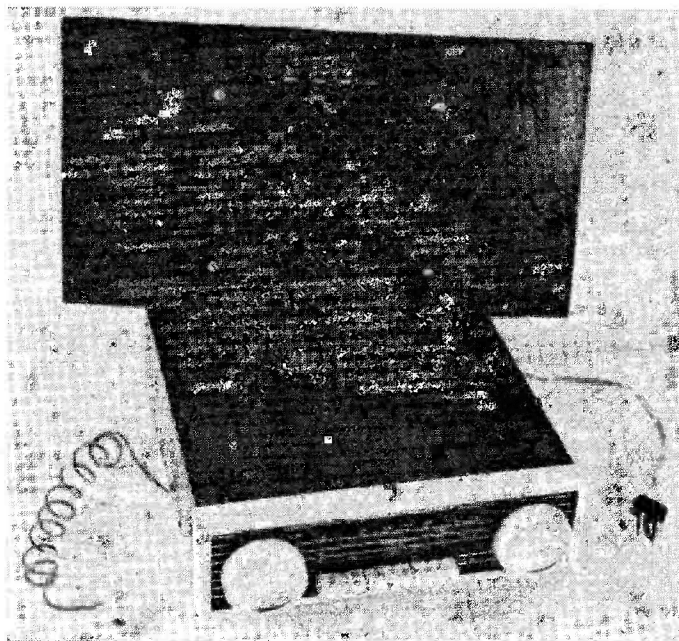

CAR RADIO DESIGNS EXPRESSLY FOR THE HOME constructor are few and far between, those that have already appeared now being several years' old with, in some cases, certain of the components no longer available. The design about to be described is the result of intensive development and research, being transistorised for economy and silent operation (no background buzz) and having printed circuit reliability and simplicity in construction.

Push button wavechange for fingertip control is featured together with a low battery consumption—the total is less than 0.5A—thereby enabling the radio to be used for hours with the car engine switched off.

The radio, once completed, is completely contained with a cabinet measuring some 7 x 2 x 7in (deep) and will therefore fit almost any car which has a 12 volt supply. The output is some 1.5 watts undistorted, this being adequate for the confines of any car, and fidelity is provided by a push-pull transistor output stage.

Sensitivity and selectivity are excellent and complete medium-wave coverage together with reception of the long-wave B.B.C. Light programme (tuneable) is provided.

An illuminated dial with gilt control knobs ensure that the front panel is attractive to the eye and an enhancement to any car.

It is important to note that the receiver is intended for use with cars having the positive 12 volt supply earthed. Reversal of supply polarity can damage the transistors permanently.

The Highwayman can be installed satisfactorily by anyone who has a basic knowledge of car electrical systems together with some mechanical ability and although the fitting of this receiver will be described fully, it is only fair to point out that there are no "short cuts" to achieving a satisfactory installation. The vibration and electrical interference in a moving vehicle is severe and a car radio that is poorly installed is most likely to become a constant source of trouble and annoyance. If the reader is in doubt regarding his ability to install the receiver, we would recommend that it be carried out by a competent car radio mechanic. Similar reservations apply also to the actual construction of the receiver.

The Circuit

This is shown in Fig. 1, from which it will be seen that it comprises a mixer/oscillator, V_1 (ECH83); a 470 kc/s i.f. amplifier, V_2 (EBF83); a driver transistor, TR_1 (OC82D) and a transistor push-pull output stage TR_2 , TR_3 (OC82 matched pair), working into a 3Ω speaker.

L_1 is a $25\mu\text{H}$ r.f. choke and L_2 is the medium-wave aerial tuning coil, this tuning over the medium waveband by mechanically withdrawing the internal iron-dust slug from the centre of the coil (permeability tuning) when S_1 is in the appropriate position. TC_2 is a trimmer capacitor. With S_1 in the long-wave position, both C_1 and TC_1 are brought into circuit, effectively covering the Light programme wavelength. L_3 is the long-wave loading coil, this being connected to chassis when

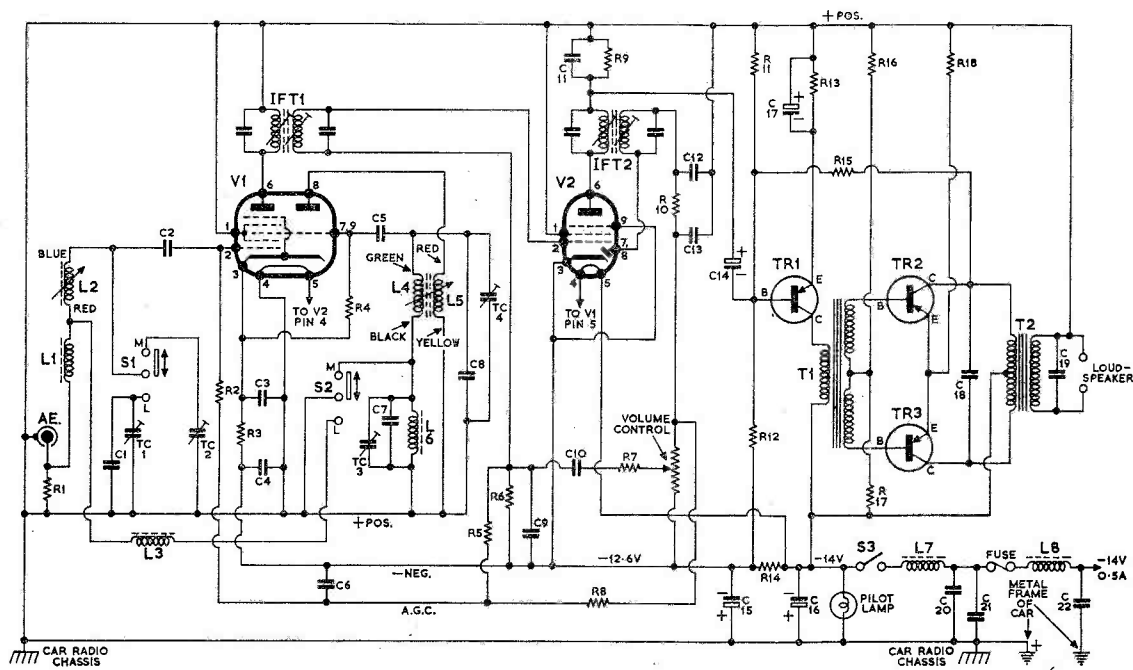

D7

Fig. 1. Circuit of the "Highwayman" car radio

Components List

Resistors ($\frac{1}{4}$ watt unless otherwise stated)

R ₁	330k Ω 20%
R ₂	470k Ω 20%
R ₃	47 Ω 10%
R ₄	47k Ω 10%
R ₅	10M Ω 20%
R ₆	4.7M Ω 20%
R ₇	330k Ω 20%
R ₈	1M Ω 20%
R ₉	2.7k Ω 10%
R ₁₀	100k Ω 20%
R ₁₁	10k Ω 10%
R ₁₂	68k Ω 10%
R ₁₃	1k Ω 10%
R ₁₄	220 Ω 10%
R ₁₅	680k Ω 20%
R ₁₆	18 Ω 5%
R ₁₇	1.5k Ω 5%
R ₁₈	6.8 Ω 10% 1 watt
VR ₁	500k Ω log.

Capacitors

C ₁	330pF 2.5% Polycap
C ₂	70pF ceramic
C ₃	0.1 μ F Polycap
C ₄	0.1 μ F Polycap
C ₅	56pF ceramic
C ₆	0.04 μ F Polycap
C ₇	150pF 2.5% Polycap
C ₈	330pF 2.5% Polycap

C ₉	220pF ceramic
C ₁₀	0.01 μ F ceramic
C ₁₁	0.01 μ F ceramic
C ₁₂	100pF ceramic
C ₁₃	470pF ceramic
C ₁₄	2 μ F electrolytic
C ₁₅	100 μ F electrolytic
C ₁₆	100 μ F electrolytic
C ₁₇	25 μ F electrolytic
C ₁₈	0.1 μ F Polycap
C ₁₉	0.04 μ F Polycap
C ₂₀	R.F. Bypass (see text)
C ₂₁	0.5 μ F paper
C ₂₂	0.5 μ F paper

Valves

V ₁	ECH83 (6DS8)
V ₂	EBF83 (6DR8)

Transistors

TR ₁	OC82D
TR ₂ , TR ₃	OC82 (matched pair)

Inductors

L ₁ , L ₇ , L ₈	25 μ H RF chokes
L ₂	MW aerial coil
L ₃	LW aerial loading coil
L ₄ /L ₅	MW oscillator coil
L ₆	LW oscillator loading coil (All Clyne Radio Ltd.)

Loudspeaker

3Ω Elliptical complete with baffle board (Clyne Radio Ltd.)

Fuse

2A rating, complete with plastic holder assembly. (Clyne Radio Ltd.)

Pilot Bulb

12V 2.2W MES

Transformers

T₁ Push-pull driver (Clyne Radio Ltd.)
T₂ Push-pull output (Clyne Radio Ltd.)

Miscellaneous

Chassis, tuning unit, printed circuit board, valve-holders, screening cans, chassis cover, wire, solder, nuts, bolts and washers, etc., etc. (Clyne Radio Ltd.)

S₂ is in the appropriate position.

V₁ functions in the normal manner, L₄ and L₅ being the medium-wave oscillator coils. The lower end of L₄ is connected to chassis when S₂ is in the medium-wave position, this effectively shorting out the long-wave oscillator loading coil L₆ together with the associated capacitors C₇ and TC₃. TC₄ is the trimmer capacitor for the medium-wave oscillator coil L₄. In the long-wave position, L₆ together with the two associated capacitors TC₃ and C₇, are switched into series with L₄. The i.f. signal from V₁ is applied, via the secondary winding of IFT₁, to the grid of the i.f. stage V₂.

The output voltage appearing across IFT₂ is taken, via R₁₀, to the diode load formed by the volume control (500kΩ). The signal is now applied back to the grid of V₂ via the slider of this control, R₇, C₁₀, and the secondary of IFT₁. Amplification at a.f. is carried out by the pentode section of V₂ and the resultant output is applied to the base of the driver transistor TR₁ via the electrolytic capacitor C₁₄.

T₁ is the push-pull driver transformer, the secondary of which applies the audio signal output from TR₁ into the bases of TR₂ and TR₃, the output from these appearing across the push-pull output transformer T₂.

R₈ and C₆ together provide the a.g.c. time constant, a.g.c. then being applied to V₂ via the resistor R₅ and the mixer/oscillator stage via R₂.

The inductor L₈ and the associated capacitor C₂₂ are the initial pulse interference suppression components, these being mounted as near to the car battery as possible. L₇ together with C₂₁ provides additional suppression at the receiver power input, C₂₀ being an r.f. bypass component.

Construction—Printed Circuit Board Assembly

All components should be fitted to the Paxolin side of the printed circuit board and solder joints made on the copper side.

The first task is to fit and solder the two valve-holders to the printed circuit board, see Figs. 2 and 3.

With reference to Fig. 2, solder the following resistors in the positions indicated:

- R₂ 470kΩ 20%—yellow, violet, yellow
- R₃ 47Ω 10%—yellow, violet, black—silver
- R₄ 47kΩ 10%—yellow, violet, orange—silver
- R₅ 10MΩ—brown, black, blue
- R₆ 4.7MΩ—yellow, violet, green
- R₇ 330kΩ—orange, orange, yellow
- R₈ 1MΩ—brown, black, green
- R₁₂ 68kΩ 10%—blue, grey, orange—silver
- R₁₀ 100kΩ—brown, black, yellow

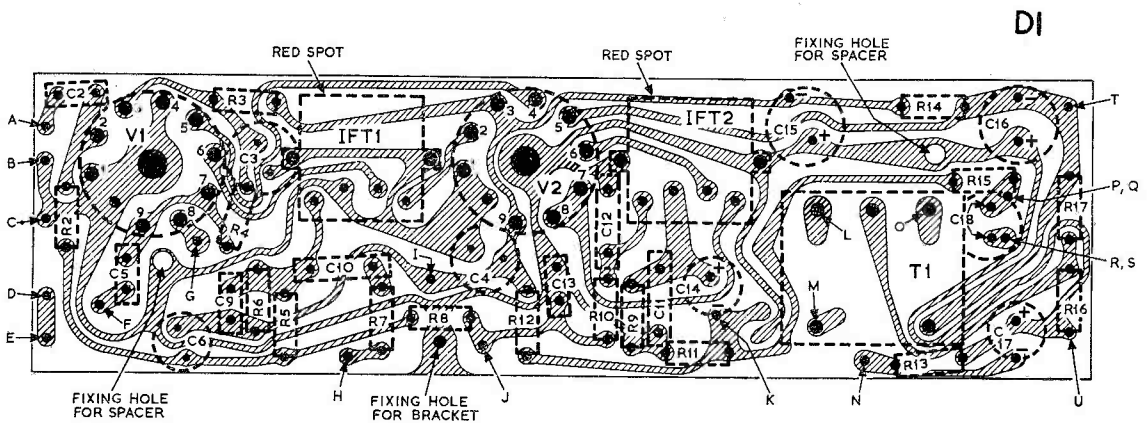

Fig. 2. The printed circuit board (copper side) showing the position of components. For additional printed circuit board information, see Figs. 3 and 4. Note that all black spots indicate soldered joints and that black spots designated with a letter are lead destinations. Solder leads K, L, M, N, O, P, R and U to the copper side of the board and all remaining leads to the reverse side of the board

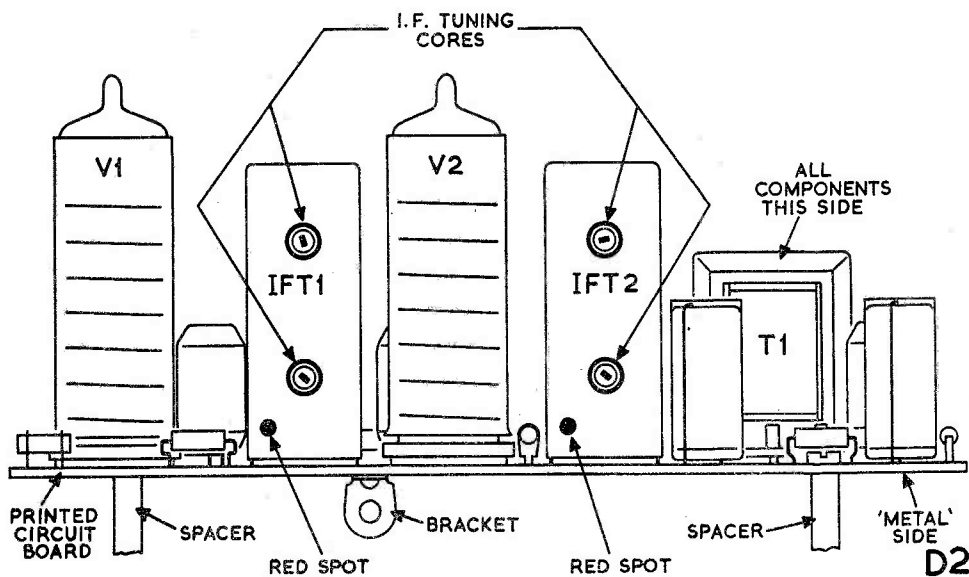

Fig. 3. Showing the positions of the main components when mounted on the printed circuit board

- R₉ 2.7kΩ 10%—red, violet, red—silver
- R₁₁ 10kΩ 10%—brown, black, orange—silver
- R₁₃ 1kΩ 10%—brown, black, red—silver
- R₁₄ 220Ω 10%—red, red, brown—silver
- R₁₅ 680kΩ—blue, grey, yellow
- R₁₇ 1.5kΩ 5%—brown, green, red—gold
- R₁₆ 18Ω 5%—brown, grey, black—gold

Having completed the foregoing, solder into position the following capacitors:

- C₂ 70pF ceramic—violet, violet, black, black, black
- C₅ 56pF ceramic—violet, green, blue, black, black
- C₉ 220pF ceramic—red, red, brown, black
- C₁₀ 0.01μF (10,000pF) ceramic—brown, black, orange
- C₁₃ 470pF ceramic—yellow, violet, brown, black
- C₁₁ 0.01μF (10,000pF) ceramic—brown, black, orange
- C₁₂ 100pF ceramic—yellow, brown, black, brown, black

Obtain a solder tag and bend it so that a right-angle is formed. (See Figs. 3 and 6.) This is then used as a bracket and is secured, using a self-tapping screw, to the copper side of the printed circuit board and soldered in order to hold it in position firmly. Examining the printed circuit board, a small hole will be found below R₈ (see Fig. 2) where this screw should be housed.

Cut a 7in length of single stranded lead and solder one end to point T on the printed circuit board. (See Figs. 2 and 6.)

Cut a 10in length of twin screened lead and prepare the ends as shown in Fig. 6. At one end,

fit a short piece of sleeving over the braid lead (I) and solder the various wires, as shown, to points H, I, J, on the printed circuit board. (See Figs. 2 and 6.)

Solder IFT₁ into position on the printed circuit board as shown in Figs. 2 and 3, ensuring that the red spot on the side of the can is uppermost. Carefully ease the clips and leads through the board and solder both these leads and clips to the copper side.

Having completed the above, fit and solder the following components to the printed circuit board.

- C₃ 0.1μF Polycap
- C₄ 0.1μF Polycap
- C₆ 0.04μF Polycap
- C₁₄ 2μF electrolytic. Note the polarity markings on this component (+ and -) and on the printed circuit board diagram, Fig. 2. These markings must agree with each other.
- C₁₅ 100μF electrolytic, note the polarity markings.
- C₁₆ 100μF electrolytic, note the polarity markings
- C₁₇ 25μF electrolytic, note polarity markings
- C₁₈ 0.1μF Polycap

Next, obtain the driver transformer T₁ and note that this can only be fitted to the printed circuit board when the three tags are uppermost. Bend over the tags after insertion through the board, and solder them into circuit.

Solder IFT₂ into position as shown in Figs. 2 and 3, ensuring that the red spot on the side of the can is uppermost. Carefully ease the clips and leads through the board and solder them into position.

Fit the can earthing clips to each valveholder.

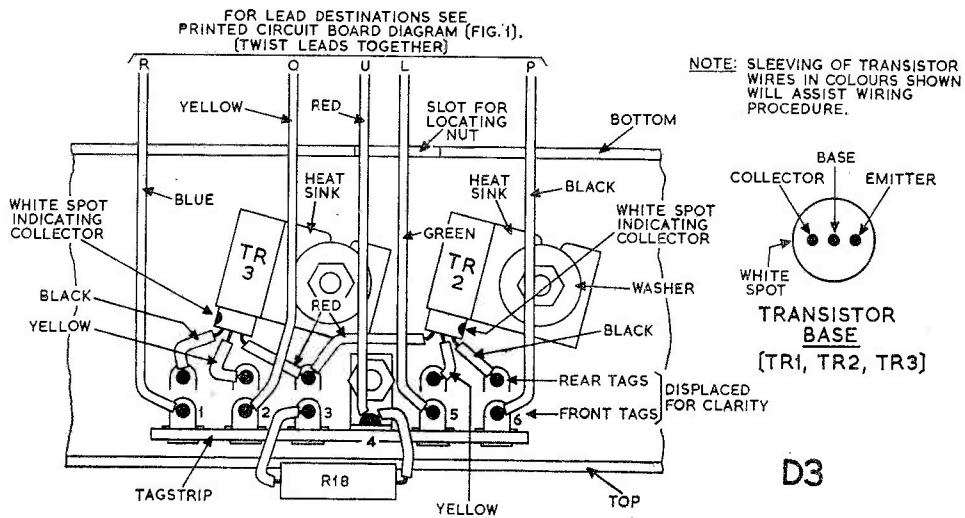

Fig. 4. The rear panel assembly and transistor connections

These clips fit between valvholder tags 1 and 9 and are pushed through the board and then soldered. They are mounted in such a manner that they bend away from the centre of the valvholder.

Fit the 4BA x 1½in bolts and spacers to the printed circuit board, fitting a nut on the end of each bolt—see Figs. 2 and 6.

Take TR₁ (OC82D) and fit sleeving to each lead as in Fig. 6—red to emitter, yellow to base and black to the collector. *Do not cut the leads.* Solder to points N, K and M on the copper side of the board, see Fig. 2.

Main Chassis Assembly

Take the main chassis sub-assembly (see Fig. 6) and fit the following components into position.

The 4-bank trimmer, using two 6BA x ¼in bolts and nuts. Note here that a solder tag and the earth tag of a 3-way tagstrip is fitted under one of these bolts where shown.

The volume control potentiometer (500kΩ) with the tags uppermost as shown in Fig. 6.

The push-button unit using two 4BA x ¼in bolts and nuts through the front of the assembly.

Output transformer T₂—note the position of the

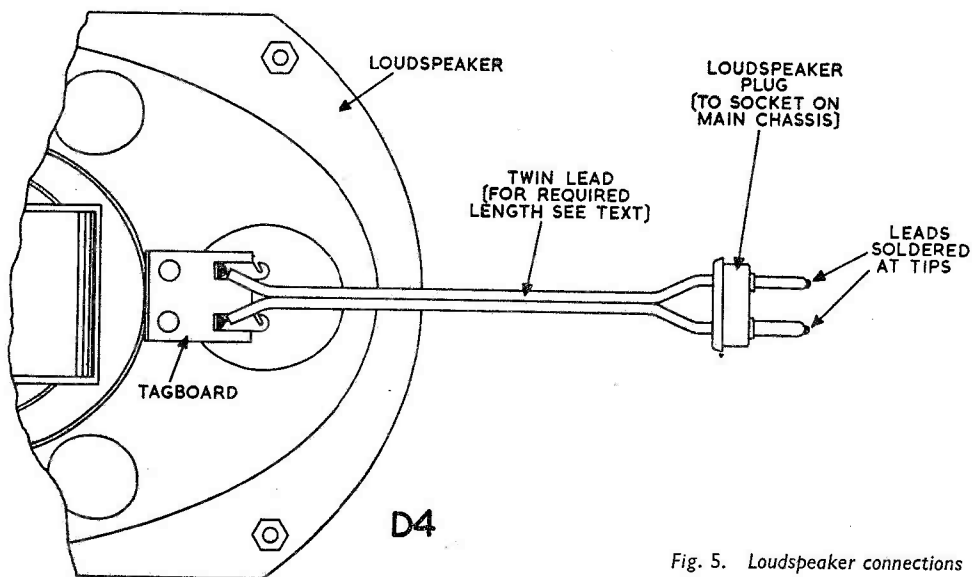

Fig. 5. Loudspeaker connections

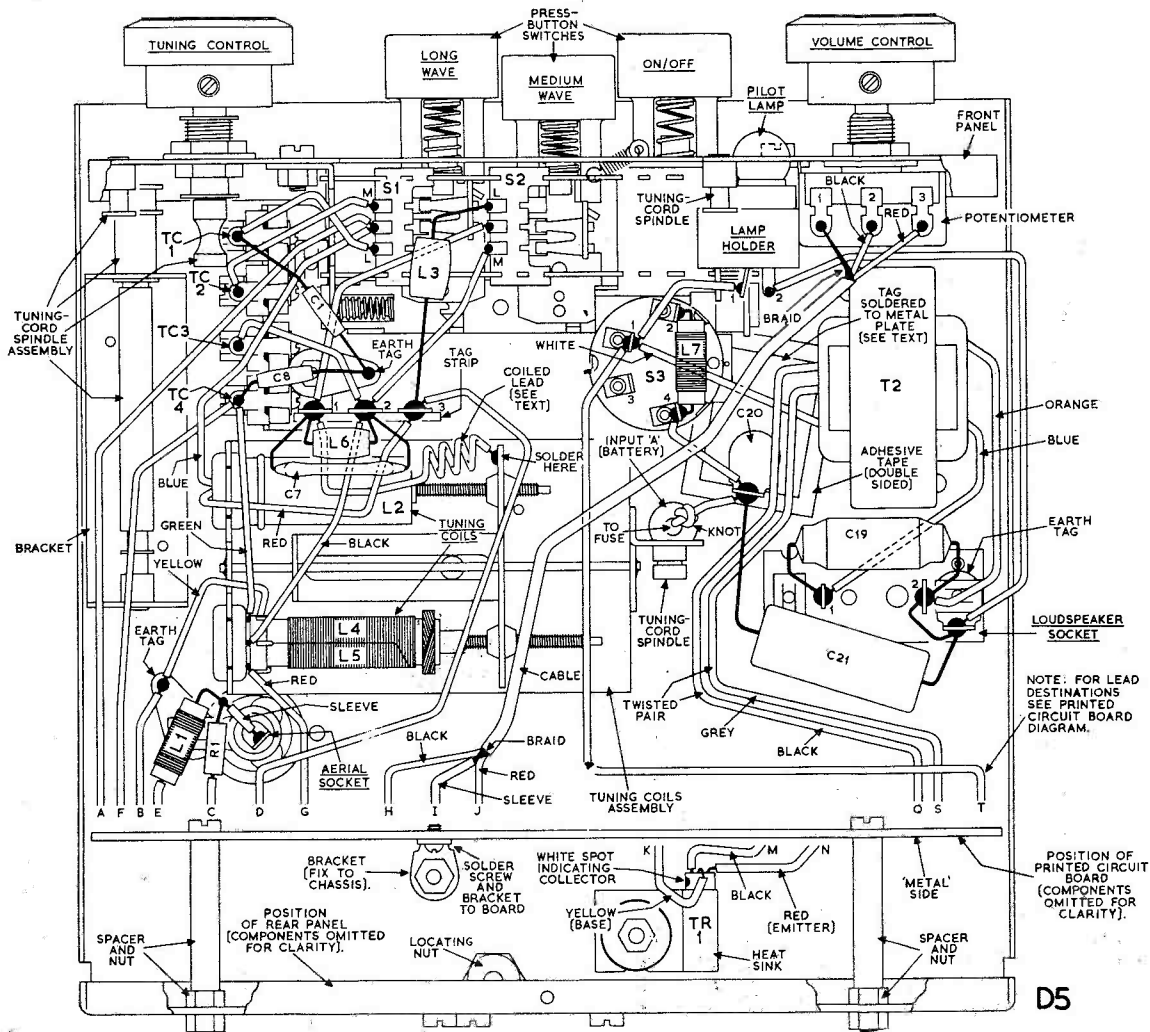

Fig. 6. Main chassis wiring details

coloured leads before fitting. Bend the two metal lugs over on the underside of the main chassis.

Large grommet to input hole "A".

Loudspeaker socket, using two 6BA x 1/4 in bolts and nuts plus a solder tag, as shown in Fig. 6. Note here that the plug holes in the socket are of differing sizes, and that this should be borne in mind when fitting the speaker into circuit.

Fit a 6BA x 1/4 in bolt and nut, together with an earthing solder tag, to the hole adjacent to the aerial input socket (under L₁—see Fig. 6).

Remove the backing material from both sides of the adhesive tape and press down firmly in the position indicated (adjacent to T₂). This forms the dielectric for C₂₀.

Press the small metal plate on to the top of the adhesive tape, thus completing the assembly of C₂₀.

Solder tag 2 of the loudspeaker socket to the adjacent earth tag.

Solder the orange and blue leads from T₂ to the loudspeaker socket (see Fig. 6), also fitting C₁₉ (0.04μF Polycap) into position at the same time.

Twist one end of L₁ (r.f. choke) and R₁ (330kΩ—orange, orange, yellow) together, and solder this junction to the centre tag of the aerial input socket, leaving the other ends of L₁ and R₁ free for the time being.

Rear Panel Assembly

Obtain the chassis rear panel and bolt a 6-way tagstrip in position using a 4BA x 1/4 in bolt and nut. Fig. 4 clearly shows the position of the tagstrip and, with reference to Fig. 6, the correct position may be easily ascertained.

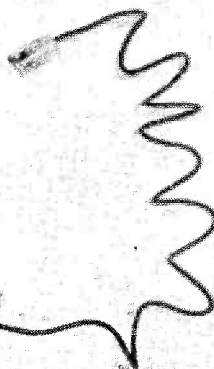
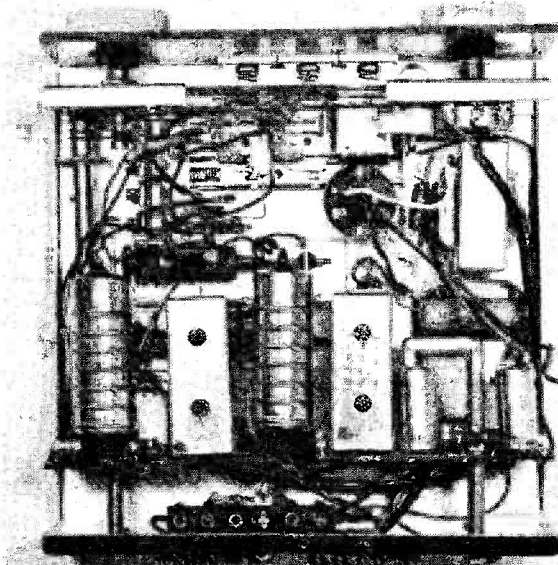

Plan view of the completed car radio chassis with top cover removed

Remove the two OC82 transistors TR₂ and TR₃ from the package and identify the lead connections from Fig. 4. Fit coloured sleeving to each lead exactly as shown in the diagram and *do not cut the transistor leads*. Solder each OC82 transistor to the rear tags as shown.

Carefully fit a heat sink to each OC82 transistor and, using 4BA x 1/4 in bolts plus a washer under each nut, bolt them both securely to the rear panel.

Fit sleeving to the ends of R₁₈ (6.8Ω 10% 1 watt—blue, grey, gold, silver) and solder into position between tags 3 and 4 (see Fig. 4).

Cut a 6 in length of single stranded lead for each of the following colours: black, green, red, yellow and blue. Prepare one end of each lead and solder to the 6-way tagstrip exactly as shown in Fig. 4. Leave the other ends of these leads free for the time being.

This completes the rear panel assembly.

Fitting the Printed Circuit Board and Rear Panel

Take the printed circuit board assembly, prepare the free ends of the five coloured leads that have just been fitted to the rear panel and solder these ends to the printed circuit board as shown in Figs. 2 and 4. It will be noticed that these coloured leads are identified R, O, U, L and P, and they must be soldered to the points similarly identified on the printed circuit board.

Bolt the rear panel assembly to the printed circuit board (see Fig. 6) by pushing the ends of the extension bolts through the holes in the rear panel and then fitting 4BA nuts in order to hold these assemblies together.

Carefully align the lower edge of the rear panel with the rear edge of the main chassis and fit two small self-tapping screws through the holes in the underside of the main chassis that align with the holes in the lower edge of the rear panel.

Next, bolt the bracket (formed earlier by bending a solder tag) that is fixed to the lower edge of the printed circuit board securely to the main chassis using a 4BA x 1/4 in bolt and nut.

Carefully slide the remaining heat sink over TR₁ (OC82D) and bolt down securely to the main chassis using a 4BA x 1/4 in bolt, washer and nut.

Solder into position C₂₁ (0.5μF) between the tag of C₂₀ and the earth tag fitted to the loudspeaker socket.

Solder the free end of lead T (earlier fitted to the printed circuit board) to tag 1 of the on/off switch S₃ (see Fig. 6).

Join the free end of the white lead from the output transformer T₂ also to tag 1 of S₃.

Solder into circuit choke L₇ between tags 2 and 4 of S₃.

Screw into position the 12V 2.2 watt bulb to the plastic lampholder and ease the holder on to the metal bracket adjacent to the volume control (see Fig. 6).

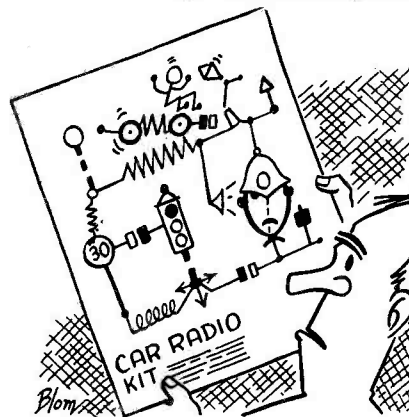

Join a short lead to tag 1 of the lampholder and tag 1 of S_3 .

Solder a short lead between tag 2 of the lampholder and the earth tag on the loudspeaker socket.

Connect a short length of lead between the tag of C_{20} and tag 4 of S_3 .

Join the grey and black leads Q and S from T_2 to points Q and S on the printed circuit board.

Solder the free ends of the twin screened cable that comes from the printed circuit board to the tags on the volume control potentiometer (see Fig. 6)—braid to tag 1; black to tag 2 and red to tag 3.

Fit a short length of sleeving to the free ends of both L_1 and R_1 (330k Ω , orange, orange, yellow) and solder to the printed circuit board (leads E and C).

Join a short lead (B) between the printed circuit board and the earth tag adjacent to the aerial socket.

Solder the free end of the yellow lead from L_4 , L_5 coil to the same earth tag.

Join the free end of the red lead from the same coil to the printed circuit board (point G).

Connect the green lead from L_4 , L_5 coil to the tag on TC_4 trimmer.

The free end of the black lead from the same coil

Connect C_1 (330pF 2.5% Polycap) between TC_1 trimmer tag and the adjacent earth tag.

C_8 (330pF 2.5% Polycap) is now connected between TC_4 trimmer tag and the adjacent earth tag.

Connect a short lead between TC_1 tag and tag L on S_1 , also a short lead from TC_2 tag and tag M on S_1 .

Similarly, connect a short lead between the tag of TC_3 and tag 2 of the 3-way tagstrip.

Connect lead F between the tag on TC_4 and point F on the printed circuit board.

The free end of the blue lead from L_2 coil is now connected to the centre tag of S_1 —extend this lead if necessary by adding an extra length of p.v.c. covered wire.

Connect lead A between the printed circuit board and the centre tag of S_1 .

Final Assembly

With reference to Fig. 7, assemble the fuseholder and the 2A fuse, and join the suppressor unit into circuit. Lead A is approximately 8in in length. The lead between the fuseholder and the suppressor unit and car battery supply is supplied ready fitted to the assembled suppressor unit. Any excess may

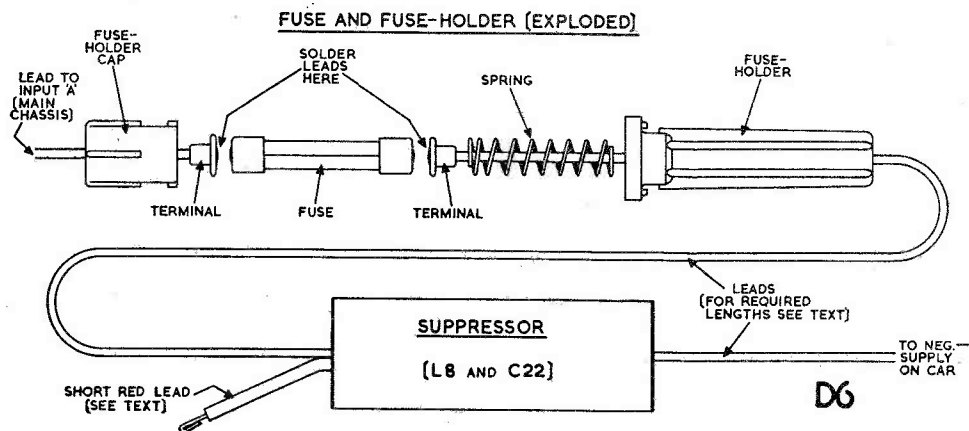

Fig. 7. Suppressor and fuseholder assembly

is now soldered to tag 2 of the tagstrip adjacent to L_2 coil—see Fig. 6.

Connect C_7 (150pF 2.5% Polycap) between tags 1 and 2 on the same tagstrip.

In parallel with C_7 , fit choke L_6 —coded with a green sleeve.

From tag 3 of the same tagstrip connect lead D to the printed circuit board.

Join a short lead between tag M on S_2 wavechange switch and tag 2 on the 3-way tagstrip.

Connect a lead between the centre tag of S_2 and tag 1 on the 3-way tagstrip.

Solder the free end of the red lead from L_2 coil to tag 3 of the 3-way tagstrip.

Connect L_3 , coded with a yellow sleeve, between tag L on S_2 and tag 3 of the 3-way tagstrip.

be removed, this of course depending on the final position of the car radio when installed within the car itself.

Feed the end of lead A through the grommet in the main chassis and tie a large knot in this lead as shown in Fig. 6, soldering the end of the lead to the tag on C_{20} .

Obtain the loudspeaker and bolt securely to the baffle using four 4BA x $\frac{1}{2}$ in bolts and nuts together with washers. Should the holes between the loudspeaker frame and baffle fail to align correctly, force a hole or holes through the baffle using a pointed object—such as a small screwdriver, etc.

With reference to Fig. 5, join a suitable length—depending on the final position of the loudspeaker—of twin stranded lead to the loudspeaker tags

and, to the other ends, solder the 2-pin plug.

Take a 4in length of single stranded lead and wind closely around a small diameter screwdriver to form a coiled lead. This is soldered between the moving bar on the tuning unit and tag 1 on the 3-way tagstrip (see Fig. 6).

Insert the ECH83 (or the equivalent 6DS8) into V_1 valveholder carefully, and the EBF83 (or the equivalent 6DR8) into the V_2 valveholder.

Carefully slide the screening cans over both valves ensuring that the can earthing clips fitted to the valveholders are seated *inside* the cans.

Fit and secure into position the Perspex dial, front panel and both control knobs.

The assembly of the car radio is now complete.

Alignment

Connect a suitable source of 12V d.c. to the receiver, the positive (+) supply to the case or chassis and the negative (-) to the "A" lead input. Connect the loudspeaker by inserting the two-pin plug into the output socket.

Switch on the receiver, whereupon the dial bulb should light up. Allow sufficient time for the valves to warm up, set wavechange to the medium-wave band, advance the volume control and rotate the tuning control to 550 metres approximately. Set the signal generator to 470 kc/s and feed a modulated signal into the aerial input socket. Adjust the cores of IFT_1 and IFT_2 for maximum signal, reducing the output from the signal generator as necessary.

Alter the signal generator to 540 kc/s and adjust the core of L_4 , L_5 for maximum signal by using a thin pair of pliers and drawing the brass threaded rod attached to the core either in or out of the coil. Adjust the core of L_2 in the same manner for maximum output. Set the signal generator to 1.5 Mc/s, tune the receiver to 200 metres and adjust TC_4 trimmer for maximum signal. Similarly, peak TC_2 and finally repeat the whole of the above procedure.

Press the long-wave push-button and alter the signal generator to 200 kc/s. Tune the receiver to 1,500 metres and adjust TC_3 trimmer for maximum signal and similarly adjust TC_1 trimmer.

Finally, the metal cover may be fitted over the receiver using the small self-tapping screws to secure it to the main receiver chassis.

Interference Suppression

As many readers will know, probably to their cost, a motor vehicle is a notorious generator of radio interference and it is essential that this interference be suppressed at the source—this is easily said but often very difficult to achieve satisfactorily.

The ignition system, if not efficiently suppressed, will produce a continual "clicking" or "popping" noise in the loudspeaker and similarly the dynamo, if not suppressed, will cause a "whine" which will increase in intensity as the engine is "revved".

Judicious attention to the following should ensure interference-free reception but it must be emphasised that no definite rules can be laid down that will apply to all and every car. As the writer has found

in practice, age and various faults peculiar to individual vehicles (and makes) often produce variations with respect to the causes and cures (where one is possible) and each car must receive individual attention.

The first advice the writer would impart to readers installing *any* car radio is that the aerial should be mounted on the rear of the car when the engine is situated at the front and *vice versa*.

Some cars have r.f. "hot spots" around the engine and bulkhead—side valve engines being, in the writer's opinion, very troublesome in this respect. Mounting the aerial therefore, as far from the engine as possible, with good quality coaxial cable being fed *inside the body of the car* to the receiver is always a good start when battling against ignition interference.

Most modern cars will have a suppressor resistor already fitted to the distributor head and, where this is not the case, then one should be fitted. These are usually of the screw-in type and are easily available from most garages. If this type is not available then a cut-lead type of resistor (suppressor) may be fitted. This suppressor should be fitted in the main h.t. lead from the distributor to the coil and *must be sited as close as possible to the distributor*.

Suppressor resistors should be fitted to each sparking plug, the "clip-on" type being the best for this purpose although the cut-lead type having woodscrew connectors may be used, provided these are fitted as close as possible to the plugs.

Where suppressor resistors or resistive leads are already fitted to the distributor and/or plugs, the fitting of additional suppressors will worsen the interference.

A $1\mu\text{F}$ metal cased bypass capacitor should be fitted to the dynamo, the lug of the capacitor being mounted on the dynamo fixing nut and fixed securely so that a good earth connection is made. The flying lead of the capacitor must be connected to the live output terminal—the car lead connected to this terminal being usually coloured yellow. *On no account should this capacitor be connected to the dynamo field terminal otherwise severe damage will be caused to the dynamo.*

A similar bypass capacitor should be mounted on the ignition coil bracket and the flying lead of the capacitor connected to the "SW" terminal of the coil (i.e. the low tension lead connected to the ignition switch).

On some vehicles it may be found necessary to connect another bypass capacitor to the voltage regulator, although this is not generally required with the majority of cars. Where it is found necessary to fit such a capacitor it must be connected to the *voltage regulator terminal only*.

The $1\mu\text{F}$ bypass capacitors referred to above may be obtained from most large garages and most certainly from car electrical workshops.

Installation

The dimensions of the car radio are 7 x 2in and it will therefore fit into the standard cut-outs provided in the dashboards of some cars. Alternatively,

the radio may be mounted on L brackets below the dashboard. Whichever method is used, the brackets should be of substantial material and all bolts well tightened—the use of shake-proof washers is strongly advised.

The bushes on the side of the receiver case are 2BA and the actual length of the bolt required will depend on the thickness of the brackets used. In any event, not more than $\frac{1}{4}$ in of bolt should project into the bushes.

Scrape away the paint around one of the bushes and deal similarly with the corresponding bracket in order to ensure that a sound earth connection is made to the receiver.

The loudspeaker may be mounted in any convenient position, although suitable openings are usually now provided. It will be found that a considerable increase in volume will result in most cars if the speaker is mounted on the shelf behind the rear seat. The baffle board may require trimming in order to obtain a good fit and, as the baffle is of compressed cardboard, this presents no difficulties. No fixing holes have been provided to fix the baffle board to the car since the position of such holes

will, of course, be determined both by the final position of the board and the make of car.

Connections

The live lead from the receiver must be connected to the A1 terminal of the junction box. This lead carries the fuseholder at the set end and has the suppression interference unit at the end remote from the set. The *black* lead from this unit is that which should be connected to the A1 terminal, the *red* lead being connected to the earthing point—a nearby screw head would suffice. If the suppression unit cannot be passed through the grommet hole in the bulkhead, then the lead should be cut and later reconnected.

The aerial plug should now be inserted into the coaxial socket (to the right underside of the receiver looking at the front) and pushed tightly home. The 2-pin loudspeaker plug is inserted into the 2-pin socket on the left-hand side of the bottom of the receiver. Note that the speaker plug has one pin of larger diameter than the other, the larger pin facing the left-hand side of the receiver when the plug is inserted into the socket.

Certification of High Fidelity Amplifiers

As mentioned in our feature "News and Comment" on page 835 of the June issue, we publish herewith some details of a certification scheme for high fidelity amplifiers, the end result of which is the protection of customers from exaggerated claims. For those readers who would like to pursue the matter further, see under Further Information, page 927.—Editor.

MANUFACTURERS OF HIGH fidelity amplifying equipment can now apply for certification to show that performance claims have been checked by an independent testing authority. This certification scheme, together with a full test specification, has been introduced by the Audio Manufacturers' Group of the British Radic Equipment Manufacturers Association, and it forms an important landmark in the manufacturing and marketing of a.f. equipment in this country. Amplifiers which have undergone the necessary tests will be able to carry a "certification label" bearing the A.M.G. insignia and the information that the manufacturer's specification has been verified against A.M.G. Test Procedure. The label will indicate no specific performance for the particular amplifier which carries it, but it will mean that the validity of the manufacturer's claims has been independently confirmed.

All manufacturers of audio amplifiers may participate in the certification scheme, and it is not restricted to members of A.M.G. A number of approved "test houses" have been established for measurements on amplifiers. Amplifiers are checked at these test houses against the A.M.G. specification, after which application is made for the A.M.G. certification. To qualify for registration all data given in technical publicity material must be covered by test house certificate, and the manufacturer must undertake that all production of the equipment concerned will maintain the performance exemplified by the verified sample. Any modification to the specification must be notified to A.M.G. immediately it occurs.

The function of the certification scheme is to protect customers from exaggerated claims, and rigid rules have been drawn up specifying the minimum number of performance parameters that a manufacturer must

present. It is not permissible, for instance, to quote figures for rated output and frequency response only.

It is stated by A.M.G. that "apart from its value to the industry, the certification scheme will be welcomed by the public. Purchasers of high quality amplifiers rarely have the necessary equipment or experience to carry out the elaborate tests needed to check the manufacturer's performance claims."

The certification covers pre-amplifiers, power amplifiers, integrated amplifiers and stereo equipment; and it excludes signal generating sources (such as pick-ups or tape decks) and loudspeakers.

Minimum Performance Data

To achieve certification the following minimum performance data must be submitted by the manufacturer:

- Harmonic distortion
- Rated output voltage (pre-amplifiers)
- Rated output power (power or integrated amplifiers)
- Sensitivity
- Frequency response for level position, with uncorrected inputs
- Frequency response for level position, with equalised inputs (pre-amplifiers and integrated amplifiers)
- Hum and noise
- Damping factor
- Cross-talk (stereo equipment)
- Power consumption and current drain.

The A.M.G. Specification

The A.M.G. Specification covers a wide range of parameters and methods of test. Those with most interest to the high fidelity enthusiasts are detailed here in considerably abbreviated form.

Amplifiers shall be tested under standard conditions of measurement. For mains-operated apparatus, a.c. supply voltages shall be within $\pm 2\%$ of the rated figure, have a frequency within $\pm 2\%$ of the lowest rated supply frequency, and be sinusoidal with less than 2% harmonic content. Where applicable, d.c. supply ripple must not exceed 5%. Battery-operated amplifiers shall be checked with the battery type specified by the manufacturer. Unless an input impedance is specified, the input to the amplifier will be fed from a source impedance of $10k\Omega$, whilst the output terminals of power or integrated amplifiers will be loaded by a resistor within $\pm 5\%$ of the value specified by the manufacturer. Pre-amplifiers must be terminated by a $100k\Omega$ resistor shunted by a $1,000pF$ capacitor unless otherwise specified by the manufacturer.

The measurement signal, unless otherwise specified, shall consist of a 1,000 c/s tone, the r.m.s. value of all frequency components other than the fundamental being less than 20% of the rated harmonic distortion of the amplifier.

Amplifiers using valves must be pre-conditioned for at least one hour with all covers in place. Amplifiers using transistors must be pre-conditioned for two hours with all covers in place, and with a 1,000 c/s input giving an output equal to 20% of the rated output.

Harmonic distortion may be measured with either a distortion percentage meter, which automatically sums the power in all the harmonics and gives the result as a percentage of output voltage, or a wave analyser. The latter measures the values of the individual harmonics, from which the total value can then be calculated. Where a simple harmonic distortion figure is quoted, this shall be at 1,000 c/s. If it is desired to plot the characteristic curve for harmonic distortion, the input voltage shall be adjusted such that the amplifier continually operates at rated output, input frequency being varied between the upper and lower limits where measured harmonic distortion is five times the value claimed by the manufacturer at 1,000 c/s.

The *frequency response characteristic* of an amplifier is defined as the

curve showing variation of gain with frequency relative to gain at 1,000 c/s. With power amplifiers the input voltage is adjusted such that the amplifier continually operates at one-quarter of the rated output power, input frequency being varied between the limits of half the minimum to twice the maximum of the range of frequencies over which the manufacturer claims a level response (within $\pm 1dB$). This process is then repeated at full output power, either over the previous range or between the frequency limits which require 20dB increase in input voltage to maintain the rated output, whichever is the smaller range. With pre-amplifiers, measurements are made over the same range as for power amplifiers at one-quarter of rated output power, the pre-amplifier output being at one-half the rated output voltage. Frequency response characteristics are then taken for level control position, with equalisation applied, with bass and treble controls at the full "cut" or "boost" positions, and for each position of filter controls.

No tests for *intermodulation distortion* are specified, it being considered that the study of measuring and expressing intermodulation distortion has not reached a stage where a standard method can be recommended. If intermodulation distortion tests are made, the method used should be stated with the results.

Hum and noise is defined as meaning all voltage components delivered to its load by an amplifier operating with no input signal applied. It must be measured by an instrument with full-wave rectifying characteristics, which responds to the average value, and which is calibrated to indicate the r.m.s. value of a sinusoidal waveform. For pre-amplifiers a test signal at 100 c/s is applied to give rated output voltage. The test signal is then removed and the input shunted by a non-inductive screened resistor of $47k\Omega$, unless the input is low impedance whereupon the resistor value equals the source impedance specified by the manufacturer. The output voltage is then measured. The equivalent hum and noise signal input voltage is given by:

$$\frac{\text{Hum and noise output voltage}}{\text{Signal output voltage}}$$

The process is repeated with the gain control adjusted to give half the rated output voltage.

For power amplifiers the input is shunted by a non-inductive screened resistor of $47k\Omega$, unless the input is low impedance whereupon the

resistor value equals the source impedance specified by the manufacturer. The hum and noise level in decibels is given by

$$10 \log_{10}$$

To measure the *damping factor* of a power amplifier, a 50 c/s input is initially applied to produce one quarter of the rated output power in the load resistor. The voltage across the output is then measured. Without adjusting the input, the load resistor is removed, and the open-circuit output voltage measured. Then:

$$D.F. = \frac{V_2}{V_1 - V_2}$$

where D.F. is the damping factor, and V_1 and V_2 the no-load and on-load voltages respectively.

The *stability* of a power amplifier is defined as its ability to operate without the generation of spurious oscillations when used with a capacitive load. The amplifier is tested with a capacitor connected across any output and no other load. If the amplifier is claimed to be unconditionally stable, the test is made with a range of capacitor values, in steps of $0.01\mu F$ from 0.01 to $0.1\mu F$, and in steps of $0.1\mu F$ from 0.1 to $1\mu F$. If no special claims for stability are made, the value of the capacitor shall be such that its reactance at 200 kc/s is equal to the nominal impedance of the output being used (e.g. $0.05\mu F$ approximately for 15Ω output). Capacitive loading in excess of this is unlikely in domestic installations. With the various capacitors connected, the output is coupled to a wide-band oscilloscope to check for evidence of spurious oscillation with no input applied, and with the input swept over 10 c/s to 70 c/s.

To measure *cross-talk* in stereo equipment, one amplifier has its input shunted by a non-inductive screened resistor of $47k\Omega$ or, if the input is low impedance, with a resistor whose value equals the source impedance specified by the manufacturer. The output is coupled, via a high-pass filter having

$$\times \text{ Signal input voltage.}$$

a cut-off frequency of 100 c/s, to an instrument calibrated to read the r.m.s. value of a sinusoidal waveform. The outputs of both amplifiers are terminated by the specified load resistance. A 200 c/s signal having the same amplitude as that which

gives rated output at 1,000 c/s is then applied to the other amplifier, and any voltage appearing across the

$$\frac{\text{Output power with input shunted}}{\text{Rated output power}}$$

output of the first measured. Crosstalk in decibels is given by

$$20 \log_{10} \frac{\text{Cross-talk output voltage}}{\text{Signal output voltage}}$$

A second test is carried out with an input signal at 5,000 c/s, and the whole process is next repeated with the amplifiers reversed. The worst figure given by these four measurements is then specified as the crosstalk performance of the equipment at its rated output.

No test is specified for *transient response*, it being considered that none of the methods currently used are comprehensive enough to cover all transients. If transient tests are made, the method used, including measuring frequency, rise-time and overshoot, should be given with the results.

Treatment of Complaints

If a complaint concerning the

performance of a particular amplifier in the certification scheme is made (within 90 days of the date of purchase) and if the manufacturer has serviced the amplifier and stated that it is up to standard, or has declined to take any action, the following procedure is adopted.

The amplifier under query shall be submitted to the test house which originally tested the equipment, the complainant and the manufacturer each depositing with A.M.G. a testing fee depending upon the parameter(s) to be checked. The A.M.G. will be notified of the result of the test. If the amplifier meets the manufacturer's specification, the complainant's fee will be forfeit and the manufacturer's fee returned to him. The complainant shall be provided with a copy of the test report. If the manufacturer declines to lodge a deposit, or to take any other action under the complaints procedure, the certificate shall be withdrawn and the Trade Press notified accordingly. Similarly, if the amplifier submitted for test fails to meet the manufacturer's specification, the certificate shall be withdrawn and the Trade Press notified; also the manufacturer's deposit shall be

forfeited and the complainant's deposit returned to him. The manufacturer shall be provided with a copy of the test report.

The certificate will also be withdrawn and the Trade Press notified if, one calendar month after the manufacturer has been notified, any undertakings given in the application for registration are not being complied with.

If, for any reason, a manufacturer no longer wishes to be bound by the conditions attached to the certification, he may apply to A.M.G. to have his equipment withdrawn from the register. The Trade Press shall be notified that this is a voluntary withdrawal.

Further Information

The full title of the A.M.G. Specification is "Specification for methods of measuring and expressing the performance of Audio Frequency Amplifiers", and it is available at 10s. 6d. (plus postage) from the Secretary, Audio Manufacturers' Group, 49 Russell Square, London, W.C.1. Full details of the certification scheme are also available.

A FAMILY RADIOGRAM

PART 2

by A. S. CARPENTER

This article concludes our two-part series describing the construction of a comprehensive radiogram which is especially intended for family entertainment. A particular feature of the instrument is that it may be fitted into a ready-manufactured cabinet, thereby ensuring a professional presentation with the minimum of carpentry. Last month's article dealt mainly with the amplifier and its power pack, and we now carry on to the tuner unit

The Superhet Tuner

THE TUNER UNIT WILL DOUBTLESS APPEAL TO many readers since it is, as was mentioned earlier, a self-contained unit which can easily be put to uses other than in the present equipment. Major circuit details are shown in Fig. 9.

Compactness is the keynote here, plus efficiency and simplicity. Reliability of operation rules out trick circuitry and a conventional design is adopted. V_1 is a modern frequency changer and V_2 functions as intermediate frequency amplifier, signal demodulator and a.g.c. diode.

A self-contained, home-built coil pack is incorporated and this, together with efficient i.f. transformers, provides a good range of listening pleasure on both the medium and long wavebands.

The tuner is powered by a small mains isolating transformer, and half-wave rectification is used, the anodes of the valve rectifier, V_3 , being strapped. If preferred, a miniature contact cooled metal rectifier can be used instead of V_3 for rectification. Audio signals are conveyed to the amplifier by screened cable from a stand-off insulator ("I" in Fig. 14) mounted on the tuner chassis top plate.

Components List (Fig. 9)

Resistors ($\frac{1}{2}$ W except where stated)

- R₁ 18k Ω 1W
- R₂ 18k Ω 1W
- R₃ 33k Ω 1W
- R₄ 220 Ω
- R₅ 56k Ω
- R₆ 470k Ω
- R₇ 1M Ω
- R₈ 100k Ω
- R₉ 190 Ω
- R₁₀ 56k Ω
- R₁₁ 2.2k Ω 1W
- R₁₂ 2.2k Ω 1W
- R₁₃ 68 Ω 1W
- R₁₄ 470k Ω
- R₁₅ 1M Ω

Capacitors (C₁ to C₃ are in coil pack)

- C₄ 0.01 μ F, paper
- C₅ 0.01 μ F, paper
- C₆ 50pF mica
- C₇ 50pF mica
- C₈ (a and b) 500pF nominal, twin gang
- C₉ 0.01 μ F paper
- C₁₀ 0.01 μ F paper
- C₁₁ 0.01 μ F paper
- C₁₂ 50pF mica
- C₁₃ 0.01 μ F paper
- C₁₄ 200pF ceramic or mica
- C₁₅ 200pF ceramic or mica
- C₁₆ 0.01 μ F paper
- C₁₇ 4 μ F electrolytic, 350WV
- C₁₈ 16 x 16 μ F, electrolytic 350wV

Valves

- V₁ ECH81
- V₂ EBF80
- V₃ EZ80

Transformers

- T₁, T₂ Weymouth P6 or Denco IFT11.
- T₃ Mains input Secondaries: 0-250V at 30mA, 6.3V at 1.5A.

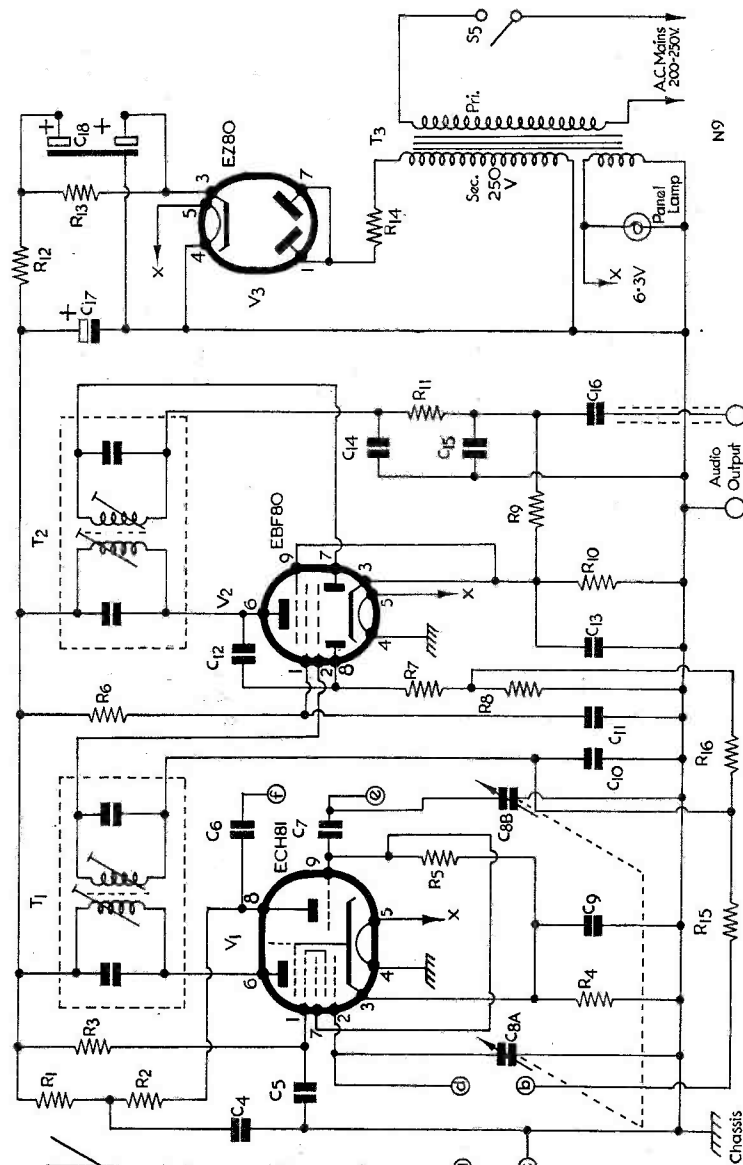

Fig. 9. Theoretical circuit of the tuner

Chassis
8 $\frac{1}{4}$ x 4 $\frac{1}{4}$ x 1 $\frac{1}{2}$ in. (Fig. 13)

Panel
14 $\frac{1}{2}$ x 4 x $\frac{3}{8}$ in. (Fig. 12)

Valveholders
B9A (3)

Panel Lamp and Holder
MES 6.3V, 0.15A

Lens and Bush
Bulgin 1-hole, $\frac{3}{8}$ in fixing type D197

Switch
On/off toggle, 1-pole

Miscellaneous

- Dial drum, 2 $\frac{1}{4}$ in dia. and drive shaft (see text)
- Aerial-earth socket strip
- Control knobs (2)
- Grommets, solder tags, etc.

Fig. 10. Theoretical circuit of the coil pack

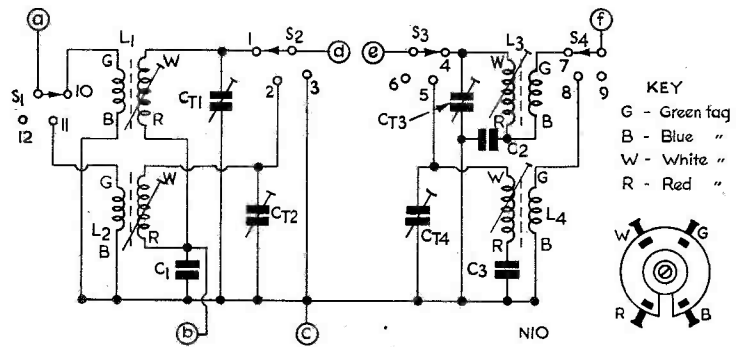

Components List (Fig. 10)

- Coils**
 L₁ HA3
 L₂ HA1
 L₃ HO3
 L₄ HO1
 } Weymouth "H" range

Switch
 4-pole, 3-way miniature

- Capacitors**
 C₁ 0.01μF ceramic
 C₂ 500pF mica
 C₃ 180pF mica

Trimmers
 CT_{1, 2, 3, 4} 3-30pF concentric

Chassis
 See text

The Coil Pack

The coil pack used here is unique and is a companion to one previously built by the author of which details were given in an earlier issue.¹ The earlier version served a special purpose in that it selected three pre-set transmissions. The pack used here is identical in size and is built on a similar chassis, viz. a small size discarded Elastoplast waterproof dressing tin, the lid of which is removed and placed over the bottom of the tin to provide an extra thickness of metal. Since the pack is eventually fitted to a non-metal panel, the use of the tin is desirable to isolate the coils from unwanted hand effects.

Coils from the Weymouth "H" range are again chosen because of their simplicity of fixing, this requiring a single 6BA bolt. The dust cores are headed with brass stems for trimming purposes and these fracture less easily than those in which the screwdriver slot is part of the core material.

The theoretical circuit diagram of the coil pack is given in Fig. 10. Aerial coil, L₁, and oscillator coil, L₃, embrace the medium-waveband with L₂ and L₄ as their long-wave counterparts. A short-wave range is not fitted although there are sufficient contacts on the wavechange switch to include one; the pack would, however, tend to become congested.

Use of the pack enables the whole tuning "heart" to be wired up independently of the main chassis,

and this aids construction. Six flying leads are used—including one for the chassis connection—to enable the pack to be connected into the remainder of the circuit. In the diagram these are lettered (a)-(f) and are connected into the main tuner circuit at the points marked in Fig. 9. Lead (d) for example connects to the signal grid of V₁ and S₂ is arranged to ensure that at all times this grid receives bias even if the switch is accidentally rotated to position 3. Position 3 mutes the tuner.

Mechanical Details—Coil Pack

The small physical dimensions of the pack "chassis"—see Figs. 11 (a), (b) and (c)—makes trimmer mounting a minor problem and the best method found was to use concentric trimmers (30pF) instead of the more usual type. The manufacturers recommend trimmer values of 50pF but the difference is negligible in practice. When the tin lid is placed over the bottom a lip due to its edge remains, and this helps to secure the trimmers. Four equidistant slots are filed in this lip to accept the earthy lugs of the trimmers, which are then firmly soldered in position. The locations of the other items can be seen from the diagram and the coils should be oriented as shown.

Some coil packs use the threaded section of the wavechange switch for fixing but this means that the switch and its wiring are floating during the mounting process. Here, two separate mounting holes are provided (see Fig. 11 (a)). The switch spindle needs to be approximately 1/2 in long (excluding the bush). In addition to the trimmers three fixed capacitors are required.

Wiring the Coil Pack

This is not a tedious operation but one that requires to be done carefully to avoid confusion. A soldering iron with a pencil bit is needed and this should be hot enough to allow very quick joints to be made. An assortment of differently coloured leads is also needed. Referring to Fig. 11 (b) it will be observed that the outermost tags, or "ways", of the rotary switch have been given numbers. The four "poles" at the centre are presumed to each control three of the "ways" with tags 1, 2 and 3 coming under the influence of the top right hand

¹"A 3-Station Switched Coil Pack", by A. S. Carpenter, *The Radio Constructor*, July 1961.

“pole” tag and so on.² Connections should be made as follows, remembering that references to “chassis” are to the coil pack chassis.

- (1) Brown lead from green tag, L₁ to tag 10 on switch.
- (2) Brown lead from green tag, L₂ to tag 11 on switch.
- (3) Red lead from white tag, L₁ to tag 1 on switch.
- (4) Red lead from tag 1 on switch to CT₁.
- (5) Red lead from white tag, L₂ to tag 2 on switch.
- (6) Red lead from tag 2 on switch to CT₂.
- (7) Blue lead from blue tag, L₁ to chassis.
- (8) Blue lead from blue tag, L₂ to chassis.
- (9) Connect tag 3 on switch to chassis.
- (10) Green lead from red tag, L₂ and connect C₁ from the junction to chassis. Fly lead (b) connects here also.
- (11) White lead from white tag, L₃ to tag 4 on switch.
- (12) White lead from tag 4 on switch to CT₃.
- (13) White lead from white tag, L₄ to tag 5 on switch.
- (14) White lead from tag 5 on switch to CT₄.
- (15) Black lead from red tag, L₃ to blue tag, L₃. Connect C₂ to chassis from this point.
- (16) Connect C₃ from red tag, L₄ to chassis.
- (17) Grey lead from green tag, L₃ to tag 7 on switch.
- (18) Grey lead from green tag, L₄ to tag 8 on switch.
- (19) Connect blue tag, L₄ to chassis.
- (20) Connect flying leads to the appropriate switch poles and chassis. (See Fig. 10.)

Note: Trimmers CT₁ and CT₃ are medium-wave aerial and oscillator trimmers with CT₂ and CT₄ their long-wave counterparts.

The Tuner Panel

This extends the whole depth of the cabinet on the left side, as may be seen in the appropriate photograph, and carries the wavechange switch and

² Miniature 4-pole, 3-way switches of the type employed here may vary in the relative positions of the central and outside tags. The switch employed should be set fully counter-clockwise (spindle pointing to the reader) whereupon the outside contacts switched in will be 1, 4, 7 and 10.—EDITOR.

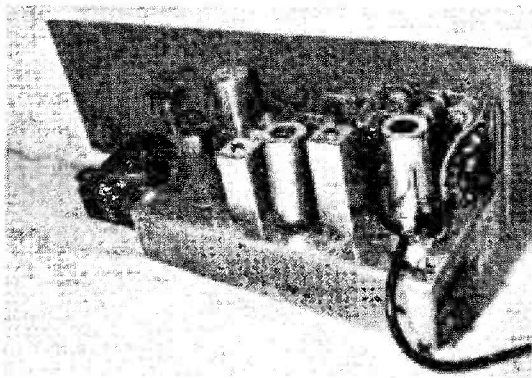

Above-chassis view of the tuner unit

coil pack, tuning scale, drive knob, warning lens and on/off switch. Details of the panel—which is made from hardboard and bolted to the tuner chassis—are shown in Fig. 12. In use the panel is bolted to the chassis front flange and the tuner rests on the motor board on its rear flange so that the valves are horizontal. A rectangle of wood $14\frac{1}{2} \times 4\frac{1}{4} \times \frac{3}{8}$ in then separates the tuner top from the turntable and supports the upper edge of the panel. Screws may be passed through the panel into this section if desired. The panel is eventually French polished.

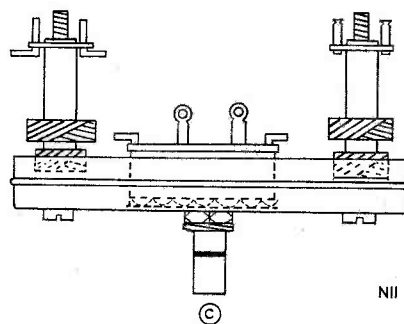
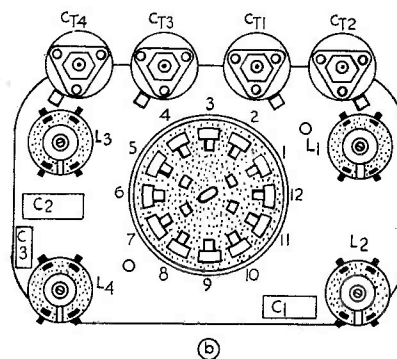
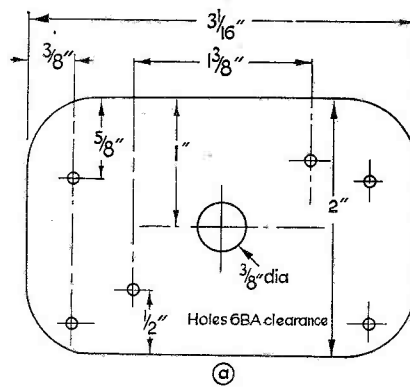

Fig. 11. Mechanical details of the coil pack

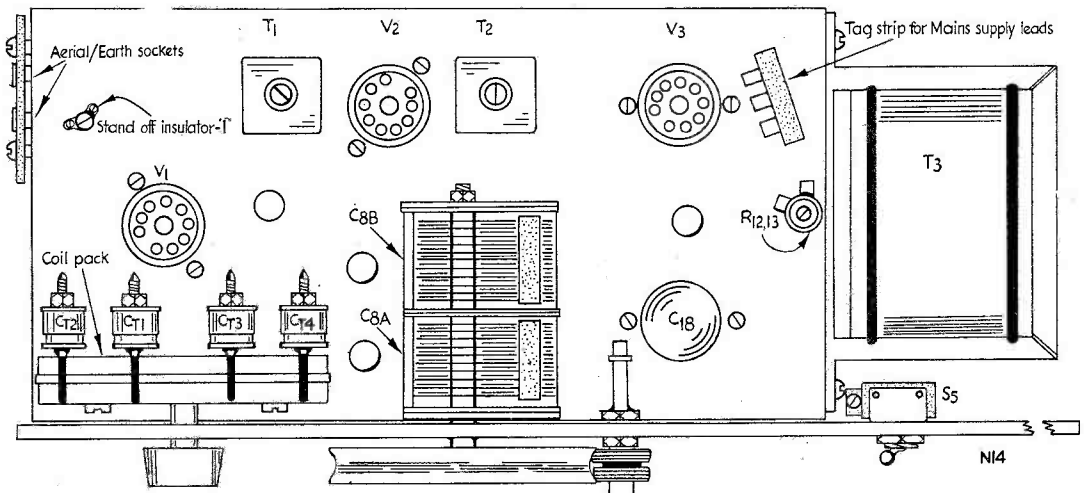

Fig. 14. The tuner above-chassis layout

to ensure that the driving shaft is correctly placed and cannot slip.

The Distributor Panel

As mentioned earlier, the distributor panel is used for inter-connecting purposes. It is illustrated in Fig. 17. It consists of a 2-pole on/off switch which ensures that the mains supply is completely disconnected when in the "off" position, a 5-way connecting block and a socket strip for feeding the external loudspeaker. The mains supply must be distributed to three points: (1) the gram motor, (2) the amplifier power pack, (3) the tuner. The way this is done is shown in the diagram. The panel is secured to the hardboard back of the cabinet (which is clip fitted) so that the on/off switch dolly is easily accessible. The separate units can then be connected or removed speedily and safely by laying the back of the cabinet flat. All leads should be made long enough to permit plenty of free movement.

Cabinet Preparation and Requirements

The cabinet was purchased from a reputable source together with the autochanger already fitted to order and mounted on its motor-board as described last month, not centrally, but to the right-hand side and allowing sufficient space for the on/off/reject control to be operated.

Prior to fixing the equipment three $\frac{1}{4}$ in holes are drilled in the motor board approximately 2in from the left hand side of the cabinet looking at it from the front. These are ventilation holes for the tuner. A long, horizontal slot is also cut in the hardboard back in the section appearing *above* the motor board for ventilation purposes. Next, four $\frac{3}{8}$ in holes are located with care and cut in the cabinet front to accept the amplifier control spindles. Another $\frac{3}{8}$ in hole is also located and cut for the warning lens.

The distributor panel is then fixed to the inside of the back panel and apertures cut for the tuner aerial-earth sockets, etc.

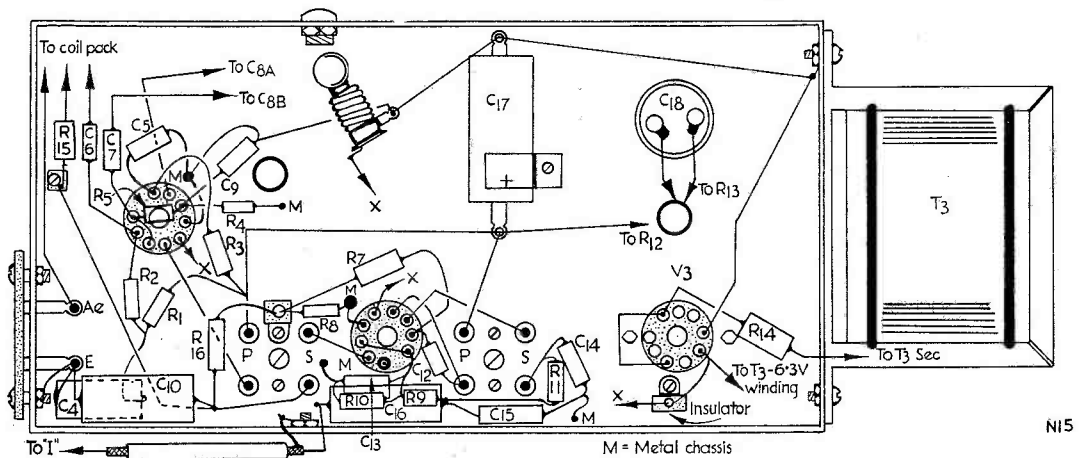

Fig. 15. The tuner below-chassis layout

Legs for the cabinet—purchased separately—are of modern styling with brass ferrules and are approximately 16in long. Although these can be fitted to the cabinet direct a superior method is to fix them to a suitable piece of plywood of the same size as the cabinet base (which must then be fitted with rubber feet to permit a cooling air flow) and so form a plinth.

Fitted to the rear of the UA8 autochanger, just below the motor-board, is a tagstrip similar to that depicted in Fig. 18. A length of coaxial cable is connected here as follows: braiding to the black tags and inner conductor to the red tag. The yellow and blue tags are only required when a stereophonic set-up is used, so here they are not required. The free end of the coaxial cable is then connected to a coaxial plug for subsequent connection to the amplifier gram socket.

Setting up the Radiogram

Initially it is not necessary to fit the tuner and this is left until the gram function has been dealt with. Also, the remaining equipment should be primarily tried outside the cabinet before being fitted.

Assuming that the usual checks have been made for faults in wiring, etc., the amplifier, power pack, motor and speaker are all connected to the distributor panel, leaving the mains lead until last. The necessary inter-unit connections are completed, tone controls set at half travel (also VR₄) and the selector switch set to Gram. VR₁ is set to approximately quarter travel and the main on/off switch closed. As soon as possible, a voltage check should be made at pins 3 of the output valves. If the reading is low the apparatus should be switched off immediately and the fault located. A reading of approximately 11V will be satisfactory. Risk of incorrectly phased feedback is also likely and might necessitate reversing the feedback connections at T₁ secondary.

The following voltage readings above-chassis were obtained under no signal conditions on the prototype using a Weston Analyser (sensitivity 1,000Ω per volt) with VR₄ set to give a zero voltage reading across the primary winding of T₁.

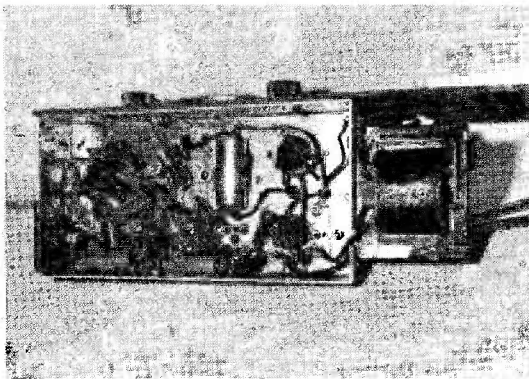

Below-chassis view of the tuner unit

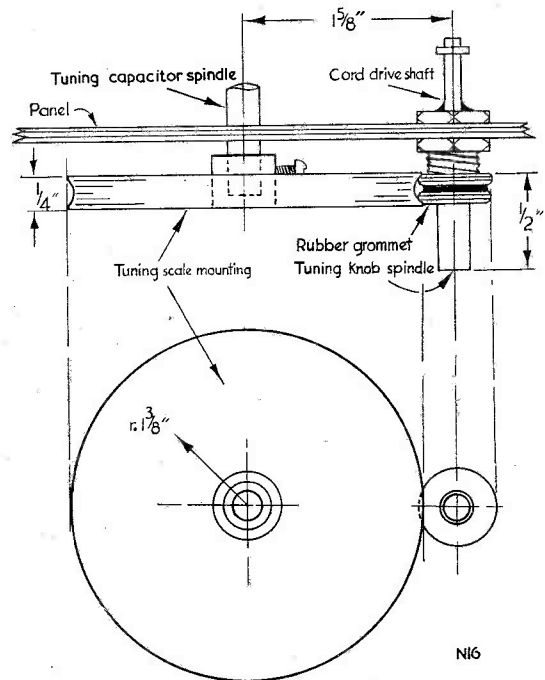

Fig. 16. Details of the reduction drive and scale

Location	Voltage	Meter Range Set
Junction black lead, T ₁ and R ₁₅	320	1,000V
Junction C ₁₇ , R ₁₅	220	250V
Cathodes, V ₃ , V ₄ (pins 3)	11	50V
Pin 3, V ₁	1.2	10V
Pin 8, V ₁	1.4	10V

If all is well a record may be played experimentally. The units may then be switched off and placed in the cabinet.

The Tuner

The tuner can, if preferred, be set up independently of the other apparatus, the output being temporarily injected into the pick-up sockets of a standard broadcast receiver. The output can even be heard in headphones. Usual superhet alignment techniques are adopted, the intermediate frequency transformers being trimmed to 465 kc/s. Coil pack trimmers are adjusted at the high frequency end of the tuning scale and dust cores at the low frequency end. The tuner *can* be aligned fairly well without a signal generator but this tends to become a tedious process when a consequently doubtful intermediate frequency is in use. (Pre-aligned i.f. transformers are, however, usually obtainable.)

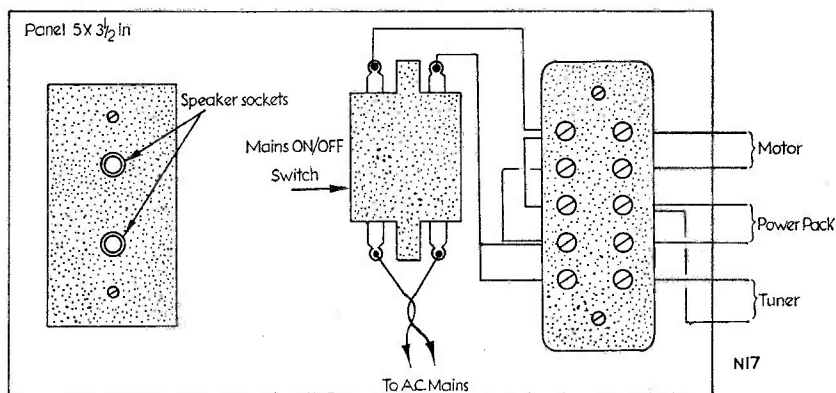

Fig. 17. Layout of the distribution panel

If coil trimmers refuse to peak properly at either maximum or minimum settings the main tuning capacitor should be reset to very slightly greater or less capacitance as required, and a fresh attempt made. Improved quality of output is likely to result if the cores associated with the i.f. transformer secondaries are very slightly detuned on completion of alignment. The a.g.c. operation can be checked by tuning to a strong signal and then momentarily short circuiting C_{10} to chassis, whereupon volume should increase as bias is reduced.

Finally, all control knobs can be fitted correctly and the units finalised. In the prototype four engraved knobs are used for the amplifier controls, viz., "Radio/Gram", "Treble", "Bass", and "Volume", these being set so that the lettering is upright when in the positions normally used with increased boost or increased volume occurring if the appropriate knob is turned clockwise. This allows the controls to be reset to their original positions with reasonable accuracy.

The Loudspeaker

It is scarcely necessary to mention that a good unit or units is essential and that these should be capable of handling the frequency range and output without stress. A good enclosure is desirable and this is likely to vary in shape and type somewhat

Components List (Fig. 17)

- Panel (dimensions 5 x 3 1/2 x 1/8 in), hardboard, plywood, etc.
- Speaker socket strip
- 5-way connection block
- On/off toggle switch, 2-pole

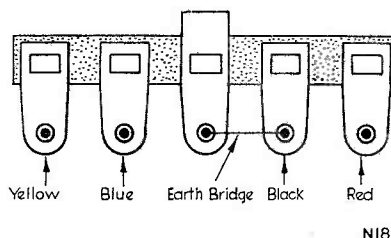

Fig. 18. The tagstrip fitted to the UA8 autochanger

with differing environments. That used with the prototype is not dissimilar to one described in an earlier issue of this journal³ but with a 10in unit fitted. Four legs to match those fitted to the equipment cabinet then give the completed Family Radiogram a look of distinction.

³ "A Small Bass Reflex Enclosure", by M. J. Pitcher, B.Sc., *The Radio Constructor*, August 1961.

New Compact Microwave Generator

The M-O Valve Co. Ltd. has started production of a compact microwave generator embodying a new focusing principle. The valve, Type OPX1, is an electrostatically-focused backward wave oscillator which has been named the Ophitron.*

The mechanical problems inherent in the design of oscillators for microwave frequencies are such that particular difficulties arise in altering the operational frequency by variation of mechanical dimensions. The backward wave oscillator principle overcomes this difficulty by variation of an electrical potential and, in the Ophitron, this principle is combined with electrostatic focusing of the electron beam, resulting in a device which is extremely compact and robust, has good low noise performance and which operates within a wide frequency range variable by single knob control. The device is about 9in long and 1/4in in diameter and weighs only 12oz.

The Ophitron system has been designed for simple operation. A single stamped-out periodic structure and two flat focusing plates form the propagating path for the r.f. wave and set up the periodic electrostatic field which focuses the electron beam. The electrostatic focusing principle also assists in reducing ion noise.

The Ophitron at present being produced operates over a frequency range of 8.5 to 12.5 kMc/s with variation of the supply voltage from 600V to 2kV and gives a power of tens of milliwatts.

The Ophitron can be used wherever a wide electronic tuning range X-band low power oscillator is required. Because of its small size and light weight it has a clear advantage over the magnetically focused backward wave oscillator and its wide electronic tuning range gives it an advantage over reflex klystrons. More specifically, it can be used in wide frequency coverage receivers, as a test source for laboratory use, in test equipment for military use, and in place of reflex klystrons in a number of applications.

* After the Greek: a serpent, the word being suggested by the undulating path of the electron stream flowing along the structure Registered Trade Mark.



RADIO

topics

By **RECORDER**

ONE OF THE MINOR IRRITANTS IN the life of the service engineer must surely be dust. I refer, of course, to that fine soft dust which finds its way into the works of radio and television sets and which rests, like a thick velvety pall, over all the resistors, capacitors and valves. Apart from the fact that such dust combines with the lubricants used for variable capacitor and potentiometer spindles to form what Smithy the Serviceman described as "Black Jam" in last year's August issue, it does not seem to interfere too much with the working of electronic equipment. Nevertheless, it is a nuisance, and it makes what should be a clean job unnecessarily unpleasant. Also, it gets into the air and on to the clothes.

All else being equal, the thickness of dust on a chassis should vary directly as the time between servicing. Other factors can, however, have considerable effect on the thickness of the deposit, the most important being the use or otherwise of a vacuum cleaner in the same room. If a vacuum cleaner is regularly employed, the dust found on a radio or television chassis is normally very much less.

Television Repair

Recently, I undertook a repair on an early 12-channel television receiver and encountered quite a few interesting points about dust. The set must have rested undisturbed for many years because the chassis was covered with the thickest layer of dust I have ever seen. When switched on, valve heaters could be vaguely discerned through the gloom like street lamps in a fog. As the fault could have been caused by the surface dirt I left this undisturbed during initial tests. These didn't help

me but, before I started cleaning things up, I noticed an interesting point which I shall recount later.

Tidying up was a relatively quick process, most of the dirt on the surface of the chassis passing quite easily into a vacuum cleaner. A final flick-around with a cloth made things fairly presentable.

The fault was pretty straightforward. Every ten to twenty seconds the picture would suddenly dim and open out, or "bloom"; after which it would take a further second or so to return to its normal brightness and size. The initial dimming was accompanied by an audible, but not visible, spark from some point in the chassis. Since low e.h.t. causes both dimming and "blooming", it was reasonably certain that the snag was the result of a spark in the line output stage, either in the line output valve circuit or the e.h.t. circuit. The spark could then give a sudden drop in e.h.t., a subsequent delay occurring before e.h.t. built up again to its previous level. As it was more likely that the e.h.t. voltage would cause an audible spark than the voltages associated with the line output valve (and because it was easier to look into the e.h.t. circuit anyway!) I carefully cleaned up the associated components, hoping that I was similarly removing any spark discharge path that existed. This did not clear the snag but it did show a visible spark occurring inside the EY51 e.h.t. rectifier. The spark had previously been hidden under the grime which covered this valve, and a new EY51 put the set back into proper working order.

A final touch, due to dust again, was to clean the face of the tube with cotton wool plus a little water and detergent. A minor process, but it made the cowboys and Indians brighter than they had been for many a long moon.

An interesting fact resulting from the general clean-up of the chassis was that a spot appeared on the screen shortly after switching off. Such a spot is, of course, the result

of a still-hot cathode emitting electrons to the screen, the e.h.t. voltage for the final anode remaining stored in the reservoir capacitor formed by the tube inner and outer graphite coatings. With this receiver the effect hadn't been seen for years! Despite the fact that my cleaning efforts hadn't removed the e.h.t. spark, there must have still been a pretty heavy discharge path through the grime. A discharge path whose resistance, incidentally, was quite low enough to discharge the tube reservoir capacitance almost immediately after the set was switched off.

The interesting point I referred to earlier, and which occurred when the set was in its original dusty state, was mainly discernible around the deflector coils. These carry a pulse voltage of several kV during flyback, and the dust between an adjacent chassis point and the coils had formed into short "hairs" following the lines of electrostatic force between the two conductors; in the same way as iron filings follow lines of magnetic force. Each time the spark occurred the "hairs" wavered, drooping slightly then returning to their original position.

So, if you want to see lines of electrostatic force suspended in mid-air, collect some really fine dust. It may be as effective for this purpose as iron filings are for magnetic fields.

Remote Volume Control

It is always a little fascinating to learn about what goes on behind the scenes in Court circles. You may recall that, during Queen Juliana's recent silver wedding celebrations, Amsterdam was invaded, for the Royal wassail, by sovereigns from all over the world.

Part of the festivities included a banquet at the Amstel Hotel where, according to Paul Tanfield in the *Daily Mail*, the Court Chamberlain had a special assignment. It was his function to press a button connected to the orchestra pit in accordance with signs made to him by Queen Juliana. Three long presses on the

button meant "Stop"; three short presses—"Start"; short and long presses alternately—"Play louder"; three short then three long presses—"Play softer".

I've been trying to make up my mind since as to whether this isn't the most expensive, or most inexpensive, remote volume control system I've ever heard about.

PayVision

The Pilkington Committee has not yet, at the time of writing these notes, made its report, and so I cannot be too certain whether a description of the new PayVision Scheme will be topical or otherwise. At any rate, the principles involved are of sufficient interest to warrant passing on the information I have at the present time.

The PayVision system has been designed by Marconi's Wireless Telegraph Company Ltd., and offers a somewhat unusual method of supplying programmes to customers on the "pay-as-you-view" principle. The programmes are brought to the home by coaxial cable, no signals being transmitted over the air. The system can be used with any existing television set and does not affect existing programme reception; instead, it offers three new channels piped along the cable. There is no coin insertion, nor do meter readers have to visit the viewer's home.

The PayVision programmes are coupled to the receiver by way of a small control box which is no larger than the average book. This unit connects to the PayVision cable and to the aerial socket of the existing television receiver. Push-buttons on the control box select the various PayVision channels, whilst a small removable key in the side of the unit allows the desired channel to be switched to the receiver, as well as preventing accidental or unauthorised acceptance of a programme.

To obtain a PayVision programme the viewer first switches his television tuner to an unused channel (which will vary for different parts of the country). He will then receive a Pre-View channel which gives details of forthcoming attractions, together with full programmes for the day in both sound and vision. The Pre-View channel is available at all times and is free of charge. To select one of the three PayVision channels the viewer next presses the appropriate push-button on the control box, and turns the key to buy a programme. No programme can be bought until the key is operated.

Turning the key causes a signal to be passed back through the cable distribution system to the accounting

centre, where the data is collected and processed by computing devices into individual subscriber accounts. Viewers receive regular statements, and the central accounting system eliminates the necessity of having coin boxes or meter readers.

An advantage of the central accounting system is that this also provides information on the size of an audience watching a particular channel. The actual receipts for any programme can be assessed immediately.

It is stated that the PayVision system can offer a greater clarity of picture, as the signal is received via closed-circuit techniques; also, there is no need for scrambling and expensive de-coding equipment at the receiver to prevent "pirating". Further, there is no transmission over the crowded space available on the air. The receiver can continue to pick up normal broadcast transmissions in addition to the PayVision programmes and it requires no modification. The PayVision system can be used in any country, and can operate on any line standard (black and white or colour) which is used at the present or which may be adopted. In addition, the system offers, free of charge, two f.m. sound radio channels transmitted over the incoming coaxial cable. These only require a normal v.h.f. set for their reception in the home.

The PayVision unit can be installed in the home at a cost of £5. The average cost of programmes would be 2s. 6d., with some public service and educational programmes free. Typical programmes, for which a charge would be made, could include first run feature films, plays from the West End and Broadway, and entire operas and ballets.

To date, a company—PayVision Programmes Ltd.—has been formed. In the interests of high quality programming, this company has an Advisory Board consisting of prominent members of the entertainment industry and including Larry Adler, Johnny Dankworth and Henry Sherek.

Evergreen Industry

Whilst many members of the public like to relax by watching television, others prefer to listen to the gramophone. And, surprising as it may seem, a high proportion of the latter still listen to the acoustic gramophone!

I am indebted to the E.M.I. house journal, *Eminews*, for this interesting item of information. According to *Eminews*, 320 million acoustic gramophone needles are still used every year throughout the world.

By far the largest demand comes from countries without the full benefit of electricity, but there is still, nevertheless, a substantial market in Europe and the U.K.

Although the acoustic needles marketed by E.M.I. Records are produced outside the E.M.I. Group, they still have to conform to very rigid specifications. From every batch of 500,000 needles, 1,000 are given a visual inspection by microscope and 100 are mechanically tested for temper. Needles are also tested by being played through a record on an H.M.V. Model 102 portable gramophone, a machine which was introduced in 1920. After being played through the record, the needle is scrutinised under a "shadow-scope" where the flat worn on the tip is measured. The wear should not exceed 0.005in.

Safe Handling Cabinet

With modern manufacturing and research techniques, toxic, inflammable and radio-active materials have to be handled for assembly or measurement in dust-free conditions. However, such materials must be fully screened from the operator if injury is not to occur.

Some years ago, Pandect Instrument Laboratories Ltd., Wellington Road, High Wycombe, Bucks, encountered this problem in the luminising of instrument dials, and the Pandect Safe Handling Cabinet was especially designed in consequence. The Cabinet has been so successful in use, and it meets regulations so adequately, that Pandect Instrument Laboratories have since manufactured 60 more cabinets for other companies, some of these going to overseas organisations.

Special features of the Pandect Cabinet are complete electrical bonding to earth, a work area which is sealed from the atmosphere and other parts of the cabinet, the maintenance of the seal at all times, and magnetic non-slip cabinet furniture. The work area is fully illuminated by fluorescent lighting and the work is viewed through a large plate of heavy duty glass.

Specimens or components are passed into the work area through an air lock, and gloves are changed without breaking the seal. Air is extracted or pumped in continuously via "Harwell" sub-micron filters which, in normal use, only require replacement after five years. Accessories provided include glass shelves, a magnetic and adjustable chrome-plated work table, magnetic based mixing palettes and a weighing balance.

NOW! YOU can MASTER ELECTRONICS!

**BRITAIN'S MOST COMPREHENSIVE PRACTICAL
COURSE IN RADIO
ELECTRONICS • TELEVISION!**

**THESE SPECIAL TRAINING
KITS — YOURS TO KEEP**



**Multi-Range
TEST METER**

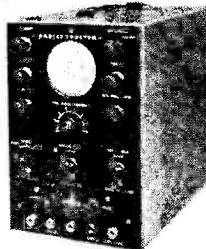

**CATHODE RAY
OSCILLOSCOPE**

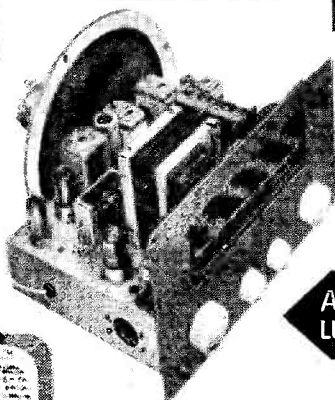

**AM and VHF/FM
LUXURY RECEIVER**



SIGNAL GENERATOR



**Complete set of
Picture Way books and
Experimental Manuals**

**LEARN BY BUILDING
NOW for your
CAREER • HOBBY
OWN BUSINESS**

YOU RECEIVE

- Complete kits of equipment as illustrated.
- Complete set of experimental manuals.
- Complete set of "picture-way" theory books.
- Modern test-yourself examination sheets.
- Study programme.
- Unlimited consultation with Tutors.

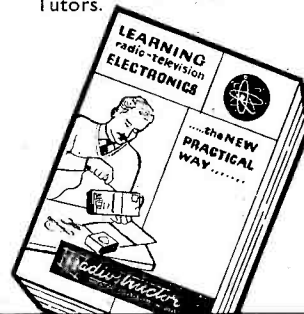

**FREE
BROCHURE
POST NOW**

RADIOSTRUCTOR

TO RADIOSTRUCTOR (DEPT. M.31)
READING, BERKS.

Name _____
Address _____
**BLOCK
CAPS
PLEASE**

(We do not employ representatives)

7.62

MINISETS LTD Hatherley Mews London E17

6-Stage Portable Transistor Radio

- ★ All parts including transistors direct from manufacturers
- ★ Pre-assembled circuit board ensuring ease of construction
- ★ Full medium-wave coverage
- ★ After-sales service
- ★ Attractive two-tone case 9" x 6" x 4"
- ★ Push-pull output, 350 milliwatts
- ★ 5" high flux speaker
- ★ Built-in Ferrite Rod aerial. No external aerial or earth required
- ★ High performance, many stations received on test

Can be built for **£5.40** P.P. 3/-
Or with long-wave 8/- extra

Full instructions 1/6 (Free with order)

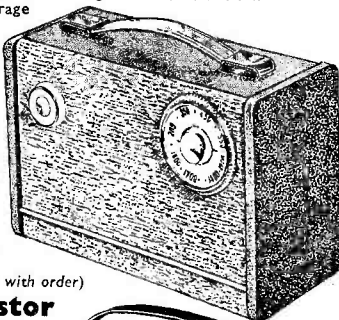

6-Stage Transistor Pocket Portable

- ★ Can be built for **£4.19.6** P.P. 2/6
- ★ Completely self contained, no aerial or earth required.
- ★ Push-pull output, 250 milliwatts.
- ★ 3" high flux speaker
- ★ Pre-assembled circuit board with simple instructions ensuring easy construction
- ★ High Q Ferrite Rod Aerial
- ★ After-sales service
- ★ Can be supplied with long-wave 6/- extra

Full instructions, price list 1/6 (Free with order)

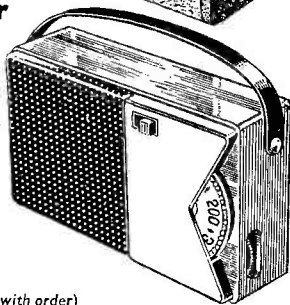

3-Transistor Radio (plus 2 diodes)

Total building **70/-** P.P. 2/6

- ★ Pre-assembled circuit board, ensuring easy construction
- ★ Full medium-wave coverage
- ★ Attractive case 5½" x 3" x 1½"
- ★ All components including transistors are brand new and direct from manufacturers
- ★ Ferrite Rod aerial coil, no external aerial or earth required
- ★ 2½" high flux speaker direct from manufacturer
- ★ After-sales service

Send 1/6 for instructions, circuit and price list

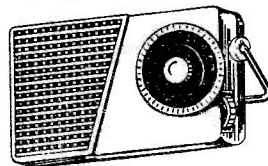

2-Transistor Radio (plus 2 diodes)

Ideal for personal listening

- ★ Built-in Ferrite aerial
- ★ Sensitive earpiece
- ★ All parts including transistors direct from manufacturers
- ★ Pre-assembled circuit board and easy-to-follow instructions
- ★ After-sales service
- ★ Can be built for **50/-** P.P. 2/-

Full instructions, etc., 1/6 (Free with order)

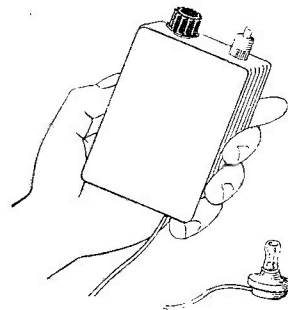

EVERYTHING FOR THE ENTHUSIAST

HEADPHONES. DHR5B (very sensitive), 2,000 ohms 22/6. P. & P. 2/-.

AMERICAN 807 VALVES. Ex-W.D. 7/6 each, 4 for 25/- P. & P. 2/-

MULTI-WAY CABLE. 3-core screened 1/- yd.; 12-core screened 2/- yd. First grade Mike Cable 9d. yd. P. & P. 2/-.

10-WAY CABLE (5 pairs), screened and plastic covered. Any length cut, 1/8 per yd. P. & P. 1/6 min.

TOUGH POLYTHENE LINE. Type ML1 (100 lb) 2d. per yd. or 12/6 per 100 yds. Type ML2 (220 lb) 4d. per yd. or 25/- per 100 yds. Post free.

ABSORPTION WAVE-METERS. 3.00 to 35.00 Mc/s in 3 switched bands, 3.5, 7, 14, 21 and 28 Mc/s ham bands marked on scale. Complete with indicator bulb. A MUST for any hamshack. ONLY 22/6. Post free.

RACK MOUNTING PANELS. 9" x 5½", 7", 8½" or 10½" black crackle finish, 5/9, 6/6, 7/6 and 9/- respectively, postage and packing 2/-.

SPECIAL OFFER

Bumper Bargain Parcels of Resistors, Condensers and Pots. 10/- and 5/- Post Free

GELOSO V.F.O. UNITS. 4/102 with new dial and escutcheon. Outputs on 80, 40, 20, 15 and 10. For 2-807 or 6146 tubes. Only **£8.5.0.** 3 valves to suit, 24/-, All post free.

ALSO P1 TANK COILS for 1 or 2 valve P.A. 24/- P. & P. 2/-.

ROTARY CONVERTERS 6V input, 250V 125mA output. Only 5½" x 3" x 3" 17/6 each. P. & P. 3/-. Ditto 12V input, 490V 65mA output 17/6 each. P. & P. 3/-.

SUPER BANDCHECKER AND MONITOR. This new, sensitive, absorption wavemeter is fitted with 0-500 microammeter and is also a most useful phone monitor. Covers 3.5-35 Mc/s in 3 switched bands. only 3 gns.

SHADED POLE MOTORS. 230V or 110V operation. Ideal for fans, blowers or models. One only: 12/6, plus 2/- P. & P. Or pair: £1, plus 2/6 P. & P.

CERAMIC COIL FORMERS. 2½" x 1½". IDEAL FOR VFO or P.A. on Mobiles, 1/9 each or 17/6 doz.

BTX. 3½" x 1½" with 32 Grooves for P. Tanks 6/- ea.

TFX. 2½" Dia. 5" WINDING SPACE. Ideal Hi Power Lin. Amps 8/6.

MOSLEY TRI-BAND BEAMS

T33, JR, 3 EL ... **£24.15.0**
TA32 JR, 2 EL ... **£17.10.0**
V3 JR, Vertical 3 Band **£7.10.0**

PLACE YOUR ORDER EARLY

AERIAL EQUIPMENT

COPPER WIRE. 14g. h.d.: 140' 17/-; 70' 8/6; 7/25 stranded: 140' 10/-; 70' 5/-, plus 2/- P. & P.

RIBBED GLASS INSULATORS. 3" 1/9 each. P. & P. 1/6 up to 12.

TWIN FEEDER. 300 ohm twin ribbon feeder, similar K25. 6d. per yd. K358 Telcon (round) 1/6 per yd. Post on above feeder and cable 1/6 any length.

SUPER AERIAL CABLE 1/8 per yd. P. & P. 2/-.

CERAMIC FEEDER SPREADERS. Type F.S. 6" 10d. each. P. & P. 2/- up to 12.

CERAMIC "T" PIECES. Type AT for centre of dipoles, 1/6 each. P. & P. 1/-.

NEW MOSLEY POWER BEAMS. Write for details. 300 watt, 50 ohm COAX, ½" dia. very low loss, 1/9 yd. P. & P. 2/-.

SHELL INSULATORS. 2" 9d. each, 8/- doz. P. & P. 2/- up to 12.

CHAS H. YOUNG LTD (Dept. R)

110 DALE END BIRMINGHAM 4

(Tel. all departments) CEN 1635

SPECIAL BARGAIN OFFER!

"6 + 1"

TRANSISTOR RADIO KIT

PRICE BARRIER SLASHED—A

fourth bulk purchase of this popular Kit enables us to pass on latest price reduction direct to Constructor. Kit is a modern, sensitive, quality receiver with all latest circuit features and is complete with 7" x 3 1/2" speaker (3 ohms), and all circuit and assembly instructions. 6 BVA transistors and germ. diode. Printed Circuit. Med. and L/W. Ferrite aerial and car radio coupling. 500mW output. Attractive gild dial and slow motion drive with "Clear Vu" tuning knob, etc.

... using 3 latest type surface Barrier Transistors

Now Only £6.19.6

Complete Kit carriage 2/6

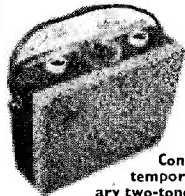

Contemporary two-tone available 25/- extra

New Boxed	VALVES	Guaranteed	All	Electrolytics	All Types	New	Stk.		
1T4	6/-	IECC83	8/-	PCC84	9/6	25/25V	1/9	8+8/450V	4/6
1R5	7/6	ECL82	10/6	PCF80	9/6	50/12V	1/9	15+16/450V	5/6
1S5	7/6	ECL80	10/6	PCL83	12/6	50/50V	2/-	32+32/275V	4/6
3S4	7/6	EF80	8/-	PCL84	12/6	100/25V	2/-	50+50/350V	6/6
3V4	7/6	EF86	12/6	PL81	12/6	8/450V	2/3	60+250/	
DAF96	9/-	EL84	8/6	PL82	9/6	4/350V	2/3	275V	12/6
DF96	9/-	EY51	9/6	PL83	10/6	16+16/450V	5/6	100+200/	
DK96	9/-	EY86	10/-	PY32	12/6	32+32/450V	6/6	275V	12/6
DL96	9/-	EZ81	7/6	PY81	9/6				
ECC81	8/-	GZ32	12/6	PY82	7/6				
ECC82	8/-	EM84	9/6	U25	12/6				

RECORDING TAPE—REDUCED BARGAIN PRICES

Famous American Columbia (CBS) Premier Quality Tape at NEW REDUCED PRICES. A genuine recommended Quality Tape—TRY IT! Brand new, boxed and fully guaranteed. Fitted with leader and spot foils.

Standard	Long Play	Double Play
5" 600ft, 13/-	900ft, 17/6	1,200ft, 31/6
5 1/2" 900ft, 16/-	1,200ft, 19/6	1,800ft, 37/6
7" 1,200ft, 21/-	1,800ft, 28/6	2,400ft, 47/6

Post and Packing, per reel, 1/-, plus 6d. each for additional reels.

SPECIAL OFFER—3" mfrs. surplus tape, 225ft, 4/9. P. & P. per reel 6d. Plastic Tape Reels 3" 1/3, 5" 2/-, 5 1/2" 2/-, 7" 2/3. Plastic Spool Containers, 5" 1/6, 5 1/2" 2/-, 7" 2/3. 3" message tape 150', 3/9. P. & P. 6d.

Alumin. Chassis. 18g. Plain Undrilled, folded 4 sides, 2" deep. 6" x 4", 4/6, 8" x 6", 5/9, 10" x 7", 6/9, 12" x 6", 7/6, 12" x 8", 8/- etc.

Alumin. Sheet. 18g. 6" x 6", 1/-, 6" x 9", 1/6, 6" x 12", 2/-, 12" x 12", 4/6 etc.

Jack Plugs. Standard 2 1/2" Igranitic Type, 2/6. Screened Ditto, 3/3. Miniature 1 1/2", 2/3. Screened Ditto, 2/6.

Jack Sockets. Open Igranitic Moulded Type, 3/3. Closed Ditto, 3/9. Miniature Closed Type, 1/9. Sub-min (deaf aid) ditto, 1/3.

Phono Plugs 1/-. Phono Sockets (open), 1/-, Ditto Closed, 1/6. Twin Phono Sockets (open), 1/6.

Soldering Irons. Mains 200/220V or 230/250V, Solon 25 watt Int., 22/6. Spare Elements, 4/6. Bits, 1/-, 65 watt, 27/6 etc.

Mains Neon Tester—Vest Pocket Screwdriver with Neon Indicator. For 200/250V Mains, Bargain, 2/9.

Condensers—Silver Mica. All values, 2pF to 1,000pF, 6d. each. Ditto, Ceramics 9d. Tub. 450V T.C.C., etc., .001 mfd. to .01 and 1/350V, 9d. .02—1/500V 1/-, .25 Hunts 1/6. 5 T.C.C. 1/9, etc., etc.

MULLARD "3—3" HI-FI AMPLIFIER

3 VALVES 3 WATT

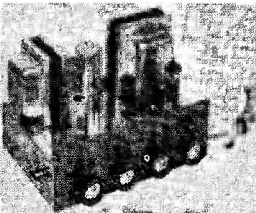

3 ohm and 15 ohm Output A really first-class Amplifier giving Hi-Fi quality at a reasonable cost. Mullard's latest circuit. Valve line-up: EF86, EL84, EZ81. Extra H.T. and L.T. available for Tuner Unit addition. This is the ideal companion Amplifier for FM tuner units.

TECHNICAL SPECIFICATION—Freq. Response: ± 1dB, 10 Kc/s. Max. Bass Boost 14 dB, at 80 c/s. sensitivity: 100 MV. for 3W, output. Output Power (at 400 c/s): 3W, at 1% total harmonic distortion. Hum and Noise Level: At least 70 dB, below 3W.

COMPLETE KIT (incl. valves, all components, wiring diagram, and special quality sectional Output Trans.)

ONLY £6/19/6 carr. 4/6d. Complete wired and tested 8 gns. Wired power O/P socket and additional smoothing for Tuner Unit, 10/6 extra.

Bronze Escutcheon Panel, Printed Vol., Treble, Bass, On-Off, supplied with each Kit.

Recommended Speakers—WBHF 10 12 £5, Goodmans Axiom 10 £5/15/8, Axiette £6/10, or Axiom 112 £8/10.

Volume Controls—5K—2 Meg-ohms, 3" Spindles Morganite Midget Type. 1 1/2" diam. Guar. 1 year. LOG or LIN ratios less Sw. 3/-, DP. Sw. 4/6. Twin Stereo less Sw. 6/6. D.P. Sw. 8/-.

COAX 80 OHM CABLE
High grade low loss Cellular air spaced Polythene—1/4" diameter. Stranded cond. Famous mfrs. Now only 6d. per yard.
Bargain Prices—Special lengths 20 yds. 9/-, P. & P. 1/6. 40 yds. 17/6. P. & P. 2/-, 60 yds. 25/-, P. & P. 3/-
Coax Plugs 1/-, Sockets 1/-, Couplers 1/3. Outlet Boxes 4/6.

Close Tol. S/Micas—10% 5pF—500pF 8d. 600—5,000pF 1/-, 1% 2pF—100pF 9d. 100pF—500pF 11d. 575pF—5,000pF 1/6.
Resistors—Full Range 10 ohms—10 megohms 20% 1/4 and 1/2 W 3d., 1/2 V 5d. (Midget type modern rating) 1W 6d, 2W 9d. Hi-Scab 10% 1/2 W 5d., 1/2 W 7d. 5% 1/2 W 9d., 1% 1/2 W 1/6.
W/W Resistors 25 ohms to 10K 5W 1/3, 10W 1/6, 15W 2/-.
Preset T/V Pots. W/W 25 ohms—50 K 3/-. 50 K—2 Meg. (Carbon) 3/-.

JASON FM TUNER UNITS
Designer-approved kits of parts:
FMT1, 5 gns. 4 valves, 20/-.
FMT2, £7. 5 valves, 37/6.
JTV MERCURY 10 gns.
JTV2 £13.19.6, 4 valves, 32/6.
NEW JASON FM HANDBOOK, 2/6. 48 hr. Alignment Service 7/6. P. & P. 2/6.

Speakers P.M.—3 ohms 2 1/2" E.M.I. 17/6. Goodmans 3 1/2" 18/6, 5" Rola 17/6. 6" Elac 18/6. 7" x 4" Goodmans 18/6. 8" Rola 20/-. 10" R. x A. 25/-, 9" x 6" Goodmans 25/-. E.M.I. Tweeter 29/6.

Speaker Fret—Expanded bronze anodised metal 1/2" and 3/4" diamond mesh, 4/6 sq. ft., multiples of 6" cut. Max. width 4 ft.

TYGAN FRET (contemp. pat.) 12" x 12" 2/-, 12" x 18" 3/-, 12" x 24" 4/-, 18" x 18" 4/6

BARGAINS 4-SPEED

Single Players carr. 3/6
Garrard TA Mk. 2 £7.19.6
Collaro "Junior" 75/-
B.S.R. Latest Model TU12 79/6
E.M.I. Junior "985" 89/6
Auto-Changers carr. 5/-
Garrard RC209 9 1/2 gns.
Garrard "Auto-Slim" £8.12.6
Collaro (C60) £7.15.0
B.S.R. (UA14) De-Luxe Model £7.10.0

RECORD PLAYER CABINETS

Contemporary style, rexine covered cabinet in mottled red and white polka dot. Size 18 1/2" x 13 1/2" x ht. 8 1/2", fitted with all accessories including baffle board and anodised metal fret. Space available for all modern amplifiers and auto-changers, etc. Uncut record player mounting board 14" x 13" supplied.

Cabinet Price £3.3.0 Carr. and Ins. 5/-

2-VALVE 2 WATT AMPLIFIER

Twin stage ECL82 with vol. and neg. feedback tone control. A.C. 200/250V with knobs, etc., ready wired to fit above cabinet. £2.17.6. P. & P. 1/6. 6" Speaker and trans, 22/-, P.P. 2/-
Complete R/Player Kit as ill. inc. BSR UA14 Unit, £12.19.6. Carr. 7/6.

ENAMELLED COPPER WIRE—1lb reels, 14g-20g, 2/6; 22g-28g, 3/-; 30g-40g, 3/9. Other gauges quoted for.

PVC CONNECTING WIRE—10 colours (for chassis wiring, etc.)—Single or stranded conductor, per yd., 2d. Sleeving 2d. yd.

TRANSISTOR COMPONENTS

Midget I.F.'s—465 Kc/s 1/2" diam. 5/6
Osc. Coil—1/8" diam. M/W. 5/3
Osc. coil M. & L.W. 5/9
Midget Driver Trans. 3.5:1. 6/9
Ditto O/Put Push-pull 3 ohms 6/9
Elect. Condensers—Midget Type 12V 1mfd-50mfd, ea. 1/9. 100mfd, 2/-.
Ferrite Aerial—M. & L.W. with car aerial coupling coil, 9/3.

Condensers—150V. wkg. .01 mfd., to .04 mfd., 9d. .05 mfd., 1 mfd., 1/-, .25 mfd., 1/3. .5 mfd., 1/6, etc.

Tuning Condensers. J.B. "00" 208+176pF, 8/6. Ditto with trimmers, 9/6. 365pF single, 7/6. Sub-min. 2" DILEMIN 100pF, 300pF, 500pF, 7/-.

Midget Vol. Control with edge control knob, 5kΩ with switch, 4/9, ditto less switch, 3/9.

Speakers P.M.—2" Plessey 75 ohms, 15/6. 2 1/2" Continental 8 ohms, 13/6. 7" x 4" Plessey 35 ohm, 23/6.

Ear Plug Phones—Min. Continental type, 3ft. lead, jack plug and socket, High Imp. 8/-. Low Imp., 7/6.

TRANSISTOR BARGAINS

Brand New—BVA 1st Grade

OC44	10/6	OC70	5/6
OC45	9/6	OC71	6/-
OC81	7/6	GEX34	2/9
2/OC81	15/6	OA70	2/9
GET114	6/6	OA81	2/9
OC72	7/6		

SPECIAL OFFER

OC44 } 21/6
2/OC45 }
OC81D } 19/6
2/OC81 }

TRIMMERS, Ceramic (Compression Type)—30pF, 70pF, 9d.; 100pF, 150pF, 1/3; 250pF, 1/6; 600pF, 1/9.

PHILIPS, Bee Hive Type (conc. air spaced)—2-8pF, 1/-; 3-30pF, 1/-.

KNOB—Modern Continental types: Brown or Ivory with Gold Ring, 1" dia, 9d. each; 1 1/2", 1/- each; Brown or Ivory with Gold Centre, 1" dia., 10d. each; 1 1/2", 1/3 each. LARGE SELECTION AVAILABLE.

METAL RECTIFIERS, STC Types—RM1, 4/9; RM2, 5/6; RM3, 7/6; RM4, 16/-; RM5, 21/-; RM4B, 17/6.

SIEMENS TYPES—Contact cooled, 250V, 50mA, 7/6; 250V, 85mA, 10/-; 250V, 125mA, 15/-; 250V, 300mA; 26/6.



Send for detailed bargain lists, 3d. stamp. We manufacture all types Radio Mains Transf. Chokes, Quality O/P Trans., etc. Enquiries invited for Specials, Prototypes for small production runs. Quotation by return.

RADIO COMPONENT SPECIALISTS

70 Brigstock Rd., Thornton Heath, Surrey
THO 2188 Hours: 9 a.m.,—6 p.m., 1 p.m. Wed. Terms C.W.O. or C.O.D. Post and Packing up to 1/2 lb 9d., 1 lb., 1/3 3 lb., 2/3 5 lb., 2/9 8 lb. 3/6

THE MODERN BOOK CO

The Radio Amateur's Handbook. By A.R.R.L. 1962 Ed. 36s. Postage 2s.

The Amateur Radio Handbook. By R.S.G.B. 34s. Postage 2s.

Electronic Organ Handbook. By H. Emerson Anderson. 40s. Postage 1s.

The All-In-One Tape Recorder Book. By J. M. Lloyd. 12s. 6d. Postage 6d.

Solution of Problems in Telecommunications & Electronics. By C. S. Henson. 27s. 6d. Postage 6d.

Radio Control Handbook. By H. G. McEntee. New Edition. 40s. Postage 1s.

Tape Recording Year Book, 1961-62. 6s. Postage 1s.

Cine Year Book 1962. 10s. 6d. Postage 1s.

Fun With Electronics. By G. Davey. 12s. 6d. Postage 1s.

Transistor Audio Amplifier Manual. By C. Sinclair. 6s. Postage 6d.

Radio Communication. By J. H. Reyner & P. J. Reyner. 55s. Postage 1s. 6d.

Amateur Radio Call Book. By R.S.G.B. 1962 Ed. 4s. 6d. Postage 6d.

Handbook of Electronic Tables and Formulas. By D. Herrington & S. Meacham. 15s. Postage 9d.

Maintenance Manual. By Mullard. 16s. Postage 1s.

Radio Valve Data. 7th Ed. Compiled by "W.W.". 6s. Postage 10d.

Service Valve Equivalents. By R.S.G.B. 2s. Postage 6d.

We have the Finest Selection of British and American Radio Books in the Country
Complete catalogue 1s.

19-21 PRAED STREET (Dept RC) LONDON W2

Telephone PADddington 4185

TRANSISTOR TAPE RECORDER

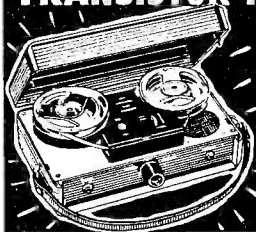

Semi-assembled kit
ONLY £6-19-6!!
with all accessories!!

At Last! A Portable Tape Recorder everyone can afford supplied in **MONEY SAVING** semi-assembled kit form. Yes! Anyone can build it—the difficult work is already done—simply connect colour coded leads to corresponding colour coded parts. **BUILT IN LESS THAN**

TODAYS VALUE £12-12-0

ONE HOUR. This recorder will give you **ENDLESS FUN** plus the amazing satisfaction of doing it yourself and the **SAVING** of at least **£5.** **LOOK** at all these **ACCESSORIES** you get at absolutely **NO EXTRA CHARGE:** 100ft recording tape, personal earphone, hand microphone, telephone recording device, carrying handle and batteries.

ORDER NOW — you must not miss this wonderful Tape Recorder Bargain—if you don't agree it's worth 12 gns. we will refund your money. Complete with all accessories and instructions

FOR ONLY **£6. 19. 6** P. & P. 3/6

Relda Radio Ltd

Mail Orders to:
DEPT. "R" 32a COPTIC ST. LONDON W.C.1 MUSEUM 9606

Our goods must be seen to be appreciated—a visit to our showrooms at 87 Tottenham Court Road, London, W.1, will be most rewarding!

FREE! EARN

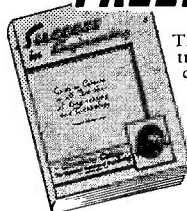

There's plenty of room at the top for technically trained men—room for YOU if you want quick promotion or a better-paid, more interesting career. N.I.E. can quickly give you a *guaranteed* spare-time Postal Training, in the comfort of your own home, and open up a whole new world of opportunity for you.

MORE

Find out, as thousands of others have done, how *easy* it is to learn at home with N.I.E. Send for *Success in Engineering*—136 pages of information you can *use*—and details of pay-winning Courses in all branches of Engineering, Building, Local Government, etc. Get your copy today—FREE!

SOON

Mech. Eng. Draughtsmanship
Struct. Eng. Aero & Auto Eng.
A.M.I. Mech.E.
A.M. Brit. I.R.E.
A.M.I.M.E.
L.I.O.B.
A.M.I. Mun.E.

Elect. Eng. Civil Eng. Handicrafts
Radio & TV
A.M.I.C.E.
A.M.I.P.E.
A.F.R. Ae.S.
A.M.I. Struct. E.
M.R.S.H., etc.

N.I.E. Guarantees—
"Success—or no Fee"

POST COUPON NOW!

Please send me a FREE copy of "Success in Engineering".



NAME

ADDRESS

Subject or exam of interest

NATIONAL INSTITUTE OF ENGINEERING
(Dept. 445) 148-150 Holborn London EC1

THE GATEWAY TO BETTER LIVING

SMALL ADVERTISEMENTS

Private: 3d. per word, including address.
Minimum charge 2/6.
Use of Box Number, 2/- extra.

Trade: 9d. per word. Minimum charge 12/-.
Terms: Cash with order.

All copy must be received by the 6th of the month for insertion in the following month's issue. The Publishers cannot be held liable in any way for printing errors or omissions, nor can they accept responsibility for the *bona fides* of advertisers.

PRIVATE

WANTED. Filament voltage extension unit for Avo valve tester.—Blanks, 38 Wood View, Hemel Hempstead, Herts.

FOR SALE. Jason Mercury II tuner. Complete, £5.—227 Charlbury Road, Nottingham.

FOR SALE. Philips "Personic" pocket radio, ex. cond., £10. Clyne "Popular Four" 3 valve receiver, £3 10s. Codar "Clipper" 2 valve, 2 transistor short-wave set with batteries, £4. H.A.C. short-wave set with batteries, £3.—D. J. Dando, 11 Whitepost Hill, Redhill, Surrey.

FOR SALE. "Linear" tape amp., £6. "Regent" 4 valve portable (assembled), £4.—Paston, 7 Broadfields Avenue, London, N.21. Telephone LAB 6410.

WANTED. C.R.T. ICP1, ICP31, DH3-91, etc. State condition.—Robertson, 9 Meadway, Knebworth, Herts.

FOR SALE. National HRO receiver, complete coils, mint condition.—Box No. F155.

FOR SALE. *Wireless World* Vols. 31-39, five bound, one copy missing from Vol. 38; November 1939-December 1953 (February 1945 missing); various I.E.E. journals 1939-59; Haynes quality receiver, £6. Buyer collects this.—Fisher, 51 Bemsted Road, London, E.17.

WANTED. Audio signal generator. Full details please to—73 Mackintosh Place, Cardiff.

TRADE

"MAKING ELECTRONIC EQUIPMENT FOR THE LAB." Contains circuits for a wide range of equipment for the Lab. A "MUST" for every Lab. Price 3s. 6d.—High Fidelity Co., 18 Melville Road, Birmingham 16.

PRIVATE TUITION given in G.C.E. ordinary level mathematics (London area). Terms reasonable.—Box No. F154.

TRANSISTOR PORTABLES. Lux-on-air, £7 19s. 6d. Pocket Companion, £8 10s. Good Companion, £11 15s.—H. Griffiths, 7 Ivy Road, Sutton Coldfield, Wars.

LEARN RADIO AND ELECTRONICS the NEW Practical way. Very latest system of experimenting with and building radio apparatus—"as you learn"—FREE Brochure from: Dept. RC10 Radiostructor, Reading, Berks.

PANL, recognised for many years as the unique one-coat black crackle finish. Brush applied, no baking. Available by post in eighth-pint cans at 3s. 9d. from G. A. Miller, 255 Nether Street, London, N.3.

continued on page 943

JACKSON



the big name in **PRECISION** components

Precision built radio components are an important contribution to the radio and communications industry. Be sure of the best and buy Jackson Precision Built Components

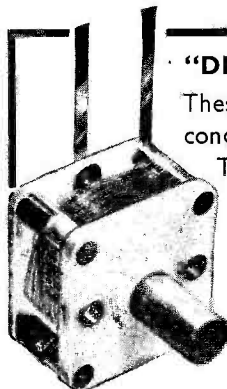

"DILEMIN" CONDENSERS

These miniature solid dielectric condensers are only $\frac{7}{8}$ " square. The $\frac{1}{4}$ " dia. spindle projects $\frac{1}{2}$ " from the front plate. Low loss construction provides Power Factor better than .001.

Write for literature

JACKSON BROS. (LONDON) LTD.

Dept. R.C., KINGSWAY-WADDON, SURREY

Phone: Croydon 2754-5 Grams: Walfico, Souphone, London

SMITH'S of Edgware Road BLANK CHASSIS

Precision made in our own works from commercial quality half-hard Aluminium. Two, three or four sided.

SAME DAY SERVICE

of over 20 different forms made up to YOUR SIZE. Order EXACT size you require to nearest $\frac{1}{16}$ " (maximum length 35", depth 4").

SPECIALS DEALT WITH PROMPTLY

SEND FOR ILLUSTRATED LEAFLET

Or order straight away, working out total area of material required and referring to table below, which is for four-sided chassis in 18 s.w.g. (for 16 s.w.g. add $\frac{1}{4}$ "th)



48 sq. in.	4/-	176 sq. in.	8/-	304 sq. in.	12/-
80 sq. in.	5/-	208 sq. in.	9/-	336 sq. in.	13/-
112 sq. in.	6/-	240 sq. in.	10/-	368 sq. in.	14/-
144 sq. in.	7/-	272 sq. in.	11/-	and pro rata	
	P. & P. 2/6		P. & P. 2/9		P. & P. 3/-

Discount for quantities. Trade enquiries invited. Spray finish arranged for quantities of 25 or over.

FLANGES ($\frac{1}{4}$ ", $\frac{3}{8}$ " or $\frac{1}{2}$ ") 6d. per bend.
STRENGTHENED CORNERS, 6d. each corner.
PANELS. The same material can be supplied for panels, screens, etc. Any size up to 3ft at 4/6 sq. ft. (16 s.w.g. 5/3). P. & P., up to 72 sq. in. 1/3, 108 sq. in. 2/-, 144 sq. in. 2/6 432 sq. in. 2/9, 576 sq. in. 3/3.

H. L. SMITH & CO. LTD

287/289 EDGWARE ROAD LONDON W2
Telephone PAD 5891/7595

NEW  **GUARANTEE.** **MARKED**  **AND TESTED SUCH AS**
MONEY BACK **TRANSISTORS** **XA101, XA102, XB103, XC101, ETC.**
20/- PER PACKET OF 10.
UNMARKED BUT TESTED MOST RADIO 
TYPES 20/- PER PACKET OF 16.
UNMARKED UNTESTED 20/- PKT OF 40. **POST**
DUDS MAY BE SUITABLE AS DIODES 20/- PKT OF 80. **FREE**
ANY 2 PACKETS 37/6 **CASH WITH ORDER** **QUANTITY**
K.R. WHISTON (DEPT RC T), NEW MILLS, STOCKPORT. **DISCOUNT**

What about that 12 w.p.m.

Morse Code Test ?

You can only reach the goal by keen listening and constant practice with a Morse Key. The amount of "hard labour" involved depends on the method of training.

The CANDLER System

will help you as it has helped thousands of others over many years, and give you a sound basis. It turns a difficult task into a pleasurable pursuit.

Send 3d. stamp for details of our Special Course for Amateur Transmitting Licence

The CANDLER System Co.

Dept. RC, 52b ABINGDON ROAD, LONDON, W8

Candler System Co., Denver, Colorado, U.S.A.

A SERVICE IN SMALLS

CAPACITORS:

Ceramic all values 1-5,000pF, 6d. Paper 150v .001, .002, .003, .005, .01, .02, .04, .05, .1, 9d. .25, .5, 1/3.

SUB-MIN ELECTROLYTICS 15V 1, 2, 4, 5, 8, 10, 16, 32, 50 mfd., 2/- . 8V, 100, 250, 500 mfd., 2/6.

MINIATURE RESISTORS 10Ω-10m, 3d.

TRANSISTORS

OC71, 6/6, OC44, OC45, OC81 only 6/9 each. OA81 Diodes, 2/8

NEW COMPONENTS LIST SENT ON REQUEST

STUART SPARES D2

34 ESSEX ROAD RUSHDEN NORTHANTS

AMAZING RESULTS

FROM THE

"OLIVER"

5 STAGE TRANSISTOR RECEIVER

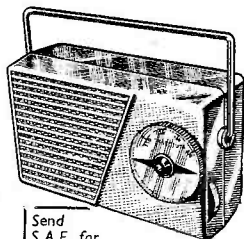

A highly sensitive receiver using top grade transistors and components Fully tunable over medium and long waves.

- Can be built in 1 hour
- High flux moving coil speaker
- Built-in ferrite rod aerial
- Specially designed coils for maximum signal strength
- Volume on/off control
- Eyeleted circuit board
- Easy to follow building plans

Send S.A.E. for **FREE** Layout plans and parts lists

Total Building Costs

ONLY

65/- Plus P. & P. 2/6

EXPLORE THE WORLD ON THIS 1-VALVE SHORT WAVE RADIO

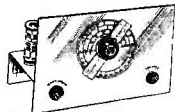

Total Building Costs only **35/-**

P. & P. 2/-

- ★ Receives speech and music from all over the world.
- ★ Construction price includes valve and one coil covering 40-100 metres.
- ★ Can be extended to cover 10-100 metres.
- ★ Can be converted to 2 or 3 valve.

Send 2/- for wiring diagram and components price list.

R.C.S. PRODUCTS (Radio) LTD
 11 Oliver Road · London · E17 (Mail Order Only)

NEW

P.W. POCKET S'HET

NEW CONTEMPORARY CASE

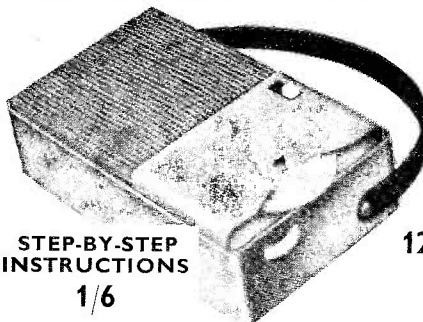

CASE

12/6 Retail

STEP-BY-STEP INSTRUCTIONS

1/6

The Pocket Superhet is a boosted version of a high quality miniature receiver for operation on Medium and Long Waves. Circuit uses 6 special transistors and incorporates modern miniature matched components of the best quality which combine to give superb performance. Printed board construction ensures success by the simple Step-by-Step instructions.

OSMOR 418 BRIGHTON ROAD
 S. CROYDON SURREY

SMALL ADVERTISEMENTS

continued from page 941

TRADE—continued

THE INCORPORATED PRACTITIONERS IN RADIO AND ELECTRONICS (I.P.R.E.) LTD. Membership conditions booklet 1s. Sample copy of I.P.R.E. Official Journal 2s. post free.—Secretary, 20 Fairfield Road, London, N.8.

SERVICE SHEETS (1930-1962) from 1s. Catalogue 6,000 models. 1s. 6d. S.A.E. enquiries.—Hamilton Radio, 13 Western Road, St. Leonards, Sussex.

"MEDIUM WAVE NEWS." Monthly during DX season.—Details from B. J. C. Brown, 196 Abbey Street, Derby.

METALWORK. All types cabinets, chassis, racks, etc., to your specifications.—Philpott's Metalworks Ltd., Chapman Street, Loughborough.

RADIO AMATEUR COURSE. A postal course for those wishing to take the Amateur Examination. A sound basic training in radio communication. Very reasonable terms. Send for brochure.—Premier School of Radio, 3 Kerry Crescent, Calne, Wiltshire.

RECEIVER TYPE B.C. 624 CHASSIS, suitable for conversion 2 metres, new condition, less valves and relay 5/6. Post 4/.—Arthur Sallis (Radio Control) Ltd. 93 North Road Brighton Sussex.

FIND TV SET TROUBLES IN MINUTES from that great book *The Principles of TV Receiver Servicing*, 10s. 6d., all book houses and radio wholesalers. If not in stock, from Secretary, I.P.R.E., 20 Fairfield Road, London, N.8.

VALVES, 9d.: 6AL5, 6AM6, 6D2, 6F12, 6F13, 6F14, 6F15, 8D23, 9D2, 15D2, 78, C2C, D1, D77, D152, DD6, EB91, EF50, EF91, P61, SP61, UB41, UF42, VR35, VR51, VR107, VR137, VR201, Z77. More at 1/9, 2/9 and 5/9. Post: 1—9d., 6—1/6. Stamp for FREE list.—P.P. Components Ltd., 623 Romford Road, Manor Park, London, E.12.

JOIN THE INTERNATIONAL S.W. LEAGUE. Free Services to members including Q.S.L. Bureau, Amateur and Broadcast Translation, Technical and Identification Dept.—both Broadcast and Fixed Stations, DX Certificates, contests and activities for the SWL and transmitting members. Monthly magazine, "MONITOR", containing articles of general interest to Broadcast and Amateur SWLs, Transmitter Section and League affairs, etc. League supplies such as badges, headed notepaper and envelopes, QSL cards, etc., are available at reasonable cost. Send for League particulars. Membership including monthly magazine, etc., 21s. per annum.—Secretary ISWL, 12 Gladwell Road, London, N.8.

THE INTERNATIONAL HAM HOP CLUB is a non-profit making organisation open to RADIO AMATEURS and SHORT WAVE LISTENERS. OBJECT: To improve international relationships through an organised system of hospitality. MEMBERS offer overnight hospitality to visiting members, subscription 10s. per annum. ASSOCIATE MEMBERS invite radio amateurs to visit their stations. Associate membership 5s. per annum. FAMILY EXCHANGE holidays arranged, also FRIENDSHIP LINKS between radio clubs. The Club's official journal is free to both Full and Associate members.—Hon. Gen. Secretary: G. A. Partridge, G3CED, 17 Ethel Road, Broadstairs, Kent.

G2ACC offers you . . .

CATALOGUE NO. 12

9d. post free, refunded on first order.

56 pages, over 2,000 guaranteed items by the leading manufacturers with data.

SOUTHERN RADIO AND ELECTRICAL SUPPLIES

SORAD WORKS REDLYNCH SALISBURY WILTS Telephone Downton 207

EDDY'S (NOTTM) LTD

DEPT. RC

172 ALFRETON ROAD · NOTTINGHAM

NEW OR SURPLUS VALVES GUARANTEED AND TESTED BY RETURN POST

AC2/Pen	EL38	9/6	TDD4	7/6	6J5G	2/9	7C5	6/11
DD	EL81	9/6	UB41	7/6	6K7G	1/11	7C6	7/11
CL33	EL91	4/6	VP23	6/6	6P28	9/6	10F1	5/-
CY31	EZ40	5/11	1D5	7/6	6CH6	8/-	10P13	9/6
EB41	EZ80	5/11	1L4	3/3	6K8G	5/6	12A6	5/-
EB91	GT1C	5/-	1T4	3/6	6L6G	7/6	12K7	5/3
EBF80	HL23DD	6/6	1S5	4/9	6P25	9/6	12Q7	5/3
ECC85	KT33C	6/6	1R5	5/6	6Q7G	5/11	20D1	8/6
EF36	MU14	6/-	6AC7	3/3	6SA7M	5/9	20P3	12/6
EF37	PCF82	7/11	6AG5	3/-	6SG7M	4/9	25L6GT	7/11
EF41	PL33	9/6	6C4	3/6	6SJ7M	5/9	30FJ	6/11
EF42	PL36	10/6	6BW7	6/11	6SN7GT	4/6	80	6/11
EF50	PY31	9/6	6F1	5/-	6SL7GT	5/9	954	1/6
EF91	PZ30	9/6	6F13	5/-	6U4GT	10/6	955	3/6
EF94	PEN36C	8/-	6F15	5/-	6V6G	5/9	956	2/6
EL32	R19	11/-	6F33	6/6	6X4	4/6		

NIFE ACCUMULATORS 1.25V. Size 3" x 2 1/2" x 3/8", weight 13 oz., 2/11 each. P. & P. 2/- one only, add 9d. per cell.

THROAT MIKES 2/- each. Super model, 3/- ea. Post 10d. Could be used for electrifying musical instruments, etc.

VIBRATORS 12 volt 4 pin, 5/11. 6 volt 4 pin, 9/11. Post 1/6.

LUXEMBOURG AERIALS 3/11, post 6d. No technical knowledge required.

V.H.F. AERIALS 6/11. Post 10d. Easy to fit. No technical knowledge required.

ALL ABOVE ARE NEW AND GUARANTEED

VALVES EX. EQUIPMENT. EF80, 9d. ea., 5 for 2/11. 10F1, 9d. ea., 5 for 2/11. EB91, 9d. ea. 6F15, 9d. ea. 6F1, 9d. ea. Post 6d.

Any parcel insured against damage in transit for only 6d. extra per order. All uninsured parcels at customers risk. Post and Packing 6d. per valve extra. C.W.O. or C.O.D. only. C.O.D. charge 3/- extra S.A.E. with enquiries.

★ VALVES New Tested & Guaranteed

1R5	6/6	6X4	7/6	DK96	8/-	EZ40	6/6
1S5	6/6	12A7T	6/-	DL92	6/9	EZ80	6/6
1T4	4/6	12AU7	6/-	DL94	7/6	EZ81	7/-
3S4	6/9	12AX7	7/6	DL96	8/-	GZ32	10/6
3V4	7/6	12BH7	10/6	EB91	4/6	KT66	15/-
5U4G	6/-	12K7GT	8/6	EBC41	9/6	PL81	12/6
5Y3GT	7/6	12K8GT	13/6	ECC81	6/-	PL82	10/6
5Z4G	9/-	12Q7GT	6/6	ECC82	6/-	PY81	8/-
6AK6	6/6	25A6G	10/6	ECC83	7/6	PY82	7/-
6AL5	4/6	25L6GT	9/-	ECC84	7/6	PCC84	9/6
6AM6	4/-	35Z4GT	8/6	ECC85	8/6	PCF80	9/-
6AT6	7/6	35L6GT	9/6	ECC82	7/6	PCF82	11/-
6BA6	8/6	5763	10/6	ECH81	10/6	PCL82	7/6
6BE6	7/6	DAF91	6/6	ECH42	8/6	PCL83	12/6
6BR7	10/6	DAF96	8/-	ECL80	9/6	PCL84	8/6
6BW6	8/6	DCC90	11/6	EF41	8/6	U76	8/6
6J7GT	8/6	DF91	4/6	EF80	8/-	UBC41	10/-
6K7G	7/6	DF96	8/-	EF86	9/6	UCH42	10/6
6K8GT	8/6	DH76	8/6	EF91	4/-	UF41	10/-
6Q7G	7/6	DH77	7/6	EL41	9/-	UL41	8/-
6SL7GT	8/-	DK91	6/6	EL84	8/-	UY41	8/-
6V6G	7/6	DK92	7/6	EY51	7/6	W76	8/6

MATCHED PAIRS. EL84, 17/-; EL85, 25/-; 6V6G, 17/-; 6BW6, 18/-; KT33C, 19/6; 807 14/6 pair; KT66, 32/6.

SETS OF VALVES

DK96, DF96, DAF96, DL96 "REGENT"	29/6 per set
DK91, DF91, DAF91, DL92, or DL94	21/- per set
1R5, 1T4, 1S5, 3S4, or 3V4	21/- per set
6K8, 6K7, 6Q7, 6V6, 5Z4, "G" Types	27/6 per set
12K8, 12K7, 12Q7, 35L6, 35Z4, "GT" Types	35/- per set
ECH42, EF41, EBC41, EL41, EZ40	37/6 per set
UCH42, UF41, UBC41, UL41, UY41	35/- per set

P.P. OP. TRANSFORMERS. MR 3-15 ohms for EL84, 6V6, 6BW6, etc., 18/6; Op. Pen. 50mA, 5/6; 30mA, 4/6.

P. & P. 6d., over £1 post paid. C.O.D. 3/-

R. COOPER G8BX 32 SOUTH END CROYDON SURREY CROYDON 9186

The thrills of VHF can now be yours for only 39/6d, complete kit! Tunable 150-100 Mc/s, simplified construction, write today for leaflet. Also if a newcomer to Amateur Radio ask for free copy of the world famous "Globe-King" kits and receivers, stamp please to cover postage:

Johnsons (Radio) St. Martin's Gate Worcester

H.A.C. THE ORIGINAL SUPPLIERS OF SHORT-WAVE KITS

One valve Super Sensitive All-dry Short-wave Receiver, Model "K". Complete kit including valve and chassis, 77/- (Other S.W. kits from 25/-). Before ordering call and inspect a demonstration receiver, or send stamped envelope for full specification, catalogue and order form.

H.A.C. SHORT-WAVE PRODUCTS (DEPT. R) 44 OLD BOND STREET LONDON W1

SPARES, VALVES, TUBES 1930-1960

Guaranteed perfect, set tested, ex-working equipment

5U4	4/-	7S7	6/-	20P1	4/-	KT81	6/-	PY80	4/-
5R4	6/-	10P13	4/-	20P3	6/-	N37	6/-	PY81	4/-
6AQ5	4/-	10P14	4/-	20P4	12/6	PCC84	4/-	PY82	4/-
6AU6	4/-	12A7	2/6	185BT	10/-	PCF80	4/-	PZ30	4/-
6BG6	12/6	12AU7	4/-	ECC85	5/-	PCL82	4/-	U191	7/6
6BQ7A	5/-	12AX7	4/-	ECC88	5/-	PCL83	4/-	U403	6/-
6CH6	6/-	12BH7	4/-	ECF80	5/-	PenA4	5/-	U801	15/-
6U4	6/-	12E1	6/-	ECF82	5/-	PenA5	4/-	UCH42	6/-
6SN7	2/6	12SN7	4/-	ECL80	4/-	PL81	4/-	UL41	4/-
6SJ7	4/-	20D1	2/6	EL38	4/-	PL82	4/-	OC44	8/6
7B7	5/-	20F2	4/-	EL81	6/-	PL83	4/-	OC45	7/6
7C5	5/-	20L1	4/-	EL90	6/-	PY31	4/-	OC201	15/-

Most pre-war 4, 5, 7, 9-pin valves 5/- each. P. & P. 6d. per valve
VALVE PARCEL. 12 assorted, all different, 8/6. Postage 1/6.
CONSTRUCTOR'S PARCEL. 2 lb mixed resistors, condensers pots, valveholders, electrolytics, etc. 7/6, postage 2/6.

Send S.A.E. with enquiries or for list of 1,000 valves

ST. JOHN'S RADIO 3 Jews Row, SW18 Tel. VAN 8822

TRANSISTOR POCKET RADIOS only 29/6 NO MORE TO PAY
BULK PURCHASE ENABLES US TO MAKE THIS FANTASTIC OFFER AND WITH MONEY BACK GUARANTEE!

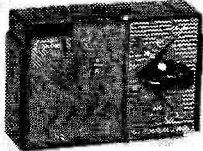

The "SAN REMO" 5 Star so tuned that it brings the voices of star entertainers and vocalists dramatically to life—in your home, office, etc. . . . Only 4 1/2" x 2 1/2" x 1 1/4" fits easily into your pocket or handbag. **Works for months off 8d. battery.** Should last a lifetime.

Anyone can assemble it in an hour or two with our easy plan. Complete set of parts including miniature speaker, —everything only 29/6 plus 2/6 P. & P. C.O.D. 2/6 extra. (Parts can be bought separately.) Limited period—so order before it's too late.

DEMONSTRATIONS DAILY

CONCORD ELECTRONICS (DEPT. 6)

210 CHURCH ROAD HOVE SUSSEX

SURPLUS RADIO SUPPLIES

2 LAING'S CORNER MITCHAM SURREY

Don't miss this Bargain!

50 MICRO AMP METER

By Sagamo Weston

19/6

LIMITED QUANTITY

Postage and packing 2/6

NYLON P.T.F.E.

ROD BAR SHEET TUBE STRIP WIRE

No quantity too small List on application

BRASS COPPER BRONZE ALUMINIUM LIGHT ALLOYS

H. ROLLET & CO LTD

6 CHESHAM PLACE, LONDON, SW1

BELgravia 4300

Also at Liverpool, Birmingham, Manchester, Leeds

Quality Components FOR CONSTRUCTORS

capacitors, resistors, coils, valves, diodes, controls, chassis, transformers, speakers, pick-ups, cartridges, stylii, and all types of components in stock.

PRICE LISTS AVAILABLE ON REQUEST

J. T. FILMER

82 DARTFORD ROAD
 DARTFORD KENT
 Telephone Dartford 24057

LEARN

RADIO & TV SERVICING

For your own business / hobby

by a new exciting no maths system, using practical equipment recently introduced to this country

FREE BROCHURE FROM

RADIOSTRUCTOR

DEPT. G103 · READING · BERKS.

7.62

TRANSISTOR PORTABLE RADIO KIT. £5.17.6 plus post. 3/6.

Covers medium and long waves, no aerial or earth required. No difficult aligning necessary. Build for your holidays now. Also **POCKET RADIO KIT 65/-** post. 2/-, with personal earphone, medium and long wave.

Red Spot Transistors, 2/3; White Spots, 2/3; Yellow/Green, 3/3; OC71, 6/-; OC72, 7/6; OC44, 7/6; OC45, 9/-; Sub-min. Electrolytics 2, 4, 8, 10 16, 32, 50µF, 2/-; 100µF, 2/9; 250, 500, 1,000µF, 3/3. Silicon Rectifier bargain, 70 piv. 1/2A, 3/3. Receiver R109 (2 to 12 Mc/s), brand new, £3.0.0. Carr. 20/-; Silicon Rectifiers, 400 piv. 1/2A, 3/9. Gortler Transistor Amplifier, 1 watt, £4.12.6. Multimeter EP10K, £4.5.0. Ardente Trans. D239, 8/6; D240, 8/6; D131, 10/-; D132, 10/-; Transformer, 250-0-250V, 6V and 5V, 15/-; Hearing Aid Mike, 31/6. Super Coax., 75 ohms, 6d. yd. Valves, 6X5, 5/6; 6V6, 5/6; 1L4, 5/6. Electrolytics: 8µF 500V, 2/3; 8+16µF, 3/3; 100+100 (375V), 3/9; V. Cond. 0.0005 t. gang trimmers and slow m., 9/6. Transistor Holders, 1/-.

Terms—Cash with order. Post extra, excess refunded. Our Reflex Rx, best 2-transistor Receiver. Send 10d. stamps for notes.

MOORE'S EXPERIMENTAL SUPPLIES Dept. C
 8 & 10 GRANVILLE STREET SHEFFIELD 2 Telephone 27461

The SAVOY 4-TRANSISTOR POCKET RADIO

with moving coil speaker
NO SOLDERING NO DRILLING NO AERIAL

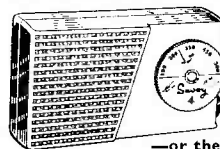

4 transistors and two diodes in a 5-stage reflex circuit, push-pull output. Full medium wave. Size 5 1/4" x 3 x 1 1/2". Simple instructions and Assembly Tool provided.

85/- Battery 2/3. P.P. 2/9 extra
 —All parts sold separately

—or the **SAVOY SUPER-3** 49/6 Bat'y 1/-
 with 3 transistors and 2 diodes. Size 4 1/4" x 2 3/8" x 1 1/4" P.P. 2/- extra

SAVOY ELECTRONICS LTD 15 Maiden Lane London WC2 (Back of Adelphi Theatre)

ALL-TRANSISTOR TIME SAVER OFFICE OR HOME TELEPHONE PICK-UP AMPLIFIER

★ No more "holding on" wasting time waiting for your call to come through. When it does the amplifier can be switched off if required. No connections, just press the pick-up coil to back of phone as below. Fully Guaranteed. Housed in attractive Gold Finish Cabinet.

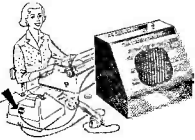

BUILT, TESTED, READY TO USE

£5. 10. 0

P.P. 2/6.

TRANSISTOR BABY-ALARM
Very sensitive, £5.10.0. P.P. 2/6.



MODEL TH-L33

2,000 ohms per volt AC/DC. Size 5" x 3½" x 1½".

79/6

with test leads, battery and instructions.

0/10/50/250/500/100 volts D.C., 0/10/50/250/500/1000 volts A.C., 0/500µA/10/250mA., D.C.

3 ranges resistance 0/10K/100K/1 Meg. Capacity and dB ranges. Large scale.

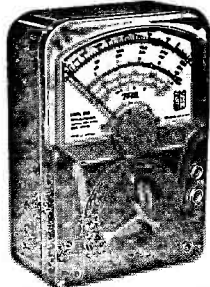

MODEL 500

30,000 ohms per volt multi-meter

£8. 19. 6

8 Ranges D.C. volts to 1 kV.
7 Ranges A.C. volts to 1 kV.
5 Ranges D.C. current to 12 amps.
3 Range resistance to 60 meg.
Short circuit, Buzz test. Output meter, dB, etc., etc. Size 6½" x 4½" x 2½". With Leads, Batteries and Instructions.

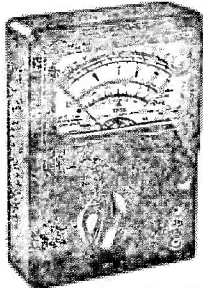

MODEL TP55

A.C./D.C. voltage up to 1,000 in 5 ranges. D.C. current 4 ranges up to 500mA. 4 range resistance to 10 megs. Capacity dB scales, etc. 20,000 ohms/volt. Fully Guaranteed

£5. 19. 6

With Test Leads, Battery and Instructions. Size 5½" x 3½" x 1½".

ALL METERS FULLY GUARANTEED FOR 6 MONTHS

WE CAN SUPPLY MOST OF THE COMPONENTS USED ON CIRCUITS PUBLISHED IN THIS AND OTHER MAGAZINES QUOTATIONS BY RETURN NEW ILLUSTRATED CATALOGUE 1/-

1. 4-Transistor Two-way Intercomm. 2-way buzzing, 2 speakers, ready to use, 8 gns. P.P. 2/6.
2. Miniature 15 watt Solder Iron, ⅝" bit. Ideal for all printed circuit work, 29/6. P.P. 1/6.
3. New Model Control Book with 60 pages of transistor circuits, 7/6. P.P. 6d.
4. Complete Set of Meter Leads with Prods, Clips, etc., with pouch, 8/6. P.P. 1/-.
5. Telephone Recording Coil to record conversations. For all amplifiers and recorders, 14/- P.P. 9d.
6. Printed Circuit Kit, to etch your own circuits. Complete with boards and details, 19/6. P.P. 1/-.
7. Miniature 850 ohm Record/Playback Tape Head, with mounting block, 12/6. P.P. 9d.
8. 4,000 ohm lightweight Headphones with leads. Very sensitive, 12/6. P.P. 1/-.
9. Transistor Pocket RF, IF Generator for Radio, TV, etc. Fault finding, 52/6. P.P. 1/-.
10. 8-Range All Transistor Signal Generator, 200 kc/s to 220 Mc/s: RF, AF, IF, HF, etc., £7.10.0. P.P. 3/6.
11. GS12C (Dekatron) Bi-directional 12-way indicator tube. Brand new, 25/-.
12. Caby M1 Pocket Multimeter, 2,000 ohms per volt. With leads and instructions, 54/- P.P. 1/6.
13. 4½-9 volt Tape Recorder Motor, 12/6. P.P. 1/-.
14. 30 watt Pocket Solder Iron, with pocket pouch and mains plug, 18/6. P.P. 1/-.
15. 931A Photo Multiplier. Brand new, 60/-.
16. 1 kc/s Transistor Audio Test osc., variable output, 39/6. P.P. 1/6.
17. Crystal Contact Microphone. Very sensitive. Ideal for Guitar, 12/6. P.P. 9d.
18. 4-Transistor Telephone Amplifier. Amplifies without connection to 'phone. Ideal for office, works or home, £5.10.0. P.P. 2/6.
19. Practical Transistor Circuits. 40 circuits to build, 3/6.
20. Personal Earphones with leads, Jack plug and socket, 600 ohm, 10/6; 1,000 ohm, 12/6; Crystal 9/6. (1/6 cheaper less socket.)
21. W/W Erase Head, FE7, 7/6. P.P. 6d.
22. Dynamic Microphone, 49/6. P.P. 1/6.
23. Transistor Signal Inspector. A new design pocket size tester for fault finding on valve or transistor radios, TV, amplifiers, etc. Built-in indicator and batteries with detachable probe, 52/6. P.P. 1/6.
24. Extension Speaker Unit. Plugs into phone socket of most portables. Gives big set volume. Ideal for car use, 57/6. P.P. 1/6.
25. New 2-way Intercomm. for office, home or works. 2-way calling, etc. Moulded Cabinets, 89/6. P.P. 1/6.

Miniature Panel Meters

0/50µA (D.C.)	39/6	0/5mA (D.C.)	27/6
0/500µA (D.C.)	32/6	0/300V (D.C.)	27/6
0/1mA (D.C.)	27/6		

Brand New Boxed

26. 7-Section Telescopic Aerial, 12/6. P.P. 1/-.
27. LA1 Ferrite Pot Core, 12/6. P.P. 6d.
28. New 4-station Transistor Intercomm. Calling, Talking, etc. Complete, 13gns. P.P. 3/6.
29. 4,000 ohm Lightweight Sensitive Headphones, 12/6.
30. No. 19 Set Crystal Calibrator with Handbook, 79/6. P.P. 2/-.
31. ACOS 43-2 High Output 2½" Xtalmic Insert, 10/6. P.P. 6d.

4 TRANSISTOR PUSH-PULL AUDIO MODEL PK-543 AMPLIFIER

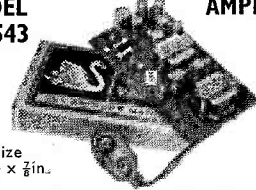

Size 3 x 1½ x ¾ in.

A ready-built, miniature 250mW push-pull amplifier incorporating input and output transformers, 4 transistors, 9 volt battery snap cord, speaker and volume connection leads. Ideal for use with record players, intercoms, hearing aids, tape recorders, etc. Complete with full instructions and circuit diagram.

PRICE 52/6 P.P. 1/6.

SUITABLE 2½" SPEAKER, 16/6.

TRANSISTORS 1st GRADE

AF117	9/6	OC83	6/-	OC139	13/6
AFZ12	35/-	OC84	8/6	OC140	29/-
AC107	14/6	OC75	7/-	OC200	10/6
OC71	5/6	OC35	18/-	OC201	31/-
OC72	7/-	OC44	9/3	OC22	23/-
OC76	7/-	OC45	8/6	OC71	29/-
OC81	7/-	OC170	9/6	OC41	9/-
OC78	7/-	OC171	10/6	OC42	9/6
AF102	27/6	AF115	10/6	ORP12	15/6

Send for New List of Fully Guaranteed Transistors, Diodes, Zener Diodes, Silicon Rectifiers, etc. All 100% 1st Grade. We stock a semi-conductor device for every need.

SPECIAL REDUCTIONS FOR SETS

TYPE 38, TRANSMITTER RECEIVER

Complete with 5 valves. In new condition. These sets are sold without guarantee but are serviceable. 22/6 P.P. 2/6

Headphones, 7/6 pair. Junction Box, 2/6. Throat Mike, 4/6. Aerial Rod, 2/6.

CRYSTAL MICROPHONES

- ACOS 39-1. Stick Microphone with screened cable and stand (list 5 gns.), 32/6. P.P. 1/6.
- ACOS 40. Desk Microphone with screened cable and built-in stand (list 50/-), 15/- P.P. 1/6.
- ACOS 45. Hand Microphone with screened lead, very sensitive, 25/- P.P. 1/6.
- 100 C. Stick Microphone with muting switch and screened cable, detachable desk stand, cord and neck, 39/6. P.P. 1/6.
- MC 24. Stick Microphone with muting switch and cable, 25/- P.P. 1/6.
- LAPEL. Miniature Mic. With clip. Ideal for recording, 15/- P.P. 1/6.

BATTERY ELIMINATOR AND CHARGER

Replaces PP3 or T6003 9 volt batteries to run transistor radios from mains. Also charges to give 5 times normal battery life. Fitted neon indicator and supplied with full details, 29/6. P.P. 1/6. 'Petic' type 18/6, P.P. 1/6.

BATTERY RECORD PLAYER



★ 6-7½ volt Garrard turntable with crystal pick-up. Plays 45 r.p.m. Ideal for above amplifier.

65/- P.P. 1/6.

★ PORTABLE RECORD PLAYER CABINET for above player and amp, 22/6 for 7" x 4" speaker. P.P. 1/6.

Henry's Radio Ltd

PADDINGTON 1008/9

5 HARROW ROAD LONDON W2

Open Mon. to Sat. 9-6, Thurs. 1 o'clock
Send 1/- stamp for Illustrated Price List

Please Turn Page

Redesigned 'Contessa' Mk. III

★ combined portable and car radio ★

- NOW** WITH 600mW MELLOWTONE OUTPUT ON MEDIUM AND LONG WAVES
- NOW** FITTED HORIZONTAL TUNING SCALE WITH ALL STATIONS CLEARLY MARKED
- NOW** SUPPLIED WITH SIX MULLARD TRANSISTORS AND TWO DIODES
- NOW** FITTED RECORDING SOCKET AND CAR AERIAL SOCKET
- NOW** SUPPLIED WITH TWO-TONE BEIGE OR TWO-TONE BLUE CABINET WITH GOLD FITTINGS

GUARANTEED THE VERY BEST OBTAINABLE

- All parts sold separately ●

The New "CONTESSA" 6-Transistor Portable Superhet Radio. Features simple printed circuit construction and fully illustrated building instructions, with all parts clearly marked and identified. Fitted with 8" Ferrite aerial. Double IFTs and the latest in components and design. Full tuning of both Medium and Long Wave bands with unbeatable selectivity and sensitivity. Clearly marked station dial and room-filling "MELLOWTONE" push-pull output are standard features.

TOTAL COST

£10.19.6 P.P. 3/6

OVERALL SIZE

10½" x 7½" x 3½"

- Detailed Leaflet on Request ●

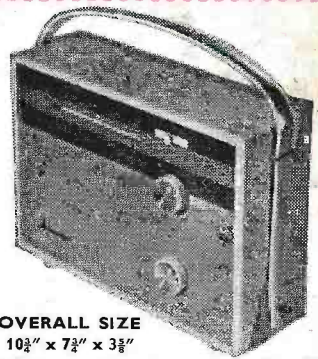

★ ALL THESE EXTRA FEATURES AT NO EXTRA COST ★

— The ideal portable, at home or by the sea —

"TRANSFIVE" PORTABLE RADIO

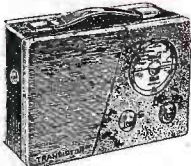

Medium and Long Wave Portable

8½ x 6½ x 3½ in.

£6.19.6 P.P. 2/6

A simple to build 5-Transistor and Diode, Printed Circuit, Medium and Long Wave Portable. Features 5" speaker, Car aerial socket, Mullard transistors and carded components. Building plans free on request. THE IDEAL PORTABLE. Full after-sales service and guarantee.

"QUINTET" MEDIUM AND LONG WAVE POCKET RADIO. PUSH-PULL SPEAKER OUTPUT

Size 5½" x 3" x 1½"

Red or Blue with Gold trim

Total Cost £5.10.0 P.P. 2/-

A 5-Transistor and Diode medium and Long Wave Printed Circuit loudspeaker Radio. Features Mullard transistors and plainly marked printed circuit with carded components. Excellent results with full station separation guaranteed. Including Radio Luxembourg. Push-pull output up to 200mW. Fitted phone/record socket and car aerial socket. Full after-sales service and guarantee.

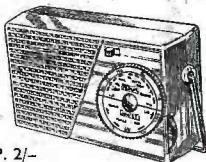

"CAPRI" POCKET SIX. 6-TRANSISTOR MEDIUM AND LONG WAVE POCKET SUPERHET RADIO

- SIZE 4½" x 2¾" x 1¼" REALLY POCKET SIZE ●

The most compact 6-transistor and diode radio with speaker available to the home constructor. Features the latest in miniature components and circuitry. Supplied with Mullard transistors and two-tone moulded cabinets in red/white or blue/white with gold fittings. All components are supplied in packets and clearly identified. A printed circuit is used with fully illustrated building instructions. Push-pull output coupled with a sensitive and selective circuit make the "CAPRI" hard to beat. Fitted Earphone/Record socket.

- FULL AFTER-SALES SERVICE AND GUARANTEE
- ALL PARTS SOLD SEPARATELY—DETAILED LEAFLET ON REQUEST

★ DESIGNED BY EXPERTS FOR THE HOME CONSTRUCTOR ★

TOTAL COST £7.10.0 P.P. 2/- (Battery 2/6)



"CARVERTER"

Mobile Transistor Short Wave Converter As featured in the May edition of *The Radio Constructor*. Just plugs into the aerial socket of your car radio. Crystal controlled—covers amateur and Short Wave broadcast bands from 5 to 16 Mc/s.

Supplied complete with long life battery and 37/40 metre band crystal. Send 1/- stamp for full Booklet.

Total cost with sprayed cabinet, etc.

69/6 P.P. 2/-

No modifications to car radio at all.

750mW 4-TRANSISTOR PUSH-PULL AMPLIFIER

(over 1 watt peak output)

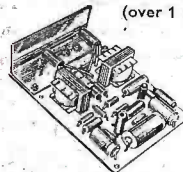

- ★ Uses OC71/OC81D, 2-OC81
- ★ ±3dB 70 c/s to 12 kc/s
- ★ Overall size 4" x 2½" x ¾"
- ★ Built on printed circuit

BUILT & TESTED 69/6 P.P. 1/6 OR COMPLETE KIT 62/6 P.P. 1/6
Ideal for Record Player, Intercom., Baby Alarm for Tuners, etc.

3 ohm output, fully guaranteed, 9 volt operated. Descriptive leaflet with uses FREE on request

"PW-6" SUPERHET RADIO

Medium and Long Wave Radio

Size 5½ x 3½ x 2 in.

£8.10.0 P.P. 2/-

Modified version of previously advertised "PW" Superhet. Now with new style Two Tone Cabinet. First grade components and transistors. Printed circuit. Features matched set of 6 Transistors. New 2½" quality speaker and new illustrated building instructions.



"RANGER 3"

Size 4½" x 3" x 1¼"



69/6 P.P. 1/6

A Three-Transistor Two Diode Personal Radio for Medium Waves and Amateur top band and shipping. Quality output on personal phone. Fitted air spaced tuner, vol. control. No aerial or earth. Luxembourg guaranteed.

Brand new Stereo Amplifiers ready to use, 79/6, P.P. 2/-

PLEASE TURN PAGE

Henry's Radio Ltd
PADdington 1008/9

5 HARROW ROAD LONDON W2
Open Monday to Sat. 9-6, Thurs. 1 o'clock
Send 1/- Stamps for Illustrated Price Lists