

VOLUME 15 NUMBER 10
A DATA PUBLICATION
PRICE TWO SHILLINGS

May 1962

**"Carverter" Mobile
Short-Wave Converter**

- Low-Cost Electronic Timer
- Single Transistor Capacitance Relay
- Transistor Crystal Calibrator
- A Capacitance Tester
- The "Double-Two" Simple Receiver/Amplifier
- Ideas for an Aerial Mast
- Miniature Economical Oscilloscope
- Printed Circuit Soldering
- Versatile 10-Watt Amplifier
- Variable Periodic Switch
- Omnidirectional Loudspeaker Enclosure for Stereo
- Amateur Radio in the U.S.S.R.
- Useful Soldering Stand



6 SIX GOOD REASONS WHY YOU NEED THE NEW EDITION OF THE **Mullard** MAINTENANCE MANUAL



Mullard

MAINTENANCE MANUAL 16/-

SECOND EDITION

1 This is a completely new and up-to-date edition including data on all current replacement valves, semiconductors and cathode ray tubes. It contains valuable new material essential as reference for every Service Engineer.

2 Supplementary data sheets will be issued from time to time to provide data on new types. This service is included in the initial price of 16/-.

3 The binding of this edition is specially designed to allow the supplementary data sheets to be inserted simply and without glueing.

4 The manual contains full data on 178 separate types and the equivalents list of current types provides cross-references to 480 types.

5 All devices are listed in alphabetical order for easy reference.

6 The data on each type has been carefully compiled to supply the information which the Service Engineer is most likely to require, including very clear base diagrams for each type.

Published by Mullard Ltd. U.K. Price 16/-.
Get your copy from your radio dealer or
order direct from MULLARD LTD., MULLARD
HOUSE, TORRINGTON PLACE, LONDON,
W.C.1. (Postage and packing 1s. 0d. extra.)



NOTE: A few copies of the previous edition
are still available at 10/6d. each (postage and
packing 1/- extra).

MVM 4224

designed for

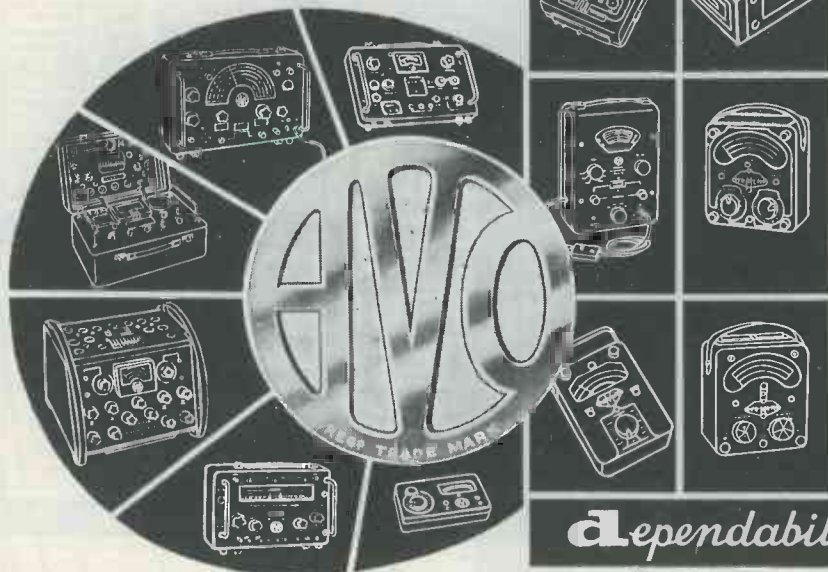

dependability

The new "AVO" Mk. IV Valve Characteristic Meter is typical of the ingenuity of design and high standard of workmanship that exemplify all of the multi-range instruments in the wide "Avo" range.



It is a compact and comprehensive meter that will test quickly any standard receiving valve or small transmitting valve on any of its normal characteristics under conditions corresponding to a wide range of DC electrode voltages. The method of measuring mutual conductance ensures that the meter can deal adequately with modern TV receiver valves. It does many useful jobs too numerous to mention here, but a comprehensive pamphlet is available on application.

List Price **£92** complete with Instruction Book and Valve Data Manual

AVO LTD

AVOCET HOUSE 92-96 VAUXHALL BRIDGE ROAD . LONDON S.W.1.

VICTORIA 3404
(12 lines)



FREE TO AMBITIOUS ENGINEERS

— THE LATEST EDITION OF ENGINEERING OPPORTUNITIES

Have you sent for your copy?
ENGINEERING OPPORTUNITIES is a highly informative 156-page guide to the best paid engineering posts. It tells you how you can quickly prepare at home for a recognised engineering qualification and outlines a wonderful range of modern Home Study Courses in all branches of Engineering. This unique book also gives full details of the Practical Radio & Electronics Courses, administered by our Specialist Electronics Training Division—the *B.I.E.T. School of Electronics*, explains the benefits of our Employment Dept. and shows you how to qualify for five years promotion in one year.

We definitely Guarantee
"NO PASS — NO FEE"
 Whatever your age and experience you cannot afford to miss reading this famous book. If you are earning less than £25 a week, send for your copy of "ENGINEERING OPPORTUNITIES" today—FREE.

BRITISH INSTITUTE OF ENGINEERING TECHNOLOGY (Incorporating *E.M.I. Institutes*)
 (Dept. SE/23), 29 Wright's Lane, London, W.8

THE B.I.E.T. IS THE LEADING ORGANISATION OF ITS KIND IN THE WORLD

WHICH IS YOUR PET SUBJECT ?

Mechanical Eng.,
 Electrical Eng.,
 Civil Engineering,
 Radio Engineering,
 Automobile Eng.,
 Aeronautical Eng.,
 Production Eng.,
 Building, Plastics,
 Draughtsmanship,
 Television, etc.

GET SOME LETTERS AFTER YOUR NAME!

A.M.I. Mech.E.
 A.M.I.C.E.
 A.M.I.Prod.E.
 A.M.I.M.I.
 L.I.O.B.
 A.F.R. Ae.S.
 B.Sc.
 A.M. Brit. I.R.E. City & Guilds
 Gen. Cert. of Education
 Etc., etc.

PRACTICAL EQUIPMENT

Basic Practical and Theoretic Courses for beginners in Radio, T.V., Electronics, Etc.,
 A.M. Brit. I.R.E. City & Guilds Radio Amateurs' Exam.
 R.T.E.B. Certificate
 P.M.G. Certificate
 Practical Radio
 Radio & Television Servicing
 Practical Electronics
 Electronics Engineering
 Automation

INCLUDING TOOLS!

The specialist Electronics Division of *B.I.E.T. (Incorporating E.M.I. Institutes)* NOW offers you a real laboratory training at home with practical equipment. Ask for details.

B.I.E.T. SCHOOL OF ELECTRONICS



POST COUPON NOW!

Please send me your FREE 156-page "ENGINEERING OPPORTUNITIES"
 (Write if you prefer not to cut page)

NAME





ADDRESS

.....

SUBJECT OR EXAM THAT INTERESTS ME

With a VALTOCK AUTOMATIC BLOWLAMP

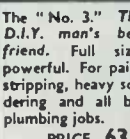
YOU CAN DO SO MANY JOBS SO WELL

 <p>The "2000." Ideal for model makers, hobbyists and service engineers for fine delicate work, soft soldering, glass bending, etc. PRICE 14/7</p>	 <p>The "Major." A larger version of the "2000" fitted with flame shield to give large flame: for most big soldering jobs about the house. PRICE 30/-</p>
 <p>The "No. 3." The D.I.Y. man's best friend. Full size, powerful. For paint stripping, heavy soldering and all big plumbing jobs. PRICE 63/-</p>	 <p>Soldering Iron attachment. Fits the "Major" and "2000". Gives you a soldering iron anywhere—away from electrical supplies. PRICE 5/-</p>

and the **SLOTGRIP torsion Screwdriver**
 POSITIVELY GRIPS SCREWS ON THE END OF ITS BLADE

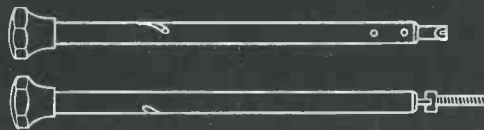
	<p>For putting screws in awkward places. Automatic action. Push—it grips. Pull—it's released. PRICE 5" 7/6 10" 12/-</p>
---	---

Get them at your local hardware shop or send to us for name of nearest stockist

VALTOCK LTD. Regency House 1-4 Warwick St. London W1 Telephone GERrard 1667

A NEW **BRIMAR** DOUBLE TRIODE

*particularly suitable for
Tape Recorders and
Instrumentation*

HIGH GAIN
Amplification Factor μ 140

LOW NOISE
Grid Hum Level $3 \mu\text{v}$

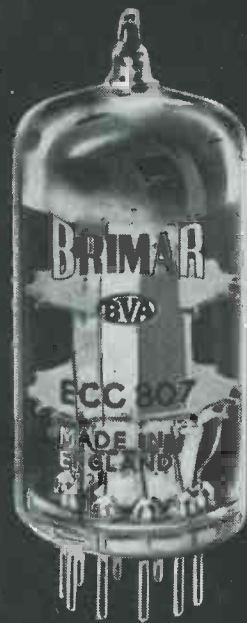
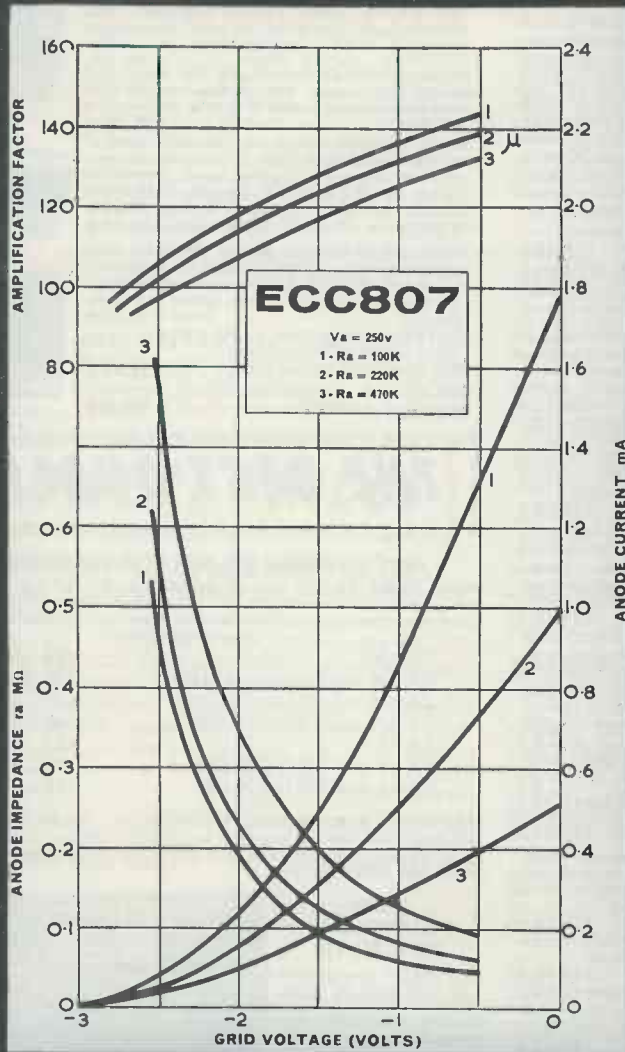

better make it



Brimar Commercial Division

THORN-AEI RADIO VALVES & TUBES LIMITED, ROCHESTER, KENT. Tel. CHATHAM 44411



Heathkit

DAYSTROM

THE FINEST ELECTRONIC KITS IN THE WORLD



RSW-1

4-WAVEBAND TRANSISTORISED PORTABLE RECEIVER, Model RSW-1. This model possesses Medium, Trawler and two Short-wave bands and is mid-way between the domestic broadcasting and professional general communications receiver. Ideal and inexpensive for those who wish to listen to world broadcasts, shipping and aviation communications. It is not the set to buy if you wish only to enjoy domestic broadcasting. In a handsome leather case, it has retractable whip aerial and socket for car radio use.

£22.10.0

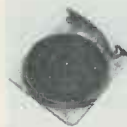

GL-58

TRANSCRIPTION RECORD PLAYER (STEREO). Manufactured by Goldring-Lenco. This 4-speed unit is fitted with a G60 pick-up arm. Infinitely variable speed adjustment from 33½ to 80 r.p.m. Fixed speed of 16 r.p.m. Its balanced turntable (3½ lb) reduces rumble, wow and flutter to very low level. The unique lowering device fitted provides absolutely safe means of placing pick-up on record

£20.12.0



TA-1M

DECADE CAPACITOR Model DC-1. Capacity values 100µF to 0.111µF in 100µF steps.

£6.5.6



O-12U

AUDIO SIGNAL GENERATOR, Model AG-9U. 10 c/s to 100 kc/s, switch selected. Distortion less than 0.1%. 10V sine wave output metered in volts and dB's.

£19.19.6



DC-1

HI-FI SINGLE CHANNEL AMPLIFIER, Model MA-12. 12W output, wide freq. range, low distortion.

£10.19.6

RESISTANCE CAPACITANCE BRIDGE Model C-3U. Measures capacity 10pF to 1,000µF, resistance 100Ω to 5MΩ and power factor. 5-450V test voltages. With safety switch.

£8.6.6

BALUN COIL UNIT, Model B-1U. Will match unbalanced co-axial lines to balanced lines of either 75 or 300Ω impedance.

£4.9.6

AUDIO WATTMETER, Model AW-1U. Up to 25W continuous, 50W intermittent.

£14.14.0

AUDIO SINE-SQUARE WAVE GENERATOR, Model AO-1U. Covers 20 c/s to 150 kc/s and square waves to 50 kc/s in four ranges. Maximum output 10V, distortion less than 1%.

£12.18.6

AUDIO VALVE MILLIVOLTMETER, Model AV-3U. 1mV-300v A.C. 10 c/s to 400 kc/s.

£13.18.6



AG-9U

HI-FI STEREO/MONO PRE-AMPLIFIER, Model USP-1. Extremely versatile unit. Gain may be preset over a wide range. Input 2mV-20mV. Output 20mV-2V

£6.17.6

MATCHED HI-FI STEREO KIT
We offer as a "packaged deal" the following matched Hi-Fi Stereo Equipment:

4-speed Record Player (RP-1U) ... £12.16. 4
6W Amplifier (S-33) ... £12. 8. 6
Twin Speaker Systems (SSU-1) ... £21.15. 0



MA-12

Cost of Units ... £46.19.10
At an "all in" price of ... £44. 9. 4
Pedestal Speaker legs £2.2.0 optional extra.

AMATEUR TRANSMITTER, Model DX-100U.

The world's most popular, compact and completely self contained Amateur Transmitter covers all amateur bands: 160-10 m. 150W D.C. input. Careful design has achieved the stability and high performance for which the DX-100U is noted and no less than 35 disc ceramic capacitors reduce TVI to a minimum.

£71.10.0

HI-FI AM/FM TUNER, Model AFM-1. Available in two units which, for your convenience, are sold separately: Tuning heart (AFM-T1—£5.11.6 incl. P.T.) and I.F. amplifier (AFM-A1—£19.8.0). Printed circuit board. 8 valves. Built-in power supply. Attractive cabinet. Total

£24.19.6

HI-FI FM TUNER, Model FM-4U. Also available in two units as above: R.F. tuning unit (£3.5.0 incl. P.T.) with I.F. output of 10.7Mc/s, and amplifier unit, with power supply and valves (£11.11.0)

Total £14.16.0

TRUVOX D83 & D84 TAPE DECKS. High quality mono/stereo tape decks.

D83, 2 track, for highest fidelity.

£31.10.0

D84 (identical presentation), 4-track, for most economical use of tape.

£29.8.0



DX-100U



FM Tuner



Truvox Mk. 6

THE BEST QUALITY

TAPE RECORDING AND REPLAY HI-FI AMPLIFIER

Mono model TA-1M, Stereo model TA-1S. For use with most tape decks. Thermometer type recording indicators, press-button speed compensation and input selection, 3-position bias level and printed circuit construction

TA-1M	£18 2 6
TA-1M and Collaro "STUDIO"	£30 10 0
TA-1M and TRUVOX D83	£47 2 6
TA-1M and TRUVOX D84	£45 5 0
TA-1S	£23 6 0
TA-1S and TRUVOX D83	£52 6 0
TA-1S and TRUVOX D84	£50 9 6

HEATHKIT ELECTRONIC WORKSHOP, Model EW-1. This new educational kit will teach and amuse your children, it can make 21 exciting experiments including transistor radios, burglar alarm, radio or TV silencer, intercom., etc

£7.18.0

HI-FI EQUIPMENT CABINETS

Our four equipment cabinets meet a wide variety of tastes and requirements: the "CHEPSTOW" was designed for those who have little floor space, the contemporary "MALVERN" for the Tape and Gram. enthusiast, and the "GLOUCESTER" Mk. I and II for those with traditional tastes. All parts are pre-cut and drilled for easy assembly, and left "in the white". Prices from £11.5.6 to £17.18.6.



The "Gloucester" (open)

Available directly from

DAYSTROM Ltd Dept. RC5, Gloucester, England



DX-40U

SINGLE SIDEBAND ADAPTOR. Model SB-10U. May be used with most A.M. transmitters. Less than 3w R.F. input power required for 10w output. Operation on 80, 40, 20, 15 and 10m bands on U.S.B., L.S.B. or D.S.B. **£37.6.0**



GD-1U

AMATEUR TRANSMITTER. Model DX-40U. Covers all amateur bands from 80 to 10 metres; crystal controlled. Power input 75W C.W., 60W peak controlled carrier phone. Output 40W to aerial. Provision for V.F.O. Filters minimise TV interference. **£32.10.0**



S-33

GRID-DIP METER. Model GD-1U. Functions as oscillator or absorption wave meter. With plug-in coils for continuous frequency coverage from 1.8 Mc/s to 250 Mc/s. **£10.9.6**



"STUDIO"

Three Additional Plug-in Coils Model 34-1U extend coverage down to 350 kc/s. With dial correlation curves. **15/-**

TRANSISTORISED VERSION. Model XGD-1. Similar to GD-1U. Fully transistorised with a frequency range of 1.8 to 45 Mc/s. **£10.8.6**

6-W STEREO AMPLIFIER. Model S-33. 3 watts per channel, 0.3% distortion at 2.5 w/chnl., 20dB N.F.B. Inputs for Radio (or Tape) and Gram., Stereo or Monaural, ganged controls. Sensitivity 100mV. **£12.8.6**

COLLARO "STUDIO" TAPE DECK. The finest buy in its price range. Operating speeds: 1½, 3½ and 7½ i.p.s. Two tracks. "Wow" and "flutter" not greater than 0.15% at 7½ i.p.s. Long Term Speed Stability better than 0.5%. **£17.10.0**

VARIABLE FREQUENCY OSCILLATOR. Model VF-1U. Calibrated 160-10 m. Fundamentals on 160 and 40 m. Ideal for our DX-40U and similar transmitters. **£11.2.0**

TRANSISTOR PORTABLE RADIO. Model UXR-1. Pre-aligned I.F. transformers, printed circuit and a 7" x 4" high-flux speaker. Real hide case. **£14.18.6**

HI-FI STEREO AMPLIFIER. Model S-88. 16W output, 10mV basic sensitivity. Ganged controls. Stereo/Monaural gram., radio and tape recorder inputs. Push-button selection. Two-tone grey metal cabinet. **£26.12.6**

HI-FI SPEAKER SYSTEM. Model SSU-1. Ducted-port bass reflex cabinet "in the white". Twin speakers. With legs **£11.18.6** **£10.17.6**

2½in. SERVICE SCOPE. Model OS-1. Light, compact portable for service engineers. Dim. 5" x 8" x 14½" long. Wt. 10½lb. **£19.10.0**

VALVE VOLTMETER. Model V-7A. 7 voltage ranges d.c. volts to 1,500 a.c. to 1,500 r.m.s. and 4,000 peak to peak. Resistance 0.1Ω to 1,000MΩ with internal battery. D.C. input impedance 11mΩ. dB measurement has centre-zero scale. Complete with test prods, lead and standardising battery. **£13.0.0**

TRANSISTOR INTERCOM. Models XI-1U & XIR-1U. The master unit uses a 4-transistor amplifier, constructed on a printed circuit board, and an internal 9V battery. Remote stations use a similar battery for calls only. Up to five remote units can be ordered for each master. XIR-1U (remote) **£4.3.0** XI-1U (master) **£10.15.6**

ELECTRONIC SWITCH. Model S-3U (Oscilloscope Trace Doubler.) Enables a single beam oscilloscope to give simultaneous traces of two separate and independent signals. Switching rates approx. 150, 500, 1,500, 5,000 and 15,000 c/s. Sig. freq. response 0-100 kc/s. +1dB. Separate gain controls and sync. output. Sig. input range 0.1-1.8V r.m.s. **£10.15.6**

CAPACITANCE METER. Model CM-1U. Direct-reading 4½" scale. Full-scale ranges 0-100μF, 0-1,000μF, 0-0.01μF and 0-0.1μF. **£14.15.0**

R.F. SIGNAL GENERATOR. Model RF-1U. Up to 100 Mc/s fundamental and 200 Mc/s on harmonics and up to 100mV output on all bands. **£11.18.0**

POWER SUPPLY UNIT. Model MGP-1. Input 100/120V 200/250V, 40-60 c/s. Output 6.3V, 2.5A A.C.; 200, 250, 270V, 120mA max. D.C. **£4.16.6**

MULTIMETER. Model MM-1U. Ranges 0-1.5V to 1,500V A.C. and D.C.; 150μA to 15A D.C.; 0.2Ω to 20MΩ. 4½" 50μA meter. **£11.18.6**

THE "MOHICAN" GENERAL COVERAGE RECEIVER. Model GC-1U. With 4 piezo-electric transmitters, variable tuned B.F.O. and Zener diode stabiliser, this is an excellent fully transistorised general purpose receiver for Amateur and Short wave listeners. Printed circuit boards, telescopic whip antenna, tuning meter and large slide-rule dial, 10 transistors. **£38.15.0**



VF-1U



UXR-1



S-88



SSU-1



OS-1



V-7A



GC-1U

AT LOWEST PRICES

MONEY-SAVING "PACKAGED DEALS"

For the benefit of customers wishing to purchase several units of their Hi-Fi equipment at the same time, useful price reductions are offered. Such "Packaged Deals" may include RECORD PLAYERS and TAPE DECKS of your preference, not necessarily featured in our catalogue. Two money-saving examples are given below and quotations for your own special requirements will gladly be sent on request.

GL-58 Transcription Unit	£20.12.0	TA-1M	£18. 2.6
S-33 Stereo Amp.	£12. 8.6	Collaro "STUDIO"	£17.10.0
Twin SSU-1 Speakers (Bookcase Type)	£21.15.0	USC-1	£18.18.6
		MA-12	£10.19.6
	£54.15.6		£65.10.6
Packaged	£50.19.0	Packaged	£59.10.0



THE "COTSWOLD"

THE "COTSWOLD". This is an acoustically designed enclosure 26" x 23" x 15½" housing a 12" bass speaker with 2" speech coil, elliptical middle speaker together with a pressure unit to cover the full frequency range of 32-20,000 c/s. Capable of doing justice to the finest programme source, its polar distribution makes it ideal for really Hi-Fi Stereo. Delivered complete with speakers, cross-over unit, level control, Tygan grille cloth, etc. All parts pre-cut and drilled for ease of assembly and left "in the white" for finish to personal taste. **£21.19.0**

★ SEND THIS COUPON NOW FOR FURTHER INFORMATION
(Please write in BLOCK CAPITALS)

NAME _____
ADDRESS _____

Without obligation please send me (Tick here)

BRITISH HEATHKIT CATALOGUE _____
FULL DETAILS OF MODEL(S) _____

DAYSTROM LTD DEPT RCS
GLOUCESTER ENGLAND

A member of the Daystrom Group, manufacturers of the
WORLD'S LARGEST-SELLING ELECTRONIC KITS

ARMSTRONG AF 208 AM/FM RADIOGRAM CHASSIS

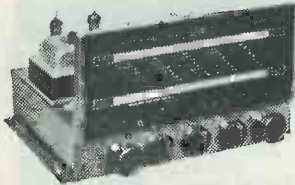

★ Full VHF Band (87-108 Mc/s.) and Medium Band. 187-570M. ★ 7 Valves ★ 5 Watts Output ★ 15dB Negative Feedback ★ Separate wide range Bass and Treble Controls ★ 2 Compensated Pick-up Inputs ★ Frequency Response 30-22,000 c.p.s. ★ 2dB ★ Tape Record and Playback Facilities ★ Continental Reception of Good Programme Value ★ For 3, 7½ and 15 ohm speakers. Send S.A.E. for leaflet.

Price **22 Guineas** Carr. Free

LATEST "E.M.I." 4 SPEED SINGLE RECORD PLAYER

Acos Hi-Fi Pick-up for LP, and/or 78, 7", 10" and 12" records. Silent motor, heavy turntable, auto stop. Completely assembled on base plate.

Special offer **£6. 5. 0** post free

Or with Stereo/Monaural Pick-up **£6.19.6**

SINGLE SEPARATE BARGAIN

Ready built complete with B.S.R. TU9 4-speed Gram Pick-up unit. Handsome portable case. 3-watt amplifier with 2 valves and speaker.

Our Price **£8. 19. 6.**

I.F. TRANSFORMERS 7/6 pair

465 kc/s Slug Tuning Miniature Can. 1¼" x 1" x 1". High Q and good band width. Data sheet supplied.

New boxed VALVES 90-day Guarantee

1RS	7/6	6K8G	7/6	EA50	1/6	IEZ80	7/6
1S5	7/6	6L6G	10/6	EABC80	8/6	EI148	1/6
1T4	6/6	6N7M	6/6	EB91	6/6	HABC80	12/6
2X2	3/6	6Q7G	8/6	EC33	8/6	HVR2A	6/6
3S4	7/6	6S7A7	6/6	EC41	8/6	MU14	9/6
3VA	7/6	6S7M	6/6	EF80	10/6	P61	3/6
5U4	7/6	6SN7	6/6	ECC84	9/6	PCB84	9/6
5Y3	7/6	6V6G	6/6	ECF80	9/6	PCF80	9/6
5Z4	9/6	6X4	7/6	ECH42	10/6	PLC82	11/6
6AM6	5/6	6X5	6/6	ECL80	10/6	PEN25	6/6
6B8	5/6	12A6	7/6	ECL82	10/6	PL81	12/6
6BE6	7/6	12AT7	8/6	EF39	5/6	PL82	10/6
6BH6	9/6	12AU7	8/6	EF41	9/6	PY80	7/6
6BW6	9/6	12AX7	8/6	EF50	5/6	PY81	9/6
6D6	6/6	12BE6	8/6	EF80	8/6	PY82	7/6
6F6	7/6	12K7	6/6	EF86	12/6	SP61	3/6
6H6	3/6	12Q7	6/6	EF92	5/6	UC41	9/6
6J5	5/6	35L6	9/6	EL32	5/6	UC42	9/6
6J6	5/6	35Z4	7/6	EL41	9/6	UF41	9/6
6J7G	6/6	80	9/6	EL84	8/6	UL41	9/6
6K6GT	6/6	807	5/6	EY51	9/6	UY41	8/6
6K7G	5/6	954	1/6	EZ40	7/6	U22	8/6

SETS OF VALVES

DK96, DF96, DAF96, DL96	8/6 each	or 27/6 set.
1RS, 1T4, 1S5, 354 or 3V4		19/6
6K8, 6K7, 6Q7, 6V6, 5Z4 or 6X5		27/6
ECH42, EF41, EBC41, EL41, EZ40		37/6
ECH81, EF89, EBC81, EL84, EZ80		39/6
12K8, 12K7, 12Q7, 35L6, 35Z4		35/6

NEW ELECTROLYTICS FAMOUS MAKES

TUBULAR	TUBULAR	CAN TYPES
1/350v.	2/-	50/350v. 5/6
2/350v.	2/3	100/25v. 3/-
4/450v.	2/3	250/25v. 3/-
8/450v.	2/3	500/12v. 3/-
16/450v.	3/-	8+8/450v. 3/6
32/450v.	3/9	8+16/450v. 3/9
25/25v.	1/9	16+16/450v. 4/3
50/25v.	2/-	16+16/450v. 4/3
50/50v.	2/-	32+32/350v. 4/6
		16/450v. 5/-
		32/350v. 4/-
		100/270v. 5/6
		2,000/6v. 4/-
		5,000/6v. 5/-
		32+32/350v. 5/6
		32+32/450v. 6/6
		32+32+32/350v. 7/6
		50+50/350v. 7/6
		64+120/350v. 11/6
		100+20/275v. 12/6

COMPLETE RADIO CHASSIS

£4.19.6 post free

4 Mullard valves, 5" speaker, frame aerial, 4 pre-set stations. 1 long, 3 med. wave.

Superhet Circuit.

Size 9" x 6" x 5½" high. Tested ready for use.

200/250V A.C.-D.C. Mains. Brand New

DE LUXE MODEL

As above but with illuminated dial. Fully tunable over medium wave 200-550 M and long wave 1,000-2,000 M.

Bargain Price **£5.19.6**

MAINS TRANSFORMERS

200/250 AC Post 2/- each

STANDARD 250-0-250, 80 mA., 6.3 v. tapped 4 v., 4 a., Rectifier 6.3 v. l. a. tapped 5 v. 2 a. and 4 v. 2 a.	22/6
Ditto 350-0-350	29/6
MINIATURE, 200 v., 20 mA., 6.3 v. l. a.	10/6
MIDGET, 220 v., 45 mA., 6.3 v. 2 a.	15/6
SMALL, 220-0-220 v., 50 mA., 6.3 v. 2 a.	17/6
STANDARD, 250-0-250 65 mA., 6.3 v. 3.5 a.	17/6
HEATER TRANS., 6.3 v. 1 l. a.	7/6
Ditto 6.3 v. 3 a.	10/6
Ditto 1.4, 2, 3, 4, 5, 6.3 v. 1 l. a.	8/6
MULLARD "510" OSRAM "912"	
300-0-300, 120 mA., 6.3 v. 4 a. c.t., 6.3 v. 2 a. tapped 5 v.	38/6
GENERAL PURPOSE LOW VOLTAGE. Outputs 3, 4, 5, 6, 8, 9, 10, 12, 15, 18, 24 and 30 v. at 2 a.	22/6
AUTO. TRANS. 150 w., 0, 10, 120, 200, 230, 250 v.	22/6
AUTO. TRANS. 500 w., 0, 115, 200, 230, 250 v.	82/6

O.P. TRANSFORMERS. Heavy duty 50 mA., 4/6. Miniature 3V4, etc., 4/6. Small, pentode, 4/6. Multi-ratio push-pull, 7/6. Multi-ratio push-pull 10 w., 15/6. Goodmans heavy duty 10/20 w. 6K push-pull, 30/-; Elstone ultra-linear 10 w. 45/-.

L.F. CHOKES 15/10 H. 60/65 mA. 5/-; 10 H. 85 mA. 10/6; 10 H. 120 mA. 12/6; 10 H. 150 mA. 14/-

TELEVISION REPLACEMENTS

Line Output Transformers from 45/- each, NEW Stock and other timebase components. Most makes available. S.A.E. with all enquiries

FULL WAVE BRIDGE CHARGER RECTIFIERS.

2, 6 or 12 v. 1 l. a., 8/9; 2 a., 11/3; 4 a., 17/6. Free charger circuit.

CHARGER TRANSFORMERS. Tapped input 200/250 v. for charging at 2, 6 or 12 v. 1 l. a., 15/6; 2 a., 17/6; 4 a., 22/6.

4 AMP. CAR BATTERY CHARGER with amp. meter Leads, Fuse Case, etc., for 6 v. or 12 v., 69/6.

BOOKS (List S.A.E.)

40 Circuits for Germanium Diodes	3/-
"W.W." Radio Valve Data	6/-
High Fidelity Speaker Enclosures	5/-
Valve and TV Tube Equivalents	9/6
TV Fault Finding	5/-
Quality Amplifiers	4/6
Radio Valve Guide. Books 1, 2, 3 or 4.	5/- each
Transistor Superhet Receivers	7/6
Practical Radio Inside Out	3/6
Master Colour Code	1/6

TINNED COPPER WIRE 16 to 22 swg. ½ lb. 3/-

COPPER ENAMEL WIRE ½ lb. 16 to 22 s.w.g. 2/9, 24 to 30 s.w.g. 3/6, 32 to 40 s.w.g. 4/6

CRYSTAL MIKE INSERT

Precision engineered. Size only 1¼" dia. x 1"

ACOS CRYSTAL MIKE 40 ... 25/-

ACOS STICK MIKE 39-1 ... 35/-

T.S.L. DE LUXE STICK MIKE ... 35/-

SPEAKER FRET. Gold choke, 17in. x 25in., 5/-

25in. x 35in., 10/- TYGAN, 52in. wide, 10/-

26in. wide from 5/- ft. Samples S.A.E. Expanded Metal, Gold, 12in. x 12in., 6/-.

BAKER SELHURST LOUDSPEAKERS



12" Baker 15W Stalwart 3 or 15/2, 45-13,000 c.p.s. 90/-

12" Stereo 12W, 35-16,000 c.p.s. Foam suspension £6.17.6

12" Baker Ultra Twelve, 20 c.p.s. to 25 kc/s £17.10.0

15" Auditorium, Bass Mk II 35W 20 c.p.s. to 12 kc/s. £18

LOUDSPEAKERS P.M. 3 OHM. 2 1/2in. 3in. 4in.-19/6;

5in. Rola, 17/6; 7in. x 4in., 18/6; 4in. Hi-Fi Tweeter, 25/-; 8in. Plessey, 19/6; 6in. Goodmans, 18/6; 10in. R.A., 30/-; 12in. Plessey, 30/-; 10in. x 6in. E.M.I. 27/6; E.M.I. 13 1/2" x 8" 45/-; Stentorian HF1012 10in., 95/-; HF1016, £8. 12 in. R.A. 15/6

CRYSTAL DIODES. G.E.C., 2/-; GEX34, 4/-; OAB1, 0.7A, 3/-; Crystal Coils HAX, 3/-

CRYSTAL SET BOOKLET 1/-

H.R. HEADPHONES, 4,000 ohms, brand new, 15/- pair. Low resistance phones, BA5, 7/6 pair.

SWITCH CLEANER FLUID, squirt spout, 4/6 tin.

C.R.T. BOOSTER TRANSFORMERS

For Cathode Ray Tubes having heater cathode short circuit and for C.R. Tubes with falling emission, full instructions supplied.

TYPE A. LOW LEAKAGE WINDINGS. OPTIONAL 25% and 50% BOOST ON SECONDARY: 2 V. OR 4 V. OR 6.3 V. OR 10.3 V. OR 13.3 V. WITH MAINS PRIMARIES. 12/6.

TWIN GANG CONDENSERS. Miniature transistor gang 208 and 176 pf, 10/6 each; 365 pf, miniature, 1 1/2in. x 1 1/2in. x 1 1/2in., 500 pf standard with trimmers, 9/-; midget, 7/6; midget with trimmers, 9/-

SHORT WAVE. Single 25pF, 50 pF, 75 pF, 100 pF, 160 pF, 5/6 each.

TUNING AND REACTION CONDENSERS. 100 pf, 300 pf, 500 pf, 3/6 each, solid dielectric.

CONDENSERS, 0.001 mfd., 7kV T.C.C., 5/6; ditto 20 kV., 9/6; 0.1 mfd., 7 kV., 9/6; 100 pf to 500 pf Micas, 6d.; Tubular 500 v., 0.001 to 0.05, 9d.; 0.1, 1/-; 0.25, 1/6; 0.1/350 v., 9d.; 0.5/500 v., 1/9; 0.01/2,000 v., 1/9; 0.1/2,000 v., 3/6.

CERAMIC CONDENSERS. 500 v. 0.3 pf to 0.01 mfd., 9d.; 0.1/30v., 1/3.

SILVER MICA. 10% 5 pf to 500 pf, 1/-; 600 pf to 3,000 pf, 1/3; close tolerance (plus or minus 1 pf), 1.5 pf to 47 pf, 1/6; ditto 1% 50 pf to 815 pf, 1/9; 1,000 pf to 5,000 pf, 2/-.

465 Kc/s. SIGNAL GENERATOR. Total cost 15/- Uses B.F.O. Unit ZA 30038 ready made. SOCKET SIZE 2 1/2in. x 4 1/2in. x 1 1/2in. Slight modifications required, full instructions supplied. Battery 7/6 extra 69 v. + 1 1/2 v. Details S.A.E.

WAYCHANGE SWITCHES

2 p. 2-way, 3 p. 2-way, short spindle ... 2/6

8 p. 4-way 2 wafer, long spindle ... 6/6

2 p. 6-way, 4 p. 2-way, 4 p. 3-way, long spindle 3/6

3 p. 4-way, 1 p. 2-way, long spindle ... 3/6

Waychange "MAKITS". Wafers available: 1 p. 12 wafer, 2 p. 6 wafer, 3 p. 4 wafer, 4 p. 3 wafer, 6 p. 2 wafer, 1 wafer, 8/6; 2 wafer, 12/6; 3 wafer, 16/-.

Additional wafers up to 14, 3/6 each extra.

TOGGLE SWITCHES, s.p. 2/-; d.p., 3/6; d.p.d.t., 4/-; Rotary Toggle, s.p., 3/6, d.p., 4/6.

JACKS. English open-circuit 2/6, closed-circuit 4/6, Grundig-type 3-pin 1/3

JACK-PLUGS. English 3/-, Screened 4/-, Grundig 3-pin 3/6.

JASON F.M. TUNER COIL SET, 29/-

H.F. coil, aerial coil, oscillator coil, two i.f. transformers 10.7 Mc/s., detector transformer and heater choke. Circuit and component book using four 6AM6, 2/6. Complete Jason FMT1 kit, Jason chassis with calibrated dial, components and 4 valves, £6.5.0.

VALVEHOLDERS. Pax. int. oct., 4d. EA50, 6d. B12A, CRT, 1/3. Eng. and Amer. 4, 5, 6, and 7 pin, 1/-.

MOULDED MAZDA and int. Oct., 6d.; B7G, B8A, B8G, B9A, 9d. B7G with can, 1/6. B9A with can, 1/9. Ceramic, EF50, B7G, B9A, Int. Oct., 1/-.

B7G, B9A cans, 1/- each.

RADIO COMPONENTS

Our written guarantee with every purchase. Buses 133 or 68 pass door. S.R. Stn. Selhurst

VOLUME CONTROLS

Long spindles. Midget 5K ohms to 2 Meg. No. sw. D.P. Sw 3/- 4/6 Linear or Log Tracks.

80 ohm Coax Cable

Semi-air spaced 3in. Stranded core, 6d. yd. 40 yds. 17/6; 60 yds. 25/- Fringe Quality, Air Spaced 1/- yd.

EXTENSION SPKR. CONTROL 10 Ohm 3/-.
TELESCOPIC CHROME AERIALS 13in. extending to 43in. 8/6 each. Coax adaptor plug — 1/6 extra.

RESISTORS: Preferred values. 10 ohms to 10 meg. 1/2 w. 4d.; 1 w. 4d.; 1 w. 6d.; 1 1/2 w. 8d.; 2 w. 1/-.
HIGH STABILITY. 1/2 w. 1%. 2/- Preferred values. 10 ohms to 10 meg. Ditto 5%, 100 ohms to 5 meg. 9d. 5 watt) **WIRE-WOUND RESISTORS** (1/3 15 watt) 25 ohms-10,000 ohms (2/- 125K to 50K 10 w. 3/-)

WIRE-WOUND Pots. 3 WATT. Pre-set Min. TV Type. All values 10 ohms to 25K, 3/- ea.; 30K, 50K, 4/-; Carbon 30K to 2 meg., 3/-

WIRE-WOUND 4 WATT POTS. Long Spindle, Values, 50 ohms to 50K, 6/6; 100K, 7/6.

TRIPLEXERS, Bands I, II, III, 12/6
COAXIAL PLUGS, 1/- **PANEL SOCKETS, 1/-** **LEAD SOCKET, 2/-** **OUTLET BOXES, 4/6** **BALANCED TWIN FEEDER, 6d. yd., 80 or 300 ohms** **TWIN SCREENED FEEDER, 1/6 yd. 80 ohms.** **TRIMMERS.** Ceramic 30, 50, 70 pF. 9d.; 100 pF. 150 pF. 1/3; 250 pF. 1/6; 600 pF. 750 pF. 1/9; Philips, 10 pF, 30 pF. 1/- each.

1962 RADIOGRAM CHASSIS



Three Wavebands S.W. 16 m.-50 m. M.W. 200 m.-500 m. ECH81, EF89, EBC81, L.W. 800 m.-2,000 m. EL84, EZ80

12-month Guarantee. A.C. 200-250V. 4-way switch. Short-Medium-Long-Gram. A.C.C. and Negative Feedback, 4.2 watts. Chassis 13 1/2" x 5 1/2" x 2 1/2". Glass dial size 10" x 4 1/2", horizontal or vertical. Two Pilot Lamps. Four Knobs, Walnut or Ivory. Aligned and calibrated. Chassis isolated from mains.

BRAND NEW £9.10.0 Carr. 4/6

Matched Speakers 8" 17/6; 10" 25/-; 12" 30/-

BLACK CRACKLE PAINT. Air drying, 3/- tin. **NEON MAINS TESTER SCREWDRIVER, 5/-** **SOLDER RADIOGRADE, 4d. yd., 1 lb. 5/-.**

HIGH GAIN TV PRE-AMPLIFIERS

BAND I B.B.C. Tuneable channels 1 to 5. Gain 18 dB. EBC84 valve. Kit price 29/6 or 49/6 with power pack. Details 6d. (PCC84 valves if preferred.)
BAND III I.T.A.—Same prices. Tuneable channels 8 to 13. Gain 17 dB.

PAXOLIN PANELS. 1 1/2 in. x 10 in. x 8 in., 2/-.
MINIATURE CONTACT COILED RECTIFIERS. 250 v. 50 mA, 7/6; 250 v. 60 mA, 8/6; 250 v. 85 mA, 9/6. 200 mA, 21/-; 300 mA, 27/6.

SELENIUM RECT. 300 v. 85 mA, 5/6.
COILS. Weirite "P" type, 3/- each. Osmor Midget "Q" type, adj. dust core from 4/- each. All ranges.

TELETRON D.W.R. L. & M. Med. T.R.F. with reaction, 4/6; Med. only DR, 3/6.
FERRITE ROD AERIALS. M.W., 8/9; M. & L., 12/6.

FERRITE ROD AERIALS. L & M. for transistor circuits, 10/- each.
FERRITE RODS 8 in. x 3 in., 3/-; 8 in. x 1 1/2 in. 3/-.

ALUMINIUM CHASSIS. 18 s.w.g. Plain, undrilled. 4 sides, riveted corners, lattice fixing holes, 2 1/2 in. sides. 7 in. x 4 in., 4/6; 9 in. x 7 in., 5/9; 11 in. x 7 in., 6/9; 13 in. x 9 in., 8/6; 14 in. x 11 in., 10/6; 15 in. x 14 in., 12/6; 18 in. x 16 in. x 3 in., 16/6.

ALUMINIUM PANELS. 18 s.w.g., 12 in. 12 in. 4/6; 14 in. x 9 in., 4/-; 12 in. x 8 in., 3/-; 10 in. x 7 in., 2/3; 8 in. x 6 in. 2/-.

H.F. CHOKES, 2/6. Osmor, QC1 6/9.
T.R.F. COILS A/HF, 7/- pair; HAX, 3/-, DRR2, 4/-.
ALADDIN FORMERS and cores. 1 in. 8d., 3 in. 10d. 0.3 in. **FORMERS** 5937 or 8 and cans TV1 or 2, 3 in. sq. x 2 1/2 in. or 3 in. sq. x 1 1/2 in., 2/- with cores.
SLOW MOTION DRIVES. Epicyclic ratio 6-1, 2/3.
SOLOIN IRON, 25 w., 200 v. or 230 v. 24/-.
PRECISION Sub-miniature Iron. 200 or 240 v. 29/6;
MAINS DROPPERS. 3 in. x 1 1/2 in. With adj. sliders. 0.3A, 1,000 ohms, 4/3; 0.2A, 1,000 ohms, 4/3.
LINE CORD. 0.3 A 60 ohms per foot, 0.2 A 100 ohms per foot, 2-way, 1/- per foot; 3-way 1/- per foot.
MIKE TRANS. 50:1, 3/9; 60:1 potted, 10/6.
P.V.C. CONN. WIRE, 8 colours, single or stranded, 2d. yd.
SLEEVEING, 1 or 2 mm, 2d.; 4 mm, 3d.; 6 mm, 5d. yd.

AMERICAN "BRAND FIVE" PLASTIC RECORDING TAPE

Double Play	7" reel, 2,400 ft.	60/-	Spare Plastic Reels
	5" reel, 1,200 ft.	37/6	
Long Play	7" reel, 1,800 ft.	35/-	
	5 1/2" reel, 1,200 ft.	23/6	3" 1/6
	5" reel, 900 ft.	18/6	4" 2/-
			5" 2/-
Standard	7" reel, 1,200 ft.	25/-	5 1/2" 2/-
	5" reel, 600 ft.	16/-	7" 2/6

"Instant" Bulk Tape Eraser and Head Defluxer, 200/250V A.C. 27/6. Leaflet S.A.E.

QMAX CHASSIS CUTTER

The cutter consists of four parts: a die, a punch, an Allen screw and key.
1 1/2" 14/6, 3/4" 14/9, 3/8" 15/6, 1/2" 15/9, 1" 17/6, 1 1/4" 17/6, 1 1/2" 20/-, 1 3/4" 20/6, 1 3/8" 22/6, 2" 34/3, 2 1/4" 37/9, 2 1/2" 44/3, 1" square 31/6, 1 1/8" square 28/-.

"REGENT" 4 VALVE

"96" RANGE

VALVES

Kit Price

£6.6.0

carr. 4/-



PRINTED CIRCUIT BATTERY PORTABLE KIT

Medium and long wave. Powerful 7 x 4 in. high Flux Speaker. T.C.C. Printed Circuit and condensers. Components of finest quality clearly identified with assembly instructions. Osmor Ferrite Aerial Coils. Rexine covered attache case cabinet. Size 12 in x 8 in. x 4 in. Batteries used B126 (L5512) and AD35 (L5040), 10/- extra. Instructions 9d. (free with kit). Cossor Mains Unit suitable for above 39/6. Sold separately. Details free.

MONARCH RECORD PLAYER



The Brilliance Successful
Monarch
World's Best 4-Speed Autochanger

BUILD IT YOURSELF using 4-SPEED BSR MONARCH AUTOCHANGER. **READY BUILT 3W AMPLIFIER, HANDSOME PORTABLE CASE, HIGH FLUX LOUDSPEAKER, FULL INSTRUCTIONS SUPPLIED**

Total Price **£12.10.0**
Carr. and ins. 5/-

RECORD PLAYER BARGAINS

4 Speed Autochangers: **POST 2/-** each
BSR, U.A.14 £7.10.0
BSR, U.A.12 Stereo/Monaural £8.5.0
Garrard Autoslim £8.17.6
4 Speed Single Players:
Garrard TA Mk. II £8.0.0
Garrard 4 HF Transcription £17.19.6
Garrard Stereo Heads £2 extra.
All Sapphire Stylis available from 6/-.
All Crystal Cartridges available from 21/-
AUTOCHANGER ACCESSORIES
Amplifier player cabinets with cut boards, 63/-.
2-valve amplifier and 6 1/2" speaker for above, ready mounted on baffle, 12 in. x 7 in., 3 in. deep. Wired and tested ready for use. £4.15.0.

ARDENTE TRANSISTOR TRANSFORMERS

Type D3035, 7.3 CT:1 Push Pull to 3 ohms for OC72, etc., 1 in. x 3 in. x 3 in., 9/6.
Type 3034, 1.75:1 CT. Push Pull Driver for OC72, etc., 1 in. x 3 in. x 3 in., 9/6.
Type D3058, 11.5:1 Output to 3 ohms for OC72, etc., 1 in. x 3 in. x 3 in., 9/6.
Type D167, 18.2:1 Output to 3 ohms for OC72 etc., 3 in. x 3 in. x 3 in., 12/-.
Type D239, 4.5:1 Driver Transformer, 3 in. x 3 in. x 3 in., 10/-
Type D240, 8.5:1 Driver Transformer, 3 in. x 3 in. x 3 in., 10/-
ARDENTE TRANSISTOR VOLUME CONTROLS. Type VC1545, 5K with switch, dia. .9 in., 8/-.
Type VC1760, 5K with switch, dia. .7 in., 10/6.
DEAF AID EARPIECE, Xtal or magnetic 7/6.

WEYRAD

COILS AND TRANSFORMERS FOR A 2-WAVE TRANSISTOR SUPERHET WITH PRINTED CIRCUIT AND FERRITE ROD AERIAL

Long and Medium Wave Aerial—RA2W. On 6 in. rod, 7 in. diameter, 208 pF. tuning, 12/6.
Oscillator Coil P5011AC. Medium wave. For 176 pF. tuning, 5/4.
1st and 2nd I.F. Transformer—P5012CC. 470 kc/s, 1 1/2 in. diameter by 3 in. high, 5/7.
3rd I.F. Transformer—P5013CC, to feed diode detector, 6/-.
Driver Transformer—LFDT2, 1 1/2 in. x 3 in. x 3 in., 9/6.
Printed Circuit—PCAL. Size 2 1/2 in. x 8 in. Ready drilled and printed with component positions, 9/6.
7 in. x 4 in., 35 ohm Speaker, 25/-.
Wavechange Switch 3/6.
Set of 6 Mullard Transistors and diode, 42/6.
These components are approved by transistor makers and performance is guaranteed.
Constructor's Booklet with full details, 2/-.

NEW MULLARD TRANSISTORS

Audio OC71 6/- R.F. OC44 10/6
OC72 7/6 OC45 9/6
Sub-miniature Electrolytics (15 V.) 1 mfd., 2 mfd., 4 mfd., 5 mfd., 8 mfd., 25 mfd., 100 mfd., 2/6. Diodes OA71, OA81, 3/-; GEX 34 4/-.

B.B.C. Pocket 2 Transistor. M.W. and L.W.; Radio Kit, 22/6. Phones 7/6 or deaf aid earpiece, 7/6.

"P.W." Pocket 6. Transistor kit. All parts, printed circuit and cabinet. Osmor Designed Kit, £3.15.0. Mk. II all the latest modifications.

SPECIALISTS

337 WHITEHORSE ROAD
WEST CROYDON Telephone
THO 1665

P. & P. charge 1/-, over £3 post free. C.O.D. 2/- (Export welcome. Send remittance and extra postage)

JACKSON

the big name in PRECISION components

Precision built radio components are an important contribution to the communications industry. Be sure of the best and buy Jackson Precision Built Components

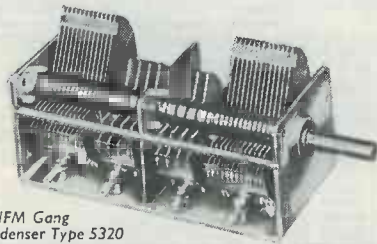

AM/FM Gang
Condenser Type 5320

JACKSON BROS. (LONDON) LTD

STAND Q733
AT THE
I.E.A. EXHIBITION

KINGSWAY, WADDON, SURREY

Telephone Croydon 2754-5
Telegrams Walfico, Souphone, London

RADIO MAIL ORDER Co.,

108, FITZJOHN'S AVE, N.W.3

NEW 4-SPEED TRANSISTOR RECORD PLAYER

usual price £23, to make up as follows:
Luxurious covered cabinet in red or blue containing 1-watt transistor amplifier, 9" x 4" quality L.S. Motor board takes E.M.I. 4-Spd. unit. Dimensions 7" x 13" x 14". £7. 10. 0d. P.P. & Ins. 7/6d. 4-speed E.M.I. motor, turntable and pick-up £3. 10. 0d. P.P. & Ins. 6/-.



All items may be purchased separately but if ordered together,

send
10 gns.
plus 13/6d. P.P. & Ins.

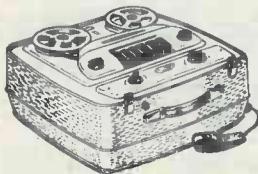

NEW TAPE RECORDER normally £50.

Complete and cartoned. Latest Collaro Studio Unit with 3 motors. 3-Speeds, all equalised. Fast re-wind. Digital counter and pause control. Superimposing facilities. Safety switch and sockets for radio or gram inputs. Recording level indicator. Piano key controls. Pocket in lid with microphone, tape and spare reel. Dimensions 9" x 16" x 18". Housed in luxuriously styled wooden cabinet covered with imitation leather and Vynair.

Send
24 gns. plus 21/- P.P. and Ins.

TABLE RADIO cabinet in selected walnut veneers measuring 9" x 13" x 6". Cost manufacturer £2. Our price 15/- plus 2/6d. P.P. & Ins. 7-Transistor radio chassis to fit above cabinet complete with knobs and scale. 7-transistors, 2-diodes. Large ferrite aerial. Long and medium wave. 600 m.V. into 7" x 4 1/4" L.S. £12. 0. 0d. plus P.P. & Ins. 10/-.

Each item sold separately but if bought together send £12. 12. 0d. only plus 12/6d. P.P. & Ins.

12 gns.

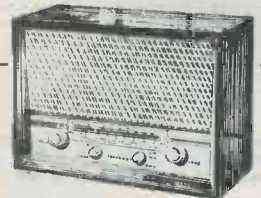

SMITH'S of Edgware Road BLANK CHASSIS

Precision made in our own works from commercial quality half-hard Aluminium. Two, three or four sided.

SAME DAY SERVICE

of over 20 different forms made up to YOUR SIZE. Order EXACT size you require to nearest 1/16" (maximum length 35", depth 4").

SPECIALS DEALT WITH PROMPTLY

SEND FOR ILLUSTRATED LEAFLET

Or order straight away, working out total area of material required and referring to table below, which is for four-sided chassis in 18 s.w.g. (for 16 s.w.g. add 1/4 th)

48 sq. in.	4/-	176 sq. in.	8/-	304 sq. in.	12/-
80 sq. in.	5/-	208 sq. in.	9/-	336 sq. in.	13/-
112 sq. in.	6/-	240 sq. in.	10/-	368 sq. in.	14/-
144 sq. in.	7/-	272 sq. in.	11/-	and pro rata	
P. & P. 2/- (2/6)		P. & P. 2/6 (2/9)		P. & P. 2/9 (3/-)	

Discount for quantities. Trade enquiries invited. Spray finish arranged for quantities of 25 or over.

FLANGES (1/4", 3/8" or 1/2") 6d. per bend.

STRENGTHENED CORNERS, 6d. each corner.

PANELS. The same material can be supplied for panels, screens, etc. Any size up to 3ft at 4/6 sq. ft. (16 s.w.g. 5/3). P. & P., up to 72 sq. in. 1/- (1/3), 108 sq. in. 1/9 (2/), 144 sq. in. 2/- (2/6), 432 sq. in. 2/6 (2/9), 576 sq. in. 2/9 (3/3).

Prices in brackets are for P. & P. on 16 s.w.g.

H. L. SMITH & CO. LTD

287/289 EDGWARE ROAD LONDON W2
Telephone PAD 5891/7595

TERMS: Cash with order only

NEW AUTO-CHANGE HI-FI RECORD PLAYER

usual price £30, to make up as follows:
Beautiful cabinet in red and beige complete with push/pull Hi-Fi amplifier. Dimensions 9" x 16" x 17". Mains Indicator, separate Bass/Treble controls, large speaker. Complete with motor board ready to accept Collaro Studio Auto Changer. £10. 0. 0d. plus £1. P.P. & Ins. Collaro Studio Auto Changer new and ready to fit. £7. 19. 6d. plus 7/6d. P.P. & Ins.



All items may be purchased separately but if ordered together,

send
17 gns.
plus £1. P.P. & Ins.

EACH UNIT GUARANTEED NEW AND UNUSED. TESTED AND WORKING PERFECTLY BEFORE DESPATCH.

Premier RADIO

23 Tottenham Court Road London W1 Telephone MUSEum 3451/2 and 309 Edgware Road London W2 Telephone PADdington 6963

4-TRANSISTOR PORTABLE RADIO

MAY BE BUILT FOR 95/- Plus 3/6 P. & P.



PP7 Battery Extra 3/3

A 4-transistor and 1-diode portable receiver ideally suited for the young enthusiast, having full medium waveband coverage and internal ferrite rod aerial. It incorporates a pre-tagged circuit chassis ensuring ease of construction, a hi-flux 5" speaker is used and the receiver is housed in an attractive two-tone rexine-covered cabinet.

The "Petite" PORTABLE



MAY BE BUILT FOR £7.0.0 plus 5/- P. & P.

Batteries extra

HT 10/- (Type B126) or equiv.
LT 1/6 (Type AD35) or equiv.

★ Size only 8" x 8" x 4 1/2"

★ Instruction book 1/6

Battery Eliminator, available in component form price 37/6 plus 2/- P. & P.

WE HAVE BEEN APPOINTED STOCKISTS FOR FULL RANGE OF STERN'S RADIO (Fleet Street)

Famous Mullard Designs such as Type 'C' Tape Pre-amplifier and Erase Unit, including separate Power Supply. Complete Kit of Parts £14. 0. 0 or Completely assembled and tested

£17. 0. 0

Also available Less Power Supply at £11.15.0 and £14.10.0 respectively. Stern's Model HF/TR3 Mk.2. Tape Amplifier Complete Kit of Parts £13.14. 0 or Completely assembled and tested

£17. 0. 0

Complete Mullard 5-10 Amplifier with Pre-amplifier on same Chassis Complete Kit with Parmeko O/P and Mains Transformers £11.10. 0

Completely assembled and tested £13.10. 0

Complete Mullard 3-3 Amplifier Kit £7.10. 0

Completely assembled and tested £8.19. 6

Mullard 10-10 Stereo Power Amplifier based on the famous Mullard 5-10 Complete Kit of Parts £18.10. 0

Completely assembled and tested £21. 0. 0

(Control Unit on Main Chassis) Also available with separate dual-channel Pre-amp. Complete Kit for Power Amp. & Pre-amp £26. 0. 0

Completely assembled and tested £30. 0. 0

All components used in these kits are of the highest possible standard and strictly to circuit specifications.

Full descriptive literature available on these products and Circuit Diagrams may be purchased separately.

TRANSISTOR SUPERHET RADIO

May be built for

£8.19.6

Plus 2/6 P. & P.

PP3 Battery extra at 2/6

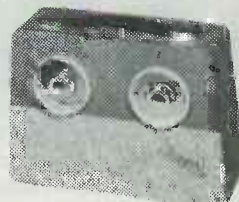

Using 6 Transistors and one Diode and internal Ferrite Rod Aerial, with provision for Car Radio Aerial. Full medium and long waveband coverage and 6 x 4 High Flux Speaker. When constructed the Receiver is housed in an attractive two tone case, size 10 1/2" x 7 1/2" x 3 1/2".

THE "MID-FI" A NEW DESIGN

4W AMPLIFIER KIT MAY BE BUILT FOR 95/- plus 3/- P. & P.



A new circuit for the home constructor requiring a good quality med. powered amplifier for reproduction of records or f.m. broadcasts. Technical spec.: sep. bass and treble controls. Valves: EF86, EL84, EZ80. Voltage adjustment for a.c. mains from 200/250V, 3 or 15Ω imp. Neg. feedback. Size 7" x 5" x 2", overall ht. 5". Silver hammered finished chassis.

THIS MONTH'S SNIPS !!

1. TO OPERATE YOUR RAZOR FROM CAR BATTERY or suitable for many other uses, we offer Motor Generator 12v. input, 200v. output, which must have cost at least £10 to make, for only 17/6 plus 3/6 post.

2. "SUPER 3" as described in April issue—we can offer all components separately or complete set, but in our attractive case. 42/6 plus 2/6 post and Insurance.

3. VERY SPECIAL BARGAIN. 6 transistor superhet—everything except speaker and cabinet—proved circuit complete with full instructions and matched set of transistors. 85/- plus 2/6 post and Ins.

DON'T MISS THIS !!

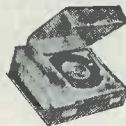

4. CABINET AND PICK-UP Cabinet for battery record player. Size approx. 9" x 11" x 5" allows for 7" x 4" speaker and amplifier. Nicely covered two tone. Must have cost at least £2 to make. New and perfect. Offered whilst stocks last 27/6 plus 4/6 post and Ins.

MOST POPULAR PORTABLES or CAR RADIOS

"Works better than my 25 gn. '.....'!" We hear this remark so many times and feel this is why our Companion portables are growing more and more popular.

The "Good Companion" Mk. II

In the "de-luxe" cabinet as illustrated it costs £10.19.6 to build—but what a set!

Scan these pages: you will find nothing to compare with its specification. It uses transistors instead of I.F. transformers, has variable feedback as well as all the usual features, A.V.C., Push-pull output, Ferrite Aerial, Slow Motion Tuning, etc., etc., and is a very powerful Medium & Long Wave set, conservatively rated at 750mW. Every component used is by a famous maker, such as American Philco MADT R.F. transistors—Mullard A.F. transistors—Jackson Brothers' tuning condensers—Rolan-Celestion loudspeaker—Dubilier—T.C.C.—Morganite resistors and controls. Also full after sales service available. You will definitely be doing the right thing if you buy a Good Companion.

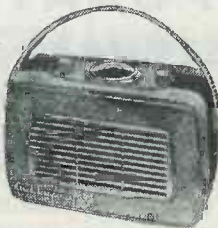

COSMOCORD PICK-UPAs illus: with cartridge and headrest. Ready, new and perfect. Suitable for 45 or 33 records. 12/6 plus 2/6 post and Ins. EXTRA SPECIAL OFFER The above two items if ordered together will be supplied for 37/6 plus 4/6 post and Ins.

The "Tremendo Companion"

If you don't mind the battery consumption being a little higher and you want really big output then order The "Tremendo". This has an undistorted output of almost 1 1/2 watts and is probably the most powerful home constructor set available today. Complete building cost of this is £11.5.0 which includes the transfiler (Mk. II circuit) batteries, cost 3/6 (two required).

The "Pocket Companion"

This is without doubt the most modern and best pocket set available. It uses the very latest I.F. transistors, Philco R.F. transistors, airspaced tuning condenser in Superhet circuit covering M.W. and L.V. Complete building cost £6.15.0, Battery 2/-, Post & Ins. 2/6. Data free with parts or separately 2/6.

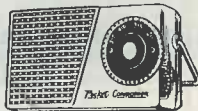

T.R.F. POCKET PORTABLES

Still available as previously advertised, all are complete with cabinet similar to "Pocket Companion".

THE "PIMPERNEL"

Five transistors, 3in. Moving Coil Speaker. 79/6 plus 2/6 postage and insurance.

THE POCKET "4"

Undoubtedly the easiest to build set available, three transistors and one diode. 42/6 plus 2/6 postage and insurance.

THE SOLDERLESS "3"

Two transistors, miniature earphone. Assembled like a Meccano set, ideal for juveniles and beginners. 37/6 plus 2/6 postage and insurance.

ELECTRONIC PRECISION EQUIPMENT LTD

★ Orders received by post are despatched from our warehouse, Dept. 34, 66 Grove Road, Eastbourne, and to save time, please post your order to this address. Please include enough for postage. Callers, however, should use one of the following addresses:

520 High Street North
Manor Park, E.12

42-46 Windmill Hill
Ruislip, Mdx.

266 London Road
Croydon

29 Stroud Green Road
Finsbury Park, N.4

246 High Street
Harlesden, N.W.10

THE MODERN BOOK CO

Radio Control Handbook. By H. G. McEntee. (New and Revised.) 40s. Postage 1/-.

An Electronic Organ for the Home Constructor. By A. Douglas. 15s. Postage 9d.

The Electronic Musical Instrument Manual. By A. Douglas. 37s. 6d. Postage 1s.

A First Course in Sound Recording and Reproduction. By "Decibel". 12s. 6d. Postage 6d.

The Microphone Guide. By J. Borwick. 7s. 6d. Postage 6d.

Maintenance Manual. By Mullard. 16s. Postage 1s.

Brimar Valve and Teletube Manual No. 9. 6s. Postage 1s.

Radio Valve Data. 7th Ed. Compiled by "WW". 6s. Postage 10d.

World Radio Reception Map and Guide 1961/2. Published by Philips 7s. 6d. Postage 1s. 6d.

The Radio Amateur's Handbook. A.R.R.L. 1962 Ed. 36s. Postage 2s.

Amateur Radio Call Book R.S.G.B. 1962 Ed. 4s. 6d. Postage 6d.

World Radio TV Handbook 1962 Ed. 18s. 9d. Postage 9d.

Model Radio-Control. By E. L. Safford. 21s. Postage 1s.

The Superheterodyne Receiver. By A. T. Witts. 20s. Postage 6d.

Hints and Kinks for TV Radio & Audio. By M. Clifford. 18s. 6d. Postage 1s.

Handbook for Radio Operators. G.P.O 6s. Postage 1s.

We have the Finest Selection of British and American Radio Books in the Country
Complete catalogue 1s.

19-21 PRAED STREET (Dept RC) LONDON W2

Telephone PADdington 4185



SCOTTISH INSURANCE CORPORATION LIMITED

38 EASTCHEAP · LONDON · EC3

TELEVISION SETS, RECEIVERS AND TRANSMITTERS

Television Sets, Receivers and Short Wave Transmitters are expensive to acquire and you no doubt highly prize your installation. Apart from the value of your Set, you might be held responsible should injury be caused by a fault in the Set, or injury or damage by your Aerial collapsing.

A "Scottish" special policy for Television Sets, Receivers and Short Wave Transmitters provides the following cover:

- (a) Loss or damage to installation (including in the case of Television Sets the Cathode Ray Tube) by Fire, Explosion, Lightning, Theft or Accidental External Means at any private dwelling-house.
- (b) (i) Legal Liability for bodily injury to Third Parties or damage to their property arising out of the breakage or collapse of the Aerial Fittings or Mast, or through any defect in the Set. Indemnity £10,000 any one accident.
- (ii) Damage to your property or that of your landlord arising out of the breakage or collapse of the Aerial Fittings or Mast, but not exceeding £500.

The cost of Cover (a) is 5/- a year for Sets worth £50 or less, and for Sets valued at more than £50 the cost is in proportion. Cover (b) and (ii) costs only 2/6 a year if taken with Cover (a) or 5/- if taken alone.

Why not **BE PRUDENT AND INSURE** your installation—it is well worth while **AT THE VERY LOW COST INVOLVED**. If you will complete and return this form to the Corporation's Office at the above address, a proposal will be submitted for completion.

NAME (Block Letters).....
If Lady, state Mrs. or Miss
ADDRESS (Block Letters).....

J/B

MINISETS LTD Hatherley Mews London E17

6-Stage Portable Transistor Radio

- ★ All parts including transistors direct from manufacturers
- ★ Pre-assembled circuit board ensuring ease of construction
- ★ Full medium-wave coverage
- ★ After-sales service
- ★ Attractive two-tone case 9" x 6" x 4"
- ★ Push-pull output, 350 milliwatts
- ★ 5" high flux speaker
- ★ Built-in Ferrite Rod aerial. No external aerial or earth required
- ★ High performance, many stations received on test

Can be built for **£5.40** P.P. 3/-
Or with long-wave 8/- extra

Full instructions 1/6 (Free with order)

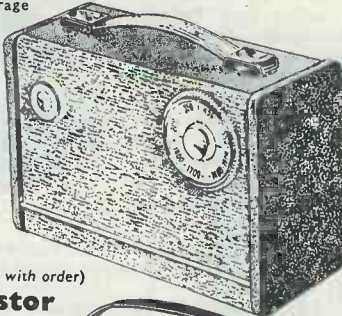

6-Stage Transistor Pocket Portable

- ★ Can be built for **£4.19.6** P.P. 2/6
- ★ Completely self contained, no aerial or earth required.
- ★ Push-pull output, 250 milliwatts.
- ★ 3" high flux speaker
- ★ Pre-assembled circuit board with simple instructions ensuring easy construction
- ★ High Q Ferrite Rod Aerial
- ★ After-sales service
- ★ Can be supplied with long-wave 6/- extra

Full instructions, price list 1/6 (Free with order)

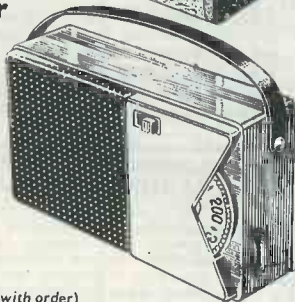

3-Transistor Radio (plus 2 diodes)

Total building **70/-** P.P. 2/6

- ★ Pre-assembled circuit board, ensuring easy construction
- ★ Full medium-wave coverage
- ★ Attractive case 5 1/2" x 3" x 1 1/2"
- ★ All components including transistors are brand new and direct from manufacturers
- ★ Ferrite Rod aerial coil, no external aerial or earth required
- ★ 2 1/2" high flux speaker direct from manufacturer
- ★ After-sales service

Send 1/6 for instructions, circuit and price list

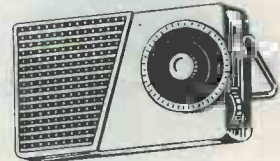

2-Transistor Radio (plus 2 diodes)

Ideal for personal listening

- ★ Built-in Ferrite aerial
- ★ Sensitive earpiece
- ★ All parts including transistors direct from manufacturers
- ★ Pre-assembled circuit board and easy-to-follow instructions
- ★ After-sales service
- ★ Can be built for **41/8** P.P. 2/-

Full instructions, etc., 1/6 (Free with order)

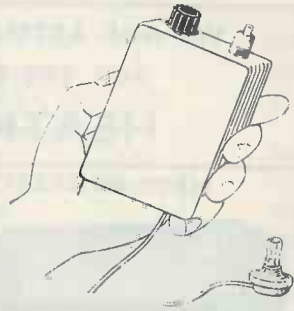

EVERYTHING FOR THE ENTHUSIAST

HEADPHONES. DHR5B (very sensitive), 2,000 ohms 22/6. P. & P. 2/-.

AMERICAN 807 VALVES. Ex-W.D. 7/6 each, 4 for 25/- . P. & P. 2/-

MULTI-WAY CABLE. 3-core screened 1/- yd.; 12-core screened 2/- yd. First grade Mike Cable 9d. yd. P. & P. 2/-.

10-WAY CABLE (5 pairs), screened and plastic covered. Any length cut, 1/8 per yd. P. & P. 1/6 min.

TOUGH POLYTHENE LINE. Type ML1 (100 lb) 2d. per yd. or 12/6 per 100 yds. Type ML2 (220 lb) 4d. per yd. or 25/- per 100 yds. Post free.

Absorption Wave-Meters. 3.00 to 35.00 Mc/s in 3 switched bands, 3.5, 7, 14, 21 and 28 Mc/s ham bands, marked on scale. Complete with indicator bulb. A MUST for any hamshack. ONLY 22/6 Post free.

RACK MOUNTING PANELS. 9" x 5 1/2", 7", 8 1/2" or 10 1/2" black crackle finish, 5/9, 6/6, 7/6 and 9/- respectively, postage and packing 2/-.

SPECIAL OFFER

Bumper Bargain Parcels of Resistors, Condensers and Pots. 10/- and 5/- Post Free

GELOSO V.F.O. UNITS. 4/102 with new dial and escutcheon. Outputs on 80, 40, 20, 15 and 10. For 2-807 or 6146 tubes. Only £8.5.0. 3 valves to suit, 24/- . All post free.

ALSO P1 TANK COILS for 1 or 2 valve P.A. 24/- . P. & P. 2/-.

ROTARY CONVERTERS 6V input, 250V 125mA output. Only 5 1/2" x 3" x 3" 17/6 each. P. & P. 3/- . Ditto 12V input, 490V 65mA output 17/6 each. P. & P. 3/-.

SUPER BANDCHECKER AND MONITOR. This new, sensitive, absorption wavemeter is fitted with 0-500 microammeter and is also a most useful phone monitor. Covers 3.5-35 Mc/s in 3 switched bands. only 3 gns.

SHADED POLE MOTORS. 230V or 110V operation. Ideal for fans, blowers or models. One only: 12/6, plus 2/- P. & P. Or pair: £1, plus 2/6 P. & P.

CERAMIC COIL FORMERS. 2 1/2" x 1 1/2". IDEAL FOR VFO or P.A. on Mobiles, 1/9 each or 17/6 doz.

BTX. 3 1/2" x 1 1/2" with 32 Grooves for P. Tanks 6/- ea.

TFX. 2 1/2" Dia. 5" WINDING SPACE. Ideal Hi Power Lin. Amps 8/6.

MOSLEY TRI-BAND BEAMS

T33 JR, 3 EL ... £24.15.0
TA32 JR, 2 EL ... £17.10.0
V3 JR, Vertical 3 Band ... £7.10.0

PLACE YOUR ORDER EARLY

AERIAL EQUIPMENT

COPPER WIRE. 14g. h.d.: 140' 17/-; 70' 8/6; 7/25 stranded. 140' 10/-; 70' 5/- . plus 2/- P. & P.

RIBBED GLASS INSULATORS. 3" 1/9 each. P. & P. 1/6 up to 12.

TWIN FEEDER. 300 ohm twin ribbon feeder, similar K25, 6d. per yd. K358 Telcon (round) 1/6 per yd. Post on above feeder and cable 1/6 any length.

SUPER AERAXIAL CABLE 1/8 per yd. P. & P. 2/-.

CERAMIC FEEDER SPREADERS. Type F.S. 6" 10d. each. P. & P. 2/- up to 12.

CERAMIC "T" PIECES. Type AT for centre of dipoles, 1/6 each. P. & P. 1/-.

NEW MOSLEY POWER BEAMS. Write for details. 300 watt, 50 ohm COAX, 1/2" dia., very low loss, 1/9 yd. P. & P. 2/-.

SHELL INSULATORS. 2" 9d. each, 8/- doz. P. & P. 2/- up to 12.

CHAS H. YOUNG LTD (Dept. R)

110 DALE END BIRMINGHAM 4

(Tel. all departments) CEN 1635

HOME RADIO OF MITCHAM

Dept. AC, 187 London Road, Mitcham, Surrey. MIT 3282. Shop hours: 9.0 to 6.0 p.m. (Weds. 1.0 p.m.)

TWO NEW GOODMAN'S SPEAKERS



AXIETTE 8"

6 watts 15 ohms die-cast chassis with new FERObA II high flux magnet. Price £5.10.0 post 1/6.

AXIOM 10"

10 watts 15 ohms 10" die-cast chassis with new FERObA II high flux magnet. Price £6.2.6 post 1/6.

WE ARE ACTUAL STOCKISTS FOR THE FAMOUS HEATHKITS

BUILD A MARTIN RECORDAKIT

It is easy to build a quality Tape Recorder with one of these complete trouble-free kits. The high quality amplifiers are already assembled and wired on to printed circuit boards and a few simple tools are all that is required to build. Send 3d. stamp for fully illustrated leaflet.



RECORDAKIT "A" Four-track BSR deck, complete with amplifier, two-tone leatherette covered cabinet and speaker, and full instructions. Price 24 gns.

RECORDAKIT "B" Two-track BSR deck, complete with amplifier, two-tone leatherette covered case and speaker, and full instructions. Price 21 gns.

RECORDAKIT "C" Two-track 3 speed Collaro Studio tape deck, complete with high quality amplifier, two-tone leatherette covered cabinet with Hi-Fi 9" x 5" speaker, and full instructions. Price £29.18.0

NEW EDDYSTONE RECEIVERS



Two exciting new long range communication receivers from the most famous British manufacturer.

"840C" 5 ranges covering 10 metres (30 Mc/s) to 600 metres (500 kc/s). 8 valves including sensitive RF stage and BFO. Smart modern streamlined appearance and built-in speaker. Price £58.0.0 carriage paid U.K.

"940" General purpose professional standard communications receiver covering 480 kc/s to 30 Mc/s in five ranges. 13 valves including 2 RF stages and also special SSB detector. Built-in "S" meter and push-pull output. Price £125 carriage paid U.K.

FULL RANGE OF EDDYSTONE COMPONENTS AND ACCESSORIES

LEARN BASIC ELECTRONICS AND RADIO BY "PICTURE BOOK" METHOD

This is an exciting and fascinating way of learning the basic theory and practice of radio. Based on the latest research into simplified teaching techniques. Only the essential facts are explained, simply and clearly, with an individual illustration for each one. These wonderful books were originally developed for training Service personnel and are now available for all. Complete course comprises six books which are available separately. Price 14/- each, post 1/-, or complete set of six together, price 72/-, post 1/6. SEND 3d. STAMP FOR ILLUSTRATED LEAFLET.

TRANSISTOR SIX

Smart new cabinet and improved circuit make this a first-class transistor portable. Sensitive superhet circuit with internal ferrite rod aerial and 2 1/2" moving coil speaker. Printed circuit for ease of construction.

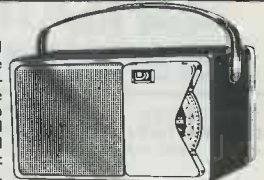

Covers Medium and Long wavebands. Start building one now ready for your summer holidays. All parts are available separately. Full constructional data and price list 1/6 post 6d. Complete kit of brand new parts and Mullard transistors £8.19.6.

MULLARD TRANSISTORS—PRICES DOWN AGAIN!

OC44 9/3, OC45 9/-, OC70 6/6, OC71 6/6, OC72 8/-, OC75 8/-, OC76 8/-, OC78 8/-, OC81 8/-, OC140 36/-, OC170 13/6, OC171 14/6, OCP71 19/6. ALL BRAND NEW AND BOXED. PLEASE ADD 6d. POST TO ORDER.

HOLIDAYS AHEAD!



Now is the time to invest in this easy modern way of electric shaving. The UNIC dry shaver operates from a single U2 battery and will give you a quick close shave anywhere. Ideal for holidays, car rallies, camping, etc. Swiss engineered. Price £2.19.6 complete.

SHORT-WAVE AERIALS

For the really serious long-distance short wave listener the Mosley wave-trap dipoles offer superb performance. Two models available: RD5 for the main amateur bands, 10, 15, 20, 40 and 80 metres, price £8. SWL7 for broadcast bands, 11, 13, 16, 19, 25, 31 and 49 metres, price £7, 3d. stamp for leaflets.

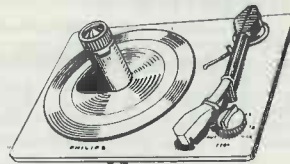

4 speed Hi-Fi Record Player unit by Philips, model AG1016. Gives excellent results from mono and stereo records of all types. Precision engineered, robust construction, arm lifting and lowering device. Extra adaptor available for playing 45 r.p.m. records automatically. Price 13 1/2 gns. post 3/6. (Adaptor 10/6 extra.)

HEADPHONES



Lightweight high-resistance headphones suitable for crystal sets, simple valve or transistor sets, short wave receivers, etc.

Price 15/- post 1/6.

IMPORTANT NOTICE

WITH EFFECT FROM 1st MAY, 1962, THIS SHOP WILL CLOSE AT 6 P.M. (WEDNESDAY 1 P.M.). OPEN ALL DAY SATURDAY UNTIL 6 P.M.

ARMSTRONG CHASSIS

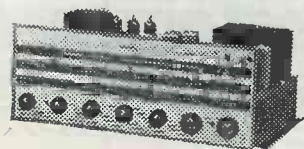

Here you have complete radio and Hi-Fi stereo on one compact chassis! Long, Medium and VHF radio, push-pull mono and stereo audio output, pre-amp. tone control unit, facilities for tape. Price £44.15.0.

ALL OTHER ARMSTRONG RADIO AND AMPLIFIER MODELS IN STOCK, FROM 22 gns.

THE Radio Constructor

Incorporating THE RADIO AMATEUR

MAY 1962

Suggested Circuits No. 138: Low-Cost Electronic Timer, <i>by G. A. French</i>	734
Single Transistor Capacitance Relay, <i>by J. Burgess</i>	737
Electronic Coin Counting System	739
Transistor Crystal Calibrator, <i>by K. Berry</i>	740
A Capacitance Tester, <i>by Colin Weston</i>	742
Can Anyone Help ?	743
Amateur Radio in the U.S.S.R., <i>by Rudolf Svoren</i>	744
Understanding Radio, Part 9, <i>by W. G. Morley</i>	746
Zener Diode Stabilised Power Supplies, Part 1, <i>by D. Bell</i>	751
Faults in Gas-Filled Power Rectifiers and their Remedies <i>by Beverly Court</i>	754
Releasing Welded Mains Switch Contacts, <i>by L. E. Higgs</i>	755
"Carverter" Mobile Short-Wave Converter	756
A Useful Soldering Stand, <i>by J. Anderson</i>	759
The "Double Two" A Simple Receiver/Amplifier, <i>by A. S. Carpenter</i>	760
Miniature Economical Oscilloscope, <i>by M. J. Darby</i>	766
Ideas for an Aerial Mast	772
Beginner's Transistorised Morse Oscillator, <i>by Roger H. Read</i>	773
Printed Circuit Soldering, <i>by P. Reynolds</i>	774
Omnidirectional Loudspeaker Enclosure for Stereo, <i>by A. Campbell Gifford</i>	775
Practical Considerations in the Design and Construction of Mercury Vapour Power Supplies, <i>by Beverly Court</i>	778
News and Comment	780
Radio Topics, <i>by Recorder</i>	781
Variable Periodic Switch, <i>by M. A. Hammond</i>	783
Trade Review, Eagle Products Transistor Inter-phone Set, Model TI-302	786
Book Review	786
Versatile 10-Watt Amplifier, <i>by V. E. Holley</i>	787

© Data Publications Ltd, 1962

CONTENTS may only be reproduced after obtaining prior permission from the Editor. Short abstracts or references are allowable provided acknowledgment of source is given.

CONTRIBUTIONS on constructional matters are invited, especially when they describe the construction of particular items of equipment. Articles should be written on one side of the sheet only and should preferably be typewritten, diagrams being on separate sheets. Whether hand-written or typewritten, lines should be double spaced. Diagrams need not be large or perfectly drawn, as our draughtsmen will redraw in most cases, but all relevant information should be included. Photographs should be clear and accompanied by negatives. Details of topical ideas and techniques are also welcomed and, if the contributor so wishes, will be re-written by our staff into article form. All contributions must be accompanied by a stamped addressed envelope for reply or return, and should bear the sender's name and address. Payment is made for all material published.

OPINIONS expressed by contributors are not necessarily those of the Editor or the proprietors.

TRADE NEWS. Manufacturers, publishers, etc., are invited to submit samples or information of new products for review in this section.

TECHNICAL QUERIES must be submitted in writing. We regret that we are unable to answer queries, other than those arising from articles appearing in this magazine; nor can we advise on modifications to the equipment described in these articles.

CORRESPONDENCE should be addressed to the Editor, Advertising Manager, Subscription Manager or the Publishers, as appropriate.

REMITTANCES should be made payable to "DATA PUBLICATIONS LTD."

Vol. 15, No. 10

Published Monthly

Annual Subscription 29/-
(including postage)

Editorial and
Advertising Offices

57 MAIDA VALE LONDON W9

Telephone

CUNningham 6141
(2 lines)

Telegrams

Databux, London

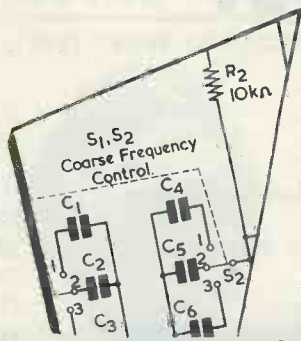

The circuits presented in this series have been designed by G. A. FRENCH, specially for the enthusiast who needs only the circuit and essential data

suggested circuits



No. 138 LOW-COST ELECTRONIC TIMER

THIS MONTH'S SUGGESTED CIRCUIT is not new nor is it original. It is based on a circuit for industrial timing operations which has been employed for some years in the United States and which is, apparently, incorporated in a time delay unit manufactured in that country by General Electric Co. The circuit has been published in *Radio-Electronics*,* to which due acknowledgement is made, and appears here with one slight modification.

So far as the writer is aware, the circuit has not been given prominence in Britain, and this is one reason for its inclusion in the Suggested Circuit series. Other reasons are the ingenious manner in which the device operates and the very few components required. The writer has assembled an experimental set-up using the circuit, and the results obtained are described in this article. This experimental set-up gave timing periods ranging from less than 0.5 to 15 seconds.

The Circuit

In the accompanying diagram it

* "Relays and Electronics", part 5, by Tom Jaski, *Radio-Electronics*, November 1961.

will be seen that the a.c. mains supply is applied to a heater transformer and to the triode and relay timing circuit. The latter operates directly from the a.c. supply, and there is no necessity for an h.t. rectifier.

It will be helpful to consider circuit operation when switch $S_{1(a)(b)}$ is open, as it is in the diagram. Under this condition the cathode of the triode connects to the upper a.c. supply line via the $10k\Omega$ resistor R_2 . Since the anode is also connected, via the relay coil, to the upper a.c. supply line, no anode current flows and the relay is de-energised. The grid of the triode is connected to one plate of C_1 . At the same time, the other plate of C_1 is connected to an a.c. potential, the magnitude of which (relative to the upper a.c. supply line) may be varied by adjusting R_2 . The grid and cathode of the triode function as a diode, causing C_1 to become charged to a voltage proportional to that tapped off by R_2 , the right hand plate being negative.

To operate the circuit, switch $S_{1(a)(b)}$ is closed. $S_{1(b)}$ completes the external switching via the break contacts of the relay, and $S_{1(a)}$

connects the cathode of the triode to the lower a.c. supply line. The full a.c. supply is now applied across the triode and relay coil. The triode can only conduct when the upper a.c. supply line is positive and, at the start of the timing period, it is cut off by the negative voltage on the right hand plate of C_1 . C_1 discharges into its parallel resistor R_4 until, after some time has elapsed, the grid goes sufficiently positive for the triode to conduct and pass current through the relay coil. This current (which flows only when the upper a.c. supply line is positive) causes the relay to energise, whereupon its contacts break the circuit to the controlled equipment and the timing period is complete. $S_{1(a)(b)}$ is next re-set to the open position, thereby allowing C_1 to charge once more via the grid and cathode of the triode. A further timing period can then be initiated by closing $S_{1(a)(b)}$.

The operation of the circuit during the timing period may require a little further amplification, as it is complicated by the fact that the supply is alternating. Assuming the cathode to be at zero potential, the situation during the timing period is that both the triode anode and the

left hand plate of C_1 receive alternating potentials which are in phase. When C_1 has discharged sufficiently, both grid and anode then have their most positive potentials at the same instant. A current, roughly similar to that given by a half-wave rectifier, flows in consequence through the relay coil and causes this to energise. Capacitor C_2 is connected across the relay coil to prevent chatter.

Potentiometer R_2 varies the length of the timing period, and it does this in two ways. Firstly, when $S_{1(a)}(b)$ is open it varies the charge potential appearing across C_1 , this potential increasing as the slider of R_2 moves downwards. Secondly, it varies the potential on the left hand plate of C_1 when $S_{1(a)}(b)$ is closed. The lower the position of the slider, the more negative is the left hand plate of C_1 when the triode anode is positive. Both these effects are additive, and they allow R_2 to offer a wide range of timing period control, the longest period being given when the slider is at the lower end of the track.

It will be noted that the circuit can cause the grid of the triode to pass what may be a relatively heavy pulse of current to C_1 at the instant when $S_{1(a)}(b)$ is opened. Also, the grid may receive high potentials negative of cathode both when $S_{1(a)}(b)$ is open and when it is closed. These negative potentials are considerably in excess of the quoted limiting values for the valves employed in the writer's set-up, and this point is discussed in greater detail later.

Results with the Circuit

The circuit was built up in practical form and tried out. In its initial form R_3 was omitted, the lower end of R_2 connecting direct to the lower a.c. supply line. A 12AT7 (ECC81) with both triodes strapped was employed in the V_1 position, this valve being chosen because it has a short grid base and would therefore cause relay current to rise more rapidly at the end of the timing period. Successive timing periods would then be made more constant, since shifts in energising current requirements in the relay would have less effect. A relay with a $5k\Omega$ coil was used, this being adjusted to energise at 5mA. C_2 was given a value of $8\mu F$.

The circuit worked reliably but it was found that it became erratic when the slider of R_2 was set to the extreme lower end of its track. After C_1 had discharged sufficiently under

this condition, triode anode current did not rise reliably but developed a series of low current pulses somewhat akin to motorboating. This effect may have been due to grid blocking; and it was, in any event, cleared by inserting the limiting resistor R_3 between R_2 and the lower a.c. supply line. This restricted the range of R_2 and prevented adjustments in this potentiometer from entering the unstable region.

The timing periods offered ranged from less than 0.5 up to 15 seconds, and were readily adjustable by R_2 . The charging of C_1 , when $S_{1(a)}(b)$ is

3.5 seconds. This was with the 15 second timing period.

The 12AT7 was then replaced by a 12AU7 (ECC82), both triodes again being strapped. The circuit functioned reliably with this valve, but the timing period given when R_2 slider was at the lower end of its track was slightly shortened because the longer grid base of the 12AU7 caused it to energise the relay after less discharge in C_1 . When R_2 slider was at the lower end of its track, the rise in relay current from 2 to 10mA took up some 8 seconds. Final relay current under these

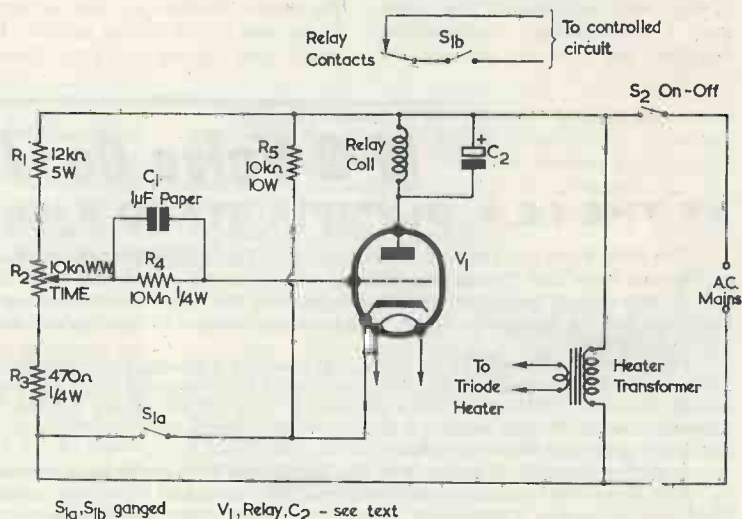

open, must obviously take a finite time, but it was found that successive timing periods were of correct length even when $S_{1(a)}(b)$ was quickly opened and closed again. The final relay current at the end of the timing cycle was 8mA for all settings of R_2 except for those where the slider was very close to the lower end of the track. At the extreme lower end of the track, final relay energising current was 11mA.

Relay current rose fairly sharply at the end of the period, this being mainly due to the choice of a valve with a short grid base. For the longest timing period given by the experimental circuit, it was found that a rise from 2 to 10mA occupied

conditions was 16mA. For other settings of R_2 the 12AU7 gave a final relay current of 12mA.

Valve Operating Conditions

As was mentioned above, the grid of the triode may pass a relatively heavy pulse of charging current to C_1 when $S_{1(a)}(b)$ is opened. This pulse is limited mainly by R_5 . It would be possible to reduce the momentary grid current by increasing the value of R_5 , but such a course would also increase the time taken for C_1 to charge. Increasing R_5 may therefore necessitate leaving $S_{1(a)}(b)$ open for a second or two, to enable C_1 to charge, before commencing a further timing period. It

should be pointed out that R_5 has a high wattage rating not because of the grid current it passes but because, when $S_{1(a)}$ (b) is closed, it is connected across the a.c. supply. Higher values in R_5 would result in lower wattage ratings.

High negative voltages relative to cathode are applied to the grid. When R_2 slider is at the bottom end of its track, these can rise to nearly twice the peak value of the a.c. supply! This is well in excess of the limiting negative grid voltages of 50 and 100 quoted by Mullard for the ECC81 and ECC82 respectively.

The writer experienced no difficulties due to grid current and grid voltage when he tried out the timing unit. *Nevertheless, constructors building the circuit around the*

12AT7 or 12AU7 (or their equivalents) must appreciate that high grid-cathode voltages appear and that such valves are being operated, in consequence, well outside their ratings in this respect. The risk of damaging the valve thereby rests with the constructor.

The original American circuit employs a 6J5 in the V_1 position. The writer does not have a limiting grid voltage figure for this valve but it may well be in excess of those just quoted for the 12AU7 and 12AT7; whereupon the 6J5 would be a more reliable choice. A 6J5 would give results similar to a single 12AU7 triode, including especially the slower increase in relay current at the end of the timing period. It might also require a slightly lower

energising current in the relay than the 5mA used by the writer.

The Relay

The resistance of the relay coil should not be of great importance so far as circuit functioning is concerned. It should be remembered that one end of the coil is at the same potential as the upper a.c. supply line and that there should be reliable insulation between the coil and the contacts.

The value of C_2 depends upon the relay employed and it should, preferably, be just large enough to clear relay chatter. Excessively high values in C_2 will slow the rise in energising current at the end of the timing period, and are best avoided.

M-O Valve Co. Ltd.

AT THE I.E.A. OLYMPIA STAND K456—28th May-2nd June

The M-O Valve Co. Ltd. will be exhibiting on Stand K456 at the Instruments, Electronics and Automation Exhibition at Olympia from 28th May to 2nd June.

A selection of industrial valves and cathode ray tubes representative of the extensive range marketed by the Company will be displayed. These have wide applications in the fields of communications, radar, industrial electronics and oscillography.

Many new devices will be on show, and prominent among these will be the Ophitron*, a new microwave generator using the latest electrostatic focusing techniques and featuring ultra lightweight and low noise as well as the voltage tuning facilities of backward wave oscillators. The OPX1 covers X-band, 8,500 to 12,000 Mc/s, with power output greater than 10mW and without frequency holes. The output coupling is by standard waveguide. The valve is 9in long and $\frac{3}{4}$ in in diameter and weighs 8oz.

A special feature will be made of the Company's wide range of microwave devices, including travelling wave tubes. Also of outstanding interest will be the E2986, the largest thyratron available in the world today. This is a deuterium-filled metal-envelope water-cooled valve with a mean power of 150kW and a peak power of 175MW. The anode voltage is 35kV. The metal envelope construction enables all the electrodes to be easily cooled, and by eliminating grid emission and gas density changes due to hot electrodes, enables a very high power to be achieved in a relatively small envelope. In certain circumstances at least half of the energy loss in a hydrogen or deuterium thyratron can appear in the grid, and the metal valve is able to dissipate this energy far more efficiently than the ceramic envelope type of thyratron.

The greater dielectric strength of deuterium, compared with hydrogen, enables an anode voltage of 40kV to be achieved. The cathode is of the impregnated tungsten type, and is associated with a secondary emitter to give a maximum peak current of 10,000A with a heater power of 1.8kW.

The deuterium gas filling is continuously replenished by means of a titanium deuteride reservoir, which is controlled by barretter and thermistor to give a constant gas pressure with wide variations in supply voltage and ambient temperature.

A representative selection of magnetrons will include the E2989, a compact high-efficiency low voltage X-band rugged valve featuring ultra-rapid warm-up and very low missing pulse rate. This magnetron is capable of withstanding an acceleration of 10g at 20 c/s, rising to 30g at 100 c/s and remaining at 30g up to 5 kc/s. Under these conditions the output frequency will not change by more than ± 2 Mc/s. The anode voltage is 2-2.5kV, output power 1-3kW (pulse), and pulse length 0.1-1.0 μ s and the valve can operate with an ambient temperature range of -40°C to $+100^\circ\text{C}$, and at pressures down to 35mm of mercury.

A recent addition to the M-O V range of transmitting valves is the EHT7, a high voltage triode with a thoriated tungsten filament designed as a pulse modulator or switching valve at hold-off voltages up to 100kV when immersed in oil, or 60kV when used in air. The valve is rated for average anode loading of 1.2kW in oil or 1kW in air.

A wide range of cathode ray tubes will be on display including many double-gun types. One such tube which is attracting wide attention from oscilloscope manufacturers is the 1000F, a double-gun helical p.d.a. tube with a 10cm diameter screen for use in general purpose oscilloscopes in which independent signals are displayed on a common timebase.

Deflection sensitivity in the x direction is 24V/cm and in the y direction 14V/cm with a gun voltage of 1.2kV and a final anode potential of 4kV. The line width is approximately 0.4mm. The two guns scan a common window of 6.3cm x 6.3cm. Side pin connections to the deflector plates contribute to low input capacitance.

* Registered Trademark

Single Transistor Capacitance Relay

By J. BURGESS

As our regular readers will be aware, switching devices operated by changes of capacitance appear in these pages from time to time. However, the single transistor capacitance relay described in the article which follows has the distinction of using a unique principle, in that it compares variations in the resonant frequency of its own tuned circuit with that of a broadcast transmitter.—Editor.

THE CAPACITANCE RELAY IS, ON PAPER AT LEAST, one of the most amusing and useful devices open to ready construction by the experimenter interested in elementary electronics. A common principle of operation consists of arranging for an oscillator to feed r.f. power to an aerial—usually a metal plate—and adjust the oscillator until it is just “critical”, i.e. until it is just about to stop oscillating. Under these conditions, a sharp change of current will occur if any object or person closely approaches the plate. This change in current can be made to actuate a relay which then switches the external circuit. Typical uses for a capacitance relay which spring to mind are the opening and closing of house or garage doors, the switching of a loud-speaker, and so on. Other uses will readily suggest themselves to the imaginative constructor.

Many capacitance relays require fairly complex circuitry if adequate sensitivity is to be achieved, and it is not uncommon to see double valves employed as oscillators with yet another stage to amplify the current changes to usable proportions. In the capacitance relay described in this article very few components are required, and the complete circuit may be powered by a single 3 volt battery.

The Circuit

The circuit of the relay appears in Fig. 1 and, as may be seen, it requires a single transistor and very few other components. The circuit consists of an oscillator coupled to a short aerial or sensing plate. If the relay were replaced by a pair of headphones it would be possible to tune in a local station by adjusting C_1 , heterodynes being heard on either side of the correct tuning point in the normal manner associated with an oscillating detector. With the present circuit there is a change in emitter current between the condition when the tuned circuit is exactly resonant with the received transmission and when it is slightly detuned. This change in emitter current is sufficient to actuate a relay.

When the circuit is set up such that exact resonance with the received signal is achieved, detuning will be caused if any object or person approaches the aerial or sensing plate. In consequence the relay will be actuated and the action of a sensitive capacitance relay is realised.

Construction and Operation

Before entering into constructional details, it might be as well to discuss the actual components required. The transistor and the coil depend on the locality in which the relay is to be used. For example, in the mid-Hertfordshire area, where the prototype was built, the most powerful station is the transmitter at Brookmans Park sending out the Home Service on 330 metres. This means that the tuned circuit must be capable of resonating at

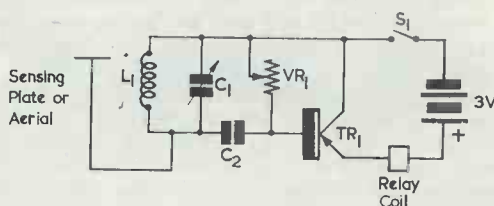

M328

Fig. 1. Circuit of the relay

Components List

(Fig. 1)

- | | |
|-----------------|--|
| TR ₁ | Transistor. Yellow/Green spot |
| C ₁ | 500pF variable |
| C ₂ | 1,000pF |
| VR ₁ | 500kΩ pre-set |
| S ₁ | On-off switch |
| L ₁ | 50 turns 28 s.w.g. enamelled wire on a 1in length of $\frac{3}{4}$ x $\frac{1}{8}$ in ferrite rod (See text) |
| Relay | Siemens high-speed with two 1.7kΩ coils (See text) |

908 kc/s, and that a transistor capable of oscillating up to 1 Mc will suffice. Details of the coil in the prototype are given in the Components List, and it is assumed that the constructor will be capable of making up a coil to suit his own particular local station. Where there are two local stations it is worth spending a little time determining which is the stronger since, all other things being equal, the stronger the received signal the more sensitive the capacitance relay.

The relay connected in the transistor emitter circuit of the prototype is a Siemens high-speed type with two $1.7k\Omega$ coils. These are connected in parallel to give a d.c. resistance of 850Ω . It is important that relay coil resistance should not exceed $1k\Omega$ and this point should be borne in mind if an alternative relay is employed.

The construction of the unit is a simple matter. If the variable capacitor and the pre-set potentiometer are mounted on a small panel, the transistor and C_2 can be secured very readily to these two components. When the unit has been constructed it is as well to check that it is working as a receiver by connecting a headphone in place of the relay coil and using a 3ft length of wire as an aerial. VR_1 should then be set to insert maximum resistance and the unit switched on. If, on rotating the tuning capacitor, a series of heterodynes can be heard, all is well.

The next step consists of setting up the capacitance relay. The most difficult task here is that of adjusting the tuning capacitor so that it is at "zero beat" with the local transmitter, as indicated by headphones connected in place of the relay coil.

The sensing aerial, or plate, must be mounted in the position in which it is to be finally used, as any alterations here will detune the capacitance relay. Quite a lot of patience was required when tuning up the prototype, since the tuning capacitor had to be adjusted for 908 kc/s whilst the operator's hand was away from the unit. This necessitated tuning to a frequency just off 908 kc/s, so that the oscillator drifted exactly on to tune when the hand was removed.¹

After tuning has been accomplished, the headphones are replaced by the relay coil and a series milliammeter. VR_1 is then adjusted until the change in relay current is $0.5mA$ or more when the hand approaches the sensing aerial or plate. With the components employed in the prototype it was found that the required initial current was $2mA$, this dropping to less than $1.5mA$ when the aerial was approached. Care should be taken to avoid setting VR_1 to insert too low a resistance, or the transistor may pass excessive current and become damaged.

The final process consists of adjusting the relay so that it opens on a change of energising current from 2 to $1.5mA$; whereupon setting up is complete.

It was found, with the prototype, that adjustments remained stable for at least several weeks.

¹ It is possible that hand capacity effects would be reduced by connecting the collector of the transistor to earth and using an earthed metal panel or case.—EDITOR.

Radiation and Sensitivity

By its very nature, the unit is radiating a signal on the same frequency as a main B.B.C. station. This, however, is not as serious as it would appear. In practice, the radiation emitted is very weak and cannot be detected outside the room in which the unit is used. If the unit is used outside, the radius of detectable radiation is about 20ft at the most, and that with a very sensitive receiver.²

Another point is, of course, that the unit cannot function when the local station is not radiating. This is quite unavoidable, but can only be considered a disadvantage by those who work on night-shifts or throw all-night parties requiring the use of capacitance relays!

So far as sensitivity is concerned, a well adjusted unit with a sensing plate of 1ft by 1ft should be able to operate with a man at a distance of 10 to 15ft. A failure to achieve this sensitivity would be due to incorrect adjustment of the tuning or bias.

Measurements

In order to assess the operation of the unit, some measurements were made with the prototype. The relay coil was replaced by a headphone and series milliammeter, and the unit was set up as described above. VR_1 was adjusted to give an emitter current of $2mA$.

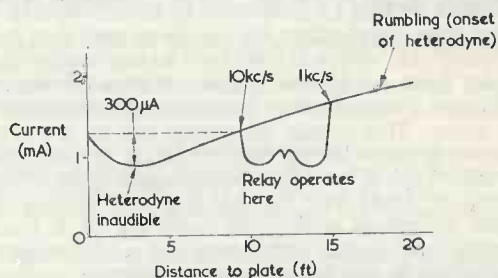

Fig. 2. The results of measurements made with the prototype

Under these conditions, the programme modulation of the received signal was heard in the headphone. As the sensing plate was approached a rumbling noise (indicating the onset of a heterodyne) was heard, and the programme became distorted. The rumbling started at a distance of some 15 to 20ft from the sensing plate, and was accompanied by a gradual drop in emitter current. The rumbling rose in frequency until, for a distance of some 12 to 15ft, the heterodyne had increased to about 1 to 2 kc/s. At this point the relay opened.

As the plate was closer approached the emitter current dropped further and the heterodyne frequency rose above the limit of audibility. When the plate was very closely approached, emitter current rose slightly, but not sufficiently to cause the relay to operate again.

The results of this test are illustrated graphically in Fig. 2.

² Radiation can be kept to a low level by using a short sensing aerial or a short connection to the sensing plate.—EDITOR

Electronic Coin Counting System

OUR MANY BANK CLERK READERS ARE FINDING their jobs increasing in interest as more and more electronic apparatus is introduced into the banks. Sometimes the introduction of new techniques is resisted, but we believe the promotion opportunities now offered by the big banks has been greatly assisted by the use of electronic systems.

Recently A.P.T. Electronic Industries Ltd. supplied to one of the well known London banks the first model of their new APTEC 100 range of coin counting systems. The model supplied was designed to a specification drawn up by the International Coin Counting Machine Co. Ltd.

This range of electronic counting systems is intended for use with mechanical coin sorting machines and provides counting facilities at speeds of up to 400 coins per second mixed in up to 10 denominations.

The problem of dealing with counts occurring at the same time in two or more different sorting channels has been solved by the use of a special circuit which is the subject of a patent application.

The total number of coins of all denominations, the total of each denomination and the aggregate value of all coins can be displayed separately, the method of display being by cold cathode tubes. Facilities can be provided for printing out totals by

any normal low speed read-out device such as a typewriter or add-lister, and for punching tape or cards as part of an integrated data processing system.

In addition to the counting facility, a given number of coins, either of all denominations or of each denomination separately, can be set into the counter and some specific action, such as arresting the action of the sorter or giving an audible or visible signal, taken when the total is reached.

In the model illustrated, silver coins of sterling currency only are dealt with, the total number and value of all coins being displayed at the front of the unit. The channel totals are also available but are not displayed. The M.1000 sorting machine works at a speed of 500 coins per minute, which is well within the speed capability of the counter.

The systems are constructed on modular principles, thus not only simplifying the design and maintenance of systems for particular applications, but also enabling existing systems to be extended in order to incorporate facilities which were not originally provided. The APTEC 100 measures approximately 20 x 16 x 17in high (51 x 41 x 43cm), and are supplied as case units. If required, the electronic chassis can be removed from the case and mounted on a standard 19in rack or console.



APTEC 100 coin counting system in use with M.1000 sorting and bagging machine



Transistor Crystal Calibrator

By K. Berry

THIS ARTICLE DESCRIBES A TRANSISTOR CRYSTAL calibrator which was built to generate 100 kc/s and 1,000 kc/s markers for receiver calibration purposes. It has also proved very useful as a source of time marker pips in order to check the timebase calibration of cathode ray oscillographs.

The unit is self-powered and readily portable, weighing only 2lb 10oz including its battery.

Operation

The circuit employed is shown in Fig. 1. It consists of two entirely separate crystal oscillators and their associated pulse generating amplifiers. The use of four transistors where two, plus coil and crystal switching, would do may be questioned, but in this instance it was done to simplify construction by avoiding the need to switch the coils and crystals. Obviously this is a somewhat expensive luxury and in Fig. 2 the circuit is shown redrawn with just two transistors, the crystals and tuned circuits being switched. The circuit of Fig. 2 will function just as readily as that of Fig. 1.

The crystal oscillator (OC44) feeds directly into an unbiased common emitter amplifier (OC44). This amplifies the negative half-cycles only, the positive half-cycles driving the transistor further into cut-off. Because of the large amplitude of the input signal the second transistor is rapidly "bottomed", resulting in output pulses with a fairly fast rise time (0.12 microsecond approx.). Faster pulses (0.03 microsecond) than this could be obtained by differentiating these pulses and using the differentiated output to drive a VHF transistor such as the OC170, but no details of such circuitry have been included since it is felt that the present cost of v.h.f. transistors would make the application of limited interest.

Equipments and construction

In the original unit, two ex-Government crystals were used, and any available crystal should suffice. The tuned circuits were made from long and medium-wave coils removed from an old radio. Suitable coils are made by most well-known coil

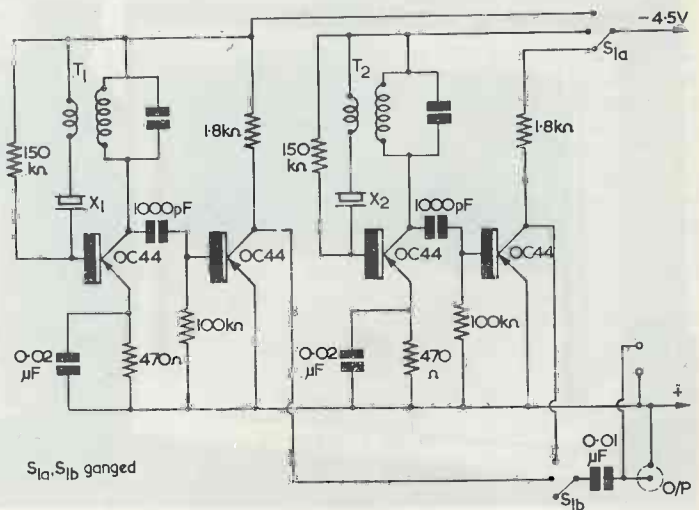

Fig. 1. The circuit employed in the prototype crystal calibrator

M321

Components List
(Fig. 2)

Resistors

- R₁ 150k Ω
- R₂ 470 Ω
- R₃ 100k Ω
- R₄ 1.8k Ω

Capacitors

- C₁, C₂ See text
- C₃ 0.02 μ F
- C₄ 1,000pF
- C₅ 0.01 μ F

Transistors

- TR₁, TR₂ OC44 Mullard

Crystals

- X₁ 100 kc/s ex-Government
- X₂ 1 Mc/s ex-Government

Switches

- S₁ 2-pole, 2-way
- S₂ Single-pole, single-way

Coils

- T₁ Long-wave r.f. coupling coil. (Tuned winding connects to C₁)
- T₂ Medium-wave r.f. coupling coil. (Tuned winding connects to C₂)

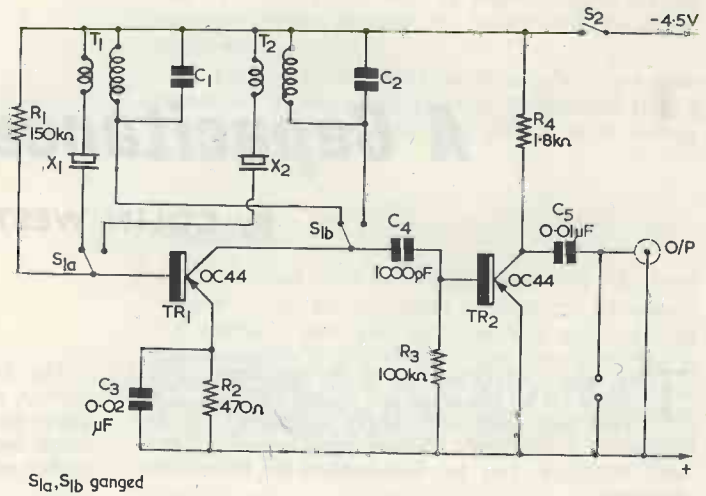

Fig. 2. An alternative circuit which offers the same performance as that of Fig. 1, but which requires fewer transistors

Miscellaneous

- Output socket, or sockets
- 4.5V battery
- Chassis, case, etc.

manufacturers. The use of coils with dust iron slugs is recommended since this allows some variation in coil inductance to be made, thereby simplifying the construction by enabling fixed tuning

capacitors to be used. Of course, there is no reason why compression trimmers should not be used if it is so desired. Since no specific coil is specified it is impossible to state the exact value of the tuning capacitors, but these can be arrived at quite easily as follows. Having wired up the circuit, connect a 2-gang 500pF variable capacitor across the coil (the fixed plates should be connected to the collector) and swing the capacitor from minimum to maximum. At some point in the travel, the circuit should oscillate. (Check by listening on a receiver tuned to the 200 kc/s Light programme for 100 kc/s or 300 metres (1 Mc/s) medium-wave for 1,000 kc/s. It is then quite easy to estimate the fixed capacity required to tune the circuit from the setting of the variable capacitor.

Should it not be possible to obtain oscillations then the connections to one winding of the coil should be reversed.

The prototype calibrator was housed in an Eddystone die-cast box with a built-in 4½ volt dry battery. Since the consumption of the calibrator is only 4mA approx., the life of the battery should be its normal shelf life or longer.

The die-cast box has outside dimensions of 2¼ x 4⅝ x 7⅜ ins approx., and the complete instrument is shown in the accompanying photograph.

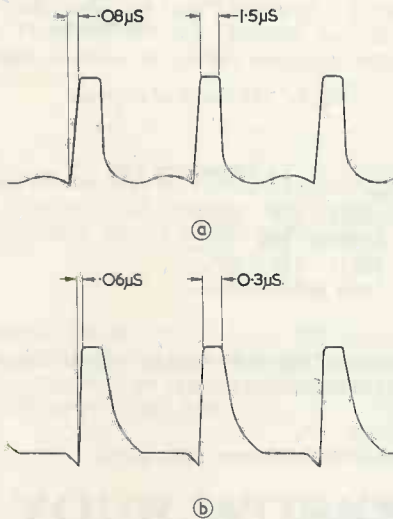

Fig. 3. (a) Output waveform of the prototype at 100 kc/s and (b) the 1 Mc/s output waveform

A Capacitance Tester

By COLIN WESTON

THE SMALL INSTRUMENT TO BE DESCRIBED WILL work on all the usual a.c. mains voltages. The two test leads are simply connected to the capacitor under test. Capacitances between $0.1\mu\text{F}$ and $0.0005\mu\text{F}$ can be measured with reasonable accuracy.

Operation

Unit "off". Switch in position 2.

Leakage Test. Switch in position 1. One test terminal is then connected to the d.c. negative output whilst the other terminal is connected via the neon indicator to the d.c. positive output.

A good capacitor applied to the test terminals will produce a single flash whose intensity depends on the value of the capacitance in circuit, after which the neon will remain dark. A fairly good capacitor (i.e. one with only a slight leak) will allow the neon to flash again at intervals ranging from a few seconds up to a minute or more, while a really bad one will permit a continuous glow to be seen.

Internal Open-circuit Test. Switch in position 3. A.C. is now allowed to flow continuously through both capacitor and neon. If the capacitor is large enough, and the full value of R_4 is in circuit, the neon will strike and will remain alight. Then, by slowly reducing the total resistance in parallel with the neon lamp by reducing R_4 , the voltage across the neon will be made to fall to a point at which the glow is extinguished. It will be found that the setting of R_4 offers a measure of the capacitance of the capacitor under test, and a scale, reading directly in microfarads, can be calibrated.

Calibration

The unit can easily be calibrated by putting the switch in position 3 and placing capacitors of known values across the test terminals. The points at which the neon is extinguished on varying the value of R_4 can then be marked on the R_4 scale. Typical calibration points with the prototype are shown in Fig. 2.

Notes

With a $0.1\mu\text{F}$ capacitor under test, the current, at the moment of extinction of the neon glow, will be about 6mA . Most of this current is carried by R_4 so it is inadvisable to prolong this part of the test longer than necessary.

The fixed $10\text{k}\Omega$ resistor R_3 limits the possible current through R_4 , and its value was chosen to allow the instrument to read up to $0.1\mu\text{F}$. A lower value in R_3 would extend the range to include higher values of capacitance but would increase the

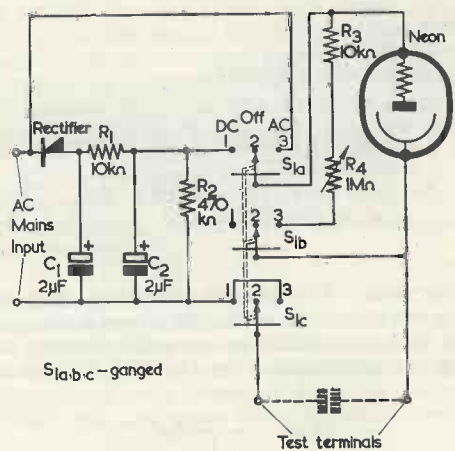

M312

Fig. 1. The circuit of the tester

Components List

Resistors

R_1	$10\text{k}\Omega$	$\frac{1}{2}\text{W}$	20%
R_2	$470\text{k}\Omega$	$\frac{1}{2}\text{W}$	20%
R_3	$10\text{k}\Omega$	$\frac{1}{2}\text{W}$	20%
R_4	$1\text{m}\Omega$	potentiometer	

Neon

Miniature bayonet socket mains type (with internal series resistor)

Capacitors

C_1, C_2 $2\mu\text{F}$ 350 w.v. electrolytic

Rectifier

Any suitable low current type

Switch

$S_{1(a), (b), (c)}$ 3-pole, 3-way

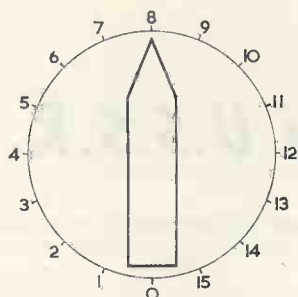

Capacitance	Dial Reading
0.1 μ F	12
0.01 μ F	11
0.005 μ F	10
0.004 μ F	9.5

M313

Fig. 2. Typical calibration points obtained with the prototype

risk of burning out R_4 . A higher value, though reducing current through R_4 , would limit the range of the instrument.

A 1m Ω potentiometer with a log track was employed in the prototype. It is possible that a linear track component may give a more evenly spaced scale.

Construction

No detailed plan of construction will be given since it is left to individual preference. However, the author's unit was built into a wooden box approximately 6 x 6 x 4ins. One practical hint is to use a dark shade round part of the neon to facilitate observation of the flashes. A convenient method is to make a cylinder out of black cardboard to fit over the bulb.

CAN ANYONE HELP?

Requests for information are inserted in this feature free of charge, subject to space being available. Users of this service undertake to acknowledge all letters, etc., received and to reimburse all reasonable expenses incurred by correspondents. Circuits, manuals, service sheets, etc., lent by readers must be returned in good condition within a reasonable period of time

HRO Senior Receiver.—D. Bowers, 88 Grenfell Avenue, Saltash, Cornwall, would like to receive modification details using both miniature and octal valves.

* * *

Double Tube Indicator Unit 110QB/13.—T. Howard, 22 The Pits, Isleham, Ely, Cambs, would like to obtain the manual or circuit diagram, borrow or purchase.

* * *

Raymond Model 59.—R. Dykes, 68 Conleach Road, Speke, Liverpool 24, requires the circuit diagram and component layout of this radiogram.

* * *

Oscilloscope Circuit.—D. F. Jones, 187 Hook Road, Epsom, Surrey, has acquired a VCR97 c.r.t. and wishes to purchase or borrow circuit of an oscilloscope built around this tube.

BC453 "Q" Fiver.—Sgt. P. G. Turner, R.A.M.C., Army School of Health, Keogh Barracks, Ashvale, Nr. Aldershot, Hants, would like circuit diagram and any information on modifications to this receiver.

* * *

TR1998 Transmitter/Receiver No. 10D/17980.—A. Wright, 4A Nepal Avenue, Atherton, Manchester, requires the manual or circuit of this 100 Mc/s–156 Mc/s equipment.

* * *

Eddystone 358 Receiver.—R. V. Chanter, St. Peter's R.C. Secondary School, Woolwich New Road, London, S.E.18, requires the coil winding details together with information on the trimmers of the Range A coil pack (22–31 Mc/s) particularly of the oscillator coil. Alternatively, the school radio club would be willing to purchase a complete Range A pack.

IN YOUR WORKSHOP . . .

We regret that we have had to omit this popular feature for this month

Amateur Radio in the U.S.S.R.

By Rudolf Svoren*

In this exclusive article our contributor deals generally with amateur radio, then carries on to describe past and present features of the movement as represented by amateurs in the U.S.S.R.

SITTING AT YOUR RADIO OF AN EVENING, YOU MUST have frequently come across small sections of the short wavebands allotted to amateurs. In the 10, 15, 20, 40 and 80 metre bands, you can hear at any time of the day and night the rattle of Morse code, together with conversations in some strange language in which words are interspersed with incomprehensible combinations of letters and figures. If, in this symphony of signals, you hear call signs beginning with the letter "U", this will mean that you are picking up the voice of a Soviet radio amateur.

With the help of a home radio station a radio amateur contacts a colleague living at the other end of the world. After hearing his reply he holds the so-called "QSO", a short talk about the weather, the family, or a new type of transmitting aerial. Thus, without seeing each other, people get acquainted and become friends.

Soviet Radio Amateurs

Soviet radio amateurs include real experts at short-wave communication. Foremost among them is President of the Soviet Radio Amateur Federation, Ernest Krenkel. In 1937 he was awarded the honorary title of Hero of the Soviet Union. Together with his three comrades Krenkel accomplished an eight months' drift on an ice-floe across the Arctic Ocean. Since the day when he first sent regards from the drifting ice-floe to his colleagues, Krenkel's call sign has been known to radio amateurs on all continents. In the U.S.S.R. Krenkel's example started a good tradition, and today Soviet radio amateurs work at scientific stations in the Arctic and Antarctic and with whaling flotillas.

Mention must also be made of amateurs' expeditions to regions having no local amateur radio stations as yet. Communication with these regions is very important for radio amateurs, for it entitles them to special diplomas. Not long ago Vsevolod Vorobyov, a Moscow radio amateur, undertook an expedition to the Tuva Autonomous Republic in the south of Central Siberia. The interest in his trip was so great that in 25 days of work Vorobyov

established 1,116 contacts with fellow radio amateurs in 80 countries. "They did not give me a moment's rest," he later said to his Moscow colleagues. "One call followed another, everyone being anxious to talk with faraway Tuva."

The development of the radio amateur movement is promoted by radio clubs functioning in almost all cities and in many villages, plants, schools and institutes. Every such club has a radio station for members who do not have transmitters of their own. The work of the club is guided by a council composed of experienced radio amateurs, engineers and prominent scientists.

In recent years the clubs have been organising competitions of a new type, such as the "field day", when radio amateurs go out of town and establish long-range contacts on ultra-short waves. Very popular also is "fox hunting," when a radio amateur



The radio station of Lvov State University records the signals of the world's first artificial earth satellite. Illustration shows, left to right, laboratory assistant G. Vdovenko and students V. Tsybulsky and G. Krainyuk receiving signals from the satellite

* Novosti Press Agency.

Operators at the Leningrad city radio club receiving signals from an artificial earth satellite



is required to find, with the help of a miniature receiver, the "fox" (i.e. the transmitter) hidden in shrubs or on a tree. This sometimes involves covering up to ten miles of country within an hour.

Amateurs also compete in high-speed reception and transmission. A record is 470 letters per minute, received by ear and typed. Few typists could work so fast! It should be borne in mind that the competitors hear coded signals which almost merge at such a speed.

The first Sputnik

All data on the first Sputnik was published in *Radio*, a magazine for Soviet radio amateurs, several months before the launching. At that time the magazine had a circulation of 300,000 copies (it has doubled since), many of which went abroad.

The publication of the programme of Soviet Sputnik launchings in *Radio* was not accidental. At the request of scientists, tens of thousands of Soviet radio amateurs received the signals of the Sputniks and immediately reported to the Central Radio Club, from whence this information was sent to the Academy of Sciences, with the well-known address: "Moscow, Sputnik". Thus there appeared an extensive network of amateur radio stations which was joined by some foreign radio amateurs.

This large-scale experiment is not the only instance of scientific work conducted by Soviet radio amateurs. They regularly study radio wave propagation conditions, receive long-range telecasts, and not long ago did a colossal job in helping to compile a map of the electric properties of soil in

the U.S.S.R. In the course of this work hundreds of amateurs riding cars, motor-cycles, bicycles or on foot, and equipped with special instruments in most cases made by themselves, covered many thousands of miles through the forests and fields of Siberia, the Ukraine, the Far East, and the deserts of Central Asia and Kazakhstan. All this work was unpaid, although the best amateurs were presented by the Ministry of Communication with motor-cycles, TV sets and cameras.

The design of radio equipment

But even participation in scientific work does not end the activities of Soviet amateurs. They also pay great attention to the designing of radio equipment. Every year the radio clubs arrange exhibitions of equipment made by amateurs. From these the best models are sent to the All-Union Exhibition in Moscow.

The biggest and most interesting departments of such exhibitions are those devoted to automation of production, and electronics in medicine. Radio amateurs who are specialists in their fields, such as doctors, metal-workers, railway workers, agronomists or builders, and who at the same time are familiar with electronics, build remarkable instruments and devices. Many instruments are patented, and some of them go from the exhibitions to factories or laboratories.

Soviet radio amateurs include the first cosmonaut Yuri Gagarin, who was awarded the title of Master of Radio Amateurism for the establishment of the first outer-space radio station.

THE MEDWAY HAMFEST AND MOBILE RALLY

The Medway Amateur Receiving and Transmitting Society (MARTS) have combined with the radio society of Elliott Bros. Ltd. for the purpose of holding a Hamfest and Mobile Rally on 20th May, 1962, at 2.30 p.m. at Elliott's canteen, Rochester Airport. Ample space will be available for some 500 visitors and parking for 300 mobiles will be provided.

A large range of valuable prizes will be available for winners of the various gigantic raffles, etc. A mobile judging event will also be held.

Any reader of *The Radio Constructor* who can attend will be welcome—why not make a day of it and take along the YF, YL, Jr/Ops, etc.

Admission by tea ticket, also obtainable at the entrance, Adults 4s., Juniors 2s. All catering is free.

Route 1. From London. Rochester Bridge, Star Hill, City Way to Rochester Airport. (Elliott's).

Route 2. From East Kent. Watling Street, Chatham Hill, Chatham-Maidstone Road to Rochester Airport. (Elliott's).

Route 3. From Maidstone. Maidstone-Chatham Road to Rochester Airport. (Elliott's).

Individual and Club enquiries should be made at the earliest opportunity, stating the approximate number attending (catering purposes); to W. E. Nutton, G6NU, 42 Richmond Road, Gillingham, Kent.

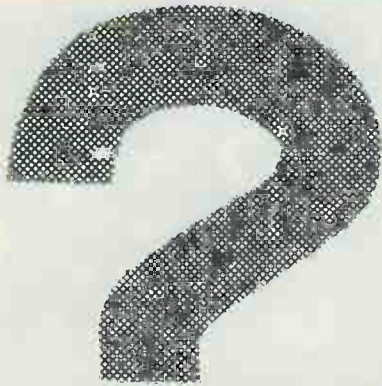

understanding radio

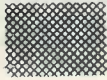

The ninth in a series of articles which, starting from first principles, describes the basic theory and practice of radio

part 9

By W. G. MORLEY

IN LAST MONTH'S ARTICLE, WE DISCUSSED theoretical aspects of the capacitor (or condenser) dealing with dielectric constant, leakage and dielectric strength. We shall now carry on to practical capacitors.

Practical Fixed Capacitors

When we considered resistors we saw that these may either be variable or fixed components. The same applies to capacitors, *variable capacitors* being components whose capacitance may be altered by means of a simple control. Capacitors whose value may not be so adjusted are then classified as *fixed capacitors*.

Practical fixed capacitors fall into categories which are defined by the dielectric material employed, and we shall commence by discussing the *mica capacitor*.

The Mica Capacitor

Mica is a natural material, and it has been employed as a capacitor dielectric from the early days of radio. It has the property that it may be split accurately into thin sheets, these having thicknesses which can be as small as 0.0005in.

There are two basic methods of constructing a mica capacitor. The first method consists of sandwiching a sheet of mica between two metal foils, as in Fig. 38(a), the metal foils then forming the plates of the capacitor. If a higher capacitance is required additional sheets of foil and mica may be employed, giving thereby a multi-plate capacitor, as shown in Fig. 38(b). Some means of holding the assembly together is required in order to ensure that capacitance does not vary with age or handling, and this may be provided by means of a suitable clamp.

Lead-out wires are coupled to the appropriate foil or foils of a mica capacitor by several methods, these including spot-welding, soldering, rivetting or eyeletting. Frequently, the lead-out is provided by a narrow metal tape instead of a wire, this enabling better contact to be made to the foil and reducing mechanical strain at the point of connection.

The alternative method of manufacturing mica capacitors consists of firing, or otherwise depositing, a thin layer of silver onto the mica. The silvering then functions as a plate. A single mica sheet may be employed in capacitors made in this way; alternatively, a multi-plate capacitor may be built up as illustrated in Fig. 38(c), in which silvering is deposited on one side of each mica sheet. Since the silvering is deposited directly on to the mica there can be no shift in their relative positions, and silvered mica capacitors have very stable values of capacitance in consequence.

Lead-out connections for silvered mica capacitors may be obtained by much the same processes as are employed with the foil type. Again, thin metal tapes may be used instead of lead-out wires.

Both foil and silvered mica capacitors are manufactured at the present, but the silvered mica component is usually preferred for applications in radio and electronic work where high stability of capacitance is required. The two types cannot normally be differentiated by visual examination (particularly if they are covered by a protective coating or by a housing) unless some marking, such as a maker's reference number, is printed on the outside. It is fairly safe to assume, however, that most (if not all) of the mica capacitors employed in British radio and television receivers at the present time are of the silvered mica type. Occasionally, the letters SM (silvered mica), PSM (protected

silvered mica) or SMP (silvered mica protected) are printed on the outside of the component.

Mica capacitors may, in general, be distinguished from other types of capacitor by reason of their typically flat construction.

To protect the basic capacitor against the effects of humidity and mechanical damage, it is encased in a protective coating. This may take a number of forms, the cheapest consisting of a coat of enamel or a thin coat of wax. Alternative coatings may comprise thicker coatings of wax, wax applied over a basic coating of enamel, hard "cements" and so on. Improved protection is given by embodying the basic capacitor into a moulding, whereupon a very strong component results which has considerable resistance to humidity and mechanical shock. The component then becomes known as a *moulded mica capacitor*. Usually, the moulding resin is phenol-formaldehyde. If extremely high protection against humidity is required, an epoxy resin may be employed instead.¹ For capacitors employed in the manufacture of domestic equipment the usual protective finish is wax or hard "cement".

The mica capacitor has the advantage of having a high insulation resistance, a representative figure being of the order of 5,000MΩ. The breakdown voltage is some 500 to 1,500 for a sheet of mica 0.001in thick, and typical working voltages for components of the type employed in radio work are 250, 350, 500 and 750. The temperature coefficient of a silvered mica capacitor lies normally between zero and P60.² This is, relatively, a low figure and the silvered mica capacitor is, in consequence, very useful in applications where changes in capacitance due to rises in temperature are required to be small.

Mica capacitors of the type employed for normal radio work have values ranging from some 5pF to 0.05μF, capacitances above 0.005μF being, however, only rarely encountered. The higher capacitances require bulky multi-plate assemblies which are more expensive to manufacture than components of similar value having alternative dielectrics. Unlike resistors, there is no general trend to use preferred values of capacitance with mica capacitors and these components usually have "round number" values (e.g. 20pF, 100pF, 500pF, etc.) or specific values dictated by the circuits into which they connect. Normal tolerances on value are ±20%, ±10%, ±5% and ±2%. Low value components may have tolerances expressed in units of capacitance (e.g. ±0.5pF) instead of in percentage.

Mica capacitors manufactured in this country normally have their value and tolerance printed on them. Where no unit of capacitance is given it may be assumed that this is in picafarads. If no tolerance is given it is safest to assume a ±20% component. Colour coding instead of printing is employed on some moulded mica capacitors (usually American) and the codes employed will be given in the next article in this series.

¹ Bakelite is a familiar phenol-formaldehyde resin, and Araldite a familiar epoxy resin.

² Temperature coefficient was dealt with in last month's article.

Mica capacitors are also manufactured having large capacitances and/or working voltages, typical examples of the former being 0.25μF and, of the latter, 2,000 working volts. Such capacitors are mounted in bulky plastic or metal housings, and are not encountered in normal radio work.

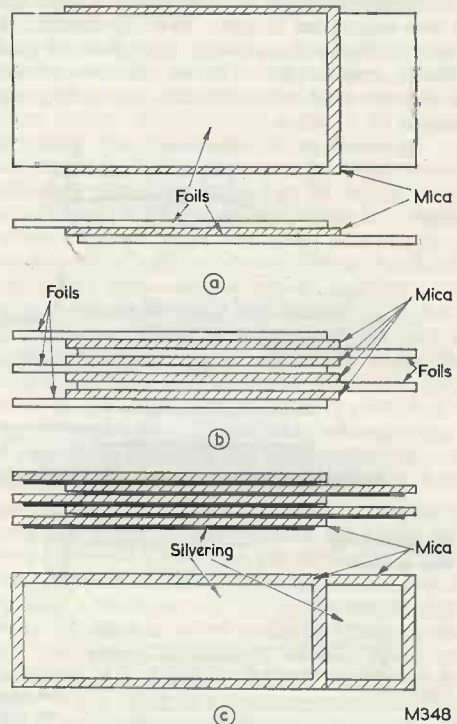

Fig. 38 (a). The construction of a two-plate mica capacitor. Two further pieces of mica may be positioned on the outside of the assembly to provide insulation for the foils.

(b) A multi-plate mica capacitor

(c). The basic construction of a multi-plate silvered mica capacitor.

Paper Capacitors

Paper (suitably treated for electrical purposes) is a very useful dielectric, because it enables capacitors with relatively high values and small physical dimensions to be manufactured at low cost. A typical example of a *paper capacitor* is shown in Fig. 39(a). In this diagram we have two strips of metal foil and four strips of paper, these being so arranged that, when they are rolled up, a cylinder is formed in which the foils are separated from each other by two layers of paper. In consequence a capacitor is made, the two foils providing the plates and the paper strips the dielectric. The relatively high capacitances offered by paper capacitors are due to the large surface areas of the plates which are the result of the rolled-up construction.

Connections to the foils of Fig. 39(a) are made by introducing thin conducting strips into the roll during winding, as in Fig. 39(b). Lead-out wires may then be connected to these strips. If the capacitor has a large value (and, therefore, a large foil surface area) two or more conducting strips for lead-out connections may be introduced into the roll at different points to ensure that a good contact with low resistance results. In some circuits, heavy charge or discharge currents may flow to or from the plates, and the use of more than one connecting strip ensures that an adequate conducting path is available.

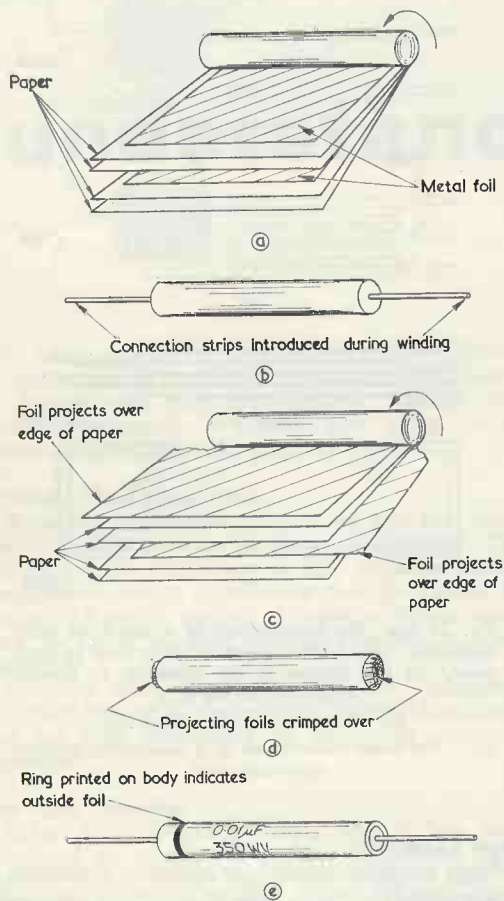

M349

An alternative method of winding the foils and paper is shown in Fig. 39(c). In this diagram the foils and paper are interleaved as before, but one foil projects over one edge of the roll and the other foil projects over the other edge. After winding is complete the projecting portions of the foils are crimped over so that they are all in electrical contact with each other. See Fig 39(d). Lead-out wires are then affixed to the crimped-over sections.

The assembly of Fig. 39(c) and (d) has the feature that connection is made to all parts of the foils

which constitute the capacitor plates, instead of at one or several points only. Shortly, in this series of articles, we shall find that a coiled up conductor possesses a property called *inductance*. Inductance in a capacitor is undesirable for most radio applications and it is necessary to keep this as low as possible. Inductance in the assembly of Figs. 39(c) and (d) is almost non-existent because all the parts of the coiled conductor are short-circuited together. A capacitor of this type is, as a result, described as a *non-inductive paper capacitor*. The foils of the assembly of Fig. 39(a) and (b) are not short-circuited together, with the consequence that inductance may not be cancelled out, and this assembly is described as an *inductive paper capacitor*.

In practice, it is possible to have negligible inductance in a capacitor using the inductive construction by suitably positioning the connecting points into the roll; and the descriptions "non-inductive" and "inductive" tend to become somewhat irrelevant. It may be assumed that paper capacitors manufactured for radio applications have very low or negligible inductance, irrespective of their construction.

Fig. 39 (a). The foil and dielectric of a paper capacitor are wound up in the manner shown here.

(b). Connection to the foils may be made by introducing connection strips during winding.

(c). An alternative method of assembly, in which the foils project over the edges of the roll.

(d). The projecting edges of the foils are then crimped over, as shown here.

(e). A typical paper capacitor. This type is housed in an impregnated cardboard tube, and the whole is covered with wax.

It will have been noted that *two* strips of paper were interposed between the metal foils shown in Figs. 39(a) to (d) despite the fact that, at first sight, a single strip of paper would appear to be just as adequate and would also result in a cheaper and smaller capacitor. Normally, however, a single strip of paper is never employed between the foils. This is because it is almost impossible to economically produce paper which does not have occasional "pin-holes", areas of thin cross-section, or particles of conducting material. When two papers are used, it is extremely unlikely that two random faults will coincide and there is, in consequence, very little risk of breakdown of the capacitor. It should be noted that the working voltage of the capacitor so formed is that applicable to only one sheet of the paper (assuming it to be free of imperfections). If double the working voltage were required it would be obtained by adding a third sheet of paper between foils, one layer of paper still being looked upon merely as a safeguard against faults in the others. In practice, up to six layers of paper may be interposed between foils to provide capacitors of different working voltages. Control of working voltage may also be obtained by varying the thickness of the paper strips.

The fact that two papers are required for capacitors employing metal foils has led to the development of the *metallised paper capacitor*. This employs a single layer of paper between the plates, the latter consisting of a thin layer of metallising deposited on the paper itself. The reason why a single layer of paper may now be employed is that the metallised paper capacitor has *self-healing* properties. If, when a voltage is applied to the plates of the capacitor a breakdown occurs due to an imperfection in the paper, the metallising around the breakdown point is burnt away by the current. As a result, the metallising is automatically cleared from points where the paper has imperfections, and the dielectric consists mainly of paper having good dielectric strength.

Since the metallised paper capacitor requires only one layer of paper between conducting surfaces, and since the surfaces are themselves very thin, this component can be made smaller than the foil equivalent. Working voltages for metallised foil capacitors with single paper spacing may extend up to some 200 volts. Two or more layers of paper can be employed if higher working voltages are required, whereupon the size tends to approach that of foil capacitors having the same value. Lead-out connections to metallised capacitors may be made in the same manner as with foil capacitors.

When a paper capacitor has been rolled up, there will be a complete turn of one of the plates (foil or metallising) on the outside. If the capacitor is mounted in an insulated housing this outside layer of conducting material can function as a screen³ and the lead-out wire connecting to it is usually identified by a ring printed around the body of the capacitor, as in Fig. 39(e). Sometimes this lead-out wire is identified by the letters O.F. (for Outside Foil) printed on the body instead of the ring.

The paper used for paper capacitors is specially processed and offers high absorption of impregnating materials together with very low chemical activity. Typical impregnants are petroleum jelly and impregnating wax. Large paper capacitors mounted in metal containers may employ impregnating oil, but this is uncommon with the smaller types used in radio work. The insulation resistance of paper capacitors varies somewhat according to the class of impregnant used, but it is generally lower than that of mica capacitors. Figures between 500 and 8,000M Ω for a 0.01 μ F component would be typical. Also, insulation resistance drops markedly with temperature, and may fall by more than half for an increase of only 15°C. Unless carefully protected, paper capacitors are prone to humidity effects, whereupon their insulation resistance drops by a very large amount. This was a particularly common failing in early paper capacitors, which were protected on the outside by an impregnated cardboard tube and a wax coating. If such capacitors were mounted in radio chassis where temperatures were high (due to the heat dissipated by other components) the continual heating and cooling cycles given as the

equipment was switched on and off reduced the protection given by the outer covering, particularly at the lead-out points. Such capacitors were liable in consequence to suffer catastrophic falls in insulation resistance due to the ingress of moisture.

Many modern paper capacitors still employ an impregnated cardboard tube housing together with a wax covering, but present-day manufacturing methods have largely overcome the humidity problems given with the earlier components. Even so, this type of capacitor should not be mounted in positions where temperature exceeds 60°C or so. Apart from the cardboard tube housing, paper capacitors may also be protected by being moulded in insulating waxes or resins, or by being fitted in metal cylinders having insulated seals for the lead-out wires. In all these instances the component retains its typical tubular appearance with a lead-out wire at either end. Large paper capacitors (from some 1 μ F upwards) may be housed in plastic or metal containers fitted with terminals, solder tags, or flexible lead-out wires. Multiple units incorporating more than one capacitor may also employ a plastic or metal housing, this being provided with the requisite number of terminals. Sometimes, the metal case itself provides the connection for one of the plates of the capacitor or capacitors it houses.

Paper capacitors of the wire-ended tubular type are normally manufactured within the range 500pF to 0.5 μ F. Working voltages are, typically, 150, 250, 350, 500, 750 and 1,000, although individual manufacturers may sometimes specify intermediate figures. There is no general trend towards using preferred values, and paper capacitors usually have round figure values (e.g. 0.005 μ F, 0.02 μ F, etc.). A paper capacitor is regarded as a low tolerance component, tolerances on capacitance being $\pm 20\%$ or $\pm 25\%$ according to value, type, and manufacturer. Occasionally, radio or television makers specify $\pm 10\%$ capacitors for a particular circuit. Such capacitors are selected by the capacitor manufacturer and are coded by private agreement. High-grade paper capacitors for Services requirements may also have tolerances of $\pm 10\%$, but such components will not normally be encountered by the amateur. The values of paper capacitors are usually printed on the case; although a colour code, which will be given in next month's article, may sometimes be employed with lower-value types.

The temperature coefficient of the paper capacitor is not an important factor, because it is usually employed in circuits which require a low tolerance component. Also it may vary widely according to the type of impregnant employed for the dielectric. A high grade component should shift in capacitance by less than $\pm 2\%$ for a rise in temperature from 25 to 50°C.

Plastic Film Capacitors

The development of plastic film capacitors has made very great strides over the past ten years, and a particular type, employing polystyrene, is now in mass-production at prices competitive (for the lower

³ Screening will be discussed in a later article.

capacitances) with the longer established capacitors.

The *polystyrene capacitor* uses a rolled up construction similar to that of the paper capacitor, a thin polystyrene film providing the dielectric between the conductors. The latter may either be metal foil or metallising deposited on the polystyrene. In the case of metal foil capacitors it is usual to interpose two or more films of polystyrene between the foils in order to guard against occasional weak spots. Metallised polystyrene capacitors require only one film. In the event of breakdown this film then burns away with the same self-healing action as occurs with the metallised paper capacitor. Polystyrene foil capacitors tend to be somewhat bulkier than paper capacitors of the same value and working voltage, whilst metallised polystyrene capacitors are commensurate in size. Lead-out connections are made by inserting connecting strips, or the lead-out wire or tape itself, into the roll during winding, as with the paper capacitor of Fig. 39(b). Although this implies the inductive method of termination, the connecting points are so chosen that inductive effects are negligible. No impregnation of the dielectric film is required and, after completion, the capacitor may be sealed by an overall coating of polystyrene.

The major advantage of polystyrene capacitors is that they have exceptionally high leakage resistances, a typical figure for a 0.01 μ F mass-produced component being of the order of two million megohms. It is reported that a 1 μ F polystyrene foil capacitor, charged initially to 500 volts, had lost less than 10% of its charge after a period of 2 years! Metallised polystyrene capacitors tend to have lower leakage resistances because the self-healing action which occurs at any weak spot in the dielectric reduces its efficiency at that point. A typical figure would be in the tens of thousands of megohms. Because of the nature of the dielectric, polystyrene capacitors are less liable to absorb moisture than paper capacitors.

Polystyrene capacitors are manufactured over a wide range of values from some 10pF to 0.5 μ F. Again "round figure", rather than preferred, values are generally employed. Normal tolerances are $\pm 25\%$, $\pm 20\%$, $\pm 10\%$ and $\pm 5\%$, values and tolerances (if lower than 20%) being printed on the body of the capacitor. Sometimes, a band is also printed around one end of the body to indicate the "outside foil". The temperature coefficient of the polystyrene capacitor is low and, quoting from manufacturers' figures, lies between N90 and N210 for the foil type. The metallised type has a negative temperature coefficient which is slightly lower. Working voltages for both types are of the order of 150, 300, and 450.

A limiting factor with polystyrene capacitors is given by the fact that polystyrene melts at fairly low temperatures. Polystyrene capacitors should not, in consequence, be mounted at hot points in equipment chassis. Also, the polystyrene dissolves readily in solvents such as benzene. At present, polystyrene capacitors are manufactured only in the tubular form with wire lead-outs.

The more recently introduced *polyester capacitors* employ a plastic dielectric film in the same manner as do polystyrene capacitors. The dielectric film is polyester,⁴ this material being capable of functioning over a wide temperature range. It is possible to employ some polyester capacitors at temperatures of 125°C or more.

Like the polystyrene type, the polyester capacitor has a high insulation resistance, a typical figure being in excess of 100,000M Ω . The capacitance range currently available lies between some 0.001 μ F and 0.1 μ F with working voltages of the order of 250 or 350. Temperature coefficient is positive and varies over the range of operating temperatures. Speaking in general terms, polyester capacitors give an increase in capacitance of some 1 to 2% for a rise in temperature of 20°C. Polyester capacitors are manufactured in the tubular wire-ended form with values and tolerance (usually $\pm 20\%$) printed on the body.

Ceramic Capacitors

Production techniques which are completely different from those employed for the manufacture of mica, paper and plastic film capacitors are used for the making of *ceramic capacitors*. In these the dielectric is ceramic, the plates consisting of metallising (usually silver) which is fired or otherwise deposited on to the surface of the ceramic.

Ceramic is a hard brittle substance which, by suitable heat treatment, may be formed into almost any shape desired. Advantage is taken of this fact in the manufacture of ceramic capacitors and these appear in the form of tubes, discs, cups or any other shape which offers specific advantages for a particular application. Also, the different ceramics have a very wide range of dielectric constants and of temperature coefficients. This fact may be similarly exploited in the manufacture of components for particular applications.

Ceramic capacitors are usually classified in two broad groups, one of these embracing ceramics with a low dielectric constant and the other embracing ceramics with a high dielectric constant. These are known as *low-K* and *high-K* types respectively, the letter K signifying "dielectric constant".

The dielectric constants of ceramics in the low-K group extend from 6 to around 500 and, in the high-K group from around 500 to 3,000 or more. When it is remembered that the dielectric constant of mica is of the order of 7 to 7.3 only, it will be realised that the high-K ceramics allow the production of relatively large value capacitors with very small dimensions.

Next Month

In next month's issue we shall conclude on the subject of fixed capacitors, carrying on to colour codes and variable capacitors.

⁴ Polyester is manufactured under the trade names: Melinex, Mylar or Terylene.

By
D. BELL

Part One

Zener Diode Stabilised Power Supplies

TO OBTAIN A STABILISED POWER SUPPLY WHOSE source impedance is low enough to be comparable with that of a battery without the complications of valve stabilising, zener diodes can be used. The advantage of the low source impedance is that it improves the regulation of the supply (the variation of output voltage with varying load) and reduces, or prevents, instability (oscillation or interaction due to feedback from a common coupling point, i.e. the power supply).

A zener diode is a semiconductor device which when back-biased (conventional current being passed from cathode to anode) exhibits the property of a stabiliser. The characteristic of a zener diode is shown in Fig. 1 (a). From this it can be seen that, in the turnover or zener region at point X, the voltage across the diode is substantially constant for small changes in current.

A similar property is exhibited by the more commonly known gas-filled stabiliser tubes, but zener diodes have an advantage over these tubes in that a continuous range from some 2.9 to 150V is available, thus extending much lower than can be obtained with gas-filled stabilisers.

The "striking" voltage of the zener diode is not greater than the "operating" voltage, whereas the gas-filled stabiliser requires a "striking" voltage which is considerably higher than the "operating" voltage. The zener diode also has a much lower internal resistance. A typical neon stabiliser characteristic is shown in Fig. 1 (b).

Stabiliser Action

Fig. 2 shows a power supply stabilising circuit, in which the stabiliser could be a zener diode. As the input voltage rises the current in the diode increases (this being apparent from the characteristic shown in Fig. 1 (a)), and the voltage dropped across the series resistor, R, increases. This increase is such that the difference between the input voltage and the output voltage is all developed across the series resistor R, and the output remains constant. $V_o = V_{in} - V_R$.

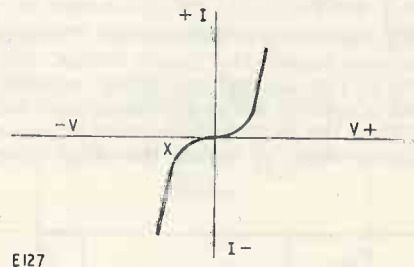

E127

Fig. 1 (a). Zener Diode characteristic

Zener Diode Selection

To select a zener diode for a specific purpose the following points must be considered.

- (1) Voltage.
- (2) Current,
 - (a) the minimum operating current required to produce stabilisation.
 - (b) the maximum allowable current (the power dissipation of the diode).
- (3) Internal (Slope) Resistance.

(1) *Voltage.* Diodes are available from some 2.9 to 150V, Table I giving a typical selection of available types. Diodes can be connected in series to produce a stabilised voltage equal to the sum of the individual diode voltages. When added in series,

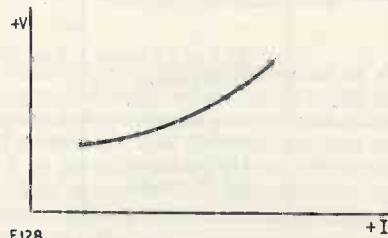

E128

Fig. 1 (b). Neon Stabiliser characteristic

however, only diodes capable of dissipating the maximum power requirements should be used and they should all have a similar minimum stabilising current requirement. On no account should diodes be connected in parallel.

(2) *Current (a).* The minimum operating current to produce stabilisation is given by the manufacturer but it can be easily checked with a meter. The minimum stabilising current varies with diodes of different type and manufacture, e.g. the AEI VR525A requires a minimum operating current of 20mA for stabilisation on the linear part of the characteristic, whereas the Mullard OAZ200 requires only 1mA.

In general, low current diodes are used for reference purposes and high current diodes for stabilisation.

(b) The maximum current allowable can be calculated from the manufacturer's power rating, with

$$I_{\max} = \frac{W_{\max.}}{V_{\text{diode}}} \quad \text{Care must be taken to ensure}$$

that the power rating is not exceeded. Normally the manufacturer quotes two power ratings, one when mounted in free air and one when mounted on a heat-sink of specific size at a given ambient temperature. (When the diode is being used at an ambient temperature which is higher than that quoted by

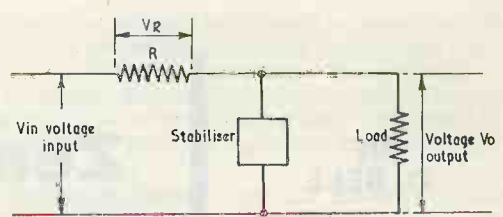

E129

Fig. 2. Stabilisation principle

the manufacturer the current in the diode should be reduced from the maximum quoted.) The maximum current rating required depends mainly on whether the load across the diode is constant or variable and on the amount of input voltage variation.

Zener diodes are available with power dissipations of from 120mW to 15W.

(3) *Slope Resistance.* This is defined as the change of voltage measured over the linear part the change of current of the characteristic and, from an examination of the latter, it can be seen that the slope varies with the operating current, the greater the current the

TABLE 1

Manufacturer	Type	Voltage ²	Minimum Stabilising Current	Power Rating	Notes
Mullard	BZ series	6 to 8V	1mA	210mW at 45° C.	
	OAZ 200 series (14 in series)	3.3 to 15V	1mA	260mW at 45° C. 420mW at 45° C.	Using 3.5 x 3.5cm 16 s.w.g. aluminium heat sink
	OAZ 22 series	5.3 to 9.6V	1mA	1.9W at 45° C.	Greater with heat sink
A.E.I. (including B.T.H.)	VR series (12 in range)	2.9 to 10.6V	20mA	Type B—2W at 25° C. Type A—5W mounted on 1½in square of 21 s.w.g. copper	Type B—wire ended Type A—stud mounting, wire ended
Brush Xtal Co.	Z5 to Z10 series	5 to 11V		120mW at 45° C. 240mW at 45° C.	With heat sink
	ZL5 to Z3 series (8 in range)	3 to 36V		1.25W at 45° C. 5W at 45° C.	With 60 x 60 x 2mm heat sink
Texas	155015 to 155150 series (25 in range)	15 to 150V		8W at 50° C. stud temp.	Conventional and reverse polarity types

¹ This table is intended to be representative only of zener diodes currently available. Users of zener diodes should consult the appropriate manufacturer's literature for full details of correct operating condition rather than work solely from figures given here.

² Figures given here may include production spreads.

lower being the internal resistance. Typical values are from 1 to 40 ohms depending on the diode type and the operating current.

Setting-up the Voltage

The characteristic curve shows that the voltage varies over the range of current. It is, therefore, possible to set the voltage of the diode to a selected value. This can be done by monitoring the output voltage and at the same time varying the current through the diode—by increasing the voltage input or by decreasing the series resistor value. Increasing the input voltage increases the current, and vice versa. In carrying out this operation, care must be taken to ensure that the maximum power dissipation of the diode is not exceeded and that allowance is made for input voltage fluctuation (as may occur if the latter is derived from the mains).

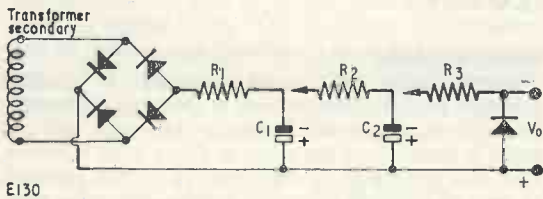

Example of Design

A mains power supply is required with the following characteristic: 10V, 200mA output from a low impedance less than 10Ω. A suitable diode is the 10 Volt, 5 Watt AEI VR10A. Therefore, $I_{max} = \frac{W_{max}}{V_{diode}} = \frac{5}{10} = 500\text{mA}$.

The minimum current, $I_{min} = 20\text{mA}$, and we will, in this case, work at a diode current of 50mA, giving a total current, through the series resistor of $200 + 50 = 250\text{mA}$.

The value of the series resistor depends on the output voltage from the rectified a.c. and on the most suitable biasing point for the diode. Let us assume that a full-wave bridge circuit is used and that three 6.3V windings of a transformer are connected in series to give approx. 19V. The rectifier output from the bridge will be approximately 1.2 times the transformer secondary voltage, therefore $V_{d.c.} = 1.2 \times 19 = 23\text{V}$.

Mains fluctuations of $\pm 10\%$ would give a spread on this voltage of about 20 to 25V, and the highest figure should be used in the calculations.

$$\text{Therefore } R_{series} = \frac{V_{max} - V_{diode}}{I_{max}} = \frac{25 - 10}{250} \cdot 10^3 = 60 \text{ ohms}$$

$$\begin{aligned} \text{Resistor wattage rating} &= V_{dropped} \cdot I_{max} \\ &= \frac{15 \cdot 250}{10^3} \\ &= 3.8\text{W} \end{aligned}$$

therefore the series resistor should be made up to give an effective total of 60 ohms at 4 watts.

If semiconductor diodes are used in the bridge rectifier circuit a series resistor must be inserted between the output from the rectifier and the reservoir capacitor, this being necessary to limit the surge current which flows in charging the reservoir capacitor when the power supply is switched on, and to limit the recurrent peak currents. The value of the resistor is given approximately by peak secondary voltage of the transformer

maximum surge current rating of the rectifier and it should have a greater value than the calculated value. A stage of RC filtering can be added at little further expense by division of the calculated value for the series resistor R and the addition of one capacitor (as shown in Fig. 3). From this it can be seen that the series resistor R is now made up of $R_1 + R_2 + R_3 = 60 \text{ ohms}$.

Zener Diode Applications

Zener diodes can be used for providing a stabilised h.t. voltage supply (though the h.t. diodes are as yet expensive), an l.t. supply for stabilised heaters, or low voltage supplies to replace batteries.

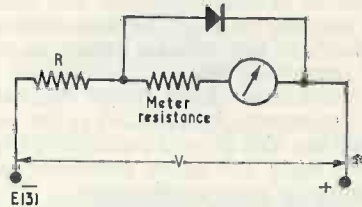

They can also be used as meter overload protection devices by connecting the diode across the meter as shown in Fig. 4; the series resistor must be included to limit the current in the diode to a safe value and it would, in effect, be one of the multipliers. When the voltage across the diode reaches the striking value it conducts and the meter is by-passed. A centre-zero meter can be protected by using a symmetrical diode, one which operates in both directions.

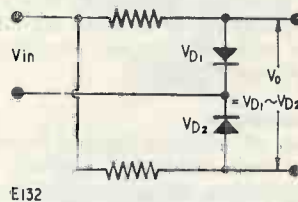

Two zener diodes can be connected as shown in Fig. 5 to give a voltage output equal to the difference of the zener-diode voltages and yet with a low output resistance. Diodes can also be cascaded as shown in Fig. 6 to provide a very stable reference voltage which, when mounted in a temperature controlled oven, has a stability which is comparable with that of a reference cell.

The standard symbols and methods of connection

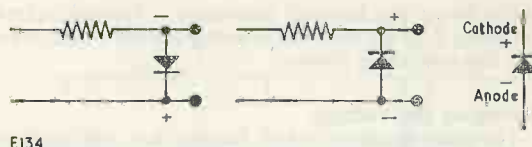
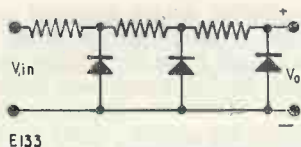

are shown in Fig. 7. In the conventional diodes the cathode is the stud-end, i.e. the end bolted to the heat sink or, preferably, chassis; but this can only be done when the chassis, the common line, is

positive. With the reversible zener diodes the anode is the stud-end and this provides a negative common line.

(to be continued)

FAULTS IN GAS-FILLED POWER RECTIFIERS AND THEIR REMEDIES

By BEVERLY COURT

GAS-FILLED RECTIFIERS CONTAIN A GAS SUCH AS mercury vapour, xenon, argon, or a combination of mercury vapour and xenon. This article is intended to assist the reader in diagnosing possible faults in any of these valves, as well as the means of remedying them.

Many constructors build power supplies for use with p.a. equipments, transmitters or for experimental use, and the high current capabilities of gas-filled rectifiers at fairly low anode potentials make their use attractive for these applications.

Cold Start

Premature failure of gas-filled rectifying valves is usually due to h.t. and filament voltages being applied at the same time when switching on. This type of failure can be said to be the result of a cold start under full load conditions. The fault may easily be avoided when first constructing the power supply by incorporating a suitable delay switch in the filament circuit. This offers the further advantage of ensuring that the user does not have to rely on his own judgement in delaying the application of h.t.

Damage to gas-filled rectifiers by cold starts is due to cathodic sputtering or internal arc-back. These developments will also damage associated components in the power supply.

Ambient Temperature

In the case of mercury vapour rectifiers, it is essential that such valves be operated within the ambient temperature limits specified for the type used. This is an important requirement and it is essential, therefore, that the constructor allows for adequate ventilation when housing the power supply. Exceeding the ambient temperature limit affects the peak inverse voltage rating, with the result that the life of the valve will be greatly reduced. At the same time, high voltage surges can result if the rectifier is operated below its rated minimum ambient temperature. This is because the pressure within the valve is then insufficient.

Socket Contacts

Deterioration of socket contacts is another problem that the constructor is likely to encounter. Poor electrical contact increases resistance and can cause a serious voltage drop at fairly high currents. This will naturally shorten the life of the rectifier, as well as creating excessive heat at the valve pins. The generation of heat is progressive, with the result that the valve is eventually destroyed, together with the socket.

Filament Voltage

Any increase in filament voltage will also shorten valve life, because of the consequent increase in the operating temperature of the filament or cathode. This can cause the emissive coating to be boiled off, thereby reducing the ability of the rectifier to conduct the current at which it is rated.

As mentioned earlier in this article, arc-back can be the result of an insufficient warm up period. It can also be traced to the fact that the valve filament is being run in excess of its rated voltage. In practice, this fault is usually identified by the continual blowing of equipment fuses. Failure of the fuses to blow will most definitely destroy the valve rectifier.

High Arc-Drop

Gas-filled rectifier valves that develop high arc-drop can usually be identified by a faint coloured glow together with a low d.c. output voltage across the load. Rectifiers which exhibit no glow whatsoever are not conducting and, in a full-wave circuit, low d.c. output voltage to the load will similarly result.

Check Components

In conclusion, it is advisable to check all associated components of the power supply before replacing a faulty gas-filled rectifier. If any of these components are faulty, they may similarly damage or destroy the replacement rectifier.

Releasing Welded Mains Switch Contacts

by L. E. HIGGS

DURING WORK ON A TV RECEIVER EMPLOYING A combined volume / brilliance / on-off switch control, the switch was operated while a short-circuit existed across the mains volts dropper. The result was a pair of blown fuses and the switch contacts welded in the "On" position. The construction of most mains switches is such as to discourage repair and it is usually easier to replace the complete assembly.

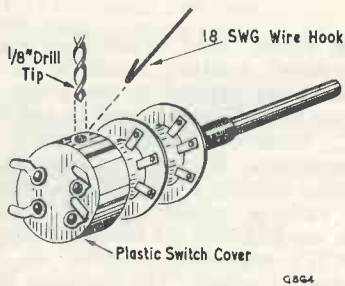

Fig. 1. Drilling the switch cover

But in this instance, due to the special type of control and the inconvenience and delay in obtaining another, an attempt at repair was made—without the tedium of removing from the chassis. First a $\frac{1}{8}$ in hole was carefully drilled in the mains switch plastic cover, ensuring that the tip of the drill did not project into the switch space after breaking through. Then a small hook was made from a piece of 18 s.w.g. copper wire was inserted and the contact carrier was fished for with the spindle turned to the "Off" position. The first attempt showed that the access hole had been drilled on the wrong side, making it impossible to pull the carrier. Another, more suitably placed, hole enabled a slight tug at the contact carrier (spindle turned to the "Off" position) to release the lightly welded points. A smudge of Vaseline was squeezed into the hole and washed in with a few drops of carbon tetrachloride to lubricate any roughness of the

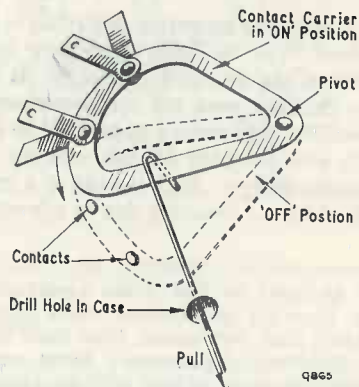
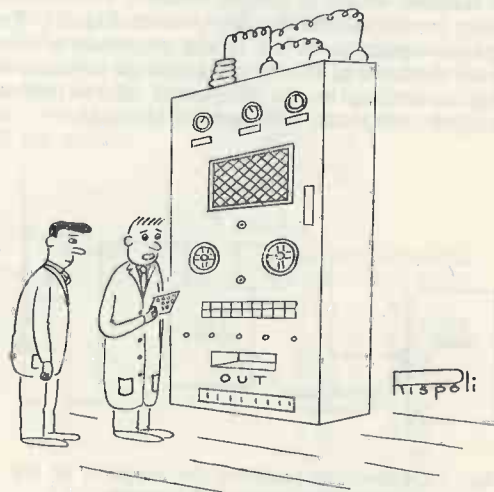

Fig. 2. A view of the switch interior, showing how the contact carrier is pulled off

contacts. The control was operated a few times in quick succession without the contacts sticking—and it has continued to operate satisfactorily ever since.



"It says 'mind your own business!'"

Cover Feature

"Carverter" Mobile Short-Wave Converter

designed by

D. J. FRENCH*

Grad. I.E.E.

The short-wave converter described in this article is of especial interest because of the principles involved. The oscillator frequency in the converter is fixed, being selected by plugging in a crystal of the desired frequency. At the same time, station selection is achieved by tuning the main receiver over the medium-wave band, whereupon it covers the corresponding range of heterodyne frequencies appearing in the output of the mixer. In consequence, tuning arrangements are provided by the existing receiver, with a resultant considerable simplification in converter design. Also, the use of a crystal controlled oscillator ensures freedom from frequency drift and from detuning due to vibration and similar causes.—Editor.

MANY READERS OF *The Radio Constructor* who are also car enthusiasts must often have wished that they could tune their car radio over the short-wave spectrum. Most car radios in use today, at least in this country, cover both medium and long-waves but very few cater for the short-wave addict; whilst transmitting amateurs construct special receivers to cover the frequencies in which they are interested.

The Carverter mobile short-wave converter described in this article affectively enables any car radio to receive both amateur and broadcast stations at the flick of a switch—the unit being a transistor crystal controlled converter, powered by a mercury type battery, which is simply inserted between the existing car aerial and the radio. (See Fig. 1.) The frequency coverage of the model described is from 5 to 16 Mc/s (60 to 19 metres) although this may be varied according to the frequency of the crystal employed—see under Frequency Coverage.

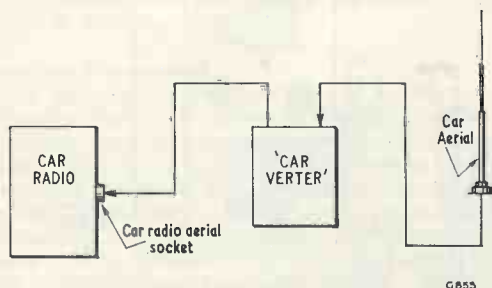

Fig. 1. Connections required for operation of the "Carverter" short-wave converter

* Henry's Radio Ltd.

Circuit

With the 3-pole 2-way switch S_{1A} , S_{1B} , S_{1C} , in the "short-wave" position, incoming signals from the car aerial are applied to the broadcast band filters formed by inductors L_1 and L_2 and capacitors C_1 and C_2 , these eliminating unwanted medium-wave transmissions. Short-wave signals are induced into the tuned winding of the HF516 inductor (L_3), the 100pF variable capacitor C_3 sensitivity control tuning this winding over the selected range.

The OC171 transistor operates as a crystal oscillator and r.f. mixer. The incoming short-wave signal is mixed with the crystal fundamental frequency, the resulting output across the r.f. chokes RFC₁ and RFC₂ being the signal frequency minus the crystal frequency—such output appearing on the medium-wave band of 550 to 1,600 kc/s. This output is now passed to the aerial input socket of the car radio, the tuning and volume controls of which are operated in the usual manner.

For normal medium and long-wave reception, switch S_{1A} , S_{1B} , S_{1C} is connected such that it automatically connects the aerial direct to the car radio input socket and disconnects the battery from the converter.

Frequency coverage

As previously mentioned, the model described here has a frequency coverage of 5 to 16 Mc/s. As the output of the converter is from 550 to 1,600 kc/s higher than the crystal selected, any crystal having a fundamental frequency between 4.5 Mc/s and 14.5 Mc/s may be plugged into the unit. For example, a 6.25 Mc/s crystal would provide a coverage of from 6.8 Mc/s to 7.85 Mc/s. Hence, by

Components List

Capacitors

- C₁ 500pF ceramic
- C₂ 100pF styrene
- C₃ 100pF variable airspaced
- C₄ 100pF styrene
- C₅ 1,000pF ceramic
- C₆ 1,000pF ceramic

Resistor

- R₁ 100kΩ 10%

Inductors

- L₁, L₂ QA8 aerial, (Osmor Radio Ltd)
- L₃ Type HF516 (Henry's Radio Ltd)
- RFC₁, RFC₂ (Henry's Radio Ltd)

Transistor

- OC171 Mullard

Switch

- S_{1A}, S_{1B}, S_{1C}, S_{1D} 4-pole, 2-way yaxley type

Crystal Holders (Henry's Radio Ltd)

- 1 FT243 type
- 1 10XJ combined 10X type
- 1 10XJ subminiature type
- 1 B7G base

Miscellaneous

- Paxolin chassis, drilled and tagged (Henry's Radio Ltd)
- Pre-drilled cabinet (Henry's Radio Ltd)
- 3.9V Mercury battery pack
- Car radio coaxial socket and plug
- 1yd coaxial cable
- 1 car fitted with car radio!

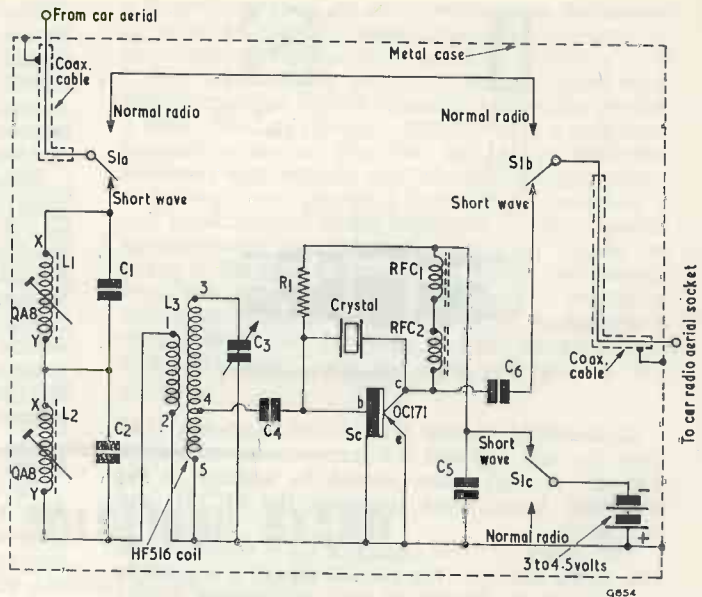

Fig. 2. Circuit of the "Carverter" short-wave converter

Construction

The completed converter is built into a metal cabinet some $4\frac{7}{8} \times 3\frac{1}{8} \times 1\frac{7}{8}$ in, the components being mounted on a drilled and tagged Paxolin board fixed to the removable front panel by means of four 6BA bolts spaced from the metal with three 6BA nuts. The panel itself is secured to the cabinet by means of two small self-tapping screws.

Four types of crystal holders are fitted to the unit thus enabling crystals with differing socket requirements to be plugged in. The Osmor QA8 coils are clipped into the holes provided on the Paxolin board. The battery and the HF516 inductor are secured to the board with a length of cord.

A 4-pole 2-way yaxley switch is supplied. Only three poles of this are used in the actual circuit, the fourth pole being used as an anchoring tag for the coaxial cable links to the car radio input and the car aerial.

tuning the car radio, the dial will be found to cover just over a 1 Megacycle "swing". The particular frequency range just mentioned covers the whole 40 metre amateur band and also the 39 metre broadcast band. The table accompanying this article will act as a guide to the frequencies that may be covered by using specific crystals.

The frequency coverage of the converter may also be altered by modifying either L₃ or capacitor C₃, or both. Increasing the number of turns on the tuned winding, or alternatively connecting fixed value capacitors in parallel with C₃, would allow the use of lower frequency crystals in order to cover frequencies lower than those shown in the table. Decreasing the number of turns on the tuned winding of L₃ or alternatively reducing the value of C₃, or both, would allow crystals having a fundamental frequency of up to 30 Mc/s or so to be used.

Battery

The 3.9V battery pack should last for some estimated twelve months life. Standard 3 or 4.5V dry batteries could, of course, be used if required.

TABLE

Crystal Frequency (Mc/s)	Frequencies covered by car radio (Mc/s)
4	4.55 to 5.60
5	5.55 " 6.60
6	6.55 " 7.60
7	7.55 " 8.60
8	8.55 " 9.60
9	9.55 " 10.60
10	10.55 " 11.60
11	11.55 " 12.60
12	12.55 " 13.60
13	13.55 " 14.60
14	14.55 " 15.60

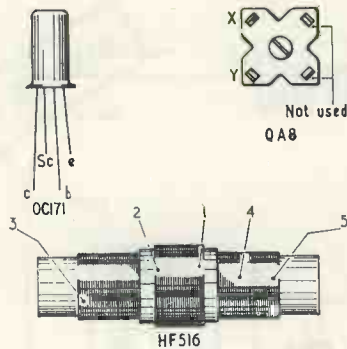

Fig. 3. Coil and transistor connections

Connections to the HF516 coil (L_3), the QA8 coils (L_1 and L_2) and the transistor are shown in Fig. 3. A heat shunt should be applied to the transistor leads when soldering the OC171 into circuit.

The 100pF variable capacitor C_3 is bolted to one side of the cabinet. The coaxial socket is secured to the cabinet by means of two self-tapping screws after 3 to 4in of coaxial lead has been soldered to it. The coaxial lead to the car radio aerial input socket is passed through the side of the cabinet via a rubber grommet. A knot should be tied in this lead in order to prevent undue strain on the soldered connections.

The layout of the components within the unit are shown in Fig. 4 from which it will be seen that it is reasonably compact whilst, at the same time, being fairly easy to construct with the few parts involved.

Fig. 4. Component layout diagram of the converter. Note that this is shown in exploded form for reasons of clarity

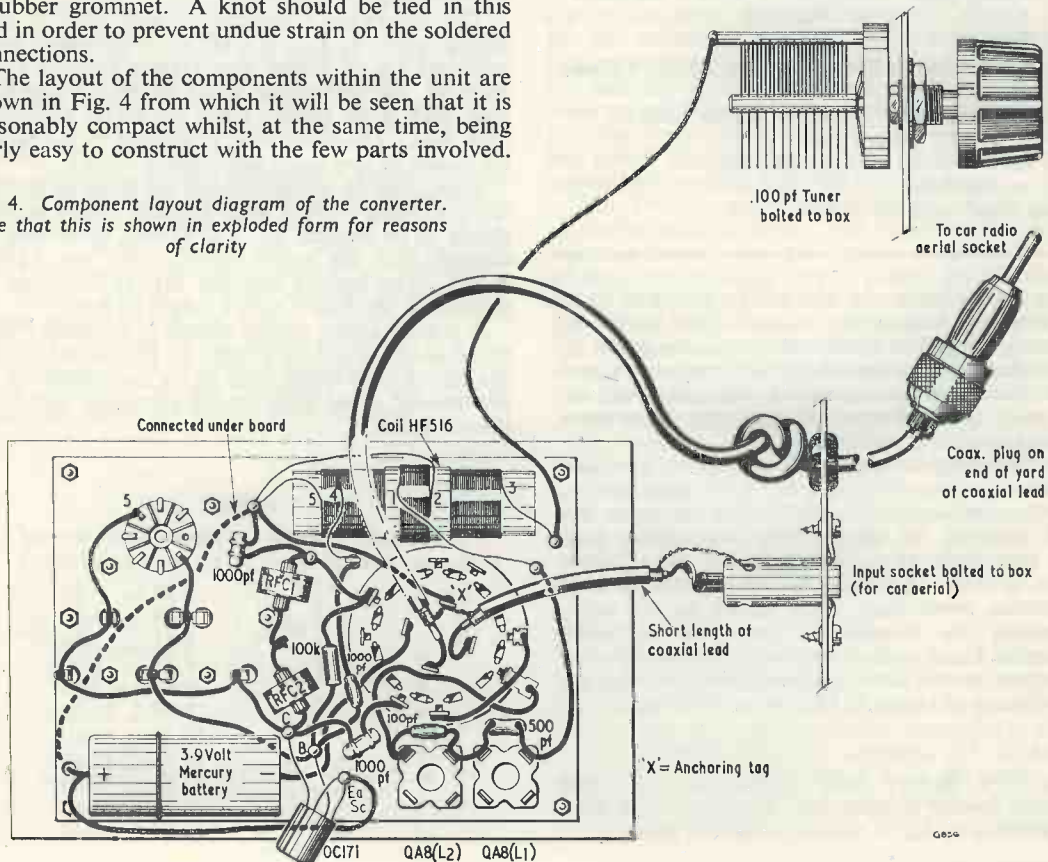

Once the components have been secured to the Paxolin board and soldered into circuit, the board should be secured to the panel as previously described. The variable capacitor C_3 , and aerial input components having been fitted in the first instance to one side of the metal cabinet.

When assembling the unit, ensure that the coaxial leads within the cabinet do not foul the vanes of C_3 . Before finally securing the panel to the cabinet, the dust core of L_1 should be set approximately in the middle of the winding, whilst that of L_2 should be positioned at the bottom of the winding.

The unit may be mounted anywhere within the vehicle but ideally should occupy a position conveniently near the existing car radio installation, as this provides ease of operation and maximum efficiency.

Using the Carverter

To use the Carverter connect up as shown in Fig. 1, select a crystal which will produce the required coverage (see table), and plug into the appropriate crystal socket. Switch on the existing car radio, set the Carverter to the "short-wave" position and tune the car radio over the medium-wave band. Instead of the usual medium-wave broadcast stations, short-wave transmissions will

now be heard—the sensitivity control C_3 then being adjusted for optimum results.

Should any medium-wave transmissions cause breakthrough, then the cores of both L_1 and L_2 should be adjusted until they are eliminated.

For normal medium-wave reception the Carverter should be switched to the “normal radio” position.

Many short-wave broadcast stations will be heard using crystals near to those quoted in the table. Amateur transmissions on the 40 metres band may be received by using any crystal having a fundamental between 5.65 and 6.4 Mc/s. Similarly, the 20 metre amateur band may be covered by using any crystal having a fundamental frequency between 12.85 and 13.4 Mc/s.

For those interested in radio control, this circuit

will produce good results operating on harmonics in order to monitor radio control transmitters, or any other transmitter working up to 100 Mc/s.

The Carverter is an ideal mobile short-wave converter which should appeal to any reader having a radio fitted to the car. Additionally, it will have occurred to readers that this short-wave transistor converter may equally well be used with any mains or battery radio provided that the main receiver is not fitted with a ferrite or frame aerial. Normal medium-wave transmissions would of course be heard if this were the case. The writer understands from the editorial staff of *The Radio Constructor* that many requests are received from readers for a simple short-wave converter and the design offered herewith would seem an ideal solution to this demand.

A USEFUL SOLDERING STAND

By J. ANDERSON

THE STAND DESCRIBED HERE WAS MADE WITH THE idea of collecting together all the odd bits of soldering equipment scattered about the workshop. The measurements quoted are suitable for an average sized constructor's iron and are not critical, since the dimensions depend solely on the size of the iron used.

The construction is shown in the accompanying diagrams and they are self-explanatory. The tin is secured to one end of the strip of wood by means of two 3in nails, the projecting points of these then being sawn off so that two metal pegs are left which fit into two corresponding holes drilled in the bench top thus holding the stand in position. An old tobacco tin was used, this also being useful here in catching odd snippets of wire and drops of solder-slag, etc.

The cavity at the other end of the stand was cut to hold a small coil of cored solder in wire form; the row of holes at this end are easily made with a standard set of drills, their purpose being to hold spare soldering iron bits having their working ends upwards.

The iron itself is supported on bridges of 18 gauge wire bent into the shape shown and pushed into holes drilled in the wood. A line of such holes can be drilled, if desired, to accommodate soldering irons of various lengths.

A strip of fine emery paper was glued alongside one side of the stand, to allow for the quick and easy cleaning of bits.

Before assembly the wood, to prevent it smouldering at any time, was soaked in a solution of alum, easily purchased from any chemist. If this refinement is desired, the wood should be soaked in a saturated solution for two days, left to dry, and the process again repeated. Unless the wood has been seasoned,

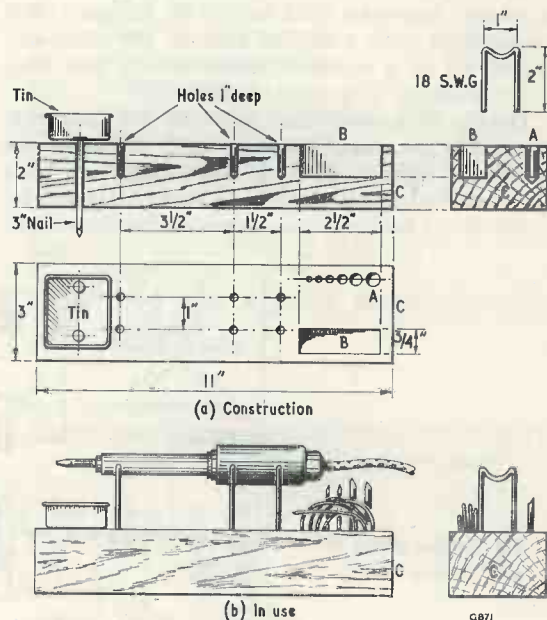

this procedure may alter its shape slightly, and thus it is advisable to soak the wood before drilling the various holes, etc.

The problem of the soldering-iron flex getting in the way whilst working was solved by suspending it in a loop of p.v.c. covered wire from the roof. This keeps the flex out of the way and at the same time allows it to slide to and fro in an easy manner.

THE DOUBLE TWO

A Simple Receiver-Amplifier

by A. S. CARPENTER

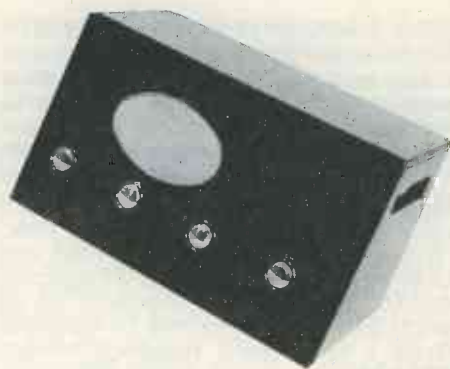

SIMPLE RADIO RECEIVERS ARE OFTEN RESTRICTED to two valves, one of which operates as a leaky-grid detector cum a.f. amplifier whilst the other provides sufficient audio power to operate a loudspeaker. At the same time, simple amplifiers designed to reproduce gramophone records in two valve arrangements—although the two valves are sometimes contained in a single envelope.

It is not unreasonable to assume, therefore, that a simple two-valve unit could be designed that conjunction with a crystal pick-up are often also would act as a complete radio receiver and also, when required, as a small amplifier.

Details of a unit that performs the dual role admirably are presented here and, although the quality of reproduction and radio range are both very satisfactory, it should be borne in mind by constructors that only two valves are employed and

results cannot be expected to equal those given by more ambitious equipment.

On "Radio" the unit covers both the Medium and Long wavebands, whilst on "Gram" radio signals are automatically rejected so that gramophone records may be reproduced.

The Circuit

The circuit is given in Fig. 1 and, considering the "Radio" function first, it will be noted that some unusual features are included. There is, for example, no variable tuning capacitor. This is due to the use of a special dual-wave inductor that acts as a self-contained ferrite aerial. The large core of the inductor is brought out on an extension spindle to which a control knob may be fitted for station selection purposes. Although adequate self pick-up results in many areas, separate aerial and earth

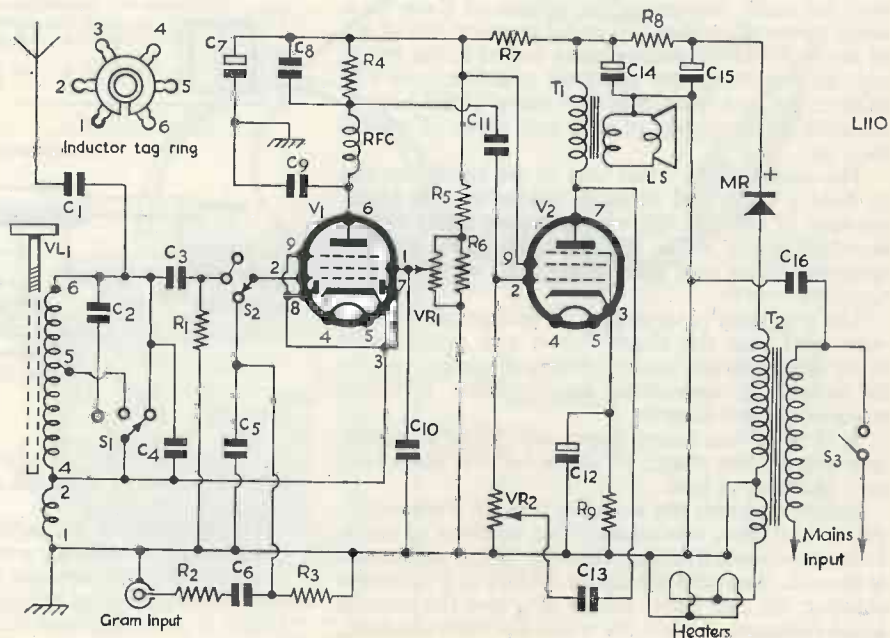

Fig. 1. The circuit of the "Double Two"

sockets are provided on the unit for users who, like the author, are less favourably situated.

The method of connecting the inductor to V_1 is also unusual and enables the valve to operate in e.c.o. mode, oscillation being controllable by means of VR_1 which also functions as the on/off switch. The cathode and grids 1 and 2 of V_1 constitute a triode, their phase relationships being correct for oscillation. Component values associated with this section are chosen to ensure a smooth control of regeneration and V_1 can be brought to its most sensitive operating point at the edge of oscillation with remarkable ease.

The demodulated signal appears at the anode of V_1 , residual r.f. being removed by the filtering action of the r.f. choke in conjunction with capacitors C_8 and C_9 . The stage is also decoupled by means of C_7 and R_7 .

The audio signal is then passed to V_2 for final amplification. V_2 operates in conventional manner, apart from the fact that a portion of the output is fed back to the grid circuit via C_{13} . The grid resistor of V_2 is made a potentiometer so that the amount of feedback may be varied. It should be noted that this is not the usual "top cut" circuit.

A good quality 3½in speaker is an integral part of the unit as also, is a self-contained power supply of simple design. The current demanded by the unit (less than 50mA) enables a miniature contact-cooled rectifier to be used and this performs excellently in conjunction with a half-wave mains transformer. In some cases the capacitor C_{16} , connected to chassis from S_3 , might not be required and can be omitted; when it is used, however, it must have an adequate voltage rating.

Components List

Resistors—½ watt 10%

R_1	330k Ω
R_2	270k Ω
R_3	6.8k Ω (see text)
R_4	270k Ω
R_5	180k Ω
R_6	47k Ω
R_7	2.2k Ω
R_8	1k Ω (3 watt)
R_9	270 Ω
VR_1	50k Ω potentiometer, Lin, with S.P. switch ¹
VR_2	500k Ω potentiometer, Lin

Valves

V_1	EBF80
V_2	EL84
VL_1	Teletron FX25 variable inductance, self-tuned aerial

Output Transformer

T_1	50:1 ratio
-------	------------

Sectional Universal Chassis

8in x 4in x 2in

Speaker

Elac. 3½in square type, 3 Ω voice coil

Rectifier

Contact cooled, 250V 50mA

RF Choke

Osmor, all-wave

Capacitors

C_1	75pF ceramic or mica
C_2	500pF (see text)
C_3	150pF ceramic or mica
C_4	100pF ceramic or mica
C_5	680pF ceramic or mica
C_6	5,000pF mica
C_7	4 μ F electrolytic wire ended, 350V
C_8	220pF ceramic or mica
C_9	220pF ceramic or mica
C_{10}	0.01 μ F
C_{11}	0.01 μ F
C_{12}	25 μ F electrolytic, tag ended, 12V
C_{13}	200pF ceramic or mica
$C_{14,15}$	16 x 16 μ F can-type electrolytic, 350V, with clip
C_{16}	0.01 μ F 1,000V d.c.

Mains Transformer— T_2

Mains, input, secondary—0–250V, 60mA, 6.3V
1.02A min. if no pilot lamp is used²

Selector Switch— S_1, S_2

Yaxley type rotary switch (see text)

Miscellaneous

- 1 Aerial/Earth socket strip
- 1 Coaxial socket, flush mounting
- 4 Control knobs
- 2 Valve bases, B9A
- 2 Tag strips, 3 free tags
- 1 Stand off insulator (see text)
- Panel material, wood, speaker fret, solder tags, nuts, bolts, etc.

¹ If desired, VR_1 and R_6 may be combined together in a single 25k Ω potentiometer.

² A suitable transformer for T_2 (with a 2A heater winding) is obtainable from Southern Technical Supplies, 83 Station Road, Portslade, Sussex, under type number 1128.

Fig. 2. Above chassis layout of the receiver-amplifier. In company with Fig. 3, this diagram is drawn to scale, thereby indicating component positioning. Control spindle spacing is shown in Fig. 5

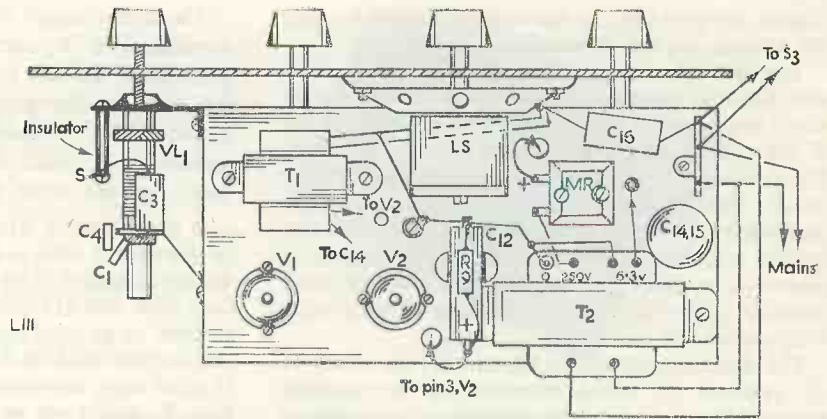

The Amplifier Function

When $S_{1,2}$ is rotated to the third, "Gram", position—as depicted in Fig. 1—the aerial inductor is effectively isolated since its tuned winding becomes short-circuited. At the same time the signal grid of V_1 is connected to the gram input socket. If the output from a crystal pick-up is fed to this socket the unit will now perform as an amplifier.

Although V_2 performs in the same way as before, V_1 does not, and VR_1 , which acted previously as the regeneration control now operates to vary volume. In the anode circuit of V_1 the r.f. choke offers no opposition to the audio frequency and C_8 and C_9 , which previously acted as parts of a filter, now serve partly as paralleled frequency correction components. Frequency correction is also applied to the input circuit of V_1 and this, together with the large range of control afforded by VR_2 , enables very pleasing results to be obtained from e.p. and l.p. recordings. Quality can be further enhanced by

connecting a larger extension speaker to the secondary of T_1 .

Constructional Notes

The positions of the various controls can be seen from the layout and wiring diagrams, Figs. 2 and 3, and although component positioning is not excessively critical, it will be found convenient to orientate the valveholders and control potentiometers as shown. A 4-pole, 3-way selector switch is depicted but other types may be used provided that at least two poles and three settings exist. The chassis dimensions are 8 x 4 x 2 in deep, and Figs. 2 and 3 are drawn to scale. Control spindle spacing is given in Fig. 5.

To enable the tuning inductor VL_1 to obtain a high degree of self pick-up it requires to be mounted clear of the chassis and a suitable mounting bracket is shown in Fig. 4. This may be made from 16 s.w.g. aluminium or a similar material. A panel is also

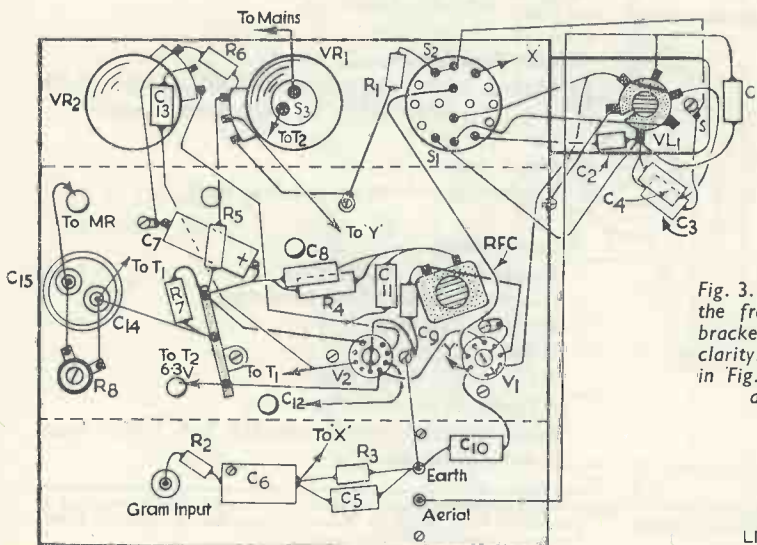

Fig. 3. The below chassis layout. In this diagram the front and rear aprons (together with the bracket for VL_1) are shown flat for reasons of clarity. The tag marked "S" in this diagram (and in Fig. 2) is a stand-off anchor tag. The side aprons of the chassis are not shown here

required—see Fig. 5—and this is held to the chassis by means of the two lower speaker bolts. A $\frac{1}{2}$ in strip of wood holds the panel clear of the chassis. The panel is inclined slightly in the prototype cabinet in order to improve the frontal appearance and bring the control knobs to a more convenient height, but should an upright mounting be preferred the panel may be shortened to the broken line shown in Fig. 5.

The tuning inductor is secured by means of a spring spine clip, but to ensure a more rigid fixture a straining wire of 16 s.w.g. copper wire should be soldered from tag 4 to the chassis side flange as shown in Fig. 2. In Fig. 3 the wiring around VL₁ has been expanded slightly in the interests of clarity.

A fixed capacitor of 500pF will be found already connected between tags 4 and 6 when the inductor is purchased and this should be carefully removed and replaced by one of 100pF (C₄, Fig. 1*). The freed 500pF capacitor may then be used as C₂. Use of a stand-off insulator ("S" in Figs. 2 and 3) will be found helpful as an anchor point. Tag 3 of the inductor is also used as an anchor point.

It will be found beneficial to remove the inductor core completely prior to wiring, so that the tags are more easily accessible. When all major components are in position wiring up may be embarked upon using leads covered with differently coloured insulation to facilitate final checking. Holes in the chassis through which leads pass should be fitted with grommets.

Testing

The completed wiring should be carefully checked and the valves inserted. Particular attention should

* If the process of removing this capacitor is liable to cause damage to the coil leads connecting to tags 4 and 6, the capacitor wires should be cut rather than unsoldered.—EDITOR.

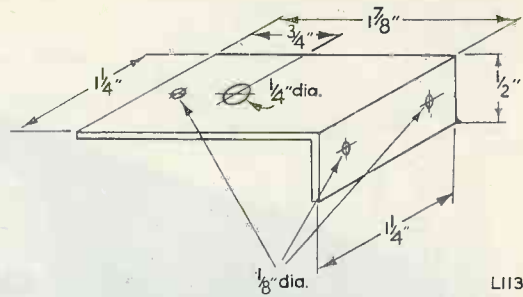

Fig. 4. The dimensions of the inductor mounting bracket

be paid to the connections to the metal rectifier and to the electrolytic capacitors to ensure that correct polarity has been observed.

Ohmmeter tests may then be made to ensure that no direct short-circuit exists between the h.t. positive rail and chassis, but do not be dismayed if the meter needle swings over to a low resistance reading when first connected. If all is well it should move fairly quickly to a much higher resistance reading as the electrolytic capacitors charge. Should the meter pointer continue to show a low reading do not attempt to insert the mains plug until the fault condition existing has been cleared. Ohmmeter checks may also be made from the two valve signal grid pins to chassis to ensure that a circuit exists at all positions of the selector switch; these readings should be high due to the values of the grid resistors. A similar test may be made from each side of the mains plug to chassis in turn, an open-circuit indication being obtained if all is well irrespective of the setting of the on/off switch. When the meter prods are connected to the mains plug terminals, however, a low resistance reading should be obtainable when S₃ is closed and an open-circuit indication when it is opened.

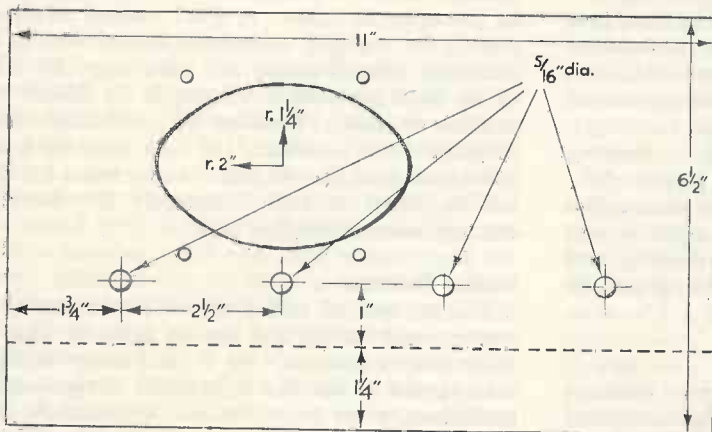
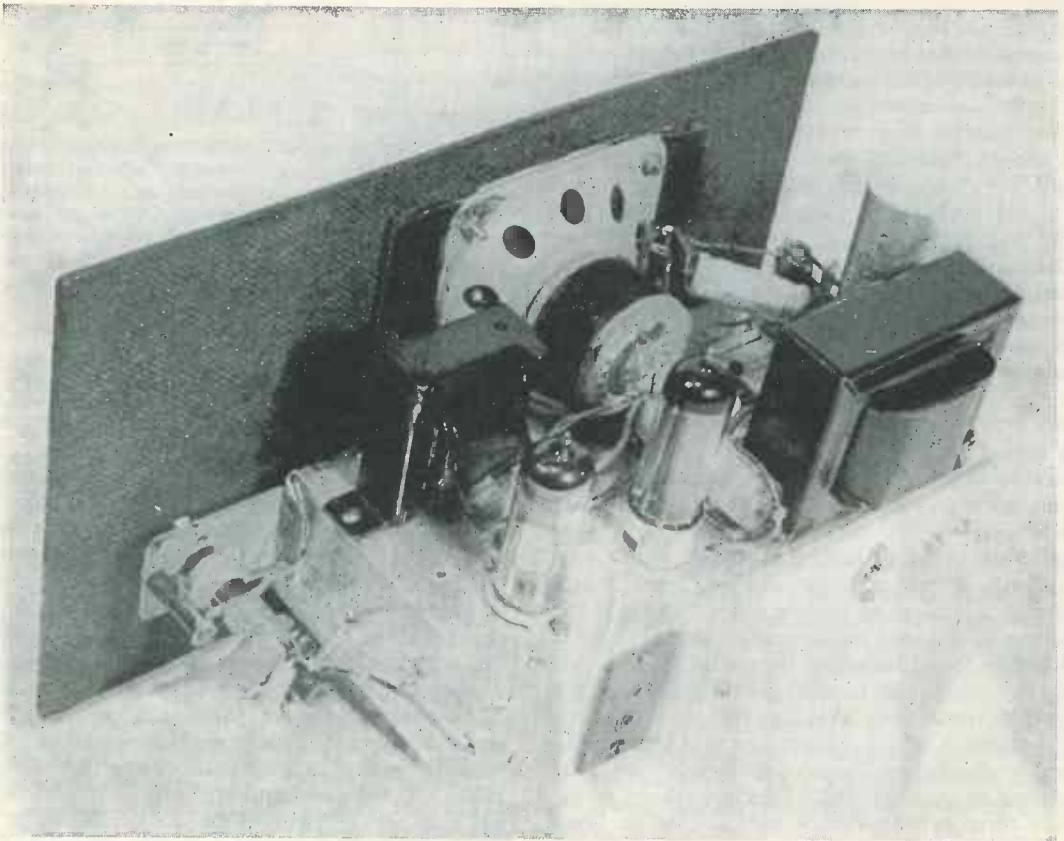

Fig. 5. The dimensions of the front panel. If an upright mounting is preferred, this may be cut at the broken line

LII4



A rear view of the "Double-Two" receiver-amplifier

Setting Up—Radio Function

When all is satisfactory the inductor core should be refitted and set so that it is approximately one half inserted into the former. Should it seem a trifle loose a layer of thin paper glued along its entire length will rectify the trouble.

The brass bush supplied should then be fitted into a control knob and the latter secured to the inductor spindle. The unit may be switched on and, with S_1, S_2 , turned to one of the broadcast band positions (and an aerial connected if considered necessary), no difficulty should be experienced in locating various transmissions. During this process VR_1 should be adjusted to bring the receiver close to the oscillation point. When no external aerial is used the receiver will be found somewhat directive and may need to be rotated slightly to strengthen the signal.

Setting Up—"Gram" Function

For gram reproduction it merely becomes necessary to insert a plug, connected with screened cable to a pick-up, into the Gram Input socket and

to rotate the selector switch to the appropriate position. A BSR Monarch autochanger performed well with the prototype. The value of R_3 might need some slight alteration depending upon the output afforded by a particular pick-up. If loud-speaker volume is inadequate this resistor needs to be increased in value. A good method of determining the required value is to adjust VR_1 to its minimum volume setting and then vary the value of R_3 until the overall volume is the *lowest* one is likely to need. Rotating VR_1 will then make adequate audio available, but care must be taken not to overload the speaker. Adjustments to VR_2 will be found to cater adequately for the bass characteristics of modern discs.

Station Indicator

The method of tuning prohibits the use of a conventional tuning dial but an indicator can be made from a piece of $1\frac{1}{2}$ in x $\frac{1}{2}$ in Perspex suitably marked and let into the front panel at right-angles to it close to the control knob. A cardboard disc indicator may then be pasted to the base of the

Fig. 6. A suggested alternative r.f. input circuit employing a tuning capacitor

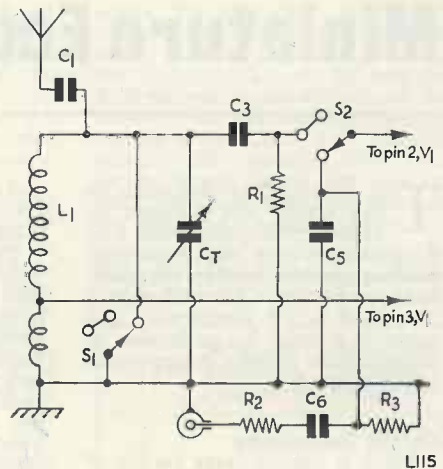
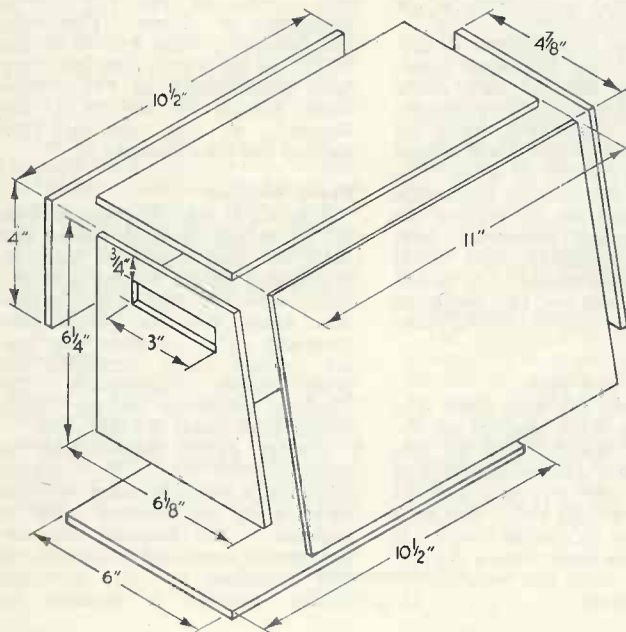

Fig. 7. The dimensions for the cabinet employed with the prototype. The front panel is that shown in Fig. 5

LI16.

knob. This was not done in the prototype as the values chosen for C_2 and C_4 in conjunction with circuit "strays" allowed the Light programme on 200 kc/s to be left tuned in, switching to the Medium waveband then resulted in the local Home Service transmission being received.

An Alternative Arrangement

Where the use of a conventional tuning capacitor is preferred, or where a less expensive, single waveband arrangement is desired, VL_1 may be omitted and the circuit of Fig. 6 tried. The inductor in Fig. 6, L_1 , can consist of an unused broadcast band coil with approximately 10–20 turns wound off on to a pencil from the "earthy" end to establish the cathode tapping point and then wound back on again. Alternatively, the existing "earthy" end of the winding may be made the tapping point and some 10–20 turns of fine, insulated wire wound on in the same direction as the existing turns from this point to form the cathode/chassis winding; this method will alter the waveband coverage slightly since the inductance value will be increased. The

second method has the advantage of obviating the necessity of making connections to the coil wire, which may be of the litz type.

If a primary winding exists it might also be possible to use this for aerial connection purposes. A single-gang variable capacitor, CT , of approximately 500pF will be suitable for tuning.

The above remarks are purely theoretical, and no practical tests on the efficiency of the circuit of Fig. 6 have been made.

Cabinet

The author professes little skill in carpentry and realises that the prototype cabinet work could be improved upon considerably. The dimensions given in Fig. 7, however, result in a cabinet of quite pleasing appearance. Internally fitted reinforcement strips of $\frac{1}{2} \times \frac{1}{2}$ in wood were used to strengthen the construction, and slots were cut in the sides to provide both ventilation and handholds. Plywood $\frac{1}{8}$ in thick was used throughout except for the panel, which was $\frac{3}{8}$ in. If desired a 6.3 volt pilot lamp may be fitted to the front panel.

Miniature Economical Oscilloscope

By M. J. DARBY

THE OSCILLOSCOPE DESCRIBED IN this article was designed by Messrs. Electronic Tubes Ltd, Kingsmead Works, High Wycombe, Buckinghamshire, who are the manufacturers of the 1CP31 cathode ray tube used in the instrument. The writer is grateful for permission to reproduce the relevant design details in this article.*

Current Oscilloscopes

There is quite a large variety of oscilloscopes on the market ranging from small portable models to the complicated laboratory instruments which employ many valves, which may have a frequency response level to about 100 Mc/s and which are so large and heavy that, together with their power supplies, they are most conveniently pushed about on a trolley. Such large oscilloscopes

* Messrs. Electronic Tubes Ltd. wish to point out that, whilst they manufacture the tube for this oscilloscope, they cannot enter into any correspondence concerning constructional difficulties encountered with the instrument.—EDITOR.

cost some hundreds of pounds, but are very useful instruments in the research laboratory.

The average experimenter or serviceman can, on the other hand, gain a great deal of very useful information from a fairly inexpensive oscilloscope which will have the further advantage that it will occupy only a small amount of space. The oscilloscope described in this article has been designed to achieve the utmost economy consistent with reasonable sensitivity and good practical performance. A small cathode ray tube and two miniature valves are the only electronic tubes employed.

The Cathode Ray Tube

The cathode ray tube used is a 1CP31 which is the smallest oscilloscope tube manufactured in this country. It has a screen diameter of a little over one inch and is fitted with a B8G (loctal) base. This tube is about 4.2in in overall length. It is, in fact, little larger than a conventional loctal valve and weighs only about 1.4 ounces.

The phosphor used in the 1CP31 is now known as type P31 and is blue-green in colour. This tube has previously been known as the 1CP1, but the screen type has lately been re-designated as P31. Older tubes known as the 1CP1 are identical, in fact, although the number has been changed.

Power Supplies

The 1CP31 may be operated with an h.t. supply of only 350 to 600 volts, but care should be taken to ensure that the h.t. voltage does not drop below 350 volts or the fluorescent screen may be permanently damaged. This comparatively low h.t. voltage vastly simplifies the power supply arrangements. The absolute maximum voltage rating for the final anode is 1,000 volts.

Further circuit simplification is obtained with the 1CP31 because this tube is so constructed that the focusing of the electron beam is automatic. The focusing electrode is internally connected to the cathode and therefore no h.t. potential divider network is required to

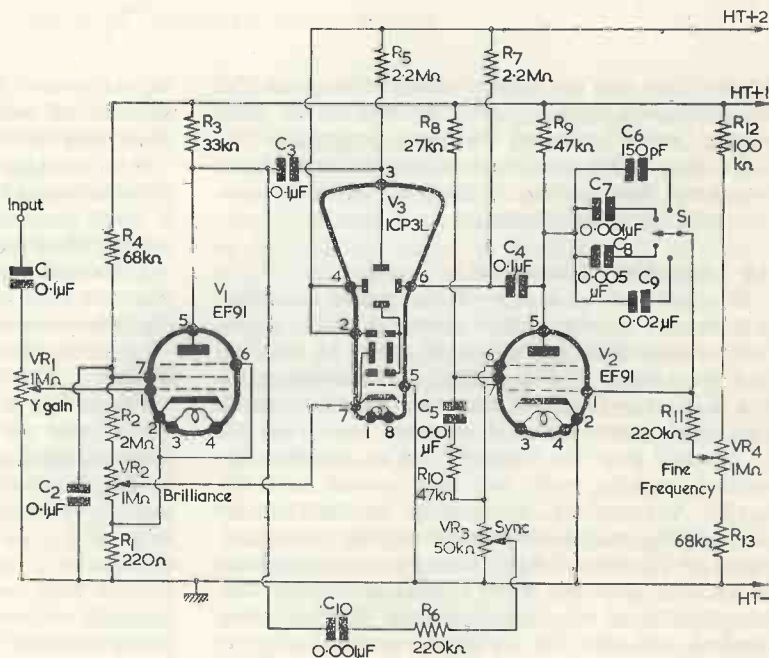

Fig. 1. Circuit of the oscilloscope

M314

supply h.t. to the focusing anode.

The tube heater requires 6.3 volts at 0.55 amp. There is a maximum peak heater-cathode voltage rating of 250.

The bias for the cathode ray tube may be conveniently obtained by connecting the cathode of the tube to a potential divider in the screen-grid-cathode circuit of a valve amplifier (as in the Fig. 1 circuit) or by employing a bypassed resistor in the tube cathode circuit to provide "auto-bias" by the same method as that commonly used in valve circuits (see Fig. 7).

Owing to the presence of a transparent conducting film connected to anode between the fluorescent screen and the glass face, the tube may be operated with its cathode at earth potential without distortion occurring in the trace when an earthed object is brought near to the screen.

Timebase

An oscilloscope is used to produce a kind of graph in which the X axis is time and the Y axis is the instantaneous voltage under test. If the trace is to be undistorted, it is necessary that the spot traverses the screen (or a portion of it) from left

to right at a constant speed. A timebase circuit is used to generate the "saw-tooth" voltage required to deflect the spot horizontally. In the Fig. 1 circuit the valve V_2 provides this timebase voltage for the X deflector plates. V_2 functions as a Miller-transitron relaxation oscillator.

The switch, S_1 , is the coarse frequency control; it switches one of the four capacitors C_6 , C_7 , C_8 or C_9 into circuit. The approximate frequency coverage for each range is shown in Table 1. In any one range the frequency is continuously variable from approximately the minimum to the maximum values shown in Table 1 by means of the fine frequency control, VR_4 . The maximum frequency in any one range is about ten times the minimum frequency of that range.

Principle of Operation

Let us assume that the capacitor selected by S_1 is initially charged to the full (or nearly to the full) h.t. potential. The anode of V_2 will be at a lower potential than the h.t. positive supply owing to current flow through the anode resistor, R_9 . The grid voltage is thus negative with respect to h.t. by the voltage drop

across R_9 plus that across the selected capacitor. As the cathode of V_2 is at h.t. negative potential, the grid potential will be negative with respect to the cathode of the valve by an amount equal to the voltage drop across R_9 . No grid current will therefore flow. As anode current flows, the selected capacitor discharges itself through the valve-anode-cathode circuit.

Table 1. Maximum and minimum sweep frequencies for various ranges.

Range	Minimum Repetition Frequency	Maximum Repetition Frequency
1	22 c/s	200 c/s
2	65 c/s	600 c/s
3	300 c/s	2,800 c/s
4	2,000 c/s	20,000 c/s

When the anode is at a fairly high potential, the screen-grid current and therefore the screen-grid potential remain almost constant. Under such conditions, i.e. above the "knee" of the I_a/V_a curve of the pentode with a constant screen-grid voltage, the anode current will remain almost constant as the anode voltage falls. Thus the selected capacitor supplies a constant current and the fall in anode potential of V_2 is almost linear with respect to time. This falling potential is applied to the X_1 deflector plate of the 1CP31 by means of the a.c. coupling C_4R_7 , the X_2 plate being kept at the constant potential of the h.t. +2 supply. Thus the electron beam is deflected by the X deflector plates so that the spot on the screen covers equal horizontal distances for equal times.

As the anode potential of V_2 drops below that of the screen-grid, some of the electrons which have passed through this grid will be attracted back to it. Thus the anode current decreases, the screen-grid current increases, the voltage drop across the screen-grid resistor, R_8 , increases and the screen-grid potential decreases with respect to the cathode. This decreased screen potential is coupled to the suppressor-grid by the a.c. coupling C_3R_{10} ; the potential of the suppressor will therefore become negative when the screen-grid potential falls. The negative suppressor-grid repels the electron beam and in consequence reduces the anode current and increases the screen-grid current; causing a further decrease in screen-grid and suppressor voltage. Thus the effect is cumulative and the anode current is quickly cut off.

Components List

(Fig. 1)

Resistors

R_1	$\frac{1}{4}$ watt	220 Ω
R_2	$\frac{1}{4}$ watt	2M Ω
R_3	$\frac{1}{2}$ watt	33k Ω
R_4	$\frac{1}{2}$ watt	68k Ω
R_5	$\frac{1}{4}$ watt	2.2M Ω
R_6	$\frac{1}{4}$ watt	220k Ω
R_7	$\frac{1}{4}$ watt	2.2M Ω
R_8	$\frac{1}{2}$ watt	27k Ω
R_9	$\frac{1}{2}$ watt	47k Ω
R_{10}	$\frac{1}{4}$ watt	47k Ω
R_{11}	$\frac{1}{4}$ watt	220k Ω
R_{12}	$\frac{1}{4}$ watt	100k Ω
R_{13}	$\frac{1}{4}$ watt	68k Ω

Capacitors

C_1	500wV	0.1 μ F
C_2	350wV	0.1 μ F
C_3	350wV	0.1 μ F
C_4	350wV	0.1 μ F
C_5	350wV	0.01 μ F
C_6	350wV	150pF
C_7	350wV	0.001 μ F
C_8	350wV	0.005 μ F
C_9	350wV	0.02 μ F
C_{10}	350wV	0.001 μ F

Valves

V_1	EF91, 6AM6, Z77
V_2	EF91, 6AM6, Z77
V_3	1CP31 (or 1CP1) Elec- tronic Tubes Ltd

Potentiometers

VR_1	1M Ω linear
VR_2	1M Ω linear
VR_3	50k Ω linear
VR_4	1M Ω linear

Switch

Single-pole, four-way rotary wafer (S_1).

Other Components

Tube Escutcheon: Type S.I.C. 5165, Standard Insulator Co.
Valveholders: 2 B7G, 1 B8G.
Tagboards: 1 77/090/11 or similar (2 x 11 way) Carr Fastener.
1 $\frac{3}{8}$ in AE or similar (1 way) Carr Fastener.

Control Knobs

Bulgin K107 or similar.

Power Input Socket

Carr Fastener 75/444.
Plug and plug cover 2745 and 2706.

Y Input Sockets

Wander plug type.

The anode voltage rises during cut-off and the capacitor selected by S_1 is charged through R_9 . When the anode voltage is high enough, anode current flows even if the suppressor is negative. This causes a reduction in screen-grid current which in turn leads to an increased screen-grid potential and, by virtue of the a.c. coupling, to an increased suppressor-grid potential, until the valve is again operating with voltages similar to those it had at the commencement of the cycle. The anode potential then begins to fall again in a linear manner and the cycle is repeated.

Sweep Frequency

If a large capacitor is selected by S_1 , it will take a long time to discharge and the sweep frequency will be low. The control-grid potential of V_2 is largely controlled by the setting of VR_4 . The more positive the potential of this grid, the greater the anode current flowing through V_2 and the more rapidly the capacitor selected by S_1 discharges. VR_4 acts, therefore, as the fine sweep frequency control.

Y Amplifier

The nominal sensitivity of the cathode ray tube in the Y direction is $\frac{110}{V_{a3}}$ mm per volt. Therefore if 400 volts is applied to the final anode of the tube, the voltage required to deflect the spot by 1 mm is $\frac{400}{110}$, or 3.6 volts. Full screen deflection would require $28 \times 3.6 = 101$ volts. (Screen diameter is approximately 28 mm.)

In order to examine waveforms of small amplitude, a Y amplifier must be employed. The Y amplifier shown in Fig. 1 is a conventional resistance-capacitance coupled single stage amplifier, V_1 , the bias capacitor being omitted in order to increase the frequency response somewhat by means of the negative feedback thus introduced.

The gain of the amplifier—and hence the height of the oscilloscope trace for a certain input voltage—is controlled by means of the potentiometer VR_1 . When this control is in the mid-position, the stray capacitances (valve input, wiring and potentiometer) will be more effective in shunting the input than when the gain control is at maximum. Consequently the maximum frequency of satisfactory operation varies with the setting of the gain control, being greatest at the maximum gain setting (see Table 2).

Sensitivity

If an input of 1.5 volts R.M.S. is applied to the Y input terminal, the trace produced will scan the tube completely in the vertical direction at maximum gain. Thus a voltage of about 0.05 volts R.M.S. is required for a deflection of 1 mm.

The output voltage from the Y amplifier is coupled to the cathode ray tube by R_3C_3 . One of the Y plates of the cathode ray tube is internally connected to the final anode.

Table 2. The frequency response at various settings of the Y amplifier gain control.

Gain	Upper Limit of Flat Frequency Response	Frequency at which gain falls to 0.7 of that at 1,000 c/s
Full	50 kc/s	300 kc/s
Half	15 kc/s	80 kc/s

Synchronisation

If a stationary trace is to be obtained on the face of the cathode ray tube, it is necessary that the timebase sweep frequency should be an exact fraction of the frequency of the waveform under examination. It would be extremely difficult to adjust the timebase fine frequency control VR_4 so that a steady trace could be obtained, and even if this adjustment were carried out satisfactorily the slightest change in frequency of either the timebase or the input voltage under examination would cause the trace to move across the screen continuously.

In order to synchronise the timebase frequency to the frequency of the amplified waveform under examination, part of the amplified input voltage is taken from the anode of the Y amplifier via $C_{10}R_6$, and is applied to the suppressor and screen-

grid circuit of V_2 via VR_3 . If a negative synchronising pulse obtained from the anode of V_1 is applied to the suppressor circuit of V_2 slightly before anode current cut-off in this valve, the cumulative action would occur slightly earlier than would otherwise be the case. This cumulative action leads to the cutting off of the anode current of V_2 and the returning of the spot on the face of the tube to the left hand side of the screen.

The timebase frequency must be adjusted to a setting approximately equal or slightly lower than the desired value. The synchronising voltage (i.e. the amplified Y voltage) will then enable a stationary trace to be obtained.

If the synchronising signal is fed into V_2 at too high a voltage, the sawtooth waveform may become distorted. The potentiometer VR_3 should therefore be adjusted (if necessary, in combination with VR_4) so that the synchronising voltage fed to V_2 is little more than that required to obtain a steady trace. The smaller the signal input voltage, the greater the fraction of it which is required for synchronisation.

Power Supplies

No internal power supply is included in the oscilloscope, as a suitable supply would normally be available from other equipment. In some servicing applications the power supply could even be obtained from the equipment under test. The tube itself requires, from the h.t. +2 line, between 350 and 600 volts at a few microamps, whilst the Y amplifier and timebase generator require a supply of between 200 and 350 volts (h.t. +1) at 10 to 20 milliamps. It is possible to run the h.t. +1 and h.t. +2 lines from the same h.t. supply of 350 volts, but overscanning of the cathode ray tube will then occur in a horizontal direction. As was mentioned above, the tube should not be allowed to run at less than 350 volts.

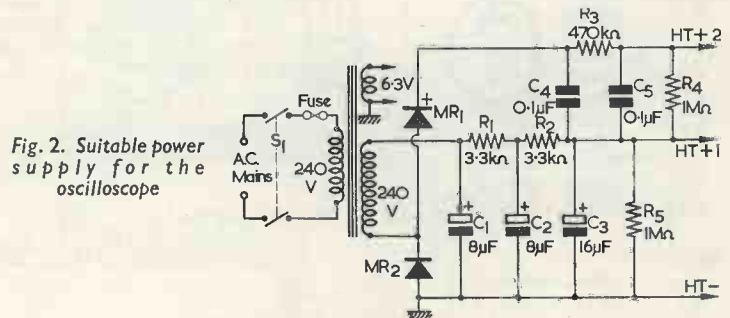

Fig. 2. Suitable power supply for the oscilloscope

M315

Those readers who wish to construct a power supply especially for feeding the oscilloscope will find the circuit of Fig. 2 suitable.

Construction

The complete oscilloscope—without power supplies—can be constructed on a chassis 5 x 5 x 2in deep of 18 s.w.g. aluminium. Suggested drilling details for the chassis, the front panel and the cathode ray tube support bracket are shown in Figs. 3, 4 and 5 respectively. Where two of these pieces of metal are bolted together, the drilling dimensions are stated for one of the two only, the other being drilled to fit. The timebase generator and Y amplifier valves are mounted on opposite sides of the cathode ray tube. The upright section of the tube support bracket is forward of its two 6BA mounting bolts. It should be noted that, with the chassis dimensions given, the tube face may appear in front of the front panel. If desired, the position of the tube support bracket on the chassis can be adjusted to cater for individual tubes, and this may necessitate mounting holes for the brackets whose positions differ from those given in Fig. 3. The drilling dimensions in Fig. 5 apply to a tube base with its fixing holes in line with the centre line of the spigot. Resilient material should be provided between the panel and the glass of the tube.

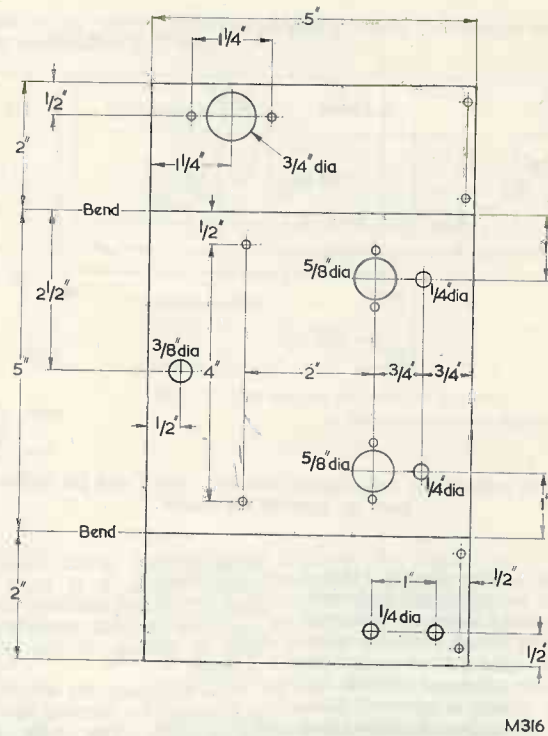

M316

Fig. 3. Chassis drilling details. Holes not marked are 6BA clearance. The two 2in sections are bent upwards, towards the reader

Components List (Fig. 2)

Resistors

R ₁	1/2 watt	3.3kΩ
R ₂	1/2 watt	3.3kΩ
R ₃	1/4 watt	470kΩ
R ₄	1/4 watt	1MΩ
R ₅	1/4 watt	1MΩ

Capacitors

C ₁	350wV	8μF	electrolytic
C ₂	350wV	8μF	electrolytic
C ₃	350wV	16μF	electrolytic
C ₄	350wV	0.1μF	
C ₅	350wV	0.1μF	

Rectifiers

MR ₁	250 volt	1mA
MR ₂	250 volt	30mA

Switch

S ₁	2-pole mains	on/off
----------------	--------------	--------

Transformer

Primary: 0-240V, 50 c/s.
 Secondaries: (1) 6.3V 1.2A,
 (2) 240V 30A.
 (Teledictor type TE6 or similar.)

Fuse

1	250mA.
---	--------

A suitable escutcheon is specified in the Components List for Fig. 1.

Care should be taken to ensure that the tube socket hole and the hole in the front panel are coaxial. The angle between the Y axis of the

tube and the centre line of the base spigot key is 22.5 ± 5 degrees.

A suitable under-chassis wiring diagram is shown in Fig. 6. It may be found convenient to solder the components to the tagboard before

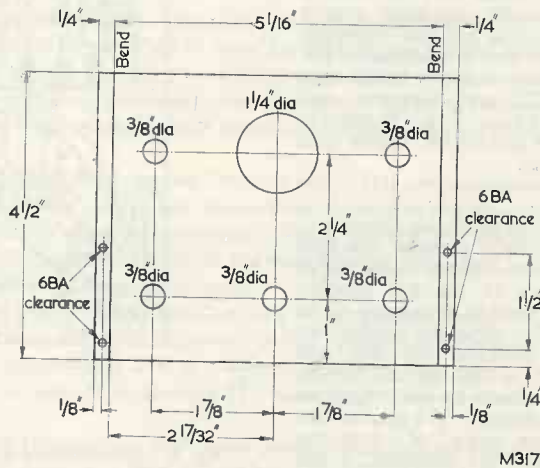

M317

Fig. 4. Front panel drilling details

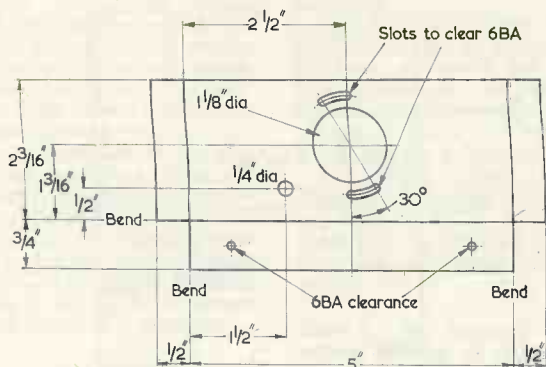

M318

Fig. 5. The cathode ray tube support bracket. The $\frac{1}{2}$ and $\frac{3}{4}$ in sections are bent up, towards the reader

this is fitted to the chassis. Major components, including the tagboard, can then be fitted to the chassis, care being taken to ensure that the valveholders and tagboard are orientated correctly. The valve and cathode ray tube heater wiring is inserted next, after which the tagboard connections may be joined to the relevant valveholder tags, tube socket and h.t. supply points. Finally the components which are mounted directly in the wiring are inserted and the connections to the brightness and synchronisation controls above the chassis are made. The capacitors C_6 to C_9 inclusive may be mounted directly on the switch, S_1 .

The tube is not very susceptible to interference from magnetic fields, especially at higher h.t. voltages, but a mu-metal shield may be fitted if desired. Suitable mu-metal shields are manufactured by: The Telegraph Construction and Maintenance Co. Ltd, Crawley, Sussex, under type number ET2; and Magnetic and Electrical Alloys Ltd, Burnbank, Hamilton, Lanarkshire, under type number ST39.

Testing, etc.

As with most electronic equipment, it is worthwhile quickly checking that there is no direct short circuit across either of the h.t. supplies before the unit is connected to its power supply. When the oscilloscope has been switched on and has warmed up, a line should appear across the screen as the brightness control is adjusted. If a spot is seen on the screen instead of a line, this indicates that the timebase is not functioning and the circuit connected to V_2 should be examined. If,

however, the screen remains completely blank, it is most probable that h.t. is not reaching the cathode ray tube or that excessive cathode bias is cutting off the tube anode current.

The timebase line should be made horizontal by turning the tube and its socket. The tube socket is mounted in slots (see Fig. 5) which enable this operation to be easily carried out.

The fine frequency control, VR_4 , should be moved through its complete range, with S_1 successively in

each of its four positions. The horizontal line should remain on the screen during the whole of this test, showing that the timebase functions over the whole of each of the four ranges.

A 50 c/s signal, such as that from a heater supply, may now be applied to the Y input terminals and it should be possible to control the height of the trace by means of the Y gain control, VR_1 . With the coarse frequency control S_1 set in its lowest frequency position (i.e. with the largest capacitor, C_9 in circuit), it should be possible to obtain synchronised traces corresponding to $\frac{1}{2}$, 1 and 2 cycles by use of the fine frequency and synchronisation controls. With the coarse frequency control set to the next position, a trace corresponding to $\frac{1}{2}$ cycle should be obtainable with approximately the same setting of the fine frequency control as when the two cycle trace was obtained with the coarse frequency control in the lowest frequency position.

Table 3 shows typical voltages appearing at valve electrodes for an h.t. +1 potential of 235 volts.

The oscilloscope may be tested more completely if an audio frequency signal generator is available.

Lissajous Figures

Those readers who wish to construct the simplest possible unit using the 1CP31 tube (without

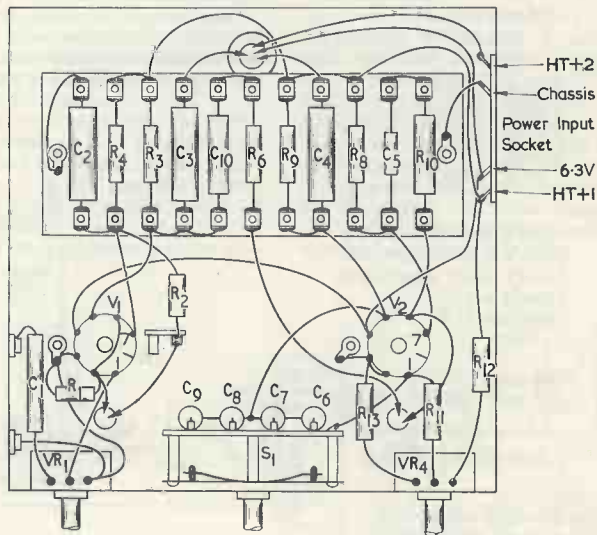

M319

Fig. 6. Under-chassis wiring diagram. Wires ending in arrowheads are passed through grommets in the chassis. The components R_5 , R_7 , VR_2 , VR_3 and V_3 are fitted above the chassis

Table 3. Typical voltages appearing at the electrodes of the valves, as measured with a model 7 Avometer for an h.t. +1 supply potential of 235 volts.

Valve	Grid g_1	Screen g_2	Suppressor g_3	Anode	Cathode
V ₁	0	+140	+0.8	+110	+0.8
V ₂	-0.3 to -0.5*	+170	-0.1	+70 to +80*	0

* Voltage reading dependent on the setting of VR₄

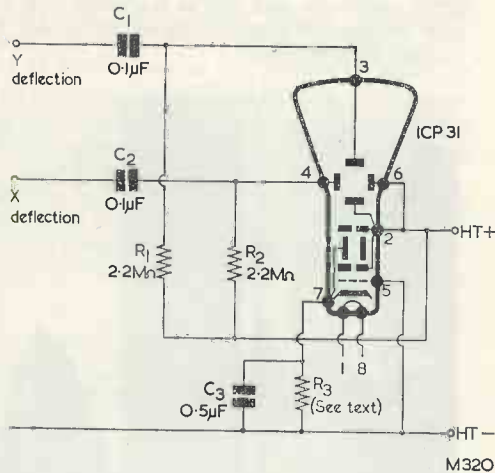

Fig. 7. This simple circuit can be used to display Lissajous figures

amplifier or timebase) for displaying Lissajous figures or for other purposes, will find the circuit of Fig. 7 suitable. The value of the resistor R_3 required in this circuit depends on the h.t. supply voltage. For h.t. supply voltages of 350, 500 and 600 volts, the values of R_3 required are 500k Ω , 620k Ω and 690k Ω respectively and increase in proportion up to 1M Ω at the maximum permissible tube voltage of 1,000 volts.

STC INTEGRATED ELECTRONIC SYSTEMS DIVISION FORMED AT ENFIELD

Standard Telephones and Cables Limited is to concentrate its electronic systems activities in a new division, the Integrated Electronic Systems Division, the headquarters of which are to be at Burleigh House, Great Cambridge Road, Enfield, Middlesex. This move, which will strengthen the Company's activities, particularly in the industrial control and automation fields, will involve the transfer of electronic computer production from Newport, Monmouthshire, to Enfield, and its integration with the Instrumentation and Control Division already there, and with the Message Switching Division at New Southgate, London.

Announcing this today, Mr. H. A. Saye, General Manager of the new Division, said: "This combination of know-how and technical skills will enable STC to design and supply control and automation systems of any size, incorporating computer-switching, data transmission and supervisory control techniques. These systems will employ the most advanced techniques in that they will combine STC's traditional skills in the telecommunication field with the more recent developments in the data handling and electronics fields generally".

The STC computer factory at Newport is being taken over by the Company's Transmission Systems Group which already has substantial manufacturing facilities in Newport. The expansion of the Transmission Systems Group will mean that the total number of manufacturing staff employed by STC in Newport will be at least maintained.

The manufacturing facilities for the new Division will be at existing STC factories at Chase Side, London, N.11, and Progress Way, Enfield, Middlesex.

Mr. H. A. Saye, the General Manager of the new Division, has had fifteen years of management experience both in the United States and in Europe in the control and automation field, having been concerned with engineering, manufacturing and marketing aspects of systems of this kind.

IDEAS FOR AN AERIAL MAST

SUPPORTING A LONG WIRE AERIAL CAN PRESENT quite a few problems. The chimney stack can usually be worked into the scheme at one end, but the other end has also to be raised into the air for best results. In addition, the whole thing must be kept fairly taut if drooping feeders and consequent loss of height are to be avoided. The following ideas, which have been used successfully by the author, may be of interest to others with similar problems.

Aerial poles

Wooden poles of the thirty to thirty-five foot length class are expensive these days and are difficult to get transported to one's QTH. They need almost yearly painting and can warp badly in alternate sunny and rainy weather. On the other hand, a 2½ in diameter aluminium alloy pole 20 or so feet long is now readily available as a TV aerial array support, and can be purchased from most metal suppliers dealing in this type of equipment. Moreover, such dealers will usually deliver it without much fuss.

The extra height can then be provided by making up a reinforced concrete post to which the pole can be fitted. In the writer's case, a post was made of concrete—three of sand to one of cement—poured into a mould made of ½ in boarding. Reinforcement was provided by a few lengths of old iron piping of suitable length purchased from a nearby scrap yard. Block the mould up well all along its length, or lay it flat on firm level ground, since it becomes quite heavy once the semi-fluid concrete mix is in and, if not well supported, will sag badly. Leave for at least a couple of weeks to really harden off, and keep some sand and cement over to help in bedding the post in the ground. Dig a fairly big hole for the post, say three feet deep and about as much in diameter. Mount the post upright in this hole and get someone to hold it vertical whilst you pack in broken bricks, stones, or any other hard rubble which may be available. Finally fill in the spaces with the sand and cement mixture, this being made quite fluid so that it permeates the crevices thoroughly. Once dry, this will support your post very firmly.

Mounting the pole

The aluminium pole should be fixed to the post with a couple of iron brackets similar to that shown in the photograph. These can be made up at the local blacksmith's quite reasonably. Each bracket consists of three parts, two similar in shape to hold the pole and fit round the post and the third to fit round the back of the post. The photo shows the details clearly.

Erection of the lightweight pole presents no problems. A pulley and halliard are attached to the top, one end of the halliard going to the end of the aerial and the other being brought down the

mast. And here we are presented with another problem: how to fix the halliard so that the inevitable variation in length with changing weather conditions can be taken care of. The writer used to use heavy weights—window sashcord weights were suitable—but for long aeriels with heavy feeders, these were often not heavy enough. Just recently he discovered that spare springs can be purchased for the "chest expanders" beloved by the physical culture enthusiasts. There are two "strengths" of these—"20 lbs" and "40 lbs". For a 132ft antenna, centre-fed with twin feeders, you need the "40 lbs" spring and if fitted as shown it will keep the long wire aerial extremely taut and at the same time will take care of any strains produced by wind, rain or varying temperature.

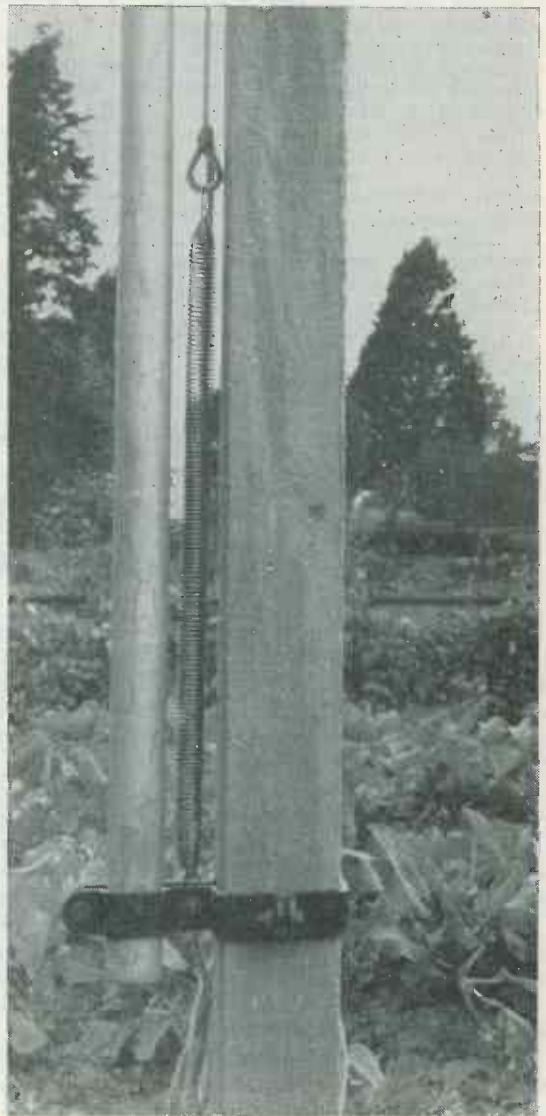

Beginner's Transistorised Morse Oscillator

By Roger H. Read

THIS OSCILLATOR IS DESIGNED TO HELP THOSE people who are learning Morse, particularly those who are trying to reach the G.P.O. standard of twelve words per minute in order to obtain an amateur transmitting licence.

When built, the oscillator is quite small and may be housed in a simple case easily and cheaply. The circuit uses a p.n.p. Mullard OC70 transistor. Alternatively, a "red spot" surplus transistor may be employed if so desired. The oscillator provides a clean note without clicks or chirps and does not, of course, require any setting-up before use.

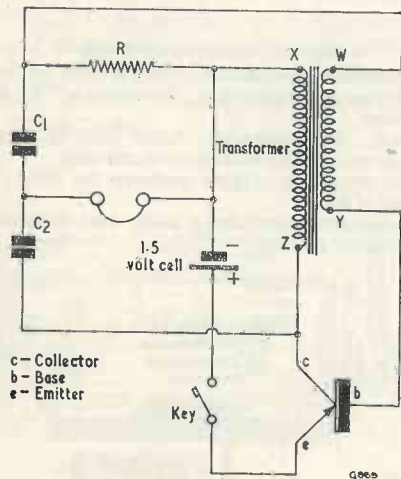

Fig. 1. The circuit of the oscillator

Components List

(Fig. 1)

- R 270k Ω $\frac{1}{4}$ watt 20%,
- C₁ 0.01 μ F paper
- C₂ 0.01 μ F paper
- 1.5V cell
- High resistance headphones
- Morse key
- Mullard OC70 transistor (or surplus "red spot")
- Transformer, Repanco TT10
- Tagboard (optional)
- Transistor holder (optional)

Construction

The construction of the writer's model appears in Fig. 2. This employs a tagboard having a central row of holes, the length used here incorporating two sets of six solder tags. It was found possible to fit the transformer below the board by passing one of its mounting lugs through a central hole and by bending the other mounting lug around the edge of the board, as shown. The remainder of the components are then fitted above the board.

In Fig. 2 the connections from the transistor are identified e, b or c accordingly, the appropriate transistor connections being shown in the inset diagram and in Fig. 1. Similarly, the connections from the transformer are identified by the letters W, X, Y and Z.

It will be helpful to mount the components above the board in the first instance. In the diagram, the transistor is shown fitted to a transistor holder.

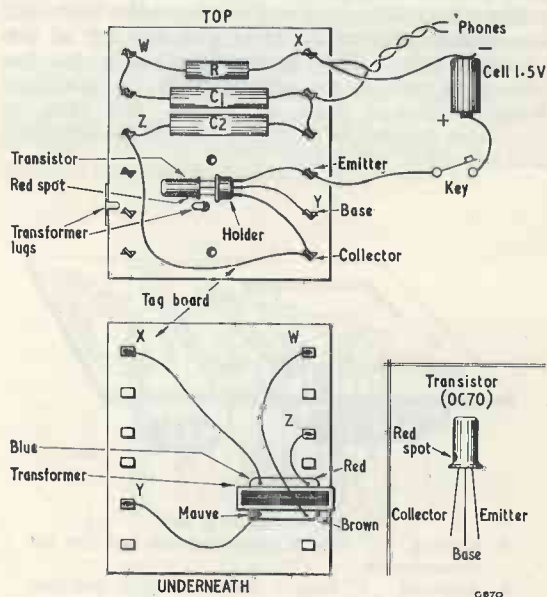

Fig. 2. The layout employed with the prototype oscillator

This holder may be omitted, if desired, the transistor lead-outs being connected directly to the appropriate tags. Great care should be taken to avoid overheating the transistor, a heat shunt or a pair of taper-nosed pliers being applied to each transistor lead-out wire when the corresponding tag connection is soldered.

The 1.5 volt cell, headphones and Morse key are not, of course, mounted on the tagboard.

Layouts other than that shown in Fig. 2 may be used, provided that the transistor and transformer connections correspond to those given in Figs. 1 and 2.

Printed Circuit Soldering

By P. REYNOLDS

THE WRITER HAS RECENTLY ENCOUNTERED SEVERAL people who have assembled printed circuit kits and, without exception, the soldering on these could have been vastly improved. Connections were of the "blob solder" type, in which the wires have been pushed through the holes in the printed panel, solder made to run around in an uneven blob, and the wire finally cut off level with the top of this so-called joint. The "blob-solder" technique has also been noticed on commercially manufactured boards although here, of course, this may be inevitable because of mass production requirements and automatic assembly.

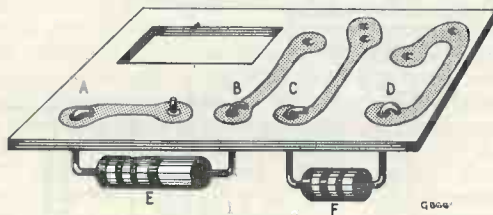

- Fig. 1. Formation of wire
- A. Correct. "L" bend is correctly made and lays flat on conductor.
 - B. Incorrect. "L" bend is incorrectly made and does not lay flat on conductor.
 - C. Incorrect. "L" bend does not lay flat on conductor, but is slightly above it.
 - D. Incorrect. Resistor tail "hooked" on to conductor.
 - E. Correct. Resistor $\frac{1}{2}$ in from panel.
 - F. Incorrect. Resistor too far from panel.

When high speed production is not an important factor, much neater joints can be made quite easily and without undue effort. Also, one can be confident that no dry joints exist when the work is complete. The accompanying diagrams illustrate correct and incorrect methods of wire forming and soldering, and are based on standards such as would be required for Government contract work. The writer has had considerable experience in wiring printed circuit boards in the correct manner shown in the diagrams, and he now finds this easier to carry out than the "blob" method he used previously.

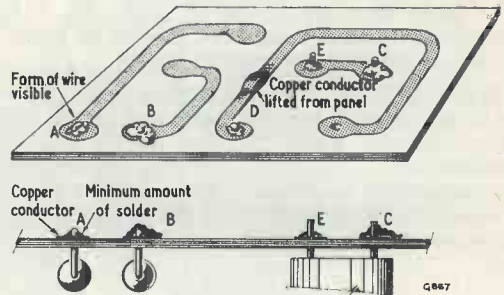

- Fig. 2. Application of solder
- A. Acceptable. Minimum of solder is used, and build up does not exceed $\frac{1}{8}$ in. Formation of "L" bend visible.
 - B and C. Not acceptable. Solder build up exceeds $\frac{1}{8}$ in and has run outside conductor area.
 - D. Not acceptable. Copper conductor has lifted from face of panel.
 - E. Acceptable. Minimum of solder used to establish electrical contact.

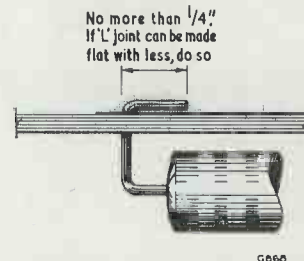

Fig. 3. Detail of an acceptable "L" joint

Fig. 1 illustrates correct and incorrect methods of forming wires, whilst Fig. 2 shows correct and incorrect soldering. The captions for Fig. 1 and Fig. 2 describe each example illustrated. It should be noted that joints C and E in Fig. 2 are not laid flat, this being due to the fact that the wires (or tags) here are lead-outs for coils and similar components. These cannot be bent over, as in the case of resistors and capacitors. Fig. 3 shows a detail of a satisfactory "L" joint.

Omnidirectional Loudspeaker Enclosure for Stereo

By A. Campbell Gifford

THESE IS NOTHING VERY ORIGINAL ABOUT THE idea of having a single cabinet omnidirectional speaker enclosure for stereo. However, what the writer has endeavoured to do here is to achieve a multi-speaker enclosure in a single cabinet giving no direct radiation of sound at all. The resultant effect is that the enclosure can be put in almost any position in a room, and that the effective area of stereo sound to be heard is more than doubled in width and depth when compared with conventional methods employing two separate wall-type speaker enclosures. Also, it substantially reduces the "hole in the middle" effect.

lagged and has a felt divider down the middle. The mid-range and treble units are situated at either end of the cabinet and face outwards, their beams being deflected by a pair of doors which direct the sound back toward the wall. The angles of the doors are adjusted according to the size of the room in which the unit is playing. The setting of these doors is very simple and most effective in use.

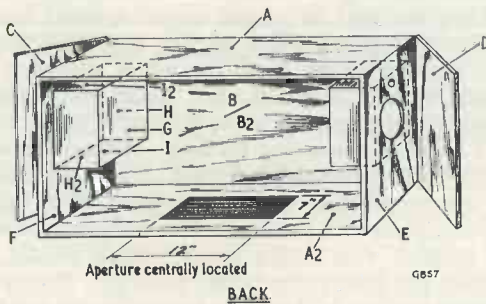

Fig. 1. This diagram identifies the various parts of the enclosure and shows the position of the aperture in the bottom

In its simplest form the unit requires a pair of 10 or 12in speakers, a pair of 8in speakers and a two-way crossover network for each set. In its most elaborate form the unit can use a pair of 12 or 15in speakers, a pressure type for mid-range, and a couple of tweeters and two crossover networks.

The basic design is simple, the two bass speakers operate in a common enclosure which is heavily

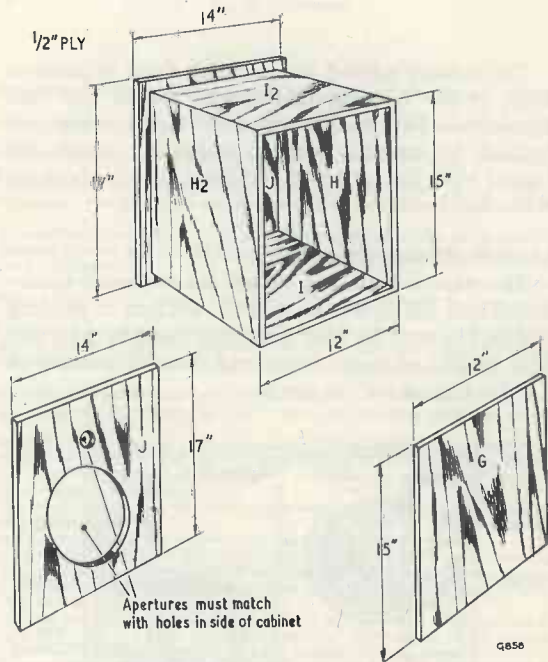

Fig. 2. Details of the enclosures employed for the top, or middle and tweeter, speakers. The holes illustrated in part J have dimensions suitable for these speakers, the small hole not being required if a tweeter is not used. The inside of each enclosure should be lagged with half-inch carpet underfeltng

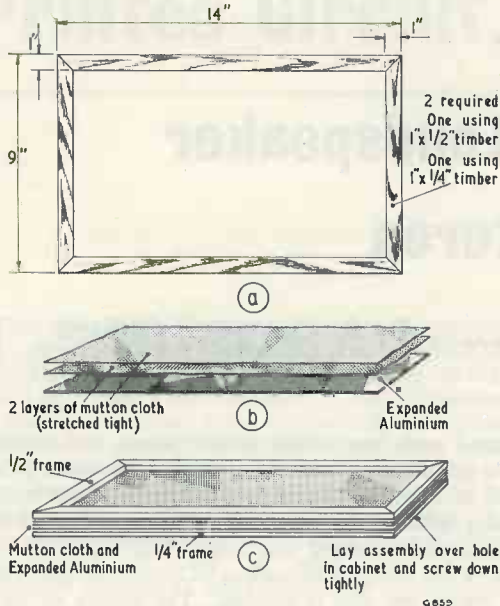

Fig. 3. The acoustic filter. The framework is shown at (a), the filter material at (b), and the complete assembly at (c)

The cabinet is fitted with a simple form of acoustic filter at the bottom, immediately below the bass speakers. The mid-range and treble units are housed in separate sealed enclosures which are lagged with $\frac{1}{2}$ in carpet underfelted on top, bottom, sides and back.

Method of construction

The unit is built mainly of $\frac{3}{4}$ in veneered blockboard and $\frac{1}{2}$ in plywood. A small amount of beading will be required for edge finishing, together with two 27in lengths of piano hinge and a small quantity of $\frac{3}{4}$ x $\frac{1}{4}$ in edging for the doors.

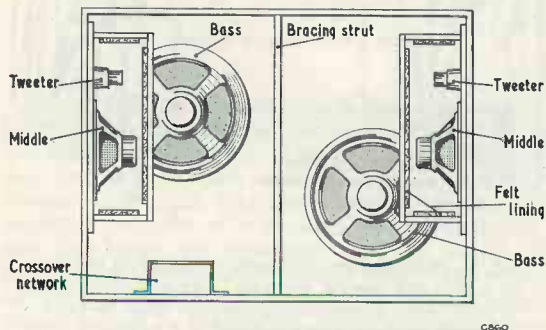

Fig. 4. Looking into the cabinet from the front (with side panels removed from the two internal enclosures)

From the $\frac{3}{4}$ in blockboard cut out parts A, A2, B, B2, (B and B2 are the front and the back), C, D, E, and F. (See Figs. 1 and 5.) From $\frac{1}{2}$ in plywood cut parts G, H, H2, I and I2. These last parts need to be duplicated for the other end of the cabinet and their dimensions are given in Fig. 2. Also needed are two parts J, which is similarly shown in Fig. 2.

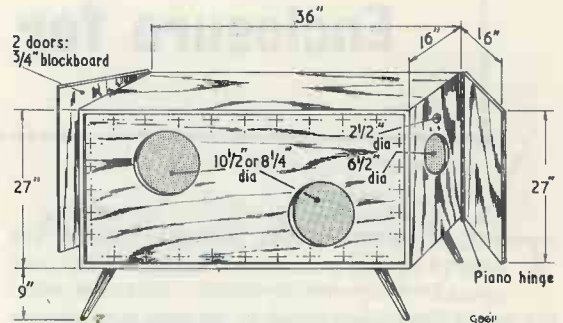

Fig. 5. The main dimensions of the cabinet. If $\frac{1}{2}$ in edging is used along the top and front of the doors these will need to be cut to dimensions $\frac{1}{2}$ in shorter than those shown. When the front and side panels are covered with Tygan folded over the edges before assembly, their dimensions should be modified to allow for the thickness of material. The diameters for the speaker apertures are typical

The top framework for the acoustic filter can be cut from $\frac{1}{2}$ x 1in deal and made like a picture frame. See Fig. 3. Material and expanded aluminium can then be stapled on and secured with a similar framework made of 1 x $\frac{1}{4}$ in wood glued and screwed to the top. The whole can then be drilled through in six or eight places and screwed down over the aperture in the bottom of the cabinet.

It must be noted that the front of the cabinet is dummy—no sound issues from it. It may, therefore, be left as polished wood or covered with Tygan fabric, whichever is preferred. The end panels should be covered with Tygan fabric, which should be applied and folded over before assembly. Whatever jointing method is chosen remember to cut not less

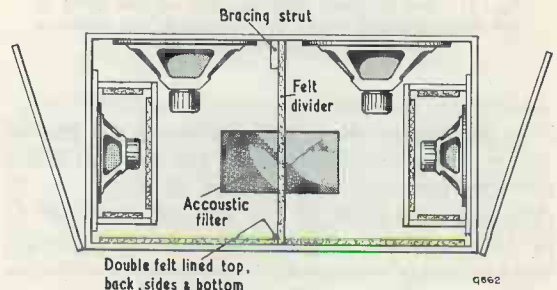

Fig. 6. Looking into the cabinet from the top

than $\frac{1}{16}$ in smaller to allow for the space taken up by the fabric. An alternative method is to make a complete wrap around with the fabric, but this is expensive since not less than two yards will be needed to make a job of it. The four legs can be purchased quite cheaply from any good do-it-yourself shop.

There is a bracing piece of 4 x 1 in wood down the middle of the main speaker mounting board, (see Figs. 4 and 6); this should be screwed and glued into position early on and it will, of course, be $1\frac{1}{2}$ in shorter than the height of the speaker mounting board, i.e. $25\frac{1}{2}$ in.

Whatever system of jointing is used, the employment of glue blocks and generous quantities of glue is to be recommended. This makes for a solid, rigid structure and aids in simplicity of construction, especially if it is a single-handed job.

Care should be taken to mount the mid-range (and, if used, top) speakers in their enclosures before assembling the front and back of the cabinet. The crossover networks should be screwed down to the

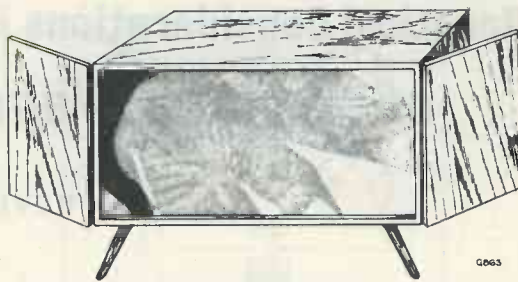

Fig. 7. Front view of the finished cabinet. There are no speaker apertures in the front panel, the sound being radiated from the back and sides

base of the cabinet and connected to a socket in the bottom, to which a plug can be fitted from the outside.

The felt lining for the main cabinet should be fixed with glue or Pliobond, and the panel pinned every six inches or so.

Unique TV Outside Broadcast/Videotape Recording Vehicle

Built in record time for use on the continent of Europe is a Marconi mobile four-camera television outside broadcast and Videotape recording unit of a type and standard believed to be unique in the world.

The unit, which has been manufactured for InterTel, N.V., a new television programme recording organisation operating throughout Europe, had its first assignment scheduled for 15th January at a theatre in Vienna.

The complete unit consists of two semi-trailer vehicles, one housing the camera channels and associated equipment and the other the Ampex Videotape recorders. Each is towed by a 7 ton Bedford long wheelbase tug.

The installation is believed to be the most comprehensive of its type in the world, embodying many new features. Although in the form of two separate vehicles, each with its own prime mover, the television and Videotape recording units are designed to operate in conjunction whilst on the move.

InterTel, N.V., of Amsterdam, Holland, is the holding company of an international group of InterTel companies engaged in the production of television programmes on an international basis. These companies are at present located in Paris; Brussels, Munich, London and New York, and further ones will be incorporated in the immediate future in Rome, Madrid and Stockholm.

The activities of the group are based on the concept that, especially on the continent of Europe, a healthy development of television can be achieved only through international co-ordination of programme production. Wherever practicable the InterTel group intends to develop its own facilities, of which the Marconi mobile unit is amongst the first.

The Group plans to operate in the closest possible co-operation with existing broadcasting organisations, whether private or governmental. Its first productions, all recorded on magnetic Videotape, were simultaneously purchased by the television authorities of Germany (West Deutsche Rundfunk), Austria, Switzerland and Finland. Initial financing of the InterTel organisation is effected by a group of private bankers from a dozen countries.

The complete outside broadcast unit consists of two Bedford 7 ton long wheelbase tugs and two semi-trailer vehicles; in both cases the overall dimensions, including the tugs, are 44 feet long by 8 feet wide by 13 feet high. One vehicle houses the four camera channels and associated equipment and the other the Videotape recording equipment.

Electrical power for both vehicles is normally provided by a 40kVA 50 or 60 c/s diesel-electric generator which is fitted behind the driver's cab of the recording vehicle. The output of the generator is fed to a 40kVA transformer housed in the front of this vehicle and then on to two 20kVA automatic voltage regulators which give 117 volts at the selected periodicity to all the electronic equipment. Alternatively a range of external power sources can be fed direct to the transformer on which suitable selector switches are provided.

The complete outside broadcast unit is designed to operate whilst on the move; to this end the camera vehicle is connected to the recording vehicle by 20 feet of cable harness which is fitted with tension spring arrangements at either end.

Provision for the stowage of cable drums is made on a special drum rack situated behind the Bedford tug head of the camera vehicle.

The camera vehicle embodies four Marconi Mark IV image orthicon camera channels Type BD 863, a matrix mixer Type BD 920 incorporating 12 inputs, A/B (i.e. mixing along two outputs), cut and special effects, and a 10-channel sound mixer Type BD 966 with facilities for group fading. The sound mixer together with the audio tape recorders occupy an entirely separate compartment, a feature not previously incorporated in O.B. vehicles. The vision equipment throughout is designed to operate on 405, 525 or 625 line standards.

For the first time in outside broadcast vehicles "Hands Off" technique is used for the camera channels. This is an important characteristic of the camera design in that the inherent stability is such that after only a very short warm up period, the majority of controls can be set up and forgotten, and therefore only a remote control panel operated by one man is provided for lift and iris of each camera channel.

Special talk-back and private line equipment using the Marconi BD 887 communication unit is incorporated. All the electronic equipment is mounted in standard 7 foot cabinets, and comprehensive mains protection circuits are provided.

The camera vehicle itself is constructed of aluminium interlocking sections with insulation board and "Hardec" panelling on the inside. The production and sound control areas are fully air-conditioned; the heat generated in the equipment area is extracted by roof fans. (A camera can be mounted on the roof, which is reinforced, and a platform is provided for the use of operating personnel.) Another camera can be fitted to a special "cow-catcher" on the front of the Bedford tug, and a further camera on the roof of the recording vehicle.

The recording vehicle is of generally similar dimensions and overall construction. It houses two Ampex VR1000C Videotape recorders, together with monitoring and interswitch equipment. Full remote control of "stop", "start", "record" and "play" is provided for both machines at a central control position. As stated earlier, the 40kVA generator is fitted behind the driver's cab of the tug and in the recording vehicle itself a 40kVA transformer is installed, with facilities for switching any incoming supply source to the two vehicles.

Practical Considerations in the Design and Construction of Mercury Vapour Power Supplies

By BEVERLY COURT

TO APPRECIATE POWER SUPPLIES UTILISING MERCURY vapour rectifiers, the reader must first have a knowledge of the valve rectifier. Mercury vapour rectifiers are distinct from the vacuum type, the reason being that the current is carried by mercury ions which are produced within the valve by the collision of electrons with the molecules of mercury. This phenomenon is easily recognised by the presence of a blue glow within the glass envelope and is commonly known as ionisation. It is this ionising process that neutralises the space charge surrounding the cathode and which causes the internal resistance of the rectifier to be reduced. This characteristic allows the mercury vapour rectifier to have an excellent regulation property, thus enabling large currents to be passed from cathode to anode with very little loss. The voltage drop is more or less constant in any mercury vapour rectifier and is usually of the order of 15 volts.

This drop will remain the same so long as the maximum ratings of the valve are not exceeded. It is essential therefore to bear in mind that, to avoid positive ion bombardment which will destroy the cathode, the cathode heating voltage must be applied prior to the application of the anode voltage. This delay enables the cathode to reach correct operating temperature and thus provide the necessary full emission. Should this delay of anode potential be ignored the voltage drop would be excessive, resulting in the bombardment of the cathode and its destruction. Delaying the h.t. also ensures that the condensed mercury temperature has been raised to the minimum value at which the rectifier will satisfactorily operate.

It may be as well to mention that the rectifier must only be operated within the condensed mercury temperature limits specified by the manufacturer. Too low a temperature raises the voltage at which the rectifier will strike, and is not to be recommended

for cathode life. At the same time, too high a temperature will reduce the peak inverse voltage that the rectifier will be able to withstand.

Mercury vapour rectifiers should be mounted vertically in a well ventilated position, and should be free from any interference such as r.f. fields. It is also necessary to ensure that no r.f. is allowed to filter back into the rectifiers; suitable chokes should be used to prevent this.

To appreciate the power supply it is necessary for the reader to understand the various ratings and a brief mention of such parameters will assist in evaluating such a supply. Voltage and current ratings of mercury vapour rectifiers are based upon the maximum peak inverse voltage and the maximum peak and maximum average anode current. The maximum peak inverse voltage is the highest peak voltage that the rectifier can withstand in the reverse direction to that in which it is designed to conduct, whilst the maximum peak anode current is the highest current the rectifier will safely handle in the direction in which it is designed to pass current. The maximum mean anode current can be stated as being the highest value of current that the rectifier will withstand with a stable load.

The relationships between the various ratings can be easily calculated and they depend upon the type of circuit used. Two such circuits are shown in Figs. 1 and 2, the latter being the most popular with the amateur fraternity. The single phase half-wave circuit is difficult to filter, whereas the full-wave version is much easier to filter and is therefore preferred.

In the case of the single phase half-wave rectifier circuit, the maximum transformer secondary r.m.s. voltage can be calculated from the following expression:

Fig. 1. Single phase half-wave rectifier circuit

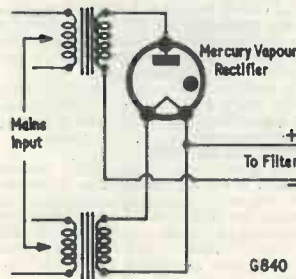
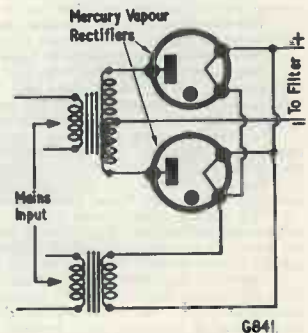

Fig. 2. Single phase full-wave rectifier circuit



0.7 x Peak inverse voltage of the rectifier.

Whereas, for the full-wave circuit, the maximum transformer secondary r.m.s. voltage is equal to:

0.35 x Peak inverse voltage of the rectifier.*

Other relationships for these two basic rectifier circuits are given in the table and will prove extremely useful to the constructor. It must, however, be remembered that the relationship values given do not take into account the voltage drop in the mains

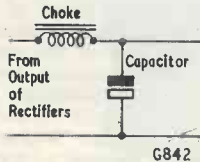

Fig. 3. Single section filter

transformer, rectifiers or filter choke windings under load conditions. That is to say, the output voltage of a power supply is reduced by the voltage drop through the rectifier, which in these cases is 15 volts, the transformer windings and the filter choke windings. Also, the output is further influenced by the type of filter system used.

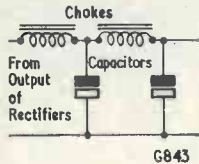

Fig. 4. Double section filter

So much for voltage and current relationships. Let us now refer to Fig. 5 which shows a method of delaying, for specified periods, the application of h.t. after switching on. Suitable delay switches are available today at reasonable cost, and are in the range of the constructor's pocket. Types suitable for the present application are the DLS10, DLS15 and DLS16, these being manufactured by Associated Electrical Industries Ltd.

Filter systems adopted and preferred for high voltage power supplies, such as those using mercury vapour rectifiers, employ a choke input, (Figs. 3 and 4). They have the advantage of being able to provide good voltage regulation as well as the ability to limit surges of current when first switching on.

* Another way of stating this is that, for both full-wave and half-wave rectifiers (assuming a choke input filter), the peak inverse voltage is 1.41 times the r.m.s. voltage across the total secondary winding.—Editor.

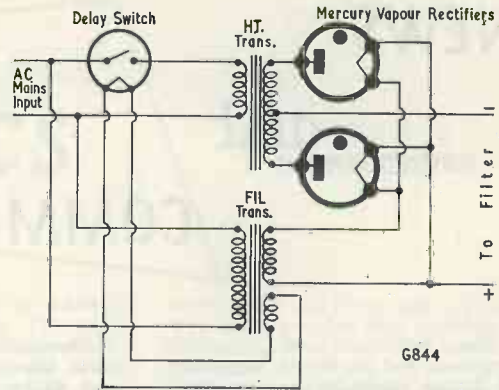

Fig. 5. Single phase full-wave rectifier circuit with delay switch incorporated for delaying the application of h.t. to the rectifier anodes

Furthermore, this type of filter limits the peak anode current during conduction in the mercury vapour rectifiers.

In many cases a swinging choke is used, the reason being that it is more economical since the inductance rises from its normal value at the rated load current to a high value at a low load current.

TABLE

Circuit	DC Output volts at Input to Filter	Maximum DC Output Current
Single Phase H.W.	0.45 x r.m.s. Voltage at Anode	1 x Maximum Average Anode Current of Valve
Single Phase F.W.	0.9 x r.m.s. Voltage at Anode	2 x Maximum Average Anode Current of 1 Valve

Swinging chokes are available from many advertisers in this journal together with various types of mercury vapour rectifiers which are suitable for amateur use. Such rectifiers include well-known types such as the 866A, ESU866, ESU101, RG3-250 and the GU50.

In conclusion, it is as well to mention that mercury vapour rectifiers should at first be operated with filament power only for approximately 30 minutes. This will distribute the mercury properly. Also, such valves must be operated vertically, base down, and in a well ventilated position free from draughts.

Pye TV Link for Jersey

Pye Telecommunications Limited of Cambridge have been awarded a further British Post Office contract for microwave link equipment to be used temporarily in the Channel Islands.

I.T.A. television transmissions from Cornwall will be received on the Island of Alderney and relayed over the 6,000 Mc/s microwave link to Jersey. Complete standby equipment will also be provided.

The 6,000 Mc/s microwave equipment will be suitable for 405 or 625 line television transmissions and will be installed by Pye engineers as part of the contract.

NEWS

and

COMMENT

The Institution of Electrical Engineers and the British Institution of Radio Engineers have recently made an important announcement which, we surmise, may in due course have significant results for some of our professional-readers.

The Councils of the two bodies have set up a Joint Committee with the following terms of reference:

"To suggest and to examine means by which, through collaboration between the two Institutions, the progress of electronic and radio engineering can be fostered, and to make recommendations for submission to the Councils of the two Institutions."

A Talking Computer

A system that enables a large computer to talk with people is being developed in the United States by Motorola Inc. of Chicago. It is called a "digital to voice converter", and works by combining photographically stored information and voice recordings.

Scientists believe that vocal information provided by a computer would be particularly useful in air traffic control for producing flight plans, giving pilots clearance, and issuing weather information. The system could also be used by banks and for automatic inventory control, as well as for supplying weather information for a telephone dialling service.

Motorola scientists have worked on the assumption that a vocabulary of 1,000 words accounts for about 80% of all conversations in English. As this small vocabulary allows the expression of most ideas, they believe that a vocabulary of several thousand words could provide computers with good conversational ability. Their new system will, therefore, store a vocabulary of several thousand words in the computer's "memory".

Associated TV Prize

The first award of the Associated Television Prize, given to the student who, in the opinion of Mr. Len

Mathews, A.T.V.'s Assistant Technical Controller (Communications and O.B.s), submits a specialist paper on television in the graduated examination of the British Institution of Radio Engineers which is worthy of a special prize, has been awarded to Wilfred Bennet, of 5 Wimborne Avenue, Blurton, Stoke-on-Trent. The paper which Mr. Bennet completed was set and corrected for the Institution's 1960 examinations by Mr. Mathews.

Since September 1959 Mr. Bennet has been a shift engineer with the Independent Television Authority. He was a radio operator during service with the R.A.F. and after demobilisation worked as a television service engineer with several Staffordshire companies.

Canadian Milestone

Last year the Canadian Broadcasting Corporation celebrated its 25th anniversary and this year it completes 10 years of television. C.B.C. claim to operate the longest television network in the world extending from the Atlantic to the Pacific. In addition to the national networks, there are many privately-owned radio and t.v. stations, some with affiliations to C.B.C.

Canada is, of course, a bilingual country and it is a considerable achievement that nearly all its 18,000,000 inhabitants scattered over such vast territory can be offered a complete radio and television service in both English and French.

Nigerian Milestone

Northern Nigerian television and sound broadcasting began recently. Initially broadcasting is from Kaduna, this being the first of several stages of a scheme to provide sound broadcasting in the whole of Northern Nigeria and television in the main areas.

E.M.I. Ltd. together with Granada and the Northern Nigeria Radio Corporation—a government body—have formed a company to provide equipment, programme material

and finance for the new service.

The initial installation includes an educational television system, a low-power transmitter to provide a public service, and a medium-power short-wave sound broadcasting system. Later stages will include a high-power television station at Jaji, and a microwave link system linking Kaduna with Kanu.

The Electroneers

The above is the latest of the Mullard films, providing another behind-the-scene view of the stimulating world of electronics, where new and exciting applications for industry are continually evolving. Such developments are frequently dependent on the creation of special valves and tubes to meet increasingly exacting specifications and with higher and higher efficiencies.

Dealing with a highly technical subject in a straightforward yet imaginative way, this new Mullard 20-minute colour film highlights the vast amount of research, organisation and knowledge behind the design and manufacture of these precision devices. Basically it is the life story—from prototype to production—of one special type of microwave valve called a travelling wave tube developed for multi-channel radio communications networks. At the same time it is also the story of the other three hundred and more equally specialised Mullard tubes and valves for applications ranging from radar and machine tool control to the measurement of minute electrical currents.

The film opens at the Mullard Research Laboratories where the product begins life as a few notes on a scrap of paper. The greater part of the action is, however, set in the company's Microwave Valve Plant—the biggest production centre for travelling wave tubes in Europe. The film also shows the work of the Mullard Applications Laboratories in fields as diverse as cooking and rock-splitting where modern microwave valves can help to solve a variety of problems.

Made by R.H.R. Productions Ltd., *The Electroneers* was written and produced by Richard Tambling. It will be available on 16mm stock for distribution to engineers in industry and government departments, educational establishments, radio and electronic societies and film societies. In addition it will find a wide audience among radio and t.v. dealers at the regular film meetings staged by Mullard throughout the country.

(continued on page 783)



RADIO

topics

By RECORDER

IF, SOME 25 YEARS AGO, YOU wanted to instal R/T in your Tiger Moth, the thing to do was to fit a transmitter-receiver type TR9 (complete with 2 volt accumulator and 120 volt h.t. battery) and couple this to an aerial suspended between wing tips and tail, and fitted at each end with glorified versions of Woolworth's china insulators. If you had a larger aircraft and decided to include equipment a little more powerful, the small fixed aerial could be augmented by a stainless steel wire trailing aerial, the latter being complete with several dozen lead beads at the end to weigh it down and catch unwary birds on the bonce.

Things have changed a lot since those days, and modern aircraft carry a considerable amount of radio and radar equipment, including HF transmitters having outputs of the order of several hundred watts. At the same time, the greater speeds of modern aircraft have rendered the earlier types of aerial almost completely obsolete. A trailing aerial could hardly be employed in a fast jet, and the drag of even small "whip" aerials can reach serious proportions at the higher speeds.

Suppressed Aerials

The answer to this problem consists of employing suppressed, or "flush", aerials, these using the airframe itself as a radiator. Thus, transmission and reception on v.h.f. or u.h.f. can be achieved with the aid of a slot aerial instead of a projecting dipole or quarter-wave rod, the slot appearing in the outer metal surface of the aircraft. The aerodynamic shape of the aircraft is not altered by the presence of the aerial, as the surface is continued

unbroken over the slot by means of an insulating material. Obviously, the aerial has to be positioned at a point where radiation in the desired direction takes place without introducing weaknesses into the airframe.

What is probably the most difficult requirement is the provision of a suppressed aerial for HF transmitters, since the frequencies involved are too low to allow the appearance of an element having a simple relationship to wavelength. In any event, the HF services of an aircraft are liable to require transmissions on many different frequencies. A common method of providing a suppressed HF radiator consists of introducing a notch aerial into the aircraft structure and of matching this to the HF transmitter by way of an aerial tuning unit. A notch aerial is an open-ended slot, and it may be positioned so that the open end appears at the leading edge of a wing or fin, the notch then extending back along the metal surface of the aircraft. Other positions may also, of course, be employed.

The accompanying photograph shows the Notch Aerial Tuning Unit type 7400 designed by Marconi's Wireless Telegraph Company for use in the Vickers VC10 aircraft. This tuning unit will be standard equipment in all aircraft of this type, and it is also suitable for the de Havilland Trident and for any other aircraft where a notch of suitable dimensions can be provided. In the Vickers VC10 and the de Havilland Trident the notch is accommodated in a section of the fin. In the Vickers Vanguard, a suitable notch is available in the wing root.

The Tuning Unit automatically matches the output of the HF transmitter to the impedance of the notch by motor-driven variable inductors and capacitors operated by servo circuits. The phase and magnitude of the input from the transmitter and the output to the notch are continually compared by discriminator circuits. The latter control the variable matching reactances, driving these to a position

where input and output are in phase. The notch aerial is then matched to the transmitter at the radiated frequency.

The frequency range over which the Tuning Unit functions is from 2 to 25 Mc/s, and it handles peak powers up to 1,000 watts. Input impedance is 52Ω and standing wave ratio is not greater than 1.3 to 1, whilst the time taken to tune to a new frequency is not longer than 10 seconds. The length of the Unit in

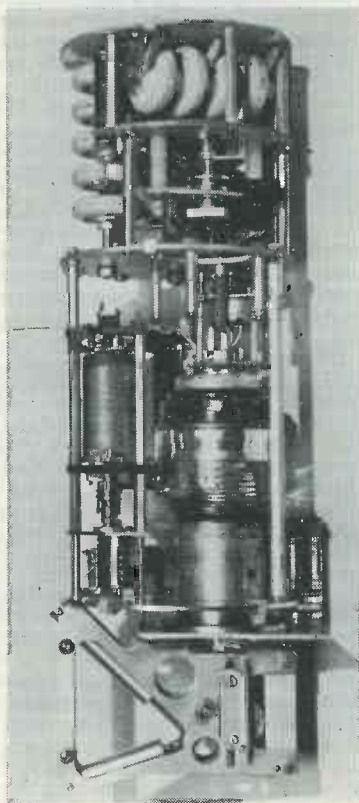

The Marconi Notch Aerial Tuning Unit type 7400, illustrating the variable reactances employed for matching the transmitter to the notch. (Photo: Marconi's Wireless Telegraph Company, Ltd.)

its cylindrical case is approximately 22in, and its maximum diameter is 7in. Finally, the inductance of the notch into which the unit feeds lies between 1.1 and 1.3 μ H. Which can hardly be described as high impedance!

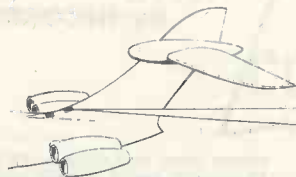

The variable reactances are clearly visible in the photograph. On the left is an inductor with its axis vertical, and this is capable of being rotated by the motor beneath it. On the right hand side is a high vacuum variable capacitor with the familiar internal metal bellows construction. Immediately above the variable capacitor and in the second compartment from the top is a rotary switch having a short-circuiting metal segment. The circular components in the top compartment and to the left of the switch are high working voltage fixed capacitors, having values of the order of 270 and 330pF.

The Tuning Unit is fitted in a pressurised cylindrical case to ensure constant performance under all conditions and, of course, to obviate the effects of ionisation which occur at high altitudes. The diagram shows a typical installation in which the Unit is mounted adjacent to the notch in an aircraft tail fin.

A Russian Fireball

Talking of television tuners, it must be quite a few years now since the original "Fireball" Band I-Band III tuner first saw the light of day under the aegis of Standard Coil Products Co., Inc., of Illinois (whose name now, incidentally, is Standard Kollsman Industries, Inc.). After a successful introduction in America, a considerable number of tuners based on the Fireball design have been made in this country under licence to Standard Coil Products.

The basic feature of the Fireball is the considerable miniaturisation effected by dispensing with the usual drum turret assembly and by mounting all the coils on a disc. Channel selection is achieved by rotating the disc by a spindle passing through the centre, contacts on the disc coupling to fixed contacts on the chassis. There are a number of other design points in the Fireball, of which perhaps the most interesting is the use of self-supporting single

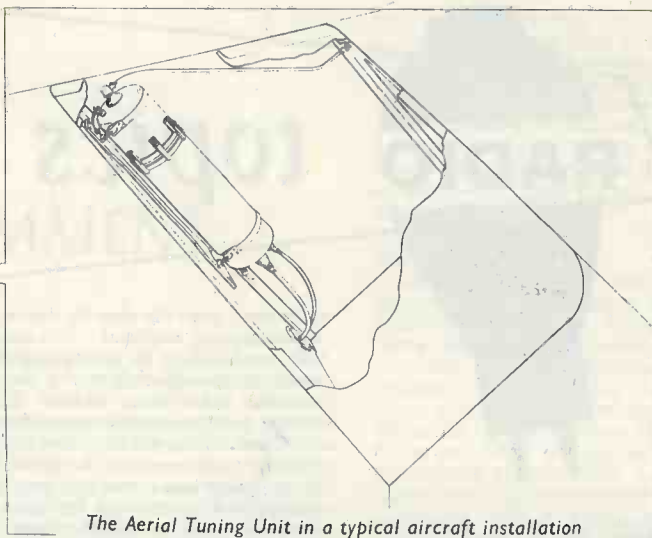

The Aerial Tuning Unit in a typical aircraft installation

aerial coils instead of the older double-wound coils. The latter operated as an r.f. transformer, the primary matching the aerial to the tuned secondary. With the Fireball arrangement the aerial coil acts as a pi filter element, and is tuned by the delightfully simple process of changing the shape of the coil, either by opening out the turns or by squeezing it out of its cylindrical form.

A Band I-Band III tuner unit based on the Fireball disc principle now seems to have appeared in Russia, and this is described in the February issue of the Soviet magazine *Radio*. So far as I can ascertain the tuner is amateur-built, which would represent quite an achievement.

The circuit employed is fairly conventional, although there are several discrepancies from current tuner practice in this country. For instance, the single winding input coupling is replaced by a double-wound aerial input coil, despite the disadvantage that two extra contacts per channel are required on the disc. The tuned secondary of the aerial coil couples to a standard double-triode cascode, with a peaky choke between the triodes; and neutralising is provided with the aid of a trimmer, instead of with fixed capacitors as is our practice. The cascode feeds into a standard band-pass pair, and thence to the grid of the pentode mixer. The latter is combined in one envelope with a triode oscillator which, apart from the method of obtaining fine tuning, functions in normal fashion. Also wired in normal manner is the i.f. output from the anode of the mixer.

The method of obtaining fine tuning is unconventional so far as British practice is concerned. There is no variable fine tuning capacitor on the tuner chassis. Across the oscillator coil, and isolated from it by a 110pF capacitor in each leg, is a coil wound on a ferrite core and having some 16 turns. The core has a diameter of 5mm. Also wound on this core (or coupled magnetically to it) is a second coil having 1,400 turns. A direct current is caused to flow through the 1,400 turn coil and is derived from a 12.6 volt heater source. The 12.6 volt supply is rectified and smoothed by a 50 μ F reservoir capacitor, a series 1k Ω resistor and a 200 μ F smoothing capacitor. The voltage across the 200 μ F capacitor is then fed to the 1,400 turn coil via a 10k Ω variable resistor. Adjusting the variable resistor will vary the current flowing through the 1,400 turn coil and will, in consequence, vary the incremental permeability of the core on which it is wound. Changes in incremental permeability will then cause corresponding changes in the inductance of the coil across the oscillator circuit. The overall effect is that fine tuning is achieved remotely by means of the 10k Ω variable resistor.

The rectified d.c. voltage obtained from the 12.6 volt supply just mentioned is negative of chassis, and a 470k Ω potentiometer couples to it after further smoothing by a second smoothing resistor and capacitor following the reservoir capacitor. This potentiometer controls gain, its slider being coupled to the input grid of the cascode via the aerial coil secondary and a conventional decoupling circuit.

100 Up

On 29th March, the Minister of Defence, Mr. Harold Watkinson, opened a new R.A.F. Transmitting Station which will make Aden's communications centre the most modern and best equipped in the Royal Air Force.

The new transmitting station has been built at Hiswa and there is also a new receiving station at Saltpans and a new message centre at H.Q. Middle East Command.

The transmitting station is the

largest in any of the three services and has a "forest" of 100 aerial masts!

One Up

Several newspapers recently reported a most interesting theatrical experiment. A Broadway play was televised live to Rochester, 300 miles away, where an audience of more than 2,000 people could see the Biblical drama *Gideon*, starring Frederic March.

The screen at Rochester was 20ft

by 15ft and the people there could hear such incidentals as the shuffling of feet and the murmur of the Broadway audience between acts.

The special correspondent of the London *Daily Telegraph*, in particular, made many interesting observations but that which caught our eye was his statement "The process is a British product by the Marconi Wireless and Telegraph Co. which the Americans are using because they concede that it is years ahead of anything they can produce."

VARIABLE PERIODIC SWITCH

By M. A. HAMMOND

THE DESIGN OF THE UNIT DESCRIBED IN THIS article is based on "Suggested Circuits, No. 121".¹

The Circuit

In the circuit diagram given in Fig. 1, the relay coil and its contacts are illustrated with the "detached" method of presentation. The rectangle

designated $\frac{RLA}{2}$ represents the 500Ω coil of the

relay, the two contacts RLA₁ and RLA₂ being shown in the de-energised position.

When the unit is initially switched on, capacitor C₁ and the capacitor selected by S₂ commence to charge to the supply voltage via the series resistors R₁ and R₂ and contacts RLA₁ of the relay. The capacitor selected by S₂ charges at a slower rate than the fixed capacitor C₁ because of the presence of R₂. During this charging period, the transistor collector current is insufficient to energise the relay. As the potential across the selected capacitors rises to the required level the increased transistor collector current energises the relay, whereupon contacts RLA₁ open and C₁, together with the selected capacitance, commences to discharge into the base-emitter circuit of the transistor. When the capacitors

are sufficiently discharged, the transistor collector current falls and allows the relay to de-energise. Contacts RLA₁ close, thereby applying the negative supply potential to R₁, and the next cycle commences.

External switching is accomplished by the operation of the second set of contacts, RLA₂. In the writer's unit a plug (PL₂) and socket (SKT₃) are employed for external connections. A "make" switching facility is available from PL₂ and a change-over facility from SKT₃.

The advantage of the present circuit, over that previously described, is that a range of timing periods is available by adjustment of the switch S₂.

Power Supply

Fig. 1 illustrates the switching unit powered by a mains driven supply; this being an alternative to a 12 volt battery. Diodes MR₁ and MR₂ rectify in a full wave circuit, R₄ being selected to allow 12 volts (±1 volt) to appear across C₁₀.² (A 330Ω resistor was satisfactory in the prototype.) The mains transformer employed had a 6.3 volt winding and this was used for external requirements (via socket SKT₃) and also as a voltage source for testing, as described later. The mains supply to the transformer is fed into the unit via plug PL₁.

Constructional Details

It is not proposed to detail any precise layout since this is non-critical. In the author's case, the complete unit was comfortably housed on a chassis measuring 8 x 4 x 1½ in deep, this being fitted with a cover which gave an overall height of 6 in. It will

¹"A Single Transistor Periodic Switch", *The Radio Constructor*, December 1960, by G. A. French, to whom due acknowledgment is made.

²The power supply is, of course, non-critical, and any components similar to those specified could be employed in their place provided that they offered the desired rectified potential and current. Or a 12 volt battery could be used.—*Editor*.

Fig. 1. The circuit of the variable periodic switch. The plugs and socket shown here were used in the author's unit and are optional

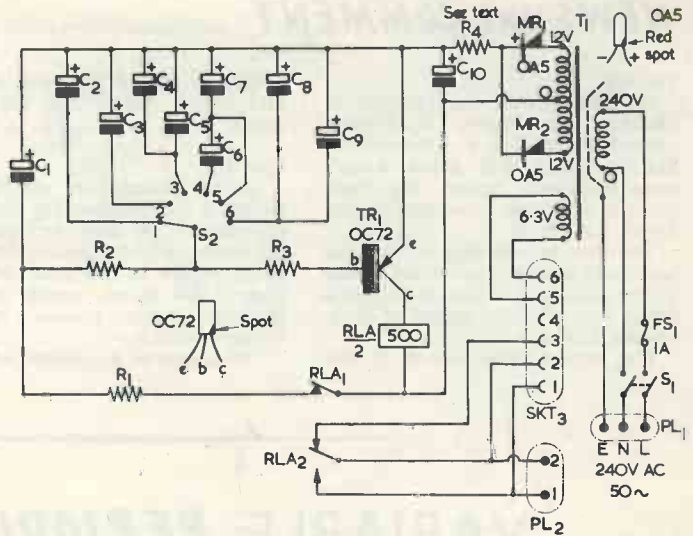

M259

be seen from Fig. 1 that parallel combinations of electrolytic capacitors are used at positions 3 and 6 of S_2 . These combinations provide capacitances of 200 and 2,000 μ F respectively and were used because the individual values (100 and 1,000 μ F) are readily available. The parallel combinations can, of course, be replaced by single components of the total value if these can be obtained.

Components List (Fig. 1)

Resistors

- R₁ 10k Ω $\frac{1}{4}$ watt 20%
- R₂ 10k Ω $\frac{1}{4}$ watt 20%
- R₃ 1k Ω $\frac{1}{4}$ watt 20%
- R₄ 300 Ω $\frac{1}{4}$ watt (see text)

Capacitors (all electrolytic)

- C₁ 100 μ F 12WV
- C₂ 50 μ F 6WV
- C₃ 100 μ F 6WV
- C₄ 100 μ F 6WV
- C₅ 100 μ F 6WV
- C₆ 1,000 μ F 6WV
- C₇ 1,000 μ F 6WV
- C₈ 1,000 μ F 6WV
- C₉ 1,000 μ F 6WV
- C₁₀ 500 μ F 25WV

Semi-conductors

- TR₁ OC72 (with heat sink clip)
- MR₁ OA5
- MR₂ OA5

Miscellaneous

- RLA Post Office type 3000 with 500 Ω coil
- T₁ Pri. 0-24V, Secs. 12-0-12V, 6.3V
- FS₁ Miniature fuse holder and 1A fuse
- S₁ d.p. on/off toggle
- S₂ 1 pole, 6-way rotary
- *PL₁ 3-way mains plug and cable socket
- *PL₂ 2-way cable plug and socket
- *SKT₃ 6-way socket and cable plug

* Optional.

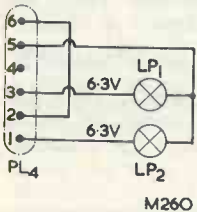

Fig. 2. A test circuit for checking switch operation

M260

Testing

When the unit has been constructed to the circuit given in Fig. 1 it is advisable to check transistor connections and polarity before switching on. Fig. 2 shows a simple test rig which may be connected to the circuit to check operation. The plug PL₄ fits into socket SKT₃, whereupon the 6.3 volt winding of the transformer is applied to the two lamps via the changeover contacts, RLA₂, of the relay. When the relay is de-energised lamp LP₁ is illuminated and when it is energised, lamp LP₂ is illuminated.

The table shows the results obtained with the writer's unit for different settings of the switch S_2 . Switching cycle periods from 1.5 to 7 seconds are available.

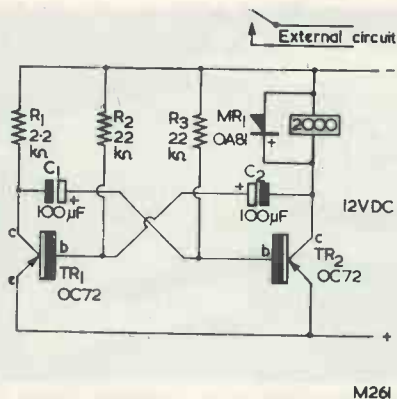

Fig. 3. An alternative form of periodic switch which offers 50:50 operation. Current consumption should lie between 19 and 29mA

Alternative Switch Circuit

It will be seen from the table that a 50:50 on-off time ratio is not given with the circuit described.

TABLE

S2 Position	Time Illuminated (Seconds)		Complete Cycle Current mA
	LP1 Relay De-energised	LP2 Relay Energised	
1	0.5	1	22-26
2	0.5	2	22-28
3	0.75	3	22-32
4	0.75	4	21-33
5	1	5	20-33
6	1	6	19-31

However, by using the multivibrator principle, as shown basically in Fig. 3, a 50:50 balance is obtainable. Variations in timing cycle can be obtained here by varying the values of C_1 and C_2 . The multivibrator circuit requires two transistors in addition to a protective diode across the relay coil to prevent the formation of high reverse voltages. The current consumption of the multivibrator circuit should lie between 19 and 29mA.

Canada to make Colour TV Recordings of Surgical Operations

One of the most interesting features in the new extension to the Halifax, Nova Scotia, Infirmary is the provision of an EMI closed-circuit colour television camera system which can be brought into use in any one of four operating theatres. The contract for supplying this equipment was negotiated by EMI Electronics' Canadian company, EMI-Cossor Electronics Ltd.

Permanent visual records of surgical operations will be kept by means of a video recorder which will store information in colour on video tape. This tape can be played back at any time either in colour or monochrome.

Designed so as to be readily transportable from one operating theatre to another, the colour camera will be used to observe operations via a remotely-controlled mirror mounted on a boom over the operating table. This camera will be under the control of a local cameraman—usually a member of the hospital medical staff—who will at all times be able to keep the operation under the closest observation.

A second EMI television camera—transmitting black and white pictures—will also be used to observe operating procedures in four of the operating theatres. This camera is provided with a remotely-controlled pan and tilt head.

Video signals from both cameras are transmitted to a control room in the basement where the camera switching takes place, and the resulting picture is then routed to an adjoining lecture room where it is displayed on a 8 x 6ft screen by means of a colour television projector.

Provision is also made for a monochrome television camera in the autopsy room, and for a colour camera in the maternity section of the hospital. Since the lecture room containing the large screen is restricted in the accommodation of students, an additional colour receiver will be placed in a second auditorium.

An audience in the lecture room will be able to listen to the voice of a surgeon or commentator during an operation, and the lecturer in this room carries remote switching for raising and lowering the screen, dimming or extinguishing the lights and controlling the amplifier.

EMI colour television is already widely used in many parts of the world, and its application to surgery has been impressively demonstrated at several medical conferences.

TRADE REVIEW . . .

Eagle Products

Transistor Interphone Set

Model TI-302



The "Eagle Products" Interphone Model TI-302 is a fully transistorised intercom system. There are two stations, these being coupled together by 60ft of twin flex supplied with the set. Installation consists quite simply of fitting a battery to the master station and of coupling the two stations together by means of the twin flex. This latter is terminated in phono plugs which fit into sockets at the rear of the stations. Also provided are a number of staples for securing the flex between the stations.

The master station is provided with a three-way key switch giving "Standby" (Off), "Listen" and "Talk". The "Talk" position is spring-loaded, the switch returning to "Listen" when the knob is released. In the "Standby" position the battery is disconnected from the amplifier. A "Call" button is fitted at the remote station which, if pressed when the master station is at "Standby", causes the intercom amplifier to be switched on and to generate a loud tone, thereby attracting attention. Since transistors are used, the amplifier comes into instant operation when the "Call" button is pressed and when the key switch is subsequently set to "Listen" or "Talk".

The master station includes the amplifier, this employing three transistors and offering an output of 200mW. A gain control is also fitted. Power is

provided by a 9 volt battery, such as the Vidor T6003 or equivalent, this fitting inside the master station case. The loudspeaker/microphone units are conventional miniature moving coil loudspeakers. The cabinets for the two stations are available in either black or ivory high impact plastic, and their dimensions are $3\frac{1}{2} \times 1\frac{1}{4} \times 3\frac{1}{8}$ ins (master station) and $3\frac{1}{2} \times 1\frac{1}{4} \times 3\frac{1}{8}$ ins (remote station). The two stations of a set are shown in the accompanying illustration.

When tested, it was found that the set gave good results, sensitivity being such as to allow reliable conversation when speaking several feet away from the units. Despite the very small size of the stations, reproduction was very clear and there was ample volume. When one station was positioned near the loudspeaker of a good quality receiver reproducing orchestral music, it was found that the fidelity and volume at the other station was of the same order as would be given by a conventional transistor superhet receiver of the same size.

The Model TI-302 Interphone is marketed by B. Adler and Sons (Radio) Ltd, 32A Coptic St., London W.C.1. (who also maintain servicing facilities) and is available from all leading wholesalers. The retail price is 12 guineas complete in fitted gift box.

Book Review . . .

THE SUPERHETERODYNE RECEIVER, Seventh Edition. By Alfred T. Witts, A.M.I.E.E. 203 pages, 5in by $7\frac{1}{2}$ in. Published by Sir Isaac Pitman & Sons Ltd. Price 20s.

The fifth edition of this book appeared in 1941, to be followed, after a reprinting, by the sixth edition in 1944. There were two subsequent reprintings in 1946 and 1950, and the book is now launched in its seventh edition. Obviously, a lot has happened since 1944 and, indeed, almost the entire book has been re-written for the present edition.

The Superheterodyne Receiver covers all aspects of the superhet, including frequency changing principles, local oscillators, a.g.c., and frequency modulation. A chapter is devoted to communications receivers, another to television receivers, and a third to transistor a.m. receivers. A final chapter includes circuits of commercially manufactured superhets, and describes their operation.

The approach is entirely non-mathematical and the book could be read by anyone who understands simple valve operation and the functioning of a t.r.f. receiver. The wide scope of the book does not allow for great detail in all of the sections covered, but it nevertheless contains a wealth of well-explained and reliable information on basic superhet principles. It can afford, in particular, an excellent introduction to the subject for the student, the beginner, or the junior service engineer.

VERSATILE

10-watt AMPLIFIER

By V. E. HOLLEY

THIS IS A COMPACT LOW-COST AMPLIFIER SUITABLE for many purposes. Used with a gramophone pick-up it will provide music for dancing in a small hall or, with a microphone, will serve for public announcements or a vocalist or to emphasize a solo instrument in a band. It is also suitable for use with an electric guitar. Two separate inputs are provided so that two signals can be mixed in controllable proportions and the whole equipment can be accommodated together with a 10in speaker in a case about 18 x 18 x 6in so that it is conveniently portable.

Output Stage

As can be seen from Fig. 1, the output stage employs a pair of 6V6 valves in push-pull. They should be fairly well matched but exact matching is not essential because they share a common bias resistor and this arrangement tends to balance the two valves. The signal currents cancel out in the resistor and so a bypass capacitor is not required.

It is worth mentioning here that the amplifier should not be switched on unless both output valves are in place. The stage is operated with 285 volts on anodes and screens and under these conditions the theoretical maximum output is 12-14 watts. This will not be realised, however, unless two speakers are used, because most 10in units will not handle more than 10 watts. The 2.2k Ω resistor R₁₅ ensures that the screen voltage does not rise above that at the anodes. The optimum load, anode to anode, is 8,000 Ω and to match this to a 15 Ω speaker, the output transformer must have a ratio of about 25:1. It need not be an expensive component because its shortcomings will to a large extent be made good by negative feedback; all that is necessary is that it should be able to handle the required power output. If it is desired to use a 3 Ω speaker, the required transformer ratio is 55:1 but the 25:1 ratio will still be required in order to provide adequate voltage for the feedback loop. The transformer specified in the components list gave reliable results in the prototype.

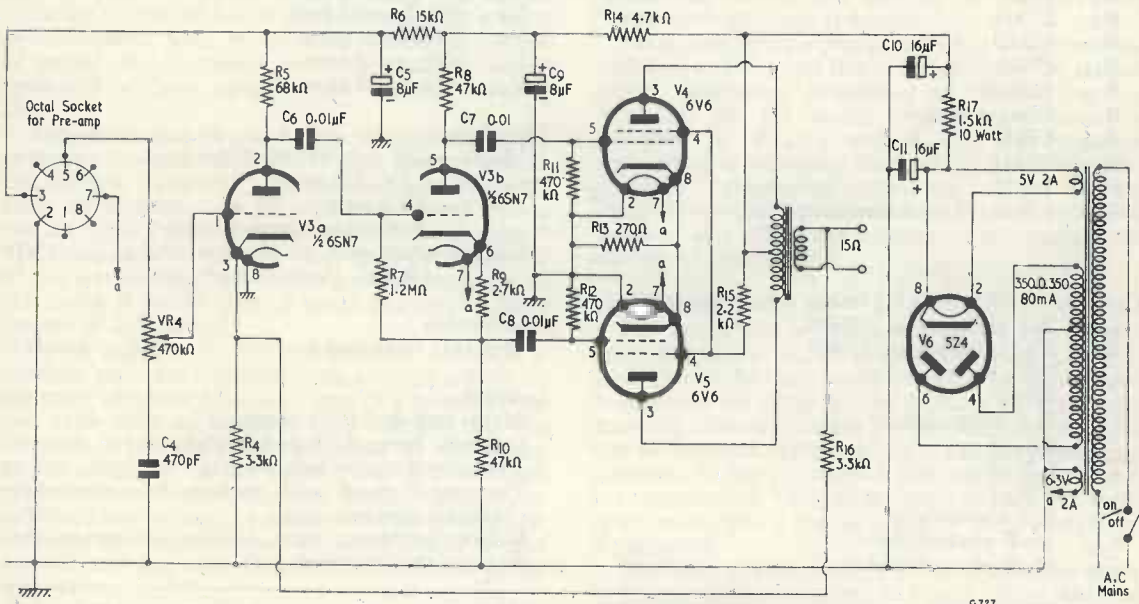

Fig. 1. Circuit of the main amplifier

Inverter

The two signals required to operate the output stage are derived from the anode and cathode circuits respectively of one-half of a double-triode valve, 6SN7, connected as a phase inverter. The circuit shown is simple and reliable and, because of heavy negative current feedback in the cathode load resistor, is linear in the extreme. The feedback also has the effect of raising the impedance between grid and earth to a very high value, about $10M\Omega$ in this case, so that the grid becomes susceptible to electrostatic hum pick-up, and it is for this reason that the phase inverter circuit used here is sometimes given a bad name. However, if the load resistor in the previous stage is not too high in value and the coupling capacity is adequate, the impedance to chassis is much reduced and no trouble will be experienced. R_7 is the grid resistor, and is returned to the junction of the bias and cathode load resistors. As R_9 is quite small in relation to R_{10} , there is no point in bypassing it. The gain of the phase inverter stage is 0.9 on each side, so it does not make any significant contribution to the gain of the amplifier. The two load resistors, R_8 and R_{10} , should be

matched as accurately as possible being, at worst, $\pm 5\%$. This applies also to the grid resistors of the following stage, R_{11} and R_{12} .

Voltage Amplifier

The remaining half of the 6SN7 is used as a voltage amplifier with an anode load of $68k\Omega$. The cathode resistor R_4 , which is not bypassed, provides a suitable point for the injection of negative voltage feedback derived from the secondary of the output transformer via R_{16} . The values of R_4 and R_{16} are selected so that in parallel they provide the proper bias for V_{3a} , while in series they cause the desired proportion of the output voltage to be fed back to the cathode of the valve. As there is no bypass capacitor in the cathode circuit, the valve operates with both current and voltage feedback. In the grid circuit is a tone control network, VR_4/C_4 . Only a small capacity is needed here as the input impedance is made fairly high by negative feedback.

Pre-amplifier and Mixer

A pair of pentode voltage amplifiers working into a common load is employed for pre-amplification

Components List

Resistors (1 watt 10% unless otherwise stated)

R_1	$1.2M\Omega$
R_2	$2.2k\Omega$
R_3	$270k\Omega$
R_4	$3.3k\Omega$
R_5	$68k\Omega$
R_6	$15k\Omega$
R_7	$1.2M\Omega$
R_8	$47k\Omega^1$
R_9	$2.7k\Omega$
R_{10}	$47k\Omega^1$
R_{11}	$470k\Omega^1$
R_{12}	$470k\Omega^1$
R_{13}	270Ω , 5 watt
R_{14}	$4.7k\Omega$
R_{15}	$2.2k\Omega$
R_{16}	$3.3k\Omega$
R_{17}	$1.5k\Omega$, 10 watt (see text)

Capacitors (500V working unless otherwise stated)

C_1	$2\mu F$ electrolytic, 350WV
C_2	$50\mu F$ electrolytic 25WV
C_3	$0.01\mu F$
C_4	$470pF$
C_5	$8\mu F$ electrolytics
C_6	$0.01\mu F$
C_7	$0.01\mu F$
C_8	$0.01\mu F$
C_9	$8\mu F$ electrolytic ²
C_{10}	$16\mu F$ electrolytic ²
C_{11}	$16\mu F$ electrolytic ²

Potentiometers (all log law)

VR_1	$470k\Omega$
VR_2	$2M\Omega$
VR_3	$470k\Omega$
VR_4	$470k\Omega$

Valves

V_1	EF80, B9A base
V_2	EF80, B9A base
V_3	6SN7, octal base
V_4	6V6, octal base
V_5	6V6, octal base
V_6	5Z4, octal base

Transformers

Mains—	$350-0-350V$, 80-100mA. $6.3V$, 2.5 amp. 5V 2 amp. Preferably "drop-through"
Output—	Push-pull, 10-12 watts, 6V6 to 3 or $15\Omega^3$ (R.S.C. (Manchester) Ltd.)

Loudspeaker

10in 15Ω voice coil

Sundries

Mains switch, 250V, 1 amp.
Indicator lamp, 6.3V and holder
Two closed circuit jack sockets
Two octal plugs and sockets for connecting speaker and pre-amp.
Rubber grommets, wire, sleeving, hardware, etc.
Aluminium for chassis

¹ R_8 R_{10} and R_{11} R_{12} should be matched within $\pm 5\%$ or better.
² C_5 C_9 and C_{10} C_{11} are dual components.

³ An equivalent output transformer offering outputs at 3, 5, 8 or 15Ω is available, and this may prove more useful if more than one speaker is to be employed.

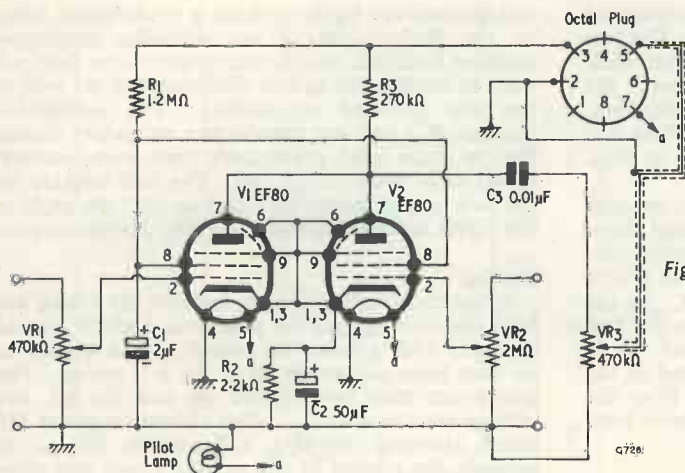

Fig. 2. Circuit of the mixer and pre-amplifier unit

and mixing in the circuit given in Fig. 2. As the anode resistance of the valves is very high, the usual isolating resistors are not required between them and practically the full gain of the pentode stage can be realised. The two signals applied to the grids can be mixed in any desired proportions by means of the potentiometers VR₁ and VR₂, and the setting of one control can have no effect upon the other. Thus speech can be superimposed on music or amplification can be provided for a vocal duet, using two microphones, etc. The potentiometers VR₁ and VR₂ can be any value to suit the signal source; in the prototype, VR₁ is used for an electric guitar amongst other applications, while VR₂ suits a record player or a crystal microphone. The output from the combined anode circuit is taken to a third potentiometer, VR₃, by means of which the volume of sound can be varied for both channels simultaneously without upsetting the balance between them.

The valves may be almost any voltage amplifying pentodes though, as amplifier and speaker are in one cabinet, those with any tendency to microphony must be avoided. An EF86 is the natural choice but the EF80 will do very well and is much cheaper.* The screen-grids need to be decoupled by a capacity of not less than 0.25μF and as a paper capacitor of this value is rather large, a small electrolytic component of 2μF is used.

Power supplies for the pre-amplifier, which is a separate unit, are obtained from an octal socket on the main amplifier chassis by way of a suitable plug and cable and, as the gain from the grid of V_{3a} onwards is not high, the signal can be introduced to the amplifier by the same route in a screened cable without picking up any audible hum. The screening also serves as a common return connection between the two chassis. An octal socket is also provided on the main chassis for connection to the speaker.

* The EF80 is a high slope r.f. pentode, but it functions adequately in this circuit.—EDITOR.

Power Supply

The mains transformer must be capable of supplying up to 80mA at 350 volts for the h.t., about 2.5A at 6.3V for the valve heaters and it must have a 5V 2A winding for the rectifier, which in the prototype is a 5Z4. Any other rectifier which can pass 80mA at 350V would be suitable, the only requirement being that the proper heater supply for it is available from the transformer. As it will be required to operate for prolonged periods in an enclosed cabinet, it is well to select a transformer capable of, say, 100mA from the h.t. secondary so that heat generation is reduced, and it should be of a type which can be very firmly attached to the chassis to survive the hazards of transport. A "drop-through" type is best.

Main smoothing is provided by R₁₇ in conjunction with C₁₀ and C₁₁ and this is sufficient for the output stage. Additional smoothing and decoupling for V_{3b} and for the earlier stages respectively are provided by R₁₄/C₉ and R₆/C₅. No separate decoupling is necessary between V_{3a} and the pre-amplifier. Depending upon the output of the transformer-rectifier combination employed, the value of R₁₇ may need adjustment to produce the correct h.t. line voltage.

Construction

The equipment is constructed in two units corresponding to the circuit diagrams in Figs. 1 and 2. This allows the main amplifier with its heavy components to be fitted at the bottom of the floor-standing cabinet while the pre-amplifier and controls can be mounted higher up in a convenient operating position. In the prototype it was convenient to have the tone control, VR₄, on the main chassis, but there is no reason why it should not be in the pre-amplifier if preferred.

The main chassis is of 16 s.w.g. aluminium sheet to the measurements given in Fig. 3. Note that one end is left open for ventilation and that an additional vent is provided above R₁₇. The pre-amplifier

chassis shown in Fig. 4 has no heavy components and 18 gauge aluminium is suitable for it. The two valves are mounted on a small aluminium shelf with their associated components below; the arrangement will be clear from the illustration. Valveholder orientation in both main amplifiers and pre-amplifier chassis should be as shown in Figs. 5 and 6.

Construction of the main amplifier can proceed in any desired order. There is nothing critical about the layout but, as the equipment is portable, particular attention should be paid to rigidity of wiring and the secure anchoring of components. In the pre-amplifier, it is convenient to make up the two valves and their associated components as a separate sub-assembly which can be secured in the chassis with bolts or self-tapping screws after the input sockets and volume controls, etc., have been fitted and wired up.

Wiring and Components

Wiring diagrams are given in Figs. 5 and 6. Flexible p.v.c. covered wire is recommended for the heaters, and 22 gauge tinned copper for the rest, lengths of more than an inch or so being covered with sleeving. Reliability is a design feature and it is recommended that all resistors should be 1 watt except R_{17} (10 watts) and R_{13} (5 watts). For the same reason capacitors should be 500V working except C_2 for which 25V will be adequate, and C_1 which is 350WV. The characteristics of the output

transformer are liable to have a pronounced effect on the performance of any amplifier employing negative feedback and the constructor who does not wish to experiment in this direction will do well to use the specified component. The connection between R_{16} and the transformer secondary should not be made until preliminary tests and measurements have been carried out. The jack sockets for the two inputs should be wired so that the grids of the valves are earthed when the jacks are withdrawn.

Testing

When construction is complete and the wiring has been checked against the diagrams, a check should be made with a meter between C_{11} and chassis to see that there are no shorts in the h.t. wiring. The power can then be switched on and the h.t. rail voltage measured at C_{10} . This should be about 310 which allowing for bias, will provide 285 or so between the anodes of the output valves and their cathodes. If there is any appreciable departure from these figures, the value of R_{17} should be adjusted as necessary. The resistor R_{16} may now be connected temporarily to the transformer secondary. This may bring a loud protest from the amplifier in the form of an oscillation, in which case the connections to the output transformer primary or secondary (but not both) should be reversed to make the feedback negative. In order to prevent damage to the loudspeaker the amplifier should be kept in the oscillating condition for a very short time only.

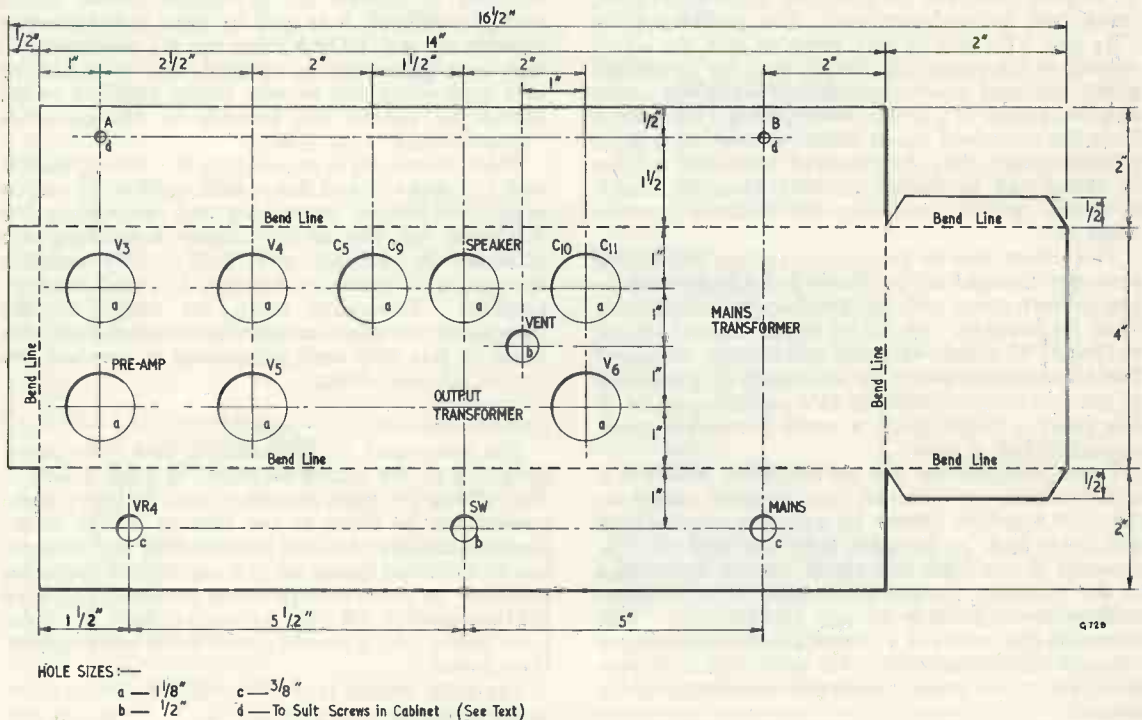
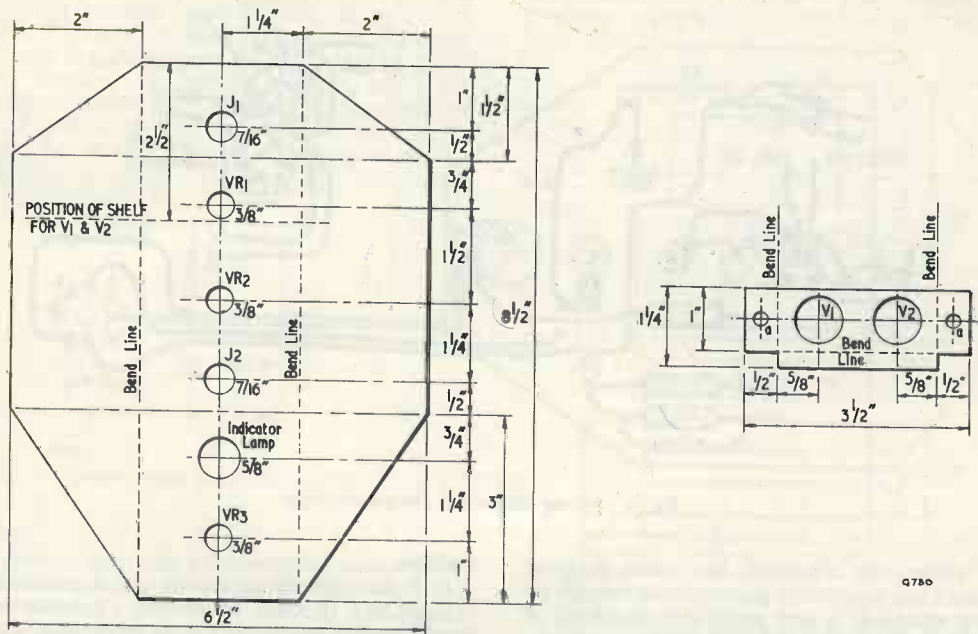

Fig. 3. Main amplifier chassis



9780

Fig. 4. Pre-amplifier chassis and valve mounting shelf. The width between the two bend lines (2 1/2 in) is to the outside surfaces after bending. Valve tray fits into panel and is secured by bolts or self-tapping screws through holes (a)

With correct feedback the hum level should be very low.

Operation

The best results will be obtained with VR₁ and VR₂ fairly well advanced and the volume controlled by VR₃. In this way, hum and noise voltages

originating in the pre-amplifier will be reduced along with the signal. The mains connection should be by three core cable, the earthed conductor being taken to the chassis. This will greatly reduce, if not entirely eliminate, electrostatic hum pick-up when operating with a high impedance input and long cables. Although not designed for high fidelity in

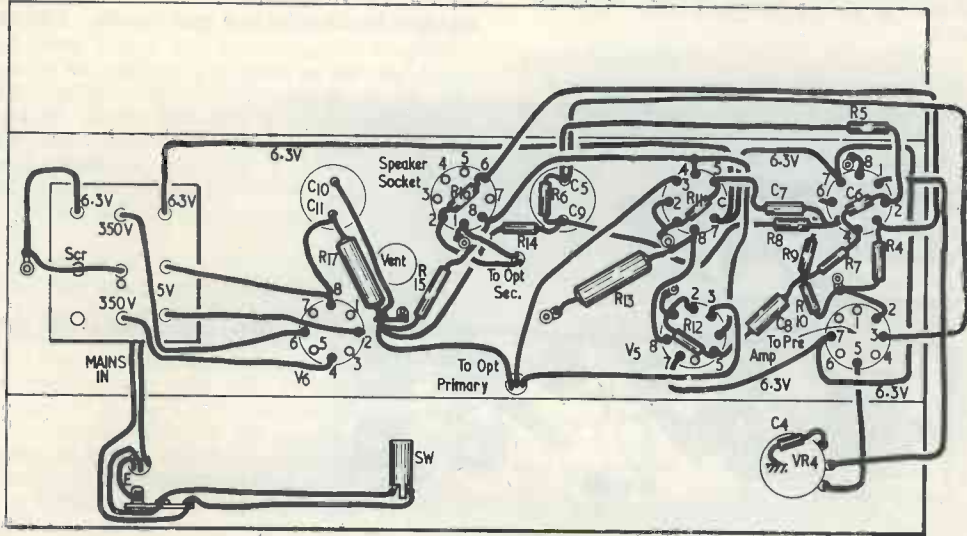

9731

Fig. 5. Wiring diagram of the main amplifier. The speaker connects to pins 1 and 2 of the speaker socket

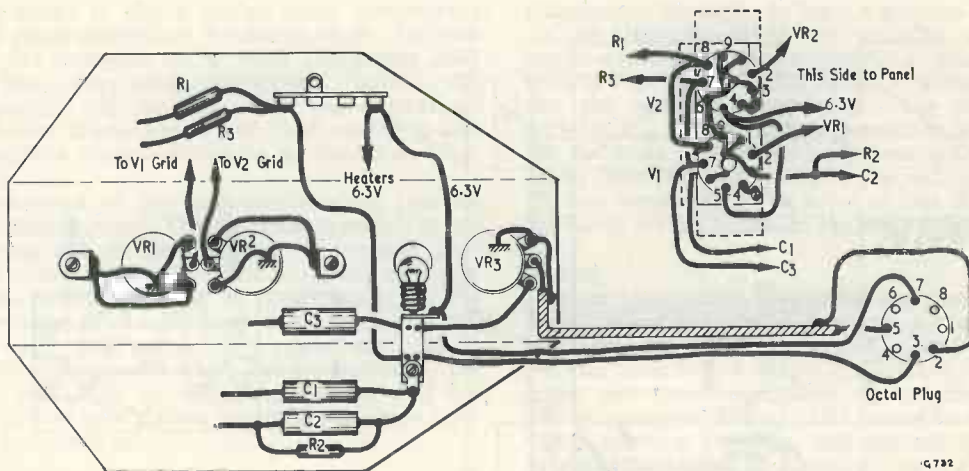

Fig. 6. Wiring diagram of the pre-amplifier

the true sense, the amplifier has quite a good response and will reproduce gramophone records or radio programmes at a very acceptable standard of quality. If it is to be used with a pick-up, compensation will be needed for recording loss. Popular types of crystal pick-up require compensation and, in the prototype, this was done with the circuit given in Fig. 7 which, when connected to VR₂, presents to the pick-up at middle and high frequencies, a load of approximately 0.5MΩ. A crystal microphone may be connected direct to VR₂. If connected to VR₁, there will be some low frequency attenuation which may on occasion be useful to produce clean crisp speech for announcements. A moving coil microphone can be connected to VR₁ via a suitable transformer. All connections to the amplifier should, of course, be made with efficiently screened cable.

Cabinet

It is convenient to house the equipment in a cabinet 18 x 18 x 6in, fitted with a suitable carrying handle at the top, and it is an advantage if a compartment is provided in which cables, microphones and other ancillary equipment can be stowed. Such a cabinet can be constructed quite easily from 3/4in plywood; no intricate joinery is required and only simple tools are needed.

Cut the front 18in square and make in it an aperture 9in in diameter for the speaker in the position shown in Fig. 8 (a). This position makes allowance for a stowage compartment about 2 1/2in deep at the top of the cabinet. The aperture can be cut without much difficulty by first making a 1in hole on the circumference with a brace and bit and cutting away the unwanted wood with a coarse hacksaw blade held in a pad handle. Cut next the

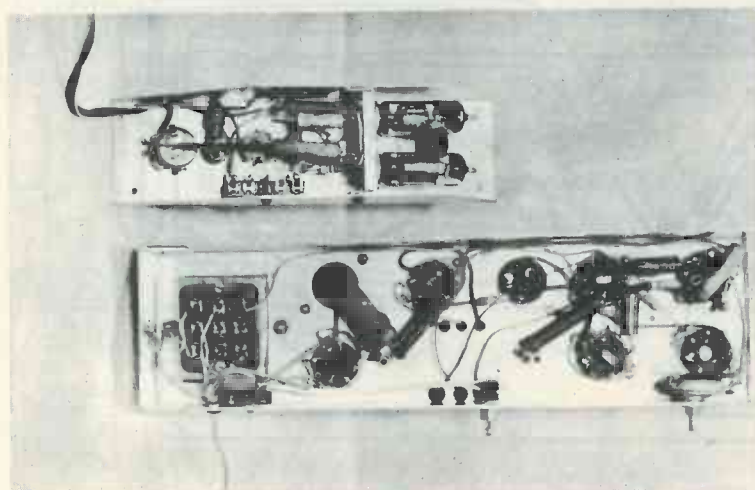

Under-chassis view of both units

sides, each 18 x 6in, and the top, bottom, and the shelf for the stowage compartment, all of which should be 17½ x 6in. In one of the sides, an aperture must be cut for the control panel as in Fig. 8 (b), and half a dozen ½in holes should be cut in the bottom for ventilation. A lot of labour will be saved, of course, if the timber merchant can be persuaded to cut all the pieces accurately to size on a saw bench.

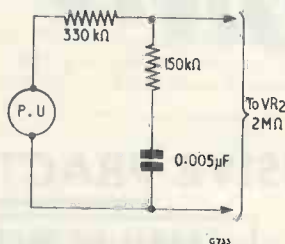

Fig. 7. Compensation for crystal pick-ups

Assembly

The cabinet can now be assembled temporarily, using ordinary butt joints secured with 1in panel pins driven halfway home. Having obtained a satisfactory fit, mark the joints for subsequent identification and dismantle. The joints can now be coated with a good casein glue and reassembled, the panel pins being driven right home. Some of the modern proprietary glues set very hard indeed and any surplus around the joints should be wiped off while it is still liquid. When the glue is hard, internal strengthening should be added by fitting ½in square wood fillets, glued and screwed with 1in x 6 wood screws along the whole length of each joint. Similar fillets should be fitted all round the rear edge of the cabinet, being inset ⅜in so as to leave a recess into which the back of the cabinet can be fitted. The bottom rear fillet should be secured with screws only as it will need to be removed when fitting and removing the amplifier. The back of the cabinet is screwed to the rear fillets and adds considerably to the strength of the job. It should be of ⅜in ply, 17½ x 14½in, with large apertures for ventilation as in Fig. 8 (c). An additional piece of ply, 17½ x 2½in should be attached to the top of the cabinet by hinges to form a cover for the stowage compartment.

Fitting the Pre-amp

In order that the control knobs shall not project unduly the aperture in the side of the cabinet should first be covered with a piece of ⅜in ply 9 x 4in, down the centre line of which has been cut a series of ⅜in holes corresponding with the positions of the controls, etc., as in Fig. 4. The pre-amplifier can then be attached to this panel by ⅜in wood screws. Cut the spindles to length and fit the knobs. It is useful if each knob has a marker so that its position can be seen at a glance, and this can well take the form of a small indentation drilled on the periphery and filled with white paint. If a lens is not available for

the indicator lamp, a piece of thin coloured Perspex or similar material can be fitted between the plywood panel and the chassis.

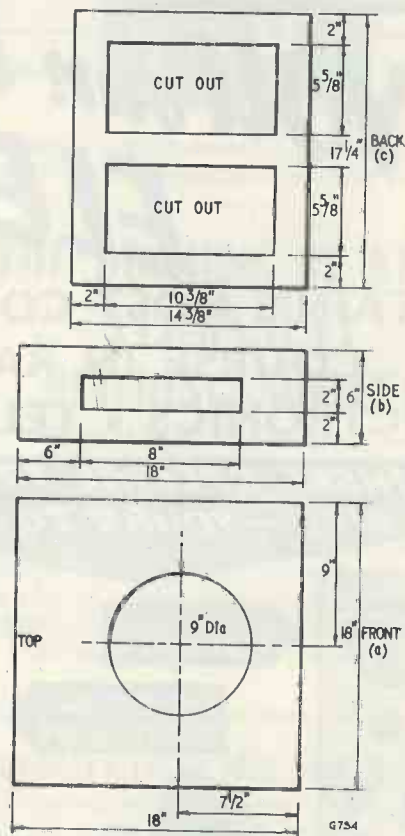

Fig. 8 (a). Front of cabinet, (b) cut-out for control panel and (c) back of cabinet

Main Amplifier

If the main chassis has been made accurately to the measurements given in Fig. 3, its overall width allowing for the thickness of metal at the bends will be 4½in, which is the distance between the front and rear fillets on the floor of the cabinet. Make a cardboard template of the chassis runner showing the exact positions of the holes A and B in Fig. 3 and with its aid make corresponding holes for wood screws in the bottom front fillet. Remove the heads from two 1in wood screws, cut fresh screwdriver slots and insert the screws into the fillet so that they project ⅜in. Slide the amplifier into position so that the holes A and B fit over the headless screws. Fit the rear fillet and drill horizontally through it and through the chassis beyond, two ⅜in holes at positions approximately opposite A and B. Enlarge and countersink the holes in the wood only. If two wood screws of suitable diameter are now inserted, they will have a self-tapping action as they enter the aluminium and the chassis will be very firmly secured.

NOW YOU can MASTER ELECTRONICS!

**BRITAIN'S MOST COMPREHENSIVE PRACTICAL
COURSE IN RADIO
ELECTRONICS • TELEVISION!**

**THESE SPECIAL TRAINING
KITS — YOURS TO KEEP**



**Multi - Range
TEST METER**



**CATHODE RAY
OSCILLOSCOPE**

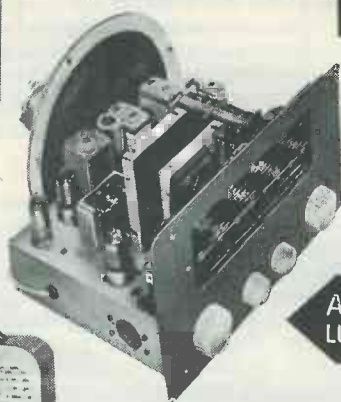

**AM and VHF/FM
LUXURY RECEIVER**

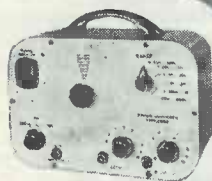

SIGNAL GENERATOR



**Complete set of
Picture Way books and
Experimental Manuals**

**LEARN BY BUILDING
NOW for your
CAREER • HOBBY
OWN BUSINESS**

YOU RECEIVE

- Complete kits of equipment as illustrated.
- Complete set of experimental manuals.
- Complete set of "picture-way" theory books.
- Modern test-yourself examination sheets.
- Study programme.
- Unlimited consultation with Tutors.

**FREE
BROCHURE**

POST NOW

RADIOSTRUCTOR

TO RADIOSTRUCTOR (DEPT. M.31)
READING, BERKS.

Name.....

Address.....

.....

.....

(We do not employ representatives) 5.62

**BLOCK
CAPS
PLEASE**

SMALL ADVERTISEMENTS

Private: 3d. per word, including address.
Minimum charge 2/6.
Use of Box Number, 2/- extra.

Trade: 9d. per word. Minimum charge 12/-.
Terms: Cash with order.

All copy must be received by the 6th of the month for insertion in the following month's issue. The Publishers cannot be held liable in any way for printing errors or omissions, nor can they accept responsibility for the *bona fides* of advertisers.

PRIVATE

FOR SALE. 160M-3,000M U.S.A.F. receiver, covers shipping, amateurs, broadcast, etc., 2 R.F., 2 I.F. speaker, 115/230V, 10 gns. BC-221 Hallicrafter's receivers, S-27, S-27CA, S-36A, S-37 (27 Mc/s-225 Mc/s).—S.A.E.: Wright, 4A Nepal Avenue, Atherton, Manchester. Telephone: Atherton 991.

FOR SALE. Cossor 701K F.M. receiver, built, tested, unused, less speaker, £5.—P. Plater, 228 Stafford Road, Wallington, Surrey.

WANTED. Mullard 3 valve preamplifier and t.v. tuner.—Smith, 2 Melrose Road, Biggin Hill, Kent. Telephone: Biggin Hill 2502.

FOR SALE. Mullard "3-3" amplifier and preamplifier, used for only one month. All offers considered.—Stoker, 9 The University, Glasgow W.2.

FOR SALE. 15 ohm 8in. Axiote in Nordyk mahogany enclosure, £8. Delivered in Kent.—Williamson, 12 New Rents, Ashford, Kent.

FOR SALE. Receiver 109, brand new in box. Built-in speaker. Full set valves. Also carrier. £4 15s., plus carriage.—12 Woodwards Road, Daisy Hill, Westhoughton, Lancs.

FOR SALE. R107, as new. AC/DC operation, spare valves, £8 o.n.o. Carriage paid.—Lawrence, 25 Rowden Hill, Chippenham, Wilts.

FOR SALE. Eddystone 888A communications receiver, complete amateur bandspread, 11 valves, crystal calibrator, S meter and loudspeaker, etc., £70. Carriage paid.—13 Raydons Gardens, Dagenham, Essex.

FOR SALE. Radiogram cabinet. Forward auto changer. Wharfedale 8in. Golden unit. £10.—Petts, 7 Chedworth House, Geldeston Road, London, E.5.

FOR SALE. Haynes TV components: TQ116 osc. trans.; TUY5/86 frame osc.; LUS8F frame feed choke; S112 scanning unit; line output trans.; p.m. focusing unit; e.h.t. trans. 10KVA Brimar C12 tube and mask, £5; Record player and amp, full working order, £8. Memset 15 amp main switches, 10/-. Brayhead and G.E.C. TV turrets, 35/-. M/C meters, 0-40V, 0-5 amp 5KV, 10/-. RF 0-4 amps, 5/-. Wearite coil PHF2, 3/-. 0-5 mA, 5/-. Valves, 832s, 10/-.; 829, 15/-.; 807s new, 5/-. RCA master oscillator unit MI-19427B complete with stabilised P/P rack mounting and calibration booklet, £7 10s. A.C. turntable and pick-up 78, 30/-. EF50s, 1/6. ATP7, 5/-. Electron multipliers, 10/-. 24G triodes 815s, 10/-. HRO power pack rack mounting, 30/-. Postage extra.—G6MN, Castle Mount, Worksop, Notts.

continued on page 797



ESTABLISHED

1865

Savings in this old established Building Society combine sound investment with an attractive return

THE DUCHESS OF KENT PERMANENT BUILDING SOCIETY

Member of the Building Societies Association

Shares are in units of £25 each (maximum investment £5,000) . . . BUT, for the smaller saver, Subscription Share accounts may be opened with any sum from 1/- upwards. Interest is payable half-yearly on Fully Paid Shares—credited annually on Subscription Shares—all interest accrues monthly

Withdrawals at short notice

INTEREST IS AT 4% PER ANNUM
(There is NO DEDUCTION FOR INCOME TAX, as this is paid by the Society)

For further information apply to
**DUCHESS OF KENT
PERMANENT BUILDING SOCIETY**
103 Cannon Street London EC4
Telephone MANSion House 8011

Please send to me, without obligation, free brochure and a copy of the audited statement of accounts. (I understand that I shall not be troubled with circulars or calls by representatives)

Name.....
(If lady, please state Mrs. or Miss)

Address.....

R.C.

(Please use Block Capitals for both name and address)

SPECIAL BARGAIN OFFER!

"6 + 1"

... using 3 latest type surface Barrier Transistors

TRANSISTOR RADIO KIT

Now Only **£6.19.6**

PRICE BARRIER SLASHED—A

further bulk purchase of this popular Kit enables us to pass on latest price reduction direct to Constructor. Kit is a modern, sensitive, quality receiver with all latest circuit features and is complete with 7" x 3 1/2" speaker (3-ohms), and all circuit and assembly instructions. 6 BVA transistors and germ. diode. Printed Circuit. Med. and L/W. Ferrite aerial and car radio coupling. 500mW output. Attractive gilt dial and slow motion drive with "Clear Vu" tuning knob, etc.

Complete Kit carriage 2/6



Contemporary two-tone cabinets 9"x5"x3 1/2" available 25/- extra

New Boxed	VALVES	All Guaranteed	Electrolytics	All Types New Stk.
1T4	6/-	ECC83 8/-	IPCC84 9/6	25/25V 1/9
1R5	7/6	ECL82 10/6	PCF80 9/6	50/12V 1/9
1S5	7/6	ECL80 10/6	PCL83 12/6	50/50V 2/-
3S4	7/6	EF80 8/-	PCL84 12/6	100/25V 2/-
3V4	7/6	EF86 12/6	PL81 12/6	8/450V 2/3
DAF96	9/-	EL84 8/6	PL82 9/6	4/350V 2/3
DF96	9/-	EY51 9/6	PL83 10/6	16+16/450V 5/6
DK96	9/-	EY86 10/-	PY32 12/6	32+32/450V 6/6
DL96	9/-	EZ81 7/6	PY81 9/6	60+250/ 2/3
ECC81	8/-	GZ32 12/6	PY82 9/6	4/350V 2/3
ECC82	8/-	EM84 9/6	U25 12/6	16+16/450V 5/6
				100+200/ 12/6
				32+32/450V 6/6
				275V 12/6
				Ersin Multicore Solder 60/40 3d. per yard. 1/4lb. 2/6, etc.

RECORDING TAPE—BARGAIN PRICES
Famous American Columbia (CBS) Premier Quality Tape at **NEW REDUCED PRICES**. A genuine recommended Quality Tape —TRY IT! Brand new, boxed and fully guaranteed. Fitted with leader and stop foils.

Standard	Long Play	Double Play
5" 600ft. 13/-	900ft. 17/6	1,200ft. 31/6
5 1/2" 900ft. 10/-	1,200ft. 19/6	1,800ft. 37/6
7" 1,200ft. 21/-	1,800ft. 28/6	2,400ft. 47/6

Post and Packing, per reel, 1/-, plus 6d. each for additional reels.
SPECIAL OFFER—3" mfrs. surplus tape, 225ft. 4/9. P. & P. per reel 6d.
Plastic Tape Reels 3" 1/3, 5" 2/-, 5 1/2" 2/-, 7" 2/3. Plastic Spool Containers 5" 1/6, 5 1/2" 2/-, 7" 2/3.

Volume Controls—5K-2 Megohms, 3" Spindles Morganite Midget Type, 1 1/2" diam. Guar. 1 year. LOG or LIN ratios less Sw. 3/-. DP. Sw. 4/6. Twin Stereo less Sw. 6/6. D.P. Sw. 8/-.

Condensers—Silver Mica. All values, 2pF to 1,000pF, 6d. each. Ditto, Ceramics 9d. Tub. 450V T.C.C., etc., .001 mfd. to .01 and 1/350V, 9d. .02-1/500V 1/- .25 Hunts 1/6. .5 T.C.C. 1/9, etc., etc. **Close Tol. S/Micas**—10% 5pF-500pF 8d. 600-5,000pF 1/- .1% 2pF-100pF 9d. 100pF-500pF 11d. 575pF-5,000pF 1/6. **Resistors**—FuH Range 10 ohms-10 megohms 20% 1/4 and 1/2W 3d., 1/2W 5d. (Midget type modern rating) 1W 6d, 2W 9d. Hi-Stab 10% 1/2W 5d., 1/2W 7d. 5% 1/2W 9d., 1% 1/2W 1/6. **W/W Resistors** 25 ohms to 10K 5W 1/3, 10W 1/6, 15W 2/-. **Pre-set T/V Pots.** W/W 25 ohms.—50 K 3/-. 50 K-2 Meg. (Carbon) 3/-.

COAX 80 OHM CABLE
High grade low loss Cellular air spaced Polythene—1/4" diameter. Stranded cond. Famous mfrs. **Now only 6d. per yard.** **Bargain Prices**—Special lengths 20 yds. 9/- . P. & P. 1/6. 40 yds. 17/6. P. & P. 2/-. 60 yds. 25/- . P. & P. 3/-. Coax Plugs 1/-. Sockets 1/-. Couplers 1/3. Outlet Boxes 4/6.



Tape Recorder Kit Special Offer
Latest 5 valve circuit based on Mullard's design. Magic eye and tone controls. Printed circuit **Radio and Mike Inputs**. A sensitive quality recorder at special Unit Kit prices.
Amplifier Kit 90/- B.S.R.
4 Valves 37/6 Monardeck Tape
Power Pack 38/6 Unit £8.10.0
Send 3d. stamp, full details. Handbook, circuit and instructions, 2/6.
Bargain Price complete kit £16.10.0 carr. 7/6

JASON FM TUNER UNITS
Designer-approved kits of parts:
FMT1, 5 gns. 4 valves, 20/-
FMT2, £7. 5 valves, 37/6.
JTV MERCURY 10 gns.
JTV2 £13.19.6. 4 valves, 32/6.
NEW JASON FM HANDBOOK, 2/6. 48 hr. Alignment Service 7/6. P. & P. 2/6.

Speakers P.M.—3 ohms 2 1/2" E.M.I. 17/6. Goodmans 3 1/2" 18/6. 5" Rola 17/6. 6" Elac 18/6. 7" x 4" Goodmans 18/6. 8" Rola 20/- . 10" R. x A. 25/- . 9" x 6" Goodmans 25/- . E.M.I. Tweeter 29/6.



Send for detailed bargain lists, 3d. stamp.

We manufacture all types Radio Mains Transf. Chokes, Quality O/P Trans., etc. Enquiries invited for Specials, Prototypes for small production runs. Quotation by return.

RADIO COMPONENT SPECIALISTS

70 Brigstock Rd Thornton Heath Surrey Hours: 9 a.m.-6 p.m., 1 p.m. Wed. THO 2188
Terms C.W.O. or C.O.D. Post and Packing up to 1/4lb, 9d.; 1lb, 1/3; 3lb, 2/3; 5lb, 2/9; 8lb 3/6

Speaker Fret—Expanded bronze anodised metal 8" x 8" 2/3, 12" x 8" 3/4, 12" x 12" 4/6, 12" x 16" 6/4, 24" x 12" 9/4, 36" x 12" 13/6, etc. etc.

TYGAN FRET (contemp. pat.)
12" x 12" 2/-, 12" x 18" 3/-,
12" x 24" 4/-, 18" x 18" 4/6

BARGAINS 4-SPEED PLAYER UNITS

Single Players carr. 3/6
Garrard 4 S.P. £6.19.6
Garrard TA Mk. 2 £7.19.6
Collaro "Junior" 75/-
B.S.R. Latest Model TU12 79/6
E.M.I. Junior '985' 89/6
Auto-Changers carr. 5/6
Garrard RC209 .9 gns.
Garrard "Auto-Slim" £8.12.6
Collaro C60 £7.15.0
B.S.R. (UA14) De-Luxe Model £7.10.0

TAG STRIPS—2 or 3 way, 2d.; 4 or 5 way, 3d.; etc. 28 way (cut suit yourself), 1/6

GROUP BOARDS—Tagged, 2" x 1/2", 10 way, 2/-; cut any size in multiples of 5 way, 1/-

VALVE HOLDERS—Paxolin: Int. Oct., 6d. Moulded: B8G, 9d. each; Nylon or Moulded Ceramic: B7G, B9A unskirted, 9d. each; B7G, B9A skirted, 1/- each; B7G with Can, 1/6 each; B9A with Can, 1/9 each; B9A with Can, 1/9 each; B9A with Can, 1/9 each.

ENAMELLED COPPER WIRE—1/4lb reels: 14g-20g, 2/6; 22g-28g, 3/-; 30g-40g, 3/9. Other gauges quoted for.

PVC CONNECTING WIRE—10 colours (for chassis wiring, etc.)—Single or stranded conductor, per yd., 2d.

RECORD PLAYER CABINETS

Contemporary style, rexine covered cabinet in mottled red and white polka dot. Size 18 1/2" x 13 1/2" x ht. 8 1/2", fitted with all accessories including baffle board and anodised metal fret. Space available for all modern amplifiers and auto-changers, etc. Uncut record player mounting board 14" x 13" supplied.

Cabinet Price £33.0 Carr. and Ins. 5/-

2-VALVE 2 WATT AMPLIFIER

Twin stage ECL82 with vol. and neg. feedback tone control. A.C. 200/250V with knobs, etc., ready wired to fit above cabinet. £2.17.6. P. & P. 1/6. 6" Speaker and trans. 22/- . P.P. 2/-

TRANSISTOR COMPONENTS

Midget I.F.'s—465 Kc/s 1/2" diam. 5/6
Osc. Coil—1/2" diam. M/W. 5/3
Osc. coil M. & L.W. 5/9
Midget Driver Trans. 3.5:1 6/9
Midget O/Put Trans. Push-pull to 3 ohms. 6/9

Elect. Condensers—Midget Type 1mfd-50mfd, ea. 1/9. 100mfd, 2/- 12V wkg.

Ferrite Aerial—M. & L.W. with car aerial coupling coil 9/3

Condensers—150v. wkg. .01 mfd., to .03 mfd. 9d. .05 mfd., .1 mfd. 1/- .25 mfd. 1/3. .5 mfd. 1/6. Etc.

Tuning Condensers. J.B. "00" 208+176pF 8/6. Ditto with trimmers 9/6. 365pF single 7/6. Sub-min. 3/4" DILEMIN 300pF, 500pF 7/-.

Speakers P.M.—2" Plessey 75 ohms 15/6. 2 1/2" Continental 8 ohms 13/6. 7" x 4" Plessey 35 ohm 23/6.

Ear Plug Phones—Min. Continental type, 3ft lead, jack plug and socket. High Imp. 8/- . Low Imp. 7/6.

1 Watt—4 Transistor Amplifier—6V operation

Ideal gram unit or general audio amplifier. Based on G.E.C. 4 Trans. circuit. 1 watt output in standard 3 ohms speaker. Vol. control and neg. feedback. Chassis size 6 1/2" x 3 1/2" x 1 1/2". Consumption 10mA quiescent—250mA at 1 watt. Sensitivity 6 mV. Freq. response ±3dB 110 c/s-16 kc/s.

Complete Kit less speaker 59/6. carr. 2/6

TRANSISTOR BARGAINS

Brand New—BVA 1st Grade
OC44 10/6 873 9/-
OC45 9/6 GET114 6/6
OC81 7/6 OC72 7/6
2/OC81 15/6 OC70 5/6
XA102 10/- OC71 6/-
XA101 9/6 GEX34 2/9
XB103 7/6 OA70 2/9
XC101 8/6 OA70 2/9
874 9/6 OA81 2/9

SPECIAL OFFER
OC44 OC81D } 19/6
2/OC45 } 21/6 2/OC81 }

CRT. HTR. ISOLATION TRANSFORMERS

New improved types, low capacity small size and tag terminated a.c. 200/250V. Secondaries nil. +25%, +50%, BOOST for 12V, 4V, 6.3V, 10.5V, 12V or 13V tubes. Each type 12/6 each. P. & P. 1/6.

TRIMMERS, Ceramic (Compression Type)—30pF, 70pF, 9d.; 100pF, 150pF, 1/3; 250pF, 1/6; 600pF, 1/9. **PHILIPS, Bee Hive Type** (conc. air spaced)—2-8pF, 1/-; 3-30pF, 1/-.



TOGGLE SWITCHES—SP on-off ex-Gov., 9d.; SPDT ex-Gov., 1/3; SP on-off Bulgin type, 1/9; DPST ditto, 3/6; DPDT Bulgin type, 4/6, etc., etc.

KNOBS—Modern Continental types: Brown or Ivory with Gold Ring, 1" dia., 9d. each; 1 1/2", 1/- each; Brown or Ivory with Gold Centre, 1" dia., 10d. each; 1 1/2", 1/3 each. **LARGE SELECTION AVAILABLE.**

METAL RECTIFIERS, STC Types—RM1, 4/9; RM2, 5/6; RM3, 7/6; RM4, 16/-; RM5, 21/-; RM4B, 17/6.

SILICON RECTIFIERS—Miniature—Wire ended: Westinghouse type 1WP6, 125V, 500mA, size 1/2" x 1/2", 12/6; Plessey type REC50, 125V, 300mA, size 3/4" x 1/2", 10/6; REC51, 250V 300mA, size 3/4" x 1/2", 21/6. **SIEMENS TYPES**—Contact Cooled: 250V, 50mA, 7/6; 250V, 85mA, 10/-; 250V, 125mA, 15/-; 250V, 300mA, 26/6.

SMALL ADVERTISEMENTS

continued from page 795

PRIVATE—continued

FOR SALE. 1962 series 100 multimeter, £9.—40 Glendale Avenue, Edgware, Middlesex. Telephone: ST0 7989.

FOR SALE. Tape reproducer (not recorder) incorporating 20 c/s changeover switch, original cost £80. Bargain at £20. Telephone Liberty 7948 (Morden, Surrey).

WANTED. Four CK505AX valves, one Teletron EH10, one Ekco TMB272.—R. Reiss, 34 Nursery Lane, Moortown, Leeds 17.

TO CLEAR. G.E.C. 1,000 kc/s calibrator unit, 230V a.c. mains, including crystal, £3. Audio amplifier linear L45, neat unit in small cabinet, 200/250V a.c., £5. Rotary transformers, 12V in, 480V 40mA out, 12/6; 12V in, 285V 60mA out, 17/6. New accumulators: Willard Radio-20-2, 2 volt at 7/6 each; Varley dry VPT, 2 volt, 10/- each. Mic. trans. Woden MT101 at 7/6. Demonstration gyro unit with rotary converter power unit, 12 volt d.c., 30/- . Box of assorted large capacitors, about 50, £1. Box of assorted transformers, audio types, about 20, 15/- . Box of various switches, about dozen or so, 10/- . 3-gang receiver type capacitor, 10/- . Mains power supply, 275V 60mA out, 50/- . Valves: all at 5/- each: 5Y3GT, 5R4GT, 6BW6, T20, VT136, 955 with base, 6AT6, 6SA7, 6SK7, 6AG7, 6BA7, VR150/30, DL92, IS5, EL91, IS4, 6V6, 5Z4GT, 12AT7, 3M4, ECC82. Postage and packing extra.—Box No. F.147.

TRADE

LEARN RADIO AND ELECTRONICS the NEW Practical way. Very latest system of experimenting with and building radio apparatus—"as you learn".—FREE Brochure from: Dept. RC10 Radiostructor, Reading, Berks.

PANL, recognised for many years as the unique one-coat black crackle finish. Brush applied, no baking. Available by post in eighth-pint cans at 3s. 9d. from G. A. Miller, 255 Nether Street, London, N.3.

THE INCORPORATED PRACTITIONERS IN RADIO AND ELECTRONICS (I.P.R.E.) LTD. Membership conditions booklet 1s. Sample copy of I.P.R.E. Official Journal 2s. post free.—Secretary, 20 Fairfield Road, London, N.8.

SERVICE SHEETS (1930-1962) from 1s. Catalogue 6,000 models. 1s. 6d. S.A.E. enquiries.—Hamilton Radio, 13 Western Road, St. Leonards, Sussex.

"MEDIUM WAVE NEWS." Monthly during DX season.—Details from B. J. C. Brown, 196 Abbey Street, Derby.

METALWORK. All types cabinets, chassis, racks, etc., to your specifications.—Philpott's Metalworks Ltd., Chapman Street, Loughborough.

continued on page 799

★ VALVES New Tested & Guaranteed

1R5	6/6	6X4	7/6	DK96	8/-	EZ40	6/6
1S5	6/6	6X5GT	6/6	DL92	6/9	EZ80	6/6
1T4	4/6	12AT7	6/-	DL94	7/6	EZ81	7/-
354	6/9	12AU7	6/-	DL96	8/-	GZ32	10/6
3V4	7/6	12AX7	7/6	EB91	4/6	KT66	15/-
5U4G	6/-	12BH7	10/6	EBC41	9/6	PL81	13/6
5Y3GT	7/6	12K7GT	8/6	ECC81	6/-	PL82	10/6
5Z4G	9/-	12K8GT	13/6	ECC82	6/-	PY81	8/-
6AK6	6/6	12Q7GT	6/6	ECC83	7/6	PY82	7/-
6AL5	4/6	25A6G	10/6	ECC84	7/6	PCC84	9/6
6AM6	4/-	25L6GT	9/-	ECC85	8/6	PCF80	9/-
6AT6	7/6	35Z4GT	8/6	ECF82	7/6	PCF82	11/-
6BA6	8/6	35L6GT	9/6	ECH81	10/6	PCL82	7/6
6BE6	7/6	5763	10/6	ECH42	8/6	R19	12/6
6BR7	10/6	DAF91	6/6	ECL80	9/6	U26	10/6
6BW6	8/6	DAF96	8/-	EF41	8/6	U76	8/6
6J7GT	8/6	DF91	4/6	EF80	8/-	UBC41	10/-
6K7G	7/6	DF96	8/-	EF86	9/6	UCH42	10/6
6Q7G	7/6	DH76	8/6	EF91	4/-	UF41	10/-
6SL7GT	8/-	DH77	7/6	EL41	9/-	UL41	8/-
6SN7GT	8/6	DK91	6/6	EL84	8/-	UY41	8/-
6V6G	7/6	DK92	7/6	EY51	7/6	W76	8/6

MATCHED PAIRS. EL84, 17/-; EL85, 25/-; 6V6G, 17/-; 6BW6, 18/-; KT33C, 19/6; 807 14/6 pair; KT66, 32/6.

SETS OF VALVES

DK96, DF96, DAF96, DL96 "REGENT"	29/6 per set
DK91, DF91, DAF91, DL92, or DL94	21/- per set
1R5, 1T4, 1S5, 354, or 3V4	21/- per set
6K8, 6K7, 6Q7, 6V6, 5Z4, "G" Types	27/6 per set
12K8, 12K7, 12Q7, 35L6, 35Z4, "GT" Types	35/- per set
ECH42, EF41, EBC41, EL41, EZ40	37/6 per set
UCH42, UF41, UBC41, UL41, UY41	35/- per set

P. P. OP. TRANSFORMERS. MR 3-15 ohms for EL84, 6V6, 6BW6, etc., 18/6; Op. Pen. 50mA, 5/6; 30mA, 4/6.

P. & P. 6d., over £1 post paid. C.O.D. 3/-

R. COOPER G8BX 32 SOUTH END CROYDON SURREY CROYDON 9186

RETURN-OF-POST SERVICE

All cash orders are dealt with on the day of receipt.
H.P. orders subject to slight delay but kept to minimum.

● TAPE RECORDING EQUIPMENT

ALL CARRIAGE FREE	TAPE DECKS		Hire Purchase	
	Cash Price	Deposit	Mthly.	Pmnts.
B.S.R. TD2	£8.19.6	£1.16.6	12	of 13/7
Latest COLLARO Studio	£12.19.6	£2.12.6	12	of 19/-

TAPE AMPLIFIERS

MARTIN RECORDER KITS. 8311V for Collaro Studio Deck, 11 gns. 8312M for B.S.R. Deck, 8 gns. Carrying cases available.

TAPE PRE-AMPLIFIERS

ARMSTRONG PABO-3. This is a ready made version of the Mullard Tape C Pre-amplifier. Price £16.16.0. Hire Purchase Deposit £3.8.0 and 12 monthly payments of £1.4.7.

MULLARD TAPE C PRE-AMPLIFIER. We stock complete kits and all components. Send for list.

MARTIN. Pre-amp kit for Collaro Studio Deck £8.8.0.

H.P. terms available on Decks, Amplifiers and Cases. Send for quote.

● GRAMOPHONE EQUIPMENT

ALL LATEST MODELS ALL POST FREE	Hire Purchase		
	Cash Price	Deposit	Mthly Pmnts.

RECORD CHANGERS

GARRARD AUTOSLIM (GC8 PU)	£7.19.6	£1.12.6	12 of 12/3
B.S.R. UA14 (TC8 PU)	£7.17.6	£1.12.6	12 of 12/1
B.S.R. UA14 Monarch (TC8S Stereo/LP/78)	£8.17.6	£1.16.6	12 of 13/5

SINGLE RECORD PLAYERS

GREENCOAT 45 UNIT (Battery 9v)	£4.19.6	£1. 9.6	3 of £1.6.8
GARRARD TA (GC8 PU)	£8. 2.6	£1.12.6	12 of 12/6
B.S.R. TU12 (TC8 PU)	£4. 5.0	£1. 5.0	3 of £1.3.4

TRANSCRIPTION UNITS

GARRARD 4HF (GC8 PU)	£17.19.6	£3.11.6	12 of £1.6.5
PHILIPS AG1016	£13. 9.6	£2.14.6	12 of 19/2

Many of the above can be supplied for stereo working. Send for our Gramophone Equipment List for details.

All items Post Free. (C.O.D. fee extra on orders up to £10.)

WATTS RADIO (MAIL ORDER) LTD

54 CHURCH ST. WEYBRIDGE SURREY Weybridge 4556

Please Note: Postal business only from this address.

OUR NEW 5-STAGE POCKET TRANSISTOR PORTABLE

In attractive two-tone contemporary case, with gold plated speaker grill and attractive dial. Size only 5½" x 3½" x 1½". No aerial or earth required—completely self-contained. Genuine 3" high flux p.m. speaker. First grade transistors. Push pull output—250mW. Volume control with on/off switch. Condenser tuning. Easy assembly on eyeletted circuit board. Socket for personal listening. Full instructions, etc., 1/6 (Free with order). **TOTAL BUILDING COSTS £4.19.6** P.P. 2/6. Earpiece 9/- extra if reqd.

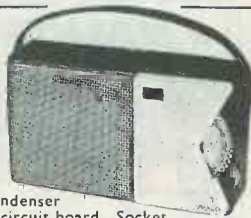

EXPLORE THE WORLD ON THIS 1-VALVE SHORT WAVE RADIO

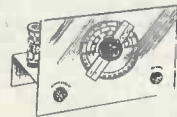

Total Building Costs only 35/- P. & P. 2/-
 ★ Receives speech and music from all over the world.
 ★ Construction price includes valve and one coil covering 40-100 metres.
 ★ Can be extended to cover 10-100 metres.
 ★ Can be converted to 2 or 3 valve.
 Send 2/- for wiring diagram and components price list.

5 STAGE SUPER SENSITIVE TRANSISTOR PORTABLE THE "BOBETTE"

EASY TO BUILD ★ FIRST GRADE PARTS
 A truly portable transistor radio giving full medium wave reception. Incorporates 5" High Flux Speaker, push pull output, first grade transistors, High-Q ferrite aerial, socket for car aerial, pre-tagged circuit board for easy construction. Attractive two-tone case. All parts sold sep.



Total Building Costs £5.2.6 P. & P. 2/6
 Send 1/6 for itemised price list & full assembly instr. (free with order)
R.C.S. PRODUCTS (Radio) LTD
 11 Oliver Road · London · E17 (Mail Order Only)

NEW P.W. POCKET S'HET NEW CONTEMPORARY CASE



STEP-BY-STEP INSTRUCTIONS 1/6

12/6 Retail

The Pocket Superhet is a boosted version of a high quality miniature receiver for operation on Medium and Long Waves. Circuit uses 6 special transistors and incorporates modern miniature matched components of the best quality which combine to give superb performance. Printed board construction ensures success by the simple Step-by-Step instructions.

OSMOR 418 BRIGHTON ROAD S. CROYDON SURREY

TRANSISTOR POCKET RADIOS



BULK PURCHASE ENABLES US TO MAKE THIS FANTASTIC OFFER AND WITH MONEY BACK GUARANTEE!

only 37/6 No more so tuned that it brings the voices of **star entertainers and vocalists dramatically to life**—in your home, office, etc. . . . Only 4½" x 2½" x 1½" fits easily into your pocket or handbag. **Works for months off 8d. battery.** Should last a lifetime. Anyone can assemble it in an hour or two with our easy plan. Complete set of parts including miniature speaker, carrying case—everything only 37/6 plus 2/6 P. & P. C.O.D. 2/6 extra. (Parts can be bought separately.) **Limited period—so order before it's too late.**

Remember, money back guarantee, even if set is built up.
DEMONSTRATIONS DAILY

CONCORD ELECTRONICS (DEPT. B25/4)
 210 CHURCH ROAD HOVE SUSSEX

THE RADIO CONSTRUCTOR BOUND VOLUMES

Attractively bound in blue cloth, with gold-blocked spine

Volume 12, August 58 to July 59 £15.00 (postage 2/3)

Volume 13, August 59 to July 60 £15.00 (postage 2/3)

Volume 14, August 60 to July 61 £15.00 (postage 2/3)

Where all issues of a volume are returned for exchange 12/6 (postage 2/3)

Indexes for volume 14 are now available, price 6d., postage 3d. A limited number are also available for volumes 4, 6, 11, 12 and 13 at the same price.

Easibinders for the old format 12/6 (postage 9d.)

DATA PUBLICATIONS LTD
 57 MAIDA VALE LONDON W9

SMALL ADVERTISEMENTS

continued from page 797

TRADE—continued

RADIO AMATEUR COURSE. A postal course for those wishing to take the Amateur Examination. A sound basic training in radio communication. Very reasonable terms. Send for brochure.—Premier School of Radio, 3 Kerry Crescent, Calne, Wiltshire.

RECEIVER TYPE B.C. 624 CHASSIS. suitable for conversion 2 metres, new condition, less valves and relay 5/6. Post 4/—Arthur Sallis (Radio Control) Ltd. 93 North Road Brighton Sussex.

"MAKING ELECTRONIC EQUIPMENT FOR THE LAB." Contains circuits for a wide range of equipment for the Lab. A "MUST" for every Lab. Price 3/6.—High Fidelity Co., 18 Melville Road, Birmingham 16.

FOR SALE. About 70 "Emidicta" Dictation Machines, various conditions, some working. Purchaser to collect—Offers?—Office Services Department, Norwich Union Fire Office, Surrey Street, Norwich, Norfolk.

FIND TV SET TROUBLES IN MINUTES from that great book *The Principles of TV Receiver Servicing*, 10s. 6d., all book houses and radio wholesalers. If not in stock, from Secretary, I.P.R.E., 20 Fairfield Road, London, N.8.

VALVES, 9d.: 6AL5, 6AM6, 6D2, 6F12, 6F13, 6F14, 6F15, 8D23, 9D2, 15D2, 78, C2C, D1, D77, D152, DD6, EB91, EF50, EF91, P61, SP61, UB41, UF42, VR35, VR51, VR107, VR137, VR201, Z77. More at 1/9, 2/9 and 5/9. Post: 1—9d., 6—1/6. Stamp for FREE list.—P.P. Components Ltd., 623 Romford Road, Manor Park, London, E.12.

LEARN ABOUT TRANSISTORS. Send for details of home study course, including experiments. Apparatus remains your property.—Home-Study Courses, 30 Craven Street, Strand, London, W.C.2.

JOIN THE INTERNATIONAL S.W. LEAGUE. Free Services to members including Q.S.L. Bureau. Amateur and Broadcast Translation. Technical and Identification Dept.—both Broadcast and Fixed Stations, DX Certificates, contests and activities for the SWL and transmitting members. Monthly magazine, "MONITOR", containing articles of general interest to Broadcast and Amateur SWLs, Transmitter Section and League affairs, etc. League supplies such as badges, headed notepaper and envelopes. QSL cards, etc., are available at reasonable cost. Send for League particulars. Membership including monthly magazine, etc., 21s. per annum.—Secretary ISWL, 12 Gladwell Road, London, N.8.

THE INTERNATIONAL HAM HOP CLUB is a non-profit making organisation open to RADIO AMATEURS and SHORT WAVE LISTENERS. OBJECT: To improve international relationships through an organised system of hospitality. MEMBERS offer overnight hospitality to visiting members, subscription 10s. per annum. ASSOCIATE MEMBERS invite radio amateurs to visit their stations. Associate membership 5s. per annum. FAMILY EXCHANGE holidays arranged, also FRIENDSHIP LINKS between radio clubs. The Club's official journal is free to both Full and Associate members.—Hon. Gen. Secretary: G. A. Partridge, G3CED, 17 Ethel Road, Broadstairs, Kent.

LEARN RADIO & TV SERVICING

For your own business / hobby
by a new exciting no maths system, using practical
equipment recently introduced to this country

FREE BROCHURE FROM

RADIOSTRUCTOR

DEPT. G103 · READING · BERKS.

5.62

TRANSISTOR PORTABLE RADIO KIT. £5.17.6 plus post. 3/6. Covers medium and long waves, no aerial or earth required. No difficult aligning necessary. Build for your holidays now. Also **POCKET RADIO KIT 65/- post. 2/-**, with personal earphone, medium and long wave.

Red Spot Transistors, 2/3; White Spots, 2/3; Yellow/Green, 3/3; OC71, 6/-; OC72, 7/6; OC44, 9/6; OC45, 9/-; Sub-min. Electrolytics 2, 4, 8, 10 μ F, 32, 50 μ F, 2/-; 100 μ F, 2/9; 250, 500, 1,000 μ F, 3/3. Silicon Rectifier bargain, 70 piv. 1/2A, 3/3. Receiver R109 2 to 12 Mc/s, brand new, £3.10.0. Carr. 20/-; Silicon Rectifiers, 400 piv. 1/2A, 4/-; Gortler Transistor Amplifier, 1 watt, £4.12.6. Multimeter EP10K, £4.5.0. Ardense Trans. D239, 8/6; D240, 8/6; D131, 10/-; Transformer, 250-0-250V, 6V and 5V, 15/-; Hearing Aid Mike, 31/6. Super Coax., 75 ohms, 6d. yd. Valves, 6X5, 5/6; 6V6, 5/6; 1L4, 5/6. Electrolytics: 8 μ F 500V, 2/3; 8+16 μ F, 3/3; 100+100 (375V), 3/9; V. Cond. 0.0005 t. gang trimmers and slow m., 9/6. Transistor Holders, 1/-.

Terms—Cash with order. Post extra, excess refunded. Our Reflex Rx, best 2-transistor Receiver. Send 10d. stamps for notes.

MOORE'S EXPERIMENTAL SUPPLIES Dept. C
8 & 10 GRANVILLE STREET SHEFFIELD 2 Telephone 27461

EDDY'S (NOTTM) LTD

Dept. RC
172 ALFRETON ROAD · NOTTINGHAM

SALE

VALVES ALL TESTED AND GUARANTEED

1L4 2/6, 1R5 4/11, 1S5 3/11, 1T4 2/11, 5U4G 4/3, 5Y3GT 5/6,
6AG5 2/11, 6AC7 3/6, 6B8G 2/6, 6BW7 5/11, 6CH6 5/-,
6K7G 1/6, 6K8G 5/6, 6F33 5/-, 6SL7GT 5/11, 6SN7GT 3/11,
6SG7M 2/11, 6X4 3/11, 7C5 5/-, 10F1 5/-, 10P13 7/6, 12A6
4/6, 12K7 3/11, 12Q7 3/11, 25L6GT 6/6, 35Z4 4/6, 35L6GT
7/6, DM70 5/-, ECC85 5/11, EF36 2/6, EF37 3/-, EF37A 4/6,
EF50 9d., GT1C 3/6, KT33C 5/11, EL32 5/-, PY80 5/6,
PL36 12/6, HL23DD 5/-, EL91 3/11, PCL84 9/6.

SPEAKERS, EX-EQUIPMENT. 7" x 4", 6½". 5/-
each. Post 1/-.

GERMANIUM DIODES. 6/- doz. Post 6d.

MORSE TAPPERS. Good quality. 2/6. Post 1/-

HEADPHONE CORDS. 6ft. 2 prs. for 2/6. Post 1/-

JACK PLUGS. Standard. 2 for 2/6. Post 1/-

VALVES, EX-EQUIPMENT. EF80 6d. ea. 5 for 1/11,
20P1 2/6, EF50 6d. ea., IOF1 9d. ea. 5 for 2/6, EF91 6d.,
EB91 6d., 6F15 9d., 20F2 1/6, 6F33 6d., L77 6d.

Any parcel insured against damage in transit for only 6d.
extra per order. All uninsured parcels at customer's risk.
Post and packing 6d. per valve extra. C.W.O. or C.O.D.
only. C.O.D. charge 3/- extra. S.A.E. with enquiries.

The thrills of VHF can now be yours for only 39/6d, complete kit! Tunable 150-100 Mc/s, simplified construction, write today for leaflet. Also, if a newcomer to Amateur Radio, ask for free copy of the world famous "Globe-King" kits and receivers, stamp please to cover postage:

Johnsons (Radio) St. Martin's Gate Worcester

H.A.C. THE ORIGINAL SUPPLIERS OF SHORT-WAVE KITS

One valve Super Sensitive All-dry Short-wave Receiver, Model "K". Complete kit including valve and chassis, 77/- (Other S.W. kits from 25/-) Before ordering call and inspect a demonstration receiver, or send stamped envelope for full specification, catalogue and order form.

H.A.C. SHORT-WAVE PRODUCTS (DEPT. R) 44 OLD BOND STREET LONDON W1

SPARES, VALVES, TUBES 1930-1960

Guaranteed perfect, set tested, ex-working equipment

5U4	4/6	10P13	6/-	ECH42	6/-	PL33	4/6	U25	10/-
5Z4	6/-	12AT7	3/-	EAF42	6/-	PL81	4/6	U35	4/6
6AQ5	6/-	12AU7	4/6	EL33	6/-	PL82	4/6	U37	12/6
6AU6	4/6	12AX7	4/6	EL38	6/-	PL83	4/6	U107	7/6
6BA6	4/6	12BH7	7/6	EL41	6/-	PY31	4/6	U191	10/-
6BG6	12/6	20L1	6/-	EL90	6/-	PY82	4/6	U403	6/-
6CH6	6/-	20P1	6/-	KT36	6/-	U08	10/-	UAF42	6/-
6U4	7/6	20P3	7/6	KT61	6/-	PY80	4/6	UCH42	6/-
6X4	4/6	185BT	12/6	KT63	6/-	PZ30	6/-	UL41	4/6
757	7/6	B36	6/-	N37	6/-	U14	5/-	UL46	4/6
7CS	6/-	ECC85	6/-	PCC84	6/-	U22	4/6	UL44	4/6
10F1	4/6	ECF80	6/-	PCF80	6/-	U24	10/-	UY41	4/6

Most pre-war 4, 5, 7, 9-pin valves 5/- each. P. & P. 6d. per valve

VALVE PARCEL. 12 assorted, all different, 8/6. Postage 1/6.

CONSTRUCTOR'S PARCEL. 2 lb mixed resistors, condensers pots, valveholders, electrolytics, etc. 7/6, postage 2/6.

Send S.A.E. with enquiries or for list of 1,000 valves

ST. JOHN'S RADIO 3 Jews Row, SW18 Tel. VAN 8822

G2ACC offers you—

POPULAR CATALOGUE ITEMS

Woden. Modulation Transformers: UMO, 25 watts R.F. input, 54/6; UMI, 60 watts R.F. input, 73/6; UM2, 120 watts R.F. input, 102/-; UM3 240 watts R.F. input, 110/- . Driver Transformers: DT1, 49/6; DT2, 56/-; DT3, 48/- . Mains Transformers: RMS10A, 44/6; RMS11A, 44/6; RMS12A, 59/6; PTM13A, 81/-; PTM16, 118/6; PTM17, 151/6.

Postage extra on orders under £3.

These are some of the items held in stock for immediate delivery. CATALOGUE No. 12. 56 pages illustrated with over 2,000 new guaranteed items by leading makers. 9d. post free (refunded on first order).

SOUTHERN RADIO & ELECTRICAL SUPPLIES

SO-RAD WORKS · REDLYNCH · SALISBURY · WILTS

Telephone Downton 207

SURPLUS RADIO SUPPLIES

2 LAING'S CORNER MITCHAM SURREY

OUR CATALOGUE CONTAINS OVER

400 BARGAINS

AT PRICES BELOW MANUFACTURERS' COSTS

Send for it Today, Price 2/6 post free

2/- refunded on first order of 10/- or over

F. M. KIT

consisting of 1 Discriminator, 2 I.F.'s, 1 F.M. Gang (with 3:1 Reduction Drive), 2 First Grade Diodes.

PRICE 12/6 POST FREE

NYLON P.T.F.E.
ROD BAR SHEET TUBE STRIP WIRE
No quantity too small List on application
BRASS COPPER BRONZE ALUMINIUM LIGHT ALLOYS

H. ROLLET & CO LTD

6 CHESHAM PLACE, LONDON, SW1 BELGRAVIA 4300
Also at Liverpool, Birmingham, Manchester, Leeds

Quality Components FOR CONSTRUCTORS
capacitors, resistors, coils, valves, diodes, controls, chassis, transformers, speakers, pick-ups, cartridges, stylii, and all types of components in stock.

PRICE LISTS AVAILABLE ON REQUEST

J. T. FILMER

82 DARTFORD ROAD
DARTFORD KENT
Telephone Dartford 24057

BETTER BRIGHTER PICTURE TUBES BRAND NEW THROUGHOUT

excepting glass

12"	...	£4.10.0	New Silver Screen and
14"	...	£5. 5.0	Aluminising. All makes:
15"-17"	...	£5.15.0	Mullard, Mazda, Emiscope,
21"	...	£7.15.0	Coscor, Brimar, Emitron, etc.

REBUILT MULLARD AND MAZDA TUBES

12"	...	£3. 0.0	All Tubes FULLY
14"	...	£4. 0.0	GUARANTEED 12 MONTHS.
15"-17"	...	£4.10.0	Dispatch same day.
21"	...	£6.10.0	Cash with order.

Carriage and Insurance 10/-

S.T.S. LTD. 35 Pound Street Carshalton Surrey
Telephone Wallington 9665

Record Changers—Players—Tape Decks

GARRARD Auto-Slim	...	£8. 5.0
GARRARD R.C.209	...	£9. 8.6
GARRARD T.A. Mark II	...	£7.10.0
B.S.R. UA14	...	£7.15.0
B.S.R. T.U.12	...	£4. 2.6
B.S.R. T.D.2 Tape Deck	...	£7.10.0
COLLARO Studio Tape Deck, 3 speeds	...	£10.10.0

NEW LIST NOW AVAILABLE

H. F. JAMES 21 Claremont Road Twickenham Middx
Telephone POPesgrove 3579

The SAVOY 4-TRANSISTOR POCKET RADIO

with miniature coil speaker

NO SOLDERING NO DRILLING NO AERIAL

4 transistors and two diodes in a 5-stage reflex circuit, push-pull output. Full medium wave. Size 5¼" x 3 x 1½". Simple instructions and Assembly Tool provided.

85/- Battery 2/3. P.P. 2/9 extra
All parts sold separately

—or the SAVOY SUPER-3 49/6 Bat'y 1/-
with 3 transistors and 2 diodes. Size 4¼" x 2½" x 1¼" P.P. 2/- extra

SAVOY ELECTRONICS LTD 15 Maiden Lane London WC2 (Back of Adelphi Theatre)



MODEL 500

30,000 ohms per volt multimeter

£8. 19. 6

P.P. 2/-

- 8 Ranges D.C. volts to 1 kV.
- 7 Ranges A.C. volts to 1 kV.
- 5 Ranges D.C. current to 12 amps.
- 3 Range resistance to 60 meg.

Short circuit Buzz test, Output meter, dB, etc., etc. Size 6½" x 4½" x 2¼". With Leads, Batteries and Instructions.



AVO-7

Famous Multimeter. Reconditioned and fully guaranteed.

Full A.C./D.C. voltage and current, resistance, dB, power, etc., etc. Supplied with Batteries, Leads and Instructions.

£11. 10. 0

Regd. Post 5/-

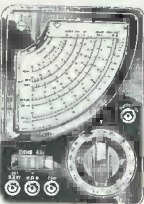

MODEL 200H

20,000 ohms per volt. Size 4½ x 3½ x 1½ in.

£6. 19. 6 P.P. 1/6

With Test Leads, Battery and Instructions. 6 Ranges D.C. voltage to 2½ kV.

5 Ranges A.C. voltage to 1 kV.

- 3 Ranges D.C. current to 250 mA.
- Resistance to 6 megs. Leather Case
- Capacity and dB ranges. 12/6 extra

MODEL TP55

A.C./D.C. voltage up to 1,000 in 5 ranges. D.C. current 4 ranges up to 500 mA. 4 range resistance to 10 megs. Capacity, dB scales, etc. Size 5½ x 3½ x 1½ in.

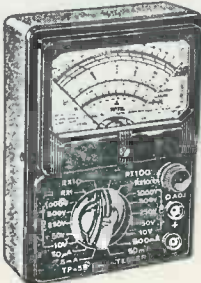

MULTIMETER

20,000 ohms/volts

£5. 19. 6 P.P. 1/6

With Test Leads, Battery and Instructions.

ALL METERS FULLY GUARANTEED

WE CAN SUPPLY MOST OF THE COMPONENTS USED ON CIRCUITS PUBLISHED IN THIS AND OTHER MAGAZINES QUOTATIONS BY RETURN

1. 4-Transistor Two-way Intercomm. 2-way buzzing, 2-speakers, ready to use, 8 gns. P.P. 2/6.
2. Miniature 15 watt Solder Iron, ½" bit. Ideal for all printed circuit work, 29/6. P.P. 1/6.
3. New Model Control Book with 60 pages of transistor circuits, 7/6. P.P. 6d.
4. Complete Set of Meter Leads with Prods, Clips, etc. with pouch, 8/6. P.P. 1/-.
5. Telephone Recording Coil to record conversations. For all amplifiers and recorders, 14/- P.P. 9d.
6. Printed Circuit Kit, to etch your own circuits. Complete with boards and details, 19/6. P.P. 1/-.
7. Miniature 850 ohm Record/Playback Tape Head, with mounting block, 12/6. P.P. 9d.
8. 4,000 ohm lightweight Headphones with leads. Very sensitive, 12/6. P.P. 1/-.
9. Transistor Pocket RF, IF Generator, for Radio, TV etc. Fault finding, 52/6. P.P. 1/-.
10. 8-Range All Transistor Signal Generator, 200 kc/s to 220 Mc/s: RF, AF, IF, HF, etc., £7.10.0. P.P. 3/6.
11. GS12C (Dekatron) Bi-directional 12 way indicator tube. Brand new, 12/6.
12. Caby M1 Pocket Multimeter, 2,000 ohms per volt. With leads and instructions, 54/- P.P. 1/6.
13. 4½-9 volt Tape Recorder Motor, 12/6. P.P. 1/-.
14. 30 watt Pocket Solder Iron, with pocket pouch and mains plug, 18/6. P.P. 1/-.
15. 931A Photo Multiplier. Brand new, 60/-.
16. 1 kc/s Transistor Audio Test osc., variable output, 39/6. P.P. 1/6.
17. Crystal Contact Microphone. Very sensitive. Ideal for Guitar, 12/6. P.P. 9d.
18. 4-Transistor Telephone Amplifier. Amplifies without connection to 'phone. Ideal for office, works or home, £5.10.0. P.P. 2/6.
19. Practical Transistor Circuits. 40 circuits to build, 3/6.
20. Personal Earphones with leads, Jack plug and socket, 600 ohm, 10/6; 1,000 ohm, 12/6; Crystal 9/6.
21. W/W Erase Head, FE7, 7/6. P.P. 6d.
22. Dynamic Microphone, 49/6. P.P. 1/6.
23. Battery Eliminator and Charger, for PP3-type 9 volt batteries. To run pocket Radios from mains and charge battery, 29/6. P.P. 1/-.
24. Extension Speaker Unit. Plugs into phone socket of most portables. Gives big set volume. Ideal for car use, 57/6. P.P. 1/6.
25. Transistor Portable Tape Recorder. Ideal Dictaphone, £12.

Miniature Panel Meters

0/50µA (D.C.) 39/6
0/500µA (D.C.) 32/6
0/1mA (D.C.) 27/6
0/5mA (D.C.) 27/6
0/300V (D.C.) 27/6
Brand New Boxed

Components

We stock the largest range of miniature components in the country. Send 1/- stamp for new catalogues.

26. 7-Section Telescopic Aerial, 12/6. P.P. 1/-.
27. LA1 Ferrite Pot Core, 12/6. P.P. 6d.
28. FX1011 Miniature Ferrite Pot Core, 7/6. P.P. 6d.
29. Miniature Jack and Socket, 3/6. P.P. 6d.
30. No. 19 Set Crystal Calibrator with Handbook, 79/6. P.P. 2/-.
31. Caby Mighty Minor Pocket Multi-Tester, 54/- P.P. 1/-.
32. Siemens High Speed 1700-1700 Relay, 15/-

4 TRANSISTOR PUSH-PULL AUDIO MODEL PK-543 AMPLIFIER

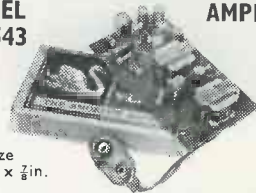

Size 3 x 1½ x 7/16 in.

A ready-built, miniature 250mW push-pull amplifier incorporating input and output transformers, 4 transistors, 9 volt battery snap cord, speaker and volume connection leads. Ideal for use with record players, intercoms, hearing aids, tape recorders, etc. Complete with full instructions and circuit diagram.

PRICE 52/6 P.P. 1/6.

SUITABLE 2½" SPEAKER, 16/6

TRANSISTORS

NEW PRICE REDUCTIONS

AF117	9/6	OC83	6/-	OC139	13/6
AFZ12	35/-	OC84	8/6	OC140	29/-
AC107	14/6	OC75	7/-	OC200	10/6
OC71	5/6	OC35	18/-	OC201	31/-
OC72	7/-	OC44	9/3	OC22	23/-
OC76	7/-	OC45	8/6	OC71	29/-
OC81	7/-	OC170	9/6	OC41	9/-
OC78	7/-	OC171	10/6	OC42	9/6
AF102	27/6	AF115	10/6		

Send for New List of Fully Guaranteed Transistors, Diodes, Zener Diodes, Silicon Rectifiers, etc. We stock a semi-conductor device for every need.

SPECIAL REDUCTIONS FOR SETS

TYPE 38, TRANSMITTER RECEIVER

Complete with 5 valves. In new condition. These sets are sold without guarantee but are serviceable.

22/6 P.P. 2/6

Headphones, 7/6 pair. Junction Box, 2/6. Throat Mike, 4/6. Aerial Rod, 2/6.

CRYSTAL MICROPHONES

ACOS 39-1. Stick Microphone with screened cable and stand (list 5 gns.), 32/6. P.P. 1/6.

ACOS 40. Desk Microphone with screened cable and built-in stand (list 50/-), 15/- P.P. 1/6.

ACOS 45. Hand Microphone with screened lead, very sensitive, 25/- P.P. 1/6.

100 C. Stick Microphone with muting switch and screened cable, detachable desk stand, cord and neck, 39/6. P.P. 1/6.

MC 24. Desk Microphone with muting switch and cable, 25/- P.P. 1/6.

LAPEL. Miniature Mic. With clip. Ideal for recording, 15/- P.P. 1/-.

1 WATT TRANSISTOR AMPLIFIER

★ EMI 4-Transistor Amplifier with 7" x 4" speaker, tone and volume controls. Ready assembled. For use with crystal pick-ups. 6-9 volt operated, 89/6. P.P. 1/6.

BATTERY RECORD PLAYER



★ 6-7½ volt Garrard turntable with crystal pick-up. Plays 45 r.p.m. Ideal for above amplifier.

65/- P.P. 1/6.

★ PORTABLE RECORD PLAYER CABINET for above player and amp, 22/6 for 7" x 4" speaker, P.P. 1/6.

Henry's Radio Ltd

PADdington 1008/9
5 HARROW ROAD LONDON W2

Open Mon. to Sat. 9-6, Thurs. 1 o'clock

Send 1/- stamp for Illustrated Price List

★ Please Turn Page

Published in Great Britain by the Proprietors and Publishers Data Publications Ltd. 57 Maida Vale London W9

Printed by A. Quick & Co. (Printers) Ltd. Oxford Road Clacton-on-Sea England

Obtainable abroad through the following Collects Subscription Service Continental Publishers & Distributors Ltd. William Dawson & Sons Ltd. Australia and New Zealand Gordon & Gotch Ltd. Electronics Publications (Australia) South Africa Central News Agency Holland "Radio Electronica"

Registered for transmission by Magazine Post to Canada (including Newfoundland)

"CAPRI" - POCKET SIX RADIO



Size only
4½ x 2½ x 1½ in.

Really
Pocket
Size!

£7.10.0 P.P. 2/-
(Battery 2/6)

A new design 6-Transistor Printed Circuit Superhet for Medium and Long Waves. Uses all sub-miniature parts. Sub-min. Mullard Transistors. Quality speaker output, fitted earphone. Record Sockets. Cabinets Red/White or Blue/White with Gold fittings.

DETAILS ON REQUEST

"RANGER 3" A Three Transistor Two Diode Personal Radio for Medium Waves. Amateur top band and shipping. Quality output on personal 'phone. Fitted air-spaced tuner, vol. control. No aerial or earth. Luxembourg guaranteed.



69/6 P.P. 1/6

"TRANSFIVE" PORTABLE RADIO



Medium
and
Long Wave
Portable

8½ x 6½ x 3½ in.

£6.19.6 P.P. 2/6

A 5-Transistor (Mullard) and Diode, Printed Circuit, Medium and Long Wave Portable. Features 5in. speaker Car aerial socket, Mullard transistors and carded components. Excellent results guaranteed. **DETAILS ON REQUEST**

750mW 4-TRANSISTOR PUSH-PULL AMPLIFIER

(over 1 watt peak output).

- ★ Uses OC71/OC81D, 2—OC81.
- ★ ±3dB 70 c/s to 12 kc/s.
- ★ Overall size 4" x 2½" x ¾".
- ★ Built on printed circuit.

BUILT & TESTED **69/6** P.P. 1/6 OR COMPLETE KIT **62/6** P.P. 1/6
Ideal for Record Player, Intercomm., Baby Alarm for Tuners, etc.

3 ohm output, fully guaranteed, 9 volt operated
Descriptive leaflet with uses FREE on request.

TRANSISTOR SIGNAL INJECTOR

A new design pocket size tester for fault finding on valve or transistor radios, T.V., amplifiers, etc. Built-in indicator and batteries with detachable probe, 52/6 P.P. 1/6.

PLEASE

Henry's Radio Ltd

PADDington 1008/9

TURN
PAGE

5 HARROW ROAD LONDON W2
Open Monday to Sat. 9-6 Thurs. 1 o'clock

Send 1/- Stamps for Illustrated Price Lists

"CONTESSA"

6 TRANSISTOR MEDIUM AND LONG WAVE SUPERHET
★ TERRIFIC SENSITIVITY ★
UNBEATABLE IN PERFORMANCE AND APPEARANCE
COMBINED PORTABLE AND CAR RADIO

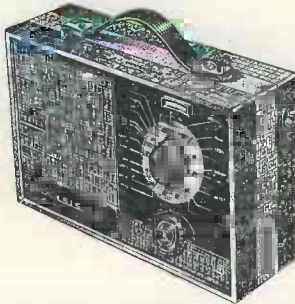

Employs the latest techniques. Double tuned IP'S AVC and first-grade components are standard features. Excellent tone, sensitivity and selectivity on both wavebands.

Descriptive Leaflet on Request.

- ★ 425mW Push-Pull Output.
- ★ 6 "Top-Grade" Ediswan Transistors.
- ★ New Type Printed Circuit with all Components marked.
- ★ Full Medium and Long Wave Tuning.
- ★ High "Q" Internal Ferrite Aerial.
- ★ Car Radio Adaptation and AVC.
- ★ Slow Motion Fingertip Tuning with Station Names clearly marked.
- ★ "Hi-Fi" Quality Speaker.
- ★ Attractive Rexine Covered Cabinet, Red/White or Blue/White.

TOTAL COST OF ALL PARTS

£10.19.6 P.P. 3/6

★ NO EXTRAS TO BUY ★

WITHOUT DOUBT THE "CONTESSA" IS THE FINEST PORTABLE AVAILABLE TO THE HOME CONSTRUCTOR. GOOD LOOKS, QUALITY OUTPUT, AMAZING SENSITIVITY, EASE OF CONSTRUCTION. SIZE 10½ x 8 x 3½ ins.

"QUINTET" POCKET RADIO

Size

5½ x 3 x 1½ in.

Red or Blue
with
Gold trim

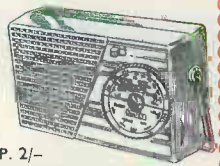

£5.10.0 P.P. 2/-

A Five Transistor and Diode Medium and Long Wave Printed Circuit Loudspeaker Radio, with Excellent Results including Luxembourg, guaranteed with full station separation. Supplied with Mullard Transistors and Carded Components. Fitted earphone/record socket.

Full Details and Diagrams On Request
Performance will amaze you

"RANGER 2"

A Two Transistor Two Diode Personal Pocket Radio. Covering medium waves and top band.



Supplied with battery and quality Personal 'Phone.

Size
4½ x 3 x 1½ in.

No aerial or earth. **55/-** P.P. 1/6

"PW-6" SUPERHET RADIO

Medium
and
Long Wave
Radio

Size

5½ x 3½ x 2 in.



£8.10.0 P.P. 2/-

Modified version of previously advertised "PW" Superhet. Now with new style Two Tone Cabinet. 1st grade components and transistors. Printed circuit.

DETAILS ON REQUEST

TRANSISTOR PORTABLE TAPE RECORDER

BUILT AND TESTED

- ★ Play/record up to 30 minutes.
- ★ Built-in speaker volume control batteries and play/record/rewind.
- ★ Quality reproduction.
- ★ Sturdy case 6 ½ x 2½ in.

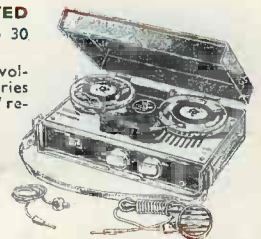

£11.19.6

Post free

FULLY GUARANTEED

Supplied complete with microphone, tape, batteries and personal phone.

MODEL TH-L33



2,000 ohms per volt AC/DC. Size 5" x 3½" x 1½".

79/6

P.P. 1/6.

with test leads, battery and instructions.

0/10/50/250/500/1000 volts D.C.,
0/10/50/250/500/1000 volts A.C.,
0/500µA/10/250mA., D.C.

3 ranges resistance 0/10K/100K/1 Meg. Capacity and dB ranges.

FULLY GUARANTEED

POCKET SOLDERING IRON

★ Pocket Soldering Iron, 220/250V A.C./D.C. 30 watts, complete with mains plug, case, etc. Handle unscrews to cover element enabling iron to be carried in pocket, 18/6. P.P. 1/-.

"CARVERTER"

CAR RADIO SHORT WAVE CRYSTAL CONTROLLED CONVERTER

A new transistor design (see page 758) requiring no modification to existing car radios.

Ideal for all short wave bands.

PRICE LIST ON REQUEST